



Adhesives and Sealants

General Knowledge, Application Techniques, New Curing Techniques

Handbook of Adhesives and Sealants
Volume 2



Editor: Philippe Cognard

ADHESIVES AND SEALANTS

General Knowledge, Application Techniques,
New Curing Techniques

Handbook of Adhesives and Sealants – Volume 2

Elsevier Internet Homepage - <http://www.elsevier.com>

Consult the Elsevier homepage for full catalogue information on all books, major reference works, journals, electronic products and services.

Elsevier Titles of Related Interest

Joining of Materials and Structures

Robert Messler

2004, 0-7506-7757-0

Fracture of Polymers, Composites and Adhesives II

J.G. Williams, A. Pavan, Bamber Blackman

2003, 0-08-044195-5

Adhesion Science and Engineering

Pocius

2002, 0-444-51140-7

Related Journals:

Elsevier publishes a wide-ranging portfolio of high quality research journals, encompassing the adhesives, composites, and polymer fields of materials science. A sample journal issue is available online by visiting the Elsevier web site (details at the top of this page). Leading titles include:

International Journal of Adhesion and Adhesives

Construction and Building Materials

Mechanics of Materials

Composites Science and Technology

Composites Part A: Applied Science and Manufacturing

Composites Part B: Engineering

Polymer

European Polymer Journal

Dental materials

NDT International

Reinforced Plastics

All journals are available online via ScienceDirect: www.sciencedirect.com

To contact the Publisher

Elsevier welcomes enquiries concerning publishing proposals: books, journal special issues, conference proceedings, etc. All formats and media can be considered. Should you have a publishing proposal you wish to discuss, please contact, without obligation, the publisher responsible for Elsevier's Material Science programme:

David Sleeman

Publishing Editor

Elsevier Ltd

The Boulevard, Langford Lane

Kidlington, Oxford

OX5 1GB, UK

Phone: +44 1865 843265

Fax: +44 1865 843987

E.mail: d.sleeman@elsevier.com

General enquiries, including placing orders, should be directed to Elsevier's Regional Sales Offices – please access the Elsevier homepage for full contact details (homepage details at the top of this page).

ADHESIVES AND SEALANTS

General Knowledge, Application Techniques,

New Curing Techniques

Handbook of Adhesives and Sealants

Volume 2

SERIES EDITOR

PHILIPPE COGNARD

Versailles, France



ELSEVIER

Amsterdam – Boston – Heidelberg – London – New York – Oxford
Paris – San Diego – San Francisco – Singapore – Sydney – Tokyo

ELSEVIER B.V.
Radarweg 29
P.O. Box 211, 1000 AE
Amsterdam, The Netherlands

ELSEVIER Inc.
525 B Street, Suite 1900
San Diego,
CA 92101-4495, USA

ELSEVIER Ltd
The Boulevard, Langford Lane
Kidlington, Oxford OX5 1GB UK

ELSEVIER Ltd
84 Theobald's Road
London, WC1X 8RR UK

© 2006 Elsevier Ltd. All rights reserved.

This work is protected under copyright by Elsevier Ltd., and the following terms and conditions apply to its use:

Photocopying

Single Photocopies of single chapters may be made for personal use as allowed by national copyright laws. Permission of the Publisher and payment of a fee is required for all other photocopying, including multiple or systematic copying, copying for advertising or promotional purpose, resale, and all forms of document delivery. Special rates available for educational institutions that wish to make photocopies for non-profit educational classroom use.

Permissions may be sought directly from Elsevier's Rights Department in Oxford, UK: phone (+44) 1865 853333, e-mail: permissions@elsevier.com. Requests may also be completed on-line via the Elsevier homepage (<http://www.elsevier.com/locate/permissions>).

In the USA, users may clear permissions and make payments through the Copyright Clearance Center, Inc., 222 Rosewood Drive, Danvers, MA 01923, USA; phone: (+1) (978) 7508400, fax: (+1) (978) 7504744, and in the UK through the Copyright Licensing Agency Rapid Clearance Service (CLARCS), 90 Tottenham Court Road, London W1P 0LP, UK; phone: (+44) 20 7631 5555; fax: (+44) 20 7631 5500. Other countries may have a local reprographic rights agency for payments.

Derivative Works

Tables of contents may be reproduced for internal circulation, but permission of the Publisher is required for external resale or distribution of such material. Permission of the Publisher is required for all other derivative works, including compilations and translations.

Electronic Storage or Usage

Permission of the Publisher is required to store or use electronically any material contained in this work, including any chapter or part of a chapter.

Except as outlined above, no part of this work may be reproduced, stored in retrieval system or transmitted in any form or by any means, electronic, mechanical, photocopying, recording or otherwise, without prior written permission of the Publisher.

Address permissions requests to: Elsevier's Rights Department, at the fax and e-mail addresses noted above.

Notice

No responsibility is assumed by the Publisher for any injury and/or damage to persons or property as a matter of products liability, negligence or otherwise, or from any use or operation of any use or operation of any methods, products, instructions or ideas contained in the material herein. Because of rapid advances in the medical sciences, in particular, independent verification of diagnoses and drug dosages should be made.

First edition 2006

ISBN-13: 978-0-08-044708-7

ISBN-10: 0-080-44708-2

Printed in Great Britain.

06 07 08 09 10 10 9 8 7 6 5 4 3 2 1

Working together to grow
libraries in developing countries

www.elsevier.com | www.bookaid.org | www.sabre.org

ELSEVIER

BOOK AID
International

Sabre Foundation

Contents

Colour Plates		xxvii–xlii
Chapter	1. Theories of Adhesion	1
	<i>John Comyn</i>	
	1.1. Introduction	1
	1.2. Adhesion by Chemical Bonding	2
	1.2.1. Covalent Bonds	2
	1.2.2. Ionic Bonds	9
	1.2.3. The Unique Properties of Water	13
	1.2.4. Hydrogen Bonds	15
	1.2.5. Lewis Acid–Base Interactions	15
	1.3. Adhesion by Physical Adsorption	17
	1.3.1. Introduction	17
	1.3.2. van der Waals Forces	17
	1.3.3. Measurements of Surface Forces	19
	1.3.4. Interpretation of Contact Angles	23
	1.3.5. Thermodynamic Work of Adhesion	34
	1.3.6. Practical Applications of Wetting	39
	1.4. The Electrostatic Theory of Adhesion	40
	1.5. Mechanical Interlocking	41
	1.6. Adhesion by Interdiffusion	41
	1.7. Weak Boundary Layers	45
	1.8. Pressure Sensitive Adhesion	45
Chapter	2. Equipment for the Application of Adhesives and Sealants: Mixing, Metering, Coating or Applying the Adhesives	51
	<i>Philippe Cognard</i>	
	2.1. Methods of Application of Adhesives, Sealants and Related Products	52
	2.2. Preparation Before Bonding	53
	2.2.1. Surface Preparation of Materials	53
	2.2.2. Conditioning of Materials Before Bonding	55
	2.2.3. Stabilisation of Materials	56
	2.2.4. Conditioning of Workshops in Temperature and Humidity	56
	2.2.5. Preparation of Adhesives and Sealants	57
	2.2.6. Mixing and Metering of Two-Component Products	58

2.3. Adhesive Coating, General Rules	59
2.3.1. Different Methods	59
2.3.2. Classification of the Different Coating/Dispensing Systems	61
2.4. Hand Application Techniques	61
2.4.1. Brush Application	61
2.4.2. Notched Trowel	62
2.4.3. Manual or Hand Roller Application	65
2.4.4. Trowel and Knife Application	65
2.4.5. Syringe and Needle Application	65
2.4.6. Effects of Pressure and Time on Dot Size	69
2.4.7. Guns for Cartridges	71
2.4.8. Two-Component Cartridges and Static Mixers	72
2.4.9. Squeeze Bottles	77
2.4.10. Other Manual Application Techniques	79
2.5. Spraying	81
2.5.1. Air Spray (or Low Pressure Spray)	82
2.5.2. Airless Spray	91
2.5.3. Hot Spray	93
2.5.4. Automatic Spraying	94
2.5.5. Spraying Two-Component Adhesives	97
2.5.6. Hot Melt Adhesive Guns for Jetting	99
2.6. Application of Adhesives and Sealants by Extrusion Techniques	100
2.6.1. Extrusion of Fluid Adhesives (less than 50,000 mPa.s)	101
2.6.2. Extrusion of Thick, Viscous Products (Sealants, Structural Adhesives for Thick Joints, Viscosities Higher than 50,000 mPa.s)	107
2.6.3. Continuous Application, Roll Coating	109
2.7. Coating on Roll Stocks, Roll Application, Knife Application	110
2.7.1. Knife and Doctor Blade Coating	110
2.7.2. Air Knife	113
2.7.3. Roll Coating, Different Techniques	114
2.7.4. Die Coaters	125
2.7.5. Special Roll Coaters for Specific Machines	128
2.8. Disc and Wheels Applicators	132
2.9. Stencil or Stereotyped Application and Techniques Issued from Printing	134
2.9.1. Typography	137
2.9.2. Heliogravure (engraved rollers)	137
2.9.3. Offset	137
2.9.4. Silk Screen Printing	138
2.9.5. Rotary Screen Printing	138

2.10. Curtain Coaters	140
2.11. Dip Coating	144
2.11.1. Manual Dipping	145
2.11.2. Automatic Dip Coating	145
2.11.3. Dip Coating of Roll Stocks	146
2.11.4. New Applications	148
2.12. Gravity Fed Adhesives, Ball Valves, Tampons	148
2.12.1. PAFRA Ball Valve Applicators (or Similar Ball Valves from Other Suppliers)	149
2.13. Electro-pneumatic Guns for Cold Adhesives	150
2.14. Metering and Mixing of Two-Component Adhesives and Sealants	155
2.14.1. General Information	155
2.14.2. Metering	156
2.14.3. Mixing	160
2.14.4. Extrusion/Dispensing	162
2.14.5. Spraying	163
2.14.6. Cleaning by Flushing with Solvents	164
2.14.7. Control Systems	164
2.14.8. Examples of Complete Systems for Metering, Mixing and Dispensing Two-Component Adhesives/ Sealants	164
2.14.9. Application of Two-Component Hot Melts	166
2.15. Automatic or Robotic Application with Syringes	167
2.16. Application of Powders	170
2.17. Application of Dry Adhesives, Film Adhesives	171
2.17.1. Pressure Sensitive (PS) Tapes, Labels and Roll Stocks	172
2.17.2. Dry Film Adhesives	174
2.17.3. Films or Textiles Pre-Coated with a Dry Adhesive	178
2.17.4. Pellets	178
2.17.5. Preformed Tapes	179
2.17.6. Pre-Measured Doses for Two-Component Adhesives or Sealants	181
2.17.7. Adhesive Sticks	181
2.18. Special Techniques	182
2.18.1. Foaming	182
2.18.2. Potting, Casting and Encapsulating	184
2.19. List and Adresses of Suppliers of Equipment for the Application of Adhesives and Sealants	186
2.19.1. Conditioning of Wood, Paper, Before Bonding, Ovens	186
2.19.2. Mixing and Metering	186

2.19.3.	Hand Tools	187
2.19.4.	Syringe and Needles Application	187
2.19.5.	Cartridges for Sealants, Guns for Cartridges, One and Two-Component Cartridges	188
2.19.6.	Spraying Equipment, Spray Guns, Air Spray, Airless, Hot Spray	188
2.19.7.	Pumps	189
2.19.8.	Spray Booth and Lines	189
2.19.9.	Hot Melts Jetting Guns	189
2.19.10.	Extrusion Guns	190
2.19.11.	Roll Coaters	190
2.19.12.	Die Coaters, Slot Dies	191
2.19.13.	Edge Banding Machines	191
2.19.14.	Labelling Machines	191
2.19.15.	Bookbinding Machines, Bonding Equipment	191
2.19.16.	Stencil, Typographic, Offset Equipment	192
2.19.17.	Curtain Coaters	192
2.19.18.	Ball Valve Applicators	192
2.19.19.	Electropneumatic Valves	192
2.19.20.	Pressure Sensitive Tapes Unwinders	192
2.19.21.	Film Adhesives	193
2.19.22.	Robots	193
2.19.23.	Rotary Screen Applicators	193
Chapter 3.	Design and Stress Calculations for Bonded Joints	197
	<i>Richard J. Moulds</i>	
3.1.	Adhesives – Stress Matters	198
3.1.1.	The Basic Stresses	198
3.1.2.	Stressed Adhesive	198
3.1.3.	Shear Strength	200
3.2.	Lap Joints – Stress Distribution	202
3.2.1.	The Adherends	202
3.2.2.	Elastic Limit of the Adhesive	204
3.2.3.	Stress Distribution in Lap Joints	205
3.2.4.	The Influence of the Adhesive Modulus	214
3.2.5.	Stress Distribution in Tubular Joints	216
3.3.	Joint Designs for Bonding	220
3.3.1.	The Simple Lap	220
3.3.2.	Thicker Section Lap Joints	221
3.3.3.	Concealed Joints	224
3.3.4.	Co-axial Joints	225
3.4.	Stress Mathematics	227
3.4.1.	Elastic Behaviour	227
3.4.2.	The Volkersen View	228

	3.4.3. Goland and Reissner Consider Bending	229
	3.4.4. Hart–Smith Consider the Plastic Zone	229
	3.4.5. Data Needed for Stress Calculations	230
	3.5. Practical Testing	230
	Software for the Design and Calculation of Bonded Joints	231
Chapter	4. Heat-Resistant Adhesives	233
	<i>Guy Rabilloud</i>	
	4.1. Introduction	234
	4.2. Polymer Properties	237
	4.2.1. Molecular Weight Determination	237
	4.2.2. Thermal Properties	239
	4.3. Polymer Chemistry	243
	4.3.1. Linear Polymer Precursors	244
	4.3.2. Precyclised Polymers	246
	4.3.3. Condensation Oligomers	250
	4.3.4. Thermosetting Resins	254
	4.4. Resin Characterisation	260
	4.4.1. Infrared Spectroscopy	261
	4.4.2. Nuclear Magnetic Resonance	261
	4.4.3. High Performance Liquid Chromatography	263
	4.5. Adhesive Properties	265
	4.5.1. Lap Shear Strength Measurement	265
	4.5.2. Precyclised and Linear Polymers	266
	4.5.3. Thermosetting Resins	271
	4.5.4. Condensation Prepolymers	280
	4.6. Applications	290
	Heat Stable Adhesives	300
Chapter	5. UV-Radiation Curing of Adhesives	303
	<i>Christian Decker</i>	
	5.1. Introduction	303
	5.2. Different Types of UV-Curable Adhesive Resins	305
	5.2.1. Photoinitiated Radical Polymerisation	306
	5.2.2. Photoinitiated Cationic Polymerisation	314
	5.2.3. Dual-Cure Systems	319
	5.3. Applications of Radiation-Curable Adhesives	322
	5.3.1. Structural Adhesives	322
	5.3.2. Pressure Sensitive Adhesives (PSAs)	326
	5.3.3. Release Coatings	329
	5.4. Conclusion	331
	List of Suppliers for UV Curing Techniques, Adhesives and UV Equipment	341

Chapter 6.	Elastic Bonding and Sealing in Industry	355
	<i>Bernd R. Burchardt and Peter W. Merz</i>	
6.1.	Introduction	355
6.1.1.	Historical Background	355
6.1.2.	Strength and Stiffness of Adhesives	361
6.1.3.	Adhesives are Process Materials	364
6.2.	Principal Advantages and Limits of Elastic Bonding	365
6.2.1.	Principal Advantages	365
6.2.2.	Limits of Elastic Bonding	374
6.3.	Long-Term Durability and Ageing Tests	376
6.3.1.	Long-Term Durability	376
6.3.2.	Ageing Tests	379
6.4.	Joint Design and Calculation for Elastic Bonding	
	Applications	381
6.4.1.	Joint Design	381
6.4.2.	Calculating the Strength of Elastic Adhesive Joints	386
6.4.3.	The Finite Element Method in Adhesive Joint Design	392
6.5.	Basics	396
6.5.1.	Main Features of Adhesion	396
6.5.2.	Different Adhesion Models	398
6.5.3.	Substrates	402
6.5.4.	Surface Preparations	404
6.5.5.	Chemical Pretreatments	406
6.5.6.	Adhesives	410
6.5.7.	Comparative Performance Data for Elastic Adhesives	417
6.6.	Curing of Reactive Adhesive Systems	419
6.6.1.	Strength Development Requirements: The Key to Production Speed	419
6.6.2.	Selecting the Right Adhesives	422
6.7.	Process and Application Technology	422
6.7.1.	Adhesive Application	422
6.7.2.	Equipment and Typical Application	423
6.7.3.	Quality Assurance	427
6.7.4.	Physiological Aspects	431
6.7.5.	Regulations	432
6.8.	Elastic Bonding in Practice	432
6.8.1.	Crash-Resistant Direct Glazing Adhesives	432
6.8.2.	Bonding of Truck Cabins	439
6.8.3.	Sika's PUR-Hybrid Products	443
6.8.4.	Use of Elastic Adhesives and Sealants in Marine Industries	446
6.8.5.	Bonding of Insulation Glasses into PVC Sashes by Reactive Warm Melt	452

6.8.6. Instant-Fix Bonding of Headlamp Assemblies by Reactive Warm Melts	453
6.8.7. Fast-Curing 2C Polyurethane Adhesives	458
6.8.8. Disassembly and Repairs	458
6.8.9. Bonding of Parquet/Timber Floors	461
6.8.10. Facade Cladding	465
6.8.11. Water-Swelling Sealants	468
6.8.12. Bonding of Staircases	471
6.8.13. Rail Fastening	472
6.9. The Future of Elastic Bonding	475
Glossary	477
The Company Behind this Chapter	479
Index	481

This Page Intentionally Left Blank

Preface to Volume 2

Scope of the Handbook

The Handbook of Adhesives and Sealants discusses in detail all aspects and techniques related to adhesives and sealants:

- *every scientific and technical issue*, such as theories of adhesion, chemical and physical properties of adhesives and sealants, technical characteristics, (discussed in Volume 1), design and calculation of bonded joints (Volume 2), surface preparation before bonding (Volume 1), dispensing and metering equipment (Volume 2), methods of assembly, drying and curing, and other general information related to adhesives and sealants.
- *every chemical type of adhesives and sealants*: More than 30 chemical families of polymers and resins are used to formulate adhesives and sealants, thermoplastic polymers such as acrylics, vinyl emulsions, EVA, vinyl acetate-ethylene, rubbers modified with resins and tackifiers, polyamides, thermosetting resins such as UF, RF phenolics, epoxies, polyurethanes, in liquid, paste, film or solid form, pressure sensitive adhesives, etc. We discuss each family in detail in a separate chapter each, to explain the technical characteristics, formulation, methods of use and application of each of these chemical types.
- *every industry which uses or could use adhesives or sealants*: Almost all industries need to assemble parts at some time during its production cycle, and therefore every industry will use adhesives or sealants. We have at least one chapter dealing with each industry, and for those industries which use large quantities of adhesives and sealants, for many assembly jobs, we may need several chapters, for instance for automotive, construction, woodworking, paper and packaging, graphic arts, electronics, etc.
- Bonding of every material: metals, plastics, wood, composites, textiles, paper and cardboard, glass, ceramics, stones, concrete, etc.

We will try to place each Chemical type chapter near to the chapter dealing with the Industry using these types of adhesives and sealants, so that each volume will focus on one main field: for instance, in Volume 3 that will be devoted to Construction, we will study the adhesives for construction, civil engineering, the silicone sealants, the woodworking and furniture adhesives, acrylic adhesives and sealants. Those working in the construction industry can then get fairly complete information from that volume. However, construction

is so important that we will have another volume only for construction and related techniques/industries.

How to use the Handbook

The Handbook may be used in many different ways:

1. One way is to buy the volumes dealing with your field of knowledge, your industry, or the raw materials and equipment that you are using. Please refer to the general summary/list of contents of the whole Handbook in order to find the volumes and chapters you need, or ask to the Publisher, Elsevier UK, for the publishing calendar. We plan to publish a total of about 100 chapters, 9 volumes, in the next 4 to 5 years. In each volume, we will provide a summary of previous volumes and the next three volumes.

Some important sectors will benefit from reading several chapters, in order to cover all aspects:

- for instance, automotive adhesives and sealants will be studied in Volume 5 and again in a later volume, and readers should refer to other chapters related to the automotive industry such as metal bonding, bonding in mechanics, bonding composites, epoxy adhesives, industrial sealants, etc.
- adhesives for electronics have been studied in depth in Volume 1, but we plan to have another chapter on this topic in another volume, probably in Volume 7.
- construction and civil engineering adhesives and sealants will be studied in several chapters.
- textiles, garments, non-woven disposable products, footwear will be studied in several chapters and several volumes.
- similarly, packaging, paper products, graphic arts, PS tapes and labels, bookbinding, cigarette manufacturing, will require six chapters in three different volumes.

Authors have already begun writing about these topics.

2. Another way is to browse through our unique, very comprehensive alphabetical index, containing more than 2000 significant and useful words, in order to find the chapters and pages where we deal with these specific subject headings.

Each volume has its own alphabetical index and besides this, we will provide you with the complete alphabetical index on a regular basis every year.

3. Each volume, each chapter is more or less self-supporting and can be read separately.

However, chapters may be linked together in several ways: for instance, readers of the chapter ‘Automotive Adhesives’ are advised to read also the chapters ‘Metal Bonding’, ‘Composites Bonding’, ‘Epoxy Adhesives’ (because epoxy adhesives are often used in automotive body-in-white assembly), ‘Design and Calculation of Bonded Joints’ (because this is an important issue for designers in the Automotive manufacture), and it may be also interesting for them to read the chapter ‘Aerospace, a Pioneer in Bonding’ (because the aircraft industry has pioneered and developed bonding techniques for metals and composites, which bring a huge amount of technical knowledge to all the other structural bonded assemblies in other industries).

Every engineer or designer should also read the general chapters such as: ‘Technical Characteristics of Adhesives and Sealants’, ‘Metering and Dispensing of Adhesives and Sealants’, ‘Physics and Chemistry of Adhesives and Sealants’, ‘Assembly, Drying and Curing of Adhesives and Sealants’.

The Twelve Steps for the Selection of Adhesives and Sealants

In order to explain our approach to the study of adhesives and sealants in this book, we describe the 12 steps for the selection of an adhesive or sealant or binder and the method of production and production equipment.

Fig. 1 shows these 12 steps and how they are linked together.

The table of contents of our Handbook follows more or less these steps:

- Several chapters are devoted to the ‘Materials to be bonded’ (metals, plastics, wood, composites). These chapters explain the important properties of adhesives and sealants used for these materials, the method of designing the joints, selecting the adapted adhesives and sealants, and also provide many practical examples of bonding in all industries,
- Mechanical and other properties (chemical and physical properties) have been studied in the chapter, e.g. Technical Characteristics in Volume 1, and they are also studied in each of the Chemical families,
- Design and calculation of joints are studied in this volume and will be studied again from a different standpoint later in the Handbook,
- Metering/Dispensing/Application methods is a big and important chapter of this Volume 2, where we have reviewed all the methods of dispensing/application for every type of adhesive and sealant, in all industries,
- Methods of assembly, drying and curing will be studied in detail in Volume 4, including all the curing techniques which are available,
- Regulations, standards, safety regulations will be an important topic later in the Handbook,

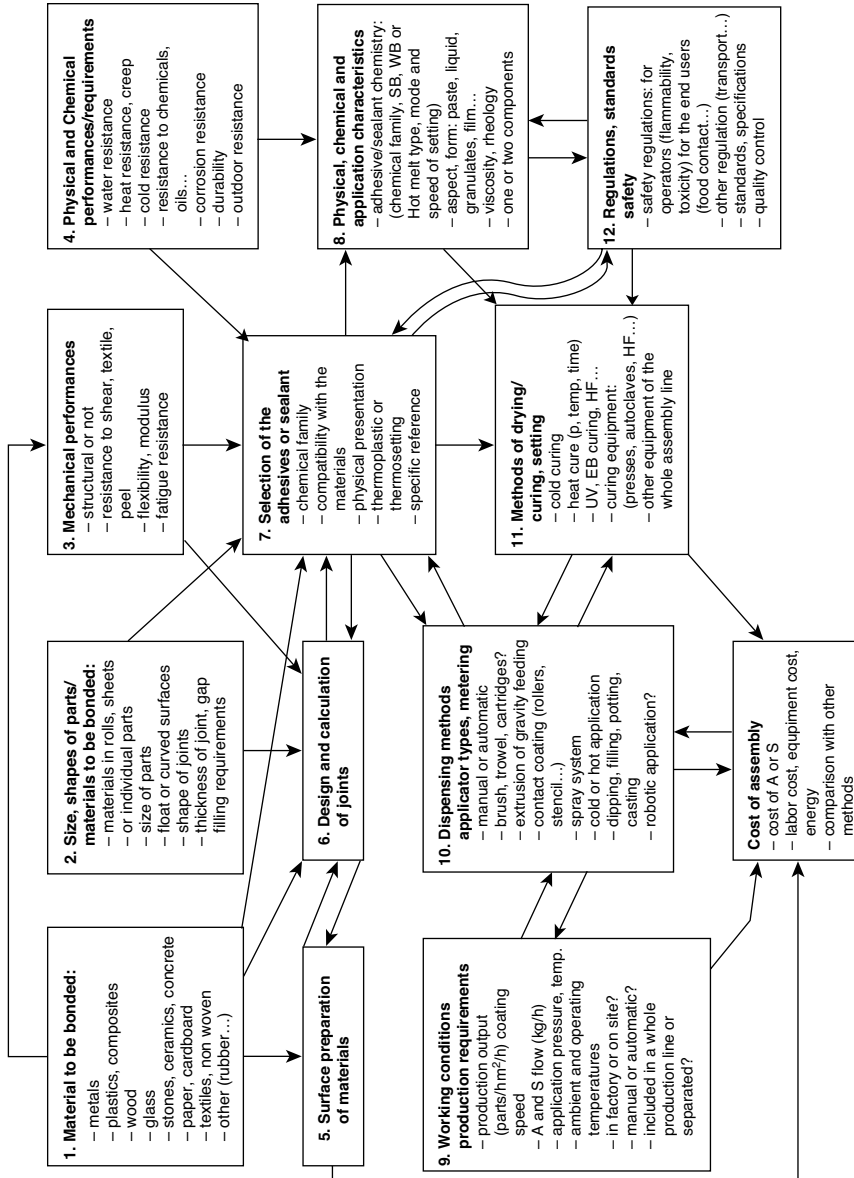

Figure 1: The 12 steps for selecting an adhesive or sealant, the method of production and production equipment – relationship between the steps.

- And of course, the selection of adhesives and sealants will be another very important chapter, it will be studied later in this Handbook, because it is important to gain the basic knowledge of adhesives and sealants before we explain how to select the adhesives and sealants and the equipment.

List of Contents of Volume 1

In Volume 1, we have provided general information about adhesives and sealants with the chapters ‘Technical Characteristics of Adhesives and Sealants’, ‘Surface Preparation before Bonding’ and ‘Polyurethane Adhesives and Sealants’.

Then we have seen, with the chapter ‘Aerospace, a Pioneer in Bonding’, how high performance bonding techniques have developed in this demanding industry, during the last 50 years, for structural assembly of metals and composites. This is useful for almost every reader because it provides detailed information on structural bonding.

Fig. 2 in the colour plate section shows that many aircraft parts are bonded with adhesives. If adhesives can work for aircraft parts, then they may be used for all other high performance applications.

The last chapter of Volume 1 was devoted to ‘Adhesives for Electronics’, a recent, high tech industry, where the utilization of adhesives is mandatory because there is no alternative method of assembly (parts are very small), and where the requirements are very demanding and very specific for the adhesives. It also shows that adhesives may or may not be electrically conductive, and may be tailor-made for specific applications.

Presentation of Volume 2

- **Theory of Adhesion** (Chapter 1) explains all the theories which have been used so far to understand the mechanisms of adhesion. This is very important for scientists, students, people involved in R & D, manufacturers of adhesives and suppliers of surface preparation materials.
- **Metering and Dispensing Adhesives and Sealants** (Chapter 2) is the first chapter of a series dealing with application, assembly, drying and curing, which will include:
 - Chapter 2 of Volume 2: Dispensing of adhesives and sealants (excluding dispensing of hot melts which are studied in another volume), this chapter is useful in many applications with many end uses in most industries. It is a very basic and important chapter, and it is useful for every reader (see Fig. 3).

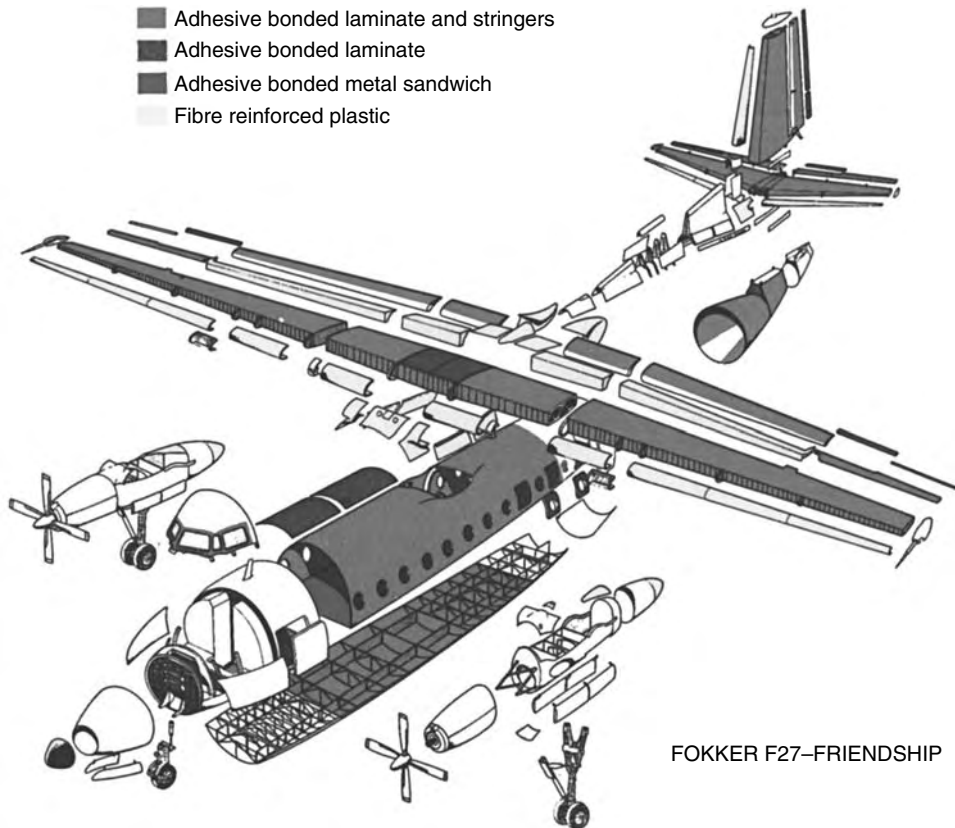

Figure 2: Many aircraft parts are bonded with high performance adhesives, on this FOKKER F27 as well as on the Airbus A380 (Refer Plate 1 for colour code).

- A separate chapter, in Volume 4 will deal with the **application of hot melt adhesives**.
- Another chapter in Volume 4 will explain the **drying and curing of all types of adhesives**.
- The last chapter will be: **application, drying and curing of sealants**, in Volume 5,
- **Design and Calculation of Bonded Joints** (Chapter 3) is very important for the engineers and the designers of bonded parts, involved in structural bonding; it is linked sometimes to the Theory of Adhesion, and later in the Handbook, we will have another chapter which will introduce computer software that may be used for design and calculation.



Figure 3: Roll coater for laminating unit (by courtesy of Faustel USA).

Then in Chapters 4 and 5 we study some high-technology adhesives.

- **Heat-Resistant Adhesives** (Chapter 4), studies high-performance adhesives which display high heat resistance and are used in aerospace, aircraft construction, and we believe these adhesives will be used soon in other industries such as automotive, adhesives for mechanics, abrasives and industrial equipment.

Until 1980, the best organic adhesives could only resist upto 150–200°C service temperatures. Since then, new improved adhesives have been developed

(bismaleimides, polyimides) that resist up to 300°C (or even 400°C for a limited period of time).

- **UV Curing** (Chapter 5) provides the chemical understanding of UV curing, and later other chapters will study UV curing equipment and also applications in pressure sensitive adhesives, laminating and other industries.

We will also study Electron Beam (EB) curing, HF or microwave drying, induction heating in other chapters, later in the Handbook.

Fig. 4 illustrates the UV curing of an adhesive for laminates, for instance.

- The last chapter, **Flexible Bonding and Sealing** is quite an innovative work which explains why flexible polyurethane adhesives may be sometimes a better choice, even for structural or semi-structural bonds, because the work required to break the bond may be higher than with a rigid epoxy structural adhesive. This is demonstrated in Fig. 5.

All the authors of this Handbook are very knowledgeable scientists, practitioners, engineers, chemists, managers of leading companies or R & D centres, who have worked long years in their given field, and therefore their papers are quite useful, comprehensive and reliable.

Forthcoming Volumes

In the volumes that follow, we will start a comprehensive study of:

- all chemical and physical types of adhesives and sealants (20 chapters),
- all the industries where adhesives and sealants are or may be or should be used (20 to 25 chapters),
- all the techniques that are used or may be used in the near future for bonding, sealing, jointing, curing, etc.
- and all the materials that may be assembled by adhesives and sealants (10 chapters).

Volume 3: (to be published in 2006). This volume will on focus **Construction and Woodworking**, with the following list of contents:

Chapter 1: Construction Sealants, by Philippe Cognard, including technical characteristics, different chemical types, applications in building, standards and regulations. This chapter will complement the chapters: Silicone Adhesives and Sealants, MS Polymer Adhesives and Sealants, Polyurethane Adhesives and Sealants, Civil Engineering Sealants, which will be discussed in Volume 3 and also in later volumes.

Chapter 2: Acrylic Dispersion Adhesives and Sealants, by Dr Urban, scientist at BASF, Germany, the world leader for acrylic polymers and emulsions; it will

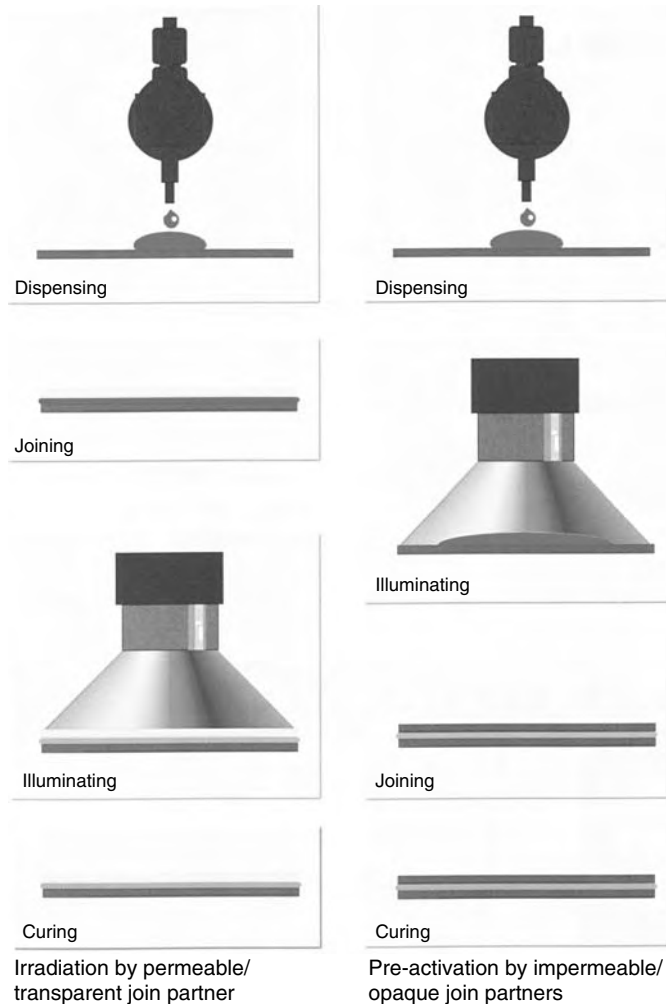
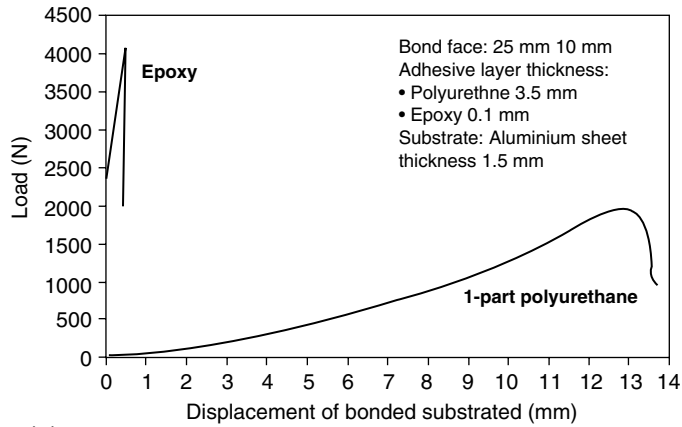

Figure 4: UV curing of an adhesive for laminates (source DELO Germany).

include basic chemistry, technical characteristics, formulations, end uses in construction, decoration, pressure sensitive adhesives and products.

Chapter 3: Furniture and Woodworking Adhesives, by Philippe Cognard, (170 pages) including requirements, technical characteristics, manufacturing techniques and woodworking machines, detailed study of the numerous end uses, standards.



(a)

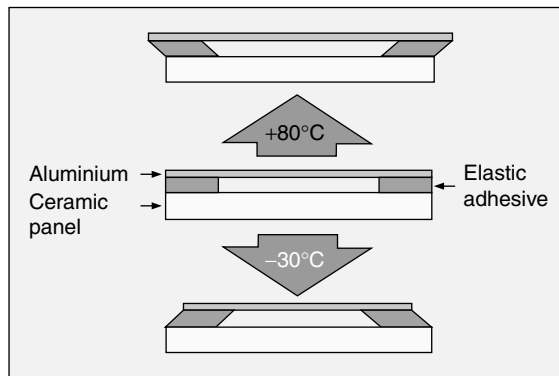

(b)

Figure 5: (a) Comparative tensile lap-shear test. (b) Flexible PU adhesive will adapt readily to movement differences due to the variations of temperature (sources SIKA AG).

Fig. 6 shows an interesting application of wood adhesive: 3D boards may be finished with PVC laminated foils by vacuum pressing. The figure shows the three steps of manufacturing. Doors of kitchen cabinets and home doors are now often made by using this technique.

Chapter 4: Chemistry of Silicone Sealants and Adhesives, by Dr Andreas Wolf, a scientist at Dow Corning. This is a very important and comprehensive chapter (180 pages), which explains, with many exclusive technical and scientific information, the chemistry of silicones, their technical characteristics, the formulation of silicone sealants, their applications in all industries, and mainly in construction of course, including a very large bibliography.

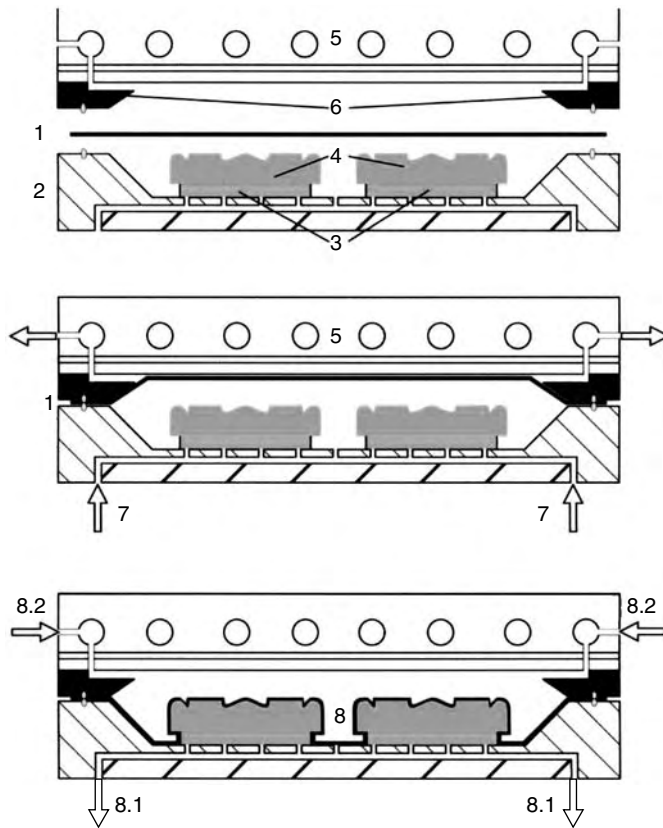

Figure 6: 3D laminating of PVC film onto 3D panels (made of MDF). This is a heat laminating on a vacuum press (courtesy of Bürkle Germany).

- | | | |
|-------------------------|----------------------|-----------------------------|
| 1 = PVC film | 2 = laying pallet | 3 = supports for the panels |
| 4 = 3D MDF boards | 5 = heating plates | 6 = top sealing frame |
| 7 = preheating pressure | 8 = pressure chamber | 8.1 = vacuum |
| 8.2 = forming pressure | | |

Chapter 5: Thermosetting formaldehyde based adhesives, by Dr A. Pizzi, a detailed study of UF, PF, RF and MF adhesives and glues, their chemistry and their uses in woodworking, panels and furniture (this chapter will be followed in later volumes by a chapter on ‘Wood Based Panels’ and a chapter on ‘Isocyanate Based Adhesives’).

Volume 4 will deal with the large volume applications and industries: packaging, laminating, graphic arts, pressure sensitive adhesives, and will include several chapters on hot melt adhesives (EVA based hot melts, styrenic polymers based hot melts, hot melt adhesives markets) because hot melts are a very large market in these industries.

Packaging is the largest user of adhesives because every day each home uses 10 different packages of food products: bottles of various drinks: water, milk, juices, beer, wine, several other packs of meat, fish, frozen foods, dry foods, rice, noodles, and many other food packaging, each pack may only use less than one gram but each of us probably uses several grams of adhesives each day in all those packaging.

Fig. 7 shows the dispensing of hot melt adhesive with jetting guns, which is the most widely used piece of equipment in packaging and paper industry, but we will also explain many other dispensing techniques in these chapters.

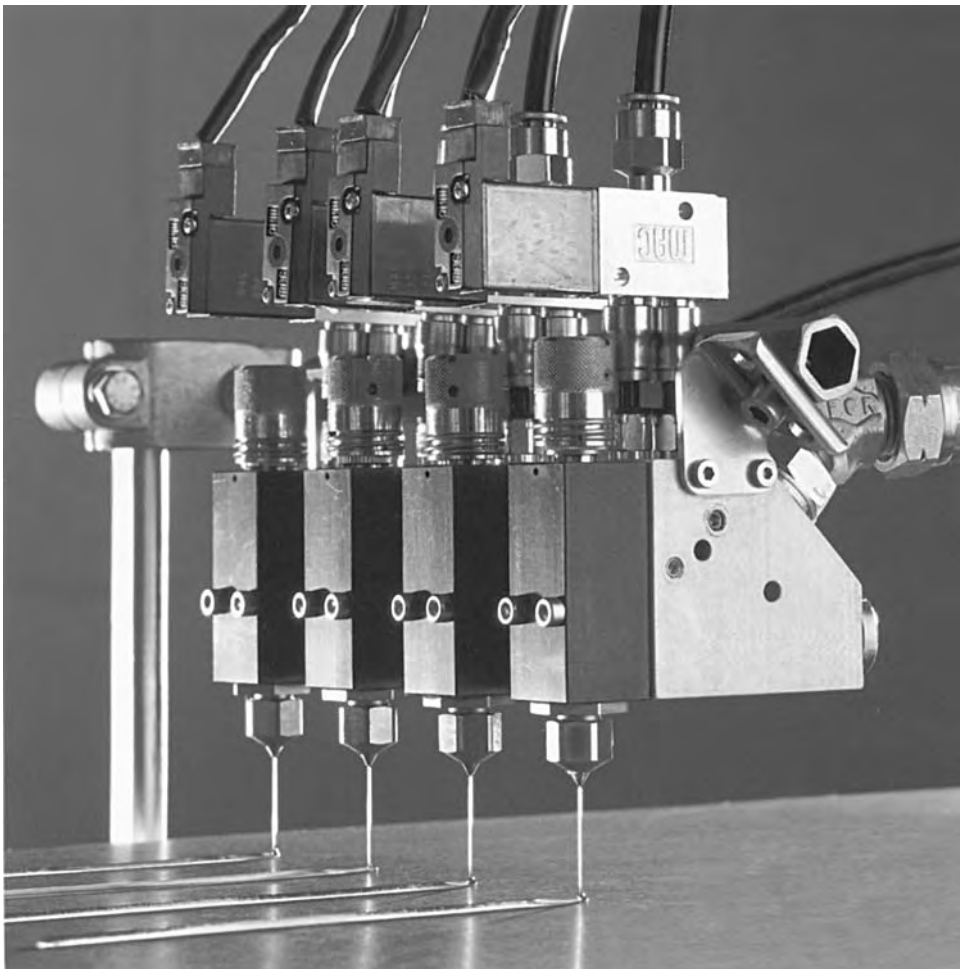

Figure 7: Dispensing of hot melt adhesives with jetting guns (source Robatech).

The detailed contents of Volumes 5, 6 and 7 will be announced later in due course of time after publication of Volumes 3 or 4.

In **Volume 5**, we will study high-performance and structural adhesives such as epoxies, bonding metals, plastics, rubbers, adhesives for transportation equipment, and also some new curing techniques.

All engineers and designers working in automotive, aircrafts, transportation equipment, metal working, plastics, composites and rubber industries, naval construction, mechanics, etc. should read Volume 5.

We wish you now a very useful and interesting reading. Do not hesitate to contact me or Elsevier if you have some questions, requests or suggestions, because this Handbook has been written for you, and we may add other chapters in the near future; should you need it, ask for it.

Philippe Cognard
Chief Editor
August 2005
Versailles, France

This Page Intentionally Left Blank

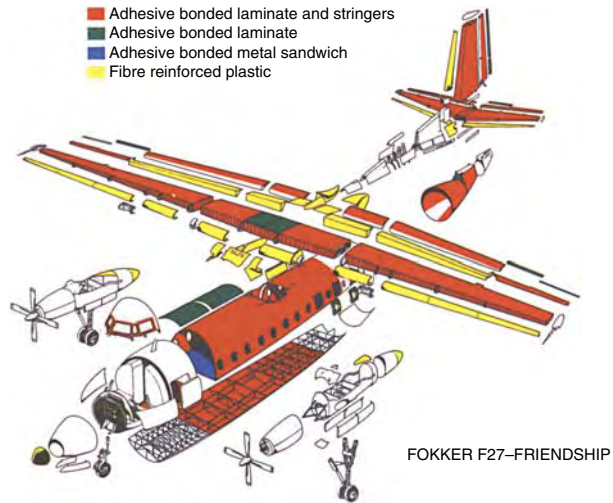

Plate 1: Many aircraft parts are bonded with high performance adhesives, on this FOKKER F27 as well as on the Airbus A380.



Plate 2: Roll water for laminating unit (by courtesy of Faustel USA).

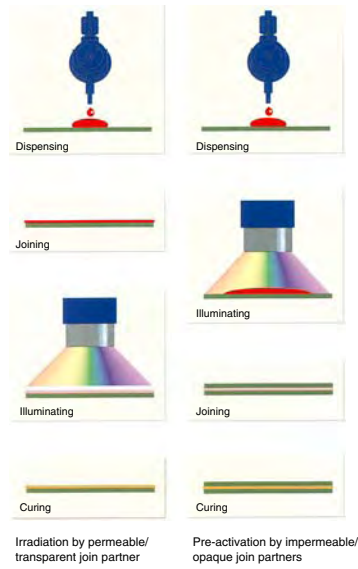

Plate 3: UV curing of an adhesive for laminates (source DELO Germany).

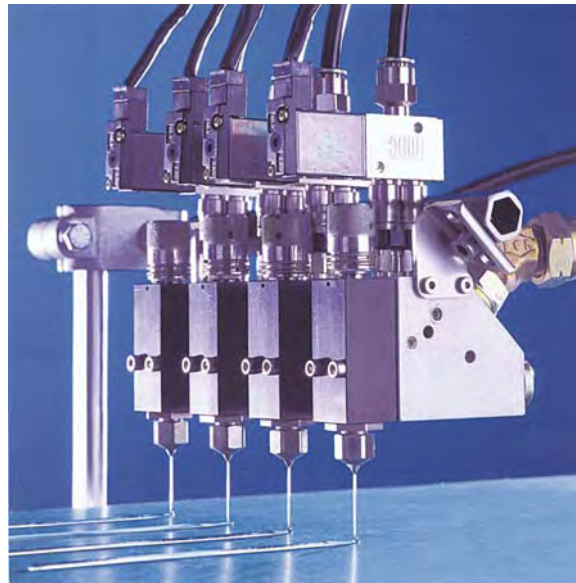

Plate 4: Dispensing of hot melt adhesives with jetting guns (source Robatech).

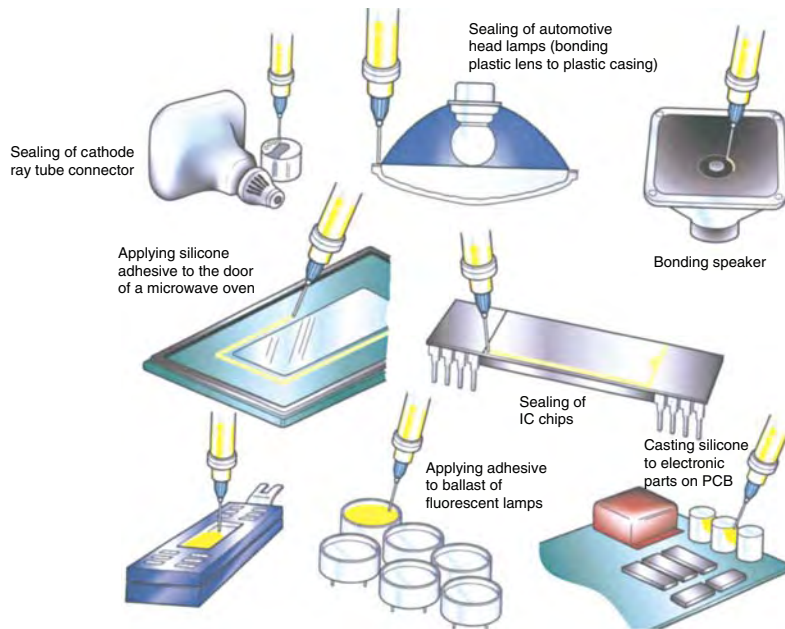

Plate 5: Syringe dispenser applications (by courtesy of Fisnar).

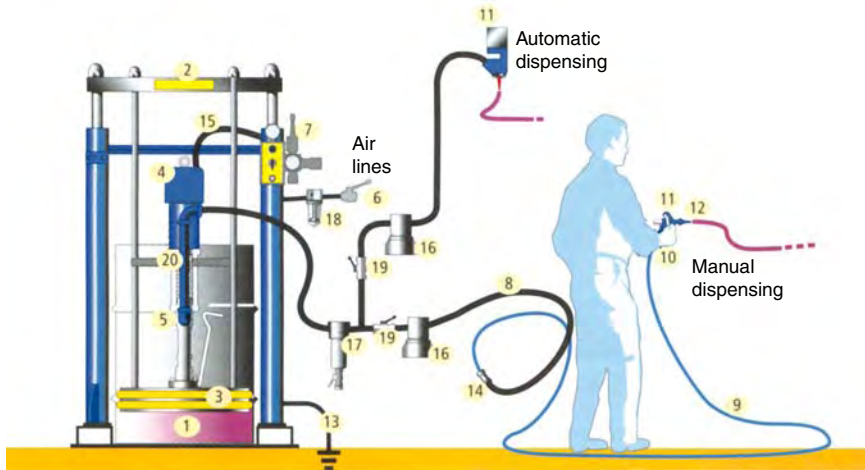

Plate 6: Hand gun for two-component adhesives with static mixer (TAH Industries, USA).

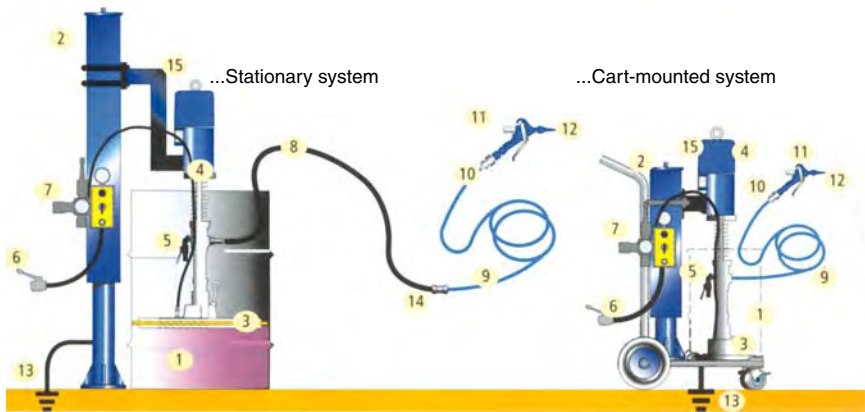

Plate 7: Hand spraying of a fluid adhesive from a 20 l pressure pot (source Kremlin).

1) STATIONARY TWIN-POST RAM



2) STATIONARY SINGLE-POST RAM



- 1 Material drum 2 Ram with drum centering clamps and air controls 3 Follower plate with a purge and vent 4 Pump 5 Bleed and pressure valve relief 6 Main air line shut-off valve 7 Shut-off and bleed air valve 8 High-pressure hose (large diameter) 9 High pressure hose (smaller diameter, flexible) 10 Swivel 11 Dispensing valve 12 Dispense tip 13 Ground 14 Adaptor 15 Air supply hose 16 Fluid pressure regulator 17 Material filter 18 Air filter 19 High-pressure shut-off valve 20 Pump outlet

Plate 8: High production rate spraying installations with 200 l drum ram and follower plate (source Rexson).



Plate 9: Graco Swirl spraying with 'Precision Swirl' gun on the roof of an automotive (source Graco Belgium).



Plate 10: Roller Coater (by courtesy of Bürkle Germany).



Plate 11: Faustel Roll Coater.



Plate 12: Bürkle EFA 12 laminating machine (by courtesy of Bürkle Germany).



Plate 13: Cartridge style coater showing a slot die coating cartridge – mainly used for water based PSA adhesive.



Plate 14: Stencil wheel applicator working with hot melt adhesive (RA 80 wheel applicator from Nordson) width upto 800 mm (by courtesy Nordson).



Plate 15: Needle applicator for cold glue
(source Robatech Switzerland).



Plate 16: Application of adhesive in bead form
on a plastic part with hand held gun equipped
with a static mixer (source Graco, Belgium/USA).



Plate 17: Robotic application of silicone adhesive/sealant on Fisnar robot equipped with syringes of adhesive/sealant (robot Scara TMB 100).



Plate 18: Robotic application of a structural adhesive on an automotive production line (source Graco).

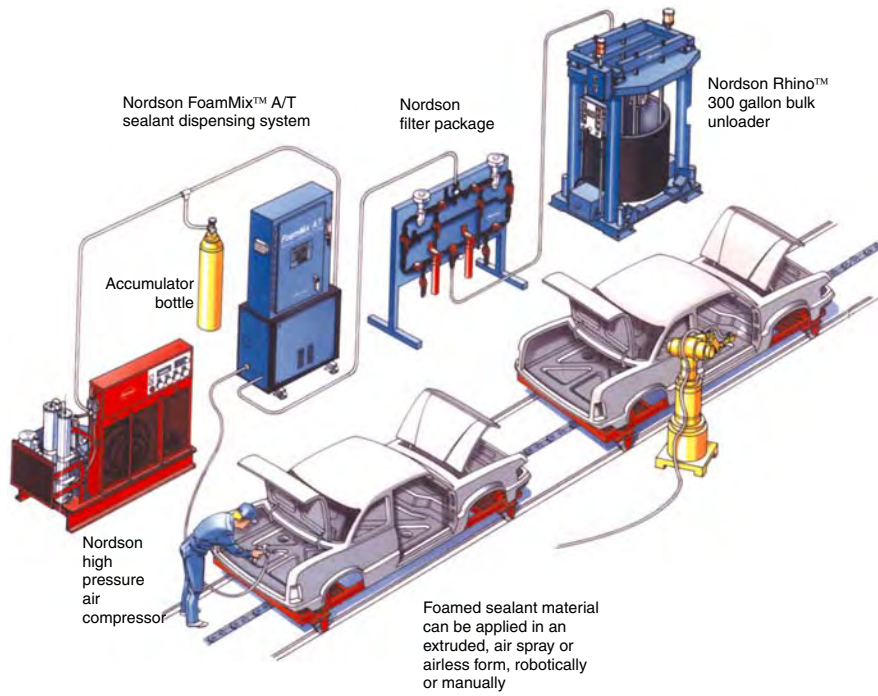

Plate 19: Nordson Fommix® installation to produce foamed sealants (source Nordson).

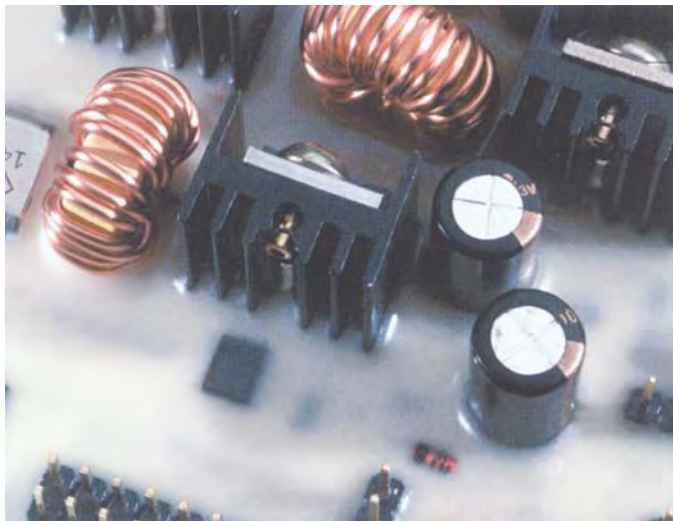

Plate 20: Casting of electronic circuit carriers (source Delo Germany).



Plate 21: EUROFIGHTER Typhoon. Modern fighter aircraft need heat stable adhesives for the bonding of some parts that become very hot during flight and combat.



Plate 22: Gums and cartridges for the application of adhesives and sealants.

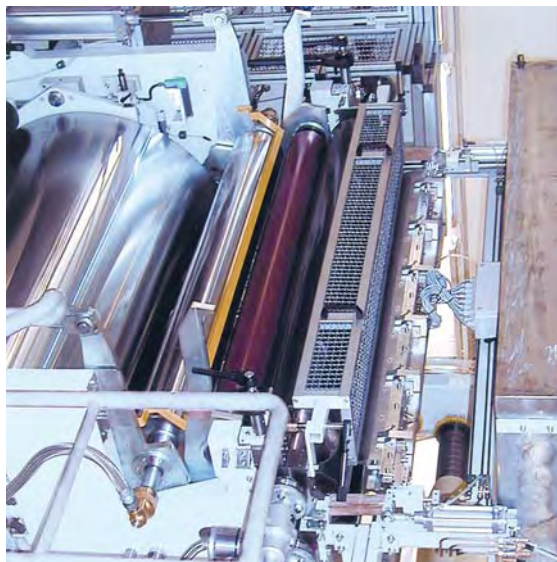

Plate 23: PAK 400-2 Coating head – Roll and nozzle application system for hot melts and UV cross linkable acyclic adhesives (source KRONERT, Germany).

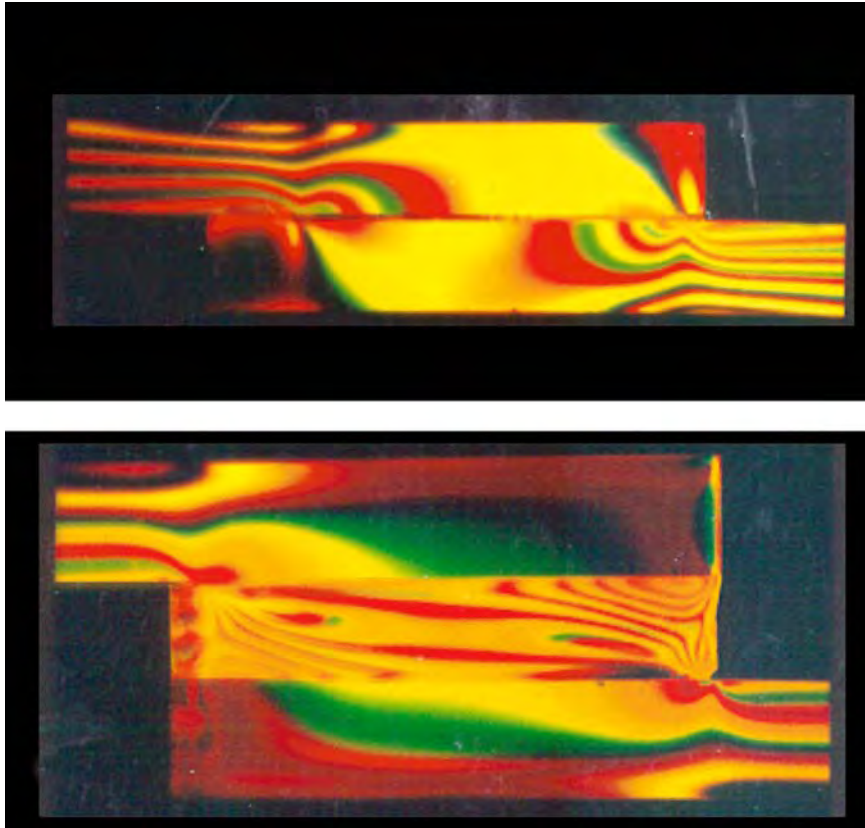

Plate 24: Stress patterns in photo elastic models: **thin and thick-layer rigid adhesive bonds.**

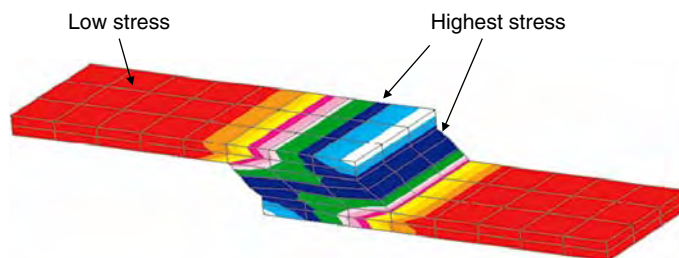

Plate 25: Example of FEM of shear loading.



(a)



(b)

Plate 26: Modern trains owe their stylish looks to a combination of glass, plastics and lightweight metals bonded together with adhesives. (a) Train before cabin bonding. (b) Direct glazed front cabin bonded to the train.

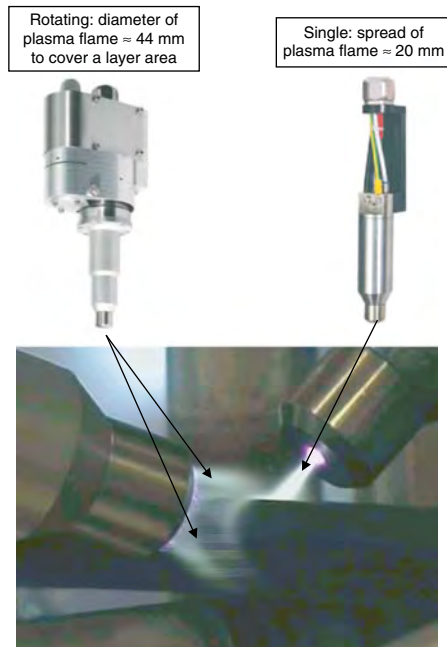

Plate 27: Open air plasma generators.



Plate 28: Application of adhesive.

Chapter 1

Theories of Adhesion

John Comyn

Studied chemistry at Bristol University (BSc 1964) and physical chemistry at Leeds and Belfast Universities (PhD Leeds 1967) and then appointed to teach polymer chemistry at Leicester Polytechnic. Resigned in 1989 to work as a consultant but became a visiting fellow at Loughborough University and a visiting professor at De Montfort University (formerly Leicester Polytechnic). Awarded a DSc by Bristol University in 1994. For many years has been joint editor-in-chief of the International Journal of Adhesion and Adhesives.

Keywords: Adhesion by chemical bonding; Adhesion by diffusion; Contact angle; Contact mechanics; Covalent bonds; Critical relative humidity/water concentration; Electrostatic theory; Hydrogen bonds; Ionic forces, ion-pairs; Latex adhesives; Lewis acids and bases; Other coupling agents; Physical adsorption; Pressure sensitive adhesion; Silane coupling agents; Surface tension; Water sensitivity; Wetting; Wood; Work of adhesion.

1.1. Introduction

An adhesive must do two things when applied to surfaces which are to be bonded. It must first wet the surfaces, as manifested by spreading and making a contact angle approaching zero. It must then harden to a cohesively strong solid.

Wetting involves making intimate contact between the molecules of the adhesive and the atoms and molecules in the surface. Hardening can be by chemical reaction, loss of solvent or water, or by cooling, but there is an exception in the case of pressure sensitive adhesives which remain permanently fluid. When this intimate contact is made, van der Waals forces are built, but other intermolecular forces such as chemical bonds may be formed at the time of contact or during the hardening process. However, this will depend on the chemistry of the adhesive and the substrate. If the adhesive can penetrate into the substrate before hardening, then mechanical interlocking will contribute to the strength of the adhesive bond. Intertwining of polymer molecules in the adhesive with those in the substrate would be the result of molecular interdiffusion across the interface. These four

phenomena underlie the *physical adsorption, chemical bonding, mechanical interlocking* and *diffusion theories* of adhesion.

There are two further theories namely *electrostatic* theory and *weak boundary layer* theory. All are discussed in detail below.

1.2. Adhesion by Chemical Bonding

The *chemical bonding theory* of adhesion invokes the formation of covalent, ionic or hydrogen bonds or Lewis acid–base interactions across the interface. Typical strengths of these bonds are shown in Table 1, where they are compared with van der Waals forces, which are the source of physical adsorption. The interactions are listed roughly in the order of size, and it can be seen that the strongest are considerably stronger than the weakest. The ionic interactions have been calculated for an isolated pair of ions in a vacuum and those involving aluminium and titanium might occur when epoxide adhesives are used with these metals. The strengths of covalent bonds are typical for bonds of these particular types. It is a possibility that C–O bonds are formed when isocyanate adhesives are used on substrates with hydroxyl groups such as wood and skin. The Si–O bond is formed when silane coupling agents are used on glass. Hydrogen bonds involving fluorine are stronger than other types, and this is because fluorine is the most electronegative element; the values listed here are taken from Jeffrey [1]. The data for Lewis acids and bases are actually enthalpies of mixing and are taken from Drago, Vogel *et al.* [2].

1.2.1. Covalent Bonds

There is much evidence that covalent bonds are formed with silane coupling agents. Silane coupling agents are generally considered to chemically react with both substrate and adhesive, so forming a system of covalent bonds across the interface, which is both strong and durable. They were first used to treat glass fibres before their incorporation into liquid resins of polyester or epoxide to make a composite. Without appropriate treatment, water can enter along the glass–resin interface with catastrophic results. Some compounds of titanium and zirconium are also used as coupling agents mainly for filler particles in polymers, but those of silicon are the most important.

1.2.1.1. Silane Coupling Agents

Silane coupling agents have the general structure $R-Si(OR')_3$, where R is a group that can react with the adhesive of liquid resin and R' is usually methyl or ethyl.

Table 1: Typical strengths of chemical bonds and van der Waals interactions

Type of interaction	Energy (kJ mol ⁻¹)
Ionic	
Na ⁺ Cl ⁻	503
Al ³⁺ O ²⁻	4290
Ti ⁴⁺ O ²⁻	5340
Covalent	
C–C	368
C–O	377
Si–O	368
C–N	291
Hydrogen bond	
–OH···O=C– (Acetic acid)	30 ± 2
–OH···OH (Methanol)	32 ± 6
–OH···N (Phenol-trimethylamine)	35 ± 2
F ⁻ ···HF (Acetic acid)	163 ± 4
F ⁻ ···HOH (Acetic acid)	96 ± 4
Lewis acid–base	
BF ₃ + C ₂ H ₅ OC ₂ H ₅	64
C ₆ H ₅ OH + NH ₃	33
SO ₂ + N(C ₂ H ₅) ₃	43
SO ₂ + C ₆ H ₆	4.2
van der Waals forces	
Dipole–dipole	≥ 2
Dipole–induced dipole	0.05
Dispersion	≥ 2

They are normally applied to adherends from dilute solution in water or ethanol–water (1–2% by volume) and left to drain and dry. They can also be added to adhesives. The main advantage is not to increase the strength of newly made joints, but to improve durability in the presence of water or water vapour. Structures of some commercially available silanes are shown below.

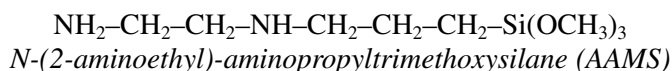
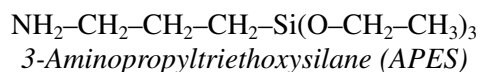

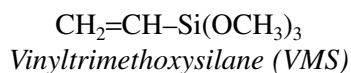
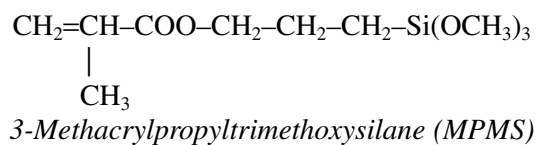
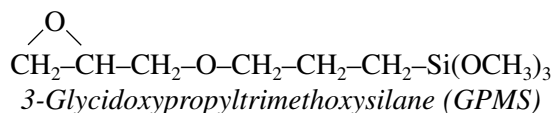

The -R groups in the APES and AAMS contain amines, which would make them reactive with epoxide adhesives or liquid resins. As GPMS contains epoxide groups, it would react with amine groups in adhesives or resins. The carbon-carbon double bonds in MPMS or VMS would copolymerise with styrene and unsaturated polyester in liquid resins, by a free radical mechanism.

Silanes react with the surface of glass, and then adhesive or liquid resin by the following sequence of reactions, which is also shown in Fig. 1.

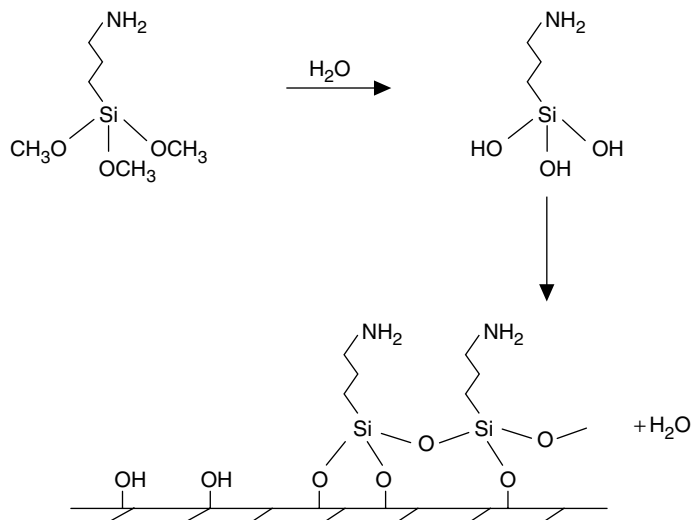

Figure 1: The reaction of the coupling agent 3-aminopropyl trimethoxysilane with the surface of glass.

- (i) Hydrolysis of $-\text{Si}(\text{OR}')_3$ to trisilanol $-\text{Si}(\text{OH})_3$, which is a fast reaction.
- (ii) Self-condensation polymerisation of trisilanol, and its reaction with surface $-\text{OH}$ groups to produce a polysiloxane network, which is covalently bonded to the surface; this is a slower reaction.
- (iii) Once the adhesive is applied, it reacts with the R group, with the result that there is a continuous chain of covalent bonds from the substrate to the adhesive.

Glass and silanes are both compounds of silicon, and in using them together we have the inherently favourable situation of like compounds reacting together. Walker [3–5] has shown, however, that silanes are generally effective in improving the adhesion of polyurethane and epoxide paints to a range of metals including aluminium, steel, cadmium, copper and zinc.

The effectiveness of silanes in bonding to aluminium has been demonstrated by Ulrén and Hjertberg [6]. Adhesives which were a copolymer of ethylene and VMS, or a terpolymer with butyl acrylate added, each containing 0.2–0.3 mol%. Adhesives with VMS gave peel strengths of 1800–3000 N m^{-1} , whereas adhesives without it gave the following lower peel strengths.

Low density polyethylene	(non-polar)	100 N m^{-1}
Copolymer of ethylene and butyl acrylate	(has polar groups)	700 N m^{-1}
An ionomer	(has ionic groups)	1500 N m^{-1}

After immersion in water at 85°C the terpolymer with VMS gave peel strengths of 9000 N m^{-1} , indicating that a strong, hydrolysis-resistant covalent bond is formed between aluminium and silane.

Kinloch *et al.* [7] used the fall in strength of bonded joints in boiling water as an indicator of the efficiency of GPMS with glass adherends. A large glass structure, which from its nature involved room temperature curing, had started to fail after only months of exposure in a temperate climate. Laboratory experiments confirmed the incipient instability of the system without a coupling agent, but also gave a confident basis for the prediction of decades of life with the silane coupling agent.

A graphic illustration of the effectiveness of silane coupling agents is shown in Fig. 2 [8], which shows the strengths of some bonds of glass bonded to lead alloy with an epoxide adhesive. Some of the glass specimens were treated with APES. The joints were exposed to warm, wet air (100% r.h. at 50°C) and it was observed that the joint strength falls to zero without the silane, but falls a moderate amount and then tends to level out when APES is used. In fact, after 96 days of exposure, most of the joints without the silane had fallen apart.

Gettings and Kinloch [9] measured the strengths of some butt joints with cylindrical mild steel adherends, bonded with an epoxide adhesive, after immersion in water at 60°C. They showed that in this instance, GPMS is a more effective coupling agent than APES, although it could be expected that both would react

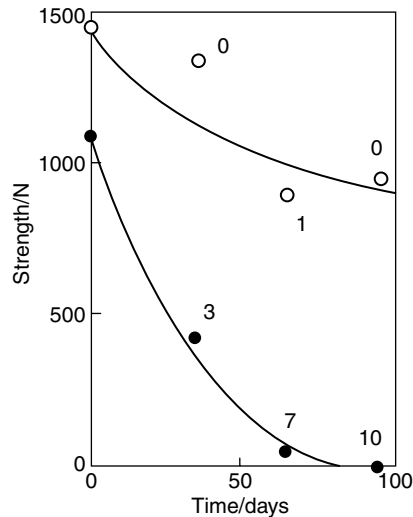

Figure 2: Failure loads of lap joints of glass to lead, bonded with an epoxide adhesive, on exposure to air at 100% relative humidity and 50°C. ● untreated glass, ○ glass treated with the coupling agent 3-aminopropyltriethoxysilane. The numbers indicate the number of joints, out of a total of 10, which fell apart during exposure [8].

with epoxide adhesives. Indeed, one of the current problems with silanes is the difficulty in identifying the most effective one. Examination of the steel surfaces by secondary ion mass spectrometry SIMS showed an ion of mass to charge ratio (m/z) 100, which corresponds to FeOSi^+ when only GPMS was used as the primer. With stainless steel both FeOSi^+ and CrOSi^+ ions were detected. This was taken to indicate that covalent bonds are formed of the type metal–O–Si across the interfaces.

More recently, Turner and Boerio [10] examined plasma polymerised amorphous silica films on aluminium and titanium by X-ray photoelectron spectroscopy (XPS) and reflection-absorption infrared (RAIR), which indicated the formation of Ti–O–Si and Al–O–Si bonds. In lap joints, these gave very strong interfaces with no interfacial failure.

SIMS has been used to detect Fe–O–Si units on iron which had been treated with GPMS [11]. Here, the time of flight SIMS was employed, which is a high resolution technique. The actual charge to mass ratio m/z of this ion is 99.9067, but other ions with similar m/z are possibly present. These include FeO_2C^+ with $m/z = 99.9248$ and Si_3O^+ with $m/z = 99.9256$.

There are similar doubts about peak assignment in the case of aluminium treated with GPMS. Here, [12], an ion has been assigned to Al–O–Si⁺ where $m/z = 70.9534$, but there are other possible assignments. However, the assignment

is strengthened by the presence of a peak at $m/z = 85$, which can be assigned to $\text{Al-O-Si}^+=\text{CH}_2$.

There are many papers in the literature in which other spectroscopic techniques have been used to examine the interaction of silanes with silica, glass and metal surfaces.

The compound 3-aminopropyldimethylethoxysilane (ADES) $\text{NH}_2\text{CH}_2\text{CH}_2\text{CH}_2\text{Si}(\text{CH}_3)\text{OCH}_2\text{CH}_3$ has only one alkoxy group, and it may therefore react with a substrate without the complication of transfacial Si-O-Si units being formed. Diffuse-reflectance Fourier transform infrared (FTIR) spectra of ADES [13] on titanium dioxide powder showed a weak peak at 950 cm^{-1} , which is due to Si-O-Ti groups. When alumina was used with ADES, a peak at 963 cm^{-1} was assigned to Si-O-Al groups.

Inelastic electron tunnelling spectroscopy (IETS) has been used to study some silanes on aluminium oxide. The technique records vibrational spectra of an adsorbed monolayer. Silanes can be applied to the oxidised metal from solution or vapour, and devices are completed by evaporation of a top electrode which is usually of lead, because of its superconductivity. The device is cooled to the temperature of liquid helium (4.2 K) to minimise thermal broadening. Most electrons (>99%) pass through the device elastically, but a small number excite vibrational modes. It is these that are detected and displayed as a spectrum. Both IR and Raman modes can be observed; the selection rule for IET spectroscopy is one of orientation, in that bonds which are aligned perpendicular to the surface give the most intense peaks.

The IET spectrum of triethoxysilane is shown in Fig. 3 [14]. There is a strong and sharp peak at 2191 cm^{-1} due to Si-H vibrations which are perpendicular to the surface, so showing that the silane molecules are adsorbed tripod-like by the three ethoxy groups on aluminium oxide. The Si-H bending mode at 880 cm^{-1} is also strong.

The IET spectrum of GPMS [15] shows no sign of the epoxide group at 940 cm^{-1} , but C=C is present at 1595 cm^{-1} and C=O at 1646 cm^{-1} ; these are absent in GPMS. This serves to show that the reactions of silanes at surfaces can be quite complicated.

1.2.1.2. Other Coupling Agents

Coupling agents based on titanium and zirconium have been used to improve adhesive properties between polymers and filler-particles and to treat aluminium alloy for adhesive bonding [16]. Like the silanes, they react with surface hydroxyl groups as shown below, but there is no condensation polymerisation to produce a polymer network at the interface.

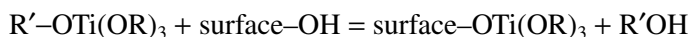

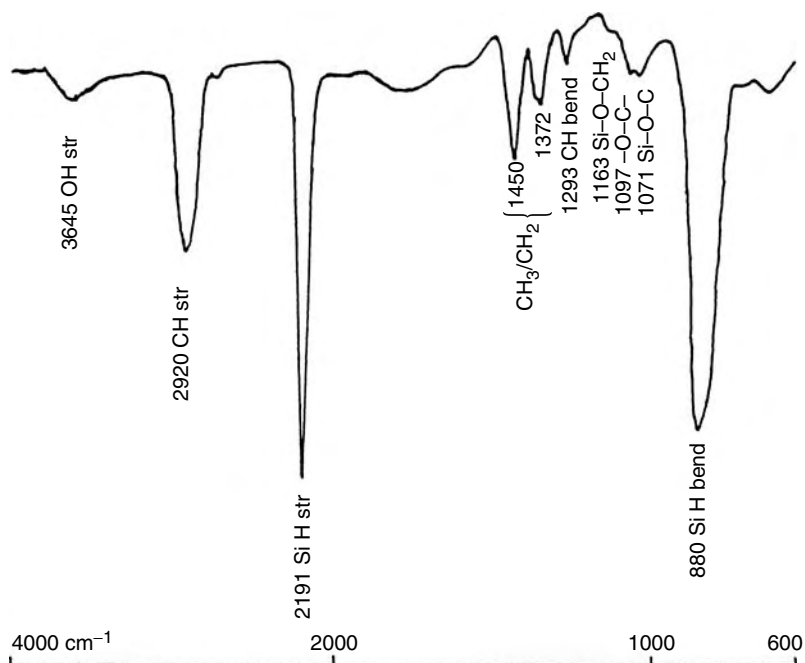
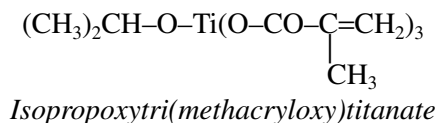
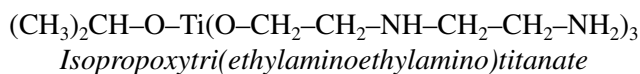

Figure 3: Inelastic electron tunnelling spectrum of triethoxysilane on aluminium oxide [14].
Crown Copyright.

Two examples of titanate coupling agents are shown below. The first contains amine groups and would be suitable for use with epoxide adhesives. Zirconate coupling agents have very similar structures to the titanates.



Other types of coupling agents include 1,2-diketones for steel [17], nitrogen heterocyclic compounds for copper [18], and some cobalt compounds for the adhesion of brass-plated steel tyre cords to rubber [19].

1.2.1.3. Bonding to Wood

If wood is treated with an adhesive containing an isocyanate, it is possible that these would react with hydroxyl groups on cellulose or lignin to produce urethane linkages as shown below:

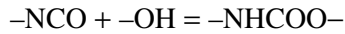

Using solid state ^{15}N nuclear magnetic resonance (NMR) spectroscopy, Bao *et al.* [20] found little evidence for this when two types of wood (Aspen and Southern Pine) were treated with polymerised diphenylmethane diisocyanate. However, evidence for such linkages was obtained by Zhou and Frazier [21], but now using NMR spectroscopy with both ^{15}N and ^{13}C nuclei.

Another approach to improve adhesive bonding to wood is to graft acid anhydrides to its surface, and then react the resulting carboxylic acid group with the adhesive. Mallon and Hill [22] used ^{13}C NMR and FTIR to show that succinic anhydride reacts with hydroxyl groups on wood, and the acid groups can subsequently be reacted with hexamethylene diamine. The reaction scheme is shown in Fig. 4.

Hill and Cetin [23] also chemically modified wood with the anhydrides of propionic, crotonic and methacrylic acids, and FTIR provided evidence that only the latter becomes grafted to wood. If styrene was subsequently polymerised whilst in contact with the grafted wood, a free radical copolymerisation of styrene and the grafted methacrylic groups ensued.

1.2.2. Ionic Bonds

The potential energy E_{\pm} of two ions separated by distance r is given by Eq. (1), and some values calculated from this appear in Table 1. Here z_1 and z_2 are the

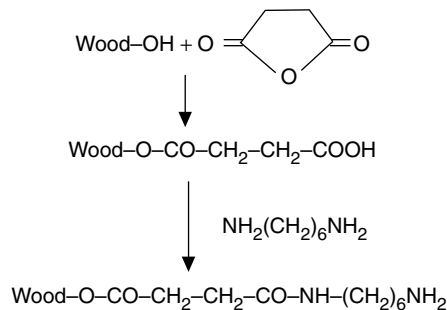

Figure 4: The reaction of succinic anhydride with wood, followed by reaction of the carboxylic group with 1,6-diaminohexane [22].

valencies of the ions, e is the electronic charge, ϵ_0 is the permittivity of a vacuum and ϵ_r is the relative permittivity of the medium.

$$E_{\pm} = \frac{z_1 z_2 e^2}{4\pi\epsilon_0\epsilon_r r} \quad (1)$$

Some spectroscopic evidence for the formation of ionic bonds across adhesive interfaces is as follows. Using reflectance IR, Bistac *et al.* [24] showed that for an ethylene-vinyl acetate polymer grafted with 1% of maleic anhydride, and bonded to iron or zinc, new absorptions were present which were attributed to carboxylate ($-\text{COO}^-$), and their presence coincided with strong adhesion. In an IR study of the bonding of maleic anhydride to naturally oxidised aluminium, Schneider *et al.* [25] showed that the anhydride is hydrolysed in the early stages of adhesion, taking about 1 min on exposure to laboratory air. They suggested that the hydrolysed acid is bonded to two aluminium cations as shown in Fig. 5.

There is evidence from XPS spectra that the silane APES forms a quaternary ammonium ion $-\text{NH}_3^+$ on quartz [26]. This will form an ion-pair with oxide ions on the quartz surface. The evidence is that there is a peak at the binding energy of 400.1 eV which is assigned to N^+ ; the uncharged N atom has a binding energy of 402.1 eV. A similar situation was observed for diethanolamine (used as a model compound for an adhesive) on aluminium coated with plasma polymerised hexamethylenedisiloxane [27]. Here, the telling peak was at 401.5 eV.

It has been demonstrated using IETS [28] that when the ester-containing polymers polymethyl methacrylate and polyvinyl acetate are placed in contact with aluminium oxide, peaks which can be assigned to the carboxylate ion arise. Specifically, these are due to the symmetric and asymmetric vibrational modes of $-\text{COO}^-$ which are located at about 1450 and 1610 cm^{-1} . More recently, Devdas and Mallik [29] showed, using IETS, that a number of carboxylic acids adsorbed on alumina show such peaks; an example is that pyruvic acid $\text{CH}_3\text{CH}_2\text{COCOOH}$ shows the peaks at 1450 and 1605 cm^{-1} .

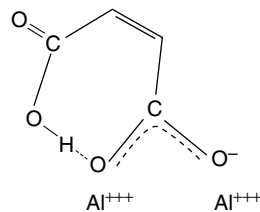

Figure 5: The attachment of maleic anhydride to aluminium (after Ref. [25]).

Perhaps the strongest evidence for interfacial ion-pairs is the fact that carboxylic acids enhance adhesion to metals, and commercial adhesives such as structural acrylics often incorporate this feature.

A major problem with all adhesive joints is their sensitivity to water, and a possible explanation for this when adhesion is through ion-pairs is the high relative permittivity of water; at 20°C, the relative permittivity is 80.2 making it much higher than that of any common solvents. The next highest seems to be dimethylacetamide at 37.8, but for chloroform the value is 4.8 and that for hydrocarbons is about 2.

The force between two isolated ions in a medium F_{\pm} is given by Eq. (2).

$$F_{\pm} = \frac{z_1 z_2 e^2}{4\pi\epsilon_0\epsilon_r r^2} \quad (2)$$

Epoxide adhesives have low values of ϵ_r , about 4 or 5 and phenolics are probably similar. Hence a small amount of water entering an adhesive would increase ϵ_r and lower F_{\pm} , not to zero, but to a fraction of its original value. Complete removal of water would restore F_{\pm} to its original value.

The relative permittivities of mixtures of water with organic solvents are approximately linear with composition. If this is the case for water-adhesive mixtures and the relative permittivity of the adhesive reasonably represents that surrounding the interfacial ion-pairs, then strength reductions can be calculated. The results of the calculation, using $\epsilon_r = 5$ for adhesives and 80 for water are compared with some actual falls in strength in Table 2 [30]. Agreement between the measured and calculated values in Table 2 is considered to be quite good, and so supports these joints owing much of their strength to ion-pairs.

The data in Table 2 were for single lap joints in aluminium prepared with etching in chromic acid, and bonded with a number of epoxide and phenolic adhesives;

Table 2: Comparison of experimental and calculated falls in joint strengths on aging at 100% relative humidity at 50°C

Adhesive	Fall in joint strength %	
	Measured	Calculated
Modified epoxide BSL 312	50	36
Epoxide nylon FM1000	78	68
Epoxide DGEBA/DAPEE	40	45
Nitrile phenolic 1	54	40
Nitrile phenolic 2	37	20
Nitrile phenolic 2 with primer	14	18
Vinyl phenolic	45	56

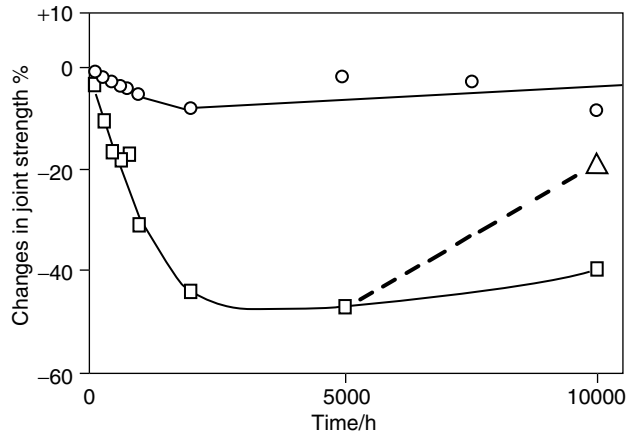

Figure 6: Strengths of lap joints in aluminium alloy bonded with a vinyl phenolic adhesive on exposure to wet air at 50°C. ○ Aged at 50% r.h. and □ 100% r.h. △ aged at 100% r.h. for 5000 h, then at 50% r.h. for a further 5000 h [30]. Crown Copyright.

in some cases primers were used. The joints were exposed to wet air at 100% relative humidity and 50°C, for up to 10,000 h and changes in joint strengths for two adhesives are shown in Figs 6 and 7. Such behaviour is typical of joints in aluminium and structural adhesives, where the metal has been pre-treated by etching or anodising in chromic or phosphoric acid, in that joints are partially weakened on exposure to water. In cases where the metal has been subjected to abrasion or

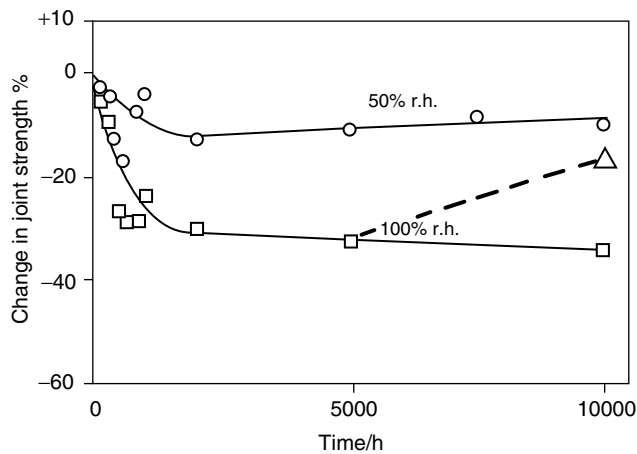

Figure 7: Strengths of lap joints in aluminium alloy bonded with a modified epoxide adhesive on exposure to wet air at 50°C. ○ Aged at 50% r.h. and □ 100% r.h. △ aged at 100% r.h. for 5000 h, then at 50% r.h. for a further 5000 h. [30]. Crown Copyright.

degreasing, joint strengths may fall to zero. Here it can be seen that there was an initial fall in strength over the first 2000 h, followed by a period where the strengths basically remain the same. This initial drop is controlled by water diffusing into the adhesive layer.

The ion-pair mechanism allows partial weakening of joints in the presence of water, with recovery when the joints are dried out. This is in contrast to the physical adsorption theory which predicts the reduction in strength to zero as water displaces the adhesive from the metal oxide, and no recovery as a glassy adhesive would have insufficient molecular mobility for it to re-establish intimate contact with the substrate. The joints which are now under discussion all showed some recovery on drying out, as is shown by the triangular points in Figs 4 and 5. Recovery is not complete but may have become so with a longer period of drying.

1.2.3. *The Unique Properties of Water*

Water is a liquid with extreme properties. If ion-pairs are significant interfacial forces, then it is the high relative permittivity which causes weakening. If physical adsorption is the mechanism of adhesion, then it is the high surface tension of water (see Table 9), which enables it to displace adhesives from metallic surfaces.

A current issue which has not been adequately explained is that there is a critical water concentration (or critical relative humidity (r.h.)), below which structural adhesive joints in metals are not weakened; above it they are progressively weakened.

Laboratory tests on the durability of such joints generally expose them to air of high humidity (e.g. 80–100% r.h.). It has been frequently observed that joints can withstand exposure at lower humidities (e.g. 50% r.h. or less) for long periods without weakening. For example, DeLollis [31] has referred to some epoxide-aluminium joints which showed no loss of strength after exposure to laboratory humidity for up to 11 years. Gledhill *et al.* [32] exposed butt joints with an epoxide adhesive at 55% r.h. and 20°C for 2500 h and found no weakening. In experiments on some epoxide adhesives, Comyn *et al.* [33–35] found no significant weakening of joints after exposure for 10,000 h at about 45% r.h. and 20°C. Also Comyn *et al.* [30] found no weakening when joints in aluminium alloy with a range of phenolic and epoxide adhesives were exposed at 50% r.h. and 50°C for up to 10,000 h. The same joints were weakened on exposure at 100% r.h.

Such information led to the proposal from Gledhill *et al.* [32] that there must be a critical concentration of water in the adhesive, and corresponding relative humidity in the surroundings, which demarcates conditions under which weakening will occur from those under which it will not. In a joint which is absorbing

water, there may be an outer zone where the critical water concentration is exceeded, and this zone can be regarded as a crack in the bondline which can be dealt with by fracture mechanics. The hypothesis was tested with some butt joints bonded with an epoxide immersed in water at 20, 40, 60 and 90°C and also in air at 20°C and 55% r.h. All the water-immersed joints became weaker, and it could be shown using the fracture mechanics approach that the strengths of the joints could be correlated if the critical concentration of water in the adhesive was 1.35%.

Further evidence for a critical water concentration comes from Ohno *et al.* [36] for joints of mild steel bonded to PMMA with an acrylic dental adhesive, immersed in water at 37°C. Water entered the bonds by diffusion through the plastic adherend, and the steel surface inside the joints could be visually examined through the PMMA and adhesive. After immersion, the joints were subjected to 20 thermal cycles between liquid nitrogen (−196°C) and water at 40°C, which showed that the interface was broken by water when its concentration reached 48% of the equilibrium concentration in PMMA. No changes were visible on the steel surface at the 48% water level, but at 95%, small white spots appeared and the surface then gradually turned black due to corrosion.

Brewis *et al.* [37] attempted to locate the critical conditions for some aluminium joints bonded with an epoxide adhesive. Surface preparation of the aluminium alloy adherends was done by sandblasting; this method was chosen because of the poor durability of sandblasted joints, a factor which could give rapid results particularly sensitive to changes in relative humidity. The locus of failure was the interface between the adhesive and aluminium oxide. Joints stored for 192, 504 and 1008 h did not weaken with increasing r.h. A slight weakening was evident after 2016 h, and this became greater after 5040 and 10,080 h. After 2016 and 5040 h, it was possible to place a straight line through the data, but at 10,080 h the locus had a kink at 65% r.h. This is the critical relative humidity for these particular joints and it corresponds to a critical concentration of water in the adhesive of 1.45%, a value which is very similar to that of 1.35% obtained by Gledhill *et al.* [32].

Available experimental evidence on the uptake of water vapour by structural adhesives is that the isotherms are straight lines or gentle curves [38]. The consequence of this is that at 50% r.h. the adhesive layers in metal joints would be expected to absorb significant amounts of water. The point to be taken from this information is that water absorption isotherms of epoxide adhesives do not show any sharp changes which might be the cause of the critical r.h.

Even if the isotherms did show any discontinuities, they would not account for a critical r.h. This is because the main role of the adhesive in durability is in transmitting water to the adhesive interface. Water in the surroundings would eventually

reach equilibrium with water in the adhesive, and also with the water at the interface. Hence the equilibrium distribution of water between the surroundings and the interface will be independent of the adhesive. A tentative explanation for the critical r.h. involved different levels of salt hydration [37].

1.2.4. Hydrogen Bonds

Hydrogen bonds probably contribute to the attachment of postage stamps to envelopes where the adhesive (polyvinyl alcohol) and paper (cellulose fibres) both contain $-OH$ groups. Wood is also rich in cellulose and the reactive adhesives based on formaldehyde contain hydroxyl or amine groups capable of participating in hydrogen bonds.

Hydrogen bonds are weak and they are easily broken and readily formed. The bond consists of a hydrogen atom which is bonded to two other atoms, that is two atoms are bridged by a hydrogen atom. It consists of one short normal $A-H$ bond and a longer $H\cdots B$ bond, so forming $A-H\cdots B$.

The $A-H$ bond is a normal covalent bond, and the dominant view is that the $H\cdots B$ bond is dominantly electrostatic. The evidence is that it is only formed between atoms which are electronegative (O, N, F, S) and the strongest bonds are made with fluorine, which is the most electronegative of all. The reason why hydrogen is unique in forming such bonds is that it can approach other atoms closely on account of its small size and absence of inner shell electrons. The bond does not have to be linear as the electrostatic force is not directional.

Agrawal and Drzal [39] consider that hydrogen bonding is very important in the adhesion of a polyurethane formed from toluene diisocyanate and 1,4-butane diol bonded to float glass, but dipole-dipole forces also contribute. Nagae and Nakamae [40] investigated the nylon 6-glass fibre interface using laser Raman spectroscopy. Shifts in peaks due to $>C=O$ and $>NH$ groups indicated the formation of interfacial hydrogen bonds, but these were weaker than those in the bulk nylon 6.

1.2.5. Lewis Acid-Base Interactions

Conventional or Brønsted acids are donors of protons (hydrogen ions H^+) and the bases are proton acceptors. The concept dates from 1923. In 1938, G.N. Lewis proposed a broader definition in that an acid is an electron acceptor and a base is an electron donor.

Boron trifluoride is an example of a Lewis acid and ammonia is a Lewis base. Ammonia is also a Brønsted base, but boron trifluoride is not a Brønsted acid.

Because of the low position of boron in the periodic table, BF_3 is electron deficient, which means that it has an sp^3 orbital containing no electrons. In ammonia, there is a non-bonded sp^3 orbital but this now contains two electrons. The two molecules join together by the two electrons being shared as shown in Fig. 8; heat is liberated.

Lewis acids and bases have attracted much attention in adhesion science in recent years. The strengths of Lewis acids and bases can be obtained from their heats of reaction ($-\Delta H$) in poorly solvating solvents (usually hexane, cyclohexane or tetrachloromethane). The heats are related to E_A and C_A which are empirical parameters for the acid, and E_B and C_B which are those for the base [2], by Eq. (3),

$$-\Delta H = E_A E_B + C_A C_B \quad (3)$$

E_A and E_B are considered to be the susceptibilities of the acid and base to undergo electrostatic interactions, and C_A and C_B are their susceptibilities to form covalent bonds. The heats of reaction can be measured by direct calorimetry or from shifts in IR spectra. An example of the latter is the shift in the OH stretching frequency of phenols ($\Delta\nu$), when they react with amines in tetrachloromethane or tetrachloroethene, which is given by Eq. (4) [2].

$$-\Delta H/\text{kcal mol}^{-1} = 0.0103 \Delta\nu(\text{cm}^{-1}) + 3.08 \quad (4)$$

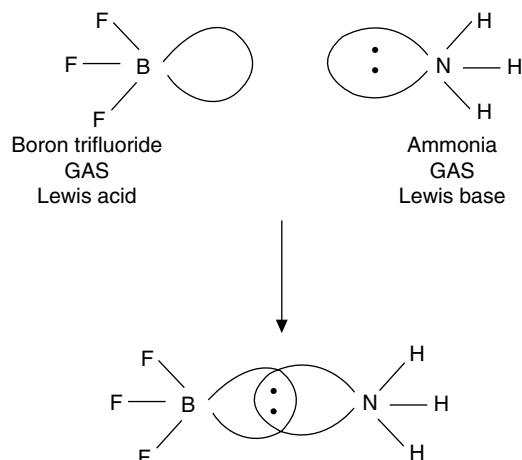

Figure 8: The reaction of boron trifluoride (a Lewis acid) with ammonia (a Lewis base) by the sharing of a pair of electrons.

Table 3: Values of E and C for some Lewis acids and bases

Compound	Number of measurements	C_A	C_B	E_A	E_B
Iodine	39	1.00		1.00	
Phenol	34	0.442		4.33	
Boron trifluoride	5	3.08		7.96	
Pyridine	21		6.40		1.17
Dimethylformamide	4		2.48		1.23
Dimethylsulfoxide	14		2.85		1.34
Benzene	5		0.707		0.486
Ethyl acetate	14		1.74		0.975

Some values are given in Table 3. They are based on a large number of measurements of $-\Delta H$, with iodine $E_A = 1.00$ and $C_A = 1.00$ as the reference compound, in the old units of $(\text{kcal/mol})^{1/2}$.

There is some consideration of such acid–base interactions in the section below on contact angles. The application to adhesion has been reviewed by Chehimi [41].

1.3. Adhesion by Physical Adsorption

1.3.1. Introduction

Physical adsorption contributes to all adhesive bonds and so is the most widely applicable theory of adhesion. The basis for adsorption is that van der Waals forces, which occur between all atoms and molecules when they are close together, exist across interfaces. These are the weakest of all intermolecular forces, but their strengths are more than adequate to account for the strengths of adhesive joints. van der Waals forces are of three types, namely the forces of attraction between molecules with permanent dipoles, those between a permanent dipole and a nonpolar molecule, and those between nonpolar molecules. The nature of these forces is outlined below, and more detail is given by Atkins and de Paula [42].

1.3.2. van der Waals Forces

1.3.2.1. Forces between Permanent Dipoles

The strongest van der Waals forces are those between molecules which have permanent dipoles. They are also known as Keesom forces. The potential energy

in a vacuum, of a pair of permanent dipoles is given by Eq. (5), where μ_1 and μ_2 are the dipole moments, ϵ_0 is the permittivity of a vacuum, k is Boltzmann's constant and T the absolute temperature.

$$E_{\text{pp}} = \frac{-2\mu_1^2\mu_2^2}{3kT(4\pi\epsilon_0)^2 r^6} \quad (5)$$

1.3.2.2. Forces between Permanent and Induced Dipoles

An electric field surrounds a permanent dipole, and this will induce a temporary dipole in an atom or non-polar molecule; hence a force of attraction is produced. The induced dipole moment (μ_i) is given by Eq. (6), where α is the polarisability of non-polar entity and E is the electric field.

$$\mu_i = \alpha E \quad (6)$$

The potential energy for such an interaction is given by Eq. (7), where μ_1 is the moment of the permanent dipole. This phenomenon is also known as the Debye induction.

$$E_{\text{pi}} = \frac{-\mu_1^2\alpha}{4\pi\epsilon_0 r^6} \quad (7)$$

1.3.2.3. Dispersion Forces

The weakest van der Waals forces occur between non-polar entities, and are termed dispersion or London forces. They arise because such species have temporary fluctuating dipoles such that at any instant the centre of gravity of the electrons does not coincide with the nucleus. Dispersion forces are responsible for many phenomena including the liquefaction of argon (boiling point, -186°C ; enthalpy of vaporisation, 6.43 kJ mol^{-1}).

The approximate potential energy of a pair of such molecules, separated by distance r , is given by Eq. (8), where α_1 and α_2 are their polarisabilities and I_1 and I_2 are their ionisation potentials.

$$E_{\text{ii}} = \frac{-3(\alpha_1\alpha_2)^2 I_1 I_2}{2(I_1 + I_2)r^6} \quad (8)$$

The results of some calculations using Eqs (5), (7) and (8) are shown in Table 4.

Table 4: Potential energies for molecules in contact

Molecules	Type of interaction	r_0 (nm)	E (J mol ⁻¹)
H ₂ O–H ₂ O	polar–polar	0.38	–1120
H ₂ O–CH ₄	polar–nonpolar	0.43	–85
CH ₄ –CH ₄	nonpolar–nonpolar	0.30	–7800

The calculation for the attraction between two methane molecules used $I = 1133$ kJ mol⁻¹ and $\alpha = 2.593 \times 10^{-30}$ m³, and the result is quite close to the enthalpy of evaporation for methane which is 8190 J mol⁻¹. Data were taken from Ref. [43].

The potential energies for the molecules in contact (i.e. $r = r_0$) are shown. Because these are all proportional to r^{-6} , potential energies will fall to 1/64th of these values if the molecules are separated by a further intermolecular diameter (i.e. $r = 2r_0$). This demonstrates that these forces of adhesion are very short range and are experienced only by one or two layers of molecules in the interfacial layers.

1.3.3. Measurements of Surface Forces

1.3.3.1. Surface Tension of Liquids

The measurement of the surface tensions of liquids is a starting point for enumerating adhesion due to physical adsorption. They can be measured to within 0.1 mN m⁻¹ by measuring the force needed to remove a metal ring from the surface of a liquid, with a torsion balance.

A correction factor has to be applied to the measured surface tension according to a method of Harkins and Jordan [44], which has been justified theoretically by Freud and Freud [45]. Table 5 [45] shows the details of measurements for four liquids; γ_L^* is the surface tension directly obtained from the force and γ_L is the corrected value. The correction factor (F) is a function of R/V and R/r where R is the radius

Table 5: Details of surface tension measurements on pure liquids

Liquid	D (g m ⁻³)	γ_L^* (mN m ⁻¹)	V (cm ³)	R^3/V	F	γ_L (mN m ⁻¹)
Dimethylformamide	0.9487	39.5	0.340	0.754	0.934	36.9
Dimethylsulfoxide	1.10	46.5	0.345	0.742	0.935	43.5
Ethane diol	1.11	50.5	0.371	0.690	0.941	47.5
Water	0.998	72.6	0.593	0.431	0.991	71.9

of the ring from its centre to the centre of the wire and r is the radius of the wire. V is the volume of liquid raised above the free surface at the time when the surface breaks. V can be obtained from the expression $V = M/(D - d)$ where M is the mass of liquid raised, D is its density and d is the density of air saturated with the liquid. With liquids in air $D \gg d$, so the latter term can be neglected. It can be seen that the uncorrected surface tension of liquids can be too high by as much as 7%.

The surface tension of a liquid is numerically the same as its surface free energy, but the two parameters have different dimensions. The usual SI units for surface tension are millinewtons per metre (mN m^{-1}) and those for surface energy are millijoules per square metre (mJ m^{-1}).

1.3.3.2. Measurement of Interfacial Tension between Two Liquids

The interfacial tension can be obtained by measuring the force needed to remove the ring from the interface between two immiscible liquids. Because the densities of the two liquids are not greatly different, a large volume of the lower liquid is raised above the interface and quite a deep layer of the upper liquid is needed to contain it; the Harkins–Jordan correction factor is now larger.

1.3.3.3. Measurement of Contact Angles

The measurement of contact angles is relatively straightforward, their interpretation is a much more difficult matter. Contact angles for liquids on flat solid surfaces (θ) can be measured by the following methods.

- (i) Directly by viewing through a microscope with a goniometer eyepiece.
- (ii) Measuring the height (h) and radius (r) of the base of a drop, using a microscope, or by projecting an image on a screen.

$$\text{Whence } \tan(\theta/2) = h/r \quad (9)$$

- (iii) Using the Wilhelmy method, where a plate of the test solid is suspended from a microbalance and partially immersed in the liquid. The force on the balance is given by Eq. (10).

$$\text{Force} = \text{Weight of plate} + X\gamma_L \cos\theta - \text{Buoyancy in liquid} \quad (10)$$

Here X is the length of the interface between the plate and the liquid and γ_L the surface tension of the liquid. A plot of force against immersion depth for a single cycle of immersion and removal, which permits the measurement of both advancing and receding contact angles is shown in Fig. 9. The method can be adapted to measure contact angles on fibres.

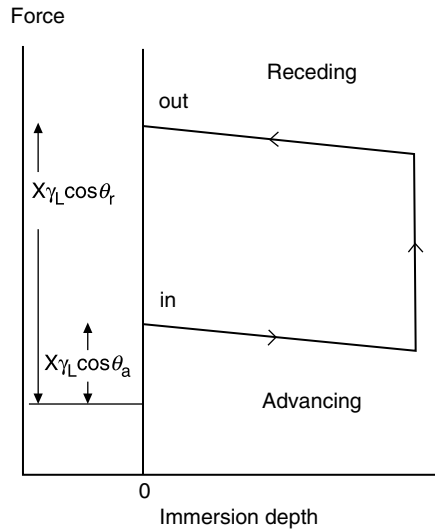

Figure 9: A graph of force against immersion depth for a solid plate in a liquid of surface tension γ_L . This is known as the Wilhelmy plate method.

- (iv) Using a modern instrument which takes a television image of the droplet, and digitally analyses this image to give the contact angle.

1.3.3.4. Contact Mechanics

The contact between rubber spheres can demonstrate the presence of forces of attraction across the interface. Eq. (11) is due to Hertz and it gives the diameter of the zone of contact d when two elastic spheres of diameter D are pressed together with a force F . Here E is Young's modulus of the material of the spheres and ν is Poisson's ratio.

$$d^3 = 3(1 - \nu^2)FD/E \quad (11)$$

Johnson, Kendall and Roberts [47] measured d for some natural rubber spheres and found deviations from the Hertz equation at low loads, but conformity at high loads. Data are shown in Fig. 10. At low loads the zones of contact were greater than predicted by Hertz. This was due to the forces of attraction between the surfaces of the two spheres, and it was shown that the diameter of the zone of contact was now given by Eq. (12), where W is the work of adhesion.

$$d^3 = 3(1 - \nu^2)D\{F + 3\pi WD/4 + [3\pi WDF/2 + (3\pi WD/4)^2]^{1/2}\}/E \quad (12)$$

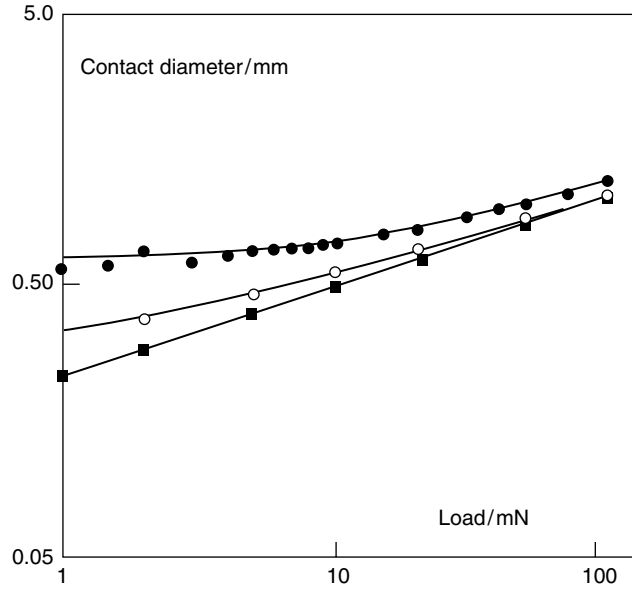

Figure 10: The diameter of the contact spot between two rubber spheres of 22 mm radius, ● as measured in air, ○ in water and ■ in a solution of sodium dodecyl sulfate [47].

At zero load the spot size is given by Eq. (13).

$$d_0^3 = 9\pi WD^2(1 - \nu^2)FD/2E \quad (13)$$

The use of Eq. (12) gave a value of $W = 71 \pm 4 \text{ mJ m}^{-2}$ for dry rubber (that is the surface free energy of the rubber is 35 mJ m^{-2}) and $6.8 \pm 0.4 \text{ mJ m}^{-2}$ in the presence of water. When immersed in a 0.01 M solution of the surfactant sodium dodecyl sulfate, the Hertz equation was obeyed, because the work of adhesion was now very low $< 1 \text{ mJ m}^{-2}$.

Eq. (12) has received much attention in the literature and is generally called the JKR equation.

Recently Rimai and Quesnel [48] measured forces needed to remove polystyrene particles, with radii in the range 1–6 μm , to polyethylene terephthalate. Forces were proportional to radius as required by the JKR theory, and work of adhesion was about 10 mJ m^{-2} . Forces were reduced when the polyester was coated with the release agents silicone, PTFE and zinc stearate, but still remained proportional to the radius.

Chaudury [49] used a plane on sphere configuration to measure the work of adhesion for polydimethylsiloxane coated with silane coupling agents with different

groups. For surfaces coated with methyl groups, the work of adhesion was 20.8 mJ m^{-2} , and this increased when polar groups were present; with $-\text{OCH}_3$ the value was 26.8 mJ m^{-2} and with $-\text{COOCH}_3$ it was 33.0 mJ m^{-2} .

Barquins and Charmet [50] applied the JKR theory to the bouncing of a steel ball on natural rubber, by measuring rebound heights. This permitted the evaluation of the work of adhesion for short contact times.

1.3.4. Interpretation of Contact Angles

1.3.4.1. Forces between a Solid Surface and a Liquid Drop

The forces acting at the periphery of a droplet making a contact angle θ with a solid surface are illustrated in Fig. 11, and are related by Young's equation (Eq. (14)).

$$\gamma_{\text{SV}} = \gamma_{\text{SL}} + \gamma_{\text{LV}} \cos \theta + \pi_e \quad (14)$$

Here γ_{LV} is the surface tension of the liquid in equilibrium with its vapour and γ_{SV} is that of the solid. π_e is the spreading pressure which is usually small and is neglected in the discussion which immediately follows.

1.3.4.2. Spreading Pressure

Adsorption of vapour on a solid surface will change the surface free energy of the solid. This will be greatest when the contact angle is low, i.e. when the liquid has a high affinity for the solid. The lowering of surface free energy is known as the spreading pressure, π_e , where

$$\pi_e = \gamma_{\text{S}} - \gamma_{\text{SV}} \quad (15)$$

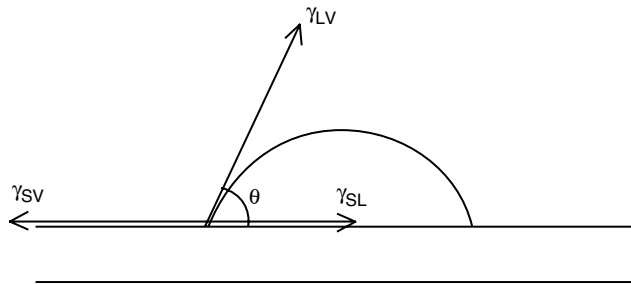

Figure 11: Forces acting at the periphery of a liquid drop on a solid surface.

Here γ_s is the surface free energy of the solid in vacuum and γ_{sv} is that when in equilibrium with the saturated vapour. π_e is usually negligible when $\theta > 10^\circ$. Spreading pressure can be obtained from the change in surface free energy accompanying adsorption. Some values are tabulated in Table 6.

Interfacial tension between two liquids. In Fig. 12 some molecules of liquid 1 are lying upon some molecules of liquid 2; both are non-polar so only dispersion forces will be acting across the interface. The force by which molecule A is attracted to its own kind is the surface tension of liquid 1 (γ_1), but what is the force which attracts it to liquid 2? Fowkes [52] considers that it is the *geometric mean* of the two surface tensions, and Wu [53] considers it to be the *harmonic mean*, i.e.

$$\text{Fowkes,} \quad \text{Interfacial attraction} = (\gamma_1\gamma_2)^{1/2} \quad (16)$$

$$\text{Wu,} \quad \frac{1}{\text{Interfacial attraction}} = 1/\gamma_1 + 1/\gamma_2 \quad (17)$$

$$\text{or} \quad \text{Interfacial attraction} = \gamma_1\gamma_2/(\gamma_1 + \gamma_2) \quad (18)$$

1.3.4.3. Geometric Mean

In the geometric mean case, the net force acting on the molecule of liquid 1 is $\gamma_1 - (\gamma_1\gamma_2)^{1/2}$ and by a similar argument the force acting on a molecule of liquid 2 at the interface is $\gamma_2 - (\gamma_1\gamma_2)^{1/2}$. Hence the total force across the interface (γ_{12}) is the sum of these, i.e.

$$\gamma_{12} = \gamma_1 + \gamma_2 - 2(\gamma_1\gamma_2)^{1/2} \quad (19)$$

Good *et al.* [54] gave a slightly different equation, i.e.

$$\gamma_{12} = \gamma_1 + \gamma_2 - 2\Phi(\gamma_1\gamma_2)^{1/2} \quad (20)$$

where Φ is an interaction parameter, which is approximately given by

$$\Phi = 4(V_1V_2)^{1/3} / (V_1^{1/3} + V_2^{1/3}) \quad (21)$$

where V_1 and V_2 are molar volumes. Φ is close to unity when the molar volumes are similar.

Table 6: Spreading pressures of liquids on polymer surfaces [51]

Liquid	Solid	t ($^{\circ}\text{C}$)	θ°	π_e (mJ m^{-2})
<i>n</i> -hexane	PTFE	25	12	3.28
<i>n</i> -octane	PTFE	25	26	4.9
water	PE	20	94	0
CH_2I_2	PE	20	52	0
hexadecane	PE	20	0	7.6
hexane	PE	20	0	14.5

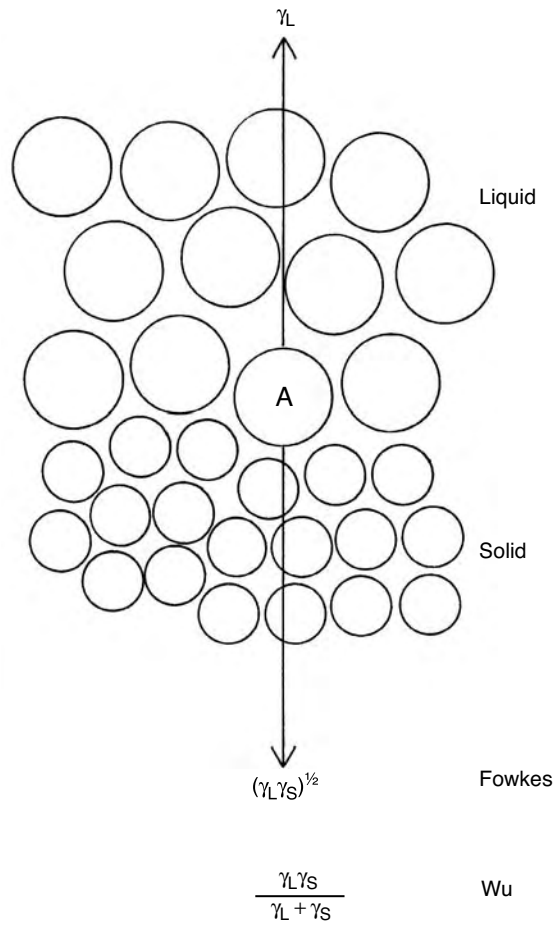

Figure 12: Forces acting on a molecule at a liquid–liquid interface.

If the liquids are polar, their surface energies are the sum of dispersion (d) and polar (p) components, i.e.

$$\gamma_1 = \gamma_1^d + \gamma_1^p \quad (22)$$

$$\gamma_2 = \gamma_2^d + \gamma_2^p \quad (23)$$

Fowkes [51] gives Eq. (24) for the interfacial free energy γ_{12} , it contains geometric mean terms for both the dispersion and polar interfacial attractions. This assumes that these can be treated independently, and that the polar-dispersion interactions can be neglected.

$$\gamma_{12} = \gamma_1 + \gamma_2 - 2(\gamma_1^d \gamma_2^d)^{1/2} - 2(\gamma_1^p \gamma_2^p)^{1/2} \quad (24)$$

Eq. (24) permits the evaluation of the polar component of the surface energy of water. The necessary measurements are the interfacial tension of n-hexadecane (liquid 1) on water (liquid 2) and the surface tensions of the two liquids. It is assumed that the polar component for the hydrocarbon is zero, and this causes the $2(\gamma_1^p \gamma_2^p)^{1/2}$ term to become zero and $\gamma_1 = \gamma_1^d$. The relationship now takes the form of Eq. (25), which permits the evaluation of γ_2^d .

$$\gamma_{12} = \gamma_1 + \gamma_2 - 2(\gamma_1 \gamma_2^d)^{1/2} \quad (25)$$

Interfacial tension between a liquid and a solid. Eq. (25) applies to the contact between a liquid and a solid. If the subscripts 1 and 2 are replaced by L and S for liquid and solid, and it is combined with Eq. (14) with the spreading pressure set at zero, then Eq. (26) is the outcome.

$$\gamma_{LV} (1 + \cos \theta)^{1/2} / 2(\gamma_L^d)^{1/2} = (\gamma_S^d)^{1/2} + (\gamma_S^p \gamma_L^p \gamma_L^d)^{1/2} \quad (26)$$

This means that if $\gamma_{LV} (1 + \cos \theta) / 2(\gamma_L^d)^{1/2}$ is plotted against $(\gamma_L^p / \gamma_L^d)^{1/2}$, the graph should be linear with an intercept $(\gamma_S^d)^{1/2}$ and a slope $(\gamma_S^p)^{1/2}$, so permitting the determination of the polar and dispersive components of the surface free energy of the solid. Such plots have been referred to as Owens–Wendt plots, examples are given in Figs. 13 and 14 [5]. Fig. 13 is for dried films of an emulsion adhesive based on a copolymer of vinyl acetate and butyl acrylate. Here $\gamma_S^d = 6.4 \pm 2.1 \text{ mJ m}^{-2}$ and $\gamma_S^p = 38.5 \pm 6.3 \text{ mJ m}^{-2}$. Fig. 14 is for the release agent zinc stearate which was pressed

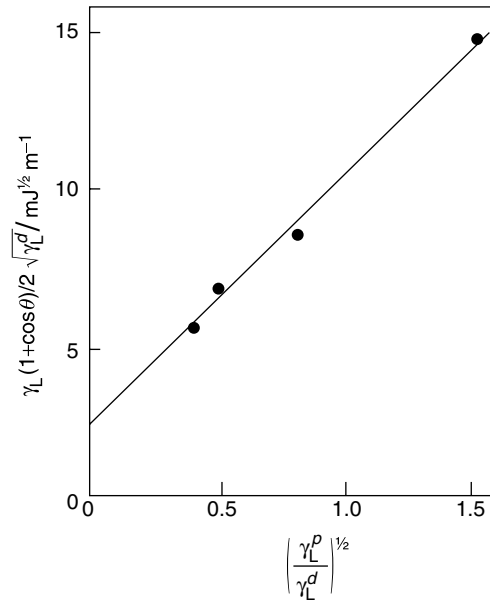

Figure 13: Plot based on Eq. (26) for liquids on a dried film from a latex adhesive. From left to right the liquids are dimethylformamide, dimethylsulfoxide, ethane diol and water [55].

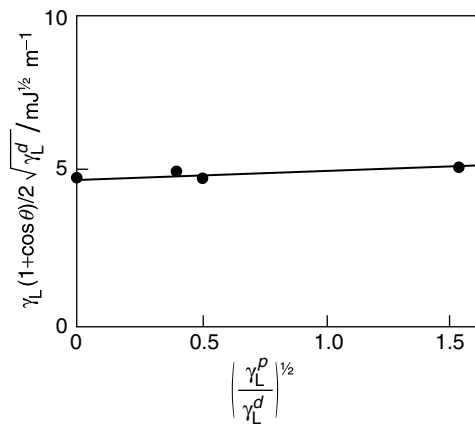

Figure 14: Plot based on Eq. (26) for liquids on zinc stearate. From left to right the liquids are *n*-hexadecane, dimethylformamide, dimethylsulfoxide and water [55].

into discs. Here $\gamma_s^d = 22.4 \pm 0.1 \text{ mJ m}^{-2}$ and $\gamma_s^p = 0.06 \pm 0.05 \text{ mJ m}^{-2}$, showing that it is the non-polar alkyl groups which dominate the surface, rather than the polar zinc carboxylate units.

1.3.4.4. Harmonic Mean

Wu [56] considers that harmonic means give more consistent results for interactions between low energy systems (such as liquids and adhesives on polymers), while geometric means are more appropriate for high energy systems (such as adhesives on metals). The harmonic equivalent of Eq. (26) is Eq. (27).

$$\gamma_{LV}(1 + \cos\theta) = 4\gamma_s^d\gamma_L^d / (\gamma_s^d + \gamma_L^d) + 4\gamma_s^p\gamma_L^p / (\gamma_s^p + \gamma_L^p) \quad (27)$$

Table 7 contains some values of the polar and dispersive components of surface free energy [57] for some polymers obtained using the geometric and harmonic mean methods. It can be seen that they are in good agreement.

Chin, McCullough and Wu [57] measured contact angles for water and diiodomethane on surfaces of silicon, silicon which had been fluorinated with $\text{Cl}_3\text{Si}(\text{CH}_2)_2(\text{CF}_2)_7\text{CF}_3$, and polydimethylsiloxane. Surface energy components were calculated using both geometric and harmonic means and these are shown in Table 8. There are many entries which are likely to be in agreement within the limits of experimental error.

The geometric mean approach has received more attention in the literature, and a reason for this is that Eq. (27) is more difficult to use than Eq. (26); the latter cannot be plotted in linear form. A non-graphical solution has been given by Wu [58].

1.3.4.5. Test Liquids

Table 9 contains a list of pure liquids for which the values of the polar and dispersive contributions to surface free energy have been quoted in the literature [52,59–61].

Table 7: Surface energies of polymers from harmonic and geometric mean calculations

Polymer	γ_s^d (mJ m ⁻²)		γ_s^p (mJ m ⁻²)	
	Harmonic	Geometric	Harmonic	Geometric
Polystyrene	26.7	26.3	5.4	5.8
Polyvinylacetate	9.4	10.2	19.2	18.4
Polymethylmethacrylate	9.0	9.3	22.7	23.0
Polydimethylsiloxane	12.1	13.5	2.0	0.6

Table 8: Surface energy components (mJ m^{-2}) of surfaces obtained using geometric and harmonic mean calculations

Surface	Geometric mean			Harmonic mean		
	γ_s^d	γ_s^p	γ_s	γ_s^d	γ_s^p	γ_s
Silicon	33.5	20	53.5	29.4	23.4	52.8
Fluorinated silicon	5.3	5.2	10.5	6.0	10.6	16.6
Silicone	7.2	14.4	21.6	8.1	16.2	24.3

The list is not a large one; there are not many liquids available for the characterisation of surfaces in this way.

The liquids in Table 9 are arranged in order of $(\gamma_L^p/\gamma_L^d)^{1/2}$ as this is the abscissa of the Owens–Wendt plot.

One liquid for which the value of γ_L^d seems suspect is 1-bromonaphthalene. It contains a polar carbon–bromine bond. I have not been able to find the dipole moment of 1-bromonaphthalene, but the values for bromobenzene, chlorobenzene and fluorobenzene which are chemically similar to 1-bromonaphthalene are 1.70 D, 1.69 D and 1.60 D, respectively. These molecules are almost as polar as chloromethane (1.97 D) and bromomethane (1.81 D), where the polarity of the

Table 9: Test liquids

Liquid	γ_L^d (mJ m^{-2})	γ_L^p (mJ m^{-2})	γ_L (mJ m^{-2})	$(\gamma_L^p/\gamma_L^d)^{1/2}$
Water	21.8 ± 0.7	51.0	72.8	1.529 ± 0.035
Glycerol	37.0 ± 4	26.4	63.4	0.845 ± 0.11
Ethane diol	29.3	19.0	48.3	0.805 ± 0.14
Formamide	39.5 ± 7	18.7	58.2	0.688 ± 0.19
Ethanol	17.0	5.4	22.4	0.563
Dimethylsulfoxide	34.86	8.68	43.54	0.499
2-Ethoxyethanol	23.6	5.0	28.6	0.460
Dimethylformamide	32.42	4.88	37.30	0.388
Dimethylsiloxanes	16.9 ± 0.5	2.1	19.0	0.352
Methylene diiodide	48.5 ± 9	2.3	50.8	0.218 ± 0.446
	50.76		50.76	0.0
Tricresyl phosphate	39.2 ± 4	1.7	40.9	0.208
Trichlorobiphenyl	44 ± 6	1.3	45.3	0.172
Pyridine	37.16	0.84	38.00	0.150
<i>n</i> -Hexadecane	27.6		27.6	0.0
1-Bromonaphthalene	47 ± 7	-2.4	44.6	$0.226i \pm 0.14$

carbon–halogen bond has a profound effect on the forces on attraction between these molecules, increasing their boiling points from that of methane (-164°C) to -24.2°C (chloromethane) or 3.6°C (bromomethane).

A further problem with 1-bromonaphthalene is that the mean value of γ_L^d is greater than γ_L which is absurd. It means that the value of $(\gamma_L^p / \gamma_L^d)^{1/2}$ is a complex number!

1.3.4.6. Critical Surface Tension

Fox and Zisman [62,63] characterised some polymer surfaces by measuring the contact angles for a series of liquids, and plotting the data in the form of $\cos \theta$ against the surface tension of the liquids. When $\theta = 0$ ($\cos \theta = 1$), the liquid spreads on the surface and the surface tension of the liquid is then equal to the *critical surface tension* γ_c of the polymer. A plot is shown in Fig. 15 for liquids on some fluorinated copolymers; the values of γ_c are obtained from the intercept with the upper abscissa. The values of critical surface tension for some polymers are given in Table 10.

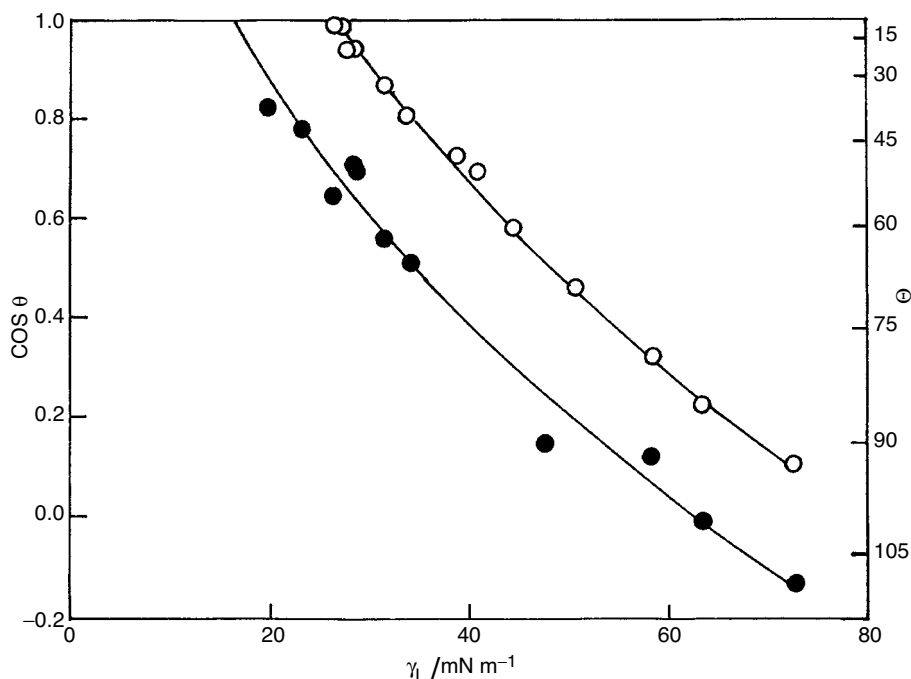

Figure 15: Fox–Zisman plot for some liquids on fluorinated polymers. ○ 50:50 tetrafluoroethylene-ethylene copolymer, ● PTFE (after Ref. [62]).

Table 10: Critical surface tensions of some polymers [64]

Polymer	γ_c (mN m ⁻¹)
Polytetrafluoroethylene	18.5
Polydimethylsiloxane	24
Polyethylene	31
Polystyrene	33
Polymethylmethacrylate	39
Amine-cured epoxide	44
Urea-formaldehyde	61

Critical surface tension is related to surface tension by Eq. (28).

$$\gamma_c = \gamma_{SV} - \gamma_{SL} = \gamma_S - \gamma_{SL} - \pi_e \quad (28)$$

i.e. γ_c is equal to or less than the true surface tension.

Generally speaking, the strength of an adhesive bond to a polymer surface will increase with its surface tension. This has been demonstrated by Levine *et al.* [65] for a number of polymers bonded with an epoxide adhesive.

De Bruyne recognised in 1957 [66] that there is a relationship between the contact angles and the strength of adhesive bonds. It is illustrated in Fig. 16 for the strengths of lap-joints in polyethylene bonded with the epoxide adhesive 'Araldite'. The polyethylene was etched for various times in chromic acid. It can be seen that the strongest adhesive bonds are obtained when contact angles for water are low.

1.3.4.7. Lewis Acid–Base Attractions

van Oss, Good and Chaudury [67] used the concept that Lewis acid–base attractions may contribute to interfacial forces, proposing Eq. (29) to relate contact angle to the numerous surface energy parameters.

$$\gamma_{12}(1 + \cos\theta) = 2[(\gamma_1^d \gamma_2^d)^{1/2} + (\gamma_1^+ \gamma_2^-)^{1/2} + (\gamma_1^- \gamma_2^+)^{1/2}] \quad (29)$$

Here γ_1^+ and γ_2^+ are the acid components of the surface free energy for phases 1 and 2, and γ_1^- and γ_2^- are the basic components. This equation is similar to that of Owens and Wendt in that it contains geometric mean terms, but effectively the polar contribution to van der Waals forces have been replaced by two

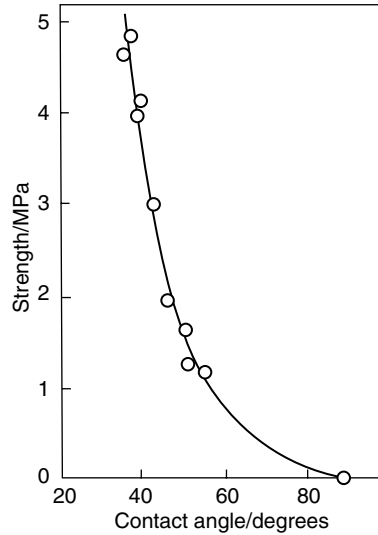

Figure 16: Dependence of strength of some lap joints in polyethylene, with the contact angle of water against the samples (after Ref. [66]).

acid–base terms. There are now six surface energy parameters instead of four, which makes calculation more difficult [68].

Some values of the parameters are given in Table 11, and here an underlying assumption is that for water, which is a neutral liquid $\gamma_1^+ = \gamma_1^- = 1/2 \gamma_L^p = 25.5 \text{ mJ m}^{-2}$.

1.3.4.8. Contact Angle Hysteresis

So far in this consideration of contact angles and the information which can be obtained from them, only equilibrium contact angles have been considered. In some circumstances different values will be observed if the droplet is grown or shrunk. The phenomenon is known as contact angle hysteresis and the corresponding angles are termed advancing and receding. Good *et al.* [69] take the view that advancing angles are more relevant to the process of forming an adhesive bond, and receding angles to their separation.

It is possible that contact angle hysteresis is due to surface roughness, or chemical heterogeneity of the surface such as might be the case with a block copolymer where the phases separate [58,70]. Alternatively, the structure of the surface may change during the time of contact. The additional causes of surface contamination, reorientation and mobility of surface segments, swelling and deformation were noted by Kasemura *et al.* [71]. They used the Wilhelmy plate method to obtain advancing and receding contact angles of water on PDMS, and polyethylene

Table 11: Dispersion and Lewis acid–base parameters for some test liquids (mJ m^{-2})

Liquid	γ_L	γ_L^d	γ_1^+	γ_1^-
Water	72.8	21.8	25.5	25.5
Glycerol	64	43	3.92	57.4
Formamide	58	39	2.28	39.6
Dimethylsulfoxide	44	36	0.5	32
Ethane diol	48	29	1.92	47
Diiodomethane	50.8	50.8	0	0

glycol with methoxy end groups, and showed that the most important factor was movements of chemical groups at the surface. Evidence was provided by XPS which showed changes in the Si:C ratio in PDMS, and increased the oxygen content at the surface of the polyethylene glycol after immersion.

Varenes and Schreiber [72] examined how contact angles change with contact time for a number of liquids (tetrahydrofuran, dichloromethane, acetone and ethyl acetate) on polystyrene, polymethylmethacrylate, a copolymer of styrene and 4-vinylpyridine, and one of styrene and methacrylic acid. Changes took place in all cases except with polystyrene. The total change was strongly dependent on acid–base contributions to the free energy of adsorption of the liquids, and the possibility was recognised of polymer surfaces becoming reorganised in contact with polar liquids. An example was that with dichloromethane on polymethylmethacrylate, the surface energy of the polymer fell from 51 to about 40 mJ m^{-2} in 20 min, and then remained static. The polar component rose from 2.9 to 4.0 mJ m^{-2} in the 20 min. All this was ascribed to the movement of methacrylate groups at the surface. No such changes take place with polystyrene.

1.3.4.9. Surface Energies of Solids

Table 12 gives surface energies for a number of materials. The plastics which are difficult to bond all have low surface energies, and can only be adequately bonded after surface treatment. Clean surfaces of the other polymers are all readily bonded. Metal oxides all have very high surface energies.

Polymers containing fluorine and silicone are prominent amongst non-stick materials, two well known examples being the use of PTFE in non-stick kitchen utensils and backing papers for sticky labels which are impregnated with PDMS.

Silicon oxygen chains have long bonds and relatively flat valence angles. The C–F bond is quite polar and, in fact, some fluoropolymers do not have low surface energies. However dipoles are vectors, and in the case of PTFE, their mutual opposition means that the molecules as a whole are non-polar.

Table 12: Surface energy parameters of solid surfaces

Solid	γ_S^d (mJ m ⁻²)	γ_S^p (mJ m ⁻²)	γ_S (mJ m ⁻²)
Plastics difficult to bond			
Polytetrafluoroethylene	18.6	0.5	19.1
Polypropylene	30.2	0.0	30.2
Polyethylene	33.2	0.0	33.2
Bondable plastics			
Polymethylmethacrylate	35.9	4.3	40.2
Nylon 66	35.9	4.3	40.2
Polyvinyl chloride	40.0	1.5	41.5
Polystyrene	41.4	0.6	42.0
Rubber modified epoxide	37.2	8.3	45.5
Amine cured epoxide	41.2	5.0	46.2
Oxides			
SiO ₂	78	209	287
Al ₂ O ₃	100	538	638
Fe ₂ O ₃	107	1250	1357

These non-stick materials can be bonded after surface treatment, which have the effect of introducing polar chemical groups to the surfaces. Methods for polyolefins include flame, corona discharge and chemical etching. Solutions of sodium naphthalenide in THF and sodium in liquid ammonia are used for PTFE.

1.3.5. Thermodynamic Work of Adhesion

The thermodynamic work of adhesion, that is the work required to separate unit area of two phases in contact, is related to surface free energies by the Dupré equation. It is the minimum work needed to separate the phases, and energies needed to break adhesive bonds often exceed this by a significant amount, because of work done in deforming the adhesive layer or the adherends. An example where much work is done on stretching the adhesive is a pressure sensitive adhesive which forms filaments before the adhesive detaches.

If the phases are separated in dry air, work of adhesion W_A is given by Eq. (30).

$$W_A = \gamma_A + \gamma_S - \gamma_{AS} \quad (30)$$

But if separation is in the presence of water, it is given by Eq. (31).

$$W_{A,W} = \gamma_{AW} + \gamma_{SW} - \gamma_{AS} \quad (31)$$

Here the subscripts A, S and W denote adhesive, substrate and water. The separation processes are illustrated in Fig. 17.

1.3.5.1. Calculations Based on the Geometric Mean

Eq. (24) can be used to write expressions for the interfacial free energies, and on substituting these into Eqs (30) and (31), Eqs (32) and (33) are obtained.

$$W_A = 2[(\gamma_S^d \gamma_A^d)^{1/2} + (\gamma_S^p \gamma_A^p)^{1/2}] \quad (32)$$

$$W_{A,W} = 2[\gamma_W - (\gamma_A^d \gamma_W^d)^{1/2} - (\gamma_A^p \gamma_W^p)^{1/2} - (\gamma_S^d \gamma_W^d)^{1/2} - (\gamma_S^p \gamma_W^p)^{1/2} - (\gamma_A^d \gamma_S^d)^{1/2} + (\gamma_A^p \gamma_S^p)^{1/2}] \quad (33)$$

If the thermodynamic work of adhesion is positive then the bond is stable, and conversely a negative value indicates instability. The parameter which has created most interest in the literature is the work of adhesion in the presence of water, as this can be used to predict joint durability.

Kinloch, Dukes and Gledhill [73] describe the use of an epoxide adhesive to bond glass to glass in the Churchill Memorial Screen at Dudley, informing us that ‘Within a few months of completion and erection in the open, pieces of glass began to fall off, confirming the thermodynamic prediction of inherent instability’.

Kinloch [74] has given a table (shown below with slight modifications as Table 13) in which the work of adhesion in air and in some liquids are compared with their tendency to debond interfacially in an unstressed condition. The fact that interfacial debonding only occurs when the thermodynamic work of adhesion is negative is a very strong evidence of the validity of thermodynamics in predicting the durability of adhesive bonds.

The data in Table 13 for the vinylidene chloride–methyl acrylate copolymer bonded to polypropylene is quoted from a paper by Owens [75]. Owens coated a polypropylene sheet with an aqueous dispersion containing 80 parts vinylidene chloride, 20 parts methyl acrylate and 4 parts acrylic acid. The dispersion was surfactant free and the polypropylene surface had been flame treated. The resulting laminates were placed in some surfactant solutions, and to quote Owens ‘In every case where $W_{A,L}$ upon immersion in the liquid is negative, the coating

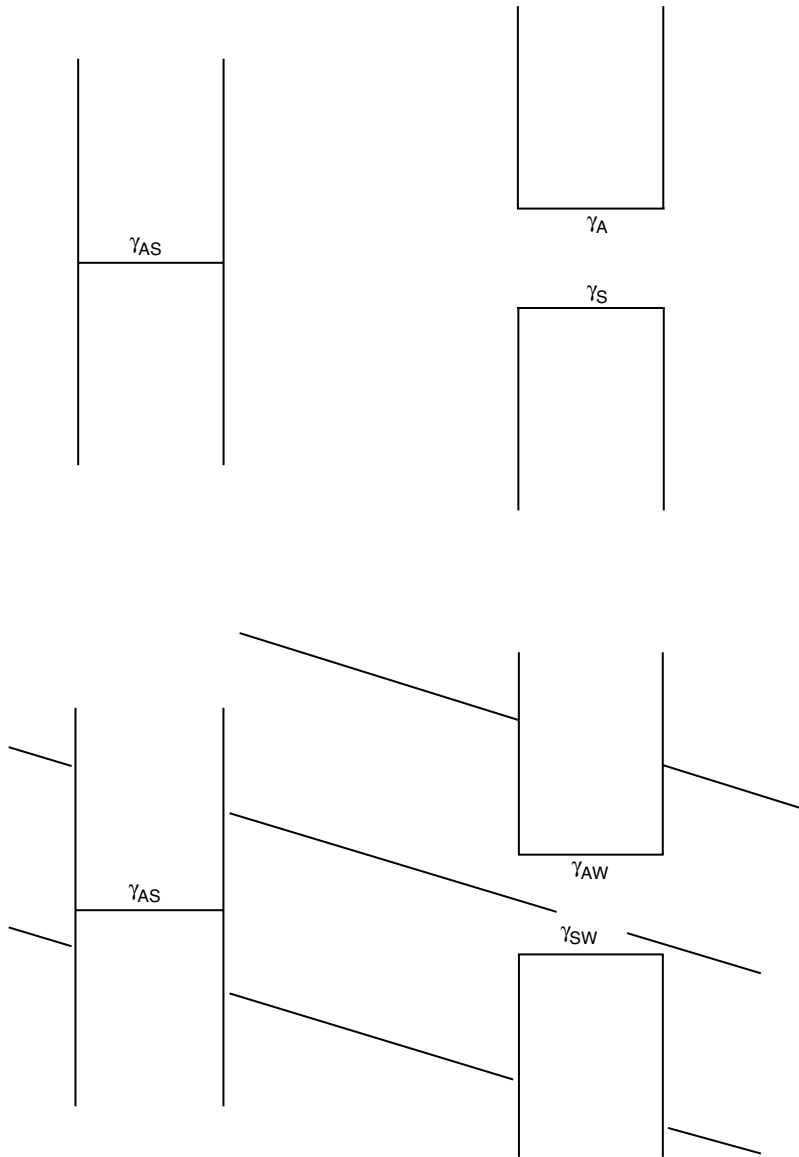

Figure 17: Separation of an adhesive from a substrate in dry air (top), and in water (bottom).

Table 13: Work of adhesion for interfaces in air and in liquids

Interface	Work of adhesion (mJ m ⁻²)		Interfacial debonding in liquid
	Air	Liquid	
Epoxy/steel	291	22 ethanol	No
		-166 formamide	Yes
		-255 water	Yes
Epoxy/aluminium	232	-137 water	Yes
Epoxy/silica	178	-57 water	Yes
Epoxy/carbon fibre composite	88-90	22-40 water	No
Vinylidene chloride- methyl acrylate copolymer	88	37 water	No
		1.4 Na <i>n</i> -octylsulfate solution	No
		-0.9 Na <i>n</i> -dodecylsulfate solution	Yes
		-0.8 Na <i>n</i> -hexadecylsulfate solution	Yes

spontaneously separated from the substrate, becoming completely detached. Where $W_{A,L}$ was positive, spontaneous separation did not occur. Where separation occurred between coating and substrate, it did so within 15 min. The films that did not show separation were left immersed for six months. At the end of this time, they still were not separated, and some effort was required to remove the coatings from the films'.

It was Orman and Kerr [77] who demonstrated that whilst ethanol swells and reduces the tensile strength of an epoxide adhesive based on the diglycidyl ether of bisphenol-A and 4,4'-diaminodiphenylmethane, it has little effect on the strength of aluminium joints bonded with the same adhesive. In contrast, water has minimal effect on the tensile strength of the adhesive, but causes large weakening of aluminium joints. The underlying reason for this is the high value of γ_L^p for water and low value for ethanol; both liquids have similar values of γ_L^d .

In contrast, it was found that in bonding a polyurethane to float glass [39], that work of adhesion was not an accurate predictor of joint strength, but there was a linear relationship between strength and the polar component of surface energy.

According to the van Oss, Good and Chaudury approach, the work of adhesion is given by Eq. (35).

$$W_A = 2[(\gamma_1^d \gamma_2^d)^{1/2} + (\gamma_1^+ \gamma_2^-)^{1/2} + (\gamma_1^- \gamma_2^+)^{1/2}] \quad (35)$$

Latex (emulsion) adhesives. In contact with water, adhesive bonds with latex adhesives may release surfactants, which will have the effect of lowering surface tension and changing the thermodynamic work of adhesion. Some latices based on copolymers of vinyl acetate were dried to give films which were then immersed in small quantities of water. The surface tensions (γ_w) fell from 72.8 mN m^{-1} to values in the range $39\text{--}53 \text{ mN m}^{-1}$ in the first hour and then remained fairly static [76]. Measurements of interfacial tensions against *n*-hexadecane showed the dispersion components of surface tension remained essentially constant but polar components were reduced into the range $6\text{--}20 \text{ mN m}^{-1}$.

If it is assumed that any lowering of γ_w will be in the polar component, then $W_{A,L}$ is given by Eq. (36).

$$W_{A,L} = W_A + 2\{\gamma_w - (\gamma_s^d \gamma_w^d)^{1/2} - (\gamma_s^p [\gamma_w - \gamma_w^d])^{1/2} - (\gamma_A^d \gamma_w^d)^{1/2} - (\gamma_A^p [\gamma_w - \gamma_w^d])^{1/2}\} \quad (36)$$

Here the subscripts W, S and A respectively indicate water, substrate and adhesive.

Calculated values of $W_{A,L}$ are plotted against γ_w in Fig. 18. Here the substrate was expanded polystyrene ($\gamma_s^d = 25.5 \text{ mJ m}^{-2}$ and $\gamma_s^p = 0.4 \text{ mJ m}^{-2}$) and 21.8 mJ m^{-2} is the value for γ_w^d . All the interfaces are most stable in pure water but W_w falls to a minimum as γ_w is lowered. These adhesive bonds are thus predicted to be stable as long as γ_w exceeds a critical value at which $W_{A,L} = 0$.

Adhesive bonds to latex adhesives can thus be self-destructive in water, and this is much the case with adhesive e in Fig. 18, which is always unstable in water. The thermodynamic prediction was confirmed by experiments in which bonds with this adhesive rapidly disintegrated in water.

1.3.5.2. Calculations Based on the Harmonic Mean

Using Wu's harmonic mean the work of adhesion is given by Eq. (37).

$$W_A = 4[(\gamma_1^d \gamma_2^d)/(\gamma_1^d + \gamma_2^d) + (\gamma_1^p \gamma_2^p)/(\gamma_1^p + \gamma_2^p)] \quad (37)$$

It has been noted earlier that Chin, McCullough and Wu [57] measured contact angles for water and diiodomethane on surfaces of silicon, silicon which had been fluorinated with $\text{Cl}_3\text{Si}(\text{CH}_2)_2(\text{CF}_2)_7\text{CF}_3$, and polydimethylsiloxane, and calculated surface energy components using both geometric and harmonic means. They also calculated work of adhesion by both methods, and also measured it directly using

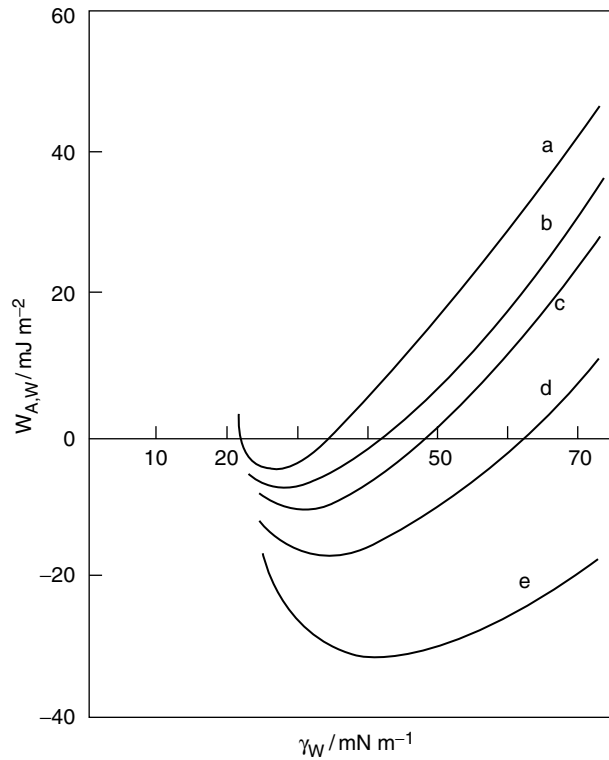

Figure 18: Dependence of work of adhesion upon the surface tension of the aqueous phase, for a range of latex adhesives bonded to expanded polystyrene [76].

the JKR method. Results from the three methods are collected in Table 14, which is not without some agreement.

1.3.6. Practical Applications of Wetting

The relationship between work of adhesion and practical adhesion has been reviewed by Packham [78].

Whereas actual measurements of contact angles are usually made in science laboratories, the principles are exploited in the water-break test and in the use of liquids of different surface tensions to assess the printability of polyolefins.

The water-break test is a simple method to check that a metal surface is clean. A few drops of distilled water are placed on the surface, or alternatively the sample can be drawn from a bath of water. If the water does not break into droplets then

Table 14: Thermodynamic work of adhesion (mJ m^{-2}) obtained by different methods

Interface	JKR	Geometric mean	Harmonic mean
Silicone–silicone	39.9 ± 2.1	43.2	48.6
Silicone–fluorinated silicone	29.8 ± 0.6	40.2	39.5
Silicone–silicon	58.1 ± 0.5	69.0	83.9

the surface is free from contamination. Uniform wetting of the metal by water indicates that it will be similarly wetted by the adhesive.

A standard test (ASTM 1982) involves wiping a polyolefin surface with a series of liquids, starting with one of low surface tension and noting the time needed for the film to break into droplets. Liquids with increasing surface tension are used until one is found which will wet the surface for just 2 s. The surface tension of the plastic then equals that of the liquid. Twenty-two mixtures of formamide and 2-ethoxyethanol are used with surface tensions in the range $30\text{--}56 \text{ mN m}^{-1}$.

Wetting is not a reciprocal property [79] in that if A spreads on B, B does not necessarily spread on A. An example of this is that a liquid epoxide resin will not spread on polyethylene, but if the resin is cured it will then be wetted by molten polyethylene. Surface tensions of epoxides are about 44 mN m^{-1} and that of polyethylene is about 30 mN m^{-1} . A solid can force liquids of lower, but not higher surface tension to wet it.

1.4. The Electrostatic Theory of Adhesion

The electrostatic theory originated in the proposal that if two metals are placed in contact, electrons will be transferred from one to the other so forming an electrical double layer, which gives a force of attraction. As polymers are insulators, it seems difficult to apply this theory to adhesives.

However Randow *et al.* [80] investigated the adhesion of some commercial ‘cling films’, as used in food packing, to glass, steel and polyolefin substrates. The cling films were made of plasticised PVC, low density polyethylene or plasticised polyvinylidene chloride. Surface smoothness was the factor which most increased adhesion by increasing the area of contact, but otherwise adhesion depended on physical adsorption and static electrification. Measurements which supported this were of contact angles with water, formamide and 1-bromonaphthalene, and of residual electric charge on both films and substrates after separation. All films showed sparking when repeatedly applied to glass and noises were produced on an AM radio during peeling.

1.5. Mechanical Interlocking

If a substrate has an irregular surface, then the adhesive may enter the irregularities prior to hardening. This simple idea gives the mechanical interlocking theory, which contributes to adhesive bonds with porous materials such as wood and textiles. An example is the use of iron-on patches for clothing. The patches contain a hot melt adhesive which, when molten, invades the textile material.

Mechanical interlocking to wood (oak) of a thermoplastic adhesive based on polypropylene has been demonstrated by scanning electron microscopy [81]. The adhesive conformed to features on the wood as small as $1\ \mu\text{m}$, and penetrated pore openings $15\ \mu\text{m}$ across to depths greater than $150\ \mu\text{m}$. Larger pores were penetrated to depths of hundreds of micrometres. The extent of interlocking was dependent on the porosity of wood, the viscosity of the molten adhesive, and the pressure and duration of bonding.

A related issue is whether roughening a surface increases the strength of an adhesive joint. Harris and Beevers [82] found no difference in adhesion to mild steel and aluminium alloy blasted with alumina grits of different particle sizes. Shahid and Hashim [83] used a structural epoxide adhesive with mild steel adherends in cleavage joints. The surfaces had been grit-blasted or diamond-polished, and surface profiled. The results are shown in Table 15, where all differences in strength seem to be the same, within experimental scatter.

1.6. Adhesion by Interdiffusion

The diffusion theory takes the view that polymers in contact may interdiffuse, so that the initial boundary is eventually removed. Such interdiffusion will occur only if the polymer chains are mobile (i.e. the temperature must be above the glass transition temperatures) and compatible. As most polymers, including those with very similar chemical structures such as polyethylene and polypropylene are incompatible, the theory is generally only applicable in bonding like linear

Table 15: Effect of surface roughness on joint strength

Average roughness (R_a) (μm)	Cleavage strength (Nm^{-2})	Coefficient of variation
0.04 ± 0.02	15.8	2.9
0.98 ± 0.05	18.3	1.3
2.97 ± 0.18	17.5	1.9
4.23 ± 0.25	17.0	3.2
6.31 ± 0.28	16.4	4.0

rubbery polymers (autohesion), and in the solvent-welding of thermoplastics. Voyutskii was an originator of the diffusion theory [84].

The free energy of mixing ΔG_m is related to the enthalpy ΔH_m and entropy ΔS_m of mixing by the Gibbs equation (38), where T is the absolute temperature.

$$\Delta G_m = \Delta H_m - T\Delta S_m \quad (38)$$

For two substances to mix ΔG_m must be negative, and in the general case of polymers ΔH_m is slightly positive, but the entropy of mixing is not sufficiently large to make ΔG_m positive. The basic cause is that mixing large molecules creates less disorder than mixing the same volume of small molecules. Nevertheless, there are a small number of polymer pairs made compatible by specific interactions. One pair is polymethylmethacrylate and polyvinylchloride, where hydrogen bonding leads to a negative heat of mixing.

Diffusion at the interface between PVC and poly- ϵ -caprolactone has been demonstrated using energy dispersive X-ray analysis (EDX) [85,86]. These polymers are compatible in the melt at all ratios, but phase separation takes place on cooling. The technique permits the measurement of the concentration–distance curve for PVC in the interfacial region. The results of work at 70°C gave a diffusion coefficient of $1.59 \times 10^{-16} \text{ m}^2 \text{ s}^{-1}$.

Voyutskii [87] has shown some electron micrographs of the interfaces of polymethylacrylate-PVC and polybutylmethacrylate-PVC prepared at 210–220°C. Mixing at the interface was much greater with the first pair.

Solubility parameter is a simple, but not particularly reliable, guide to the possibility of mixing. Forbes and McLeod [88] measured tack between three different rubbers taken in pairs. Tack between a pair of polymers was less than the average tack between identical rubbers, but the difference was less as the difference in the solubility parameters of the polymers making the bond smaller. As the optimum condition for mixing is when the solubility parameters are equal, this indicates that maximum adhesion occurs when mixing is greatest.

Skewis [89] measured the tack of rubber to rubber and rubber to glass as a function of contact time and results are shown in Fig. 19. The two factors which might contribute to tack in this case are the development of intimate contact by viscous flow of the polymer, and diffusion of polymer segments across the interface. Diffusion will not occur between polymer and glass, and the low levels of tack which develop between styrene-butadiene rubber and butyl rubber indicate low levels of diffusion. Higher levels of autohesion develop with the like polymer pairs and this was attributed to diffusion across the interface. As both viscous flow and diffusion are controlled by the same friction constant, factors which change D

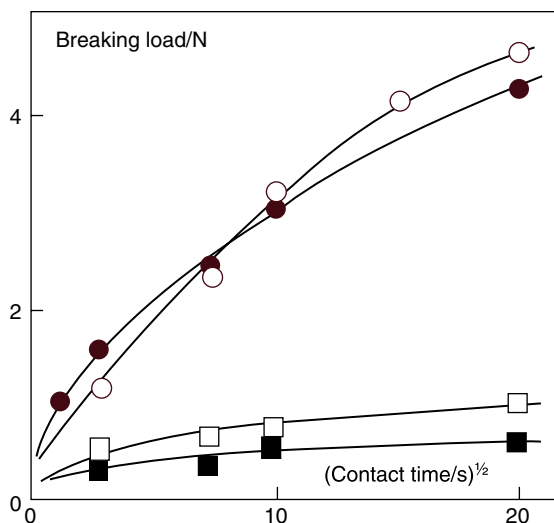

Figure 19: Adhesion as a function of contact time for styrene-butadiene and butyl rubbers. ○ SBR/SBR, ● butyl/butyl, □ SBR/butyl, ■ SBR/glass [89].

will change the viscosity in a similar manner, so making it difficult to distinguish between the effects of the two parameters.

The development of interfacial contact is the mechanism proposed for autohesion in a series of papers by Anand and his collaborators [90–94] and a summary of Anand’s objections to Voyutskii’s diffusion theory has also been published [95]. Anand makes the significant point that the instantaneous autohesive strength exceeds zero.

Voyutskii [96] examined the autohesion of polyisobutene of molar mass 150,000 pressed together for 5 min at various temperatures with a pressure of 40 g cm^{-2} . Peel strengths closely fitted an Arrhenius plot with an activation energy of autohesion of 11.7 kJ mol^{-1} , which Voyutskii claims to be ‘characteristic of the activation energy of diffusion processes’, a point of view which is not easy to substantiate. Using low molar mass polyisobutene McCall *et al.* [97] gave the much higher value for the activation energy of self-diffusion of 23 kJ mol^{-1} .

Schreiber and Ouhlal [98] annealed a number of polymer pairs in contact for up to 72 h at $60\text{--}160^\circ\text{C}$ and found substantial increases in adhesive strength for polypropylene/linear low density polyethylene and polystyrene/PVC, but not with polystyrene/PMMA and PVC/polyvinylidene chloride. With the two polyolefins in contact only dispersion forces are available, and only in the case of polystyrene/PVC are there favourable acid–base attractions. The data ‘point to significant contributions to bond

strength arising from diffusion when dispersion forces and favourable acid–base interactions act at the interface'. After an induction period, plots of strength against the square root of time are linear as shown in Fig. 20, which suggests a diffusion process. The explanation offered for the induction periods was that low molar mass polymer was removed first. In the case of polypropylene/linear low density polyethylene, the data give an activation energy of 23 kJ mol^{-1} , which is stated to be consistent with diffusion processes in polyolefins.

Two polymers that can be self-joined by swelling with solvent and then pressing together are polystyrene and polycarbonate. In this procedure, the solvent has the effect of depressing the glass transition temperature below the working temperature, so that when adherends are pressed together there is an adequate level of molecular motion for interdiffusion. After bonding, the solvent diffuses from the joint and evaporates. Titow *et al.* [99] have examined the strength and structure of joints in polycarbonate welded with either 1,2-dichloroethane or dichloromethane. The original interface is completely removed and there is no evidence of a residual parting plane. More recently, the solvent welding of polycarbonate has been studied by Change and Lee [100].

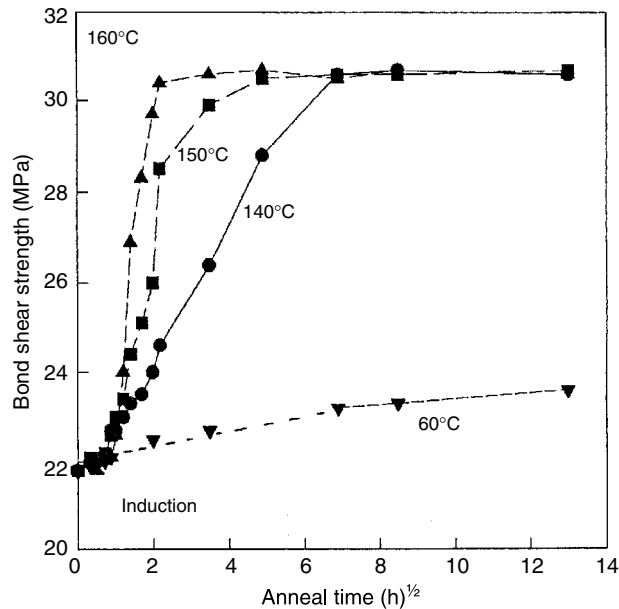

Figure 20: Strengths of lap joints of polystyrene pressed against PVC, as a function of heating time and temperature [98].

1.7. Weak Boundary Layers

The weak boundary layer theory proposes that clean surfaces can give strong bonds to adhesives, but some contaminants such as rust and oils or greases give a layer which is cohesively weak. Not all contaminants will form weak boundary layers, as in some circumstances they will be dissolved by the adhesive. However, in some cases, contaminants such as oils and greases can actually be removed by the adhesive dissolving them [101].

This is an area where acrylic structural adhesives are superior to epoxides because of their ability to dissolve oils and greases.

1.8. Pressure Sensitive Adhesion

Pressure sensitive adhesives are an exception to what was stated in the very first paragraph of this article, in that they do not harden to a cohesively strong solid. They are in fact viscous liquids, and remain so when incorporated in an adhesive joint. Nevertheless, it is essential that they adhere to substrates, and they will do so by one or more of the mechanisms which have been already described. Physical adsorption will contribute in every case, and in most cases it may be the only mechanism, but chemical bonding via ion-pairs may contribute if the adhesive contains carboxylic acid groups and the substrate is a metal. Static electrification is another possible contributor.

Zosel [102] considers that the work of separation in tack w is given by Eq. (39), where W_A is the thermodynamic work of adhesion and ϕ is the viscoelastic factor, is a function of temperature and rate. W_A is a property of the interface and ϕ of the adhesive.

$$w = W_A (\phi + 1) \quad (39)$$

Fig. 21 shows a number of stress–strain plots for the debonding of polybutylacrylate from some cylindrical steel probe tips with average roughnesses of 0.02 μm and 2 μm ; the area under these curves is w . It illustrates two points. The first is that the peaks at low strain are due to clean detachment of the adhesive from the probe, and the elongated shoulders at higher strain are due to the formation and stretching of fibrils in the adhesive.

The second point is that after a contact time of 1 s, stronger joints are formed with the smooth probes. This is because the viscous adhesive has not had sufficient time to make contact with the rougher surface, so W_A has not been maximised. Fig. 22 shows the effect of increasing the contact time. W_A is the

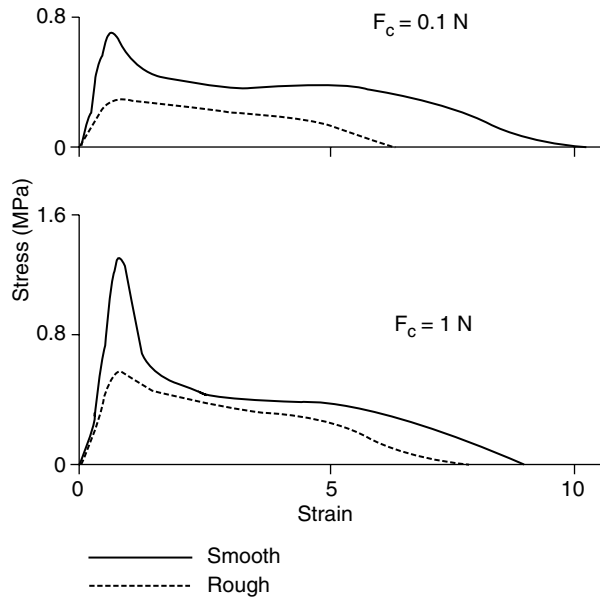

Figure 21: Stress–strain plots for the removal of steel probes from polybutylacrylate, after a contact time of 1 s [102].

driving force for pressure-sensitive adhesion, but this is opposed by the viscosity of the adhesive.

Toyama *et al.* [103] measured the tack and peel forces needed to remove plastic surfaces from three pressure-sensitive adhesives. The plastic surfaces were, in the order of increasing critical surface tension, PTFE, high density polyethylene,

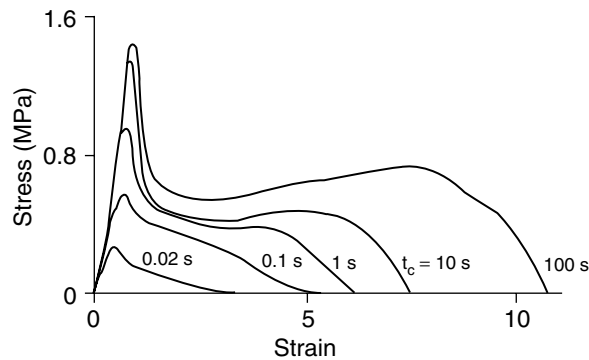

Figure 22: Stress–strain plots for the removal of a steel probe from polybutylacrylate, after various contact times t_c . The contact force was 0.3 N [102].

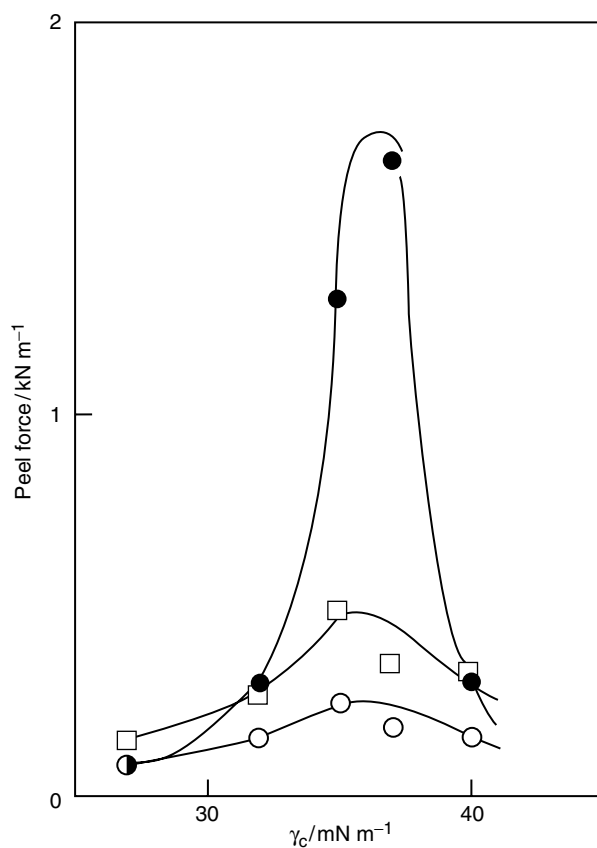

Figure 23: Relationship between peel force and critical surface tension of the substrate for ● acrylic, □ polyvinyl ether and ○ natural rubber adhesives [103]. The contact time was 168 h.

polystyrene, PMMA and nylon 6. Fig. 23 shows a plot of peel force against γ_c for the three adhesives, and here there is a value of γ_c which gives maximum adhesion. Similar behaviour was shown by the tack data. The authors noted that it is possible that maximum work of adhesion coincides with the substrate having a critical surface tension near to those of the adhesives.

References

- [1] Jeffrey, G.A., 'An Introduction to Hydrogen Bonding', Oxford University Press, 1997.
- [2] Drago, R.S., Vogel, G.C. and Needham, T.E., *J. Amer. Chem. Soc.*, **1971**, 93, 6014.

- [3] Walker, P., *J. Oil Colour Chem Assoc.*, **1982**, 65, 415.
- [4] Walker, P., *J. Oil Colour Chem Assoc.*, **1983**, 65, 188.
- [5] Walker, P., *J. Oil Colour Chem Assoc.*, **1984**, 67, 108, 126.
- [6] Ulrén, L. and Hjertberg, T., *J. Appl. Polymer Sci.*, **1989**, 37, 1269.
- [7] Kinloch, A.J., Dukes, W.A. and Gledhill, R.A. 'Adhesion Science and Technology' Part B, Ed. Lee., L-H., Plenum Press **1976**, 597.
- [8] Comyn., J., Groves, C.L. and Saville, R.W. *Int. J. Adhes. Adhes.*, **1994**, 14, 15.
- [9] Gettings, M. and Kinloch, A. J., *J. Mater. Sci.*, **1977**, 12, 2511.
- [10] Turner, R.H. and Boerio, F.J., *J. Adhesion*, **2002**, 78, 465.
- [11] Davis, S.J. and Watts J.F., *Int. J. Adhes. Adhes.*, 1996, 16, 5.
- [12] Abel, M-L., Fletcher, I.W., Digby, R.P. and Watts, J.F. *Surf. Interface. Anal.*, **2000**, 29, 115.
- [13] Naviroj, S., Koenig, J.L. and Ishida, H., *J. Adhesion*, **1985**, 18, 93.
- [14] Brewis, D.M., Comyn, J., Oxley, D.P., Pritchard, R.G., Reynolds, S., Werrett, C.R. and Kinloch, A.J., *Surf. Interface Anal*, **1984**, 6, 40.
- [15] Comyn, J., Oxley, D.P., Pritchard, R.G., Werrett, C.R. and Kinloch, A.J., *Int. J. Adhes. Adhes.*, **1989**, 9, 201.
- [16] Calvert, P.D., Lalanandham, R.P. and Walton, D.R.M., in 'Adhesion Aspects of Polymeric Coatings', Ed. Mittal K.L., Plenum Press **1983**, 457.
- [17] Nicola, A. J. Jr. and Bell, J.P., in 'Adhesion Aspects of Polymeric Coatings', Ed. Mittal K.L., Plenum Press **1983**, 443.
- [18] Yoshida, S. and Ishida, H., *J. Adhesion*, **1984**, 16, 217.
- [19] van Ooij, W. J. and Biemond, M.E.F., *Rubber Chem. Tech.*, 1984, 57, 688.
- [20] Bao, S., Daunch, W.A., Sun, Y., Rinaldi, P.L., Marcinko, J.J. and Phanopoulos, C., *J. Adhesion*, **1999**, 71, 377.
- [21] Zhou, Z. and Frazier, C.E., *Int. J. Adhes. Adhes.*, **2001**, 21, 259.
- [22] Mallon, S. and Hill, C.A.S., *Int. J. Adhes. Adhes.*, **2002**, 22, 465.
- [23] Hill, C.A.S. and Cetin, N.S., *Int. J. Adhes. Adhes.*, **2000**, 20, 71.
- [24] Bistac, S., Vallat, M.F. and Schultz, J., *J. Adhesion*, **1996**, 56, 205.
- [25] Schneider, B., Hennemann, O-D. and Possart, W., *J. Adhesion*, **2002**, 78, 779.
- [26] Kowalczyk, D., Slomkowski, S., Chehimi, M. and Delamar, M., *Int. J. Adhes. Adhes.*, **1996**, 16, 227.
- [27] Turner, R.H. and Boerio, F.J., *J. Adhesion*, **2001**, 77, 251.
- [28] Mallik, R.R., Pritchard, R.G., Horley, C.C. and Comyn, J., *Polymer*, **1985**, 26, 551.
- [29] Devdas, S. and Mallik, R.R., *Int. J. Adhes. Adhes.*, **2000**, 20, 341.
- [30] Comyn, J., Brewis, D.M. and Tredwell, S.T., *J. Adhesion*, **1987**, 21, 59.
- [31] DeLollis, N.J., *Natl. SAMPE Symp. Exhib.*, **1977**, 22, 673.
- [32] Gledhill, R.A., Kinloch, A.J. and Shaw, S.J., *J. Adhesion*, **1980**, 11, 3.
- [33] Brewis, D.M., Comyn, J. and Tegg, J.L., *Polymer*, **1980**, 21, 134.
- [34] Brewis, D.M., Comyn, J., Cope, B.C. and Moloney, A.C., *Polymer*, **1980**, 21, 1477.
- [35] Brewis, D.M., Comyn, J., Cope, B.C. and Moloney, A.C., *Polym. Eng. Sci.*, **1981**, 21, 797.
- [36] Ohno, H., Endo, K., Araki, Y. and Asakura, S., *J. Mater. Sci.*, **1992**, 27, 5149.

- [37] Brewis, D.M., Comyn, J., Raval, A.K. and Kinloch, A.J., *Int. J. Adhes. Adhes.*, **1990**, *10*, 247.
- [38] Comyn, J., *Prog. Rubber Plast. Technol.*, **1985**, *1*, 1.
- [39] Agrawal, R.K. and Drzal, L.T., *J. Adhesion*, **1996**, *55*, 221.
- [40] Nagae, S. and Nakamae, K., *Int. J. Adhes. Adhes.*, **2002**, *22*, 139.
- [41] Chehimi, M.M., Ch 2 in 'Adhesion Promotion Techniques: Technological Applications', Eds. Mittal, K.L. and Pizzi, A., Marcel Dekker Inc., **1999**.
- [42] Atkins, P. and de Paula, J., 'Atkin's Physical Chemistry' 7th Edn., Oxford University Press **2002**, 696.
- [43] 'Handbook of Chemistry and Physics' 76th Edn., Ed. Lide, D.R., CRC Press, **1995**.
- [44] Harkins, W.D. and Jordan, H.F., *J. Amer. Chem. Soc.*, **1930**, *52*, 1751.
- [45] Freud, B.B. and Freud, H.Z., *J. Amer. Chem. Soc.*, **1930**, *52*, 1772.
- [46] Comyn, J., *Int. J. Adhes. Adhes.*, **1992**, *12*, 145.
- [47] Johnson, K.L., Kendall, K. and Roberts, A.D., *Proc. Roy. Soc. London*, **1971**, *A 324*, 301.
- [48] Rimai, D.S. and Quesnel, D.J., *J. Adhesion*, **2002**, *78*, 413.
- [49] Chaudury, M.K., *J. Adhes. Sci. Technol.*, **1993**, *7*, 669.
- [50] Barquins, M. and Charmet, J.-C., *J. Adhesion*, **1996**, *57*, 5.
- [51] Wu, S., 'Polymer Interface and Adhesion' **1982**, Marcel Dekker Inc.
- [52] Fowkes, F. M. *Ind. Eng. Chem.*, **1964**, *56* (12), 40.
- [53] Wu, S., *J. Adhesion*, **1973**, *5*, 39.
- [54] Good, R.J., Girafalco, L.A. and Kraus, G., *J. Phys. Chem.*, **1958**, *62*, 1418.
- [55] Comyn, J., Blackley, D.C. and Harding, L.M., *Int. J. Adhes. Adhes.*, **1993**, *13*, 163.
- [56] Wu, S., *Rev. Macromol. Chem.*, **1974**, *11*, 1.
- [57] Chin, P., McCullough, R.L. and Wu, W-L., *J. Adhesion*, **1997**, *64*, 145.
- [58] Wu, S., 'Polymer Interface and Adhesion', Marcel Dekker Inc., **1982**.
- [59] Dann, J. R., *J. Coll. Interface Sci.*, **1970**, *32*, 302, 321.
- [60] Fowkes, F.M. and Maruchi, S., *Coatings and Plastics Preprints.*, **1977**, *37*, 605.
- [61] Kaelble, D.H., Dynes, P.J. and Cirlin, E.H., *J. Adhesion*, **1974**, *6*, 23.
- [62] Fox, H.W. and Zisman, W.A., *J. Colloid Sci.*, **1950**, *5*, 514.
- [63] Fox, H.W. and Zisman, W.A., *J. Colloid Sci.*, **1952**, *7*, 109, 428.
- [64] Bascom, W.D., *Adv. Polymer Sci.*, **1988**, *85*, 89.
- [65] Levine, M., Ilkka, G. and Weiss, P., *Polymer Letters*, **1964**, *2*, 915.
- [66] DeBruyne, N.A., *Nature* **1957**, *180*, 262.
- [67] van Oss, C.J., Good, R.J. and Chaudury, M.K., *Langmuir*; **1988**, *4*, 884.
- [68] Good, R.J. and Hawa, A.K., *J. Adhesion*, **1997**, *63*, 5.
- [69] Good, R.J., Shu, L.K., Chiu, H-C. and Yeung, C.K., *J. Adhesion*, **1996**, *59*, 25.
- [70] Garbassi, F., Morra, M., and Occhiello, E., 'Polymer Surfaces; from physics to technology', John Wiley & Sons, **1994**, 171.
- [71] Kasemura, T., Takahashi, S., Okada, T. and Maegawa, T., *J. Adhesion*, **1996**, *59*, 61.
- [72] Varennes, S. and Schreiber, H.P., *J. Adhesion*, **2001**, *76*, 293.
- [73] Kinloch, A.J., Dukes, W.A. and Gledhill, R.A., *Amer. Chem. Soc. Div. Org. Coat. Plast. Chem.*, **1975**, *35*, 546.

- [74] Kinloch, A.J., 'Durability of Structural Adhesives', Ch. 1, Ed. Kinloch, A.J., Applied Science Publishers, **1983**.
- [75] Owens, D.K., *J. Appl. Polymer Sci.*, **1970**, *14*, 1725.
- [76] Comyn, J., Blackley, D.C. and Harding, L.M., *J. Adhes.*, **1993**, *40*, 163.
- [77] Orman, S. and Kerr, C., *Aspects of Adhesion*, **1971**, *6*, 64.
- [78] Packham, D.E., *Int. J. Adhes. Adhes.*, **1996**, *16*, 121.
- [79] Sharpe, L.H. and Schonhorn, H., 'Contact Angle, Wettability and Adhesion', ACS Series No 43, **1964**.
- [80] Randow, C.L., Williams, C.A., Ward, T.C., Dillard, D.A., Dillard, J.G. and Wightman, J.P., *J. Adhesion*, **1997**, *63*, 285.
- [81] Smith, M.J., Dai, H. and Ramani, K., *Int. J. Adhes. Adhes.*, **2002**, *22*, 197.
- [82] Harris, A.F. and Beevers, A., *Int. J. Adhes. Adhes.*, **1999**, *19*, 445.
- [83] Shahid, M. and Hashim, S.A., *Int. J. Adhes. Adhes.*, **2002**, *22*, 235.
- [84] Voyutskii, S.S., 'Autohesion and Adhesion of High Polymers', Interscience, **1963**.
- [85] Price, F.P., Gilmore, P.T., Thomas, E.L. and Laurence, R.L., *J. Polymer Sci., Polymer Symposium*, **1978**, *63*, 33.
- [86] Gilmore, P.T., Falabella, R. and Laurence, R.L., *Macromolecules*, **1980**, *13*, 880.
- [87] Voyutskii, S.S., *J. Adhesion*, **1971**, *3*, 69.
- [88] Forbes, W.G. and McCleod, L.A., *Trans. Inst. Rubber Inst.*, **1958**, *34*, 154.
- [89] Skewis, J.D., *Rubber Chem. Tech.*, **1966**, *39*, 217.
- [90] Anand, J.N. and Karam, H.J., *J. Adhes.*, **1969**, *1*, 16.
- [91] Anand, J.N. and Balwinski, R.Z., *J. Adhes.*, **1969**, *1*, 24.
- [92] Anand, J.N., *J. Adhes.*, **1969**, *1*, 31.
- [93] Anand, J.N., *J. Adhes.*, **1970**, *2*, 16.
- [94] Anand, J.N., *J. Adhes.*, **1970**, *2*, 23.
- [95] Anand, J.N., *J. Adhes.*, **1973**, *5*, 265.
- [96] Voyutskii, S.S. and Zamazaii, V.M., *Rubber Chem. Tech.*, **1957**, *30*, 544.
- [97] McCall, D.W., Douglass, D.C. and Anderson, E.W., *J. Polymer Sci., Part A*, **1963**, *1*, 1709.
- [98] Schreiber, H.P. and Ouhlal, A., *J. Adhes.*, **2003**, *79*, 135.
- [99] Titow, V.W., Loneragan, R.J., Johns, J.H.T. and Currell, B.R., *Plast. Polym.*, **1973**, *41*, 149.
- [100] Change, K.C. and Lee, S., *J. Adhes.*, **1996**, *56*, 135.
- [101] Brewis, D.M., *Int. J. Adhes. Adhes.*, **1993**, *13*, 251.
- [102] Zosel, A., *Int. J. Adhes. Adhes.*, **1998**, *18*, 265.
- [103] Toyama, M., Ito, T. and Moriguchi, H., *J. Appl. Polymer Sci.*, **1970**, *14*, 2039.

Chapter 2

Equipment for the Application of Adhesives and Sealants: Mixing, Metering, Coating or Applying the Adhesives

Philippe Cognard

Philippe Cognard is an Ingénieur of the Ecole Supérieure de Physique et Chimie de Paris – France’s leading Physics and Chemistry college – and he received his Diploma in 1964.

He started his professional career in the USA the same year at the Pittsburgh Plate Glass Company moving to the Bloomfield Adhesives and Sealants Division in 1966 as a research and development chemist.

Over the years, he has held many top positions in leading adhesive and sealant companies around the world. These include:

- Rousselot, France’s main developer and supplier of adhesives – later to become Elf Atochem – in various positions in the R&D, marketing and sales departments.
- Weber et Broutin – now Saint Gobain – dealing with building adhesives and mortars
- Ato-Findley – part of the Elf Aquitaine Group that became Bostik-Findley in the Total Group after the merger between Elf and Total – as Marketing Director for Adhesives.
- In 1996, he was appointed as a Director of the Ato-Findley Adhesives company in Guangzhou, China where he oversaw the launch, marketing and sales development in this country of Ato-Findley adhesives and sealants for application areas such as; construction, woodworking and furniture, packaging, laminating, footwear, and many others. This gave him a broad and thorough knowledge of the huge Chinese market, along with all R&D, manufacturing, marketing and sales activities employed by the company.

With more than 36 years of experience in the adhesives and sealants industry, he has also written and edited several related technical books and journal papers.

Many different techniques and equipment are used to dispense and apply the adhesives and sealants on the materials to be bonded. Users of adhesives, manufacturers of adhesives and sealants and equipment manufacturers, all need to know these techniques. Several chapters in this Handbook deal with these techniques. This chapter will study in detail all the application techniques and equipment for all types of adhesives.

Keywords: one-component adhesives/sealants; two-component adhesives/sealants; two-component cartridges; add on; aerosol cans; air spray; airless spray; air knife; applicators; automatic spraying; ball valve (applicators); bead application; brush; cartridges; coverage or consumption; coextrusion; conditioning of materials; curtain coater; casting (A and S); complete systems; debubbling; detection systems; dispensing equipment; dip coating; die (slot die); dot application; doctor roll; doses; drying; dry adhesive; engraved rolls (see gravure rolls); extrusion; extrusion die; extrusion equipment; edgebanding; feeding of the A/S; film laminating; film adhesives; flexo coating; flow rate; foam application, foamed sealants; foam melt[®]; gravity feeding; guns (spray guns, cartridge guns); gravure rolls; hand roller; hand operated guns; heliogravure; hot melt application; hot melt gun; hot spray; injection (of the adhesive); joints, size, thickness; kiss roll; knife coater, knife over roll; laminating machines; labelling machines; line speed; metering, metering roll; mixing; metering systems; modes of setting; needle applicator; notched trowel; nozzle; offset; presses, hot presses; pressure (of fluids); preparation (before bonding); pumps; perforated rolls; premelter; powder application; pressure sensitive adhesive; potting; pot life; reverse roll coater; robot application; roll coaters, rollcoating, hand roller; rotary screen; silk screen separate application; slot die applicators; size and shape of parts; spraying, spray; static mixer; sealant tapes; swirl spray; syringe application; solvent based adhesives; selection of equipment; tape applicator, thermosetting adhesives; thermoplastic adhesives; thermoplastic films; trowel; unwinders (for tapes); UV curing; valve applicators, ball valves; viscosity; web speed; wheel applicators; working conditions.

2.1. Methods of Application of Adhesives, Sealants and Related Products

There are many different types of adhesives: liquid, pastes, powders, films, emulsions, hot melts, solvent-based and some 10 different modes of setting:

- evaporation and absorption by the substrates of water for the emulsion adhesives,

- evaporation and absorption of solvents for solvent based adhesives,
- heat curing of thermosetting adhesives,
- chemical reaction between the two components for the two-component adhesives,
- cooling of the hot melt adhesives,
- chemical reaction of the adhesives and sealants with humidity,
- curing by UV or EB radiations.

To these different types of adhesives correspond different techniques of application and curing. Table 1 shows the various steps of any bonding operation that we study in this and later chapters.

Fig. 1 shows these different steps. We now study steps 1, 2 and 3 of Table 1 and explain the different equipments and techniques mentioned. Steps 4 to 8 will be studied in another chapter of this Handbook titled ‘Drying, Assembly, Pressing and Curing of Adhesives’, in Volume 4.

This chapter does not discuss the application of the following special techniques:

- application of sealants, which is studied in a specific chapter in Volume 6, because sealants are always applied in thick joints and require different equipments (however several equipment studied in this chapter such as guns and cartridges and extrusion are used for sealants).
- application of hot melt adhesives, which is also addressed in another chapter, because their application techniques are different, and the readers of other volumes need this information at that time.
- robotic application, which is studied in a separate chapter written by a specialist of this technique.

Readers should refer to the Contents list in order to find these chapters.

2.2. Preparation Before Bonding

2.2.1. Surface Preparation of Materials

Many techniques exist for surface preparation, which depend on the materials to be bonded. We mention those which are most commonly used:

- planing when the surface are not flat enough for bonding (important, for instance, in woodworking for a perfect match of parts together),
- abrasion treatments on wood, leather etc. to remove surface coatings and varnishes, which could prevent a good adhesion,
- cleaning with solvents of metals, plastics, composites,

Table 1: The different steps in a bonding operation

Steps	Operations
1. Preparation of substrates	Planing, cleaning Abrading, chemical surface treatment Conditioning of materials before bonding
2. Preparation of the adhesive	Addition of fillers Dilution and adjustment of viscosity Metering and mixing of the two components
3. Coating/dispensing	Brush, trowel Spraying, extrusion Roll application (manual or automatic) Hot melt equipment Stencil, dip coating Film adhesives Pressure sensitive adhesives Preformed adhesives and sealants (in solid form)
4. Drying, waiting time, open time	Waiting for evaporation of solvents or water
5. Heat reactivation of the adhesive	
6. Assembly of parts	Hand made or automatic
7. Pressing	Time, pressure and temperature Manual (clamps) roll or platen press, Cold or hot pressing Frames, autoclaves
8. Curing, hardening, polymerization	Hot or cold curing Temperature and time different types of ovens, autoclaves Different modes of polymerization: chemical reactions, UV, HF, EB

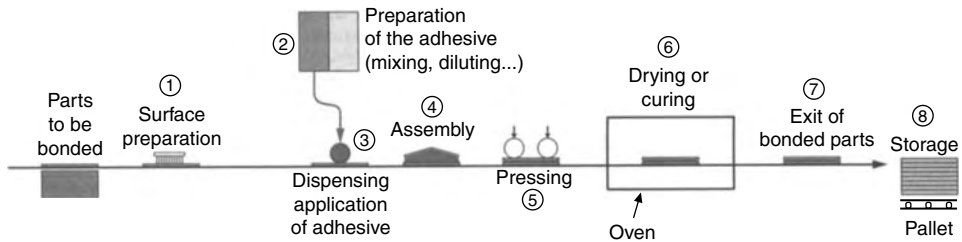

Figure 1: General installation of an adhesive bonding line.

- sanding, grit or shot blasting and abrading of metals and plastics,
- chemical cleaning,
- chemical treatment of metals before structural bonding (etching, anodisation),
- chemical treatment of plastics, in order to improve adhesion,
- mechanical or physical treatments of plastics and composites, such as corona treatment, flame treatment, plasma, to increase adhesion,
- various primers on different substrates, in order to increase adhesion.

These various techniques will be explained in the relevant chapters, for instance chemical treatments of metals are explained in a specific chapter titled ‘Surface Preparation of Metals Before Bonding’, in Volume 1, and also in the chapters ‘Bonding of Metals’ and ‘Automotive Adhesives and Sealants’. Preparation of plastics before bonding are explained in the chapter ‘Bonding of Plastics’ and so on.

2.2.2. Conditioning of Materials Before Bonding

Many materials (wood, paper, textiles) change their shape and dimensions when subjected to various changes:

- variation of temperature (expansion coefficient of metals, plastics, concrete),
- variations of humidity and water content: wood and paper expand when their water content increases and shrink when it decreases, which will cause some stress to develop in their bonds.

Once the different parts are bonded, these materials come back to their normal condition. Wood and paper shrink if they are allowed to dry in a dry atmosphere, for instance when a piece of furniture or a parquet is put in a dry house with heating during winter, the wood shrinks, the shrinking may reach up to 2 mm per metre,

so that the bond joint will be subjected to high stresses, which may eventually cause failure. Textiles may shrink when subjected to humidity and washing.

Therefore, in many cases it is mandatory:

- to stabilise as much as possible the materials before bonding, so that they will reach a temperature and a moisture content that will be as close as possible as the ones they will have during their normal service life,
- to bond it with adhesives that will not cause variations of shapes and dimensions. For instance, when a water-based adhesive is used on wood or paper, special care should be exercised so that the dimension variations are controlled and limited, and if this is not possible, a different type of adhesive should be selected.

2.2.3. Stabilisation of Materials

- Wood and paper or cardboard will be dried in ovens until they reach a water content and a dimension compatible with the normal service life, or they will be stored in a proper place with controlled temperature and humidity, Fig. 2 shows such a drying oven.
- wood planks and cement-fibre panels should be dried in ventilated stacks, so that the air circulates in between the planks or sheets or panels and evacuates excess humidity. Refer to the chapters ‘Woodworking and Furniture Adhesives’ and ‘Paper and Packaging Adhesives’ for further details.

2.2.4. Conditioning of Workshops in Temperature and Humidity

A low temperature (less than 10°C) and a high humidity (higher than 80%) causes condensation of humidity on the surface of the parts to be bonded or at the surface of the adhesive film, and this may forbid a good bond, because the condensed humidity may be deposited between the materials or on the glue line.

Therefore, the workshops should be conditioned in temperature (from 15 to 30°C) and in humidity (preferably between 30 and 65% RH). Very hot and humid countries require special formulations, probably with different solvents; for instance, adhesives used in South China in summer (which is very hot and very humid with perhaps 95% RH and 35°C) may need to be reformulated to match these special conditions.

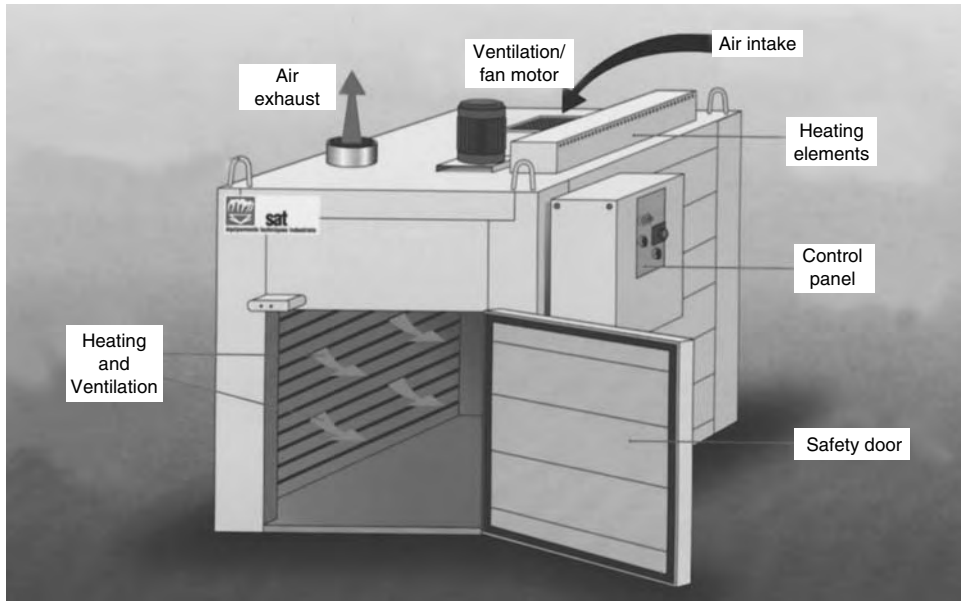

Figure 2: Drying oven (force air drying) for wood and other porous materials before bonding.

Dust and pollution must be eliminated. It is very important to refrain from using oils, greases and silicones near the bonding area because these products could jeopardise the adhesion.

2.2.5. Preparation of Adhesives and Sealants

Most adhesives and sealants are delivered as ready to use products. However there are a few cases where the users should prepare the glue mix themselves:

- by dissolving a polymer in water or in solvents, for instance the dissolution of starch in hot water to prepare the glue mix for corrugated cardboard manufacturing, or dissolution of urea-formaldehyde in water and addition of a catalyst,
- or by incorporation of fillers, for instance addition of wood flour or nutshell flour in UF resins also,
- or sometimes by adjusting the viscosity by adding water or solvent, although this is not recommended by the manufacturers.

Several manufacturers are selling dissolvers or mixers, generally stainless steel tanks, sometimes with heating systems and a mixing paddle agitator. These systems

may be adapted to the mixing time, the hourly output of adhesive and the viscosities of glue mixes.

2.2.6. *Mixing and Metering of Two-Component Products*

- For small output, mixing and metering of the two components can be done by hand, for instance with a small blade mixer. If the products contain solvents, the mixer should be spark proof,
- for larger applications on production lines, there are many mixing and metering equipments that we will study in Section 2.15. These systems are generally connected to the applicators, with all the bonding operations being a continuous operation.

In order to give our readers a good idea of what can be done in large installations, we describe hereunder a metering and mixing machine which is used in large plants for furniture and woodworking.

Mixing and Metering Machine Kontimix from Oest Mineralolwerk, Germany

This equipment is used to feed the glue mix automatically to various woodworking machines such as roll coaters, jointing machines, plywood machines, furniture assembling machines and laminating machines.

Metering

The Kontimix continuously meters liquid and powder products and mixes the two components according to the output rate. The mix is therefore always freshly mixed with the required viscosity and pH. The minimum and maximum level electrodes located between the rolls and the mixing tank monitor the mix ratio and the output of the glue mix. The liquid components are metered by adequate pumps (gear or diaphragm pumps) and the powder component by an adjustable rotating disk. The various components are continuously metered according to the formulation and are fed into a continuous mixer.

Mixing

A high-intensity mixer mixes and homogenises both components into a small volume tank. The property of the glue mixer is that it always exceeds the required output. Thus the machine works in a discontinuous way. The equipment has two tanks for the two different components and level detectors for each component.

Controls

The mixing ratio of each component, including catalysts and additives, is controlled in order to have a fully automated production, which does not require monitoring by an operator. Mixing accuracy is $\pm 1\%$ for each component.

Feeding the Roll Coater

A filling system equipped with reliable valves and a level detector maintains an accurate metering. When the rollers have more than 2.5 m width, pipes deliver the glue mix in several places along the rolls in order to obtain the same composition all along the rolls.

Cooling of the Glue Mix

When the glue mixes are highly reactive or when the output is small (for instance laminated beam arches, jointing machines, etc.), or when the temperatures are high, the glue mixes should be allowed to cool; a cooling freon coil which can go down to -10°C may cool down the resin. The glue mix may be cooled down to 8°C .

Some special machines may mix up to five liquid components and five powder components. Their output may range from 10 to 800 kg per hour.

2.3. Adhesive Coating, General Rules

2.3.1. Different Methods

The choice of the method of coating depends on several factors:

- size and shape of the parts to be coated,
- accessibility of the places to be coated,
- shape of adhesive or sealant joints,
- production output (m^2 or parts to be assembled per hour),
- viscosity and rheology of the products,
- types of adhesives and sealants, pot life when it is a two component product,
- type of solvents, flammability, noxiousness of solvents,
- required thickness or consumption of adhesives and sealants, kilograms per hour output of adhesives and sealants,
- manual or automatic application, degree of automation required,
- mode of setting of the adhesives and sealants, open time, setting speed,
- labour and equipment costs.

Table 2 summarises all the choice parameters.

We can understand from this long list that the choice of coating method and equipment is a difficult one. One of the most important parameters is the rheology and viscosity of the adhesive or sealant. For these definitions of terms, please refer to Volume 1, Chapter 2, 'Technical Characteristics of Adhesives and Sealants'. Each type of applicator requires adequate rheology and viscosity.

Table 2: Selection of the application equipment, parameters of selection

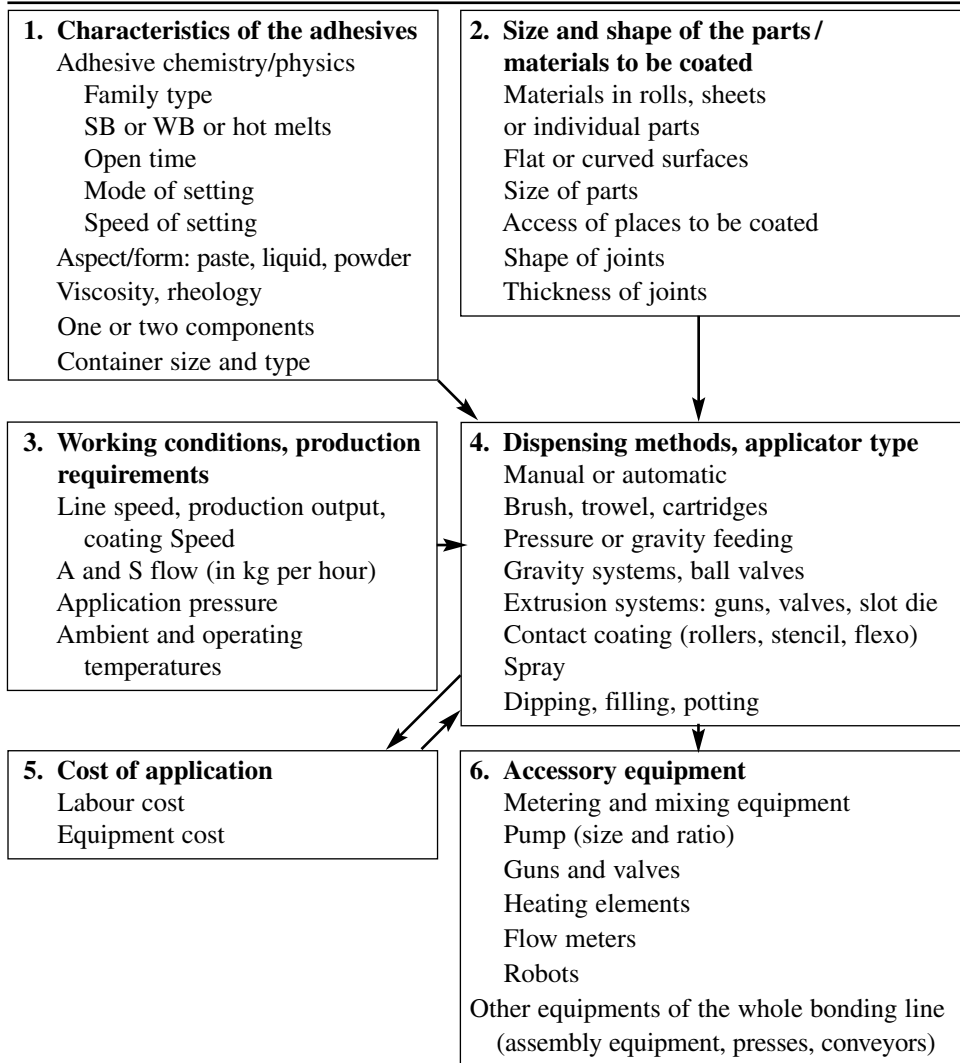

The selected mode of application should allow the application of the adhesive with a constant coverage, without any lack, or any excess, at a constant speed, at the required quantity or coverage. More and more the users seek application techniques which would allow to minimise labour costs.

We now study all the application techniques and equipment. We start with the manual and simple methods and move on to the fast, automatic systems. We first study the standard one-component paste adhesives, and then the

two-component products. The coating of primers will be studied here, but sealant application will be mostly studied in another specific chapter, in another volume of this Handbook.

2.3.2. Classification of the Different Coating/Dispensing Systems

All the pumping, transport and coating systems, for liquids and pastes may be used:

- gravity systems for the very fluid adhesives: drop feeding, pipes, dipping, silk screens, curtain coaters,
- contact coating: coaters on flat surfaces where the substrate to be coated comes into contact with the applicator, such as brush, roller coating, knife coating,
- spraying, where there is no contact with the material to be coated: air spray, airless spray, special guns for hot melt adhesives,
- extrusion and extrusion coating systems: cartridge + guns, pump + extrusion die, for thick products that need pressure to push them through the guns or dies,
- transfer systems such as stencils, flexo, silk screens, fingers, tampons, pallets,
- special systems for application on curved surfaces: dipping, robots,
- all kinds of special applicators for hot melts: dies, extrusion and spray guns, hot rolls,
- unwinding of an adhesive film, tape or roll,
- powder coatings,
- complete machines which include preparation of the adhesive, coating, assembly and pressing or curing.

Each of these techniques will be now studied in this chapter, where we will follow a different classification.

The applicators for hot melts are mentioned here, but they will be studied in more detail in a specific chapter later in this Handbook.

2.4. Hand Application Techniques

2.4.1. Brush Application

This is a very simple manual method. It needs, as all techniques, an adapted formulation:

- the adhesive must be fluid with a viscosity in the range 400 to 5000 mPa s,

- it may display some thixotropy and become fluid after mixing during application,
- the solvent should not be too volatile or else its fast evaporation would give ‘strings’ and uneven application.

Advantages:

- the brushing effect forces the adhesive to penetrate into the roughness of the surfaces, and wet the material,
- being hand operated, it allows one to work on small surfaces and contours, for instance on shoe soles and uppers.

Drawbacks:

- sometimes, the coating is uneven and the amount of adhesive deposit varies with the ability of the worker, and the adhesive does not dry everywhere at the same speed,
- cleaning of tools may be difficult and may need a solvent to be adapted.

There are some brushes which are fed with adhesive by a pressurised tank and a hose (refer to the Fig. 33 in the Section 2.6).

Utilisation:

- application of neoprene and solvent-based polyurethane adhesives in footwear,
- application of adhesives and primers on small, narrow or curved surfaces, do it yourself (DIY), small rubber parts.

2.4.2. Notched Trowel

A notched trowel is the main tool in construction for floor and wall adhesives and ceramic tile mortars, and works with both water-based and the solvent-based adhesives and mortars (Fig. 3). It is also used for a simple manual application of two components, epoxy or polyurethane adhesives, on flat surfaces, because these trowels are easy to clean.

Trowel application is convenient only for large and flat surfaces such as floors, sandwich panels, walls (with a suitable high viscosity to avoid dripping). It is used to apply heavy coatings from 200 g/m² up to several kg/m².

Sometimes the adhesive is first troweled on the surface with a flat large trowel in a rather thick coat and then the notched trowel is used to adjust the thickness by ‘combing’ this flat coat.

The depth and number of teeth or notches vary according to the amount of adhesive which should be applied.

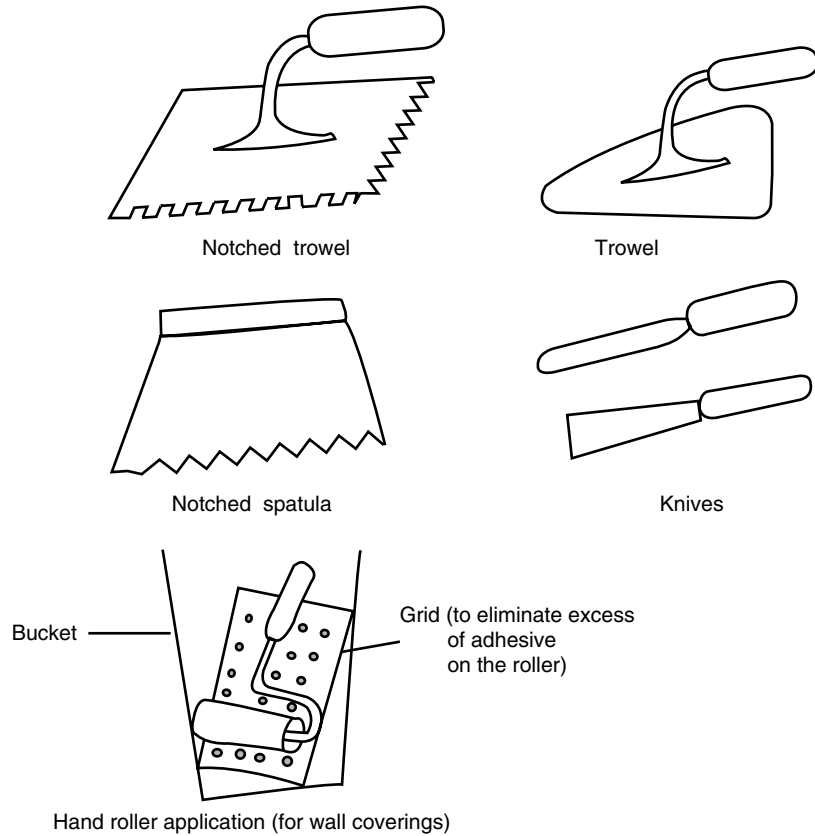

Figure 3: Several types of hand tools used in Construction/Decoration to apply adhesives, mortars, putties, etc.

After the trowel passed over the adhesive, it leaves ribs on the surface, and the height of these ribs may facilitate filling some gap between the two substrates.

If the volume of the teeth is V for 1 m^2 and the specific gravity d , the amount of adhesive applied is $V \cdot d$, expressed in kg/m^2 .

Viscosity may be within a very large range: from 3000 mPas on horizontal surfaces where there is no risk of dripping, up to 400,000 mPas on vertical surfaces.

Advantages:

- it is a fairly fast method for a manual technique: a worker may apply 10 m^2 in 2–3 min,
- these tools are very cheap (plastic notched trowels may be disposed of after using when they are worn out),



Figure 4: Viscosity of the adhesive must be adapted to the dispensing equipment. Here we show a very simple although automatic way for applying beads of starch glue on each side of a paper roll for bag manufacturing.

- the amount of adhesive applied can be metered with a fairly good accuracy, from 200 g/m^2 to 5 or 6 kg/m^2 ,
- the ribs facilitate air escape when the parts are assembled.

Drawbacks:

- notched trowels wear out quickly through abrasion on concrete floors and must be milled frequently to the exact size.

2.4.3. Manual or Hand Roller Application

Wall waterborne adhesives are frequently applied with hand rollers (wool or foam cover), as shown in Fig. 3.

There are several requirements:

- viscosity should be within the range 500 to 10,000 mPas,
- the adhesive should dry slowly so that the foam or wool cover will not dry and clog, thus this technique is only used with water-borne adhesives.

It is always necessary to apply two coats crosswise at 90° angle to obtain an even coat. Adhesive coating may vary from 80 to 200 g/m² in one pass by pressing more or less the roller on the substrate. Primers which are always fluid, may be applied conveniently and fast on large surfaces with hand rollers.

2.4.4. Trowel and Knife Application

Some mortars or putties or mastics may be applied in thick coatings or blobs or zones, on rough substrates with a trowel or knife (Fig. 3). This is frequently used in construction and civil engineering.

The mortar or putties must be very thick, at least 500,000 mPas to avoid sagging on walls (in fact, for such thick products, viscosity is no longer significant, and instead penetration or sag resistance are measured).

2.4.5. Syringe and Needle Application

For the bonding of very small parts — electronic parts, micromechanics, watches — adhesives may be applied in very small quantities with a metering syringe or a fine needle. For instance, a fraction of a milligram of adhesive may be applied on small surfaces (less than 1 mm²).

Several companies manufacture syringe applicators which may be used in manual or automatic modes, such as Fisnar USA, Electron Fusion Devices EFD, Wentworth and Kent Moore (Fig. 5).

Figs. 6 to 8 show many applications of these application equipment, in many industries, especially those where the adhesive must be applied on a small surface, or as a dot, such as electronics, Hifi, micromechanics, small appliances, jewellery etc.

The syringe may be held in the hand of the worker, but the application of the drops may be actuated by pulsed air. In manual mode, the pressure on the syringe is applied continuously and the adhesive will flow as long as the operator presses



Figure 5: Needle applicator KMI 1000 from Kent Moore.

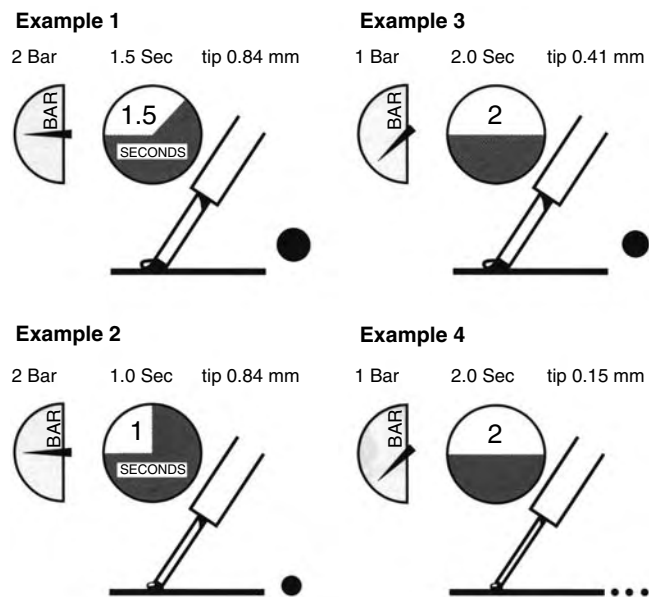

Figure 6: Effect of pressure and time on dot size in syringe application.



Figure 7: Syringe application. Three 740V-SS valves from EFD (USA) dispense microdots of UV curing adhesive on the lens of a barcod scanner (source EFD/USA).

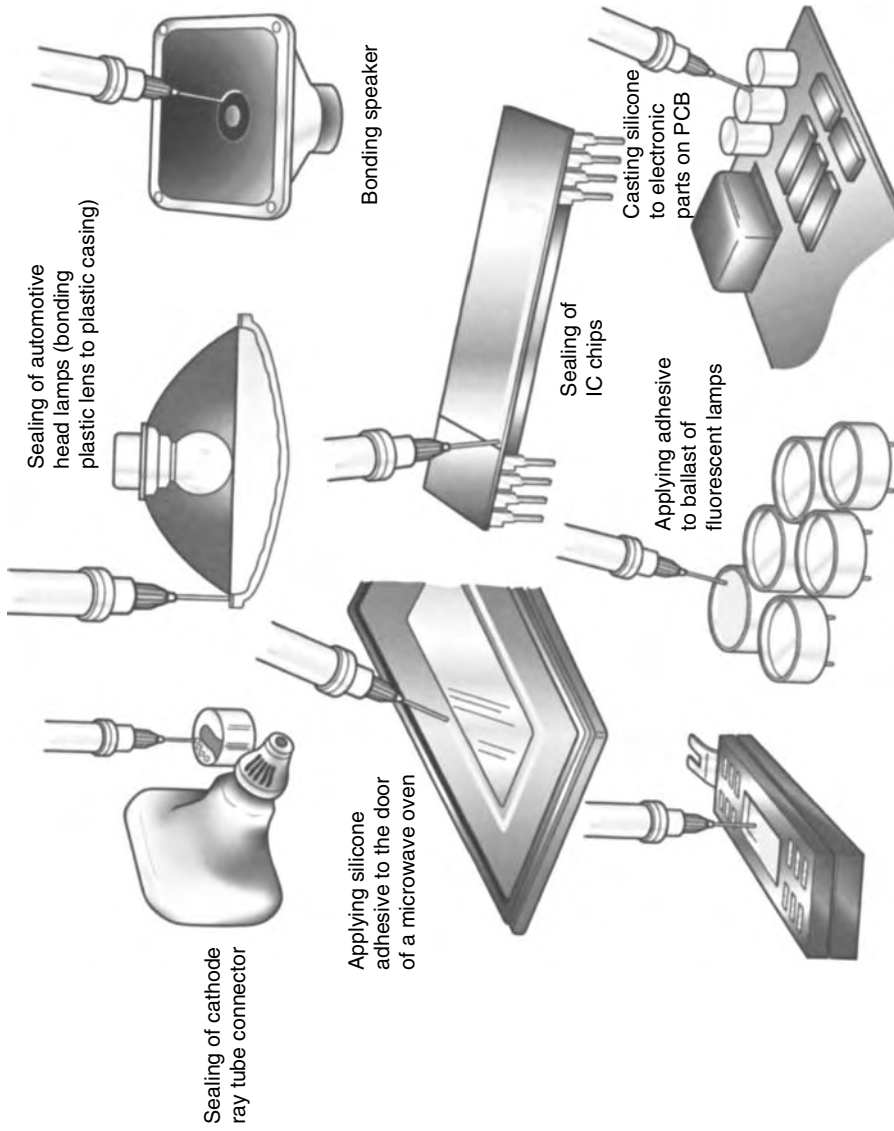

Figure 8: Syringe dispenser applications (by courtesy of Fisnar).

on the pedal. In the automatic mode, the application of a drop is determined by the preset value of the pressure applied on the syringe. This pressure pushes the liquid according to the cadence set by a timer (impulses of 5 ms to 2 s for instance). Pressure may be adjusted from 0 to 7 bars.

2.4.6. Effects of Pressure and Time on Dot Size

- Increasing either the air pressure, time duration or tip size may increase the dot size,
- thicker, more viscous liquids, require either more air pressure, longer time or a larger sized tip,
- higher pressure and/or shorter time cycles increase the dispensing speed and provide a higher output (refer to Fig. 6).

The syringes and needles are disposable and there are several sizes and materials available to customise it to the types of adhesives, the viscosity, and the quantity that should be applied (Fig. 9). Filling the syringe can be done easily with a simple equipment.

We will see in the chapter ‘Robot Application of Adhesives and Sealants’ later in this Handbook that there are also robots, with two and three axes, that may use these syringes, for instance to apply adhesives at very high speeds in electronics, and also on revolution parts. The syringes offer a very low weight and therefore can be moved at very high speed with a small robot for fast and very accurate jobs in electronics (Fig. 10).

These syringe applicators with very fine needles may apply very small dots or drops down to one hundredth of a milligram. They are widely used in electronics for surface mounting, chips bonding and in jewellery and watches. The application of the adhesive may be controlled with a special camera or an optical fibre detector. The viscosities of the adhesives may range from 100 mPas (cyanoacrylates) to 20,000 mPas (epoxies, silicones).

When dispensing two parts of epoxies, remember that in the epoxy curing process the viscosity will increase with time thus affecting the dot size. The control of the dispenser should be adjusted to compensate for the increase of viscosity.

Most adhesives dispense well and by using a small tip stringing may be eliminated. Syringe application is also the best method for filling and potting applications, with polyurethanes or silicones.

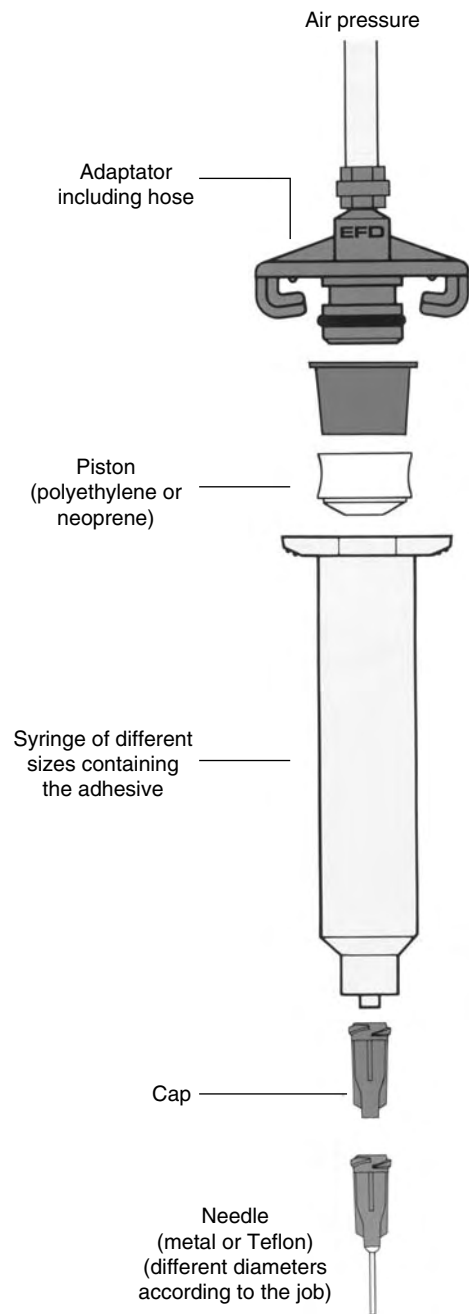

Figure 9a: EFD syringe applicator (source EFD).

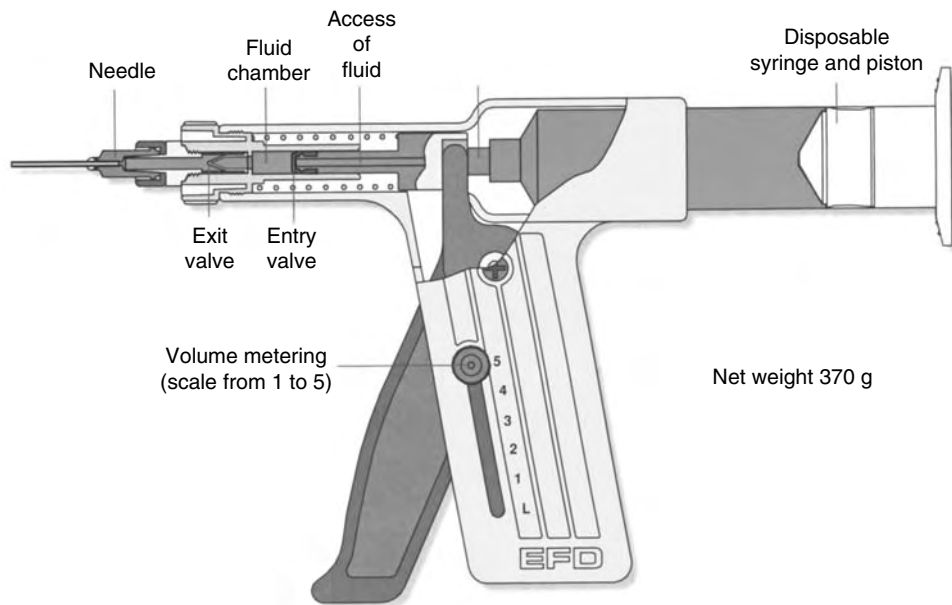

Figure 9b: DOT MAKER™ 2000 DP of EFD, USA.

2.4.7. Guns for Cartridges

Guns are used to apply cartridges of sealants (polyurethanes, silicones) and also adhesives in mastics form such as polychloroprene or MS polymer mastics. The cartridges are made of plastic (polyethylene), metal or cardboard, the bottom of the cartridge is a piston, so that when the trigger of the gun is actuated the piston will push the sealant to extrude it through a tip cut to the proper diameter (Fig. 11).

This technique is used with all kinds of sealants and putties, the viscosity should range from 200,000 to 1 million mPas. The gun can extrude a bead of product of diameters ranging from 2 to 12 mm. Fig. 12 shows the different types of guns. Guns may be hand operated or operated by air pressure, as shown in this figure. There are different sizes of cartridges:

- standard 310 ml cartridges, made of plastic, metal or cardboard with an aluminum waterproofing liner,
- big cartridges or one quart of a gallon=0.9 l in convoluted cardboard in USA,
- other sizes, refer to Fig. 13,
- plastic sausages of 600 ml (Fig. 13).



Figure 10: Robotic application with syringes.

Fig. 13 shows all the different types and sizes of cartridges available worldwide (source Kroger Maschinenfabrik, Denmark, a manufacturer of guns).

2.4.8. Two-Component Cartridges and Static Mixers

The two-component products (structural epoxydes, polyurethane adhesives and sealants, other two-component sealants) may be extruded from two-component cartridges (Fig. 15) and then mixed in a mixing device called static mixer immediately at the exit of the cartridge.

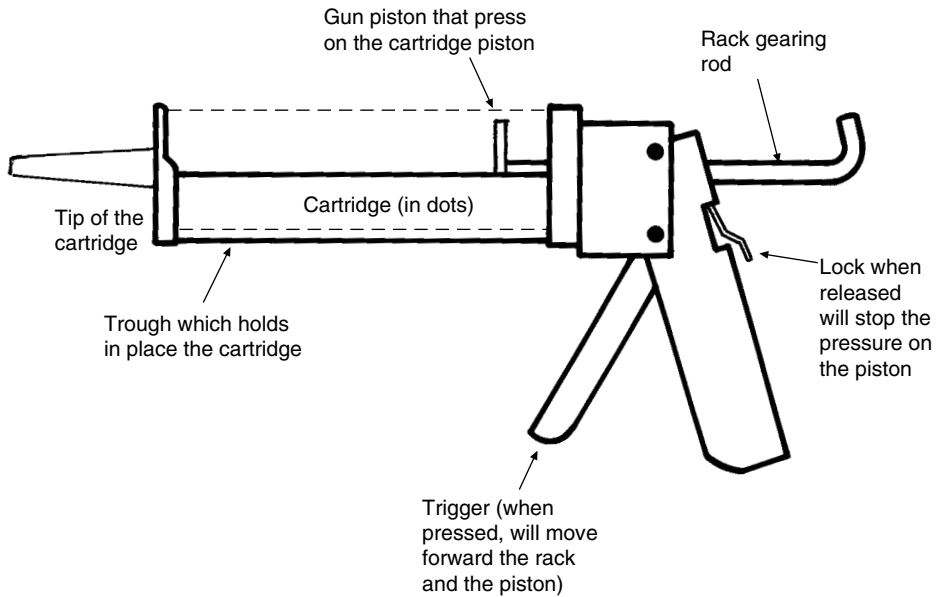

Figure 11: Hand operated gun for 310 ml cartridges.

Fig. 16 shows these static mixers. Inside the tube there are helicoidal partitions. When the adhesive comes in contact with the rib or edge of the first partition, the flow of adhesive is divided into two directions. Then, for each edge, the two flows are again divided into two channels and mix with the two others.

The helicoidal partitions generate a radial flow and several layers of product, as shown in Fig. 17(a). Fig. 17(a) shows that after five partitions there are already 32 layers, and shows the mixing effect of the helicoidal partitions. One can understand that after some 12 partitions the two components are completely mixed together. Figure 17(b) shows another type of two-component cartridge, the Semkit cartridge from Semco USA.

Advantages of cartridge application:

- adhesives or sealants may be applied in thick lines, in order to fill gaps and joints,
- easy application on linear joints such as sealing in construction, bonding panels, parquets,
- the joints may have from 1 to several mm thickness,
- this packaging is quite cheap (less than € 0.20) because it is made in very large quantities.

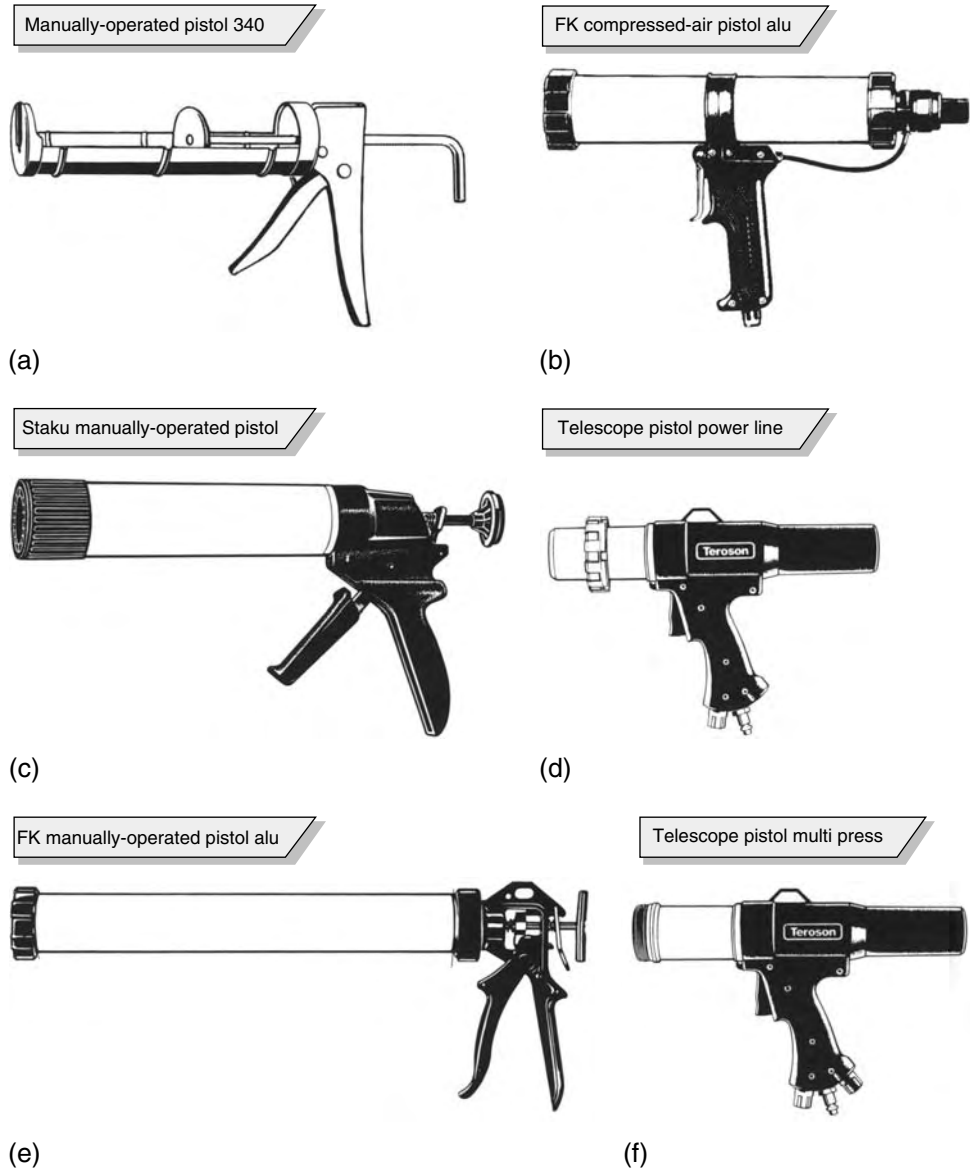

Figure 12: Various types of hand operated guns for cartridges. Some companies have developed full range of well adapted guns for cartridges.

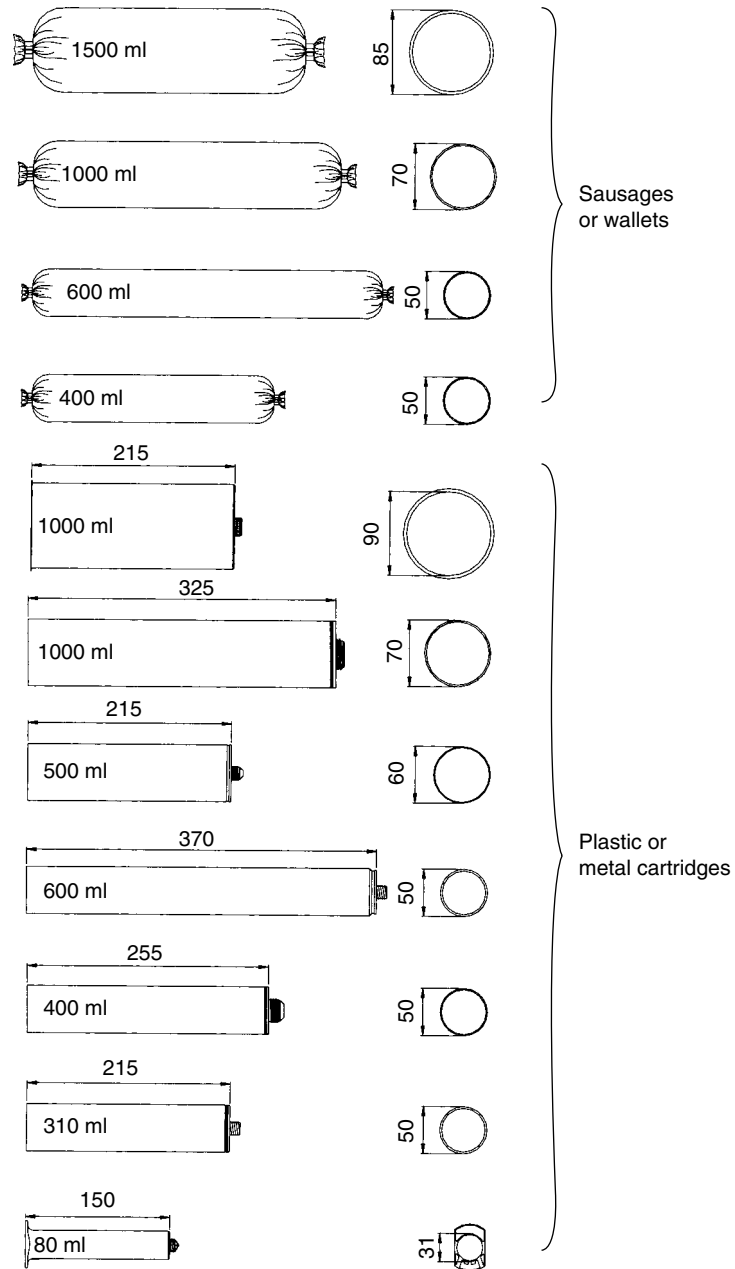

Figure 13: Different sizes of cartridges and sausages (sizes in mm).



Figure 14: Cartridge and gun application of an adhesive/sealant.

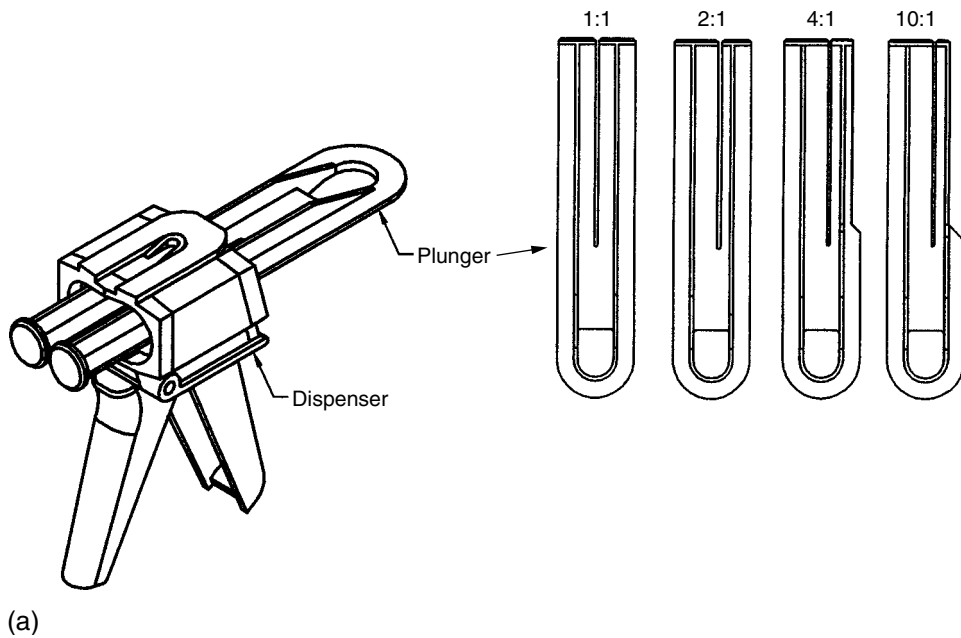

Figure 15a: Manual dispenser for two-component cartridges from TAH Industries Inc. USA – the different plunger sizes provide different ratios.



(b)

Figure 15b: Hand gun for two-components adhesives with static mixer
(by courtesy of TAH Industries, USA).

Drawbacks:

- this manual application is slow: 1 m per minute,
- size of cartridges is small: one 310 ml cartridge can only fill a few metres of joints. In USA there are larger cartridges of one quart (approximately one litre).

Automation:

It is possible to use an air pressure gun, fed with a pump (Graco, De Vilbiss, Kremlin) that pumps the adhesive or sealant from a 20 or 200 litre drum and extrudes it with a hand gun. This allows much faster application and much larger output. We will study this system in the Section 2.6.

2.4.9. Squeeze Bottles

Squeeze bottles are widely used in ‘do it yourself’ jobs, but why not use it also for professional application? Owing to its light weight, it may be carried

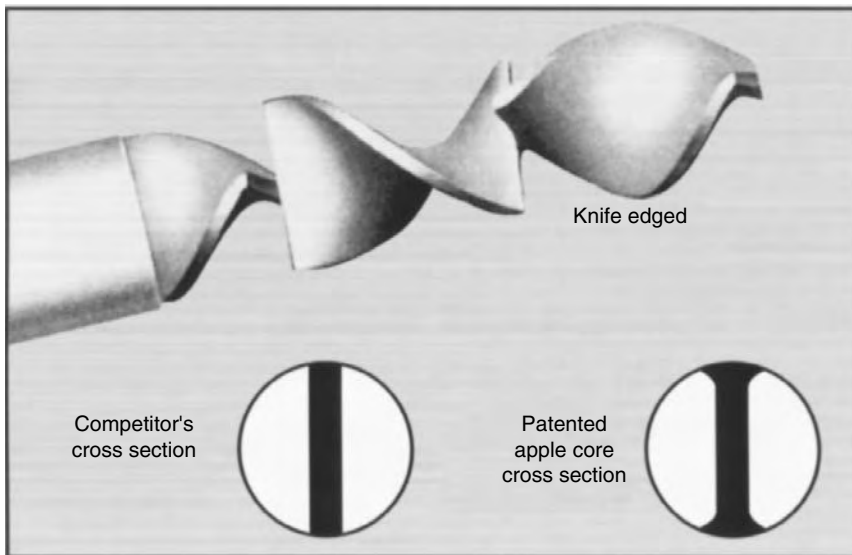

(a)

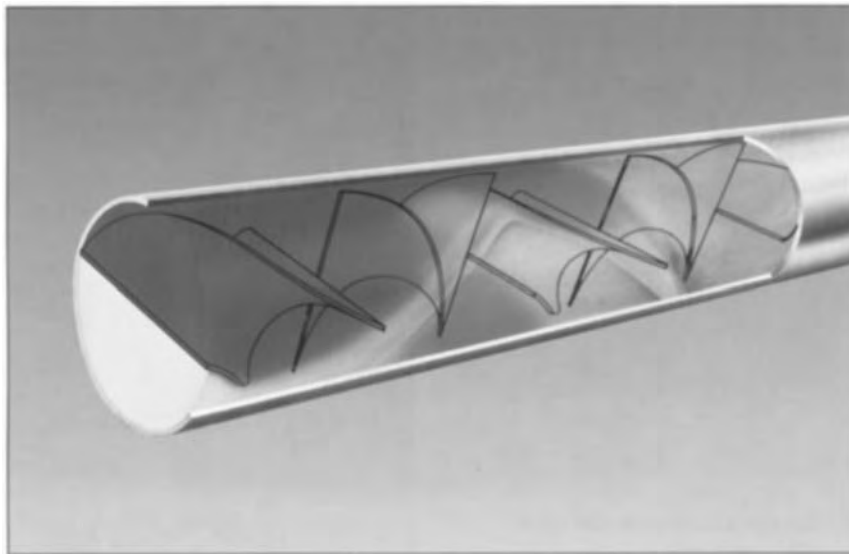

(b)

Figure 16: (a) Helicoidal structure inside the static mixer. (b) Cross section of the disposable static mixer.

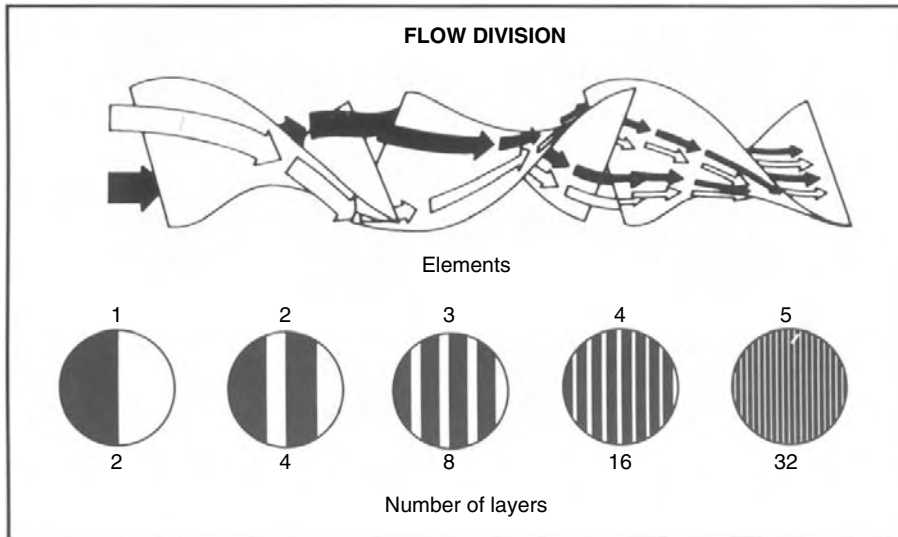

Figure 17: Mixing effect of the helicoidal partitions (source TAH Industries).

everywhere on the job site, inside the plant. This may be very useful, not only on a building site but also on a large vessel, for workers in the streets in civil engineering, etc.

The bottles are made up of polyethylene. A nozzle with adapted size and shape allows easy application of lines, beads, dots of different sizes and shapes, and it may be easily refilled when it is empty. A fine nozzle allows an accurate application in recessed parts where no other tool could access.

We may also mention here the squeezable tubes, made of metal for solvent-based adhesives or plastics for other types of adhesives (solvent-based), which are only used for DIY and office uses, and also sometimes by craftsmen for small jobs, on building site for instance.

2.4.10. Other Manual Application Techniques

- Dip coating (will be studied in Section 2.12),
- spray guns (refer to Section 1.6),
- manual hot melt guns (Fig. 19),
- pressure sensitive tapes applied by hand, application of these tapes will be discussed at the end of this chapter,
- sticks, which have been developed 20 years ago by copying ladies' lipstick,

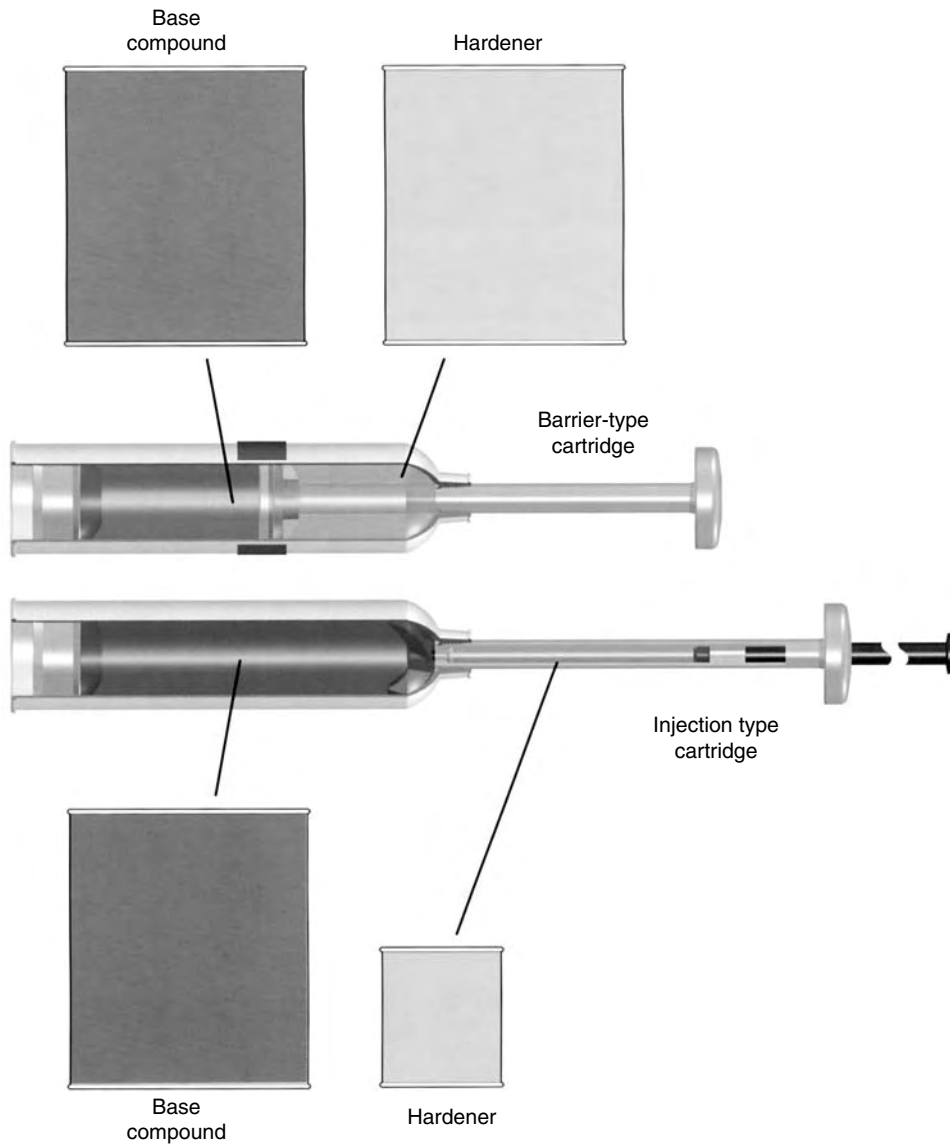

Figure 18: Semkit two-component cartridge from Semco/PRC DeSoto company. When the trigger of the gun is pulled, this breaks the barrier between the two components.



Figure 19: Hand operated portable hot melt gun using hot melt adhesive rods, and different sizes of nozzles.

- transfer from a coated plate: a stainless steel plate is coated with the adhesive, the sheets (of paper or leather) to be coated are laid carefully onto the adhesive coat and pick up a certain amount of adhesive, then the sheets are applied manually on the substrate to be bonded. This technique may be used with very fragile sheets, such as thin gauge decorative foils. The adhesive should be very fluid (100 to 2000 mPas), it should not dry on the plates, thus it should be a water-based adhesive.
- aerosol cans: although the aerosol packaging, including the propeller gas, is expensive, this technique is used in graphic and printing shops, for instance to position the films on a printing plate. It is also used by graphists, and these people frequently use pressure sensitive aerosol adhesives for a temporary positioning.

Many other application techniques could be invented just by adapting what is done elsewhere, for instance in the printing shop, in the kitchen by the cooks, or in construction.

2.5. Spraying

This technique is widely used to apply an even coat of adhesive on large and flat surfaces (Fig. 20). There are several methods of spraying:

- air spray,
- airless spray,



Figure 20: Manual air spray (source Kremlin).

- hot spray,
 - hot melt spray,
- and in all cases it may be manual or automatic.

2.5.1. Air Spray (or Low Pressure Spray)

The adhesive is pumped under low pressure, generally 1 bar, to the gun (Fig. 21). Pressurised air (pressure from 3 to 7 bars) arrives also to the bottom of the gun. Inside the spray head, the pressurised air causes the atomisation of the adhesives into small particles (less than 1 mm diameter) which are sprayed on the substrate to be coated.

The stream of adhesive is controlled (Fig. 21(b)) by the fluid pressure, its viscosity, the nozzle diameter, the spindle which may open more or less near the nozzle. The spindle is actuated by the button E.

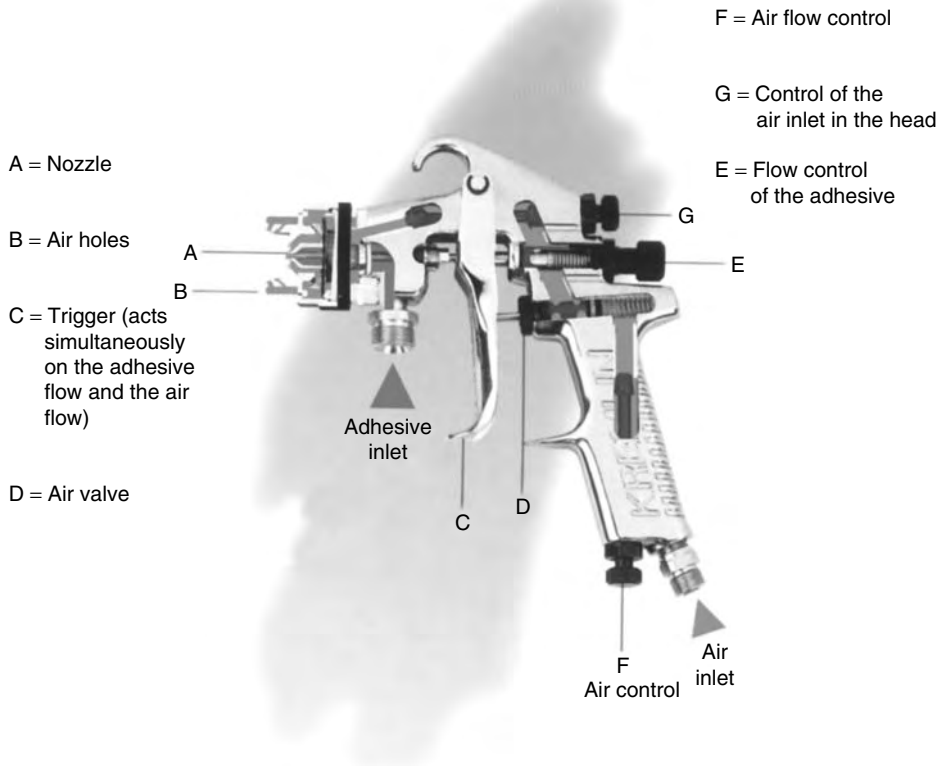

(a)

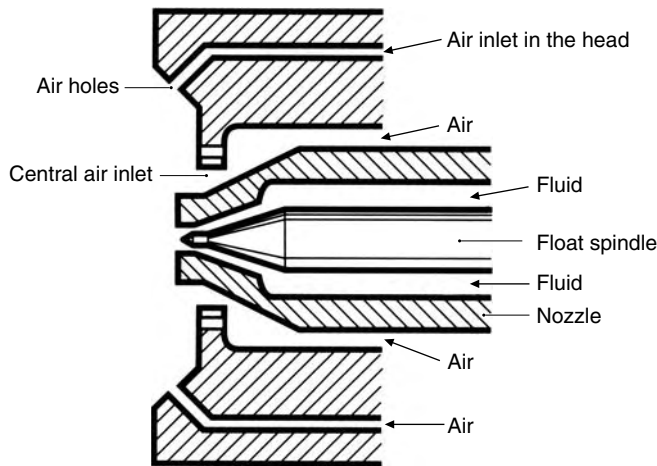

(b)

Figure 21: (a) General design of a pressurized air spray gun. (b) Detail of the head and inlets/outlets.

The atomization is controlled by the air pressure, the air inlet (controlled by button G), and the air holes on the sides of the head. The air coming out of these air holes also flattens the adhesive stream so that the adhesive stream becomes a narrow strip, instead of being in a conical shape. For instance, with a fluid polychloroprene solvent based adhesive, this strip on contact with the substrate located at a distance of 40 cm, will give a trace of 4 cm width and 50 cm length (Fig. 20).

There are several suppliers of spray guns: Kremlin, De Vilbiss, Graco, Walther, WIWA etc., and they always supply different sizes of heads and nozzles, which must be adapted to the spraying of adhesives.

For instance, the heads and nozzles which are used for paints are not suitable for adhesives, because the rheology of adhesives is different from that of paints. Generally speaking, atomization of adhesives is more difficult than paints, and solvent-based, rubber-based adhesives tend to dry fast and clog the nozzle if the adhesive is not properly formulated for spraying (refer to the chapter 'Polychloroprene Adhesives').

Therefore the adhesives suppliers work together with the spray guns manufacturers in order to adapt the adhesives to the guns and the guns to the adhesives.

The ease of spraying depends on the rheology and viscosity of the adhesive. Viscosity should be within a range from 100 to 1500 mPas. Some adhesives may need to be diluted to get the required viscosity, but this dilution should be made according to the adhesive manufacturer's instructions only, and with the proper solvent.

2.5.1.1. Pressure of the Adhesive and Flow Rate: Equipment

The choice of the equipment depends on the daily output, the size of the adhesive packagings, the length of the pipes feeding the gun, the number of guns and workers. Usually the adhesive pressure is low from 0.3 to 3 bars.

Figs. 20, 22 and 23 show some typical installations:

- the adhesive may be stored into a pressure pot (various sizes are available from 1 to 20 l),
- or it may be pumped from a drum (20 or 200 l).

Each gun may spray from 100 ml upto 1 litre per minute. Beyond 1 litre per minute, the atomization would not be fine enough.

2.5.1.2. Pump Selection and Characteristics

There are several suppliers of pumps for various fluids and some suppliers are specialised in pumps for paints, adhesives and sealants, such as Graco, De Vilbiss, Rexson and Kremlin.

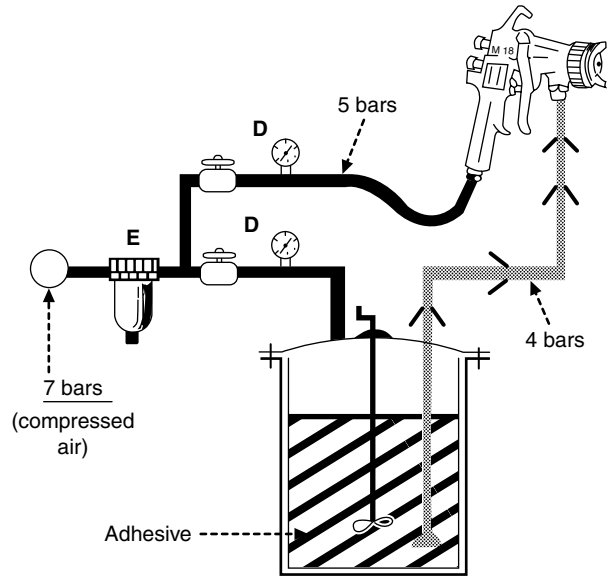

(a)

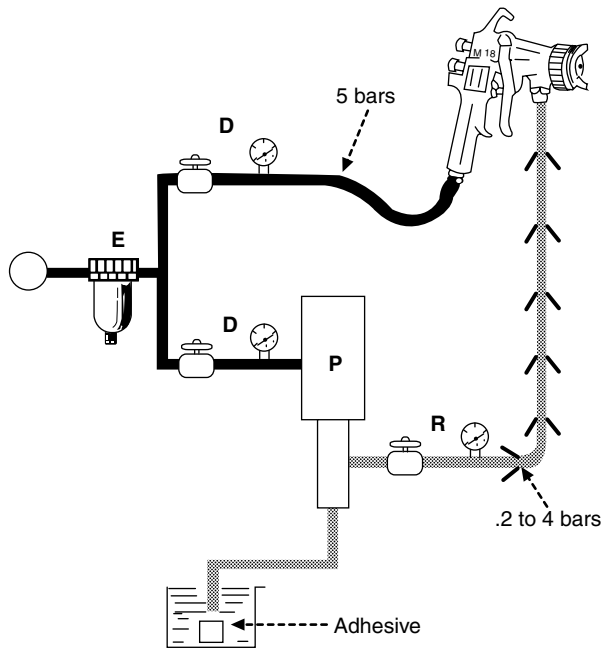

(b)

Figure 22: (a) Manual spraying installations with pressurised tank. (b) Manual spraying installations with low pressure pump (P).

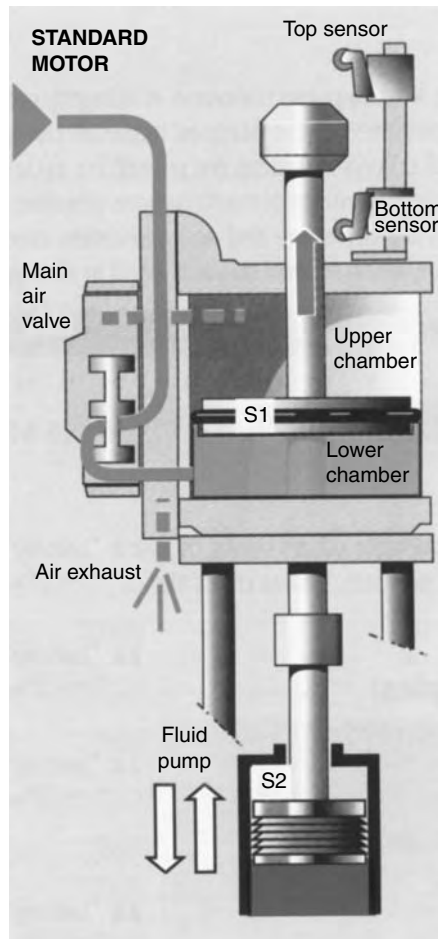

Figure 23a: Air motor pump. The air motor on the top drives the reciprocating fluid pump (source Rexson).

They offer a range of pumps. For adhesives, driving air motor pumps are used: an air motor is used to drive the fluid pump reciprocating motion to feed material. The area of the air motor piston versus the area of the pump piston creates the theoretical pump ratio.

The pump pressure ratio multiplied by the air pressure gives the stalled fluid outlet pressure; for instance, a pump ratio of 20, multiplied with an air pressure of 4 bars, will give 80 bars fluid pressure.

In the Rexson air pump, the air motor cycling is driven by two pneumatic sensors that control the main air valve that directs the air to or away from the

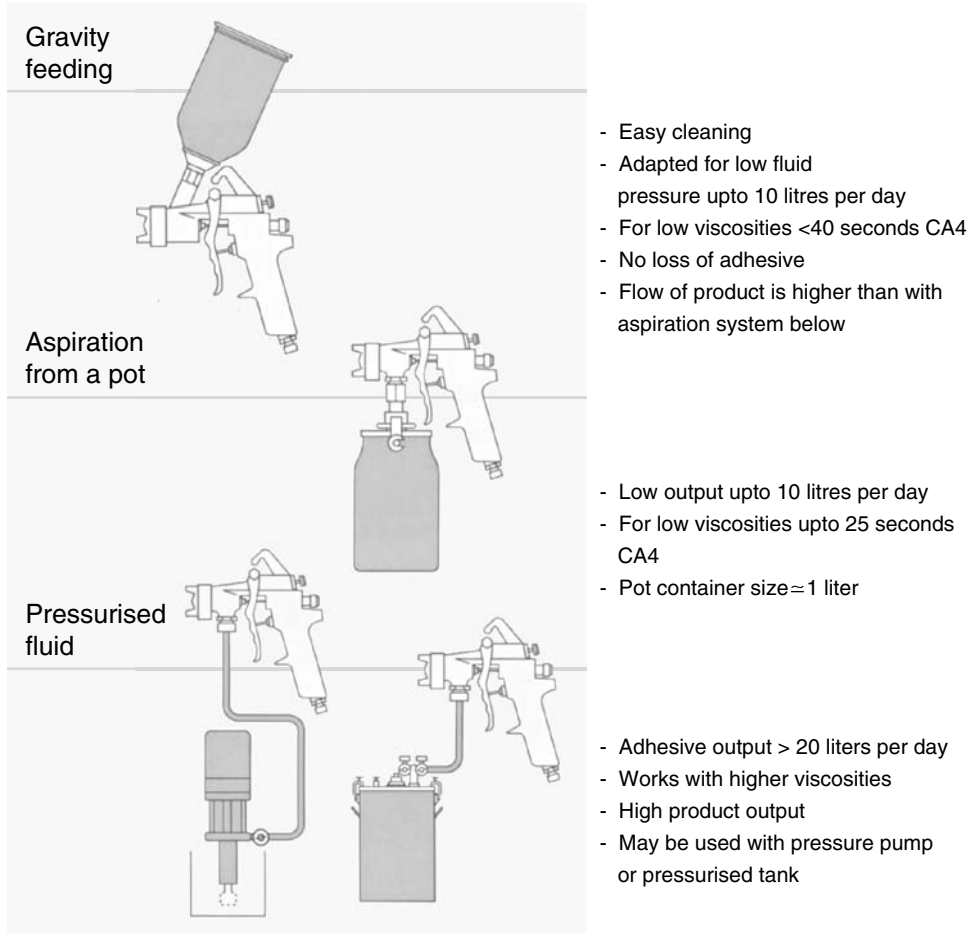

Figure 23b: Comparison between different sizes of pots and different ways of applying pressure in a spray.

driving air motor piston. The alternating flow of air to/from either the top or bottom of the air piston results in an up and down movement of the piston as shown in Fig. 23(a). The pump, pumps directly from 20 or 200 litre drums.

2.5.1.3. Air Pressure

The air pressure needed for atomization is usually from 4 to 6 bars at the spraying head. This pressure must be maintained while the air flow varies from 6 to 60 m³/h according to the adhesive and the required level of particle size. The air

1) STATIONARY TWIN-POST RAM

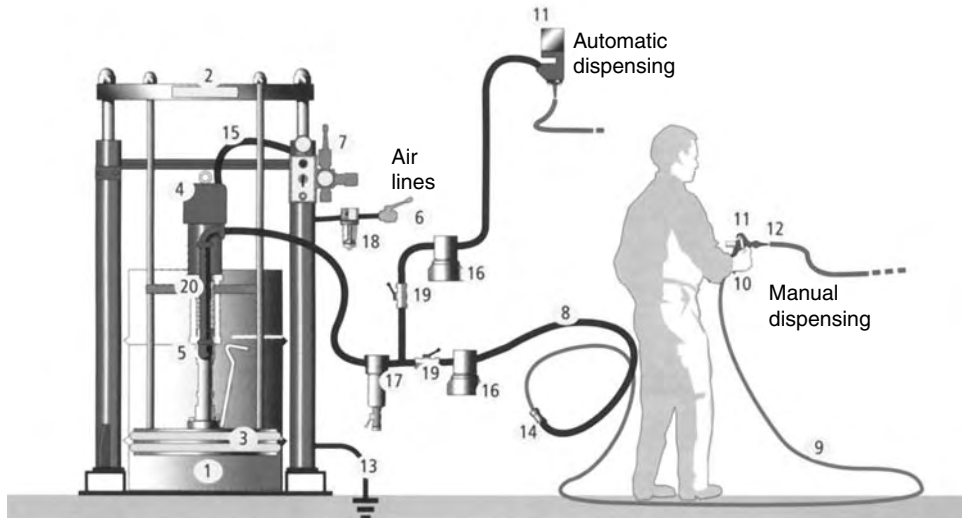

2) STATIONARY SINGLE-POST RAM

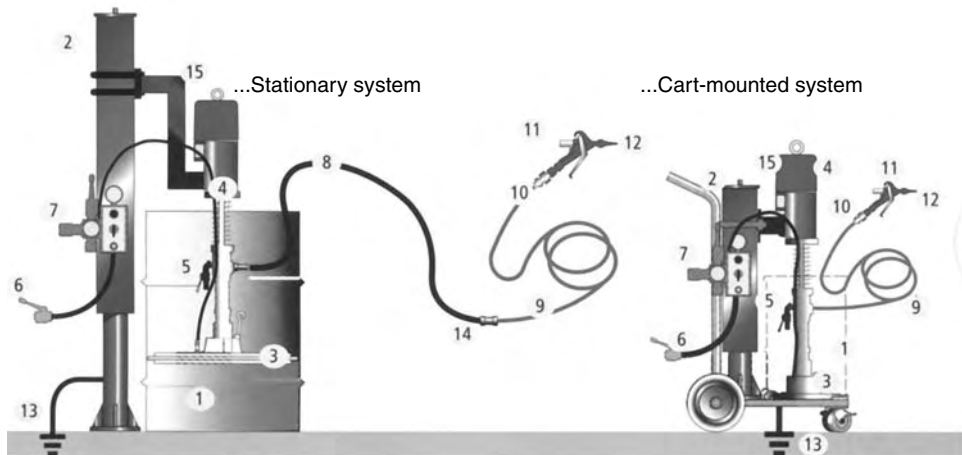

- 1 Material drum 2 Ram with drum centering clamps and air controls 3 Follower plate with a purge and vent 4 Pump 5 Bleed and pressure valve relief 6 Main air line shut-off valve 7 Shut-off and bleed air valve 8 High-pressure hose (large diameter) 9 High-pressure hose (smaller diameter, flexible) 10 Swivel 11 Dispensing valve 12 Dispense tip 13 Ground 14 Adaptor 15 Air supply hose 16 Fluid pressure regulator 17 Material filter 18 Air filter 19 High-pressure shut-off valve 20 Pump outlet

Figure 24: High production rate spraying installations with 200 l drum ram and follower plate (source Rexson).

flow varies with the gun type, the spraying head and the degree of atomization required.

2.5.1.4. Width of the Fluid Stream

The user must decide as to how much adhesive is to be sprayed per square metre. The usual add-ons are from 50 to 150 g of wet adhesive/m².

Then the width of the stream depends on the type of adhesive; low viscosity water-based adhesives will give a 50 cm width while rubber-based adhesives, such as neoprene adhesives, may give only 30 to 45 cm width. It also depends on the viscosity: the more fluid the adhesive, the easier it will be to spray it in fine particles.

2.5.1.5. Daily Output and Equipment

For high production rates, or in large plants, a powerful pump may feed several guns (Fig. 25).

2.5.1.6. Pressure Drop

Pressure drop is the resistance that prevents the adhesive from moving forward in the pipes. It depends on the internal diameter of the pipes and its length.

The pressure drop in bars is equal to

$$\frac{6.9 \times \text{flow (in l/min)} \times \text{viscosity (in mPa s)}}{D^4 \text{ (interior diameter in mm)}}$$

And the flow rate is equal to

$$\frac{\text{Pressure loss in bars/m} \times D^4 \text{ (interior diameter in mm)}}{6.9 \times \text{viscosity in mPa s}}$$

Advantages of low pressure spraying:

- easy to use,
- cost of investment is moderate,
- allows application of adhesive on large flat surfaces,
- allows fast application: with one gun, one can apply manually up to 400 g/min, i.e. 2 to 3 m² per minute, and it is possible to use several guns with several workers,
- many different types of adhesives may be applied: vinyl glues, neoprene solvent based adhesives, PU and epoxies. The adhesive formulators may easily adapt their products to spray application by lowering the viscosity for instance, and using the right solvents,

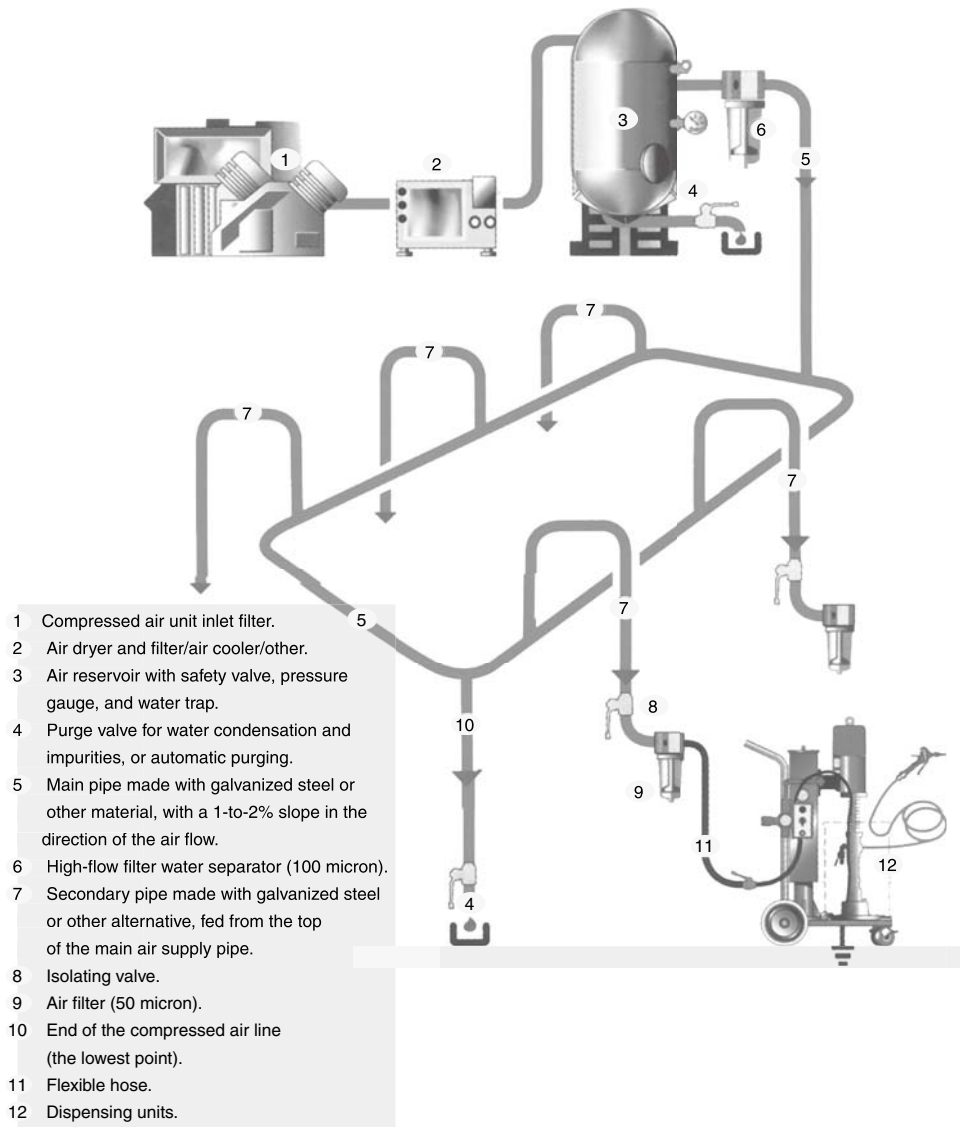

Figure 25: A typical compressed air system and multiple guns installation (source Rexson, USA).

- the set up of the gun, the proper choice of spray heads, nozzles and fluid tips allows to adapt to the type and rheology of the adhesives, and obtain a fine spray, provided the viscosity is low enough.

Drawbacks:

- with some adhesives such as rubber solvent-based adhesives, there is sometimes some fog during spray and the adhesive releases solvents in the ambient air, which may be harmful for the health of the workers. Therefore, it is mandatory to eliminate these solvent vapours by a good ventilation spraying must be made in a spray booth. The amount of solvents generated depends on the dry solids which is usually around 20% for polychloroprene solvent based adhesives. Fog depends on the type of adhesive and the solvents used.
- some adhesives give strings or ‘hairs’ during spray and this needs frequent cleaning of the working area. This depends again on the type of formulation and the solvents used. For instance, some polychloroprene adhesives may give many long hairs, but if the polychloroprene has been milled prior to dissolution, and if solvents are carefully selected, there will be much less hairs and clogging.

2.5.1.7. Multiple Gun Installation

In Fig. 25, one single large compressed air system feeds several guns. In this figure, there are several pumps, one for each gun, but we may also have one single, powerful pump which would feed several guns, from one big 200 l drum for instance.

2.5.2. *Airless Spray*

Airless spraying is based on the application of high pressure (30 to 400 bars) to the adhesive, which is forced at high speed through a small orifice (Fig. 25(b)). As the adhesive exits the orifice and comes back to ambient pressure, it expands and breaks into fine particles. The size of the orifice determines the amount of filtration required: impurities or other particles that are larger than the orifice would plug its opening.

The type of adhesive and its viscosity, determine the pressure required to get a good atomization. The pump ratio is selected according to the required flow rate of adhesive and also to the distance between the pump and the gun. Usually the pump ratios vary from 6/1 to 60/1 and the flow from 1 to 15 l/min.

The choice of the pump depends on the flow rate of adhesive required to feed one (or several) gun(s) and the pressure needed. Airless spray may yield as much as 1 to 5 l/min for one gun.

2.5.2.1. Characteristics of Airless Pneumatic Pumps

These pumps have two main characteristics:

- the fluid chamber volume: this multiplied by the number of strokes per minute gives the yield. A pump may usually beat a maximum of 100 strokes/min, thus if the cylinder volume is 30 cm³ the maximum yield will be 3 litres/min.
- the pressure delivered: the workshop air supply delivers air usually at 2 to 7 bars. The compressor should have a compression rate of 10/1 to compress the air from 5 bars to 50 bars. For safety reasons, the most powerful pumps never exceed a 60/1 ratio, which gives 420 bars with air supply of 7 bars, and this is almost the maximum pressure acceptable for the hoses. However, a higher ratio may be used when there are long hoses causing high pressure drop.

Table 3 provides the values for pressure and yield according to the pump type and strokes.

Uses of airless spray: Widely used for spraying paints, airless spray is rarely used for adhesives because the composition of adhesives makes them frequently difficult to spray with airless.

Only the water based adhesives and glues such as vinyls, acrylics, some thermo-setting glues such as UF, some fluid epoxies may be sprayed with airless spray. However, we may mention here the use of airless to spray a dispersion contact neoprene adhesive of high viscosity – 50,000 mPa s – with a coverage of 100 g/m².

Table 3: Calculation for various pumps

Ratio	Pump cylinder volume (cm ³)	Yield (l/min)	Pressure in bars		Ratio	Strokes per min	Air consumption (m ³ /h)
			Air	Fluid			
60/1	65	3.6	6	360	60/1	55	90
		2.4				37	60
		1.7				26	27
		1.0				15	20
40/1	100	6.6	6	240	40/1	66	110
		4.4				44	74
		3.0				30	50
		2				20	34
14/1	300	3.9	6	84	14/1	13	23
		2.6				8.7	15
		1.8				6	11
		1.2				4	7

Table 4: Comparison between low pressure spray and airless spray

Advantages	Low pressure spray	Airless
High yield		x
Low yield	x	
Low cost equipment	x	
Equipment allowing to spray many types of adhesives	x	
Minimum losses, no fog		x
Equipment easy to use and adjust	x	
May be automated	x	x
Possibility of hot spray	x	x
Wide stream and fast coverage		x
Fine particles spray	x	
Lower air consumption		x

2.5.3. Hot Spray

On increasing the temperature of the adhesive, its viscosity decreases. Many adhesives may be heated to 40–70°C before spraying. Fig. 26 shows the installation of such a system: the adhesive passes through a heating element (electric or hot water heater). Only a small part of the adhesive circulates in the heated section (the volume contained in the hose) and is heated.

When the worker starts spraying, the pump sucks in a certain amount of cold adhesive from its container, but the temperature at the gun remains almost constant because this amount is quickly heated in the heater and mixed with the hot adhesive which circulates.

The heater must be close to the gun so that there is no loss of heat between these two elements.

Advantages:

- constant viscosity (if the temperature is constant),
- lower viscosity which allows a finer atomization,
- the adhesive, more fluid, is easier to spray in fine particles,
- less risk of sagging on vertical surfaces: when the adhesive reaches the substrate, it has cooled down during its course in the air, and therefore it turns back to its original viscosity,
- faster drying because the solvents or water of the adhesive are already hot and evaporate faster, refer to Table 5 which indicates drying times with various techniques,

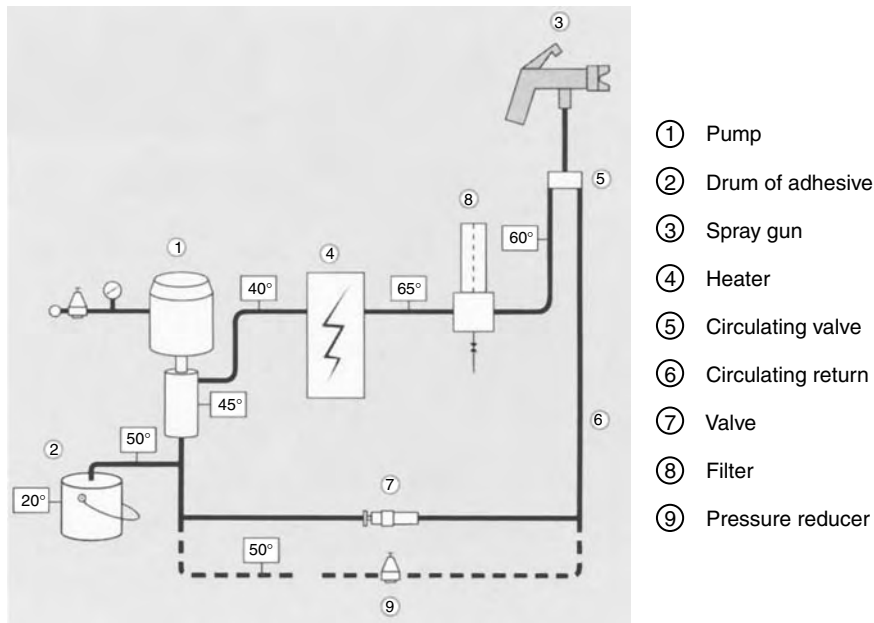

Figure 26: Hot spray indicating temperatures.

- less attack of the substrates by the solvents, because, when the adhesive reaches the substrate, a large part of the solvent has already evaporated. This allows, for instance, the spraying of solvent-based adhesives onto expanded polystyrene, without dissolving the polystyrene.

2.5.4. Automatic Spraying

Spray applications may be completely automated. Several guns and job sites may be fed by one single installation, where the adhesive circulates.

Fig. 27 shows an automatic spraying machine where two guns move automatically back and forth on top of a conveyor. This is a frequent installation for flat and large panels: sandwich panels, wood and decorative panels, laminating. The speed of application may reach 10 to 20 m²/min.

A typical automatic line would include: (Figs 27 and 28)

- a roller conveyor with motored rolls or free rolls, or a belt conveyor,

Table 5: Comparison of drying times with different application systems

Adhesives types	Brush application	Cold spray	Hot spray
Rubber-solvent based adhesive	10 min	2 min	1 min 10 s
Water based dispersion	20 min	12 min	5 min
Polychloroprene solvent based	5 min	2 min	40 s



(a)

Figure 27a: Air spray gun for automatic spray machine (source Walther, Germany).

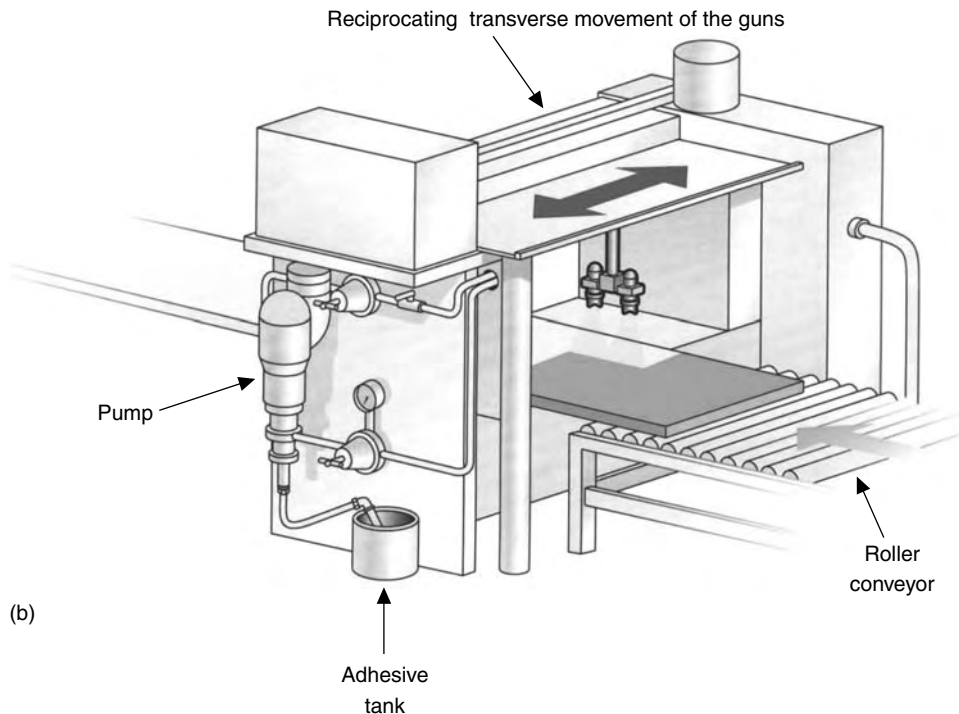

Figure 27b: Automatic spraying: the two guns move perpendicular to the conveyor.

- a robot with alternating movement holding 2, 4 or 6 guns, capable of spraying upto 1 to 3 m width,
- a closed ventilated cabin to eliminate solvents through a ventilation system, which evacuates the solvents outside. Beware of the environmental legislation that now forbids in many countries emission of large amounts of VOC (volatile organic compounds) into the atmosphere,
- a drying tunnel (hot air oven or infrared oven), which must be also ventilated to eliminate the solvent vapours quickly, the length of this tunnel depends on the acceptable temperature and the solvent evaporation rate at this temperature,
- detection systems that allow the start of spraying when the panels arrive under the spray guns and stop it when the panels exit the spraying zone; this is very important in order to spray only onto the panels and not around it, which would make a frequent and difficult cleaning of the conveyor necessary,
- a strong exhaust system to eliminate solvents or send them to a recovery unit if the volume of evaporated solvents is too high according to legislation.

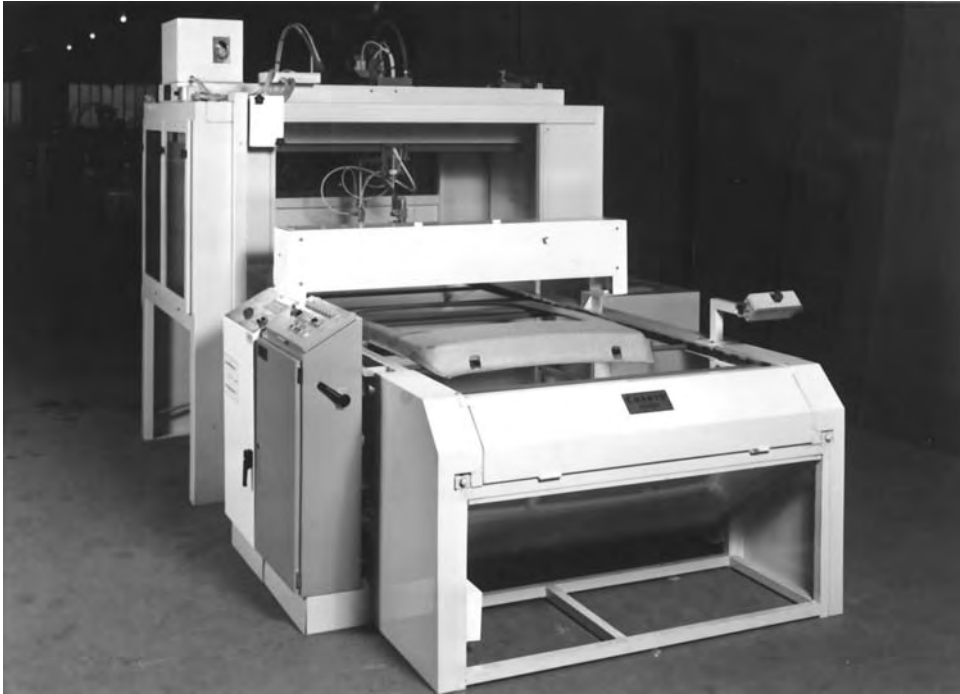

Figure 28: Bonding automotive parts by automatic low pressure spraying, showing the spraying robot, conveyor and closed ventilated booth (source Charvo, Grenoble France).

2.5.5. Spraying Two-Component Adhesives

In order to eliminate harmful solvents which are flammable and sometimes noxious, adhesives manufacturers have developed water-based adhesives, based on rubber latex or polymer dispersions, which set quickly due to the addition of an activator that reacts quickly with the base polymer and induces its quick coagulation. But the mixing should be done during the spraying in order to avoid any coagulation and clogging into the gun.

Therefore, the manufacturers of spray guns have developed special guns such as the one shown in Fig. 29. The injector valve injects the activator through a special air baffle where it is then distributed from the air cap horn holes. The activator is then proportionately blended with atomized adhesive within the spray pattern.

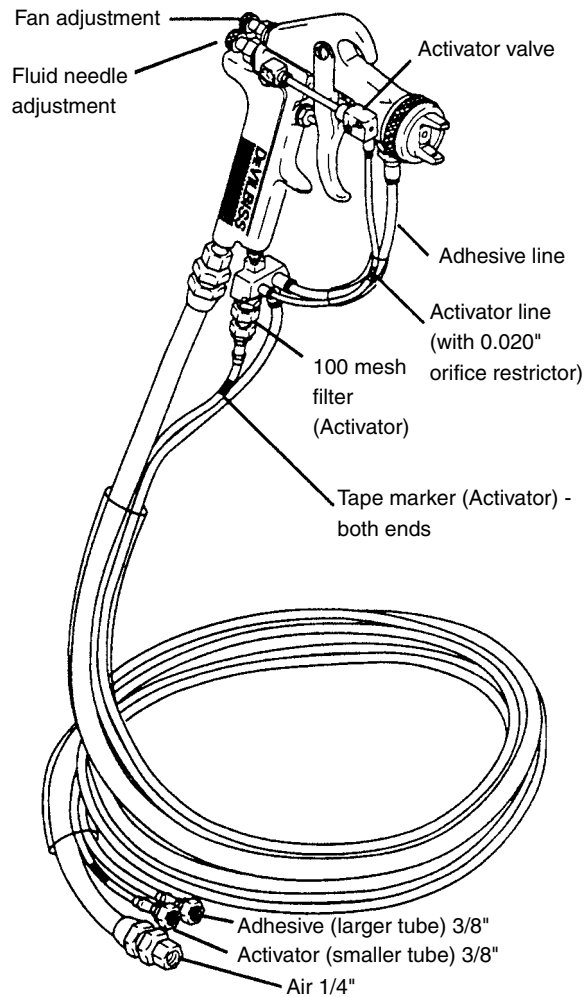

Figure 29: Two-component adhesive spraying equipment, De Vilbiss MSV-2K Probond™ for waterborne adhesives (source ITW De Vilbiss).

For instance, the De Vilbiss Probond MSV-2K gun is a high-volume, low-pressure spray gun, which limits atomizing air cap pressure to a maximum of 0.7 bar with a 4 to 6 bars air inlet pressure.

For an air cap pressure of 5 bars, the air consumption is only 18 l/min. The flow of adhesive is controlled by pressure in the tank and by the adjustment of the fluid tip and the needle, the spray fineness may be controlled with the atomization air, the width of the stream and the spray pattern are adjusted by changing the

air pressure and the adhesive pressure (average value 1.5 bars), and the flow of activator is controlled by the pressure on the activator container (usually 1 to 1.5 bars).

These two-component adhesives are usually formulated with a 10/1 ratio of adhesive to activator. The add-ons may vary from 50 to 200 g/m², depending on the job and the materials to be bonded.

Uses: The two-component adhesives are used mostly for foam bonding (seats, upholstery, mattresses), which require a very fast bond with a high tack. In the past these bonds were made with solvent based polychloroprene adhesives, and there were risks from flammability and noxiousness. Now bonding may be done with water-based adhesives that coagulate quickly due to a chemical reaction with a catalyst.

2.5.6. Hot Melt Adhesive Guns for Jetting

We will study in detail all the hot melt applications in another chapter in Volume 4 of this Handbook. However, we briefly mention here the main equipment used for hot melt application.

The difference with hot melts is that they are applied in a melted state, at temperatures ranging from 120 to 200°C according to the formulations and end uses. Usually hot melts are applied in beads or lines with special hot melt guns, such as the ones shown in Fig. 30.

But hot melts may also be sprayed, and the main technique is fiberisation or swirl application, where the bead of adhesive coming out of the gun head is swirled in the air to produce a loop pattern as shown in Fig. 31. Several equipment manufacturers: Nordson, Graco and others supply these orbital guns.

This technique gives very thin 'hairs' of adhesive, which may be sprayed usually at moderate temperatures (from 120 to 160°C). During the passage, in the air between the gun head and the substrate, the hot melt cools down quickly, and its temperature is only 50 to 70°C when it reaches the substrate, so that it may be sprayed on heat sensitive materials such as polyolefin films or polystyrene foam without damaging it.

The adhesive pattern on the substrate may be a narrow band, 8 to 20 mm wide, which can be delimited quite accurately, as shown on Fig. 31.

Several types of adhesives may be applied with this technique:

- pressure sensitive hot melts for disposable items (baby diapers, feminine napkins),
- packaging hot melts for sealing polyolefin film packagings, cartons,
- bonding heat sensitive flexible foams,
- also other types of adhesives (non hot melts). For instance Graco supplies Precision Swirl applicators to the automotive industry where it is used to apply

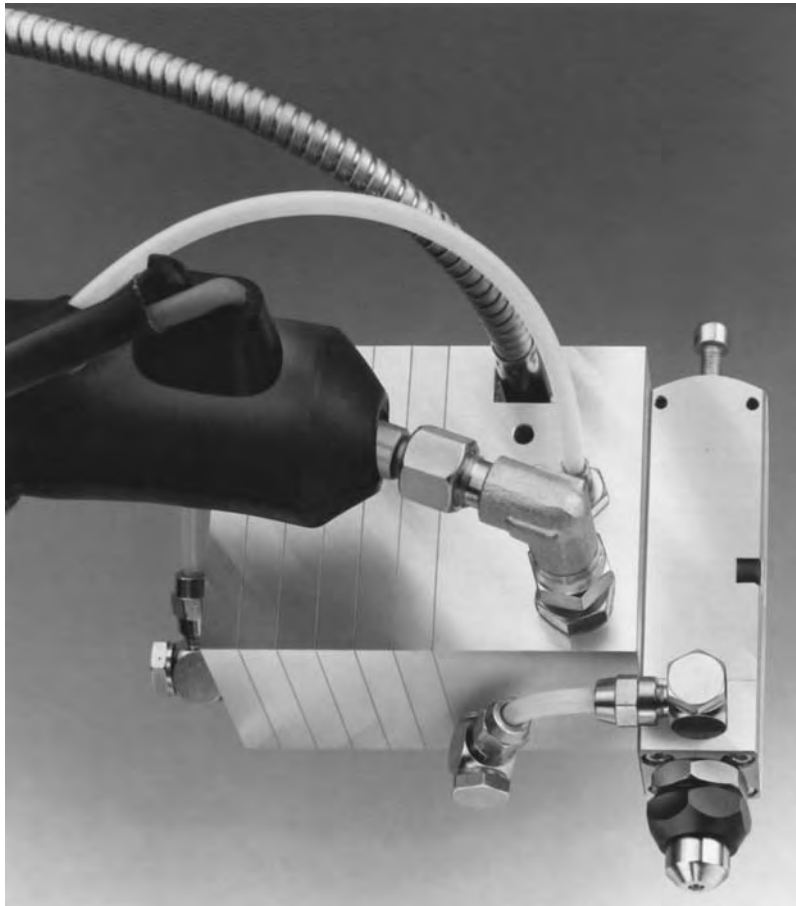

Figure 30: Hot melt gun for automatic spraying/extrusion (source Steinmeyer, Germany).

Hem flange adhesives based on epoxies and other adhesives to bond sound deadeners or other panels (see Fig. 32).

2.6 Application of Adhesives and Sealants by Extrusion Techniques

Almost all adhesives and sealants may be extruded through a hole or die or slot (Fig. 33), it is only necessary to push the product with enough pressure, and this

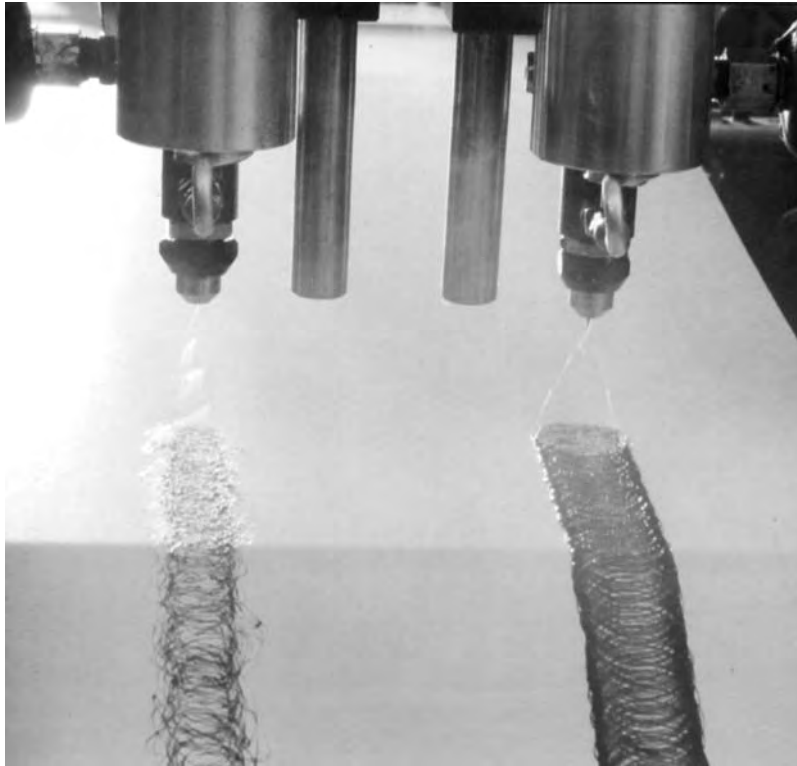

Figure 31: Swirl spraying of hot melt adhesive, showing two different patterns.

pressure depends only on the viscosity and rheology of the adhesive or sealant and the slot orifice size. Even a sealant with a viscosity of 1 million mPa s may be extruded through a hole of 3 to 5 mm diameter, provided there is enough pressure.

When it exits from the head, die or slot, the product may be applied as beads, lines, dots or bands (Fig. 34) to get the required pattern adapted to the job and the required joint shape and thickness.

2.6.1. Extrusion of Fluid Adhesives (less than 50,000 mPa s)

A simple and convenient equipment is shown on Fig. 33 and 35; it includes:

- a pressurised tank where the adhesive is pressurised up to a few bars,



Figure 32: Graco Swirl spraying with 'Precision Swirl' gun on the roof of an automotive (source Graco Belgium).

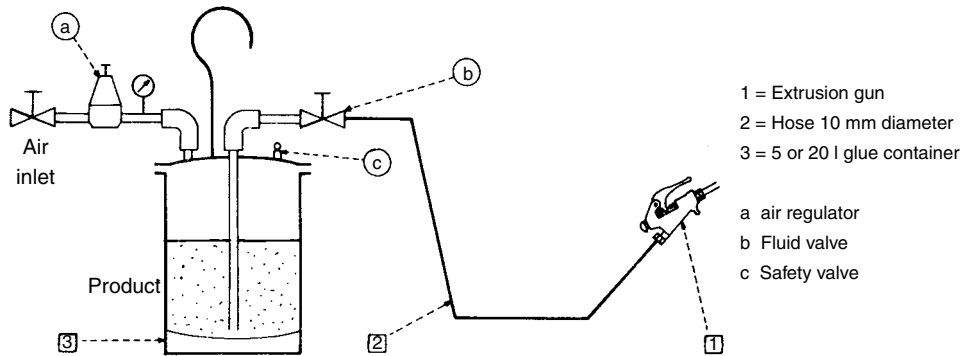

(a) General installation

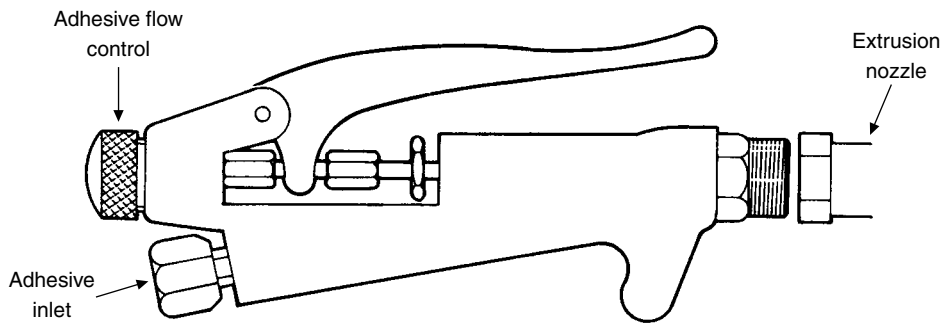

(b) Extrusion hand operated gun

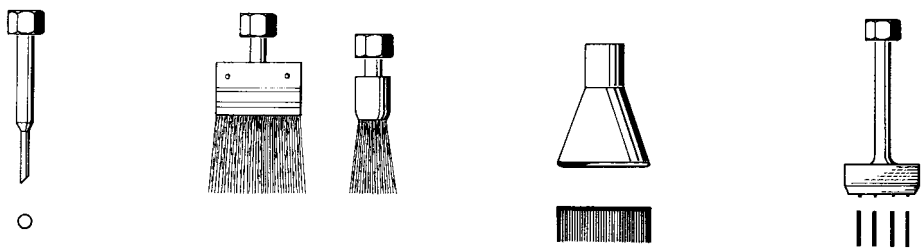

(c) Different shapes for the extrusion nozzles

Figure 33: Equipment for manual extrusion of adhesives (source Kremlin).

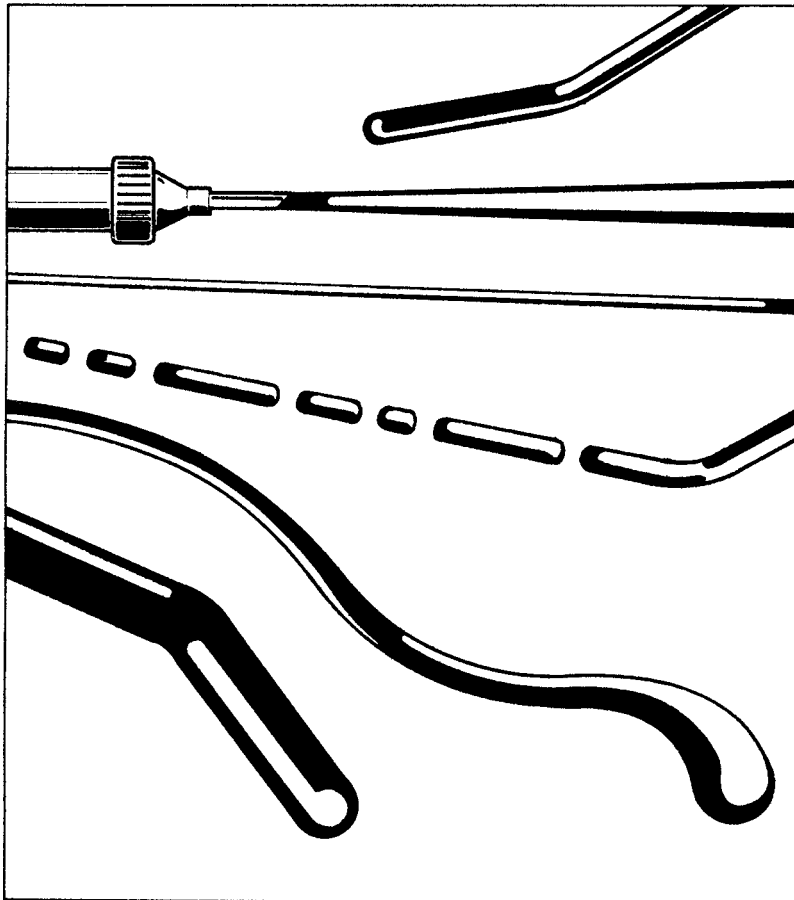

Figure 34: Different patterns available with extrusion guns.

- a hand operated extrusion valve or equipment, which releases the adhesive flow when it is triggered,
- a nozzle or die or any other tool that can deliver the desired shape (for instance, a brush or a trowel),
- many different shapes are available (Fig. 34).

This system is similar to the syringe application that we have discussed previously, but the syringes are used in small applications to deliver less than 1 g per part, while the extrusion equipments are used for much larger consumptions.



Figure 35: Pressurised tank and hand gun for extrusion of fluid and paste adhesives (at ambient temperature) (source Schneberger Germany).

We will study later in this chapter other industrial extrusion equipments for high production rate machines. This simple equipment is used in many plants:

- to close cartons with several lines of adhesive,
- to apply, in a clean way, lines of adhesive in woodworking shops, for instance to inject wood glue into the holes where dowels will be fitted (Fig. 36),

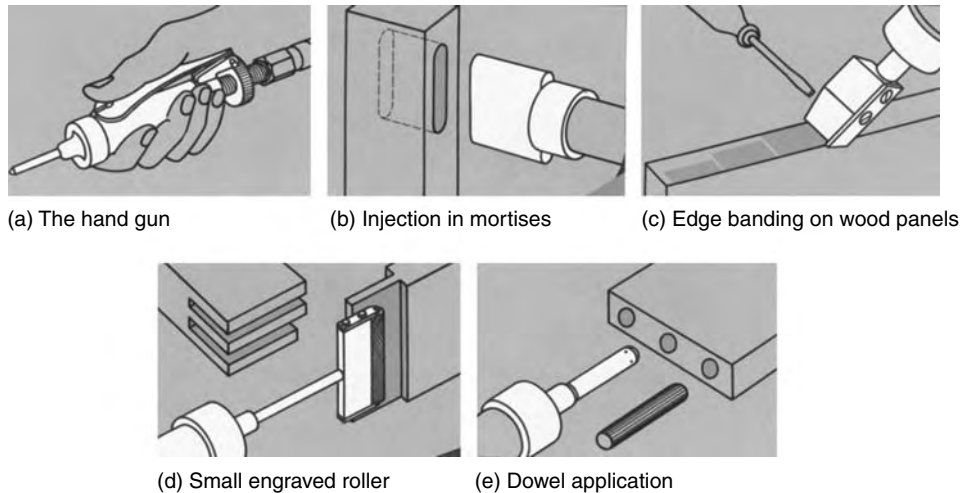

Figure 36: Examples of jobs which may be performed with some special extrusion nozzles from Schneeberger, Germany in woodworking and furniture industry.

- to apply a bead of glue in the shoe factory, for instance to bond the soles to the uppers, where this system replaces the uneven job made with a brush.

Readers should refer to the relevant chapters (‘Woodworking Adhesives’ in Volume 3, ‘Packaging Adhesives’) for further details.

Advantages:

- clean, cheap and simple equipment,
- flow of adhesive may be easily adjusted, merely by increasing pressure and increasing the diameter of the exit hole,
- no waste of product, because the worker can apply exactly the amount needed where he wants, there is no unwanted drying as with a brush, no fog as with spraying,
- even and clean application,
- it is possible to feed several job places, several workers with a central pressurised container equipped with several extrusion lines,
- it is also possible to automate the application: the glue spreaders or dies or nozzles may be operated by electric or pneumatic control, they may be included

in a complete machine, and they may apply simultaneously several lines or bands of adhesive.

2.6.2. Extrusion of Thick, Viscous Products (Sealants, Structural Adhesives for Thick Joints, Viscosities Higher than 50,000 mPa s)

2.6.2.1

Powerful pumps are needed for extrusion of viscous products and usually these pumps are equipped with a follower/wiper plate inserted in a drum, so that the product in the drum is completely wiped from the walls of the drum and there is no product left after use (Fig. 37(a)). The plate pushes the product into the pump.

The pump type (ratio and flow rate) to be used is decided according to the length of hoses between the pump and the extrusion guns, the viscosity of the product and the required flow rate.

For some fast applications such as on automotive production lines, for wind-shield application or hem flange bonding, the flow rate may be quite high: several litres per minute; we have discussed in Table 2 how to compute the flow rate according to the pump ratio.

On these fast lines, the adhesive or sealant is delivered in 200 l drums, the follower plate is powered by hydraulic jacks in order to increase the pressure on the product in the drum. The pump ratio may vary from 20/1 upto 60/1 or even more, and the hose should resist upto 200–300 bars pressure.

Fig. 37 shows a typical large extrusion installation, with multiple guns. Such equipments are used on automotive production lines, where several operators may apply adhesives or sealants in several places along the production line.

Uses: Products that may be applied and end uses:

- plastisols or epoxy for metal to metal bonding in automotive body-in-white jobs, and other structural bonding,
- polyurethane sealants for windshields,
- butyl, thiokol sealants for insulated double windows,
- two-component PU or thiokol adhesives/sealants for double window glazing,
- PU, polyester or epoxy adhesives and sealants for naval construction (bonding deck to hull in yachts, bonding stiffeners to hull in larger ships).

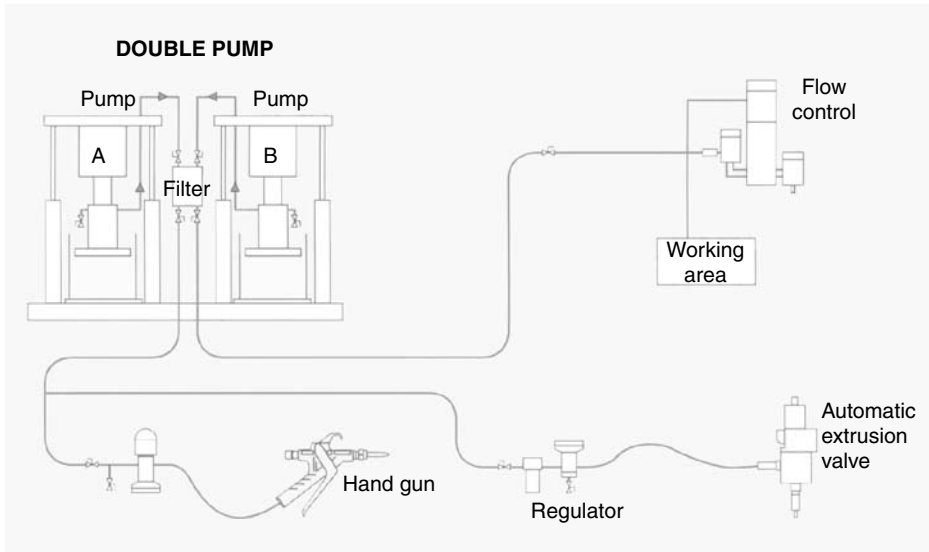

(a)

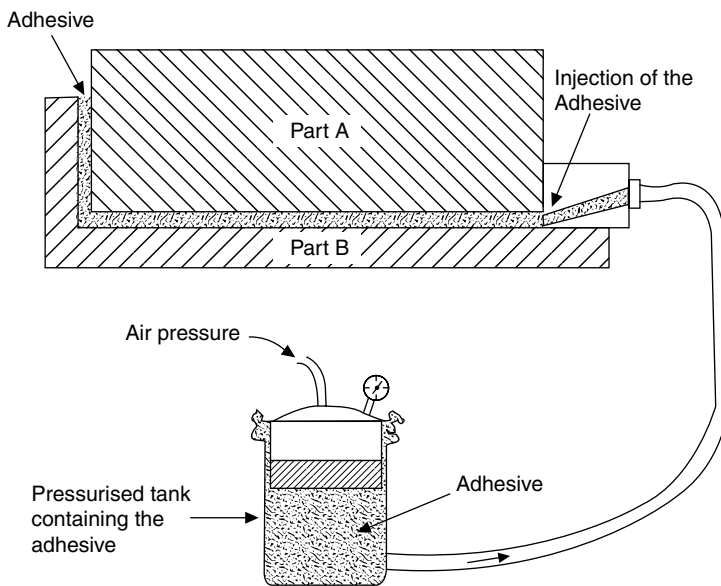

(b)

Figure 37: (a) Extrusion installation with several guns and duel pump for high flow rate. Source Kremlin, France. (b) Application of the adhesive by injection between the two parts to be bonded (sometimes used in aircraft construction).

Fig. 37(b) shows one way of injecting the adhesive between the two parts to be bonded. This technique may only be used when parts match closely together.

The suppliers of large extrusion equipment (including pumps, drum unloaders and guns) are Kremlin France, Rexson USA, Graco USA, Hilger and Kern/Dopag Germany and Switzerland, Schneeberger Germany for woodworking applications, ITW de Vilbiss (USA and Europe).

2.6.2.2. Pressure Drop Due to Length of the Hoses

For a semi-fluid adhesive of viscosity 30,000 mPas, with a pump ratio of 6/1, 6 bars air pressure and a volume of 120 cm³, Table 6 gives the flow rates according to the diameter and length of hose.

Table 6: Flow rates versus hose diameter and length

Hose diameter (mm)	Length of the hose (m)				
	5	10	15	20	25
25	18	14	10	8	5
30	22	20	15	11	8
35	26	25	19	14	10
40	26	26	25	22	18

2.6.3. Continuous Application, Roll Coating

The manual systems that we have studied were using the movement of the operator’s hand in order to realise the relative movement of the applicator and the parts to be coated. In the following application techniques, the parts to be coated move under the application system which has a fixed position. It may be rolls, die, fixed guns, doctor blade, etc. Usually the bonding operation is part of the total production line, and the adhesive applicator is integrated into a conveyor together with drying ovens, assembly system and presses.

We will now study:

- the automatic but discontinuous coating of parts and sheets which move on a conveyor, and
- the continuous coating of roll stock.

The line speed and the output in terms of square meters per hour is here much higher than the speed of manual methods studied previously. Substrates to be

coated with adhesive may be: paper, cardboard, plastic films or textiles or even thin metal foils.

2.7. Coating on Roll Stocks, Roll Application, Knife Application

2.7.1. Knife and Doctor Blade Coating

Figs. 38 and 39 show these equipments. The adhesive forms a thick fillet behind the adjustable knife. There are three systems (refer to Figs 38–41)

- knife over roll coater (Fig. 38),
- floating knife where the coating blade rests on the web away from the roll,
- doctor blade where the knife is replaced by a rounded doctor blade for a smoother application (Fig. 40).

Usually, adjustable springs press the knife or doctor blade against the web. There are several possible shapes for the knife (Fig. 41) in order to adjust to the viscosity and rheology and to the amount of adhesive required. The adhesive may

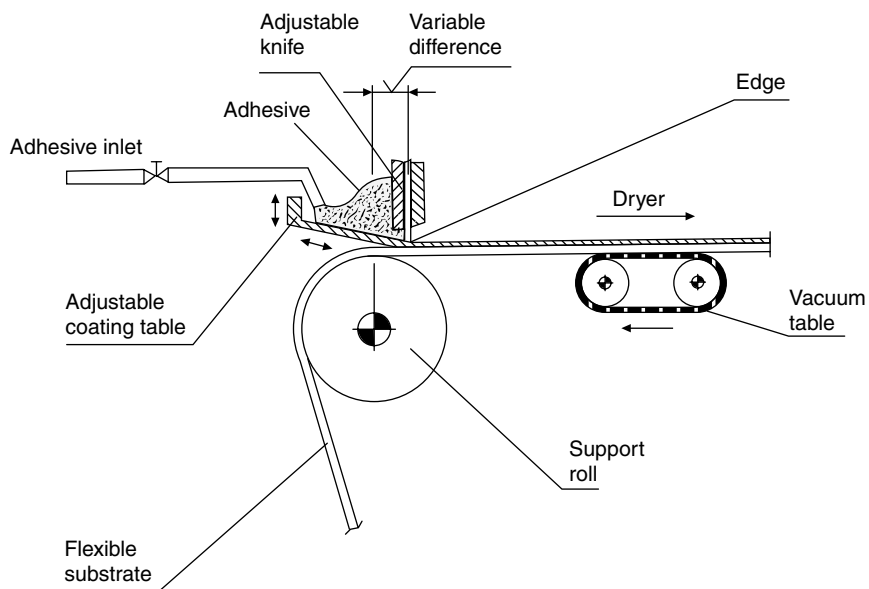

Figure 38: Knife over roll coater.

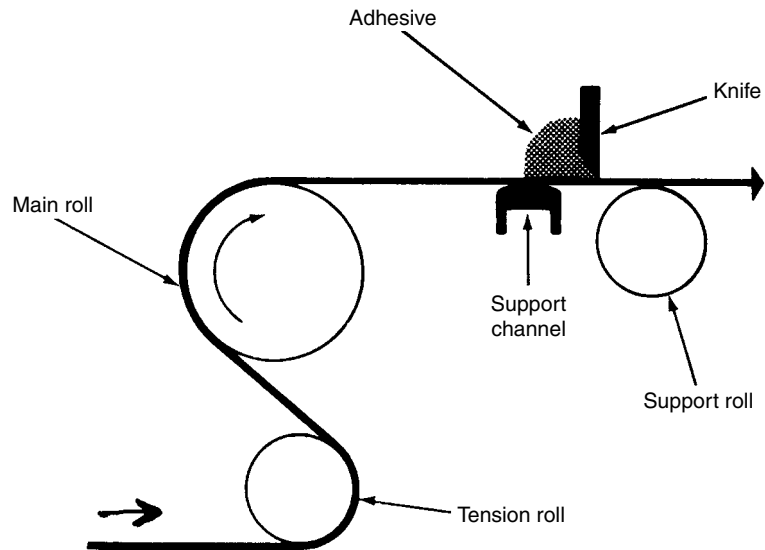

Figure 39: Knife coater with a support channel.

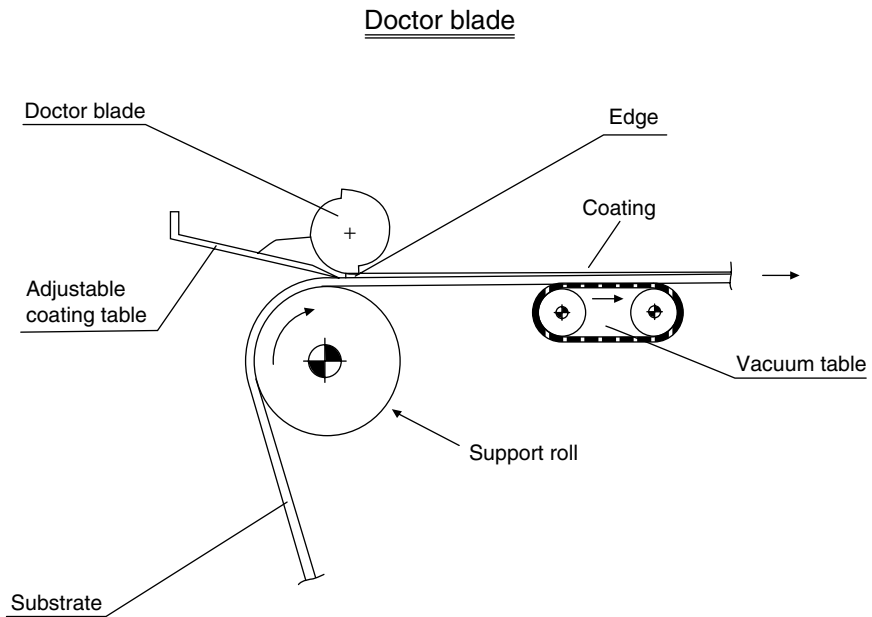

Figure 40: Roll coating with a doctor blade.

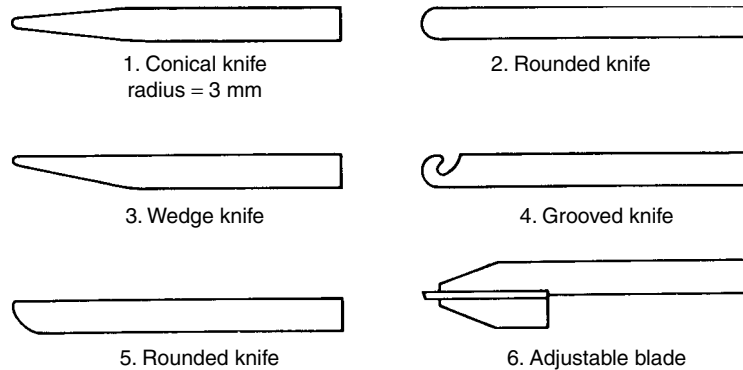

Figure 41: Different shapes of knives.

be fed by gravity, either along the knife or directly on the web or it may be pumped into a trough, which is also adjustable. The flow rate of the adhesive must be carefully set according to the line speed, the required coating weight and the width of the web. The control of the amount of adhesive may be obtained either by adjusting the gap between the knife and the support roll or by adjusting the pressure of the knife on the web.

Requirements for the adhesives:

- viscosity may vary over a very large range, from 1000 to 60,000 mPas, and this is a big advantage compared to other continuous systems such as the sophisticated roll system which can handle only a narrow range of viscosities,
- the adhesive must be free of coarse particles that would clog the knife and give ridges or scratches in the coating.
- many types of adhesives may be used: water-based dispersions, solvent-based adhesives, plastisols, and even two-component adhesives, because the knife is a simple tool which is easy to clean up at the end of the day with a solvent for instance.

The web speed may be quite fast if the viscosity is low enough: it may reach 50 m/min with a viscosity of 3000 mPas, provided the web is strong enough to prevent tearing.

The coating add-on is limited by the tension of the web against the knife. The lower the viscosity, the lower the thickness of adhesive. Add-on may vary from 20 to 200 g/m². If it is less than 20 g/m², the accuracy is poor, and there may be a difference of coating thickness from one side of the web to the other, because these simple systems do not allow a perfect parallel alignment of the knife and the rolls.

Advantages:

- high coating speed,
- wide range of viscosities,
- these systems are more simple than the multiple roll system that we will study later, and consequently they are cheaper, need less maintenance, but are not so accurate.

Drawbacks:

- coating thickness is not accurate because it depends on the tension of the web against the knife.

They are convenient when the user wants to apply a thick coating, for instance on a textile web, to impregnate the web. The thick fillet of adhesive will provide a good impregnation, and the coating thickness may reach 200 g/m² or even more.

They tend to be replaced by the more sophisticated and more accurate roll coaters.

2.7.2. Air Knife

Air knife coater works in a way similar to a normal knife coater except that the excess of coating is blown off by air under pressure (Fig. 42). This technique works only with very fluid adhesives (less than 500 mPas) with low solids. Also the solvents should dry slowly or else blowing air could cause a skinning over the adhesive surface. When working with a water-based adhesive, the blown air should be saturated with water vapour so that the excess of adhesive could be recycled.

Advantages:

- simple system,
- the equipment is fairly cheap, because it is simple,
- perfectly suited for very low add-on: from 0.3 to 20 g/m², with very fluid adhesives (less than 500 mPas),
- speed may reach 20 m/min with very fluid adhesives.

Drawbacks:

- cannot be used with thick adhesives,
- cannot be used with solvent based adhesives that would dry immediately on the surface.

Uses: The main application is in laminating two plastic films with very low coating thickness. (Readers may refer to the chapter ‘PU Laminating Adhesives’ for instance, in Volume 4).

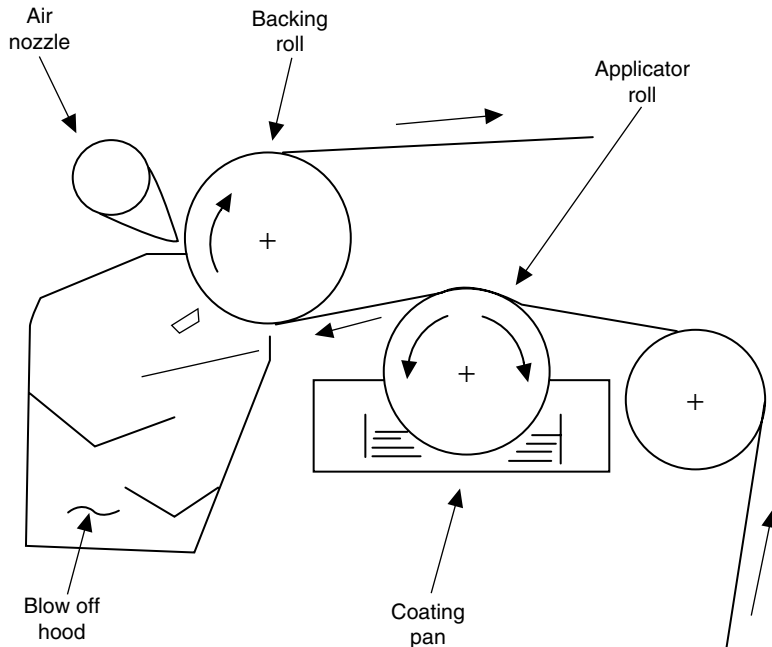

Figure 42: Air Knife Coater.

2.7.3. Roll Coating, Different Techniques

Roll coaters may be used in two ways:

- either to coat sheets (of paper, cardboard), labels, pieces of leather in footwear,
- or roll stock such as rolls of paper, plastic films, aluminum foils.

With open systems, water or volatile solvents can evaporate on the rolls. This causes thickening of the adhesive and consequently may cause a variation in the amount of adhesive applied.

This can be aggravated if heat is generated by the shear forces resulting from mixing. When the rotation speed increases, splashing and air entrapment may also occur.

Let us start with the **simple and small systems**. Fig. 43 shows the more simple roll coater: where a roll turns inside a glue trough, the parts pass on top of the roll and pick up the glue.

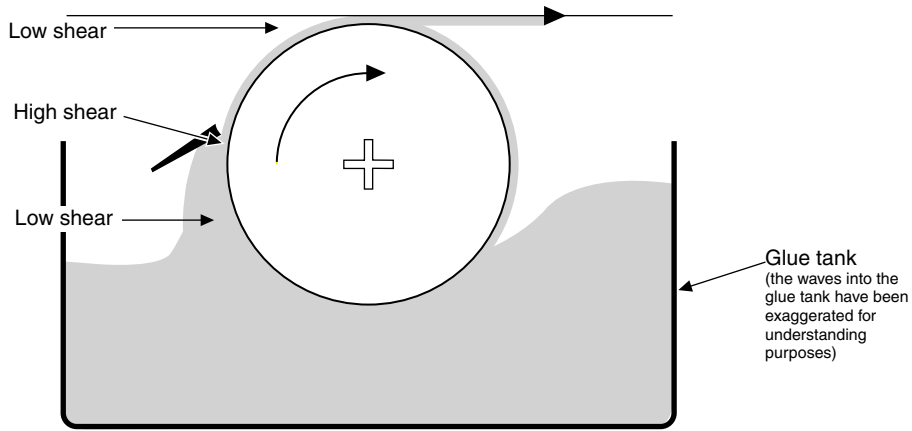

Figure 43: Roller system with blade-doctoring device, the most simple roll system.

Starting from this basic system, we may add several improvements step by step:

- first, a second roll may be added as a doctor roll or metering roll as in Figs 44 and 48,
- the space between a second and a third roll may be used as a glue reservoir (Fig. 46),

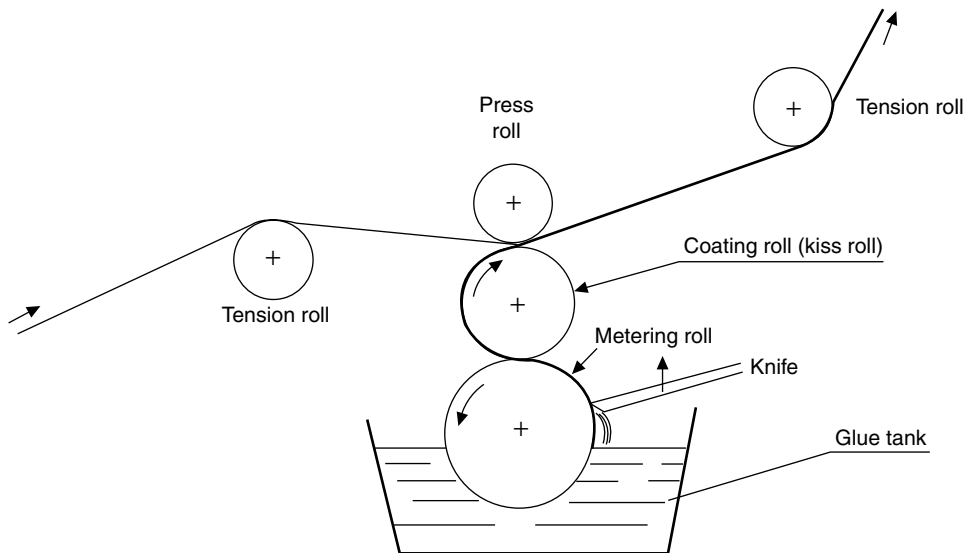

Figure 44: Three roll arrangement with a metering roll.

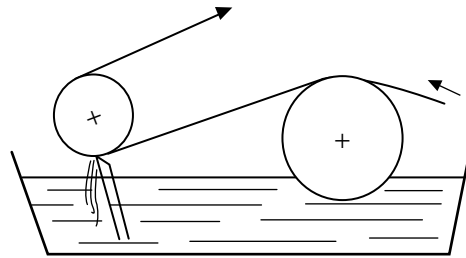

Figure 45: Knife coater, system where the rolls are under the sheets.

- the coating roll may turn in the same direction as the sheet to be coated,
- or it may turn in the opposite direction which will meter more precisely the thickness of the glue; this is called reverse roll coating,
- the coating rolls may be placed below the sheets to be coated, in this case the glue should move up on the rolls and this is possible only with some viscosities and rheology,
- or they may be on top and the glue must display some flow in order to run down by gravity.

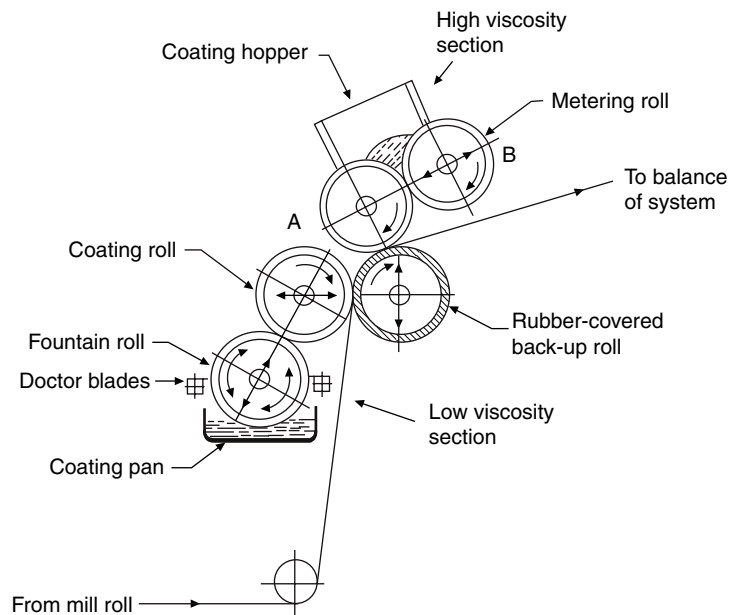

Figure 46: Arrangement for high and low viscosity material.

2.7.3.1. Rolls Under the Sheets to be Coated

In the basic system of Fig. 45, the glue will rise on the roll if it wets and adheres to the roll. In order to have this, the glue should not be too fluid because it would then immediately run down and there would not be enough glue on the roll. It should also not be too thick because the pick up roll would pick too much glue and the machine would get dirty very quickly. Therefore, the adapted viscosities should be between 1000 and 30,000 mPas. When the adhesive is fluid, the coating system may be reduced to one roll only, and the excess will run down. Coating speed: a few metres per minute.

Uses: These basic systems are used to apply fairly fluid glues and adhesives (1000 to 30,000 mPas) onto sheets of paper, cardboard in packaging plants, in book-binding, or leather pieces in footwear.

These roll coaters are very simple and cheap and are also easy to clean. Suppliers for roll coaters include Hestika Germany for footwear and leather goods, Kolbus Germany for bookbinding (bonding of decorative paper to the cardboard of the cover).

Knife coater under the sheets. With a knife coater system, thick adhesives may be used because the knife eliminates the excess of adhesive applied by the coating roll (Fig. 45). The viscosity can reach 50,000 mPas and dry solids may be high.

The coating speed may also be high. The knife is adjustable so that coating add on may be adjusted from 10 to 100 g/m².

Uses:

- textile coating such as textile to textile laminating, foam to textile bonding,
- bonding textile liners to leather,
- coating of pressure sensitive adhesives onto textiles such as band aid and surgical tapes.

Doctor roll. The gap between the pick up roll and the coating roll is adjustable and this determines the adhesive add-on. It is possible to apply thick adhesives up to 50,000 mPas and control accurately the adhesive thickness which may vary from 10 to 150 g/m². This system allows also to apply fluid adhesives at very high speed and low add-on (2 to 50 g/m²) (Fig. 40 and 48). The doctor roll reduces foaming because it squeezes the foam bubbles which could result from the agitation of the adhesive. Doctor rolls are always used in sophisticated roll coaters, when an accurate add-on is required and for high speeds.

Uses:

- glue spreading on plywood plies,
- adhesive coating on labels.

Tensioning systems. In the systems discussed until now, the coating resulted from a mere contact with the coating roller. Usually tension rolls are added as

shown in Fig. 44. These rolls press the sheet on the coating roll, and the pressure can be suitably adjusted. The tensioning rolls are usually covered with rubber. At high speed, the tensioning rolls eliminate the fluttering effects which could detach the sheet from the coating roller, therefore there are always tension rolls on the big and sophisticated high speed machines (for speeds higher than a few metres per minute).

2.7.3.2. Rolls on Top of the Sheets to be Coated

Here the adhesive runs down to the coating roller due to gravity and adhesion to the rolls. Therefore, the adhesive should not be too fluid or else it could run down too fast. These systems are used when the viscosity is within a range of 5000–50,000 mPas.

The upper part of Fig. 46 shows a simple system with three rolls. The gap between rolls A and B is adjustable in order to control the amount of adhesive. The top rolls may be fed continuously by a pump or, in small premises, by gravity; the operator re-loads the glue from time to time.

Coating two sides in one operation. This is useful when a very clean job must be performed in a multiple ply laminate; only the internal ply are coated on both sides and laid onto the adhesive coats, the external plies remain uncoated.

With these roll on top systems, all the improvements mentioned previously may be added:

- knife coating, doctor rolls,
- tension rolls,
- combination of these various improvements.

Also by combining both the systems, i.e. rolls below the sheet and rolls on top, we get a multipurpose machine, which may handle high and low viscosities and apply the adhesive on both sides of the sheet simultaneously (Fig. 46).

Fig. 47 shows a roll coater such as the one used for laminating.

2.7.3.3. Gravure Rolls

In order to calibrate the coating thickness precisely, some roll coaters use engraved rolls (Fig. 49). The thickness of the adhesive coating is set by the depth of the gravure: the adhesive penetrates into the gravure, the blade or knife scrapes the excess of adhesive on the roll. Then, all the adhesive contained in the gravure is transferred to the substrate and this gives a pattern made up of thousands of points which merge together if the adhesive is fluid. Gravure rolls can work at high speeds of upto 500 m/min, the viscosity may range from 200 to 2000 mPas.

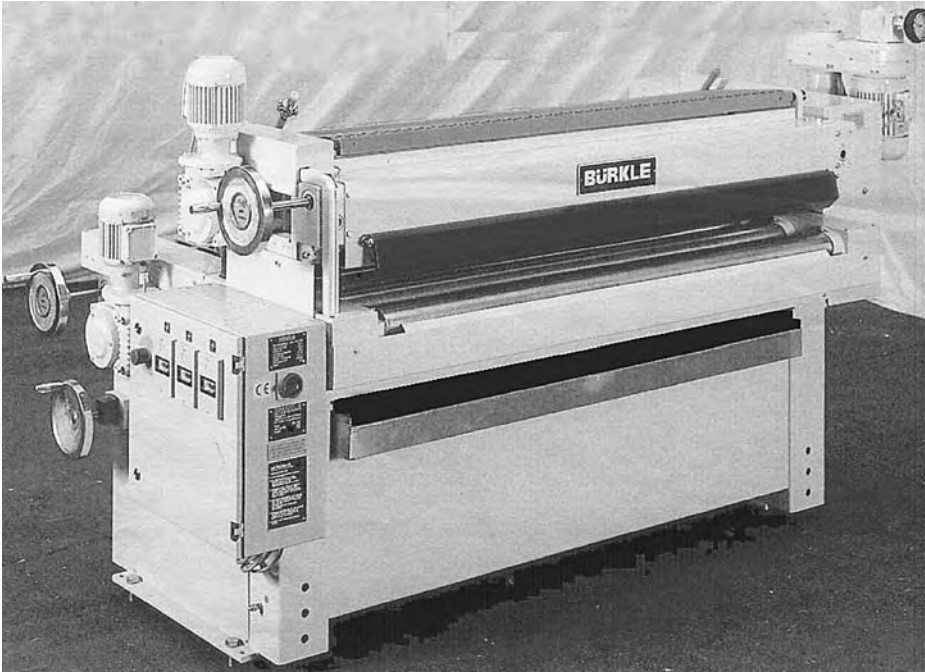

Figure 47: Roller Coater (by courtesy of Bürkle Germany).

Uses:

- textile laminating, may give a porous coat,
- film and foil laminating.

Film thickness may be very low 5 to 20 g/m² so that the bond line is very flexible and soft. There are also notched or grooved rolls (Fig. 50).

2.7.3.4. Reverse Roll Coating and Latest Machines

In the roll coaters studied above, the coating roll was turning in the same direction as the sheets. This is called kiss roll. With such a technique, the adhesive transfers only partially on the sheet, so that there are some ribs or scratches on the adhesive film. When the adhesive is fluid, these marks will disappear quickly. But if the user wants to apply a thick coat, the adhesive should have high dry solids and it should also be fluid in order to get an even, continuous film. In order to improve the quality of application, the adhesive should be applied by reverse coating, which will brush the adhesive onto the substrate and give a smooth and even coating. The thickness of the adhesive is controlled by the gap between the metering roll and the coating roll.

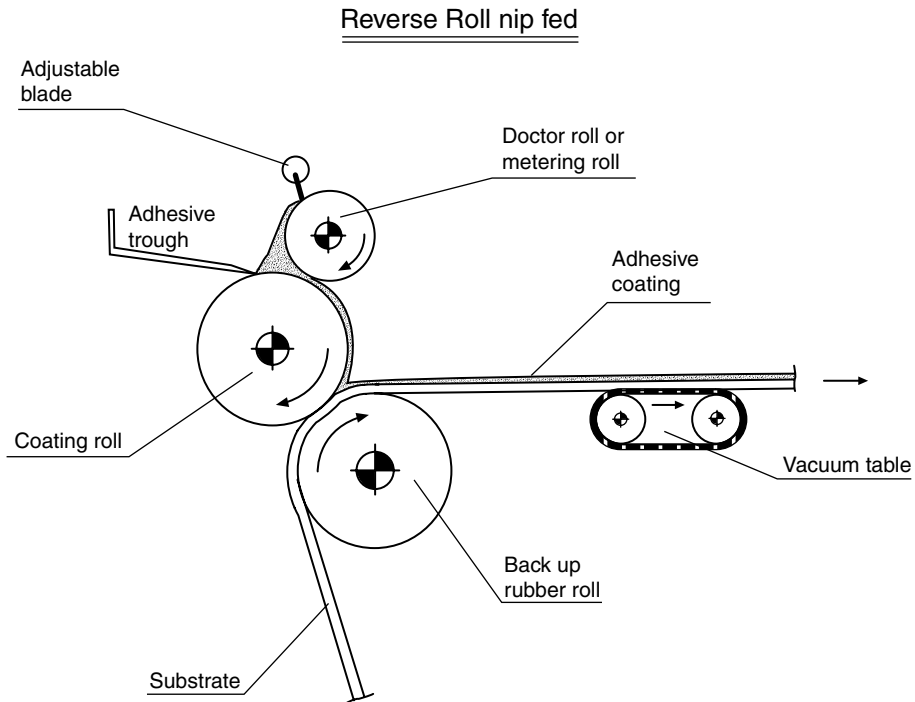

Figure 48: Reverse roll nip fed.

This technique will also allow doubling the thickness with the same viscosity and speed (Fig. 48).

Modern roll coaters may usually work in both ways, and Fig. 51 shows such roll coaters. Movable cartridges are a piece of equipment which include up to four or five rolls, the rolls may be moved into the required position to change the type of application thus giving the roll coaters some flexibility. These roll coaters are driven by a computer which controls gaps, speed of the web, flow of adhesive and the rolls are motorised individually. There are also tension rolls and the web tension is also monitored.

Uses of reverse roll coaters:

- manufacturing of pressure sensitive tapes, where the thickness of the adhesive coating must be perfectly metered at the required thickness (refer to the chapter 'Pressure Sensitive Adhesives and Products'),
- laminating of two plastic films in the manufacture of flexible packaging films, where the adhesive film is very thin, weighing only a few grams per square metre,

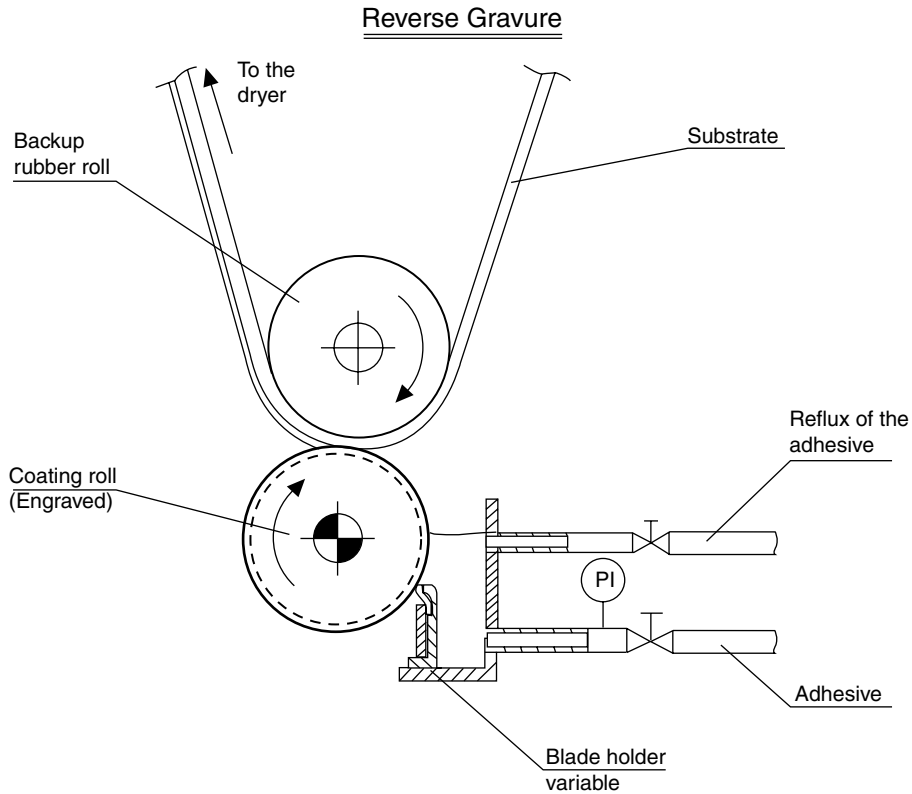

Figure 49: Reverse Gravure.

with a perfectly even film (refer to the chapter 'Polyurethane Adhesives for Flexible Laminating' in Volume 4 of the Handbook).

Heating of the adhesives resulting from the agitation: The stirring of the adhesive between the rolls increases their temperature after some time, and this may have some detrimental effects:

- drying and increase of the viscosity and solids of the solvent based adhesives,
- reducing pot life of two-component adhesives.

Uses of solvent-based adhesives with roll coaters: Usually the rolls are working in open air and thus the solvents evaporate and the adhesive dries on the rolls. Therefore solvent-based adhesives require some precautions:

- use solvents with higher boiling points,

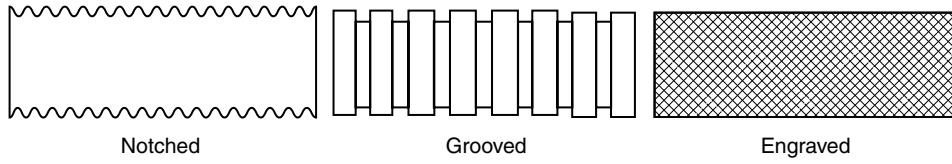

Figure 50: Different types of rolls surfaces, engraved rolls.



Figure 51: Faustel Roll Coater (source Faustel USA).

- place a hood on top of the rolls,
- in hot weather cooling of the rolls with cold water may be necessary.

Different types and materials of the rolls: The rolls may be made of metal, generally stainless steel or chromium coated steel, but some rolls may be of steel covered with rubber, for instance to apply water-based glues. The roll surface may be flat or notched, grooved, engraved, in order to hold more adhesive on the surface and calibrate the thickness of the coating. They may even have a special pattern which will be reproduced on the sheets to be coated, for instance to apply a given pattern on the substrate and bond only some areas of the substrate.

Suppliers of roll coaters: Each major and developed country has its own suppliers and manufacturers. We mention some of them here:

- In Europe: Friz/Homag, Hymmen, Burkle, Kroenert in Germany, DCM in France,
- In USA: Faustel (Fig. 51), Black brothers, Bolton and Emerson.

Readers may refer to the list of suppliers at the end of this volume.

Hot roll coaters for hot melt adhesives will be studied in the chapter ‘Application of Hot Melt Adhesives’ later in this Handbook.

A complete installation for roll coating and laminating. It is interesting to show a complete laminating line, including adhesive application, layup of the laminate and pressing/drying/curing. Fig. 52 shows such an installation from Hymmen company, Germany.

After preheating (VHZ) (in order to speed up curing reaction of the adhesive), the panels are cleaned by rotating brushes (FRB) followed by double-sided application of the base UF resin on the panels (UMZ).

After base resin application, the infrared evaporation zones TRS/ADZ evaporate the water contained in the base resin. Then the hardener is applied in the second roller system (UMA). This technique allows one to use a very fast curing system, because the two components are mixed immediately before the film is laid down on the coated panels. A special conveyor (TRK) then moves the panels to the lamination section where a heated laminating calendar (KKL) presses the paper supplied by the unwinding unit FAA to the panels.

The cutting unit cuts the paper on line. The speed of such a laminating line may reach 40 m/min by using fast curing urea–formaldehyde adhesives (refer to the Chapter 5, ‘Woodworking and Furniture Adhesives’, of Volume 3 of this Handbook).

Fig. 52(b) shows a standard laminating machine for film laminating on wood-based panels.

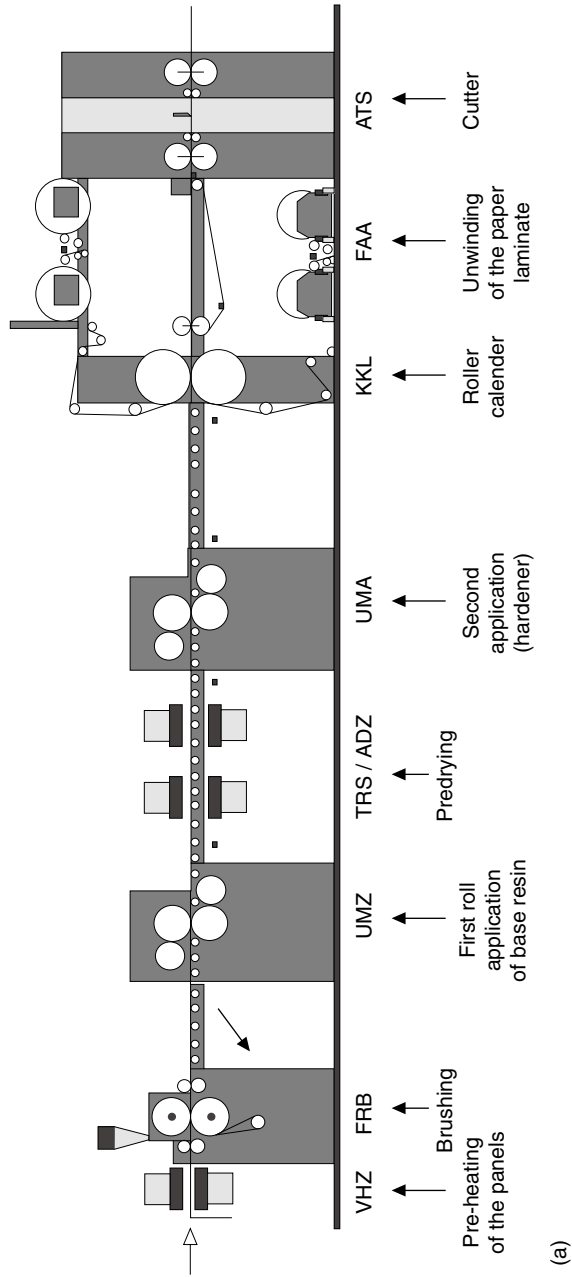

Figure 52a: Complete laminating line including roll application (separate application of base resin and hardener), drying, laminating and calendering. Source Hymmen, Germany.



(b)

Figure 52b: Bürkle EFA 12 laminating machine (by courtesy of Bürkle Germany).

2.7.4. Die Coaters

The idea that open systems do not protect the adhesives from evaporation and premature drying has led manufacturers to use closed systems, and the best one is the die or slot orifice, as shown in Fig. 53.

These die or slot systems may be adapted on a roll coater. The opening of the slot may be adjusted very accurately as also the distance between the slot and the sheet and the angle.

There are two types of slot die machines:

- those for water-based or solvent-based adhesives,
- the heated slot dies for hot melts, where this technique is frequently used, because it is easy and convenient to heat the die and the adhesive with an electric system.

Viscosities may vary from 400 to 500,000 mPas because it is enough to push the adhesive through the slot with a gear pump or a screw extruder, for instance for hot melts, and the add-on may vary from 15 to 100 g/m².

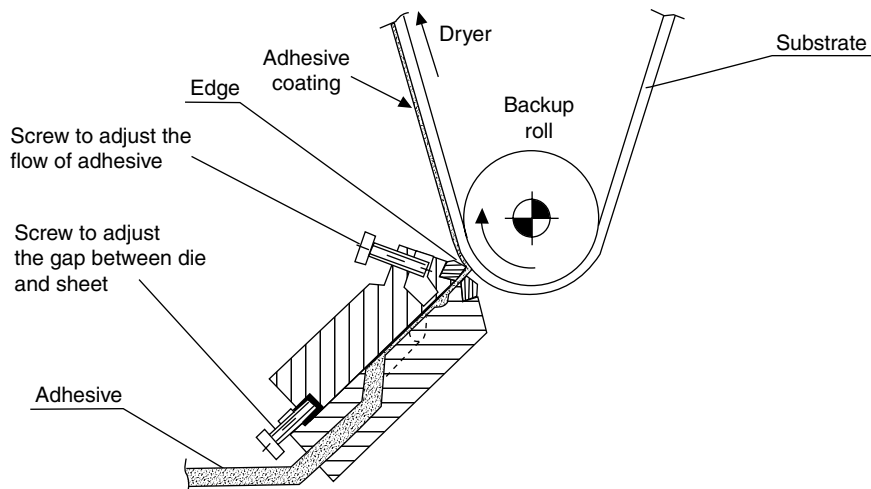

Figure 53: Slot orifice die.

Advantages:

- no evaporation of solvent-based adhesives, the die being a closed system,
- very accurate metering of the adhesive, very smooth and even coating,
- line speeds may be very high up to 300 m/min on some high-speed hot melt extrusion machines,
- width up to 2 or even 4 m.

Uses:

- Hot melt coatings: very frequently used for hot melt coating on roll stock, because it is very difficult to apply hot melts with hot rolls: their viscosity depends on the temperature and therefore a draught would change the set up completely. With a heated slot die, the heavy mass of the metal die keeps the temperature steady and consequently the viscosity of the product. Thickness may vary from 15 to 100 microns i.e. 15 to 120 g/m², flow rate 50 to 120 kg/h. A cold roll or chilled roll, cooled by cold water, cools down the adhesive coating, so that the coated rolls may be rewound quickly after coating.
- coating of pressure sensitive adhesives (solvent based, water based) in the manufacture of PS tapes, double sided tapes, band aids,
- lamination of plastic films, textiles,
- impregnation of textiles,

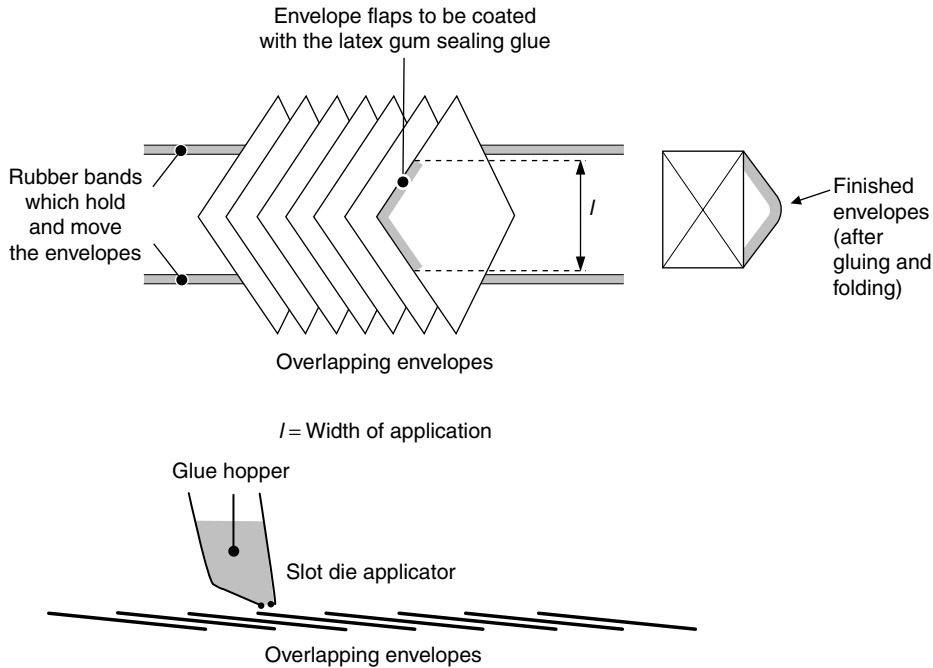

Figure 54: Slot die application of water-based glues in the Winkler Dünnebier envelope machine: the closely overlapping sheets of paper are coated by the slot applicator as a continuous band. Later the sheets of paper are coated with glue and folded in order to make the envelope.

- in the Winkler Dünnebier machines used for envelope manufacturing, a slot die applicator applies a continuous strip of glue on the envelopes which are aligned in a continuous band, each envelope overlapping the next one. The slot die makes contact with the envelopes very lightly, and the viscosity of the adhesive here is carefully controlled (see Fig. 54). The viscosity is usually 300–600 mPa·s, the adhesive must be filtered in order to avoid any grain which would clog the slot orifice. The add-on is low: from 4 to 30 g/m².

Suppliers of slot die machines:

- Bolton Emerson USA, Egan John Brown, USA,
- Nordson, for hot melt adhesives only,
- Faustel, USA (Fig. 55),
- Kroenert, Germany, and others.



Figure 55: Cartridge style coater showing a slot die coating cartridge – mainly used for water based PSA adhesive (source FAUSTEL Inc. USA).

2.7.5. Special Roll Coaters for Specific Machines

Many manufacturers of application machines are specialised in servicing a given industry, and for this industry they manufacture a range of machines which include applicators for glues and adhesives.

For instance, many German companies are specialised in woodworking machines, Italian in footwear machines, etc. For their machines, these manufacturers have designed special applicators which fit to their customers' requirements.

We will study here, briefly, some of their applicators, but these machines will be studied in more detail in the other relevant chapters in this Handbook. For instance, we have a large section dealing with woodworking bonding machines in the chapter 'Woodworking and Furniture Adhesives' in Volume 3, and the same for footwear adhesives and packaging adhesives.

2.7.5.1. Edgebanding Machines for Furniture

Here, strips of decorative materials (high-pressure laminates, PVC, wood veneers), 15 to 25 mm wide, must be bonded on the sides of a panel, which is already laminated with the same decorative material.

The machine integrates in one single machine:

- a conveyor with variable speed 15 to 60 m/min,
- feeders of the decorative materials, the edges may be supplied as rolls when they are flexible, such as PVC, or as stacks of pieces of a given length when the materials are rigid, such as solid wood edges and high pressure laminates.
- the hot melt adhesive applicator, including a vertical roll fed by a heated glue pot where the adhesive is melted at temperatures ranging from 190 to 210°C.
- on high-speed machines, the hot melt granulates are fed to the glue pot by a pre-melter located on top of the gluing equipment. Granulates first fall by gravity in a pre-heated zone at 120 to 140°C, these temperatures cannot degrade the adhesive, and then when needed they fall into the glue pot heated at 200°C. With these pre-melters, the operator does not need to refill the glue pot frequently, and the adhesive temperature always stays at the required level,
- the assembly and pressing section with a series of pressure rolls,
- a cutting section where the edges are trimmed immediately after bonding and pressing.

The gluing roll applies the hot melt on the edge of the panel, at some 150 g/m² (because the sides of the panels expose the fibres and consequently absorb the adhesive), and immediately after, the panel picks up the edge strip with the help of the tack of the adhesive. The distance between the gluing roll and the application of the strips is only a few centimetres so that the adhesive is almost at the same temperature as in the glue pot.

Suppliers of edgebanding machines. The worldwide leader in manufacturing edgebanding machines is the German company Homag with its brands Optimat, Brandt and there are other leaders and suppliers in Spain (Barberan), Italy (Biesse), Germany (Ima), Korea, Japan and Taiwan.

Edgebanding machines will be studied in detail in the chapter 'Woodworking and Furniture Adhesives', in Volume 3 of the Handbook.

It is interesting to note that until now all the edgebanding machines have been supplied with vertical rollers, which are not so easy to set up for a perfect glue application and control of glue thickness. We believe that slot die applicators could be used also in the near future (Nordson and Robatech are already offering slot die applicators for these machines).

2.7.5.2. Bottle Labelling Machines

We will explain in detail how these machines work in the chapter 'Packaging Adhesives'. However, we mention here the type of special applicator they use, because the idea might be useful for other industries who need to apply adhesives on curved surfaces (Fig. 56).

The coating roll is a vertical roll, 20 to 30 cm high, fed continuously by a circulating unit from a 20 l pail.

The pallets which oscillate around their own axis and also revolve with the big carousel, are first coated with an adhesive by contact with the coating roll, then they pass over the label magazine and pick up a label each, with the help of the tack of the adhesive (Fig. 57). Then these coated labels are sucked under vacuum by the gripper cylinder, the adhesive being outside the grippers, and finally the adhesive coated labels are pressed onto the bottles. The German company Kronos invented this system 50 years ago in order to reach high speed labelling, up to 60,000 bottles per hour with the latest machines (Canmatic).

2.7.5.3. Roll Applicators for Bookbinding Machines

In roll applicators, the back of the books or magazines, where the signatures have been pre-assembled in clamps, are moved on a conveyor in a vertical position (Figure 58(a) and (b)).

A two-roll applicator applies the hot melt adhesive onto the back of the signatures. The thickness and width of adhesive may be adjusted by the position of rolls and knives. Then the book covers are pressed onto the adhesive coat, less than one second after adhesive application. About 10 to 30 s later, the books or magazines are trimmed. This is possible because these hot melt adhesives set and cool down in a few seconds.

The largest machines (Muller-Martini or Sheridan) may bind up to 20,000 books per hour, but there are also smaller machines which bind 200 to 4000 books or magazines per hour.

The readers should refer to the chapter 'Bookbinding and Graphic Arts' later in this Handbook.

Here again, some suppliers have found that the adhesive application may be made by slot dies. Readers may refer to the chapter 'New Techniques of Application for Hot Melts' by Nordson, in Volume 4 of this Handbook.

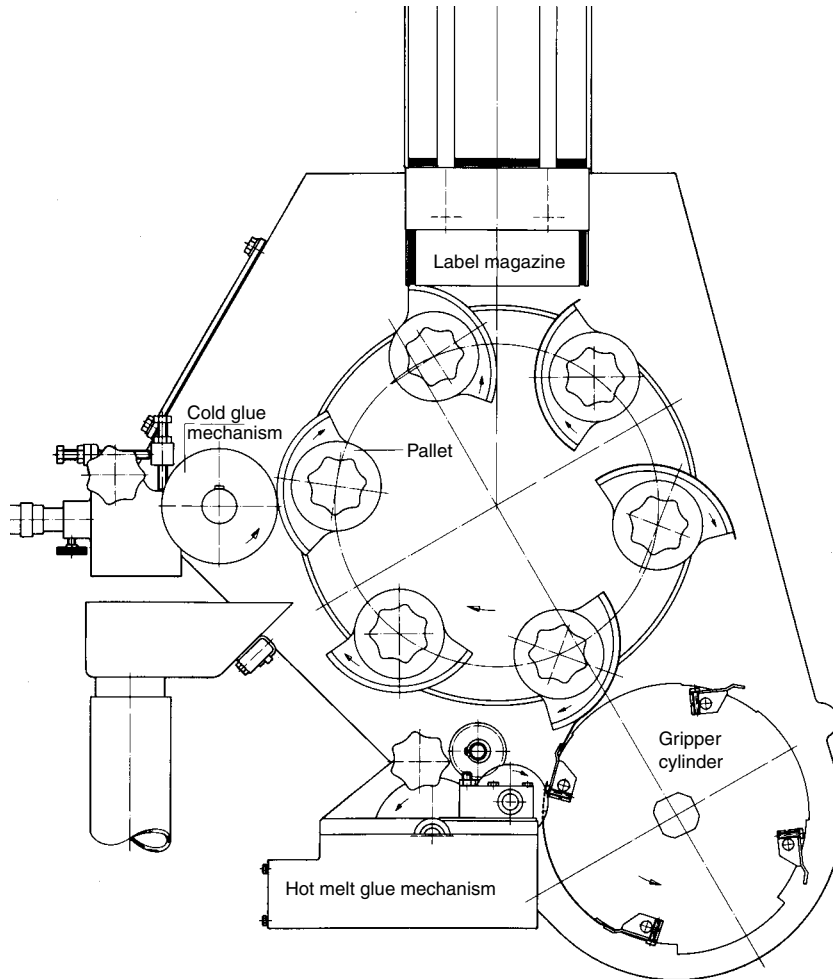

Figure 56: Labelling station of the Krones Taxomat, which is equipped with two gluing arrangements, one for a cold glue application along a central strip of the tax stamp and one for applying hot melt adhesive to the two lateral edges of the stamp (by courtesy of KRONES, Germany).

2.7.5.4. Other Roll Applicators for Special Machines

Let us mention here, other roll applicators available for special machines:

- large width (upto 2 m) roll coaters for hot melts: we shall study this in the chapter ‘Hot Melts Application’,
- small roll coaters for hot melts in shoe manufacturing.

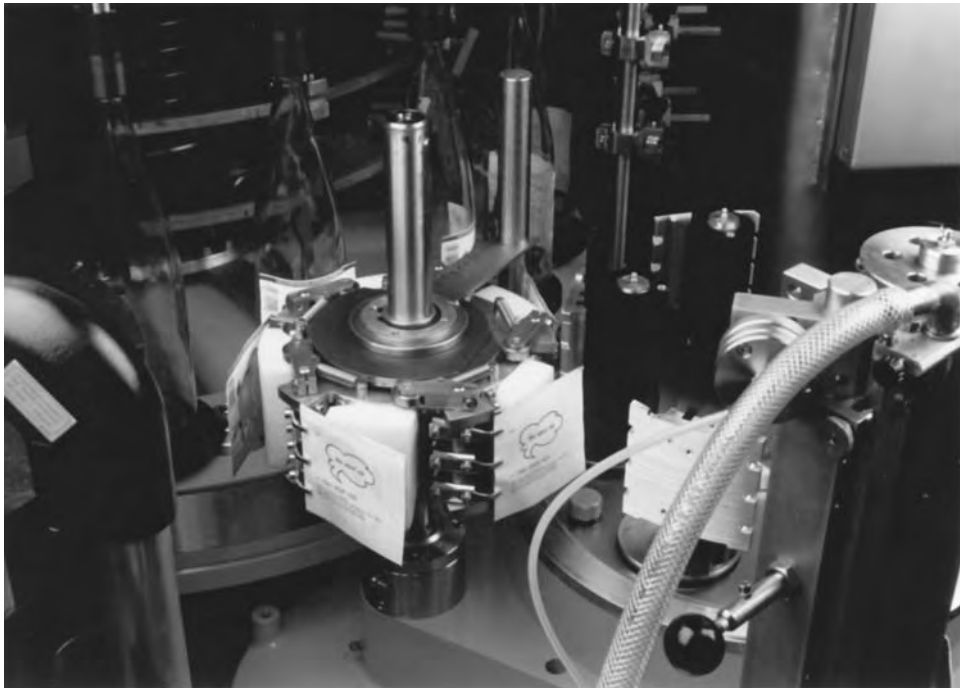

Figure 57: Bottle labelling machine – on the right, glueing roller in the center, a gripper system grip the labels on their back after adhesive application.

2.8. Disc and Wheels Applicators

In some high-speed machines, a rotating disc or wheel fed with adhesive by gravity, can apply a line or a zone of adhesive onto fast running sheets. For instance, gluer-folder carton machines use flat discs or discs fitted with pallets to apply water based adhesives on the cardboard sheets at high speed, upto 100 m/min.

Figs 59 and 60 show this system in a Bobst gluer-folder, and explain why it gives a clean application even at high speeds. The adhesive is fed by simple plastic bottles onto the top rollers, covered with rubber, then the pallets pick up the adhesive from the rolls and transfer it to the cardboard.

Of course, in order to avoid any splashing at high speed, the viscosity of the adhesive must be carefully adapted to this system.

In other machines, such as paper bag making machines, the adhesive is applied by simple flat discs (Fig. 61). The disc may be grooved to retain the adhesive into the groove or segmented in order to apply interrupted lines of glue.

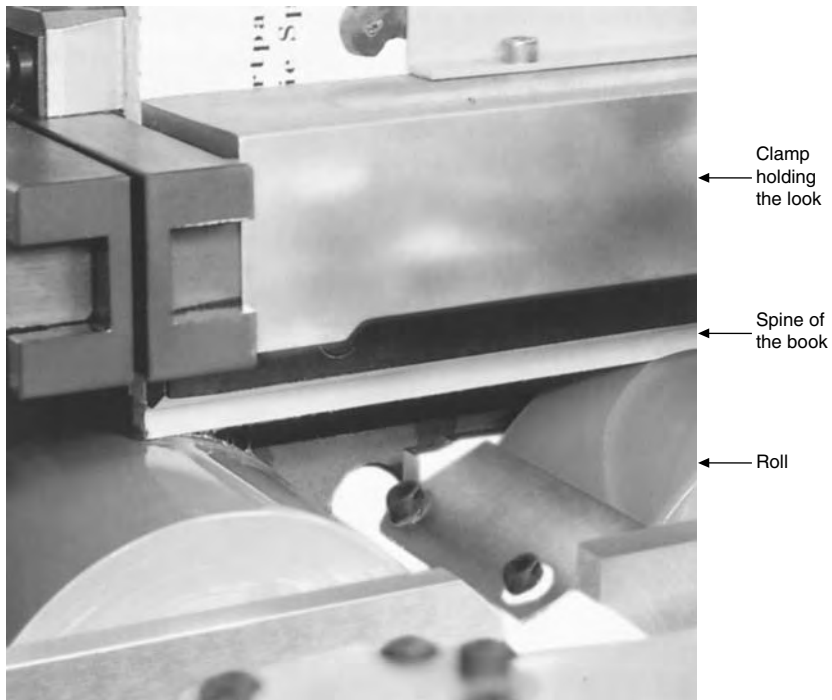
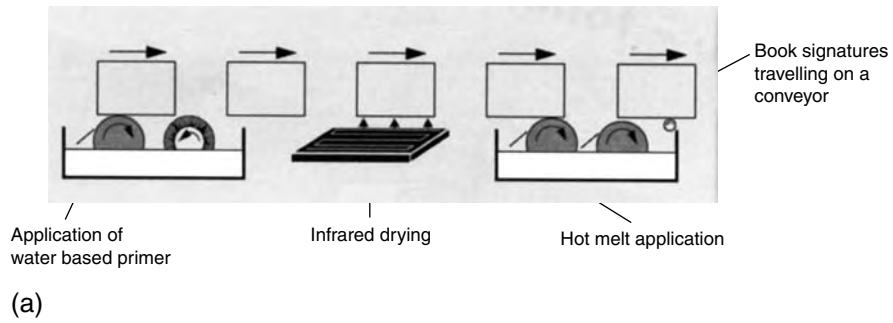

(b)

Figure 58: (a) '2 shots' application on a book-binding machine. (b) Two rolls system for the application of a hot melt adhesive on the spine of a book.

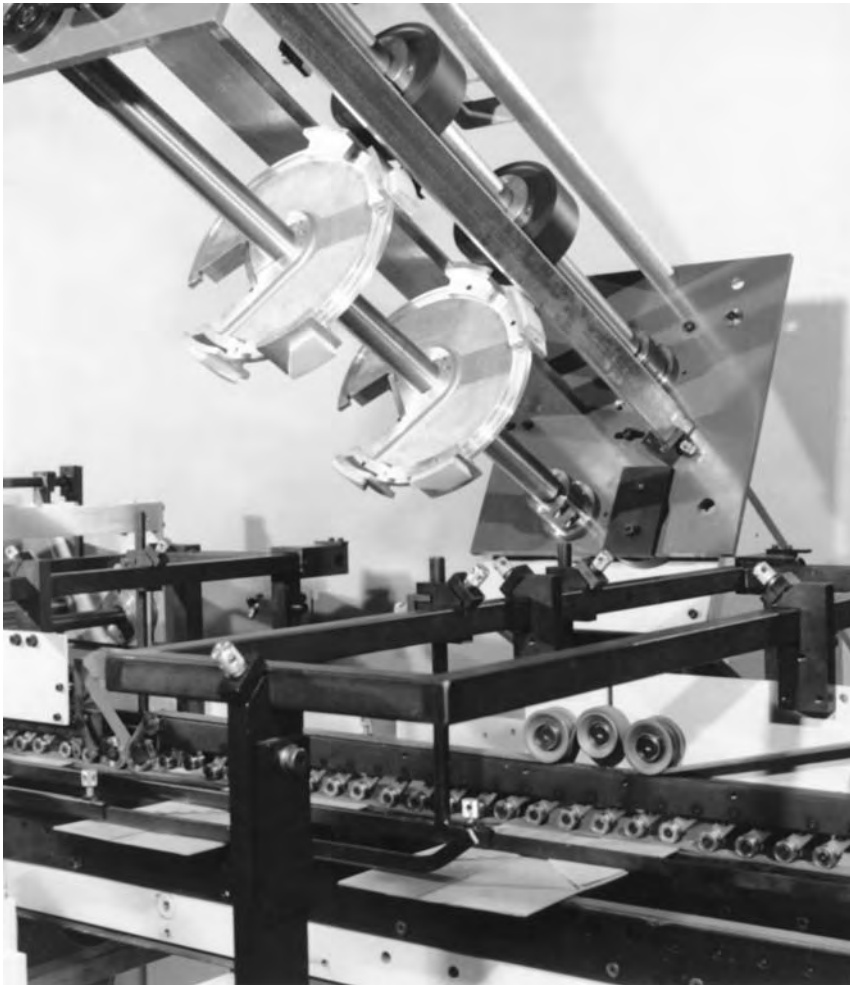

Figure 59: Disc and stencil applicator on a Bobst folder-gluer (by courtesy of Bobst, Switzerland).

2.9. Stencil or Stereotyped Application and Techniques Issued from Printing

This technique comes from the printing shops. It is very convenient to apply adhesives in a given pattern, for instance the periphery of the plastic windows of postal envelopes (Fig. 62), or the tip toe of a shoe upper. Any of the four classical printing systems may be used.

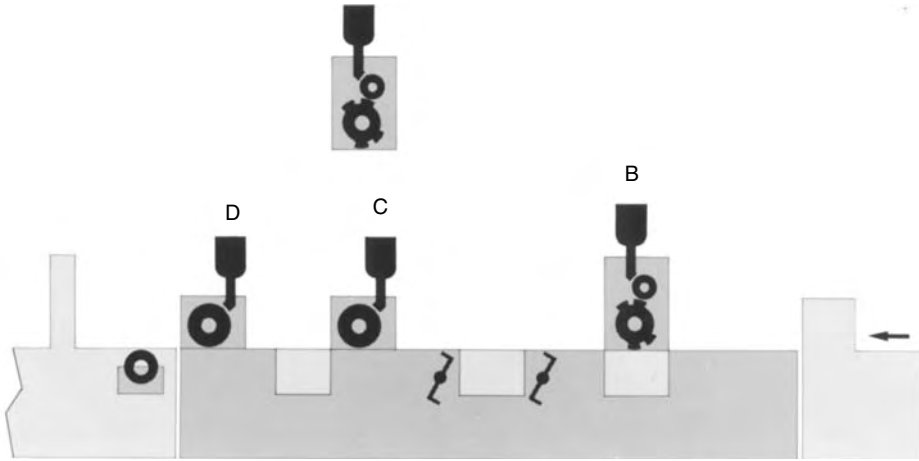

Figure 60: Several positions of the glue applicators on a Bobst folder-gluer: B before the folders, C after the folders, D end of machine (by courtesy of Bobst Lausanne, Switzerland).

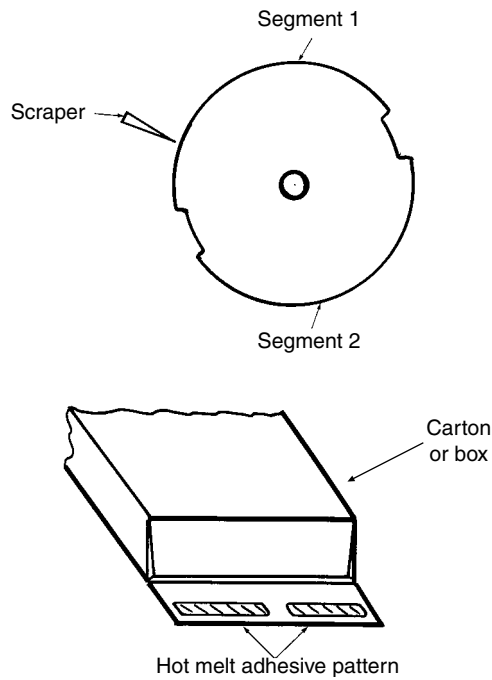

Figure 61: Adhesive pattern from two-segment wheel.

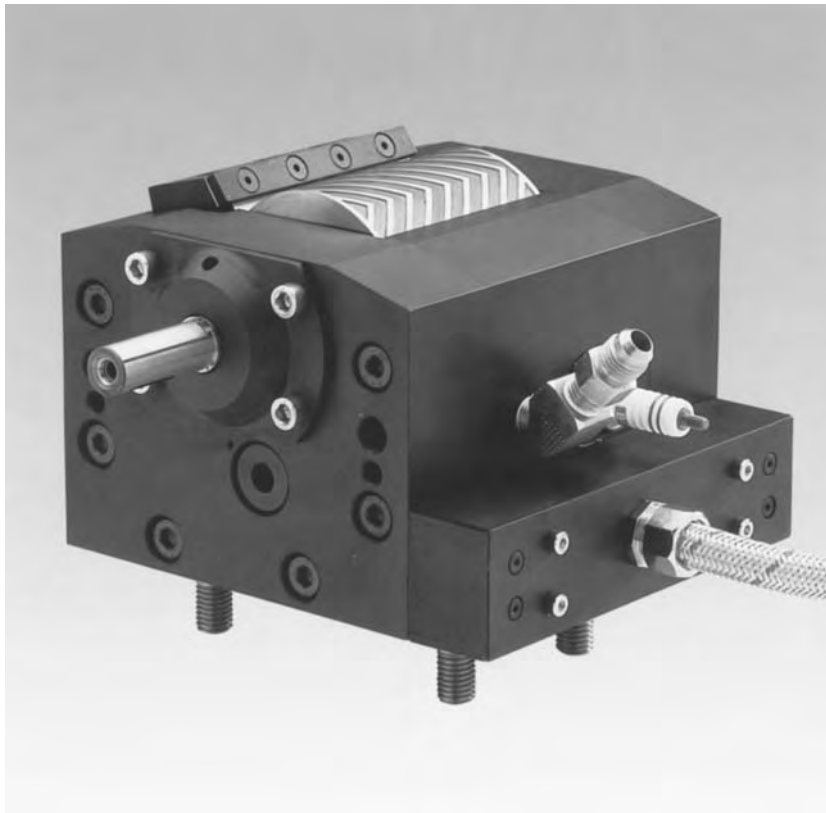
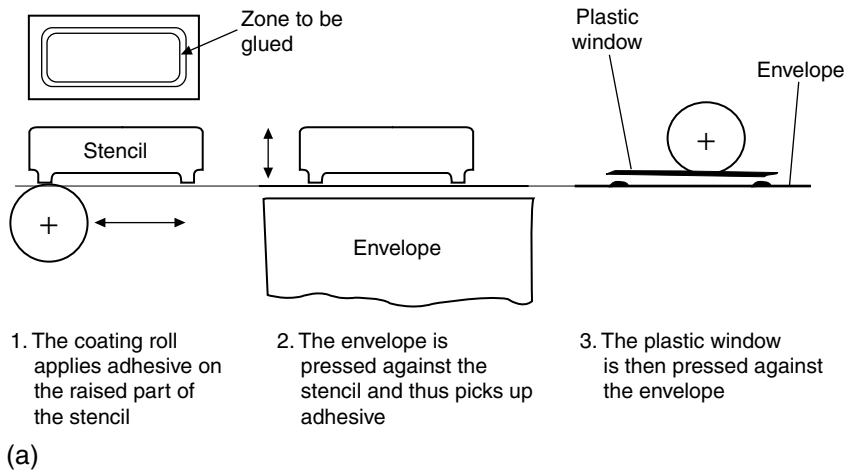

Figure 62: (a) Bonding a transparent plastic window onto an envelope with typographic stencil. (b) Stencil wheel applicator working with Hot melt adhesive (RA 80 wheel applicator from Nordson) width upto 800 mm (by courtesy of Nordson).

2.9.1. Typography

Fig. 62 shows how typography system works for the glueing of an envelope window. This technique may be very fast, up to 800 windows per minute on the Winkler–Dunnebier German machines with ethylene-vinyl acetate adhesives, viscosity 3000 mPas.

2.9.2. Heliogravure (engraved rollers)

A good example of Heliogravure printing is the manufacture of flocked wallpaper: the adhesive may be coated according to a drawing or a pattern, then the flock fibres are sprayed onto the paper. Here the adhesive must be very fluid in order to penetrate into the depth of the gravure, and also to transfer from the gravure to the substrate to be coated.

2.9.3. Offset

An example of using offset printing system is the manufacture of flocked wallpaper (refer to Fig. 63). A press blanket is made with a material on which the

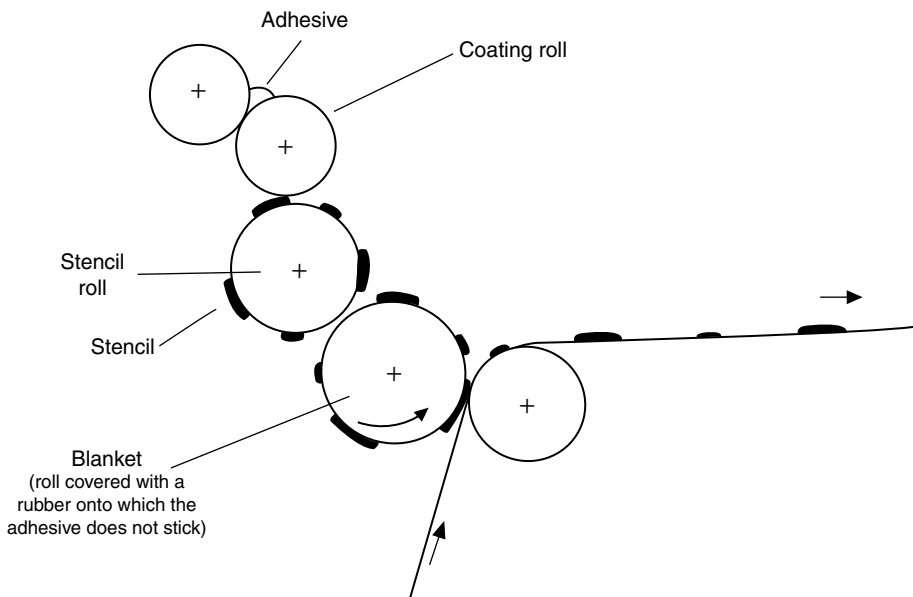

Figure 63: Offset application.

adhesive does not stick, for instance a roll coated with silicone rubber. The adhesive will thus transfer easily to the material to be coated. This technique is also used in the packaging machines (refer to Fig. 59, showing the blankets used in the BOBST folder-gluer machine).

2.9.4. Silk Screen Printing

This technique uses a frame with a textile or stainless steel screen in which some meshes have been closed and some left open in order to give the required printing pattern. A rubber knife passes over the screen to push the adhesive through the open meshes. This will provide the required pattern of coating and then flock fibres, for instance may be sprayed onto the adhesive coat.

If all meshes are left open, this gives a way for applying cleanly a thin coat of adhesive directly on textile, as a multiple point application, without staining or bleeding through the textile.

Let us mention here the temporary bonding of a fragile thin textile onto continuous rubber conveyors in the textile printing plants. Adhesives used here are polyvinyl alcohols which are soluble in hot water. After this temporary light bonding on the rubber band, the textile is printed, also by silk screen techniques, in several passes, one for each colour, then the inks are dried, the printed textile is detached from the rubber band by using hot water, and the band is coated again with PVOH for the next printing operation.

2.9.5. Rotary Screen Printing

This is a clever modification of flat silk screen printing. The paste adhesive is fed in the center of a rotary perforated drum, it is pumped through a hollow doctor blade into the rotating screen stencil and then through the holes in the drum and applied onto a web or fabric (Fig. 64). The web or fabric is running over a counter roller coated with rubber.

Coating speed may vary from 25 to 100 m/min, it gives fine patterns such as the ones shown in Fig. 65. The adhesive coating is breathable and the bond line is very flexible. These are interesting advantages for textile linings and non-woven bonding, for instance for baby diapers or garment liners.

This technique is used mostly for hot melt adhesives now (Microprint machines from Graco, Varidot applicator from Loctite (Fig. 66) for instance).

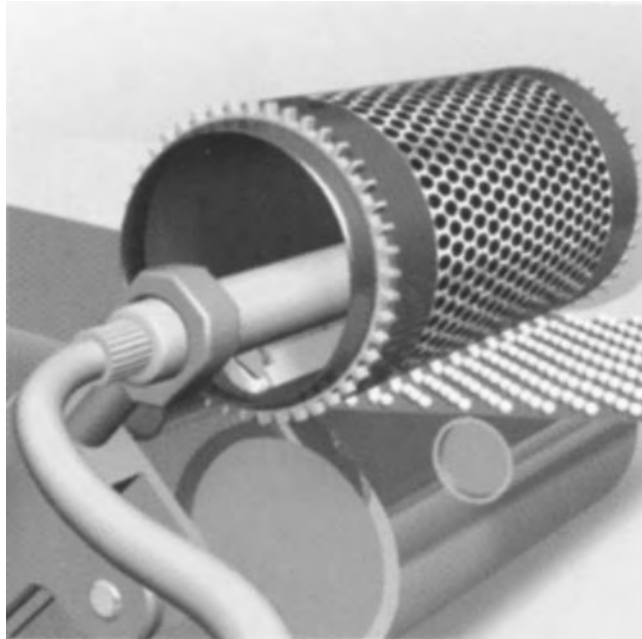

Figure 64: Rotary screen printing.

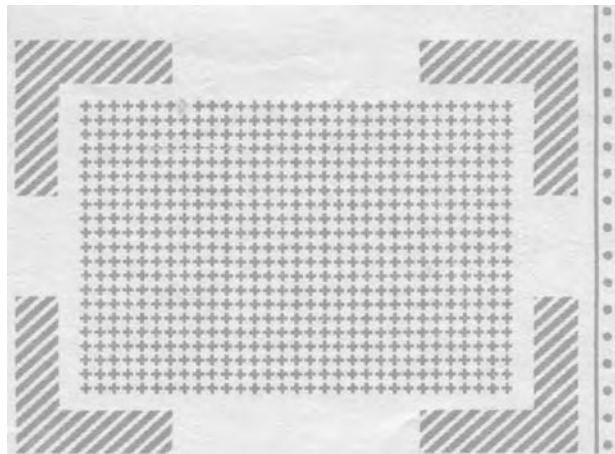

Figure 65: Examples of pattern available with rotary screen printing (Microprint machine from Graco).



Figure 66: Varidot applicator for rotary screen printing (by courtesy of Loctite).

2.10. Curtain Coaters

The fluid adhesive is pumped into a trough or a slot die, and it flows as a vertical curtain from this trough, on the panels or sheets to be coated, which move on a horizontal conveyor (Fig. 67). The excess of adhesive, on the sides or between two successive panels or sheets, is recycled in the adhesive tank. The top tank is V-shaped, with an adjustable slot orifice at the bottom.

In some modern curtain coaters, the top tank is a small volume chamber equipped with a rotating double knife. It may apply a thin film of adhesive, with reduced entrapment of air and an electronic control of thickness. With this closed application system there is no evaporation of solvents, it may work with both solvent based or water based adhesives and even the moisture curing polyurethanes.

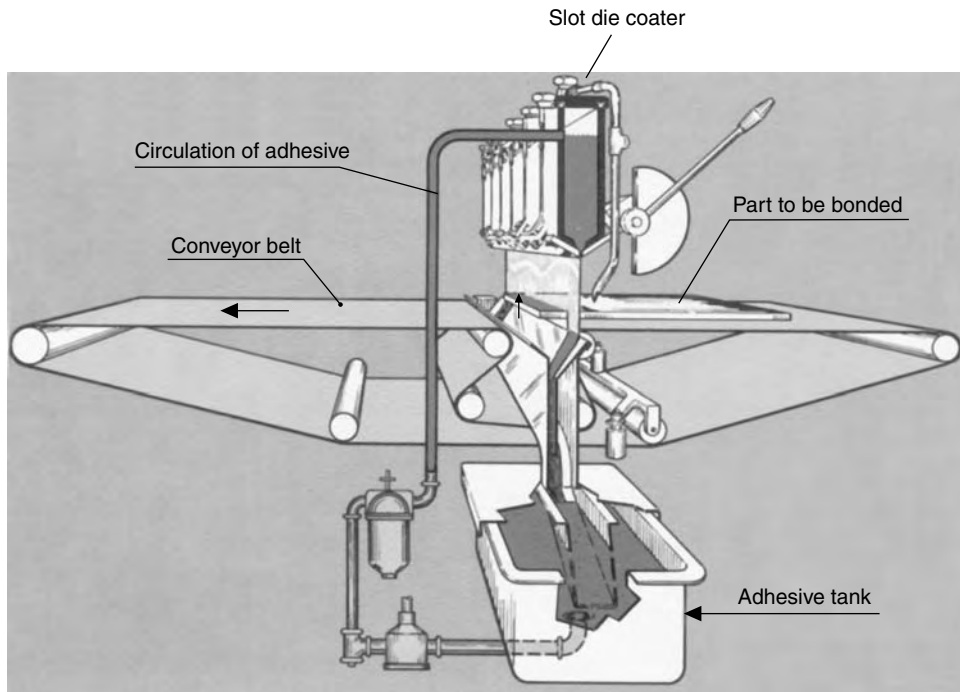

Figure 67: Steinemann curtain coater.

Refer to Fig. 67. To ensure a perfect shut down, the coating is automatically bypassed to a circulating system as the knives close.

Several factors control the flow rate:

- width of the slot,
- conveyor speed,
- flow rate and pump pressure.

Types of adhesives:

- the adhesive must be very fluid, from 50 to 400 mPas.
- if it is a solvent-based adhesive, the solvents should evaporate slowly so that the curtain will not evaporate in the air and interrupt,
- the adhesive should have high film forming capabilities so that the curtain will form again immediately after a piece passes through the curtain.

Speed of application:

May be very high, from 2 to 150 m/min, and it may be used on large surfaces (coating width upto 2 m).

Coating thickness: from 20 to 300 g/m² wet.

If all these requirements are met, the adhesive film is even, smooth, and perfectly controlled in thickness, without bubbles or scratches, and of same thickness everywhere. Curtain coating may thus be used to bond thin plastic films without any defect. There is no loss of adhesive because the excess is recycled.

Uses: Only thin and flat parts may be coated with curtain coaters as it is shown on Fig. 68.

- bonding of panels: sandwich panels, partitions, decorative panels, furniture panels, for instance vacuum pressed panels (refer to the chapter ‘Woodworking and Furniture Adhesives’ for further details),
- coating on soft materials such as flexible foams, glass fibre mats, which could not pass through a roll coater,
- coating of corrugated materials, as long as the corrugated wave is not too high, a few centimetres is acceptable.

Curtain coaters for two-component adhesives:

It is possible to use a curtain coater with two troughs and two pumps, which gives two curtains:

- the first one lays the base resin, for instance epoxy or polyurethane,
- the second one lays the hardener on top of the resin, both the components should be very fluid, so that they will mix together by mere contact between the two coats.

Such a system may be used to bond, for instance sandwich panels or other exterior grade panels with two-component adhesives that are resistant to temperature and humidity or water.

Suppliers of curtain coaters:

Faustel, Steinemann, Gasway, all from USA, also Homag Germany for vacuum press machines which are used for PVC film lamination in woodworking.

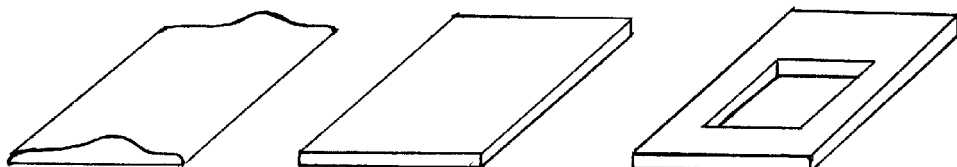

Figure 68: Examples of flat or slightly curved parts/panels that may be coated with curtain coaters.

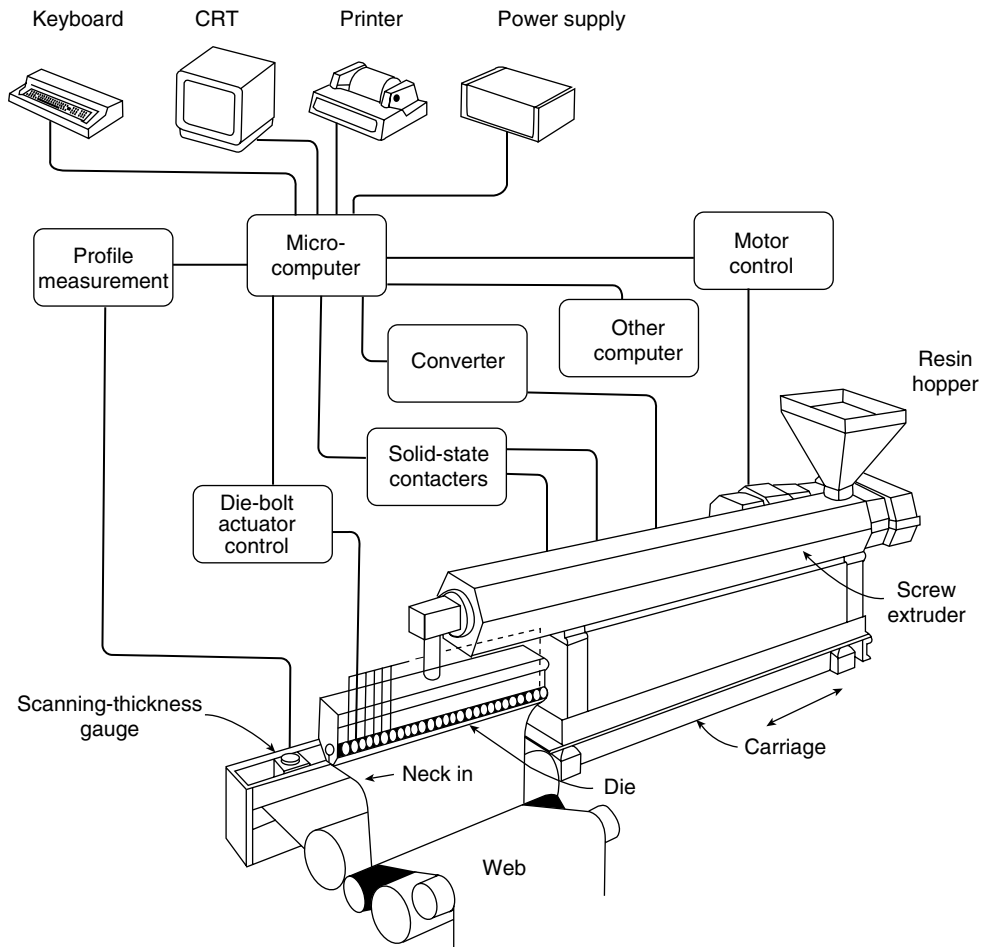

Figure 69: Extrusion coating machine with computer control for hot melt application.

Curtain coaters for hot melt adhesives and coatings and extrusion coating

With such a system, roll stocks may be coated or laminated at very high speeds of upto 200 m/min, i.e. 24,000 to 36,000 m²/h, by applying a thin adhesive coating of 15 to 20 g/m². Fig. 69 shows such a machine that includes:

- a hot melt screw extruder, which melts the hot melt granulates at temperatures ranging from 160 to 220°C, and pushes the hot melt towards the slot die extruder, under high pressure,

- a slot die extruder or curtain coater, which delivers a thin and perfectly calibrated curtain. This curtain falls on the substrate, and the main roll or ‘chill roll’ is refrigerated with cold water at 10°C, so that the hot melt will solidify very quickly and the coated substrates may be rewound immediately.

It is possible either to rewind the coated substrate, and it will be used later by a customer who wants to pack some goods by form-fill and seal technique, or the coated substrate may be laminated immediately to another material, for instance to manufacture packaging laminates (refer to the chapter ‘Packaging Adhesives’ in Volume 4).

In the aluminum to paper laminates used for milk and juice cartons, the adhesive is merely polyolefin, but in other packaging laminates the hot melt adhesive may be EVA based or other copolymers.

The extrusion coaters/laminators are very fast machines which require a perfect control of the rolls tension in order to eliminate any defect. There is always a complex system of several tension rolls, each one being driven by separate motors.

The machine may also include:

- several supply rolls with different materials,
- a Corona surface treatment equipment for plastic films, in order to improve the adhesion to the plastic films,
- sometimes a coextrusion equipment with a multiple layer system.

Eventually, we come up to very sophisticated machines such as the one shown in Fig. 69, a multipurpose machine for extrusion coating, coextrusion and laminating.

The maximum flow rate may reach 1000 kg/h with 3 to 4 m wide machines, a screw extruder of 20 cm, diameter and add on is usually from 15 to 20 g/m² for packaging/laminating applications. These large machines are fully computerised: the temperature is controlled in many places, up to 100 control points, the speed of rotation of each roll, the adhesive thickness, the flow rates of the slot die and the screw extruder are all monitored. The width of the curtain may be adjusted, taking into consideration the ‘neck-in’ that all types of adhesives show.

For more details refer to the chapter ‘Application of Hot Melts’ and ‘Adhesives for Paper, Packaging and Laminating.’

2.11. Dip Coating

Dip coating requires a very fluid adhesive 50 to 500 mPas. The parts to be coated are dipped into the adhesive tank and then they are slowly taken out and

left for a few seconds on top of the tank to let the adhesive drip. Dip coating is very interesting for complex shapes and curved parts, which could not be coated with any other technique except brush application. Dipping may be manual or automatic.

2.11.1. Manual Dipping

The adhesive should be very fluid from 50 to 400 mPas, the parts are taken out quickly (2 cm/s) because the operator cannot stay for a long time, and they must be left for 1 min to drip (Fig. 70).

The adhesive film is uneven because it is thin on top of the parts (perhaps 20 to 50 microns) and thicker at the bottom, depending on the viscosity and rheology.

Some examples of application of manual dipping are:

- dipping the heels of women’s shoes with contact adhesives (polychloroprene adhesive) before bonding a piece of decorative leather) (Fig. 70),
- dipping of small metal parts in order to coat it with primer and adhesives before rubber bonding to these metal parts (refer to the chapter ‘Rubber Bonding’).

2.11.2. Automatic Dip Coating

The parts to be coated are moved slowly with an automatic conveyor (Fig. 71). Here the parts must be recovered very slowly (10 to 50 cm/min) in order to get an even coating. The adhesive may be more viscous: 100 to 2000 mPas. The thicker the adhesive, the slower should be the recovery.

Drip marks may be avoided because the recovery speed may be slower than the dripping of the adhesive.

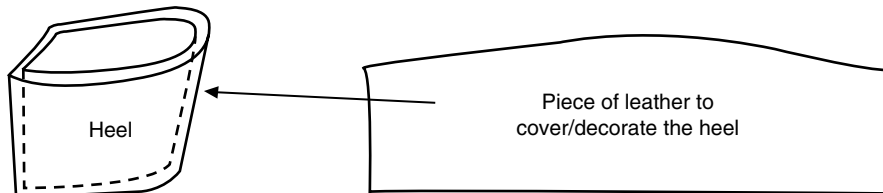

Figure 70: Bonding of leather covering to shoe heels by dipping the heels (and brushing the adhesive on the leather).

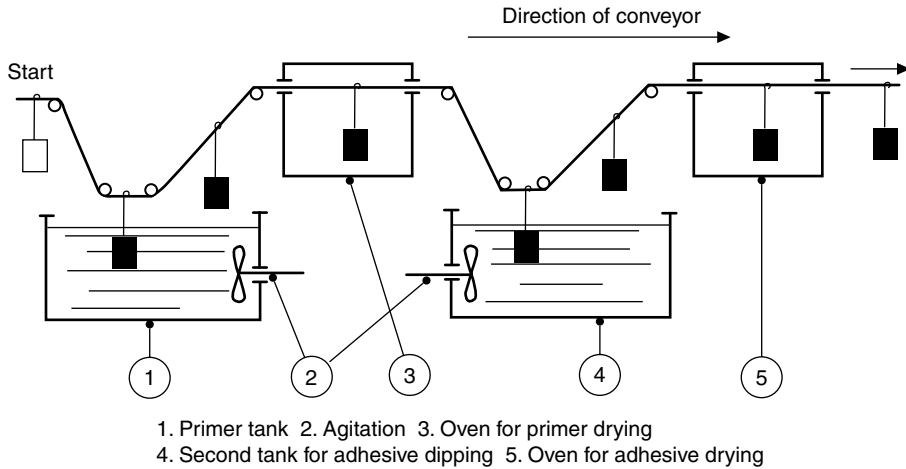

Figure 71: Dip coating of individual parts with a two coat system, primer + top coat.

The add-on may be from 40 to 200 g/m² according to the viscosity and rheology: for instance 40 g/m² for a solvent-based adhesive with a viscosity of 500 mPas and 200 g/m² with 3000 mPas.

It is also possible to coat a large number of small parts by placing it onto a grill, which is then dipped into the adhesive tank. Some examples of applications of this technique are:

- coating of metal sheets used for electric transformers,
- potting and encapsulating of electrical and electronic parts,
- dipping of screws and studs to coat it with anaerobic adhesives,
- dipping could also be used to apply adhesive only at the end of the cells of honeycomb: this would provide a bead of adhesive only at the place where bonding to facings occurs, and it would save adhesive if we compare with the full coating of the facings (Fig. 72).

All fluid adhesives may be used, either water-based emulsions that dry slowly, which gives them time to drip, or solvent-based adhesives, as long as they are very fluid, with the proper rheology.

2.11.3. Dip Coating of Roll Stocks

Fig. 73 shows such systems, which may be used for textiles. The excess of glue is eliminated by an air knife or a blade or a squeeze roll.

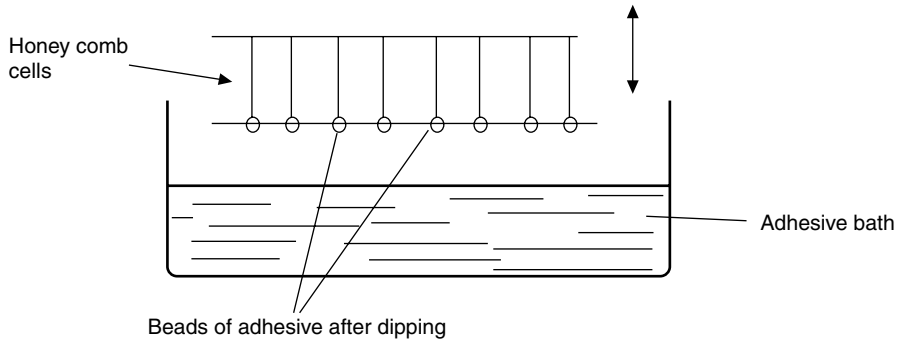

Figure 72: Coating of honeycomb cell by dipping; the honeycomb will be dipped only 2 mm inside the adhesive bath.

This technique may be used for textile webs, non-woven web, paper or foils. The non-woven webs or foams may be impregnated by binders, such as acrylic dispersion binders, but the coating weight must be controlled by squeezing out the excess adhesive or binder.

Adhesives and binders used for non-wovens: The binders should have low viscosity, from 200 to 3,000 mPas. In order to bind the fibers together with a minimum amount of adhesive, so that the non-woven will be soft and flexible, the surface tension of the binder must be controlled so that the droplets of binders will gather at the intersections (refer to Fig. 74).

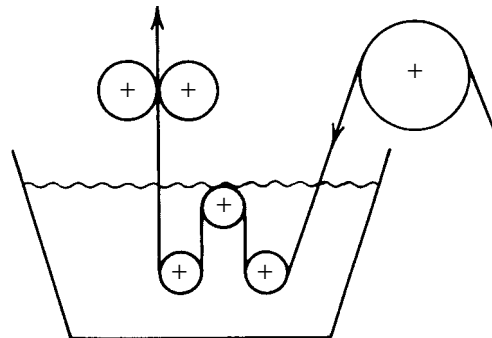

Figure 73: Integration of a textile on non-woven rollstock by dipping. (saw tooth saturator).



Figure 74: Binding non woven fibers: the droplets of binder should gather at the intersections (source WACKER).

2.11.4. New Applications

- Electric wires may be dipped into adhesive before bonding on printed circuits.
- bonding optical fibers.

2.12. Gravity Fed Adhesives, Ball Valves, Tampons

These are simple hand operated systems, which include:

- a top adhesive tank located 50 to 100 cm on top of the job place, in order to get enough pressure only by gravity,

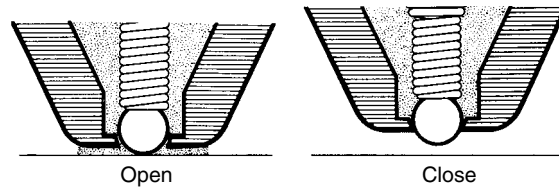

Figure 75: Ball valve applicator.

- a ball valve or another applicator. The ball valve will open and release the adhesive when it will be pressed onto the parts to be coated, as shown on Fig. 75.

These systems may apply a line or a bead of adhesive on a flat surface. Some packaging machines use a glue pot which feeds the adhesive to a blade or disc or small roll.

2.12.1 PAFRA Ball Valve Applicators (or Similar Ball Valves from Other Suppliers)

The PAFRA valves are ball systems shown in Fig. 76. When a carton or any other part is pressed against the ball, this opens the bottom orifice, and the adhesive flows through the opening. The orifice closes again thereafter. The exposure of the adhesive to the atmosphere before application is eliminated (no risk of drying). When the ball valve opens, the adhesive is spread by the flat face of the head. The ball size and the height of the gravity feed tank determines the amount of adhesive dispensed. These ball valves may be held in the hand or mounted on an automatic machine. These equipments are designed for use with water-based emulsion adhesives in the viscosity range of 1000 to 1500 mPas.

Examples of application: These ball valves are used on folder-glue for packaging and also on carton closing machines (Fig. 76). The adhesive flows by gravity from a plastic bottle. The pressure depends on the height of the bottle. The movement of the head is controlled by a solenoid. Sensors detect the sheet of cardboard. Other sensors measure the speed of the sheets. An electronic control system registers these data and instructs the valves to apply glue lines in the right places and to the right length. The valves are located very near to the folder cylinders. The speed sensors are located on a moving part which turns at the same speed as the sheets, generally on the folding rolls. The length of the glue line may be adjusted from 15 mm to 1000 mm at a speed of 70 m/min.

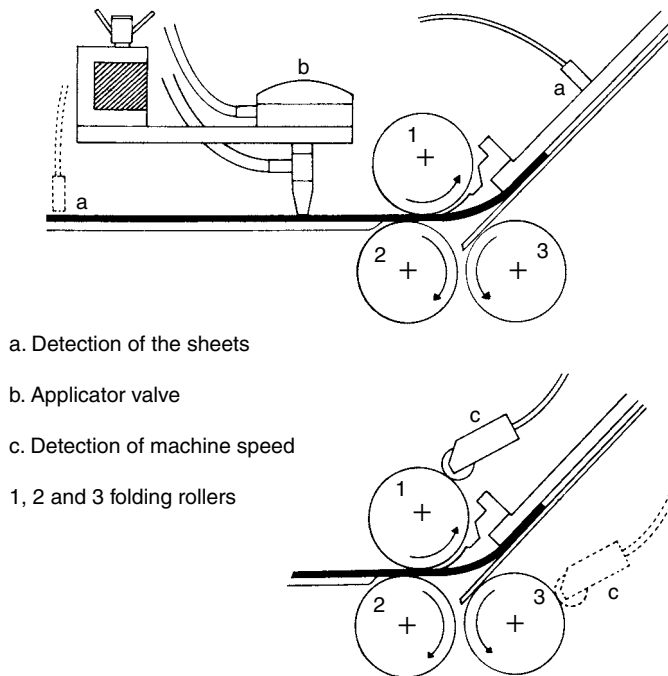

- a. Detection of the sheets
- b. Applicator valve
- c. Detection of machine speed
- 1, 2 and 3 folding rollers

Figure 76: Valve applicators on folder-gluer.

Suppliers of ball valve applicators: Besides Pafra, UK (Fig. 77), we may mention Robatech, Switzerland, and Valco, USA.

In some applicators, balls are replaced by needles, for instance in some Robatech equipments (Fig. 78).

2.13. Electro-pneumatic Guns for Cold Adhesives

Nordson offers its Walcom high speed guns which can apply fluid adhesives (up to 4000 mPas) by contact or without contact with the parts to be glued. Let us also mention Robatech (Fig. 79). Nordson has transferred his knowledge gathered with hot melts to the cold glues. The line speeds may be very high up to 700 m/min, and the deposit is made very accurately. These guns may be in contact with the parts to be coated, or without contact so that the adhesives may be applied on fragile materials such as foams, cigarette paper or fluffy non-woven without contact. The pumps are diaphragm pumps.



Figure 77: Example of ball valve application for small jobs (by courtesy of PAFRA).

Adhesives may also be applied as dots at very high speeds, thousands of dots per minute. The application is controlled by microprocessors: a numeric coder integrated to the production line synchronises the adhesive application and the line speed, with a precision of 1 mm. The flow of adhesive is also controlled by this microprocessor.

Some examples of application are:

- folder-glue in packaging lines (refer to the chapter ‘Packaging Adhesives’),
- cigarette manufacturing where the line speeds are very high (up to 9000 cigarettes per minute so that the lengthwise gluing works at 20 to 200 m/min),

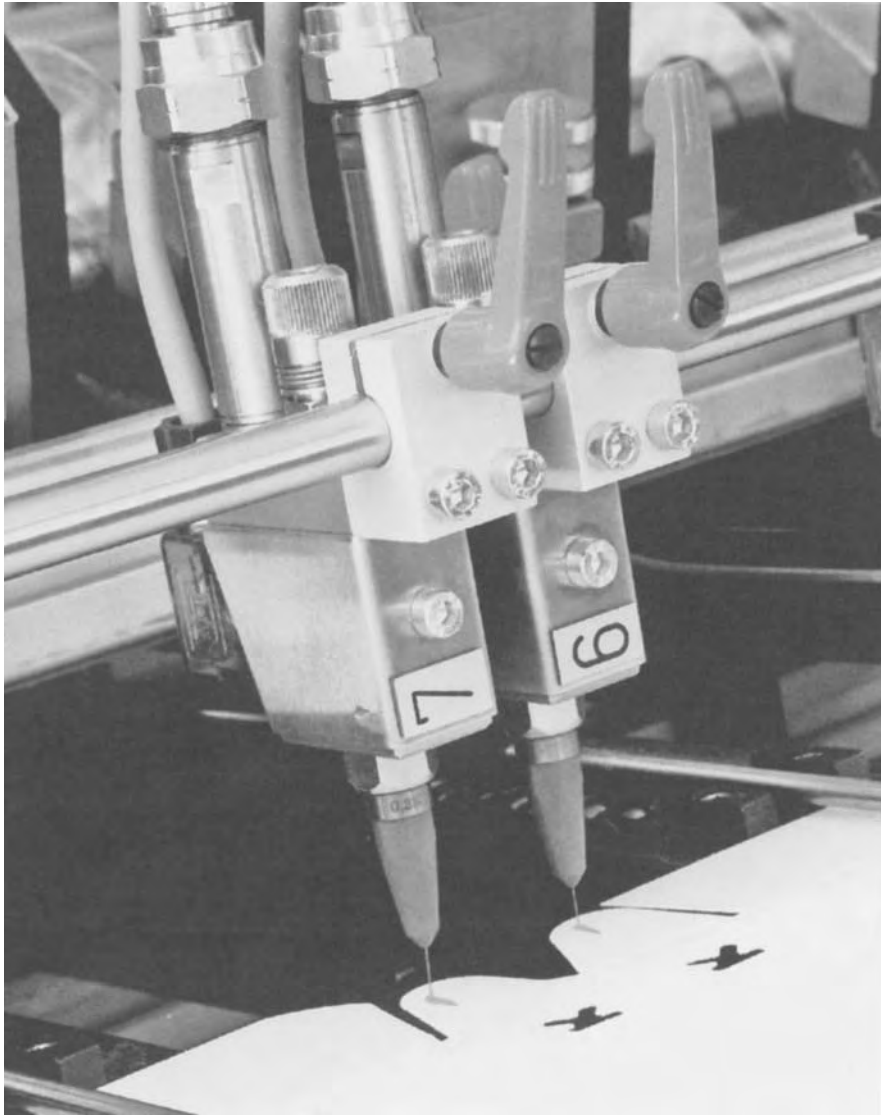

Figure 78: Needle applicator for cold glue (source Robatech Switzerland).



Figure 79: Electromagnetic gun for cold adhesives (by courtesy of Robatech Switzerland).

- paper bags, envelopes, cardboard boxes,
- textiles, non-wovens, foams.

Patterns of application for different systems: Fig. 80 shows the different patterns which may be obtained with various systems: assembly and pressing of parts together cause some enlargement by squeezing if the bead of adhesive is thick.

Type	Pattern applied	Cross-section	Final bond after assembly
Wheel/Stencil			
Spray			
Extrusion			
Jetting			
Needle			
Ball valve			

Figure 80: Comparison of patterns obtained with various applicators.

2.14. Metering and Mixing of Two-Component Adhesives and Sealants

2.14.1. General Information

There are several types of adhesives and sealants which require mixing of two components before application:

- structural adhesives such as epoxies, PUR, resorcinol-formaldehyde, structural acrylics,
- some nonstructural adhesives such as vinyls, polychloroprene, polyurethane adhesives that only need the addition of a hardener or catalyst (3–20%).

2.14.1.1. Pot life

This is the first parameter to consider. In some cases, the pot life is long enough so that the two components may be kept from one to several hours before application, but in other cases the pot life may be only a few minutes and this requires a metering and mixing machine that prepares the mix immediately before application. When the pot life is very short (a few minutes), the flow rate of the mix must be large enough so that the mixed products may be evacuated and used before the mix could harden into the equipment.

2.14.1.2. Viscosity and rheology

The pumps, metering, mixing and application systems must be adapted to the viscosity of both the components. The viscosities of the two components should be similar in order to get a good mixing effect: a very liquid product could not be mixed efficiently with a very thick product. Rheology, of course, must be also adapted: the products may be pseudoplastic, thixotropic but never dilatant (for these definitions, refer to Chapter 2 in Volume 1 ‘Technical Characteristics of Adhesives and Sealants’).

2.14.1.3. Homogenisation

Before mixing, the fillers in the adhesives must be thoroughly remixed. Some system must be used to check that the mix has been made completely, for instance by using two different colours for the two components and then checking that the colour of the mix is even.

2.14.2. Metering

Generally the two-component metering is volumetric. There are four types of machines:

- machines where the proportioning is controlled by the volumes of the cylinders. In each cylinder, a piston sucks one of the components and forces it towards the mixer. The cylinder and the piston may be changed to get different proportions.
- machines where the proportion between the two components are set by the number of strokes. Each cylinder works as a suction and force pump that feeds the mixer. When a new mixture arrives in the mixer, the products already mixed are pushed to the application system.
- machines where the metering pumps are driven by a lever system (Fig. 81), the lever motion are made shorter or longer by the horizontal displacement of a pneumatic motor situated above.
- there are also machines where electronic rheostats control electric motors which modify the displacement speed of the pistons.

There are several metering systems:

- fixed ratio: the proportions are set by the equipment manufacturer and may be changed only by changing some parts (pistons and cylinders). These machines are simple, reliable and accurate.
- ratio adjustable by the user: the proportions are set by adjusting the position of a lever (Dopag Variomix/Economix machines, Fig. 81) or the number of strokes.

Some examples of application of this technique are:

1. Fixed Ratio Hydra Cat[®] of Graco: This is a dispensing system that proportions and mixes two-component products (Fig. 82).

The fix ratio proportioner E pumps and proportions the two components materials by powering two or three positive displacement pump lowers from a common air motor. This assures that the stroke rate and stroke length of all pump lowers are identical, thus providing constant proportioning. The mix ratio is fixed by selecting compatible sets of 2 or 3 lowers. The 2 lowers system gives a 1:1 ratio, the 3 lowers system gives mix ratios above 1:1. We will see later that the mixing is made by a mixer manifold – K in the figure. The mixer manifolds can be mounted on the Hydra Cat[®] or mounted remotely, closer to the application, in order to reduce material or solvent losses.

Uses: The Hydra Cat[®] is a large equipment used for high production rates in applications such as bonding and sealing of body, doors, hoods on automotive

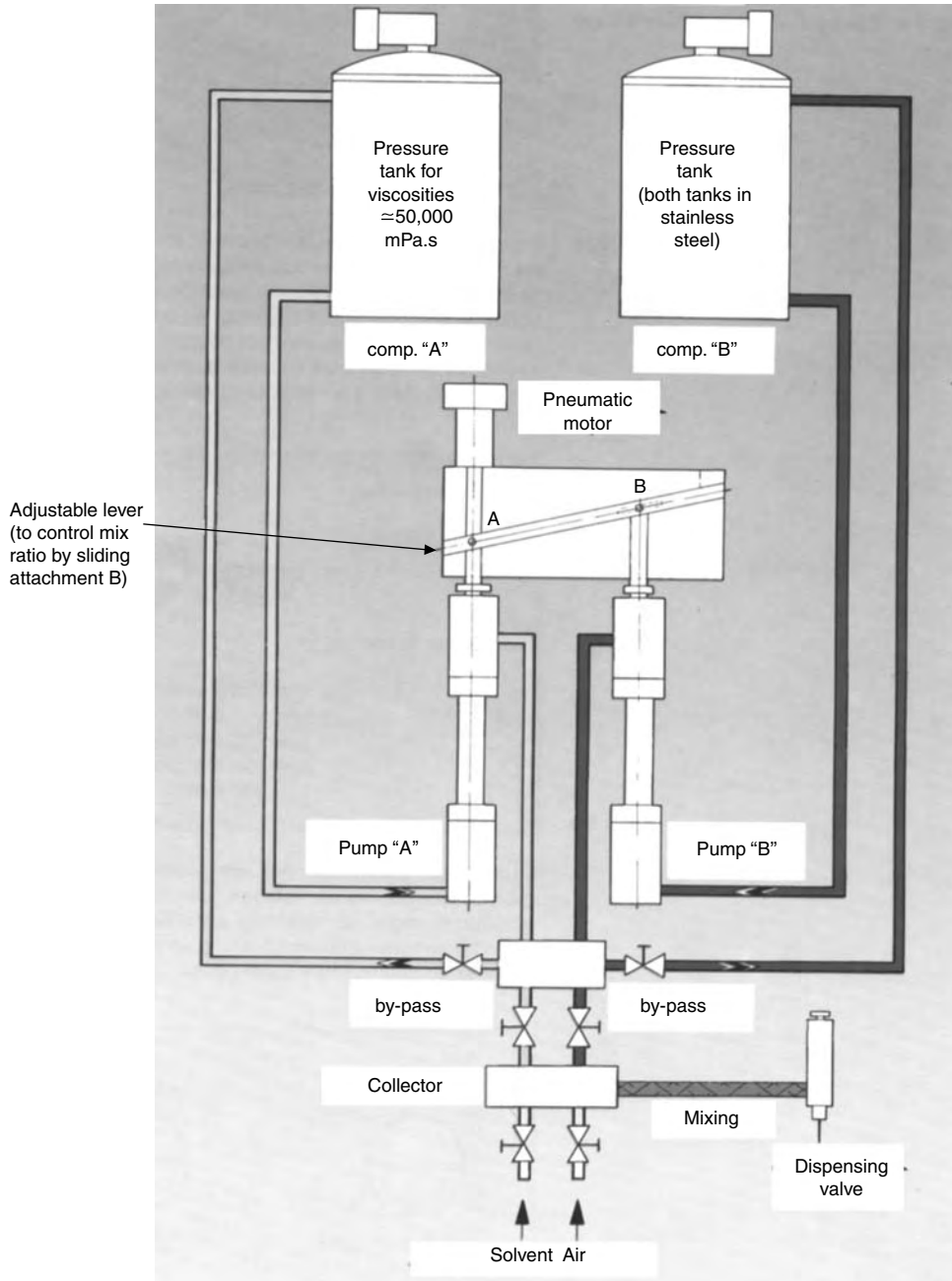
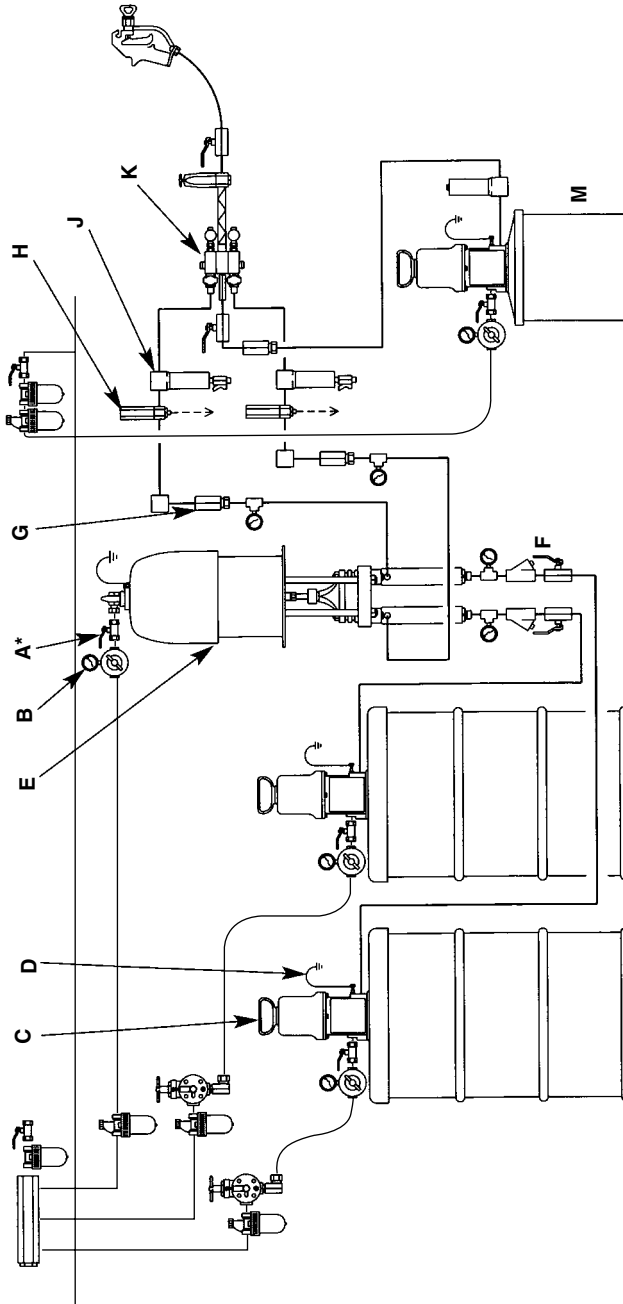

Figure 81: Dopag metering system Economix/Variomix[®] with a lever control.



- A** Bleed-type master air valve
- B** Pump air regulator
- C** Feed pump
- D** Ground wire
- E** Proportioning pump
- F** Fluid pressure gauge
- G** Check valve
- H** Automatic pressure relief valve
- J** Fluid filter
- K** Mixer manifold
- L** Fluid shut-off valve
- M** Solvent pump

Figure 82: Mixing of two-component adhesives, mechanical proportioner, fixed ratio (Hydra Cat® from Graco).

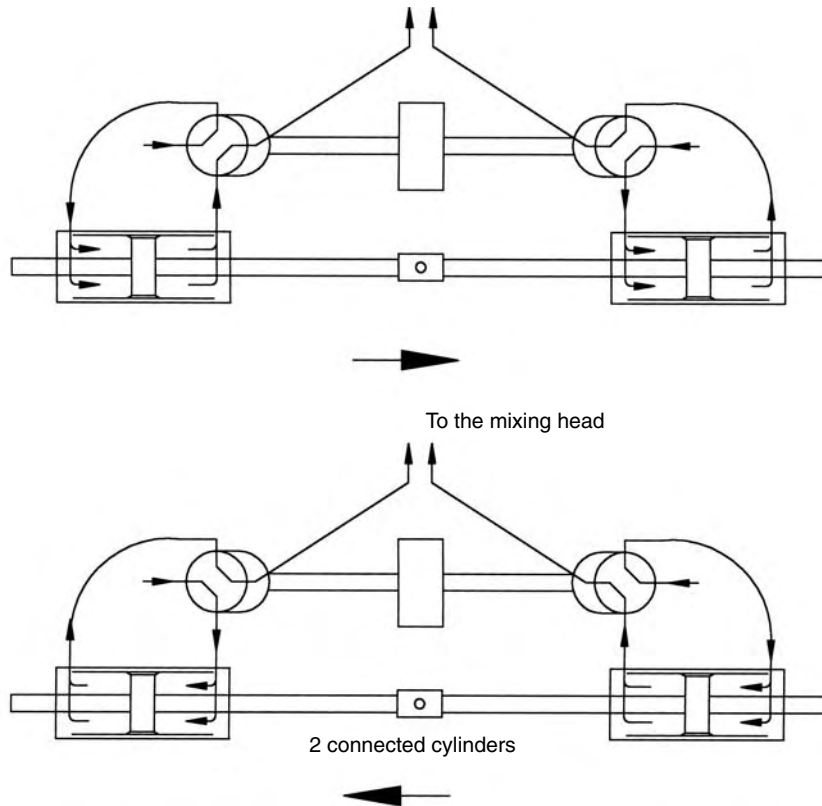

Figure 83: Graco 8900 Proportioner for metering two components by using double-acting cylinders.

production lines, double windows glazing, etc. The mixed products (for instance two-component polyurethanes) may also be pumped on a roller coating machine used for flexible film laminating.

2. Graco 8900 Proportioner: The Graco 8900 Proportioner uses fluid inlet pressure to continuously reciprocate two connected cylinders (Fig. 83). This fluid pressure is provided by two pumps which supply consistent pressure to the proportioner cylinders.

As the base volume cylinder and hardener cylinder reciprocate, they displace the two material components in the required ratio to the outlet ports. This proportioner may be used to meter and mix silicones, polyurethanes, epoxies, adhesives or polysulphide sealants.

3. Economix[®] from Dopag/Hilger und Kern: In this metering machine, the ratio of the two components is controlled by an adjustable lever. It may vary from 1:1 to 20:1, viscosities may range from 100 mPas to 50,000 mPas, the maximum pressure applied on the products is 100 bars and the flow rate varies from 2 to 4 l/min.

2.14.3. Mixing

There are two types of mixers:

- static mixers,
- dynamic mixers.

2.14.3.1. Static mixers

Fig. 84 shows this type of mixers, made of a plastic pipe inside which there are helicoidal partitions. We already discussed the mode of action of these mixers earlier. The choice of the mixers depends on the following parameters:

- viscosities of the two components,
- required degree of mixing,
- pressure loss in the mixer,
- materials to be used in the mixer,
- disposable or reusable, cleanable or not,
- price of the equipment,
- flow rate,
- pot life of the adhesive.

There are several suppliers: TAH Industries, USA, Dopag and others.

2.14.3.2. Dynamic mixers

Here the mixing is done by a gear pump or a small pneumatic motor.

Gear pumps

When a liquid goes through a single gear pump, the flow is uneven. Therefore, it is necessary to use two gear pumps; the first one provides the pressure, the second one controls the flow rate and provides the metering, pressure being the same at the entrance and at the exit of the second pump. Therefore, to meter the resin and the hardener, it will be necessary to have two pairs of gear pumps.



(a)



(b)

Figure 84: (a) Static mixer. Source TAH industries. (b) Application of adhesive in bead form on a plastic part with hand held gun equipped with a static mixer (source Graco, Belgium/USA).

Mixing by a small motor in the mixing head:

In all cases, the flow rate should be adjustable. The mixing is done by an electric or pneumatic motor. The volume of the mixing chamber may vary from 1 to 100 cm³. It is advisable to use pneumatic motors which will not 'burn' in case of premature hardening of the adhesive into the mixer that would stop the mixer.

Dynamic mixers may be used when the static mixers do not give good enough and fast mixing. The operator must be careful because the intensive mixing may raise the temperature of the mix, thus reducing the pot life.

Risks of bubbles by air entrapment: When the mixing chamber is closed, there should not be air entrapment. However, if for some reason there is air entrapped, this would be detrimental to the quality of bonding, and therefore it is necessary to use a debubbling system. There are two types of debubbling systems:

- void debubbling: used for thick products,
- centrifugal debubbler: the adhesive without foam is collected on the periphery, and the foam which has a lower density remains at the center. An example is the Beaner and Hamilton centrifuger which is often used in aircraft construction, where the adhesives performances require freedom of air entrapment (except for the syntactic adhesives, but these are specially formulated for a good cohesion).

2.14.4. Extrusion/Dispensing

Dispensing of the adhesive after mixing may be done by several techniques:

- manual extrusion with a gun which is the same gun used for mixing,
- automatic dispensing with an automatic valve equipped with tips, stainless steel needles or plastic disposable tips (Fig. 85). The valve must precisely stop the flow of adhesive and keep the last drop in order to get a clean operation.

A fixed mixing head is used when the surfaces to be coated pass below the head on a conveyor. A movable dispensing head may be used for an operator or a robot.

In some cases, the metering and mixing machine will be used to fill 600 ml cartridges that will be used manually elsewhere in the production site, with a manual gun, by other workers. For example, this is useful during the construction of a large ship, or railway carriages, or a large building where several workers may apply two-component sealants in places far away from the machine.

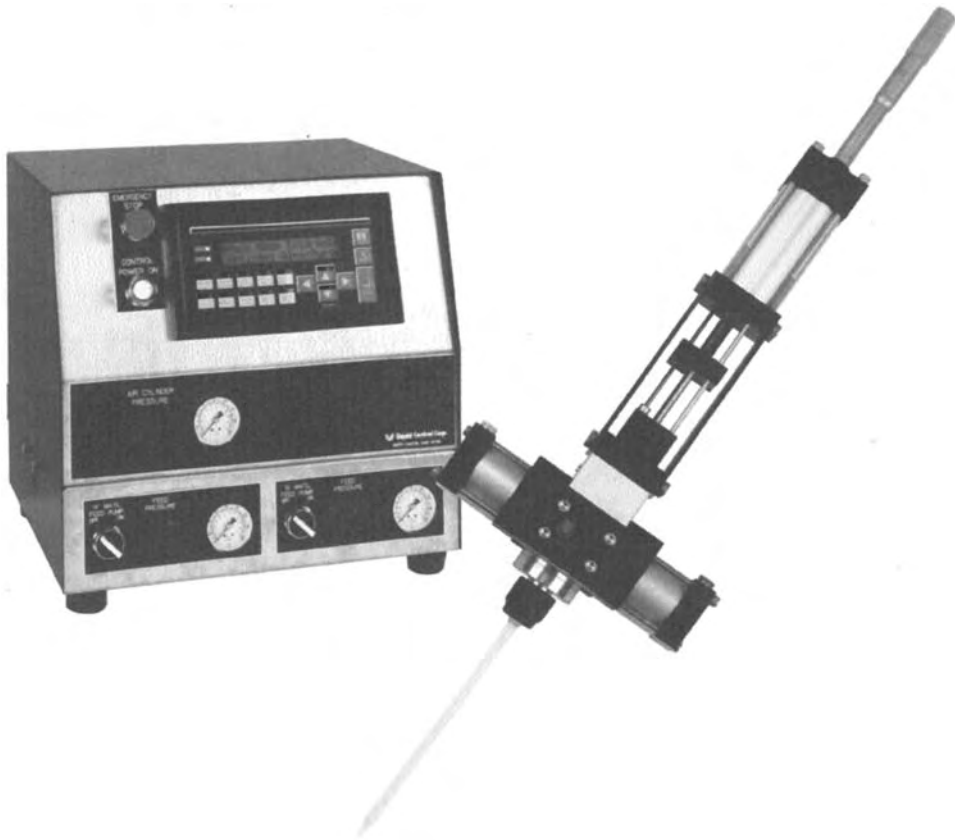

Figure 85: Automatic dispensing valve Posidot® from Liquid Control.

2.14.5. Spraying

Spray guns may be installed immediately next to the mixing heads, the nearer the better because a long stay should not be allowed in the hoses. The spray equipment will be as simple as possible when the products are fluid, the mixing ratio 50/50, the application at room cold temperature and the pot life as long as possible. If airless spray is required, the pump may raise the pressure to the high pressure required.

2.14.6. Cleaning by Flushing with Solvents

Since, the pot life is limited, it is necessary to flush the mixing head from time to time to eliminate any mix which could start to gel or harden.

Flushing is done by sending solvents under high pressure into the equipment (refer to Fig. 81). If the equipment has some recessed places, it may be necessary to dismantle the equipment in order to clean it completely.

2.14.7. Control Systems

For high-performance bonds, it is advisable or even mandatory to include several control systems:

- alarm at the end of the drum,
- control of the pressure of the two components after metering,
- flow rate control,
- control of the filters,
- control of the cleanliness of the mixer,
- and also, of course, a control of the quality of the bonds.

A microprocessor may be added to monitor all these information and stop the machine in case of problem.

2.14.8. Examples of Complete Systems for Metering, Mixing and Dispensing Two-Component Adhesives/Sealants

2.14.8.1. Multi-component metering and mixing system Variomix from Dopag (Fig. 81).

The components are taken from the pressure tanks to the metering pumps via corrosion resistant chrome steel tubes. The metering pumps are driven by the lever system and feed the two components in the desired mix ratio to the dispensing valve. If the metering ratio is changed, the total output is only slightly changed. It is possible to process the material continuously or in shots. The pressure tanks can be supplied with various capacities up to 250 litres. The metering piston pumps are driven by a pneumatic motor via the lever system. There are two separate control systems:

- the electrical part controls heating, agitators, pot life and lever,
- the pneumatic part controls operating pressure of the air cylinder and the pressure tanks, the pump for flushing.

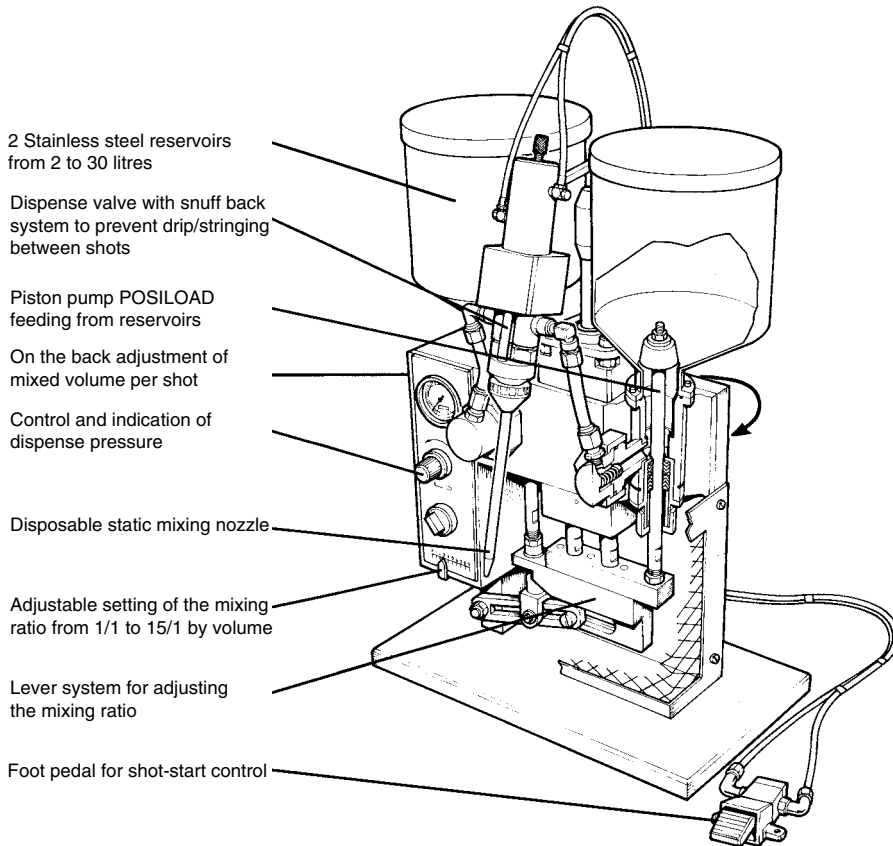

Figure 86: Metering and mixing equipment Twinflow from Liquid Control company. May handle viscosities up to 250,000 mPa.s, volume per cycle = 2 to 20 cm³, upto 30 cycles/min.

Dispensing valve: The two components are fed separately to the dispensing valve. The components are fed to the relevant valve stems via the material inputs which are protected by check valves. These stems exert a snuff effect when closing, thus preventing dripping of the mixed material from the outlet.

2.14.8.2. Twinflow[®] mixer from Liquid Control

In the Twinflow[®] VR (variable ratio) the metering pumps are here also driven by a lever system (Fig. 86). By moving the secondary pump (for the hardener), the mixing ratio changes. The total volume delivered is controlled by the displacement of the pistons. In the Twinflow[®] FR (fixed ratio), one single pneumatic jack drives

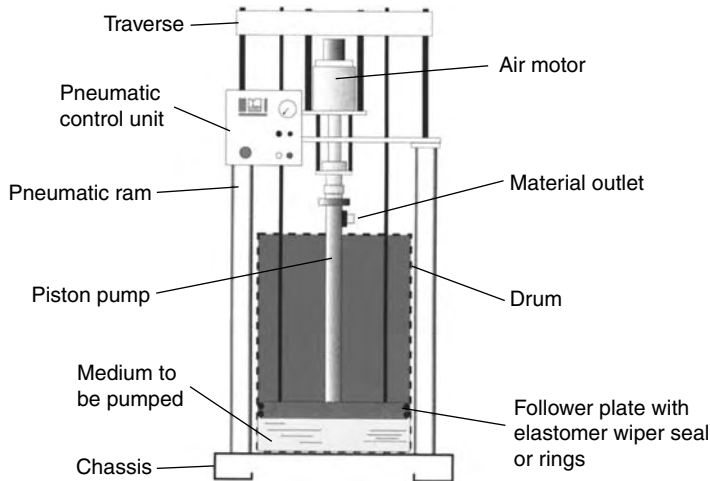

Figure 87: Drum pump (for 25 l or 200 l drums).

both the pumps simultaneously, and the mixing ratio is determined by the ratio of the sections of the two pistons. In both cases the dispensing may be done in a continuous way or by separate doses, for instance for potting.

Technical features:

- the volumetric metering is quite accurate, at $\pm 0.5\%$, the output may vary from 0.3 to 6 l/min,
- the ratio between the two components may vary from 1/1 to 200/1,
- there is no need to pressurise the products tanks because the pumps are filled by gravity.

Utilisations:

- the small systems are used for bonding or potting of small parts (electrical parts for automotive, electronics),
- the large systems (0.6 litres per stroke) are used for bonding or sealing of large parts such as automotive body or doors, sandwich panels and appliances.

2.14.9. Application of Two-Component Hot Melts

This is a very special and rare system. We will study it in further detail in the chapter ‘Application of Hot Melt Adhesives’ in Volume 4.

Suppliers of metering, mixing and dispensing equipment for the two-component adhesives:

There are many suppliers who offer:

- pumps of various types (piston, diaphragm, rods), power, flow rate,
- mixing heads, static or dynamic,
- applicators (valves, guns),
- complete machines.

Table 7 lists the various parts of equipments.

Suppliers:

- Graco, USA and Belgium,
- De Vilbiss, USA with affiliates and distributors in many countries,
- Liquid Control, in USA and Europe,
- Dopag/Hilger and Kern, Switzerland and Germany,
- Kremlin, France and other countries,
- Kent Moore, USA and Switzerland,
- Rexson, USA,
- Applicator Metallwagen, Sweden

and some other suppliers in Asia–Taiwan, China and Japan.

2.15. Automatic or Robotic Application with Syringes

In Section 2.4.5, we studied the manual syringe application. For high-speed jobs, such as surface mounting in Electronics, the syringes are operated by high-speed valves and they are installed on a high-speed robot which can move, for instance on the Fisnar robot I and J 2200, at 5 to 500 mm/s X and Y, with a repeatability of ± 0.01 mm per axis, and a resolution of 0.01 mm for X, Y and Z axis. The parts to be bonded or potted or sealed are placed under the syringe.

The robots may apply dots, lines, at high speeds and very accurately. There are also rotary dispensing systems, with rotary tables which are convenient for dispensing circular patterns. They are adjustable in rotation speed, circles, diameters and dispensing time. They dispense from barrels, cartridges or valves mounted on the Z axis gantry. Figures 88 to 90 show several applications in electronics, Hifi and other industries.

Other robotic applications: Fig. 91 shows the robotic application of a structural adhesive to bond the inside part or a car door onto the exterior shell of the door. The robot can be programmed to apply the bead of adhesive and an experienced worker monitoring the process can improve the application, for instance in moving

Table 7: Summary of various pieces of equipment needed for metering, mixing and application of adhesives and sealants

Material supply pumps	Control equipment	1K-Metering systems	2K-Metering and mixing systems	Mixing systems	Dispensing and peripheral equipments
Transfer pumps	Material pressure regulators	Pumps	Piston metering systems	Static mixers	Vacuum chambers
Drum pumps	Flow-regulating valves	Valves (ball or needle valves)	Gear metering systems	Dynamic mixers	Automated systems: robots, automatic spray ball or needle valves
Bung-mount pumps	Volume counter	Volume counter			
Diaphragm pumps	Metering computer	Computer			



Figure 88: Robotic application of silicone adhesive/sealant on Fisnar robot equipped with syringes of adhesive/sealant (robot Scara TMB 100) (by courtesy of FISNAR, USA).



Figure 89: Bonding loudspeaker with rotation table RT404 from IJ, Fisnar, USA.

faster or slower on some part of the path in order to apply the same amount of adhesive everywhere.

Further discussion on robotic applications of adhesives and sealants are done in a separate chapter 'Robotic Application', and also in the chapters 'Adhesives for Electronics' and 'Automotive Adhesives and Sealants' later in the Handbook.

2.16. Application of Powders

These systems are mostly used for hot melt adhesive powders, for instance for textile laminating, liners and we will study this in two other chapters 'Hot Melts Application' and 'Textile Bonding' in the future volumes of this Handbook.



Figure 90: High speed adhesive application with small cartridges (by courtesy of LOCTITE, USA).

2.17. Application of Dry Adhesives, Film Adhesives

In the last 40 years, many suppliers tried to find methods of clean and easy application of adhesives, glues and sealants. The main idea was to use adhesives in dry form, to avoid the stickiness and dirty application of the old glues. A need for adapted application equipment came from this. The main invention was the pressure sensitive tapes and labels, and then the hot melts supplied as dry solid granulates. There was also the preformed tape sealants, the structural adhesives supplied as film adhesives used in aircraft bonding figure 92, the heat sealable tapes and films, the hot melt sticks and lately the glue sticks for office use.



Figure 91: Robotic application of a structural adhesive on an automotive production line (source Graco).

2.17.1. Pressure Sensitive (PS) Tapes, Labels and Roll Stocks

The methods of application of pressure sensitive adhesives onto substrates, has been done previously in this chapter (roll application for water-based, solvent-based or hot melt adhesives, dies). These pressure sensitive products may be applied on other substrates, by using roll application equipments.

Besides the manual roll application for small jobs and office jobs, there are automatic machines for applying PS tapes and labels with fast machines in the plants, for various end uses, in packaging (cases and carton closing, labeling), marking and protection of goods, splicing stock rolls, waterproofing, decoration.



Figure 92: Hand lay down of a structural thermosetting epoxy adhesive film.

The fast unwinders may work at fairly high speeds upto 50 m/min, and they may also adapt to the shapes of goods in some way. (Figs 93 and 94). All the main suppliers of PS tapes and labels: 3M, Avery Dennison, TESA, SCAPA etc. supply such unwinding and application equipment.

It is interesting here to compare the three techniques which are used in packaging for cases and cartons closing in large plants, as far as the available speeds, strength, costs, ease of application, ease of opening are concerned. In the past, cases were closed and sealed with staplers. This was a fairly slow and manual application, and it is less and less used, and only for small jobs, small production output. For the medium speed production lines upto 5 cases per minute, pressure sensitive tapes, applied by automatic unwinders, are suitable and used.

For the fast packaging lines, 20 to 30 corrugated cardboard cases per minute, only the hot melt adhesives are suitable, because they may be applied at high speeds such as 20 m per min, and they set very fast, in 1 to 3 s, so that the cases may be processed further on the line immediately (stacking, storage and shipment).

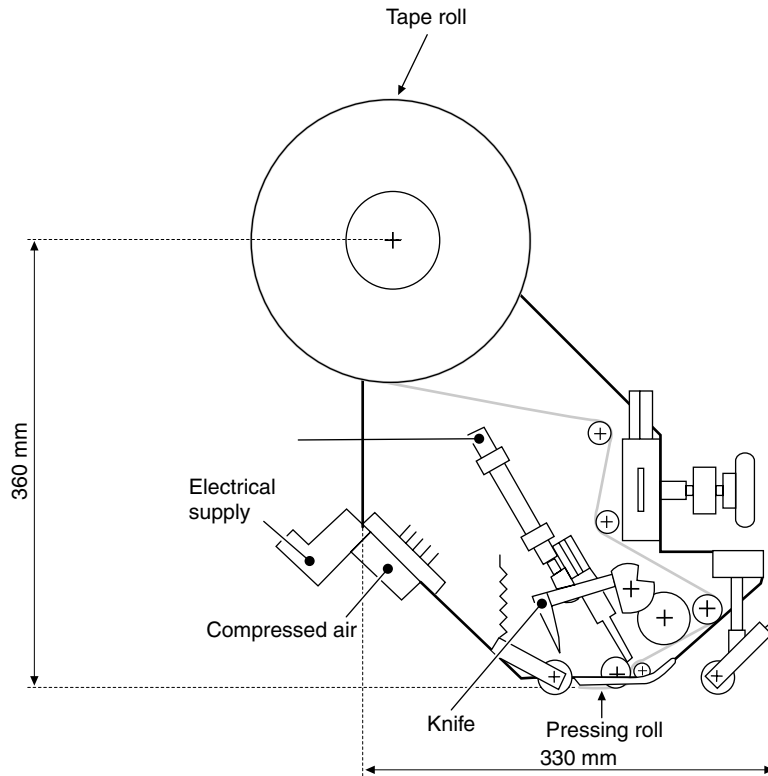

Figure 93: Unwinding and application of a fixed tape roll onto a moving substrate.

2.17.2. Dry Film Adhesives

These are adhesive films which have been coated, usually on a carrier such as a non-woven or a plastic film, and then dried to provide a dry film of adhesive, which is supplied as rolls to the end users.

Dry film adhesives provide several advantages:

- easy to use: cut it to size, no need to apply a paste,
- thickness of adhesive is perfectly controlled,
- bonding viability: the operator can check easily that they placed the adhesive in the joint.

The adhesive may be cast either as a self supporting film or cast on a substrate. Its thickness may vary from 0.2 to 0.5 mm. There may be a protective or release film, for instance a polyethylene film.

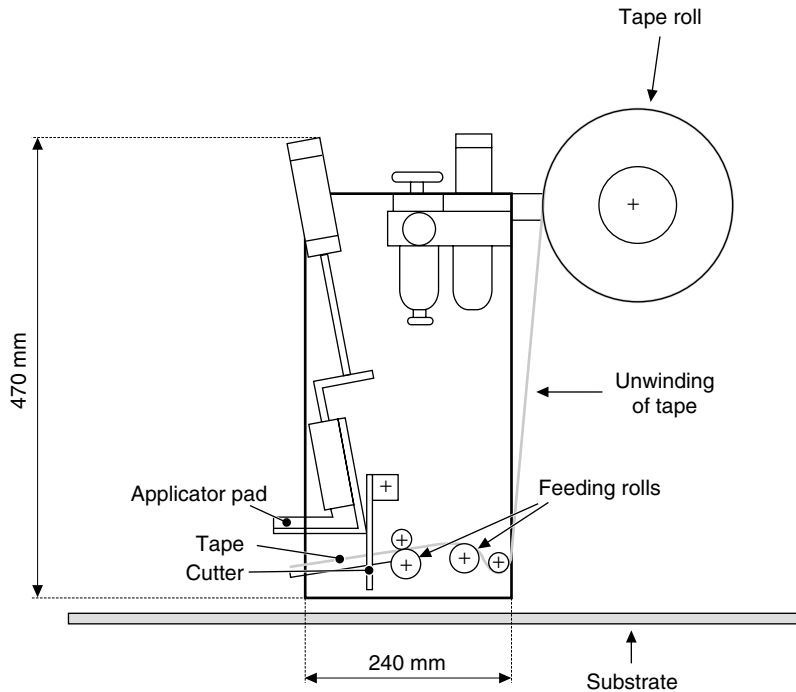

Figure 94: Unwinding and application of a fixed tape on a fixed (non-moving) substrate. Width of the tape 10–50 mm, Length of the tape 15–100 mm (source 3M).

There are three types of film adhesives:

- pressure sensitive films, which may be used for instance to bond metal identification plates on motors or other machines. These PS films may be coated on both sides of a foam tape, which provides a higher thickness, up to 2 mm for instance, and also some ‘cushioning’ effect.
- heat sealing films, that must be reactivated with heat, very often used in textile and clothes industries, let us also mention the polyvinyl butyral film used to bond several glass plates in the manufacture of safety glass,
- thermosetting structural adhesives: their main utilisation is for bonding honeycomb in aircraft manufacturing.

We will study the formulation and manufacturing of these films in the relevant chapters. For instance thermosetting structural films based on epoxies are studied in the chapter ‘Epoxy Adhesives’ in Volume 5, and also in chapter “Aerospace Bonding” in Volume 1.

A complete chapter will be also devoted to the thermoplastic heat sealing films, later in this Handbook. These thermoplastic films are used for textile laminations and for other laminating in various industries.

2.17.2.1. Application and utilisation of these film adhesives

Structural thermosetting film adhesives: The film is cut to the desired size and laid on one of the substrates (refer to Fig. 92). Parts are assembled and hot pressed in an autoclave or a hot press, for instance for a one component epoxy adhesive for 30 min at 120°C, under a pressure of 100–300 kN/m² for REDUX 312, or 60 min at 170°C with REDUX 308 or REDUX 322.

At these temperatures, the film adhesive first melts and wets the substrates, then it cures by cross-linking.

End uses:

- bonding honeycomb to aluminum sheet facings for the manufacture of aircraft sandwich panels,
- other structural bonding of metals, composites,
- Tegofilm of Goldschmidt, phenolic resin based, for the bonding of water resistant wood panels,
- some of these adhesive films, called syntactic films in Aircraft industry, foam during cure so that their thickness becomes four times higher than their original thickness. This allows the adhesive to fill the gaps between parts and also provides more flexible bonds.

We discuss the formulation and uses of structural films in several chapters ‘Bonding in Aircrafts’ in Volume 1, ‘Epoxy Adhesives’ in Volume 5, ‘Metal Bonding’ in Volume 5, etc.

Thermoplastic films, fusible films:

- e.g. polyvinyl butyral film adhesive, thickness 0.75 mm. When it is heated at 140°C in an autoclave, it sticks strongly to glass, and it is totally transparent. It is used for the manufacturing of safety glass, as we will see in the chapter ‘Bonding of Glass and Transparent Materials’,
- other thermoplastic films, based on ethylene–acrylic acid polymers, polyesters, are used, for instance, to bond textiles or PVC on automotive headliners or doors,
- EMS Griltex offers also thermoplastic non-woven grids, made of thermoplastic fusible fibers, which are widely used in garment manufacturing.

Fig. 95 shows the bonding of scouring pads: here the thermoplastic film is heat reactivated by blowing hot air or by infrared radiation. Fig. 96 shows the bonding of two materials in roll form.

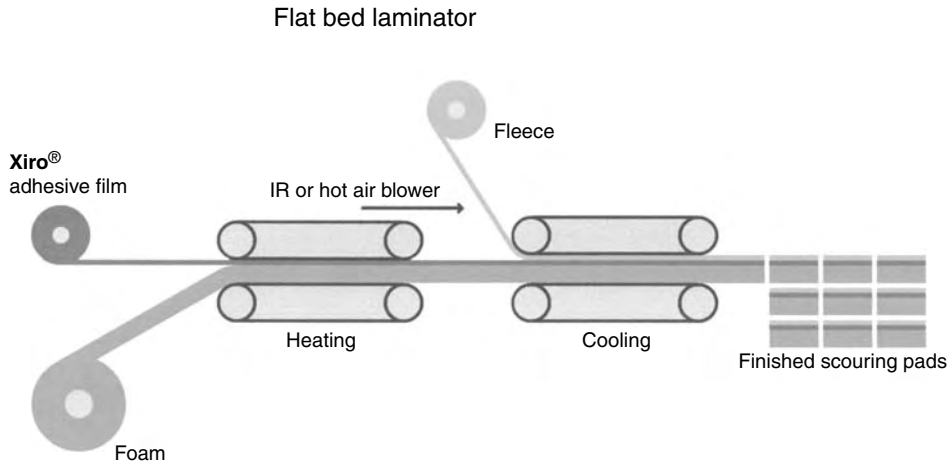

Figure 95: Bonding of scouring pads with thermoplastic fusible films. Here the thermoplastic film is heat reactivated by blowing hot air or by IR (source Collano Switzerland).

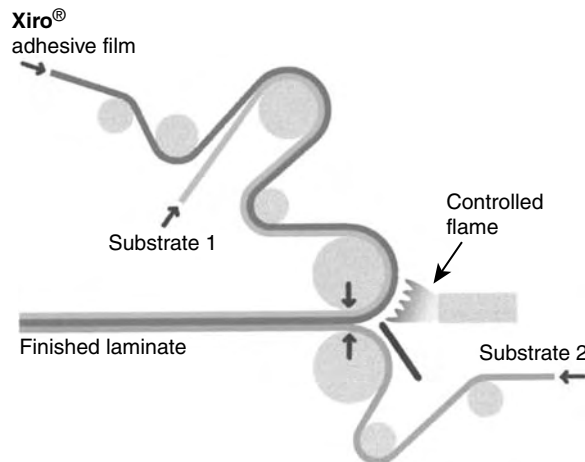

Figure 96: Bonding two materials in roll form with a thermoplastic fusible film (XIRO from COLLANO) and reactivating the adhesive film by flame immediately before laminating (by courtesy of Collano Switzerland).

The film may also be cut to the exact required dimensions and laid on one of the substrates, parts are assembled and then the adhesive film is reactivated by heat (in a heated press), it softens and bonds immediately to both the substrates.

2.17.3. Films or Textiles Pre-coated with a Dry Adhesive

Textiles for liners or lamination may be delivered as coated textiles: the textile is pre-coated in another factory with a thermoplastic adhesive and delivered in rolls to the final user.

This is a convenient way to bond textiles because it is clean and there are no messy glues. The user only needs to cut the liner to the desired shape, lay the coated liner onto the garment and then reactivate by heat the adhesive film, for instance with a heated press or a hot iron or sometimes high-frequency equipment.

End uses:

- bonding and stiffening of shirt collars: a textile liner is coated with a powder hot melt (polyamide or polyoefins), it is applied onto the textile of the shirt, heat reactivated for 5 to 10 s at 120–170°C and pressed under 1 to 5 bars with a platten press.
- shoe stiffeners for toes and back lining,
- bonding of thin, expensive leathers or other foils, for bookbinding in this case the user wants to avoid damaging these materials by staining it with a liquid adhesive. The material is pre-coated with thermoplastic adhesive, dried and delivered to the final user, who will do the bonding by heat reactivation and press.
- laminating of plastic foils to copper foils in electronics, with thermoplastic polyesters,
- repair of garments with an adhesive-coated textile.

2.17.4. Pellets

Pellets were designed in order to supply thermosetting adhesives in a convenient dry form with shapes and dimensions adapted to the bonding joints and to the exact sizes of parts to be bonded. The pellets may be delivered to the users as rings, tablets, small flat discs, with the exact shape and dimensions of the joint between the parts to be bonded.

Pellets are mostly made of fusible one-component thermosetting epoxy adhesives which contain the right epoxy/hardener ratio.

They are placed between parts to be bonded, they melt during the oven cycle and bond the parts together. They may also act as a potting and encapsulating product. The epoxy formulation may also contain conductive particles in order to allow cure by induction or high frequency. Curing conditions are those of the one-component epoxy adhesives, i.e. from 15 to 60 min at temperatures ranging from 120 to 160°C.

The advantages are: no mixing, exact calibration of the quantity of adhesive, clean application.

The main drawback is the cost which is much higher than the cost of the adhesive itself, because the cost includes the manufacturing to the exact shape and size by moulding or stamping.

They have been used for very large volume application, i.e. more than 50,000 parts to be bonded, for electrical and automotive parts, because in these cases the cost of tooling could be depreciated over large production series.

But now, with the robotic syringe application, it is more convenient and cheaper to apply the adhesives as a circular shape at high speeds.

2.17.5. Preformed Tapes

Dry adhesives and sealants may be supplied as preformed tapes or ribbons, for instance butyl, acrylic or oleoresinous sealants. They are supplied in rolls and various sections or shapes (Fig. 97) and the surface is protected by a release paper (siliconised paper).

There are three types of preformed tapes:

soft, tacky or pressure sensitive tapes or ribbons: these are used as sealants for instance between glass panels and window frames. The ribbon is unwound and pressed against one substrate, for instance the glass panel, then the fillister is closed and the ribbon must be compressed by 30% in order to get a good adhesion to the substrates and a tight seal.

heat reactivated tapes or ribbons: this is the technique called Solbit from several companies: Kelseal UK and licensees.

Solbit is a neoprene, round ribbon which has an electric wire in the centre. It is non-tacky when delivered, but it must be stored at -4°C to prevent any vulcanisation. It is used for bonding and sealing of automotive windshields as shown in Fig. 98: when the electric wire is plugged under 24 V, this heats the rubber which becomes sticky after 30 s; the windshield is pressed firmly against the ribbon, and it takes some 4 min to vulcanise the rubber.

A typical installation includes a carousel with electric plugs and pressure jigs to press the windshield on the metal frame during 4 min. The whole bonding takes

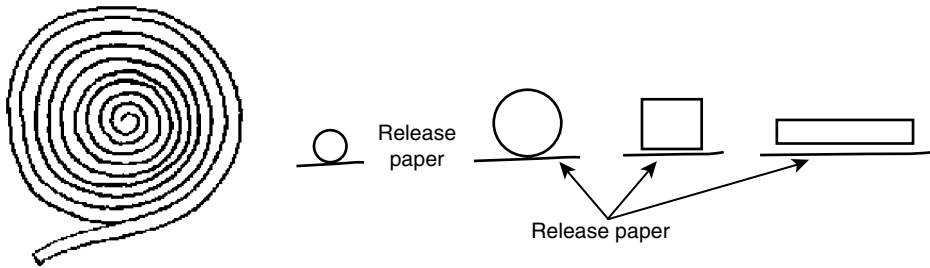

Figure 97: Roll of preformed sealant tapes and some sections and shapes available on the sealant market.

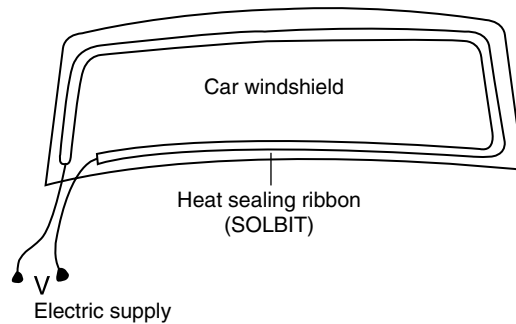

Figure 98: Heat activated ribbon Solbit® from Kelseal.

about 5 min. This type of sealant is no longer used, because of the availability of other cheaper and easier to use products. We may imagine ribbons which would contain some conductive particles in order to heat it by induction or high frequency.

two-component tapes or ribbons: Fig. 99 shows how these are made. The widely used type of two-component tape is based on epoxy two-component adhesives. The adhesive is formulated so that there is no chemical reaction at the interface. In order to use this product, the user must mix thoroughly the two components by kneading them together to get a perfect mix (both components have different colours, so that when a good mix is achieved the color becomes uniform). Then the user will press the mix onto the substrates or into a hole that is to be filled: the two components will react chemically after several hours and the mix becomes hard. The curing time is long because the product should be capable of storage before sale and utilisation.

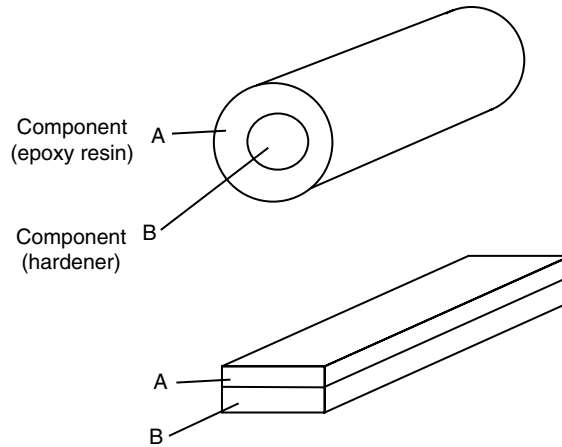

Figure 99: Two-component dry ribbons/rods or tapes (mixed by kneading in the hand).

2.17.6. Pre-Measured Doses for Two-Component Adhesives or Sealants

This is a special packaging where the two parts are placed in a pouch with two separated compartments. The separation may be a membrane or a clip (Fig. 100).

When the product needs to be used, the user breaks the separation, for instance, by pulling out a special clip, mixes the two components thoroughly by kneading the pouch and then applies the product. (This is somewhat similar to the Semkit two-component cartridges that we studied earlier.)

2.17.7. Adhesive Sticks

The idea of adhesive sticks was probably derived from the ladies' lipsticks; the adhesive sticks are made with a gelled formulation, with a consistency similar to that of a lipstick, and it can be applied easily on paper for office jobs.

This shows that the best new ideas may come from other industries and other techniques: food industry (pasta and noodles machines), cosmetics, cooking, plastics (extrusion in various shapes), potting, printing, painting, etc.

There are also hot melt adhesive sticks, that may be applied cleanly with hand guns (refer to previous Fig. 19).

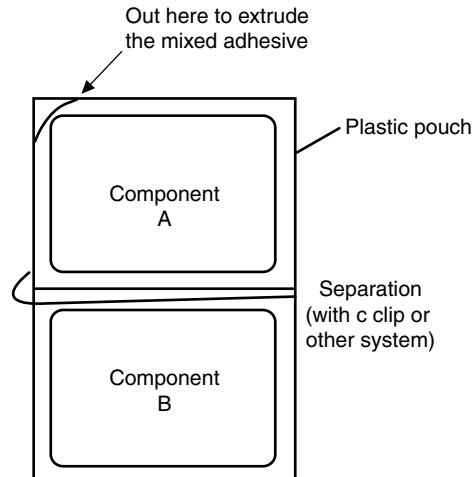

Figure 100: Two-component flexible pouches.

2.18. Special Techniques

2.18.1. Foaming

Several adhesives and sealants may be formulated to give a foamed joint. There are several chemical types:

- Polyurethane adhesives and sealants: these products are delivered in aerosol cans which deliver a bead of the product, of 3 to 5 mm diameter. The product foams immediately after extrusion so that the bead swells up to 20 times of the original volume.

This technique is used, for instance, to bond and seal a window or door frame into the masonry (Fig. 98). We will study this technique further in the chapter ‘Construction Adhesives’ in Volume 6.

- Hot melt foams (Foammelt[®] system from Nordson) (refer to Fig. 101): A hot melt is melted and a gas is injected into the jetting gun with the proper equipment. The heated gas gives tiny bubbles into the hot melt bead.

This is a very interesting technique because the bead diameter is increased so that it fills the gap between parts better, and also after pressing the two parts together, the bead will be squeezed and will cool down faster than a normal bead of hot melt (because it will be thinner). We will study it in the chapter ‘Application of Hot Melt Adhesives’, and “Industrial sealants and gasketing”.

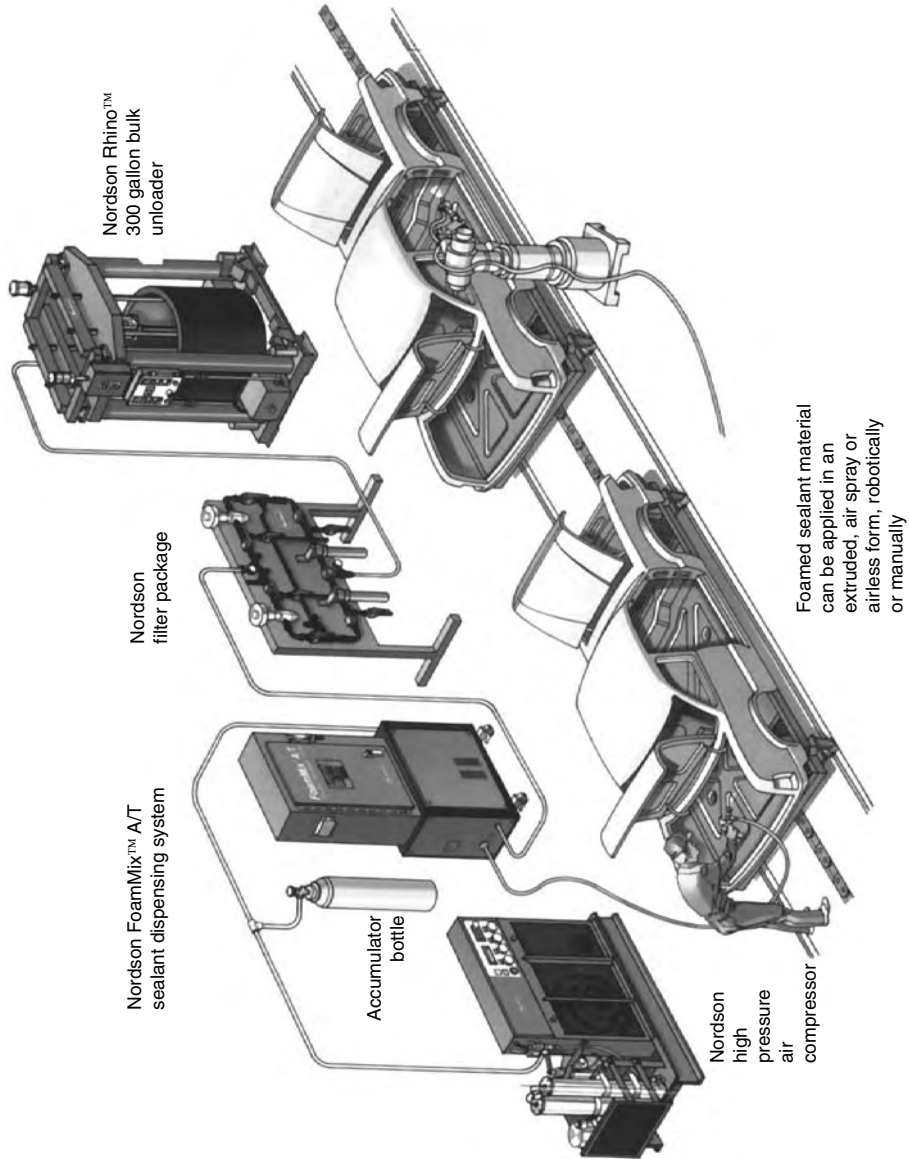

Figure 101: Nordson FoamMix® installation to produce foamed sealants (source Nordson).

- structural foamed adhesives: Let us mention the PVC plastisols and the syntactic epoxy adhesives used in aircraft construction (refer to the chapter ‘Aircrafts, Pioneer in Bonding Techniques’ in Volume 1).

These adhesives or sealants will foam during cure and their thickness will be increased four times, so that they may fill a gap, for instance the gap between two irregular shaped parts.

2.18.2. Potting, Casting and Encapsulating

Figs 102 and 103 explain these two techniques. The two components of the sealant are mixed, for instance with the metering and mixing systems that we described in 2.14, then the mix is poured either on the surface and components to be sealed, or into a ‘pot’ which covers and contains the parts to be sealed. The sealant

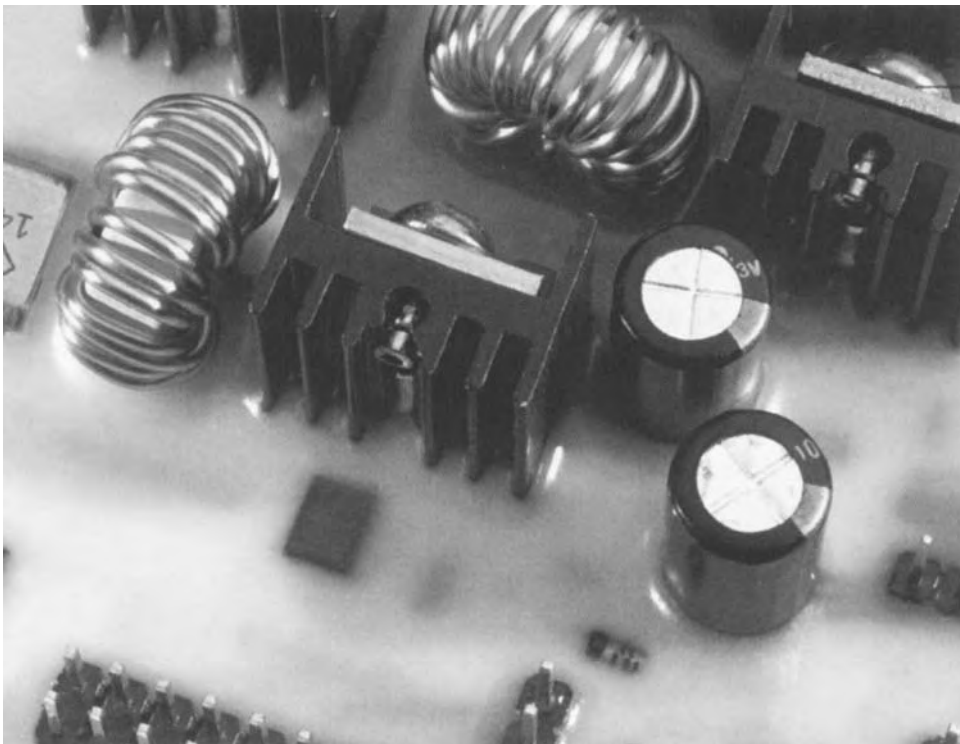

Figure 102: Casting of electronic circuit carriers (source Delo Germany).

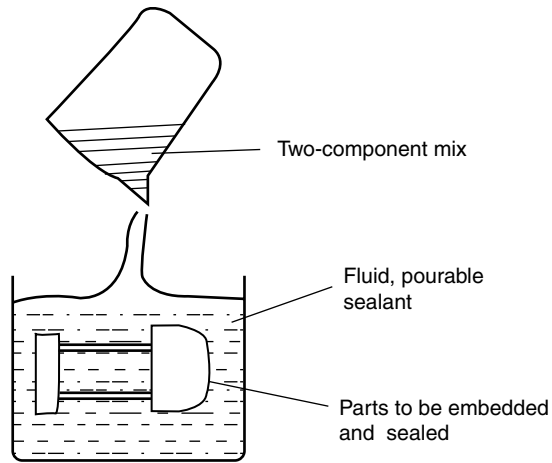

Figure 103: Potting (for instance of electrical/electronic components). The potting compound or sealant is mixed and poured into the protective 'pot' and outside the components until it covers it completely.

must be non-conductive of electricity, and it must protect the parts against humidity or other agents. Instead of pouring the mix, it is possible to fill the parts under vacuum.

Electrical connections, plugs, contacts are also protected and sealed by hot melt over molding: we will study this in the chapters 'Molding and Sealing of Electrical Parts with Hot Melts' and 'Polyamide Hot Melts', later in this Handbook.

We have now made a survey of a wide variety of application techniques; however, new techniques are being invented every year, by using all the spreading methods available and all the physical properties of polymers and materials.

As a conclusion, we can say that the increasing use of adhesives and sealants in almost all areas in life, will definitely provide many new techniques of application for many new end uses, in the future.

2.19. List and Adresses of Suppliers of Equipment for the Application of Adhesives and Sealants

Note: for all these manufacturers of equipment, we only mention here their main addresses such as Headquarters and also a few of their manufacturing facilities. However many of these companies have affiliates and distributors in many other countries: our readers may get these addresses from the Headquarters and Internet.

2.19.1. Conditioning of Wood, Paper, Before Bonding, Ovens

PAGENDORM BTT GmbH D 22761 gasstrasse 4, Hamburg, Germany
Tel.: (040) 89 0960, Fax: (040) 89 0966 66
info@pagendarm.com,
http://www.pagendarm.com

SAT Savoie Hexapole, rue Louis Armand,
BP 59, 73420 Mery, France

2.19.2. Mixing and Metering

DOPAG Langackerstrasse 25, 6330 CHAM
Switzerland, Tel.: 41 41785 5757,
Fax: 41 41 785 5700, www.dopag.ch

DOPAG France Technoparc de Lautagne,
26000 Valence, France, Tel.: 0475419060,
Fax: 0475415109, www.dopag.fr

HILGER und KERN GmbH, 68151 Mannheim, Germany
2KM GmbH, D 51705 Marienheide Rodt,
PO box 1327, Germany,
Tel.: 49 2264 4590-0, Fax: 49 2264 4590-49

I and J FISNAR Inc 2-07 Banta Place, Fair lawn,
NJ 07410, USA, Tel.: (201) 796 1477,
Fax: (201) 794 7034, info@IJFISNAR.COM

I and J FISNAR Hong Kong Ltd, Unit 208, Tak Shun
Building, 154 Wai Yip st, Kwun Tong,
Kowloon, Hong Kong, Tel.: 852 2389 2827,
Fax: 852 2389 2428, ijfisar@hkstar.com

- GRACO Inc
PO box 1441, Minneapolis, MN
55440-1441, USA, Tel.: 612 623 6000,
Fax: 612 623 6777
Sales/distribution/Service North America:
Industrial customer service,
Tel.: 800 3280211, Fax: 877 340 6427
- GRACO European
headquarters
GRACO NV, Industrieterrein,
Oude Bunders, Slakweidestraat 31, 3630
Maasmechelen, Belgium, Tel.: 32 89 770 700
Fax: 32 89 770 777, www.graco.com
- LIQUID CONTROL Corp
PO Box 2747, North Canton Ohio,
44720-0747, USA, Tel.: 330 494 1313,
Fax: 330 494 5383
- Hormec Tecnic SA
Keltenstrasse 1, CH 2563 IPSACH,
Switzerland, Tel.: 41 32 332 2000,
Fax: 41 32 332 2020,
www.hormectecnic.com
- SCHEUGENPFLUG
Gewrbepark 23, PO Box 1446,
93333 Neustadt/Donau, Germany,
Tel.: 09445/9564 0, Fax: 09445/9564 40,
www.scheugenpflug.de
- Georg Oest
Mineralolwerk GmbH
D 7290, Freundenstadt, Postfach 720, Germany

2.19.3. Hand Tools

- ITW
30 Endicott St
Danvers MA 01923, USA
Tel.: 1978 777 1100, Fax: 1978 774 5577
- Parajito
Germany

2.19.4. Syringe and Needles Application

- DELO,
Ohmstrasse 3, 86899 Landsberg, Germany,
Tel.: 49 8191 3204-0, Fax: 49 8191 3204-144,
www.delo.com

EFD	Electron fusion devices, 977. Waterman Avenue, East Providence, Rhode Island 02914-1378, USA, Tel.: 1 401 434 1680, Fax: 1 401 431 0237, www.efd-inc.com
I and J FISNAR	refer to address cited earlier
Panacol-Elosol GmbH	Obere zeil 6-8, 61440 Oberursel, Germany, Tel.: 49 6171 6202-0, Fax: 40 6171 6202-90, info@panacol.de
LIQUID CONTROL	address cited earlier
KENT MOORE	Switzerland and USA

2.19.5. Cartridges for Sealants, Guns for Cartridges, One and Two-Component Cartridges

Fishbach	USA
KROGER Maschinenfabrik	4 Geminivej, DK 2670, Greve, Denmark
PRC Desoto Inc	PPG industrie group, Pittsburg, PA, USA
PRC DeSoto Europe, Ltd	SEMCO application systems, 18 Langlands Place, Kelvin south Business Park, East Kilbride, Scotland G75 OYF, United Kingdom, Tel.: 44 1355 225 442, Fax: 44 1355 236 936
TAH Industries Inc	107 North Gold drive, Robbinsville, NJ 08691, USA, Tel.: 609 259 9222, Fax: 609 259 0957, www.tah.com

2.19.6. Spraying Equipment, Spray Guns, Air Spray, Airless, Hot Spray

De Vilbiss (ITW group)	De Vilbiss France, 163 avenue des Aureats, BP 1453, 26014 Valence cedex, France, Tel.: 04 75 75 27 00, Fax: 04 75 75 27 99
------------------------	--

Graco	see addresses cited earlier
Kremlin	150 avenue de Stalingrad, 93245 Stains cedex, France, Tel.: 33 1 49 40 25 25, Fax: 33 1 48 26 07 16, www.kremlin.com
Walther Pilot	Kärtner Str. 18-30 D 42327 Wüppertal Germany, Tel.: 49 202 7870, Fax: 49 202 787217, www.walther-pilot.de
Rexson USA	see address cited earlier
Spraying Systems	Wheaton, Illinois, USA
WIWA	GmbH, Postfach 29, D 35631 Lahnau, Germany Tel.: 49 6441 609-0, Fax: 496441 609-50

2.19.7. Pumps

Binks (ITW group)	addresses cited earlier
Graco	addresses cited earlier
Kremlin	address cited earlier
ITW De Vilbiss	address cited earlier
Rexson	24 Av. Ampere Zl. Villemelam, 91320 Wissous, France, Tel.: (33) 1 60 135900 Fax: (33) 1 69 208190, office@rexson.com

2.19.8. Spray Booth and Lines

Charvo	Grenoble, France
Ateliers MICHAUD	34 chemin des Bruyeres, BP 131, 69151 Decines Charpieu cedex, France
ITW	addresses above

2.19.9. Hot Melts Jetting Guns

Nordson corporation	11475 Lakefield drive, Duluth, Georgia 30097-1511, USA & addresses in many countries worldwide
---------------------	--

Robatech AG
Pilatusring 10, CH 5630, Muri, Switzerland,
Tel.: 41 56 675 7700, Fax: 41 56 675 7701,
www.robatech.com

2.19.10. Extrusion Guns

Dopag, Hilger und Kern: refer to addresses cited earlier
Kremlin addresses cited earlier
Schneeberger Germany

2.19.11. Roll Coaters

Black brothers USA
Bolton Emerson PO Box 2333, CH-1002 Lausanne,
Switzerland, Tel.: 41 21 20 64 51
Robert BURKLE GmbH Stuttgarter strasse 123, 72250
Freudenstadt, Tel.: (07441)58-0,
Fax: (07441)7813, www.buerkle-gmbh.de,
buerkle@buerkle-gmbh.de
DCM 45 avenue des Guillaeraies, BP 406,
92004 Nanterre cedex, France,
Tel.: 33 1 41 37 52 70, Fax: 33 1 41 37 52 71,
www.dcm.fr, dcm@dcm.fr
Faustel Inc PO Box 1000, Germantown,
WI 53022, USA, Tel.: 1 414 253 3333,
Fax: 1 414 253 3334
FRIZ GmbH Im Holderbusch 7, D-74189, Weinsberg, Germany
Tel.: 49 7134/5 05-0, Fax: 5 05-20,
www.friz.de
HYMMEN GmbH Postfach 10 15 13, 33515 Bielefeld,
Germany, Tel.: 49 521 5806-0,
Fax: 49 521 5806-190, sales@Hymen.com
Kroenert Maschinenfabrik Shutzenstrasse 105, Postfach 500 840,
2000 Hamburg 50, Germany,
Tel.: 49 411 859091

2.19.12. Die Coaters, Slot Dies

Bolton Emerson	see address cited earlier
Egon John Brown	USA
Kroenert	see address cited earlier
Nordson	see address cited earlier

2.19.13. Edge Banding Machines

BARBERAN	Pol ind. CAMI RAL, C/ Galileo 3-9, apartado postal no 160, 08860 Castelldefels, Barcelona, Spain, Tel.: 34 93 635 0810, Fax: 34 93 636 1555, www.barberan.com
BIESSE	via della Meccanica, 16, 61 100, Pesaro Italy, Tel.: 39 0721 439100, Fax: 39 0721 453248
Homag	Homagstrasse 3-5, D 72296 Schopfloch, Germany, Tel.: 49 7443 13-0, Fax: 49 7443 13-2300, www.homag.de
IMA	Germany

2.19.14. Labelling Machines

Krones AG	Böhmerwaldstresse 5, D-93068 Neutraubling, Germany, Tel.: 49 9401 703 320, Fax: 499401 702909
KHS Maschinen	Juchostrasse 20, D-44143 Dortmund, Germany, Tel.: 49 231/ 5 69-0, Fax: 49 231/ 569-1541, www.khs-ag.com

2.19.15. Bookbinding Machines, Bonding Equipment

Mueller Martini Marketing AG	Untere Bruhlstrasse 13, CH 4800 Zofingen, Switzerland, Tel.: 41 62 745 45 75, Fax: 41 62 751 55 50, http://www.mullermartini.com
---------------------------------	--

Sheridan, USA

2.19.16. Stencil, Typographic, Offset Equipment

Refer to directories of the suppliers of the printing industry (DRUPA Düsseldorf for instance)

2.19.17. Curtain Coaters

Gasway/Faustel see address cited earlier

Steinemann George KOCH and sons Inc.,
Evansville Indiana, USA

FRIZ GmbH Im Holderbusch 7, D-74189
Weinsberg, Germany Tel.: 49 7135/5 05-0,
Fax: 49 7135 05-20

2.19.18. Ball Valve Applicators

PAFRA UK

Valco Cincinnati USA

2.19.19. Electropneumatic Valves

Nordson see address cited earlier

Valco Cincinnati USA

DOPAG/Hilger und Kern see addresses cited earlier

ROBATECH see address cited earlier

2.19.20. Pressure Sensitive Tapes Unwinders

3M several locations in USA and
many countries

Avery-Dennison 150 N Orange Grove Blvd, Pasadena
CA 91103, USA Tel.: 1 626 304 2215
Fax: 1 626 792 7312, www.averydennison.com

TESA AG Quickbornstrasse 24, D 20253 Hamburg
Germany, Tel.: 4 940 49093181
Fax: 4 940 49095054, www.tesa.de

2.19.21. Film Adhesives

Hexcel 11711 Dublin Blvd, Dublin,
CA 94568-2832, USA
Tel.: (925) 551 4900, Fax: (925) 828 9202
www.hexcelconyexters.com
communications@hexcel.com

Hexcel Duxford Cambridge, CB2, 4QD, UK

3M Saint Paul, Minnesota, USA

Loctite Aerospace 2850 Willow pass road, Bay Point,
CA 94565, USA, Tel.: 1 925 458 8000,
Fax: 925 458 8030, www.loctite.com

2.19.22. Robots

Asymtek, Nordson group 2762 Loker avenue West, Carlsbad,
CA 92008-6603, USA

FANUC Japan

ABB

I and J Fisnar USA addresses cited earlier

2.19.23. Rotary Screen Applicators

Graco see address cited earlier

Table 8: Check list for the selection of method/technique of application and curing

This is a check list of all the information which are needed for the adhesive and sealant manufacturers in order to study and solve any customer's application problem.

Application of an adhesive a sealant potting/encapsulating

Size and shape of the materials or parts to be coated:

Provide a drawing of the parts to be bonded or sealed, with the dimensions.

Materials in rolls sheets individual parts surfaces are flat curved
 Dimensions: shape of joints thickness of joints

Working conditions, production requirements:

Production output (parts or m² per hour) line speed
 Flow of adhesive/sealant (in kg per hour) number of operators
 Adhesive or sealant consumption (in grams/m² or per piece):
 Operating and ambient temperature: application on site or in the factory

Technical characteristics of the adhesive or sealant:

If you already use an adhesive or sealant, or if you have already selected one, answer to these questions

Aspect/form: liquid paste solid granulates powder other (specify)

Water based solvent based chemical reaction cold hot hardening
 One component two components Hot melt other

Viscosity or consistency: rheology
 Mode of setting: drying of water solvent at ambient or elevated temperature:
 chemical reaction in this case indicate temperature, time and pressure for curing
 and mixing ratio
 waiting time before assembly open time pot life if 2 components

Supplier and reference of the existing adhesive or sealant:

Method of application: indicate either the existing method or the one you are considering for the future:

Manual or automatic

Brush trowel cartridges and gun hand roller

Spraying: air spray airless hot spray air and fluid pressures

Roll coater extrusion slot die stencil valve (type) other (specify)

Pressure or gravity feeding dipping filling/potting

For hot melts indicate: jetting spraying extrusion, slot die other:

For these equipment indicate the specific type or machine, supplier...

Indicate the production speed in meters or m² per min

Assembly

Mode of assembly, jigs, pressure during and after assembly

Manual or automatic assembly speed of assembly:

Drying or curing conditions and equipment:

– Ambient temperature drying drying conditions (temperature, humidity, time)

– drying at elevated temperature: conditions, temperature, time

hot air oven IR autoclave High frequency UV curing EB curing

induction heating if possible provide more detailed information about the equipment...

Cost requirements

Estimated cost of bonding operation: separate cost of the A or S

and cost of labor equipment per m² or per piece

estimated budget for the cost of equipment

which pieces of equipment do you have already and wish to use ?

Is the bonding /sealing operation included in a complete production line or is it separated ?

Any other information ?

People to contact

Company name and address

This Page Intentionally Left Blank

Chapter 3

Design and Stress Calculations for Bonded Joints

Richard J. Moulds

Richard Moulds graduated in chemistry whilst studying epoxy technology with Shell Research. He focussed on Civil Engineering applications by joining Tarmac and continued to study Polymer Technology at the South Bank University, London. Five years later he returned to Shell to develop a range of epoxy based building products. In the early 1970s, Richard was transferred to a new enterprise with Avdel Adhesives as Product Manager for epoxy based adhesives for use in industry. Avdel Adhesives became Permabond when acquired by Unilever and subsequently, Bondmaster following a transfer to ICI.

The benefits of enhanced toughness using dispersed phase low modulus rubbers was established and commercialised in projects like the first all bonded car (British Leyland's ECV3) and the bonded carbon fibre drive shaft concept following design studies with Harwell Technology. This technology was expanded by working with Imperial College, London, to understand how an adhesive could outperform welding in many circumstances provided that the distribution of stress within a joint was fully understood. This valuable work gained commercial acceptance following its use in bonding light weight bicycle frames for the American team at the Los Angeles Olympics, where the press publicised the associated gold medal achievements as 'the unfair advantage'.

Richard worked with many industrial partners to encourage the bonding process in design circumstances where the increased performance available with adhesives provided improved, economic and durable structures. This was exemplified when he was selected as the adhesive consultant for the Thrust SSC project, where the world land speed record was raised by 130 mph to match the speed of sound.

The art of creating structures is limited by the selected technique of fastening components together. We all have a concept of robust and dependable assemblies

based on real life experiences, but is a spot welded car or an aircraft wing covered in rivets really the best way to hold materials together. As we learn more about the concept of bonding and the utilisation of the total surface area to accommodate stress, there is an increasing need to step back and consider the implications of changing to bonding. The following pages show how simple models can be used to guide design engineers in their quest for economic, dependable products.

Keywords: Adhesive modulus; Adhesys expert system; Co-axial joints; Compression; Concealed joints; Creep; Elastic limit; Epoxy; Epoxy composite; Finite element analysis; Glue line thickness; Goland and Reissner; Hart–Smith; Heat exchanger; Hooke’s Law; Joint designs; Joint thickness; Lap shear strength; Peel; Plastic behaviour; Polyurethane; Pipe bonding; Shear stresses; Shear modulus; Stress distribution; Thick adherend shear test; Tubular joints; Volkersen equation; Young’s modulus

3.1. Adhesives – Stress Matters

3.1.1. The Basic Stresses

When two materials are required to be fastened together, we expect some stress to be associated with the assembly in normal use. At the design stage, we have the opportunity to consider all practical options. If we wish to accommodate maximum loads, the adhesive would perform to the highest level if the stress were to put the adhesive into compression (Fig. 1).

Redesign of the joint to avoid cutting the hole or slot, means that the applied load generates a tensile rather than a compressive load (Fig. 2).

If the load is applied in an asymmetric manner, the stress concentration will have implications with respect to the adhesive performance. In its extreme, this is considered to be a cleaving or peel stress (Fig. 3).

3.1.2 Stressed Adhesive

The supplier of adhesive will normally provide strength data which is relevant to a specific use. Compressive strength would be needed for a grout to support a railway line, shear strength to assemble a bicycle frame, tensile strength in the manufacture of bonded rubber ‘O’ rings and peel strength for the assembly of multilayer laminates.

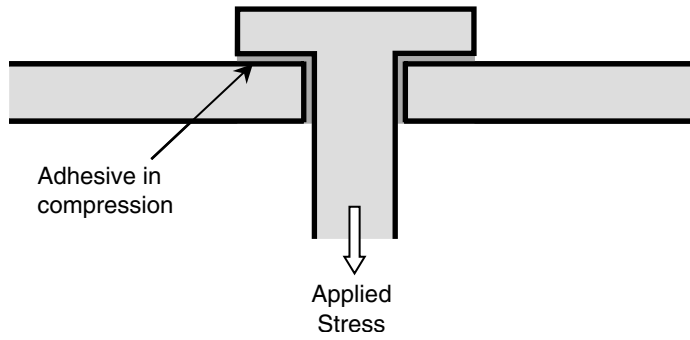

Figure 1: This is an example of a joint design which encourages compressive loads rather than tensile forces.

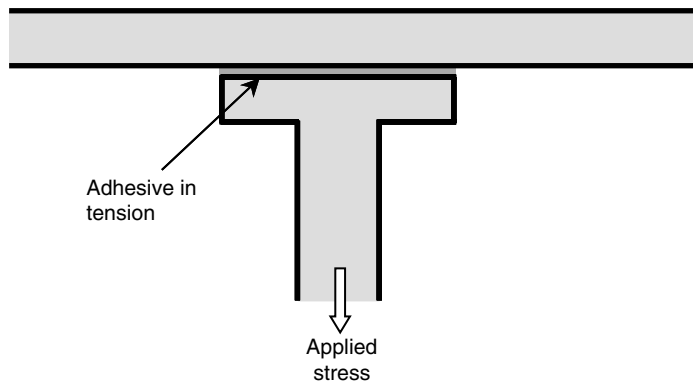

Figure 2: The tensile load is more destructive in terms of adhesive bonding.

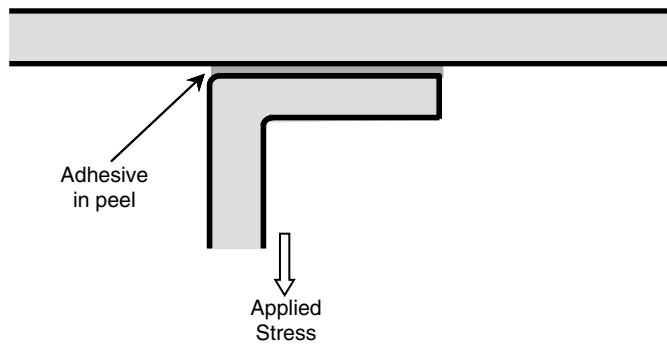

Figure 3: Under peeling conditions adhesive performance will be much reduced.

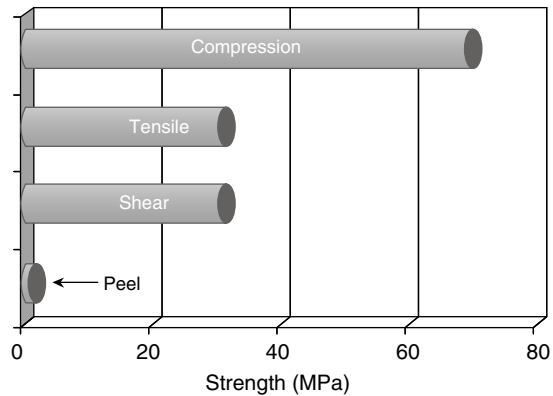

Figure 4: Comparison of failure stresses for a high-performance adhesive.

If we consider the load bearing capabilities of a high strength structural adhesive under all these conditions, it is clear that the nature of the joint is fundamental in achieving satisfactory performance (Fig. 4).

The best two part epoxy adhesives, used to bond a joint measuring 25 mm square, are capable of withstanding 70 MPa (10,000 psi) in compression, 31 MPa (4,500 psi) in shear or tensile mode and 1 MPa (150 psi) in peel.

The implication here is that when compressive forces can be introduced, even very high loads can easily be accommodated and therefore many adhesives can be considered as potential candidates.

The rubber bearing pads for structural beams in road bridge construction use conventional epoxies to ensure the correct location and allow uniform stress distribution. The lower cost structural polyurethanes are used to seal and support double glazing panels in tower block construction. Cyanoacrylates bond rubber gaskets onto the ends of filters to provide a seal and absorb vibration. Toughened epoxies are used to bond the highly stressed wind turbine blades to the central hub in a flanged joint and in combination with bolts. The bolts ensure that the adhesive is performing under compression.

Perhaps the most useful consideration in understanding stress distribution is to consider a lap joint where the adhesive is subjected to shear stresses.

3.1.3 Shear Strength

If we take two strips of mild steel and overlap them, we can measure the strength of the joint and relate this to a force per unit area (Fig. 5).

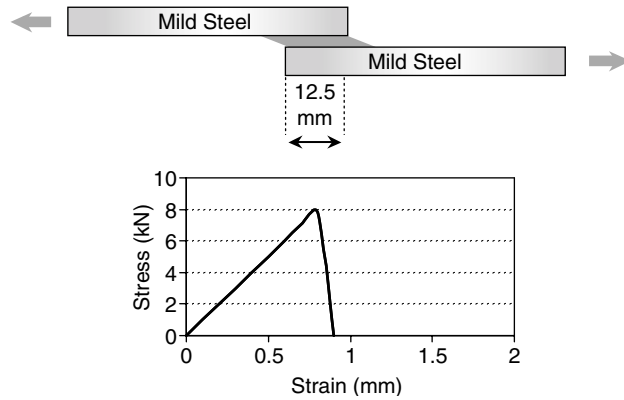

Figure 5: An overlap area of 12.5×25 mm provides the stress/strain curve as shown.

If we divide the stress at failure by the area of bond, we have a joint strength of 25 MPa. By doubling the bond area we might expect a failure stress of around 16 kN. This turns out to be true if we double the bond width, but if we double the overlap, a different picture is seen (Fig. 6).

It is clear that the stress distribution cannot be uniform over the bond area. From a design viewpoint it is essential that this situation is fully understood.

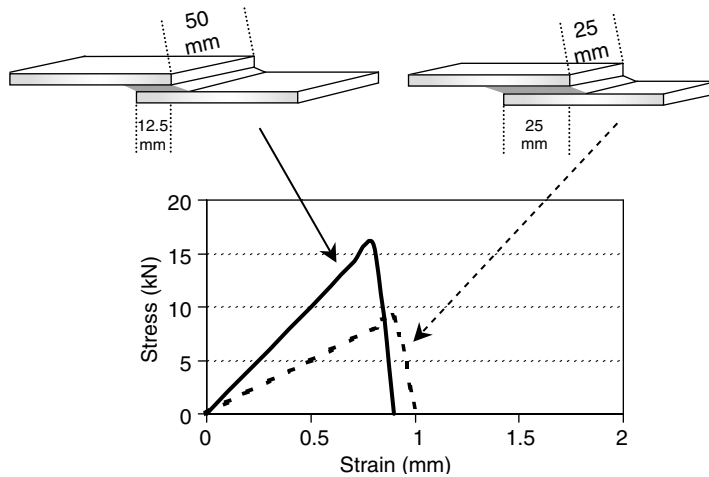

Figure 6: Doubling the overlap gives little increase in the failure load.

The following sections are focused on understanding the way stress is carried and how this can be manipulated to achieve improved and cost effective assembly.

3.2. Lap Joints – Stress Distribution

3.2.1. The Adherends

The most common assembly when bonding two surfaces together is to overlap them and most adhesive companies supply data in the form of lap shear strength. This format can teach us a great deal about bonding design (Fig. 7).

Take a very rigid material, like glass, and bond two pieces together using a very low modulus adhesive. The low modulus will encourage any stress to be distributed uniformly over the bond area. The objective in structural bonding is to transfer and distribute stress and strain in such a way that the integrity of the structure is maintained.

If we reverse the situation and bond two very flexible pieces of rubber together with a rigid, high modulus adhesive, a different picture emerges. The tensile strain

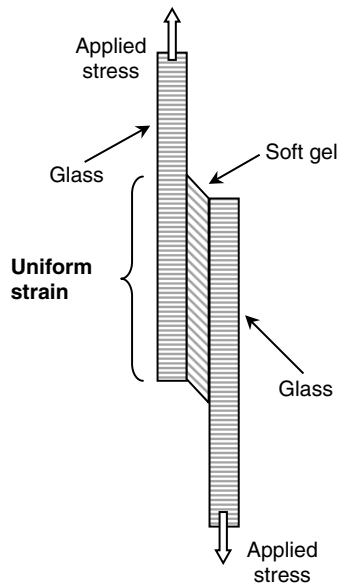

Figure 7: An assembly where uniform stress distribution is favoured.

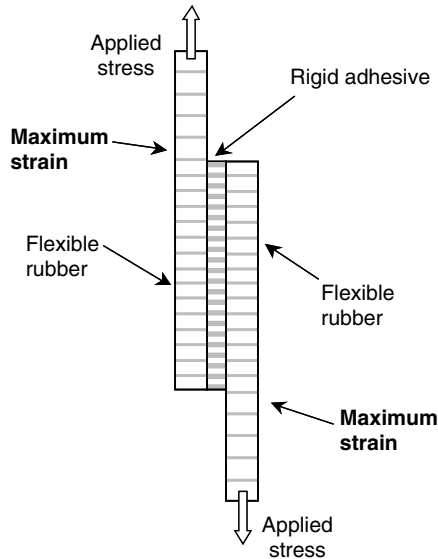

Figure 8: Maximum strain and stress occur at the ends of the joints.

in the left hand rubber adherend is at a maximum up to the point where it meets the right hand strip and tails off to a minimum at the lower end. The same is true for the right hand rubber strip working in reverse (Fig. 8). The high modulus adhesive restricts the movement of the double thickness of rubber and creates stress concentration at the ends of the joint. This means that in the real situation, the ability to accept load will be influenced by

1. The modulus of each adherend
2. The thickness of each adherend
3. The modulus of the adhesive and
4. The thickness of the adhesive.

In reality, all substrates and adhesives show some degree of elastic behaviour and so we have a situation where the stress levels within the adhesive layer are normally much higher towards the ends of the joint (Fig. 9).

The finite element analysis technique has been used very successfully to confirm the regions of concentrated stress and strain. In this technique, the bonded assembly is subdivided into small elements and the forces relevant to each element are computed using basic mathematical equations. This is very useful, particularly in the understanding of complex joint designs.

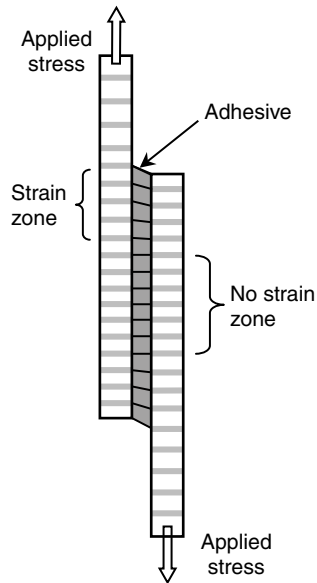

Figure 9: The high stresses at the ends of the joint control the load capability.

If we make the assumption that the bonded assembly should operate within the elastic region of each of the material parts, the computed analysis for simple joints can be used to indicate the basic principles for accommodating stress in an acceptable manner.

In order to do this, we need to have information on all the factors which will influence the forces experienced in the joining of two components.

3.2.2 Elastic Limit of the Adhesive

The elastic limit can be established by using the 'thick adherend shear test' to determine the stress/strain relationship. This test uses steel adherends which are so thick that under the test conditions, their distortion is small and the influence on the data is acceptably low. A typical curve is shown in Fig. 10.

The area below the stress/strain curve within the elastic region is a measure of the ability of an adhesive to absorb energy. High energy absorption means that the likelihood of bond failure is reduced.

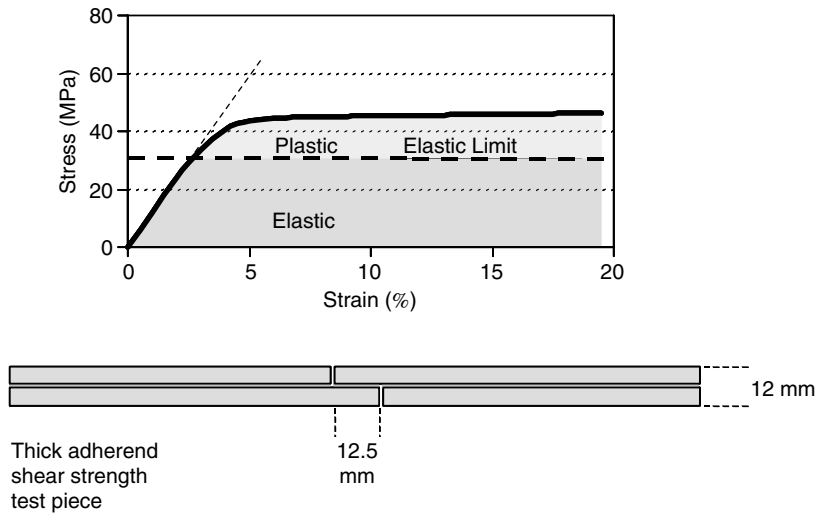

Figure 10: The stress/strain curve for a typical structural adhesive.

It is important to establish the elastic limit of an adhesive. When an assembly is required to function for many years, it is critical that the maximum stress experienced by the joint does not exceed this value. If the applied stress is higher involving the plastic behaviour of the adhesive, a limited life only can be expected.

The thick adherend shear test also provides data on the modulus of the adhesive. If we use this data along with a knowledge of the modulus and thermal expansion of the two materials being bonded together, it is possible to compute the stress levels experienced by a simple lap joint.

The analysis which follows is based on the pioneering work carried out by the Harwell Laboratory of the United Kingdom Atomic Energy Authority and is based on their 'Adhesys' expert system.

3.2.3 Stress Distribution in Lap Joints

Consider a lap joint with an overlap of 25 mm and a length for the purposes of stress calculation of only 25 mm. For the initial assessment two pieces of mild steel of thickness 1.5 mm are bonded together using an adhesive of modulus 0.4 GPa, an elastic limit of 19 MPa and a glue line thickness of 0.05 mm. When a high load of 3000 N is applied, the distribution of stress is calculated to be as follows (Fig. 11).

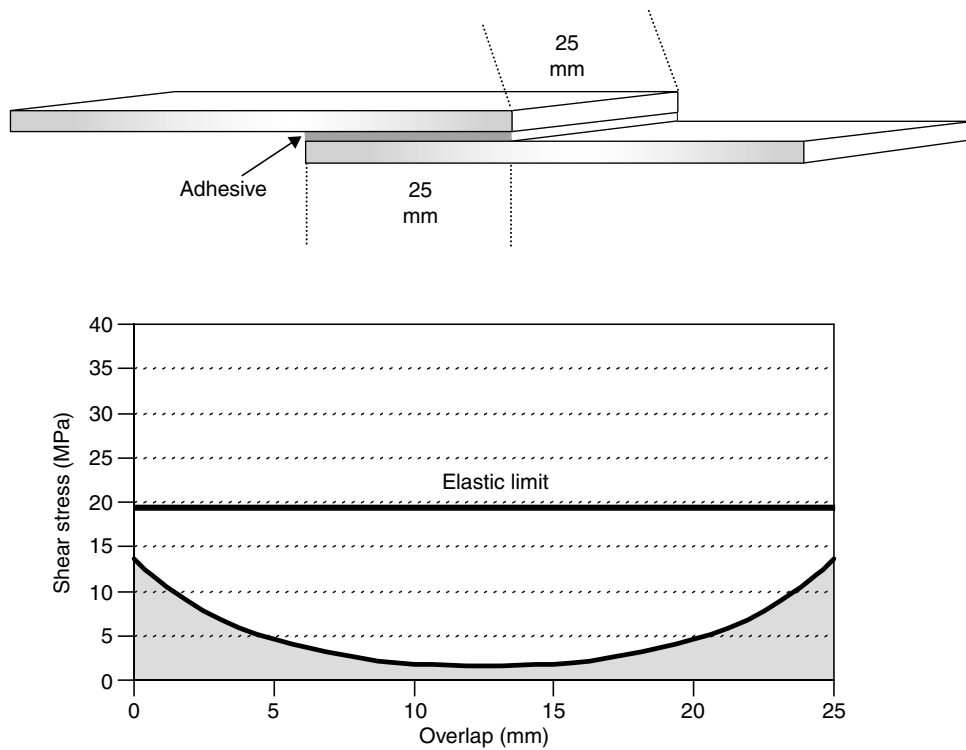

Figure 11: Stress distribution in the bonded assembly.

A maximum stress of 13.6 MPa at the two ends of the overlap joint is well within the elastic limit of the selected adhesive. If we increase the load to 4000 N, the stress is accommodated as shown in Fig. 12.

The increase in the maximum stress in the joint to 18 MPa is still acceptable and the stress carried by the central zone remains the same. A further incremental change pushes the stress level above the elastic limit (Fig. 13).

If we assume that the load of 5000 N has to be accommodated, we can consider how to manipulate the assembly. The first consideration is to increase the overlap length from 25 mm to 75 mm without changing any other parameters (Fig. 14).

Increasing the overlap length has virtually no benefit in reducing the maximum stress. The analysis shows that the stress in the central zone is reduced to zero. From an adhesive performance point of view, an area of low stress means that the joint will not suffer from creep under load. Reduction in joint overlap by 35 mm

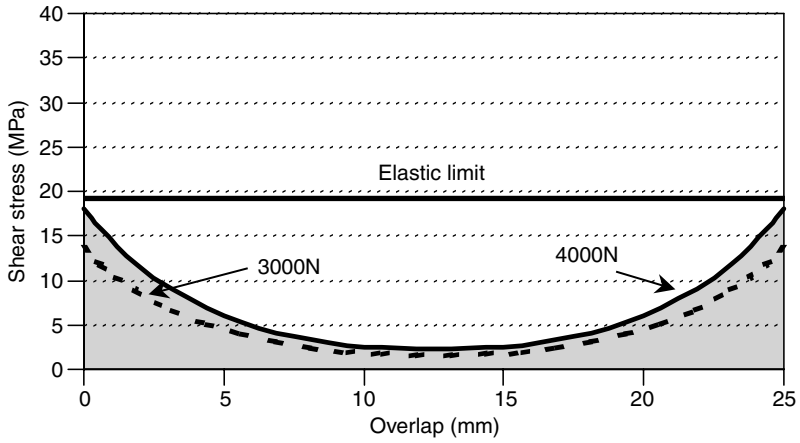

Figure 12: The effect of increasing the load to 4000 N.

is clearly an option worth considering in these circumstances, without any influence at all on stress distribution.

If the length of the joint can be increased, then a small increase solves the problem (Fig. 15).

Instead of changing the length of the joint, we can increase the thickness of the two pieces of steel which are being bonded. An increase from 1.5 mm to 2.5 mm gives the following stress re-distribution (Fig. 16).

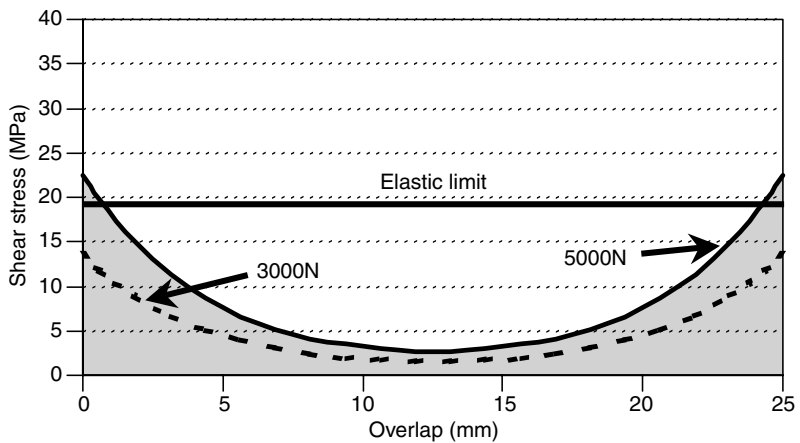

Figure 13: Increased load to 5000 N results in permanent damage to the bond.

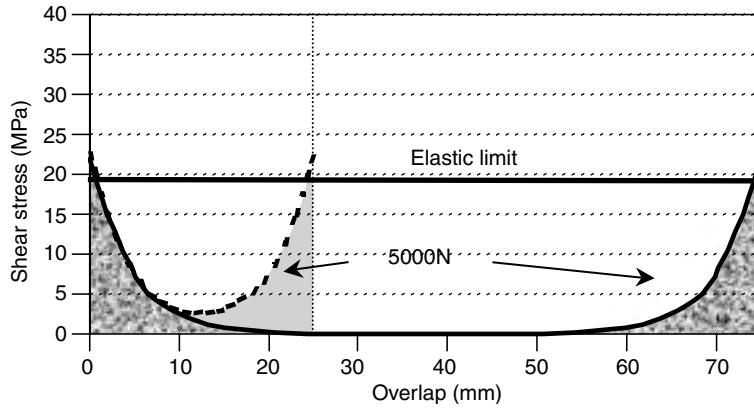

Figure 14: Increased overlap does not influence the maximum stress.

A third option is to control the glue line thickness. A glue line of 50 microns (0.05 mm) is normally considered quite generous for a small joint. If we control the gap so that the glue line is increased to 100 microns, then the stress is handled in a more acceptable manner (see Fig. 17).

The significant benefit of increased and controlled glue line thickness has resulted in the availability of adhesives with in built minimum glue line control. This is achieved by incorporating a percentage of equal-sized round particles of the appropriate diameter.

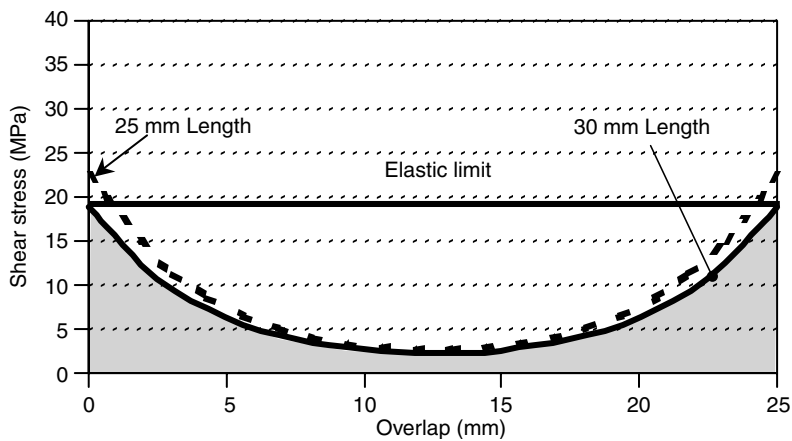

Figure 15: A 20% increase in joint length avoids exceeding the elastic limit.

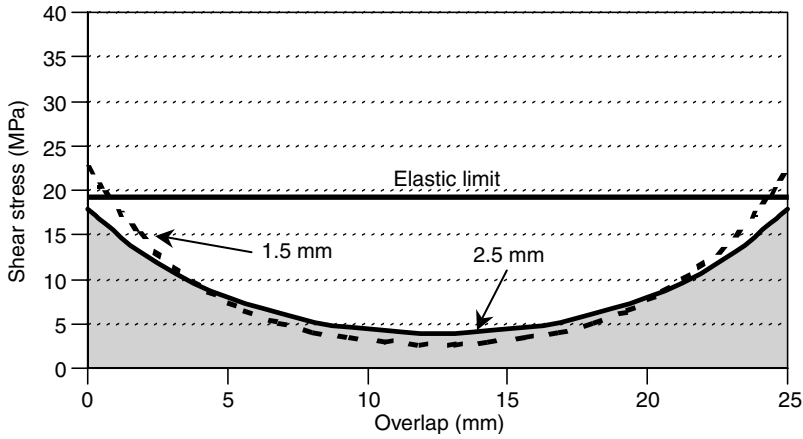

Figure 16: Thicker adherends reduce the maximum stress levels.

If we increase the glue line thickness further, the stress levels become even more uniform, as shown in Fig. 18.

Putting these two potential improvements in load bearing capacity together, the joint of standard dimensions can now accept a load which is double the original maximum without exceeding the elastic limit (see Fig. 19).

Bonding steel to steel is often considered in situations like replacing spot welds in the assembly of primary structures in the automotive industry. However, one of the

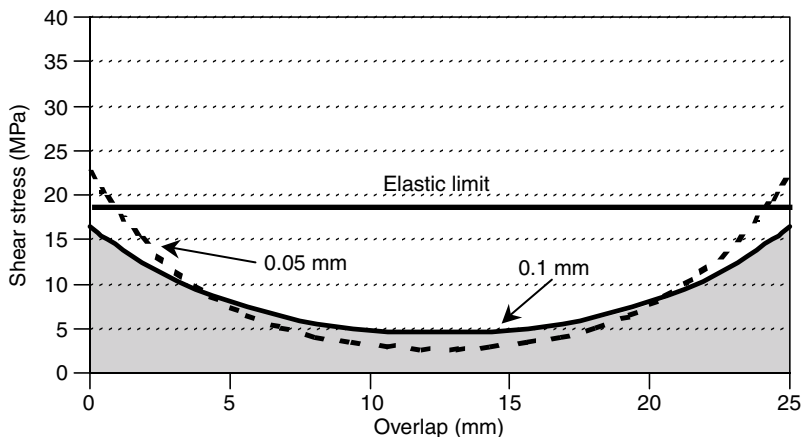

Figure 17: Thicker glue lines give much better stress distribution.

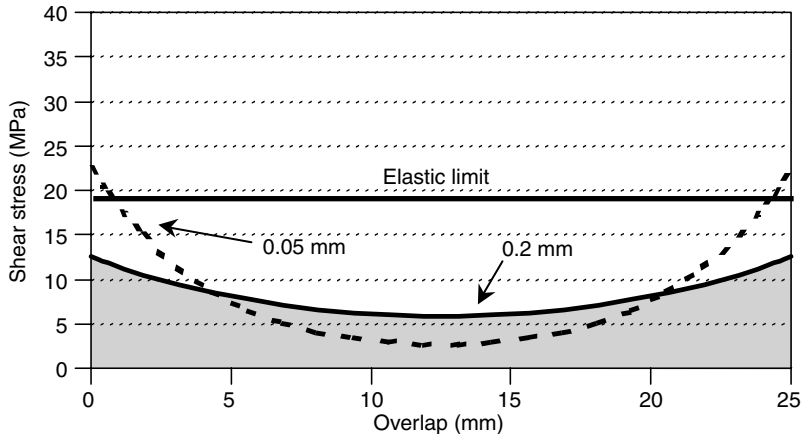

Figure 18: The stress distribution for a glue line thickness of 200 microns.

main economic benefits of adhesives is that dissimilar materials can be assembled equally well. The assembly of bicycles is a good example of this where carbon fibre composites, aluminium alloys, steel and titanium components are selected by the designers to provide high performance economic structures.

The stress analysis program can be used to help understand the changes in stress distribution which result from these modifications. Using the same basic

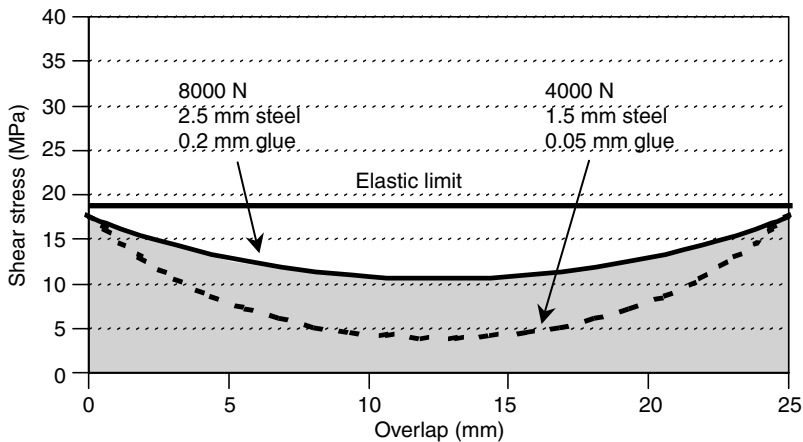

Figure 19: Steel of 2.5 mm and a glue line of 0.2 mm allow an increased load up to 8 kN.

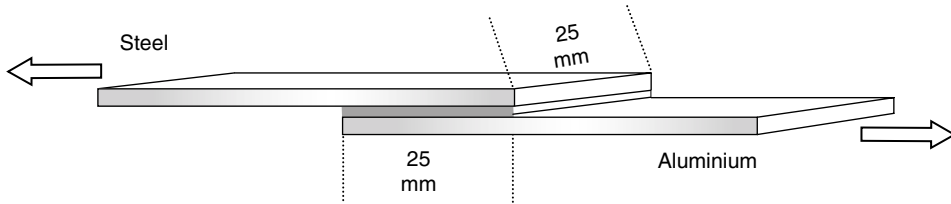

Figure 20: Aluminium replaces one of the steel adherends.

assembly, we can explore the effect of changing one piece of steel with an aluminium alloy (see Fig. 20).

In Fig. 21 we can see how the stress is concentrated at the leading edge of the aluminium to steel interface. The modulus of one adherend has been changed from 210 GPa to 69 GPa.

The level of stress generated at one end of the overlap is clearly unacceptable if a load of 5000 N is being applied to the assembly. By doubling the thickness of the aluminium, we can reduce the stress, but it is still not within the acceptable limit for elastic behaviour (as shown in Fig. 22). An example of the practicality of this type of assembly is found later, where naval ship's decks had to be rapidly repaired in response to the Falklands campaign. In order to cope with the environmental conditions, bonded

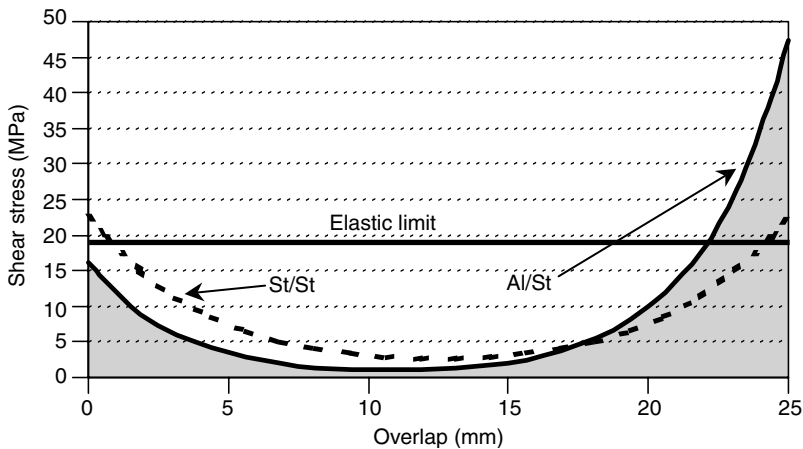

Figure 21: An asymmetric stress pattern is the result of bonding different metals together.

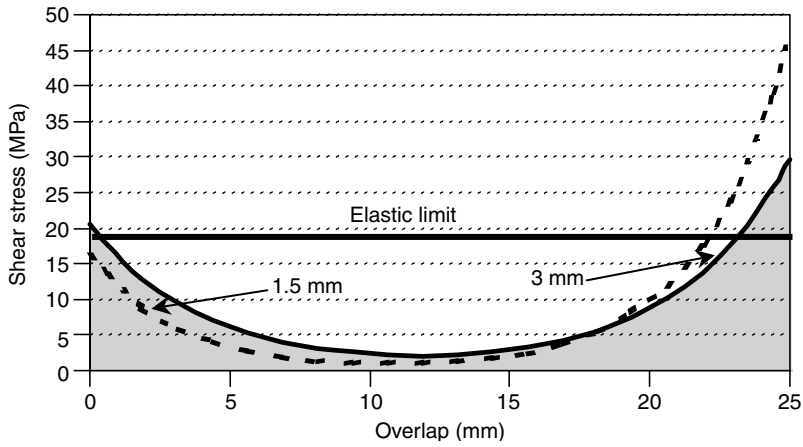

Figure 22: Increased thickness of aluminium is a good step in the right direction.

steel plates were designed to repair stress cracks in the aluminium superstructure in preference to welding. The use of sound engineering principles in this structural bonding resulted in successful assembly, even after more than 20 years in service.

If we increase the glue line thickness in addition to increasing the aluminium thickness, then we have a condition which meets the need to design within the elastic region (Fig. 23).

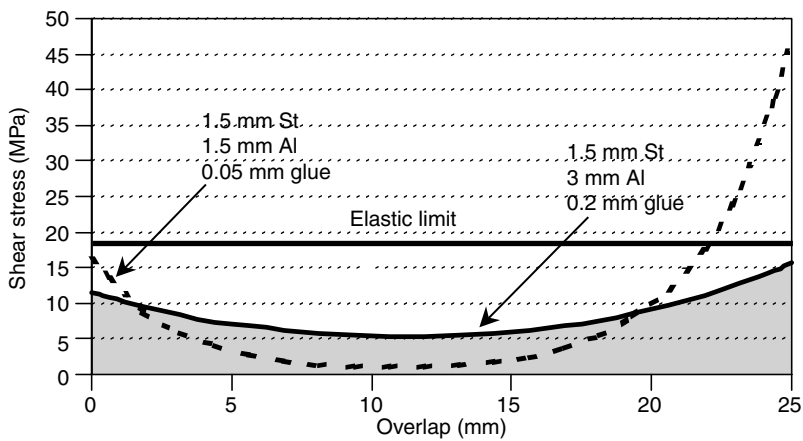

Figure 23: Aluminium to steel bonding which is well engineered.

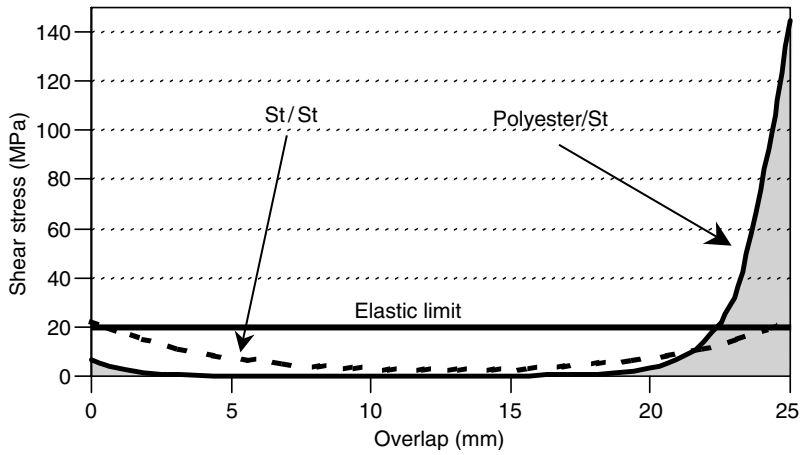

Figure 24: Bonding glass reinforced polyester to steel.

Changing the modulus of one adherend to 9 GPa by using a glass reinforced polyester laminate, results in more dramatic stress concentration (see Fig. 24).

The joint would fail in practice well before the load of 5000 N could be applied, since no polyester composite could achieve the strength requirement. To cope with the imposed load, the thickness of the polyester and the adhesive would need considerable modification as shown in Fig. 25.

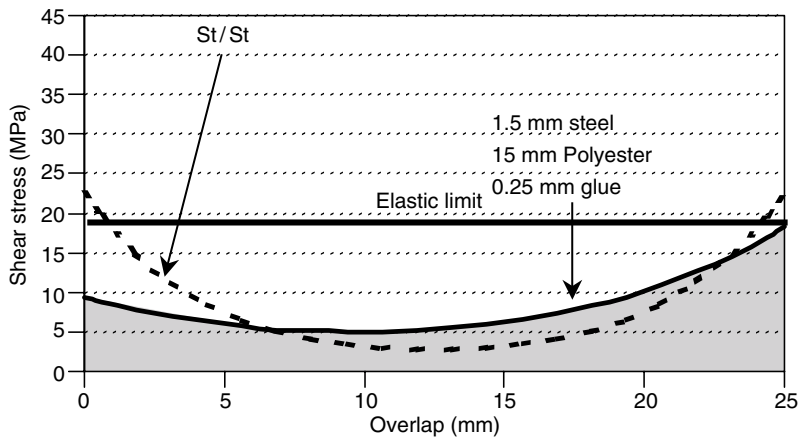

Figure 25: Significant increases in the thickness of the polyester and glue line provide the required stress distribution.

3.2.4 The Influence of the Adhesive Modulus

If we consider the modulus of the adhesive as the variable factor, it is clear that the adhesive type can significantly change the stress distribution. To show this effect, a selection of typical adhesives and their moduli are compared in the following table.

Adhesive	Modulus (GPa)
Polyurethane	0.1
Toughened acrylic	0.2
Two part epoxy	0.4
Single part epoxy	1.5

We can see the comparative picture using two part epoxy and polyurethane adhesives. In this example, only the value of the modulus is changed. The results are shown in Fig. 26. This is a 25 mm square joint with 1.5 mm steel adherends and a glue line of 0.05 mm, with an applied load of 5000 N.

This appears at first sight to be a good option. However, when the modulus of the adhesive is reduced, the elastic limit is also reduced and the net result is usually negative. Fig. 27 shows that the load on the polyurethane product takes the whole of the joint into the plastic region. The challenge to the adhesive manufacturer is

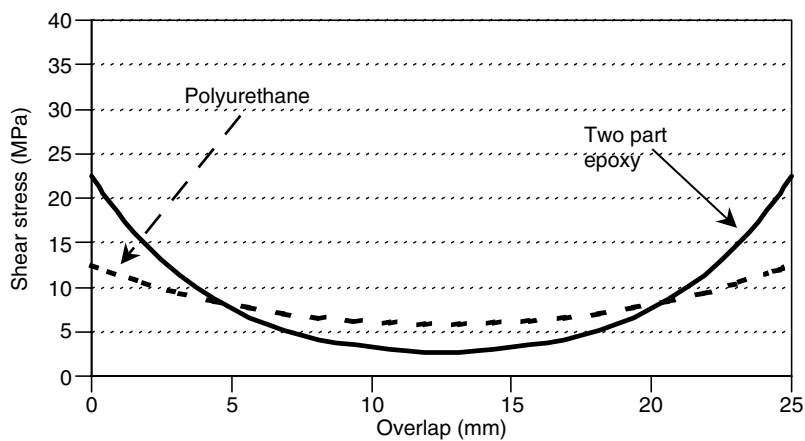

Figure 26: The low modulus polyurethane gives improved stress distribution.

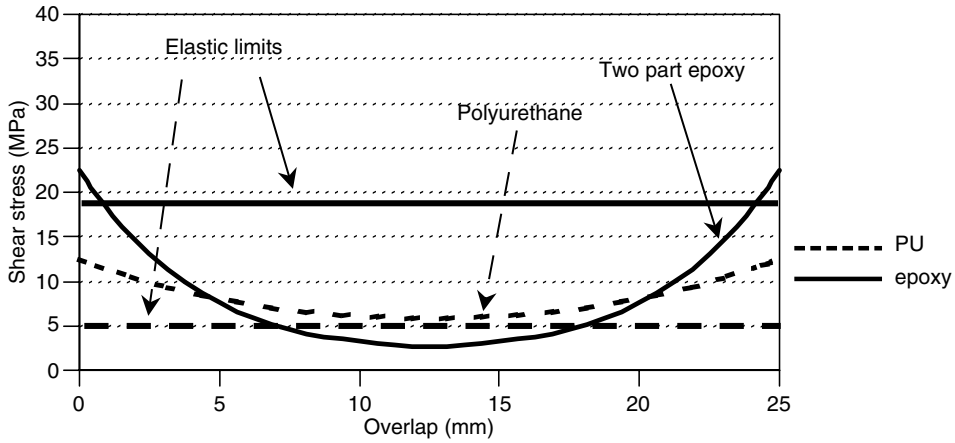

Figure 27: The low elastic limit of polyurethane adhesives counteracts the benefit of low modulus.

to design a low modulus adhesive with a high elastic limit. For the time being the other techniques of improving stress distribution will be needed.

If the high modulus single part epoxy is selected for comparison, the end stresses increase as would be expected but the elastic limit is still too low to permit a completely elastic behaviour (Fig. 28).

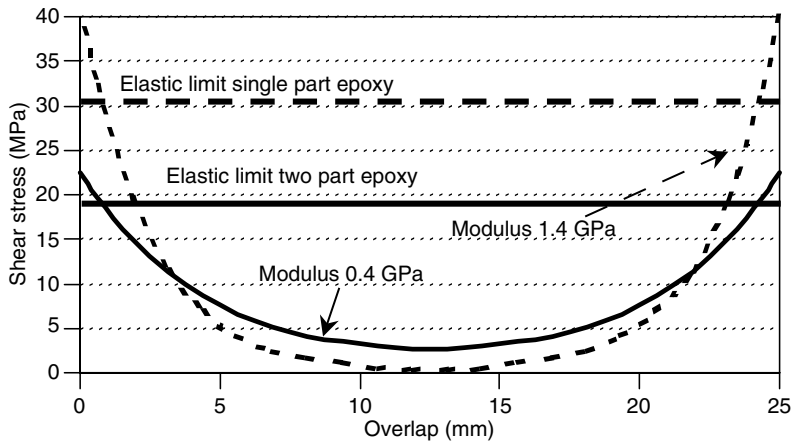

Figure 28: Single part epoxies generally display high elastic limits, but end stresses are higher still.

The selection of a particular adhesive type is for reasons other than modulus and associated stress distribution. This might be for example, specific adhesion, chemical resistance, setting speed, gap fill capability, durability, heat resistance, fire performance, electrical properties, thermal conductivity, colour, toxicity or price. Low modulus adhesives are used very successfully in low stress applications to accommodate differential thermal expansion in applications like bonding glass to aluminium in double glazing assembly.

3.2.5 Stress Distribution in Tubular Joints

From a stress distribution viewpoint, a co-axial tubular joint is much preferred since this type of joint cannot be subjected to the destructive peel stresses. We can consider a tube which slides inside the second tube such that the adhesive fills the annular gap (Fig. 29).

We will consider a torsional load on a co-axial joint, with an overlap of 25 mm using a single part hot setting epoxy adhesive. The inner tube external diameter is 25 mm and both tubes are 1.5 mm thick steel. A torsional load of 100 Nm and a glue line of 0.05 mm gives a stress distribution as shown in Fig. 30.

The stress situation is not acceptable. However, if the glue line thickness is increased from 0.05 mm to 0.25 mm, not only is the stressed joint satisfactory, but it is still satisfactory with a 50% load increase from 100 Nm to 150 Nm (see Fig. 31).

The graph shows that much of the central area carries no stress and therefore, a reduction in the overlap length could be considered without any significant change in load bearing capacity (see Fig. 32).

If we change the tubes material from steel to aluminium, in order to cope with the 100 Nm torsional stress, we will need to increase the outer tube to 2 mm thickness

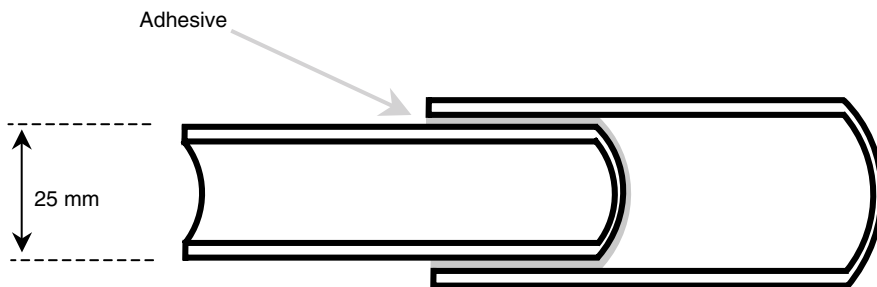

Figure 29: A section through a co-axial tubular joint.

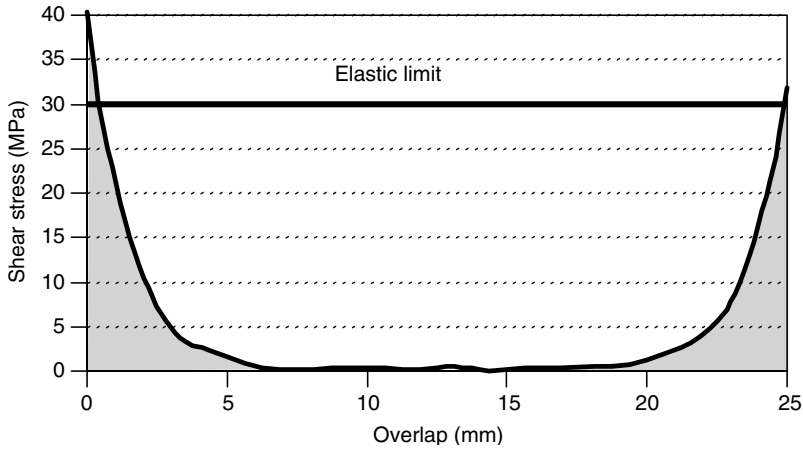

Figure 30: The end stresses exceed the elastic limit in the chosen joint.

and the inner tube to 3 mm. Under these conditions, a 0.2 mm glue line thickness is enough. The stress distribution is shown in Fig. 33.

One of the benefits of using structural adhesive bonding is that different metals can be joined together. For example, in the assembly of bicycle frames, the all steel construction needed for the brazing technique has been replaced to provide lighter

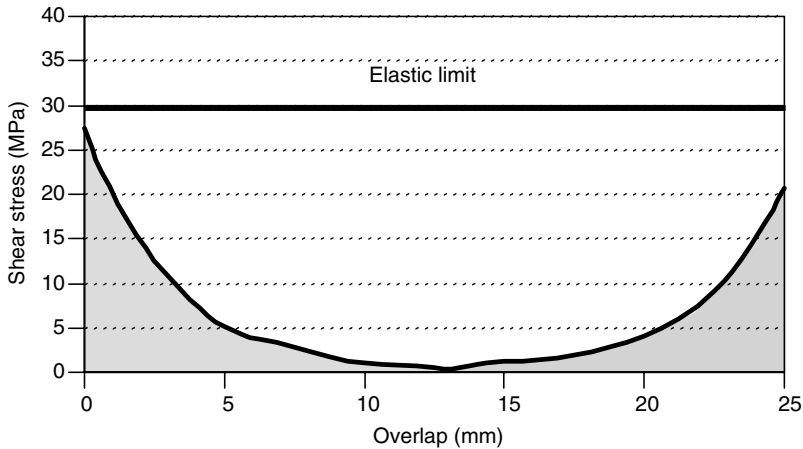

Figure 31: An increase in glue line thickness to 0.25 mm is satisfactory even with a 50% stress increase.

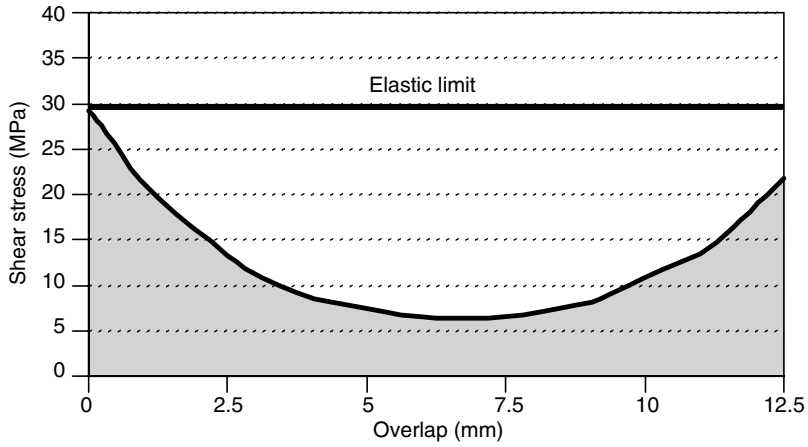

Figure 32: An overlap of 12.5 mm gives acceptable stress distribution.

weight construction with improved design. Fig. 34 shows the effect of replacing 2 mm of aluminium for the outer tube with 1 mm of steel.

If the steel thickness is increased to 1.5 mm, the imbalance in tube flexibility results in the stress level being increased at one end, beyond the elastic limit. This effect is clearly seen in Fig. 35.

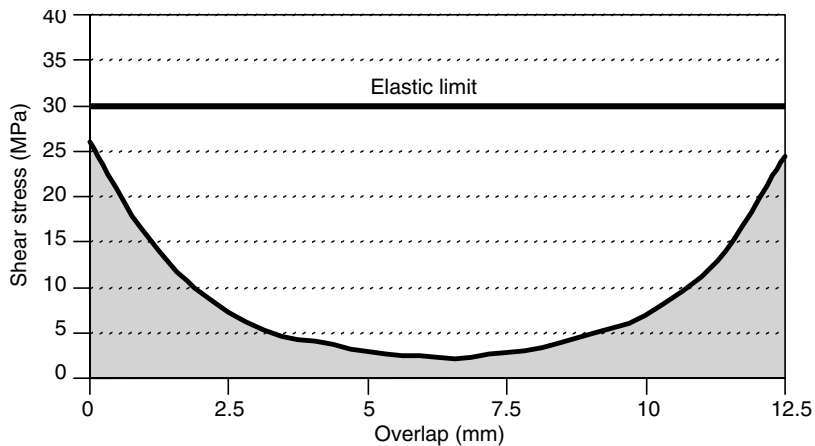

Figure 33: The lower modulus aluminium requires an increase in metal thickness.

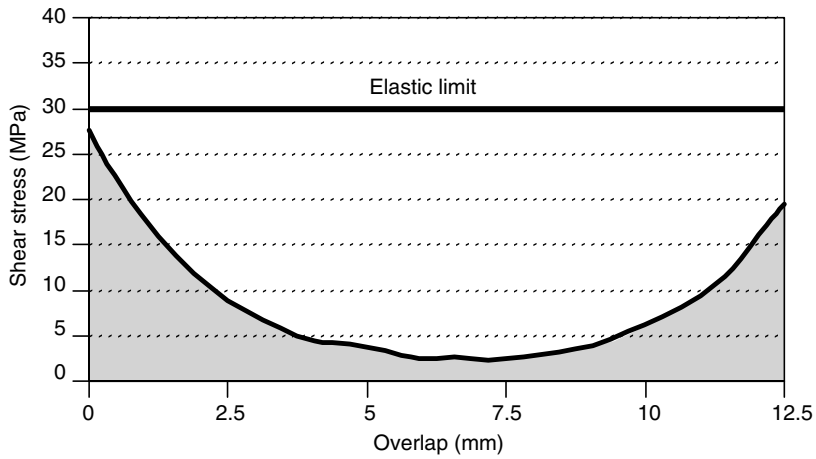

Figure 34: Steel (1 mm thick) replaces aluminium of thickness 2 mm and provides similar stress distribution.

If we assume that the objective is to join a 1.5 mm thick steel tube to a 3 mm thick aluminium tube, but we reverse the joint so that the steel fits inside the aluminium, then the stress distribution is much more acceptable (see Fig. 36).

The bonded assembly of aluminium and steel can now accept a torsional load of 150 Nm without exceeding the elastic limit (see Fig. 37).

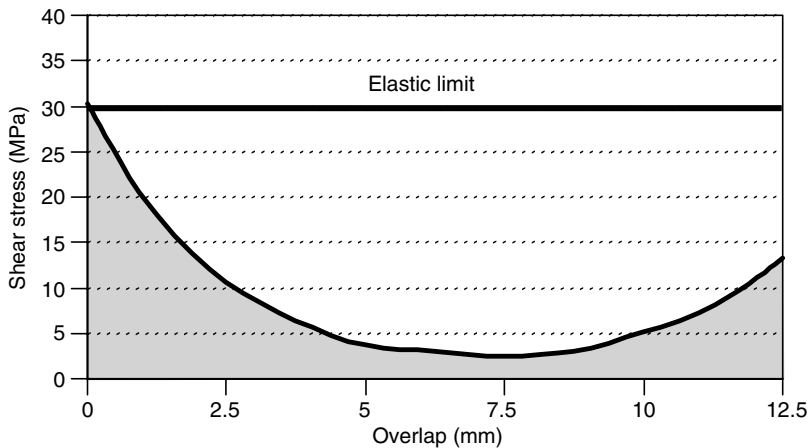

Figure 35: Thicker steel changes the stress distribution.

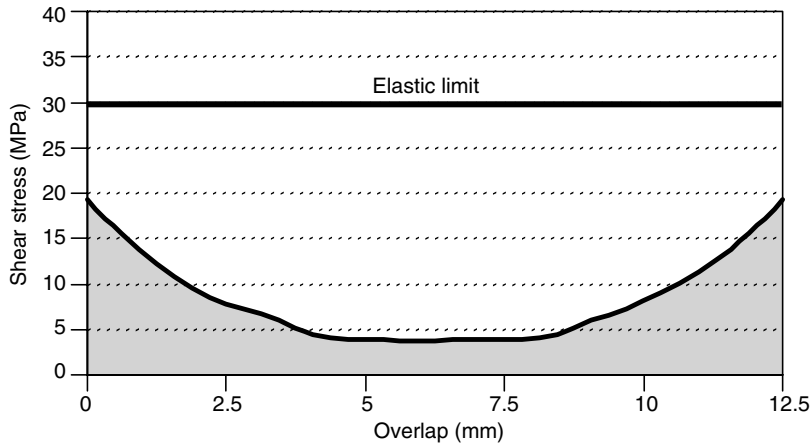

Figure 36: The steel tube inside the aluminium tube provides much improved stress distribution.

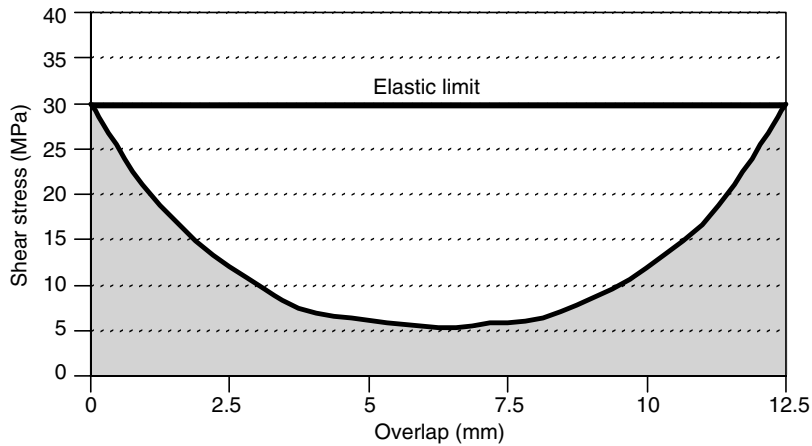

Figure 37: Good stress distribution results in a 50% increase in maximum load capability.

3.3. Joint Designs for Bonding

3.3.1 The Simple Lap

When we wish to assemble two pieces of thin metal by overlapping them, it is clear that a relatively thick glue line especially at the ends of the joint will allow for a significant increase in joint capability. When metal sheets are guillotined or



Figure 38: The joint ends have improved design if the glue line thickness increases in this high stress area.

stamped out, the edge will not normally be square. This can be used to our advantage as shown in Fig. 38.

In the example of poor joint design, the distorted metal creates a favourable thick glue line over most of the joint, but minimises the thickness at the critical joint ends. If a separation dimple is placed in the middle of the joint (the low stress area), this will control the glue line without compromise of joint strength (see Fig. 39).

A normal glue line thickness, without glue line control, is often less than 0.025 mm. In order to cope with high stresses, the glue line should be much thicker, in the region of 0.2 to 0.3 mm. Some adhesives are available today, which automatically control the glue line to a specific thickness. However, the use of dimples can have benefits in situations where electro-deposition of paint is important. Adhesives generally provide electrical insulation between components which would prevent the deposition of paint.

3.3.2. Thicker Section Lap Joints

Where heavy duty plates are required in construction, the use of contouring around the edges can be extremely beneficial. An example of this is the repair of the aluminium superstructures of naval ships. Localised high stresses occur during extreme weather conditions due to differential movement between the hull and the



Figure 39: Provide joint separation in the low stress area.

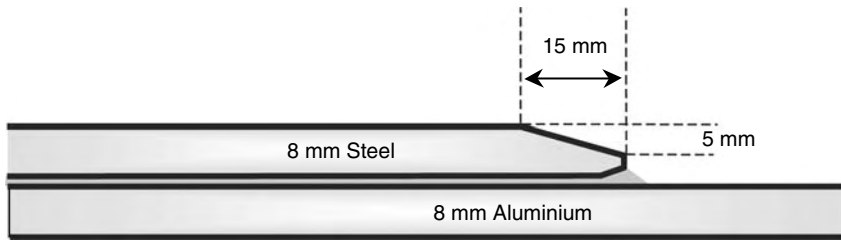

Figure 40: A heavy duty steel plate is contoured at the edges to minimise stress concentration.

superstructure. A combination of the optimum joint design and a tough structural adhesive outperforms re-welding, drilling out the crack tip or any other method tried to overcome design problems.

Fig. 40 shows the edge detail of a plate which is bonded over a crack in the structure to re-distribute the stress in an acceptable manner. This technique is now used for commercial ships to take advantage of the simple low cost solution.

A glue line of minimum 0.5 mm is used and the thixotropic adhesive is required to fill gaps up to 3 mm in the vertical or horizontal plane. Attachment of the heavy steel stiffening plate requires a few bolts to carry the load whilst the adhesive is setting. The bolts are set back from the edge of the plate in a low stress area so that the hole and the bolt do not interfere with the function of the stiffener (Fig. 41).

A very useful example of the benefit of careful design of joint ends can be seen when bonding thin metal to relatively thick epoxy composite. The choice of epoxy

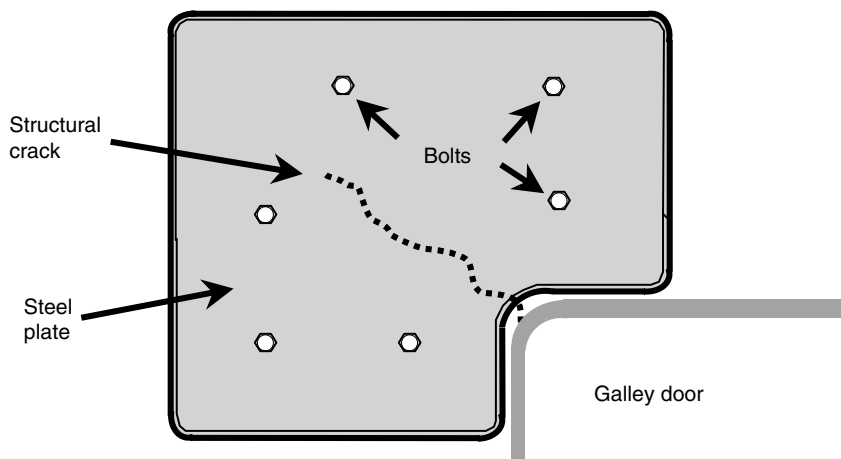

Figure 41: Bolts locate the plate and adhesive distributes the stress.

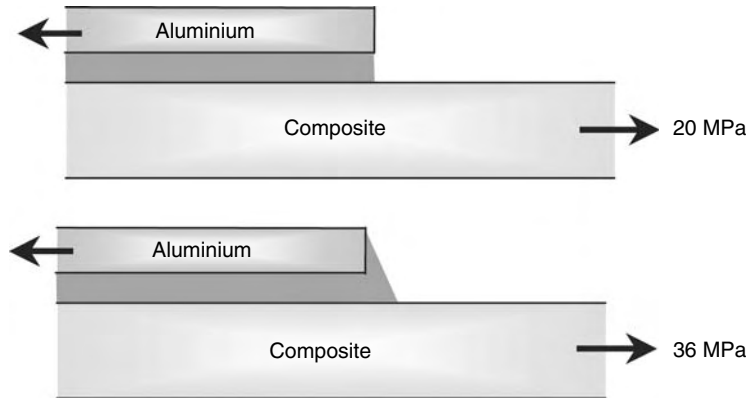

Figure 42: Excess adhesive outside the joint improves the load bearing capability.

composite rather than polyester is simply to increase the substrate strength to clearly show the benefit. When 1.5 mm thick aluminium was bonded to 3.0 mm epoxy composite in a simple lap joint, the latter failed at a stress level of 20 MPa. If an adhesive is applied outside the joint at an angle of 60° , the joint still fails within the composite but at a level of 36 MPa (see Fig. 42).

This means that an adhesive capable of making a fillet might be judged to be almost twice as strong as its more fluid twin without the realisation that the adhesive profile has significantly changed. If the angle of the excess adhesive is changed to 45° and the aluminium is tapered at 45° , further improvements are possible (Fig. 43).

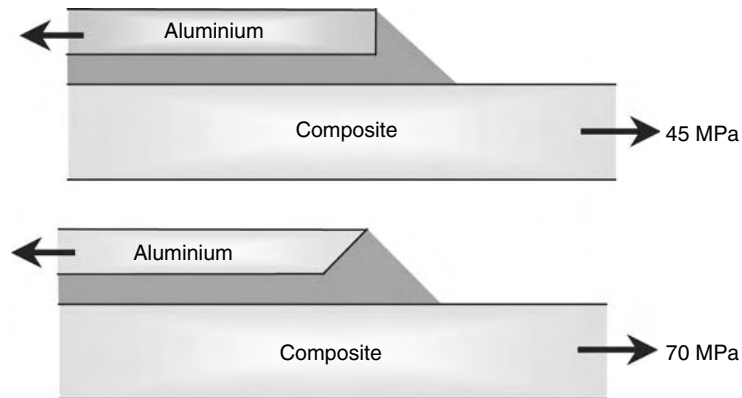

Figure 43: The best design can provide three times the strength.

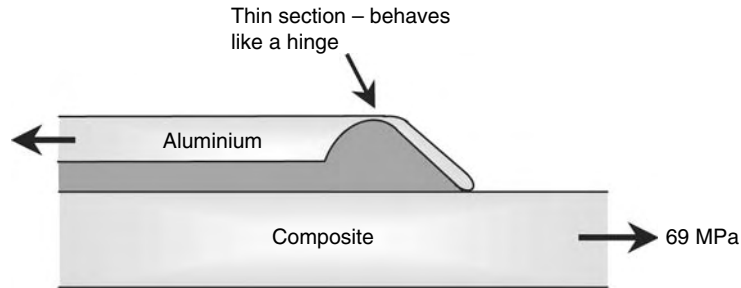

Figure 44: The aluminium flap tailors the adhesive and improves appearance.

For many bonding applications, the appearance of the joint is important. The adhesive outside the joint improves performance significantly, but generally detracts from the aesthetic appearance. The following option may be beneficial in achieving a clean joint (Fig. 44).

When the aluminium carrying the adhesive is placed on the composite, excess adhesive bends back the flap to allow extra adhesive to escape from the joint. Once the aluminium is in position, the flap can be pressed back to the composite surface and the excess removed.

3.3.3 Concealed Joints

The same principles can be applied to panels which butt together, in order to produce a completely smooth profile. In effect, we have two adjacent lap joints (Fig. 45) and this is a common joint used, for example, in the construction of buildings or aerodynamic shapes.

Thin sheet metal or composite panel work often requires increased stiffness and this is now commonly achieved by bonding an appropriate stiffening component to the reverse side of the panel. Many designs do not take account of the high edge

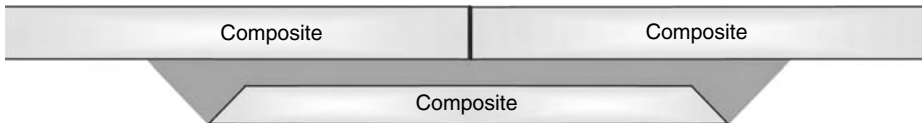

Figure 45: The joining component is hidden on the reverse side.

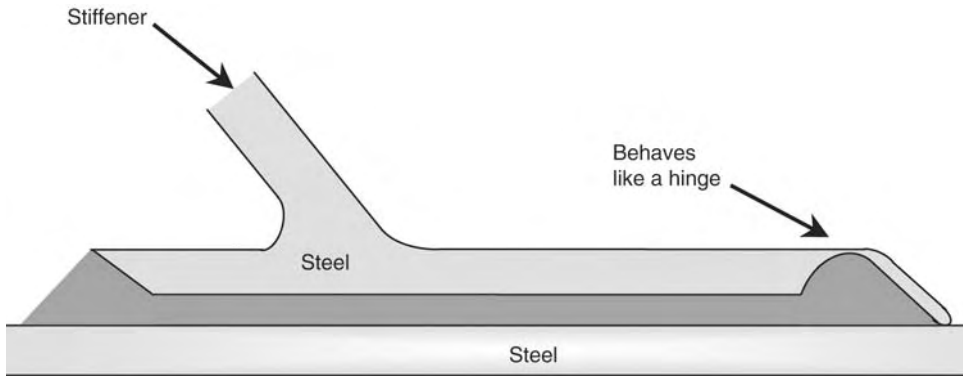

Figure 46: Stiffener for sheet steel.

stresses and this results in the shadow through of the stiffener. The use of both thick glue lines and stiffener profiling help to alleviate this condition (Fig. 46).

3.3.4 Co-axial Joints

This type of joint has the considerable advantage that peel/cleaving forces are reduced to an absolute minimum. The challenge for the designer is usually to ensure that the joint is completely filled with adhesive. The hurdle to be overcome in assembling two tubes is shown in Fig. 47. The radial modifications at the tube ends reduce stress concentrations and assist in efficient joint closure.

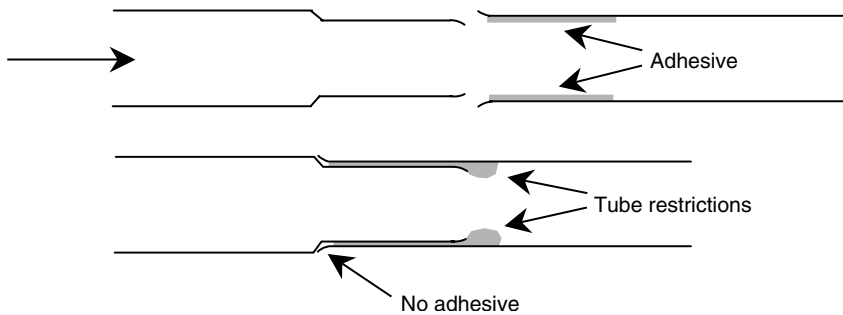

Figure 47: Closure of the tubes tends to displace the adhesive in a less than ideal manner.

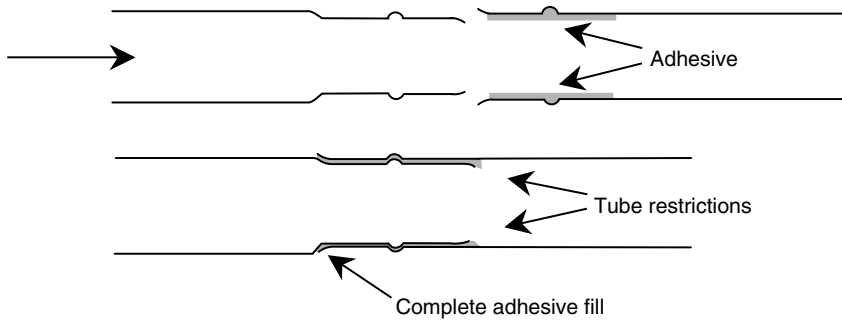

Figure 48: Complete filling of the joint with less adhesive.

A refinement to the joint ensures a complete fill every time. Three or four small indentations around the outer tube which will match with the same number of bumps in the inner tube allow assembly with misalignment and then a twist to locate and compress the adhesive layer (see Fig. 48). This technique ensures that the critical areas at the ends of the joint are completely filled.

One of the first practical uses of finite element analysis of stressed joints was the design of a steel end fitting to a carbon fibre tube to be used for power transmission. The requirement for the joint to exceed the performance of the tube itself, resulted in the design of a refined clevis connection. This design was theoretically the best option and in practice withstood the rigours of world motor rallying. The practical confirmation of achievement cannot be underestimated and in this case, torque loads of up to 430 break horse power under a wide range of temperatures and climatic conditions were encountered. The basic design is shown in Fig. 49.

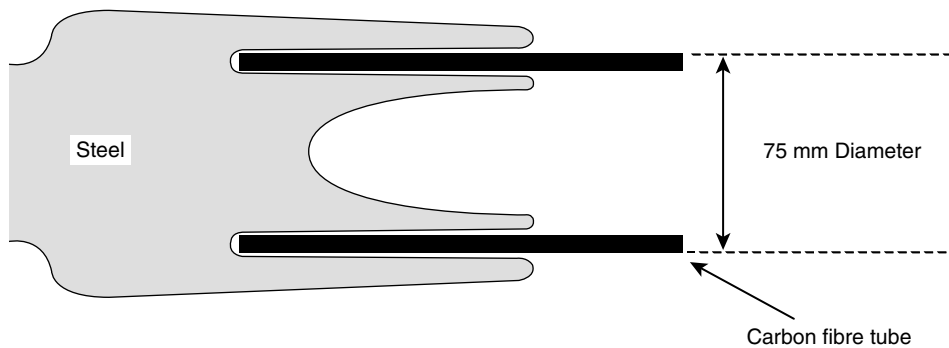

Figure 49: Both sides of the tube are used to provide satisfactory structural bonding.

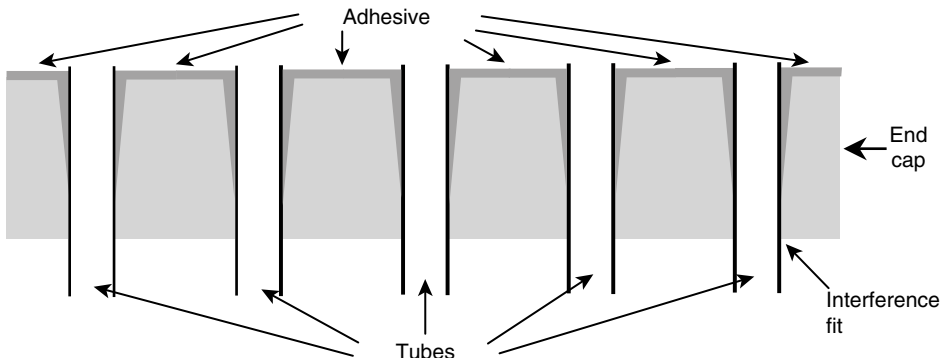

Figure 50: The adhesive fills the recess in the end cap and flows into the tapered holes.

Co-axial joints are also common in the design of filter or heat exchanger end caps. Here, the bonding process has replaced soldering or brazing. In these cases, because stress levels on the joints are low, an interference fit at one end of the joint can provide the basis of simple low cost assembly. If a cluster of tubes are required to be bonded and sealed, the selection of a free flowing adhesive, with the required performance under service conditions in combination with a simple moulded end cap, is the answer (see Fig. 50).

The interference fit means that a large number of tubes can be assembled into a single cap and then the bonding/sealing process follows in a single operation. The free flowing adhesive will find its own way into the tapered holes, but not pass the tight fit at the base. The tapered holes also provide greater strength where significant pressures are encountered.

3.4. Stress Mathematics

3.4.1. Elastic Behaviour

The slope of the initial part of the stress/strain curve for a structural adhesive is linear and relates to Hooke's Law, which states that the force applied to a spring and the resultant elongation are proportional. If the extending force is removed, then the components return to their original shape and condition. Materials operating in this way are referred to as linear elastic materials. Although the adhesive will also behave in a plastic manner at higher stress levels, from a design point of view, we will ignore this part of the response.

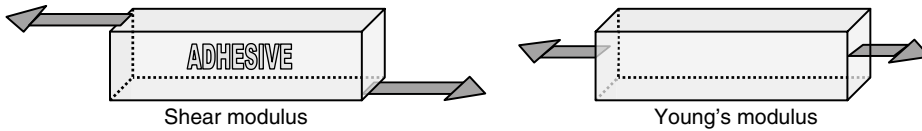

Figure 51: Shear modulus involves an asymmetric load.

The stress/strain curve gives us the shear modulus of the adhesive. This differs from the Young's modulus, which relates to the tensile behaviour (see Fig. 51).

When a shear load is applied, the adhesive is displaced to the trapezium shape and the shear modulus is the ratio of the applied stress to the displacement angle.

The shear modulus and Young's modulus are related as follows

$$\text{Young's modulus} = \text{shear modulus} \times (2 + 2 \times \text{Poisson's ratio})$$

3.4.2. The Volkersen View

The overlap joint was first analysed by Volkersen in 1938 and he concluded that the maximum concentration of shear stress in an adhesive at the ends of an overlap $\eta_c(\text{max})$ was

$$\eta_c(\text{max}) = \left[\frac{\Delta}{W} \right]^{1/2} \left(\frac{W - 1 + \cosh \Delta W}{\sinh(AW)^{1/2}} \right)$$

where Δ is a dimensionless coefficient and W is a function of the moduli and adherend thickness.

If both the adherends are the same size and the same material, then $W = 2$ and the equation becomes

$$\eta_c(\text{max}) = \left(\frac{\Delta}{2} \right)^{1/2} \coth \left(\frac{\Delta}{2} \right)^{1/2}$$

The maximum shear stress is therefore dependent on the dimensionless coefficient Δ , which can be calculated using the following formula.

$$\Delta = \frac{Gl^2}{Edt}$$

where

G = Adhesive shear modulus

d = Thickness of the adherend

l = Overlap length

t = Adhesive layer thickness.

E = Young's modulus of the adherend

3.4.3 Goland and Reissner Consider Bending

Goland and Reissner took the analysis a stage further in 1944 by taking account of the bending of adherends just outside the joint area when high stresses were applied. They derived an expression for the maximum shear stress τ (max) in a thin layer of adhesive at the ends of a joint with two different adherends as follows.

$$\tau(\text{max}) = \left(\frac{1 + 3k(2\Delta)^{1/2} \coth(2\Delta)^{1/2} + \frac{3}{4}(1 - k)}{4} \right) \tau_0$$

where k = bending moment and τ_0 = load/bond area

3.4.4 Hart–Smith Consider the Plastic Zone

In 1973, Hart–Smith took this a stage further by considering the plastic deformation of an adhesive in addition to the elastic response. This work, coupled with the finite element analysis technique provided the platform for calculation of stress distribution in complex nonlinear joints. The finite element approach to stress analysis is very convenient because the number of elements can be increased in areas of significant stress change.

Although computing times of several hours are needed, it is possible to achieve predictions for the performance of complex assemblies. To explore these options in detail, contact the Department of Mechanical Engineering, Imperial College of Science, London.

3.4.5. Data Needed for Stress Calculations

The objective of this chapter has been to show how the simple elastic behaviour of adhesives can be used as a guide to basic design. This facility is available through the PAL computer programme, available from Bondmaster, and the worked examples shown are the result of using this programme.

The parameters required to use this programme are:

1. The type of joint to be considered – co-axial or simple lap
2. Joint length (mm)
3. Joint overlap (mm)
4. Applied load (N)
5. Adherend materials – surfaces to be bonded
6. Adherend Young's modulus (GPa)
7. Adherend coefficient of thermal expansion (m/m/°C)
8. Adhesive shear modulus (GPa)
9. Adhesive elastic limit (MPa)
10. Glue line thickness (mm)

3.5. Practical Testing

At the end of the day, confidence in structural bonding is the result of not only sound theory, but also thorough practical testing. The opportunity to test products to the limit often manifests bonding in specialist areas, and it is less obvious that the same technology can be used in construction generally in order to create improved economic designs.

Software for the Design and Calculation of Bonded Joints

Componeering Inc. Itämerenkatu 8, FIN-00180 Helsinki, Finland
Tel.: + 358 9 4342 1550,
Fax: + 358 9 4342 1551,
esacomp@componeering.com,
www.componeering.com

BONDMASTER Division Bondmaster®
National Starch & chemical Limited
Bondmaster Division,
Woodside Road,
Eastleigh, SO50 4 EX,
United Kingdom,
Technical Helpline: Tel.: 023 8061 9822,
Fax: 023 8065 2270,
Customer Service: Tel.: 023 8068 3268,
Fax: 023 8061 9284.
helpine.europe@bondmaster.com,
www.bondmaster.com

BONDMASTER address in other countries
Asia-Singapore,
Tel.: +65 6299 0881,
Fax: +65 6299 0609,
helpline.asia@bondmaster.com

France
Tel.: +33 (0)4 74 02 39 42,
Fax: +33 (0)4 74 02 39 43,
helpline.europe@bondmaster.com

Deutschland,
Tel.: 0800 400 2300,
Fax: 0800 400 2100,
helpline.europe@bondmaster.com

United Kingdom
Tel.: +44 (0)23 8062 9628 or 08000 698 7000
Fax: +44 (0)23 8065 2270,
helpline.europe@bondmaster.com

This Page Intentionally Left Blank

Chapter 4

Heat-Resistant Adhesives

Guy Rabilloud

In 1962, Guy Rabilloud got a doctorate in chemical and physical sciences from the Nobel prize laureate of physics Louis Néel. Two years later, he joined the department of fine chemicals at IFP, the French Petroleum Institute. For 30 years, he studied and developed new heat-resistant polymers for the advanced technologies, signing more than 150 patents and scientific publications. During the decade 1970–1980, he was also associate professor in macromolecular chemistry at the universities of Grenoble and Lyon. In the early 1980s, he became assistant manager of Cemota, a subsidiary of IFP created to develop, manufacture and commercialize high-performance polymers for the electronic and aerospace industries. In 1990, he spent one year as a consultant attached to the Singapore Institute of Standards and Industrial Research. Dr Rabilloud is the co-author of several books dealing with the applications of polymers, including adhesives, films and composite materials. He recently published three books providing an overview on the use of polymers in electronics, in particular conductive adhesives and heat-resistant insulating films.

Keywords: Acetylene-terminated resins; Adhesive properties; Application of structural adhesives; Bismaleimide (BMI) adhesives; Coefficient of linear thermal expansion (CTE); Condensation of oligomers; Condensation prepolymers; CTBN rubbers; Degree of polycondensation (DP); Dielectric properties; Epoxy novolacs; Epoxy-phenolic adhesives; Fracture energy; Fracture toughness; Glass transition temperature; Heat of polymerisation; Heterocyclic polymers; High performance liquid chromatography (HPLC); Imidisation kinetics; Infrared spectroscopy; Isothermal thermogravimetric analysis (ITGA); Lap shear strength; Maleimide-terminated resins; Mechanical properties; Molecular weight determination; Nadimide-treated resins; Norbornene-terminated imides; Nuclear magnetic resonance; Peel strength; Polyamic acids; Polybenzimidazoles; Poly(ether-imides); Polyimides; Polyimide precursors; Poly(isoimides); Polyphenylquinoxalines; Precyclised polymers; Processability window; Processing conditions; Rheological profiles; Self standing films; Telechelic oligomers; Thermal properties; Thermomechanical analysis; Thermoplastic adhesives; Thermosetting resins; Viscosity.

4.1. Introduction

In contrast with inorganic materials such as metals, alloys, or ceramics, which can work at high temperatures for years, the thermal stability of organic polymers is a time–temperature dependent parameter. Accordingly, heat resistance is defined as the time during which an organic material can be subjected to a given temperature. Typically, a thermally stable polymer must be safely utilised for 30,000 h at 200°C, 10,000 h at 250°C, 1000 h at 300°C, 10 h at 400°C, or for a few minutes at 500°C. Depending on the application, the safety margin is either an acceptable weight loss (5–10%) resulting from pyrolysis or oxidation, or a decrease of the initial mechanical properties. It will be seen later on that below the onset of thermal degradation the tensile modulus of films, the flexural modulus of composite materials, or the lap shear strength of adhesives remain relatively stable for a long time. Then, their value rapidly drops within a few hours.

From a theoretical point of view, the highest achievable thermal stability of organic polymers should be attained with poly(1,4-phenylene) **I**. Its macromolecular backbone, represented in Fig. 1, contains only carbocyclic aromatic rings connected at the 1,4-carbon atoms. However, there is no chemical method to prepare this polymer because it does not exhibit any melting point and solubility as soon as the degree of polymerisation n exceeds 5–6. This observation was the key factor in developing the ‘polyheterocyclisation’ concept, involving alternate aromatic carbocyclic and heterocyclic rings. The former are carried out by the ‘monomers’, whereas the latter are formed during either the polycondensation reaction or the processing stage.

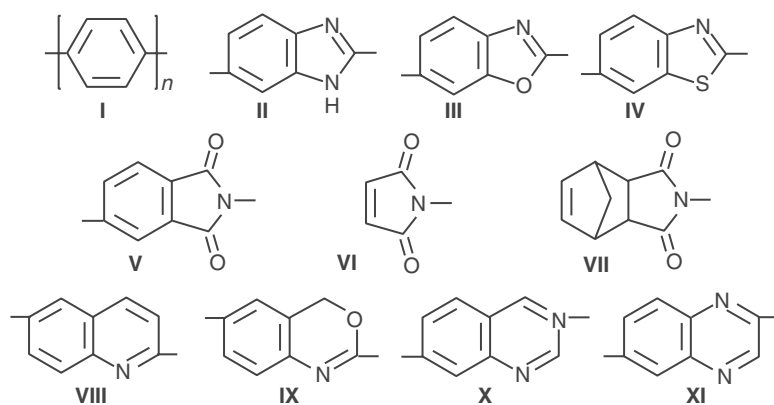

Figure 1: Examples of carbocyclic and heterocyclic repeating units used to build the macromolecular backbone of heat resistant polymers: **I** poly(1,4-phenylene) or poly(*para*-phenylene), **II** benzimidazole, **III** benzoxazole, **IV** benzothiazole, **V** isoindole-1-one (imide), **VI** pyrroledione or maleimide, **VII** bicycloheptylpyrroledione or nadimide, **VIII** quinoline, **IX** benzoxazine, **X** quinazoline, **XI** quinoxaline.

Some examples of heterocycles incorporated in polymer repeating units are provided in Fig. 1 to illustrate the versatility of the chemistry explored over the last few decades.

Many thermally stable heterocyclic polymers have been studied for more than thirty years but few of them have achieved commercial development. The main reason is not the non-availability of the starting reagents or monomers but the extreme conditions required to process these materials, generally related to the insolubility of most polymers in any solvent, except sometimes strong inorganic acids. Examples are the fully aromatic polybenzimidazoles, polybenzothiazoles, poly(imidazoquinazolinediones) and 'ladder' polymers made of highly rigid fused polycyclic structures. In the literature, these polymers are described as 'brick dust' materials because they are obtained only in the form of non-fusible orange, red or even black powders.

Obviously, heterocyclic polymers synthesised at high temperatures (350–450°C) exhibit an outstanding thermal stability, up to 500°C, when they are subjected to dynamic thermogravimetric analysis (TGA). This, however, can be misleading because the stringent conditions of polycondensation in solid or semi-solid phases are sometimes over the actual onset of thermal decomposition. This has been demonstrated with carborane-containing macromolecules considered to be the most thermally resistant polymers because they do not exhibit any weight loss below 700°C. The apparent high thermal stability of poly(carboranylene-azomethines) [1] and poly(carboranylene-dihydrobenzothiazoles) [2] is an artefact because the weight loss due to the degradation of the organic moieties is hidden by the gain in mass resulting from oxidation of the carborane cage into boron oxide and boric acid.

During 1960–1970 an impressive number of heterocycles were engaged in macromolecules without taking into account their processability. At the present time a few heterocyclic polymers have found general acceptance in the industry as heat-resistant adhesives, dielectric and insulating films, high-modulus fibres, protecting overcoats, and matrices for composites. The data plotted in Fig. 2 extend those published by Schwartz [3] and Keimel [4] and show the progressive increase in thermal stability of the most important classes of polymers used to make structural adhesives. The upper line, joining the early vinyl-phenolic resins to the American Cyanamid FM 34 and Rhône-Poulenc Nolimid 380 (both are condensation polyimide precursors), represents the search for the highest thermal stability. The adhesives close to the lower line are significantly less heat resistant but often easier to process. As previously stated, the thermal stability is expressed either as a time–temperature dependence or as an adhesive strength–temperature relationship.

The basic chemistry of aromatic polyimides was first disclosed in patents filed by Du Pont de Nemours [5] for polypyromellitimides and later on by Edwards [6, 7] for polyimides prepared with various aromatic dianhydrides and diamines. They compose

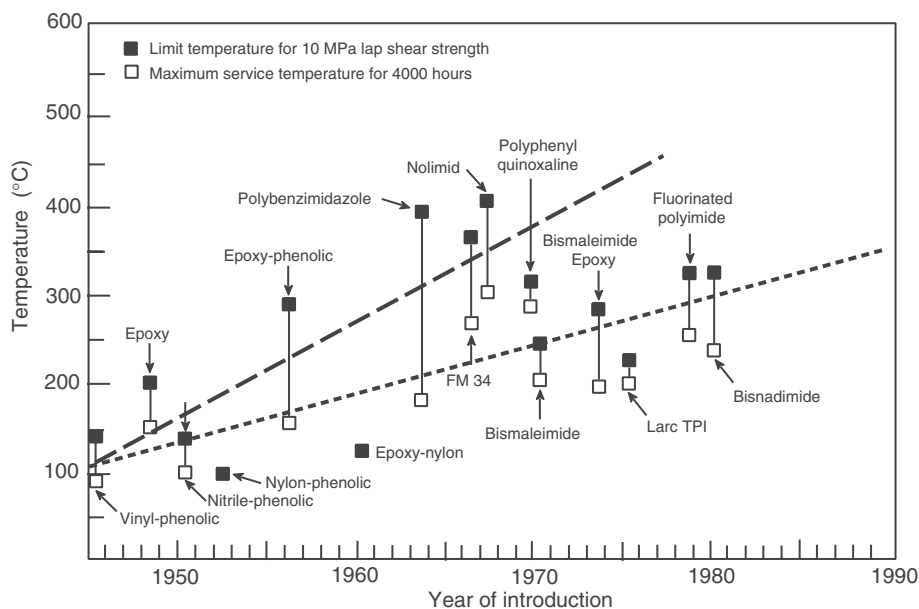

Figure 2: Thermal stability of structural adhesives as a function of their year of introduction in the technical literature or on the market place.

certainly the family of heat-resistant polymers which provides most of the existing high-performance organic materials. They are now available from many manufacturers in the form of both polyimide precursors, such as polyamic acids and polyamic esters, and as precyclised soluble and melttable polyimides. Far behind this series are the commercially available polybenzimidazole, produced by Hoechst-Celanese [8] to make heat resistant fibres and fabrics, and polyphenylquinoxaline developed at IFP in the early 1980s. Extensive reviews of the chemistry and applications of heterocyclic polymers, particularly polyimides, can be found elsewhere [9–14].

Heat-resistant polymers were initially developed for aerospace uses requiring a continuous service temperature of approximately 260°C. However, legislation on energy efficiency and safety requirements continues to expand the market potential, in particular for polyimides, in the ground and aerospace transportation industries. The development of commercial polyimides that are melt processable on conventional moulding equipment boosted the use of these materials. Because of their high flexural modulus and compressive strength, polyimides are now widely used in load-bearing applications in automotive and aircraft structures. New under-the-hood parts made of thermoplastic or thermosetting polyimides have been developed based on the high heat stability and resistance of these polymers

to automotive lubricants, fuels and coolants. Thermoplastic polyimides are tough and exhibit good impact strength, whereas thermosetting oligomers display inherent brittleness. High molecular weight linear polyimides are stiff with tensile modulus in the range 2–6 GPa for films and 3–5 GPa for moulded materials. Tensile, flexural and compressive strengths are excellent below the glass transition temperature (T_g). The T_g determines the method of processing and the maximum temperature at which a polymer can be used in any given application.

4.2. Polymer Properties

4.2.1. Molecular Weight Determination

Oligomers and polymers are characterised by measuring their inherent viscosity (η_{inh}), which is obtained by using an Ubbelohde viscometer. Inherent viscosity is calculated by the relation $\eta_{inh} = (t_1/t_0)/C$, where t_1 and t_0 are the flow times of the polymer solution and pure solvent, respectively, and C is the polymer concentration generally expressed in g dl^{-1} . Both relative and inherent viscosity values, determined at various concentrations, are then plotted as a function of C and the intrinsic viscosity $[\eta]$ is calculated by extrapolation to zero concentration by using Huggins' and Kraemer's relations. Detailed information on the relationship between viscosity data and polymer molecular weight of polyphenylquinoxalines can be found in a previous book [15]. It was demonstrated that these polymers do follow Huggins' law $\eta_{red} = [\eta] + k'[\eta]^2C$ with, however, quite high and variable values for the k' constant. Two techniques have been used to measure the molecular weight of heterocyclic polymers in solution: light scattering analysis and gel permeation chromatography. They are illustrated here by experiments conducted with two polymers that are reported in Section 4.3 (Polymer Chemistry).

4.2.1.1. Light Scattering Analysis

Light scattering analysis was employed to determine the molecular weight of long-chain precyclised polyphenylquinoxaline **15** (Fig. 10), while size exclusion chromatography was found to be most suited to separate the components of low-molecular-weight polyimide oligomers **31** obtained by thermal polycondensation of the mixture of monomers **30a** and **30b** (Fig. 5). Weight average molecular weights are often calculated from low angle light scattering analysis according to the relation $KC/\Delta R_\theta = 1/M_w + 2A_2C$, where A_2 is the second virial coefficient, K the polymer optical constant and ΔR_θ the excess Rayleigh's ratio. The general relationship between the weight average molecular weight and the intrinsic viscosity is generally expressed by Mark–Houwink's equation $[\eta] = KM_w^a$, whereas the

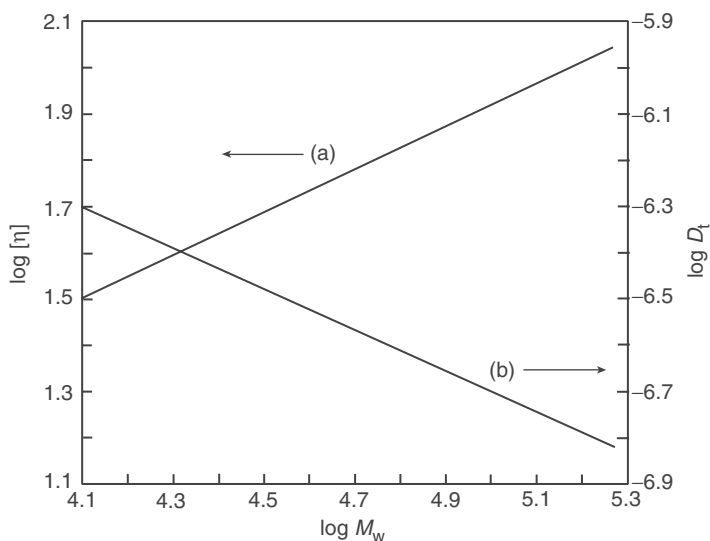

Figure 3: Dependence of (a) intrinsic viscosity $[\eta]$ and (b) diffusion coefficient D_t on the molecular weight M_w of the polyphenylquinoxaline **15** shown in Fig. 10.

translational diffusion coefficient D_t is also coherently related to the molecular weight by the following power law function: $D_t = KM_w^{-b}$. As an example, Fig. 3 displays the dependence of $[\eta]$ [line (a)] and D_t [line (b)] on the molecular weight M_w for polyphenylquinoxaline solutions in chloroform.

4.2.1.2. Size Exclusion Chromatography

Size exclusion chromatography (SEC), also known as gel permeation chromatography (GPC) separates the molecules according to their effective size in solution using a stationary phase in the form of either cross-linked polymers that swell in contact with a solvent or a microporous polymer of rigid structure. The small molecules diffuse into the pores of the gel, where they are temporarily retained so that they move more slowly through the column. Conversely, the large molecules cannot enter the pores, are excluded and freely move through the column, appearing first in the chromatogram. Molecules of intermediate size are retained to a lesser extent than the smaller species and move through the column at speeds dependent on their size.

Because the effective size in solution is closely related to the weight average molecular weight (M_w), the accurate measurement of M_w requires the availability of a series of standards of known molecular weights close to monodisperse ($M_w/M_n < 1.1$). By plotting the logarithm of M_w versus the elution volume or retention time, a calibration curve is drawn. Samples of the polymer under study are then chromatographed on the same column and the elution volumes of the

peaks are compared to the calibration curve to estimate the molecular weight. This means that unavoidable errors result when the calibration made with narrow polystyrene standards is used to characterise polymers of other types. Estimations of M_w obtained with this method are often referred to as polystyrene equivalent molecular weights and their actual values can be in error by a factor of 2 or 3.

In the case of polyimides, it is worth noting that the self-condensable monomer **30 a–b** (Fig. 15) is a particularly interesting material because the early stages of its thermal polycondensation can be easily monitored by using SEC. The spectra drawn in Fig. 4 were recorded at various time intervals during the polycondensation of the monomer in solution in benzyl alcohol at 105°C. The experimental conditions of SEC analysis are reported in another book [15]. The first chromatogram shows that the starting material comprises 84% of monomer **30**, 15.2% of dimer, and 0.8% of trimer. The digits (0 to 7) plotted on the top of the peaks correspond to the number of monomer units minus one (m in formula **31**), which are clearly separated on the SEC curves. Additional computer calculation provides data up to a degree of polycondensation of 12 (13 monomer units). The molecular weight peak of high intensity progressively shifts from 300 to 3690 g mol⁻¹ as the inherent viscosity of the oligomer mixture increases from 0.05 to 0.22 dl g⁻¹. This makes it possible to draw an internal standard or self-calibration curve, the linear regression coefficients of which are a slope of -0.14, a Y-intercept of 6.48 and a determination coefficient of 0.9997. It is obvious that, in this case, the molecular weight accuracy is excellent in the early stage of the polycondensation reaction because the oligomers used as internal standards have the same chemical structure at any stage of the polymerisation. In this particular case, SEC analysis has proved to be the most accurate method for checking the batch-to-batch consistency in the production of polyimide oligomers.

4.2.2. Thermal Properties

4.2.2.1. Dynamic Thermogravimetric Analysis

The thermal and thermal-oxidative stabilities of polymers are determined by dynamic thermogravimetric analysis (TGA) using a temperature ramp of 10°C min⁻¹. The curves representing the change in polymer weight versus temperature in flowing air and in argon, respectively, are reported in Fig. 5 for polyphenylquinoxaline **15**. The onset of thermal decomposition in an inert atmosphere is approximately located at 560°C, while polymer oxidation in air begins at 500°C. However, even if TGA can be considered as the most useful tool for determining the thermal stability, the results must be taken only as a crude indication of the thermal resistance.

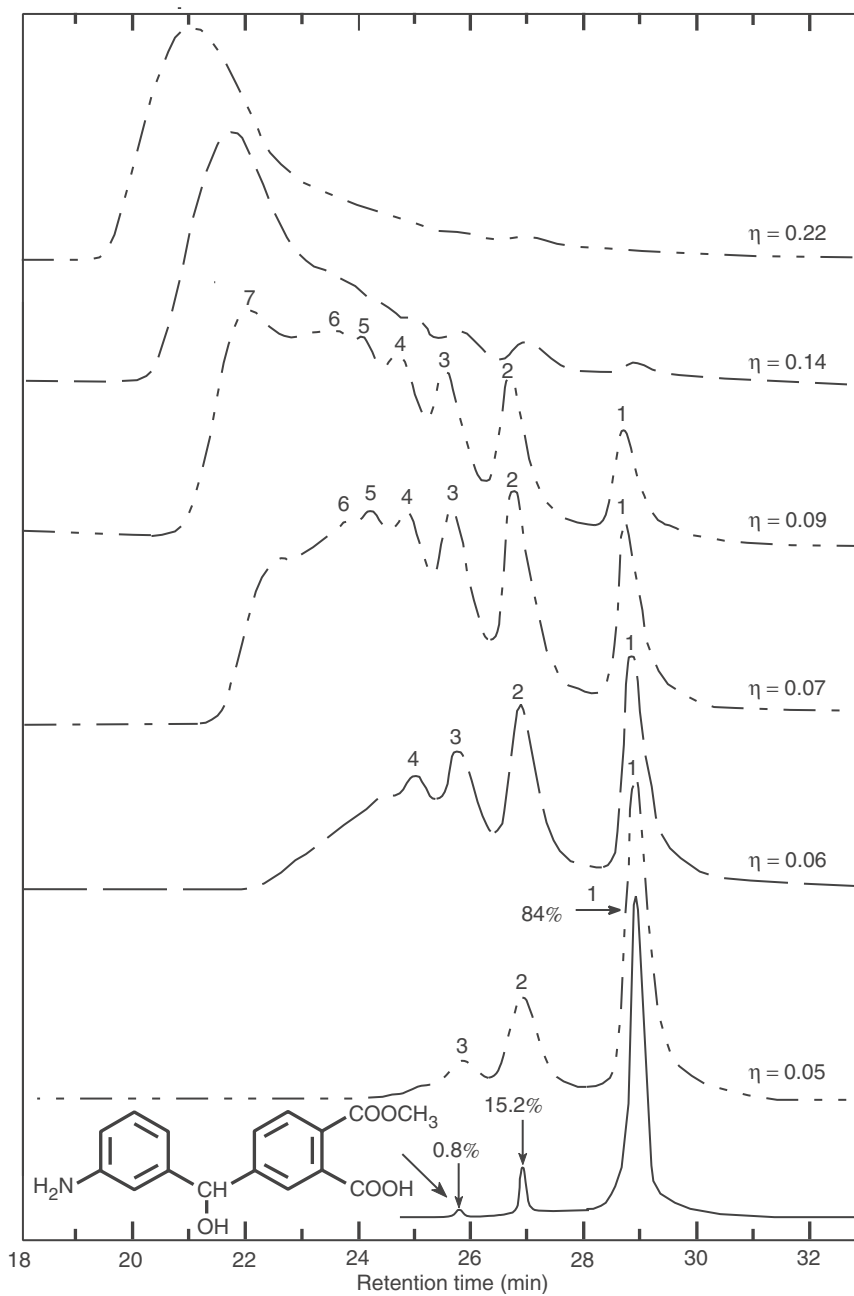

Figure 4: Size exclusion chromatographic analysis of the mixture of oligoimides **31** (Fig. 15) at various degrees of polycondensation in solution at 105°C in benzyl alcohol.

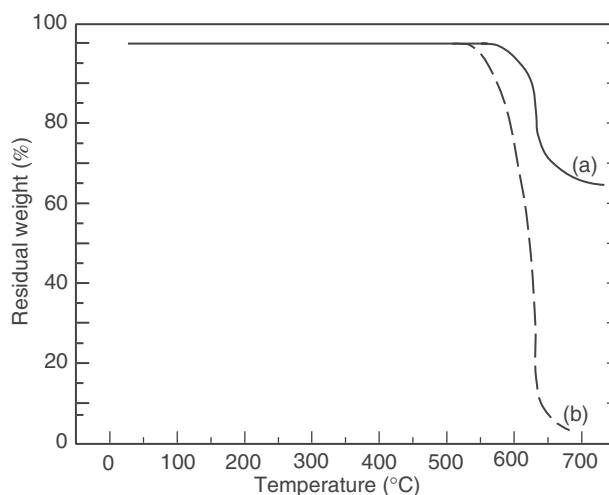

Figure 5: Dynamic thermogravimetric analysis of polyphenylquinoxaline **15** in argon (a) and in air (b) at a heating rate of $10^{\circ}\text{C min}^{-1}$.

An impressive amount of data published in the literature indicate, based on thermogravimetric analysis, that many heterocyclic polymers can be used at temperatures greater than $350\text{--}400^{\circ}\text{C}$. All experiments conducted later with these polymers, in actual long-term thermal operations, showed that heat-resistant polymers exhibit only a very short-term thermal stability at the onset of degradation revealed by TGA. In actual use, the thermal stability of a given polymer is approximately 150 to 200°C less than the value provided by dynamic thermogravimetric analysis. It is, however, worth noting that significant differences exist between materials such as films and adhesives. In the former case, the surface area subjected to pyrolysis or oxidation is far greater than the periphery of an adhesive joint.

4.2.2.2. Isothermal Ageing

As stated in the previous paragraph, dynamic TGA cannot provide useful information on the behaviour of polymers subjected to high temperature stressing during long periods of time. Using the same analytical apparatus, isothermal thermogravimetric analysis (ITGA) can be considered as more representative of the actual thermal stability of polymers. Isothermal ageing in flowing air over a wide temperature range, from 250 to 550°C , was used to determine the thermal-oxidative stability of polyphenylquinoxaline films on the basis of the results presented in Fig. 6. Since mechanical and electrical properties show significant variations when the polymer weight loss is greater than 5% , a first estimate of the

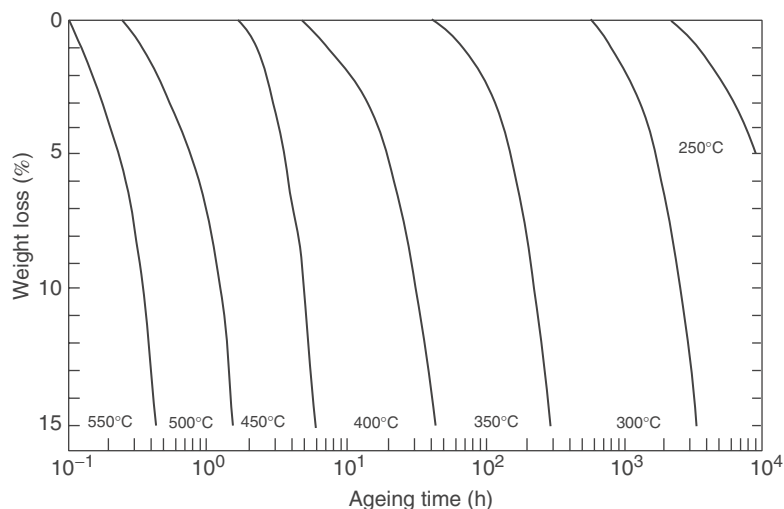

Figure 6: Isothermal thermogravimetric analysis of polyphenylquinoxaline **15** in flowing air in the temperature range 250–550°C.

useful lifetime would be roughly: 10,000 h at 250°C, 1500 h at 300°C, 20 h at 400°C, 45 min at 500°C and 3 min at 600°C.

To support this assumption, the variation of the mechanical properties of polyphenylquinoxaline films during isothermal ageing in air at 250, 300 and 350°C was studied and reported by Verdet et al. [17]. At 250°C, the initial values are very stable over an ageing time of 1000 h and the mechanical properties remain unaffected by air oxidation. After 1000 h at 300°C, the tensile modulus increases from 2.3 to 2.65 GPa and the tensile strength from 132 to 153 MPa. Finally, at 350°C both the modulus and ultimate strength significantly change within the first 200 h, thus indicating material degradation due to air oxidation. These results correlate very well with the thermal stability data determined by isothermal ageing curves of Fig. 6, which demonstrates that the polymer is unaffected after 1000 h ageing at 250°C, but loses approximately 2% of its initial weight when heated for the same time at 300°C, and 9% after 200 h at 350°C. In addition, the elongation at break decreases from 8 to 1% after 200 h at 350°C, while the glass transition temperature increases from 340–350 to 415°C within 400 h at that temperature. These results have been explained [15] as the consequence of thermal cross-linking at high temperatures.

4.2.2.3. Thermomechanical Analysis

As adhesive compositions are most often obtained by mixing an organic binder with inorganic fillers and various additives, thermomechanical analysis is generally

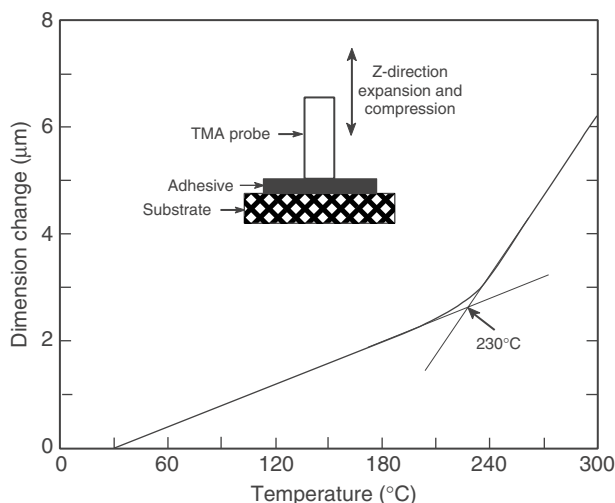

Figure 7: Thermomechanical analysis (TMA) of polyimide **32** loaded with 70% by weight of silver flakes.

conducted with an expansion probe. The output of the thermal analyser is a curve plotting the variation of adhesive thickness as a function of the temperature which is increased at a rate of $10^{\circ}\text{C min}^{-1}$. Fig. 7 illustrates the typical behaviour of polyimide **32** loaded with silver flakes and cured for 30 min at 275°C .

The first linear region with a slope of $4.5 \times 10^{-5} \text{ K}^{-1}$ is associated with the glassy state, followed at about 230°C by a change to a second linear region of higher slope of the order of $1.2 \times 10^{-4} \text{ K}^{-1}$. This change in slope is caused by a second-order thermodynamic transition of the organic material from the glassy to the rubbery state, which is one definition of the glass transition temperature (T_g). Thus, thermomechanical analysis provides both the T_g value and the coefficients of linear thermal expansion (CTE) before and after T_g .

4.3. Polymer Chemistry

As shown in Fig. 2, only some epoxy-phenolic compositions and a limited number of heterocyclic polymers exhibit long-term thermal stability at 200°C and higher temperatures. In the heterocyclic series, only polybenzimidazoles, polyimides and polyphenylquinoxalines have been subjected to extensive testing at high temperature. Several classification schemes are commonly used in the literature to represent these polymers. In the following discussion, the polymer chemistry is presented in the form

of four general classes: linear polymer precursors, precyclised thermoplastic polymers, condensation oligomers, and thermosetting resins. Polybenzimidazoles belong to the third category whereas polyphenylquinoxalines are fully cyclised thermoplastic materials. Only polyimides have representative polymers in the four series.

4.3.1. Linear Polymer Precursors

The method used to prepare aromatic polyimides is illustrated in Fig. 8 with the reaction of 1,2,4,5-benzenetetracarboxylic acid dianhydride (pyromellitic acid dianhydride, PMDA) **1** and 4,4'-oxybisbenzeneamine (oxydianiline, ODA) **2** [5]. After a charge transfer complex between compounds **1** and **2** is initially formed, propagation occurs via the amine nucleophilic attack at the carbonyl groups of the cyclic anhydride. The reaction is actually a step polycondensation, but it looks like a polyaddition or polymerisation because the condensation by-product remains chemically bonded to the aromatic ring. It has been demonstrated that the propagation reaction is reversible with, however, equilibrium constants greater than 10^5 l mol^{-1} in polar aprotic solvents which form stable complexes with the free carboxyl groups. Basic solvents thus decrease the reverse reaction and favour the formation of high molecular weight polyamic acids at ambient temperature. Thus, dianhydride **1** and diamine **2** lead to the intermediate PMDA–ODA polyamic acid **3**.

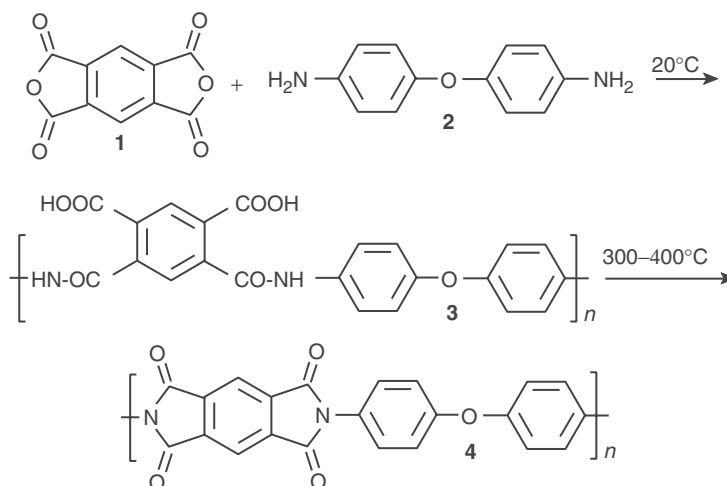

Figure 8: Reaction of 1,2,4,5-benzenetetracarboxylic acid dianhydride (PMDA) **1** with 4,4'-oxybisbenzeneamine (ODA) **2** providing the intermediate high molecular weight polyamic acid **3**, which is subsequently cyclodehydrated into aromatic polyimide **4**.

One point which deserves to be mentioned is that the synthesis of polyamic acids is a solid–liquid interfacial polymerisation because of the low solubility of aromatic dianhydrides in organic solvents. This is also the predominant mechanism when polyphenylquinoxalines are prepared from poorly soluble aromatic tetraamines (see Section 4.3.2.1). In both cases, very high molecular weight macromolecules are formed almost immediately along with low molecular weight polymers in regions of unbalanced stoichiometry. The net result is that polyamic acids and polyphenylquinoxalines generally exhibit a broad molecular weight distribution with a number average molecular weight M_n close to that predicted by step-growth theory and M_w several times higher than the theoretical value. There exists, however, a significant difference between these two families of polymers because the reversibility of the former reaction makes solutions of polyamic acids prone to equilibration during storage at temperatures higher than -10 to 0°C . As an example, M_n reaches a value of 11,000 within 1.5 h after all PMDA has been added and remains constant for the following few hours of storage at 31°C . In contrast, the value of M_w is approximately 90,000 after 30 min and decreases to less than 60,000 in 5.5 h. It has been demonstrated that the polyamic acid reequilibration is predominantly governed by the reversion of amic acids to anhydride and amine, which subsequently react with other antagonistic groups to reach the equilibrium [18].

Polyamic acid **3** is the soluble precursor of PMDA-ODA polyimide **4**, which was the first commercially available aromatic polyimide film (Kapton®) from Du Pont de Nemours [19]. Solutions of polyamic acid **3** in *N*-methylpyrrolidone (NMP) typically contain 13–15% solids by weight and can be deposited onto the surface of various substrates to produce films with thicknesses in the range of 0.5 to 500 μm . After solvent evaporation, polymer **3** is subjected to thermal imidisation (cyclodehydration) by a multistage heating culminating at 300 – 400°C , to produce films of polyimide **4**. One typical heating cycle is one hour each at 100, 200 and 300°C . When cured on inorganic substrates, polyamic acid **3** provides films of polypyromellitimide **4** exhibiting good adhesion to metals and ceramics. However, the very high glass transition temperature (385°C) of this polyimide does not allow its use to bond two metallic parts. To produce polyimides with lower T_g while maintaining high thermal stability, Du Pont introduced in 1972 a series of fluorinated polyimides whose formulae are displayed in Fig. 9 [20].

The chemistry of these polymers is based on the dianhydride of 4,4'-[2,2,2-trifluoro(1-trifluoromethyl)ethylidene]bis(1,2-benzenedicarboxylic acid) **5** (6FDA) that is reacted with ODA **2** to produce polyimide **8** (Du Pont NR 150 A2®). The other polymers in this series are copolyimide NR 150 B2® composed of repeating units **8**, **9** and **10** obtained by reacting dianhydride **5**, with ODA **2**, 1,3-benzenediamine **6** (*meta*-phenylenediamine, MPDA) and 1,4-benzenediamine **7**

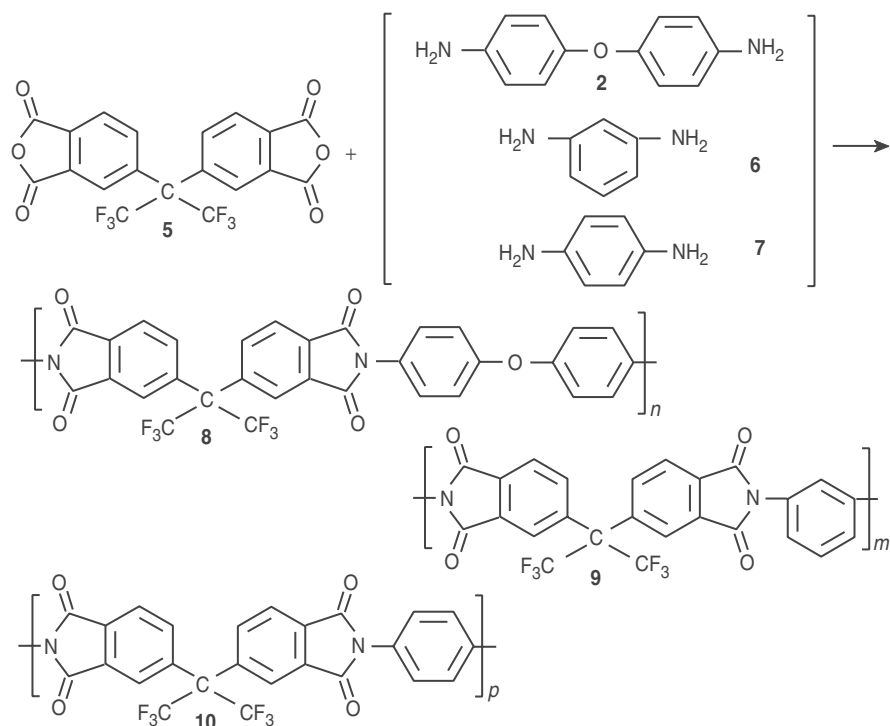

Figure 9: Synthesis of fluorinated polyimides marketed by Du Pont. NR 150 A2[®] is polyimide **8** prepared from 4,4'-[2,2,2-trifluoro(1-trifluoromethyl)ethyldiene]bis(1,2-benzenedicarboxylic acid) dianhydride (6FDA) **5** and ODA **2**. NR 150 B2[®] is a copolyimide synthesised by reacting dianhydride **5** with diamines **2**, **6** and **7**. The macromolecule is formed of randomly distributed repeating units **8**, **9** and **10**. NR 05X[®] is a copolyimide comprising recurring units **10** (75%) and **8** (25%).

(*para*-phenylenediamine, PPDA). The last copolymer, NR 05X[®], contains recurring units **8** (25%) and **10** (75%). These polymers are tailored to cover a broad range of glass transition temperatures by using diamines **2**, **6** and **7** providing flexible, semi-rigid and rigid repeating units. Primarily developed as resin binders for the fabrication of composite materials, other versions were then marketed by Du Pont to fulfill the requirements of high-performance adhesives.

4.3.2. Precyclised Polymers

Polymers discussed in the previous section consist of linear polyimide precursors (polyamic acids) that are transformed into polyimides during the processing stage.

This means that water molecules evolve within the adhesive layer and must be removed to avoid the formation of large voided areas. To circumvent this drawback, research was focused on the synthesis of fully cyclised heterocyclic polymers, which are intrinsically thermoplastic, even though the T_g can be extremely high. Polyphenylquinoxalines, poly(isoimides), and poly(ether-imides) have been extensively studied to prepare structural adhesive films and pastes.

4.3.2.1. Polyphenylquinoxalines

A significant breakthrough was made in 1967 when Hergenrother and Levine reported the synthesis of phenyl-substituted quinoxalines by reacting aromatic tetraamines with bis(α -diketones) in *meta*-cresol solvent [21, 22]. The reaction occurs at room temperature within a few hours, producing high molecular weight precyclised polyphenylquinoxalines. The three polymers **15**, **16** and **17** shown in Fig. 10 are prepared by reacting [1,1'-biphenyl]-3,3',4,4'-tetramine **11** with (1,4-phenylene)-1,1'-bis[2-phenyl-1,2-ethanedione] **12**, (1,3-phenylene)-1,1'-bis[2-phenyl-1,2-ethanedione] **13**, and 1,1'-(oxydi-4,1-phenylene)bis[2-phenyl-1,2-ethanedione] **14**, respectively.

Most polyphenylquinoxalines show no crystallinity in wide-angle X-ray diffraction studies. Their amorphous nature is primarily due to the configurational disorder carried out in the backbone of the polymer chains by the presence of

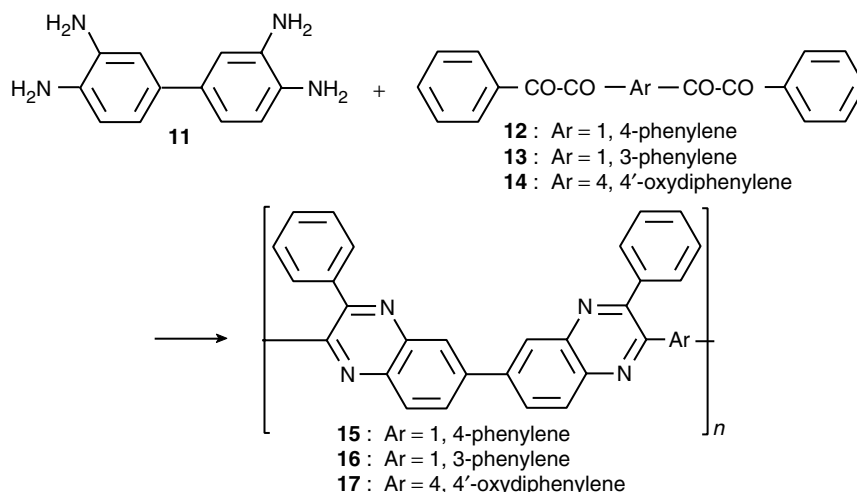

Figure 10: Synthesis of polyphenylquinoxalines **15**, **16** and **17** by reaction of [1,1'-biphenyl]-3,3',4,4'-tetramine **11** with (1,4-phenylene)-1,1'-bis[2-phenyl-1,2-ethanedione] **12**, (1,3-phenylene)-1,1'-bis[2-phenyl-1,2-ethanedione] **13**, and 1,1'-(oxydi-4,1-phenylene)bis[2-phenyl-1,2-ethanedione] **14**.

different isomers [15]. Glass transition temperature values decrease from 360°C for polymer **15** to 320°C for **16** and 290°C for **17**. However, the T_g significantly increases when the polymers are heated at temperatures below the onset of fast oxidative degradation. Becker and Raubach showed that some dephenylation and dehydrogenation reactions occurred at high temperature producing macro radicals [23]. The subsequent recombination of closely spaced radical pairs then led to interchain cross-linking. This thermal reaction is commonly applied to the polyphenylquinoxaline adhesives used to bond metallic substrates. For example, when polymer **15** is heated in a vacuum bag for 1 h at 400°C, its glass transition temperature increases from 350 to 415°C.

4.3.2.2. Poly(isoimides)

If thermal imidization of polyamic acids remains the predominant technique to make polyimide films, the main drawback of this method is the production of water molecules during the processing stage. This, obviously, increases the probability of including voids and structural defects in the bulk of the final material. Because imidization is an intramolecular dehydration reaction, water can also be taken off by using chemical reagents. A particular case of chemical cyclodehydration is observed when dicyclohexylcarbodiimide or trifluoroacetic anhydride are used as dehydrating agents [24]. Instead of producing polyimides, these chemical compounds give polyheterocycles that are cyclic isomers of the imide rings, that is, polyisoimides or polyiminolactones.

Chow et al. investigated the isoimide to imide conversion process with commercial Larc-TPI samples [25]. As illustrated in Fig. 11, the reaction of 3,3',4,4'-benzophenone tetracarboxylic acid dianhydride **18** and 3,3'-carbonylbisbenzeneamine **19** leads to polyamic acid **20**. Dehydrocyclisation to poly(isoimide) **21** is then performed in solution by adding dicyclohexylcarbodiimide (DCC) or trifluoroacetic acid anhydride. Polymer **21** is generally processed from its solutions in polar organic solvents, dried and converted to polyimide **22** by thermal isomerisation.

Using a Rheometrics mechanical spectrometer and powdered polymer samples, the authors compared the rheological behaviour of two polymers with similar chemical compositions but different structures. The rheological profiles of polymers **21** and **22** were determined between 140 and 400°C by increasing the temperature at 10°C min⁻¹ from 140 to 190°C and from 300 to 400°C. In the predominant region of isoimide–imide conversion (190–300°C), the temperature was raised by 2 or 5°C increments, the dynamic viscosity η being measured at each temperature step. At 190°C, the viscosity of poly(isoimide) **21** was approximately 5×10^4 Pas and decreased to a minimum value of 10 Pas at 243°C as the polymer softened and melted. Thermal conversion to polyimide **22** concurrently

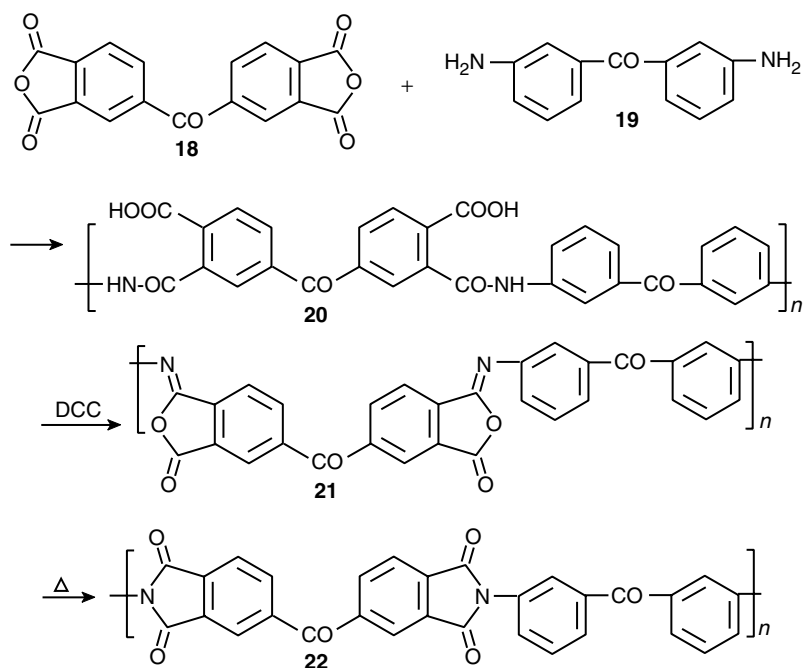

Figure 11: Reaction of 3,3',4,4'-benzophenonetetracarboxylic acid dianhydride (BTDA) **18** with 3,3'-carbonylbisbenzeneamine **19** in the presence of dicyclohexylcarbodiimide (DCC) leading to polyisimide (polyiminolactone) **21** via the intermediate polyamic acid **20**. Isoimide-imide conversion predominantly occurs by heating polymer **21** at 300°C, followed by a final excursion at 350–400°C.

induced an increase in dynamic viscosity to 10^6 Pas at 27°C. The rheological response of polyimide **22** was studied in a separate experiment which showed a large drop in viscosity from 2×10^7 Pas at 250°C to 10^5 Pas at 275°C, in the region of the glass transition temperature. This work demonstrates that the isoimide form enhances the processability of polyimides because the melt viscosity can be reduced by several orders of magnitude. In addition to Larc TPI **22**, structural adhesives have been prepared at the Langley NASA research centre from other polyisoimides leading to the three polyimides represented in Fig. 12.

Larc TPI-ODA **23** is a copolyimide containing repeating units **22** (95 mol%) and **23** (5 mol%) with a T_g of 250°C and a processability better than that of the homopolymer **22** [26]. Larc TPI-SO₂ **24**, prepared from BTDA and 3,3'-sulphonylbisbenzeneamine, has a T_g in the range 220–250°C according to the cure cycle [27]. Larc TPI-IA **25**, synthesised by reacting 4,4'-oxydiphthalic anhydride with 3,4'-oxybisbenzeneamine exhibits a T_g of 243°C [28].

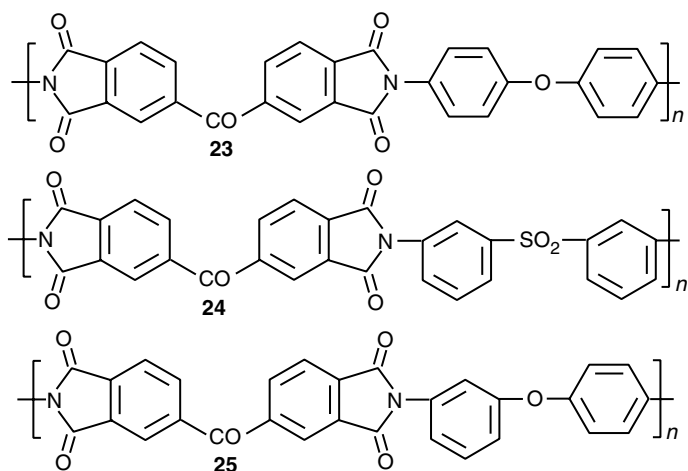

Figure 12: Chemical formulae of polyimides belonging to the Larc TPI series: Larc TPI-ODA **23**, Larc TPI-SO₂ **24** and Larc TPI-IA **25**.

4.3.2.3. Poly(ether-imides)

Ultem 1000[®] **26** (Fig. 13) marketed by General Electric is a poly(ether-imide) representative of a series of thermoplastic polyimides that can be used as adhesives or moulding materials for applications at moderate temperatures ($T_g = 220^\circ\text{C}$).

4.3.3. Condensation Oligomers

The long-chain semi-rigid polymers described in the previous sections are thermoplastic materials with glass transition temperatures ranging from 220 to 350°C. This means that they must be heated at temperatures at least 100°C higher than the

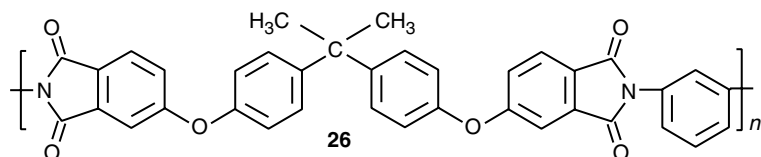

Figure 13: Chemical formula of General Electric Ultem 1000[®] thermoplastic poly(ether-imide) **26** with a macromolecular backbone comprising two oxygen bridges and one methylethylidene linking unit between the aromatic rings.

T_g for the adhesive to flow and wet the substrate during the bonding process. One of the ways explored to do that is the synthesis of low molecular weight oligomers prepared by a controlled step polycondensation at moderate temperatures. Fig. 2 indicates that the so-called ‘condensation oligomers’ were the first high temperature structural adhesives marketed by Narmco for polybenzimidazoles and Rhône-Poulenc for polyimides. Studying the synthesis of polybenzimidazoles, Vogel and Marvel reported the melt polycondensation process shown in Fig. 14 [29].

Equimolar amounts of powdered 1,3-benzenedicarboxylic acid diphenyl ester **27** and [1,1'-biphenyl]-3,3',4,4'-tetramine **11** are heated in a special apparatus at 260°C for 30 min. The polycondensation proceeds and generates molecules of phenol and water by-products. At this stage, low molecular weight oligomers, generally represented by the simplified formula **28**, are produced. In the actual process, the mixture still contains large amounts of monomers **27** and **11**, and uncyclised *ortho*-amino-amide structures. When the blend becomes solid, it can be used to prepare adhesive pastes after it has been crushed to produce a fine tan-coloured powder. High molecular weight polymer **29**, which is the raw material to fabricate polybenzimidazole fibres, is obtained by evacuating the system to 0.025 mm Hg while the temperature is raised to 340°C. The polymer is soluble in formic acid and concentrated sulfuric acid, producing stable solutions that are used to cast stiff and tough films or solution spun fibres. In the case of structural

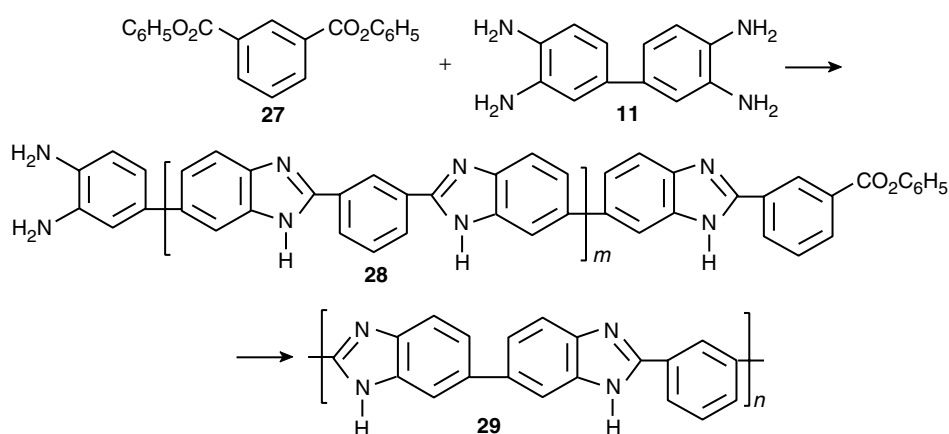

Figure 14: Step polycondensation of 1,3-benzenedicarboxylic acid diphenyl ester **27** with [1,1'-biphenyl]-3,3',4,4'-tetramine **11** leading to intermediate oligomers **28**. When heated at high temperature, the oligomer mixture provides high molecular weight polybenzimidazole **29**.

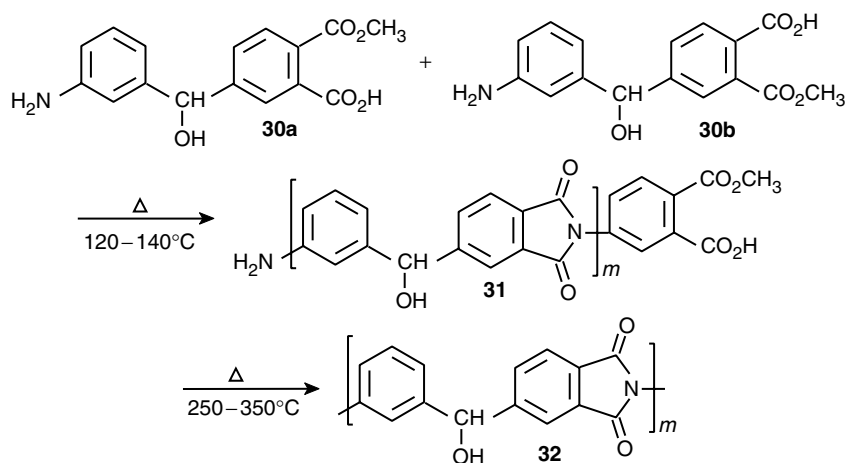

Figure 15: Synthesis of oligoimide **31** precursor of polyimide **32** by thermal polycondensation of self-condensable monomers **30a** and **30b** carrying amine and *ortho*-acid-ester groups on the same molecule.

adhesives, prepolymer **28** is cured under pressure at 316°C , followed by a postcure treatment at 370°C for 3 h.

The concept of 'self-condensable reactive monomers', shown in Fig. 15, was developed to produce heat resistant structural adhesives with a high level of dry matter content [30]. The method of synthesis generates two isomers **30a** and **30b** whose molecules carry an amine group and an antagonistic *ortho*-acid ester centre. Compounds **30a** and **30b** differ only in the position of the carboxylic acid group relative to the secondary alcohol ($-\text{CHOH}-$) linking unit.

The thermal polycondensation in solution of these monomers is controlled to provide low molecular weight oligomers **31** with a degree of polycondensation (DP) m in formula **31** of approximately 10. Solutions of the oligomers in *N*-methylpyrrolidone at 35–40% by weight exhibit the viscosity required to prepare adhesive compositions loaded with metallic particles. Films or pastes of oligomers **31** are then cured at high temperature ($300-350^\circ\text{C}$) to increase the DP. Once completed, this reaction produces high molecular weight polyimide **32**. Compared to other polyimides, the adhesive strength is significantly enhanced because of the thermal reflow that occurs during the cure cycle. When cured at temperatures lower than 300°C , polyimide **32** has a glass transition temperature of 230°C , sufficiently high for the electronic industry. By contrast, the structural adhesives intended to be used in aerospace applications are prepared by blending the

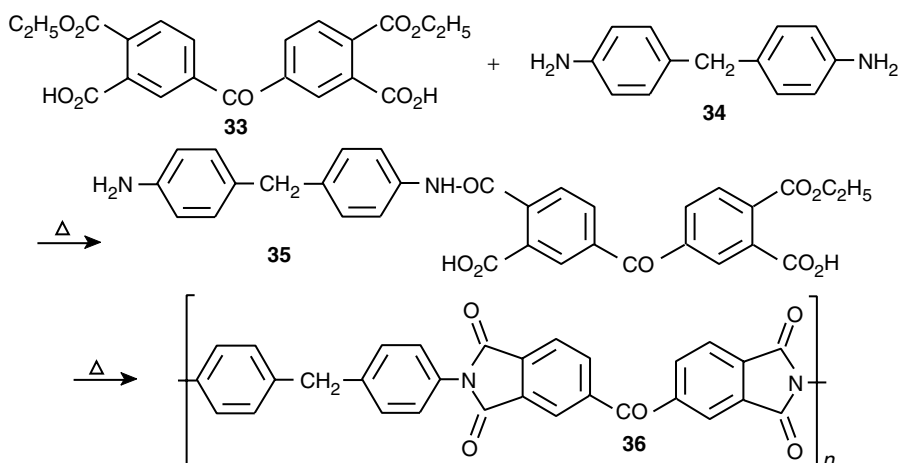

Figure 16: Synthesis of polyimide precursor **35** by the controlled polycondensation in solution of the bis-*ortho*-acid ester **33** and 4,4'-methylenebisbenzeneamine **34**. The reaction initially gives short-chain amide-acid such as **35** that are transformed into polyimide **36** when the adhesive is processed at high temperature.

oligomer mixture **31** with aromatic diamines in order to increase the formation of a cross-linked network.

Structural adhesive FM 34[®] marketed by American Cyanamid is based on a similar chemistry using the reactants shown in Fig. 16. The bis(*ortho*-acid ester) **33** is prepared *in situ* by the reaction of BTDA with ethyl alcohol in polar aprotic solvents. After 4,4'-methylenebisbenzeneamine **34** has been added in stoichiometric amount, the solution is heated to 130–150°C. The reaction mechanism leading to high molecular weight polyimides when ODA is opposed to the diethyl esters of different tetracarboxylic acids has been published [31].

The authors suggest that the most probable scheme is an initial intramolecular cyclisation of the *ortho*-acid ester centres generating the corresponding anhydrides which then react as usual to produce polyamic acids, finally subjected to thermal imidization. The intermediate compound **35** in Fig. 16 would be the first step of polyamic acid formation when one anhydride group has been produced and immediately opened by one amine function. The reaction is thermally controlled to produce oligomers which are marketed in the form of either adhesive films, pastes, or solid powders. Polycondensation and imidization are completed on processing at high temperature, followed by a postcure at 316°C.

4.3.4. Thermosetting Resins

High molecular weight linear polyimide precursors and precyclised polymers are best suited for the fabrication of self-standing films and protective coatings, requiring good mechanical properties at elevated temperature. However, these polymers are not convenient for making adhesive compositions or composite materials. Even a thermoplastic polyimide such as General Electric Ultem® 1000 with a T_g of 223°C must be extruded at a temperature significantly higher than 300°C. In addition, when the linear polymers are dissolved in organic solvents, the concentration is limited to about 15% by weight. This means that the drying schedule must be carefully conducted to evaporate a large amount of solvents mainly by diffusion through relatively thick layers. In ‘open to air’ conditions – films, varnishes, coatings – adequate cure cycles provide homogeneous films without structural defects. In the case of adhesives, where evaporation is often limited to small peripheral areas, entrapped bubbles or voids can be the source of delamination because of the high stresses concentrated in these local defects.

To circumvent solvent-related problems, researchers developed the concept of polymerisable heterocyclic telechelic oligomers. Low molecular weight polyheterocycles are synthesised with respective quantities of the two monomers far from the stoichiometry. The average molecular weight generally falls in the range of 1000 to 3000 g mol⁻¹ and the terminal functions of the oligomers are then end-capped with compounds containing unsaturated double (ethylenic) or triple (acetylenic) carbon–carbon bonds. Theoretically, all thermosetting polyimides should have melting points lower than the polymerisation temperature to ensure adequate flow and good wetting properties during processing. In practice, this ideal behaviour is rarely encountered in the three main families of oligomers reported in the following sections. Excellent reviews on the chemistry, processing and properties of oligoimides terminated by maleimide, nadimide and acetylene groups can be found elsewhere [32]. Most of these materials were used as organic binders to make adhesives and composites for the aerospace industry. The general requirements for these types of oligomers is a combination of opposite properties such as high T_g and good processability (low viscosity before cross-linking), long-term resistance to oxidation and radical cross-linking, low moisture uptake and high content of aromatic and heterocyclic rings, good mechanical properties, etc. Most of the end-capped telechelic oligomers polymerise with complex kinetic laws depending on the conversion rate. This is because, in many cases, gelation and vitrification occur at a low degree of conversion. Recent studies on the polymerisation mechanisms and chemical behaviour of the main families of heat resistant oligomers are briefly discussed in the following sections.

4.3.4.1. Maleimide-Terminated Resins

Oligomers end-capped with maleimide rings, which are known as bismaleimide (BMI) resins, exhibit thermal stability intermediate between epoxies and polyimides. BMI systems are mainly used to fabricate structural composites capable of sustaining temperatures up to 230°C. Specific versions, such as American Cyanamid FM 32 and Ciba-Geigy Kerimid 601 have been developed to prepare adhesive compositions. Fig. 17 displays a typical constitutive unit of various commercial BMI resins based on bismaleimide **38**, prepared from maleic anhydride **37** and 4,4'-methylenebisbenzeneamine (MDA) **34**.

However, a number of other aromatic diamines, in particular the alkyl-substituted MDA derivatives, have been converted into the corresponding bismaleimides to study the effect of the chemical structure on both the melting and

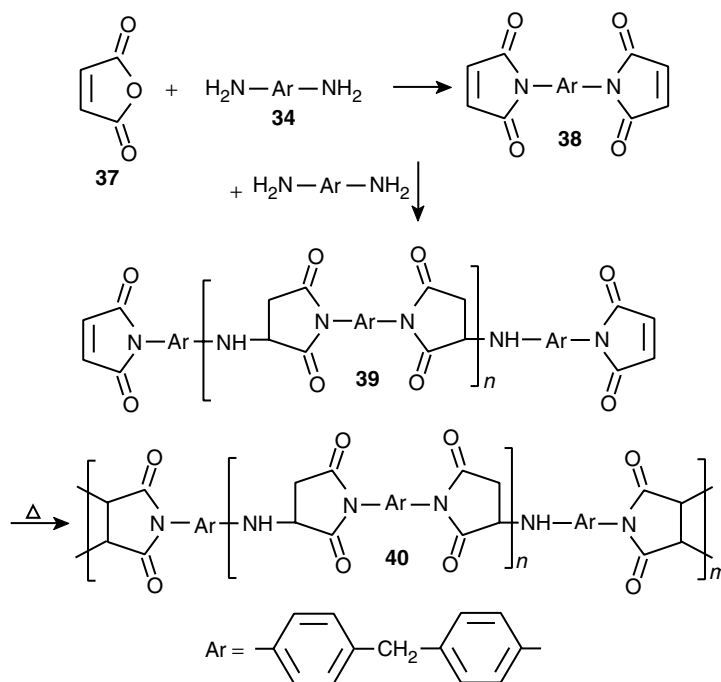

Figure 17: Examples of bismaleimide (BMI) monomer **38** and maleimide-terminated resin **39** prepared via Michael-type addition of 4,4'-methylenebisbenzeneamine **34** to the carbon-carbon double bond of BMI **38**. Thermal polymerisation of oligoimide **39** generates the cross-linked network **40**.

curing temperatures. Most of these bismaleimides are crystalline materials with high melting points in the range of 150–250°C. The chemical reactivity of these resins is a consequence of the electron-deficient carbon–carbon double bond which can be subjected to different reactions such as nucleophilic attack of amines or thiols, radical polymerisation, ene-, diene- and cyclo-additions. Polymers known as poly(amino-bismaleimides) or polyaspartimides are prepared by Michael's reaction, which is a controlled addition of amine functions to the ethylenic double bond. This is illustrated in Fig. 17 with bismaleimide **38** and MDA **34** whose respective proportions are calculated to produce oligomers **39**. This reaction has been used to increase the distance between the cross-linking sites with, however, two opposite effects. The fracture toughness increases with the degree of polymerisation n , whereas the glass transition temperature decreases. Kerimid® 601 developed by Rhône-Poulenc [33,34], and now produced by Ciba-Geigy, is a typical example of this type of oligomer prepared via Michael's addition. BMI is also the base material of commercial resins such as Compimid® 353 developed by Stenzenberger [35]. Addition polymerisation occurs at 150–250°C without evolution of volatile by-products.

Thermal polymerisation of short chain BMI resins occurs through radical polymerisation of the maleimide double bond producing highly cross-linked and brittle networks. A number of experimental results have been published that allow one to correlate the chemical structure of BMIs with the 'processability windows $T_p - T_m$ ', where T_p is the onset of polymerisation exotherm and T_m is the maximum of the melting temperature curve determined by differential scanning calorimetry. A study by Stenzenberger reports data of Technochemie GmbH comparing the melting point, maximum of exotherm peak and heat of polymerisation of various bismaleimide resins in relation to their chemical structure [32]. For similar chemical formulas, *meta*-isomers melt at lower temperatures than those with *para*-catenation but exhibit higher heat of polymerisation. This behaviour suggests that monomer conversion is more complete before vitrification for compounds with flexible chains. In addition, it was shown that the glass transition temperature of polymerised BMIs decreases with the increase in distance between the cross-links. Radical polymerisation is the most commonly used method for this category of thermosetting polyimides.

The thermal stability of cured bismaleimide formulations during long-term ageing experiments was found to be intermediate between the heat resistance of epoxy-novolacs and that of norbornene-terminated polyimides or nadimide resins discussed in the following paragraph. Composite materials made with BMI resins can be safely used for about 10,000 h at 200°C and approximately 100 to 200 h at 240°C. For long-term applications at 300°C, that is, 2000–3000 h, other resins are more effective.

4.3.4.2. Nadimide-Terminated Resins

Historically, norbornene-terminated imide oligomers were developed at TRW Inc. by reacting 4,4'-methylenebisbenzeneamine with 3,3',4,4'-benzophenonetetracarboxylic acid dianhydride and (3 α ,4 β ,7 β ,7 α)-tetrahydro-4,7-methanoisobenzofuran-1,3-dione, also known as 5-norbornene-2,3-dicarboxylic acid or nadic anhydride [36,37]. The relative quantities of the two anhydrides are calculated to produce short-chain polyamic acid oligomer with, for example, a molecular weight of 1300 ($n = 1.67$) for the commercially available Ciba-Geigy P13N[®] material. Imidisation first occurs to produce oligoimides terminated by reactive norbornene groups which polymerise at temperatures in the range of 280–350°C. However, materials made with P13N solution or moulding powder encountered many processing problems and this class of oligomers achieved little commercial success.

The concept of norbornene-terminated oligoimides was further studied at the NASA Lewis Research Centre by researchers who developed the 'polymerisation of monomeric reactants (PMR)' approach [38]. The method, represented in Fig. 18, involves a blend of both the dimethyl ester of 3,3'-benzophenonetetracarboxylic acid **42** and the monomethylester of 5-norbornene-2,3-dicarboxylic acid **41** with 4,4'-methylenebisbenzeneamine **34** in solution in methanol.

Fibres or fabrics are impregnated with the low viscosity solution and the solvent is removed at a relatively low temperature to provide tacky prepreps containing the three monomer reactants and 5–10% by weight of residual methanol. To prevent

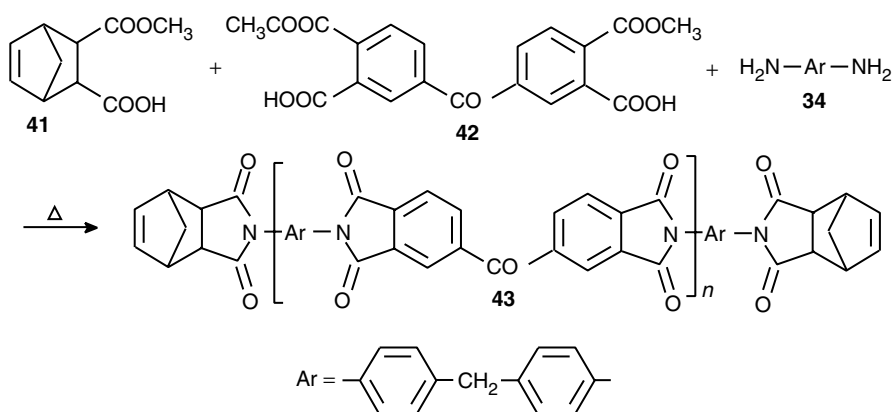

Figure 18: Chemical sequences involved in the polymerisation of monomer reactants (PMR) process. The average molecular weight of intermediate oligomer **43** is controlled by the relative amounts of monoester **41**, diester **42** and diamine **34**.

Chain extension of bisnadimide **43** occurs at high temperature via the reverse Diels-Alder polymerisation process.

any reaction of the monomers, prepreg rolls protected with polyethylene films are stored at low temperature (-18°C).

At temperatures between 120 and 230°C , polycondensation and imidisation occur *in situ* to form nadimide end-capped oligoimides **43** with significant evaporation of methanol and water that must be eliminated before final curing. This obviously implies that a complicated curing schedule, alternating partial vacuum and applied pressure, has to be implemented to prepare void-free composites. Up to now, the most widely known PMR resin is PMR-15, optimised to exhibit the best overall performance. An impressive number of experiments were conducted to achieve a chemical composition containing diester **42**, monoester **41** and diamine **34** in a molar ratio of 2.087:3.087:2, corresponding to a formulated molecular weight of the imidised oligomer **43** of 1500 g mol^{-1} . The final cure is performed between 280 and 320°C via complex reaction sequences involving the liberation of cyclopentadiene. Thermal polymerisation of nadimide resins obviously depends on the experimental conditions which can impede (high pressure) or allow cyclopentadiene evaporation. As with other highly cross-linked systems, the reaction mechanism can be studied only in the first few polymerisation steps. It seems now established that the *endo*–*exo* nadimide isomerisation takes place below 200°C , whereas cyclopentadiene is released above 250°C [39,40]. Studies with model compounds show that dienophile exchange and *endo*–*exo* isomerisation occur via Diels-Alder/retro Diels-Alder equilibrium at relatively low temperature, that is, 160°C , both reactions being easier with the *endo* isomer. Comparing the mechanical properties and heat resistance of composites prepared with PMR-polyimides made with different aromatic diamines, Alston demonstrated [41] that 4,4'-methylenebisbenzeneamine **34** was essential to obtain the optimum results. In addition, Vannucci provided evidence that the nadimide end-caps contribute most to the thermal degradation of the cross-linked resins [42].

4.3.4.3. Acetylene-Terminated Resins

In 1868, Berthelot discovered the method of synthesis of benzene by the cyclotrimerisation of three molecules of acetylene. Applied to telechelic oligomers terminated by acetylenic groups, this method could provide the most thermally stable networks. This concept was applied in 1974 to synthesise the new thermo-setting resins displayed in Fig. 19 [43,44]. They are prepared by reacting BTDA **18** with 3,3'-(1,3-phenylenedioxy)bisbenzeneamine **44** and 3-ethynylbenzeneamine **45**. Fig. 19 shows the expected formation of amide acid **46**, which is soluble in acetone and other low-boiling polar solvents, whereas polyimide oligomer **48** is soluble only in *N*-methylpyrrolidone. Three types of oligomers became commercially available through National Starch Chemical Company: Thermid AL 600[®] for the amide acid structure **46** (or more probably the corresponding amide ester),

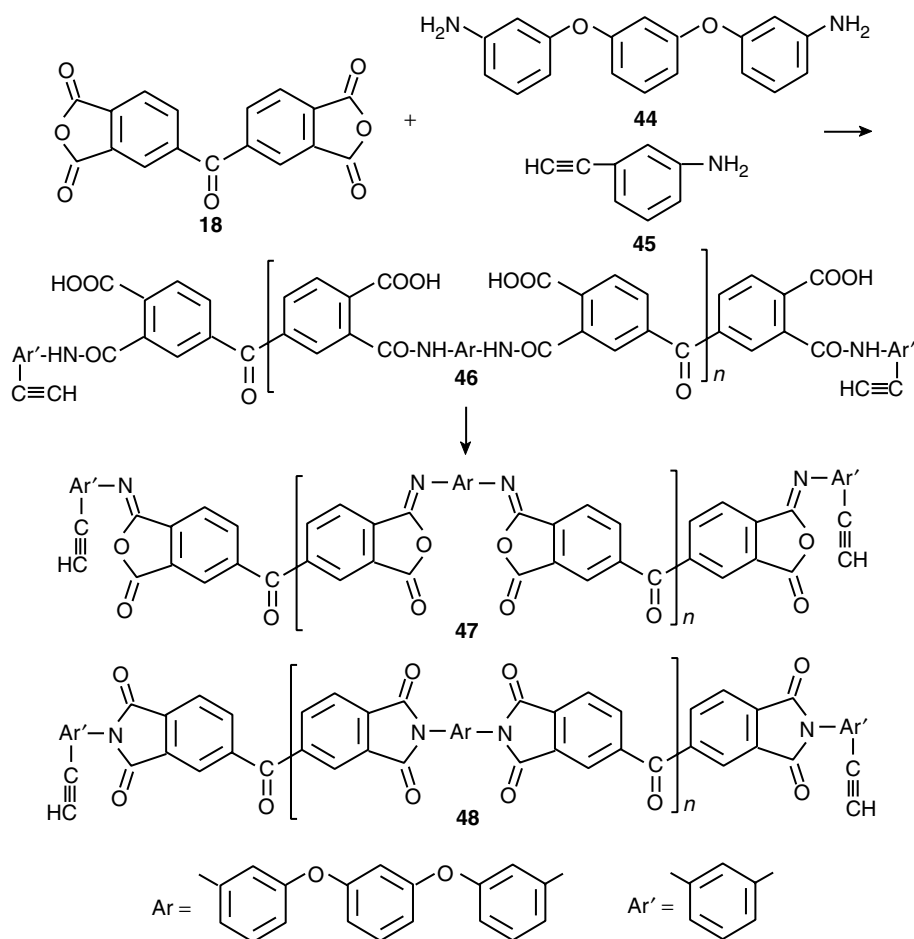

Figure 19: Acetylene-terminated polyimide precursors synthesised by reacting BTDA **18** with less than the stoichiometric balance of 3,3'-(1,3-phenylenedioxy) bisbenzeneamine **44** and the complement to stoichiometry of 3-ethynylbenzeneamine **45** as end-capping agent. Low molecular weight polyamic acid **46** is then chemically cyclised to poly(isoimide) **47** or thermally cyclodehydrated to give polyimide **48**.

Thermid 600[®] for imide **48** and Thermid IP 600[®] for the isoimide form **47**. This latter material is obtained when the amide acid **46** is chemically cyclodehydrated with dicyclohexylcarbodiimide [45].

As a general class of polymers, polyisoimides are less symmetric than the corresponding polyimides with, therefore, better flow (lower T_g) and solubility. The processing window of preimidized Thermid 600 **48** is very narrow because

the resin has a melting point of 195–200°C and polymerisation starts in this temperature range. Thermid FA-700, prepared from 6FDA dianhydride **5**, exhibits better characteristics with a melting temperature of approximately 170°C and a good solubility in solvents such as γ -butyrolactone, *N,N*-dimethylformamide and tetrahydrofuran.

Even though other classes of ethynyl-terminated oligomers have been reported in the literature, only the Thermid® series is produced in commercial quantities. If formation of benzene rings from acetylene triple bonds was expected in the earlier studies, later works demonstrated a more complex chemistry during the cure cycle with only 30% of the ethynyl groups undergoing cyclotrimerisation [46]. Polymerisation starts at approximately 150°C with a heat of polymerisation in the range of 100 to 160 kJ mol⁻¹, these values being far from the 200 kJ mol⁻¹ measured for the trimerisation of acetylene into benzene. Electron spin resonance spectroscopy shows an intense signal corresponding to free radical species during the thermal polymerisation of ethynyl-terminated oligomers [47]. Studies with model compounds indicate the formation of low molecular weight oligomers containing aromatic rings and polyene structures.

The formation of aromatic rings has been observed by ¹³C-NMR spectroscopy [46], whereas benzene and naphthalene derivatives can be separated by high performance liquid chromatography [48]. 1,7- and 2,7-disubstituted naphthalene dimers and 1,2,3-, 1,2,4- and 1,3,5-trisubstituted benzenes have been isolated and identified. At the end of the thermal polymerisation, the weight ratio (dimers + trimers)/oligomers is approximately 30/70. It seems conclusively established that ethynyl-terminated polyimides form only low molecular weight oligomers with highly conjugated polyene and aromatic structures.

4.4. Resin Characterisation

As discussed in Section 4.2, polymers are initially characterised by their molecular properties in solution, that is, inherent and intrinsic viscosities, molecular weight, and molecular weight distribution. As polycondensation is generally performed in solution, measurements are often conducted directly in the polymerisation solvent. However, it is sometimes necessary to precipitate polymer molecules in non-solvent, such as alcohol, diethyl ether or chlorinated hydrocarbons. Then, the thermal properties are determined with either polymer films or precipitated powder by thermogravimetric analysis, isothermal ageing, and thermo-mechanical analysis. Additional information is obtained by means of other techniques including infrared and sometimes UV–visible spectroscopies, nuclear magnetic resonance and high-performance liquid chromatography.

4.4.1. Infrared Spectroscopy

Before the advent of Fourier transform infrared spectroscopy (FTIR), IR analysis had been only used to obtain qualitative information on the polycondensation process because of the low polymer concentration versus large amounts of organic solvents. With FTIR, the situation changed with computer programs allowing one to subtract solvent absorption peaks from the global spectra. Then, infrared spectroscopy became a powerful analytical tool to monitor the formation of polyamic acids by observing the intensity changes of anhydride absorption peaks. But more often, IR spectroscopy has been extensively used to study, by transmission or reflection, the thermal imidisation of very thin films. This is done by following the intensity changes of imide absorptions at 1780 cm^{-1} ($\nu_{\text{C=O}}$ symmetrical stretch), 1380 cm^{-1} ($\nu_{\text{C-N}}$ stretch) and $720\text{--}725\text{ cm}^{-1}$ ($\delta_{\text{C=O}}$ bending). Intensities are either compared to those of films assumed to be completely imidised [49,50] or normalised [51,52] against internal absorption bands of the aromatic rings at about 1500 and 1015 cm^{-1} .

Thus, FTIR has been used to determine the imidisation kinetics by plotting the degree of imidisation as a function of the temperature in the range $150\text{--}350^\circ\text{C}$ [53]. At any temperature, the curves clearly show an initial fast imidisation reaction followed by a second slow step. The slopes of the linear parts of the curves provide the two reaction rates k_1 and k_2 characterising the imidisation process. For example, at 200 , 250 and 300°C , the values of k_1 are 6.9×10^{-2} , 2.96×10^{-1} and 1.18 min^{-1} , while k_2 values are approximately 5.5×10^{-3} , 4.2×10^{-2} and 1.4×10^{-2} . Drawing the linear function $k = f(1/T)$ for k_1 and k_2 allows the calculation of the activation energies of the two consecutive dehydration processes.

Although infrared spectroscopy provides valuable information on the cyclisation process, there is a general lack of agreement over the degree of imidisation actually achieved. In particular, it was shown that the dielectric properties are more sensitive to the final cure temperature with a continuous decrease of the dielectric dissipation factor ($\tan \delta$) between 300 and 400°C [53]. It is, however, not clear whether this phenomenon is due to completion of the imidisation process or to enhanced chain packing. Curves of Fig. 20 illustrate the results obtained with capacitors made of metal–insulator–semiconductor structures in the range $200\text{--}400^\circ\text{C}$. It is obvious that $\tan \delta$ decreases with increasing cure temperature to reach a minimum when cure is achieved at $350\text{--}400^\circ\text{C}$.

4.4.2. Nuclear Magnetic Resonance

In the analysis of pure organic compounds, virtually all hydrogen and carbon atoms can be identified by using high resolution ^1H and ^{13}C nuclear magnetic

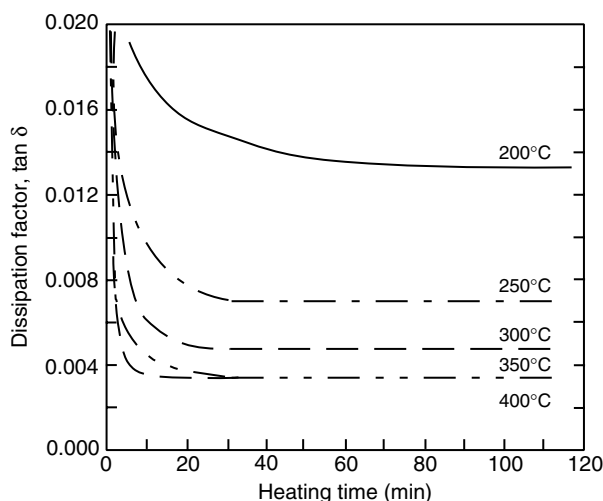

Figure 20: Degree of imidisation of polyamic acids determined by the variation of the dielectric dissipation factor ($\tan \delta$) versus heating time at different temperatures between 200 and 400°C. Experiments are performed at 100 kHz with metal–insulator–semiconductor capacitors built by microlithography on silicon wafers.

resonance (NMR) spectrometers. ^1H NMR spectra of epoxy and epoxy-novolac resins have been published in a previous publications [16]. Solid-state NMR has been used to study the chemical and physical structure of polymers, as well as the diffusion processes in solid polymer matrices [54]. Fig. 21 provides the spectra of imide monomer **30a–b** and polyimide **32** (Fig. 15) in solution in dimethylsulphoxide- d_6 .

It can be seen that all carbon atoms are recognised by using additive increments that are calculated from the chemical shift data observed on various model molecules of increasing complexity. It is worth noting that many changes occur during the polycondensation of the monomer mixture. In particular, the disappearance of the methyl ester at 53.1 ppm and the deshielding of the 3-, 4-, and 5-carbon atoms at the *ortho*- and *para*-positions of the primary amine group, which shift from 115.7, 116.3 and 118.9 ppm to 126.3, 129.0 and 124.5 ppm, respectively. The formation of the imide ring also has a strong influence on the resonance of the quaternary 15-carbon atom at 147.6 ppm, which is deshielded to 153 ppm in the imide molecule.

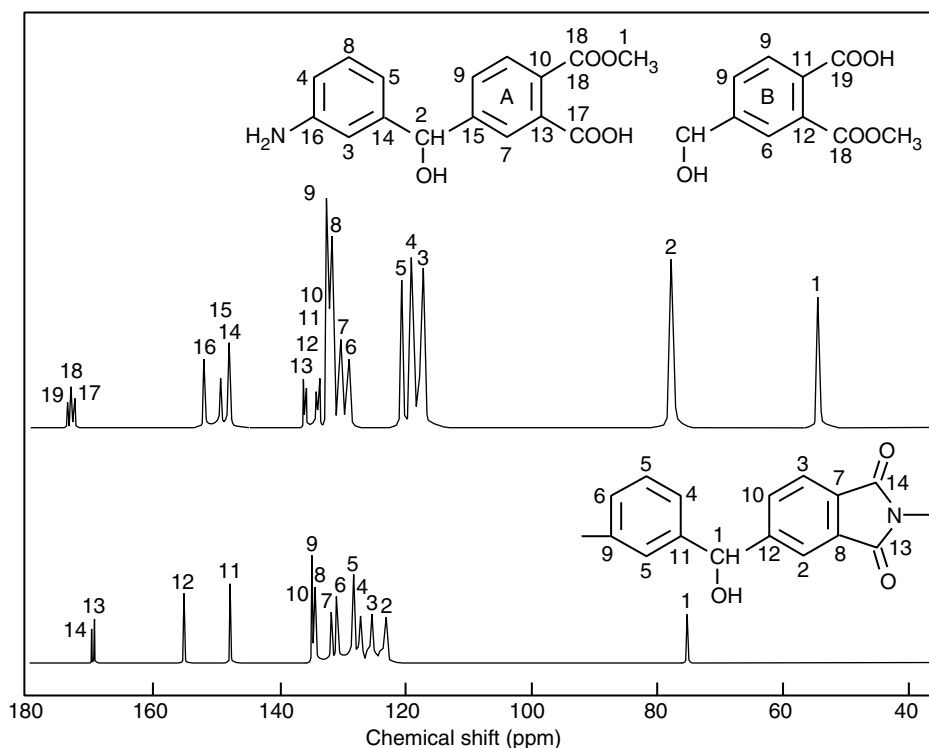

Figure 21: ^{13}C nuclear magnetic resonance spectra of the mixture of monomers **30a–b** and polyimide **32** (Fig. 15) in dimethylsulphoxide- d_6 . Polyimide **32** is obtained by heating the monomers at 275°C for 30 min.

4.4.3. High Performance Liquid Chromatography

In liquid–solid or adsorption chromatography, the chemical components are adsorbed on the hydroxyl sites of polar adsorbents such as powdered silica and alumina packed in the column, and elution is performed with solvents of increasing polarity [55]. High performance liquid chromatography (HPLC) is a variant incorporating high pressure pumps and automated metering units to change the gradient of the mobile phase, providing a fast and high-resolution separation. The separation mechanism depends upon the differential distribution of the organic components between the liquid mobile phase and the solid stationary phase and the time spent in each phase. The most difficult aspect of HPLC is the selection of the solvent system and of the column because the separating power depends on the interactions between the components and the two phases. With a careful

adjustment of the chromatographic conditions, HPLC has the ability to separate isomeric mixtures if the polar groups of the organic compounds are appropriately matched with the more polar sites of the stationary phase. The technique is generally applicable to organic materials of molecular weight ranging from 100 to 1000 g mol^{-1} .

In general, HPLC gives accurate results with nonionic materials but it can be also used to separate ionic compounds by using the reversed-phase method employing a non-polar stationary phase and a mobile phase consisting of water as the base solvent, to which a miscible organic solvent such as methanol is added to adjust the solvent strength. This separation technique is illustrated in Fig. 22 with the polyimide monomers **30a–b** (Fig. 15), which are prepared by the catalytic hydrogenation of the corresponding benzophenone derivatives.

This reaction leads to two isomers: 4-(3-aminobenzoyl)-1,2-benzenedicarboxylic acid 1-monomethyl ester **c** in the headline $X=\text{CO}$ and 4-(3-aminobenzoyl)-1,2-benzenedicarboxylic acid 2-monomethyl ester **d**. Hydrogenation of the

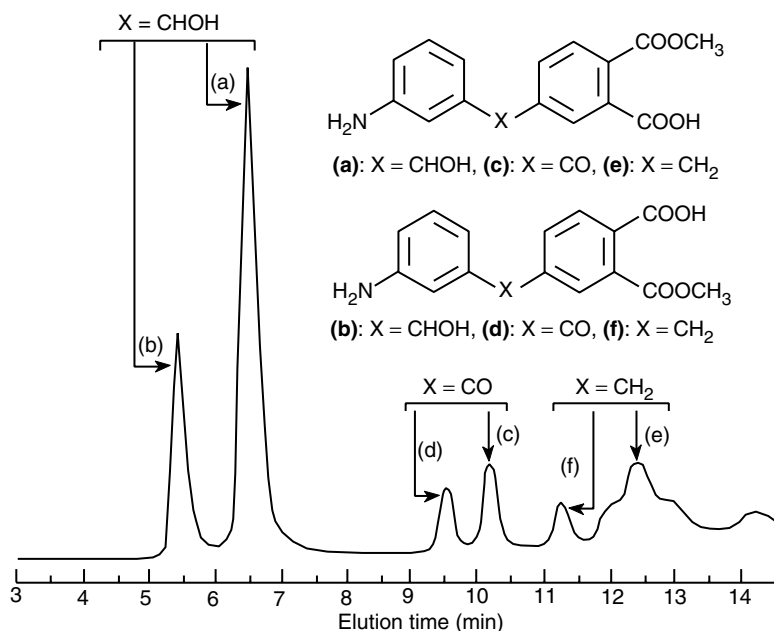

Figure 22: High performance liquid chromatographic analysis of self-condensable monomers **30a–b** ($X=\text{CHOH}$) prepared by hydrogenation of the carbonyl groups of the corresponding benzophenone derivatives **c** and **d** ($X=\text{CO}$). HPLC reveals the presence of fully hydrogenated linking units **e** and **f** ($X=\text{CH}_2$).

benzophenone carbonyl group of compounds **c** and **d** with palladium on charcoal catalyst is not selective and the final material is a mixture of the six isomeric monomers containing the carbonyl ($-\text{CO}-$), hydroxymethylene ($-\text{CHOH}-$) **a-b**, and methylene ($-\text{CH}_2-$) **e-f** linking units between the two aromatic rings. The quantitative determination of all compounds was performed by reverse phase HPLC of monomer **30a-b**. Fig. 22 shows that the chromatogram, recorded with a UV detector at a wavelength of 254 nm, exhibits all the expected peaks, which were identified by separately analysing samples of each couple of isomers. Carbonyl-linked compounds **c** and **d** ($\text{X}=\text{CO}$) are the starting materials before hydrogenation, whereas methylene-linked monomers **e** and **f** ($\text{X}=\text{CH}_2$) were obtained after hydrogenation has been completed.

4.5. Adhesive Properties

According to the final use, there exist different methods to measure the adhesive strength of polymeric materials. The island blister test and 90° peel test are particularly suited to determine the level of adhesion of very thin films in electronic applications. In the case of structural adhesives, the lap shear strength of three- or multiple-layer structures is a typical standard.

4.5.1. Lap Shear Strength Measurement

The mechanical properties of adhesive joints are primarily determined by applying an in-plane shear stress to the assemblies. Fig. 23 shows the single lap shear configuration recommended in ASTM D 1002, Federal Specification MMM-A 132 and Federal Test Method Standard No. 175.

The adhesive layer is applied between two aluminium coupons (2024-T3 alloy), etched with chromic acid prior to bonding, typical dimensions of which are 15.24 cm length, 2.54 cm width, and 0.15 cm thickness, with an overlap length of 1.27 cm, leading to a bonding area of 3.226 cm^2 . The assembly is maintained with one or two clamps exerting a slight pressure and cured in an air-circulating oven according to the appropriate thermal schedule. The lap shear strength is then measured with a tensile machine at a pull rate of $1 \text{ to } 2 \text{ mm min}^{-1}$ and expressed in MPa on an average of five specimens. Obviously, this lap shear configuration combines a predominant shear stress with significant peel and cleavage stresses arising from the adhered bending. The lap shear strength method is of universal use in the adhesive industry because of its ease in specimen preparation and testing alike. In addition, the variation of the lap shear strength as a function of the test temperature can

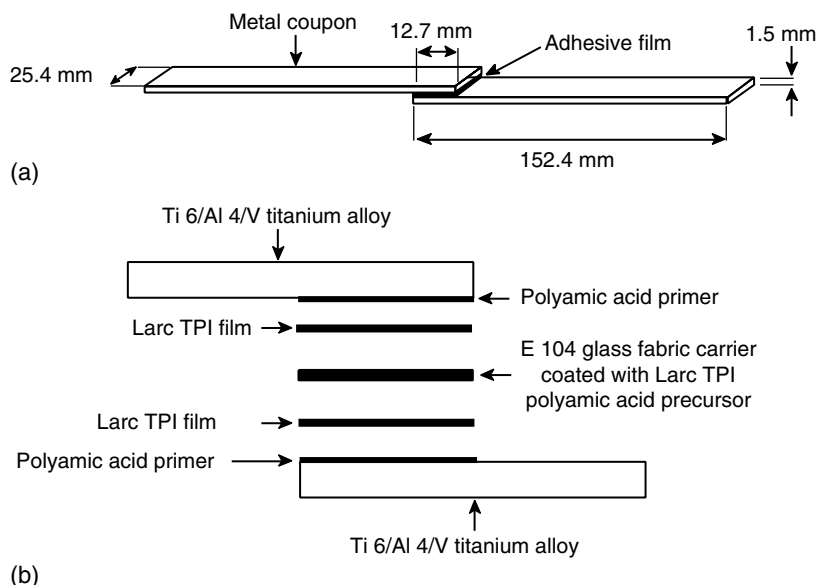

Figure 23: Lap shear strength determination: (a) test specimen recommended in ASTM D1002 standard; (b) multilayer process used to bond titanium alloy coupons with thermoplastic Larc TPI polyimide adhesive.

be easily determined by using a heating chamber. The adhesive strength values discussed in the following sections have been obtained by this standard method.

4.5.2. Precyclised and Linear Polymers

4.5.2.1. Polyphenylquinoxalines

As reported in Section 4.3.2.1, polyphenylquinoxalines are amorphous thermoplastic polymers which can be processed above their glass transition temperature. However, if not subsequently subjected to cross-linking reactions, the T_g constitutes the upper operating temperature of the bonded assembly. Another point to take into consideration with heat-resistant adhesives is that void-free bond lines can be obtained only if the solvents are completely evaporated before processing. This means that the T_g -lowering effect of solvents cannot be used to conduct the bonding operation in less drastic conditions. There is, therefore, a need to find a compromise in selecting the most convenient polymer for a given application because the higher the glass transition temperature, the better the adhesive strength at temperatures above 250°C, but the harsher the process parameters.

This can be illustrated by the first adhesive reported by Hergenrother and prepared by coating a solution of polyphenylquinoxaline **16** ($T_g = 318^\circ\text{C}$) on a fibre-glass fabric to achieve, after drying, a 0.28 mm thick adhesive film containing 0.2% residual solvent [56]. This film was used to bond titanium alloy coupons with an applied pressure of 0.34 MPa and increasing the temperature from the ambient to either 316°C for one hour or to 400, 427 and 455°C for one hour each. In the first case, the initial lap shear strength was 33.7 MPa at 20°C and 25.5 MPa at 232°C , dropping slightly to 24.8 MPa after 5000 h at 232°C . However, thermoplastic failure (4.8 MPa) was observed when the specimen was heated to 316°C . Conversely, the specimens cured up to 455°C exhibited initial strengths of 24.1 and 13.8 MPa at 20 and 316°C , respectively, decreasing to 10.3 MPa after 500 h at the latter temperature.

Hergenrother published additional results to compare the adhesive properties of polyphenylquinoxalines **16**, **17** (T_g 290°C) and a polymer (T_g 285°C) synthesised by reacting 4,4'-carbonylbis(1,2-benzenediamine) with (1,4-phenylene)-1,1'-bis[2-phenyl-1,2-ethanedione] **12** for bonding both stainless steel and titanium coupons [57]. When cured at 371 or 399°C , the three polymers exhibited similar adhesive strengths of 31–34 MPa at 22°C and 23–25 MPa at 232°C , virtually unchanged after 8000 h at that temperature. All but adhesive **16** heated to 455°C exhibited thermoplastic failure at 316°C . Hergenrother and Progar also reported the results obtained with polyphenylquinoxaline **16** for bonding both titanium alloy specimens and carbon-fibre composite materials [58]. This study showed that a cure cycle ending at 399°C provided a very good lap shear strength at 316°C for the composite/composite assemblies but not for the Ti/Ti structure.

4.5.2.2. Linear Polyimide Precursors

Polyimide **22** (Fig. 11), commonly referred to as Larc-TPI[®] has been extensively evaluated as a structural adhesive by Progar and St. Clair [59,60]. As for polyimide NR 056X[®] (Fig. 9), early work demonstrated that diglyme was a good solvent for the intermediate polyamic acid **20** and diglyme solutions provided the highest level of adhesive strength. Different variants of this polymer are produced by Mitsui Toatsu which provides the polyamic acid either in diglyme solution at 29% concentration or in the form of adhesive films with a thickness of 46 μm . These films exhibit the following properties: T_g 250°C , specific mass 1.33 g cm^{-3} , fracture energy (G_{1c}) 2.6 kJ m^{-2} , tensile modulus 3.72 GPa, elongation at break 4.8% and tensile strength 136 MPa [61]. The most effective and reliable technique for bonding large areas is that shown in Fig. 23. Test specimens made of $\text{Ti}_6\text{Al}_4\text{V}$ titanium alloy, subjected to surface treatment with Pasa-Jell 107 are coated with a thin layer of Larc TPI polyamic acid **20** and dried. The adhesive joint consists of two Larc-TPI polyimide films in contact with the metal surfaces and a central

E-104 glass fabric carrier impregnated with Larc-TPI polyamic acid. The cure cycle is carried out under a pressure of 2.1 MPa by heating the assembly from the ambient to 343°C at a rate of 8°C min⁻¹, followed by 1 h at that temperature. A postcure treatment at 343°C for 4–6 h is applied to the assemblies that are subsequently tested at temperatures higher than the T_g .

The 25°C Ti/Ti lap shear strength values reported in the literature are scattered between 32 and 43 MPa, with 37 MPa being more common. Fig. 24 shows the change in lap shear strength observed with Ti/Ti specimens subjected to long-term ageing at 232°C [62]. The initial value of 13.8 MPa progressively increases to 15.2 MPa after 1000 h and to about 24 MPa after 10,000 h. As shown in Fig. 24, this later value remains constant over a long period of time, that is, 40,000 h when the test was completed.

The high melt viscosity of Larc-TPI at 350°C (10⁶ Pas) prohibits its use as an adhesive for bonding metallic or laminate skins on core honeycombs to make high strength sandwich structures. The work of Chow et al. discussed in Section 4.3.2.2 demonstrates that the melt viscosity of the poly(isoimide) form **21** of Larc TPI is of the order of 10 Pas at 240–250°C, compared to 2 × 10⁷ Pas for polyimide **22** [25]. A semi-crystalline form of Larc-TPI has been obtained by chemical imidisation of the polyamic acid with acetic anhydride and triethylamine [63]. The differential scanning calorimetric curve exhibits an endotherm at 274°C due to melting of the crystalline sites. The value of the initial inherent viscosity (0.22 dl g⁻¹) indicates, however, that the lower melt viscosity also results from lower molecular weight polymer.

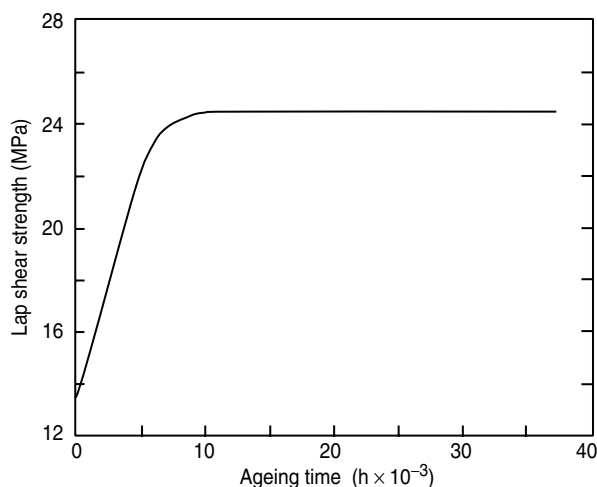

Figure 24: Lap shear strength values determined with Ti/Ti assemblies bonded with Larc TPI adhesive during long-term thermal ageing in air at 232°C.

Various copolyimides including the chemical structure of Larc-TPI were evaluated in the late 1980s. A paper reports that the polymer Larc TPI-ODA made from the reaction of BTDA with 95 mol% of 3,3'-carbonylbisbenzeneamine and 5 mols% of 4,4'-oxybisbenzeneamine (copolyimide containing the repeating units **22** and **23** (Fig. 11 and 12) has a T_g similar to that of Larc-TPI (250°C), but exhibits better processability [64]. Ti/Ti bonding provides lap shear strength values of 32.4 and 21.1 MPa at 25 and 232°C, respectively. Other copolymers have been prepared by incorporating various amounts of 3,3'-(1,3-phenylenedioxy)bisbenzeneamine into the macromolecular backbone of Larc-TPI [65]. Fig. 12 displays the chemical formulae of polyimides evaluated as thermoplastic adhesives for high temperature uses. The polyamic acid form of polymer **24** (Larc PI-SO₂) is synthesised from BTDA and 3,3'-sulphonylbisbenzeneamine, while polyimide **25**, referred to as Larc-TPI IA, is produced by reacting 4,4'-oxybis(1,2-benzenedicarboxylic acid) dianhydride with 3,4'-oxybisbenzeneamine [66,67]. The glass transition temperature of polyimide **24** varies from 220 to 250°C according to the cure cycle applied, while polymer **25** has a T_g of 243°C.

Table 1 lists the lap shear strength values measured with Ti/Ti test specimens bonded with these thermoplastic polymers: Larc-TPI, Larc TPI-ODA, Larc IA and Larc PI-SO₂. The heat resistance of the four polymers in oxidative conditions was determined in an air circulating oven at 204°C for 1000 and 5000 h.

Table 2 provides the lap shear strength properties of a water-soluble version of Larc-TPI obtained using a two-step synthesis. In the first stage, the polyamic acid form of this polymer is prepared as usual in diglyme solution and then precipitated in water as a fine powder [68]. Once dried the solid is dissolved in an aqueous solution of *N,N*-dimethylethanolamine to form the corresponding polyamic acid quaternary salt. The experimental data reported in Table 2 compare the adhesive properties of this water-soluble polymer, referred to as Larc TPI (H₂O), to those

Table 1: Comparison of the lap-shear strength values measured with Ti/Ti assemblies bonded with Larc-TPI, Larc-TPI-ODA, Larc-IA and Larc-PI-SO₂

T^a (°C)	Lap shear strength (MPa)			
	TPI	ODA ^b	IA	SO ₂
25	33.0	28.3	44.2	32.1
177	29.5	21.9	36.6	–
204	25.2	15.4	28.4	–
232	17.5	–	9.3	24.5

^a Test temperature.

^b 32.4 and 21.1 MPa at 25 and 232°C, respectively, after a postcure treatment.

Table 2: Lap-shear strength values of Ti/Ti test specimens bonded with a commercial grade of Larc-TPI compared to the data obtained with the water-soluble version Larc-TPI (H₂O)

<i>T</i> ^a (°C)	Lap shear strength (MPa)	
	Larc-TPI	TPI (H ₂ O)
25	33.5	28
232	19.7	20
25 ^b	26.9	23

^a Test temperature.

^b After 5000 h ageing in air at 232°C.

measured from a commercial grade of Larc-TPI. The last row of the table indicates the lap shear strength determined after the specimens have been subjected to thermal ageing in air at 232°C for 5000 h.

The lap shear strength values listed in Table 3 show that Larc-IA exhibits the best adhesive properties up to 204°C before and after thermal ageing at that temperature but Larc-TPI remains better when adhesion is measured at 232°C.

To date, no high molecular weight condensation polyimide combines excellent adhesive properties, easy processability without volatile evolution and low

Table 3: Lap-shear strength of Ti/Ti test specimens bonded with polyimides of the Larc-TPI series as a function of the test temperature before and after thermal ageing in air at 204°C

Polyimide	Time (h)	Lap shear strength (MPa) at °C			
		25	177	204	232
Larc-TPI	0	33.0	29.5	24.5	17.5
	1000	32.9	29.9	27.8	23.3
	5000	27.1	25.7	26.0	23.7
Larc-TPI-ODA	0	28.9	22.3	20.8	18.1
	500	25.0	22.5	22.1	17.0
	1000	28.3	18.4	17.5	15.3
Larc-IA	0	44.2	36.6	28.4	9.3
	1000	35.0	33.4	30.4	9.7
	5000	29.0	30.9	30.4	7.9
Larc-IA + 50% Al	0	43.8	33.2	28.7	13.6
	1000	42.9	34.3	31.3	12.9
	5000	34.1	28.3	24.5	7.7

melt viscosity. The results discussed in Section 4.5.4.1 show that condensation oligomers, such as Nolimid 380 and FM 34B, are the most effective adhesives for long-term uses at temperatures greater than 250°C. They have, however, a major drawback, which is also encountered with high molecular weight polyamic acids. A large amount of volatile compounds – solvents and by-products from cyclodehydration – evolves during the cure cycle. This results in severe processing problems, particularly for large area parts which exhibit a high degree of porosity. Larc-TPI and its associated modifications were tailored to reduce the melt viscosity by significantly decreasing the molecular weight, using unbalanced stoichiometry, and blocking the terminal functions with end-capping agents.

4.5.3. Thermosetting Resins

Addition-type polyimides, which are thermosetting resins, were developed to improve the processability of polyimides, but their thermal stability is severely degraded by the presence of aliphatic bonds in place of the aromatic nuclei. However, the adhesive strength has been evaluated for the bismaleimide- (Section 4.3.4.1), bisnadimide- (Section 4.3.4.2) and acetylene-terminated (Section 4.3.4.3) imide oligomers.

4.5.3.1. Maleimide-Terminated Adhesives

As previously stated, bismaleimides are crystalline compounds with melting points in the range 100–210°C. A few examples are given in Table 4 which provides the melting temperatures T_m , the maximum temperatures of the exothermic peak T_{max} and the polymerisation enthalpies ΔH . Diamines based on 4,4'-methylenebisbenzeneamine carrying methyl and ethyl substituents exhibit melting points around 250°C, while the only bismaleimide melting at about 100°C is the compound obtained from the reaction of maleic anhydride with 6-amino-1-(4-phenyl)-1,3,3-trimethylindane.

The chemistry of bismaleimides has been briefly discussed in Section 4.3.4.1 which outlines that neat BMI resins form brittle networks. The values characterising the shock resistance and crack propagation of a given material are the stress intensity factor, K_{IC} , and the fracture energy, G_{IC} , which indicates the relaxation of the strain energy. In highly cross-linked networks, such as those formed by tetrafunctional epoxy resins, K_{IC} is of the order of 0.5 MPa m^{0.5} and G_{IC} values are around 60 J m⁻², whereas the data obtained for a thermoplastic polyimide are respectively 2.8 MPa m^{0.5} and 3.5 kJ m⁻². The fracture toughness of cured BMIs is approximately 100 J m⁻², increasing by a factor of two on chain extension between the two terminal double bonds. For example, the fracture energy of polymer **40** (Fig. 17) is

Table 4: Melting temperature T_m , temperature at the maximum of the exothermic peak T_{max} and polymerisation enthalpy ΔH for some bismaleimides

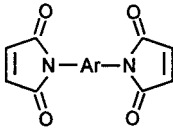
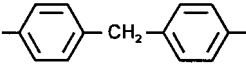
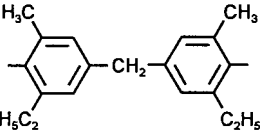
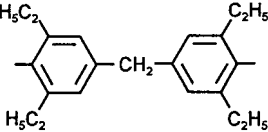
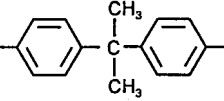
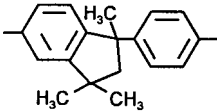
				
Ar	T_m (°C)	T_{max} (°C)	ΔH (J g ⁻¹)	
	155–157	235	198	
	150–154	298	187	
	149–151	328	206	
	235	290	216	
	90–100	203	89	

enhanced when the molecular ratio of BMI **38** to 4,4'-methylenebisbenzeneamine **34** is increased.

Several methods have been investigated to improve the fracture toughness of BMI resins, the most used technique being the incorporation of a second phase formed by the dispersion of rubber particles into the cross-linked matrix. Carboxyl-terminated butadiene-acrylonitrile elastomers (CTBN), which are very effective with epoxy resins, are also frequently added to BMI adhesives. The general formula of CTBN rubbers is:

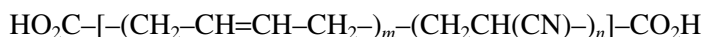

where the number average molecular weight is in the range of 1300–3500 g mol⁻¹ with, in this later case, typical values of 5 and 10 for m and n , respectively. Starting from a homogeneous mixture, three steps characterise the cure cycle: phase segregation, gelation and vitrification. The final material is composed of rubber particles with average diameters between 1 and 5 μm dispersed within the continuous BMI matrix. The maximum fracture resistance is obtained for 15–20% CTBN, resulting in fracture energy values multiplied by a factor of 20 to 30. It has been demonstrated that mixtures of CTBN Hycar 1300-X8 and bismaleimide Compimide 353 could be copolymerised at 170–200°C to provide two-phase materials containing dispersed rubber microspheres [69]. Fig. 25 shows that the fracture energy increases with the quantity of CTBN rubber, which can be as high as 50%. The flexural modulus at high temperature (250°C), however, rapidly decreases to become close to zero at 50% CTBN concentration.

Another method used to improve the fracture energy of BMI resins consists in mixing the thermosetting material with linear thermoplastic polymers. This can be illustrated by the behaviour of mixtures containing Compimide[®] 796 and TM 123 BMI resins with GE Ultem 1000[®], poly(ether-imide) **26** (Fig. 13) [70]. The critical stress intensity factor K_{IC} of the linear polymer is six times higher than that of the BMI matrix and does follow the mixture law for all BMI/Ultem combinations. The linear polyimide can also be added as 20–40 μm spherical particles to the BMI resin before it is polymerised. In another example, particles of a soluble

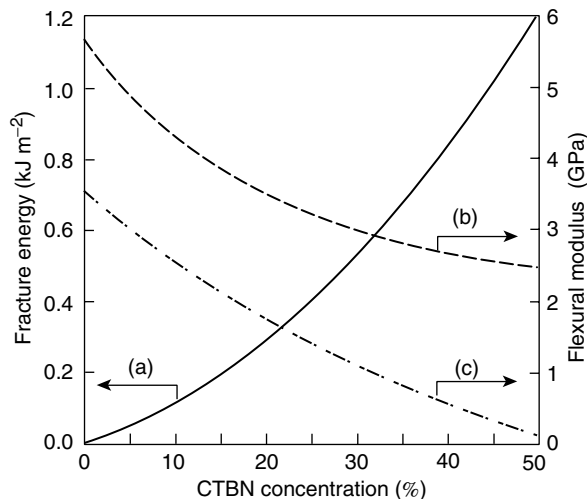

Figure 25: Changes of the fracture energy (a) and flexural modulus at 25°C (b) and 250°C (c) for CTBN-BMI adhesives as a function of the CTBN-rubber content [69].

precyclised polyimide (Ciba-Geigy XU 218[®]) are dispersed in BMI monomer, which is subsequently melted at 177°C and cured at 232°C [71]. The two-phase material obtained by this means exhibits a glass transition temperature of 348°C compared to only 260°C for the BMI resin without polyimide additive.

The fracture energy values published in the literature have been generally determined with either neat resins or composite materials and exceptionally with adhesives. The actual fracture energies of thermoplastic and thermosetting adhesives are, in fact, considerably lower than those measured with moulded resins [72]. This discrepancy can be explained by the pressure–temperature conditions used in the bonding techniques. They would not allow the melted resins to flow and wet the metal surfaces. Moreover, the small thickness of the adhesive joint limits the level of plastic deformation in contact to the propagating cracks. Table 5 summarises, by order of increasing energy, the fracture energy values measured at room temperature for some commercial adhesives.

Melt processable thermoplastic adhesives, such as Udel P1700[®] ($G_{1C} = 306 \text{ J m}^{-2}$), Upjohn 2080[®] and Torlon 4000T[®] have fracture energies similar to that of the modified nadimide-terminated polyimide Larc 13/AATR[®] containing 20% of acrylonitrile-butadiene rubber. Compared to the melted form, adhesive films of Udel P1700[®] exhibit a fracture energy close to 1.7 kJ m^{-2} . In the group of thermosetting adhesives, Cyanamid FM 73[®] and Plastilock 650–655[®] possess the best properties of fracture resistance, surprisingly followed by the ethynyl-terminated HR 602. These data show that judiciously formulated thermosetting polymers can provide excellent adhesives.

Table 5: Fracture energies G_{1C} of commercially available high performance adhesives, measured at ambient temperature [72]

Adhesive trade mark	Type of material	G_{1C} (J m ⁻²)
Narmco SR 5208	Modified epoxy resin	82
Hexcel HX 976	Condensation polyimide	94
Cyanamid FM-300K	Modified epoxy resin	191
Upjohn 2080	Thermoplastic copolyimide	310
Cyanamid FM 34B-18	Condensation oligoimide	385
Larc 13/AATR	CTBN-modified bisnadimide	387
Torlon 4000 T	Poly(amide-imide)	480
Du Pont NR 056X	6FDA-based polyamic acid	620
Hughes HR 602	Ethynyl-terminated oligoimide	815
Plastilock 650	Nitrile rubber modified phenolic	1037
Plastilock 655	Nitrile rubber modified phenolic	1513
Udel PI 700	Thermoplastic polysulfone	1620
Cyanamid FM 73	Modified epoxy resin	2107

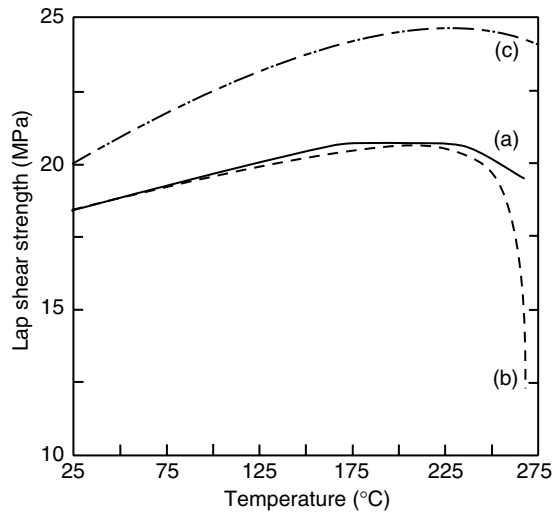

Figure 26: Lap-shear strength versus temperature measured on Al/Al assemblies bonded with: (a) American Cyanamid FM 32 [73], (b) Dexter-Hysol EA 9655 and (c) Dexter-Hysol LR100-774 [74] BMI adhesives.

Commercial bismaleimide adhesives are generally blends of BMI resin, various nucleophilic co-reactants, and toughening compounds. A number of chemical systems were studied and developed by Rhône-Poulenc, General Electric, American Cyanamid and many other companies but the thermal stability of BMI-based adhesives does not exceed 230°C for long-term uses. Fig. 26 illustrates some data published by American Cyanamid for Al/Al assemblies bonded with FM 32 BMI adhesive cured at 177°C for 4 h under 0.28 MPa [73]. The two other curves refer to BMIs from Dexter-Hysol Corporation [74]. Aluminium coupons were bonded with EA 9655 under 0.17 MPa at 177°C for 1 h, followed by 2 h at 232°C, whereas the bonding conditions for LR 100-774 were 0.2 MPa, 1 h at 177°C and 2 h at 246°C. The resistance to humidity for Al/FM 32/Al structures was tested after 72 h in boiling water, providing lap shear strengths of 20.3, 20 and 19 MPa at 25, 177 and 203°C, respectively.

4.5.3.2. Nadimide-Terminated Adhesives

The chemistry of norbornene-terminated polyimide oligomers, also referred to as nadimide-terminated resins is discussed in Section 4.3.4.2. A paper by St. Clair and Progar reports the first experiments made using nadimide resins as structural adhesives [75]. The polyimide Larc-13, used in this study, belongs to the PMR

category with 3,3'-methylenebisbenzeneamine replacing the 4,4'-isomer employed as the diamine of the PMR 15 formulation. The *meta*-catenation provides excellent melt-flow properties allowing bonding in an autoclave. Titanium specimens bonded under 0.34 MPa with a final cure temperature at 329°C, followed by a postcure at 343°C exhibit lap shear strength values of 22.8 and 19.3 MPa at 25 and 260°C, respectively. Another study indicates that the adhesion strength of the Ti/Ti assemblies drops to 8.3 MPa after ageing in air for 2000 h at 232°C [76]. Even though certain types of assemblies with the Larc-13 resin have demonstrated good mechanical properties, the fracture resistance had to be improved by adding either rubbery materials or linear thermoplastic poly(amide-imides) [77].

The Larc-13 adhesive has been tested for bonding ceramics to titanium alloys as parts of cruise missiles requiring short-term resistance at 600°C, as well as for pieces implemented in the space-shuttle and YF-12 aircraft. Even if the global performance is satisfactory, the brittleness inherent to the Larc-13 system is a limiting factor. The addition of various rubbery materials significantly improves the shock resistance, elongation to rupture and toughness, but to the detriment of the tensile strength, elastic modulus and other thermomechanical properties. The Larc-13 adhesive is no longer commercialised because of the high cost of the diamine, which was replaced by 3,3'-sulphonylbisbenzeneamine in a modified version.

With PMR resins, the mixture of the three monomers is applied to a glass fabric as either a methanol solution or after addition of different wetting and flow control agents and eventually fillers (aluminium and silica powders). The melt process provides excellent quality films which have been tested by Rockwell International for the space shuttle. The adhesive, used to bond metal parts or sandwich honeycombs, presents excellent resistance to 315°C [78]. The American Cyanamid commercial adhesive FM 35 is based on the PMR 15 resin chemistry. Bonding tests made with aluminium specimens give lap shear strength values of 35.8, 21.4 and 21.7 MPa at 25, 260 and 288°C, respectively [79]. Titanium alloy coupons bonded at 288°C with this adhesive under 0.28 MPa pressure exhibit lap shear strengths of 21.7, 17.2 and 13.8 MPa at the same test temperatures. When the final cure temperature is increased to 329°C, the adhesive joint becomes more brittle and the lap shear strength decreases significantly. Within the framework of the studies intended to make high performance adhesives for the space shuttle, Stenersen and Wyke compared the properties of the nadimide-terminated oligoimides in development [78]. Table 6 lists some of the results obtained with Larc-13, Larc-160 and PMR 15 used to bond different substrates.

The authors outlined that certain parameters had to be optimised to achieve valuable mechanical properties with adhesives based on the PMR concept. In particular, they investigated the effects of the treatments applied to the surfaces prior to bonding, the nature of the glass cloth carrier and the partial drying of the

Table 6: Lap-shear strength values obtained with nadimide-terminated adhesives used to bond titanium, stainless steel and composite materials

Substrate	T^* (°C)	Lap shear strength (MPa)		
		Larc 13	Larc 160	PMR 15
Titanium	25	17.9	16.3	17.4
	316	14.2	14.1	12.3
Steel	25	16.2	18.8	19.8
	316	13.8	14.5	14.3
Composite	25	18.9	19.5	15.7
	316	15.1	15.1	14.0

*Test temperature.

adhesive film intended to eliminate the maximum amount of solvent and to partially convert the polyamic acids into polyimides. This can be considered as the most critical point because the residual solvent plays an important role during the bonding process. Its presence offers the tackiness and drapability required by large area substrates. It also increases both the surface wetting and low melt viscosity necessary to achieve optimum adhesion strength.

All heat-resistant high-performance adhesives, either thermoplastic or thermosetting, impose very constraining operating conditions. If relatively high values of the room temperature lap shear strength are easily achieved, the assemblies must be subjected to postcure treatments to obtain maximum adhesive strength at high temperatures. As a rule of thumb, the assembly has to be postcured at a temperature at least equal to or greater than the test temperature. The data in Table 7 show the lap shear strength changes observed with assemblies made of stainless steel coupons

Table 7: Effect of a postcure treatment at 316°C on the lap-shear strength of stainless steel coupons bonded with Larc-13 and Larc-160 adhesives based on nadimide-terminated polyimide oligomers

Postcure time at 316°C (h)	Lap shear strength (MPa)			
	Larc 13		Larc 160	
	25°C	316°C	25°C	316°C
2	20.7	13.1	22.4	12.4
10	18.6	14.5	18.6	13.1
20	17.9	15.2	17.2	13.1
125	17.2	14.5	16.5	12.4

bonded with Larc-13 and Larc-160 nadimide-terminated PMR resins and exposed to 316°C postcure for 2–125 h.

When heat-resistant adhesives are applied by using the temperature and pressure recommended by the manufacturers, the adhesive properties at room temperature are generally very good, but the lap shear strength at high temperature is significantly lower. This results from the compromise imposed by the existing production tools. In these conditions, the degree of polymerisation (or cross-linking) does not reach a value high enough to obtain the optimum mechanical properties at 300°C or more. The lap shear strength values listed in Table 7 show that an adequate postcure treatment slightly decreases the adhesion strength at room temperature but significantly enhances the adhesion at 316°C. It is worth noting that the adhesive strengths measured after 20 h at 316°C are similar to the values obtained with condensation polyimides such as Nolimid 380[®] and Du Pont NR 056X[®].

4.5.3.3. Acetylene-Terminated Adhesives

Polymers **46**, **47** and **48** (Fig. 19) were all evaluated as heat-resistant structural adhesives for bonding titanium alloys, copper and composite materials. The thermal polymerisation of the ethynyl end-groups starts at about 200°C with so narrow a processing window that the reaction must be completed by postcuring the assemblies for 16 h at 315°C or 4 h at 370°C. Typical lap shear strength values measured for Ti/Ti bonding are 22.1 MPa at 25°C, and 13.1 and 8.3 MPa at 232 and 260°C after 1000 h ageing at these two temperatures, respectively. The main problem lies in the very fast reaction rate of the ethynyl groups just below the glass transition temperature, resulting in poor substrate wetting in the early stages of the bonding process. A paper by Kuhbander and Aponyi shows that hydroquinone can retard to some extent the polymerisation of the acetylenic triple bonds and thus offers better processing conditions [80]. Titanium specimens bonded under 0.34 MPa at 316°C, followed by a postcure at 343°C, exhibit lap shear strengths of 26.2 MPa at 25°C, 14.5 MPa at 288°C and 17.6 MPa at 288°C after ageing at that temperature for 500 h.

Hanky and St. Clair evaluated [81] a series of imide oligomers end-capped with ethynyl groups. Polyamic acid **50** and polyimide **51** in Fig. 27 were prepared from BTDA **70**, 3,3'-sulphonylbisbenzeneamine **49** and 3-ethynylbenzeneamine **45** with a degree of polycondensation n varying between 1 and 3.

The authors prepared other oligomers with 3,3'-methylenebisbenzeneamine and 3,3'-carbonylbisbenzeneamine as diamine components. The results of differential scanning calorimetry measurements listed in Table 8 indicate the thermal range of polymer flow for polyimide **51** as a function of its molecular weight. T_s is the temperature where the polyimide starts to flow, T_{\min} represents the temperature corresponding to the minimum of the endothermic peak and T_{\max} is the maximum of the exothermic polymerisation peak. Note that endothermic and exothermic

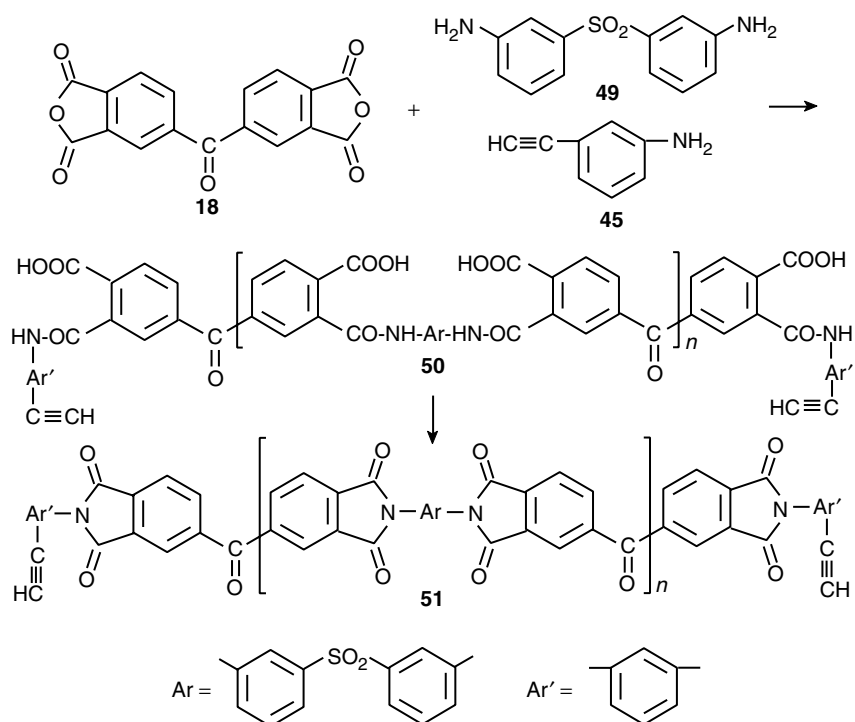

Figure 27: Chemical formulae of the polyamic acid **50** and polyimide **51** oligomers prepared from BTDA, 3,3'-sulphonylbisbenzeneamine **49** and 3-ethynylbenzeneamine **45**.

Table 8: Thermal characteristics of the imide oligomers **51** determined by differential scanning calorimetry

n	T_s (°C)	T_{\min} (°C)	T_{\max} (°C)	T_g (°C)
1	165	195	271	305
2	168	198	284	284
3	181	211	298	253

reactions succeed one another over a few degrees without clear separation between the two phenomena. The last column of the table provides the glass transition temperature achieved with fully cured polymers. As expected, the T_g decreases when the molecular weight of the oligomers is increased.

Titanium alloy ($\text{Ti}_6\text{Al}_4\text{V}$) test samples were bonded with acetylene-terminated polyimide oligomers **51**, with degree of polycondensation $n = 1, 2$ and 3 , under

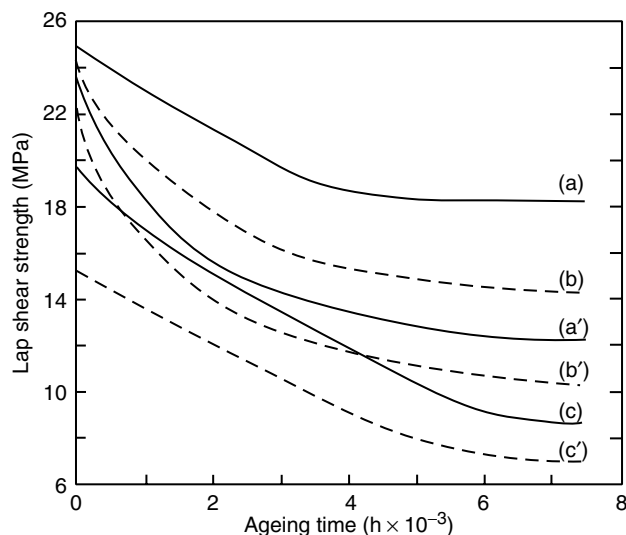

Figure 28: Lap-shear strength versus ageing time in air at 177°C for Ti/Ti specimens bonded with polyimide oligomers **51**. Curves (a–c) are lap-shear strength values measured at 25°C for oligomers with $n = 3, 2$ and 1 , respectively, whereas curves (a'–c') refer to lap-shear strengths measured at 177°C in the same order of molecular weights.

0.34 MPa pressure at 300°C without postcure. The variation of the lap shear strength values measured at 25 and 177°C during thermal ageing in air at 177°C is illustrated by the curves of Fig. 28. They clearly demonstrate that the higher the molecular weight of the oligomers, the better the resistance to degradation in long-term thermal-oxidative conditions.

The results presented in this section show that polyimide adhesives are far from the versatility offered by epoxy resins, which can be processed as solventless resin–hardener combinations without volatile evolution during the curing step. Even though several polyimides exhibit good adhesive properties at high temperature, in long-term ageing tests and in humid conditions, the shortcomings inherent to the chemistry of heterocyclic polymers have not been solved yet.

4.5.4. Condensation Prepolymers

4.5.4.1. Polyimides

Historically, the adhesives based on reactive condensation prepolymers were the first materials to be extensively studied, developed and introduced to the market.

One of the best performing polyimide in this category is Nolimid® 380 produced by Rhône-Poulenc after an extensive series of tests [82]. The resin binder is the mixture of monomers **30a** and **30b**, as well as the low molecular weight polyimide **31** of Fig. 15. Typical compositions are prepared as previously reported by mixing the two monomers and 4,4'-oxybisbenzeneamine, in *N*-methylpyrrolidone and methanol [15]. To this solution, introduced into a roll-mill, are added aluminium powder (400 mesh) and El Monte Chemicals Arsenone® as antioxidant. Nolimid 380/glass tapes are made by depositing the adhesive composition on both sides of E-112 glass fabric carriers and then drying at 90°C for 10 min in an air circulating oven. Other adhesive layers are coated and dried in order to obtain a final weight of 650 g m⁻², the weight of residual solvent accounting for approximately 15%.

Once cleaned, the metal surfaces are coated with a primer prepared by roll-milling 200 g of adhesive composition and 500 g of methanol. A first layer of primer is applied to the metal parts, dried for 10 min at 90°C, covered with a second layer of primer and finally dried at 90°C for 1 h in an air circulating oven. The adhesive film is inserted between the two primed metal surfaces and the assembly is placed between the platens of a hydraulic press preheated to 316°C. A pressure of 0.3–0.5 MPa is applied and the test specimens are cured at 316°C for 1.5 h, before cooling down to 100°C under pressure. The assemblies are removed from the press and postcured in an air circulating oven as follows: the temperature is raised from 20 to 300°C in 1 h, then from 300 to 350°C in 5 h and left at 350°C for 5 h. The lap shear strength values determined at different temperatures are plotted in Fig. 29 for TU-2 Ti/Ti assemblies [curve (a)] and Z10 CNT 1810 stainless steel coupons [curve (b)].

Ti/Ti test specimens were subjected to long-term ageing in flowing air at 260 and 300°C, the adhesive strength being measured every 500 h. The curves fitting the lap shear strength data are plotted in Fig. 30 in which curves (a) and (b) provide the adhesive strength determined at 23 and 260°C, respectively for specimens aged at 260°C. The initial increase in adhesion, generally observed with most condensation polyimide adhesives, is commonly attributed to additional curing reactions. These two curves demonstrate the excellent stability of the adhesive joint after 12,000 h of air-ageing at 260°C. Curves (c) and (d) are drawn from the lap shear strength values measured at 25 and 300°C, respectively, during isothermal ageing in air at 300°C. The threshold value of 15 MPa is preserved for 5000 h at that temperature, but the rate of degradation increases significantly after 7000 h to reach a final adhesion strength of 5.9 MPa after 10,000 h at 300°C. Thermal ageing at 275°C, not shown in the figure, results in lap shear strength values lying between these two boundaries.

Ageing tests were also performed with stainless steel specimens subjected to thermal-oxidative stressing at 300°C for 2000 h. The experimental results are plotted

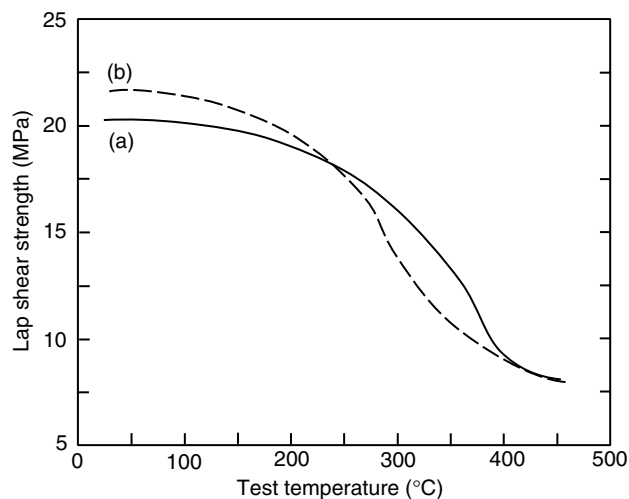

Figure 29: Variation of the lap-shear strength as a function of the test temperature between 25 and 450°C. Assemblies made by bonding: (a) TU-2 titanium alloy; (b) Z10 CNT 1810 stainless steel with adhesive films prepared from condensation oligomers **31**.

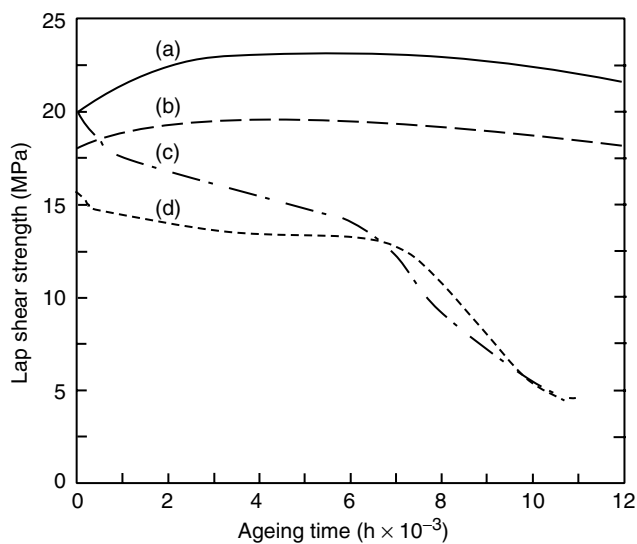

Figure 30: Variation of the lap-shear strength as a function of the ageing time in flowing air for TU-2 titanium alloy bonded with polyimide precursors **30**. Assemblies aged at 260°C: lap-shear strength measured at room temperature (a) and at 260°C (b). Assemblies aged at 300°C: lap-shear strength measured at room temperature (c) and at 300°C (d).

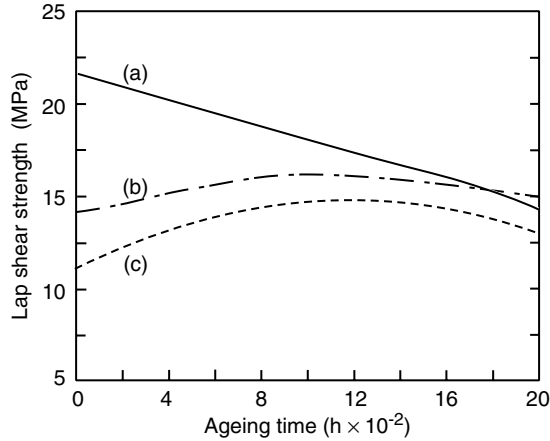

Figure 31: Variation of the lap-shear strength as a function of the ageing time in flowing air at 300°C for Z10 CNT 1810 stainless steel coupons bonded with Nolimid 380 polyimide precursor. Curves (a), (b) and (c) fit the lap-shear strength values measured at 25, 300 and 350°C, respectively.

in Fig. 31 where curves (a), (b) and (c) show the variation of the lap shear strength values measured at 25, 300 and 350°C, respectively.

The resistance of the TU-2 titanium assemblies to shorter term exposure at high temperature was determined at 340, 377, 400 and 450°C. The lap shear strength data plotted in Fig. 32 were determined at the corresponding ageing temperature.

Specimens of both TU-2 and 6Al4V titanium alloys were also subjected to the so-called 'Mach 3 Fighter' test, which consists of 500 h ageing at 300°C, followed by 24 h at 340°C and 1 h at 350°C. At the end of the test, the lap shear strength was measured at 25, 300 and 350°C. Before ageing, the initial strengths were 20, 15.5 and 12.5 MPa at these temperatures, respectively. Lap shear strengths of the aged specimens slightly decreased from 20 to 18 and 16 MPa for TU-2 and 6Al4V alloys when measured at 25°C. By contrast, they increased by 10–15% for the measurements made at 300 and 350°C. Finally, the resistance of the polyimide joints to humidity was determined with assemblies exposed to water immersion at room temperature and to 100% relative humidity at 50°C for one month each. The lap shear strength of wet specimens was 13–15 MPa increasing to 15–18 MPa for the same samples dried at 100°C. FM 34® of American Cyanamid presents some analogy with the previous class of condensation prepolymer. Even though its composition is not clearly displayed, it seems to be prepared from the reaction of

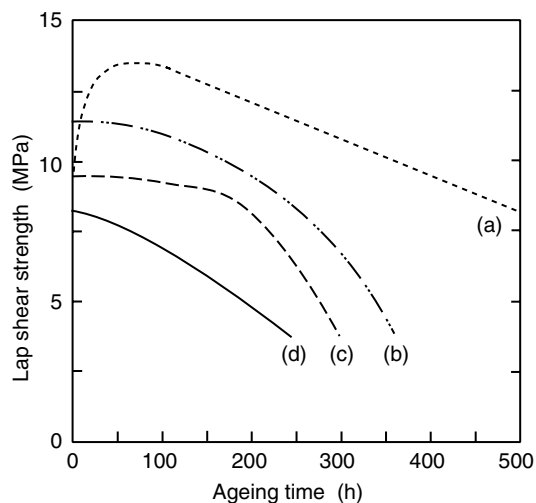

Figure 32: Variation of the lap-shear strength as a function of the ageing time in flowing air for TU-2 titanium alloy bonded with Nolimid 380 polyimide precursors. The strength of adhesion is measured at the ageing temperatures: (a) 340, (b) 377, (c) 400 and (d) 450°C.

4,4'-carbonylbis(1,2-benzenedicarboxylic acid) dimethyl ester **33** with 4,4'-methylenebisbenzeneamine **34** (Fig. 16) in NMP solution. The FM 34 brand, which contained arsenic derivatives, was withdrawn from the market and replaced by FM 34B-18 without arsenic pentasulphide.

As for all the other adhesives retaining relatively large amounts of solvents and other potential volatile materials, the best processing technique is to place the assembly in a bag allowing one to apply a partial vacuum while the adhesive is cured in an autoclave. The results of Table 9, published by the manufacturer, were

Table 9: Lap-shear strength of stainless steel coupons bonded with FM 34B-18 adhesive cured at 371°C under 0.28 MPa pressure

Ageing conditions	LSS* (MPa) at	
	24°C	260°C
Before ageing	27.9	16.1
After 750 h at 260°C	23.2	15.5
After 2000 h at 260°C	18.7	9.7
After 192 h at 316°C	10.9	8.8

*LSS: lap shear strength.

obtained with stainless steel specimens bonded at 371°C under 0.28 MPa [83]. Compared to Nolimid 380, the initial adhesive strength is improved by about 26%, but the resistance to air oxidation at 260 and 315°C is not as good.

High performance adhesives based on the *in situ* polycondensation of monomer precursors of polyimides were developed by Gibbs using the chemistry evolved from the NR 150[®] series of polyimides where 4,4'-[2,2,2-trifluoro(1-trifluoromethyl)ethylidene]bis(1,2-benzenedicarboxylic acid) dianhydride is opposed to various aromatic diamines in NMP [84,85]. The chemical formula of the NR 150-A2 polyimide **8** is shown in Fig. 9 with, however, a fabrication process involving the tetracarboxylic acid (6FTA) instead of the dianhydride **5**. NR 150-B2 also known as Avimid[®] N is synthesised by reacting the same fluorinated tetracarboxylic acid with 1,4-benzenediamine **7** (95 mol%) and 1,3-benzenediamine **6** (5 mol%) in a mixture of NMP and ethanol. The last brand, Du Pont NR[®] 056X, is a composition of oligomers whose thermal polycondensation provides a polyimide comprising the recurring units **8** and **10** in Fig. 9. This material is prepared by dissolving in diglyme the fluorinated acid, 75 mol% of 1,4-benzenediamine **2** and 25 mol% of 4,4'-oxybisbenzeneamine **7**. A paper by Blatz reports that replacing NMP by the less polar diglyme, which has a lower boiling point, results in better adhesion [86]. This adhesive composition containing 65 phr of aluminium powder was employed to bond Ti/Ti specimens at 316°C under 1.38 MPa. A postcure of 16 h at 316°C was required to achieve lap shear strength values above the NASA goal of 20.7 MPa at room temperature and 13.8 MPa at 316°C. In these conditions, the adhesive strength was 24.1 and 15.1 MPa at 25 and 316°C, respectively, and 13.8 MPa at 232°C after ageing for 5000 h at that temperature. Table 10 lists a few examples of polyimide materials that have been extensively tested as structural adhesives. This series includes virtually all categories of polymers such as condensation oligomers, high molecular weight polyimide precursors, precyclised thermoplastic polyimides and thermosetting telechelic addition polyimides.

Fig. 33 summarises the typical data discussed in the present section in order to compare the best performing polyimide adhesives at temperatures exceeding 200°C. It can be seen that condensation polyimides (Nolimid 380[®] and FM 34B[®]) seem to work better in ageing tests between 260 and 300°C. The thermoplastic polyimides Larc IA and Larc-TPI exhibit excellent adhesive properties between 200 and 232°C, whereas the BMI FM 32 can be used up to 200–230°C.

The best epoxy or epoxy-phenolic adhesives employed in the aerospace industry show initial lap shear strength values often higher than those of the polyimides but the maximum operating temperatures are in the range of 150–170°C. For example, the adhesion strength of Al/Al assemblies bonded with a high temperature epoxy resin is of the order of 30 MPa at 150°C and remains virtually constant when aged at that temperature for 5000 h. The adhesive film 3M Scotchweld

Table 10: Examples of polyimide structural adhesives including the main families of linear polyimide precursors as well as oligomers terminated by ethylenic double bonds and acetylenic groups.

Trade mark*	Chemistry	Presentation
Nolimid 380 ^a	Monomer 30 and prepolymer 31 (Fig. 15) + Al	Glass fibre tape
FM 34 ^b	Prepolymer 35 in solution (Fig. 16) + Al	Glass fibre tape
FM 36 ^b	Condensation prepolymer	Glass fibre tape Adhesive paste
NR 150 A2 ^c	Linear fluorinated polyimide precursor 8 (Fig. 9) + Al	Adhesive paste
NR 150 B2 ^c	Linear copolyimide precursors 9 and 10 (Fig. 9)	Solution in NMP
NR 05X ^c	Linear copolyimide precursors 8 and 10 (Fig. 9)	Solution in diglyme
Ultem 1000 ^d	Thermoplastic poly(ether-imide) 26 (Fig. 13)	Solid powder
Larc TPI ^e	Thermoplastic polyamic acid 20 and polyimide 22 (Fig. 11)	Adhesive film
Nolibond 1 ^a	Thermosetting poly(amide-imide)	Solution in NMP
Kerimid 601 ^f	Thermosetting bismaleimide 39 + diamine 34 (Fig. 17)	Solid powder
PMR 15 ^g	Mixture of unreacted monomers 41 , 42 , and 34 (Fig. 18)	Solution in methanol
Larc 160 ^h	Mixture of unreacted monomers 41 , 42 and Jeffamine	Solution in methanol
Thermid 600 ⁱ	Ethynyl-terminated imide oligomers 48 (Fig. 19)	Solid powder
Thermid IP 600 ⁱ	Ethynyl-terminated isoimide oligomers 47 (Fig. 19)	Solid powder

*Manufacturers: ^a Rhône-Poulenc, ^b American Cyanamid, ^c Du Pont de Nemours, ^d General Electric, ^e Gulf Oil/Mitsui Toatsu, ^f Ciba Geigy, ^g NASA/Ferro/Fiberite, ^h NASA/US Polymeric, ⁱ National Starch.

AF 131, based on epoxy-phenolic resins, provides Al/Al bonds with lap shear strengths of 25.5, 20 and 10.3 MPa at 180, 200 and 260°C, respectively. Solventless epoxy and epoxy-phenolic adhesives provide bond lines with a low level of porosity. This is also the case with poly(ether-imide) Ultem[®] 1000 and poly(imide-siloxanes), which are generally processed at temperatures 50–100°C above their T_g . In contrast, high porosity is observed with most condensation

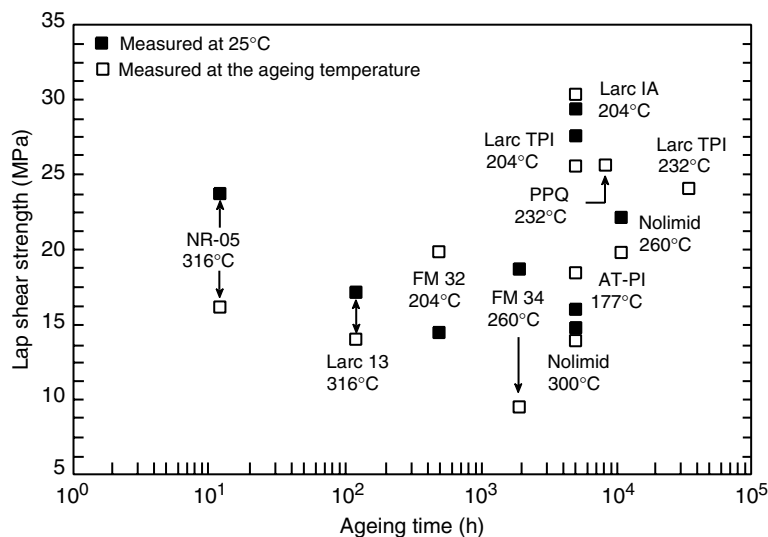

Figure 33: Comparative evaluation of the different polyimide structural adhesives from the experimental data published in the literature or provided in manufacturers' technical bulletins.

polyimides and polybenzimidazoles even if a partial vacuum is applied to help the removal of volatile by-products and organic solvents. Addition polyimides fall in between with average porosity values in the range of 4–6%.

4.5.4.2. Polybenzimidazoles

The general process used to synthesise aromatic polybenzimidazoles (PBIs) is presented in Section 4.3.3. More detailed information can be found in previously published books [87,88]. During 1960–1970 a number of publications, comparable to those on polyimides, reported the synthesis and properties of all aromatic and aryl-aliphatic polybenzimidazoles. Most of these polymers were prepared by the two-step process illustrated in Fig. 14 with the reaction of 1,3-benzenedicarboxylic acid diphenyl ester **27** and [1,1'-biphenyl]-3,3',4,4'-tetramine **11** yielding ultimately PBI **29**. All the applications – laminates and filament winding resins, adhesives, fibres and foams – used polymer **29**, which was produced in semi-commercial quantities by the Whittaker Corporation (Narmco Division) under the generic trade mark Imidite®. Currently, forty years later, this polymer is manufactured by Hoechst-Celanese and its only commercial success is in the area of heat resistant fibres and fabrics. It is, however, worth noting the adhesive properties of this polymer and the reasons explaining the major obstacles to the development of PBIs as heat-resistant adhesives.

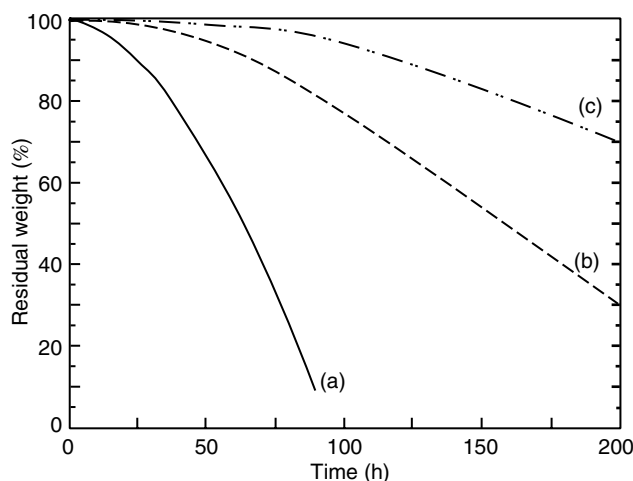

Figure 34: Isothermal ageing in air at 371°C of heat-resistant heterocyclic polymers: (a) polybenzimidazole **29**; (b) poly(*N*-phenylbenzimidazole); (c) polyimide **4** and polyphenylquinoxaline **15**.

Although original work demonstrated that PBI **29** shows no significant change on heating at 550°C and less than 5% weight loss after several hours at 600°C, the polymer exhibits appreciably lower stability in an oxidising atmosphere. The source of this instability has been attributed to the N–H group of the imidazole ring, this assumption being supported by the isothermal weight loss curves of Fig. 34.

Thermal ageing in air at 371°C shows that polybenzimidazole **29** is completely degraded after 100 h at that temperature [curve (a)]. Poly(*N*-phenylbenzimidazole) in which all N–H groups are replaced by N–C₆H₅ substituents exhibits better resistance to air oxidation with 70% weight loss after 200 h at 371°C [curve (b)], while both polyimide **4** and polyphenylquinoxaline **15** [curve (c)] are more stable with only 30% weight loss under the same time–temperature conditions.

Despite the copious evolution of phenol and water during processing, Narmco's commercial adhesive system (Imidite® 850) was based on prepolymer **28** mixed with aluminium powder, inorganic arsenic compounds such as arsenic thioarsenate or arsenic pentasulphide, and sterically hindered polyphenol antioxidant. Adhesive tapes were manufactured by hot-melt deposition of this mixture on a 112-type glass cloth carrier used in conjunction with a heat-resistant primer (polybenzimidazole or polyimide). As with all other heat resistant polymers, surface preparation of flat and honeycomb metal surfaces is an important factor in

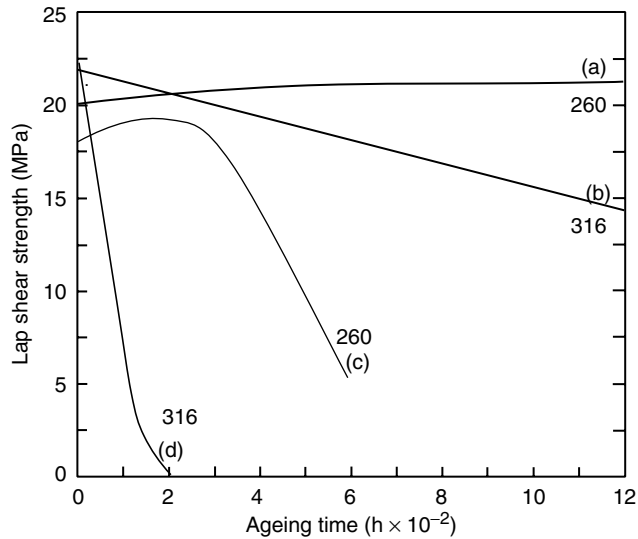

Figure 35: Variation of the lap shear strength as a function of the ageing time in flowing air for TU-2 titanium alloy coupons: Nolimid 380 at (a) 260°C and (b) 316°C; Imidite 850 at (c) 260°C and (d) 316°C.

long term ageing. Sand blasting, solvent degreasing, and acid etching are sequentially used before primer deposition. Imidite[®] 850 requires a curing schedule of 1 h at 220°C followed by 1 h at 315°C under 1.4 MPa pressure. A postcure treatment of 1 h at 371 or 400°C is then applied to improve the adhesive properties at high temperature. Polybenzimidazole adhesives exhibit high shear strength values for short periods at elevated temperatures, but the curves of Fig. 35 shows that the adhesive properties fall off rapidly on prolonged ageing. Although the strength retention of PBI adhesives at high temperature is superior to that of epoxy-phenolics, it is significantly inferior to that of condensation polyimides at 260 and 316°C.

To conclude this brief overview of the polybenzimidazole adhesives, it is quite clear from the number of test results that PBI cannot compete with polyimides. The major obstacle to the development of Imidite 850 has been its poor thermal-oxidative stability at temperatures greater than 250°C. In addition, the dependence on the use of aromatic tetraamines has introduced two other negative parameters, that is, the cost of these co-monomers and their carcinogenic properties. Furthermore, arsenic derivatives have been forbidden in adhesive composition and unsuccessfully replaced by boron powder which is not as good at preventing air oxidation of joined stainless steel alloys. Table 11 provides some key data to

Table 11: Processing conditions – pressure, temperature and postcure – for typical high-performance adhesives developed for the aerospace industries.

Adhesives	Pressure (MPa)	Curing (°C)	Postcure (time h/ temperature °C)	Voids (vol%)
Epoxy-phenolics	0.4	180	–	<2
HT-epoxies ^a	0.4	220	–	<1
PBI oligomers ^b	1.4	316	3/370	>10
Nolimid 380 ^c	0.3	316	5/350	5–10
FM 34 ^c	0.4*	180	2/316	13.8
NR 150 PAA ^d	0.5*	370	1/370	11
PPQ ^e	1.4*	400	1/425	1.4
Ultem 1000 ^f	0.4	380	–	<1
Poly(imide-siloxane)	0.1	250	–	<2
Poly(amide-imide)	0.8	200	8/250	<2
Larc TPI ^g	2.1	343	2/316	8.3
FM 32 bismaleimide	0.3	177	4/204	0.5
EA 9373 ^h	0.2	232	2/232	<1
Larc 13 bisnadimide	1.4*	316	4/316	5–8
FM 35 bisnadimide	1.4	290	10/316	5
Larc 160 PMR resin	0.7*	290	10/316	4–5
Thermid 600 ⁱ	1.4*	290	4/316	6
Thermid IP 600 ⁱ	1.4*	290	4/316	<3
Diethynyl-PPQ	0.35	370	4/370	<1

^a High temperature epoxies; ^b polybenzimidazole oligomers; ^c polyimide oligomers; ^d polyamic acid; ^e polyphenylquinoxaline; ^f poly(ether-imide); ^g thermoplastic polyimide; ^h epoxy-bismaleimide; ⁱ acetylene-terminated oligomers.

*Specimens bonded in vacuum bags (625 mm Hg) placed in autoclave at the indicated pressure.

compare the processing conditions of different high performance commercial adhesives tested for the fabrication of structural parts.

4.6. Applications

The constraints linked to the aerospace industry, which requires adhesives working at a given temperature for tens of thousands of hours, are probably the most difficult to solve. This is due to the size of the parts to be bonded as well as the

limits imposed by the existing industrial tools. Research in this domain presently focuses on thermoplastic polyimides with improved melt viscosity and on the *in situ* polymerisation route leading to high T_g systems with less volatile evolution. In the domain of polyimide adhesives, patents and scientific communications mainly focus on melt-fusible polyimides, fluorinated polyimides and poly(imide-siloxanes). Although Larc-TPI processing requires elevated temperatures and relatively high pressures, the level of adhesion obtained with this polymer was an impetus to study new thermoplastic polyimides. In the case of Larc-TPI, a lower melt-viscosity has been achieved by unbalancing the stoichiometry between BTDA and 3,3'-carbonylbisbenzeneamine and adding phthalic anhydride to block the polyimide chain ends. Using this process, Mitsui Toatsu has been expanding the market for its Larc-TPI adhesive film before introducing other varieties of thermoplastic polyimides. These adhesives are mainly poly(ether-imides) prepared from aromatic diamines comprising two or more oxygen bridges between the aromatic rings. They are characterised by relatively low glass transition temperatures (200–250°C) making them more suitable for electronic applications than as high-temperature structural adhesives.

An example of thermoplastic fluorinated polyimide adhesives is provided in Fig. 36. The first step is the reaction of 4,4'-[2,2,2-trifluoro(1-trifluoromethyl)ethylidene]bis(1,2-benzenedicarboxylic acid) dianhydride with either 4,4'-[[2,2,2-trifluoro-1-(trifluoromethyl)ethylidene]bis(4,1-phenyleneoxy)]bisbenzeneamine or 4,4'-[(1-methylethylidene)bis(4,1-phenyleneoxy)]bisbenzeneamine yielding the corresponding polyamic acids. Chemical dehydrocyclisation with trifluoroacetic anhydride and triethylamine provides the poly(ether-isoimides) **52** and **54** with η_{inh} 0.40 and 0.45 dl g⁻¹, respectively, whereas acetic anhydride and pyridine gave polyimides **53** and **55** with η_{inh} 0.75 and 0.71 dl g⁻¹, respectively [89].

Self-standing films of the four polymers were placed between 5 × 5 cm² copper foils and the assemblies were melt processed under 14.7 MPa. The peel strength value measured for the assembly bonded with polyisoimide **52** (765 N m⁻¹) was ten times higher than that found for polyimide **53**, the two polymers being processed at 260°C. Identical results, although with lower peel strengths, were obtained with polymers **54** and **55**. Polyisoimides **52** and **54** have glass transition temperatures 60–90°C lower than the temperature of the isoimide to imide conversion. This results in lower melt viscosities, and accordingly better adhesion, for the imide forms of the polymers.

Virtually all imaginable polymers that can be prepared through the polyheterocyclisation concept have been reported in the literature. After four decades of intensive research and development, only polyimides are in full commercial production. As previously outlined, polybenzimidazoles are supplied exclusively in the form

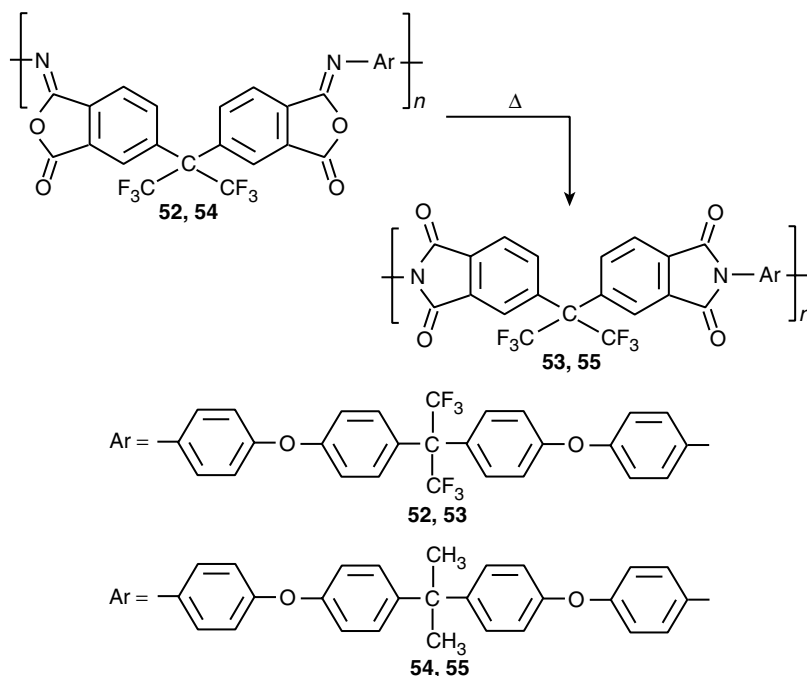

Figure 36: Chemical formulae of fluorinated thermoplastic poly(ether-isoimides) **52** and **54**, and poly(ether-imides) **53** and **55** used to prepare heat-resistant, flexible adhesive films.

of fibres and fabrics exhibiting almost complete non-flammability in air. They can be dyed with conventional dyestuffs and the resulting fabrics are used for air and spacecraft crew protection. Polyphenylquinoxaline films and coatings that have an exceptional resistance to concentrated bases (NaOH and KOH) were withdrawn from the market in 1995. Polyimides are too expensive to share a significant part of the consumer-oriented products such as coatings on cookware. For example, low-cost polyphenylene sulphide is preferred to polyimides as the base resin loaded with 15% of Teflon[®] to make nonstick coatings on the interior of cookware.

In contrast, the consumption of polyimides has increased in the electronic industry, especially for the fabrication of flexible circuitry and its associated tape automated bonding process. High level of adhesion and thermoplasticity are the prominent parameters for these applications. Compared to aerospace applications, electronics imposes new requirements because of the exposition to high temperatures that is generally limited to short-time exposures at 350 to 400°C. In the aerospace industry, Larc-TPI performs well to bond Kapton[®] to itself as to

other substrates. This is an important application because each space shuttle contains 900 kg of Kapton, while Boeing 767 and other recent civil aircraft use several hundred kilograms of polyimide films. Glass and carbon fibre reinforced composites increasingly replace stainless steel, aluminium and titanium alloys and it is preferable to adhesively bond than mechanically fasten these composite structures. A review by Politi indicates the applications and products developed by American Cyanamid to fulfil the requirements of the aerospace industry [90]. Parts subjected to high temperatures are typically the engine nacelles involving thousands of hours of exposure in the range 150–300°C, supersonic military aircraft subjected to 150–200°C for hundreds of hours, and missile applications requiring acceptable adhesive properties for a few minutes of exposure to temperatures up to 500°C. Fig. 37 shows a bonded engine nacelle.

It has been previously outlined that the thermal stability of organic materials is a time–temperature dependent concept. Thus, heat-resistant adhesives are those that can be safely used for thousands of hours between 200 and 300°C. This definition excludes the epoxy and epoxy-phenolic adhesives which are, however, the predominant classes of polymers used in aeronautics. Epoxy adhesives based on

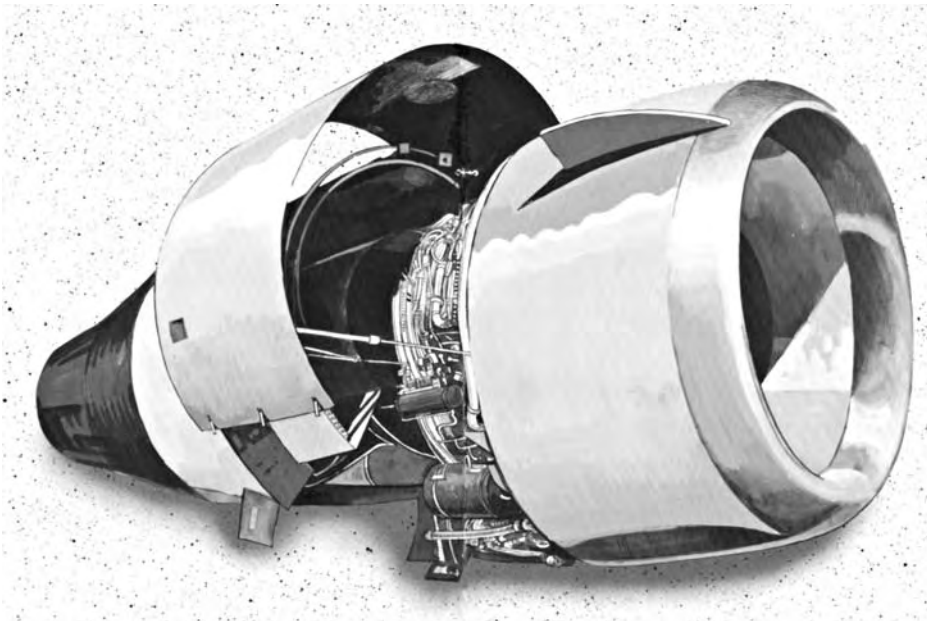

Figure 37: Jet engine nacelles are insulated sandwiches which are bonded with heat resistant adhesives including paste or film adhesives and syntactic film core materials.

multifunctional resins, such as the epoxy novolacs, are commonly used to bond aluminium alloys and epoxy matrix composite parts. They are cured at moderate temperatures, typically 150–200°C, with low pressure bonding. The adhesives designed for use on supersonic military aircraft exhibit 80% of the initial lap shear strength after 3000 h ageing at 215°C, whereas no significant drop in lap shear strength is observed after 20,000 h at 175°C for the adhesives used to bond engine nacelles. Oxidative degradation is faster in the sandwich panels formed of aluminium skins bonded to aluminium honeycombs. In this case, the assembly exhibits a 50% drop in flatwise tensile strength after 10,000 h ageing at 175°C. Although they are cured only at 150°C with a bond pressure of 0.3 MPa, epoxy-phenolic adhesives can withstand short time exposure to 400–500°C. Because of these rather moderate cure conditions, they are often preferred to polyimides for use on missiles. For example, American Cyanamid HT[®] 424 loaded with aluminium powder retains approximately 7 MPa lap shear strength at 540°C. This adhesive shows excellent strength retention after 500 h ageing at 260°C in inert atmosphere and less than 50 h when aged in air.

The graph of Fig. 33 shows that only a few polyimide resins can be used above 200°C. Taking into consideration the long-term oxidative resistance, typically 10,000 to 40,000 h, the addition polyimides exhibit a good thermal stability at 204°C for the bismaleimide and 230°C for the bisnadimide adhesives. Linear thermoplastic polyimides such as Larc-TPI and fluorinated resins retain excellent adhesion at 232°C, while condensation polyimides loaded with aluminium powder are usable at 260°C. In order to produce non-volatile adhesive films, bismaleimides are formulated through the use of reactive liquid monomers providing both drapability and plasticisation. The processing conditions of BMI adhesives are similar to those employed with high-temperature epoxies, typically 2 h at 175–180°C under 0.3 MPa pressure, followed by a postcure at 225–245°C for two additional hours. BMI adhesives fill a niche market between epoxies and other polyimide materials. The consumption of formulated bismaleimides for this application is of the order of 40–50 tons per year, at least ten times less than the quantity of bismaleimides employed to fabricate reinforced composites.

Compared to BMI adhesives, the nadimide-terminated resins discussed in Section 4.3.4.2 exhibit a better thermal-oxidative resistance, but they require a complex cure schedule in autoclaves. Condensation and imidisation of the monomer reactants is performed at 205°C under partial vacuum to remove methyl alcohol and water. Addition polymerisation of the norbornene rings is then conducted under full vacuum at 290°C with an applied air pressure of 0.7 MPa. PMR adhesives have been successfully tested for bonding parts of cruise missiles, space shuttle, and YF-12 aircraft. The lap shear strength data indicate an excellent adhesion after a long-term ageing at 232°C and approximately 200 h at 316°C.

Thermoplastic polyimides, including NR-05, Larc TPI, Larc IA and a few other adhesive films provide good quality joints exhibiting excellent adhesive strength (20–25 MPa) after 30,000 h ageing in air at 232°C. They do not require vacuum bags, but they must be processed at high temperature, typically 340–370°C. Condensation prepolymer precursors of long-chain polyimides, such as Nolimid® 380 and FM 34®, exhibit the maximum achievable thermal resistance with lap shear strength values of 20 MPa after 20,000 h at 260°C and 15 MPa after 5000 h at 300°C. However, these adhesives contained arsenic derivatives and they were withdrawn from the marketplace because of their potential toxicity. In addition, the high volatile content of these adhesives requires a two-stage thermal polycondensation process. The first step is performed in conventional autoclaves by heating the assembly for 2 h at 175–200°C under full vacuum plus 0.3 MPa air pressure. The second stage consists of heating the panels into a high-temperature oven between 290 and 350°C.

In conclusion, it is worth noting that different categories of heat-resistant adhesives have been developed for the aerospace industry. However, mechanical fastening with rivets remains the predominant technique used in the construction of civil subsonic airliners. Where adhesive bonding is required, epoxy and epoxy-phenolic resins are convenient materials exhibiting excellent adhesion up to 175°C. Supersonic military aircraft incorporate an increasing number of parts made of carbon-fibre reinforced composites using either bismaleimide or PMR resins as organic matrices. These elements can be bonded by means of the same polymers supplied as pastes or supported films. If BMI adhesives can be processed by using the conventional tools used for epoxy resins, PMR resins require expensive high-temperature autoclaves. As discussed in the previous sections, all categories of polyimides have been extensively studied to produce heat-resistant adhesives but none of them are currently used in amounts similar to those of the epoxy and epoxy-phenolic resins.

References

- [1] Rabilloud, G. and Sillion, B., *European Polymer Journal*, 1990, 26(9), 967–976.
- [2] Rabilloud G. and Sillion, B., *European Polymer Journal*, 1990, 26(9), 977–985.
- [3] Schwartz, H., *Structural adhesives development*, in *Treatise on Adhesion and Adhesives, Structural Adhesives*, Vol. 4. Marcel Dekker, New York, 1976.
- [4] Keimel, F.A., *Historical development of adhesives and adhesive bonding*, in A. Pizzi and K.a L. Mittal (Eds.), *Handbook of Adhesive Technology* (pp. 3–15), Marcel Dekker, New York, 1974.
- [5] E.I. Du Pont de Nemours and Co., Fr. Demande FR 1 239 49, 1960.
- [6] Edwards, W.M., US 3 179 614, 1965.

- [7] Edwards, W.M., *US* 3 179 634, **1965**.
- [8] Choe, E.W. and Conciatori, A.B., *Eur. Pat. Appl. EP* 115 945, **1984**.
- [9] Cassidy, P., *Thermally Stable Polymers: Syntheses and Properties*, Marcel Dekker, New York, **1980**.
- [10] Critchley, J.P., Knight, G.J. and Wright, W.W., *Heat Resistant Polymers*, Plenum, New York, **1983**.
- [11] Weber, W.D. and Gupta, M.R., *Recent Advances in Polyimide Science and Technology*, Society of Plastic Engineers, Poughkeepsie, New York, **1987**.
- [12] Bessonov, M.I., Koton, M.M., Kudryavtsev, V.V. and Laius, L.A., *Polyimides: Thermally Stable Polymers*, Plenum, New York, 2nd edition, **1987**.
- [13] Bessonov, M.I. and Zubkov, V.A., *Polyamic Acids and Polyimide Synthesis, Transformation and Structure*, CRC, Boca Raton, **1993**.
- [14] Ghosh, M.K. and Mittal, K.L., (Eds.), *Polyimides Fundamental and Applications*, Marcel Dekker, New York, **1996**.
- [15] Rabilloud, G., *High Performance Polymers, Chemistry and Applications, Polyquinoxalines and Polyimides*, vol. 2. Éditions Technip, **1999**.
- [16] Rabilloud, G., *High Performance Polymers, Chemistry and Applications, Conductive Adhesives*, vol. 1. Éditions Technip, **1997**.
- [17] Verdet, L., Pascal, T., Rabilloud, G. and Muller, G., *SPE/ANTEC Conference Proceedings*, Atlanta, USA, 904–907, **1988**.
- [18] Fjare, D.E., *Macromolecules*, **1993**, 26, 5143–5148.
- [19] Sroog, C.E., History of the invention and development of the polyimides, in M.K. Ghosh and K.L. Mittal (Eds.), *Polyimides Fundamental and Applications* (pp.1–6). Marcel Dekker, New York, **1996**.
- [20] Gibbs, H.H., *National SAMPE Symposium Exhibition*, **1972**, 17, 17–25.
- [21] Hergenrother, P.M. and Levine, H.H., *Polymer Preprints American Chemical Society, Division of Polymer Chemistry*, **1967**, 8, 501–507.
- [22] Hergenrother, P.M. and Levine, H.H., *Journal of Polymer Science*, Part A1, **1967**, 5, 1453–1466.
- [23] Becker, R. and Raubach, H., *Faserforsch. Textiltech.*, **1975**, 26, 406–407.
- [24] Angelo, R.J., Golike, R.C., Tatum, W.E. and Kreuz, J.A., Recent Advances in Polyimide Science and Technology, in W.D. Weber and M.R. Gupta (Eds.), *Society of Plastic Engineers* (pp. 67–91), Brookfield, **1985**.
- [25] Chow, A.W., Hamlin, R.D., Landis, A.L. and Lau, K.S.Y., *Journal of Rheology*, **1992**, 36, 1651–1668.
- [26] Progar, D.J., *Journal of Adhesives Science and Technology*, **1987**, 1, 53–67.
- [27] Progar, D.J., *International Journal of Adhesives and Adhesion*, **1984**, 4, 79–86.
- [28] Progar, D.J. and St. Clair, T.L., *Journal of Adhesives Science and Technology*, **1990**, 4, 527–549.
- [29] Vogel, H. and Marvel, C.S., *Journal of Polymer Science*, **1961**, 50, 511–539.
- [30] Rabilloud, G., Sillion, B. and De Gaudemaris, G., *Fr. Demande FR* 1 601 091, **1968**.
- [31] Uchimura, S., Okuda, N., Morishima, H., Suzuki, H., Sato, H. and Makino, D., Planarity of high solid type polyimides in Y. Tabata., I. Mita, S. Nonogaki., K. Horie

- and S. Tagawa (Eds.), *Polymers in Microelectronics Proceedings International Symposium* (pp. 603–616), Kodansha, Tokyo, **1989**.
- [32] Stenzenberger, H.D., Chemistry and properties of addition polyimides in D. Wilson, H.D. Stenzenberger, and P.M. Hergenrother (Eds.), *Polyimides* (pp. 79–128), Blackie, Glasgow, **1990**.
- [33] Bargain, M., Combet A., and Grosjean P., *Fr. Demande FR 1 555 564*, **1969**.
- [34] Mallet, M.A. and Darmory, F.P., *American Chemical Society, Division of Coatings and Plastic Chemistry Preprints*, **1974**, 34, 173–175.
- [35] Stenzenberger, H.D., *Applied Polymer Symposia*, **1977**, 91–104.
- [36] Lubowitz, H.R., *US 3 528 950*, **1970**.
- [37] Lubowitz, H.R., *American Chemical Society, Division of Coatings and Plastic Chemistry Preprints*, **1971**, 31(1), 561–568.
- [38] Serafini, T.T., Delvigs, P. and Lightsey, G.R., *Journal of Applied Polymer Science*, **1972**, 16, 905–915.
- [39] Wong, A.C. and Ritchey, W.M., *Spectroscopy Letters*, **1980**, 13, 503–508.
- [40] Wong, A.C. and Ritchey, W.M., *Macromolecules*, **1981**, 14, 825–831.
- [41] Alston, W.B., *National SAMPE Symposium Exhibition*, **1985**, 30, 1622–1638.
- [42] Vannucci, R.D., *International SAMPE Symposium Exhibition*, **1987**, 32, 602–612.
- [43] Landis, A.L., Bilow, N., Boshan, R.H., Lawrence, R.E. and Aponyi, T.J., *Polymer Preprints, American Chemical Society, Division of Polymer Chemistry*, **1974**, 15(2), 537–541.
- [44] Bilow, N., *ACS Symposium Series*, **1980**, 132, 139–150.
- [45] Landis, A.L. and Naselow, A.B., *National SAMPE Technical Conference*, **1982**, 14, 236–242.
- [46] Sefcik, M.D., Stejskal, E.O., McKay, R.A. and Schaefer, J., *Macromolecules*, **1979**, 12, 423–425.
- [47] Sandreczki, T.C. and Lee, C.Y.C., *Polymer Preprints, American Chemical Society, Division of Polymer Chemistry*, **1982**, 23, 185–186.
- [48] Hergenrother, P.M., Sykes, G.F. and Young, P.R., *Preprints, Division of Petroleum Chemistry, American Chemical Society*, **1979**, 24(1), 243–257.
- [49] Kreuz, J.A., Endrey, A.L., Gay, F.P. and Stroog, C.E., *Journal of Polymer Science, Part A1*, **1966**, 4, 2607–2616.
- [50] Laius, L.A., Bessonov, M.I., Kallistova, Y.V., Adrova, N.A. and Florinskii, F.S., *Vysokomolekularnye Soedineniya, Ser. A*, **1967**, 9, 2185–2192.
- [51] Koton, M.M., Meleshko, T.K., Kudryavtsev, V.V., Nechayev, P.P., Kamzolkin, Y.V. and Bogorad, N.N., *Vysokomolekularnye Soedineniya, Ser. A*, **1982**, 24, 715–721.
- [52] Pryde, C.A., *Journal of Polymer Science, Part A*, **1987**, 27, 711–724.
- [53] Sanseau, P., Study of Heat Resistant Polymers for Insulation of Interconnects in Integrated Circuits, Thèse de doctorat, Université de Grenoble, **1988**.
- [54] Ibbert, R., *NMR Spectroscopy of Polymers*, Blackie Academic & Professional, London, **1993**.
- [55] Glöckner, G., *Polymer Characterization by Liquid Chromatography*, Elsevier, New York, **1987**.

- [56] Hergenrother, P.M., *Journal of Applied Polymer Science*, **1974**, 18, 1779–1791.
- [57] Hergenrother, P.M., *Polymer Engineering Science*, **1976**, 16, 303–308.
- [58] Hergenrother, P.M. and Progar, D.J., *Adhesives Age*, **1977**, 20(12), 38–43.
- [59] Progar, D.J. and St. Clair, T.L., *National SAMPE Technical Conference*, **1975**, 7, 53–67.
- [60] St. Clair, T.L. and Progar, D.J., *Journal of Adhesives Science and Technology, Part A*, **1975**, 9, 187–198.
- [61] Cell, V.L., Stump, B.L. and Gager, H., *Journal of Polymer Science, Polymer Chemistry Edition*, **1976**, 14, 2275–2291.
- [62] Hendricks, C.L. and Hale, J.H., High temperature adhesive development and evaluation in J.D. Buckley and B.A. Stein (Eds.), *Welding, Bonding and Fastening*, **1984**; NASA CP-23187, 351–390, **1985**.
- [63] Johnston, N.J. and St. Clair, T.L., *International SAMPE Technical Conference*, **1986**, 18, 53–67.
- [64] Progar, D.J., *Journal of Adhesives Science and Technology*, **1987**, 1, 53–67.
- [65] Yamaguchi, A. and Ohta, M., *International SAMPE Technical Conference*, **1986**, 18, 229–241.
- [66] Progar, D.J., *International Journal of Adhesives and Adhesion*, **1984**, 4, 79–86.
- [67] Progar, D.J. and St. Clair, T.L., *Journal of Adhesives Science and Technology*, **1990**, 4, 527–549.
- [68] Progar, D.J. and Pike, R.A., *International Journal of Adhesives and Adhesion*, **1988**, 8, 25–32.
- [69] Shaw, S.J. and Kinloch, A.J., *International Journal of Adhesives and Adhesion*, **1985**, 5, 123–127.
- [70] Rakutt, D., Fitzer, E. and Stenzenberger, H.D., *High Performance Polymers*, **1990**, 2, 133–147.
- [71] Blair, M.T., Steiner, P.A. and Willis, E.N., *International SAMPE Symposium Exhibition*, **1988**, 33, 524–537.
- [72] Ting, R.Y. and Cottingham, R.L., *Journal of Adhesives*, **1981**, 12, 243–245.
- [73] American Cyanamid Co., FM 32 technical bulletin.
- [74] Hysol Division of the Dexter Corporation, EA 9655 and LR 100-774 technical bulletins.
- [75] St. Clair, T.L. and Progar, D.J., *National SAMPE Symposium Exhibition*, **1979**, 24, 1081–1092.
- [76] Hendricks, C.L. and Hill, S.G., *SAMPE Quarterly*, **1981**, 12, 32–37.
- [77] Hill, S.G., Sheppard, C.H. and Johnson, J.C., *NASA Contract Report*, NASA-CR-159317, **1980**.
- [78] Stenersen, A.A. and Wyke, D.H., *National SAMPE Technical Conference*, **1980**, 12, 746–758.
- [79] Riefler, R.S., *National SAMPE Symposium Exhibition*, **1985**, 30, 479–489.
- [80] Kuhbänder, R.J. and Aponyi, T.J., *National SAMPE Technical Conference*, **1979**, 11, 295–308.

- [81] Hanky, A.O. and St. Clair, T.L., *International Journal of Adhesives and Adhesion*, **1983**, 3, 181–187.
- [82] Darmory, F.P., *National SAMPE Technical Conference*, **1973**, 5, 415–422.
- [83] American Cyanamid Co., FM 34B-18 adhesive, technical data sheet.
- [84] Gibbs, H.H., *National SAMPE Symposium Exhibition*, **1972**, 17, 17–25.
- [85] Gibbs, H.H., *National SAMPE Symposium Exhibition*, **1976**, 21, 592–601.
- [86] Blatz, P.S., *Adhesives Age*, **1978**, 12(9), 39–44.
- [87] Polybenzimidazoles in H. Lee H.D. Stoffey and K. Neville (Eds.), *New Linear Polymers* (pp. 265–304), McGraw-Hill, New York, **1967**.
- [88] Polymers with heterocyclic rings in the chain in J.P. Critchley, G.J. Knight and W.W. Wright (Eds.), *Heat-Resistant Polymers* (pp. 185–321), Plenum Press, New York, **1983**.
- [89] Mochizuki, A., Teranishi, T. and Ueda, M., *Polymer*, **1994**, 35, 4022–4027.
- [90] Politi, R.E., Recent developments in polyimide and bismaleimide adhesives in T.T. Serafini (Ed.), *High Temperature Polymer Matrix Composites* (pp. 123–134). Noyes Data Corporation, **1987**.

Heat Stable Adhesives

- | | |
|--|--|
| ABLESTIK Electronic Adhesives | 20021 Susana Road,
Ran cho Dominguez,
CA 90221, USA,
Tel.: 1 310-764-4600 |
| DOW CORNING (Silicones) | PO Box 0994 Midland,
MI 486686, USA,
Tel.: 1517-496-6000 |
| BRYTE TECHNOLOGIES | 18410 Butterfield Blvd,
Morgan Hill,
California 95037, USA,
Fax: (408) 776-0700, (408) 776-0107,
www.brytetetech.com |
| GE SILICONES | 260 Hudson River Road,
Waterford NY, 12188-USA
Tel.: 1800-255-8886 |
| LOCTITE AEROSPACE-
HENKEL
TECHNOLOGIES | Loctite Aerospace
2850 Willow Pass Road
P.O. Box 312
Bay Point,
CA 94565-0031,
Tel.: 925.458.8000,
www.loctite.com

Loctite Coporation,
82, rue de Maubec,
31300 Toulouse,
France
Tel.: +33(0)5.34.36.40.64,
Fax: 33(0)5.34.36.40.69 |
| HEXCEL | Duxford, Cambridge,
CB2 4QD, United Kingdom,
Tel.: 44 (0) 1223 833141,
Fax: 44 (0) 1223 838808

1171 Dublin Blvd, Dublin
CA 94568-2832, USA,
Tel.: 1 925 551 4900,
Fax: 1 925 828 9202 |

101 East Ridge Drive, Suite 102
Danbury, CT 06810, USA,
Tel.: 1 203 798 8311
Fax: 1 203 798 8161

Rue Trois Bourdons, 54,
B-4840 Welkenraedt, Belgium,
Tel.: 32 87 307 411,
Fax: 32 87 882 895

Room B707, Yin Hai Bldg,
250 Cao Xi Rd
Shanghai 200233, China,
Tel.: 86 21 6483 6741/2,
Fax: 86 21 6483 6744

ZI La Plaine, B.P.27 Dagneux,
01121 Montluel, France,
Tel.: 33 (0)4 72 25 26 27
Fax: 33 (0)4 72 25 27 30

Am Westpark 1, D-81373,
München, Germany,
Tel.: 49 89 743 5250
Fax: 49 89 743 52520

CYTEC Engineered
Materials Inc.

Cytec Engineered Materials Inc.
1300 Revolution Street, Havre de Grace,
MD 21078, USA,
Tel.: (410) 939-8127, Fax: (410) 939-8103

Cytec Engineered Materials Inc.
1440 North Kraemer Blvd., Anaheim,
CA 92806,
Tel.: (714)666-4344, Fax: (714) 630-9410

Cytec Engineered Materials Ltd.,
Abenbury Way, Wrexham Industrial Estate,
Wrexham LL 13 9uz, Wales,
United Kingdom,
Tel.: +44 1978-665200, Fax: +44-1978-665222

LONZA (cyanate ester
resins)

Valais Works
CH 3930 Visp, Switzerland,
Tel.: 4127 948 5111, Fax: 4127 947 5633

FERRO Corp	USA
mitsui TOATSU	Japan
Du PONT De NEMOURS (polyimides)	Wilmington, Delaware, USA
WACKER (Silicones)	Johannes Hess, Strasse 24, D 88489, Burghausen, Germany
TOSHIBA (Silicones)	Japan

Note: For the Electronic heat-stable adhesives our readers may also refer to the list of suppliers published in Volume 1 of the Handbook.

Chapter 5

UV-Radiation Curing of Adhesives

Christian Decker

Prof. Christian Decker is Director of Research at the National Center for Scientific Research (CNRS) in France. He got his doctor in science degree in 1967 from the University of Strasbourg. He has been working on radiation-induced reactions in polymer materials at the Research Center on Macromolecules of Strasbourg and at Stanford Research in California. In 1975, Professor Decker joined the University of Haute Alsace to become head of the Polymer Photochemistry Laboratory at the Ecole Nationale Supérieure de Chimie de Mulhouse. His present research interests are in ultrafast light-induced polymerizations, the synthesis and characterization of UV-cured coatings, adhesives and nanocomposites, photostabilization of polymers, and laser-assisted chemical processing of polymers. Prof. Decker is the author of 300 research publications and patents, and he has given over 300 lectures in scientific meetings.

Keywords: Acrylates; Crosslinking; Dual cure; Epoxides; Glass laminates; Interpenetrating polymer networks; Isocyanates; Photo initiated cationic polymerisation; Photoinitiators; Photopolymerisation; Pressure sensitive adhesives; Release coatings; Structural adhesives; Thiol/polyene; UV radiation curing; Vinyl ethers.

5.1. Introduction

There is a growing trend in the adhesives industry to develop fast setting solvent-free resins, because of ever more stringent regulations regarding the emission of volatile organic compounds. In this respect, UV-curable adhesives appear to be ideal candidates since such liquid formulations contain no organic solvents and are readily transformed into solids by a short exposure to UV-radiation at ambient temperature. This feature, together with the resulting low consumption of energy and the high performance of the UV-cured materials, explains the increasing use of this environment-friendly technology in the adhesives industry. The subject has been extensively investigated over the past two decades and covered in several comprehensive articles and textbooks [1–10].

UV-radiation curing consists basically of a photoinitiated polymerisation of multi-functional monomers which are converted into a tridimensional polymer network according to the following reaction scheme [11]:

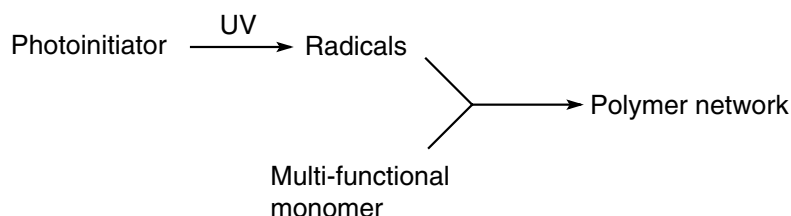

A photoinitiator is used to absorb the UV-radiation and generate upon cleavage the reactive species, free radicals or protonic acid, that will initiate the cross-linking polymerisation reaction according to a radical or cationic mechanism, respectively. Once initiating radicals or ions have been produced, the following steps (chain propagation and termination) will essentially be the same as in a conventional polymerisation, except for the much larger rate of initiation caused by the intense illumination. A liquid resin can thus be transformed into a solid polymer within a fraction of a second [12].

A unique advantage of the UV-curing technology is to provide a precise temporal and spatial control of the setting process which will occur on order, selectively in the illuminated areas. Such performance, together with cost and environmental consideration, are the main reasons why UV-curable adhesives are being increasingly used and continue to attract attention in various industrial sectors, as shown by the numerous patents taken recently on novel applications of this technology [14–19].

A crucial factor in developing high performance UV-curable adhesives is obviously to ensure an excellent adhesion onto the various types of supports (plastics, glass, metals, paper). In this respect, the absence of a solvent in the resin formulation is certainly a disadvantage, compared to solvent-based adhesives where the bonding onto organic materials is enhanced through the solvent-driven softening effect of the substrate surface. Moreover, a high strain is building up in the polymer during the ultrafast curing reaction and its concomitant volume contraction, which leads usually to a poor adhesion [13]. One way to offset this detrimental effect is by promoting the formation of van der Waals or hydrogen bonds between the UV-cured polymer and the substrate, or even covalent bonds by photografting.

Another limitation of the UV technology in adhesive applications results from the fact that curing of the resin occurs only in the illuminated areas, so that at least one part of the assembly needs to be transparent to UV light. Moreover, for complex shaped tridimensional objects, it will be difficult to harden the resin

located in the shadowed areas. Both of these issues need to be addressed to widen the field of application of UV-curable adhesives.

In this review article, the progress recently made in the development of UV-curable adhesives will be outlined, with respect to both the resin formulation and the characteristics of the photopolymer obtained. Special attention will be given to the basic chemistry involved in photo-cross-linking polymerisation and its kinetic analysis, because the final properties of UV-cured adhesives will depend on a good understanding and control of the manifold reactions occurring during such ultra-fast molecule to material transformations. The main applications of UV-curable adhesives will be discussed afterwards in consideration of the growing development of such systems in a large variety of industrial sectors where they are used as structural adhesives to bond metals, glass and plastic components, as sealants or encapsulation compounds, and as pressure-sensitive and hot-melt adhesives.

5.2. Different Types of UV-Curable Adhesive Resins

The light-induced hardening of adhesives is generally achieved by a polymerisation reaction proceeding either by a radical mechanism (e.g. for acrylic resins) or a cationic mechanism (e.g. for epoxides). Dual-cure systems, where the UV-exposure is followed by a thermal treatment have to achieve an effective curing of the insufficiently illuminated areas [20]. Typical formulations of UV-curable adhesives consist of a photoinitiator, a functionalised oligomer or prepolymer that will constitute the backbone of the tridimensional polymer network, and a monomer used as reactive diluent or plasticiser to adjust the formulation viscosity or rheology. Dual-cure systems contain some additional functionalities, usually isocyanate and hydroxy groups, in order to ensure an effective cross-linking in the dark areas upon heating.

The photoinitiator plays a key role by controlling both the rate of initiation and the penetration of the incident light, and therefore the depth of cure. The rate of polymerisation depends on the reactivity of the functional group, its concentration and on the viscosity of the resin, as well as on the intensity of the UV-radiation. The chemical structure and functionality of both the functionalised oligomer and the monomer are critical factors that determine the cross-linking density and the viscoelastic properties of the UV-cured polymer. Better adhesion is usually achieved with low-modulus elastomers showing a great affinity toward the substrate through hydrogen bonding or grafting. The different types of UV-curable resins commonly employed in adhesive applications will now be described by focusing on the chemical and kinetic aspects of the curing process, in relation to their adhesion performance.

5.2.1. Photoinitiated Radical Polymerisation

Most of the radical-type photoinitiators used in UV-curable adhesives consist of aromatic ketones which are known to generate free radicals upon UV-exposure, either by homolytical cleavage of C–C bonds, or by hydrogen abstraction from a H-donor molecule [11]:

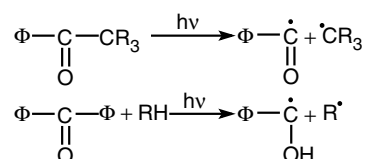

Both the benzoyl and alkyl radicals initiate the polymerisation by addition to the monomer double bond. By contrast, the ketyl radical is inactive toward vinyl double bonds, so that initiation occurs through the H-donor radical. To be efficient, a photoinitiator must effectively absorb the radiation emitted by the light source

Radical-type polymerisation

Photoinitiators

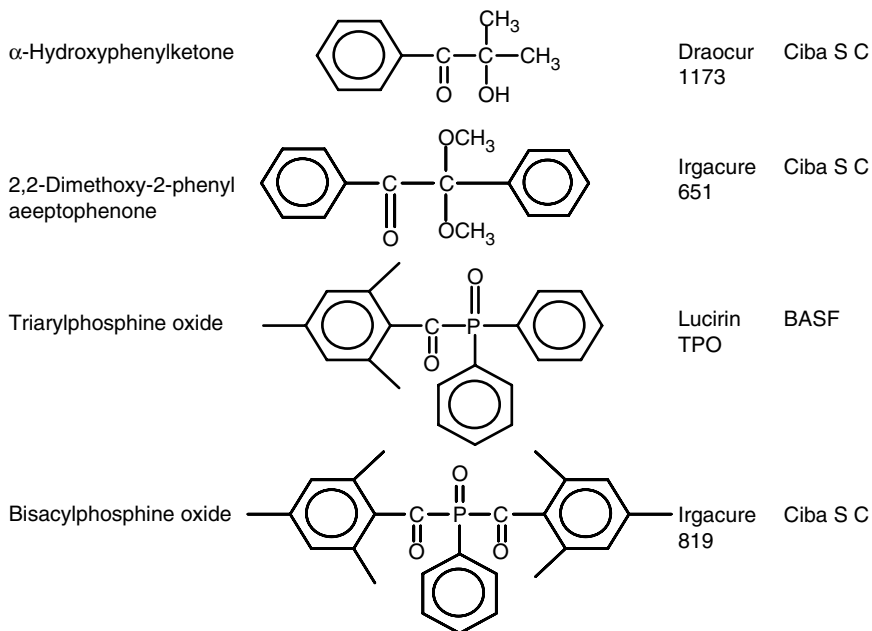

Chart 1: Chemical formula of radical-type photoinitiators.

and generate initiating radicals with high yields. There is a large number of commercially available photoinitiators which have been recently surveyed by Dietliker in a comprehensive compilation [21] and an excellent textbook [22]. The chemical formulae of some typical radical photoinitiators are given in Chart 1. Their absorption needs to overlap the emission spectrum of the UV source, usually a mercury lamp, as photochemical reactions can only occur if light has been absorbed.

5.2.1.1. UV-Curable Acrylate Resins

Acrylates are known to be amongst the most reactive monomers polymerising by a free-radical mechanism. This feature, together with the tailor-made properties of the photopolymer obtained, account for the wide use of acrylate-based UV-curable adhesives. There is a large variety of acrylate functionalised oligomers that are commercially available [23]. They differ in their chemical structures, which can be polyurethanes, polyesters, polyethers and polysiloxanes, and by their molecular weight which ranges typically between 500 and 2000 g. The photoinitiated cross-linking polymerisation of an acrylated oligomer is represented schematically in Chart 2. The final properties of UV-cured acrylate polymers depend primarily on the chemical structure of the functionalised oligomer, the degree of cure and

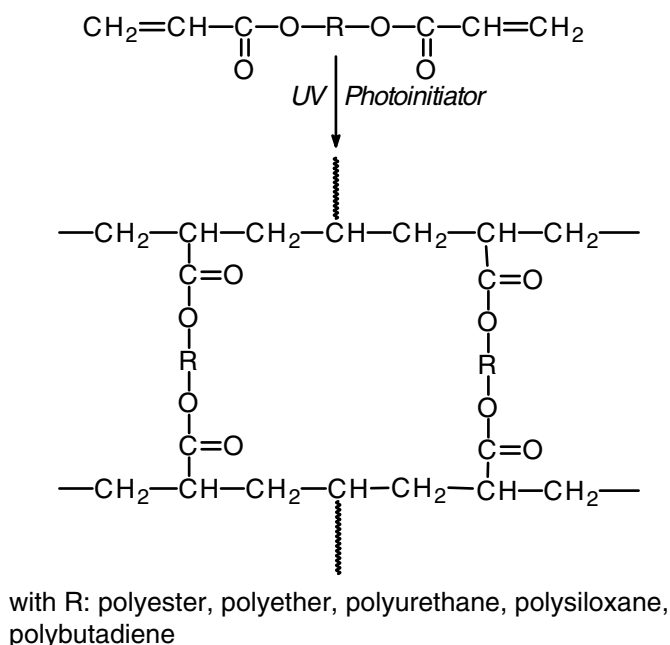

Chart 2: UV-curing of an acrylated oligomer.

the cross-linking density. Low-modulus elastomers are generally obtained with aliphatic compounds having soft segments, while hard and glassy materials are formed when aromatic structures are present in the polymer chain [24].

Because of growing molecular mobility restrictions during the light-induced liquid to solid phase change, polymerisation stops when vitrification occurs, which leads to an incompletely cured glassy material. High degrees of polymerisation (close to 100% conversion) are reached with aliphatic polyurethane-acrylates that give elastomeric materials upon UV-curing at ambient temperature, well-suited for adhesive applications. Fig. 1 shows some typical polymerisation profiles recorded by real-time infrared (RTIR) spectroscopy [25,26] for an aromatic polyether-acrylate (glassy material) and an aliphatic polyurethane-acrylate (elastomeric material), by using diacrylate and monoacrylate reactive diluents, respectively. The monomer used to lower the formulation viscosity plays a key role by controlling not only the polymerisation kinetics, but also the properties of the cross-linked polymer formed. Increasing the monomer functionality was found to accelerate the curing reaction, but also to reduce the final degree of polymerisation because of early gelation and vitrification of the irradiated sample. The greater cross-link density leads to glassy polymer materials which are hard but brittle and therefore ill-suited for adhesive applications.

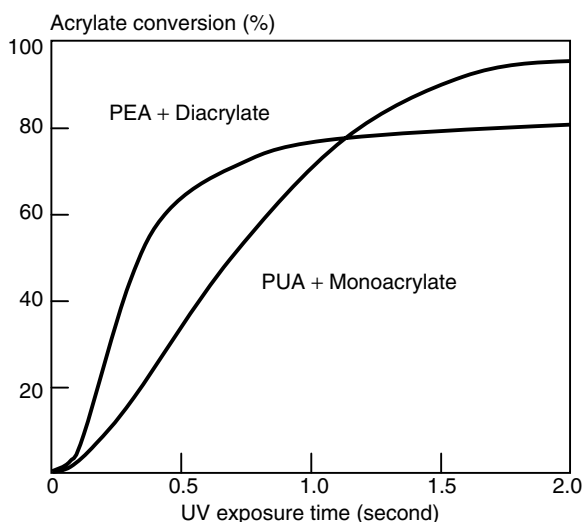
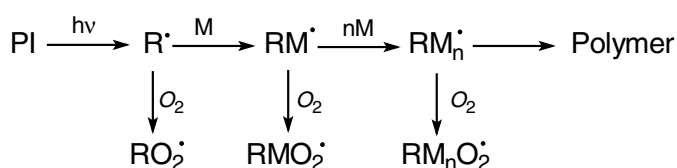

Figure 1: Polymerisation profiles recorded by RTIR spectroscopy upon UV-exposure of an aliphatic polyurethane-acrylate (PUA) or an aromatic polyether-acrylate (PEA) in the presence of a monoacrylate or a diacrylate reactive diluent (25 wt%), respectively.

Light intensity: 40 mW cm^{-2} . Laminated film.

UV-curable adhesives contain usually monoacrylates as reactive diluents (like carbamate-acrylates or isobornyl acrylate [27]) that produce soft and flexible elastomers showing a strong adhesion on various substrates. Excellent adhesion to plastics has been achieved with phenoxyethyl acrylate (Ebecryl 114 from UCB Chemicals), and to non-polar substrates with octyl-decyl monoacrylate (ODA-N from UCB), when such monomers were associated to an aliphatic urethane diacrylate oligomer (Ebecryl 230 or 270) [28]. In systems where good adhesion is difficult to achieve, chlorinated polyester resins diluted with diacrylate monomers like hexanediol diacrylate (Ebecryl 524) or tripropyleneglycol diacrylate (Ebecryl 525) proved to be very effective and are recommended for UV-curable laminating adhesives. In the case of metallic substrates, polyester acrylates associated to monomers bearing carboxylic groups (acrylic acid or its dimer) were shown to improve substantially the adhesion on metal foils [29]. Novel urethane-acrylate oligomers have been recently developed to be used as UV-curable adhesives to bond clear films to various substrates (paper, plastics, foils) and achieve superior peel adhesion [30], the best performance being reached by using a bisacylphosphine oxide (BAPO) photoinitiator [31]. With the tackifying compounds CN-3000 and CN-3001, high peel strength (8 lb-in.) has been reached, which makes these oligomers well suited for pressure-sensitive adhesive applications. In UV-curable laminating adhesives, the bond strength increases as expected with the degree of cure and thus with the UV-dose received by the sample. For a typical polyurethane-acrylate (PUA) resin, it was found to level off at a UV-dose of 0.4 J cm^{-2} [32].

One of the problems encountered in photoinitiated radical polymerisation is the inhibitory effect of atmospheric oxygen which is known to react readily with free radicals to give inactive peroxy radicals:



To cure thin coatings in contact with air, it is therefore necessary to work under intense illumination in order to consume rapidly the O_2 dissolved in the sample and shorten the exposure time during which atmospheric oxygen diffuses into the coating. This is not a problem anymore in adhesive applications which are performed under oxygen diffusion-free conditions (laminates). After a short induction period during which the dissolved O_2 is consumed by the initiator radicals, the polymerisation of the acrylate double bond proceeds as fast in the laminated sample as in an inert atmosphere and much faster than for a coating, as shown in Fig. 2 for a polyurethane-acrylate resin.

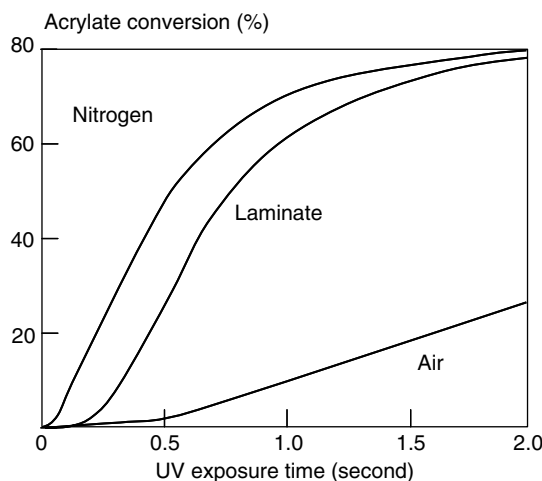
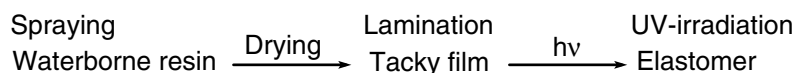

Figure 2: Inhibitory effect of oxygen on the photopolymerisation of a polyurethane-acrylate + diacrylate resin exposed to UV-radiation ($I = 20 \text{ mW cm}^{-2}$). Film thickness: $10 \text{ }\mu\text{m}$.

It is well known that adhesives need to be low-modulus elastomers, so that the resin formulation has to be designed to give, after UV-curing, a soft material with a low glass transition temperature (T_g). Fig. 3 shows some typical elastic modulus (E) and $\tan \delta$ profiles recorded by dynamic mechanical analysis for a UV-cured polyurethane-acrylate which is suitable for adhesives applications, based on its E and T_g values. It is quite soft, as shown by its Persoz hardness value of 50 s, on a scale that goes up to 400 s for glassy materials.

To ensure good adhesion, the acrylate double bond content of the UV-glue has to be kept as low as possible ($\leq 3 \text{ mol/kg}$) to minimise shrinkage. This is achieved by using relatively high molecular weight oligomers, like the aliphatic polyester urethane acrylate SR-966 from Sarkomer which provides superior adhesion onto polyethylene and polycarbonate substrates [32]. A triacrylate oligomer having a tris (2-hydroxyethyl) isocyanurate structure (SR-368 from Sarkomer) was found to promote adhesion on this type of substrates because of its highly polar character [32].

Low shrinkage and good adhesion was also achieved by using waterbased UV-curable acrylate resins, like Laromer PE-55W from BASF, associated to Irgacure 2959 from Ciba SC as photoinitiator. After drying at 80°C , the tacky film obtained proved to be an excellent adhesive to assemble glass plates or transparent films by a short exposure to UV-radiation, which transforms the tacky resin into a low-modulus elastomer. The multiple-step processing can be represented schematically as follows:



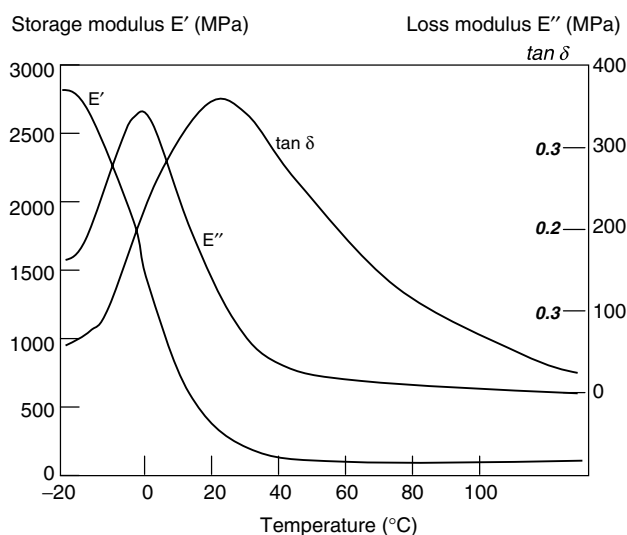

Figure 3: DMA recording of the storage modulus (E') loss modulus (E'') and $\tan \delta$ for a UV-cured acrylate elastomer.

Another important requirement for achieving excellent adhesion is to ensure a perfect wetting of the substrate by the liquid resin. It can only be achieved if the surface energy of the resin is lower than the surface energy of the substrate. This explains why it is so difficult to get strong adhesion on plastics like polyolefins or fluorinated polymers which have a low surface energy. In this case, chemical bonding of the acrylic resin through photografting proved to be the most effective way to assemble this type of materials [33]. The photoinitiator radicals may abstract hydrogen atoms from the polymeric substrate and generate reactive sites at its surface. The latter can then initiate the polymerisation of the monomer, thus ensuring a strong chemical bonding of the UV-cured resin to the organic substrate.

An effective way to improve the wetting on low energy substrates is by adding to the UV-curable formulation small amounts (< 1 wt%) of fluorinated surfactants or silicones which lower its surface energy, thus increasing the adhesion of the UV-cured material onto polyethylene and polycarbonate [34]. Fluoro or silicone functionalised acrylic monomers have been successfully used to modify the surface properties of UV-cured PUA networks [35]. Adhesion on organic substrates was also enhanced by using UV-curable resins capable of establishing hydrogen bonds, e.g. polyurethanes acrylate functionalised polymers, as well as polymers like poly(vinyl chloride) or aliphatic polyurethanes. Acrylate functionalised polymers, plasticised with a multi-functional acrylate monomer, were found to have a good adhesion on glass after photo-cross-linking and were successfully used as intercalates to rapidly produce safety glasses at room temperature [36].

5.2.1.2. Thiol-Polyene System

The photoinduced addition of a thiol (RSH) to an olefinic double bond has been used to produce polymer networks by taking multi-functional monomers [37–44]. The thiol-ene polymerisation proceeds by a step growth addition mechanism which is propagated by a free radical, chain transfer reaction involving the thiyl radical (RS^\bullet). The initial thiyl radicals can be readily generated by UV-irradiation of a thiol in the presence of a radical-type photoinitiator. The overall reaction process can be schematically represented as follows:

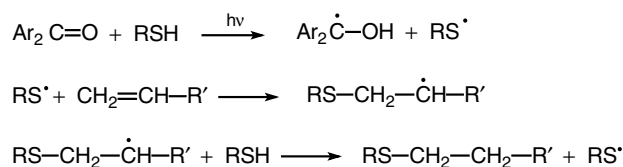

A polymer chain will be formed only if both the thiol and the olefinic compound contain at least two reactive functions, e.g. a diene plus a dithiol. With multi-functional monomers, such as a tetrathiol ($[\text{CRSH}]_4$) associated to a diene ($\text{CH}_2=\text{CH}-\text{R}'-\text{CH}=\text{CH}_2$), a three-dimensional network is produced, in which the connecting chains are made of an alternating copolymer:

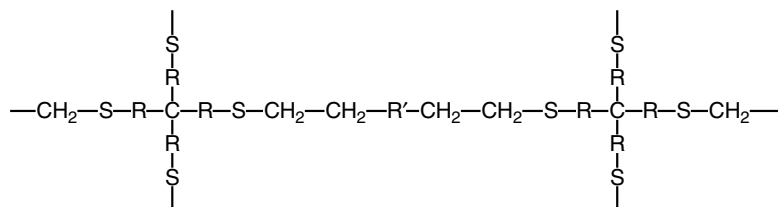

The cross-link density of the polymer network, as well as its properties, depend on the functionality, the length and the chemical nature of the polyene (R') and thiol (R) prepolymer chains, and it can thus be tailored as desired. Low-modulus polymers suitable for adhesive applications were obtained by using aliphatic prepolymer chains, in particular with polybutadiene-based elastomers which were cross-linked very efficiently by UV-irradiation in the presence of a tri- or tetrathiol [45–48]. As only a few cross-links need to be formed between the polymer chains to make the rubber insoluble, low concentrations of thiol (2 wt%) proved to be sufficient to achieve an effective and fast cross-linking. Hardening was found to hardly occur upon UV-curing (increase of the Persoz hardness from 40 to 55 s), which is essential to ensure outstanding adhesion. At the same time, the shear adhesion failure temperature (SAFT) increased from 80 to 160°C, due to the formation of the chemical network (Fig. 4).

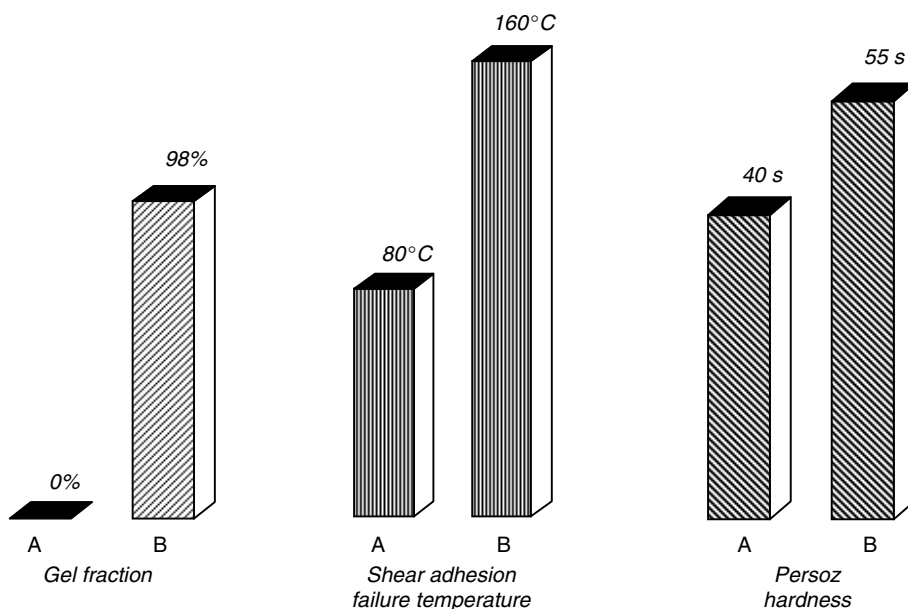
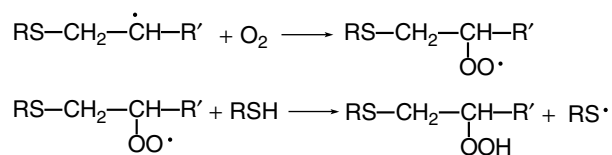

Figure 4: Properties of a styrene-butadiene elastomer containing a thiol cross-linker (2 wt%), before (A) and after (B) a 0.2 s UV-exposure at 500 mW cm^{-2} .

Fig. 5 shows some typical polymerisation profiles recorded by RTIR spectroscopy upon UV-exposure of two tetraene-tetrathiol stoichiometric mixtures containing an hydroxyphenylketone photoinitiator. As expected, a more complete polymerisation was achieved for the sample containing soft tetraene segments, which leads to a low-modulus polymer well-suited for adhesive applications. Over 90% of the thiol groups were found to have reacted within less than 1 s, both for the laminated sample and for the coating in contact with air. It should be noted that the thiol-ene polymerisation is less sensitive to O_2 inhibition than typical radical-induced polymerisations (like acrylates), because the peroxy radicals formed by O_2 scavenging of alkyl radicals are still capable of propagating the chain reaction by hydrogen abstraction from the thiol and generation of the chain carrier thiyl radical:



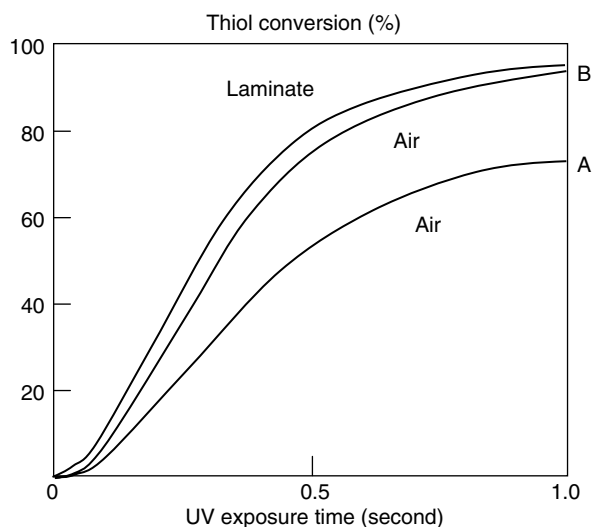

Figure 5: Photoinitiated polymerisation of a 1/1 molar mixture of a tetrathiol and a tetraene resin containing hard (A) or soft (B) segments ($I = 100 \text{ mW cm}^{-2}$). Film thickness: 15 μm .

With the development of new types of prepolymers, such as vinyl functionalised silicones [40], there has been an increased interest in the thiol/ene photopolymerisation, in particular for pressure-sensitive adhesives and sealants applications [2]. The lack of O_2 inhibition is an important advantage here because siloxane fluids are known to be highly permeable to oxygen. Resistance to moisture ingress and thermal degradation is reported to be superior [41]. Moreover, the use of cyclic alkenes, such as norbornene [39], in combination with a tetrathiol, yields cross-linked polymers showing a low volume shrinkage, which makes them particularly attractive for adhesive applications [2].

5.2.2. Photoinitiated Cationic Polymerisation

Light-induced polymerisation is one of the most efficient methods to rapidly cure monomers that are inactive towards radical species, like vinyl ethers [49,50] or epoxides [51–54]. The subject has been recently covered extensively by Crivello and Dietliker in an excellent textbook [55]. This technology has not yet achieved the commercial significance of corresponding free-radical processes, mainly because of the more limited choice of monomers available and their lower reactivity.

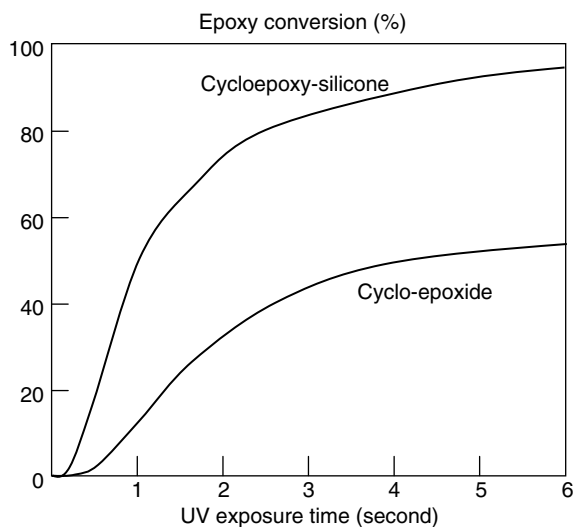
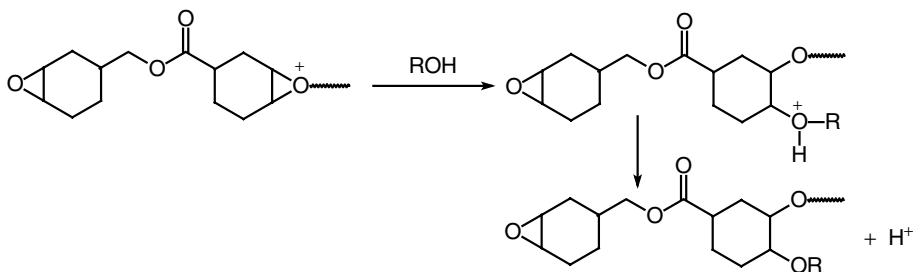

Figure 6: Photoinitiated cationic polymerisation of an aliphatic dicycloepoxide and a dicycloepoxy silicone. Diaryliodonium salt (1 wt%) photoinitiator ($I = 85 \text{ mW cm}^{-2}$).

cycloaliphatic diepoxide is due to early vitrification and related mobility restrictions, so that the hard UV-cured polymer is ill-suited for adhesive applications. The addition of ϵ -caprolactone triol (Tone Polyol from Dow Chemicals) generates a softer and more completely polymerised polymer by promoting a chain transfer reaction [60]. Higher adhesion was achieved by increasing the polyol content, as well as its molecular weight, up to an optimum value typically reached for an epoxy/hydroxyl ratio of 2.



A more flexible UV-cured polymer showing improved adhesion was obtained by using the bis (3,4 epoxy cyclohexyl) adipate (Cyracure UVR-6128 from Dow Chemicals) [61,62]. The superior adhesion achieved with such cationically UV-cured epoxides was attributed to the low shrinkage that occurs during the ring

opening polymerisation: less than 5%, compared to 10% for acrylates. It can be further enhanced if necessary by the addition of a silane adhesion promoter (Silwet A-186 from Witco Corp), in particular for metallic or silica-containing substrates [62].

5.2.2.2. UV-Curing of Vinyl Ethers

Vinyl ethers (VE) are amongst the most reactive monomers that polymerise cationically, and they are increasingly used in photocurable resins, either neat [63] or in association with epoxides [64,65], acrylates [66], maleimides [67] or unsaturated polyesters [68]. Vinyl ether end-capped polyurethane, polyether, polysiloxane and polyesters were shown to undergo fast and extensive polymerisation when exposed to UV-radiation in the presence of an arylidonium salt, with the formation of tridimensional polymer networks. The photoinitiated cationic polymerisation of a divinyl ether can be formally written as follows:

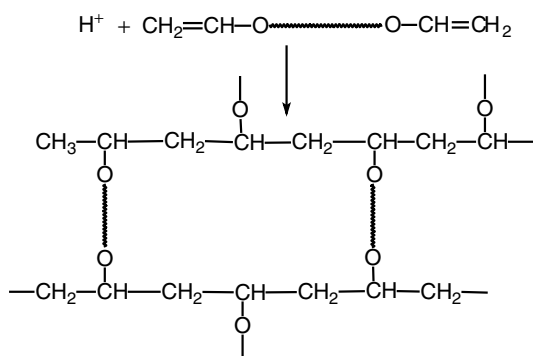

The reaction kinetics has been thoroughly investigated [50] and the subject has been covered in a comprehensive review article by Lapin [49]. Fig. 7 shows the photopolymerisation profiles of VE functionalised urethane and silicone oligomers, in comparison to that of the divinyl ether of triethyleneglycol (DVE-3) often used as reactive diluent. The UV-cured polymers thus obtained have a low elastic modulus and can be designed for adhesive applications by a proper choice of the oligomer chemical structure (aliphatic groups) and of its molecular weight ($M \leq 1000$ g).

The postpolymerisation, which is known to occur just after the UV-exposure in cationic photocuring, was easily monitored by RTIR spectroscopy, as shown in Fig. 7 for DVE-3 (dashed curve). It can be seen that, after a 0.7 s exposure to UV-radiation, the vinyl ether continues to polymerise in the dark, the conversion rising from 10% to over 90% within a few seconds. One can take advantage of such an important dark curing process to assemble non-transparent foils by means of

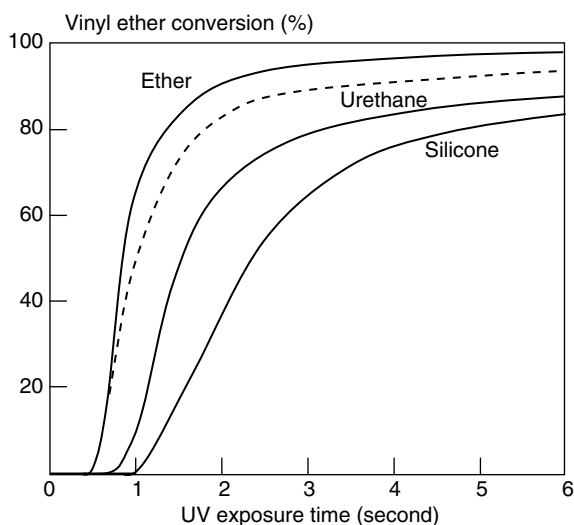

Figure 7: Influence of the chemical structure of the functionalised oligomer on the cationic UV-curing of a vinyl ether-based resin ($I = 20 \text{ mW cm}^{-2}$). (----): Post-polymerisation after a 0.7 s UV-exposure of the divinyl ether of triethyleneglycol.

UV-curable adhesives. Fig. 8 shows a schematic representation of the experimental setup. By running the UV-line at a speed of 1 m/s, the second foil will be laminated on top of the irradiated foil only 0.5 s (50 cm) after the UV-exposure, so that most of the VE polymerisation will occur in the dark. UV-curable epoxy resins were also successfully used as adhesives to laminate opaque films by such an ultrafast dark-cure mechanism [56,62].

Vinyl ether monomers, like DVE-3, proved to be very effective reactive diluents in UV-curable epoxy-based resins, not only to lower the formulation viscosity and make it suitable for spray or roller applications, but also to achieve a faster and more complete curing, as VE and epoxy monomers were shown to undergo copolymerisation by a cation-driven mechanism [50]. Moreover, the addition of vinyl ether may impart some flexibility to the UV-cured epoxide, thus improving its adhesion on flexible substrates.

5.2.2.3. UV-Curing of Hybrid Systems

The photopolymerisation of a mixture of multi-functional monomers or oligomers that polymerise by different mechanisms leads to the build-up of two interpenetrating polymer networks (IPN). An obvious requirement is that the two monomers must be fully compatible, and their polymers as well, in order to avoid segregation

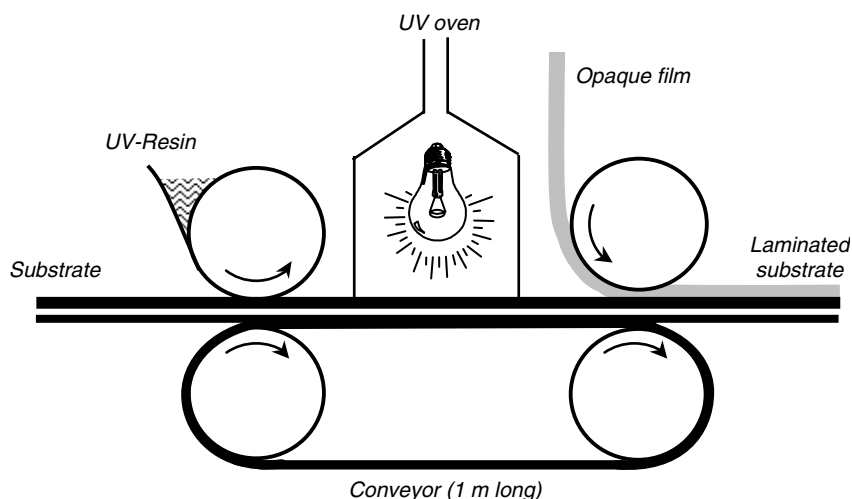

Figure 8: Experimental setup for the production of nontransparent laminated assemblies by postcuring of a photoinitiated cationic polymerisation.

and the formation of heterophasic materials. A number of monomer combinations have been successfully used to produce IPNs rapidly at ambient temperature [69], in particular mixtures of acrylate monomers with epoxides [70] or vinyl ethers [66]. Kinetic studies have shown that the two monomers can polymerise either simultaneously, or sequentially by a proper choice of the irradiation wavelength [12].

The major advantages of these UV-curable hybrid systems lie in their superior combination of properties which can be tailor-made for a given application by adjusting the proportions of the two components. The IPN formed will exhibit the main features of the two polymer networks, for instance the toughness and scratch resistance of UV-cured acrylate polymers and the elastomeric character of the cross-linked polyurethane-vinyl ether, with the expected benefit regarding adhesion and impact resistance.

5.2.3. Dual-Cure Systems

When UV-curable resins are used as laminated adhesives to protect three-dimensional objects having complex shapes, it may happen that some remote areas will not be accessible to UV-radiation and therefore remain uncured. To address the issue of such shadowed areas, dual-cure systems combining UV-irradiation and thermal treatment have been developed [71]. They contain two types of reactive functions: a UV-curable functional group (usually an acrylate double bond)

and a thermally curable functional group (usually an isocyanate associated to a polyol). The basic principle of this two step curing process is represented schematically in Chart 3 for a hydroxyl functionalised diacrylate prepolymer associated to a diisocyanate [72]. Cross-linking will thus occur even in the shadowed areas upon heating, typically at 140°C for 15 min. As the polyurethane formation by polyaddition occurs slowly at ambient temperature, such dual cure systems will consist of two-component formulations which, after mixing, have a pot lifetime of less than one day.

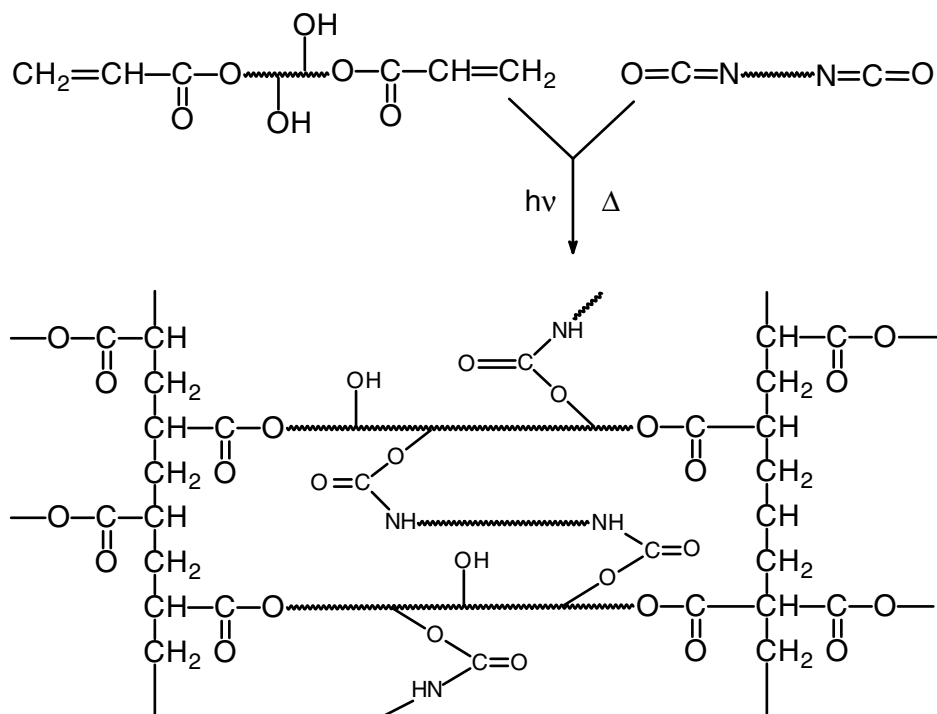

Chart 3: Dual polymer network formed by UV-curing of acrylate double bonds and thermal curing of isocyanate and hydroxyl groups.

In order to achieve the most complete curing of both types of functionality, it is recommended to start with the thermal treatment and perform the UV-exposure immediately afterwards on the hot sample. Fig. 9 shows some typical curing profiles obtained by monitoring, by means of infrared spectroscopy, the disappearance of the isocyanate group (2270 cm^{-1}) upon heating, and of the acrylate double bond (1410 cm^{-1}) upon UV-exposure.

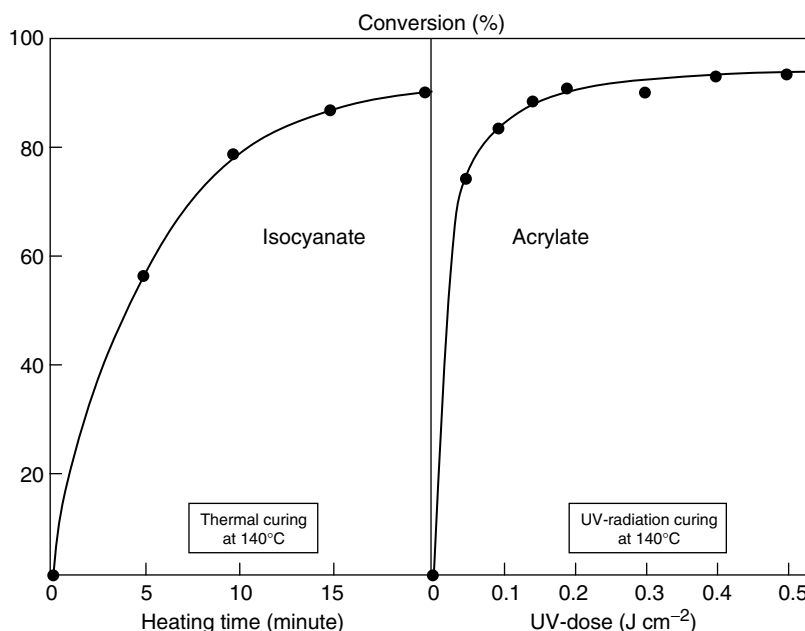

Figure 9: Dual-curing of an hydroxy-functionalised polyurethane-acrylate associated to an isocyanate cross-linker ($I = 500 \text{ mW cm}^{-2}$).

It should be noted that the diacrylate prepolymer is usually dissolved in a solvent (~50 wt.%), rather than in an acrylate monomer, so as to keep shrinkage to a minimum and ensure good adhesion. The solvent is readily removed in the early stage of the thermal treatment and does not interfere with the curing reactions, which occur actually in a solid but soft material. Here again, it is important for adhesive applications to keep hardening to a minimum, usually by introducing soft segments in the prepolymer chain and by reducing the cross-link density of the polymer network. In the case of heat-sensitive substrates, the polyaddition reaction needs to be performed at ambient temperature, after solvent flash off and UV-exposure. Cross-linking will then proceed slowly upon storage of the sample for a few days [2]. This process was shown to be accelerated by moisture curing of the isocyanate which reacts readily with water, and subsequently with the resulting amino group, with formation of an urea bond [73].

After this survey of the different types of UV-curable resins that can be used as adhesives, and the way they undergo rapid cross-linking upon illumination, we will now review the main applications of such fast-setting adhesives in various industrial sectors.

5.3. Applications of Radiation-Curable Adhesives

Radiation curable adhesives have experienced a steady growth over the past decade in various sectors of applications because they offer a number of advantages over conventional adhesives, mainly a substantial reduction in processing time for assembly operations, a much reduced emission of volatile organic compounds, a precise control of the light-driven setting process and low energy requirements. This environment-friendly technology is now being commonly used in two main classes of adhesives [2]. In the first one, adhesion is achieved by light-induced cross-linking, which will ensure a strong bonding between two components, like for structural adhesives, sealants, composites and laminating adhesives. In the second class, a tacky polymer is produced by UV-curing of a solvent-free resin and will serve as a pressure-sensitive or hot-melt adhesive. In this case, adhesion is achieved by the application of pressure and/or heat, so that the end-user is not required to employ radiation to obtain a strong bonding.

The manifold end-uses of radiation curable adhesives have been discussed in several review articles [3–5,74–77], and in particular by a comprehensive survey of these systems by Woods [2], and more recently by Dowling [7] who has listed important UV-adhesive applications such as glass bonding, plastic bonding, wire tacking, conformal coatings, potting and connector sealing in microelectronics. Some typical applications of UV-curable adhesives are summarised in Fig. 10. In this last section, we present an overview of three industrial sectors where UV-adhesives have found growing applications, namely as structural adhesives, pressure-sensitive adhesives and release coatings.

5.3.1. Structural Adhesives

A considerable amount of work has been devoted to the bonding of two elements by means of UV-curable structural adhesives [78–92]. The two parts of the assembly can be identical (homolaminates) or of a different nature (heterolaminates), and consist either of flexible films like polyesters, poly(vinyl acetate), nylon, aluminium foils and paper, or rigid transparent plates like poly(methylmethacrylate), polycarbonates, poly(vinylchloride) and mineral glass. Obviously, one of the two parts must be transparent to ultraviolet radiation in order to achieve an effective cure of the adhesive. If not so, like for photostabilised polycarbonates or polyethylene terephthalates, a photoinitiator absorbing in the near UV and visible range (like acylphosphine oxides) has to be selected. The light-induced setting process of the adhesive will involve the following three steps:

- the liquid resin is applied to one or both parts to be bonded, so as to ensure a perfect wetting of the clean surface.

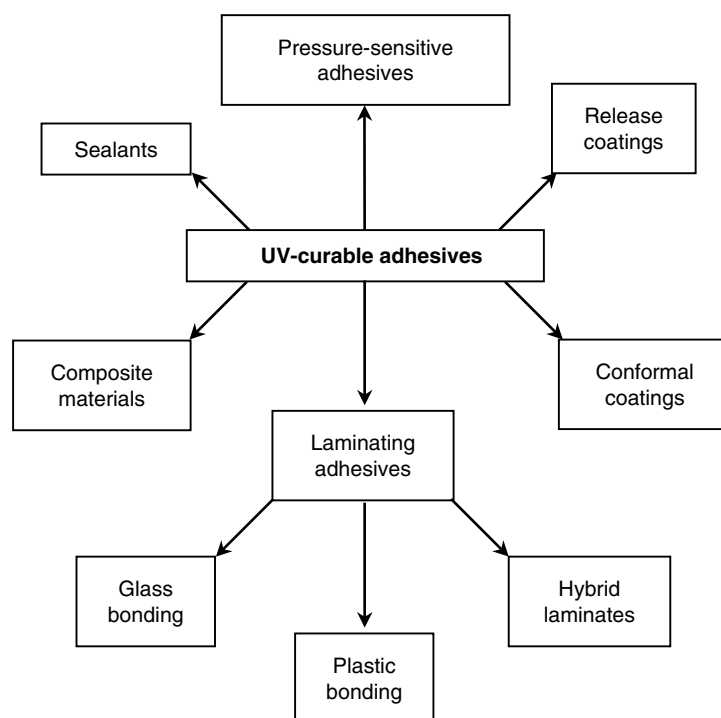

Figure 10: Applications of UV-curable adhesives.

- the two parts are assembled and positioned precisely, taking care to avoid the formation of air bubbles.
- the assembly is exposed to UV-radiation, at and during the desired time, to convert the adhesive from the liquid state to the solid state.

Some typical applications of UV-curable adhesives and sealants are illustrated in Fig. 11.

While the cure extent in thermosetting adhesives is governed by the polymerisation kinetics and the difference between the polymerisation temperature and the ultimate glass transition temperature (T_g) of the material, other factors, like the light intensity, the optical absorbance, the sample thickness and the UV-dose, strongly determine the cure extent of photosetting adhesives [79]. In this respect, it is important to know the relationship existing between these factors and the tensile properties and T_g of the UV-cured polymer which determine the adhesive strength [80].

Both radical-type and cationic-type UV-curable resins have been used in laminating adhesive applications (acrylates [14,30,31,81], thiol-ene [41,82],

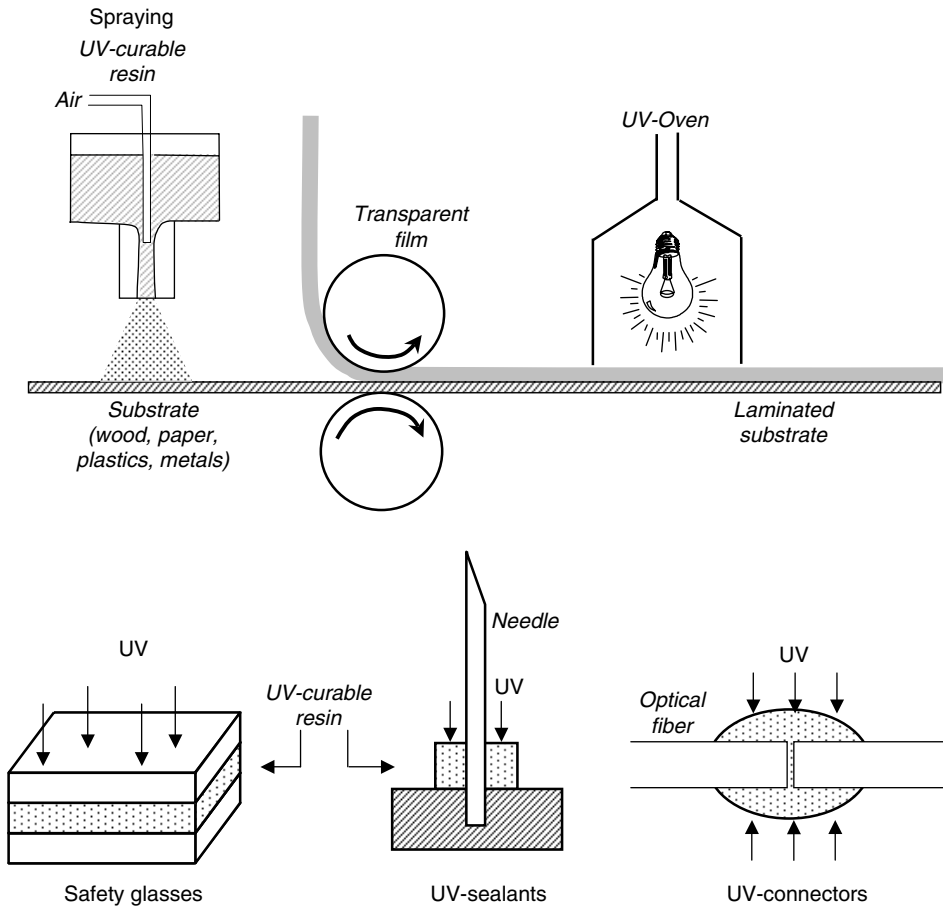

Figure 11: Various applications of UV-curable adhesives.

epoxides [83,84], vinyl ethers [85]). Here are a few examples where UV adhesives proved particularly successful to achieve a fast and resistant bonding of laminates, as well as a durable sealing of two components.

- Superfast curing (in less than 0.5 s) of acrylate adhesives for plastics has been achieved by a proper choice of prepolymers, photoinitiators and photosensitisers, and successfully used in blister packaging [81], as well as for bonding glass to plastics [78].
- Optical fibres can be connected by means of an optically clear UV-resin having a refractive index after cure as close to that of glass as possible [7]. The bonding

can be easily achieved by firing a laser beam through the fibre and using an appropriate laser-curable resin [86]. UV-cured epoxides containing silica nanoparticles have been successfully used as adhesives for fibre-chip coupling, with low optical loss and low shrinkage [87]. High transparency was achieved by fitting the refractive index of the adhesive to that of the filler ($n = 1.50$).

- For bonding of medical needles, light curable adhesives offer not only the benefit of a rapid processing, but also excellent thermal resistance, hermetic seals and high pull strength on various substrates, including polyethylene [88]. Curing of the shadowed areas was achieved by a combination with cyanoacrylates which undergo a fast anionic polymerisation in the presence of a weak base such as water.
- The use of UV-curable adhesives is a fastening method that enables quick and easy mounting of optical components in housings, with an extreme precision by allowing an accurate control of the setting time [89]. This technology is commonly used for the manufacturing of optical disks, where the bonding can be achieved by a cationic UV-curable adhesive [90]. Low volume shrinkage (1.2%) was achieved with a cyclohexane-type fluoro-epoxy resin undergoing cationic ring opening polymerisation. These highly transparent adhesives can be cured to a depth of >5 mm and show high adhesive strength and durability, making them well-suited to the fabrication of optical components that require submicron positioning accuracy.
- Glass laminates showing high impact resistance, adhesion and transparency have been obtained by photocuring of an acrylic adhesive consisting either of a liquid resin or a solid thermoplastic polymer at ambient temperature [36,91]. Safety glasses combining chemical inertness, scratch resistance, hardness of mineral glass and strong impact resistance were obtained with a three component UV-cured laminate glass/polycarbonate glass. Adhesion on glass was substantially improved by pre-coating the glass plates with a UV-cured thermoplastic polybutadiene elastomer [92].
- A cohesive bonding of non-transparent materials has been achieved by means of cationic UV-curable resins by taking advantage of the living character of cationic polymerisation, the two parts of the assembly being laminated just after the UV-irradiation [56,62]. With a biscycloepoxide-polyol resin, the peel strength reached values up to 200 g/cm within 30 min after the UV-exposure, a polyurethane resin being used if needed to improve tackiness and increase the open time. In the case of polyethylene films, the T-peel strength continued to rise for a few hours upon storage, to level up at a value of 500 g/cm [62]. Cure speed tackiness, adhesion and open time can be controlled through the epoxy/polyol ratio, the photoinitiator concentration and the UV-dose [93]. The cohesive

energy was improved by changing the molecular weight of the adhesives and the cross-link density.

- Another effective way to cure non-transparent samples is by using electron beams (EB) which can initiate both radical and cationic-type polymerisation. EB curable laminating adhesives have been shown to exhibit good performance over a wide temperature range on a variety of substrate combinations [94] and in particular for flexible food packaging [95]. This novel way of manufacturing food packages offers a number of advantages, namely, instant cure/bond development, reduction or elimination of VOC generation, fewer processing steps, lower overall operation cost and new design capabilities [96,97].
- To address the issue of the curing of shadowed areas in UV-sealants and laminating adhesives, dual-cure systems have been developed [71]. Hardening of the resin containing isocyanates is realised by a thermal treatment (NCO/OH polyaddition) or moisture curing [98], or by a redox reaction in the presence of primers under anaerobic conditions [99]. The potting and encapsulating of electronic components has been recently achieved by a UV-curable epoxy resin, even in shadowed areas, by taking advantage of a self-propagating thermal cure [100]. This allows for rapid, deep and complete polymerisation to occur throughout the entire volume.

Recent advances have made radiation-curable laminating adhesives very attractive in terms of economics, automation, quality of adhesive bond and throughput, while offering distinct advantages with respect to both energy consumption and pollution control [4].

5.3.2. *Pressure Sensitive Adhesives (PSAs)*

The concept of radiation-curable PSAs can be simply described as a rapid photoinitiated cross-linking producing a viscoelastic material where the properties of tack, peel strength and shear resistance are predetermined [4]. It is this tackiness that causes the adhesive to stick instantly when pressed against a substrate. Depending on the peel strength, PSA tapes are considered as temporary for values below 350 N/m, or permanent for peel strengths above this value. A strapping tape, which is made from a strong glass-fibre reinforced film, uses a high-strength adhesive, while carton sealing tape must be quick grabbing to a paperbound and resistant to moisture [4].

In contrast to UV-laminated adhesives, radiation is applied directly to the photo-sensitive resin, without having to penetrate through another material, very much

like for UV-curable coatings. A characteristic feature of PSAs is that they do not change their physical state during bond formation and that the end-user is not required to employ a curing step to accomplish adhesive bonding. Processing of a typical UV-curable PSA involves the following steps, illustrated in Fig. 12 [3]:

- application of the liquid adhesive to a substrate
- UV-irradiation to generate a tacky cohesive polymer
- protection of the tacky surface by a silicone paper
- removal of the protecting film and attachment of the self-adhesive product onto a material by applying a pressure.

In the production of tape adhesives, step 3 can be skipped by using a polymer film that has been release treated on one side as a substrate.

The photosensitive resin consists either of a liquid functionalised oligomer, usually with acrylate groups, or a reactive polymer which will be applied as hot melt. There are two main classes of reactive polymers: acrylic hot melts which may contain a tackifying monomer, and thermoplastic rubbers which predominantly block copolymers with polybutadiene or polyisoprene chains [3]. A radical-type photoinitiator is always needed to produce, upon UV-exposure, the free radicals that will initiate the polymerisation or cross-linking process.

The reasons for using UV-curable PSAs, rather than solvent-based adhesives, remain essentially the same as for the other UV-curable systems and include high cure speed, reduced VOC emission, low energy consumption and enhanced product performance. The subject has been extensively investigated in recent

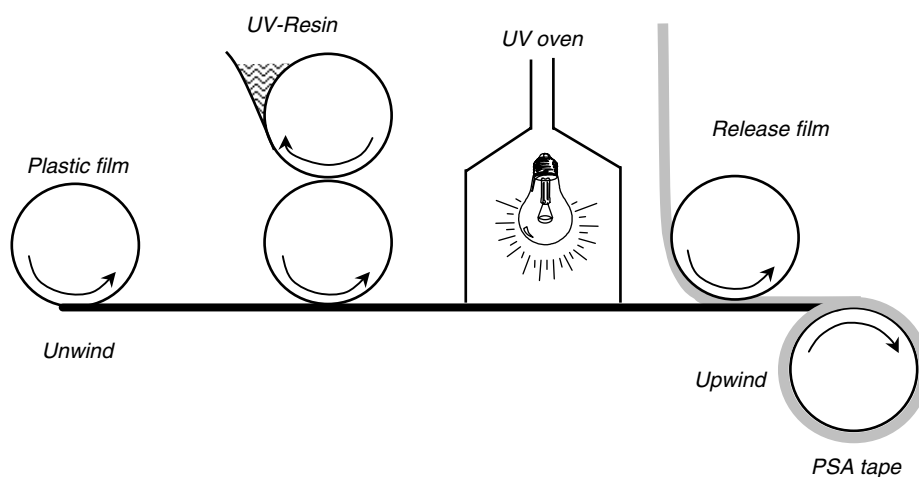

Figure 12: Manufacturing of a UV-cured pressure-sensitive adhesive.

years, as shown by the abundant literature on this topic [10,13–17,101–123]. Today, UV-curable PSAs are mainly utilised in the graphic arts, electronics and packaging to produce self-adhesive foils, tapes and labels [114].

Here are a few examples of different types of UV-cured PSAs developed in various applications:

- UV-cured pressure-sensitive adhesives are often made of low molecular weight polymers plasticised with acrylate monomers, so as to obtain a viscous material which will be transformed into a tacky polymer by photo-cross-linking. The initial resin can also be produced by photopolymerisation in order to form an acrylic syrup of suitable viscosity by UV-dose controlled conversion of the acrylate double bonds [109]. The addition of tackifying agents (hydrocarbon resins) and of monoacrylate reactive diluents to urethane-acrylate oligomers has been shown to be an effective way of obtaining UV-cured PSAs showing excellent peel strength and creep resistance on various substrates (paper, polyethylene, polystyrene, polycarbonates) [104,105]. Depending on the type of applications (labels, adhesives tapes, protective laminated films), the thickness of the adhesives can be varied between 50 and 500 μm , with peel strength values ranging from 500 to 1200 N/m and shear strength values of over 10,000 min at room temperature [105]. Because of the required incomplete cross-linking, the gel content of UV-cured PSA is usually less than 60%, and can be as low as 30% [114]. Typical applications are viscoelastic backings or transparent acrylic transfer tapes for high-performance bonding tapes. UV-curable PSAs can be applied at room temperature with flexographic and screen-printing units [108]. This technology offers an innovative way to produce new types of labels and other pressure sensitive products. Maleimide functionalised oligomers have been recently used as UV-curable pressure-sensitive adhesives, in combination with acrylic polymers [120].
- Hot-melt adhesives are dry films which melt and become tacky at elevated temperature. UV-radiation curing is used to make such materials more resistant to chemicals (solvents, hydrocarbons) and to heat, with shear adhesion failure temperature (SAFT) values above 150°C, by creating a covalently bonded polymer network [109–113]. Values up to 180°C were reached with aromatic urethane acrylate-based tackifying oligomers (CN-3000 from Sartomer), the 180° peel adhesion remaining constant at 800 g/cm after one week. As expected, increasing the UV-dose from 0.4 to 0.7 J cm⁻² makes the SAFT and tack values decrease, while the adhesion was increased up to 1400 g/cm [121]. Thermoplastic rubbers, consisting of styrenic block copolymers with polyisoprene (SIS) or polybutadiene (SBS) chains, have been successfully used as UV-curable hot-melt adhesives [15,116,117]. Photo-cross-linking, involving pendent vinyl groups, was greatly accelerated by the addition of an acrylate

functionalised oligomer [118] or a trifunctional thiol [119]. Even in the presence of air, the radical-induced chain reaction was shown to proceed within a fraction of a second to yield a low-modulus elastomer having a SAFT value superior to 160°C and an excellent chemical resistance.

- UV-acrylic hot-melts may also consist of low molecular weight polymers with chemically built-in photoreactive groups. After being coated onto the substrate at temperatures in the 120–140°C range, the film is partly cross-linked upon exposure to short wavelength UV-radiation (250–270 nm) in order to impart some cohesion and heat resistance [111]. The ratio of adhesion to cohesion is dependent on the UV-dose, which can be precisely controlled by the lamp power output and the web speed. The cross-linking process was followed in real time through the decrease of the photoreactive group (benzophenone) and found to correlate well with the shear strength which increased from an initial SAFT value of 50°C up to 180°C at a UV-dose of 1 J cm⁻² [122]. UV-acrylic hot-melts were shown to outperform the conventional solvent- or water-based acrylic polymers, as well as the thermoplastic rubber hot-melts (SIS/SBS), with respect to heat resistance, shear strength and peel strength [108]. If necessary, the degree of cross-linking of UV-curable acrylic hot-melts can be increased by the incorporation of defined unsaturations into the saturated polymer chain [109]. A novel UV-curable acrylic hot-melt PSA has been recently developed allowing contactless application, with the benefits of lower coating weights [123]. The ultimate bond strength of conventional permanent UV-curable pressure-sensitive adhesives can be varied downwards, thus opening up scope for additional applications, especially in the field of removability.

5.3.3. Release Coatings

The PSA covered substrates used by the tag and label industry need to be protected during storage by a film which should be easily removed just before use, without loss of shear strength. Such release coatings consist usually of a plastic film or a paper coated with a uniform and thin film of a reactive silicone which is cross-linked via chemical processes promoted by heat or UV-radiation [124,125]. Silicones are known to lack adhesion to most substrates because of their low surface energy, a feature which is of advantage in PSA applications for it allows an easy peeling off from the inner tape layer. The reactive group of the polydimethylsiloxane oligomer can be either a cycloaliphatic epoxide [126–128] undergoing cationic polymerisation or an acrylate double bond undergoing free radical polymerisation [129,130]. Both types of chemistry have been discussed in a comprehensive review article on photopolymerisable silicone monomers, oligomers and resins [40].

The introduction of a dimethyl-siloxane group between two cycloaliphatic epoxy groups was found to increase drastically, the reactivity of these monomers [58,131]. The cyclo epoxy group can be located at the ends of the polydimethylsiloxane chain and/or on pendent groups [132].

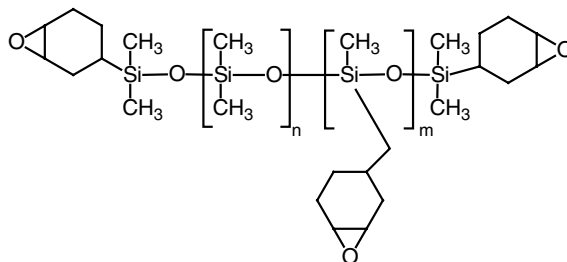

Such UV-cured polymers can work as release coatings because the low surface energy of the polydimethylsiloxane chains predominates at the coatings interface with a pressure-sensitive adhesive. The higher the work needed to remove a silicone-coated film from an adhesive-coated face stock (label), the tighter the release will be [124]. It can be controlled by the inclusion of polar groups on the silicone backbone, which will affect the bonding between PSA and silicone release coatings. Different controlled release coatings have thus been produced by UV-curing of mixtures of cycloaliphatic epoxy-silicones and linear epoxy-functionalised silicone fluids [124]. Cationic UV-curable epoxy silicones have been recently developed to achieve very low and stable release, with values as low as 4 cN/cm, for label or mastic release application [133]. The glass transition temperature was shown to strongly influence the release behaviour, the best performance being obtained when the T_g of the epoxy silicone resin component is 10 to 40°C below its use temperature. It was recently suggested that the UV-cured epoxy-silicone systems control the magnitude of release force in the same manner as their thermally cured equivalents, that is, via the viscoelastic properties of the silicone matrix, rather than through their surface properties [132].

UV-cured acrylate functionalised silicones have been successfully used as release coatings [125,129,134]. They consist of either acrylate end-capped linear polydimethylsiloxanes or of silicone chains containing pendent acrylate groups.

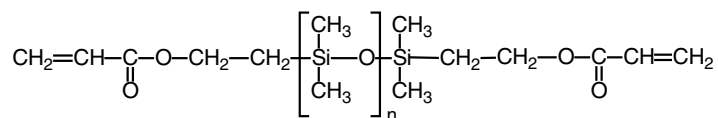

The versatility of silicone-acrylates with regard to cure speed, coatibility and release control make them ideally suited for a variety of applications, in particular for coatings having a desired release level [129]. By varying the ratio of unmodified to modified siloxy units, it was shown that the release force and subsequent adhesion are increased with the concentration of acrylate groups [125]. By producing oligomers at both ends of the release spectrum (easy and tight), one can tune the coating performance to the desired application. A kinetic study by RTIR spectroscopy of the UV-curing of such functionalised silicones clearly showed that silicone-acrylates polymerise much faster than the epoxy-silicones having the same functional group content and the same silicone backbone. Because of the strong inhibitory effect of atmospheric oxygen on the free radical polymerisation of silicone-acrylates [135], specially in thin films, it is yet necessary to perform the UV-curing under inert conditions (N_2 or CO_2 blanketing). Cure line speeds up to 10 m/s have thus been reached, with the expected gain in productivity and energy consumption [129]. Oxygen inhibition can be partly overcome by the addition of tertiary amines or trivalent phosphites [134], thus allowing the UV-curing to be performed even in the presence of relatively large amounts of air. Such performance, together with solvent-free formulations and ambient temperature operations allowing to work with heat-sensitive substrates, are the main reasons for the increasing use of UV-radiation curable release coatings in the tape and label industry.

5.4. Conclusion

UV-curable adhesives have established themselves as a significant part of the overall market for specialty adhesives because they offer a number of advantages over traditional adhesives, as illustrated in Fig. 13. One can expect this part to increase in the near future, as the ever more stringent regulations aiming to lower air pollution and energy consumption will progressively curtail the use of solvent-based adhesives.

The principal driving force behind the steadily increasing consumption of UV-adhesives will be the speed and control of the curing process, and the compatibility of radiation products with automated dispensing and assembly equipment [2]. Some progress is still needed to make this technology more competitive by improving the processing and product performance. There is currently a strong research effort aiming toward the development of resins, which can be cured by near UV and visible light, as well as of dual-cure systems to ensure an effective bonding in the shadow regions. It is also important to precisely control the bonding strength of UV-cured adhesives, depending on the considered end-uses, and to improve their toughness. Given the wide range of light-curable materials showing

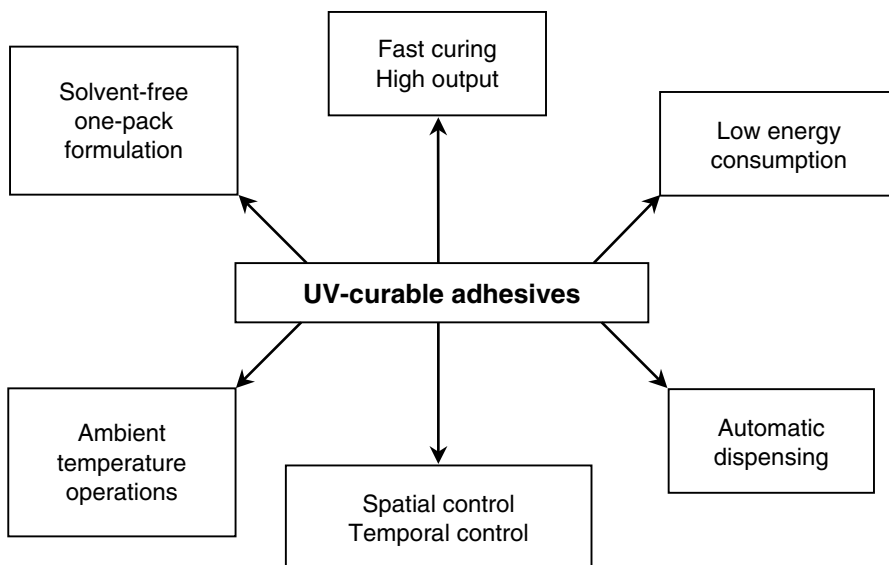

Figure 13: Performance of UV-curable adhesives.

tailor-made properties, one can reasonably assume that there will always be an UV-adhesive well suited to any one of the manifold types of bonding applications.

Acknowledgements

The author would like to thank his coworkers from the Polymer Photochemistry Laboratory, Drs. C. Bianchi, D. Decker, L. Keller, I. Lorinczova, F. Masson, K. Studer, E. Weber-Koehl and K. Zahouily. He also acknowledges the financial support from BASF, Ciba SC, Dupont Performances Coatings and CNRS.

References

- [1] Habenicht, G., Radiation-curing adhesives, *Adhesion*, **1990**, 34(11), 19–25.
- [2] Woods, J.G., Radiation-curable adhesives, in Pappas S.P. (Ed.), *Radiation Curing Science and Technology* (pp. 333–398), Plenum Press, New York, **1992**.
- [3] Huber, H.F., Radiation cure of pressure-sensitive adhesives, in *Radiation Curing in Polymer Science and Technology*, Vol. IV, Fouassier J.P. and Rabek J.F. (Eds.), (pp. 51–72), Chapman and Hall, Andover, **1993**.

- [4] Ellerstein, S.M., Lee, S.A. and Palit, T.K., Radiation-curable adhesives, in *Radiation Curing in Polymer Science and Technology*, Vol. IV, Fouassier J.P. and Rabek J.F. (Eds.) (pp. 73–86), Chapman and Hall, Andover, **1993**.
- [5] Miron, J., Radiation curing trends, in *Technology and Markets* (pp. 227–246), *J Adhesives and Sealant Council*, **1996**.
- [6] Roffey, C., Radiation-curable adhesives, in *Photogeneration of Reactive Species for UV-curing* (pp. 631–641), John Wiley and Sons, New York, **1997**.
- [7] Dowling, J.P., Ultra-violet light curable adhesives, in *Chemistry and Technology of UV and EB formulation for Coatings, Inks and Paints*, Vol. I, P.K.T. Oldring (Ed.) (pp. 1–33), SITA Technology, London, **1997**.
- [8] Togel, G., UV-curing with modern radiation devices. *Adhaesion, Kleben und Dictiten*, **1999**, 43(9).
- [9] Zöllner, S., UV-curable pressure sensitive adhesives. Features, mechanisms, milestones (pp. 543–550), *Proc. RadTech Europe Conf.*, **1999**.
- [10] Malik, R., Radiation curable PSAs provide unique benefits that cannot be achieved by exciting technologies, *Adhesives Age*, **2002**, 45(2), 35–50.
- [11] Decker, C., Photoinitiated cross-linking polymerization, *Progr. Polym. Sci.*, **1996**, 21, 593–650.
- [12] Decker, C., Kinetic study and new applications of UV-radiation curing, *Macromol. Rapid. Comm.*, **2002**, 23, 1067–1093.
- [13] Magny, B., Askienazy, A. and Pezgon, E., How to tackle adherence problems with UV formulations (pp. 507–514), *Proc. RadTech Europe*, **1995**.
- [14] Tomita, K., UV-curable acrylic adhesives composition, Japanese Patent JP 2000 109779, CA-2000-249928, **2000**.
- [15] Dupont, M.J., Mayenez, C., Radiation-curable butadiene block copolymer adhesive composition and heat resistance. World patent WO 0022062 **2000**.
- [16] Cartellieri U., Huseman, M., Ring, C., Zoellner, S., Method for producing cross-linked acrylate adhesives in hot-melt process, World patent 0228963, CA 2002-276080 **2002**.
- [17] Frances, R.S. and Edelman, R., Ultraviolet radiation-curable acrylic polymer pressure sensitive adhesives, Japanese Patent JP 200004-4887, **2000**; Frances, J.M., Delchet, L., Arnaut, C., Gambut, L., Pressure-sensitive adhesive silicone compositions. World Patent 0310257, CA-2003-97495 **2003**.
- [18] Erikson, J.R. and Zimmerman, E.M., Non aqueous solvent-free process for making UV-curable adhesives and sealants from epoxidized monohydroxylated diene polymers, World Patent WO-0181494 (2001) CA 798358 **2001**.
- [19] Kino, Y., Method and apparatus for precisely bonding optical instrument to adherends by using UV-curable adhesives, Japanese Patent JP 2003-003146, CA 2003-14421 **2003**.
- [20] Peeters, S., Overview of dual-cure and hybrid cure systems in radiation curing, in *Ref.2*, Vol. III (pp. 177–217), **1993**.
- [21] Dietliker, K., A compilation of photoinitiators commercially available for UV today, *SITA Technology Textbook*, London **2002**.

- [22] Crivello, J.V. and Dietliker, K., Photoinitiator for free-radical polymerization, in *Chemistry and Technology of UV and EB formulation for Coatings, Inks and Paints* Vol. 3. Bradley G. (Ed.) (pp. 61–325), John Wiley, Chichester, **1998**.
- [23] Webster, G., Bradley, G., Lowe, C., A compilation of oligomers and monomers commercially available for UV today, *SITA Technology Textbook*, London **2001**.
- [24] Davidson, S., Exploring the science technology and applications of UV and EB curing, *SITA Technology Textbook*, London **1999**.
- [25] Decker, C. and Moussa, K., A new method for monitoring ultrafast photopolymerization by real-time infrared spectroscopy, *Makromol. Chem.*, **1988**, 189, 2381–2394.
- [26] Decker, C. and Moussa, K., Real-time monitoring of ultrafast curing by UV-radiation and laser beams, *J. Coat. Technol.*, **1990**, 62(786), 55.
- [27] Mahmoud, M., Abdullah, Z., Mohd-nor, H., Ismail, R. and Modh-dahlan, K., Development of pressure sensitive adhesives from radiation curable palm oil acrylate resins (pp. 576–586), *Proc. RadTech Asia*, **1997**.
- [28] Product profile industrial coatings, *UCB Chemicals documentation* **2002**.
- [29] Priola, A., Gozzelino, G. and Ferrero, F., Modification of UV-curable coatings through addition of functionalized monomers, in *Radiation Curing of Polymers*, Randell, D.R. (Ed.) (pp. 143–160), Royal Chemical Society, London, Special Publication No. 64, **1987**.
- [30] Smith, D., Novel oligomers designed to enhance adhesion in laminating adhesives (pp. 41–44), *RadTech Report* March/April **2003**.
- [31] Sciangola, D.A., UV-curable laminating adhesives (pp. 1024–1032), *Proc. RadTech America* **2000**.
- [32] Trakhtenberg, M., Lapin, S. and Rea, K., Factors affecting bond strengths of UV-curable laminating adhesives (pp. 162–165), *Proc. RadTech America*, **1998**.
- [33] Decker, C. and Zahouily, K., Surface modification of polyolefins by photografting of acrylic monomers, *Macromol. Symp.*, **1998**, 129, 99–108.
- [34] Askienazy, A. and Zwanenburg, R., Adhesion optimisation through oligomer/monomer selection (pp. 205–223), *Proc. RadTech Europe*, **1993**.
- [35] Zahouily, K., Boukhaftane, C. and Decker, C., Surface modifications of UV-cured urethane-acrylate coatings by addition of fluoro or silicone acrylic monomers (pp. 803–808), *Proc. RadTech Europe*, **1999**.
- [36] Decker, C. and Moussa, K., UV-curable acrylic resins for production of glass laminates, *J. Appl. Polym. Sci.*, **1995**, 55, 359–369.
- [37] Hoyle, C.E., Hensel, R.D. and Grubb, M.D., Laser-initiated polymerization of a thiolene systems, *J. Polym. Photochem.* **1984**, 4, 69–70.
- [38] Hoyle, C.E., Hensel, R.D. and Grubb, M.D., Temperature dependence of the laser-initiated polymerization of a thiol-ene system, *J. Polym. Sci., Polym. Chem. Ed.*, **1984**, 22, 1865–1878.
- [39] Jacobine, A.F., Glasser, D.M. and Nakos, S.T., Photoinitiated crosslinking of norbornene resins with multifunctional thiols, in *Radiation Curing of Polymeric Materials*, Hoyle, C.E. and Kinstle, J.F. (Eds.), American Chemical Society, Washington DC, ACS Series **1990**, 417, 160–175.

- [40] Jacobine, A.F. and Nakos, S.T., Photopolymerizable silicone monomers, oligomers and resins, in *Radiation Curing*, Pappas S.P. (Ed.) (pp. 181–240), Plenum Press, New York, **1992**.
- [41] Jacobine, A.F., Thiol-ene Photopolymer in Radiation Curing, in *Polymer Science and Technology*, Vol. 3, Fouassier J.P. and Rabek J.F. (Eds.) (pp. 219–268), Chapman and Hall, London, **1993**.
- [42] Chiou, B.S., English, R.J. and Kahn, S.A., UV-crosslinking of thiol-ene polymers: A Rheological Study, in *Photopolymerization Fundamentals and Applications*, Scranton S.A.B., Bowman C.N. and Peiffer R.W. (Eds.), American Chemical Society, Washington DC, ACS Series **1997**, 673, 150–166.
- [43] Hoyle, C.E., Cole, M., Bachemin, M., Knang, W., Kalyanaraman, V. and Jönsson, S., Photoinitiated polymerization of selected thiol-ene systems, in *Photoinitiated Polymerization*, Belfield, K.D. and Crivello, J.V. (Eds.), American Chemical Society, Washington DC, ACS Series **2003**, 847, 52–64.
- [44] Carlsson, I., Karden, A., Lundmark, S., Manea, A., Rehnberg, N. and Svensson, L., Allyl ethers in the thiol-ene reaction, in *Photoinitiated Polymerization*, Belfield K.D. and Crivello J.V. (Eds.), American Chemical Society, Washington DC, ACS Series **2003**, 847, 65–75.
- [45] Decker, C. and Nguyen thi viet, T., Photo-cross-linking of functionalized rubbers VIII. The thiol-polybutadiene system, *Macromol. Chem. Phys.*, **1999**, 200, 1965–1974.
- [46] Decker, C., Light-induced cross-linking polymerization, *Polym. Intern.*, **2002**, 51, 1141–1150.
- [47] Decker, C. and Nguyen thi viet, T., High-speed photo-cross-linking of thermoplastic styrene-butadiene elastomers, *J. Appl. Polym. Sci.*, 77, 1902–1912.
- [48] Decker, C. and Nguyen thi viet, T., Photo-cross-linking of functionalized rubbers X. Butadiene-acrylonitrile copolymers, *J. Appl. Polym. Sci.*, **2001**, 82, 2204–2216.
- [49] Lapin, S.C., Radiation-induced cationic curing of vinyl ethers, in *Radiation Curing*, Pappas S.P. (Ed.), (pp. 241–272), Plenum Press (New York), **1992**.
- [50] Decker, C., Bianchi, C., Decker, D. and Morel, F., Photoinitiated polymerization of vinyl-ether based systems, *Progr. Org. Coat.*, **2001**, 42, 253–266.
- [51] Crivello, J.V. and Lee, J.L., The synthesis, characterization and photoinitiated cationic polymerization of silicon containing epoxy resins, *J. Polym. Sci., Polym. Chem. Ed.*, **1990**, 28, 479–503.
- [52] Decker, C. and Moussa, K., Kinetic study of the cationic polymerization of epoxy monomers, *J. Polym. Sci., Polym. Chem. Ed.*, **1990**, 28, 3429–3443.
- [53] Crivello, J.V. and S. Lin, Photoinitiated cationic polymerization of epoxy alcohol monomers, *J. Polym. Sci., Polym. Chem. Ed.*, **2000**, 38, 389–401.
- [54] Decker, C. and Nguyen thi viet, T. and Thi H.P., Photoinitiated cationic polymerization of epoxides, *Polym. Intern.*, **2001**, 50, 986–997.
- [55] Crivello, J.V. and Dietliker, K., Photoinitiators for cationic polymerization, in *Chemistry and Technology of UV and EB Formulation for Coatings, Inks and Paints*, Vol. 3, Bradley G. (Ed.) (pp. 329–468), John Wiley and Sons, Chichester, **1998**.

- [56] Albright, L.D., Lamb, K.T., Carroy, A.C. and Carter, W., Cationic UV laminating adhesives, *Proc. RadTech America*, **1998**, 166–169.
- [57] Carroy, A.C., Chomienne, F. and Nebout, J.F., Recent progress in the photoinitiated cationic polymerization of cycloaliphatic epoxy systems, *Proc. RadTech Europe*, **1997**, 303–313.
- [58] Crivello, J.V. and Lee, J.L., UV-cure of epoxy-silicone monomers, in *Radiation Curing of Polymeric Materials*, Hoyle C.E. and Kinstle J.F. (Eds.) (pp. 398–411), American Chemical Society, Washington DC, **1990**.
- [59] Eckberg, R.P. and Evans, E.R., Ultraviolet cure of epoxy fluorosilicones and related systems, *Proc. RadTech America*, **1992**, 541–552.
- [60] Carroy, A.C., Formulation for cationic radiation curable coatings, in *Chemistry and Technology of UV and EB Formulation for Coatings*, Vol. 5, P.K.T. Oldring (Ed.), Wiley J. (pp. 103–143), Chichester, **1997**.
- [61] Carter, J.W. and Braddock, J.K., Effects of key variables on retortability, flexibility and other physical properties of UV-curable cationic epoxide coatings, (pp. 499–506), *Proc. RadTech Europe*, **1995**.
- [62] Carter, J.W., Lamb, K.T., Cationic UV-adhesives laminate opaque film via dark cure mechanism (pp. 9 9099), *Adhesives and Sealants Industry* August **1999**. Cationic UV-cure of Cyacure cycloaliphatic epoxides (pp. 1–40), *Technical brochure from Union Carbide Corporation (now Dow Chemicals)*, **1999**.
- [63] Decker, C. and Morel, F., Cationic UV-curing of vinyl ether based coatings, *Polym. Mater. Sci. Eng.*, **1997**, 76, 70–74, *Surface Coatings Intern.*, **2000**, 173–180.
- [64] Dougherty, J.A. and Crivello, J.V., Photoinitiated cationic polymerization of vinyl ether-epoxy blends, *Polym. Mater. Sci. Eng.*, **1995**, 72, 410–412.
- [65] Rajaraman, S.K., Mowers, W.A. and Crivello, J.V., Interaction of vinyl ethers during photoinitiated cationic polymerization, *J. Polym. Sci. Polym. Chem. Ed.*, **1999**, 37, 4007–4018.
- [66] Decker, C. and Decker, D., Photoinitiated polymerization of vinyl ether and acrylate monomer mixtures (pp. 605–625), *J. Macromol. Sci., Pure Appl. Chem.* A34, **1997**.
- [67] Decker, C., Morel F., Jönsson, S., Clark, S. and Hoyle, C.E., Light-induced polymerization of photoinitiator-free vinyl-ether-maleimide systems, *Macromol. Chem. Phys.*, **1999**, 200, 1005–1013.
- [68] Decker, C. and Decker, D., Photoinitiated radical polymerization of vinyl-ether-maleate systems, *Polymer*, **1997**, 38, 2229–2237.
- [69] Decker, C., Photoinitiated crosslinking polymerization of monomer blends, in *Photoinitiated Polymerization*, Belfield, K.D. and Crivello, J.V. (Eds.) (pp. 92–104), ACS Series 847, **2003**.
- [70] Decker, C., Nguyen thi viet, T., Decker, D. and Weber-koehl, E., UV-radiation curing of acrylate-epoxide systems, *Polymer*, **2001**, 42, 5531–5541.
- [71] Peeters, S., Overview of dual-cure and hybrid cure systems in *Radiation Curing in Polymer Science and Technology*, Vol. 3. Fouassier, J.P. and Rabek, J.F. (Eds.) (pp. 177–217), Chapman and Hall, Andover, **1993**.

- [72] Decker, C., Masson, F. and Schwalm, R., Dual-curing of waterborne urethane-acrylate coatings by UV and thermal processing, *Macromol. Mater. Eng.*, **2003**, 288, 17–28.
- [73] Pappas, S.P. and Woods, J., UV-curable adhesives with auxiliary dark cure processes (pp. 195–200), *Proc. RadTech Asia*, **1991**.
- [74] Hinterwaldner, R., Radiation curable adhesives, *Coating*, **1989**, 22(1), 14–19.
- [75] Mistry, M. and Bustedorf, P., An overview of UV-light curable pressure-sensitive adhesives, in *Proc. Hot Melt Symp.* (pp. 37–63), Bal Harbor (Florida), **2000**.
- [76] Woods, J., UV-curable adhesives, in *Radiation Curing of Polymers*, Randell D.R. (Ed.) (pp. 102–115), Royal Society of Chemistry, London, Special Publication No. 64, **1987**.
- [77] Heindl, D., UV-curing adhesives. Best performance thanks to modification, *Adhaesion, Kleben und Dichten*, **2002**, 46(9), 26–30.
- [78] Goss, B., Bonding glass and other substrates with UV-curing adhesives, *Intern. J. Adhesion and Adhesives*, **2002**, 22(5), 405–408.
- [79] Rakas, M.A., Characterization of cure in model photo-cross-linking of acrylate systems: Relationship among tensile properties, T_g and UV-dose, *Polym. Mater. Sci. Eng.*, **1996**, 74, 164–165.
- [80] Trakhtenberg, M., Lapin, S. and Rea, K., Factors affecting bond strengths of UV-curable laminating adhesives (pp. 162–165), *Proc. RadTech America*, **1998**.
- [81] Manser, A. and Moeckel, J., A superfast UV-curing of acrylate adhesives for plastics, *Adhaesion*, **1990**, 34(7), 20–24.
- [82] Salomon, P.A., Jacobine, A.F. and Glaser, D.M., Non-acrylate photopolymer systems: adhesives properties and performance of a new radiation curable thiol/norbornene system (pp. 239–259), *Proc. RadTech America*, **1992**.
- [83] Murata, N., Nishi, S. and Sighesu, H., UV-curable transparent adhesives for fabricating precision optical components, *J. Adhesion*, **1996**, 59, 39–50.
- [84] Dake, K., The right light for epoxies. Test methods and optimum cure conditions for epoxy adhesives, *Adhesives Age*, **2002**, 45(12), 12–14.
- [85] Dougherty, J., Mekittrick, J. and Russell, G.S., UV-curable adhesives based on vinyl ethers (pp. 65–71), *Proc. RadTech America*, **1998**.
- [86] Decker, C., Laser curing, imaging and polymerization kinetics, in *Chemistry and Technology of UV and EB Formulation for Coatings, Inks and Paints*, Vol. 5., P.K.T. Oldring (Ed.) (pp. 146–251), John Wiley, Chichester, **1997**.
- [87] Battermann, A., Nanoscale sol-gel fillers in fibre-chip adhesives, (p. 1039), *Proc. RadTech Europe Conf.*, Berlin, **2003**.
- [88] Salemi, C.M. and Serenson, J.A., Light-cure adhesives for needle assembly, (pp. 32–40), *RadTech Report*, March **2003**.
- [89] Maan, N. and Zwiers, R.J., Accurate high-speed assembly of optical components in optical scanning systems using UV-curing adhesives : a positional and stability study, *J. Adhesion*, **1998**, 26, 85–100.
- [90] Matsumoto, M., Tsunematsu, N. and Ebisawa, K., Method and apparatus for manufacture of optical disks by bonding two disks substrates using cationic polymerizable UV-curable resin adhesives, Japanese Patent JP 219-608, CA 2003-97201, **2001**.

- [91] Pattein, J. and Leroy, P., Production of glass laminates by UV-cured resins. US patent 4-859-742, **1989**.
- [92] Decker, C. and Bendaikha, T., Interpenetrating polymer networks. Sunlight-induced polymerization of multifunctional acrylates, *J. Appl. Polym. Sci.*, **1998**, 70, 2269.
- [93] Verschueren, K. and Wellens, W., UV-curable laminating adhesives for transparent and non-transparent materials (pp. 565–571), *Proc. RadTech Europe*, **1999**.
- [94] Kauffman, T. and Whitman, D., EB curable technology delivers adhesion to demanding substrates (pp. 12–19) *RadTech Report*, March **2003**.
- [95] Lin, A., Lighting it up UV/EB emerges as an attractive technology for food packaging (pp. 22–30), *Adhesives Age*, Nov **2002**.
- [96] Lin, A., Meloon, D. and Hamric, J., EB adhesives go mainstream for food packaging (pp. 25–31), *RadTech Report*, March **2003**.
- [97] Lin, A., Hamric, J. and Meloon, D., Rapid processing with EB laminating adhesives (pp. 768–778), *Proc. RadTech America*, **2002**.
- [98] Grant, S.M., UV-light curing compositions for electronic assembly processes (pp. 7.5–7.14), *Proc. RadTech Europe*, **1987**.
- [99] Studer, K., Decker, C., Beck, K., Schwalm, R. and Gruber, N., Redox and photoinitiated crosslinking polymerisation, *Prog. Org. Coat*, **2005**, 53, 126–146.
- [100] Scott, G., UV-light initiated deep curing of epoxy potting compounds (pp. 803–812), *Proc. RadTech America*, **2002**.
- [101] Oehmke, R.W., An overview of radiation-cured pressure-sensitive adhesives (pp. 229–238), *Proc. RadTech America*, **1992**.
- [102] Hoffman, W.E. and Miles, D.E., UV light cured pressure-sensitive adhesives. Advantages and commercial applications (pp. 251–259), Boston, *Proc. RadTech America*, **1992**.
- [103] Karman, W. and Zöllner, S., Radiation curing of pressure-sensitive adhesives, An overview (pp. 155–165), *Proc. RadTech Europe*, Maastricht, **1995**.
- [104] Dowbenko, R., Radiation curing in *Handbook of pressure-sensitive adhesives technology*, Satas D. (Ed.), (pp. 906–924), Van Nostrand Reinhold, New York, **1989**.
- [105] Glotfelter, C.A., Low cost UV-curable pressure sensitive adhesives (pp. 528–536), *Proc. RadTech America*, Orlando, **1994**.
- [106] Erickson, J.R. and Mancini, P.A., UV-curable PSAs offer excellent performance and fast production rates, high-speed, Hi-Tech. *Adhesives Age*, **2000**, 2, 11–17.
- [107] Glotfelter, C.A., Valuable properties T_g-Region Breadth is critical to UV-curable PSA performance, *Adhesives Age*, **2000**, 2, 24–30.
- [108] Dobman, A., Applying UV-curable PSAs with printing technologies (pp. 54–59), *RadTech Report*, March **2003**.
- [109] Schumacher, K.H., Düsterwald, U. and Fink, R., UV-acrylic hot-melts. Combining hot-melt coating technology with acrylic high performance Chemistry (pp. 559–564), *Proc. RadTech Europe*, Berlin, **1999**.
- [110] Zöllner, S., UV-curable acrylic pressure-sensitive adhesives. Features, Mechanisms, Milestones (pp. 543–549), *Proc. RadTech Europe*, Berlin, **1999**.

- [111] Dorbmann, A., UV-curable hot-melt pressure sensitive adhesives, *Adhesives Technology*, **2000**, 17(2), 14–16.
- [112] Sanborn, T.U., UV-curable acrylic hot-melt PSA's from theory to commercial success (pp. 22–34), *Proc. Hot Melt Symposium*, Charlotte (USA), TAPPI Press Atlanta, **2002**.
- [113] Mistry, M. and Bustendorf, P., An overview of UV-light curable pressure sensitive adhesives (pp. 37–63), *Proc. Hot Melt Symposium*, Bal Harbor Florida, **2000**.
- [114] Nityl, K., Radiation curable pressure sensitive adhesives (pp. 185–193), *Proc. RadTech Europe*, Maastricht, **1995**.
- [115] Scheiber, M. and Braun, H., UV curable PSA's for industrial applications (pp. 194–202), *Proc. RadTech Europe*, Maastricht, **1995**.
- [116] Dupont, M. and De Keyser, N., UV-curing of styrenic block copolymer based pressure sensitive adhesives (pp. 174–184), *Proc. RadTech Europe*, Maastricht, **1995**.
- [117] Merrill, N.A., Gardner, I.J. and Hughes, V.L., Radiation curing of butyl polymers for pressure-sensitive adhesives (pp. 77–86), *Proc. RadTech America*, **1992**.
- [118] Decker, C. and Nguyen thi viet, T., Photo-cross-linking of functionalized rubbers 7 styrene-butadiene block copolymers, *Macromol. Chem. Phys.*, **1999**, 200, 358–367.
- [119] Decker, C. and Nguyen thi viet, T., Photo-cross-linking of functionalized rubbers 9 thiol-ene polymerization styrene-butadiene block copolymers, *Polymer*, **2000**, 41, 3905–3912.
- [120] Okazaki, E., Kamiya, D., Taniguchi, Y., Application of maleimides to UV-curable pressure sensitive adhesives (p. 1057), *Proc. RadTech Europe Conf.*, Berlin, **2003**.
- [121] Sartomer, New developments in Oligomers for UV/EB pressure, Sensitive adhesives, Technical information Volume 3, Number 6, May **2003**.
- [122] Tauber, A., Scherzer, T., Weiss, I. and Mehnert, R., UV-curing of a pressure sensitive coating studied by real-time FTIR spectroscopy and laboratory scale curing experiments, *J. Coat. Technol.*, **2002**, 74(927), 41–47.
- [123] Rönisch, R., Novel UV-curable pressure sensitive adhesives (p. 97), *ProcRadTech Europe Conf.*, Berlin, **2003**.
- [124] Eckberg, R.P. and Sheperd, D., Radiation curable silicone coatings controlled release design (pp. 507–513), Orlando, *Proc. RadTech America*, **1994**.
- [125] Ostreich, S., UV-curable silicones (pp. 397–403), *Proc. RadTech Europe*, Basle, **2001**.
- [126] Frances, J.M., Formulating UV/EB epoxy silicones and adhesives, (pp. 581–589), *Proc. RadTech Europe*, Berlin, **1992**.
- [127] Frances, J.M., Kerr, S. and Pinto, O., UV/EB silicone release coatings, Global approach (pp. 381–390), *Proc. RadTech Europe*, Basle, **2001**.
- [128] Riding, K.D., Recent advances in UV-curable epoxy silicone release systems (pp. 112–115), *Proc. RadTech America*, Boston, **1992**.
- [129] Hohenwater, T.E., Silicone-acrylates. Part of the total process (pp. 108–111), *Proc. RadTech America*, Boston, **1992**.

- [130] Takahashi, M., Irifune, S. and Ohba, T., Development of EB/UV curable silicone-acrylate for release coatings (pp. 564–567), *Proc. RadTech Asia*, Yokohama, **1997**.
- [131] Eckberg, R.P. and Riding, K.D., UV-cure of epoxysiloxane and epoxysilicones, in *Radiation Curing of Polymeric Materials*, Hoyle, C.E. and Kinstle, J.F. (Eds.) (pp. 383–397), Americ. Soc. Washington DC, ACS Series 417, **1990**.
- [132] Gordon, G.V., Moore, P.A., Popa, P.J., Tonge, J.S. and Vincent, G.A., Radiation cured silicone release coatings sticking lightly (pp. 994–1006), *Proc. RadTech America*, Baltimore, **2000**.
- [133] Frances, J.M., New UV-premium release system (p. 105), *Proc. RadTech Conf.*, Berlin, **2003**.
- [134] Ferenz, M., Innovative developments for UV-silicone release coatings (p. 105), *Proc. RadTech Conf.*, Berlin, **2003**.
- [135] Müller, U., New insight in the oxygen influence on the photo-cross-linking of silicone-acrylates (pp. 663–667), *Organosilicone Chem.*, **2000**.

Note of the Editor:

List of Suppliers for UV Curing Techniques, Adhesives and UV Equipment

1. Chemicals

photoinitiators, acrylate monomers, oligomers

BASF headquarters
 EDD/K-H201, D-67056 Ludwigshafen,
 Germany.
 (affiliates in many countries)

BASF Corporation, USA,
3000 Continental Drive N.
Mt. Olive, NJ 07828,
Tel.: (973) 426-4575, Fax: (973) 426-4676
www.basf-corp.com
Products: N-vinyl caprolactam, N-vinyl
formamide, vinyl ethers, tert-butyle acrylate,
butanediomonoacrylate, tertiary butyl methacrylate

BASF Corporation/Performance Chemicals
for Coatings
4330 Chesapeake Drive,
Charlotte, NC 28216, USA,
Tel.: (704) 735-1242, Fax: (704) 398-4353
Web: www.basf.com
Products: Pigments/dispersions, photoinitiators/sensitizers,
acrylate monomers, vinyl ethers, polyols/glycols, epoxy
acrylates, polyester acrylates, unsaturated polyesters, urethane
acrylates

BAYER Geschäftsfeld LS-M (Adhesives
 Materials) Gebäude F1/F46, D-41538,
 Dormagen, Germany

CIBA

Head office
Ciba Specialty Chemicals Inc.
PO Box,
CH-4002 Basel,
Switzerland,
www.cibasc.com

Ciba Specialty Chemicals
751 Roosevelt Road,
Suite 208,
Glen Ellyn, IL 60137, USA,
Tel.: (800) 323-7386, (630) 942-5000,
Fax: (630) 942-5258
www.cibasc.com,
Products: Pigments dispersions, photoinitiators/
sensitizers, fluorescent

CLARIANT

Clariant Corporation,
4000 Monroe Road,
Charlotte, NC 28205, USA,
Tel.: (704) 331-7789, (888) 463-3463,
(ext. 7789), Fax: (704) 331-7825,
www.clariant.com
Products: Additives, silicone acrylates, specialty
acrylates, photoresists

CLARIANT GmbH,
D 65840 Sulzbach, Germany,
Tel.: (069) 305-4383, Fax: (069) 317140

COGNIS

Cognis Corporation, USA,
300 Brookside Avenue,
Ambler, PA 19002,
Tel.: (215) 628 -1000, (800) 445-2207,
Fax: (215) 628-1111,
www.cognis.com,
Products: Acrylate monomers, acrylic
acrylates, acrylate oligomers, epoxy acrylates,
polyester acrylates, urethane acrylates, specialty
acrylates, polyols/glycols,
additives, photoinitiators/sensitizers

Headquarters in Germany

Cognis Deutschland GmbH

Tel.: ++49-211-7940-2022,

fax: ++49-211-798-2261,

Cognis Brasil Ltda.

Tel.: ++55-11-3848-2378,

Fax: ++55-11-3848-2349

Cognis Taiwan Ltd.

Tel.: ++886-2-2958-9766,

Fax: ++886-2-2958-1238

KINETICS Corp

PO Box 824,

Manchester, MA 1944,

Tel.: (978) 525-2415,

Fax: (978) 525-2417,

kinetics@shore.net,

Products: Photoinitiators/sensitizers,

acrylate monomers, methacrylates monomers,

acrylic acrylates, epoxy acrylates, methacrylates,

polyester acrylates, urethane acrylates

RAHN AG

Dorflistrasse 120,

Zurich, CH 8050,

Switzerland,

Tel.: ++41 1 315 42 00,

Fax: ++41 1 315 43 50

www.rahn.ch,

Products: Additives, photoinitiators/

sensitizers, acrylate monomers, epoxy

monomers. epoxy acrylates, methacrylates,

polyester acrylates, silicone acrylates,

unsaturated polyesters, urethane

acrylates, specialty acrylates

Du PONT

Du Pont Performance Coatings, USA

Rahn Corporation,
1005 N. Commons Drive,
Aurora, IL 60504, USA,
Tel.: (630) 851-4220, Fax: (630) 851-4863,
www.rahncorp.com

SARTOMER

502 Thomas Jones Way,
Oaklands Corporate Center,
Exton, PA 19341, USA,
Tel.: (610) 363-4100,
(800) SARTOMER,
Fax: (610) 363-4140,
www.sartomer.com
Products: Additives, photoinitiators/sensitizers,
acrylate monomers, methacrylate monomers,
acrylic acrylates, epoxy acrylates,
methacrylates, polyester acrylates, urethane
acrylates

SOLUTIA

Solutia Inc.
730 Worcester Street, Springfield, MA 1151, USA,
Tel.: (413) 730-2499, (800) 964-5224,
Fax: (413) 730-3394,
www.coatings-solutia.com,
Products: Additives, acrylic acrylates, urethane
acrylates, polyester acrylates, melamine acrylates,
epoxy acrylates,
polyurethane dispersion, acrylic dispersion,
waterborne UV, polyols/glycols

CAC SHANGHAI
CHEMICAL CO

785 Beidi Road,
Changning District,
Shanghai, 200335,
Republic of China,
Tel.: 86 21 6239 8696, Fax: 86 21 6239 3490,
www.cacch.com,
Products: Photoinitiators/sensitizers

UCB
UCB Chemical sector Speciality
chemicals division, rue d'Anderlecht 33—
B-1620, Drogenbos — Belgium,
Tel.: 322 334 5822, Fax: 322 378 4439,
surfacespecialties.ucb-group.com,
UCB Surface specialities, USA,
1950 Lake Park Drive/Smyrna,
GA 30080/800 433 2873, USA
comm.adv@ucb-group.com

2. Formulated UV curing and EB curing adhesives

BOSTIK FINDLEY Headquarters:
Place de l'Iris, 92062 Paris la Defense,
France. Tel.: 33 1 47969465,
Fax: 33 1 47969690, www.ato-findley.fr
Bostik Findley Inc. USA,
11320 Watertown Plank Road,
Wauwatosa, WI 53226, USA
Tel.: (414) 607-1482, Fax: (414) 774-8075
Products: Structural adhesives, pressure sensitive
adhesives, laminating adhesives

AKZO NOBEL Headquarters/adhesives
CASCO NOBEL AB
Box 11550,
5-100 61, Stockholm (Sweden),
Tel: 46 8743 4000, Fax: 46 841 8762

ELEMENTIS
SPECIALTIES 600 Cortlandt Street,
Belleville, NJ 7109,
Tel.: (973) 844-3760, (888) 442-7362,
Fax: (937) 751-3621,
www.elementis-specialties.com
Products: pressure sensitive adhesives,
laminating adhesives, medical,
cure-in-place gaskets, encapsulating and
potting compounds

ROHM and HAAS

100 Independence Mall West,
Philadelphia, PA 19106, USA,
Tel.: 1 215 592 30000, Fax: 1 215 592 3021,
poweratwork@rohmmaas.com

La Tour de Lyon-185, rue de Bercy
75579 PARIS 12,
Tél.: +33 (0)1 40 02 50 00
Télécopie: + 33 (0)1 43 45 28 19

Rohm and Haas,
727 Norristown Road,
Spring House, PA 19438-0904,
Tel.: (215) 641-7637, Fax: (215) 619-1626,
www.rohmmaas.com/AdhesivesSealants/
Products: Acrylate monomers, methacrylate
monomers, acrylic acrylates, epoxy acrylates,
methacrylates, polyster acrylates, urethane
acrylates, specialty acrylates

LESCO

LESCO Inc., USA,
23555 Telo Avenue,
Torrance, CA 90505,
Tel.: (310) 784-2930,
(800) 61-LESCO,
Fax: (310) 784-2929,
Sale@lescouv.com,
www.lescouv.com
Products: Application
equipment, wood coatings, cure/dose
measurement equipment, IR driers,
surface preparation, UV equipment, UV light
sources, UV/EB curable adhesives, cura/dose
measurement

MORFLEX Inc.

2100 High Point Road,
Greensboro, NC 27403,
Tel.: (336) 834-4962, (336) 292-1781,
Fax: (336) 854-4058
www.morfle.com

- Products: High Performance monomers for rad cure offer: accelerated cure, enhanced scratch/abrasion resistance, promotes adhesion/ flexibility, reduced irritancy and toxicity,
- NORDSON** Nordson UV,
300 Nordson Drive,
Amherst, OH 44001,
USA, Tel.: (440) 985-4002, (800) 717-4228,
uvcuring@nordson.com
www.nordsonuv.com
Products: UV equipment,
application equipment, toll coaters,
UV light sources
- Nordson Deutschland
Heinrich Hertz Str 42,
D-40699 ERKR ATH, Germany,
Tel.: 49 (0211) 92-05-0,
Fax: 49 (0211) 25 46 58
info@de.nordson.com
Fax: 516-213-8312,
www.nordson.de
- ELECO** ELECO PRODUITS
126, Boulevard Victor Hugo - 92110
CLICHY, Tél.: 01 55 21 03 50,
Télécopie: 01 55 21 03 59
eleco@eleco-produits.fr
RCS Paris B 305 108 664 - Siret 305
108 664 00015 - APE 5906,
www.eleco-produits.fr
- NATIONAL**
Adhesives National Starch & Chemical Company,
One Matrix Drive,
Monroe Township, NJ 8831,
USA, Tel.: (800) 797-4992,
Fax: (609) 409-5699,
www.nationalstarch.com,
Products: Pressure sensitive adhesives,
laminating adhesives

- DELO Industrial Adhesives Ohmstrasse 3, D-86899 Landsberg, Germany
Tel.: +49 8191 3204-0,
Fax: +49 8191 3204-144, info@DELO.de,
www.DELO.de
- PERMABOND Permabond a National Starch
& Chemical Company
North America: Permabond Engineering
Adhesives, 480 South Dean street, Englewood,
NJ 07631-6849,
Technical Helpline: 1-800-370-9647,
Fax: 1-201-567-3747,
www.permabond.com,
helpline.usa@permabond.com
- Europe: Permabond Engineering
Adhesives, Woodside Road,
Eastleigh, Hampshire, UK SO50 4EX
- EPOTECNY 7-9, rue Aristide Briand - 92300
Levallois-Perret - France
Tél.: 01 47 57 54 34, Fax: 01 47 57 54 74,
epotecny_com@yahoo.fr
- PANACOL-ELOSOL Obere Zeil 6-8,
D 61440, Oberüsel (Germany),
Tel.: 49 (700) 838 963 78,
Fax: 49 (700) 838 963 73,
tetzner@panacol.de,
www.panacol.de

3. Equipment, UV light

- American Ultraviolet Co. 212 S. Mt. Zion Road,
Lebanon, IN 46052, USA,
Tel.: (765) 483-9514,
(800) 288-9288,
Fax: (765) 483-9525,
www.americanultraviolet.com

Products: UV equipment, Cure/dose measurement,
UV light sources, spot curing equipment, shuttered
UV systems, application equipment

Electro-Lite Corporation 43 Miry Brook Rd, Danbury,
CT 06810-7414, USA, (203) 743-4059,
Fax: (203) 792-2275,
eluv@electro-lite.com,
<http://www.electro-lite.com/~eluv>

ARAYTECH Rue du Moulin de Poujard - Quartier
Basleme 37160 Descartes - France
Tel.: (33) 02 47 92 91 68,
Fax: (33) 02 47 92 91 71,
araytech@wanadoo.fr,
araytech.fr

FUSION UV curing systems Corporate Headquarters:
7600 Standish Place,
Rockville, MD 20855, USA,
Tel.: 301-251-0300, Fax: 301-279-0661

Overseas Office:

Fusion Japan, K.K.
Nanoh buildings 2F,
34-4 Hakozaki-Cho,
Nihonbashi, Chuo-ku,
Tokyo 103, Japan,
Tel.: 03-663-4580,
Fax: 03-663-3326,

FUSION UV®
SYSTEMS, INC. 910 Clopper Road,
Gaithersburg, Maryland
20878-1357, USA,
Tel.: 301 527 2660,
www.fusionuv.com,
info@fusionuv.com

Dr HÖNLE AG

Lochhamer Schlag 1
D-82166, Gräfelfing/München
Tel.: (0 89) 85 60 80,
Fax: (0 89) 85 60 81 48
uv@hoenle.de,
www.hoenle.de

Honle UV America Inc.
261 Cedar Hill Street, Bldg. C,
Marlbor, MA 01752, USA,
Tel.: (508) 229-7774,
Fax: (508) 229-8530,
lc@honleuv.com,
www.honleuv.com,
Products: Application equipment, screen printing
supplies, surface preparation, testing equipment,
UV equipment, UV light sources

IST-UV Technik

IST Strahlentechnik GmbH,
Benzstraße 4/1,
D-7448, Wolfschlugen, Germany,
Tel.: (0 70 22) 57 84/85/86

IST America Corp.
590 Territorial Drive, Suite A,
Bolingbrook, IL 60440, USA,
Tel.: (630) 771-0590, Fax: (630) 771-1190,
www.ist-uv.com,
Products: Application equipment, cure/dose-
measurement, IR driers, testing equipment,
UV equipment UV light sources

HAMAMATSU

HAMAMATSU PHOTONICS K.K.,
Electron Tube Center, 314-5, Shimokanzo,
Toyooka-village, Iwata-gun,
Shizuoka-ken, 438-0193, Japan,
Tel.: (81)539/62-5248, Fax: (81) 539/62-2205
<http://www.hamamatsu.com>,

U.S.A.: Hamamatsu Corporation: 360 Foothill Road, PO Box 6910, Bridgewater, N.J. 08807-0910, USA., Tel.: (1)908-231-1218, usa@hamamatsu.com

Germany: Hamamatsu Photonics Deutschland GmbH: Arzbergerstr. 10, D-82211 Herrsching am Ammersee, Germany, Tel.: (49) 8152-375-0, Fax: (49) 8152-2658, info@hamamatsu.de

France: Hamamatsu Photonics France S.A.R.L.: 8, Rue du Saule Trapu, Parc du Moulin de Massy Cedex, France, Tel.: (33) 1 69 53 71 00, Fax: (33)1 69 53 71 10, info@hamamatsu.fr

United Kingdom: Hamamatsu Photonics, UK Limited: 2 Howard Court, 10 Tewin Road Welwyn Garden City Hertfordshire AL7 1BW, United Kingdom, Tel.: 44-(0)1707-294888, Fax: 44(0) 1707-325777, info@hamamatsu.co.uk

Advanced Electron
Beams, inc

Advanced Electron Beams Inc.
10 Upton Drive,
Wilmington, MA 01887, USA,
Tel.: (978) 658-8600, ext. 23,
Fax: (978) 658-7999

PRIME UV SYSTEMS

416 Mission Street,
Carol Stream, IL 60188,
USA, Tel.: (630) 681-2100,
Fax: (630) 681-0022,
sales@primeuv.com,
www.primeuv.com
Products: Application equipment, cure/dose measurement, testing equipment,
UV equipment, UV light sources, consultants,
journals/publications

- RAHN Headquarters
RAHN AG
Dörflistrasse 120,
CH-8050 Zürich,
Tel.: ++41 1 315 42 00,
Fax: ++41 1 315 43 50,
rahn@rahn.ch www.rahn.ch
- RAHN USA Corp,
1005 North Commons Drive,
Aurora, Illinois 60504, USA,
Tel.: 001 (630) 851-4220
Fax: 001 (630) 851-4863,
rahn@rahn-corp.com www.rahn-corp.com
- XENON Corp Xenon Corp.,
20 Commerce Way,
Woburn, MA 01801, USA,
Tel.: (781) 938-3594, ext. 116, (800) 936-6695,
Fax: (781) 933-8804, www.xenon-crop.com,
Products: UV equipment, UV light
sources

4. Consultants, Laboratories

- Photo'n Polymers 3, rue Alfred Werner, F-68093
Experts Mulhouse Cedex (France),
Tél.: + 33 (0) 3 89 33 68 38,
Fax: +33 (0)3 89 33 67 34,
info@photonpolymers.com,
www.photonpolymers.com

**RADTECH
INTERNATIONAL**

RadTech International NA,
6935 Wisconsin Avenue Suite 207,
Chevy Chase, MD 20815,
Tel.: (240) 497-1243,
Fax: (240) 209-2337,
www.radtech.org

RadTech Europe Office,
P.O. Box 85612, NL-2508 CH,
The Hague, The Netherlands,
Tel.: +31 (0)70 312 39 16,
Fax: +31 (0) 70 363 63 48,
mail@radtech-europe.com,
www.radtech-europe.com

This Page Intentionally Left Blank

Chapter 6

Elastic Bonding and Sealing in Industry

Bernd R. Burchardt and Peter W. Merz

Bernd Burchardt completed his graduation in chemistry as Dr. rer. nat. in 1979 at the Albert-Ludwigs University of Freiburg. From 1979 to 1994, he worked for BMW as adhesives specialist for all adhesives application at BMW. This includes body shop, paint shop and assembly applications. In 1994, he moved to Sika to become the head of the R&D department for the development of elastic adhesives and was responsible for the various technologies of the 1C polyurethane adhesive. In 2001, he became the head of the R&D department for the development of structural adhesives and had to integrate into the R&D department of the acquired company Tivoli. In 2002, he moved to Sika Services AG and became the Market Research Manager and is responsible for the transfer of new technologies into the market and looking for new application opportunities of their whole product range. He has a very broad knowledge and experience with applications of adhesive bonding technology as well as know-how on the formulation of adhesives. Therefore, his knowledge covers all the aspects of adhesive bonding from the formulation of an adhesive, the engineering of adhesively bonded structures, the necessary performance profile of an adhesive and the application and process steps.

Keywords: 2C-PUR adhesives; Adhesion models; Ageing tests; Automotive Booster technology; Calculations of joints; Chemical pretreatments; Curing speed; Corrosion protection; Definition of structural bonding; Direct glazing; Disassembly and repair; Durability; Education on adhesive technology; Elastic; Elastic bonding; Elasto-plastic; Elongation at break; Even stress distribution; Fatigue curve; Fenestration; Finite element method (FEM); Flexible structural bonding; GRP (glass reinforced plastic); Handling strength; Headlamp assemblies; Highspeed tensile testers; Joint design; Material safety data sheets; Mixing; Moisture-curing polyurethane adhesive; One part PUR; Parquet adhesive; Peeling stresses; Physical-chemical pretreatments; Plasma treatment; Plastic; Primers; Quality assurance; Reactive warm melt adhesives; Reduction factors; Rigid bonding; Safe-drive-away time; Shear modulus; Speed; Static loads; Stress distribution;



Figure 1: Direct glazing of windshield glass to metallic frame on a ship.

Structural glazing; Surface preparations; Teak decks; Test of a bead; Thickness of the joint; Transport equipment; Uneven stress distribution; UV radiation; Waterswelling sealants; Wettability; Windshield bonding; Woehler diagram.

The basic principles of adhesive and sealant technology and a guide to its cost-effective use in industry are discussed in this chapter. An example is given in Fig. 1.

6.1. Introduction

6.1.1. Historical Background

In the distant past (pre-1970), bonding of structures, especially in the aircraft industry, was characterised by the use of adhesives with very high strength applied

in thin layers. This type of adhesive was usually referred to as ‘structural’ and was either based on phenolic resins (in the 1940s) or, beginning in the 1950s, on epoxy resins. They have been used for many years, but with increasing use their main disadvantage has become obvious. Such adhesives are generally very brittle and exhibit poor impact behaviour. Therefore, many attempts have been made to improve the impact resistance of epoxy adhesives. In discussion with engineers and experts familiar with adhesive bonding, the general opinion was that bonding can only be successful if the lap shear strength is higher than 10 MPa.

The structural glazing of facades was introduced in the 1960s. A silicone sealant was used to bond the isolating glass together and this fulfilled the important requirements of UV-resistance, thermal stability, durable elasticity, and adhesion to glass and frame materials (Fig. 2).

In 1964, another key development started when the US automotive industry had to fulfill safety standards which required the retention of the windshield in a crash and thus, to ensure that the occupants remained inside the car (FMVSS 212). The windshield bonding technology involved has been called ‘direct glazing’ ever since. At that time, direct glazing was achieved by the use of a material which



Figure 2: Example of structural glazing of facades, Berlin.
This requires a flexible bond and seal.

was very soft like a sealant, but cured to an elastomeric adhesive and which exhibited good adhesion property on the glass and steel substrates after appropriate surface preparation. Thus, the first Elastic Bonding adhesive was created. But according to many experts, this was a sealant and not really an adhesive.

This perception changed after the introduction of direct glazing in the European automotive industry at the AUDI A100 in 1978. All other car manufacturers then introduced this technology, stepwise one model after the other. The reason was not only to fulfill the US safety standards, but engineers soon realised that direct glazing increased the torsional stiffness of a car significantly at no additional cost.

Adhesive producers soon realised that this technology could also be used for similar applications in buses, trucks or trains. The demand for this innovative Elastic Bonding fastening technique initiated the development of the Sikaflex®-Technology based on polyurethanes.

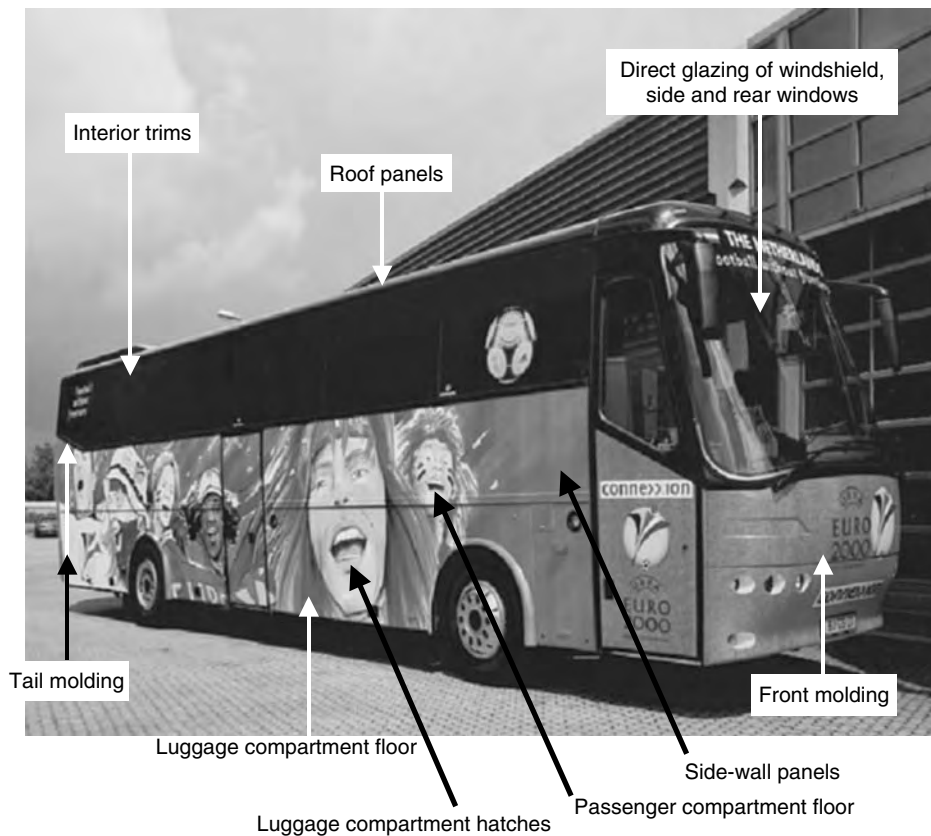

Figure 3: Variety of applications of bonding on buses.

The first use of adhesives to bond components and assemblies in the manufacture of buses dates back to the early 1980s. The modern bus industry now depends on elastic adhesives for a whole range of fastening applications (Fig. 3).

In 1992, Bombardier AG, formerly Schindler Waggon, manufactured a regional train using Sikaflex® products, where the front cabin is bonded to the train and the screens are glazed directly on the front cabin (Fig. 4).

Since 1 January 2003 and after its official start-up, the magnetic suspension railway ‘Transrapid’ has connected downtown Shanghai with the airport. A new railway track was built especially for this rail vehicle technology. The Transrapid is designed for speeds of 430 km/h and covers a distance of 60 km in approximately 8 min, thus shortening the travel time by 32 min (80%). High performance adhesives enable the front module of Transrapid to function (Fig. 5).

An optimal combination between aerodynamic and weight requirements was achieved for the ‘Transrapid’ by modular hybrid (mixed) construction methods. For example, the glass-fibre-reinforced plastic (GRP) front module is designed for maintaining aerodynamic pressure as well as for stability under cross wind forces of 500 km/h, and is bonded to the front of the aluminium structure of the rail cars with Sikaflex® products (Fig. 5).

In the meantime, Elastic Bonding Technology was established in other sectors of the manufacturing industry, such as for containers, ships and boats, refrigerators and washing machines, facades, floors, windows and many others.



Figure 4: Modern trains owe their stylish looks to a combination of glass, plastics and lightweight metals bonded together with adhesives. (a) Train before cabin bonding.



Figure 4: (continued) (b) Direct glazed front cabin bonded to the train.



Figure 5: GRP front module of 'Transrapid'.

The need to disassemble and separate the parts at some later date without undue difficulty is becoming more important. This is critical both for ease of repair and for recycling the individual components when they reach the end of their service life. These issues are discussed in more detail in Section 6.8.8. ‘Disassembly and Repairs’.

6.1.1.1. Proven Long-Term Durability

The durability of elastic adhesives, especially their long-term dynamic strength, can be demonstrated with examples. The oldest buses with adhesively bonded window glass have now been in service for over 20 years. During that time they have covered several million kilometres. Although their engines have all had to be overhauled several times, the adhesive joints continue to function, in most cases perfectly.

6.1.2. Strength and Stiffness of Adhesives

Adhesive systems can be divided into rigid, flexible structural and elastic bonding groups. A fourth group comprises sealants. These adhesive and sealant systems have a different, reversible elastic deformation and shear modulus (Fig. 6). Reversible elastic deformation is explained in more detail in the ‘Glossary/ Definition of Terms’ at the end of this chapter.

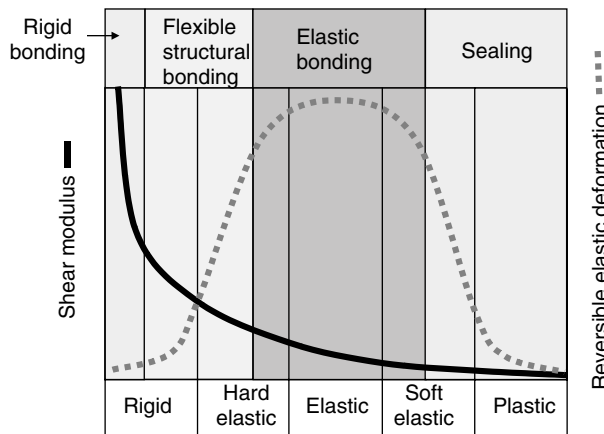

Figure 6: Different adhesive and sealant systems (schematic): reversible elastic deformation versus shear modulus.

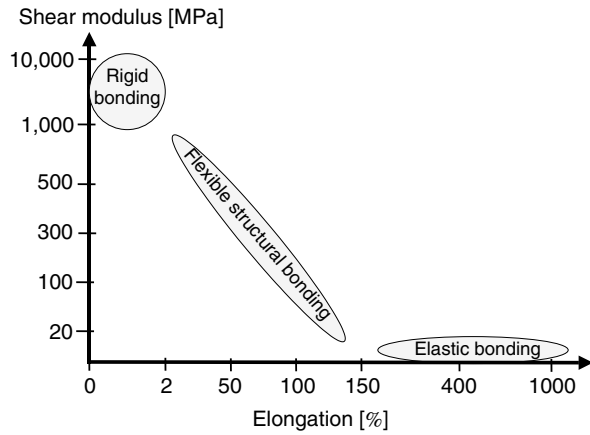

Figure 7: Shear modulus and elongation at break.

Fig. 7 shows the shear modulus and elongation at break of the three above-mentioned adhesive systems. The shear modulus defines the degree of stiffness or load transfer.

Even stress distribution in the bond line is a fundamental principle of bonding technology. An explanation is given in Fig. 8, where the load bearing capability of rigid, elastic and flexible structural bonding is compared with respect to the bond overlap. The load bearing capability is the area below the curve of the stress level.

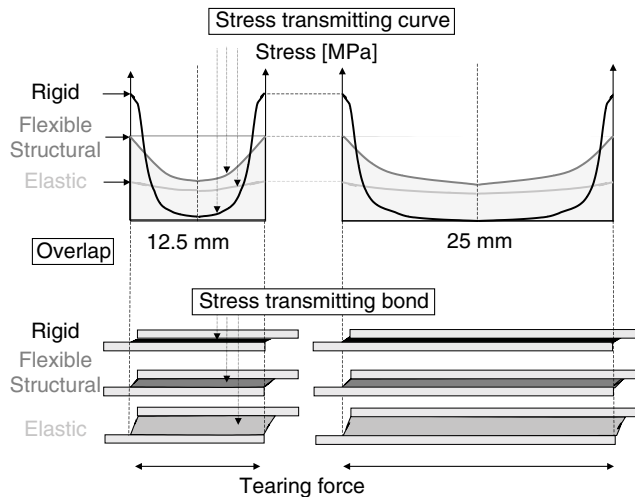

Figure 8: Stress distribution (schematic).

Rigid bonding adhesives, such as the ‘pure’ epoxy adhesives, are widely used in structural applications. They have to withstand high peak stress at the edge of the bond and have an uneven stress distribution, which leads to a reduced load-bearing capability in the joint. When the bond overlap is increased from 12.5 mm to 25 mm, the load-bearing capability does not increase significantly, since practically no stress load is transferred inside the joint. The peak load at the edge limits the strength of the bonded joint. This behaviour of high peak stress combined with a low (2%) elongation results in poor impact resistance.

Elastic bonding exhibits a much lower stress level, but in contrast to rigid bonding, the stress distribution is rather even. By enlarging the overlap, the load-bearing capability increases almost proportionally.

The ability of elastic adhesives to undergo deformation and then recover makes them resistant to sudden stresses or brief periods of overload. In moving vehicles, such stresses may result from vibrations or from sudden impact with an obstacle. Whether or not an adhesive bond can withstand overloading without damage depends on its strength and, above all, on the fracture energy. This is the energy required to deform the adhesive layer before failure occurs. It is proportional to the area beneath the curve of a graph of the tensile lap-shear strain (Fig. 9).

In this diagram, the thin, rigid bond made with a high-strength epoxy adhesive exhibits very little deformation under high loads. In comparison, the fracture energy required for the elastic polyurethane adhesive bond is much greater. The result is a significant gain in safety.

The *flexible structural bonding* is the combination of rigid and elastic bonding and provides optimised mechanical properties and maximum possible elongation, in combination with structural strength and stiffness. The load transfer of the flexible structural adhesives is lower than that of rigid adhesives and higher than

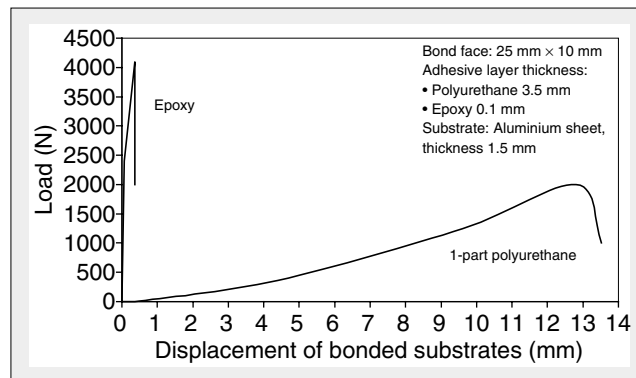

Figure 9: Comparative tensile lap-shear test (fracture energy).

that of the elastic adhesives. The elasticity in the flexible structural adhesive overcomes the disadvantages of rigid adhesives and they perform better with respect to impact, crash and durability. Even with an increase in bond overlap to 25 mm, the stress load within the joint is still transmitted.

A further discussion is given in the Section 6.2.1. 'Principal Advantages' under 'Even Stress Distribution'.

6.1.2.1. Definition of Structural Bonding

Very often people make a distinction between structural and non-structural bonding and among experts there is no single definition. In the past, the distinction was made in terms of lap shear strength. With the success of elastic bonding, this distinction is no longer valid. Structural bonding describes a joining technology, where substrates are joined dimensionally stable. With the proper design the joint transfers durable load over the expected lifetime of the structure. Under mechanical stress the strength of the joint exceeds that of the substrates.

6.1.3. Adhesives are Process Materials

Correct joint design is crucial and needs to take into account the specific mechanical properties of the substrates and the adhesives used. Simply substituting elastic adhesives for rigid fastening – such as a riveted connection – will not always achieve the desired result.

To find the best joint design, several disciplines must work together. Cooperation between chemists, mechanical engineers and process engineers is fundamental. It is important to discuss the requirements, design and other relevant issues such as ageing behaviour in the design phase.

The chemist needs to have knowledge about the basic chemistry of reactive systems and must design the adhesive according to the identified needs. Also, surface preparation is usually a decisive factor.

Mechanical engineers will design the joint and calculate the loads to be transferred and predict durability and strength through calculation.

The application and process engineers have to pre-treat the surface of substrates in the right way, to apply the adhesive to the right place and in the right amount, correctly cure the adhesive and therefore, control almost the whole process.

Adhesive suppliers support this by providing the required chemical and processing data (Fig. 10).

This above multidisciplinary approach enables one to use elastic bonding most successfully. In summary, an adhesive is a process material for bonding which

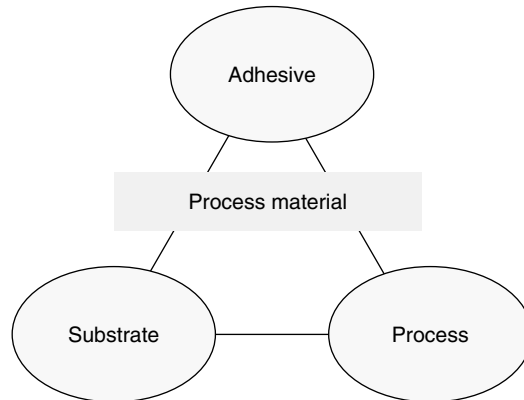

Figure 10: Elements of a process material.

requires an appropriate joint design, proper application, the right adhesive chemistry, correct preparation of substrates and proper curing.

There have been many focused efforts in education on adhesive technology during the last 10 years. For example, the Fraunhofer Institute for Assembling Techniques and Applied Material Research (IFAM) in Bremen offers certified, postgraduate education courses leading to diplomas as an adhesive bonder, an adhesive expert or an adhesive engineer. Depending on the level, these courses combine and integrate all necessary skills for the successful application of adhesive bonding technology. Additionally, several Diploma and dissertation efforts at the University of Munich evaluate the main principles of Elastic Bonding Technology in terms of design principles, calculation guidelines and general instructions for use. Thus, elastic bonding has further become an understandable and reliable joining technology.

6.2. Principal Advantages and Limits of Elastic Bonding

The purpose of this chapter is to explain the principles and mechanisms of Elastic Bonding Technology in simple language and to serve as a reference guide for the cost-effective application of adhesive technology in industrial practice.

6.2.1. Principal Advantages

The key elements of elastic bonding are described in Fig. 11.

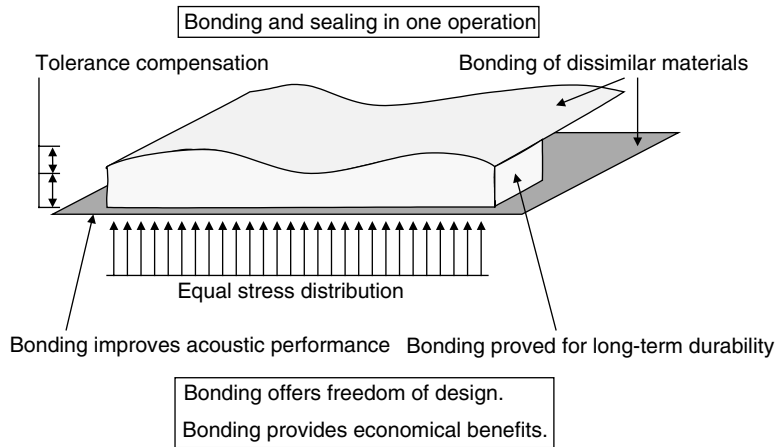

Figure 11: Key elements of elastic bonding.

6.2.1.1. Bonding and Sealing in One Operation

Elastic adhesives also act as sealants, and hence they offer a relatively simple but effective way to protect a joint against the ingress of gas or water. Adhesive-bonded joints can also be made resistant to chemical attack. Many mechanical fastening techniques also require sealing of the joint, which implies additional work and expense.

6.2.1.2. Tolerance Compensation

Manufacturing tolerances for components in the motor and general transport industries are usually measured in millimetres. This applies particularly to large components made from glass (e.g. curved windshields) or plastics (e.g. roof modules). Where a welded steel or aluminum frame provides structural support, the tolerances involved in the case of very large or very long components may well exceed one centimetre. Elastic Bonding Technology allows manufacturers to bridge gaps of this order without loss of strength.

In cases where rigid adhesives are used, the strength of the joint depends very much on the thickness of the adhesive layer. Satisfactory results can be guaranteed only if the optimum thickness of the adhesive is precisely maintained, since even slight deviations can reduce the strength of the joint by more than 50%. In the case of elastic adhesives, the actual thickness of the adhesive layer does not have such a critical influence on the strength of the joint and thickness variation can readily be accommodated (Fig. 12).

The elastic bond-line, i.e. the interfacial layer of permanent elastic adhesive should be, in general, minimally 3 mm thick.

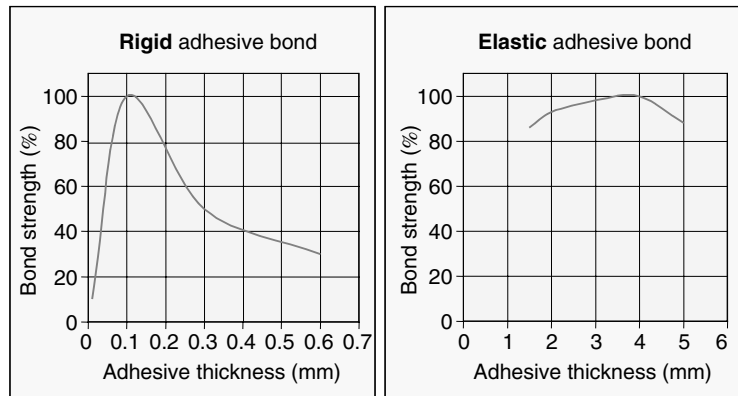

Figure 12: The effect of adhesive layer thickness on the strength of rigid and elastic adhesive bonds.

6.2.1.3. Bonding of Dissimilar Materials

Elastic bonding also plays an important role in keeping down the overall vehicle or part weight. For example, adhesively bonded body panels, which contribute directly to the structural strength of the vehicle, replace the combined weight of a structural frame and a non-load-bearing sheet metal skin. These adhesive-bonded body panels increase torsional stiffness and allow a weight saving of the substrates which can be thinner or lighter.

The need to join different materials together is often associated with lightweight designs that deliberately exploit the specific performance characteristics of the materials used. Synthetic materials and plastics, including fibre-reinforced or composites, are also being used increasingly in lightweight construction. This means that assembling techniques have to accommodate a wide spectrum of different material properties. Elastic adhesives lend themselves particularly well to this type of application. Materials of low intrinsic strength can be bonded together flexibly and without localised stress peaks, resulting in strong, load-bearing adhesive joints. Furthermore, elastic adhesives are able to compensate the thermal elongation of different substrates.

6.2.1.4. Even Stress Distribution

To ensure a durable connection and maximise the service life of the materials, an even distribution of stresses throughout the assembly is essential, particularly in the immediate vicinity of the joint. Conventional joining methods such as bonding with rigid adhesives, welding, riveting, screwing or bolting cause localised peak stresses at the joint itself.

The distribution of stresses can be clearly revealed in photo-elastic models of joint assemblies made from a transparent material that becomes doubly refractive when subjected to stress. If a beam of polarised white light is shone through a stressed component, coloured lines appear when the object is viewed through a second polarisation filter as a result of interference effects. These lines indicate areas of equal stress. If stress levels are increased, the sequence of coloured lines is repeated. The photographs below show specimen components made from clear acrylic or polycarbonate joined by different methods. In the side view of a bolted connection under load, the stress peaks around the bolt appear very clearly (Fig. 13).

(Side view)

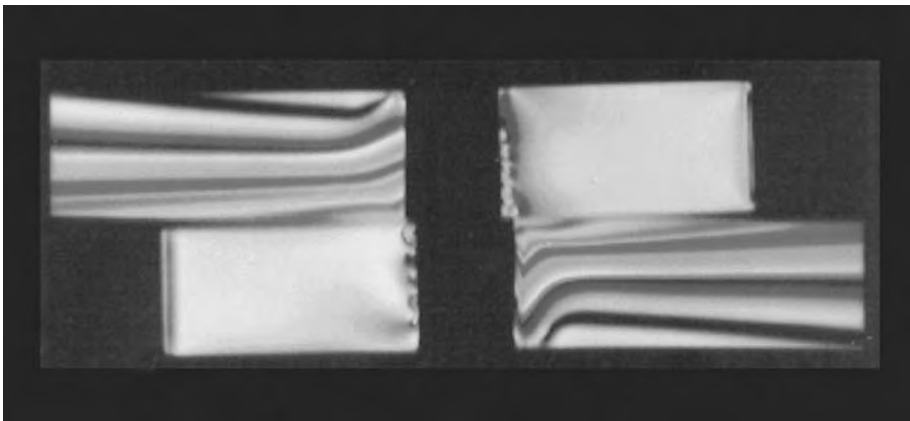

(Plan view)

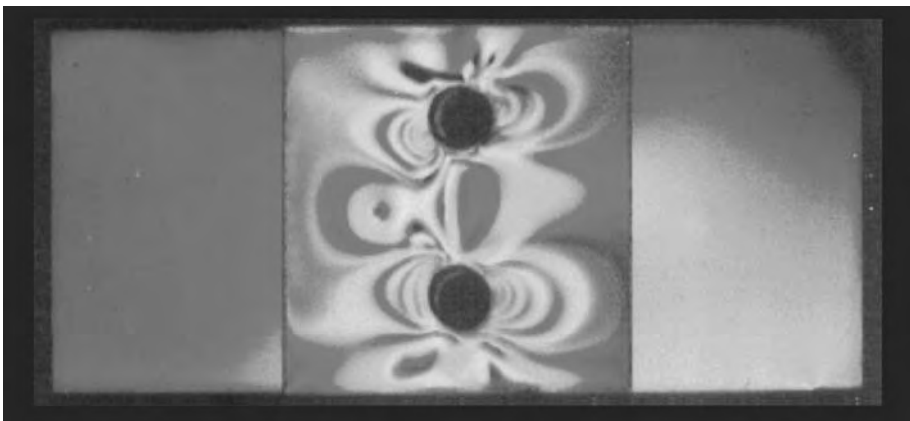

Figure 13: Stress patterns in photo elastic models: Bolted connection under load.
For easier understanding please refer to the colour section.

The unstressed zones of the component appear yellow, e.g. in the upper right-hand corner. Moving from this unstressed area towards the bolt, a series of coloured lines are crossed until the zone of greatest stress is reached around the shaft of the bolt. A plan view of the connection reveals a similar picture: a high concentration of stresses around the bolt. At these points we can expect the component to suffer damage. A similar pattern of stress distribution is observed in components that are fastened together with rivets or spot welds.

Fig. 14 shows a thin and a thick-layer rigid adhesive bond made with an acrylic adhesive cured under UV light. The expansion and deflection of the

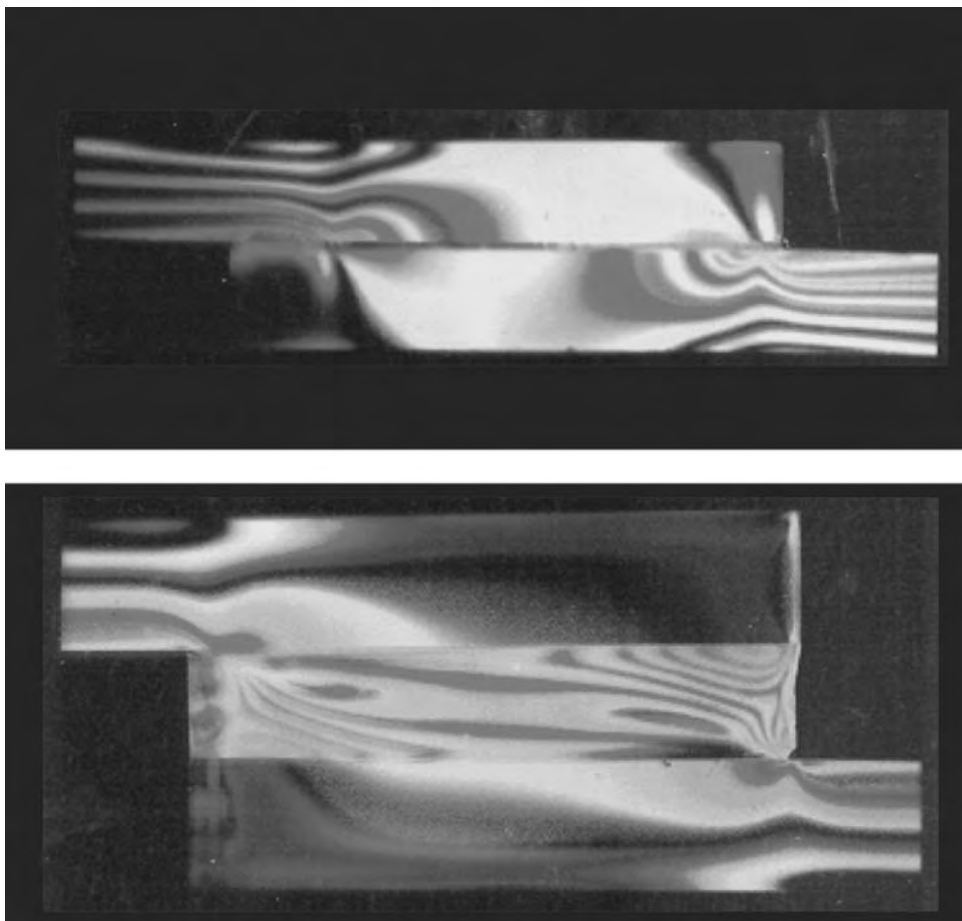

Figure 14: Stress patterns in photo elastic models: **thin and thick-layer rigid adhesive bonds** (See colour plate section for colour photographs.)

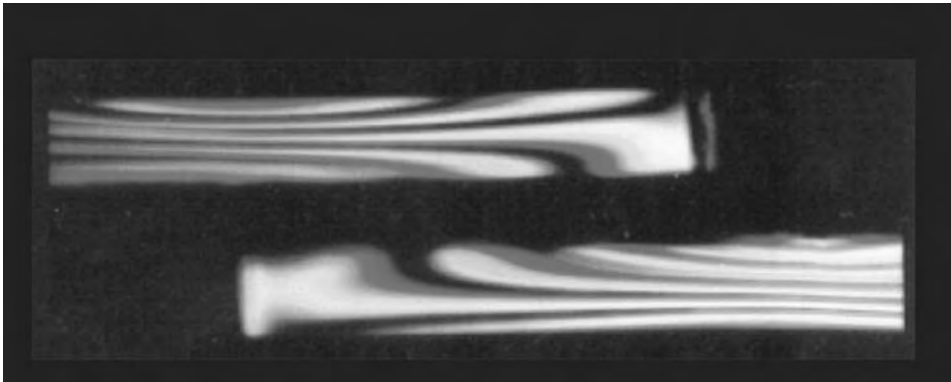

Figure 15: Stress patterns in photo elastic models: thick-layer elastic adhesive bond.

bonded substrates causes peak stress at the ends of the overlaps, which is the reason why the adhesive layer begins to break at this point. The central portion of the bond face, on the other hand, contributes very little to the load-bearing capacity of the joint.

Fig. 15 shows a thick-layer elastic adhesive bond made with a black one-part polyurethane adhesive. Here, the stresses in the bonded substrates are uniformly distributed along the bond-line, indicating that the whole area of the bond-line is contributing to the strength of the joint. Hence, the breaking strength of elastic adhesive bonds increases more or less proportionally to bonded area. In practice, this means that elastic-bonded joints can be designed to transmit relatively large forces simply by increasing the area of the bond face (length of overlap).

By contrast, the stresses in rigid adhesive bonds are concentrated at the ends of the overlaps. This effect is even more pronounced in substrates with a low modulus of elasticity as, for example, when the bond is made between plastic components rather than steel.

6.2.1.5. No Thermal Distortion

Some mechanical fastening methods involve the application of heat to the components. This can cause thermal distortion and lead to deformation and change of the material's internal structure. Correcting this kind of damage is usually very costly and labour-intensive, and offers only limited opportunity for automation. Therefore, in a line production environment, such corrective procedures are only carried out where absolutely necessary (e.g. removing visual surface indentations caused by spot-welding thin-gauge sheet metal). With elastic adhesives this corrective work is generally not needed.

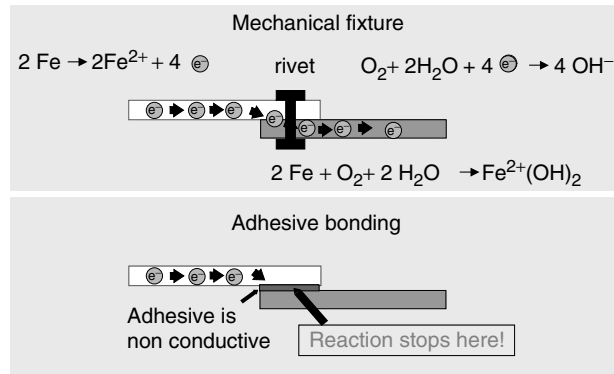

Figure 16: Galvanic corrosion between two metal sheets.

6.2.1.6. Corrosion Protection

The causes of corrosion are complex. As in the case of chemical attack, adhesive bonding has been shown to offer better protection against service corrosion and galvanic corrosion than many other mechanical assembling techniques (Figs 16 and 17).

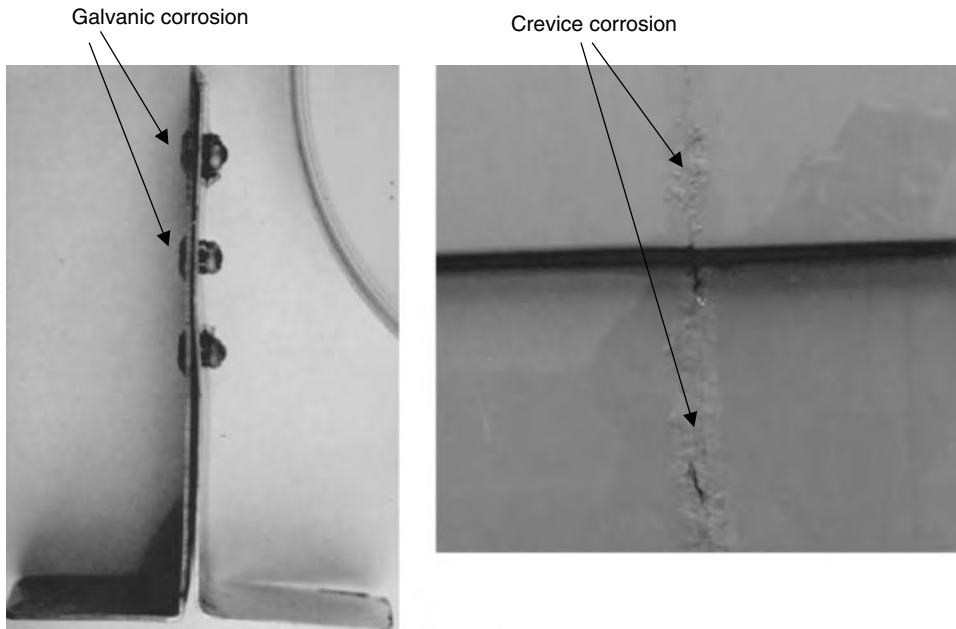

Figure 17: Examples without the use of adhesive bonding.

However, this presupposes the use of adhesives that are themselves effective electrical insulators (i.e. with a specific resistivity in excess of $10^7 \Omega \text{ cm}$). Adhesives which are bonded to metals keep water away from the adhesively bonded parts, thus preventing corrosion.

When two metal sheets are very close together even without rivets, crevice corrosion can occur. An example is shown in Fig. 17.

6.2.1.7. Bonding Improves Acoustics

Personal comfort can be improved when using bonding techniques. Highly effective noise and vibration damping can be engineered into the products. Fig. 18 illustrates the difference in acoustic properties of elastic, plastic and elasto-plastic materials such as Sikaflex®.

In Section 6.8.9., an example is described where acoustic properties play an important role.

6.2.1.8. Bonding Offers Freedom of Design

Bonding parts does not generally deform the substrates and enables aesthetically improved surfaces.

6.2.1.9. Numerical Simulation of Adhesive Joints

Computer calculations play a key role in the design and configuration of adhesive joints. Calculating the mechanical strengths of these joints, however, remains a complex and time-consuming task. Methods of calculation that are valid for rigid joints are only partly applicable to elastic connections between the components. When it comes to building prototypes or setting up test arrays, engineers have to base their calculations on reference values, which in most cases are only rough

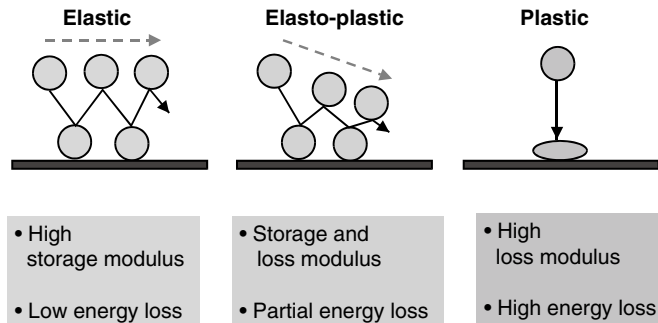

Figure 18: Acoustic properties of different materials in comparison (the principle is explained here with bouncing balls).

approximations (e.g. technical material data, such as tensile lap-shear strength, with appropriate safety margins factored into the calculations). Following extensive studies carried out at various universities and technical colleges, engineers now have access to a growing body of experimental design data that can be used to calculate the strength of an adhesive joint with the aid of finite element methods. See Section 6.4 for further details.

6.2.1.10. Economics

In many cases, elastic bonding is more economical than conventional mechanical assembling methods, i.e., using bolts, screws, rivets, welding, spot welding, clinching, clip fastenings etc.

The economic benefits of elastic adhesives compared to mechanical fixtures are that they:

- allow simultaneous sealing
- enable lighter weight design
- give more even stress distributions
- require less energy
- prevent corrosion
- improve acoustics
- provide greater freedom of design
- allow numerical simulation.

Manufacturing costs are directly proportional to the number of components to be fastened together. Bonding helps to reduce the number of individual components and encourages a modular approach to design and construction. Major auto or bus assemblies such as complete roof elements can be pre-assembled with their interior linings and then bonded with elastic adhesives to the body shell. This method avoids the high stresses associated with welding.

Thick-layer elastic adhesives are particularly effective in lowering production costs. By simply increasing the bond-line of the elastic adhesive, one can accommodate larger manufacturing tolerances. This can usually be done without significantly affecting the mechanical strength of the joint.

To summarise, elastic bonding is a modern and highly effective joining technique with a number of innovative performance characteristics, which is a welcome addition to the standard repertoire of mechanical assembling technologies. Through the selective use of these adhesives and careful attention to the specific application techniques associated with them, engineers and designers are able to design technically sophisticated products that can be manufactured economically.

6.2.2. Limits of Elastic Bonding

Apart from the advantages of Elastic Bonding Technology, one must consider its limits. When working with elastic adhesives, one should:

- avoid critical peeling stresses
- avoid too high static loads
- avoid critical temperature ranges
- avoid water (see Section 6.3.1).

These limits are explained below:

6.2.2.1. Avoid Critical Peeling Stresses

When force is applied such that it tends to peel or tear apart the faces of an adhesive joint, the stresses involved very quickly reach critical levels. In such cases, the applied load is no longer distributed over the whole area of the bond but is concentrated along a narrow line at the edge of the joint (Fig. 19). The ultimate breaking stress of the materials is rapidly exceeded, resulting in tearing or total failure of the adhesive bond.

Thick-layer elastic-bonded joints first yield before they tear when subjected to peeling forces, allowing the load to be distributed over a wider area. Consequently, the stresses within the bonded materials are kept at a relatively low level. The high tear propagation strength of polyurethanes – even after tear initiation – usually prevents sudden and catastrophic failure of the joint. This yielding behaviour means that damaged adhesive joints can often be identified and repaired before

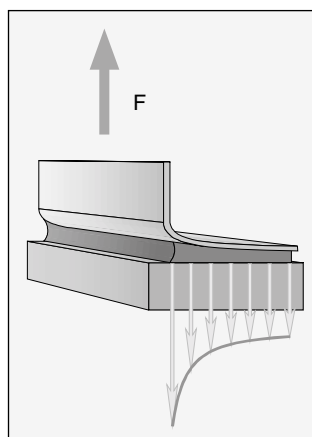

Figure 19: Stresses in an elastic-bonded adhesive joint subjected to a peeling force (F).

total failure occurs. Nevertheless, exposure to peeling stresses must be considered at the design stage and avoided by appropriate measures.

6.2.2.2. Avoid Too High Static Loads

Static load can result in creep behaviour of the bonded structure. To test this, a lap shear specimen with an adhesive thickness of 3 mm is loaded with a defined weight and the displacement (mm) between the two bonded parts is measured within the period of 1 to 4 years. Fig. 20 shows a creep test of Sikaflex[®]-252 adhesive.

When the lap shear specimen bonded with Sikaflex[®]-252 is loaded with more than 3% of the lap shear value (0.075 MPa divided by 2.5 MPa = 0.03 = 3%) creeping occurs. A rule of thumb is

Stay below the stress of **3%** of lap shear value to avoid creeping
and destruction of adhesive over the service temperature range!

6.2.2.3. Avoid Critical Temperatures

The temperature resistance of an adhesive-bonded joint is not usually as high as that of a conventional mechanically fastened joint. In many areas of application, however, the service temperature of the finished assembly is below 100°C, which is below the critical temperature range for most of these adhesives. At the same time, the possibility of exceptional circumstances must be considered, such as exposure to excessive heat in the event of fire. In such cases, it may be necessary to provide additional mechanical fixtures as backup safety systems to prevent

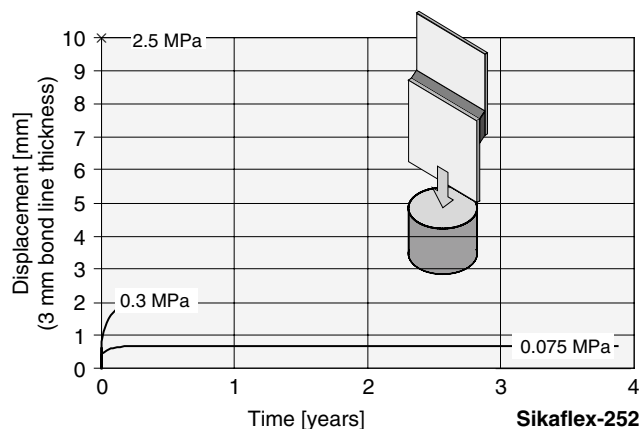

Figure 20: Creep test of Sikaflex[®]-252.

possible damage and injury from falling components or to prevent potentially hazardous leaks (e.g. from gas meters).

6.3. Long-Term Durability and Ageing Tests

6.3.1. Long-Term Durability

The long-term durability of an adhesively bonded connection, i.e. its ability to function effectively throughout its design life, is a vital prerequisite for the successful use of adhesives. Tests and experience are important to evaluate the long-term durability of a correctly bonded adhesive joint.

Elastic adhesives are organic products and as such, are subject to ageing. The design of the adhesive joint has to take into account this complex process. Various factors have a long-term impact on ageing and are listed in Fig. 21.

The effects of these factors are explained below.

6.3.1.1. The Effect of Water and Chemical Substances

Adhesive joints are exposed to attack from many different chemical products. In most cases this means short to medium-term contact with water, aqueous solutions of chemicals or fuels.

Exposure to water, especially when water penetrates into the interface between the cured adhesive and the substrate is very harmful for adhesion. Water behaves like a plasticizer and can react with the chemical groups responsible for adhesion and therefore may reduce the bonding. Intermolecular forces between the substrate

- 
- Water
 - Chemicals
(salt, detergents, fuels, gases)
 - Temperature (cold and hot)
 - UV-radiation
 - Excessive mechanical stress to the bond
 - High internal stress of thermoplastics
(⇒ stress cracking)
 - Plasticizer migration
 - Moisture content of wood
 - Other factors depending on specific uses

Figure 21: Factors affecting durability of adhesive joints.

and the primer/adhesive layer, such as dispersion, Van der Waals or hydrogen bonds, are strongly affected by the presence of water.

When bonding metals with adhesives, water may influence corrosion behaviour. The goal is to prevent the spread of corrosion beneath the adhesive layer which leads to failure of the joint (so-called bond-line corrosion). Elastic adhesives are particularly well suited to this type of application, since they are compatible with a wide range of corrosion protection systems and often aid in their function.

Elastic adhesives are resistant to most of the substances named in Fig. 20 for a limited period of time and generally, they can safely be used provided joints are designed in accordance with normal good practice (such as taking steps to prevent permanent exposure to condensed water in the case of window glass).

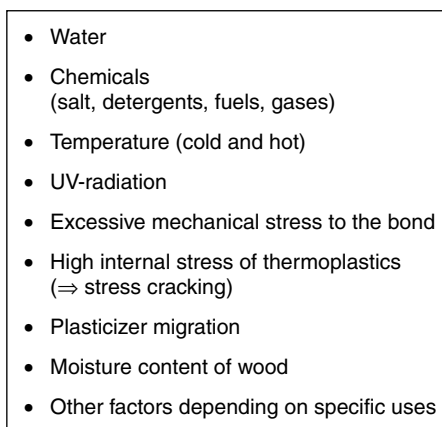
The target is primarily to lower water absorption of the primer and the adhesive and secondarily, to slow down or prohibit the destructive and damaging reaction of penetrated water by correct bond-line design. In cases where adhesive joints may be exposed to chemical attack, it is essential to seek the advice of the adhesive manufacturer.

As a general rule, the use of adhesives is not recommended where they are likely to be constantly exposed to chemical products (also standing water should be avoided). Also drying periods are required!

6.3.1.2. The Effect of Temperature Changes

The temperature resistance of elastic adhesives is low in comparison to mechanical assembly techniques. It is comparable with the temperature resistance of thermoplastics and is adequate for most applications under normal stress conditions (i.e. outdoor applications with no exposure to any additional or concentrated heat source). However, the possible effects of overheating of the adhesive (in the event of fire, for example) must be taken into account at the design stage. If there is any risk that the failure of an adhesive joint as a result of overheating could cause personal injury or collateral damage, then additional mechanical safeguards should be incorporated into the design.

At cold temperatures, elastic adhesives stiffen and elongation is reduced. This can lead to additional stresses which can diminish adhesion.

6.3.1.3. The Effect of UV Radiation

Ultraviolet radiation is a component of normal sunlight. This high-energy radiation is the primary cause of damage to the exposed surfaces of organic materials. Although the surface of elastic adhesives and sealants can be significantly degraded by UV exposure, their long-term functional effectiveness is often not impaired.

Nonetheless, additional protective measures are necessary when bonding transparent or translucent materials.

Glass and plastics, both transparent and translucent, allow light and UV radiation to pass through them. When adhesives are used with these substrates in the presence of UV, the interface between the adhesive and the substrate should be shielded to protect the boundary layer of the adhesive against possible radiation damage. This boundary layer is extremely vulnerable; all that is required is the destruction of the outermost molecules for adhesion to be significantly impaired. Alongside various recognised ways of masking the joint with a suitable opaque material (ceramic screen-printed border, cover trims, opaque paints), some manufacturers recommend the use of a black primer as the sole form of UV protection. However, long-term field trials carried out in Florida and South Africa on vehicles with adhesive-bonded window glass have shown that pretreatment with a black primer gives less effective long-term UV resistance than the primerless installation of auto glass with integral UV protection (ceramic screen-printed border with a light transmittance value of 0.1% or less).

6.3.1.4. The Effect of Mechanical Stresses

Excessive mechanical stress on the bonded substrates causes irreversible damage to the adhesive layer. Stress levels should therefore not exceed the maximum safe values determined through dynamic and static tests, although the stresses that actually occur in service cannot always be precisely predicted. Elastic adhesives exhibit a deformation behaviour that is easily measured. It is therefore possible to build prototypes and measure the degree of deformation under simulated service conditions or make FEM calculations (see Section 6.4.3). The stresses involved can be determined with the aid of the appropriate method. This procedure enables the design engineer to quantify the stresses accurately so that he can, if necessary, modify the adhesive geometry or use a product with a higher modulus.

6.3.1.5. The Effect of High Internal Stresses of Thermoplastics

Thermoplastics are characterised by the presence of internal stresses which are due, in part, to the manufacturing process (extrusion or thermal forming of sheet materials). When these materials come into contact with chemicals (especially solvents), cracks may form. This phenomenon is known as **chemical stress cracking**. However, cracking can also occur in the absence of any significant chemical contact. This group of products should be bonded with adhesives only after considering if the following conditions are met:

- The adhesive manufacturer's recommendations regarding the choice of products and the correct method of surface preparation must be followed.

- When possible, stress-free (tempered) plastic components should be used.
- The plastic components must be installed without introducing localised stresses and adequate provision must be made to accommodate movement resulting from thermal expansion (thick-layer bonding using a low-modulus adhesive).

6.3.1.6. The Effect of Plasticiser Migration

Thermoplastics and paint systems that behave like thermoplastics are quite often soluble in organic solvents. Many adhesives contain small amounts of such solvents or plasticisers. The diffusion of these products towards the boundary layer can lead to a softening of this layer at the adhesive interface. If the joint is then subjected to stress, the adhesive bond may fail. Since the diffusion process takes place very slowly, months may elapse before the damage manifests itself. Additionally, the user should seek the adhesive manufacturer's advice on an appropriate method of surface preparation.

6.3.1.7. The Effect of Moisture Content in Wood

Wood readily expands and contracts in response to changes in its moisture content. Wood and wood products – including panel products and plywood – shrink when they lose moisture. To prevent the kind of movement-induced stresses referred to in the previous section, only wood with a balanced moisture content should be selected for bonding, otherwise premature ageing occurs.

6.3.2. Ageing Tests

6.3.2.1. Adhesion Durability

What is the durability of the bonded joint? This is a key question and not so easy to answer. Many customers ask this question. Accelerated ageing and weatherability test can be carried out to prove the durability of a bond. UV-radiation can damage the substrate, the surface of the adhesive and can degrade the adhesive's properties. Higher temperature may lead to faster degradation of bonding force and water affects bonding quality to a high degree.

Artificial ageing test methods simulate the behaviour of the cured adhesive in the bonded joint under environmental influences. The exposures are for example heat, cold, moisture, chemicals or UV-radiation and their combinations. Each ageing test method defines the duration of exposure, exposure temperature, type and concentration of chemicals and joint design.

Numerous cyclic ageing tests are defined, such as for example VDA cyclic ageing test or P1210 cyclic ageing test. According to the experience of vehicle manufacturers and to the authors' experience, the adhesion of elastic bonding

adhesives is generally best proven by the peeling test of a bead after the required ageing cycles.

In practice, a bead is applied to the substrate and a sequence of ageing storage conditions is carried out, whereas after each storage test the bead is peeled off from the substrates (Fig. 22). With a gripper the bead is clamped and peeled vertical to the horizontal lying substrate by cutting the peeled bead near to the substrate with a knife.

Typical ageing storage tests are:

- 7 days storage at RT
- followed by placing the test specimens in water for 7 days and
- further followed by storing of the test specimens at 70°C and 100% relative humidity, which is called cataplasma testing.

Further, the adhesive is exposed for 1 day to heat at 80°C and up to 5000 h of UV-radiation. The requirements are that the peeling tests result in more than 75% cohesion failure.

Even if no values for peel strength are measured, this peeling test shows very sensitive adhesion or cohesion failure, which sometimes are the only criteria to be checked. Remember, the mechanical values of the adhesive can be determined by other methods. If cohesion failure occurs, the result is generally good. If there is an influence of humidity and temperature on the adhesion, this peeling test will usually show it.



Figure 22: Peeling test of a bead.

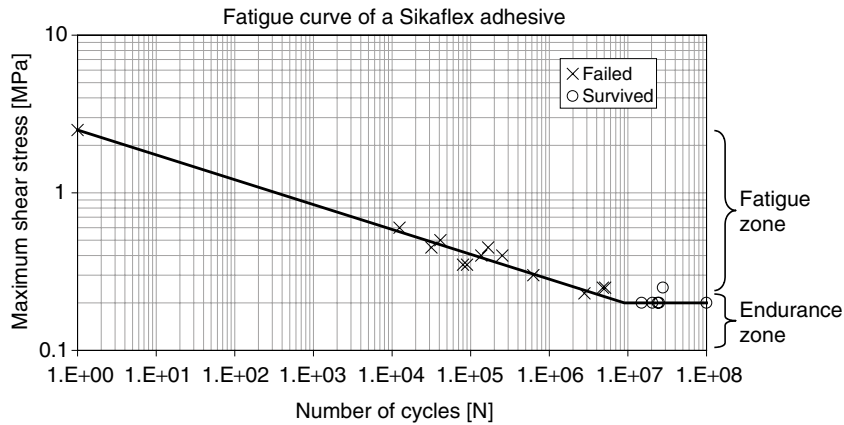

Figure 23: Principle Woehler diagram.

6.3.2.2. Fatigue Durability

By subjecting a single lap shear specimen to **dynamic cyclic load**, the fatigue behaviour of adhesive bonds is determined. The test values are plotted in the stress-cycle (Woehler) diagram where the number of load cycles is represented as a function of the component load. An example is shown in Fig. 23.

In this example, the adhesive endurance is optimal below a shear stress of 0.2 MPa.

6.4. Joint Design and Calculation for Elastic Bonding Applications

6.4.1. Joint Design*

The successful and cost-effective application of adhesive bonding technology is crucially dependent on correct joint design. The adhesive joint must be adequately dimensioned for the forces to transmit. Large static loads should be avoided wherever possible – especially where the joint is exposed to higher temperatures. In such cases, joints should be optimised to provide additional support. Similar measures should be taken to counteract peeling stresses (Fig. 24). Some examples are illustrated in the chapter ‘Technical Characteristics’ in Volume 1.

*Note of the editor for additional information about joint design the needs may refer to the Chapter “Joint design and calculation” in volume 2 of this Handbook.

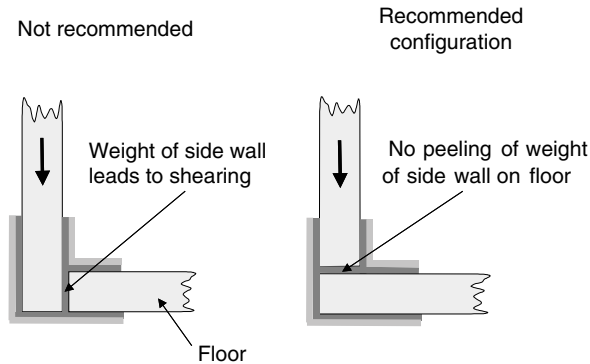

Figure 24: The stress induced by constant loading in a truck cargo body can be minimised by careful joint design.

The thickness of the adhesive layer must be sufficient to accommodate dimensional tolerances in components as well as any thermal movement. Attention must also be paid to the adverse effects that may result from climatic exposure.

In all cases, it is important to avoid standing water at the adhesive joint or seal. Fig. 25 illustrates these principles in practice, using the example of a sandwich roof panel adhesive bonded to a perimeter framing profile. If two parallel beads of adhesive are used to secure the roof panel, gaps must be left in the lower bead at regular intervals in order to drain and ventilate the cavity. Otherwise, water collecting in the cavity as a result of condensation or water infiltration that stays undetected may lead to corrosion. Similarly, the sealed joint on the outside at the junction between the roof panel and the framing profile is located in the sloping portion of the roof to assist the rapid run-off of water.

Direct glazing – the installation of window glass by means of adhesives (Fig. 26) – is one of the most common applications of Elastic Bonding Technology and the technique has been widely used in the car and bus industry for a number of decades.

In modern assembly plants, the application of the adhesive – and sometimes the actual installation of the glass – is fully automated. Direct glazed windows play an important part in improving the aerodynamics of a vehicle and thereby reducing fuel consumption. They have lower leakage rates and are more water-tight. Adhesively bonded windows also generate less noise at high speeds – and the adhesive used weighs less than a preformed rubber gasket. In the construction of buses for example, weight savings of up to 1.2 kg per linear metre of window perimeter can be achieved.

Another big benefit of this technology lies in the increased torsional stiffness of the vehicle body shell. Car designers are already taking advantage of this feature,

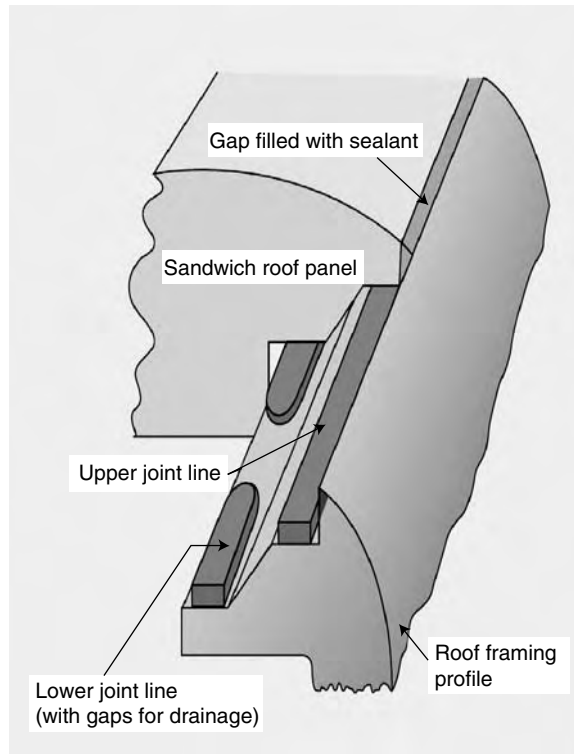
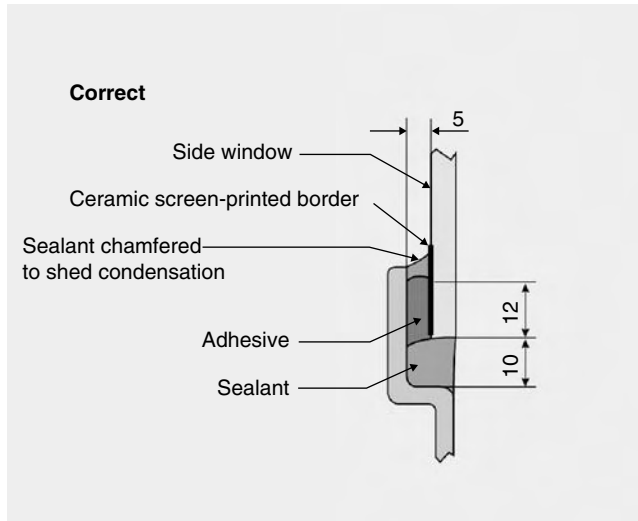

Figure 25: Detail of junction between adhesive-bonded sandwich roof panel and roof framing profile.

and many new cars now have much slimmer A, B and C pillars without any loss of overall stiffness. The stiffening function of the rear seat bulkhead can also be partially or wholly dispensed with. This saves weight – and therefore fuel – and also increases the versatility of the vehicle by making it possible to carry large and bulky objects. Direct glazing is also finding new applications outside the transport industry – for example in the manufacture of shower cabins or electrical switchgear cabinets.

In exterior direct glazing applications, the interface between glass and adhesive must be shielded against UV radiation. The usual method is to apply an opaque ceramic screen-printed border to the glass, with a transmittance value of not more than 0.1% for light of wavelengths between 400 and 500 nm (see also Fig. 48). Guidelines for the dimensioning of adhesive joints in direct glazing applications are given in Fig. 27.

The sheet metal skins of vehicle bodies used to be spot-welded onto a structural frame. The welds created a whole series of dimple marks in the metal surface,



(a)

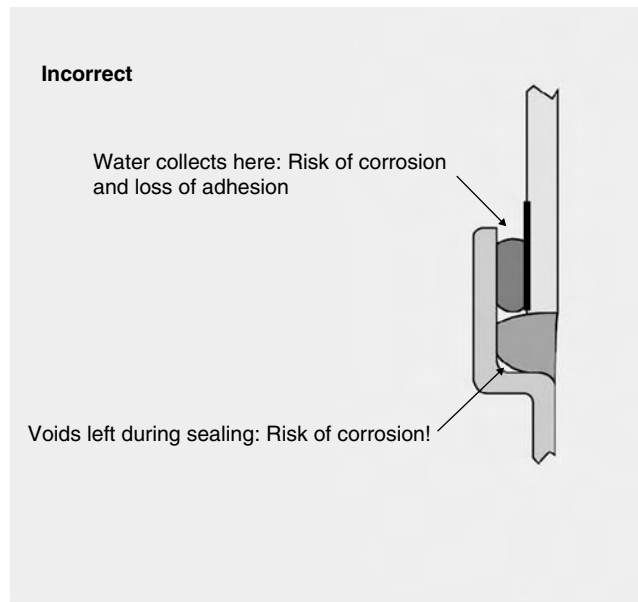

(b)

Figure 26: Direct glazing: correct and incorrect joint designs.

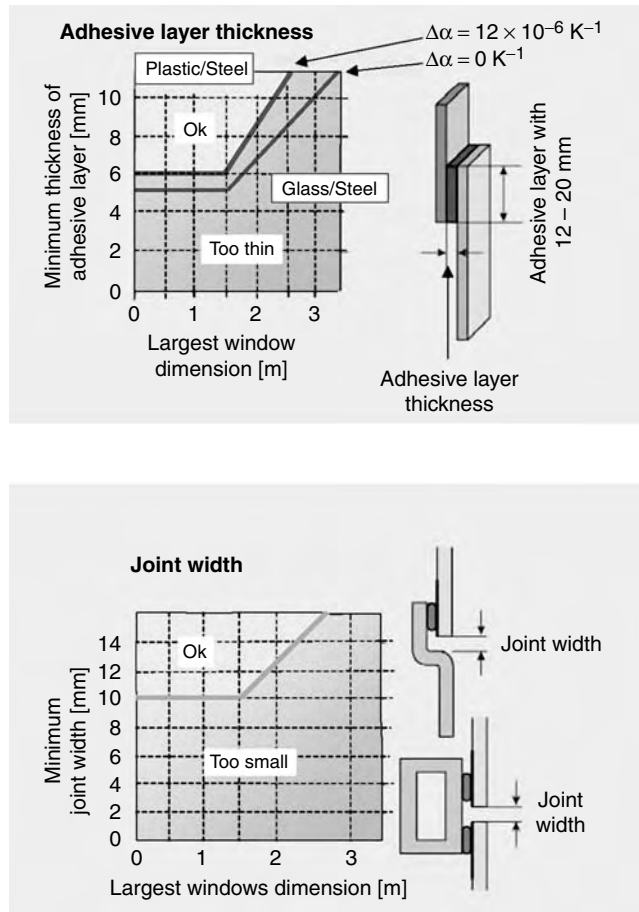

Figure 27: Dimensioning adhesive joints for direct glazing.

which had to be filled and grinded down in a separate operation to produce a smooth finish. With adhesive bonding, the metal surface generally remains completely flat and free from distortion and makes this labor-intensive process obsolete. Anti-corrosion paint coatings thus remain intact, which prolongs the life of the assembly. The inherent damping properties of the elastic adhesives extend the vehicle's operating capabilities. Last but not least, adhesive bonding opens up the possibility of using lightweight materials such as aluminum, glass-fibre-reinforced plastics (GRP) or sandwich panels.

6.4.2. Calculating the Strength of Elastic Adhesive Joints

In technical data sheets, the strength of an adhesive is generally stated in terms of its tensile lap-shear strength which is determined by performing tests on a single-lap adhesive joint. The test piece is subjected to a shearing stress by applying a tensile load axially to the two lapped substrates (Fig. 28).

Tensile lap-shear strengths are determined under ideal laboratory conditions using small test pieces. When calculating the design strength of larger assemblies, engineers have to multiply these laboratory figures with an appropriate reduction factor. Even where all the adverse influences on an adhesive joint are known, it is advisable to factor in an additional margin of safety to allow for any fluctuations in quality during the manufacturing process, so that the results of the strength calculations will always deviate on the safe side. Generally speaking, more satisfactory results are obtained by carrying out tests on the actual component or assembly. In many cases it is necessary to test the adhesive joint by applying compressive or tensile loads before the final design calculations can be performed.

Since the effect of stress peaks at the ends of the overlaps can be neglected in bonds formed with elastic adhesives, it is not normally necessary to calculate the optimum ratio of substrate thickness to length of overlap.

6.4.2.1. Reduction Factors

One-part polyurethane adhesives belong to the group of substances known as elastomers and, as such, their mechanical material properties are highly dependent on service temperature and the duration of any exposure to stress. The changes in the strength and stiffness of the elastomer when the temperature and/or the period of exposure to stress are increased can be roughly quantified by applying the reduction factors plotted on the graphs in Figs 29–31.

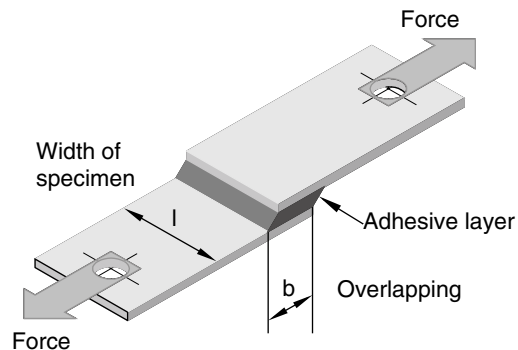

Figure 28: Single lap adhesive joint used in tensile-shear test.

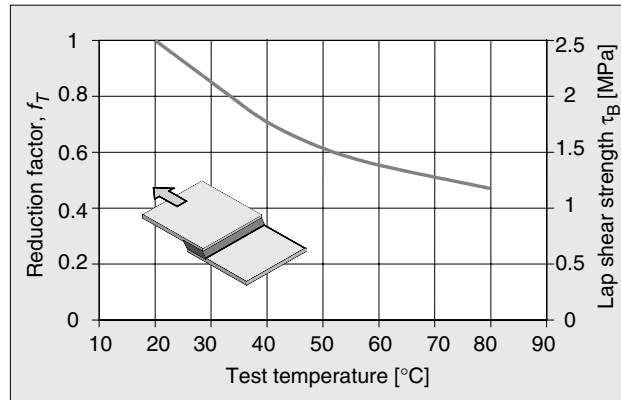

Figure 29: Reduction factor, f_T : the effect of temperature.

The reduction factor, f_T , for the effects of temperature exposure on an elastic adhesive was determined with the aid of a lap-shear test (Fig. 29). The strength of the adhesive decreases with a rise in temperature.

The results of creep rupture tests on single-lap joints yielded the reduction factor, f_L , for an adhesive bond subjected to constant static loading (Fig. 30). The strength of the adhesive decreases with increasing exposure. In constant-load tests of this kind, particularly at higher temperatures, creep strain is observed in the adhesive layer where a certain initial load is exceeded.

For this reason, a safety factor of at least 2 should always be included in the design calculations.

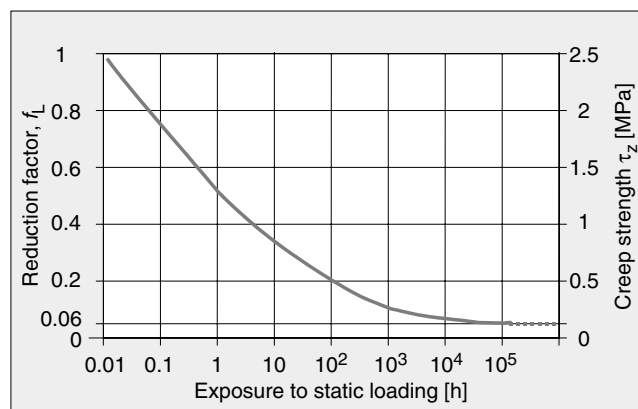

Figure 30: Reduction factor, f_L , the effect of constant load.

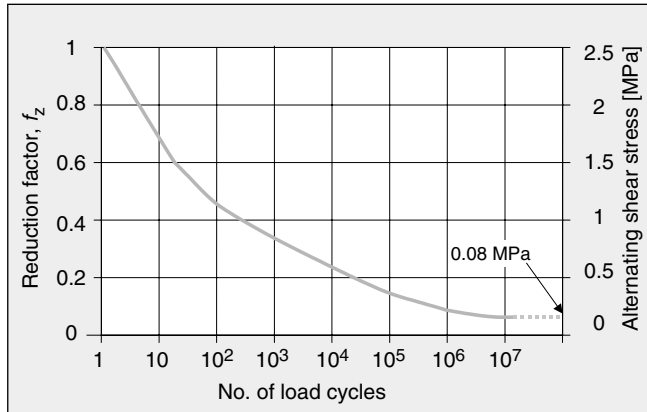

Figure 31: Reduction factor, f_z : the effect of prolonged exposure to dynamic stress.

Subjecting a test piece to **cyclic dynamic load** determines the fatigue behaviour of adhesive bonds. When the test values are plotted on a **Woehler diagram**, the appropriate reduction factor, f_z , for prolonged exposure to dynamic stress can be read off (Fig. 31).

As the number of cycles is increased, the amount of alternating shear stress that the adhesive layer can withstand is progressively decreased until the adhesive attains its service life resistance at around 20 million cycles, i.e. no further reduction in strength is observed after this point.

A statement can be made with regard to the expected service life under a certain dynamic load which is below 3% of the lap shear value (0.08 MPa divided by 2.5 MPa = 0.032 = 3.2%), see Section 6.2.2. 'Limits of Elastic Bonding'.

6.4.2.2. Multiaxial Stress

Where a number of stress components are at work in different planes, their values can be mathematically combined to produce a compound or equivalent stress, σ_v . To determine the equivalent stress for a thick-layer elastic adhesive, normal stress theory may be used. This is commonly employed for components that are mechanically restrained from undergoing expansion.

$$\sigma_v = 0.5 \sigma_z + 0.5 \sqrt{\sigma_z^2 + 4\tau^2} \quad (1)$$

where σ_v is the equivalent stress, σ_z , the tensile stress in the adhesive layer (tensile force : area of bond face), and τ , the shear stress in the adhesive layer (Shear force: area of bond face).

6.4.2.3. Sample Calculations

(1) Constant static shear stress

To estimate the required area of the bond face in joints subject to a constant static shear stress, the minimum safety factor of 2 combined with a reduction factor of 0.06 for exposure to constant static stress gives a design figure of 3% of the tensile lap-shear strength of the adhesive:

$$A_k = S_k \frac{F_{\text{Shear}}}{\tau_B \times f_L} \Rightarrow A_k = 2 \frac{F_{\text{Shear}}}{\tau_B \times 0.06} \quad (2)$$

where A_k is the area of bond face, S_k , the shearing factor, F_{Shear} , the shearing force, τ_B , the tensile lap-shear strength and f_L , the reduction factor for exposure to constant static stress.

As a general rule, 3% of the tensile lap-shear strength value may be used as a standard design figure in calculations involving constant static stress.

(2) Stresses acting on a bus windshield in an accident

Fig. 32 illustrates in a schematic form the forces acting on the windshield of a bus in an oblique frontal collision. The following sample calculation shows how the safety factor is estimated.

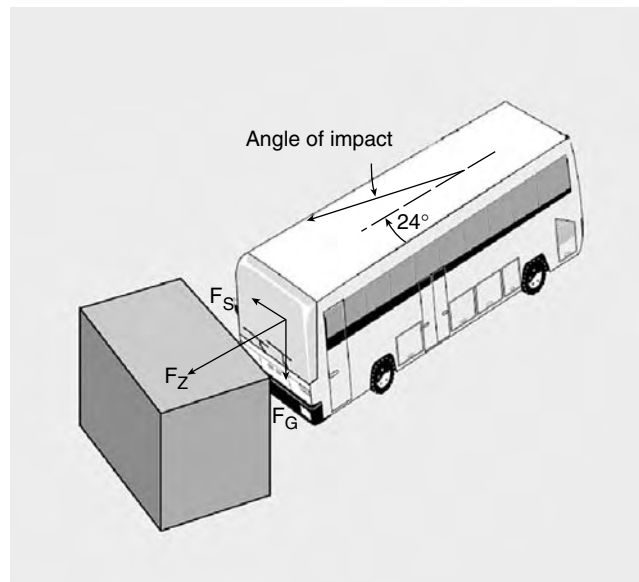

Figure 32: Stresses acting on the adhesive bond of a bus windshield in an oblique frontal collision with a stationary obstacle.

The windshield's own mass of 80 kg imposes a constant shear stress on the adhesive bond. To determine the gravitational force involved, the mass of the windshield is multiplied by the gravitational acceleration:

$$F_G = 80 \text{ kg} \times 9.8 \text{ m/s}^2 = 785 \text{ N} \quad (3)$$

where F_G is the gravitational force.

In the supposed collision, the vehicle decelerates from 80 km/h to 0 km/h in 0.2 s. During that time it covers a distance of approximately 2 m. The windshield is briefly subjected to a maximum acceleration of approximately 120 m/s² (12 g approx.). Since the vehicle in this example hits the obstacle at an angle of 24°, the forces acting on the windshield consist of a tensile and a shear component:

$$F_Z = 80 \text{ kg} \times 120 \text{ m/s}^2 \times \cos 24^\circ = 8800 \text{ N} \quad (4)$$

$$F_S = 80 \text{ kg} \times 120 \text{ m/s}^2 \times \sin 24^\circ = 4000 \text{ N} \quad (5)$$

where F_Z is the tensile force acting on the windshield and F_S , the shear force acting in the windshield.

The bonding area for the windshield is calculated by multiplying the overall length of the perimeter joint (7 m) by its width (15 mm):

$$A_k = 7000 \text{ mm} \times 15 \text{ mm} = 105,000 \text{ mm}^2 \quad (6)$$

where A_k is the bonding area.

The standard windshield adhesive used has a tensile lap-shear strength of 4 MPa. Exposure to sunlight will inevitably cause the adhesive layer to heat up, so in this example a reduction factor of 0.5, corresponding to a temperature of 60°C (see Fig. 43), has been applied. To estimate the safety factor for this adhesive joint, the tensile lap-shear strength multiplied by this reduction factor is divided by the equivalent stress (Eq. 1)

$$S_k = \frac{\tau_B \times f_T}{\sigma_v} = \frac{\tau_B \times f_T}{0.5\sigma_Z + 0.5\sqrt{\sigma^2 + 4\tau^2}} \quad (7)$$

where S_k is the safety factor; τ_B , the tensile lap-shear strength; f_T , the reduction factor for temperature exposure; and σ_v , the equivalent stress.

The pre-stressing of the adhesive layer due to static loading must also be taken into account when considering the compound stresses resulting from the collision. The various forces involved (Eqs (3)–(5)) operate for different lengths of time and at right angles to each other. To estimate the safety factor, therefore, their values in Eq. (7) are multiplied by different reduction factors (1 for short-term loading, 0.06 for constant static loading). The common plane on which these forces act and from which the resulting stresses can be calculated is the bond face A_k .

$$S_k = \frac{4(\text{N/mm}^2) \times 0.5 \times 105,000 \text{ mm}^2}{0.5 \times (8800 \text{ N/1}) + 0.5 \times \sqrt{(8800 \text{ N/1})^2 + 4\left\{(765 \text{ N/0.06})^2 + (4000 \text{ N/1})^2\right\}}} \quad (8)$$

where $S_k = 11$.

The estimated safety factor for the compound stresses at work here shows that this particular adhesive joint possesses adequate reserves of strength.

6.4.2.4. Stress Resulting from Temperature Changes

To a greater or lesser degree, temperature changes produce linear expansion or contraction in all materials. Where materials with different coefficients of linear expansion are joined together with an elastic adhesive, the adhesive must be capable of undergoing deformation and the adhesive layer must be of sufficient thickness to accommodate that movement. Taking a bus roof as an example, the calculations below illustrate the method for determining the required thickness of adhesive (Fig. 33). A GRP roof panel 8 m in length is to be adhesive-bonded to a structural steel framework. The maximum temperature difference is assumed to

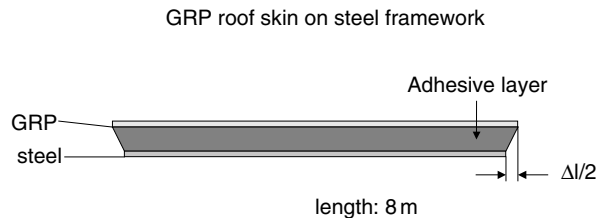

Figure 33: Stresses in an adhesive bond resulting from differential thermal expansion.

Table 1: Maximum permissible movement of the adhesive layer

Movement relative to: Adhesive layer thickness and sealing joint width	Thermal movement (e.g. very slow quasi-static)	Loading and unloading	Slight accident, infrequent incidents (e.g. derailment)	Normal service operation (dynamic, fast)
Tension/compression	20%	20%	20%	10%
Shear	50%	50%	50%	25%

be 70 Kelvin (K), based on a projected rise in temperature from 20°C to 90°C in summer.

$$\begin{aligned}\Delta I &= I_0 \times \Delta\alpha \times \Delta T \\ \Delta I &= 8 \text{ m} \times 8 \times 10^{-6} \times \text{K}^{-1} \times 70 \text{ K} \\ \Delta I &= 4.5 \text{ mm}\end{aligned}\quad (9)$$

where ΔI = difference in linear expansion; I_0 = length of object; $\Delta\alpha = \alpha_{\text{GRP}} - \alpha_{\text{steel}}$ = difference in the coefficients of linear expansion ($\alpha_{\text{GRP}} = 20 \times 10^{-6} \times \text{K}^{-1}$, $\alpha_{\text{steel}} = 12 \times 10^{-6} \times \text{K}^{-1}$).

In the case of a roof assembly that is free to move at both ends, the change in length at either end is half of the total differential movement, i.e. 2.25 mm.

As a general rule, the thickness of the adhesive layer must be greater than the total change in length.

This ensures that the maximum shear stress undergone by the adhesive layer at either end does not exceed 50%. In this example, therefore, the minimum thickness of the adhesive should be 4.5 mm. Additional design criteria for the maximum permitted movement of the adhesive layer are given in Table 1.

6.4.3. The Finite Element Method in Adhesive Joint Design

The Finite Element Method (FEM), which means method of elements with limited size, is a powerful tool for numerical solutions of mechanical problems of elastic and plastic materials. The basis is the calculation of linear equation systems by a computer. The system to calculate, i.e. structure, is divided into fitting elements

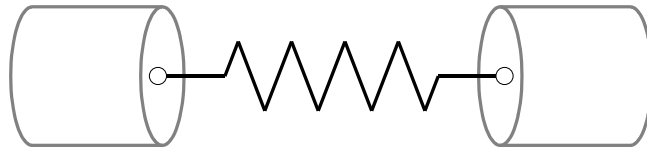

Figure 34: Spring between two elements.

joined together with nodes. By dividing the structure into a limited number of elements, an approximate solution of the problem will be reached. With increasing fineness of the element mesh, the accuracy of the solution improves.

In FEM simulation, the elastic joints can be modeled, for example, as a spring element, shell and volume element. An explanation follows in the next section.

6.4.3.1. Spring Element

For calculation of a whole vehicle, the modeling with spring elements is good because the joint can be represented with relatively big elements (Fig. 34). Increasing the number of elements is naturally advantageous (more fine resolution of joint). For the simulation with spring elements, the three stiffness values for the three displacements in translation are used. There are two springs for stiffness in shear, and one spring for tension/compression. These three springs are uncoupled and independent. The stiffness in rotation is located by several springs side by side (Fig. 35).

In the representation of the joint by spring elements, the mechanical properties of the adhesive are given with the generalised elasticity factor of stiffness. The physical units are the same as of the modulus. With the joint dimension it is possible to calculate the spring constant of the joint by the dimensionless quantity

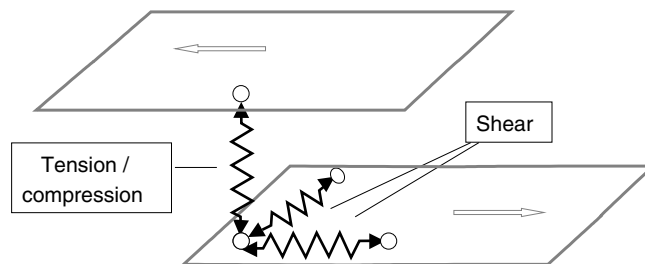

Figure 35: Three stiffnesses on the axes.

stiffness of the adhesive. The adhesive joint can be represented as a spring element in the overall structure to be calculated:

$$k = c \frac{A_k}{d} \left(\frac{\text{N}}{\text{mm}} \right) \tag{10}$$

where k = spring constant for the adhesive joint; c = stiffness; A_k = area of the bond face; d = thickness of the adhesive layer.

This spring element is also used to control the joint geometry and not allow it to exceed the maximum permissible deformations. If, for example, we assume a shear stiffness of 0.5 MPa and a section of an adhesive joint of 200 mm length with 15 mm width and 4 mm layer thickness, the spring constant can be calculated as follows:

$$\begin{aligned} k_{\text{Shear}} &= \text{Stiffness in shear} \times \frac{\text{Surface to be bonded}}{\text{Thickness of adhesive layer}} \\ &= 0.5 \times \frac{200 \times 15}{4} \left(\frac{\text{N}}{\text{mm}} \right) = 375 \left(\frac{\text{N}}{\text{mm}} \right) \end{aligned} \tag{11}$$

The spring constant for tensile/compressive stresses is determined in exactly the same way.

6.4.3.2. Volume Element (=Solid Element)

Volume elements are better than shell elements because shell elements are too soft in compression/tension. The use of at minimum one quadratic hexahedron element (20 nodes, see Fig. 36) or two hexahedron elements (8 nodes, see Fig. 37) across the adhesive thickness is advantageous.

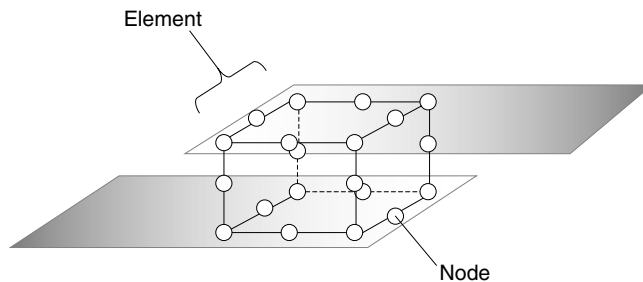
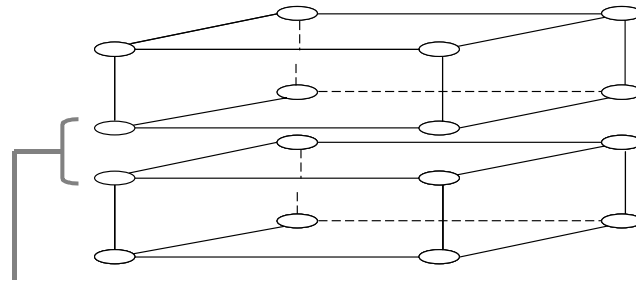

Figure 36: Quadratic hexadron element.



The two nodes are at the same place.

Figure 37: Two hexahedron elements.

The volume element is the best compromise between calculation time and accuracy of the results. A fine enough modeling of the adhesive joint – breaking down the adhesive joint in volume elements of small sizes – is important in order to reproduce their deformation behaviour. If there are no limits for modelling complexity and calculation time, increasing the number of elements is naturally advantageous. As more elements are used, the better the stress situation in the joint can be calculated.

The shear modulus is suitable as a material property for FEM (Fig. 38). For Sikaflex® adhesives, a Poisson ratio of 0.49 is suitable. The Poisson’s ratio is defined in the Glossary in more detail. This value is needed in the Hooke’s law:

$$E = G \times 2 \times (1 + \nu)$$

where E = Elastic modulus; G = Shear modulus and ν = Poisson ratio.

The mechanical data for a typical structural adhesive that can be used for calculation purposes are listed in Table 2.

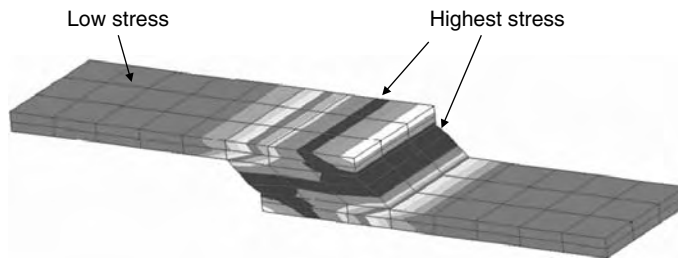

Figure 38: Example of FEM of shear loading (see colour plate section).

Table 2: Mechanical data for a typical elastic adhesive

Stress	Temperature (°C)	Stiffness (MPa)		Strength (MPa)
		Shear modulus	Compression/ Tension	
Constant static, exposure period 3 years	23	0.5	–	0.16
	70	0.1	–	0.11
Quasi-static, 60 mm/min.	23	0.7	4	2.5
Dynamic, 10 Hz with 1% displacement amplitude	23	1.5	7	–
	90	0.8	4	–
	–40	13	56	–
Dynamic, 50 Hz with 17% amplitude, up to 10 ⁸ cycles	30–40	1.2	–	0.2

6.5. Basics

6.5.1. Main Features of Adhesion

One of the most important factors in adhesive bonding is the surface condition of the substrate, i.e. the surfaces of the materials to be joined. Since adhesion takes place only at the interface between the component and the adhesive, it is evident that surface preparation or chemical pretreatment has a crucial bearing on the quality of the adhesive bond.

6.5.1.1. Adhesion and Cohesion

Adhesive bonding is based on two important properties: adhesion and cohesion. Through chemical and physical curing, the adhesive changes from a liquid or pasty state to a solid state. In the liquid state, the good wetting properties enable the adhesive to get close enough to the substrate in such a way that molecular interaction between substrates and adhesive is enabled. After the curing reaction, cohesion or internal strength is built up. The adhesion force at the interface between adhesive and substrate affects the bonding strength, see Chapter 1, 'Theories of Adhesion' for further discussion.

Considering this more closely, cohesion is defined as forces between atoms or molecules within the adhesive. Therefore, cohesion differs from adhesion, where adhesion forces occur between the different materials making up the surface of substrate and the adhesive.

6.5.1.2. Influence of Surface Structure

Adhesion is related to surface properties, and hence not only the substrates but also the surface structure influences adhesion. Surface structure is not usually flat, rather it exhibits 'mountains' and 'valleys' as well as pores (Fig. 39).

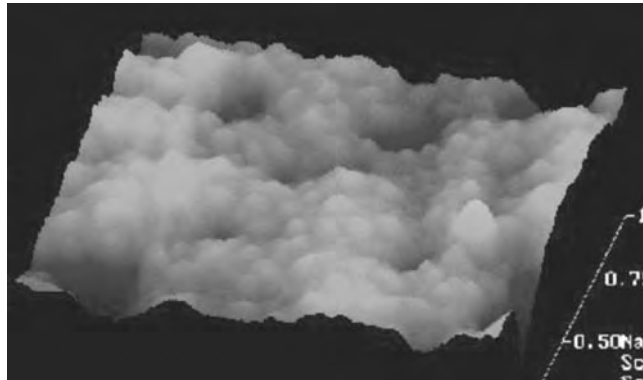

Figure 39: Topography of a surface.

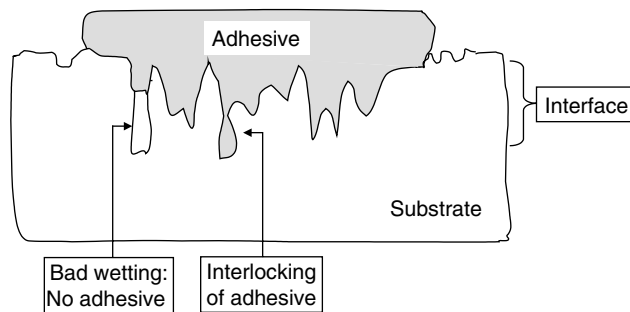

Figure 40: Features at bonding interface.

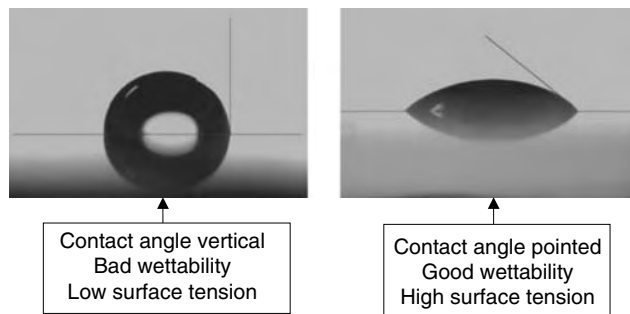

Figure 41: Contact angle and surface tension.

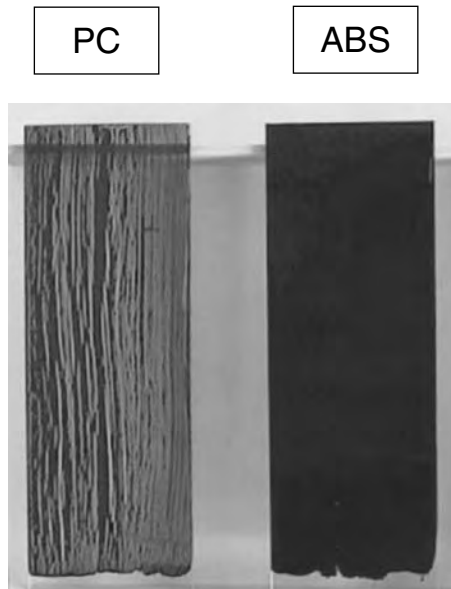

Figure 42: Different wettabilities of a primer.

With good wettability, the adhesive penetrates into the valleys and increases effective adhesion surface. Perfect bonding requires no voids or entrapment of air or dirt. In special cases, the adhesive can even interlock with the surface structure (Fig. 40).

Wettability is the result of attractive forces between the adhesive and the substrate. When the adhesive spreads excellently on the surface, an increase of wetting and penetration into the surface roughness occurs. Contact angles and surface tension can be measured (Fig. 41). Wettability is crucial for good adhesion, but it is not the only measure for adhesion because other influences play important roles.

As an example, the different wettabilities of a primer on plastics like polycarbonate (PC) and acrylate butadiene styrene (ABS) are shown in Fig. 42.

Usually a high surface tension, greater than 40 mN/m, sets the basis for good adhesion, although there is no absolute correlation between surface tension and bond strength.

6.5.2. *Different Adhesion Models**

There currently exists no uniquely valid model of adhesion but rather a series of different models each having its own field of application. The chemists' task is to combine

*Note of the editor: For more information about theory of adhesion the reader should refer to the chapter 1 "Theory of adhesion" by John Comyn, in this volume.

all the different models and evaluate their individual importance from case to case. In order to achieve this, there must be sufficient information about the materials used and characteristics of the substrate and adhesive. Some models are listed below.

(i) **Physical bonding** comprises the interactions of:

- Dipole forces
- Hydrogen bridges (Exchange of protons) and
- Dispersion forces (Van der Waals forces).

Dipole forces are effective when polarity is present and can be generated from permanent or induced dipoles. Polar molecular groups of adhesives must contact the substrate surface in the distance of 10^{-8} cm or less. An example for adhesion between polar binder and polar substrate is pictured in Fig. 43.

Hydrogen-bridge bonding is between very polar groups such as NH, OH, urea, urethane, ester, amide etc. This hydrogen group is in the middle between the two bonding partners. In polyurethane systems, hydrogen bonding has a great impact on the cohesion strength.

Dispersion forces: The long chain of a polymeric macromolecule diffuses very close to the substrate and ‘non-polar’ interactions are generated. Such Van der Waals interaction mechanism are here responsible for bonding forces. This diffusion procedure is more significant for bonding of plastics than of metals (Fig. 45).

(ii) **Chemical bonding** is the reaction between reactive groups of the adhesive and of the substrate surface. This can lead to a covalent, ionic or complex bonding as outlined in Fig. 46.

The calculated cohesion forces per square meter range as follows [1,2]:

- Molecular dipole cohesion force 200 MN
- Hydrogen-bridge cohesion force 500 MN
- Covalent cohesion force 5000 MN

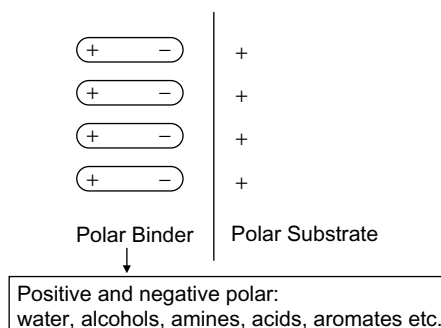

Figure 43: Example for dipole forces.

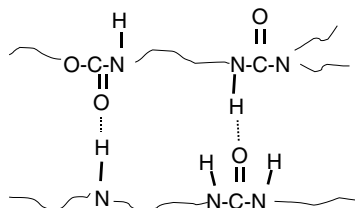

Figure 44: Hydrogen-bridge bonding.

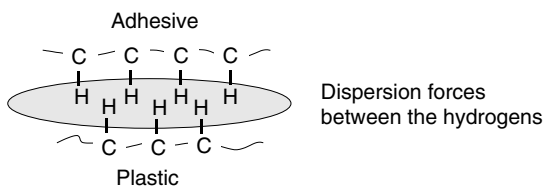

Figure 45: Van der Waals interactions are dispersion forces.

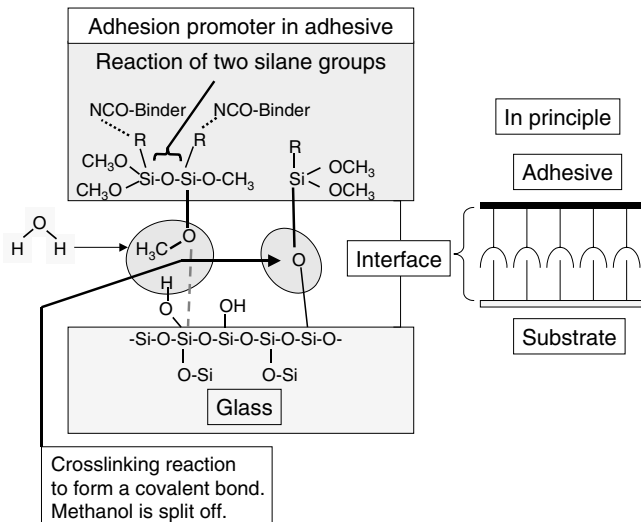

Figure 46: Chemical bonding of silane groups (model). The group R of adhesion promoter reacts with NCO-group of the binder in adhesive to form covalent bonds.

These values are significantly higher than the experimentally determined tensile strength of elastic adhesive, which is between 3 and 10 MPa. Why is there such a difference?

The cohesion force of an adhesive is built up from a wide spectrum of forces including molecular dipole, hydrogen-bridge and covalent and other cohesion forces and is a mixture of these in varying proportions.

In the adhesive material, there are weak spots which depend to a large extent on:

- homogeneity of the adhesive
- gas inclusion in the adhesive
- hard and compact segments of the adhesive
- weak and soft segments of the adhesive.

The reduction in cohesion strength in adhesives occurs when, e.g., stresses become locally extremely high between hard and soft segments during the tear test. This locally induced force per area leads to the breakage of the adhesive resulting in a cohesion failure (Fig. 47).

Besides the cohesion failure of an adhesive, the adhesion failure can take place in the boundary layer area, which is at the interface of the adhesive and the substrate. It can be the oxide layer of a metal, the surface of a substrate contaminated with oil, dirt, migrated plasticiser or a weak boundary layer, which is generally the first oriented adhesive layer on the substrate.

Substrates with low surface energy usually have few or no polar groups, which provide only little or no interaction with the adhesive. Such substrates need either a physical surface preparation, e.g. a plasma treatment or a chemical pretreatment by use of an organic adhesion promoting layered system.

There are many options for surface preparation and chemical pretreatments and they generally create a reliable, reproducible surface when prepared according to specification. These two options are discussed below.

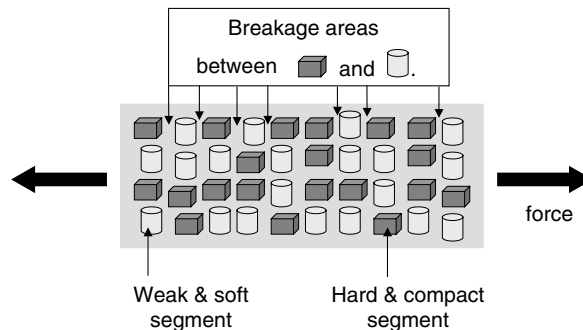

Figure 47: Where does the adhesive break during tearing?

6.5.3. Substrates

With adhesive bonding, a large variety of substrates can be joined, such as glass, ceramics, plastics, fibre-reinforced plastics, metals and wood. Many more substrates and combinations are possible and each can have significantly different properties, in particular mechanical properties and surface conditions.

6.5.3.1. Glass and Ceramics

Production methods which do not require investment in expensive technology or engineering systems are desired. UV protection has much to do with the fact that when clear glass is adhesively bonded, the bond face needs to be shielded against UV radiation by some form of opaque mask or covering. In practice, this is normally achieved by applying a (mineral) ceramic screen-printed border to the glass that is both decorative and impervious to UV radiation.

Sika introduced a primerless direct glazing system to the car industry in 1986, although the glass surfaces need to be treated with a reactive cleaning agent or activator that prevents the ingress of moisture into the bond-line.

The ceramic coatings used in the automotive market today are generally sufficient for providing UV protection, although there appears to be a trend towards better transmission values for windscreens in AGR (Auto Glass Replacement) (Fig. 48).

Sika internal studies and those made in cooperation with a car manufacturer carried out in 1996 showed that the primerless system provides good durable adhesion and outperforms black primer systems for bonded auto windscreens. The studies showed that not only UV, but also other factors contribute to the degradation of the adhesive system such as humidity, working conditions, application,

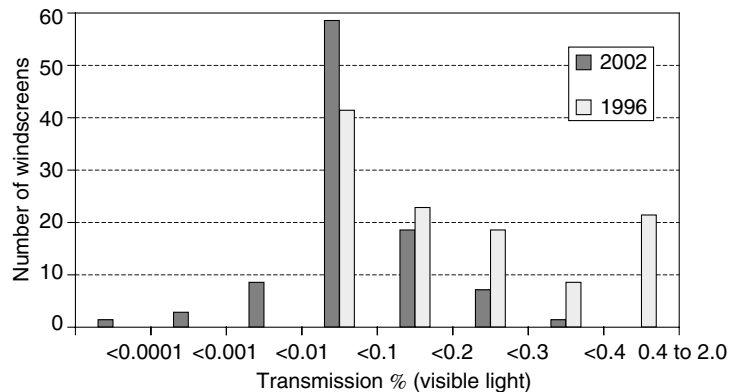

Figure 48: Transmission values of windscreens 1996 versus 2002.

design, movement, various environmental conditions and others that cannot be measured in laboratory situations, but only real world experience.

6.5.3.2. Plastics

With plastic substrates, the chemical composition has the biggest influence on adhesion. Since plastic substrates can be very different in the chemical composition, the supplier and the blend, a prediction of good adhesion without testing is almost impossible. In addition, migration of ingredients like plasticisers or residual monomers or release agents on the surface can influence adhesion as well. These effects may occur only after ageing, although good adhesion can usually be achieved with the most commonly used plastic substrates.

6.5.3.3. Fibre-reinforced plastics

Sheets or components made from unsaturated glass-fiber-reinforced polyester (GRP) undergo a process of shrinkage during polymerisation (curing), which continues for several weeks. Components made from this material should not be adhesive-bonded too soon after manufacture as the ongoing shrinkage process would place the component and consequently the adhesive bond under a constant stress. This, combined with normal service stresses, could lead to premature bond failure. Alternatively, glass-fibre components can be heat-treated for a few hours to stabilise them – a process known as tempering. Adhesive bonding of GRP materials should therefore be restricted to tempered components or components that have been stored for a period of time.

6.5.3.4. Metals

Fig. 49 suggests that most metals do not exist in pure states. Metals like steel, aluminum, titanium, zinc and many others usually have an oxide and hydroxide layer on the surface. Organic and inorganic contaminants like oil and water also cover most metals. As bonding occurs on this (sometimes dirty) oxide layer, many strategies for durable adhesion aim to stabilise it.

When the bare metal is covered with oil immediately after production, impurities and loose metal oxide, and hydroxide, are avoided. Such oil-protected metals are

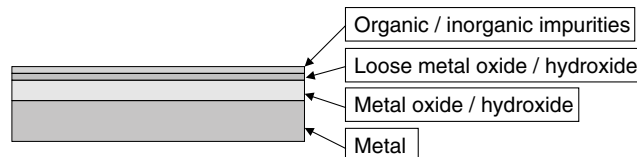

Figure 49: Build-up of metallic surfaces.

widely used in the automotive industry. These impurities and loose oxide layer(s) should be eliminated, especially for cold-curing adhesive systems.

6.5.3.5. Wood

The water content and ingredients of the wood, especially resins of conifers, may influence the bonding reaction and have a negative impact on adhesion (see Section 6.8.9.).

6.5.4. Surface Preparations

For more information on the issues of substrates preparation before bonding, please refer to the chapters:

- Surface preparation before bonding (Vol. 1)
- Bonding metal (Vol. 5)
- Bonding of composites and plastics (Vol. 5)
- Woodworking and furniture adhesives (Vol. 3)

For ageing resistant bonding, the substrate must be free of oil and dirt. Surface preparation includes simple cleaning of the surface, mechanical abrasion, thermal processes such as flame treatment as well as specialised physical–chemical techniques such as corona discharge or low-pressure plasma treatments.

Cleaning of the surface can be carried by use of a liquid system without an adhesion promoting agent such as solvent, water, detergent.

Mechanical removal, like abrasion or grid blasting, can clean the surface but the reliability of such a removal depends on the particle size and form of the grid blasting material.

Thermal oxidation, the plasma process involves different species of gas (Fig. 50). The plasma contains activated gas molecules, ions, molecule fragments and radicals and can be generated by different ways (Table 3). Plasma treatments under low pressure and fluorination require a vacuum chamber. Corona discharge has limitations in achieving optimal adhesion. In contrast, the open air plasma treatment

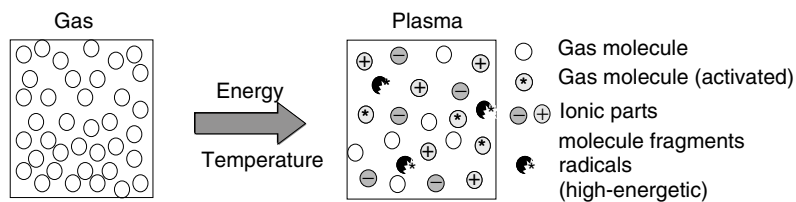

Figure 50: Plasma consists of different species of gas,
Source: PlasmaTreat® GmbH (Germany).

Table 3: Some physical–chemical pretreatments

-
- **Flame pretreatment**
The flame generates **chemically active species** like radicals, ions and molecules in the activated state. Oxygen type groups are implemented on the polymeric surface, in particular, polyolefin surfaces.
 - **Corona discharge pretreatment**
An electromagnetic field at high energy ionises the air in the environment and this generates chemically active species. Corona pretreatment provides a limited activation of the substrate surface to achieve an optimal bonding.
 - **Low pressure plasma pretreatment**
This is generated in a high-frequency (GHz) electric field via an active gas plasma at low pressure in a vacuum chamber. The gas molecules such as O₂, H₂ and N₂ interact in the electric field and generate a number of activated species, radicals and ions. The temperature remains below 100°C and is therefore called a cold plasma.
 - **Gas phase fluorination**
A gas mixture 'F₂/O₂' is used for pretreating plastics.

$$-(\text{CH}_2-\text{CH}_2)_n + 2n\text{F}_2 \Rightarrow -(\text{CH}-\text{CH})_n + 2n \text{HF}$$
 - **Sandblasting with Corund (SACO)**
(=Aluminum oxide coated with silane)
Friction of grit impact heats the substrate surface and silane adhesion promoter is implemented on surface.
Generally used for PP, PE and POM.
 - **Atmospheric pressure plasma treatment (open air)**
See text for description
-

described here requires no vacuum chamber. A small generator moves easily along the substrate in the open air and is easy to install in production.

6.5.4.1. Open-Air Plasma Treatment

An open-air plasma pretreatment can be used to activate, clean and coat surfaces at ambient conditions.

The PlasmaTreat[®] process introduces active carboxylate, ether, ketone or other oxygen-containing polar groups on the plastic surface without the use of a primer. For example, plasma treating of polypropylene increases the surface tension from 30 to 60 mN/m. The substrate to be bonded is briefly passed under a potential-free plasma flame at atmospheric pressure, thus providing good wettability and allowing application of the adhesive immediately (Fig. 51). The substrate retains its reactivity for adhesion for more than 7 days.

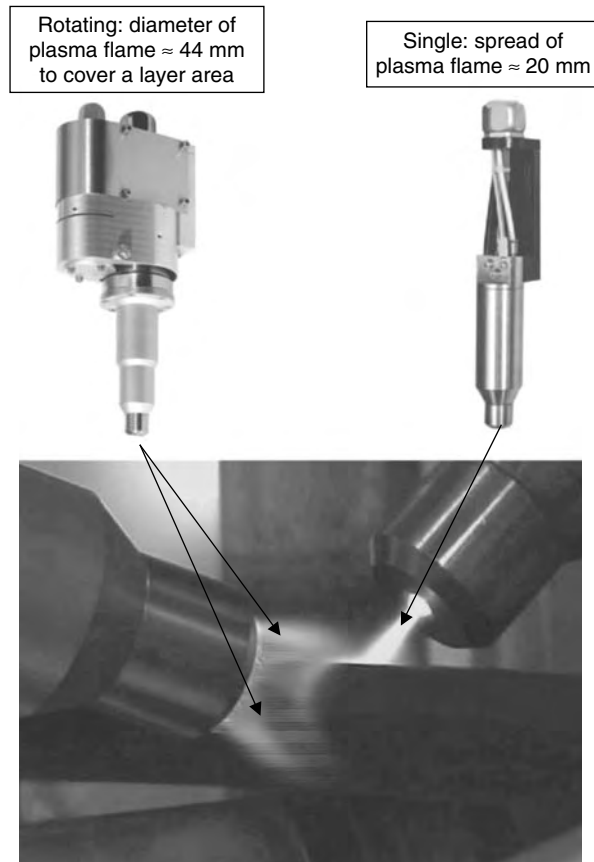

Figure 51: Open air plasma generators (see colour plate section).

No electric arc is created, which would damage parts as the ions generated by the plasma are filtered off at the plasma jet nozzle. Thus, the potential-free plasma jet can be used on or around metals. Corona treatment generates arcs on metals. As the velocity and distance of the plasma generator in relation to the substrate must be constant, manual application is not recommended.

6.5.5. Chemical Pretreatments

It is always difficult to get durable bonds on many surfaces without surface preparation or chemical pretreatments. The use of primers and a complete portfolio of activators and primers for glass, ceramic, plastics, metals, wood, etc. improves the adhesion.

Small and medium sized companies, like auto glass replacement, maintenance, repair shops etc. are often not able to invest in expensive physical pretreatments and therefore require chemical pretreatments.

On the other hand, automotive manufacturers prefer to bond without using a priming system. In 1987, a primerless direct glazing system was successfully introduced in the automotive industry which renders the black primer obsolete in many applications.

The goal remains to improve the direct adhesion to substrates by the adhesive. However, this is complex. Chemical pretreatments generally provide good wettability due to their low viscosity. The adhesive's higher viscosity reduces the wettability and also the adhesion quality.

Chemical pretreatment can be performed with an adhesion promoter, cleaners and activators providing layers of nanometer (10^{-9} m) thickness or with primers achieving coating thickness in the micrometer (10^{-6} m) range.

Activators contain low molecular weight surface-active organic substances which promote adhesion. Primers are based on higher molecular weight binders and cover the substrate with a film. Both can contain solvents or water.

Usually, primers are based on organic binders in solvents. These low-viscosity products have excellent wetting properties and functional groups that provide good adhesion on the substrate. The surface can be qualified by visual control.

The primers function depending on the materials to be bonded and their surface properties:

- to flatten topography
- to clean surface
- to introduce interacting groups (e.g. polar groups, adhesion promoters)
- to harden and reinforce the surface
- to provide UV-protection, e.g. black primers
- to improve corrosion protection.

Ecologically improved priming systems where the polymers are dissolved or dispersed in water are free of solvents. The disadvantage with these water-based primers is their long flash-off time of 1 to 3 h, which is the time before the adhesive can be applied. This hinders a fast bonding procedure and is therefore not well suited for a high-speed production. In contrast to water-based primers, activators can achieve a shorter flash-off time, since they have a thickness of nanometres. Heating by IR-sources, ovens or hot air fans can speed up the flash-off time of water. Due to VOC (volatile organic compound) regulations, future development will focus on more ecological ways of priming like phosphatising of metal sheets.

Table 4: Typical surface treatments for common substrates, Source: Sika

Material	Abrading Cleaning	Degreasing Activating	Priming	Remarks
Glass		×	(×)	UV protection
Glass with ceramic screen print		×		
ABS	Seek advice from Technical Service Department			
PVC	×	×	×	
Polycarbonate	Seek advice from Technical Service Department			
GRP	×	×	×	
Paint systems (depending on chemical composition)		×		
Steel	×	×	×	Oily sheets
Stainless steel	×	×	×	
Aluminium anodised		×	×	
Aluminium, bare	×	×	×	
Wood				Remove dust

Chemical primers, in particular the solvent-based pretreatments, are not preferred in assembly operations because of worker exposures. Physical pretreatments are preferred at high-speed assembly lines. Some substrates require a combination of plasma treatment and activators or low VOC primers. Therefore, both treatments will have their future uses.

Suitable methods of surface pretreatment for mass-production applications must be discussed and coordinated with the technical service department of the adhesive manufacturer. Adhesive manufacturers have established treatment methods for the main substrates encountered in industrial production and working instructions for users. They are in a position to offer their customers the best professional advice. This approach offers the right chemical pretreatment, which contributes best to the specific adhesive system. Table 4 lists the typical surface pretreatment options for a range of common substrates.

6.5.5.1. Sika's Chemical Pretreatments

The range of chemical pretreatments for industry is listed in Fig. 52, for construction in Fig. 53. They are chemical reactive systems on different chemical bases, e.g. silicone, isocyanate, epoxide.

<u>For PUR-adhesives</u>	
Layer thickness in nanometer:	
• Sika® Cleaner-205 and Sika Activators	
Layer thickness in micrometer:	
• Sika® Primer-204	for metals
• Sika® Primer-206 G+P	for glass and paints
• Sika® Primer-206 T	for glass
• Sika® Primer-209	for plastics
• Sika® Primer-210 T	for Alu and plastics
• Sika® Primer-215	for plastics
• Sika® Primer-290 DC	for teak deck caulking
<u>For silane-terminated adhesives</u>	
• Sika® Hybride Activator (colourless)	for PUR-Hybrids
• Sika® Primer AT (colourless)	for PUR-Hybrids (porous substrates: e.g. concrete)

Figure 52: Sika’s chemical pretreatments in the industry.

<u>For sealants</u>	
Porous substrates	
• Sika® Primer-3 (colourless)	for Sikaflex® and Sikalastic® -801 (for concrete, wood, brick, clinker, plastics)
• Sika® Primer-15 (yellowish)	for Sikaflex® (for plastics)
• Sika® Primer-30 (colourless)	for Sikasil® (for concrete)
Non-Porous substrate	
• Sika® Cleaner-1 (colourless)	for Sikaflex® and Sikasil (for glass, metals, plastics etc.)
• Sika® Primer-35 (yellowish)	for Sikaflex® and Sikasil® (for metals)

Figure 53: Sika’s chemical pretreatments for construction.

6.5.6. Adhesives

Reactive adhesives for elastic bonding are available as one-part and two-part systems, based on polyurethane (PUR), polysulphide, silicone or silane-terminated polymers, such as PUR-Hybrids and Modified Silicones (MS). These adhesive systems can be applied cold or warm or mixed with a water-based Booster component.

One-part systems are widely preferred because they are easier to use and give more consistently reliable results (less room for operator error). With two-part systems, it is necessary to check and monitor the accuracy of the mixing and dosing processes and the quality of the adhesive bond, and the additional cost and effort involved is usually justified in applications where the joint has to achieve a high initial strength very quickly.

Because of their excellent adhesion and the wide variety of different mechanical properties and working characteristics, polyurethanes are unquestionably the most important class of adhesives for elastic bonding applications. The discussion that follows explains moisture-curing systems.

6.5.6.1. One-Part Polyurethane Systems (PUR)*

The vast majority of one-part elastic adhesives are moisture-curing polyurethanes, which combine high flexibility and elongation at break with good strength characteristics. Moisture has to permeate the adhesive surface and curing starts from the outside of the adhesive to the inside.

The following chemical reaction takes place: the water reacts with the isocyanate end groups of the prepolymer to form a carbamic acid derivative. This is converted into an amine by the elimination of carbon dioxide (CO₂) and is then cross-linked with a further isocyanate group to form a polyurea (Fig. 54).

The start of the reaction is signalled by the formation of a skin on the adhesive, which marks the point from which proper wetting of the substrate can no longer take place and further improvement in adhesion can no longer be expected. The cure process becomes progressively slower as the depth of the adhesive layer increases. Adhesive joints made with this type of product should not exceed 20 mm in width in order to ensure that full cure is attained within 14 days.

The chemistry of polyurethane adhesives and sealants has been explained in the Chapter 3 of Volume 1 and readers may refer to this chapter for further information.

*For more informations about PUR adhesive and sealants, our readers may refer to the chapter 'Chemistry of Polyurethane adhesives and sealants' in Volume 1 of this Handbook.

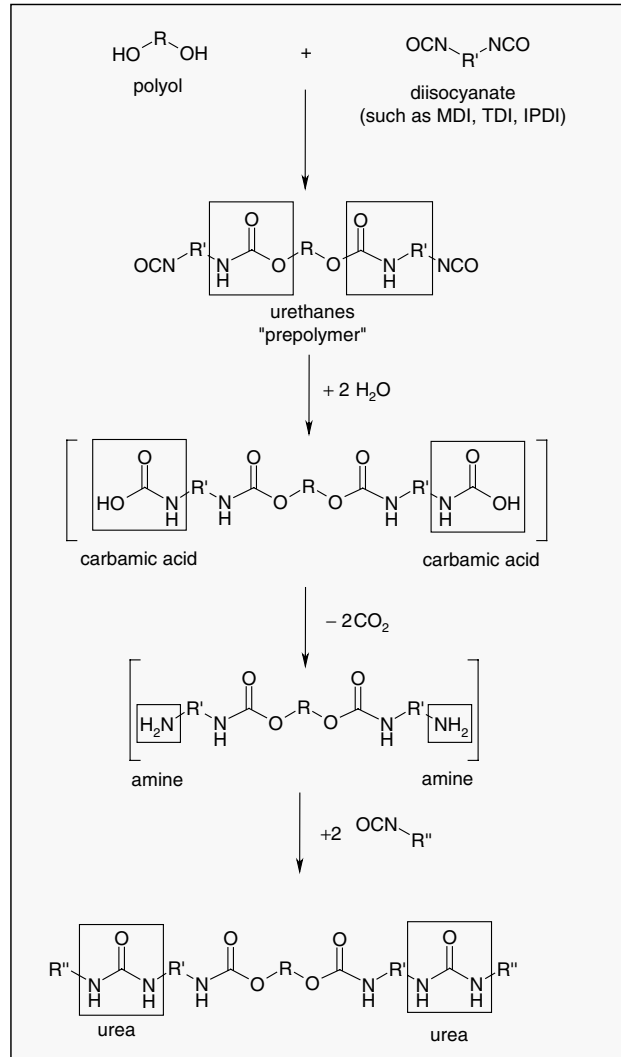

Figure 54: Schematic representation of cross-linking in a moisture-curing polyurethane adhesive. R and R' are organic polymer chains.

6.5.6.2. One-Part Polyurethane with Latent Hardener

The moisture-curing of PUR generates CO_2 , which may lead to bubble formation. Therefore, high levels of isocyanate containing compounds produces more CO_2 , which is often case for highly reactive PUR systems. The thickness of the bond-line also has an influence on the bubble formation. The thicker the bond-line,

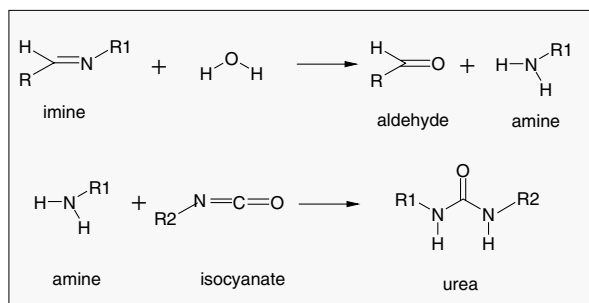

Figure 55: Mechanism of the reaction using latent hardener in the PUR system. R, R1 and R2 are organic polymer chains.

the higher the risk of bubbling. Highly reactive PUR systems used in thick bond-lines usually leads to bubbling, especially at higher temperatures.

Latent hardeners may be used to overcome this drawback (Fig. 55). At first, the imine group reacts with water and liberates an amine group which cross-links in a second step with the isocyanate group to form a urea group. No CO_2 is generated and a stable urea group is built.

Silane-terminated polymers do not cause bubble formation either, see below.

6.5.6.3. Precurving Adhesives (PC)

Pasty, *precurable* adhesives are heated up in the delivery hose and a physical and chemical reaction takes place. This reaction enhances greatly their non-sag properties and gives them significantly higher handling strength or ‘grab’. This means for example, that a car windshield installed with a precured adhesive will not slip down immediately after installation. Further information of handling strength is given in Section 6.6 entitled ‘Curing of Reactive Adhesive System’.

6.5.6.4. Reactive Warm-Melt Adhesives (RWM)

To achieve a rapid initial strength or handling strength of the bonded part, a reactive warm-melt adhesive can be used. Upon cooling of the warm-applied adhesive, the viscosity increases and the consistency of this cooled adhesive allows immediate handling. Moisture-curing of the isocyanate groups occurs at room temperature. The speed of building up the strength is intimately linked to the crystallinity and chain length, which is discussed in Section 6.6 entitled ‘Curing of Reactive Adhesive System’.

6.5.6.5. Hot-Cure Adhesives (HC)

All the adhesives discussed so far are moisture-reactive. A further variant is the hot-cure polyurethane system, which cures rapidly on exposure to heat to form a

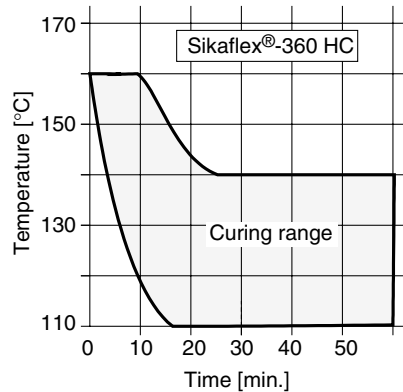

Figure 56: Baking time as a function of temperature of a commercially available adhesive.

durable elastomer. The rate of cure is temperature dependent (Fig. 56). The stated cure temperatures refer to the temperature of the adhesive and the bond faces. One must take into account the heat capacity of the substrates and the time required to warm the adhesive up to its curing temperature.

Suitable heat sources to promote rapid curing include ovens, infrared heaters, hot-air blowers, heating bars etc. Although humidity curing is also possible, it is not recommended due to quality variations of the elastomer.

The bonded pieces must be heat resistant. The open time at 23°C and 50% r.h. is adjusted to 1 h. Sikaflex®-360 HC is an example of an adhesive that is suitable for structural joints that will be subjected to high dynamic stresses (Fig. 57).



Figure 57: Lifting bar for side window bonded to glass with Sikaflex®-360 HC within 20 min at 120°C.

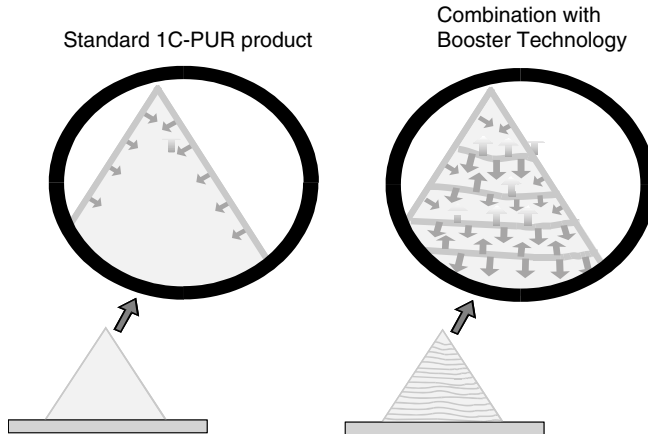

Figure 58: The effect of a cure accelerator (Booster) on adhesive cure.

6.5.6.6. Booster Technology

Strength development can be sped up by the use of a curing accelerator, called Booster (Fig. 58). This Booster Technology, which is on the market since 1995, allows one to overcome the drawbacks of 1C-PUR systems regarding complete curing of thick bond-lines between water-tight substrates and complete cross-linking at high speed.

With this technology, a small amount of a hardener paste is added by means of a short static mixer with a few mixing elements. The mixing is carried out intentionally inhomogeneously and results in a layer-type arrangement of the two components. The hardening happens through water diffusion from many interfaces of the layers

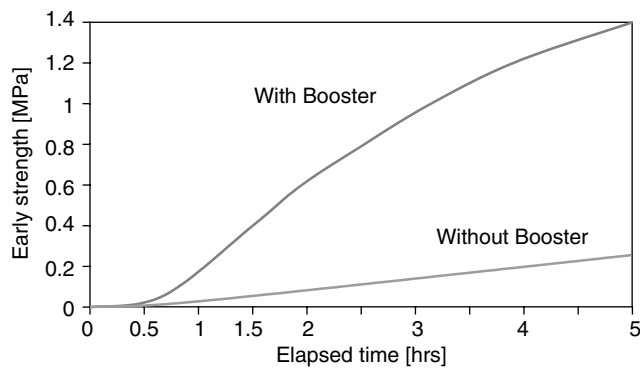

Figure 59: Comparative rates of strength development with and without Booster.

in a short time. This special 2C-PUR system is robust since the mixing ratio and mixing quality do not need to be controlled very precisely, hence applications do not have to be in a small tolerance band. Full cure takes place sooner or later and any excess water eventually evaporates.

The addition of the Booster to the adhesive has little effect on the open or working time, which is the interval between application of adhesive and joint assembly. However, a significantly faster setting results after just 2 h (Fig. 59).

6.5.6.7. Two-Component Polyurethane Systems

The Booster Technology described above works well when an open time of more than 15 min is needed. An even faster strength build up can be achieved with two-part PUR systems, e.g. those having the brand name SikaForce®.

Fig. 60 shows a range of SikaForce® products where the ‘Flexible’ adhesives like SikaForce®-7550 are used for ‘Elastic Bonding’.

The chemistry of 2C-Polyurethane adhesives is outlined in Fig. 61.

Cross-linking occurs after mixing a polyol-based, filled resin with an isocyanate-based hardener which can either be a monomeric diisocyanate or an isocyanate terminated prepolymer synthesised from a polyol with the isocyanate-containing compound. The active hydrogen groups, such as OH, NH, SH etc. react in an electrophilic manner with the isocyanate groups.

The features of 2C-PUR adhesives are:

- universality, i.e. applicable for many purposes
- excellent cost/performance ratio
- variable curing speed between fast and slow
- high durability, moisture resistance and temperature resistance up to 120°C.

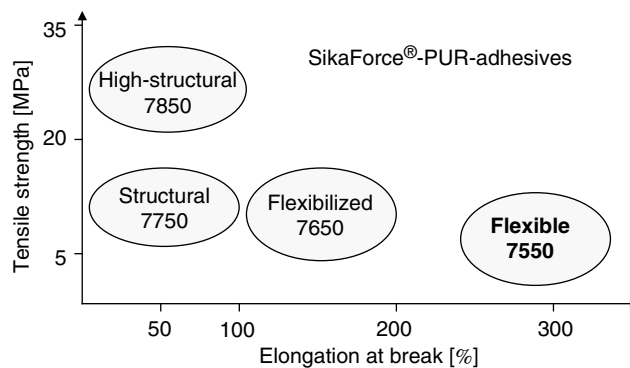

Figure 60: Overview and positioning of 2C-PUR adhesives.

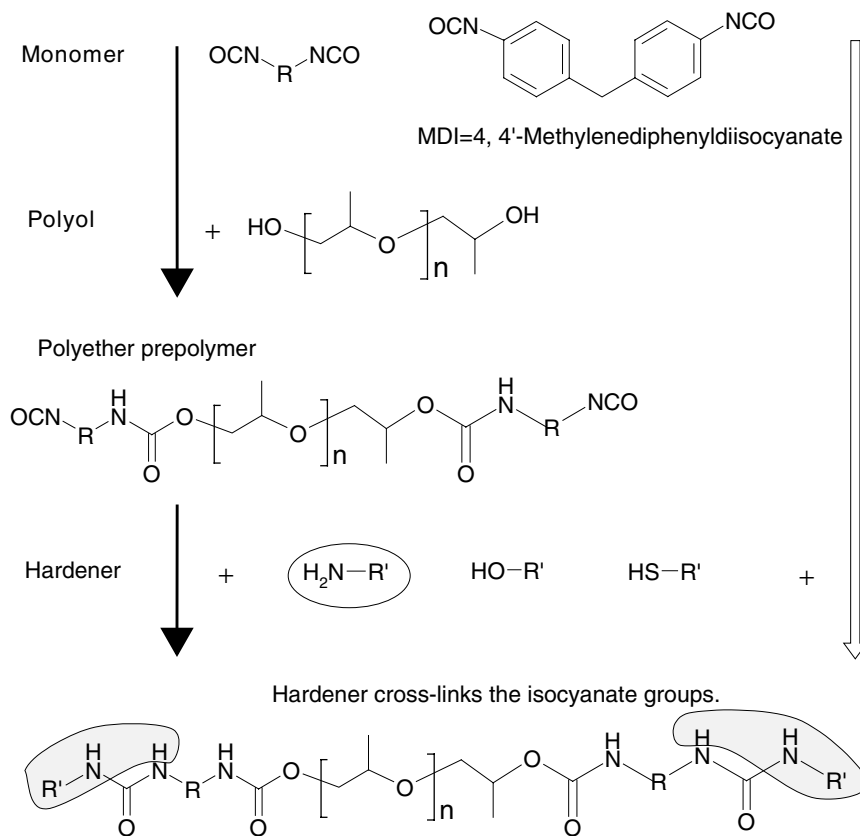

Figure 61: Curing mechanism of 2C-PUR adhesives. R and R' are polymer chains.

6.5.6.8. Silane-Terminated Polymers*

Apart from the development of polyurethane adhesives and sealants with isocyanate reactive groups, a new type of silane-terminated polymer adhesive has been developed called Polyurethane (PUR)-Hybrids. They and modified silicones (MS) and provide the benefits of:

- no bubbling or tunnelling during curing: silane-terminated polymers do not release any gaseous reaction products.
- good adhesion on many substrates with no or simple pretreatments.

*Note of the editor: For more information on Silane terminated Polymers the readers should refer to the chapter "silyl terminated polymer adhesives and sealants" in volume 6 of this Handbook.

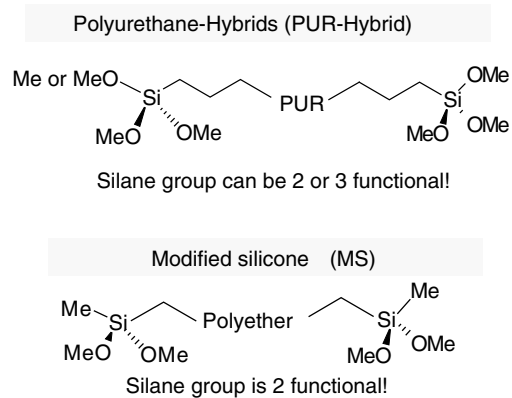

Figure 62: Functionality of PUR-Hybrid and MS systems.

MS polymers have polyether groups in the polymeric backbone and contain two active dimethoxy silane groups resulting from the hydrosilylation of the vinyl group terminated intermediate polymer.

On the other hand, PUR-Hybrids can include either two or three functional silane groups which brings additive advantages regarding mechanical properties (Fig. 62).

Such silane-terminated polymers cross-link through reaction with water. A small amount of an alcohol is released.

At present, these silane-terminated polymers have mechanical properties suitable for general use in elastic bonding applications, but usually do not achieve the same high mechanical strengths as pure polyurethane adhesives.

Section 6.8.3. entitled ‘Sika’s PUR-Hybrid Products’ provides a list.

6.5.7. Comparative Performance Data for Elastic Adhesives

For bonding, the important mechanical properties are principally E-modulus, elongation at break and viscoelastic behaviour. E-modulus governs the stiffness of the joint. Elongation at break is relevant for impact resistance and is measured after durability tests. Viscoelastic behaviour determines if creeping is expected in the application.

All adhesives specifically designed for elastic bonding have similar shear modulus in the range of 1 to 6 MPa. The elongation at break is generally between 200 and 800%. The lap shear strength varies between 2 and 6 MPa, whereby permanent static load should not be more than 3% of lap shear strength.

Table 5: Comparative performance data for elastic adhesives

Adhesive properties	Standard product	With booster	Pre-curing (PC)	Reactive Warm-melt (RWM)	Hot-cure (HC)
Specific product features	Standard	Accelerated cure	Medium handling strength	Medium to high handling strength	Rapid attainment of full cure above 100°C
Application	For general elastic bonding	For direct glazing and assembling	For direct glazing	For direct glazing and assembling	For special bonding cases
Applicable at	RT	RT/80°C	80°C	50 to 100°C	RT
Non-sagging	Medium	Good	Very good	Good	Good
Cut-off string	Short	Short	Very Short	x Very short, when crystalline	Short
Working time [min]	40	30	10	x Medium when butyl-like	240
Depth of cure after 1 day	4 mm	Fully cured	4 mm	10 to 30	Fully cured
Lap shear strength [MPa]	2.5–4.5	2.5	4.5	2–4 mm	5
Solvents	<5%	No	No	No	<5%

Table 5 shows an overview of moisture-curing PUR- and PUR-Hybrid adhesives including standard products, combinations with Booster, warm-applied pastes like pre-curing adhesives, warm-applied warm-melt and PUR-hot-cure. Specific product features, such as type of application, application temperature, non-sagging feature, cut-off string, working time, depth of cure after 1 day and solvents are shown. The handling strength of these adhesives is outlined in Section 6.6.

6.6. Curing of Reactive Adhesive Systems

Unlike mechanical joints, adhesive bonds do not immediately reach their maximum or ultimate strength because adhesives are reactive systems which need time to cure for achieving handling strength and load-bearing strength (Fig. 63).

6.6.1. Strength Development Requirements: The Key to Production Speed

Adhesive systems are in a liquid state before and during application. Depending on the reaction speed, viscosity, yield point and application temperature, they have different handling strengths. The handling strength enables transportation or a following operation on the bonded parts and plays an important role in economical production speed. Handling strength must be defined for downstream applications, such as remaining tack-free (no risk of contamination), moving assembled parts to next station, controlling quality, packaging and delivering etc. The application thus defines the handling strength required.

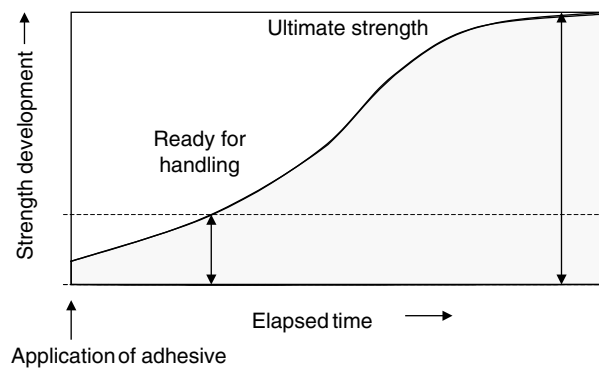

Figure 63: Schematic diagram of strength development in an adhesive bond.

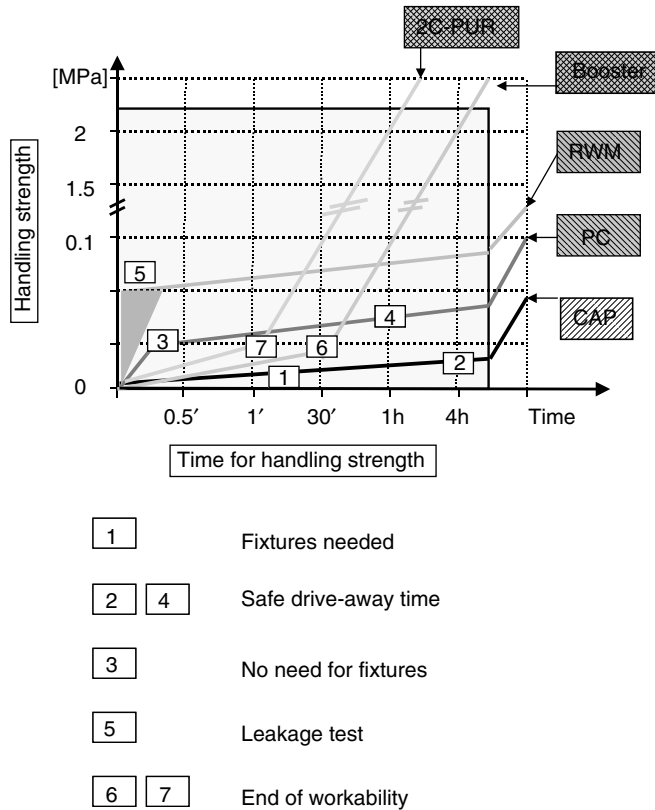

Figure 64: Early strength development of PUR-adhesives.

There are different technologies to achieve high early strength in a short time. The accompanying graph (Fig. 64) illustrates the differences in early strength development of one-part polyurethane adhesives, such as:

- standard adhesives = cold-applied paste (CAP) ⇒ Sikaflex®-2xx
- pre-curing adhesive (PC) ⇒ Sikaflex®-250 PC
- reactive warm-melt (RWM) ⇒ Sikaflex®-6xx, SikaTack®-Products
- Booster, cure with accelerator, and
- 2C-PUR system ⇒ SikaForce®-75xx.

The five common PUR-systems are explained below.

(1) *Standard adhesives*

These are cold-applied pastes (CAP) such as PUR products or PUR-Hybrid products and are unable to carry any significant loads for up to 4 h after application,

necessitating the use of jigs, clamps or other temporary fastenings to hold components in place during this period.

This is, for example, the case when auto glass is replaced. Belts and fixtures (No. 1 in Fig. 64) are required to prevent the sliding of windshield. The repair adhesive must achieve certain strength to hold the windshield at the frame in case of an accident. This means that the customer must wait till safe drive-away time (SDAT) is completed and enough handling strength is achieved. SDAT means that after a specific time of curing, a crash test can be carried out according to FMVSS 212/208 regulation (see also Section 6.8.1. 'Crash-Resistant Direct Glazing Adhesives'). SDAT for cold-applied pastes is 4 h (No. 2 in Fig. 64).

(2) Pre curing adhesive (PC)

Car manufacturers would like to bond windshields in such a way that it allows an immediate transfer to the next assembly station without the need of fixtures. Here, a precured pasty, direct glazing adhesive is warmed up to 80°C and applied along the side of the windshield. After pressing the windshield into the frame of the vehicle, the windshield remains in position after a short time with the help of physical hardening due to adhesive cooling (No. 3 in Fig. 64). The SDAT is achieved after 1 h (No. 4 in Fig. 64).

(3) Reactive warm melts (RWM)

Reactive warm melts are adhesives based on 1C-polyurethane which are applied between 50 to 100°C. There are different reactive warm melt adhesives:

- RWM type a achieves a handling strength within seconds and contains a rubber-like thermoplastic, like chewing gum. This characteristic enables prolonged wettability and hence adhesion builds up beyond cooling. Compared to semi-crystalline RWM or to crystalline hot melts applied above 100°C, a longer open time for assembly is achieved. The cut-off string is of medium length due to the long chains of rubber-like thermoplastic.
- RWM type b is semi-crystalline material and needs up to 5 min to build up the required handling strength. After this open time, the wettability ends and simultaneously high forces are built up in the adhesive material. Solidification results in shrinkage and leads to stress cracks at the interface of the bonding and in the adhesive. It behaves like candle wax. The cut-off string is minimal, since a short chain semi-crystalline binder is used.
- RWM type c is a combination of the above two approaches – immediate handling strength within seconds which is increased after a few minutes to a higher level.

Example: Efficient bonding of headlight assemblies can be performed with rubber-like RWM which also enables on-line leakage tests of each headlight

assembly (No. 5 in Fig. 64). In Section 6.8.6. entitled 'Instant-Fix Bonding of Headlight Assemblies by Reactive Warm Melts', an example is given.

(4) Booster

After application, within about 30 min (No. 6 in Fig. 64) the Booster system remains pasty and allows positioning, for example, at direct glazing. The adhesive cures completely within the next few hours.

(5) 2C-PUR systems

2C-PUR systems can cross-link within minutes and thereby their workability ends (No. 7 in Fig. 64). This high speed cross-linking can reduce the time to build up adhesion. When the speed of cross-linking is reduced and the open time is prolonged, and better adhesion is achieved.

6.6.2. Selecting the Right Adhesives

The key to a successful adhesive bond – apart from choosing an adhesive with the required performance characteristics – lies in correct application techniques. The adhesive normally develops its full strength only during the assembly process so that at least as much careful attention needs to be paid to correct application procedures as to the mechanical properties of the product itself.

Once the right joint configuration has been established, it is then a matter of selecting an adhesive that is (1) suitable for the materials to be joined and (2) simple and economical to apply. To achieve this, it may be necessary to set up a new production line that is specially geared to the adhesive bonding process. Alternatively, that process can be integrated into an existing manufacturing operation. The crucial point is to design the production process in such a way that the final strength properties of the adhesive and the adhesive bond are consistently **reproduced** in every part assembly processed. The application characteristics of the adhesive, together with the whole surface preparation sequence (cleaning, degreasing, priming) are very important.

6.7. Process and Application Technology

6.7.1. Adhesive Application

Adhesives of stiff, paste-like consistency are normally applied in the form of a triangular bead which is then compressed to its final design height (generally half of its original height) when the two substrates are brought together under pressure.

The correct bead configuration is obtained by extruding the adhesive through a nozzle with a triangular cutout in the side, which is held perpendicular to the surface. It is important to ensure, either at the design stage or by taking appropriate measures at the time of application, that the desired thickness of the adhesive is maintained. Application in bead form ensures that the adhesive makes full contact with the substrate, achieves complete wetting and eliminates air pockets. And because the adhesive does not drip or 'string', it can also be applied to vertical and overhead surfaces. It is important to make sure that any solvents contained in primers or surface activators have fully evaporated prior to application of the adhesive. The condition of the substrate should also be precisely known.

The open or working time is stated in the technical data sheet for the product concerned and must never be exceeded. It should also be borne in mind that the stated tack-free or skinning time is only applicable for the standard climatic conditions specified in the data sheet. At higher temperatures and/or relative humidity levels, the tack-free time is significantly shorter.

For large production runs and automated applications via industrial robots, the applicator nozzle must be cleaned at regular intervals to ensure a consistently clean finish. It is also advisable to maintain a constant working viscosity – independent of ambient temperature and humidity – by regulating the temperature of the delivery hoses, thus ensuring the reproducibility of the application process.

6.7.2. Equipment and Typical Application

The choice of the adhesive determines the type of application equipment required. For most industrial applications, pump-operated applicator systems are used which are designed to pump the adhesive directly from bulk drums at relatively high working pressures. Systems for using hot-applied adhesives need to be equipped with heated follower plates, hoses and guns. For automated application, additional dispensing units are necessary to meter the exact quantity of adhesive required for each application.

The working range of these pumped applicator systems is often determined by the length and manoeuvrability of the hoses. For application by hand, users have a choice of cartridges or foil wrapped portion packs (Unipacs) which are dispensed with a standard hand-operated skeleton gun (cartridges) or solid-barrel cartridge gun (Unipacs). Compressed air and battery-operated models are also available. Hot-applied adhesives for application by hand are preheated to the required working temperature in special cartridge-warming ovens (Fig. 65).

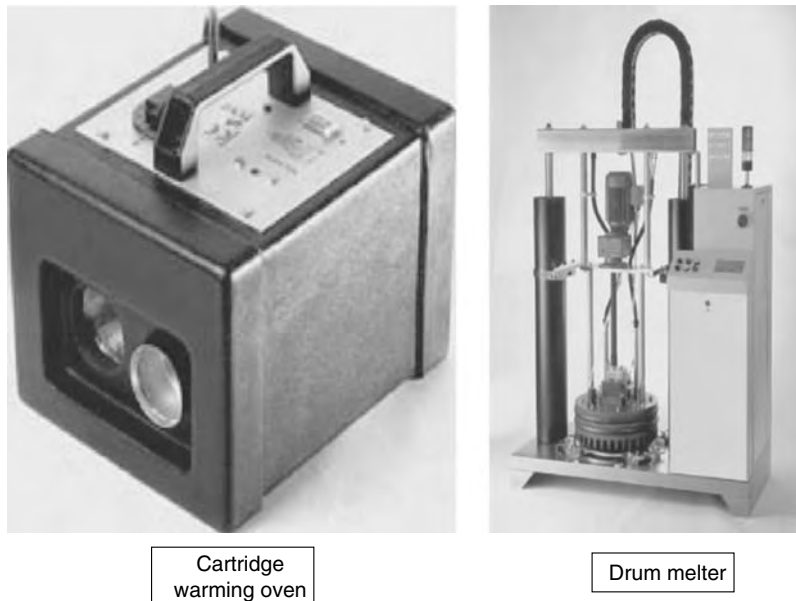

Figure 65: Different application devices.

6.7.2.1. Booster Technology

For the manually applied Booster, an adaptor was developed for screwing onto the cartridge (Fig. 66(a)). Fig. 66(b) shows a pump-operated application of a Booster system.

6.7.2.2. 2C-PUR Technologies

For manual application, the two components are filled into double cartridges and processed using a suitable cartridge gun and a mixing tube (Fig. 67).

6.7.2.3. RT-Warm-Melt 800

New pumping equipment had to be developed for warm melt adhesive for achieving an extrusion rate at a minimum of 350 g/min. Depending on the material viscosity the new pump, RT-Warm-Melt 800 can extrude up to 800 g/min (Fig. 68(a) and (b)).

The adhesive is packaged in a composite foil bag within a pail of 280 mm diameter and 380 mm height. After insertion of the composite foil bag into express tube, a hydraulic cylinder drives the adhesive into the heating chamber and then to the feeding pump. Heated hoses lead the molten adhesive to the nozzle where a volume-dosing unit can be attached.

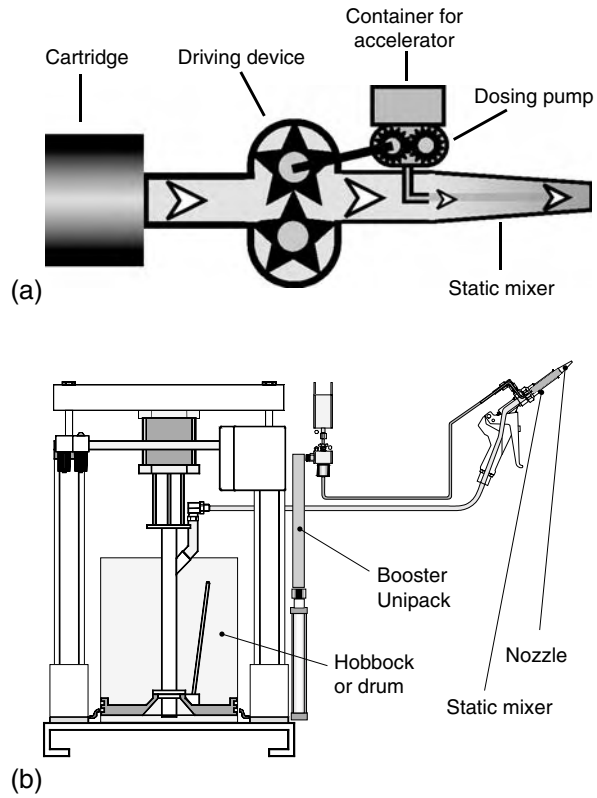

Figure 66: (a) Hand-operated application of a Booster-system (plus adaptor).
(b) Pump-operated application of a Booster-system.



Figure 67: Hand operated application of a 2C-system.

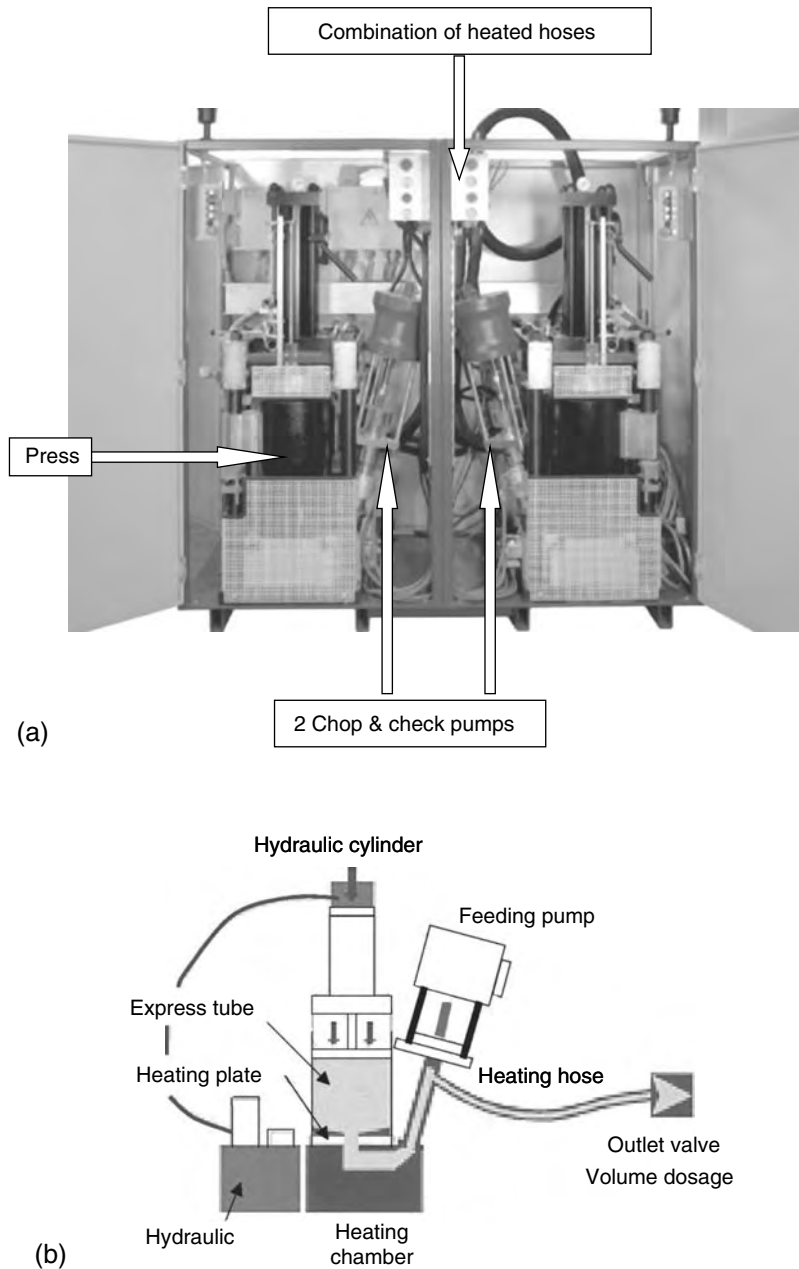

Figure 68: (a) RT-Warm-Melt 800 (*Reinhardt Technik (DE)*). (b) Active principle of RT-Warm-Melt 800. (Refer also to the colour section for figure 68a.)

The composite foil bag can easily be changed and since nearly 100% of the material is pressed out, only the collapsed bag must be thrown away. Filling the warm adhesive into 200 litre drums is not possible due to thermal degradation of the adhesive (poor heat transfer) and thus, long-term storage stability is not guaranteed in such cases.

6.7.3. Quality Assurance

Particular attention needs to be paid to establishing an effective system of quality assurance for adhesive connections. Non-destructive test methods based on ultrasound, X-rays or the measurement of electrical or thermal conductivity are available but only of limited value in practice. Specific data on adhesion cannot always be obtained by these methods. This section examines the issue of quality assurance from a practical point of view. Many years of experience have shown that only a quality assurance system that takes into account the specific features of adhesive bonding technology can produce consistently satisfactory results over an extended production period. The information outlined here should be viewed as a general checklist to be adapted to the specific requirements of each manufacturing environment.

An effective quality assurance system for elastic adhesives depends on continuous monitoring and checking of all quality-related parameters. If these are maintained within the prescribed limits, then the quality of the adhesive connection is guaranteed with little or no need to supplement these control measures with time-consuming and costly destructive testing. The overall cost of quality assurance can therefore be kept down to a commercially acceptable level.

Table 6: Factors affecting the quality of an elastic adhesive bond

Adhesive	Selected to suit the production cycle and the service stresses to which the finished assembly will be subjected
Substrate	Consistency of composition and surface condition
Surface preparation	Selected to suit the production cycle and the service stresses to which the finished assembly will be subjected
Application parameters	Working within the specified time limits (open time), taking account of temperature and relative humidity levels
Joint design	Adhesive-friendly joint design, dimensioning of joints to suit functional requirements of finished assembly
Staff training	External (e.g. IFAM Bremen) or internal courses organised in conjunction with adhesive suppliers

Table 7: Quality-related activities over the lifetime of a project

Project study	Construction of prototype	End of test phase	Series production
Design and construction adapted to adhesive technology and assembly methods	Checking and specifying correct method of substrate preparation in consultation with adhesive and paint suppliers	Evaluation of test phase, making any design changes that may be indicated	Implementation of quality assurance system
Dimensioning and configuration of adhesive joints based on existing codes of practice and design data	Construction of prototype based on design criteria for adhesive bonding. Adhesive supplier (applications engineer) to advise where necessary	Preparation of a production and quality assurance manual for adhesive bonding applications (taking account of the key application parameters temperature and relative humidity)	Periodic refresher courses and further training for personnel (corporate training programme)
Appointment of an in-house adhesives specialist to liaise between departments on all aspects of adhesive usage	Specifying type and scope of repair works	Training of assembly personnel in use of adhesives	Introduction of activities aimed at raising quality standards (e.g. quality awareness groups)

As Table 6 shows, the task of assuring the quality of the bonded assembly begins at the project stage and does not end until production ceases. A typical quality management program for adhesive applications is set out in Table 7. This model has been adopted with very satisfactory results in many areas of the manufacturing industry.

In commercial enterprises that use adhesives in series production, a sound working knowledge of adhesive technology is often confined to a few individuals in technical departments. The policy of training one technician as an in-house adhesives specialist has proven to be an efficient solution. This person is also able

Table 8: Checklist for monitoring adhesive applications

Area of responsibility	Checks and controls	Person responsible
Ensuring consistent quality of substrate	Specification (name, brand, grade, supplier, chemical composition, etc.)	Design and Engineering
	Contractual agreements specifying quality and condition of substrate (duty to inform in event of changes)	Purchasing
	Checks on incoming deliveries (name, brand, grade, product characteristics)	QA
	Correct storage (temperature, humidity, prevention of soiling, first-in first-out stock rotation)	QA/Logistics
Preparation of substrate	Specification (mechanical surface preparation, chemical products, type of application, processing schedule)	Design and Engineering/ Adhesives technician/ Adhesive supplier
	Checks on incoming deliveries (name, brand, grade, visual inspection of packs, product characteristics)	QA
	Correct storage (temperature, humidity, prevention of soiling, use of stock by expiry date)	QA/Logistics
	Subjective checks for visible defects in primers, etc. (cloudiness, sedimenting, thickening, etc.), plus checks on expiry date	QA/Foreman
Application of adhesive	Periodic checks on correct application procedures (method of application, observance of recommended drying times, correct handling of primed components prior to assembly, etc.)	QA/Adhesives technician
	Checks on incoming deliveries (name, brand, grade, product characteristics, visual inspection of packs, periodic adhesion tests)	QA

(Continued)

Table 8: Checklist for monitoring adhesive applications (*Continued*)

Area of responsibility	Checks and controls	Person responsible
Application of adhesive (continued)	<p>Correct storage (temperature, humidity, conditioning of stock to room temperature, use of stock by expiry date)</p> <p>Subjective checks for visible defects in adhesives (changes in consistency, flow behaviour, etc.), plus checks on expiry date</p> <p>Periodic checks on correct application procedures (method of application, observance of specified open times, correct joint assembly sequence, waiting times prior to further processing, etc.)</p>	<p>QA/Logistics</p> <p>QA/Adhesives technician</p>

to coordinate all aspects of adhesive usage for the project as a whole and act as a neutral advisor to the individual departments concerned.

Table 8 is intended as a guide to the preparation of a quality assurance concept. The scope and frequency of the test regime will need to be adjusted to the scale of the project and the available technical and manpower resources.

Some people, no matter how skilled they are in technical matters, are somehow skeptical about the concept of adhesive bonding. Those who work in the traditional mechanical fastening trades are especially difficult to convince. They are naturally reluctant to accept that traditional methods can be replaced by such a basic and simple joining method. Once it has been introduced however, adhesive bonding is usually quickly accepted and initial skepticism gives way to confidence that can become complacency. In the absence of a proper quality assurance system, correct application procedures may be neglected with the possible risk of joint failure at a later date. In fact, the professional use of adhesives should not be regarded any differently than the exercise of other traditional industrial skills such as welding or the application of paint coatings. The only real difference lies in the less sophisticated skills and training generally provided to operators. The successful use of adhesives presupposes a level of technical knowledge that designers, engineers and assembly personnel do not automatically possess. Hopefully, this deficit can be overcome by persuading technical colleges and vocational training institutes to integrate these themes into their educational courses. In the meantime, the manufacturing industry

must continue to fill the gap as best as it can with specialised courses and internal training schemes organised in conjunction with adhesive suppliers.

6.7.4. Physiological Aspects

6.7.4.1. Safety at Work and Environmental Safeguards

Adhesives and the products used to prepare the surface for adhesive bonding are all chemical products and as such they may contain substances that are potentially harmful to human health and to the environment. The potential risks of adhesive use, as compared to conventional mechanical joining methods, are frequently exaggerated, while the fact that other joining techniques are also subject to health and safety legislation is generally overlooked. Welders, for example, are required by law to protect themselves against the physical absorption of harmful chemical substances, such as the gases, dusts and UV-radiation given off during the welding process.

High noise levels and chemical emissions that are potentially harmful to health and the environment are undesirable. Adhesive bonding is virtually a noise-free joining method.

Some adhesives and the surface pretreatment products associated with them can release volatile and potentially harmful chemical substances. As the renowned physician and naturalist Paracelsus postulated back in the Middle Ages, the definition of a toxic substance is essentially a matter of dosage. If the dose is small enough, it poses very little risk to human health. This principle is central to government health and safety legislation aimed at safeguarding people against the inhalation of and exposure to harmful substances. The so-called occupational exposure limit is the threshold limit that defines the maximum concentration of an airborne substance to which a worker may be continuously exposed for eight hours a day, five days a week without experiencing any adverse impact on his or her health. These threshold limits are based on a combination of toxicological studies and practical experience and are subject to constant review as more scientific data become available.

It is most important to develop good working practices for adhesive bonding applications so that physical contact with these substances is avoided as far as possible. A clean working environment and careful, methodical workmanship that are required for successful adhesive bonding go a long way towards meeting this objective.

It is a must to follow the instructions outlined in
the Material Safety Data Sheet (MSDS)!

6.7.5. Regulations

The regulations relating to the use of adhesives are many and varied with considerable differences from one country to the next. It is beyond the scope of this section to provide a detailed catalogue of these rules and regulations. The discussion will therefore be confined to selected practical aspects that can be readily incorporated into a responsible safety concept. The existing legislation relates generally to the following areas:

- storage and transport
- adhesive application
- use of the finished assembly
- waste disposal.

Users with little experience in handling chemicals generally face a whole series of new challenges and for this reason they are often reluctant to use adhesives. In order to address the concerns of these users, governments therefore require adhesive manufacturers to compile a material safety data sheet incorporating all the relevant statutory information required.

The **material safety data sheets** issued for different countries do not follow a uniform pattern but they do conform broadly to the European standard material safety data sheet as defined in EC Directive 91/155/EEC. This document contains sixteen sections.

However, all the data contained in the published safety data sheets are based on a worst-case scenario. In practice, provided the products are handled with proper care and attention, the potential risks are generally less serious than they are assumed to be for the purposes of these publications – and they are certainly manageable.

For more information on the issues of ‘Physiological aspects’ and ‘Regulations’, please refer to the chapters:

- Safety and Technical Characteristics (Volume 1)
- Safe Use of Adhesives and Sealants – Regulations

6.8. Elastic Bonding in Practice

In this section, different applications of Elastic Bonding Technology are described.

6.8.1. Crash-Resistant Direct Glazing Adhesives

One-component polyurethane adhesives for direct glazing are widely used in the automotive industry. Since about 5% of car’s windshields every year are damaged,

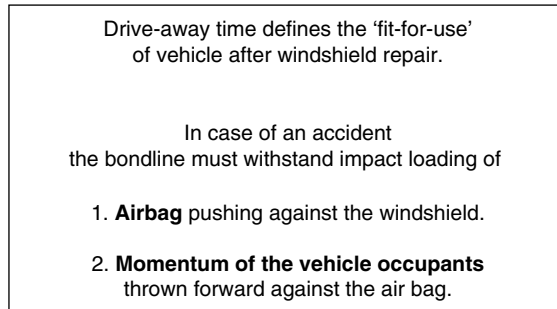

Figure 69: Definition of Safe-Drive-Away Time.

efficient and reliable replacement methods are of increasing importance. To achieve short safe-drive-away time after replacement of windshields, the adhesive must meet extremely strict requirements.

The definition of *Safe-Drive-Away Time* (SDAT) is the time required for curing of the windshield adhesive to achieve full passenger retention in the case of a defined crash (Fig. 69).

With short safe-drive-away times, costs are reduced and customers can put the car in service faster. To achieve windshield retention in the event of a frontal barrier impact, partly cured adhesives must have high initial tensile strength and fracture energy. Additionally, they must also fulfill the original equipment specifications such as good corrosion resistance, antenna suitability and mechanical performance.

Before conducting the expensive sledge test and full crash test with a car, extensive laboratory experiments are generally carried out at high speeds on various lab test machines, including small falling weight towers, impact pendulum and high-speed tensile testers.

6.8.1.1. Heading for Best Performance

Direct glazing adhesives are multi-functional and can cope with several demanding specifications. They are based on a modular system, described in Fig. 70.

During application, the adhesive must be very extrudable, non-sagging for a 10 mm high (or more) triangular bead with cut-off string below 5 mm and quick strength build up. After complete curing, mechanical and adhesion properties must robustly resist ageing. Non-conductive properties and antenna suitability must also be achieved.

For achieving passive safety, other elements are important besides the choice of adhesives. It is important to mention that the windshield is also designed to have crash-suitable behaviour.

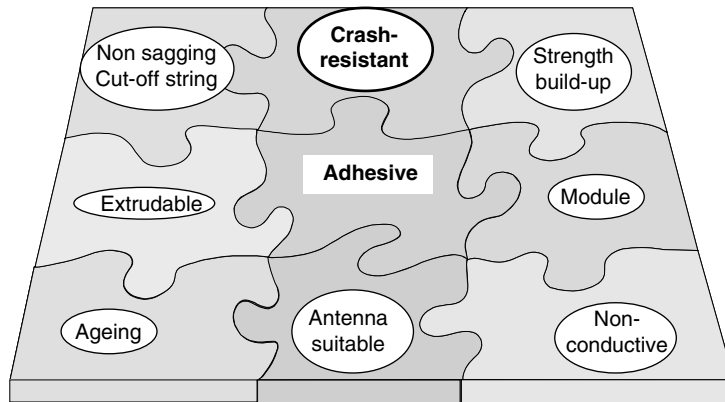

Figure 70: Modular system of a direct-glazing adhesive.

Passive safety elements are:

- windshield
- airbag
- crash zone (front and side)
- seat belt
- seat
- head rest.

This section focuses on crash-suitable performance and safe-drive-away times for adhesive systems. These issues are significant for the design of mechanical properties which ensures that the vehicle can be used as quickly as possible after repair.

6.8.1.2. Safe-Drive-Away Time and FMVSS

The main driver for Safe-Drive-Away Time is the speed in which adhesive strength builds up. The *Federal Motor Vehicle Safety Standards (FMVSS) 212/208* regulation specifies that when a vehicle traveling at 48 km per hour crashes, 75% or more of the bond-line must be retained and no more than 50% of the adhesion on one side lost, see Fig. 75.

Climate plays an important role for the curing speed since most adhesives react with moisture. Auto glass replacements are performed at temperatures between -10 and $+40^{\circ}\text{C}$ and in relative humidity between 10 and 100%. For safe drive-away, all these different conditions must be considered. Fig. 71 shows schematically the curing mechanism of a 1C-PUR with moisture.

Moisture-curing of 1C-PUR adhesives is effected by climatic conditions. As an example, Fig. 72 shows the influence of humidity and temperature on the moisture-curing of SikaTack[®]-Drive. In a standard climate ($23^{\circ}\text{C}/50\%$ r.h.), the SDAT is 4 h.

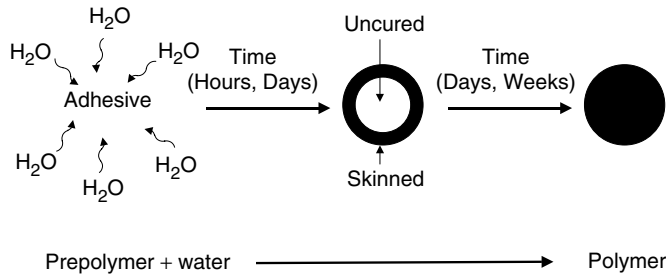

Figure 71: Moisture-curing of 1C-PUR adhesive.

Adhesive curing starts from the outside and moves inwards. As the cured skin becomes thicker, the retention strength increases until it meets the requirements mandated by the FMVSS regulations. Due to the highly viscous nature of the adhesives, a thin cured skin is often sufficient to fulfill the needs. The principal characteristics of crash-suitable adhesives are strength and energy absorption (Fig. 73).

After 1 h moisture-curing at low temperatures, energy absorption is high due to the increase in viscosity. At high temperatures, it is also high due to the enhanced

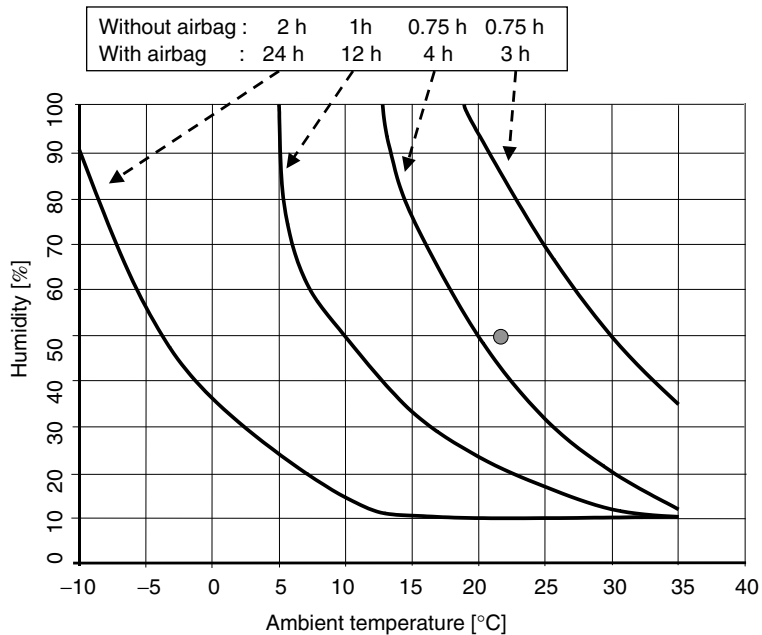

Figure 72: SDAT in function of temperature and humidity.

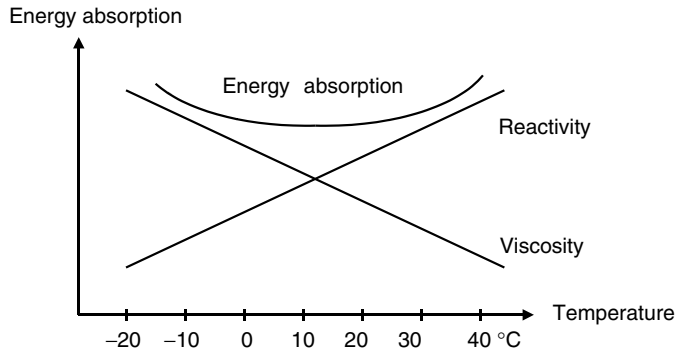

Figure 73: Energy absorption dependent on reactivity and viscosity at a defined temperature.

reactivity of the moisture-curing. Expressed differently, at low temperatures the viscosity inside the adhesive is of utmost importance. At high temperatures, the thickness of cured skin is dominant for energy absorption. Fig. 71 illustrates that partial curing results in a skin and complete curing results in an elastomer.

Crash resistance should ideally be dependent only on adhesive consistency and independent of reactivity. In an optimum situation, crash suitability would not depend on climate.

6.8.1.3. State of the Art of Crash Resistance

Crash suitable direct glazing adhesives were formulated in several ways. The applications are:

1. cold-applied 1C-PUR (SikaTack Drive (cold) and SikaTack High Modul (cold) in Fig. 74)
2. pre-cured 1C-PUR \Rightarrow pre-gellated adhesive (SikaTack Ultrafast (warm) and SikaTack Ultrafast II (warm) in Fig. 74)
3. 2C-PUR, the Booster system (SikaTack Plus Booster in Fig. 74)
4. Warm-applied 1C-PUR \Rightarrow highly reactive adhesive (SikaTack Move (warm) in Fig. 74)

Fig. 74 describes features and benefits of some common direct glazing adhesives.

All the adhesives noted in Fig. 74 have excellent performance with SDAT times between 1 and 4 h.

Crash suitability is explained in Fig. 75. Handling strength must result in crash-suitable behaviour. SDAT is the time required to achieve this crash suitability. The crash tests were performed with a double-sided air bag and unbelted dummies (Hybrid III) at 23°C and 50% r.h.

Features & benefits	①		②		③	④
	Sika Tack Drive (cold)	Sika Tack High Module (cold)	Sika Tack Ultrafast (warm)	Sika Tack Ultrafast II (warm)	Sika Tack Plus Booster	Sika Tack Move* (warm)
Component (s)	1C	1C	1C	1C	2C	1C
Appl. temp.	RT	RT	80°C	80°C	80°C	80°C
Tack-free time**	15 min.	15-30 min.	10 min.	10 min.	15 min.	15 min.
Cure of 10 mm***	7 d	7 d	5 d	6 d	2 h	5 d
High initial strength	very good	very good	very good	very good	excellent	very good
SDAT****	4 h	3 h	4 h	3 h	1 h	1 h
Black primerless	√	√	√	√	√	√
Antenna suitable	√	√	√	√	√	√
Prevents contact corr.	√	√	√	√	√	√
Modulus [MPa]	≈ 1.2	≈ 2.5	≈ 1.2	≈ 1.5	≈ 1.2	≈ 2.3

- * = Compared to SikaTack-Move lower modulus of SikaTack-Move ASAP: ≈ 1.5 MPa (ASAP means: All season, all places)
- ** = Skinning time
- *** = Cure of 10 mm width at 23°C and 50% r.h.
- **** = FMSS-212/208, with double-sided airbags

Figure 74: Variety of direct glazing adhesives.

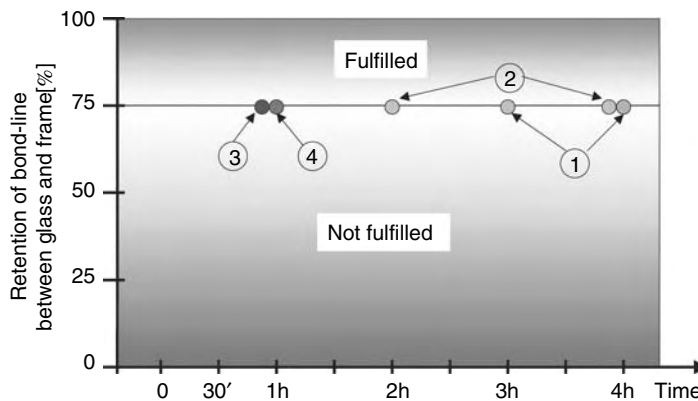

Figure 75: Safe-Drive-Away Times (passenger cars) at 23°C and 50% r.h. according to US-standard FMVSS 212/208.

6.8.1.4. Number 1: Cold-Applied Adhesives

SikaTack®-Drive (cold)

This direct glazing adhesive is applied at room temperature and is used when the customer does not require the vehicle immediately. After skinning time of 12 min, the strength is built up. The SDAT is 4 h for SikaTack®-Drive under these conditions. The adhesive cures fully within 7 days to an elastomer.

SikaTack®-High Modul (cold)

This adhesive is suitable for SDAT of 3 h, and after complete moisture-curing it becomes a high-modulus elastomer. Its shear modulus is 2.8 MPa at a deformation of 10%. The SDAT is 3 h for SikaTack®-High Modul. The complete process proceeds at room temperature.

6.8.1.5. Number 2: Precured Adhesives

SikaTack®-Ultrafast (warm): During the warm-up to 80°C, a pregellation of the adhesive occurs and it has an SDAT of 4 h.

SikaTack®-Ultrafast II (warm): During application at 80°C, the adhesive is very pasty and has strong quick-fix characteristics. It's SDAT is 2 h.

6.8.1.6. Number 3: Accelerated PUR Systems

SikaTack®-Plus Booster

This Booster Technology consists of two components: 1C-PUR system and a water containing hardener called Booster paste. It was launched in 1995. Here, the cartridge is warmed up to 80°C. After screwing the Booster adapter on the cartridge, the hardener is mixed by a short static mixer leading to a layer-type arrangement of the two components. Hardening happens through diffusion from the many interfaces of the layers, resulting in prolonged open time compared to conventional 2C-adhesives. This allows repositioning of the joint if needed. The SDAT is 1 h. Within 2 h, the boosted system cures to an elastomer and within 1 day the curing is complete.

6.8.1.7. Number 4: Warm-Applied Adhesives

SikaTack®-Move

Warm-applied adhesives do not require screwing a Booster adapter to the cartridge. This is an advantage relative to other adhesives. These are highly reactive adhesives and have quick-fix characteristics. After application, the warm melt's consistency increases due to cooling. Here, only 1 h is required to reach crash suitability. High application temperature combined with storage-stable catalyst results in a fast reaction between water and isocyanate groups.

6.8.1.8. Testing of Crash Resistance

In the laboratory, crash-performance is usually determined by the use of a high-speed tensile tester (Fig. 76). At a deformation speed of 1 m/s, the high-speed

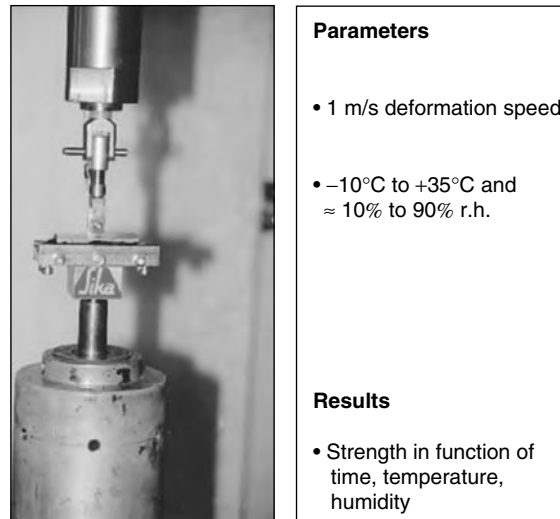

Figure 76: High-speed tensile tester

tensile stress must be equal or higher than the specified value to achieve good crash suitability.

After the direct glazing adhesive fits the targeted lab specifications related to SDAT, a vehicle crash test is performed. According to the FMVSS regulation, the vehicle speed is 48 km/h. During deceleration, passive safety elements, e.g. the crash zone, slow the vehicle down. The unbelted dummy occupants hit the airbag which presses the front windshield outward with maximum stress at a speed of about 1 m/s. The adhesive system must be strong enough to hold the windshield in position under these conditions.

The speed of 1 m/s was calculated using several iterative analysis methods. The Finite Element Method (FEM) and direct measurements on cars were performed. Therefore, the deformation speed of the high-speed tensile tester is set consistent with the speed calculated by FEM and/or the observed speed of occupants hitting the airbag. As mentioned above, the deformation speed of 1 m/s is calculated and thus may vary depending on the car type. In general practice, 1 m/s is a well established benchmark.

6.8.2. Bonding of Truck Cabins

A typical application of Elastic Bonding Technology, i.e. a truck cabin built from fibreglass and steel is described here. The cabin is supplied as a prefabricated module which is installed later on top of the cab roof (Fig. 77).

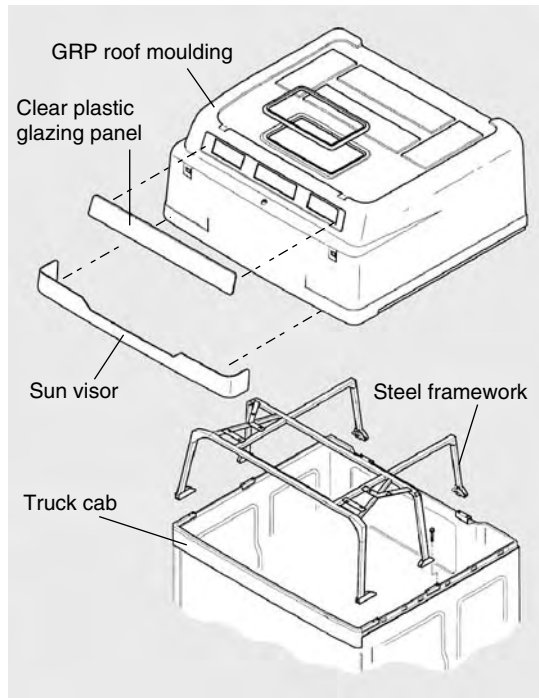

Figure 77: Cabin roof assembly for a truck cab.

When the production of the adhesively bonded cabin first started, a one-part product that cured on exposure to atmospheric moisture was used, but this was later switched to a faster curing adhesive system. Thanks to the use of Booster technology (one-part adhesive with cure accelerator) such as Sikaflex®-254 Booster, the cycle time was cut from 8 h to 2 h. In other words, output was increased by a factor of four.

The first step is to prepare the inside of the GRP roof assembly to achieve optimum adhesion to the GRP. Abrading the surface of the fibreglass molding creates a good mechanical interlock for the adhesive. The substrate is then cleaned off with a suitable cleaning agent and primed. Meanwhile, the steel substrate is also treated with a suitable metal primer. Then the adhesive is applied to the steel framework in the form of a triangular bead. To meet the demands of series production, a pump-operated applicator system is used (Fig. 78).

In this case, a non-sag elastic bonding adhesive of medium strength (tensile lap-shear strength: 2.5 MPa) was specified. This type of adhesive is particularly suitable for this kind of application where the bond face is large in area and an adhesive with good deformation characteristics is needed to accommodate differential thermal movement between the bonded substrates. Because of the high dimensional



Figure 78: Application of adhesive (see colour plate section).

tolerances associated with GRP moldings, a tall adhesive bead is required to bridge any gaps. This calls for an adhesive with good non-sag properties even when applied to vertical surfaces. While exhibiting the necessary stiffness, the adhesive specified for this application is also mechanically compliant so there is no visible deformation of the outer skin where it is bonded to the steel framework.

The steel frame with the adhesive applied is placed in a special assembly jig. The GRP shell is then lowered into position by an overhead crane and the adhesive layer is compressed to a thickness of 4–8 mm (Fig. 79).

Clamps are then applied to secure the whole roof assembly until the adhesive has fully cured. Meanwhile, the clear plastic glazing panel and a plastic sun visor are bonded to the GRP shell. The black adhesive used for all bonding applications is also used to seal the exposed joint between window lights and roof, thus producing a completely flush exterior surface.



Figure 79: Lowering the GRP roof shell onto the steel frame.



Figure 80: The fully assembled cub unit.

After 2 h, the cabin assembly is removed from the jig by an overhead crane fitted with suction clamps and lowered into position on the truck cab. The steel frame is bolted down and the GRP shell is bonded to the cab bodywork with the same elastic adhesive. This also serves to seal and weatherproof the joint between the cab and cabin (Fig. 80).

6.8.3. Sika's PUR-Hybrid Products

In the following section, representative PUR-Hybrid products are described for the construction and industry market segments:

6.8.3.1. PUR-Hybrid Systems for Construction

For indoor or outdoor joints subject to high movement, sealing can be done with the universal construction sealant Sikaflex®-20 AT. Such joints fulfill the rigorous DIN 18540 (ISO 11600, F25LM) standard (Fig. 81).

SikaBond®-66 AT is a universal assembly adhesive for construction as it is a phthalate-free PUR-Hybrid adhesive with good bonding and compatibility to polystyrene insulation. An application is described in Section 6.8.8 entitled 'Bonding of Parquet/Timber Floors'. Its mechanical properties are summarised in Fig. 82, along with those of Sikaflex®-20.

6.8.3.2. PUR-Hybrid Systems for Industry

An overview of Sika's PUR-Hybrid and some 1C-PUR products used in general industry is found in Fig. 83.

Sika has developed two medium modulus sealants for industry:

- Sikaflex®-521 UV is designed for multi-purpose sealing applications
- Sikaflex®-529 is multifunctional and combines sealing and bonding. In the repair market, car body assemblies can be seam sealed. The adhesive can be sprayed or applied with a brush. It can be over-painted which provides for perfect appearance.

- | |
|--|
| <ul style="list-style-type: none"> • Low modulus ≤ 0.4 MPa at 23°C / 50% r.h. • Low modulus ≤ 0.6 MPa at -20°C • In addition, test samples (joints) must withstand
150% elongation at RT and
100% elongation at -20°C for 24 h
without signs of adhesive/cohesive failures. |
|--|

Figure 81: Requirements of DIN 18540/25LM standard.

Construction Properties	Sealant	Adhesive
	Sikaflex®-20AT	SikaBond® -66AT
Colour	White, grey	White
Tensile strength	1.25 MPa	2.6 MPa
Elongation at break	640%	460%
Elastic recovery	<92%	
Lap shear strength	1.0 MPa	2.0 MPa
Tear strength	8.0 N/mm	17 N/mm
Shore a hardness	20	44
Tack-free time	60 min	60 min

Figure 82: Characteristics of construction PUR-Hybrids.

For elastic bonding applications in industry, the white, black and grey coloured PUR-Hybrid Sikaflex®-552 is often the right adhesive.

For acceleration of curing properties, a small amount of water-containing hardener paste, called Booster paste, can be mixed to the main component. Homogeneous mixing of the booster paste is accomplished by means of a static mixer with more mixing elements compared to the PUR Booster described in Section 6.5.6.6. entitled ‘Booster Technology’.

Sikaflex®-554 Booster has an open time of 30 min, which is about same as Sikaflex®-552 without Booster. However, the build up of strength with Sikaflex®-554

Industrial products	PUR-Hybrid	PUR
Sealants	Sikaflex®-521UV	Sikaflex®-221
Sprayable sealants	Sikaflex®-529	Sikaflex®-233S
Adhesives	Sikaflex®-552 Sikaflex®-554 Booster	Sikaflex®-252 Sikaflex®-254 Booster
Windscreen bonding adhesives	Sikaflex®-555	Sikaflex®-255 FC SikaTack®-Drive

Figure 83: Overview of industrial Sika’s PUR-Hybrid and PUR systems.

Industry Properties	Sikaflex® -521UV	Sikaflex® -529	Sikaflex® -552	Sikaflex® -555
Colour	white	sandstone	white	black
Tensile Strength	1.8 MPa	1.4 MPa	3.0 MPa	6.0 MPa
Elongation at Break	370%	130%	380%	340%
Lap shear strength			2.0 MPa	4.5 MPa
Tear Strength	7.3 N/mm	2.5 N/mm	19 N/mm	22 N/mm
Shore A	37	37	48	53
Tack-freeTime	35 min	30 min	30 min	30 min

Figure 84: Characteristics of industrial PUR-Hybrids.

Booster is much faster than that of Sikaflex®-552 and the handling strength is achieved after 2 h instead of after 7 days.

The Sikaflex®-555 direct glazing adhesive possesses the highest mechanical properties of products currently in Sika PUR-Hybrid product range (Fig. 84). The lap shear, tensile and tear strengths are higher than those of comparable MS-products.

The curing speed of PUR-Hybrid Sikaflex®-555 is between those of MS-products and PUR-adhesives (Fig. 85), although the level of catalyst and diffusion speed through the polymer backbone have an effect on the curing speed.

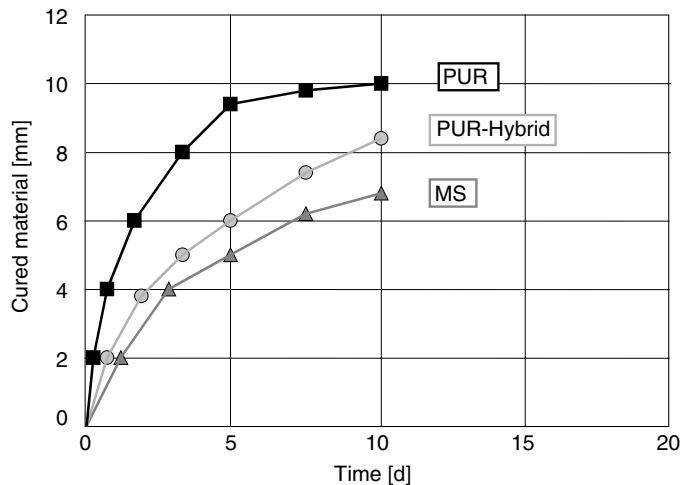

Figure 85: Comparison of curing speed.

6.8.4. Use of Elastic Adhesives and Sealants in Marine Industries

The ship building industry has undergone a dramatic change in joining technology. In the early days, deck caulking was carried out with woolen or cotton caulking yarn in combination with bituminous materials. Now, the use of elastomeric materials is common worldwide. Other elastic bonding systems have found application in joining, waterproofing, acoustic damping, insulation and for preventing galvanic corrosion. All these are properties relevant to the marine environment, particularly in the manufacture and repair of ships, boats and yachts. This article discusses several applications from deck caulking, direct glazing, flooring, bedding, levelling, cable ducts, sandwich panels and deck to hull bonding.

6.8.4.1. Elastic Bonding in Ship Construction

Adhesives are increasingly used today in modern assembly operations. Nowhere is this more evident than in boat and shipbuilding. Several important advantages are offered when using Sikaflex® Marine Systems.

The benefits are:

- bonding and sealing in **one** operation
- joining similar and dissimilar **materials**
- eliminating galvanic **metal corrosion**
- compensating **thermal expansion**
- reducing and eliminating **localised stresses**
- reducing **noise** and damping **vibration**

This bonding technology is reliable and suitable for a wide range of applications. The elastic properties after cure make such adhesives ideal for the construction of passenger ships, leisure boats, yachts, ferries, cruise ships and working boats including oil tankers, carriers, dredgers, fishing boats, oil-platforms or offshore rigs.

6.8.4.2. Totally Bonded Teak Decking System

In modern boats, timber decking is frequently constructed in the form of prefabricated wood panels which are laid over a structural deck of GRP, steel, aluminum, timber or a teak profile. Teak has been used as a decking material for hundreds of years because of its anti-rot properties. The goal is to construct a watertight teak deck, which can be enjoyed for many years to come. The structural decks require proper preparation (Fig. 86).

Fig. 87 describes the complete assembly of a teak deck.

In case of unevenness in the deck, the metal and wooden substrates have to be levelled to prevent water collecting under the teak deck which might lead to corrosion. This levelling process is carried out with SikaTransfloor®-352, a 2C-PUR flooring

<p>Heavily soiled metal surfaces should be cleaned off with a pure solvent (Sika® Remover-208) or sand-blasted and degreased with adhesion promoter containing Sika® Cleaner-205.</p>
<p>Further pretreatment is carried out with a primer:</p> <ul style="list-style-type: none"> • Glass fibre reinforced plastic (GRP) requires black-coloured Sika® Primer-206 G+P or Sika® Primer-215 • Metals (steel, galvanized, Alu) require Sika® Icosit® ZP Primer (anticorrosive primer) • Wood (timber or teak profile) requires Sika® Primer-290 DC (transparent)

Figure 86: Pretreatments with solvents, activators or primers.

system, which adheres well to primed steel. It serves to level the uneven deck surface and cures to a smooth, sound-absorbing flooring system (Fig. 88).

Bedding with Sikaflex®-298, an elastic, semi self-levelling adhesive, provides toughness between the SikaTransfloor®-352 and the teak-deck planks which are set within 45 min and prior to adhesive skin formation. Clamps, weights etc. are used to ensure that the planks are bonded without voids.

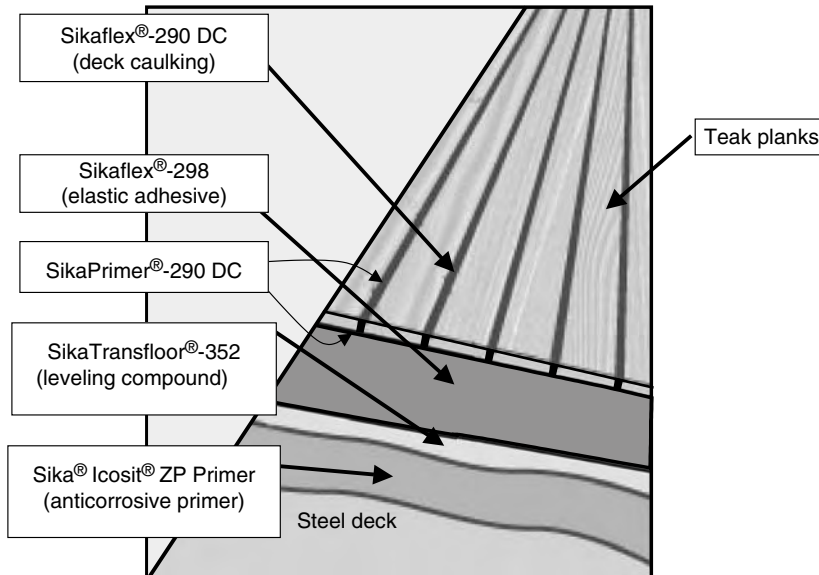

Figure 87: Products for teak decks.

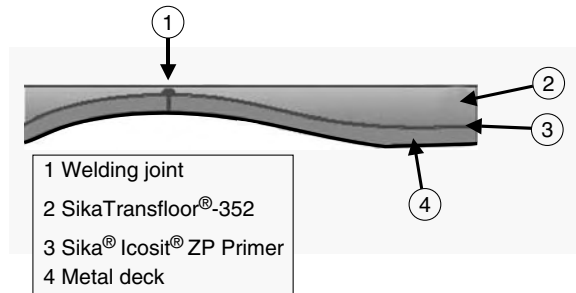

Figure 88: Layer thickness of Sika Transfloor®-352 on uneven deck surface.

A bond breaker tape is applied to the bottom of the seam and this serves to absorb the lateral movements of the teak planks. Adhesion to the bottom of the seam section should be avoided.

Finally, as soon as the bond breaker tape has been applied and the primer, SikaPrimer®-290 DC has dried, deck caulking with Sikaflex®-290 DC may begin. Sikaflex®-290 DC is a 1C-PUR sealant, which shows good resistance to UV-light exposure, heat and immersion in fresh or seawater. No cracks, chalking or loss of adhesion even under tension are generally observed. After 7 days curing, the deck is ready for belt sanding with a 80–120 grit paper followed by vacuum cleaning.

Glazing of plastic and mineral glass Most of the plastic glazing materials used in boat building are either clear acrylic sheet (PMMA) or polycarbonate (PC). Incorrectly installed plastic glazing panels are prone to stress cracking and have a higher coefficient of thermal expansion than conventional glass. Therefore, to accommodate thermal movement when designing glazing installations, an expansion gap of at least 10 mm all around the periphery must be designed between the window and the plastic glazing panel.

To minimise the risk of stress cracking, flat sheets of plastic glazing material should be installed completely flat, i.e., they should not be forced to take up curvature by the use of mechanical fastenings.

Pretreatment of PMMA and PC Glazing Panels:

- Clean with SikaCleaner®-205
- Prime with SikaPrimer®-209.

The frame can be GRP, anodised aluminum, timber, steel or aluminum coated with a two-part metal lacquer. These substrates need a pretreatment as well.

Sikaflex®-295UV (white and black) is used for bonding of plastics, whereas Sikaflex®-296 (black) is required for bonding of mineral glass.

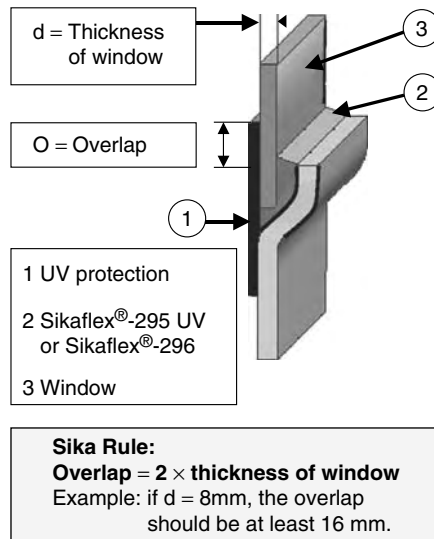

Figure 89: Recommendation for UV-protection of bondline.

The PUR adhesive bond-line must be protected against UV radiation. This can be achieved by:

- a ceramic-coated glass boarder or strip with a light transmission of $< 0.01\%$
- an external cover strip or an overlapping trim of appropriate dimensions
- covering the substrate peripherally with Sika® UV Shielding Tape.

The trim and the tape protect the bond-line as shown in Fig. 89.

6.8.4.3. Elastic Bonding/Sealing Applications

In the following, one will find other details of applications with Sikaflex®-292 elastic bonding adhesive. This IC-PUR system is thixotropic, therefore a triangular bead (8×10 mm) can easily be extruded.

• *Bonding of anti-slip plates for engine rooms*

In technical, storage or engine rooms, anti-slip plates are traditionally fixed by rivets or other mechanical fastenings. In areas which are subjected to intense vibration, these anti-slip plates often come loose resulting in costly repair work. With elastic bonding, a better distribution of the stresses is provided, thus avoiding the need for repair work while simultaneously achieving noise dampening (Fig. 90).

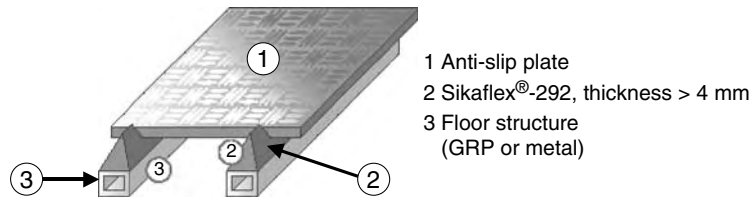

Figure 90: Bonding anti-slip plate.

- *Bonding of lightweight internal partitions*

These lightweight panels are generally composed of wooden sandwich facings and internal PUR foam or honeycomb cores. They are used as partition walls for cabins and technical rooms and provide the added advantages of weight reduction and noise absorption. Due to the low-density core used, lightweight panels cannot easily be mechanically fixed to hull structures, as done with traditional plywood panels. Thus, adhesively bonding these panels to the primary structure is advantageous (Fig. 91).

- *Deck-to-Hull Bonding*

In constructing GRP boats, one option is to design the deck and hull as one integral unit. Another option is to fabricate the hull shell separately from the deck and marry the two parts at a later stage in the assembly process. Both options have their advantages and disadvantages. By assembling and joining the deck and the hull shells with the right adhesive system, a strong, tough, elastic, long-lasting and leak proof bond can be realised.

Cable Duct and Buss Bar Fire Protection Systems

Safety is one of the major issues in a marine environment. This is why the pathways for power cables and other electrical connections need to be fire protected.

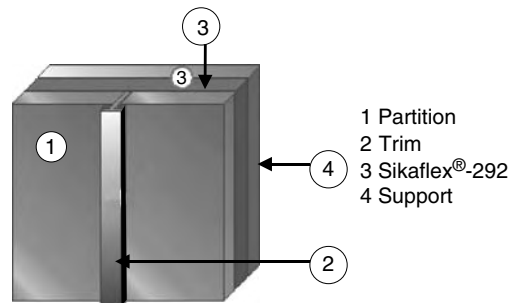

Figure 91: Bonding of internal partitions.

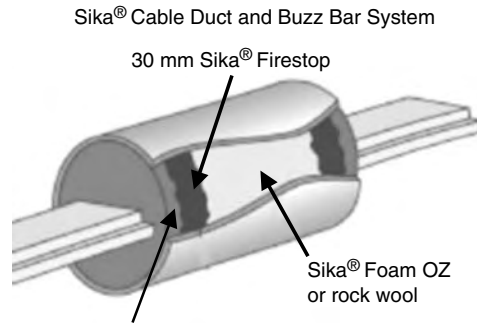

Figure 92: Cable Duct and Buzz Bar System.

To penetrate partitions, bulkheads, decks and ceilings, a steel cable duct tube is usually welded fully into the structure (Fig. 92), and is protected by the following three steps:

- (1) Insulating is achieved by
 - applying Sika-Foam® OZ Plus Marine into the penetration at a thickness of about 120 mm, depending on the length of the duct or
 - applying rock wool instead of Sika-Foam® OZ.
- (2) From both sides, fire and heat resistant Sika-Firestop® Marine is applied at a nominal thickness of 30 mm.

• Less welding, riveting, screws	⇒ reduced costs and noise
• Simplified assembly	⇒ time saving
• Thinner gauge panels	⇒ reduced material costs
• Lightweight construction	⇒ higher speeds
• Invisible fixing	⇒ architectural freedom, ⇒ smooth surfaces
• Futuristic design	⇒ improved appearance
• Noise absorption	⇒ quieter accomodation
• Less corrosion	⇒ lower maintenance costs
• Panoramic glazing	⇒ increased light and vision
• Sandwich construction	⇒ weight and cost saving
• Fire resistant systems	⇒ for fire compartment areas
• Approved	⇒ DNV, Lloyd's Register, GL, BV, USCG, ABS and RINA approvals

Figure 93: Benefits when using elastic bonding.

- (3) To cover the system and to supply elastic properties, fire retarding Sika-Firesil® Marine N is applied at a nominal thickness of 10 mm.

Modern marine construction requires modern fixing and attachment systems. Fig. 93 shows the benefits when elastic bonding and related technologies are being used. The benefits are cost and time savings combined with improved performance, comfort and safety.

Such bonding technologies are finding ever increasing application in ships, boats and off-shore construction worldwide.

6.8.5. Bonding of Insulation Glasses into PVC Sashes by Reactive Warm Melt

The direct glazing technology pioneered in the auto industry has found its way into the fenestration business. This bonding system enables improved bonding of insulation glass into PVC fenestration sashes (Fig. 94). With this direct glazing technology, one does not need to wedge the insulation glass into the frame and it

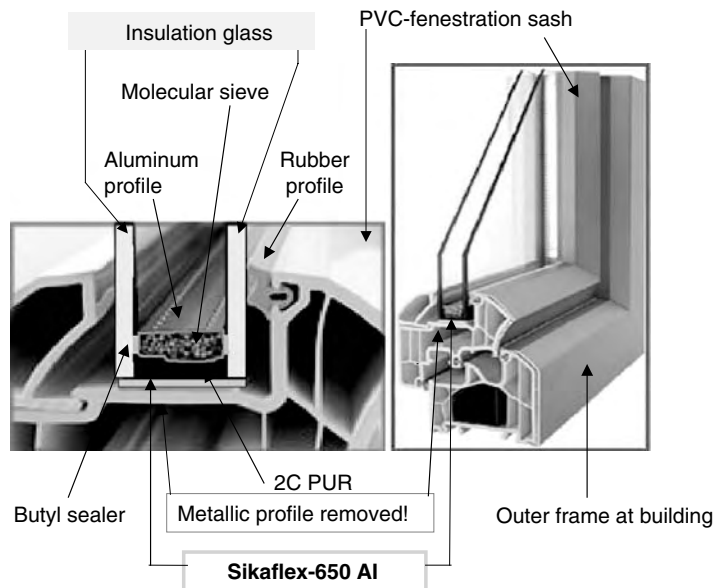

Figure 94: Edge bonding of double-glazed insulation glass into PVC-fenestration sashes. Courtesy of IFN Internorm Bauelemente GmbH Co KG (AUT),

improves the stability and the insulation of a bonded PVC window without the use of the metallic profile located in the PVC sash. No circulation of air around the edges of the PVC window occurs and the transfer of acoustic noise (sound) and heat is significantly reduced.

Another benefit comes from the fact that new designs are feasible without the use of the metallic stiffening profile. Since the window is bonded at its edge with Sikaflex[®]-650 AI, the glass of the window contributes to the load-bearing capacity and higher stiffness is achieved.

The joining of the window through bonding enables new window designs with reduced frame cross sections and higher overall stiffness, which prevents the window from unwanted bending.

In this application, the grey-coloured Sikaflex[®]-650 AI is either injected by a nozzle or sprayed at 80°C between the insulation glass and the PVC frame. After application, the polyurethane warm melt cools down and achieves sufficient handling strength after only 2.5 min, i.e., the insulating glass is stabilised in the frame. The entire bonding process can be fully automated and this enables the production process to be accelerated.

After 1 week, Sikaflex[®]-650 AI cures with moisture to a final strength of 2.5 MPa, shore A hardness of 60, 450% elongation with excellent adhesion to the substrates. For optimised adhesion on PVC, a pretreatment with SikaPrimer[®]-215 AI with a minimum open time of 10 min is applied. Further, Sikaflex[®]-650 AI must also adhere to 2C-PUR systems when present and they must also be pretreated with SikaPrimer[®]-215 AI.

The edge-bonded window has a better burglar resistance despite the fact that it can be easily cut out when repairs are needed, as in the case of automotive glass repair.

6.8.6. Instant-Fix Bonding of Headlamp Assemblies by Reactive Warm Melts

Headlamp assemblies (Figs. 95 and 96) made from different plastics can be bonded with a unique system consisting of plasma pre-treatment followed by application of a patented, warm melt adhesive using special adhesive pumping/delivery equipment. This section describes the advantages of this unique system over one or two-component conventional adhesives and butyl rubber containing hot melt sealants.

Headlamp assemblies basically consist of two parts: a transparent cover shield and body. The cover shield is generally made of polycarbonate (PC), which is scratch-protected by a hard coat e.g. by a UV-cured coating system. The body is generally polypropylene (PP) which is modified with fillers like talc. Headlamp



Figure 95: Automotive headlamp assembly, new BMW Limousine 5 series, produced at Hella KG Hueck & Co.

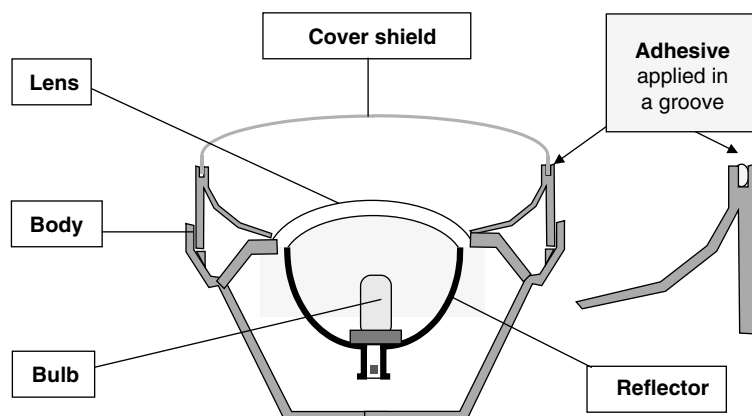

Figure 96: Build-up of a headlamp assembly.

producers also use polybutylene terephthalate (PBT) or PC for the production of the headlamp body.

6.8.6.1. Current status

Sealants or adhesives are traditionally used for producing headlamp assemblies. The most common techniques for bonding the two parts comprising the headlamp assembly are summarised below:

Reactive systems:

- 1C-adhesives based on silicone
- 2C-adhesives based on polyurethane (PU) or silicone
- Reactive hot-melts (RHM)

Non-reactive systems:

- Sealants, like butyl rubber hot melts

1C-silicone adhesives do not fulfill all customer wishes as these pasty adhesives do not keep the assembled headlights perfectly aligned and are tacky and easy to contaminate in the uncured state, which leads to additional expenses or delay in leakage quality control and the use of fixing aids such as clamps.

2C-adhesives need clamps to hold the two parts together because of their low initial viscosity. This also increases the risk of contamination.

In the case that the reaction is slow, curing can be accelerated by the use of heating equipment. A dwell time of 50 min is often required until the leakage test is feasible. The number of assemblies lost due to subsequently discovered leakage can be high and this adds cost and scrap. High scrap rates of headlamp assemblies can also occur when a mixing error occurs because multiple headlights are produced per minute. Furthermore, the pumping and dosing equipment is complex and a static mixer must be used. These static mixers must be flushed out, which results in material losses. Considerable maintenance is also needed.

On the positive side, an elastomeric consistency is built up through cross-linking and renders the part more resistant to the temperature generated from the headlamp and car engine or stress on the seal generated by additional mechanical forces on the headlamp.

Reactive hot melts are often brittle and can exhibit poor adhesion due to their fast, quick-fixing character, which sometimes leads to poor wetting, short open-times and limited non-sagging properties.

Non-reactive sealants are rubber-based hot melts and must be applied at a very high temperature (> 160°C). Since these hot melts do not cure, they remain thermoplastic. This means that additional mechanical fixtures, e.g. clamps, must be employed to prevent creeping at higher temperature. Their big advantage

is that leakage tests can be carried out instantly, which allows 100% quality control.

6.8.6.2. Market Requirements and Wishes

In-line production of headlamp assemblies is a very fast process. The principal targets for the bonding system are:

- no displacement of body and cover shield in any direction.
- touchable, no risk of contamination.
- in-line leakage quality tests. Headlamp assemblies are held in position by a stamp during test.
- no clamps or other mechanical fixtures should be required, which reduce production costs and limit design freedom.

From the adhesives and sealants listed above, *reactive warm melts (RWM)* provide the best match to the manufacturers' requirements for bonding headlamp assemblies. The unique headlamp bonding system consists of a plasma pretreatment of polypropylene and the use of reactive warm melt technology (Fig. 97).

A generic specification of the headlight producer for the headlight assemblies is outlined below:

1. bead peel test: (a) after 7 days, (b) at 90°C, (c) at -40°C, (d) after 14 days in 60°C water, (e) after 21 days at 60°C
2. leakage test (test-headlight, 30 mbar, after 2 min)
3. no loss of material after 6 h at 100°C
4. fogging (test-headlight): no optical influence
5. UV-resistance: >1500 h QUV-test
6. thermic cycle test (test-headlight, 10 cycles: -40°C ⇔ 90°C)
7. ageing test according to OEM-specification (test-headlight) ⇒ e.g. VW-P1210 for VW-Passat B5

6.8.6.3. Pretreatment

Some of the most important factors to consider when selecting a pretreatment method are its ease of use and ageing behaviour. One method often chosen is the PlasmaTreat® system for enhancing adhesion used in particular for polypropylene. The basics of the plasma-treatment are described in Fig. 50. In Section 6.5.4. the method 'Open Air Plasma Treatment' is further explained.

6.8.6.4. Reactive Warm Melt Technology (RWM)

A new RWM called Sikaflex®-630 was developed. The black coloured adhesive/sealant is applied at 95°C and achieves a tensile strength of 4.5 MPa and elongation

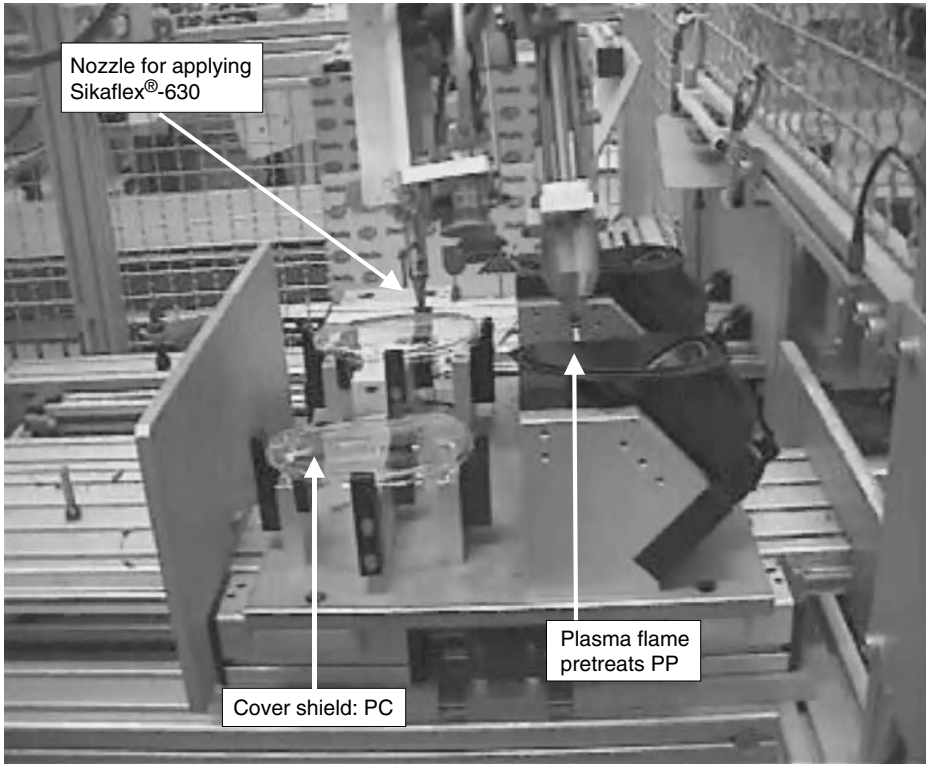

Figure 97: Production of headlamps. (Refer also to colour section.)

at break of >800% after complete moisture-curing. It cures using ambient moisture to become an elastomeric material and exhibits good adhesion to plasma treated PP and to untreated PC and hard-coated PC.

The benefits of this warm melt adhesive are:

- 1C – simple and tolerant, no mixing
- high handling strength allowing immediate joining of headlamp assemblies
- touchable and tack-free after a short time, in contrast to pasty 1C or 2C-adhesives
- possibility for immediate leakage tests at excess pressure due to the adhesive's rubber-like behaviour
- only short mechanical fixtures in one dimension are required due to the high green strength of the adhesives, similar to the butyl hot-melt system.

The instant-fix solidification of Sikaflex®-630 allows just-in-time production and packaging of the headlights, while further cross-linking of the adhesive continues during subsequent storage and transport.

More profits are generated by increasing productivity (parts per minute), considerably less cleaning (relative to 2C systems), lower maintenance times and reduced total cost due to lower equipment investment (e.g. no cabinet heater) and reduced scrap.

Pumping and delivery equipment has been designed for the application of reactive warm melt, which is described in Fig. 68 (RT-Warm-Melt 800).

New system for bonding headlamp assemblies (Fig. 97). The new system for bonding headlamp assemblies is simple to install in manufacturing facilities and includes:

- reactive warm melts
- plasma pretreatment
- pumping and delivery equipment.

6.8.7. Fast-Curing 2C Polyurethane Adhesives

Efficient, modern manufacturing processes are characterised by fast production cycles. SikaForce[®]-7550 is ideal for elastic and ultra-fast bonding operations on many different materials that are subjected to high mechanical stress. It uniquely combines rapid strength build up, elasticity up to 300%, shear strength up to 6 MPa, Shore A hardness up to 70 and adhesion properties that make it extremely versatile. One of the system's key features is its excellent bonding on many different substrates without pre-treating, such as electro-coated steel with SikaActivator[®], glass or ceramic. With SikaPrimer[®]-204, aluminum or steel can be bonded. Even plastics that are difficult to join, such as PBT and PA, can be bonded without significant difficulty using SikaForce[®].

The excellent non-sag behaviour of SikaForce[®]-adhesives allows easy bridging of gaps and clean working spaces. At present, there are two SikaForce[®]-7550 adhesives, which provide pot lives of 5 or 15 min. When the mixture of the two components is warmed, the handling time is reduced. Fig. 98 shows the handling time of SikaForce[®]-7550 L05 (pot life 5 min) when lap shear strength of 0.5 MPa on electro-coated steel is achieved.

SikaForce[®] adhesives uniquely meet the high demands of the automotive and commercial vehicle, marine, electronic, construction and general industries with regard to ageing, chemical and heat resistance (Fig. 99).

6.8.8. Disassembly and Repairs

Repairs of elastic-bonded assemblies are easily carried out with the aid of modern tools designed to facilitate disassembly. A variety of such tools are now

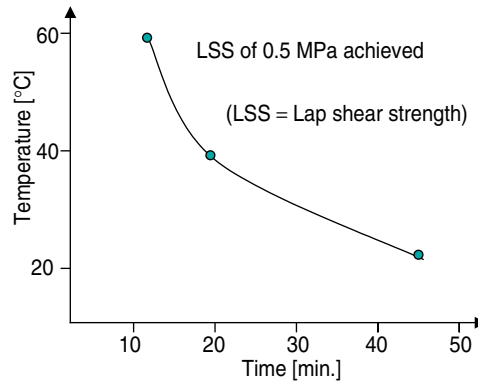

Figure 98: Handling time of SikaForce®-7550 L05.

available on the market. Windshields are removed either with a special cutting wire or with trimming knives powered by compressed air or electricity (Fig. 100). Depending on the type of vehicle, these knives are used with special offset blades designed to cut cleanly through the old adhesive without damaging the window frame.



Figure 99: SikaForce®-7550 for new modular production processes in bus construction.



Figure 100: Removing an adhesive-bonded windshield.

The sidewalls of buses or rail vehicles occasionally need to be replaced following an accident or acts of vandalism. To facilitate repairs, the sidewall assemblies are often made up of several sections, each of which can be removed separately. Since elastic adhesives are applied in layers several millimeters thick, an electric trimming knife can safely be used to break the joint without damaging the substrate.

After cutting away the damaged section, it is not necessary to remove all traces of the old adhesive. Treated with an activator, the old adhesive layer provides an excellent substrate for the new adhesive and a triangular bead of fresh adhesive is simply applied to the cut face of the original bead. Leaving the residues of the old adhesive layer in place also minimises any risk of damage to the paint finish. It is advisable to hold the new component in position before applying the adhesive, adjusting it for fit and then marking its precise position with strips of tape.

The surface of the new sidewall is then cleaned and primed in accordance with the adhesive manufacturer's instructions. Ideally, the sidewall should be positioned

over the adhesive and pressed into place with the aid of suction clamps, which can then be left in position to hold the assembly while the adhesive cures.

Assuming that the components have been painted prior to bonding, down time due to repairs is reduced to a few hours. Another time saving aspect of this type of repair is that it involves no application of heat to the components so that the removal and replacement of other heat-sensitive components, such as insulation materials or electric cables, becomes unnecessary.

6.8.9. Bonding of Parquet/Timber Floors

Parquet floors need no longer be nailed as before but can be bonded or laid to float. Parquet floors can thus be laid in a time-saving manner without the need for a sub-floor. When bonding parquet onto the substrate, elastic parquet adhesives are the most appropriate for all materials involved, and are capable of adapting to the extremely different properties of wood and cement screeds. They ensure a durable bond of the parquet even under high mechanical and climatic stress. The good bond of elastic one-part polyurethane adhesives to all common substrates, without the use of a primer, as well as the high tolerance regarding the adhesive layer thickness offer a high degree of flexibility. Elastic adhesives offer many advantages with regard to impact noise reduction and in-room noise dampening.

Wooden floors are subjected to dynamic and static loads that have to be absorbed by all the construction materials involved. Dynamic loads result from walking on the floor or from sound-induced vibrations. Significant static loads are generated by the variation of the moisture level of the wood due to climatic conditions.

The volume changes due to swelling and shrinking are accompanied by movement, which causes considerable shear stress in the adhesive layer and the substrate. The adhesive must follow the swelling of the wood reliably and in such a way that the wood not only remains undamaged but that a shear-resistant bond is formed between the parquet floor and the substrate.

At present, mainly hard and rigid adhesive systems are used. Knowledge gained from damage shows that in the case of rigid adhesive bonding, high stresses may develop – both in the wood and the substrate – due to movements that can be caused by swelling and shrinking. In the case of overstress resulting from adhesive systems of excessively high tensile strength, the surface of the cement screed is generally the weakest spot.

Fig. 101 compares adhesives as per DIN 281 with low-modulus elastic parquet floor adhesives for their tensile shear strength and elongation.

The strength of a cement screed is at maximum 1 to 1.5 MPa, which is far below the strength of adhesives per DIN 281, which stipulates a minimum tensile shear

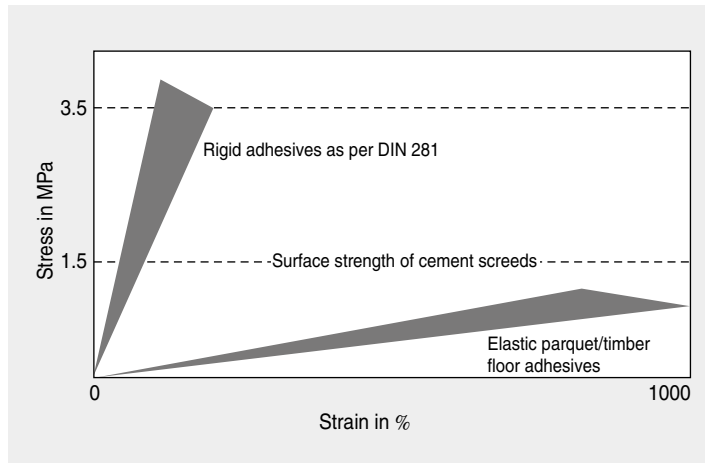

Figure 101: Position of parquet/timber floor adhesives in the stress–strain diagram.

strength of 3.5 MPa. In contrast, low-modulus elastic adhesives have a tensile shear strength of 0.7 to 1.2 MPa and an elongation at break of about 600 to 900% (DIN 53 504). Their strength is therefore significantly lower than that of the screed and the bonded parts are treated ‘gently’ right from the beginning, i.e. the surface of the screed is not destroyed.

An even distribution of stress in the bonded adhesive area is necessary to ensure a durable bond and to take full advantage of the material properties. Conventional rigid bonding, however, causes stress peaks at the edges of parquet boards. Elastic adhesives, on the other hand, transmit forces over the whole bonding surface.

These adhesives are therefore particularly suitable for large-surface bonding applications such as parquet floor laying. The high shear forces are absorbed and at the same time the substrate is not exposed to undue risk of damage. Theory shows that low-modulus elastic adhesives can ensure a shear-resistant bond of the parquet flooring to the substrate.

Tests to determine the ageing characteristics

Fig. 102 shows the results of tests, which confirm the theoretical findings.

Plain beech wood boards (21 mm thick) were bonded onto a 2 m long concrete slab by means of a DIN-approved rigid adhesive and an elastic adhesive. The objective of this test was to observe the swelling behaviour. To heighten the effect, a stop was fixed at one end, leaving room for the wood to expand in one direction only. After the curing time of the adhesives, the moisture content of the wood had increased from 9 to 22% within 10 days. The boards bonded with the DIN adhesive (Fig. 103 left) expanded by 25 mm, bowed considerably and showed evidence

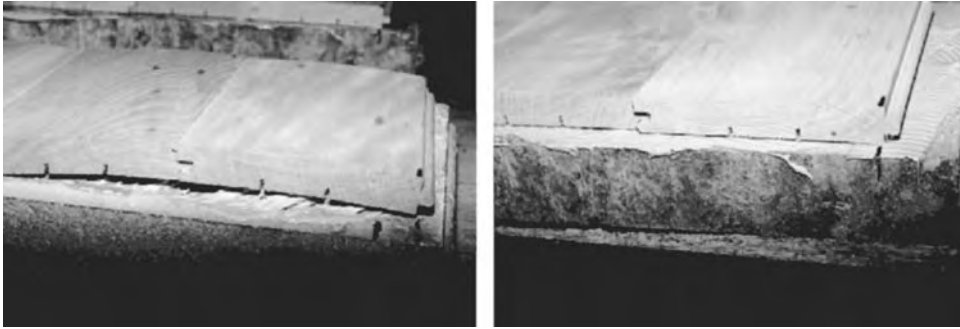

Figure 102: Test performed under extreme conditions to illustrate the performance of elastic adhesives for parquet/timber flooring; Left: adhesive as per DIN; Right: elastic adhesive.

of debonding. The elastic adhesive (Fig. 103 right), on the other hand, allowed only 1.5 mm expansion and remained completely undamaged and intact. The same variation of moisture in non-bonded, unrestrained boards would cause an expansion of approximately 80 mm.

The result of another test also shows the effect of even stress distribution. Solid 10 mm beech wood slats were bonded onto a concrete slab with a DIN-approved rigid adhesive and elastic adhesive. After the adhesives had cured, the concrete slab was exposed to cycles of moisture changes then stored for seven days at high air humidity (90% r.h.) alternating with seven days at low air humidity (30% r.h.). This corresponds to a variation of the moisture content of the wood from 16% to 4% each time. After six weeks, the elastically bonded sample showed no further changes. In contrast, the sample bonded with a solvent-based resinous adhesive showed debonding due to overstress. The reason for the intact elastic bond is an even distribution of the high forces generated by swelling. Fig. 103 shows that under equilibrium moisture conditions, a joint gap measuring a maximum of 1 mm occurs (maximum 4 mm for the sample bonded with synthetic resin adhesive).

Both tests simulate ageing behaviour under extreme conditions. This does not mean that parquet floors bonded with rigid adhesives will necessarily show this joint gap pattern. Both tests, however, highlight the improvements that can be achieved by the use of elastic adhesives for bonding parquet floorings.

Noise reduction

Today, there are, in principle, only two ways of laying parquet and laminate floors. The first method is *integral bonding* with rigid adhesives. The rigid bond to the substrate almost totally excludes resonant vibrations of the flooring. This is the best solution regarding room acoustics. Its poor impact noise damping, however, must be considered as a disadvantage. Due to the rigid connection of the

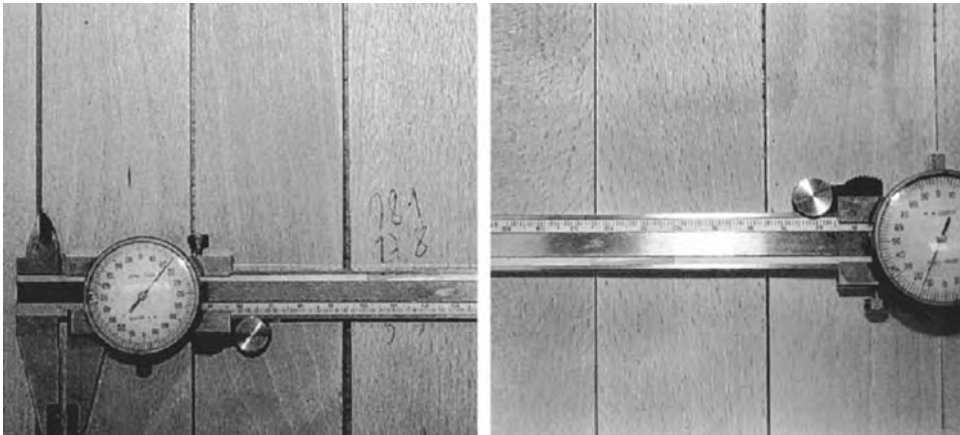

Figure 103: Influence of adhesive type on gap width in parquet/timber floors (extreme test conditions); Left: synthetic resin adhesive; Right: elastic adhesive.



Figure 104: Application of adhesive in noise-dampening floor bonding.

flooring layer to the substrate, impact noise is transmitted practically un-damped to the rooms below.

The second method is *floating laying* where the flooring is laid loosely onto a noise-deadening mat. Although this design ensures good impact noise damping, the flooring layer – due to its low weight and the fact that it is decoupled from the dampening mat – can easily be excited to resonant vibrations, which are perceived as noise radiation within the room.

Strip-wise bonding with elastic adhesives offers a new option (Fig. 104).

The elastic bond of the parquet flooring to the substrate acts as a damping element, absorbing impact noise and reducing free vibrations of the flooring layer. The damping mat also contributes towards preventing a ‘soundbox effect’. Therefore, optimal impact and air-borne noise damping is ensured. The advantages of floating floor laying and integral bonding are combined in this way.

6.8.10. Facade Cladding

Elastic sealants based on synthetic elastomers such as polysulphides, silicones or polyurethanes allow the periodically alternating movements of building structures caused by temperature fluctuations to be followed in a consistent manner. It has gone unnoticed by some that owing to the development of modern elastomeric sealants, a new field of application has emerged – the load-bearing adhesive joint.

The first step towards load-transmitting and movement-absorbing adhesive joints was taken around 1963 with the introduction of *structural glazing* in the USA. Decorative claddings are sometimes taken for granted, in particular for commercial and residential buildings and for new buildings and refurbishment work.

Cladding panels have so far been fixed mainly by screws or bolts (Fig. 105), both of which easily lead to rusty or dirty streaks. This method of panel fastening interferes with cleaning and therefore requires additional maintenance. This problem does not arise if cladding panels are fixed by means of elastic adhesive joints. Besides today’s glass facades, metal, natural stone and plastic facades are also mounted by adhesive bonding. The requirements for facade mounting are complex and elastic adhesives are ideal for mastering exactly this type of complexity, not just technically, but also economically and ecologically.

Materials and design

Facade panels made from HPL (High-Pressure Laminate), natural stone, stoneware or aluminium are used. The frame is generally made of aluminum but can also be made of planed wood. Use of such a variety of materials calls for an adhesive which is compatible with a wide spectrum of substrates and capable of absorbing, within certain limits, the different thermal and hygroscopic movements between panel and frame.

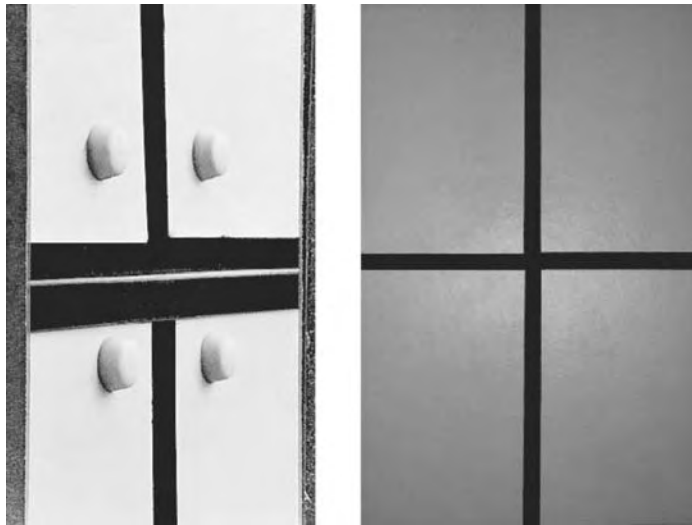

Figure 105: Comparison between adhesive bonded (right) and screwed (left) facade panels.

Thin panels are more economical and due to their low weight, allow costs to be saved with the frame overall. In the case of screwed or riveted fastening, forces are only absorbed by the face of the holes. Thin panels therefore need more fastening points. Elastic bonding spreads stress evenly (see Fig. 14) and acts in the same way as an infinite number of fastening points.

Acting forces

Different forces act upon a facade. The quasi-static forces generated by stress due to differential expansion increase the static load given by the panel weight. Relative expansion may not exceed a certain value in relation to the adhesive layer thickness (see Table 1). Depending on the height and situation of the building, dynamic forces due to wind pressure and suction are superimposed on these forces. All these forces must be absorbed by the adhesive at temperatures ranging from -30°C to $+80^{\circ}\text{C}$. Besides this, the adhesive is continuously subjected to alternating loads. These influences are accounted for in the calculation of the required bond areas and are also decisive for the maximum panel size.

Application and curing

Whereas for industrial use where bonding can be executed directly inside appropriate factories, the bonding of facade panels has to be done on site (Fig. 106), under varying climatic conditions and in difficult environments (often dust-laden ones).

One-part, moisture-curing polyurethane adhesives are often used. The curing process is therefore mainly dependent on adhesive layer thickness, temperature



Figure 106: Priming of the contact surface (left), gunning of triangular bead of adhesive (top right), positioning of the panel (bottom right).

and atmospheric humidity. The temperature during application and curing must be within the range of $+5^{\circ}\text{C}$ to $+35^{\circ}\text{C}$, otherwise the cross-linking of the adhesive will be too slow or too fast.

A double-coated, pressure-sensitive adhesive tape fixes the panel in place until the one-part polyurethane adhesive has fully cured. As a result of its foam core, the pressure-sensitive adhesive tape is 3 mm thick and ensures the uniform thickness of the adhesive layer. Because the bond of the adhesive tape is highly dependent on temperature, it is advisable not to do the bonding work at high or low temperatures.

The manufacturer's instructions for use are based upon these properties. Personnel especially trained for this purpose are generally required for this kind of work.

Approvals

Some facade panels available in the market are approved by DIBT (German institute for construction technology) for buildings up to 21 m construction

height. These approvals clearly define the permissible materials and specify that only specialists certified on the basis of a special training programme may execute the bonding work. Calculation rules for structural designs are also included. Extensive test programmes and the continuous external manufacturing control of the adhesives and facade panels are prerequisites for this type of approval. This is necessary to set the high quality requirements that adhesive manufacturers, designers and applicators have to meet in order to build a facade with a long service life.

6.8.11. Water-Swelling Sealants

Among the wide range of Sika's construction sealants, the water-swelling sealant, SikaSwell[®], shows some construction features and is described here.

In the construction area, optimal sealing is often required between hardened and fresh concrete, between two pre-cast concrete elements, etc. The special formulated moisture-reactive sealant offers a watertight construction joint in such applications. In contact with water, the sealant swells within 7 days to more than 100% of its original volume and creates a counter pressure between the surfaces that stops water flow (Fig. 107).

In Fig. 108 further examples for sealing with SikaSwell[®] S-2 are illustrated.

When SikaSwell[®] S-2 is in a confined space, its expansion results in the filling of the gaps and cracks around the construction joint (Fig. 109).

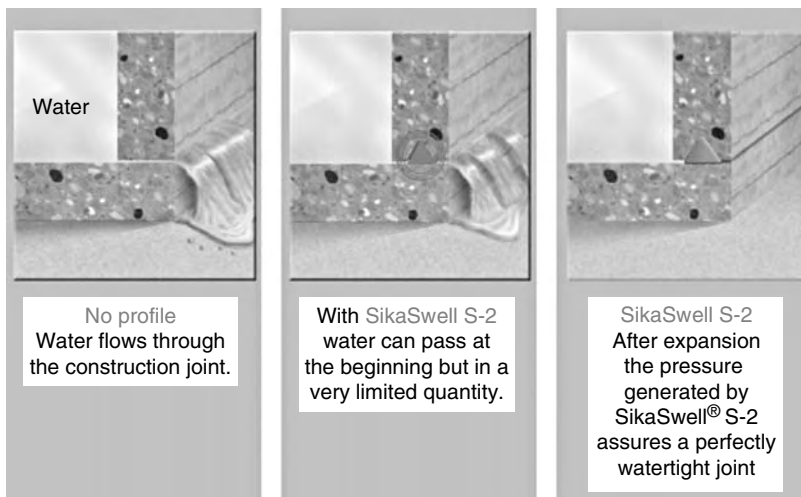

Figure 107: Example sealing of two pre-cast concretes.

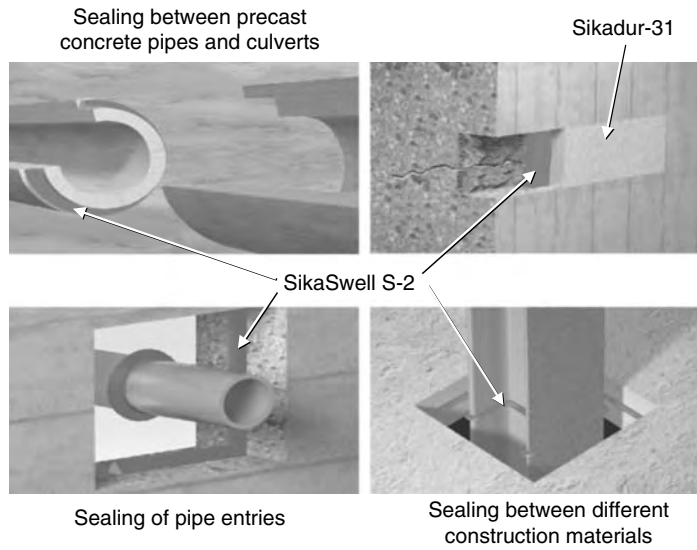

Figure 108: Further examples for sealing with SikaSwell® S-2 are illustrated.

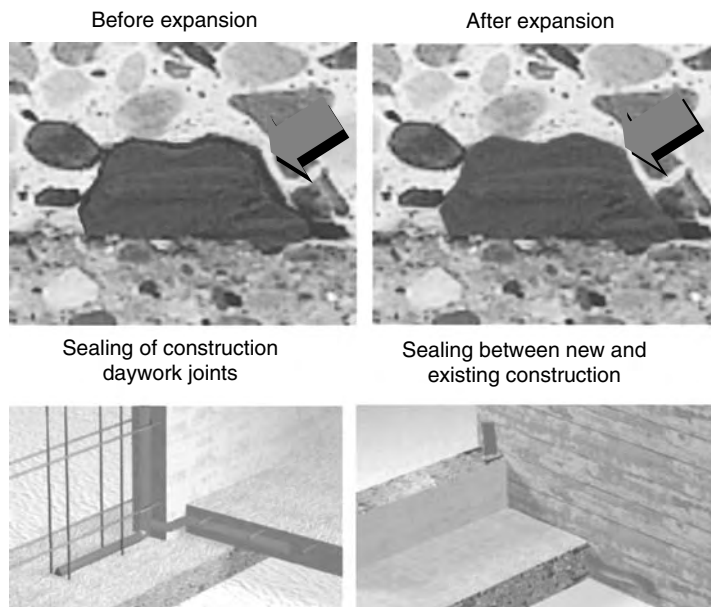

Figure 109: Filling a confined space.

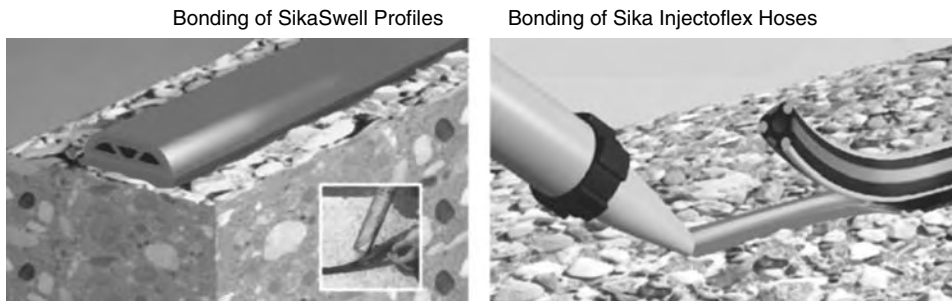

Figure 110: Bonding of profiles to concrete with SikaSwell®.

Another way to achieve this is through the placement of profiles which are bonded with SikaSwell® S-2. The SikaSwell®-Profile expands when in contact with water. When the water pressure is higher than 2 bar, the Sika Injectoflex System alone or in conjunction with other waterproofing measures are recommended (Fig. 110).

For the use of SikaSwell® S-2, a triangular bead of a width of 10 mm is applied onto the concrete. After 2 days of curing and swelling of the SikaSwell® sealant, concrete thicker than 50 cm can be applied. During concreting, care must be taken that SikaSwell® S-2 is completely covered with a dense concrete without any retained voids. This is best achieved by placing a mortar or fine concrete cover.

Fig. 111 shows the change in volume (%) after contacting sealant with water. The swelling is slow enough to avoid formation of cracks in fresh concrete.

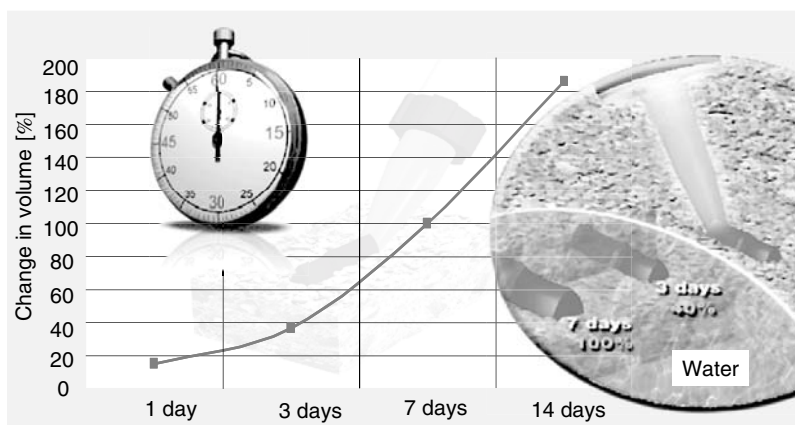

Figure 111: Swelling property of SikaSwell® S-2.

6.8.12. Bonding of Staircases

Elastic adhesives are absolutely ideal for the efficient and economical fixing of steps made of wood, natural stone, metal and concrete, indoors and outdoors. The individual steps can be bonded durably onto steel or concrete substructures or onto old stairs (Fig. 112). Elastic Bonding reduces the impact noise, i.e., less structural noise is transmitted due to acoustic decoupling. The elastic adhesive is moreover able to equalise length changes due to thermal influences. The costly drilling of holes in stone steps and steel structures is not necessary, and building tolerances from 1 to 10 mm can be offset.

A double-coated, 3 mm thick pressure-sensitive adhesive tape which serves as a mounting aid and spacer to ensure the correct adhesive layer thickness is installed before application of the adhesive. The adhesive bead is extruded parallel to the tape at a distance of about 10 mm onto the top surface of the substructure and the steps are then positioned on the adhesive beads (Fig. 113).



Figure 112: Elastically bonded stairs.

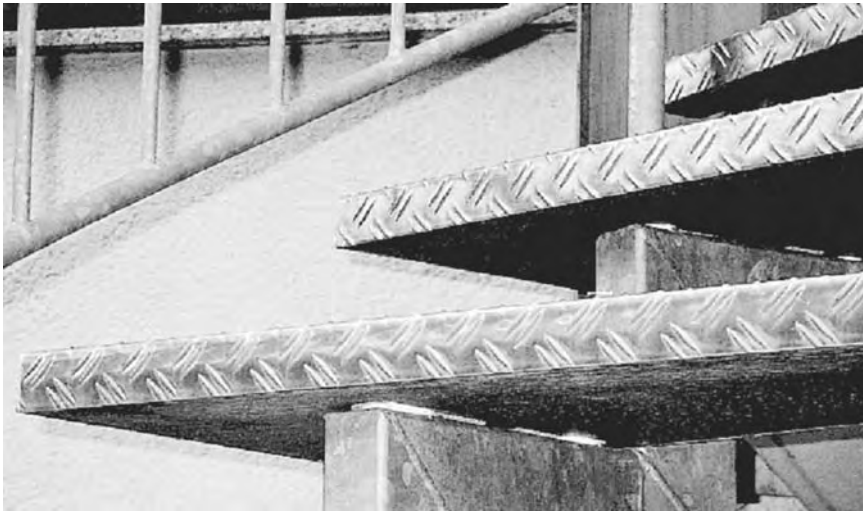

Figure 113: Wooden steps covered with (bonded) aluminum chequerplates fastened by elastic adhesive onto the galvanized steel frame.

6.8.13. Rail Fastening

In railway track laying, the rails are generally fastened onto sleepers that are embedded in ballast. The majority of tracks are laid in this manner. For a number of different reasons, it is necessary to design ballast-free trackbeds – also called slab track systems. Bridges have to be designed according to the weight of the ballast and in tunnels, excavation has to be minimised for economical reasons.

The ballast trackbed, besides providing support and lateral resistance to the sleepers, must also dampen the oscillations caused by train traffic to protect rolling stock and the rails themselves from damage and excessive wear. Specially developed elastic adhesives are able, due to their particular dampening characteristics, to assume that function of the ballast trackbed. The use of adhesives also reduces the thickness of the subrail construction to about 30 mm underpouring height and on bridges, the dead load of the ballast can be saved.

The elastic rail fastening not only dampens noise but also attenuates knocks and vibrations which act on adjacent structures and buildings, thus increasing their service life and reducing maintenance costs. A further positive aspect is that the usual track fastening hardware such as chairs, bolts, hook bolts, clips, spring elements, pads, etc. can be used as before.

There are, in principle, two different ways of rail fastening by elastic adhesives: spot-wise bonding on single supports and continuous bonding. Both methods require

the bonding work to be executed on site. The rails are aligned and afterwards bonded with a 30-mm-thick layer of adhesive.

Adhesive bonding, unlike slab track systems with prefabricated rubber mats, allows high tolerances in the trackbed because the adhesive layer takes care of level adjustments. The adhesive also ensures a load-bearing connection between trackbed and rail or chair. The elasticity and compressibility of the special adhesive and pouring compound reduce impact noise by means of insulation and vibration dampening. In addition, the electric resistance of the elastomers insulates against stray currents. These two elastic bonding rail fastening methods are explained in more detail in the following subsections.

Single supports

Single-support fastening was first used alongside the pits of maintenance halls and washing plants. Later on, the system was also used in track laying. The advantages are considerable, in particular for bridges and tunnels. In the same way as the sleepers are fastened on a ballast trackbed, the rail is fastened to single supports. The chairs are bonded at intervals of 65 cm to the concrete or steel substrate (Fig. 114).

For reasons of higher safety, the chairs are additionally fixed with bolts which are rigidly sealed into the concrete or welded onto the steel plate. Depending on the degree of loading, it is possible to use four bolts or only two diagonally arranged bolts. The rail is pressed down onto the chair by spring clips or rigid clips (K-fastening). This type of fastening is used by German and Swiss railways and on tracks for urban railways, tramways and underground railways (Fig. 115).

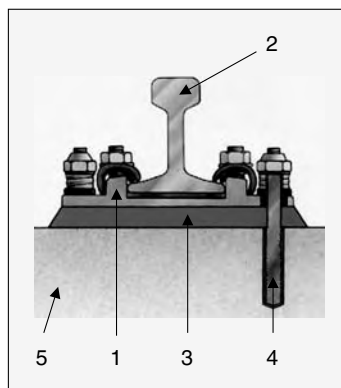

Figure 114: Single support: (1) Chair, (2) Rail, (3) Elastic adhesive, (4) Anchor bolt, (5) Concrete track bed.



Figure 115: Single support fastening on a bridge (Inselbrücke, Stuttgart, Germany).

Continuous rail bonding

The sealed-in track is an almost maintenance-free system for tramways in city centres where the rails – embedded in a two-part polyurethane adhesive – more or less ‘float’ on the road. Before the application of adhesive the surface of concrete must be pre-treated (Fig. 116).



Figure 116: Application with 2C-pump device at construction place.

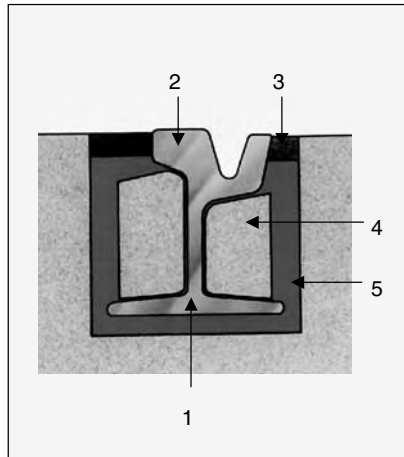

Figure 117: Continuously sealed-in rail: (1) Rail foot; (2) Grooved rail; (3) Bituminous maintenance joint; (4) Filler core; (5) Poured adhesive compound.

The rails are embedded flush with the surface of the road, so that public transportation buses or rescue service vehicles have a free lane at their disposal in an emergency.

The adhesive onto the concrete directly bonds the foot of the grooved rail. Approximately 20 mm to the right and left of the rail, a form made of moist sand or wooden slats wrapped in plastic sheeting is erected. The polyurethane compound poured underneath the rail foot evens out all irregularities of the substrate. After having bonded the cores into the cavities of the rails, the polyurethane compound can be filled into the lateral gaps (Fig. 117). As an alternative, the road surface can be completed first and then serve as the shuttering.

6.9. The Future of Elastic Bonding

Elastic bonding is recognised as a key technology which opens up many new possibilities in industrial manufacturing. Its main strength lies in its multifunctionality. Not only does it allow components made from the same or different materials to be securely joined together, it also provides additional benefits such as increased torsional stiffness, vibration-damping and greater styling freedom for the designer.

The developments pioneered in the motor vehicle and transport industry and the solutions that have already been implemented on the production line will continue to build confidence in Elastic Bonding Technology. As its use becomes more

widespread, adhesive manufacturers and users will continue to extend their knowledge of its capabilities.

Numerical calculation methods (e.g. FEM) allow the prediction of the strength and stiffness of adhesive-bonded structures. This will lead in the future to new types of adhesive assemblies that have not yet been tried in practice either because of ignorance or because of reservations about adhesive bonding – not to mention other adhesive applications so innovative that we cannot begin to imagine them today.

The technique opens up exciting new possibilities in metal construction, where the sheet metal used for conventional mechanical fastening methods is normally bare and unfinished. Adhesive bonding makes it possible to manufacture the same products from fully prefinished metal panels, thus eliminating painting as a separate production process. This saves both time and money, while also making for a cleaner and safer production and living environment.

Other new applications will be developed specifically to exploit the vibration-damping characteristics. We can therefore expect the present dynamic growth in Elastic Bonding Technology to continue well into the future.

Glossary

- Activator** Chemical agent used to prepare surfaces for bonding
- Adhesive** Non-metallic substance that joins components together by forming an interfacial bond between them
- Adhesive joint (bond-line)** Gap between two components that is to be filled with adhesive
- Adhesive layer** Layer of adhesive between two bonded substrates
- Balanced moisture content** Moisture content of a material when allowed to stabilise relative to ambient levels of atmospheric moisture
- Bond face/Bonding surface** Surface of a component that is to be bonded with adhesive
- Bonding joint** Gap between two bonding surfaces filled with adhesive
- Booster**, *see* Cure accelerator
- Clamping** Temporary securing of components in the desired position by mechanical means, with or without the application of pressure, while the adhesive is setting
- Cleaner** Chemical agent used to clean surfaces prior to bonding
- Cross-linking** Creation of a three-dimensional network through the formation of chemical bonds between molecular chains
- Cure accelerators** Substances that reduce the curing time of adhesives
- Diffusion** Migration of gases or liquids through porous material
- Dispersion adhesive** Adhesive system dispersed in water
- Elastomers** Elastomers are macromolecules with an open network structure which do not undergo plastic flow even at high temperatures approaching the point of chemical decomposition, but undergo reversible elastic deformation instead
- Fillers** Mostly inorganic additives to improve the adhesive's properties
- FEM = Finite Element Method** Calculation using iterative analysis methods
- Fracture energy** Energy that is required to cause a material to fail or fracture
- Handling strength** Stage of strength development when the adhesive-bonded assembly can be handled and passed on to the next stage of processing
- Hardener** Additive, which on account of chemical cross-linking improves the adhesive's properties (particularly its heat resistance)
- Hooke's law** Hooke's law describes the relationship between applied stress and strain in an ideal elastic solid body
- Joint assembly** Process of bringing the substrates together under light pressure so that the adhesive film is compressed to form the adhesive bond
- Monomers** Initial products of the adhesive, from which polymeric molecular chains are formed by chemical reaction

Non-sag properties Resistance of an adhesive to collapse or 'slump' when extruded in bead form

One-component Epoxy/PUR hybrid adhesive Combination and mixture of polyurethane and epoxy resin, where the epoxy group reacts with the latent hardener at high temperature

One-component polyurethane adhesive Adhesive containing isocyanates cures on exposure to moisture or to heat, when latent hardener is included

Primer Special coating designed to improve adhesion between adhesive and substrate – applied before adhesive application

Reactive adhesives Adhesives that cure or set when exposed to heat, moisture, radiation, etc.

Sealant Substance that separates a joint from any medium to which it is exposed

Shear modulus *see* chapter Technical Characteristics

Solvent Organic liquid that dissolves the base materials and other soluble adhesive constituents without effecting any chemical change

Substrates Solid layers that are to be joined together or are already joined together

Tear speed = Cross head speed Speed of which samples are subjected to destruction in the testing equipment. Normally it is between 5 and 300 mm/min

Thermosetting resins Closely cross-linked macromolecules that do not undergo plastic deformation even at high temperatures

Thick-layer adhesive bonding Elastic bonding application where the thickness of the adhesive layer exceeds 3 mm

Transmittance Ratio of the intensity of a beam of light passing through a body to its original intensity

Two-part acrylic adhesive An initiator, such as peroxides, polymerises acrylate groups of the main component

Two-part polyurethane adhesive Addition reaction of two components, main component and hardener

VDA Verein deutscher Automobilindustrie; *see* 'Cyclic ageing test'

Viscosity *see* chapter 'Technical characteristics'

Woehler diagram Representation of the magnitude of a mechanical stress to cause failure as a function of the number of load cycles

References

- [1] Walter A., *Deutsche Farben-Zeitschrift*, **1968**, 22(7), S.281–286.
- [2] Schlegel H., *Plaste und Kautschuke*, **1973**, 20(6), S.420–423.

The Company Behind this Chapter

Sika AG
Tüffenwies 16-22
CH-8048 Zurich
Tel.: 00 41/1/436 40 40
E-mail: industry@ch.sika.com
<http://www.sika.com>

The Sika Group is a leading global player in construction chemicals and industrial materials. Founded in 1910, the Swiss parent company and its world-wide subsidiaries have concentrated their activities in seven selected areas:

- Adhesive and acoustic systems
- Floorings and coatings for industry, transport and sport
- Waterproofing systems
- Underground construction
- Concrete and mortar admixtures
- Repair, protection and maintenance
- Application equipment.

In the early 1980s, Sika diversified into the chemistry of elastic adhesive bonding for industrial applications. With eight production centres in three continents, Sika is now the world's largest manufacturer of one-component polyurethane adhesives and sealants. The customer oriented solutions and services of the Sika Industry Division are marketed to the following market sectors, where they are the leaders in their field:

- Automotive OEM
- Automotive OES
- Automotive Aftermarket
- Mass-transportation vehicles
- Marine
- Appliances and industrial equipment
- Building components.

Sika's international network of production and marketing companies has now extended its operations to over 60 countries around the world. This global market presence enables the group to adapt its highly specialised know-how quickly and efficiently to the changing needs of local markets.

The company's central R&D facility in Switzerland is supported by regional Technology Centers in Germany, France, the USA, Japan, Spain, Chile and Malaysia.

Sika brand names such as Sikaflex[®], SikaTack[®], SikaMelt[®], SikaForce[®], SikaFast[®], SikaPower[®], SikaLastomer[®] and SikaBlock[®] are now firmly established in the international marketplace, where they are the expression and embodiment of a unified, market-oriented corporate philosophy. For further information, visit our web site on the Internet www.sika.com or contact your local Sika company.

Acknowledgements

We thank Kurt Diggelmann, Dr. Roland Dux, Dr. Stephan Koch, Dr. Robert Petrisko, Andreas Tellenbach, Reinhard Wappmann and Rob Zilkens for their valuable input and substantial contributions to this chapter.

Index

- 1C PUR adhesives 410–411
- 2C-PUR adhesives 415
- Acetylene-terminated resins 258, 278
- Acid–base interaction 33, 43
- Acoustics 372
- Acrylates 307–309, 313, 317, 323, 331, 341–344, 346
- Adhesion 396, 398–401, 410, 416, 421, 422, 427, 429, 433, 434
- Adhesion models 398
- Adhesive application 422, 429–430
- Adhesive modulus 214
- Adhesive properties (see also lap shear strength) 265
- Adhesive sticks 181
- Adhesives and sealants
 - Checklist for the method of application and curing 194
 - Elastic adhesives 410–417
 - Preparation 57
 - Solvent based 121
 - Viscosity 64, 112, 125, 155
 - Web speed 112
 - Working conditions 194
- Adhesys' expert system 205
- Aerosol can 81
- Ageing test 379, 456
- Air knife coater 113, 114
- Air pressure 87
- Aluminium 10, 37
- Anodising
 - in Chromic acid 11
 - in Phosphoric acid 12
- Application equipment 423
- Application of structural adhesives 289–295
- Automotive
 - headlamp assembly 453–457
 - Automotive (Headlamps...) 453, 454, 458
 - Buses 358, 361, 382, 460, 475
 - Trucks 340, 358
 - Automotive headlamps 453–455
- Ball valve applicator 148, 149, 192
- Bismaleimide (BMI) adhesives (see also maleimide-terminated resins) 255, 275
- Body-in-white 107
- Book-binding machine 130, 133, 191
- Booster technology 414, 415, 425, 438, 444
- Bottle labelling machine 130, 131, 132, 191
- Cable duct 451
- Calculation of joints 386
- Cartridge warming oven 424
- Cartridges for sealants 188
- Casting 184
- Chemical bonding 399, 400
- Chemical bonding theory 2, 3
- Chemical pretreatments 396, 401, 406–409
- Cling films 40
- Coating/dispensing 54
 - Contact coating 61
 - Extrusion 61
 - Gravity systems 61

- Hot melt applicators 61
 - Spraying 61
 - Transfer systems 61
- Co-axial Joints 225, 227
- Coefficient of linear thermal expansion (CTE) 243
- Cohesion 399, 401
- Compression 198
- Concealed joints 224
- Condensation of oligomers 250, 251
- Condensation prepolymers 280
- Conditioning of materials 55
- Conditioning of workshops 56
- Contact angles 20
 - Hysteresis 32
 - Interpretation 22
- Contact mechanics 20
- Continuous application 109
- Corona discharge 34
- Corrosion protection 371
- Corund sandblasting 405
- Coupling agents based on titanium 8
- Covalent bonds 3, 6
- Crash resistant direct glazing adhesive 432
- Creep test 375
- Critical surface tension 30
- CTBN rubbers 272
- Curing, Curing speed 365, 410, 412–416, 419, 421, 434–436, 438, 440, 444, 445, 466
- Curtain coaters 140–143, 192
 - For hot melt adhesives 143
- Definition of Structural Bonding 364
- Degree of polycondensation (DP) 239, 252
- Design and stress calculations 197
- Die coaters 125–128, 191
 - Hot melt coating 126
 - Slot die 126, 127
 - Slot die coating cartridge 128
- Dielectric properties 261
- Diffusion theory 41–43
- Dimension tolerances 366
- Dip coating 144–147
- Direct glazing 354, 356, 357, 384, 385, 397, 433–439
- Disassembly and repair 458–460
- Disc 134
- Disc and wheels applicator 132, 134
- Doctor blade coating 110, 111
- Doctor roll 117
- Double window 107
- Dry film adhesives 171, 174–177, 193
 - Thermoplastic fusible film 176, 177
 - Thermosetting film 176
- Drying time 95
- Dual cure 305, 319–321, 326, 331
- Durability 361, 376, 378, 415, 417
- Edgebanding machine 129, 191
- Elastic, Elastic bonding 358, 361–363, 366–370, 374, 375, 392, 410, 417, 418, 432, 440, 446, 447, 449–452, 462, 463, 465, 471–473, 475
- Elastic limit 204, 215
- Elasto-plastic 372
- Electropneumatic valve 192
- Electrostatic theory 40
- Elongation at break 362, 405, 411, 413, 417, 453
- Encapsulating 184
- Envelope machine 127
- Epoxide adhesive 8, 6, 11, 13, 14, 30, 36, 39, 40, 44
- Epoxide-aluminium joints 13, 14
- Epoxides 305, 315–317, 319, 324, 325
- Epoxides, UV curing 315
- Epoxy 200
- Epoxy adhesive film 173
- Epoxy composite 222, 223
- Epoxy novolacs 294
- Epoxy-phenolic adhesives 293

- Even stress distribution 362, 367–370, 460
- Extrusion installation 108
- Extrusion techniques 100, 103–108, 190
 - Extrusion coating 143
 - Extrusion/dispensing 162
 - of Fluid adhesives 101
 - Nozzles 103, 106
 - Patterns 104
 - Pumps 107
 - of Viscous products 107
- Facade panels 465–467
- Fatigue durability 381
- Fenestration 452
- Finite element analysis 392
- Finite element method (FEM) 392–396, 439
- Flexible structural bonding 362, 363
- Flow rate 84, 108, 109, 144
- Foaming 182, 183
- Fourier transform infra red (FTIR) 7, 9
- Fracture energy 273, 274, 363
- Fracture toughness 256, 272
- Glass 5, 15, 37
- Glass laminates 324
- Glass reinforced plastic (GRP) 360, 403
- Glass transition temperature 41, 242, 243, 246, 252
- Glue line thickness 229
- Goland and Reissner 229
- Gravity fed adhesives 148
- Guns for cold adhesives 150
- Hand application techniques 61
 - Brush 61
 - Guns for cartridge 71, 73, 74, 188
 - Hand roller 65
 - Hand tools 63, 187
 - Knife 65, 110
 - Manual roller see hand roller
 - Needle 66, 67
 - Notched trowel 62, 63
 - Robotic application 66, 67, 187
- Static mixer 78
- Syringe 66–68, 70, 187
- Trowel 65
 - Two-component cartridge 72, 76, 80
- Handling strength 414, 415, 419, 453
- Hart–Smith 229
- Headlamp assemblies 453, 454–458
- Heat exchanger 227
- Heat of polymerisation 256, 260
- Heliogravure 137
- Heterocyclic polymers 235, 236
- High and low viscosity material 116
- High performance liquid chromatography (HPLC) 260, 264
- Hooke's law 227
- Hot-cure adhesives 412, 419
- Hot melt adhesive 40
- Hot melt guns
 - for Automatic spraying/extrusion 100
 - for Jetting 99, 189
- Humidity 11
- Hydrogen bond 3, 15
- Imidisation kinetics 261
- Inelastic electron tunnelling spectroscopy (IETS) 7, 10
- Infrared spectroscopy 261
- Insulation glass 452
- Interfacial forces 31
- Interfacial tension 19, 23
- Interpenetrating polymer networks 312, 320, 321
- Ionic bond 9
- Ion-pairs 11, 45
- IR mode 7
- Isocyanate adhesives 8, 326
- Isothermal thermogravimetric analysis (ITGA) 242
- JKR equation 22
- JKR theory 22
- Joint design 221, 222, 375, 381, 388, 423

- Joint design and calculation 381–385
Joint thickness 209, 210
- Knife coating 110–112, 116
- Labels 172
Labelling machines 131
Lap shear strength 202, 265
 Lap shear strength measurement 264
 of Acetylene-terminated adhesives 277, 278
 of Bismaleimides BMI adhesives (see Maleimide-terminated adhesives)
 of Condensation prepolymers 279–284
 of Linear polyimide precursors 267
 of Maleimide-terminated adhesives 271, 274, 275
 of Nadimide-terminated adhesives 274, 276
 of Polybenzimidazoles 286–289
 of Polyphenylquinoxaline 266
Latex adhesives 38
Lewis acid–base interaction 15, 31
- Maleimide-terminated resins 255
 Fracture (see Fracture energy and fracture toughness)
 Lap shear strength measurement 275
 Thermal polymerisation 255
 Thermal stability 256
Manual dipping 145
Marine industries 446–451
Material safety data sheets 432
Mechanical interlocking 40
Mechanical properties 242
Metering and mixing two-component adhesives 155–162, 164–166
 Debubbler 162
 Dynamic mixers 160
 Gear pumps 160
 Static mixers 160, 161
- Modulus 214
Moisture-curing polyurethane adhesive 411, 466
Molecular weight determination 237
 Light scattering analysis 237
 Number average molecular weight M_n 238
 Size exclusion chromatography SEC 238
 Weight average molecular weight M_w 237, 238
Multiple gun installation 90
- Nadimide-treated resins 257, 294
 Lap shear strength 274
 Polyamic acid oligomers 256
 Polymerisation of monomeric reactants (PMR) 256, 257
Needle applicator 152
Non-stick materials 33
Norbornene-terminated imides (see Nadimide-treated resins)
- Nuclear magnetic resonance (NMR) 8, 9, 261
- Offset 137
- Parquet adhesive 461–465
Parquet bonding 461–465
PDMS 32, 33
Peel 198
Peel strength 43, 291
Peeling stresses 374
Permittivity of water 10
Phenolic adhesives 11, 13
Photoinitiators 304, 306, 307, 324, 341–344,
Photopolymerisation 309, 310, 314, 317, 318, 328
Photo initiated cationic polymerisation 314–316
Physical adsorption 13, 17

- Physical bonding 399
- Physical–chemical pretreatments 405
- Pipe bonding 225, 226
- Plasma treatment 404, 405, 456
- Plastic 354, 370, 372, 378, 379, 398, 399, 403–405, 448, 453
- Plastic behaviour 205
- Poly(ether-imides) 250, 291
- Poly(isoimides) 247, 258, 267
- Polyamic acids 244, 245
- Polybenzimidazoles 251, 287
- Polydimethylsiloxane 28, 30
- Polyimides 235, 239, 244
 - Fluorinated polyimides 245, 290
 - Larc TPI thermoplastic polyimide 248, 249, 267, 268, 289
 - Thermoplastic polyimides 236, 253, 289
 - Thermosetting polyimides 236
 - Polyimide precursors 254, 267
- Polyphenylquinoxalines 237, 247, 266, 267
- Polyurethane 15, 37
- Potting 184, 185
- Pre-coated films or textiles 178
- Precuring adhesives (PC) 412, 420, 421
- Precyclised polymers 246, 254
- Preformed tapes 179
- Pressure sensitive adhesives 304, 322, 323, 326–329, 345
- Pressure sensitive tapes 172
- Primer 378, 396, 401, 404, 407–409
- Processability window 256
- Processing conditions 290
- PTFE 33, 34
- Pump 84, 189
 - Airless pneumatic pump 92
 - Drum pump 168
 - for Extrusion 107
 - Low pressure pump 85
 - Pump pressure ratio 86
- PUR-Hybrid products 417, 443–445
- PVC 42
- Quality assurance 427–430
- Radical polymerisation 306
- Rail fastening 472–475
- Reactive warm-melt adhesives (RWM) 412, 421, 452
- Reduction factors 386–388
- Reflection-absorption infrared (RAIR) 6
- Release coatings 329–331
- Rheological profiles 248
- Rigid bonding 363, 367, 462
- Robotic application 72, 169
- Roll coating 110, 114–124, 190
 - Complete installation 123
 - Gravure rolls 118, 122
 - Metering roll 115
 - Reverse 119, 120
 - Reverse gravure 121
 - Rolls on top of the sheets to be coated 118
 - Rolls under the sheets to be coated 117
 - Tension roll 115
- Roll stocks 172
- Rotary screen 138–140
- Safe-drive-away time 433–435, 437
- Secondary ion mass spectrometry (SIMS) 6
- Selection of application equipment 60
- Self standing films 291
- Shear modulus 228, 361, 362, 417, 438
- Shear stresses 200
- Silane terminated polymers 416, 417
- Silane coupling agents 3, 4, 22
- Silk screen 138
- Size and shape of materials 60
- Solubility parameter 42
- Speed, speed of curing 412, 413, 434, 435, 437
- Speed of application 141
- Spraying 81–89
 - Air spray 82, 188
 - Air spray gun 83, 95, 188

- Airless spray 91–93
- Automatic spraying 94–96
- Detection systems 96
- Equipment 98, 188
- Hot spray 93, 94, 188
- Low pressure spray 82, 89, 93
- Spray patterns 154
- Spraying installations 88
- Swirl spraying 101, 102
- Two-component adhesives 97, 98
- Spreading pressure 23
- Stabilization of materials 55
- Static loads 375, 381, 387, 391, 461, 466
- Steel adherends 6
- Steel and aluminium alloy 40
- Stencil 134, 136
- Stress distribution 205, 362, 367–370, 369
- Stress resulting from temperature change 391
- Structural adhesives 322
- Structural glazing 357
- Surface free energy 26, 28, 29, 33
- Surface preparation 53, 401, 404–409, 422, 427
- Surface roughness 32
- Surface tension 19, 23, 29, 37
- Syringe application 65–68

- Tack 42
- Tape roll 174
- Tape unwinders 192
- Tapes and labels application 172
- Teak decks 447
- Telechelic oligomers 254, 258
- Tensile 228
- Tensioning systems 117
- Test of a bead 380
- Thermal properties 240
 - Differential scanning calorimetry 255, 267, 279
 - Dynamic thermogravimetric analysis TGA 234, 240
 - Isothermal ageing 241
 - Thermal stability 234
- Thermomechanical analysis 242
- Thermoplastic adhesives 235, 238, 274
- Thermosetting resins 254, 258, 271
- Thick adherend shear strength 205
- Thickness 212–213, 367, 370, 382, 467
- Thickness of the joint 392
- Thiol/polyene 312
- Transport equipment 359, 360
- Trowel application 63
- Truck calins 440–442
- Tubular joints 216
- Two-component adhesives
 - Mixing and metering 58, 97, 98, 155–167, 186
 - Pre-measured dose 181
 - Spraying 97
 - Spraying equipment 98
- Two-component hot melts
 - Application 166
 - Robotic application with syringes 167, 169, 193
- Two-component polyurethane systems 415
- Two-component tape or ribbon 180
- Typography 137

- Urethane linkage 8
- UV curable acrylates 307
- UV curable adhesives, applications 322, 324
- UV cured PSA 328
- UV radiation 377, 378, 380, 383, 402, 449
- UV radiation curing 303

- Valve applicator 150
- van der Waals forces 1, 17
 - Dispersion forces 18
 - Induced dipole 17
 - Permanent dipole 18
- Vinyl ethers 314, 317–319, 324, 341
- Viscosity 236

- Dynamic viscosity 249
- Inherent viscosity 236
- Intrinsic viscosity 236, 237
- Melt viscosity 249, 267
- Volkersen 228

- Water
 - Critical concentration 11, 13, 14
 - Critical relative humidity 13, 14
 - Unique properties 12, 32
- Water sensitivity 11, 13

- Water swelling sealants 468–470
- Wettability 398, 405, 407, 421
- Windows (see Fenestration)
- Windshield bonding 357, 389, 402
- Woehler diagram 381, 388
- Work of adhesion 34–37, 39

- X-ray photoelectron spectroscopy (XPS)
 - 6, 10, 32

- Young's modulus 228

This Page Intentionally Left Blank

