

SPRINGER  
REFERENCE

Heinz Mehlhorn  
*Editor*

# Encyclopedia of Parasitology

*3rd Edition*

 Springer

Encyclopedia of Parasitology

HEINZ MEHLHORN (ED.)

# Encyclopedia of Parasitology

Third Edition

With contributions by

H. ASPÖCK, C. BEHR, C. COMBES, A. DAUGSCHIES, J. DE BONT, G. DOBLER, J.F. DUBREMETZ, J. FREEMAN (†),  
J.K. FRENKEL, A. GESSNER, M. GUSTAFSSON, W. HAAS, H. HÄNEL, O. HANSEN, A. HARDER, M. JULSING,  
E.S. KANESHIRO, O. KAYSER, P. KÖHLER, W. LEHMACHER, M. LONDERSHAUSEN, U. MACKENSTEDT, A. MAULE,  
H. MEHLHORN, L.H. PEREIRA DA SILVA, W. RAETHER, I. REITER-OWONA, D. RICHTER, M. RÖLLINGHOFF,  
G. SCHAUB, T. SCHNIEDER, H.M. SEITZ, A.G. SMULIAN, A. SPIELMAN (†), K.D. SPINDLER, H. TARASCHEWSKI,  
A.G.M. TIELENS, A. TURBERG, J. VERCRUYSE, V. WALLDORF, W.H. WERNSDORFER

Volume 1

A–M

With 1,000 figures and 205 tables

 Springer

HEINZ MEHLHORN (ED.)

# Encyclopedia of Parasitology

Third Edition

With contributions by

H. ASPÖCK, C. BEHR, C. COMBES, A. DAUGSCHIES, J. DE BONT, G. DOBLER, J.F. DUBREMETZ, J. FREEMAN (†),  
J.K. FRENKEL, A. GESSNER, M. GUSTAFSSON, W. HAAS, H. HÄNEL, O. HANSEN, A. HARDER, M. JULSING,  
E.S. KANESHIRO, O. KAYSER, P. KÖHLER, W. LEHMACHER, M. LONDERSHAUSEN, U. MACKENSTEDT, A. MAULE,  
H. MEHLHORN, L.H. PEREIRA DA SILVA, W. RAETHER, I. REITER-OWONA, D. RICHTER, M. RÖLLINGHOFF,  
G. SCHAUB, T. SCHNIEDER, H.M. SEITZ, A.G. SMULIAN, A. SPIELMAN (†), K.D. SPINDLER, H. TARASCHEWSKI,  
A.G.M. TIELENS, A. TURBERG, J. VERCRUYSE, V. WALLDORF, W.H. WERNSDORFER

Volume 2

N–Z

With 1,000 figures and 205 tables

 Springer

*Editor:*

Professor Dr. Heinz Mehlhorn  
Heinrich-Heine-Universität  
Institut für Zoomorphologie,  
Zellbiologie und Parasitologie  
Universitätsstraße 1  
40225 Düsseldorf  
Germany

ISBN: 978-3-540-48994-8

This publication is available also as:  
Electronic publication under ISBN 978-3-540-48996-2 and  
Print and electronic bundle under ISBN 978-3-540-48997-9

Library of Congress Control Number: 2007937942

This work is subject to copyright. All rights are reserved, whether the whole or part of the material is concerned, specifically the rights of translation, reprinting, reuse of illustrations, recitation, broadcasting, reproduction on microfilms or in other ways, and storage in data banks. Duplication of this publication or parts thereof is only permitted under the provisions of the German Copyright Law of September 9, 1965, in its current version, and permission for use must always be obtained from Springer-Verlag. Violations are liable for prosecution under the German Copyright Law.

Springer is part of Springer Science+Business Media

[springer.com](http://springer.com)

© Springer-Verlag Berlin Heidelberg New York 2008

The use of registered names, trademarks, etc. in this publication does not imply, even in the absence of a specific statement, that such names are exempt from the relevant protective laws and regulations and therefore free for general use.

Product liability: The publishers cannot guarantee the accuracy of any information about the application of operative techniques and medications contained in this book. In every individual case the user must check such information by consulting the relevant literature.

Editor: Dieter Czeschlik, Heidelberg/Sandra Fabiani, Heidelberg  
Development Editor: Sylvia Blago, Heidelberg/Lydia Müller, Heidelberg  
Production Editor: Frank Krabbes, Heidelberg/Michael Reinfarth, Leipzig  
Cover Design: Frido Steinen-Broo, Spain

Printed on acid-free paper      SPIN: 10905951 2109 - 5 4 3 2 1 0

---

## Preface to the First Edition

Although in recent decades many methods have been developed to control parasitic diseases of humans and animals, chemoresistance and reduction of budgets for control have caused the problems to increase worldwide. Efforts in the “*struggle against parasites*” must be redoubled if we are not to become overwhelmed by human health problems and problems of food production. This absolute need has led to the application of various new methods to classical parasitology. Thus the different fields of parasitological research are at present expanding so rapidly that it is impossible for an individual to follow the main problems and to evaluate and recognize recent progress.

The purpose of this book is to give a comprehensive review of the facts and trends in veterinary and human parasitology, through contributions from distinguished specialists in different fields. The authors have focused their contributions on the most important and promising results, in a way which it is hoped will inform students, teachers, and researchers (zoologists, veterinarians, physicians) about those topics, which may be far from their own working fields, but knowledge of which may be necessary to develop new ideas. Thus, all chapters, the length of which will surely change in future editions, are provided with references opening the literary entrance to each field of research.

We hope that the book will be fruitful and lead to the establishment of new ideas, trends, and techniques in the struggle against parasites.

*Bochum, January 1988*

For the authors  
PROF. DR. H. MEHLHORN (EDITOR)  
Ruhr-Universität Bochum, FRG

---

## Preface to the Third Edition

Globalization is the term of our time, and includes a daily constant and extremely rapid transportation of millions of humans and animals, plants, foods, and goods over often far distances from one region of the world to any other and back.

This, of course, has increased the likelihood of a broad and intensive import and export of parasites, their vectors and/or transmitted agents of diseases, which may give rise to the local endemics arising worldwide or even pandemics of considerable impact for human and animal health and all related economic factors. Thus there are no more tropical diseases, which can be avoided by not entering such countries. Today we have traveler's disease, we have local zoonoses, and we have diseases due to imported animals and plants. The latter may have severe consequences in countries where such diseases had been absent up to now since the people, animals, and plants have not had the chance to develop immunity or other means of protection. An example is the Blue-tongue-virus-disease of ruminants – transmitted by ceratopogonid bloodsuckers, which in summer 2006 was apparently imported (inside game animals) from South Africa to Central Europe and has spread within a few months in the Netherlands, Belgium, Northern France, and wide regions of Germany seriously harming the rearing of cattle and sheep.

Therefore, we are aware that the knowledge in the field of parasitology – especially in transmission, diagnosis, and treatment – must be kept at a high level and up to date in order to fight a parasitosis, from wherever, as quickly and effectively as possible.

The presentation of our third edition of the *Encyclopedia of Parasitology* contributes to these goals in several ways. The number of keywords has been increased by about 30%, their contents include important new knowledge gained since 2001, and perception of the facts has been ameliorated by adding 20% more tables, more figures, and an even closer connection by setting more links from one keyword to another. The quick and effective finding of updated information in human, veterinary, and biological aspects of parasitology is offered by more than 40 contributors, all of whom are well-known specialists in their fields of research, and who are all active in cooperation with their governments in the daily fight against the diseases deriving from parasitic infections of all kinds.

The third edition is presented as two volumes, sorted A to Z, and in an online version, both of which make it easy for all users to obtain the needed information within a minimum of time.

I am very grateful to all coauthors for their intensive, quick reviewing and serious updating of their keywords. I also wish to express my thanks to the readers of the second edition for their broad acceptance of our book, since the complete selling of this edition made it possible to publish the present edition after such a short period.

I hope that our most recent efforts are as well accepted as with the first two editions, and that the readers of our book and the users of our online version have the same benefit as the authors, when working on our parasitologic topics.

Düsseldorf, September 2007

For the authors  
PROF. DR. HEINZ MEHLHORN (EDITOR)  
Heinrich-Heine-Universität  
Düsseldorf, Germany

---

## Acknowledgements

No one could write a book such as this without the help of many people, including our close coworkers. Their material and comments were helpful while selecting and preparing the contributions to this book. We are especially grateful to those colleagues who contributed one or several micrographs:

- Prof. Dr. G. Brugerolle, Clermont-Ferrand
- Prof. Dr. J.F. DeJonckheere, Brussels
- Prof. Dr. I. Desportes, Paris
- Dr. W. Franz, Münster
- Prof. Dr. J. Grüntzig, Düsseldorf
- Prof. Dr. I. Ishii, Japan
- Prof. Dr. K. Hausmann, Berlin
- Prof. Dr. A.O. Heydorn, Berlin
- Dr. S. Klimpel, Düsseldorf
- Prof. Dr. M. Køie, Kopenhagen
- B. Mehlhorn, Neuss
- Prof. Dr. S. Palm, Düsseldorf
- Prof. Dr. S. Saem, Teheran
- Prof. Dr. E. Schein, Berlin
- PD Dr. G. Schmahl, Düsseldorf
- Dr. J. Schmidt, Düsseldorf
- Prof. Dr. J. Schrével, Paris
- Prof. Dr. Y. Yoshida, Kyoto

All other micrographs are either from the authors of the particular chapter or from the editor.

The editor and the authors would like to thank Mrs. K. Aldenhoven and Miss S. Walter for carefully typing large parts of the manuscript, Mrs. H. Horn and Mr. S. Köhler for their excellent preparation of the micrographs, and Mrs. B. Mehlhorn for correcting the proofs. The beautiful hand drawings were produced by the late Fried Theissen (Essen) and Dr. Volker Walldorf (Düsseldorf).

Furthermore we would like to thank the publishers, especially Dr. D. Czeschlik, Mrs. S. Fabiani, Dr. S. Blago and Mrs. L. Müller (at the Publisher, Springer-Verlag Heidelberg), for their cooperation and generous support of our efforts to produce an optimum outline of parasitology.

*The Authors*



---

## Main Topics and Contributors

- Acanthocephala (Taraschewski)
- Antibodies (Seitz and Reiter-Owona)
- Arboviruses (Aspöck and Dobler)
- Behavior (Taraschewski)
- Cell penetration (Dubremetz)
- Chemotherapy against helminthoses (Raether and Harder)
- Chemotherapy against protozoan diseases (Raether and Hänel)
- Classification (Mehlhorn)
- Clinical and pathological signs of parasitic infections in domestic animals (Vercruysse, de Bont, and Dauschies)
- Clinical and pathological signs of parasitic infections in man (Frenkel and Mehlhorn)
- Connecting entries (Mehlhorn)
- Drug action in ectoparasites (Turberg and Londershausen)
- Drug action in protozoa and helminths (Harder)
- Drug tables (Raether)
- Ecological aspects (Combes)
- Ectoparasitizides (Londershausen and Hansen)
- Environmental aspects (Combes)
- Epidemiological aspects (Wernsdorfer)
- Eye parasites (Mehlhorn)
- Fine structure of parasites (Mehlhorn)
- Hormones (Spindler)
- Host finding mechanisms (Haas)
- Host parasite interface (Dubremetz and Mehlhorn)
- Immunodiagnostic methods (Seitz and Reiter-Owona)
- Immunological responses of the host (Gessner and Röllinghoff)
- Insects as vectors (Schaub)
- Life cycles (Mehlhorn and Walldorf)
- Lyme disease (Spielman, Armstrong, and Mehlhorn)
- Mathematical models (Freeman and Lehmacher)
- Metabolism (Köhler and Tielens)
- Molecular systematics (Mackenstedt)
- Morphology (Mehlhorn)
- Motility (Dubremetz and Mehlhorn)
- Nerves-structures and functions (Gustafsson and Maule)
- Novel drugs (Kayser and Julsing)
- Nutrition (Köhler and Tielens)
- Opportunistic agents, except *Pneumocystis* (Mehlhorn)
- Pathologic effects in animals (Vercruysse, de Bont, and Dauschies)
- Pathologic effects in humans (Frenkel and Mehlhorn)
- Pathology (Frenkel and Mehlhorn)
- Pentastomida (Walldorf)
- Phylogeny (Mackenstedt)
- Physiological aspects (Köhler and Tielens)
- Planning of control (Wernsdorfer)
- *Pneumocystis* (Kaneshiro and Smulian)

- Reproduction (Mehlhorn)
- Resistance against drugs (Harder)
- Serology (Seitz and Reiter-Owona)
- Strategy of control measurements (Wernsdorfer)
- Ticks as vectors in animals (Mehlhorn)
- Ticks as vectors in humans (Spielman, Armstrong, and Mehlhorn)
- Ultrastructure (Mehlhorn)
- Vaccination
  - Protozoa (Behr and Pereira da Silva)
  - Plathelminthes (Richter)
  - Nematelminthes (Schnieder)
- Vector biology
  - Insects (Schaub and Mehlhorn)
  - Ticks (Spielman and Mehlhorn)

All these topics are presented in either a single, long entry, in several smaller, separate entries and/or as inserts in other longer entries. This cooperation of specialists contributes to a better understanding of the recent complex problems in parasitology.

---

## List of Contributors

ASPÖCK, Horst, Prof. Dr.

Abteilung für Medizinische Parasitologie, Klinisches Institut für Hygiene und Medizinische Mikrobiologie,  
Medizinische Universität Wien, Kinderspitalgasse 15, 1095 Wien, Austria

BEHR, Charlotte, Dr.

Unité d'Immunologie Moléculaire des Parasites, Institut Pasteur, 25 Rue du Dr. Roux, 75724 Paris Cedex 15,  
France

COMBES, Claude, Prof. Dr.

Centre de Biologie et d'Écologie Tropicale et Méditerranéenne, Université de Perpignan, 66860 Perpignan Cedex,  
France

DAUGSCHIES, Arwid, Prof. Dr.

Institut für Parasitologie, Veterinärmedizinische Fakultät, Universität Leipzig, An den Tierkliniken 35,  
04103 Leipzig, Germany

DE BONT, Jan, Prof. Dr.

Department of Virology – Parasitology – Immunology, Faculty of Veterinary Medicine, Laboratory of Veterinary  
Parasitology, University of Gent, Salisburylaan 133, 9820 Merelbeke, Belgium

DOBLER, Gerhard, OFA Dr.

Institut für Mikrobiologie der Bundeswehr, Neuherbergstr. 11, 80937 München, Germany

DUBREMETZ, Jean François, Dr.

Université de Montpellier 2, UMR CRNS 5539, Place Eugène Bataillon, 34095 Montpellier Cedex 05, France

FREEMAN, Jonathan, Prof. Dr. (deceased)

Department Tropical Public Health, Harvard University, School of Public Health, 665 Huntington Avenue, Boston,  
MA 02115, USA

FRENKEL, Jack K., Prof. Dr. (retired from University of Kansas City, Kansas)

1252 Vallecit A Drive, Santa Fe, NM 87501–8803, USA

GESSNER, André, Prof. Dr. Dr.

Klinische Mikrobiologie, Immunologie und Hygiene, Mikrobiologisches Institut, Universitätsklinikum Erlangen,  
Wasserturmstr. 3, 91054 Erlangen, Germany

GUSTAFSSON, Margaretha, Prof. Dr.

Åbo Akademi University, Department of Biology, Biocity, Artillerigatan 6, 20520 Åbo, Finland

HAAS, Wilfried, Prof. Dr.

Institut für Zoologie 1, Universität Erlangen-Nürnberg, Staudtstr. 5, 91058 Erlangen, Germany

HÄNEL, Heinz, Prof. Dr.

Sanofi-Aventis Deutschland GmbH, Industriepark Höchst, Gebäude H 831, 65926 Frankfurt am Main, Germany

HANSEN, Olaf, Dr.

Bayer HealthCare AG, Division Animal Health, 51368 Leverkusen, Germany

HARDER, Achim, Priv. Doz. Dr.

Bayer HealthCare AG, Division Animal Health, 51368 Leverkusen, Germany

JULSING, Mattijs K., Dr.

Universität Dortmund, Fachbereich Bio- und Chemieingenieurwesen, Lehrstuhl für Biotechnik,  
Emil Figge Str. 66, 44227 Dortmund, Germany

KANESHIRO, Edna S., Prof. Dr.

Department of Biological Sciences, University of Cincinnati, P.O. Box 210006, Cincinnati,  
OH 45221-0006, USA

KAYSER, Oliver, Prof. Dr.

Pharmaceutical Biology, University of Groningen, Antonius Deusinglaan 1, 9713 AV Groningen, The Netherlands

KÖHLER, Peter, Prof. Dr. (retired from University of Zürich)

Institut für Parasitologie, Universität Zürich, Winterthurerstr. 266a, 8057 Zürich, Switzerland

LEHMACHER, Walter, Prof. Dr.

Universität Köln, Institut für Medizinische Statistik, Informatik und Epidemiologie, Kerpenerstr. 62,  
50937 Köln, Germany

LONDERSHAUSEN, Michael, Prof. Dr.

Bayer HealthCare AG, Division Animal Health, 51368 Leverkusen, Germany

MACKENSTEDT, Ute, Prof. Dr.

Institut für Parasitologie, Universität Hohenheim, Emil-Wolff-Str. 34, 70593 Stuttgart, Germany

MAULE, Aaron, Prof.

Molecular Biology: Parasitology, School of Biological Sciences, Queen's University Belfast,  
Medical Biology Centre, 97 Lisburn Road, Belfast BT9 7BL, Northern Ireland, UK

MEHLHORN, Heinz, Prof. Dr.

Institut für Zoomorphologie, Zellbiologie und Parasitologie, Heinrich-Heine-Universität, Universitätsstr. 1,  
40225 Düsseldorf, Germany

PEREIRA DA SILVA, Luiz Hildebrando, Prof. Dr.

Parasitologie expérimentale, Institut Pasteur Paris, 25 Rue du Docteur Roux, 75724 Paris Cedex 15,  
France and Centro de Pesquisas em Medicina Tropical, Secretaria de Saúde do Estado de Rondônia,  
Rodovia BR 364, Km 4.5, 7870-900 Rondônia, Brasil

RAETHER, Wolfgang, Prof. Dr. (retired from Hoechst AG Chemotherapy Department)

Freigasse 3, 63303 Dreieich, Germany

REITER-OWONA, Ingrid, Dr.

Institut für medizinische Parasitologie, Universität Bonn, Sigmund-Freud-Str. 25, 53008 Bonn, Germany

RICHTER, Dania, Dr.

Abteilung Parasitologie der Charité Universitätsmedizin, Institut für Pathologie, Malteserstr. 74-100,  
12249 Berlin, Germany

RÖLLINGHOFF, Martin, Prof. Dr.

Institut für Klinische Mikrobiologie und Immunologie, Universität Erlangen-Nürnberg, Wasserturmstr. 3,  
91054 Erlangen, Germany

SCHAUB, Günter, Prof. Dr.

Fakultät für Biologie, AG Zoologie/Parasitologie, Ruhr-Universität Bochum, Universitätsstr. 150,  
44801 Bochum, Germany

SCHNIEDER, Thomas, Prof. Dr.

Institut für Parasitologie, Tierärztliche Hochschule Hannover, Bünteweg 17, 30559 Hannover, Germany

SEITZ, Hans Martin, Prof. Dr.

Institut für medizinische Parasitologie, Universität Bonn, Sigmund-Freud-Str. 25, 53008 Bonn, Germany

SMULIAN, Alan George, Dr.

Department of Internal Medicine, Division of Infectious Diseases, University of Cincinnati, College of Medicine,  
231 Albert Sabin Way, Cincinnati, OH 45267-0560, USA

SPIELMAN, Andrew, Prof. Dr. (deceased)

Department of Tropical Health, Harvard School of Public Health, 665 Huntington Avenue, Boston,  
MA 02115, USA

SPINDLER, Klaus Dieter, Prof. Dr.

Institut für Allgemeine Zoologie, Universität Ulm, Albert-Einstein-Allee 1, 89069 Ulm, Germany

TARASCHEWSKI, Horst, Prof. Dr.

Zoologisches Institut, TH Karlsruhe, Kaiserstr. 12, 76128 Karlsruhe, Germany

TIELENS, A.G.M., Prof. Dr.

Department of Biochemistry and Cell Biology, Faculty of Veterinary Medicine, University of Utrecht,  
P.O. Box 80176, 3508 TD Utrecht, The Netherlands

TURBERG, Andreas, Dr.

Bayer HealthCare AG, Division Animal Health, 51368 Leverkusen, Germany

VERCRUYSE, Joseph, Prof. Dr.

Department of Virology – Parasitology – Immunology, Faculty of Veterinary Medicine, Laboratory of Veterinary  
Parasitology, University of Gent, Salisburyaan 133, 9820 Merelbeke, Belgium

WALLDORF, Volker, Dr.

Institut für Zoomorphologie, Zellbiologie und Parasitologie, Heinrich-Heine-Universität Düsseldorf,  
Universitätsstr. 1, 40225 Düsseldorf, Germany

WERNSDORFER, Walter H., Prof. Dr.

Abteilung für Spezifische Prophylaxe und Tropenmedizin, Institut für Pathophysiologie der  
Medizinischen Universität Wien, Kinderspitalgasse 15, 1090 Wien, Austria; former member of WHO



---

## Introduction

Starting from the early beginnings of human culture, man became aware of parasites. In animals, which developed social contacts via coat-lousing, humans noted first the crucial activities of large amounts of ectoparasites such as ticks, lice, fleas, mosquitoes, and flies, as is shown in the earliest written reports of mankind. Furthermore, those endoparasitic worms that occurred in feces in larger numbers and were big enough to be seen with the naked eye were known. Thus the physicians of the Egyptians (~2000 BC), the Greek physician Hippocrates (460–370 BC), and the natural scientist Aristoteles (384–322 BC) knew ascarids, oxyurids, and of course tape-worms very well. Their knowledge was passed on to the Romans, who called the round worms *lumbrici teretes* and the plathyhelminths *lumbrici lati*, and from there it was transmitted to later human societies, especially by propagation of manuscripts in Christian cloisters or by translations of Greek books that were being used and preserved by physicians in the Near East.

However, only a few remedies were available apart from combing (Fig. 1), catching of parasites (Fig. 2), bathing in water and/or hot sand, and eating special plants or spicy food, which were felt to decrease intestinal worm populations, as, for example, pepper does (Fig. 3). Thus the highly sophisticated physicians of the ancient Egyptian kingdoms surely did know the fatal symptoms of the schistosome-derived diseases, but the transmission pathways



**Introduction. Fig. 1.** Redrawn reproduction of a medieval engraving showing a housewife delousing her husband with a comb-like instrument.

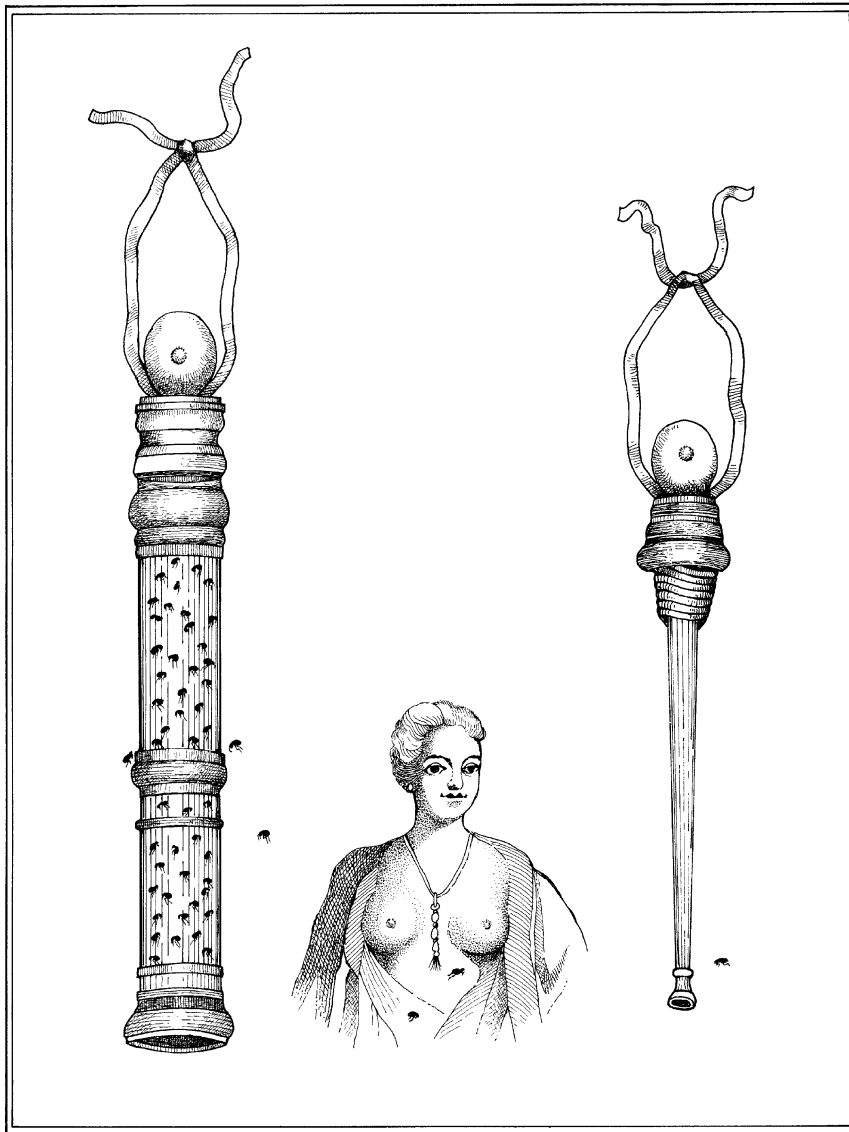

**Introduction. Fig. 2.** Redrawn reproduction of a figure from a German book of the 18th century showing two types of lady's necklace used as glooming flea-catcher.

and methods of treatment were as nebulous as they were 3,000 years later when the Holy Hildegard of Bingen (1098–1179) recommended that worms be treated with, for example, extracts of stinging nettles, dandelions, and walnut-tree leaves, as described in her book *Physica* (1150–1160) – chapter “*De causis et curis morborum*” (i.e. “On the causes and cures of diseases”). The treatment of dracunculosis by removal of the whole worm from human skin was, however, much more successful. The use of a wooden splinter, onto which this so-called Medina-worm was wound by physicians in the Near East, probably gave rise to the Aesculap-stick of our days – the symbol of an increasingly successful caste – although it is not long ago that cupping and/or the use of leeches were universal remedies (Figs. 4, 5). At the end of the Middle Ages, a new interest arose among educated people to study the natural world, and this newly awakened curiosity led people to make detailed investigations of plants and animals. Even human beings were a subject of investigation, provided religion did not prevent this (e.g., dissections of humans – even of executed and thus lawless people – were forbidden for centuries in Christian and Moslem countries). Thus at first, descriptions of the outer morphology of plants, animals, and humans became available and later – after the development of microscopical techniques – structural ground plans and histological insights into organisms were obtained. However, it was not until the middle of the 19th century that the theory of “de novo





**Introduction. Fig. 3.** Redrawn reproduction of an ambulant Renaissance pharmacist equipped with his main helper plants and therapeutical animals, including snakes and leeches.

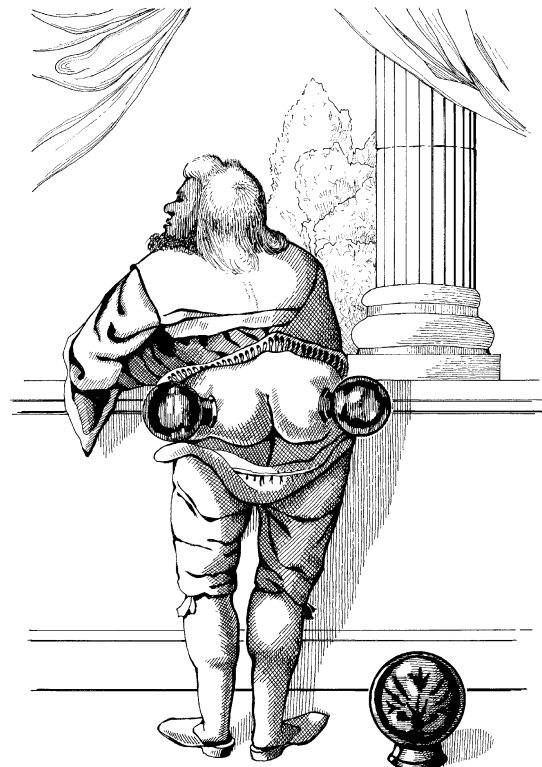

**Introduction. Fig. 4.** Redrawn reproduction of a Baroque noble using cupping-glasses in order to be bled.



**Introduction. Fig. 5.** Redrawn reproduction of a medieval engraving demonstrating the therapeutic use of the leech, *Hirudo medicinalis*, even in middle-class households.

creation” (latin: *generatio aequivoca et spontanea*), the creation of organisms from dead or anorganic material (e.g., worms develop from intestinal slime) became replaced by the idea of cellular organization and the self-reproduction of organisms as postulated in Virchows thesis (1858): “*omnis cellula e cellula*” (“each cell derives from a cell”). This growing spirit of investigation led to the discovery of numerous species of plants and animals and to the differentiation into prokaryotic and eukaryotic organization of organisms. The knowledge derived from the cell-dependent life of viruses or prions is a fruit of our century. According to their morphology and life cycles – the study of which is not completed even today – species of bacteria, fungi, plants, and animals were characterized and **systematical classifications** and **phylogenetic trees** were established. Such investigations provided a basis for the establishment of phylogenetical theories such as those of Lamarck or Darwin.

Moreover, most of the species of parasites still valid today were described in those times (cf. **Historical Landmarks**) and the term **parasite** (Greek: *parasitos* = eaters at the court = meal taster) became fixed as the word to describe those organisms that live on other animals or humans. According to the different life-cycle adaptations the latter may become:

- **Final (definite) hosts** lodging the sexual stages of the parasite
- **Intermediate hosts** lodging asexually reproducing stages of the parasite
- **Transitory/accidental/paratenic hosts** lodging parasitic stages without further reproduction
- **Vectors** representing bloodsucking parasites such as arthropods, worms or leeches which transmit other pathogens and/or parasites during their blood meal.

The constant refinement of microscopical techniques (including the establishment of electron microscopy) and the development of a broad spectrum of molecular biological methods led (especially in the last 30 years) to an explosion of the knowledge on the organization of the parasites, on the parasite–host interface, and on host immune reactions, which altogether were used to establish control measurements and to develop prophylactic strategies, drugs, and/or vaccines. Thus the third edition presented here is based on the following pillars:

- Life cycles (inclusive behavior and epidemiology)
- Morphology (up to molecular insights)
- Mechanisms of reproduction
- Metabolism and nutrition

- Host–parasite interactions
- Diseases and pathological effects
- Immune reactions
- Control measurements (including drugs, vaccines, prophylactic strategies).

The selected keywords are arranged in an encyclopedic manner and intend to outline easy interactions with many other fields of interest and importance. The simultaneously appearing online version of the book speeds up the finding of the appropriate information.

## Abamectin

### Chemical Class

Macrocyclic lactone (16-membered macrocyclic lactone, avermectins).

### Mode of Action

Glutamate-gated chloride channel modulator → [Nematocidal Drugs](#), → [Ectoparasiticides – Antagonists and Modulators of Chloride Channels](#).

## Abbreviata

Genus of physalopteroid nematodes in amphibians, reptiles, and a few mammals.

## Abdominal Pain

Leading symptom in some parasitic infections (Angiostrongyliasis costaricensis, → [Ascariasis](#) in children, → [Capillariasis](#), → [Dipylidiasis](#), → [Echinococcosis](#), → [Gnathostomiasis](#), → [Mansonelliasis](#), → [Strongyloidiasis](#), → [Taeniasis](#), → [Toxocariasis](#), → [Trichuriasis](#)).

## Abortion

Premature expulsion of an embryo or a nonviable fetus caused by parasitic infections, e.g., with → [Toxoplasma gondii](#), → [Neospora caninum](#) (syn. → [Hammondia heydoni](#)), → [Trypanosoma](#) species, → [Tritrichomonas foetus](#).

## Abscess

Inflammatory reactions around foci of parasites within hosts (e.g., → [Angiostrongylus](#), → [Leishmania](#), → [Entamoeba histolytica](#)). → [Pathology](#).

## Abundance

(Latin: *abundantia*), this ecological term describes the number of individuals within a biotope with respect to a defined area or a certain space.

## Acalculous Cholecystitis

Symptom due to infections of gall bladder, e.g., by → [Encephalitozoon intestinalis](#), → [Opisthorchis species](#).

## Acanthamoeba

→ [Amoebae](#).

## Acanthamoeba castellanii

Species of facultatively parasitic → [amoebae](#); → [Acanthamoebiasis](#), → [Opportunistic Agents](#); → [GAE](#).

Infectious leginonellae or other bacteria and viruses may be transported by such amoebae in biofilms. Life cycle see → [Amoebae](#).

## Acanthamoeba-Keratitis

Sight-threatening infection of the eye due to opportunistic *Acanthamoeba* spp., which excrete proteases that degrade basement membranes and induce cytolysis as well as apoptosis of corneal cells. This finally culminates in the dissolution of the collagenous corneal stroma.

## Acanthamoebiasis

→*Acanthamoeba* spp. have been found in the throat; mouth pipetting of fluids into cell culture has given rise to contaminated cell cultures in numerous instances. In the throat the →*amoebae* appear to be nonpathogenic. However, in patients with long-standing immunosuppression tissue invasion does occur, usually leading to →*encephalitis* which is fatal and occasionally to focal lesions elsewhere. The inflammation is mononuclear; partially in response to →*necrosis* of brain tissue and is sometimes stated to be granulomatous; hemorrhage may be marked. Large amoebic →*trophozoites* and smaller cysts with an irregular “corrugated” wall are found in the lesions. Often the →*amoebae* (Figs. 1, 2) are difficult to distinguish from macrophages; the latter have intensely staining nuclei, whereas the amoebae have vesicular nuclei and a “foamy” →*cytoplasm*. The →*inflammatory reaction* is of course variable because of immunosuppression of the patients (→*Pathology*). The amoebae are not found in the spinal fluid. Patients with the Acquired Immunodeficiency Syndrome (→*AIDS*) showed invasion of the nasopharynx with →*Acanthamoeba* spp. Other sites of involvement by *Acanthamoeba* spp. are the cornea, skin, and lung; especially in the eyes *Acanthamoeba* stages are rather common in persons using plastic lenses. Thus these species are not only →*opportunistic agents*.

**Main clinical symptoms:** Chronic brain disturbances, possibly granulomatous encephalitis (→*GAE*); eye: →*conjunctivitis*, keratitis, uveitis.

**Incubation period:** 1 day – 2 weeks.

**Prepatent period:** 1 day – 2 weeks.

**Patent period:** Weeks to months in chronic cases.

**Diagnosis:** Culture techniques.

**Prophylaxis:** Do not swim in eutrophic lakes; change fluids for contact lenses often.

**Therapy:** →*Treatment of Opportunistic Agents*.

## Acanthella

The name acanthella (Figs. 1, 2) has been attributed to the →*Acanthocephalan* stage between the →*acanthor* and the larva that is infective to the final (or paratenic) host (→*Cystacanth*, →*Acanthocephala*). Its growth begins under the serosa of the →*intermediate host* and continues in its body cavity. The morphological changes from the →*acanthor* that has survived the enclosure by the intermediate host’s haemocytes and detached itself from the intestinal wall, to the late acanthella and the →*cystacanth* are considerable, e.g., organogenesis occurs as well as a rotation of the worm’s axis through 90 degrees, while the →*tegument* of the acanthor becomes stretched to form the acanthella’s tegument. First, the central nuclear mass begins to split into different bodies which become the primordia of the organs.

The acanthella’s tegument shows remarkable differentiation during the development in the arthropod’s haemocoel. Its outer membrane forms microvilli-like protuberances (Fig. 1, page 3) that build up a membranous sponge-like envelope around the larva. Haemocytes can be found in it (Fig. 1), especially near early acanthellae and if the intermediate host is not entirely suitable. Later on the spongy vesicular cover becomes supplemented by a thin interior and an exterior layer of amorphous matter and detaches itself from the worm body, forming a gap of different width with an electron lucent granular matrix (probably liquid), Fig. 2 (page 4). Late acanthellae show everted probosces; finally the →*proboscis* becomes invaginated or the entire →*praesoma* as well as the posterior end is retracted, so that the larva appears in a cystlike shape (→*Cystacanth*). This shape is common among species with definitive hosts that chew or grind their food in their upper intestinal tract (Fig. 2).

## Acanthobdella peledina

→*Leeches*.

## Acanthobdellida

→*Leeches*.

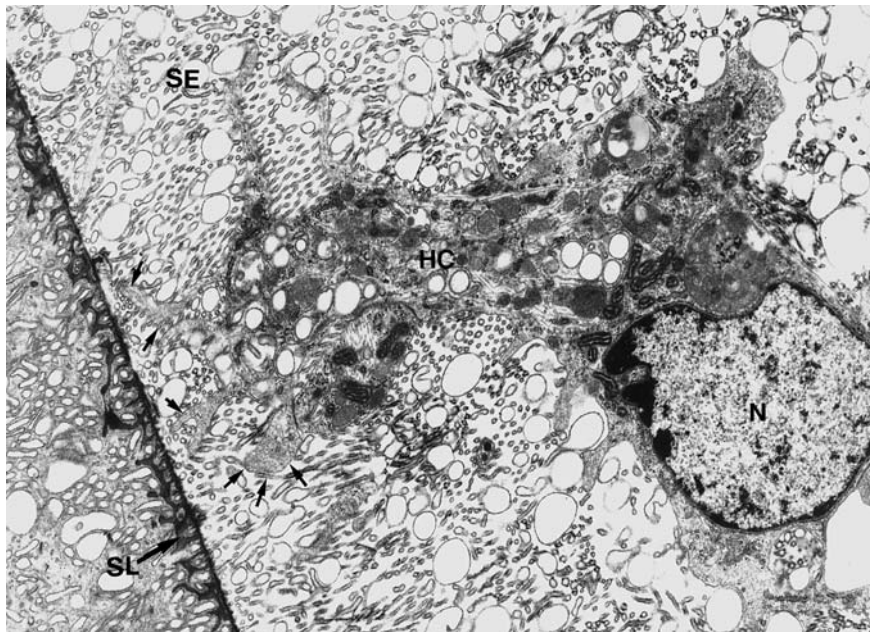

**Acanthella.** Figure 1 Transmission electron micrograph of the outer part of a young acanthella and the surrounding spongy envelope (SE) of microvilli-like outgrowths of the larva's surface. This envelope has not yet detached. A haemocyte (HC) of the intermediate host (a beetle) has invaded the envelope and come close to the worm with its →pseudopodia (arrows); *N*, nucleus of the haemocyte; *SL*, →striped layer of the developing tegument. ×3,500.

## Acanthocephala

### Name

Greek: *acantha* = thorn, *cephale* = head.

### Classification

Phylum or lower group of →Metazoa.

### General Information

Adult members of the Acanthocephala are highly specialized heterosexual, intestinal parasites that take up nutrition parenterally since they have no intestine. Vertebrates are used as final (definitive) hosts, arthropods as intermediate hosts (Table 1). The body consists of 2 major parts, the →praesoma and the →metasoma. The →praesoma comprises the →proboscis, armed with a set of specific hooks (Fig. 1, Attachment), a more or less pronounced →neck, the →proboscis receptacle, and the 2 lemnisci (Figs. 4, 16), which are cylindrical appendages of the praesomal →tegument. The tube-shaped metasoma (= trunk) is bounded by a solid body wall, enclosing the pseudocoel, which in addition to liquid is mainly filled with male or female sexual organs.

Additional morphological features as well as biological characteristics determine the affiliation to one of the classes.

### System

*Class 1:* Archiacanthocephala Meyer 1931: species have terrestrial life cycles; mammals or birds are final hosts, and insects (or millipedes) intermediate hosts; in addition, paratenic hosts are often involved; main longitudinal vessels of the lacunar system run dorsally and ventrally; usually there are 8 uninucleate →cement glands; few tegumental nuclei; ligament sacs inside the pseudocoel, also in adult worms (Fig. 16). The well known orders are:

Order: Apororhynchida

Order: Gigantorhynchida

Order: Moniliformida

Family: Moniliformidae

Genus: *Moniliformis*

Order: Oligacanthorhynchida

Family: Oligacanthorhynchidae

Genus: →*Macracanthorhynchus*

Genus: *Prosthenorhynchus*

*Class 2:* Palaeacanthocephala Meyer 1931: mostly aquatic life cycles; fish (waterbirds, seals) are final hosts, crustaceans intermediate hosts; main vessels of the lacunar system run laterally; 2–8 multinucleate cement glands; numerous tegumental nuclei; ligament sacs ruptured in adult worms.

Order: Echinorhynchida

Family: Echinorhynchidae

Genus: →*Acanthocephalus*

Genus: *Echinorhynchus*

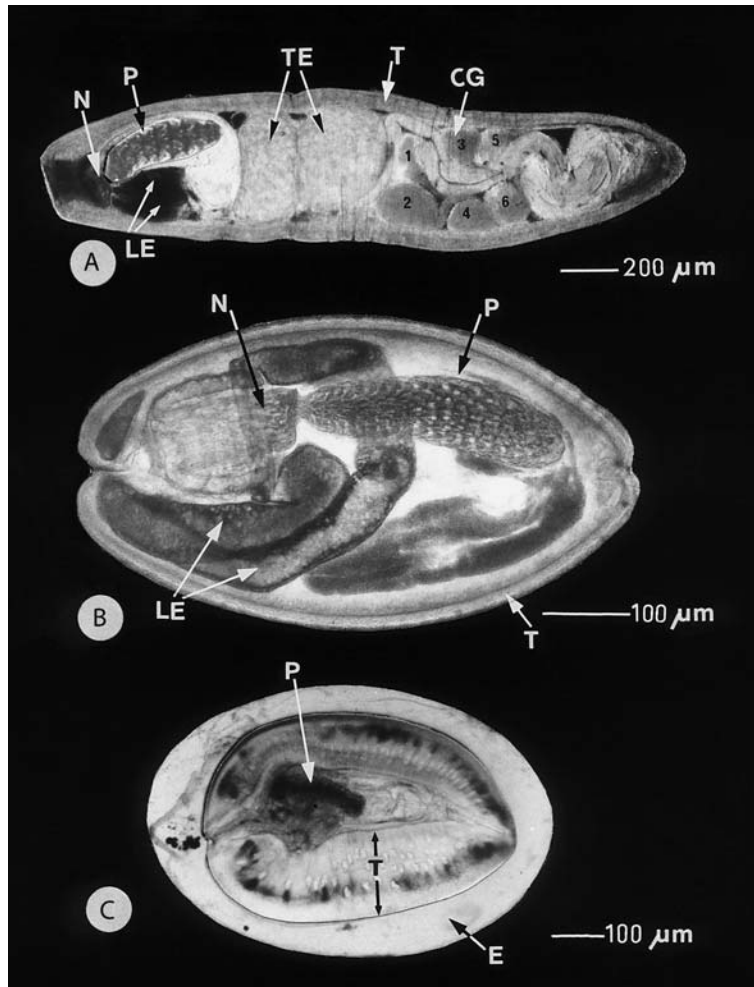

**Acanthella.** Figure 2 Infective male larvae of **A** → *Acanthocephalus anguillae*, **B** → *Filicollis anatis*, **C** → *Moniliformis moniliformis*. Note the progressing degree of encystment (from A to C) of the larvae parallel with a reduction in size and suppression of sexual organogenesis. Encystment seems to be an adaptation to the chewing or grinding activity of the final host (see life cycles). The larval envelopes (E) have been removed in A and B. The sausage-shaped larva of *A. anguillae* (A) has a very thin, closely fitting envelope. CG, → cement glands (1–6); E, → envelope; LE, → lemnisci; N, → neck; P, → proboscis (retracted); T, tegument; TE, testes.

Family: Pomphorhynchidae

Genus: *Pomphorhynchus*

Order: Polymorphida

Family: Centrorhynchidae

Family: Plagiorhynchidae

Family: Polymorphidae

Genus: *Corynosoma*

Genus: *Filicollis*

Genus: *Polymorphus*

**Class 3:** Eoacanthocephala Van Cleave, 1936: aquatic life cycles; fish (also reptiles, amphibians) are final hosts, and small crustaceans (mostly Ostracoda) intermediate hosts; main vessels of the lacunar system run dorsally and ventrally, only a single, giant uninucleate cement gland; tegument with giant nuclei; ligament sacs generally persistent in adults.

Order: Gyraacanthocephala

Order: Neoechinorhynchida

Family: Neoechinorhynchidae

Genus: → *Neoechinorhynchus*

Family: Tenuisentidae

Genus: *Paratenuisentis*

Recently, a fourth class has been erected, the Polyacanthocephala. The few known members of this group have been little studied. Fishes and crocodiles were found to be parasitized.

### Important Species

Table 1.

### Life Cycles

Figs. 2, 3.

## Attachment

Concerning the attachment to the host's intestinal wall, 2 groups can be distinguished: perforating and non-perforating acanthocephalans.

### Non-Perforating Acanthocephalans

Generally, acanthocephalans that have a short neck do not penetrate deeply into the host's intestinal wall with their praesoma, but display some mode of shallow attachment, i.e., they do not create lesions reaching as deep as into the muscular layers of the intestinal wall (Figs. 4–6, →Acanthocephalan Infections/Fig. 8). Accordingly, often even the posterior half of the proboscis does not become surrounded by host tissue (Fig. 5). Layers of connective tissue within the hosts' intestinal wall often appear to function as penetration obstacles. This might be the stratum compactum in salmonids retaining →*Echinorhynchus truttae* in superficial positions or a →collagen layer interiadly lining the intestinal mucosa of perch (*Perca fluviatilis*) affecting the mode of attachment of →*Acanthocephalus lucii* (Fig. 5). On the other hand, the tipped proboscis hooks seem to use the collagen layers as suitable substrates of anchorage (Fig. 6). In Fig. 6 a necrotic tissue with a slight infiltration of granulocytes and haemorrhagic involvement, typical of the attachment site of *Acanthocephalus lucii* and other non-perforating species, is shown (Fig. 4). When non-perforating species were experimentally inoculated into small specimens of fish not comprising penetration obstacles in their gut wall, 3 non-perforating species did not try or succeed in perforating either. And accordingly such species usually cannot be found *in toto* in extraintestinal

locations like perforating species. →*Paratenuisentis ambiguus* and *P. lucii*, both non-perforators, do not possess collagenolytic →proteinases useful in chemical support of penetration activity. So paratenic hosts do not occur in the life cycles of non-perforating acanthocephalans, but postcyclic transmission of intrainestinal worms like *Neoechinorhynchus rutili* in sticklebacks to predatory brown trout seems to be very common.

Such species either continuously or occasionally change their point of attachment, exposing them to the posteriadly directed intestinal peristalsis. In infrapopulations of *E. truttae* in brown trout all specimens have arrived at the posterior end of the small intestine by the time the worms have matured. As has been shown for *N. cylindratus*, a species that is potentially perforating, infrapopulations with high worm densities lead to enhancement of change of the point of attachment and consequently to greater posterior shift. An interesting feature can be observed in other neoechinorhynchids. Although they occupy superficial positions, they do not seem to migrate or become shifted after an initial period of establishment, due to a firm capsule of collagen fibres enclosing their small, roundish proboscis. A negative point of the proboscis remains in the intestinal wall after deattaching a worm using forceps (→Acanthocephalan Infections/Fig. 5A). Not unlikely, this massive collagen formation is provoked by the excretion of →proline (→Amino Acids) or other substances by the praesoma.

A typical non-perforating species is the archiacanthocephalan →*Moniliformis moniliformis* displaying a deep proboscis cavity and shallow attachment (→Acanthocephalan Infections/Fig. 8).

**Acanthocephala. Table 1** Some important species of the Acanthocephala

Class/Species	Size (adults, mm; egg, E, µm)	Final host	Intermediate host	Paratenic host	Geographic distribution
<b>Archiacanthocephala</b>					
<i>Moniliformis moniliformis</i>	m 30–45 f 140–270 E 90–125 × 50–62	<i>Rattus</i> spp., other rodents, occasionally humans, monkeys etc.	Cockroaches	–	Worldwide
<i>Macracanthorhynchus hirudinaceus</i>	m 50–90 f 200–650 E 90–100 × 50–56	Pigs, occasionally humans, etc.	Beetles (larvae)	–	Worldwide
<i>M. ingens</i>	m 130–150 f 180–300 E 96–106 × 51–54	Raccoons, other mammals	Beetles	Amphibia, reptilia	North America
<i>Prosthenorchis elegans</i>	m 20–40 f 30–55 E 60–65 × 41–43 (78–81 × 49–53)	Monkeys, other mammals	Cockroaches, beetles	–	South America, domestic cycle worldwide



**Acanthocephala. Table 1** Some important species of the Acanthocephala (Continued)

Class/Species	Size (adults, mm; egg, E, $\mu\text{m}$ )	Final host	Intermediate host	Paratenic host	Geographic distribution
<b>Palaeacanthocephala</b>					
<i>Acanthocephalus anguillae</i>	m 5–7 f 10–35 E 100–125 $\times$ 12–14	Chub, barbel	<i>Asellus aquaticus</i>	Small cyprinid fish*	Europe
<i>A. ranae</i>	m 5–12 f 20–60 E 110–130 $\times$ 13–16	Amphibia	<i>Asellus aquaticus</i>	–	Holarctic
<i>Echinorhynchus truttae</i>	m 8–11 f 15–20 E 100–110 $\times$ 23–26	Salmonid fish	<i>Gammarus</i> spp.	–	Europe
<i>Corynosoma semerme</i>	m 3–5 f 3–5 E 79–100 $\times$ 16–29	Seals, birds, occasionally dogs, etc.	<i>Pontoporeia affinis</i> (Amphipoda)	Various marine fish	Holarctic
<i>Pomphorhynchus laevis</i>	m 6–16 f 10–30 E 110–121 $\times$ 12–19	Chub, barbel, trout	Gammaridae	Small Cyprinidae and other fish*	Palaeartic
<i>Filicollis anatis</i>	m 6–8 f 10–25 E 75–84 $\times$ 27–31	Ducks, other water birds	<i>Asellus aquaticus</i>	–	Palaeartic
<i>Polymorphus minutus</i>	m 2–3 f 6–10 E 100 $\times$ 11–12	Ducks, other water birds	<i>Gammarus</i> spp.	–	Holarctic
<b>Eoacanthocephala</b>					
<i>Neoechinorhynchus cylindricus</i>	m 4.5–8.5 f 10–15 E 51–61 $\times$ 17–28	Predatory fish (bass, etc.)	<i>Cypria globula</i> (Ostracoda)	Small fish (bluegills, etc.)*	North America
<i>N. emydis</i>	m 6–15 f 10–22 E 20–25 $\times$ 20–22	Turtles	<i>Cypria globula</i> (Ostracoda)	Water snails	North America
<i>N. rutili</i>	m 2–6 f 5–10 E 26–27 $\times$ 14–17	Salmonid and other fish	Ostracoda	–	Holarctic
<i>Paratenuisentis ambiguus</i>	m 2.5–8 f 8–14 E 62–72 $\times$ 26–31	Eels	<i>Gammarus tigrinus</i>	–	North America, Europe (introduced)

\* This host category is not yet sufficiently investigated. Thus it remains doubtful whether these species are true paratenic hosts.

m = male, f = female, E = egg

### Perforating Acanthocephalans

Many Acanthocephalans possess a long neck which may comprise a bulbous part such as the *Pomphorhynchus* spp. (Palaeacanthocephala) with an inflated neck region (praesoma) (Fig. 1). In the eoacanthocephalan *Eocollis arcanus* it is the anterior part of the metasoma which

forms a bulb. In both cases the bulbous part functions as a dowel enabling the worm to occupy a permanent point of attachment at a specific site. The deep and quick perforation of the intestinal wall may be supported by a proteolytic enzyme as shown for *Pomphorhynchus laevis* which excretes a trypsin-like proteinase into the

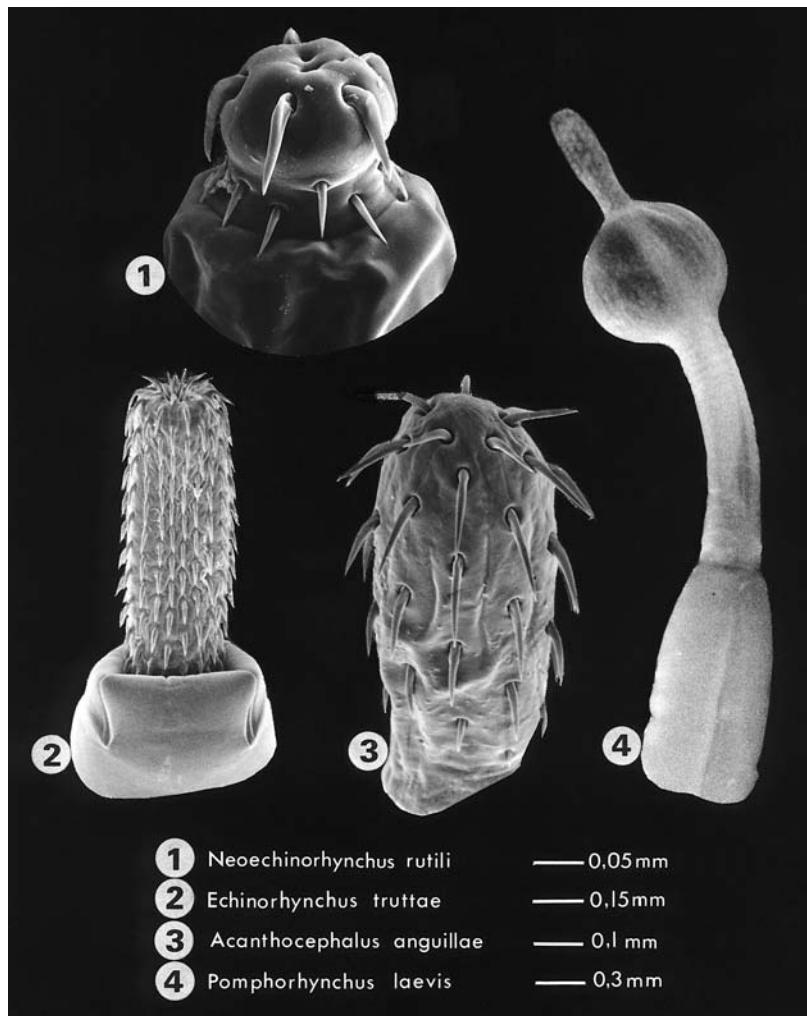

**Acanthocephala. Figure 1** SEMs of acanthocephalan praesomae.

culture medium. It has a collagenolytic activity and the molecular mass differs slightly among infectious larvae and adult worms removed from fish. The long-necked species *A. anguillae* does not display such abilities in lysing collagen and accordingly the collagenic stratum compactum of salmonid fishes retains most worms in rather superficial connections with the intestinal wall. In experimental infections in adult rainbow trout the worms take about 60 days to perforate the stratum compactum, in juveniles of the same salmonid host it occurs around 20–30 d.p.i. In the long run, only those worms which succeed in penetrating seem to survive for several months in this host, while the others probably do not have the potential to withstand the intestinal drift. As shown for *P. laevis*, typical perforating species do not change their site of attachment and thus do not become backwards shifted. In natural populations of fish hosts, species like *P. laevis*, *Eocollis arcanus*, or *A. anguillae* are not only found in positions with a praesoma deeply inbedded inside the intestinal wall, but also partly lying *in toto* inside the peritoneal cavity or viscera,

especially in small specimens or species. Obviously, in such hosts the intestinal wall or the collagen layers within it are not strong enough to withstand the worms' penetrating activity. In juveniles of goldfish experimentally infected with *A. anguillae*, the first worms started projecting into the peritoneal cavity with parts of their praesoma up from about 10 d.p.i., worms of about 20–30 d.p.i. were mostly found in various positions like lying with parts of their bodies inside one intestinal loop and projecting into another with the proboscis or anterior body (→ [Acanthocephalan Infections/Fig. 5](#)). In contrast, at 50 d.p.i. all worms recovered had taken intraperitoneal positions and most of them were already degenerating. Due to this quick death of the worms in extraintestinal positions, one may conclude that they did not leave the intestine "on purpose" but slipped into the peritoneal cavity *in toto* by lack of penetration obstacles or other features. Thus, the small fishes that became infected in these experiments should not be called → [paratonic hosts](#). However, true paratonic hosts exist in the life cycles of certain perforating

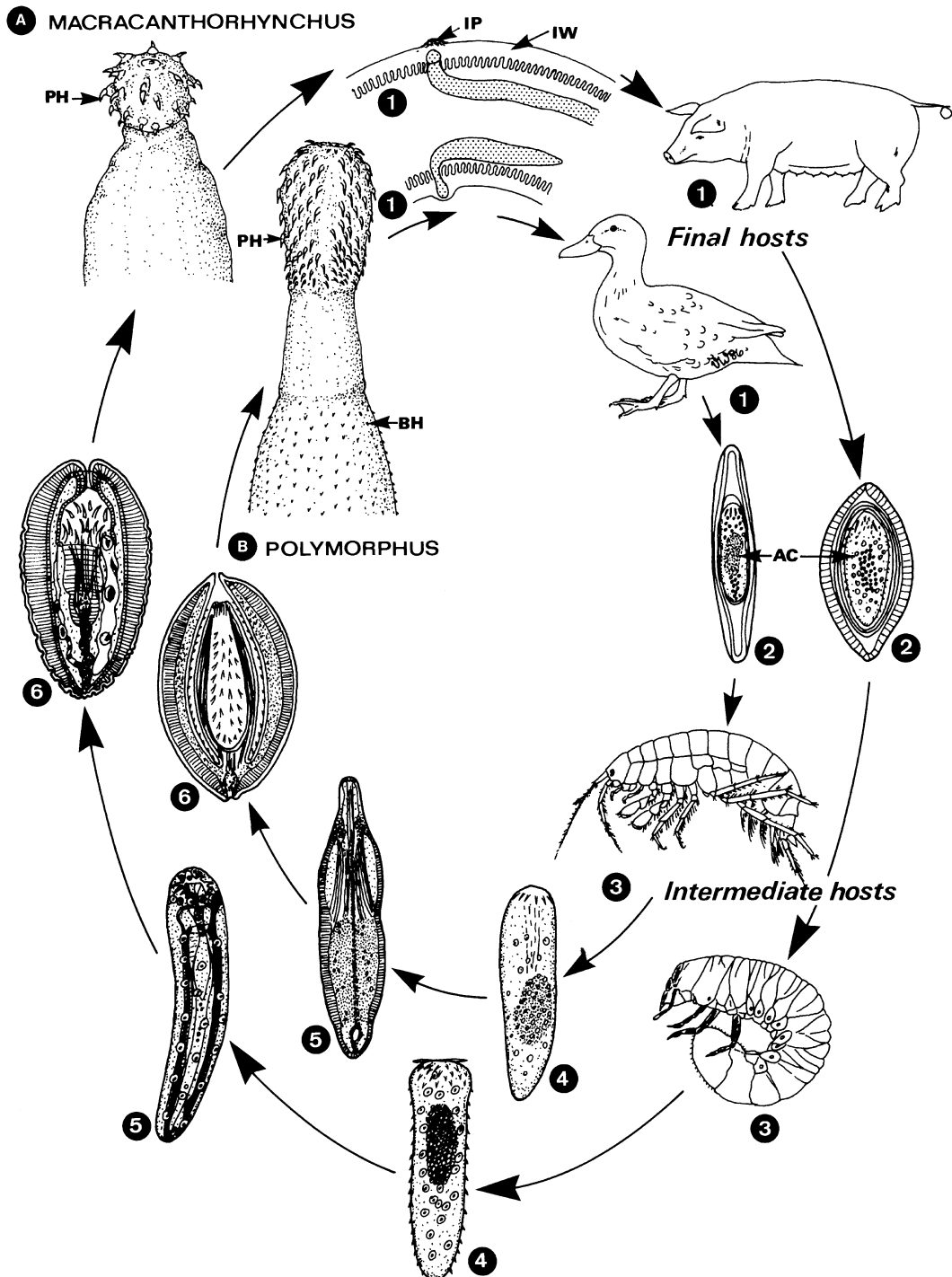

**Acanthocephala.** Figure 2 Life cycle of common acanthocephalan species. **A** → *Macracanthorhynchus hirudinaceus*; **B** → *Polymorphus minutus*. 1 The adults live in the intestine of their final hosts, being attached by their hooked proboscis. The penetration of the intestinal wall leads to inflamed protrusions (IP) appearing along the outer side. 2 After copulation the adult females excrete eggs for several months (patent period). These eggs are passed fully embryonated (i.e., they contain the hooked →acanthor larva) with the faeces of the host. 3–6 Intermediate hosts (*Gammarus* spp. or beetle larvae) become infected by ingesting infective eggs. Inside the intestine the acanthor is released from the egg (4), enters the body cavity, and is transformed into an →acanthella larva (5). The latter grows up within 60–95 days (in *M. hirudinaceus*) and is described as an infective larva (→Cystacanth). Infection of the final hosts occurs when they swallow infected intermediate hosts. The young worms reach sexual maturity within 60–90 days in *M. hirudinaceus* (after 20 days in *Polymorphus minutus*) and start egg production (= end of prepatent period). AC, acanthor; BH, body hooks; IP, inflamed protrusion of IW; IW, intestinal wall; PH, proboscis hooks; RA, released acanthor.

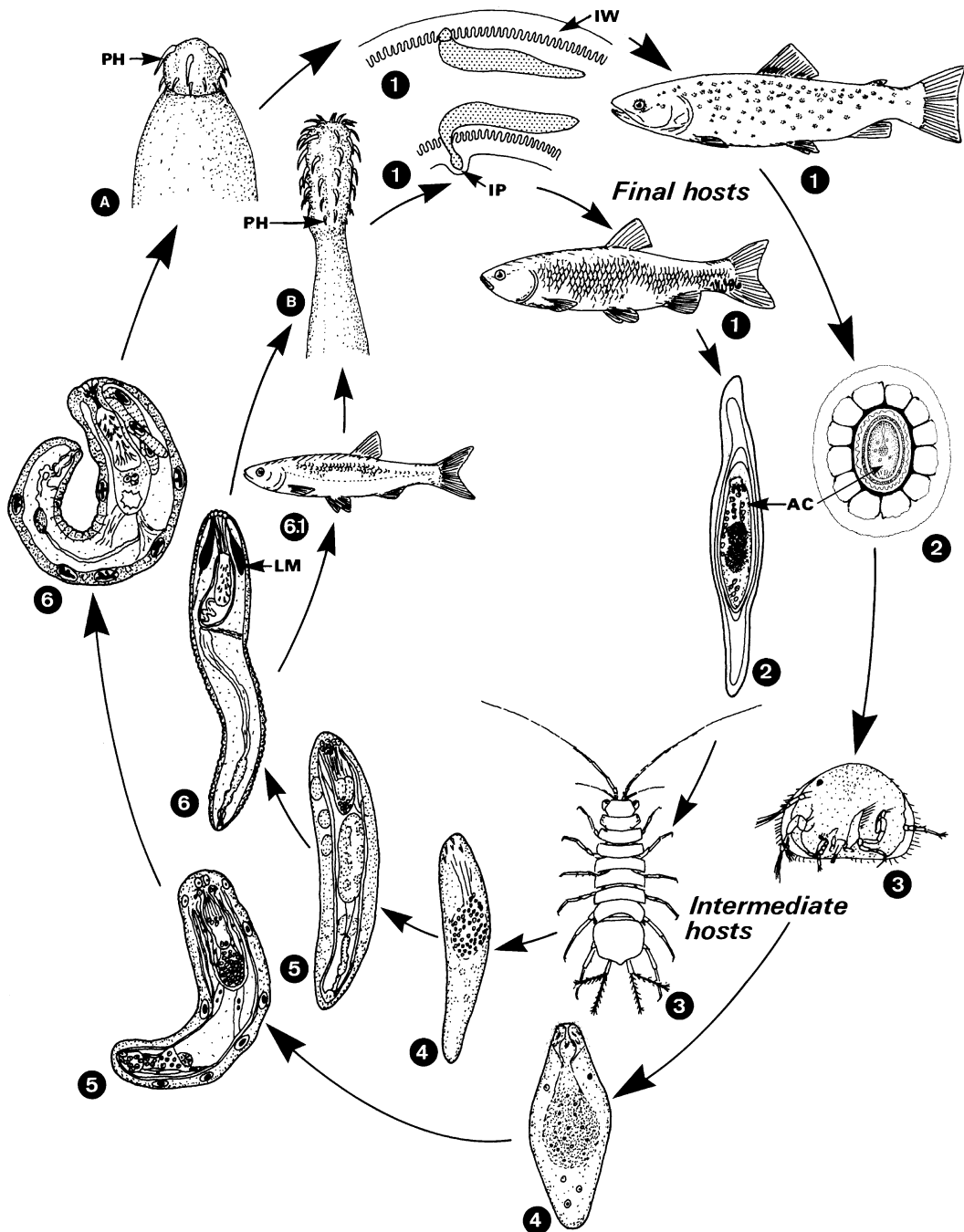

**Acanthocephala. Figure 3** Life cycle of two common acanthocephalan species parasitizing fish. **A** → *Neoechinorhynchus rutili*; **B** → *Acanthocephalus anguillae*. 1 Adults are attached to the intestinal wall of their final hosts, trout (A) or chub and other fish (B). 2 Fully embryonated eggs are passed with host's faeces. 3–6 Intermediate hosts (**A** ostracod crustaceans, **B** *Asellus aquaticus*) are infected by uptake of eggs. Inside their intestine the acanthor larva (4) is released from its → eggshell, enters the body cavity and becomes transformed into the acanthella larva (5). This stage differentiates to the infective larva without → encystation in about 30–60 days (6) depending on outer conditions. Final hosts are infected by swallowing intermediate hosts. In *A. anguillae* a → paratenic host may also become involved. When bleaks and some other fish ingest intermediate hosts (*Asellus aquaticus*), the infective larva enters the fish viscera, but there is no further development, but quick degeneration. *Neoechinorhynchus rutili* and *A. anguillae* reach sexual maturity in about 20–30 or 40–60 days, respectively (prepatent period). Adults live only for about 2–3 months (patent period). AC, acanthor; IP, inflamed protrusion of IW; IW, intestinal wall; LM, → lemniscus; PH, proboscis hooks.

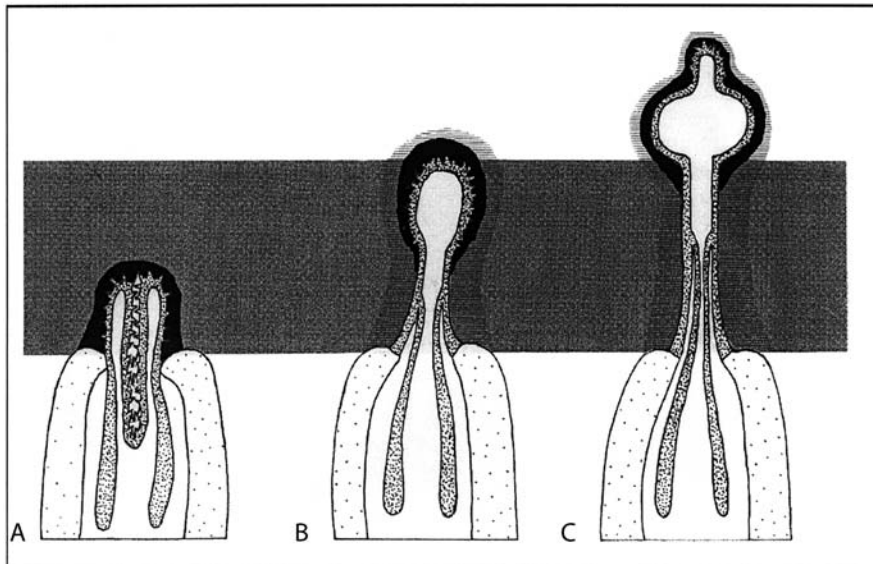

**Acanthocephala.** **Figure 4 A–C** Schematic drawings of the acanthocephalan praesoma and the corresponding mode of attachment. Black area: tissue → necrosis, hatched area: tissue neoplasia. **A** Acanthocephalan with a short neck, and lemniscis branching away from the posterior end of the praesomal tegument. A deep proboscis cavity is formed. Necrotic host tissue (black area) can be found all around the parasite's proboscis. **B** Perforating acanthocephalan with a long neck, and lemniscis branching away from the praesomal tegument at the mid-neck. In the chronic mature stage of infection the proboscis becomes deeply embedded in the intestinal wall and is usually kept fully evaginated. Necrotic host tissue is mainly confined to the proximity of the proboscis. Tissue neoplasia is pronounced also proliferating into the peritoneal cavity. **C** Perforating acanthocephalan with a long neck, a bulbus and lemnisci branching away from the praesomal tegument at the mid-neck. In the chronic (mature) stage of infection the parasite is “doweled” in the intestinal wall with the bulbus. The proboscis is usually kept fully evaginated. Necrosis is mainly confined to the tissue close to those parts of the worm that project into or border the peritoneal cavity. Tissue neoplasia especially in the peritoneal cavity is conspicuous.

acanthocephalans. → *Oncicola pomatostomi*, for instance, is parasitic in the intestine of Felidae and Canidae in Southeast Asia and Australia while it has been found under the skin of 19 species of passerine birds where it probably has a certain longevity making the birds true paratenic hosts.

Often *Macracanthorhynchus hirudinaceus* occupies extraintestinal positions in humans. The migration of this perforating acanthocephalan through the gut wall is very painful. Such infected humans with an intraperitoneally located worm might be named accidental hosts since they do not play a role in the transmission of the acanthocephalan.

Among perforating species a proboscis cavity is formed mainly during the early phase in the final host when the worm has not yet penetrated, later on, the cavity's depth and frequency of invagination are progressively reduced (→ *Acanthocephalan Infections/ Fig. 5*).

### Food Uptake

In non-perforating acanthocephalans the proboscis itself is usually kept in a more or less invaginated condition creating a deep proboscis cavity (*Fig. 4A*) which

obviously functions as a funnel collecting remnants of cells and nutrients leaking into the lesion that has been created by the worm. In eo- and palaeacanthocephalans, especially lipid substances such as triacylglycerols are highly abundant as storage lipids in the intestinal wall of fish, ducks, or seals serving as final host. As shown in *Fig. 10* lipid matter as well as, for instance, peptides deriving from the granules of eosinophilic granulocytes contribute to the efflux from the necrotic tissue. However, autoradiographic studies by Taraschewski and Mackenstedt with 2 species of eoacanthocephalans and 4 palaeacanthocephalans (2 non-perforating and 2 perforating species) show that predominantly lipid substances are absorbed at the worms' praesoma (*Figs. 7, 8*). The “→apical organ” of eoacanthocephalans, a structure not yet well understood at the tip of the proboscis, i.e., at the bottom of the proboscis cavity (*Fig. 7*), and the tegument of the anterior half of the proboscis (*Fig. 8*) play the most active role in lipid uptake. Interestingly, the proboscis hooks, too, can be considered organs well adapted to the task of lipid uptake (*Figs. 7, 8*). In accordance with their tapered and tipped construction (*Fig. 7B*) the hooks are in reach of lipid deposits which are not (yet) in contact with the surface of the praesoma. Behind the septum



**Acanthocephala. Figure 5** Light micrograph of a longitudinally sectioned (paraffin section) anterior body of *Acanthocephalus lucii* attached to the intestinal wall of a river perch (*Perca fluviatilis*). Only the intestinal mucosa has been ruptured. A thin layer of collagen fibres (arrow) interlacing this epithelium was not perforated. Also note the proboscis cavity at the anterior tip of the worm showing the normal condition of the proboscis of a non-perforating species.  $\times 20$ .

between praesomal and metasomal tegument the uptake of a  $\rightarrow$ triacylglycerol as well as of  $\rightarrow$ vitamin A was very low in *in vitro* trials. However, if “shoulders” of the metasoma were in contact with the praesomal surface during the exposition of a worm to the labelled nutrient, the shoulders too revealed a markable label (Fig. 8), suggesting that enzymes localized at the praesomal surface were involved. Uptake of amino acids as well as monosaccharides also occurs at the surface of the praesoma (Fig. 9), but the metasomal tegument seems to be the major absorptive surface for these substances.

Concerning the uptake of nutrients by adult perforating species, the mechanisms do not basically deviate from those described for non-perforating species. Since the whole praesoma is deeply embedded in the gut wall, a funnel for substances leaking into intestinal lumen is not very large. Intra-intestinally attached worms that have a bulbous can be easily recognized at the gut's exterior side ( $\rightarrow$ Acanthocephalan Infections/Fig. 6) but



**Acanthocephala. Figure 6** TEM of a transversally sectioned proboscis hook of *Acanthocephalus lucii* surrounded by necrotic and inflamed intestinal tissue of *Perca fluviatilis*. The hook: note the perforations in its  $\rightarrow$ striped layer (SL); the connective tissue of the hook does not reach into the tip sectioned here. The hook has punctually perforated the layer of subepithelial connective tissue (SC) that can be seen in Fig. 5 at a lower magnification (arrow). But the proboscis *in toto* did not perforate this layer (LA: lamina of fine amorphous material lining the mucosal epithelium). The proboscis (not seen) is either in front or behind the plane of the section.  $\times 2,000$ .

also in species without a bulbous, like *M. hirudinaceus*, a fibrous whitish  $\rightarrow$ nodule with reddened annulation around it can be seen.

### Integument

The tegument of acanthocephalans is a  $\rightarrow$ syncytium of up to 2 mm in thickness (*M. hirudinaceus*). It either contains numerous small nuclei (Fig. 13C) or specific numbers of giant nuclei in eoacanthocephalans (Table 1). The nuclei of the tegument of the metasoma (trunk) are not immersed below the tegument (Fig. 13C). In the praesoma (proboscis and neck), however, the nuclei are harboured by the lemnisci; sack-shaped outgrowths of the praesomal tegument projecting into the body cavity (Fig. 16). The tegument is supported by underlying fibres of connective tissue, partly identified as collagen, of equal thickness in all parts of the body, and by cords of circular (only in the metasoma)

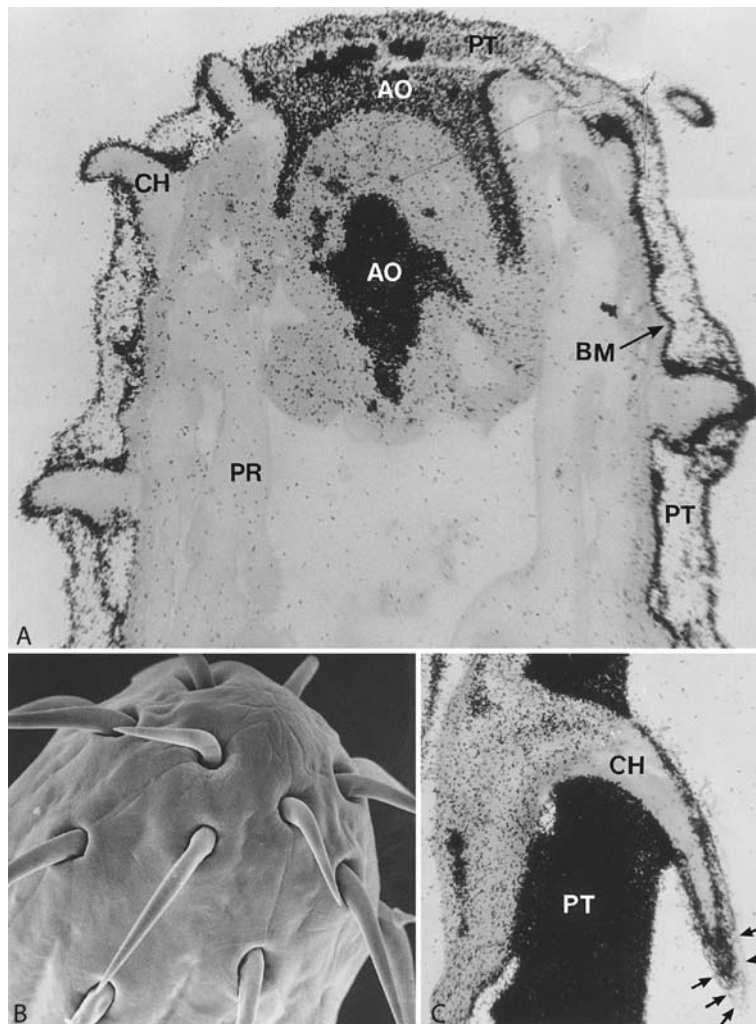

**Acanthocephala. Figure 7 A–C** Micrographs showing the proboscis tip and hooks of various acanthocephalans. **A** Longitudinal semithin section of *Paratenuisentis ambiguus* that had been exposed *in vitro* to [ $^3\text{H}$ ]-glyceroltrioleate for 5 minutes. The proboscis is fully everted, which is not the normal condition *in vivo*. Note the intense label of the “apical organ” (AO). The lipid that has been taken up by the hooks and the surrounding tegument (PT) seems to be transported along the outer membrane and the basal membrane (BM) of the tegument; CH, connective tissue of a hook; PR, proboscis retractor muscle.  $\times 3,500$ . **B** SEM of the tipped hooks at the anterior proboscis of *Acanthocephalus anguillae*.  $\times 1,600$ . **C** Longitudinal semithin section of a proboscis hook of *A. anguillae* that has been exposed to [ $^3\text{H}$ ]-labeled lipids. Note the labelled tegument of the hook underneath its striped layer. The proboscis tegument (PT) has already absorbed huge quantities of the lipid.  $\times 3,000$ . CH, connective tissue of the hook.

muscles and longitudinal muscles (in both parts of the body; Fig. 13C). These components together build up the body wall (Fig. 13C). The tegument shows a typical stratification and a differentiation related to the praesoma-metasoma organization of the acanthocephalan body.

### Metasoma

- The syncytial tegument of the Acanthocephala is delimited by a plasma membrane carrying a filamentous  $\rightarrow$ surface coat (Fig. 12A) which has a similar appearance in all systematic groups of these

worms regarding the surface of the metasoma (Fig. 12, Table 1). This  $\rightarrow$ glycocalyx also covers the pores (openings of the outer membrane’s crypts) of the tegument. It may reach a thickness of up to one  $\mu\text{m}$  or more and obviously proteoglycans are present in it. Infective larvae inside the intermediate host’s hemocoel carry the most conspicuous surface coat. The plasma membrane itself forms densely set crypts projecting into the outer part of the tegument. Their greater density in the metasoma compared to the praesoma might have to do with the heavy competition pressure between the trunk surface being located inside the gut lumen, and the host’s

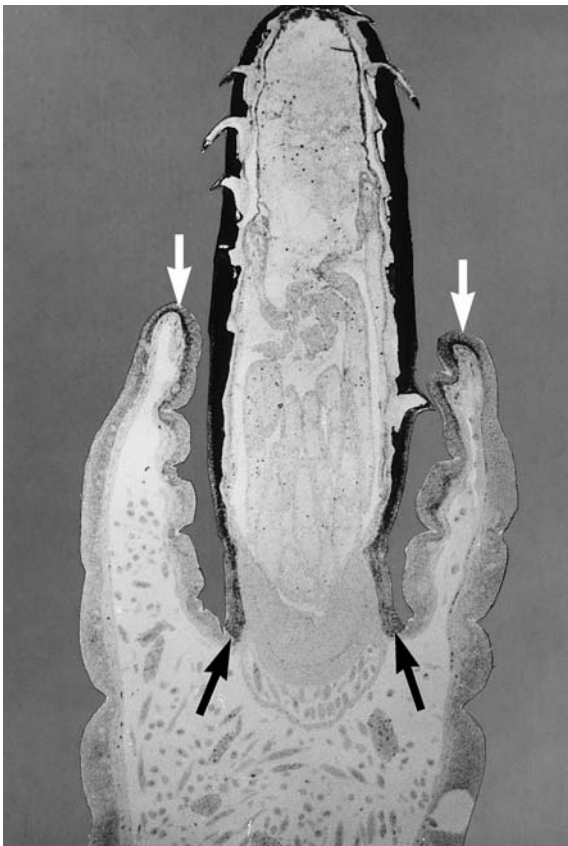

**Acanthocephala. Figure 8** Longitudinally cut semithin section of the anterior body of an *Acanthocephalus lucii* that had been *in vitro* exposed to [ $^3\text{H}$ ]-vitamin A for 15 minutes. Note the intense label of the anterior half of the proboscis tegument which lines the proboscis cavity normally formed. Behind the septum between the praesomal and the metasomal tegument (black arrows) almost no absorbance of the substance offered has taken place. However, it appears that the accidentally formed “shoulder” of the metasoma that obviously was in contact with the praesoma during the exposure has attained some label in its tegument (white arrows), suggesting that this part of the metasoma took advantage of enzymatic activity prevailing at the praesomal surface.  $\times 60$ .

intestinal mucosa for the absorbance of nutrients. The crypts have been calculated to increase the worm’s “outer” surface 20- to 80-fold. The crypts have slender necks with electron-dense annulations underneath their outer openings (seen as pores by SEM) and they form branches directly underneath the pores or further inside the tegument. The crypts are considered extracytoplasmic digestive organelles which under the influence of surface hydrolytic enzymes maximize the opportunities of food absorption by these gutless worms. So it might be a point of debate whether the membrane limiting the lumen of the crypts really is an “outer” surface (Fig. 12).

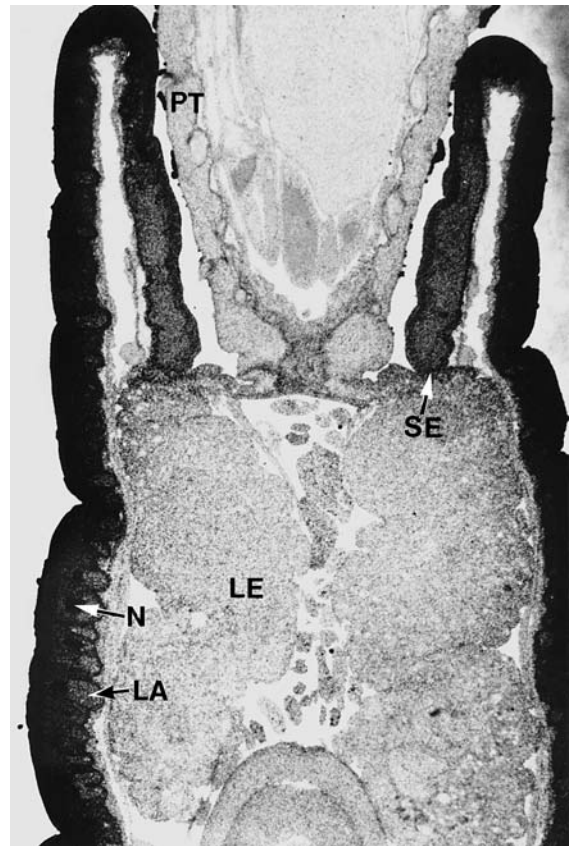

**Acanthocephala. Figure 9** Autoradiographically treated longitudinal section of the anterior body of a female *Echinorhynchus truttae* that was exposed to [ $^3\text{H}$ ]-lysine for 8 minutes. Note the less intense label of the presomal tegument (PT) compared to the metasomal tegument.  $\times 100$ . SE, septum between the presomal and the metasomal tegument (compare Fig. 12B); LA, tegumental lacunar system; LE, lemniscus; N, nucleus.

- Interiably, the outer membrane is supported by an electron-dense layer of about  $5\ \mu\text{m}$  in thickness. Due to perforations of this “ $\rightarrow$ cuticle” by the crypts, this layer obviously having stabilizing functions is seen as a striped layer in TEM micrographs (Fig. 12). Usually the longitudinal extension of the membrane-crypts considerably exceeds the diameter of the striped layer, forming a spongy belt rich in pinocytotic activity (Fig. 12). This layer is considered a “ $\rightarrow$ vesicular layer” by a few authors.
- The  $\rightarrow$ feltwork layer adjoining underneath again seems to contribute to the skeletal task of the tegument but its diameter is about 5 times larger than that of the striped layer ( $\rightarrow$ Acanthella/Fig. 1, showing this feature in the praesoma). It is characterized by fibres displaying no particular order, and normally it contains large amounts of  $\rightarrow$ glycogen. Metasomal spines, present in many palae- and eoacanthocephalans (Table 1),





**Acanthocephala. Figure 10** Semithin section of the proboscis of a specimen of *Neoechinorhynchus rutili* attached to the gut wall of a naturally infected juvenile rainbow trout. Note the conspicuous quantities of lipid (LI) accumulating at the worm's proboscis. They seem to derive from the surrounding necrotic tissue. Also, fused granules from degranulated eosinophilic granulocytes (arrow) are abundant, fusing with the lipid drops. In such a methylene-blue-stained section the lipid attains a greenish-golden colour while the fused granules are a deep blue. Thus both substances can be distinguished well.  $\times 100$ . AO, apical organ.

have been described as outgrowths of the feltwork layer and are thus invested by a thin cover of a somewhat condensed striped layer. These trunk spines, often ornamenting a wider part of the ventral surface than of the dorsal side, are thought to act as additional  $\rightarrow$ holdfast organs.

- The more proximal radial layer (Fig. 13C) occupies more than 70% of the tegumental diameter. This layer is considered to be the main metabolic centre of the acanthocephalan body. During the (allometric) growth of the worms it is mainly the increase in diameter of the radial layer which leads to a thicker tegument. This layer is characterized by radially arranged fibres connected to the basal membrane.

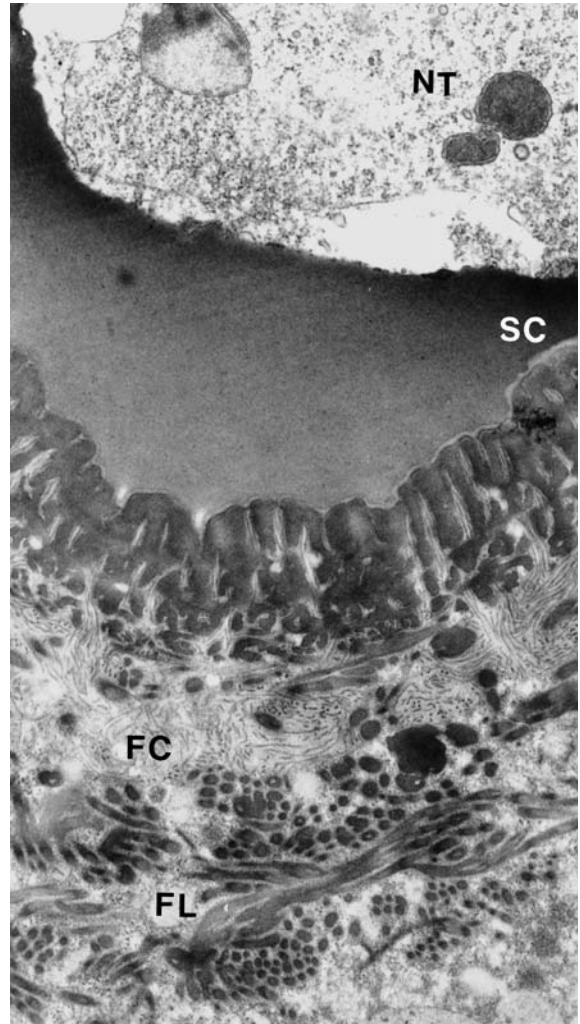

**Acanthocephala. Figure 11** Transmission electron micrograph of a section through the distal part of the praesomal tegument of *Acanthocephalus anguillae* (in a rainbow trout, 90 dpi). Note the thick lipoid surface coat (SC) between the tegument and the necrotic tissue (NT) at the point of attachment, also the fused crypts of the outer membrane (FC) with supporting microfibrils in it and the underlying feltwork layer (FL). A section with little osmiophilic content of the fused crypts was chosen in order to show the microfibrils in it.  $\times 25,000$ .

Electron-dense matter accumulates around the spokes (Fig. 13C). This layer harbours the tegumental nuclei (Fig. 13C) and the major canals of the lacunar system (Fig. 14C). The lumen of this system is poor in organelles and electron-dense matter (Fig. 14C) and in autoradiographic trials it takes up and/or retains less nutrients than the surrounding  $\rightarrow$ cytoplasm. Also its  $\rightarrow$ glycogen content is low in contrast to the true radial layer, which usually stores plenty of this  $\rightarrow$ carbohydrate. Apparently contractions

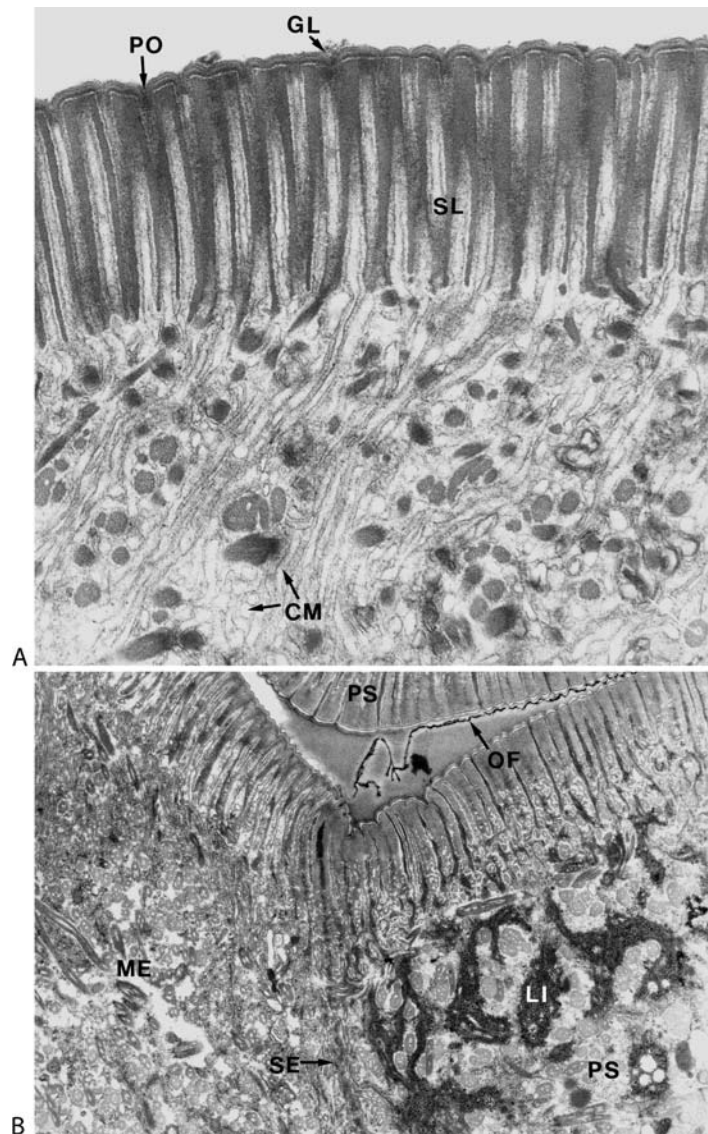

**Acanthocephala. Figure 12 A, B** TEMs of the distal part of the adult acanthocephalans' tegument. **A** Section through the metasomal tegument of *Acanthocephalus lucii*. Note the striped layer (SL) functioning as a cuticle. It is perforated by densely set crypts of the outer membrane (CM). PO, pore of a crypt; GL, glycocalyx (which is thin on the specimen shown here). **B** Section through the area around the septum (SE) separating the praesomal tegument (PS) (which is folded in this worm shown *in vivo*) from the metasomal tegument (ME) of *Acanthocephalus anguillae*. Note the abundance of lipid (LI) in the praesoma and the osmiophilic film (OF) obviously shed from the praesomal surface into the thick, apparently liquid surface coat of the praesoma.  $\times 28,000$ .

of the subtegumental musculature (Fig. 13C) act as the motive force for fluid flow inside the lacunas. However, it remains unclear whether these caverns fulfil functions of a circulatory system.

- The basal membrane, interiadly bounding the tegumental syncytium, shows a typical labyrinthine structure. Along its distal surface it is supported by amorphous matter, whereas a thin lamina of a fine matrix lines the proximal side of the membrane (Fig. 13C).

### Praesoma

The tegument of the praesoma is separated from that of the trunk by a septum composed of fibres and adherent amorphous matter (Fig. 12B). So even the lacunar cavities are part of 2 different systems, which might make sense considering the assumed involvement of hydrostatic pressures in the protrusion, invagination, and retraction of the proboscis or the entire praesoma. Within the praesoma mainly the neck possesses lacunar cavities. The praesomal tegument reveals major differences compared to

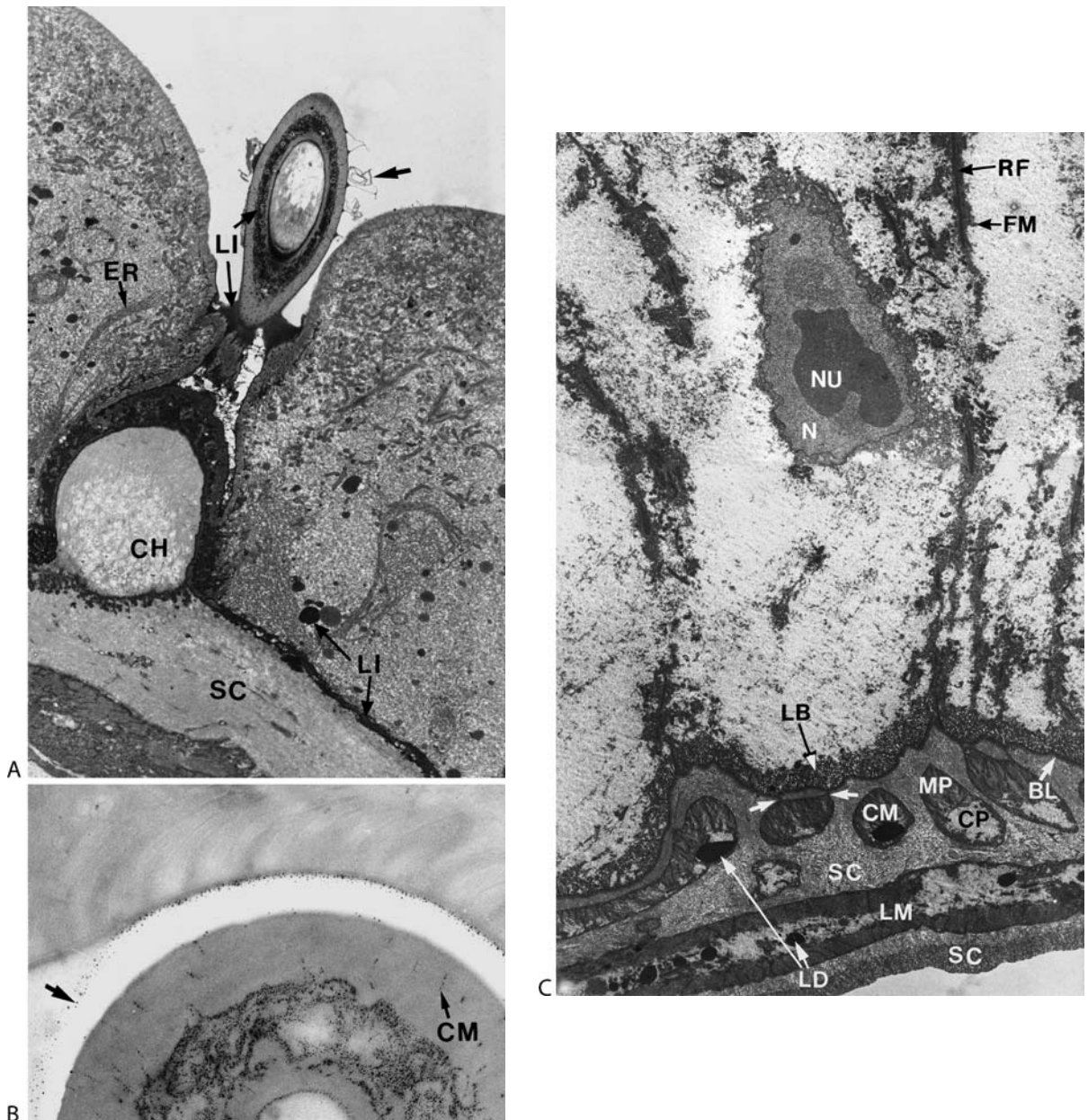

**Acanthocephala. Figure 13 A–C** TEMs of sections through the proboscis tegument and hooks of the eoacanthocephalan *Paratenuisentis ambiguus*. **A** The curved hook which is retracted in this micrograph is sectioned twice, at its connection with the subtegumental connective tissue (*CH*, connective tissue of the hook) and at its tipped outer portion. Note the lipoid substance (*LI*) being excreted through the pores in the hook, which (or a similar substance) is also abundant in the surrounding tegument; *SC*, connective tissue of the presomal tegument; *ER*, rough endoplasmic reticulum.  $\times 10,000$ . **B** Cross section through a retracted hook and neighbouring proboscis tegument. The section has been treated according to the electron microscopical PAS-staining method by Thiéry. Note the mucus-like carbohydrates inside (*CM*, crypt of the hook's outer membrane) and outside the hook (arrow).  $\times 56,000$ . **C** TEM of the basal part (radial layer) of the metasomal tegument of an adult *Acanthocephalus anguillae*. Note the radially arranged fibres (*RF*) with fibrous, electron-dense material (*FM*) attached to them, the labyrinthine basal membrane (*LB*) and the cords of subtegumental musculature (*CM*, circular muscle, *LM*, longitudinal muscle) consisting of an outer myogenic portion (*MP*) and an inner non-contractile portion (*CP*); *BL*, basal lamina, *LD*, lipid drop, *N*, nucleus, *NU*,  $\rightarrow$  nucleolus, *SC*, subtegumental connective tissue.  $\times 50,000$ .

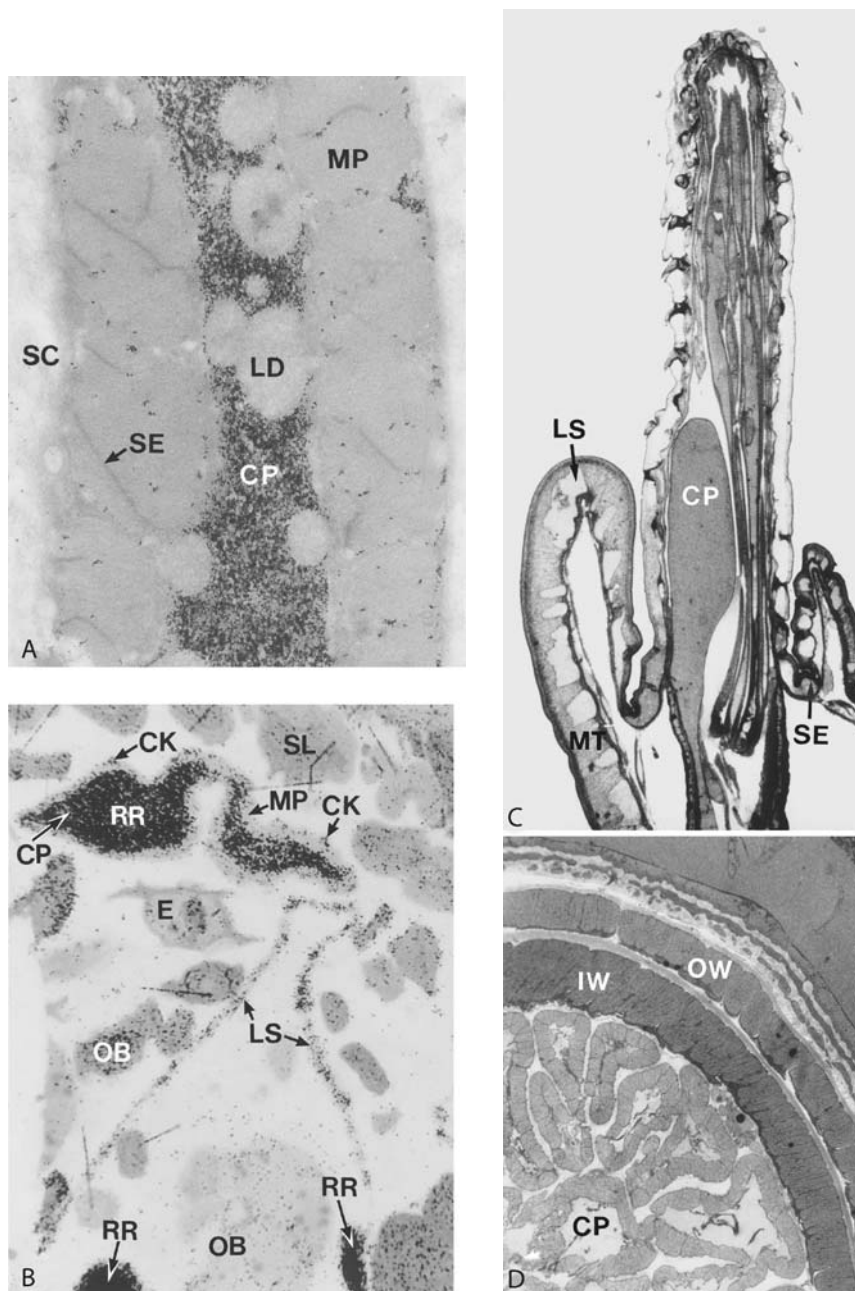

**Acanthocephala.** Figure 14 **A, B** Micrographs of acanthocephalan muscles of *Paratenuisentis ambiguus* showing their bi-component construction comprising an outer myogenic belt (MP) and an enclosed cytoplasmic portion (CP). **A** Longitudinally ultrathin-sectioned subtegumental muscle of an infectious larva. The section has been treated according to the electron microscopical PAS method of Thiéry in a mode to visualize glycogen. Note the intense Thiéry label in the core of the muscle; LD, lipid drop, SC, subtegumental connective tissue, SE, septum.  $\times 260$ . **B** Transversally semithin sectioned body cavity of an adult worm that was exposed to  $^3\text{H}$ -glucose and then autoradiographically treated. The intense label in the cytoplasmic portion of the receptoracle retractor muscles (RR) seems to be due to glucose-metabolites (probably mainly glycogen) incorporated in these muscles; CK, knobs on the muscle's surface also showing the bi-portion structure, E, egg, LS, ligament strand, OB, ovarian ball, SL, subtegumental longitudinal muscle.  $\times 300$ . **C, D** Semithin sections of the praesoma (and partly the metasoma: C) of adult acanthocephalans. **C** Longitudinal section showing the cytoplasmic "finger" (CP) of the (inner) receptacle wall projecting into the proboscis. Also note the lacunar system (LS) inside the metasomal tegument (MT); SE, septum between praesomal and metasomal tegument.  $\times 30$ . **D** Transverse section through the receptacle wall musculature (IW, inner wall, OW, outer wall) of *Acanthocephalus lucii*; note the tubular structure of the proboscis retractor musculature with its cytoplasmic cores (CP) of low density.  $\times 150$ .

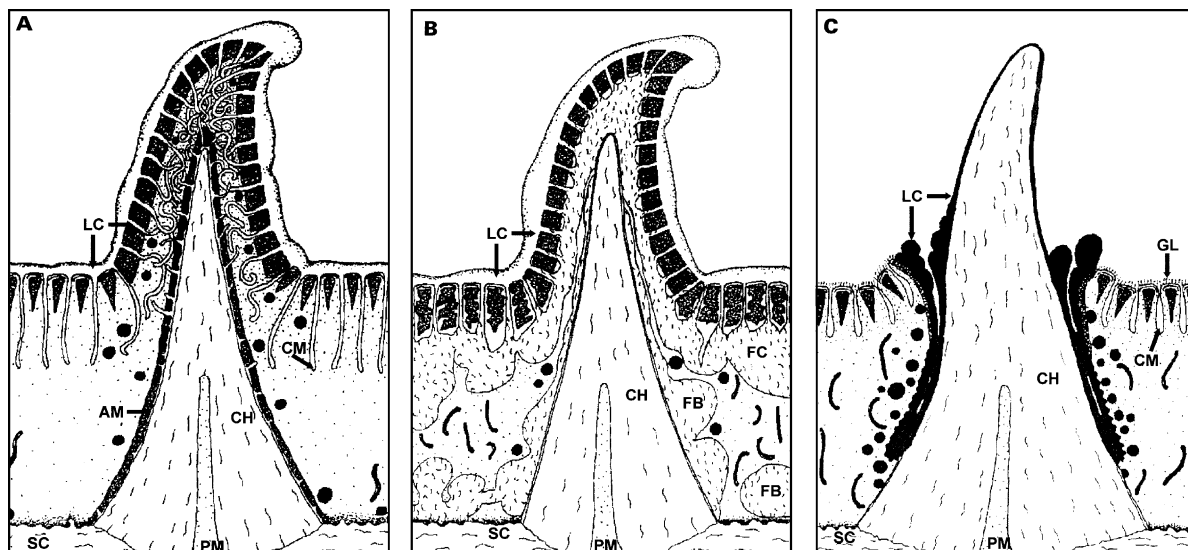

**Acanthocephala. Figure 15 A–C** A Schematic drawing of an eoacanthocephalan proboscis hook and surrounding tegument. Note the tegumental cover of the hook's connective tissue (CH), and the crypts of the outer membrane (CM) entangling with "crypts" of the tegument's basal membrane externally lining the connective tissue of the hook. These crypts perforate a layer of amorphous matter (AM) covering the connective tissue of the hook's tegument. LC, lipid coat on the hooks and on the tegument; PM, finger-shaped protuberance of the subtegumental musculature; SC, subtegumental connective tissue. B Schematic drawing of a palaeacanthocephalan proboscis hook and surrounding tegument. Note the tegumental cover of the hook's connective tissue (CH), the lipid coat (LC) on the tegument and the hook, the fused crypts of the outer membrane (FC) supported by fibres, and the fused crypts of the basal labyrinth (FB) which possibly are continuous with the latter fused crypts. PM, finger-shaped protuberance of the subtegumental musculature; SC, subtegumental connective tissue. C Schematic drawing of an archiacanthocephalan proboscis hook and surrounding tegument. Note that the connective tissue of the hook (CH) has no tegumental cover and is invested only by alipoid coat (LC) which is discharged by the tegument into the pouch surrounding the hook. The proboscis tegument carries a fuzzy →glycocalyx (GL), and the crypts of the outer membrane (CM) are not fused. PM, finger-shaped protuberance of the tegumental musculature; SC, subtegumental connective tissue.

that of the metasoma and these features become more prominent towards the anterior part of the proboscis. Generally, the praesomal tegument contains more amorphous, electron-dense matter, more →mitochondria, and rough and smooth endoplasmic reticulum (Fig. 13A) as well as lipid (especially in eo- and palaeacanthocephalans, Figs. 13A, 15) than the metasomal tegument. Interestingly, a submersion of the tegumental nuclei only occurs in the praesoma. The lemnisci harbouring the nuclei (Fig. 16) do not show a specific stratification like the tegument they branch away from. They too contain lacunar spaces, and are very rich in lipid.

The surface coat of the praesomal tegument reveals systematics-related specificities (Fig. 15) and shows interesting links with the host–parasite interactions (→Acanthocephalan Infections). The fine structure and obviously also the chemical composition of the surface coat vary among the classes. Regarding archiacanthocephalans the optical impression of the praesomal glycocalyx resembles that of the metasoma, although it is more coarsely structured and more osmiophilic than the latter. Shedding of the surface coat frequently or often occurs and seems to follow a complexation of host's

anti-parasitic enzymes or antibodies with the surface coat (→Acanthocephalan Infections/ Fig. 5A). Eoacanthocephalans and palaeacanthocephalans reveal a lipid, non-fuzzy surface coat which may reach a thickness of several microns (Fig. 11) and shows a matrix which suggests a liquid or semiliquid condition. In addition to lipid, mucus-like carbohydrates are also present in it. Often osmiophilic films, perhaps representing a "glycocalyx," can be seen in it, and it is rather likely that these films are shed into the voluminous coat once the outer membrane has become loaded with anti-parasitic →peptides of the host's defense system (Fig. 12B). Unfortunately, the chemical properties of the acanthocephalan →surface coat have not been extensively studied to date.

The (pores of the) praesomal crypts are less densely set and the striped layer measures half or less in diameter than the trunk surface. In Palaeacanthocephala the single crypts are fused underneath the striped layer, forming large caverns with stabilizing fibres in them (Fig. 15B). The other systematic groups have retained their individual crypts (Fig. 15A, C). Generally, the strata of the tegument as described from the trunk cannot be well distinguished: due to the abundance of fibres

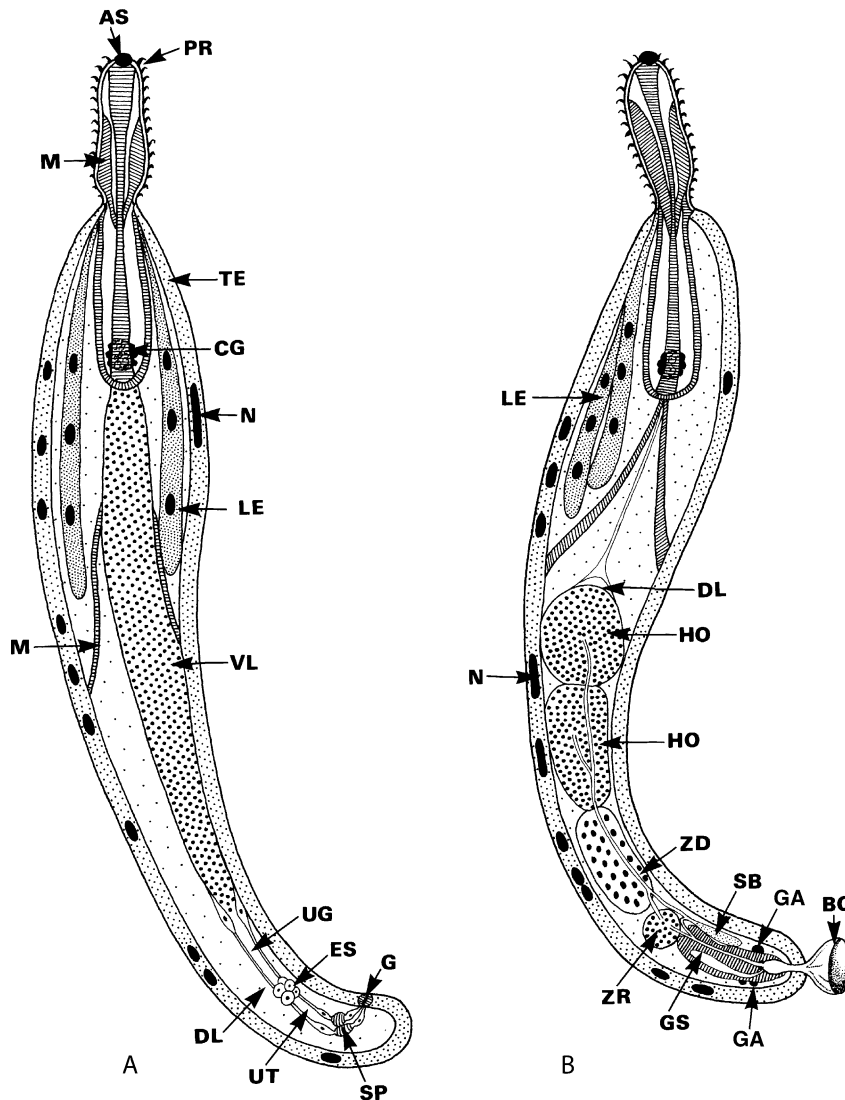

**Acanthocephala. Figure 16** A DR of a female acanthocephalan (*Paratenuisentis ambiguus*, Eoacanthocephala) with emphasis on the sexual organs (most muscles omitted). It has been reduced in size (length) compared with the male worm. The ventral ligament sac leading into the uterine bell is specific to eoacanthocephalans. Note the lack of genital ganglia (GA) in the female worm. For the inscriptions of the non-sexual organs see B. Eggs and floating ovaries inside the ligament sacs are not shown (Fig. 18A). B DR of a male acanthocephalan (*Paratenuisentis ambiguus*, Eoacanthocephala) with emphasis on the sexual organs. Most muscles are omitted. The single polynucleate cement gland and the presence of a cement reservoir and a seminal vesicle are specific to eoacanthocephalans. AS, apical sensory organ; BC, bursa copulatrix (evaginated); CG, cerebral ganglion; DL, “dorsal” ligament sac; ES, egg-sorting apparatus; G, genital opening; GS, Saeftigen’s pouch; HO, testes; LE, lemnisk; M, muscle; N, giant nucleus; PR, proboscis with hooks (evaginated); SB, seminal vesicle; SP, sphincter; TE, tegument; UG, uterine bell; UT, uterus; VL, “ventral” ligament sac; ZD, cement gland; ZR, cement reservoir.

they often all together appear like a feltwork layer. The metasomal labyrinthine structure of the basal membrane is considerably reduced and instead its coating with amorphous material is more pronounced.

### Proboscis Hooks

Irrespective of the systematic affiliation of the worms the hooks (Figs. 7B, 13A, B, 15) possess a central cone

of connective tissue which partly has been demonstrated to contain collagen and/or →chitin. This major part of the hook arises from the subtegumental connective tissue. In its proximal part it encircles a finger-like projection of the subtegumental longitudinal musculature (Fig. 15). But this musculature tie is not present in all hooks of all species, implying that not all hooks can be individually retracted.

In eo- and palaeacanthocephalans the fibrous core of the hooks carries a condensed tegumental cover making these holdfast organs pointed (Figs. 13, 15A, B). The striped layer does not markedly differ between eo- and palaeacanthocephalans but in eoacanthocephalans the crypts are not fused but entangle with finger-form protrusions of the tegument's basal membrane inside the hooks (Fig. 15A). In both of these subclasses the tipped hooks are capable of discharging lipid substances through their pores (Fig. 13A). Mucus-like carbohydrates also contribute to the excreted matter (Fig. 13B) and, rather likely, enzymes are also contained in it which thus far can only be hypothesized. The grease-like surface coat of the hooks may be very voluminous (Fig. 15). Amazingly, however, the hooks are also capable of absorbing nutrients from the host tissue surrounding them (see [Food Uptake](#)).

In archiacanthocephalans the hooks do not bear a tegumental vestment and the naked cone of the connective tissue, thus piercing the tegument, is less pointed than the hooks of the 2 other systematic groups (Fig. 15C). Obviously, the hooks attain their slippery surface cover by dipping into a pit encircling them; this annular cleft filled with a highly osmiophilic lipid paste deriving from the surrounding tegument (Fig. 15C).

Uniformly in all systematic groups of the Acanthocephala, the close tegumental surrounding of the hooks is rich in lipid droplets, mitochondria, and rough (Fig. 13A) as well as smooth endoplasmic reticulum, indicating elevated metabolic activity.

### Proboscis Cavity

Contrary to the way in which acanthocephalans are usually shown in drawings made from dead worms (Fig. 16), *in vivo* and *in situ* the acanthocephalan proboscis is normally kept in a semi-invaginated position, especially among species with superficial attachment (Fig. 4). Thus a proboscis exhibiting a more or less deep anterior cavity resembling a mouth opening should be part of our idea of these gutless worms. Among eo- and palaeacanthocephalans inside the proboscis cavity the tegumental surface including the hooks appears as a labyrinth with remnants of host cells and tissue between its curves and with grease occupying all external niches of the labyrinth at its bottom plane.

In Archiacanthocephala the proboscis cavity is not filled with grease in its inner part and the labyrinth is lined by the fuzzy →glycocalyx described under →praesoma.

### Musculature

Relatively few investigations have dealt with the fine structure of the acanthocephalan musculature. Some

muscles, such as the receptacle retractor muscles, appear obliquely striated, e.g., fibres are connected to Z-line-like structures.

The basic feature of the acanthocephalan musculature is its 2-component structure composed of an outer myogenic, contractile belt and a cytoplasmic core enclosed by it (Figs. 13C, 14). The interior part seems to have a function in energy storage.

Usually glycogen is very abundant in it (Fig. 14A) and in autoradiographic experiments with labelled glucose, the glucose, or more likely metabolites of it like glycogen, accumulates in the cytoplasmic core (Fig. 14B). The cords of subtegumental musculature follow this bi-component composition (Fig. 13C), as do the retractor muscles (Figs. 14B–D). In addition the receptacle retractor muscles also carry small knobs on their surface which have non-contractile cores (Fig. 14B). In all these muscles the central non-contractile portion may contain plenty of organelles, mainly mitochondria, or may be rather electron-lucent, suggesting a higher fluidity than the latter cytoplasm. Inside the proboscis retractor musculature a low viscosity core should enable a quick directional shift of the enclosed cytoplasm when the proboscis cavity is formed or discontinued. An interesting differentiation is shown by the proboscis receptacle musculature enclosing and thus forming the hollow into which the proboscis can be retracted. In palaeacanthocephalans it consists of a double wall which has almost no non-contractile portion (Fig. 14D). In eoacanthocephalans it is considered single-walled but the “receptacle protruder musculature” exteriorly surrounding the receptacle without being firmly connected to it probably represents the outer wall of the receptacle. It reveals the described 2-portion structure. The inner wall basically consists of a firm, contractile wall but on its dorsal inner side a conspicuous sack-shaped cytoplasmic outgrowth with a very narrow contractile outer cover projects into the posterior half of the proboscis (Fig. 14C). The cytoplasmic finger seems to function as the major glycogen deposit of the praesoma. In archiacanthocephalans the inner wall consists of plane myogenic tissue whereas the outer wall is formed by spirally arranged single muscle cords with non-contractile cores. Due to this spiral arrangement the retraction and protrusion of the praesoma (not only the proboscis can be invaginated) are performed in a torsion-like, screwing fashion.

### Excretory System

Excretory products of most acanthocephalans seem to be released exclusively through the body wall, but it is not known whether this takes place through the whole tegument or through special regions. In addition,

oligacanthorhynchids and probably other archiacanthocephalans have protonephridia. Their efferent canals either lead into the vas deferens (male) or into the uterine bell (female). Two types of protonephridia are known:

- Dendric type: numerous flame cells drain into branched canals which lead into a central canal;
- Saccular type: the flame cells drain into an encapsulated bowl and a subsequent central canal.

Excretory products of acanthocephalans seem to be similar to other helminths, containing lactate, succinate, etc. Ethanol, however, has been described as the main excretory product of *→Moniliformis moniliformis*. There is still controversy over whether acanthocephalans are osmoconformers or not, but most species seem to have little osmoregulatory ability.

## Reproduction

Acanthocephalan reproduction as well as the fine structure and genesis of the *→oocytes* and spermatozoocytes show some unique features.

### Reproductive Organs

Acanthocephalans are *→dioecious*. Male worms are usually smaller than females, and in addition *→sexual dimorphism* may affect other features such as trunk spination. Only males have a pair of genital ganglia (and a bursal ganglion, so far only described for *M. moniliformis*), whereas both sexes have a *→cerebral ganglion*. Sensory papillae of the genital region are confined to males. And indeed only males seem to be active in finding a sexual mate and copulation. In female worms the sexual organs lie within 2 ligament sacs (Fig. 16A) which rupture in palaeacanthocephalans and some eoacanthocephalans. The male sexual organs are located within only one ligament sac (Fig. 16B).

The **male** gonads and accessory organs are enclosed by the dorsal ligament sac (the ventral sac does not persist in males), and further posteriad, by the muscular genital sheath (Fig. 16B). The organs are attached to the ligament strand which keeps them in position. Males normally have 2 testes, but *→monorchidism* is rather frequent. A seminal vesicle may be present (Eoacanthocephala). The vasa efferentia fuse to form a vas deferens, which fuses with one or several ducts of the cement gland(s) to form a genital canal. Cement glands are significant accessory organs (1–8 in number), and eoacanthocephalans have a separate cement reservoir. The cement locks the female vagina after copulation until the first embryonated eggs are released, and forms typical copulatory caps on the posterior tips of inseminated females. But dominant males may also use this secretion to prevent inferior male competitors from fertilizing females of the respective

infrapopulation. If protonephridia are present, the genital canal is joined by the (ciliated) excretory canal. The genital (or urogenital) canal leads into the *→bursa copulatrix* (Fig. 16B). The muscular terminal part of the genital canal inside the bursa is considered a penis. Additional accessory organs are the *→Saeftigen's pouch* and a few glandular structures associated with the bursa that are not yet well known. The fluid-filled muscular Saeftigen's pouch is connected with the lacunar system of the bursa tegument. By its contraction it regulates the hydrostatic pressure of the bursa and thus its protrusion or invagination (Fig. 16B).

The **female** reproductive system consists of 2 major tubes:

- The ligament sacs (or the pseudocoel if the sacs are ruptured) that contain the *→floating ovaries* (ovarian balls).
- An efferent duct system including a complex *→egg-sorting apparatus* which is unique among helminths.

The 2 ligament sacs are interconnected at their anterior end. Posteriad, one sac leads into the uterine bell while the other is connected to a lateral opening of the subsequent apparatus (Fig. 16A).

The muscular efferent duct consists of the uterine bell, the egg-sorting apparatus, the uterus, and the vagina which is enclosed by 1 or 2 genital sphincters (Fig. 16A). Eggs from the dorsal (Archiacanthocephala) or ventral (Eoacanthocephala) ligament sac are "sucked" into the funnel-shaped bell which leads into a narrow duct. The subsequent egg-sorting apparatus of *M. moniliformis* consists of 2 lateral pockets, 2 dorsal median cells, 2 anterior ventral median cells, 2 posterior ventral median cells, and 2 lappet cells. It ensures that normally only embryonated eggs are found in the host's faeces. By a complex interaction between the muscular activity of the bell wall and the cells and pockets of the apparatus, only embryonated eggs are allowed to enter the uterus, while immature ones are forced back into the ventral (Archiacanthocephala) or dorsal (Eoacanthocephala) ligament sac. The egg-sorting mechanism is not fully understood. The uterus is surrounded by layers of muscles and fibrous material. The vagina is a narrow duct which connects the uterus with the gonopore (Fig. 16A) and was found to carry glandular appendages in some species. The gonopore of a few species is surrounded by genital spines, and after insemination is generally blocked by a copulatory cap imposed on it by the male until eggs are released.

### Gametogenesis

Acanthocephalan reproduction as well as the fine structure and genesis of the oocytes and spermatozoocytes show some unique features. Acanthocephalan



→spermatozoa are filiform (Fig. 17) and consist of a nucleocytoplasmic spermatozoan body rich in glycogen, and a flagellum. They measure 20–80 µm in length depending on the species, and obviously do not possess mitochondria or acrosomes. They contain a longitudinal chromatin strand (which is not membrane bound), 2 lateral rows of “dense inclusions” of unknown function and a →centriole which gives rise to the flagellum. The →axoneme of the free flagellum consists of →microtubules which in most species are arranged in a  $(9 \times 2) + 2$  pattern, but also either 1 or 3 central tubuli have been found even within one species. The microtubules may show typical dynein arms, but the pattern is not consistent (Fig. 17). Among the phases of →spermatogenesis the spermiogenesis is best described. It is characterized by several events:

- The centriole of the flagellum migrates from the posterior to the anterior region of the spermatid while the spermatids are still connected in clusters (Fig. 17B) by cytophoral stalks. The flagellum then extends slightly posteriorly (while the nucleus becomes elongated) and finally it extends greatly anteriorly (Fig. 17C). Thus, as a result of this extension the spermatozoan body becomes reversed in relation to the free flagellum.
- The nuclear membranes disintegrate to form the nucleocytoplasmic body (Fig. 17A, C). Only a remnant of the nuclear envelope remains.
- The mitochondria disappear from the spermatozoan body.
- The spermatozoan body detaches from the spermatid’s residual body containing the mitochondria.

Several species of acanthocephalans have been found to be precocious, e.g., mature spermatozoa have been found in male larvae.

Mature oocytes are spherical cells that lie below the surface of the free-floating ovaries (ovarian balls) and show typical electron-dense inclusions (Fig. 18A, C). The floating ovaries derive from the ovarian primordium of some larval stage. Immature floating ovaries have a thick surface coat and lack microvilli-like structures of their outer membrane. Mature ones consist of 2 syncytia, i.e., the central oogonial syncytium and the peripheral supporting syncytium. Furthermore they contain developing oocytes which seem to derive from the oogonial syncytium. The superficial supporting syncytium reveals microvilli-like outgrowths of its surface which absorb nutrients from the body cavity, as can be demonstrated by autoradiographic experiments. Fertilized ovaries (and unfertilized mature ovaries of a few species) apparently lose their →microvilli (Fig. 18C). The actual process of

oogenesis from oogonia to mature oocytes is not yet well known.

### Fertilization

Acanthocephalan females may become inseminated subsequently several times. But little is known about how the worms attract each other – if they do so – prior to copulation and insemination. According to observations by Richardson et al. in the palaeacanthocephalan →*Leptorhynchoides thecatus*, parasitizing in green sunfish, mate finding follows a very simple pattern. Individuals of both sexes are usually positioned inside the pyloric ceca in a mode such that their posterior ends extend into the intestinal lumen within the small area from which the ceca originate. So emigration to find a mate is unnecessary (see also →Behavior). There is still a lack of evidence about the function of the copulatory cap which locks the vagina of inseminated females during the prepatent period. Some philosophical debate has been held about the applicability of the “→selfish gene theory” preventing males with inferior genes from reproduction. There are still open questions on acanthocephalan copulation and fertilization.

The following steps of fertilization have been documented: oocysts become fertilized whilst lying underneath the surface (syncytium) of an ovary. The flagellum of the sperm attaches to the surface of the ovary (Fig. 18B), which leads to an inflation of the flagellar apex. The subsequent penetration of the spermatozoan through the supporting syncytium into the oocyte (Fig. 18C) apparently initiates meiosis and the formation of polar bodies. The electron-dense inclusions of the mature oocyte move to the periphery and initiate the formation of a →fertilization membrane around the →zygote. The zygote now becomes ovoid and gives rise to a fertilization gap between its surface and the supporting syncytium of the ovary.

### Postzygotic Development

The first step of postzygotic development is the formation of the first larva, the →acanthor.

Females of all acanthocephalans release fully embryonated eggs. Prepatent periods of worms from homoiothermic hosts last between 22 days (*Polymorphus minutus*) and 70 days (*Macracanthorhynchus hirudinaceus*); in poikilothermic hosts development depends on the temperature. These same 2 species may remain patent for a maximum of only 25 days (*P. minutus*) or for up to 10 months (*M. hirudinaceus*).

After being taken up by the →intermediate host the acanthor changes its morphology and becomes an →*Acanthella* – the stage between the acanthor and the larva that is infective to the final (or paratenic) host.

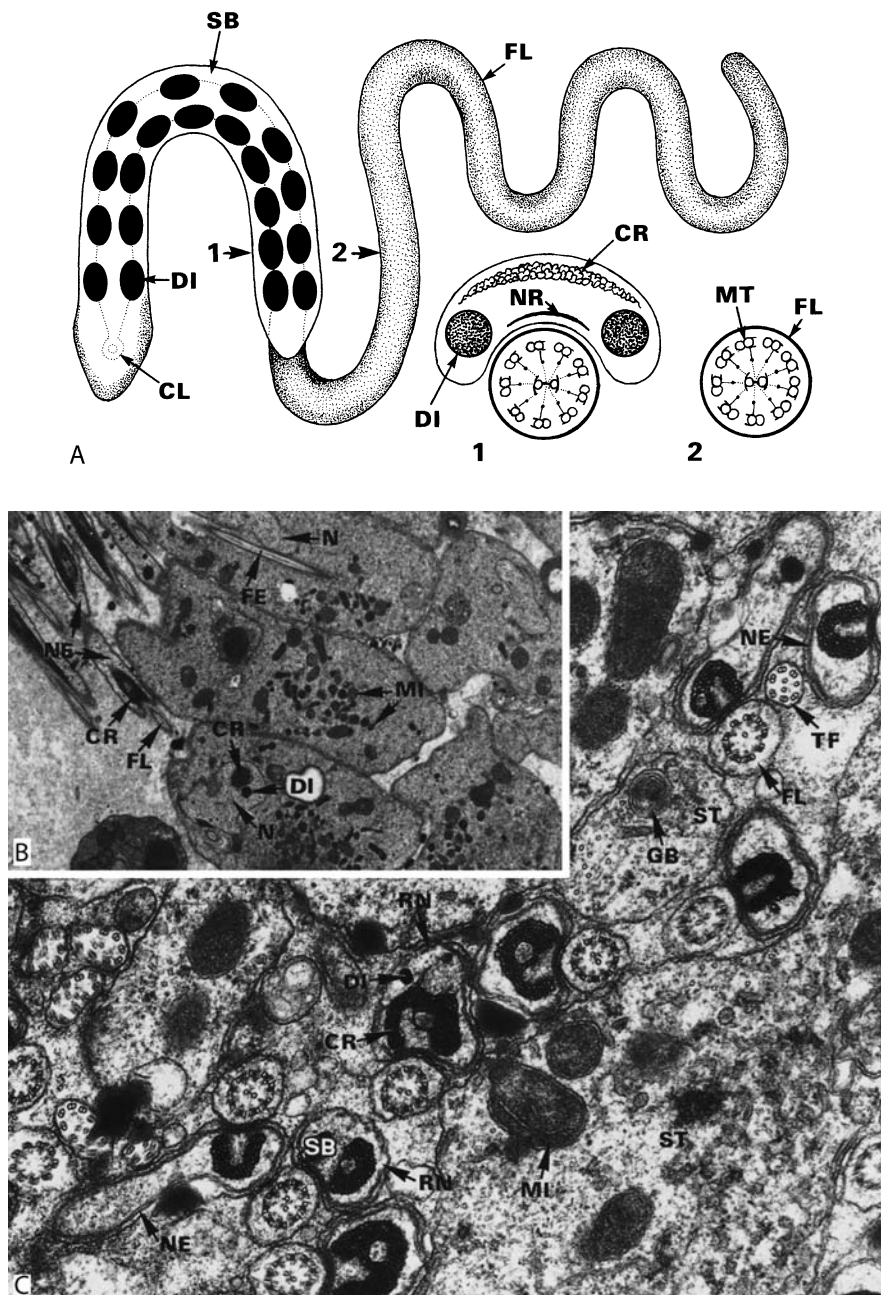

**Acanthocephala.** Figure 17 A–C Acanthocephalan spermatozoan and spermatid morphology. **A** DR of an acanthocephalan spermatozoan. 1, 2 Transverse sections through the spermatozoan body ( $\times 2$ ) and through the flagellum ( $\times 3$ ). **B** Transmission electron micrograph of a cluster of spermatids of *Echinorhynchus truttae* in the process of nuclear and flagellar elongation, i.e., spermiogenesis. Note the numerous mitochondria (MI) inside the spermatids.  $\times 6,840$ . **C** TEM of a transverse section through spermatids (ST) and early spermatozoans (SB) of *E. truttae*. Note the apparent lack of mitochondria in the spermatozoan body and the rupturing nuclear envelopes (RN) in some spermatozoans.  $\times 39,900$ . CL, centriole; CR, chromatin; DI, electron-dense inclusions; FE, flagellum extending from the anterior part of a spermatid posteriad; FL, flagellum; GB, Golgi body; MI, mitochondrion; MT, microtubules with dynein arms; N, nucleus; NE, nuclear envelope; NR, remnant of nuclear envelope; RN, rupturing nuclear envelope; SB, spermatozoan body; ST, spermatid; TF, terminal flagellum.

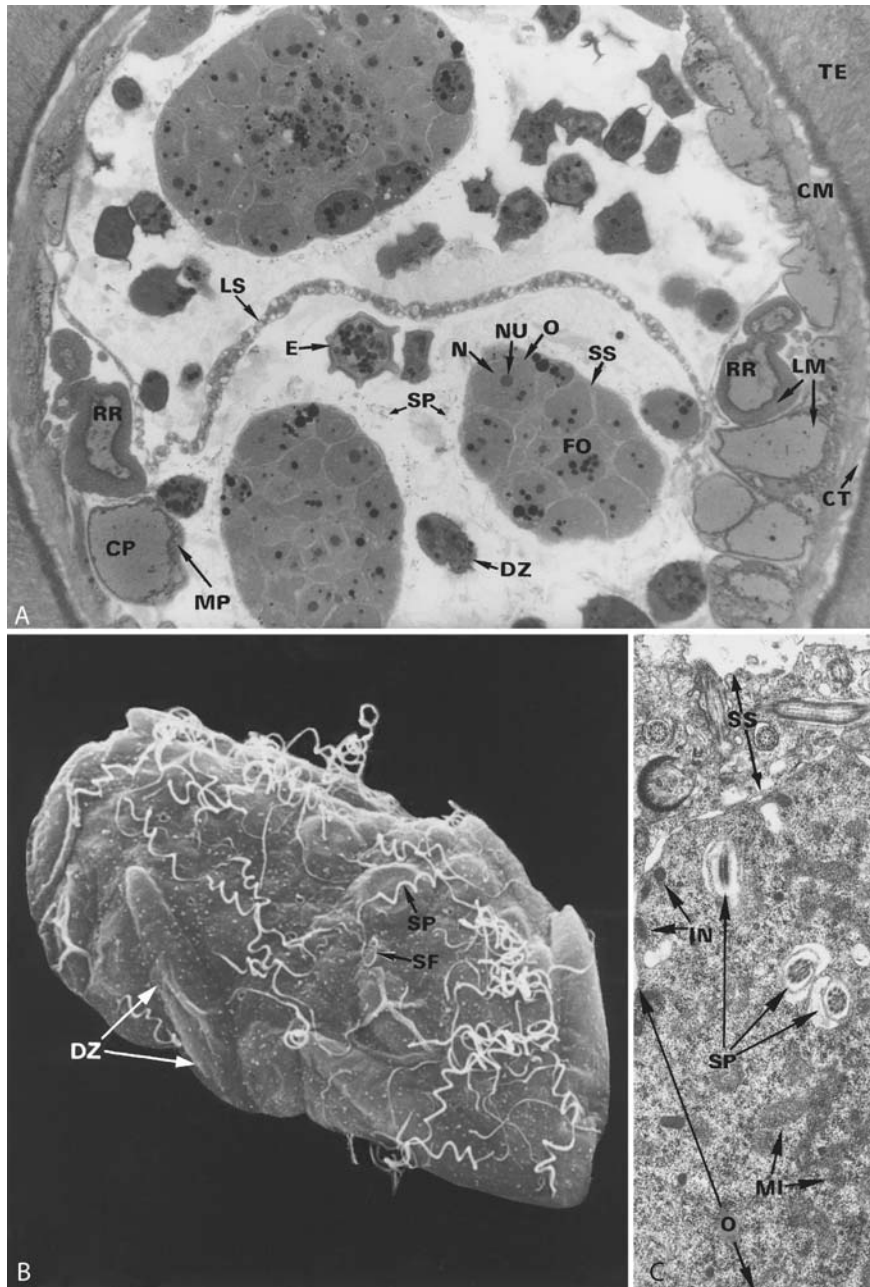

**Acanthocephala. Figure 18 A–C** Micrographs of acanthocephalan floating ovaries and fertilization of the enclosed oocytes. **A** LM. Floating ovaries (FO) are contained within the 2 ligament sacs which are separated by the fibrous ligament strand (LS) (*Paratenuisentis ambiguus*, Eoacanthocephala). Note the oocytes (O) lying underneath the surface syncytium (SS) of the ovaries, adhering sperms (SP), the detached zygotes (DZ), and the shell-coated developing eggs (E).  $\times 260$ . **B** SEM. A floating ovary from the body cavity of *Acanthocephalus anguillae* (Palaeacanthocephala) shows numerous sperm at its surface. The flagellum is visible as a slender prolongation of the spermatozoon body. Note the detaching zygotes (DZ) which already resemble the spindle shape of the mature eggs.  $\times 4,560$ . **C** TEM. Sperm have penetrated the surface syncytium and the underlying oocyte (zygote?) of a floating ovary of *Neoechinorhynchus rutili*. The accumulation of “inclusions” (IN) at the oocyte’s margin seems to follow fertilization and possibly initiates the formation of the eggshell.  $\times 16,450$ . CM, circular musculature; CP, cytoplasmic part of muscle; CT, connective tissue; DZ (black), detached zygote; DZ (white), detaching zygote; E, shell-coated developing egg; FO, floating ovaries; IN, inclusion; LM, longitudinal musculature; LS, ligament strand; MI, mitochondria; MP, myogenic part of muscle; N, nucleus of oocyte; NU, nucleolus of oocyte; O, oocyte; RR, receptacle retractor muscle; SP, spermatozoa; SS, surface syncytium of floating ovary; TE, worm’s tegument.

## Acanthocephalacidal Drugs

### General Information

The large to medium-sized →**acanthocephalans** are thorny (spiny)-headed worms with an elongated →**proboscis** armed with recurved hooks parasitizing the digestive tract of a wide range of vertebrate animals throughout the world, and occasionally found in humans. They have been placed in their own phylum since their affinities to other parasites are not well defined. The sexes are separate, males being much smaller than females. The life cycle of acanthocephalans infecting mammals involves intermediate hosts. There are a number of genera in the dung beetle family Scarabaeidae and cockroaches containing the infective stage of worm (→**Cystacanth**, which is really a young adult) or vertebrates, which act as paratenic hosts (e.g., mice, and frogs) harboring re-encysted cystacanths. No acanthocephalans are primarily human parasites.

Two species of these worms may infrequently infect humans more often than others. One species is →**Moniliformis moniliformis**, which commonly parasitized rats and other **rodent hosts**, the other *Macracanthorhynchus hirudinaceus* (adults resemble *Ascaris suum*), a common parasite of pigs and wild boars, ubiquitous in areas where **pigs** are kept free. The final host (swine, occasionally man) becomes infected by ingesting either the infected grubs or the adult beetles and rarely the infected vertebrate. Infections may frequently occur in China and Indonesia and other parts of Southeast Asia, but also in most other countries of the world though *M. hirudinaceus* is absent from Western Europe. In **humans**, the adult worms, which are attached to the wall of the small intestine, cause diarrhea, GI disturbances, and →**vomiting** but also serious complications, such as severe ulcerative enteritis or perforation of the bowel resulting in peritonitis. The pathogenic

significance of *M. hirudinaceus* is similar for pigs causing →**granuloma** formation at the site of attachment in the small intestine, →**weight loss** and, rarely in heavy infections, penetration of the intestinal wall resulting in fatal peritonitis.

Very important parasites of Central and South American **monkeys** are →*Prosthenorchis elegans* (very common), and *P. spicula* (less common). These acanthocephalans are now found throughout the world where primates are kept in zoos or elsewhere in captivity and where they have introduced the parasites. In heavy infections there is diarrhea, →**anorexia**, and debilitation often associated with death caused by perforation of the intestinal wall by adult worms.

There are 2 genera which may cause enteritis in **aquatic birds**, e.g., *Filicollis* (*F. anatis*) and *Poly-morphus* (*P. minutus*). The intermediate hosts in both cases are crustaceans. Pathogenic effects produced by adult worms attached to the intestinal wall resemble those that are seen in mammals.

Pathogenicity of numerous **fish** acanthocephalans is species-specific and varies considerably. There are species which penetrate through the intestinal wall, thereby entering the body cavity of fish. Other species remain in the lumen of intestine, showing frequent or less frequent change of attachment site. Intermediate hosts are crustaceans, and various fishes may serve as paratenic hosts. In the fish industry disastrous economic losses may be due to acanthocephalans, especially when fish farming is practiced with overcrowded fish populations.

### Prevention and Treatment

Prevention and treatment of →**Acanthocephala** infections can be seen in **Table 1**, which are in general problematic. In man, usually Acanthocephala eggs are not passed with the feces since worms may not mature to adults. Diagnosis is made by x-ray examination or endoscopy. Serological tests are not available.

**Acanthocephalacidal Drugs. Table 1** Control and treatment of acanthocephala infections in humans and animals

Host (other information)	Parasite (other information)	Control and treatment (nonproprietary name, miscellaneous comments)
Humans acquire the parasite by ingesting beetles as food	<i>Macracanthorhynchus hirudinaceus</i> (pig), <i>Moniliformis moniliformis</i> (rodents)	Prevention can be effected by rodent control and keeping of food intended to be eaten cold in beetle-proof containers may help to prevent accidental infection; treatment is not well established; <b>niclosamide</b> (→Cestodocidal Drugs) has been successfully used in Nigeria, loperamid hydrochloride, an antidiarrheal agent, proved very active in <i>M. hirudinaceus</i> infected pigs (see below); in China, surgery is often practiced to remove adult worms from heavily infected patients

**Acanthocephalacidal Drugs. Table 1** Control and treatment of acanthocephala infections in humans and animals (Continued)

Host (other information)	Parasite (other information)	Control and treatment (nonproprietary name, miscellaneous comments)
Pig, wild boar (other occurring in carnivores like wolf, domestic dog, badger, fox), others are <i>M. catalinum</i> , and <i>M. ingens</i> , <i>Oncicola canis</i>	<i>M. hirudinaceus</i> <b>egg</b> containing the acanthor larva with rostellar hooks is large, ovoid and has a thick, dark brown, textured shell <b>egg</b> of <i>O. canis</i> is relatively small, ovoid, brownish, and has a smooth, thick shell	Where pigs are kept in small sties or runs regular removal and suitable disposal of feces containing eggs will help in reducing the infection; older drugs such as carbon tetrachloride, tetrachloroethylene, and nicotine sulphate have been used; the drug of choice appears to be <b>loperamid</b> hydrochloride which at 1.5 mg/kg twice daily × 3 days kills 100% adult and pre-adult worms without showing side effects; <b>fenbendazole</b> (→ Nematocidal Drugs, Animals) at 20 mg/kg × 5 days and levamisole may also be effective; a single intramuscular dose of 0.3 mg/kg <b>doramectin</b> reduced <i>M. hirudinaceus</i> worm burden in naturally infected pigs by 62%
Monkeys infection may be common in zoos	<i>Prosthenorchis elegans</i> <i>P. specula</i> <b>eggs</b> in feces are smaller than those of <i>M. moniliformis</i>	Insecticides and good sanitation will control the intermediate hosts (cockroaches, <i>Blattella germanica</i> ); dithiazinine iodide has been effective; other drugs (see pig) may also affect adult worms and may be used by way of trial
Hedgehog adult worms of different species measure 0.5– 12 cm in length	<i>Prosthenorchis rosai</i> <i>Nephridiorhynchus major</i> and others <b>eggs</b> in feces have a thick shell	Pathogenic effects of adult worms may be ulcerative enteritis, GI disturbance and peritonitis caused by perforation of intestinal wall; intermediate hosts are insects; prevention is not possible; treatment with fenbendazole (20–50 mg/kg × 5 days in feed), other benzimidazole carbamates (→ Nematocidal Drugs, Animals), loperamid or levamisole may be used by way of trials
Rodents (mice, rats) parasite has a worldwide distribution	<i>M. moniliformis</i> <b>egg</b> is larger than that of <i>M. hirudinaceus</i> , elongated oval, has a thick, smooth, clear shell	Strategic use of insecticides may control intermediate host (cockroaches) in laboratories; treatment of rodents is similar to that used with <i>M. hirudinaceus</i> (see hedgehog, above); infections have been reported on rare occasions in humans and are acquired by accidentally ingesting of beetles with food; adult worm has a pseudosegmentation of the body; adult female worm can reach >20 cm in length
Aquatic birds parasite has minor veterinary importance	<i>Filicollis anatis</i> <i>Polymorphus minutus</i> (syn. <i>P. boschadis</i> ) <b>eggs</b> in feces are relatively small and spindle-shaped	Worldwide distribution; prevention is impossible because of the ubiquitously occurring freshwater isopods and other crustacean intermediate hosts; treatment is unknown but fenbendazole (20–50 mg/kg × 5 days in feed), other benzimidazole carbamates (→ Nematocidal Drugs, Animals), and loperamid may be used by way of trial; acanthocephalan infections

**Acanthocephalacidal Drugs. Table 1** Control and treatment of acanthocephala infections in humans and animals (Continued)

Host (other information)	Parasite (other information)	Control and treatment (nonproprietary name, miscellaneous comments)
		( <i>Centrorhynchus lancea</i> , <i>Mediorhynchus taeniatus</i> ) have been reported in free-living houbara bustards in the United Arab Emirates
Finfish: <sup>1</sup> non-predacious	<sup>1,2,4,5</sup> <i>Pomphorhynchus laevis</i>	These acanthocephalans may cause heavy infections accompanied by high mortality in aquaculture - the selective breeding and raising of fish in “fish farms”; commercial fresh water or marine intensive fish farming in certain locations in Europe and particular in India and China may not only suffer disastrous economic losses caused by para sites but also considerable pollution of water by food and chemicals (see Anonymous, Nature 386: 105 – 110, 1997); in trout, <b>loperamid</b> infed proved effective at 50 mg/kg/day × 3 days killing 100% adult and preadult worms without obvious adverse effects; the drug is not licensed for food fish
<sup>2</sup> predatory	<sup>3,5</sup> <i>Neoechinorhynchus rutili</i>	
<sup>3</sup> freshwater	<i>N. rutili</i>	
<sup>4</sup> saltwater	<sup>6</sup> <i>Acanthocephalus lucii</i>	
<sup>5</sup> brackish water	<sup>7</sup> <i>A. anguillae</i>	
<sup>6</sup> perch, eel	<sup>4,8</sup> <i>Echinorhynchus gadi</i>	
<sup>7</sup> salmonoid fishes	<sup>7</sup> <i>E. truttae</i> , others	
<sup>8</sup> cod	<sup>8</sup> <i>E. gadi</i>	

## Acanthocephalan Infections

### Attachment

Generally, acanthocephalans that have a short →neck do not deeply penetrate into the host's intestinal wall with their →praesoma, i.e., they do not create lesions reaching as deep as the muscular layers of the intestinal wall (→*Acanthocephala*/Fig. 4). In contrast, many acanthocephalans possess a long neck which may comprise a bulbus as an inflated part of the neck (Figs. 1, 6). The bulbus functions as a dowel enabling the worm to occupy a permanent point of attachment at one site. Long-necked species perforate the tunica muscularis or the whole intestinal wall of the hosts with their praesoma (Fig. 1). In small hosts with thin intestinal wall parts of the metasoma (Fig. 2) or entire worms may be found in extraintestinal positions. The perforation of the intestinal wall may be supported by proteolytic enzymes.

### Cellular Host Responses

#### Successive Cell Assemblages

The specific composition of host cells accumulating at the worm's praesoma follows a certain sequence which is related to the worm's mode of attachment. During the first days p.i. only necrotic tissue surrounding the praesoma can be found. After about 3–5 days p.i. a belt of inflammatory tissue with haemorrhagic involvement

starts forming (Fig. 7). From about 10 days p.i. onwards the further succession of cell assemblages depends on the type of attachment. At the praesoma of perforating species the inflammatory tissue becomes dominated by macrophages maturing into epithelioid cells and another belt of connective tissue which attains a blue colour in Azan-stained paraffin sections, starts forming (Fig. 2). Later on, this belt may become considerably reinforced and interspersed with fibroblasts and →collagen fibres and an outer belt of connective tissue (Fig. 3B, C) sometimes consisting of plane collagen fibres (Fig. 3C) is built up. The attachment site of the eoacanthocephalan →*Neoechinorhynchus rutili*, although non-perforating, is characterised by a pronounced accumulation of collagen fibres (Fig. 3A). In contrast, species with shallow attachment seem to change their point of attachment prior to the formation of connective tissue at the site of the temporary anchorage, and a concentric zonation of neoplastic tissue around the parasite's praesoma does not emerge. Haemorrhagic spots (Fig. 7B) may occur in all the tissue belts mentioned here.

#### Longitudinal Zonation of Defence Cells

Among perforating species like →*Pomphorhynchus laevis* the chronic stage of infection not only reveals concentrically arranged belts of necrotic, inflammatory, and connective tissue (Fig. 1) but also a longitudinal zonation can be figured out. Near or inside the peritoneal cavity the necrotic belt is very conspicuous. It is very

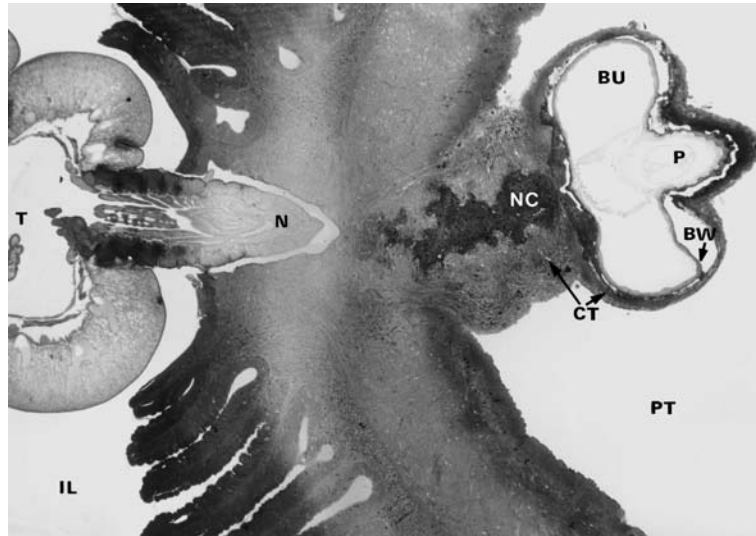

**Acanthocephalan Infections. Figure 1** Micrograph of a semithin section of *Pomphorhynchus laevis* (penetrating species) in a naturally infected adult chub (*Leuciscus cephalus*). The upper praesoma (e.g., P, proboscis; BU, bulbus; upper neck not visible) has penetrated the host's peritoneal cavity (PT). The praesoma has become encapsulated by connective tissue (CT) which degenerates in close contact to the worm's anterior neck and its bulbus.  $\times 40$  BW, bulbus wall; IL, intestinal lumen; N, neck; NC,  $\rightarrow$  necrosis; T, trunk (metasoma).

rich in lipids that seem to become absorbed by the worm's  $\rightarrow$ tegument. In contrast, at the lumen side of the intestinal tube the necrotic belt almost does not exist and defence cells form a closely fitting belt of solid compensatory tissue (Fig. 1). The question arises whether this zonation is host- or parasite-induced. Taking also the histopathology of *N. rutili* into consideration (Fig. 3A) it appears that the described zonation of the host's tissue is largely brought about by the parasite.

### Proboscis Hooks

Irrespective of the type of construction, i.e., whether a tegumental outer cover exists (compare  $\rightarrow$ Acanthocephala/ Fig. 15) the hooks always provoke the most pronounced accumulation of granulocytes. In *N. rutili* the small roundish  $\rightarrow$ proboscis with its large hooks the attracting of granulocytes towards the hooks, and the surrounding tegument is very severe in salmonids and other fish during the acute initial phase of the infection and it has been suspected that this is induced by the parasite benefiting from it in aspects related to nutrition or attachment (Fig. 4B).

### Infections in Fish, Birds, and Mammals

In contrast to the paucity of information available on many aspects of host-parasite interactions of acanthocephalans, these worms are very common in many wild-living vertebrates as well as cultured fish. Species like  $\rightarrow$ *Moniliformis moniliformis* can be easily kept in a laboratory in cockroaches and rats. It offers huge quantities of tissue and Surface Coat. So it would be very useful for physiological and molecular studies.

In fish hosts the inflammatory response is dominated by granulocytes (Fig. 7) and macrophages/epitheloid cells depending on the conditions described above. Usually eosinophils are the most abundant granulocytes (Fig. 7A) but in eels, for instance, eosinophilic granulocytes rarely occur and thus heterophilic granulocytes dominate in the tissue near the praesoma of  $\rightarrow$ *Paratenuisentis ambiguus* or other parasites of eel. Fish-specific melano-macrophages, also may occur near the acanthocephalan praesoma. Plasma cells, however, (documented from fish) also may occur but do not seem to play the same role as, for instance, in mammals. In fish immunoglobulins develop relatively slowly during the course of an infection, precipitins are rare, and the only immunoglobulin class produced is IgM being better at agglutination and complement activation than precipitation. Very little is known about the use of antibodies of fish against acanthocephalans.

In birds (ducks infected with  $\rightarrow$ *Filicollis anatis*, Fig. 6) heterophils represent the major granulocyte fraction (Fig. 7B). Macrophage giant cells frequently occur in the tissue near the parasite's praesoma, and also plasma cells are contained in it depending on the stage of infection.

In mammals a progressed stage of infection is accompanied by the abundance of plasma cells near the worm surface (Fig. 5B) after having passed through an acute phase of infection associated with a mass occurrence of eosinophilic and heterophilic granulocytes (Fig. 5A, C). In rats infected with *M. moniliformis* the occurrence of plasma cells up from about 10 d.p.i. (Fig. 5B) corresponds with the increase of worm-specific IgE-antibodies as described elsewhere.

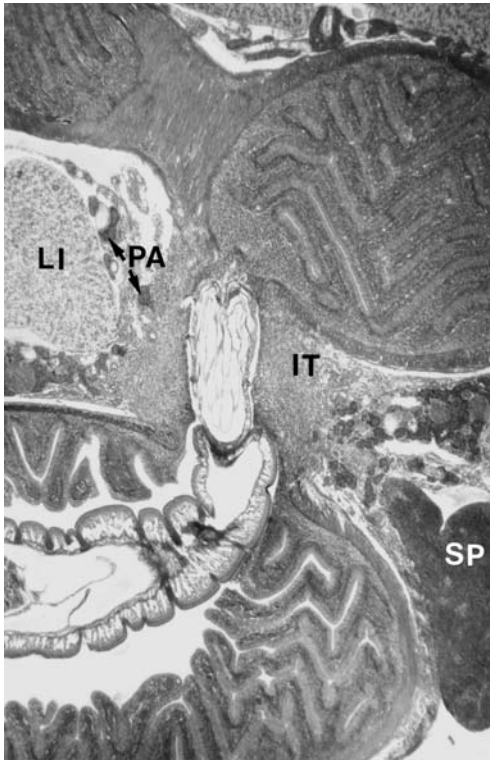

**Acanthocephalan Infections.** Figure 2 LM of a paraffin section showing a longitudinally sectioned male *Acanthocephalus anguillae* in an experimentally infected goldfish fingerling, 18 d.p.i. The worm has perforated the intestinal wall of one loop with its praesoma and the anterior portion of its metasoma and now has ruptured the outer part of another loop's wall. The extraintestinal part of the worm is enclosed by inflammatory tissue (IT).  $\times 80$ . LI, liver; SP, spleen; PA, pancreas.

Several fish researchers have often been amazed by the high intensities, often exceeding 100 specimens per gut, with acanthocephalans like the perforating species *Pomphorhynchus laevis*, being tolerated without showing external signs of disease.

In birds and mammals, however, different species of perforating acanthocephalans have been involved in  $\rightarrow$ morbidity and mortality, especially under elevated worm intensities as shown by a domestic duck infected with *F. anatis* (Fig. 6). This polymorphid palaeacanthocephalan also causes  $\rightarrow$ weight loss,  $\rightarrow$ anaemia, debility, apathy, and somnolence among infected ducks.

In mammals and birds the involvement of secondary infections and the infiltration of bacteria from the deep lesions into the peritoneal cavity seem to contribute to this pronounced pathology. In swine the sites of attachment of the perforating archiacanthocephalan *Macracanthorhynchus hirudinaceus* are marked on the outer surface by a caseous  $\rightarrow$ nodule with a reddened annulation around it. It frequently abscesses with bacterial involvement, which may lead to perforation of the gut wall. Human patients in China and Southeast

Asia have suffered unbearable  $\rightarrow$ abdominal pain during the passage of the entire worm or parts of it into the peritoneal cavity which is accompanied by infiltration of eosinophils and neutrophils, massive  $\rightarrow$ oedema, and large quantities of serosanguineous exudate in the body cavity near the site of perforation. Prior to 1980 perforating acanthocephalans (mainly  $\rightarrow$ *Prosthenorchis elegans* and occasionally *Oncicola spirula*) infecting primates held in zoos were the cause of numerous fatal cases among these hosts. But since then no further cases have been published, probably due to the resulting growing awareness of this threat in zoological gardens since then. The perforation canal through the intestinal wall harbouring the parasite was filled with inflammatory exudate enriched with scattered masses of bacteria and acute peritonitis was diagnosed to be the cause of death in many cases reported by several authors. Less than 15 specimens of *P. elegans* are considered sufficient to cause mortality in squirrel monkeys.

In contrast to these descriptions from 3 perforating acanthocephalans, *M. moniliformis* with its superficial attachment (Fig. 8) does not create mortality among rats, and in these hosts as well as in accidental human cases where a worm had been measured to be 26.5 cm in length, the symptoms of morbidity are much less pronounced. All these findings suggest that the depth of penetration of an acanthocephalan species is an important criterion influencing the course of pathology at least in host-parasite associations involving mammals or birds as final hosts.

### Praesoma Morphology Influencing the Host-Parasite Interface

The praesoma of eo- and palaeacanthocephalans is invested by a lipoid surface cover ( $\rightarrow$ *Acanthocephala/Integument*/Fig. 11). It probably fulfills defence functions but obviously also incorporates lipids from necrotic host tissue which then becomes absorbed by the parasite ( $\rightarrow$ *Acanthocephala*/Fig. 10). Within this coat, osmiophilic films seem to be shed from the parasite's surface ( $\rightarrow$ *Acanthocephala*/Fig. 12B). Whether these are loaded with peptides or substances deriving from defence mechanisms of the host will have to be proven in experiments.

The phenomenon of shedding ( $\rightarrow$ *Capping*) of surface coat can be commonly observed from *M. moniliformis* in rats (Fig. 5A, C). Large patches of the fuzzy surface coat detach from the praesomal worm surface into the surrounding necrotic inflammatory tissue/exudate. It happens during the acute phase of infection associated with a granulocyte response as well as later on when plasma cells accumulate at the praesoma. One may conclude that host's enzymes and/or antibodies bind to this coat until it is shed by the parasites. In transmission electron micrographs patches of detached coat attain a more coarsely structured and more electron



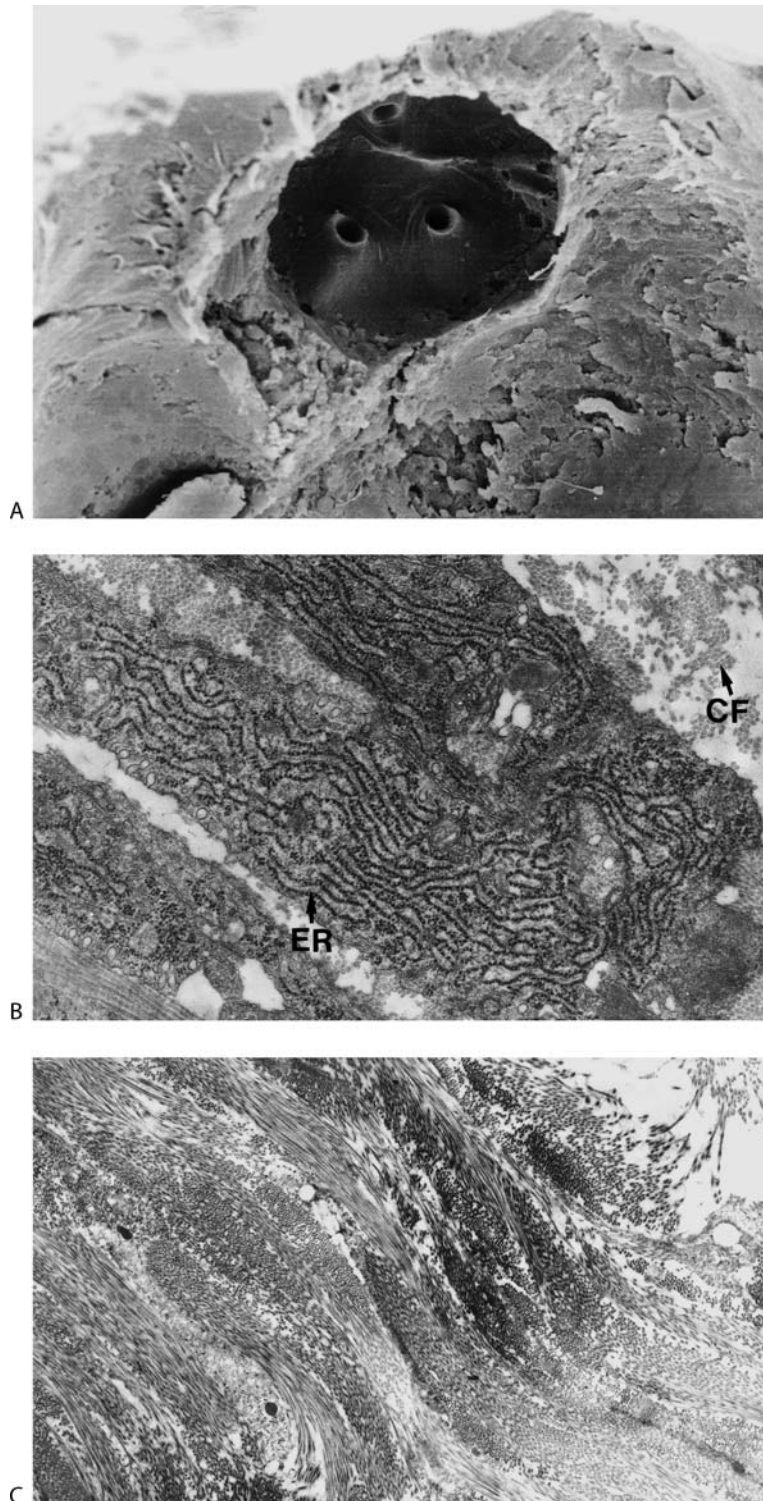

**Acanthocephalan Infections. Figure 3 A–C** Micrographs of connective tissue in the intestinal wall of fishes infected with acanthocephalans. **A** SEM showing the former point of attachment of a proboscis of *Neoechinorhynchus rutili* in the intestinal wall of a naturally infected rainbow trout. Collagen fibres have formed a firm capsule appearing as a “print” of the proboscis. **B** TEM of fibroblasts (ER: rough →endoplasmic reticulum) and excreted collagen fibres (CF) in the outer connective tissue belt encapsulating the proboscis of the perforating species *Acanthocephalus anguillae* in an experimentally infected rainbow trout 30 d.p.i. **C** TEM of firm connective tissue consisting of plane collagen fibres near the outer margin of the neoplastic tissue encircling the bulbus of a large specimen of the perforating species *Pomphorhynchus laevis* in a chub.

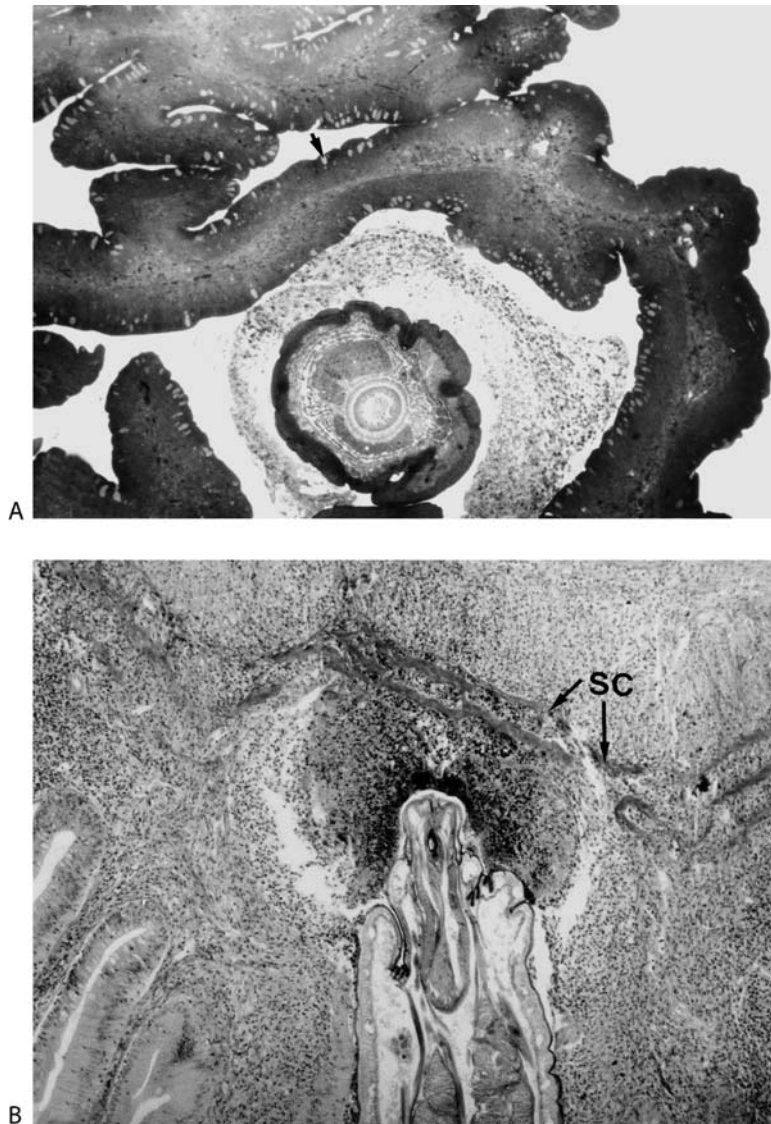

**Acanthocephalan Infections. Figure 4 A–B** Light microscopical micrographs of sections of acanthocephalans and surrounding tissue of the fish hosts' intestinal wall. **A** Semithin cross section through the anterior metasoma of a young adult *Acanthocephalus anguillae* and surrounding intestinal plicae. The worm is surrounded by a “cloud” of cells and liquids leaking from the intestinal wall into the gut lumen. Also note the densely set, hyperplastic goblet cells in the mucosa (arrow). **B** Paraffin longitudinal section through the anterior third of a *Neoechinorhynchus rutili* in a naturally infected grayling (*Thymallus thymallus*). Note the huge inflammatory reaction around the worm's praesoma. *SC*, collagenous stratum compactum.

lucent appearance compared to the →glycocalyx still lining the surface (Fig. 5A, C).

#### **Leakage of Liquids, Cells, and Debris from the Lesion**

The phenomenon of leakage from the lesion created by a worm into the intestinal lumen has been documented in many acanthocephalans (Figs. 4A, 8). It seems to be most pronounced at the climax of the acute phase of infection at the point of attachment of perforating species (Fig. 4A). Having reached a progressed chronic stage, the opening of the lesion heading towards the intestinal lumen almost tightens up by the host so that

the leakage decreases (Fig. 1). Most non-perforating species, on the other hand, seem to switch their site of attachment prior to a severe →inflammatory reaction with an accompanying leakage.

#### **Abrasion, Erosion, Compression**

Usually the mucosal surface within the range of an acanthocephalan →metasoma, also becomes mechanically affected by movements and the body pressure of the worms, especially close to the lesion. Also, many acanthocephalans possess body spines which support a burrlike affiliation of parts of the metasoma

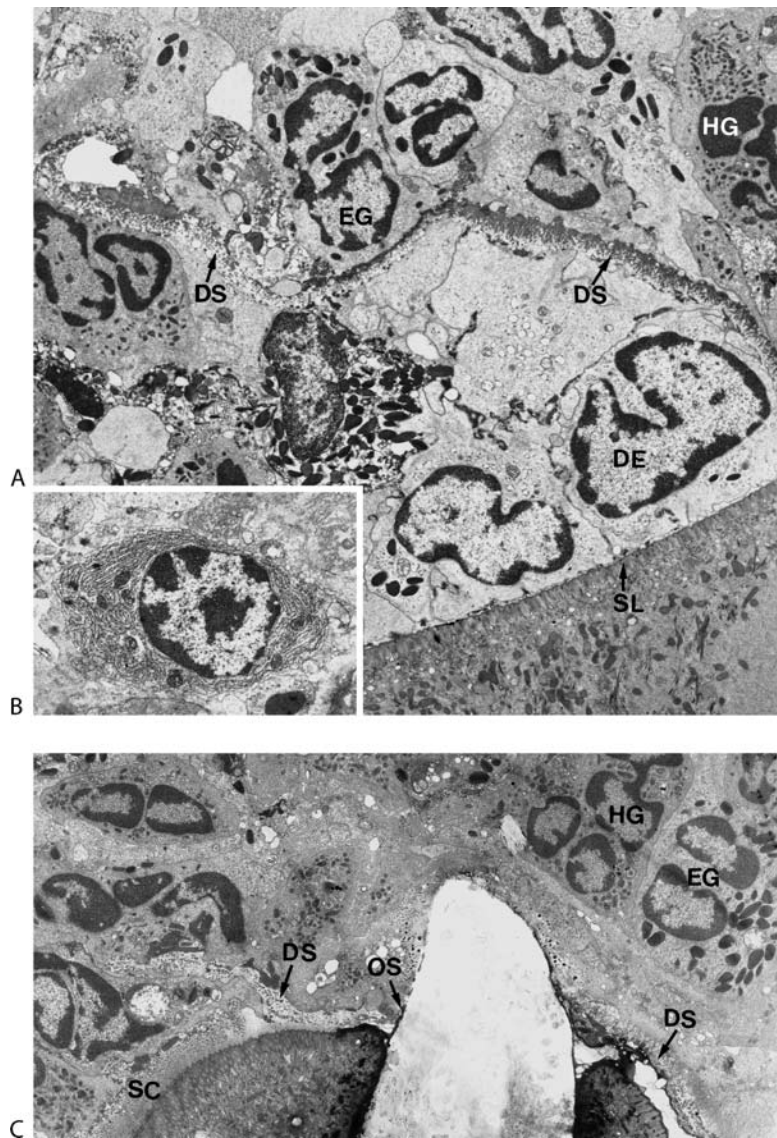

**Acanthocephalan Infections. Figure 5 A–C** TEM of the proboscis surface and of surrounding host tissue of *Moniliformis moniliformis* in rats. *DS*, detached surface coat; *DE*, degranulated eosinophilic granulocyte; *EG*, eosinophilic granulocyte; *HG*, heterophilic granulocyte; *SC*, surface coat; *SL*, →striped layer of the tegument; *OS*, osmiophilic substance deriving from the annular cleft around the “naked” hook. **A** Acute phase of infection, 10 d.p.i. Eosinophilic and heterophilic granulocytes form dense populations near the praesoma. Large patches of the surface coat have detached from the worm. **B** Plasma cell out of a dense association of such cells near the surface of a worm, 60 d.p.i. **C** 10 d.p.i. infection. Note the fine fuzzy structure of the surface coat still adhering to the worm’s praesomal surface while other portions of it have detached.

with the mucosal surface which should have some scratching effect.

#### Increased Diameter of the Intestinal Wall

A local increase in thickness of the intestinal wall at the site of anchorage is well described in acanthocephalans. In addition also other parts of the host’s gut which are not in contact with the worms may be enlarged in diameter.

#### Distention of the Intestine

The rat intestine in its length may be extended due to a single specimen of *M. moniliformis*. Also certain appendages like pyloric caeca were found to become almost doubled in diameter due to the acanthocephalans (→*Leptorhynchoides thecatus*) inhabiting the caeca. Interestingly intestinal caeca seem to be a preferred environment of several intestinal helminths, and one acanthocephalan has been found to create its own caecal microhabitat. This species, *N. carpiodi*, also exhibits

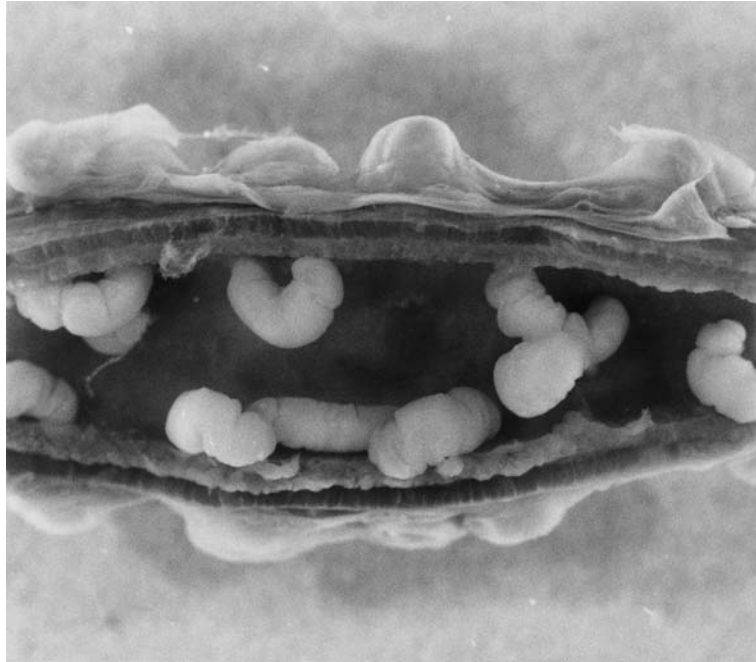

**Acanthocephalan Infections. Figure 6** LM of an opened intestine of a domestic duck naturally infected with *Filicollis anatis*. The trunks (metasoma) of the worms can be inside the gut lumen whereas the praesomal bulb encapsulated by neoplastic tissue is seen at the outer side of the intestinal wall; The worm density of *Filicollis anatis* shown here potentially creates mortality among ducks.

that social clustering exists among acanthocephalans. Up to 20 or more worms can be found together inside deep caverns surrounded by collagen capsules seen as expansions at the outer intestinal wall.

#### Occlusion of the Intestine

A few acanthocephalans such as *Macracanthorhynchus hirudinaceus* reach considerable size, i.e., more than half a meter in length. High worm burdens have been mentioned to have occluded the intestinal tube leading to mortality among piglets.

#### Negative Influence on Metabolic Parameters

As in other helminths which are better investigated than acanthocephalans one should expect that various physiological parameters of the hosts become negatively influenced by an acanthocephalan infection, especially under the influence of a co-stressor like insufficient energy supply or unsuitable temperatures. Indeed, growth, weight gain, and blood sugar concentrations of rats infected with *Moniliformis moniliformis* were most conspicuously altered when diets with low amounts of carbohydrates were offered. Among starlings experimentally infected with moderate numbers of *Plagiorhynchus cylindraceus* only negative effects (on the weight of male host individuals) could be observed under deficient temperatures.

#### Fever

Elevated body temperatures due to acanthocephalan infections have been reported in domestic ducks as well as in primates and humans.

#### Goblet Cell Hyperplasia

Several authors have reported inflated goblet cells along the intestinal mucosa in hosts (fish, rats) infected with acanthocephalans, also their density was found to – increase due to acanthocephalan infections (Figs. 4A, 8). Concerning primary infections of perforating acanthocephalans permanently remaining at one point of attachment, this defence measure might be ineffective. But young worms supplementing an established infestation as well as specimens of non-perforating acanthocephalans showing a non-sessile behavior, should be affected by an excess of mucins deriving from goblet cells.

#### Skeletal Deformations

Notes exist, that describe brown trout, heavily infected with different acanthocephalan species, to show deformed backbones and/or shortened gill operculae or fins. This may have to do with the recently detected very high absorptive capacity of acanthocephalans for calcium and other minerals.

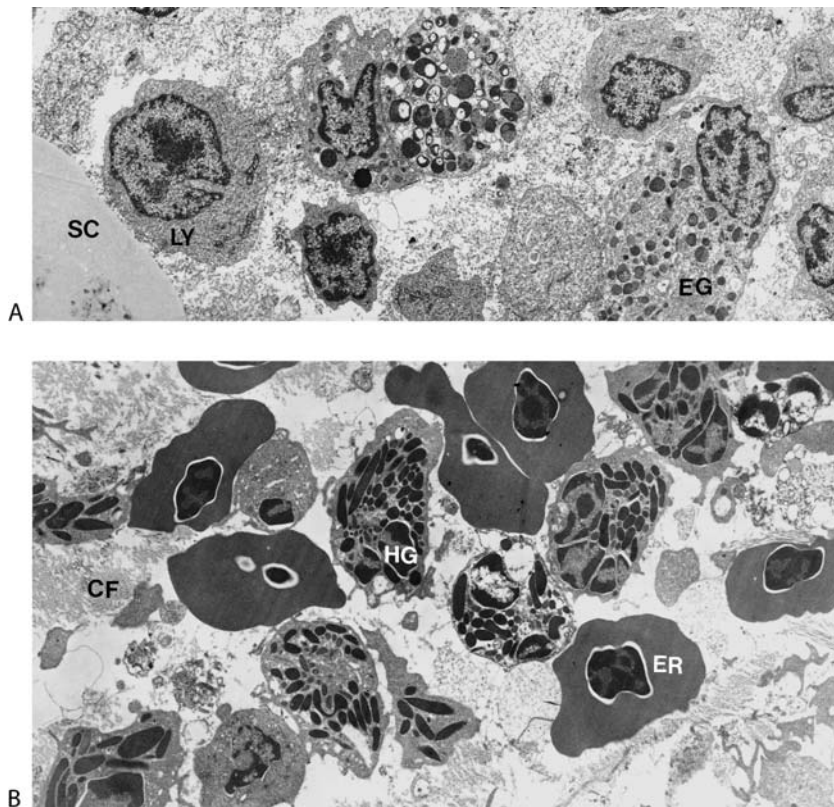

**Acanthocephalan Infections. Figure 7 A, B** TEM of granulocytes and erythrocytes near the praesoma of acanthocephalan species. **A** Acute infection of *Acanthocephalus anguillae* in a carp, 14 d.p.i. The eosinophilic granulocytes (EG) have attained different stages of degranulation. LY, lymphocyte; SC, surface coat of the worm's praesoma. **B** Inflamed and haemorrhagic loose neoplastic tissue of a naturally infected duck near the anterior bulb/proboscis of a *Filicollis anatis*. ER, erythrocyte; HG, heterophilic granulocyte; CF, collagen fibres.

### Infections in Humans

Two species of archiacanthocephalans and three species of palaeacanthocephalans ([→Acanthocephala](#)) have been found in humans. Cases of *Macracanthorhynchus hirudinaceus* have been reported mainly in China and Thailand, of *Moniliformis moniliformis* in many tropical and subtropical countries. Specimens of *M. moniliformis* are located inside the intestine, where they reach sexual maturity. All other acanthocephalans recovered from humans do not reproduce in this accidental host. *Acanthocephalus rauschii*, *A. bufonis*, and *Corynosoma strumosum* (parasites of fish, amphibians, and seals, respectively) have been obtained from human patients in Alaska (*A. rauschii* and *C. strumosum*) and Indonesia (*A. bufonis*). *A. rauschii* was located in the peritoneum, and the other two palaeacanthocephalans in the gut.

Infections with *M. hirudinaceus* and *M. moniliformis* usually occur among small children who, willingly or accidentally, ingest insects. In parts of Asia, however, where raw or undercooked insects are customarily eaten, adult humans also become infected; symptoms of

infection such as weight loss, intermittent fever, bulging abdomen, diarrhea, and severe pain are well described. In a hospital in China 115 cases of acute abdominal colic due to *M. hirudinaceus* were reported over a period of only 3 years. Often *M. hirudinaceus* in humans occupies extraintestinal positions. The migration of this perforating acanthocephalan through the gut wall is very painful. An adult volunteer who swallowed infective larvae of *M. moniliformis* suffered from abdominal pain beginning from the 20th day after infection. It seems that *M. moniliformis* does not lead to a great inflammatory reaction; however, abdominal surgery on patients infected with *M. hirudinaceus* revealed a serosanguinous exudate in the peritoneum, inflamed parts of the intestine with [→nodules](#) of up to 3 cm in diameter, and/or intestinal perforations. Thus, in humans both species show a pathogenicity similar to that in their major hosts, i.e., rats and swine (*M. hirudinaceus*) respectively.

### Therapy

[→Acanthocephalacidal Drugs.](#)

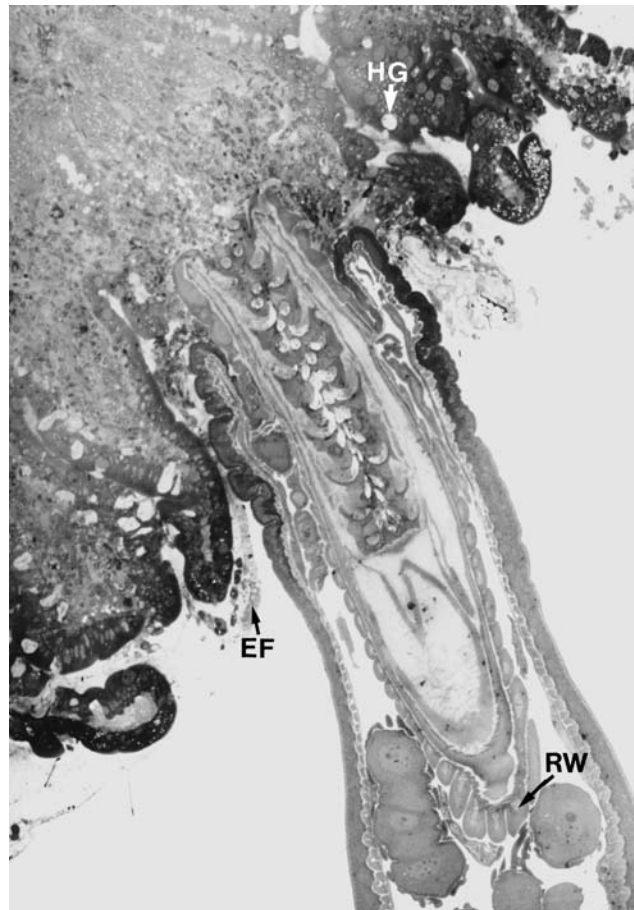

**Acanthocephalan Infections.** **Figure 8** Semithin longitudinal section of the praesoma and anterior trunk of a 20-d.p.i.-specimen of *Moniliformis moniliformis* in a rat. Note the superficial attachment, the deep proboscis cavity (most of the proboscis is invaginated), the hyperplastic goblet cells (*HG*), and the efflux (*EF*) from the lesion into the intestinal lumen. *RW*, spirally arranged muscle cords of the outer receptacle wall.

## Acanthocephalus

### Important Species

[Table 1.](#)

### Classification

Genus of [→Acanthocephala.](#)

### Life Cycle

[→Acanthocephala.](#)

**Acanthocephalus. Table 1** Important species of the genus *Acanthocephalus*

Species	Size (adults, mm; egg, $\mu\text{m}$ )	Final host	Intermediate host	Paratenic host	Geographic distribution
<i>Acanthocephalus anguillae</i>	m 5–7 f 10–35 E 100–125 $\times$ 12–14	Chub, barbel	<i>Asellus aquaticus</i>	Small cyprinid fish	Europe
<i>A. ranae</i>	m 5–12 f 20–60 E 110–130 $\times$ 13–16	Amphibia	<i>Asellus aquaticus</i>	–	Holarctic

m = male, f = female, E = egg

## Acanthocephalus anguillae

→Acanthocephala.

## Acanthocephalus lucii

→Acanthocephala.

## Acanthocheilonema

Genus of the family →Filaridae, →Nematodes. New genus name for →*Dipetalonema*.

## Acanthocheilonema viteae

→Nematodes, →*Dipetalonema*.

## Acanthor

The first larva of →Acanthocephala (→Acanthocephala/Reproduction, →Acanthocephala/Figs. 2,3). During the first equal cell divisions after fertilisation 2 polar bodies usually appear at the end of the embryo that will become the anterior end of the acanthor. Further equal and unequal divisions show a kind of spiral cleavage resulting in micromeres and macromeres. In a later stage, the central nuclear mass (inside the central syncytium) appears. However, there is no formation of a digestive tract at any phase of development. In addition, the very early embryo attains a syncytial organisation. Thus, it is difficult to decide what is ectoderm, endoderm, or mesoderm. During the course of development the embryo detaches from the floating ovary and the single →eggshell differentiates into the different envelopes.

Mature acanthors consist of 3 syncytia. The central →syncytium (median), the epidermal syncytium

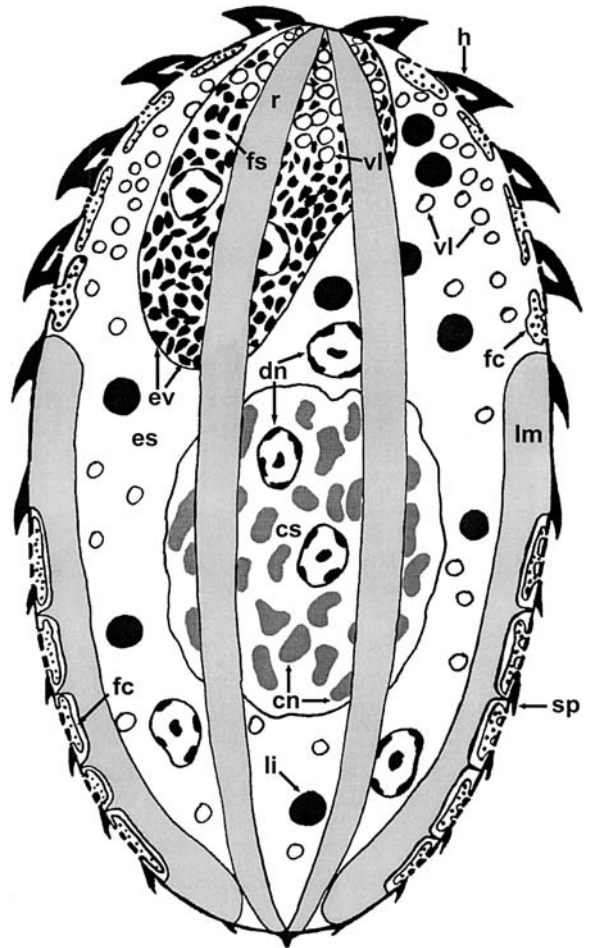

**Acanthor.** Figure 1 Schematic drawing of a hatched acanthor of the eoacanthocephalan *Paratenuisentis ambiguus*. The frontal syncytium (fs) is rich in electron-dense vesicles (ev) as well as vacuoles containing electron-lucent mucus-like matter (vi). The central syncytium (cs) harbours condensed nuclei (cn) and a few decondensed nuclei (dn). The epidermal syncytium (es) forms most of the body including fused crypts of the outer membrane which contain round electron-dense granula. The surface of the larva is armed with hooks (h) and body spines (sp). The 2 retractor muscles (r) enable the larva to perform invaginations of the anterior body. The hind body may contract itself by the action of the 10 longitudinal muscle cords (Im, only 2 are drawn); li, lipid drop. (Reitze and Taraschewski unpubl.)

(caudal), and the frontal syncytium (Fig. 1). Within the central syncytium there are 10 subepidermal longitudinal muscles and 2 more centrally located retractor muscles. According to descriptions of Albrecht et al. from acanthors (of 3 species) that were still inside the mother's body cavity and enclosed by eggshell-envelopes, the subepidermal muscles are connected via

cytoplasmic bridges with the central nuclear mass. However, in hatched acanthors of *→Paratenuisentis ambiguus* collected from the gut of its crustacean *→intermediate host*, no connections between the central syncytium and the subepidermal muscles could be found; the muscles were part of the epidermal syncytium (Fig. 1). So probably the bridges described may get lost during the final maturation of the acanthor or the hatching process. The central nuclear mass contains condensed as well as decondensed nuclei. The latter are also found in the epidermal and the frontal syncytium (Fig. 1). The epidermal syncytium forms the outer surface and most of the larva's body. It contains numerous *→vacuoles* with mucus-like electron-lucent content which are concentrated near the surface of the anterior half (Fig. 1). In acanthors of *→P. ambiguus* the crypts of the outer membrane are fused underneath the larva's surface and harbour electron-dense granules which may have a function during the penetration of the larva into the haemocoel of the intermediate host. The electron-dense vesicles as well as the vacuoles with electron-lucent content inside the frontal syncytium could probably also be involved in the task of penetration, chemically supporting the action of the hooks. Stimulated acanthors of *Moniliformis moniliformis* have been found to discharge chitinase, but this enzymatic activity has not been localised at the acanthor's body. Hooks are most prominent at the anterior surface and decline in size towards the larva's posterior end (Fig. 1). Acanthors are rich in *→glycogen* in the *→cytoplasm* between the muscles, nuclei *→mitochondria*, and inclusions (Fig. 3A).

Mature acanthors of acanthocephalans are enclosed by 4 eggshells separated by interstices containing granular electron-lucent material (Figs. 2, 3, 4A). However, eggs of *→Neoechinorhynchus* species become complemented by a fifth envelope (E0) creating a fifth voluminous outer interstice (Fig. 2C). The outermost, first envelope seems to derive from the "*→fertilisation membrane*". Usually it is thin but can be reinforced by outgrowths of the underlying eggshell (Figs. 3B, 4A). This envelope (E2) was found to contain keratin in all 3 groups of the Acanthocephala. In palaeacanthocephalans it forms more or less filiform outgrowths (Figs. 2A, 3A, 3B) entangling with algae or leaves (the food substrates of the intermediate hosts) once the outermost envelope has disintegrated in the water. In archiacanthocephalans, the second eggshell is interspersed with the respective outermost interstice and seems to function in protecting the egg from dissipation and other negative outer influences (Figs. 2B, 4A). Among archiacanthocephalans the underlying tripartite third envelope also comprises keratin, while eo- and palaeacanthocephalans do not have keratin in this eggshell. The fourth,

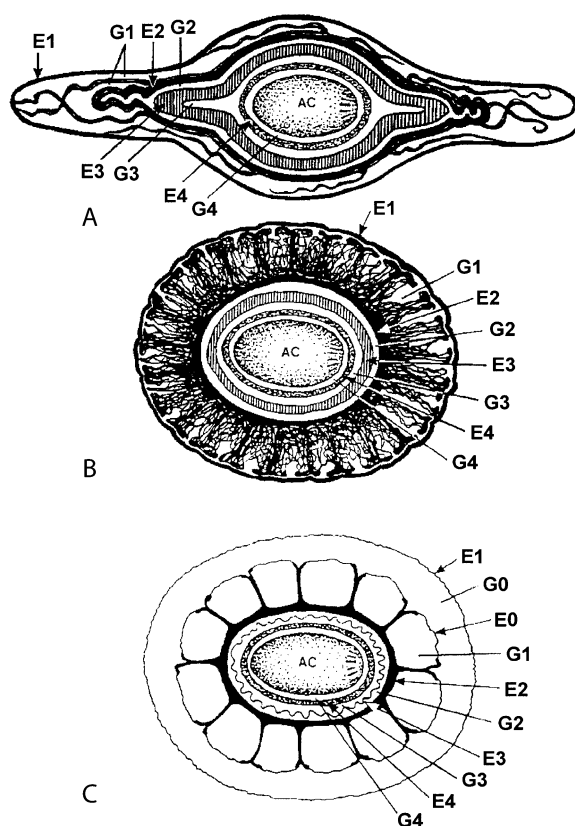

**Acanthor. Figure 2** Schematic drawings of the eggshells of Palaeacanthocephala (A), Archiacanthocephala (B), and a neoechinorhynchid eoacanthocephalan of the genus *Neoechinorhynchus* (C). E, eggshells (envelopes); G, granular interstices; AC, Acanthor. A. Note the filiform outgrowth of the second eggshell. B. The second eggshell creates a thick mesh of amorphous matter intermingling with the first interstice. C. Note the existence of 5 eggshells and 5 interstices, respectively. The 2 outermost interstices are loaded with carbohydrates. The eggshell E2 seems to keep the E0 eggshell in position. The E3 eggshell is just a membrane.

innermost eggshell contains *→chitin* among palae- and archiacanthocephalans (Fig. 3C). In eoacanthocephalans, however, this innermost eggshell lacks chitin. The interstices contain carbohydrates which together with the envelopes seem to have different functions.

As a general rule, the outer envelopes and interstices appear to be ecologically related, accomplishing functions in parasite transmission, etc. In archiacanthocephalan eggs the outer part of the eggshell swells when exposed to digestive influences so that the inner part containing the acanthor is passively released (Fig. 4B). The interior envelopes (Figs. 2, 3, 4A) seem to be systematic related and obviously fulfil tasks belonging to the principle requirements of the acanthor.



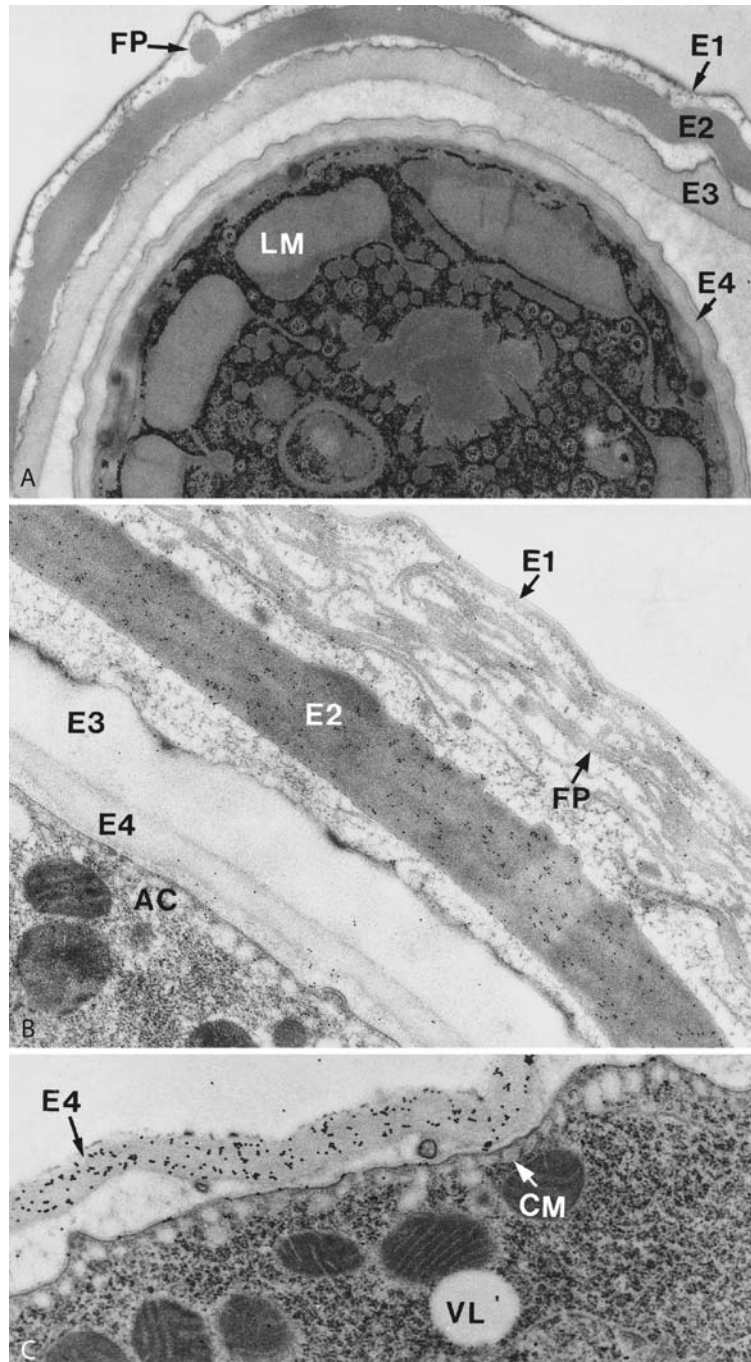

**Acanthor. Figure 3** TEMs of sections through eggshell envelopes and interstices enclosing acanthors of palaeacanthocephalans treated in different fashions. **A** Egg of *Acanthocephalus anguillae* incubated according to the electron microscopical PAS-method of Thiéry in a mode to visualise glycogen (dark granules in the acanthor). Also note the 4 eggshells (E1–E4) and the transversally sectioned subepidermal longitudinal muscles (LM); *FP*, filiform protuberance of E2. **B** Egg of *Polymorphus minutus* incubated with anti-keratin and subsequently with a second antibody labelled with colloidal gold. Note the gold granules on eggshell E2 and its outer filiform protuberances indicating keratin in the second envelope. This section does not show the granular interstice between the 3rd and the 4th envelope. As can be seen under **A**, the width of the interstices is different. *AC*, acanthor. **C**. Innermost envelope (E4) and acanthor of *P. minutus* after incubation with lectin wheatgerm agglutinin (coupled with colloidal gold granules) in a mode that chitin is visualized. Note the gold label on E4, also the crypts of the acanthor's outer membrane (CM) and the glycogen granulation between the mitochondria and the vacuole of electron-lucent content (VL) (probably mucus).

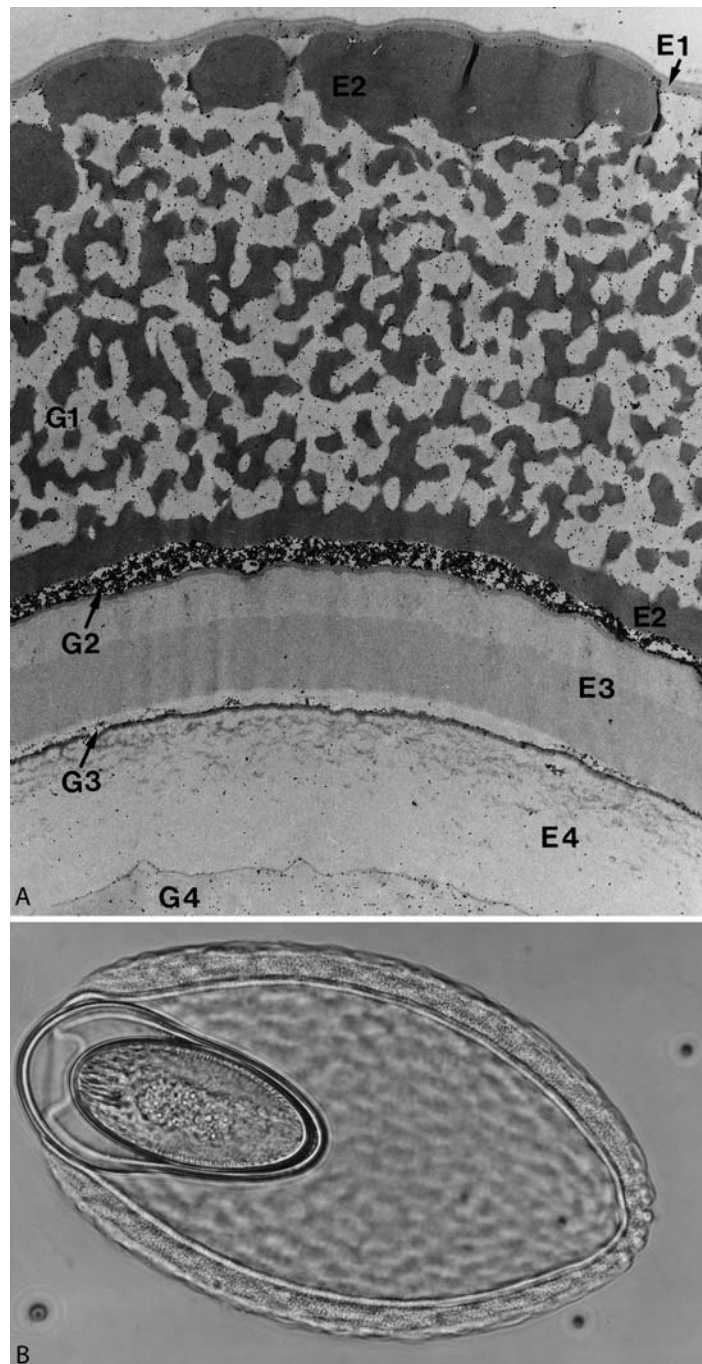

**Acanthor. Figure 4** Micrographs showing envelopes, interstices and an acanthor (B) of the archiacanthocephalan *Macracanthorhynchus hirudinaceus*. **A** The ultrathin section has been incubated with chitinase and subsequently with lectin wheatgerm agglutinin coupled with gold granules. The innermost envelope E4 therefore does not show a chitin-gold-label as it would without the enzyme treatment. According to competition experiments with *N*-acetylglucosamine and triacetyl chitotriose it becomes evident that the partly intense label in the granular interstices is due to different carbohydrates but not chitin. The acanthor is not seen. Note that E1 and E3 are tripartite; G1–G4: granular interstices separating the envelopes; E1–E4: envelopes. **B** Light microscopical micrograph of an egg that has been incubated in sodium docecyl sulfate (SDS) and dithiothreitol (DTE) to extract proteins including keratin. Consequently, the outer 2 envelopes swell considerably and eventually rupture due to an increase of the osmotic pressure. Therefore the acanthor seen still enclosed by the keratin containing E3 envelope and the E4 envelope that has chitin, “shoots” out of its enclosure, suggesting that the digestive activity in the gut of the intermediate host largely contributes to the hatching process of the acanthor.

## Acanthosis

Symptom in →*onchocerciasis*, with thickening of the epidermis and increased melanin in the upper dermis; skin thickening in Scabies →*Sarcoptes*.

## Acanthostomum

→*Digenea*.

## Acarapis woodi

→*Mite* of honey bees that lives in the tracheoles and thus blocks oxygen transport (Fig. 1). The female mite reaches a size of  $180 \times 100 \mu\text{m}$ . The disease has to be announced to government. Treatment by chlorfenson or dimeform.



**Acarapis woodi. Figure 1** Adult male miteset free from bee tracheole.

## Acari

### Name

Greek: *acari* = mite.

## Acaridae

→*Acarina*.

## Acarina

### Classification

Order of →*Arthropoda*.

### General Information

The order Acarina, including →*mites* and →*ticks*, contains numerous economically and medically important species that are parasitic on humans, domesticated or hunted animals, and crops, food, etc. Unlike other chelicerates, members of the Acarina lack a visible body division. Thus, the abdominal segmentation has disappeared and the abdomen has fused with the praesoma; the portion of the body on which the legs are inserted (the →*podosoma*) is broadly joined to the portion of the body behind the legs (the →*opisthosoma*) to form the →*idiosoma* (Fig. 1). Another general feature of the group is the appearance of the anterior (head) region carrying the mouth parts (a pair of →*chelicerae* and of →*pedipalps*), this region being called the capitulum or gnathosoma. The chelicerae and pedipalps are variable in structure, depending on their function in the different groups (→*Argas*/Fig. 1, →*Ixodes*/Fig. 1, →*Mites*/Fig. 1, →*Neotrombicula autumnalis*/Fig. 1). Chelicerae may appear needle-like for piercing the skin of hosts or toothed (as in →*ticks*) for anchoring to the →*integument* of the host.

### System

The classification of the Acarina, which as adults have four pairs of legs, is still a matter of controversy; with respect to the parasitic stages, the following system, which is based on the location of the openings of the tracheal system (stigma or spiracle), covers all parasitic species:

Subphylum: →*Chelicerata*.

Class: Arachnida.

Order: Acarina.

Suborder: →*Metastigmata* (ticks; large species with recurved teeth, a pair of tracheal →*spiracles* is located behind third or fourth coxae).

Family: →*Argasidae* (→*Argas*).

Family: →*Ixodidae* (→*Ixodes*).

Suborder: →*Notostigmata* (large leathery primitive free-living →*mites*; four pairs of spiracles behind the fourth coxae).

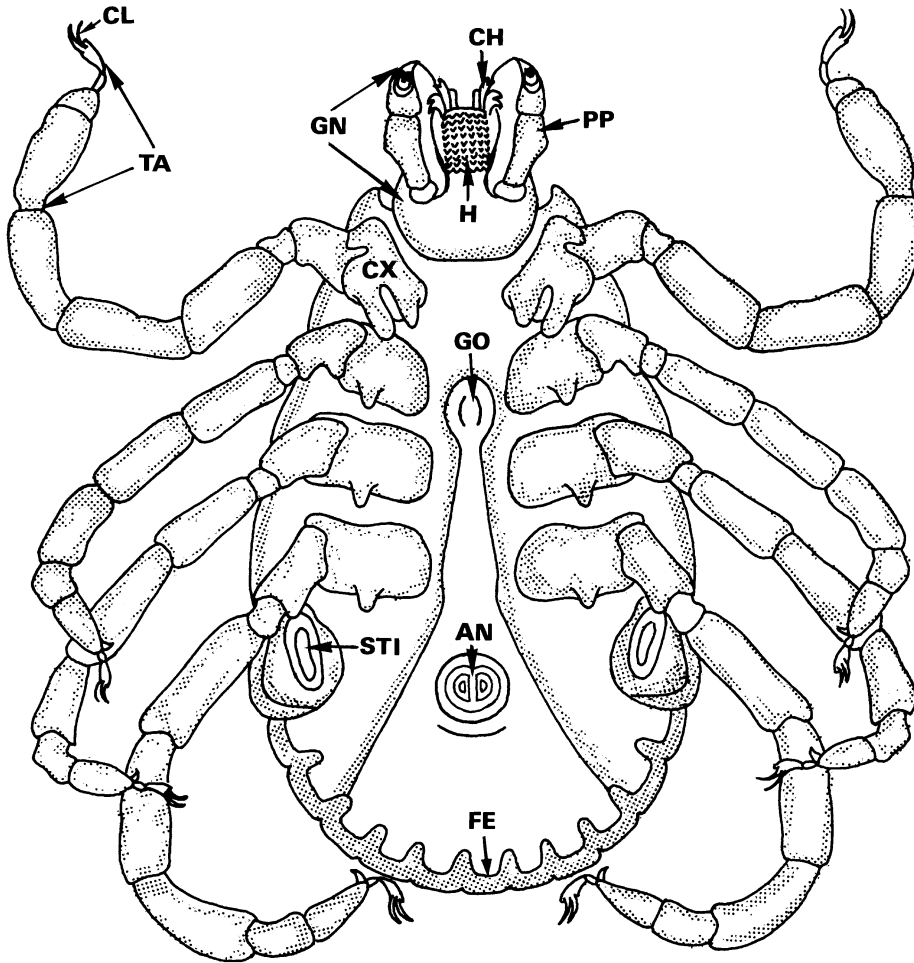

**Acarina. Figure 1** Diagrammatic representation of an ixodid tick (e.g., *Dermacentor* sp.) from its ventral side. *AN*, anus; *CH*, chelicera; *CL*, claw; *CS*, sheath of chelicera; *CX*, coxa; *E*, esophagus; *EM*, pulvillus; *FE*, festoon; *GN*, gnathosoma (capitulum); *GO*, genital opening; *H*, →hypostome; *PP*, pedipalpus; *SA*, salivary duct; *SC*, →scutum; *STI*, stigma; *TA*, tarsus.

Suborder: →**Tetrastigmata** (large predatory mites, two pairs of spiracles: one pair by the third coxae, the other behind the fourth coxae).

Suborder: Mesostigma (parasitic and free-living mites; a pair of spiracles behind third or fourth coxae).

Family: →**Dermanyssidae** (→Mites).

Family: →**Liponyssidae** (→Mites).

Suborder: →**Prostigmata** (trombidiform mites with a pair of spiracles located anteriorly near mouth region; many free-living predatory species and some parasitic families).

Family: →**Demodicidae** (→Mites).

Family: →**Trombiculidae** (→*Neotrombicula autumnalis*).

Suborder: →**Astigmata** (mites without spiracles, including storage-, scabies-, mange-, and itch-mites).

Family: →**Acaridae**

Family: →**Glyciphagidae**

Family: →**Sarcoptidae** (→Mites).

Suborder: →**Cryptostigmata** (oribatid or beetle mites; typical spiracles absent, but the tracheal system is usually associated with the basis of the first and third pairs of legs).

## Acariosis, Animals

Several →mites infest animals and cause significant dermatologic diseases. These may be occasional parasites e.g., harvest mites (*Trombicula*) or obligatory parasites like →*Sarcoptes* and →*Demodex* genera. Mites may be free-living on the surface of the skin

(*Cheyletiella*, →*Chorioptes*), superficial burrowers (→*Sarcoptes*) or may penetrate more deeply (*Demodex*). The parasitic mites of the families →*Sarcoptidae* and *Psoroptidae*, known as “→*mange mites*”, generally give rise to well-defined dermatoses. The lesions are the result of mechanical damage to the skin and probably also of →*hypersensitivity* reactions to toxic secretions (→*Pathology/Fig. 30*).

→*Sarcoptes scabiei* (→*Sarcoptic Mange*) occurs commonly in pigs, dogs and cattle; and more rarely in horses, sheep, goats and cats. The so-called feline →*scabies* is caused by →*Notoedres cati*. The several varieties of →*Sarcoptes scabiei* may represent strains of the same mite which have become more adapted to particular hosts. The mites burrow into the skin. It has long been suspected that antigens from the mites themselves, their faeces, or their moulting and hatching fluids are responsible for the allergic reactions observed. Clinical signs are similar in all species and consist of a papillar eruption accompanied by severe →*pruritus*. The intense scratching caused by the pruritus may lead to →*alopecia*, secondary bacterial infections, lichens and hyperpigmentation. The skin becomes thickened in severe cases. Clinically affected animals may become debilitated and lose weight or fail to properly gain weight. Feed efficiency is reduced and the hide may suffer considerable damage. Severely affected pigs may also become anaemic. The distribution of the lesions is characteristic in the various hosts.

→*Psoroptic mange* is a serious disease in cattle and sheep, less so in horse and goats. The causative mites are species of →*Psoroptes* and are host-specific. Mites penetrate the epidermis to suck body fluids, and cause a local reaction with formation of vesicles. The exudate from the vesicles coagulates and dries on the skin surface, resulting in the formation of a →*crust* or scab of varying thickness. The mites move to the edge of the scab, and the lesion increases in size. There is marked pruritus, and scratching results in alopecia, erosions and →*lichenification*. Lesions usually begin in areas thickly covered by hair or wool. Debilitation, reduced productivity and occasionally death may follow severe infestations. In goats *Psoroptes cuniculi* is known as the “earcanker” mite because of its predilection for the ear (causing otitis).

→*Chorioptic mange* occurs commonly in cattle, sheep and horses, and more rarely in goats. The *Chorioptes* mites are host-specific and live on the surface of the skin. Generally, it is a less severe condition than psoroptic or sarcoptic mange. Lesions consist of alopecia, erythema, excoriations and (small) crusts associated with pruritus. The mites have a predilection for the perineum, udder, caudal areas of thigh, rump and feet. Lesions caused by *Chorioptes equi* start as a pruritic dermatitis affecting the distal limbs around the

foot and fetlock. A moist dermatitis of the fetlocks develops in chronic cases.

→*Otodectes cynotis* is an obligate parasite of the external skin surface, mainly the external ear canal of cats and sometimes dogs. The major lesion is thus otitis externa.

*Demodex* spp. lives in the hair follicles and sebaceous glands of dogs, cats, cattle and goats. Demodicosis is of clinical importance in dogs. It is less common in cats and other animals. Mites are often present on healthy animals without causing obvious lesions, but heavier infestations produce mechanical damage to the skin. As the mites multiply in hair follicles and sebaceous glands, the hairs fall out. Enlargement and rupture of adjacent follicles and glands leads to cyst formation. Secondary pyoderma associated with staphylococcal infection is a common complication in the dog. Skin lesions in this animal may range from small localised patches of alopecia, in which the skin may appear normal, to more generalised dermatitis with loss of hair, thickening and discoloration of the skin. In the pustular form of the condition, small pustules are formed in the hair follicles. Dogs with generalised demodicosis may have a concurrent pododemodicosis, which is characterised by interdigital →*erythema* and alopecia or interdigital furunculosis with associated →*oedema* and pain. Pododemodicosis may be the only manifestation of the disease. In cattle and goats *Demodex* lesions consist of small elevated →*nodules* of varying size. Most lesions appear on the shoulder, head and →*neck* region. Nodular demodicosis is characterised by the permanent formation of new nodules when the older ones disappear. Nodules arise when granulomatous inflammation is complicated by secondary bacterial infection.

Other ectoparasitic mites include →*Dermanyssus gallinae*, *Lynxacarus radovsky*, →*Trombiculidae* (chiggers) and *Cheyletiella yasguri*, *C. blakei* in dogs and cats, and *Psorogates ovis* in sheep. Clinical signs include erythema and pruritic papulocrustous eruptions. →*Cheyletiellosis* in dogs and cats is typically more severe in young animals, with the primary lesion being scaling over the dorsal midline. Pruritus is variable.

## Therapy

→*Acarizides*, →*Nematocidal Drugs, Animals*, →*Arthropodicidal Drugs*.

---

## Acariosis, Humans

→*Scabies*, →*Sarcoptes*, →*Demodex*, →*Neotrombicula*, →*Arthropodicidal Drugs*, →*Ectoparasiticidal Drugs*.

## Acarizides

→Ectoparasitocidal Drugs, →Arthropodicidal Drugs.

## Acarodermatitis

Skin symptom (straw itch) due to bites of mites, e.g., of →*Pyemotes ventricosus*, which lives as larva and nymphs at the cost of various insect pests.

## Acarus siro

→Mites.

## Acceptable Daily Intake

### Synonym

→ADI.

### Definition

Dose of a drug residue in edible tissues, such as meat, various organs and fat, which during the entire lifetime of a person seems to be without obvious risk to health based on all toxicological data known at the time.

### General Information

The ADI for humans may be determined by applying a safety factor of 1:100, or a safety factor of at least 1:1000 in case of a teratogenic drug. Therapeutic claims made by the manufacturer must coincide with safety and tissue residue data for the drug approved by government regulatory agencies (→Chemotherapy).

## Acephal

Greek: *a* = not, *kephale* = head; term means without head, e.g., describes appearance of the larvae of flies (→Brachycera).

## Acetabulum

Holdfast organ in →tapeworms, ventral sucker in →trematodes and attachment point of *os ileum*, *os pubicum* and *os ischium* in the human skeleton.

## Acetylcholine (ACh)

→Nervous System of Platyhelminthes.

## Acetylcholine-Neurotransmission-Affecting Drugs

### Mode of Action

Fig. 1.

### Structures

Fig. 2.

### Organophosphates

#### Important Compounds

Dichlorvos, Diuredosan, Frento, Metrifonate, Coumaphos, Haloxon, Naphthalophos, Vapona.

#### Synonyms

Dichlorvos: Atgard, Dichlorman, DDVP, Equigard, Equigel, Task.

Diuredosan: Uredofos, Sansalid.

Metrifonate: Trichlorphon, Anthon, Bilarcil, Combot, Dipterex, Difrifon, Dylox, Dyrex, Mastotem, Neguvon, Tugon; in: Bubulin, Combotel, Dyrex T.F., Equizole, Neguvon A, Telmin B.

Coumaphos: Asuntol, Baymix, Co-Ral, Meldane, Muskatox.

Haloxon: Eustidil, Halox, Loxon; in: Haloxil.

Naphthalophos: Amdax, Maretin.

### Clinical Relevance

Metrifonate was introduced as insecticide in 1955. It exerts activity in →*Taenia solium* →neurocysticercosis. Diuredosan is active against *Taenia* spp., →*Dipylidium caninum*, *Mesocostoides corti* and is only slightly active against *Echinococcus granulosus*. Fospirate is active against *T. hydatigena*.

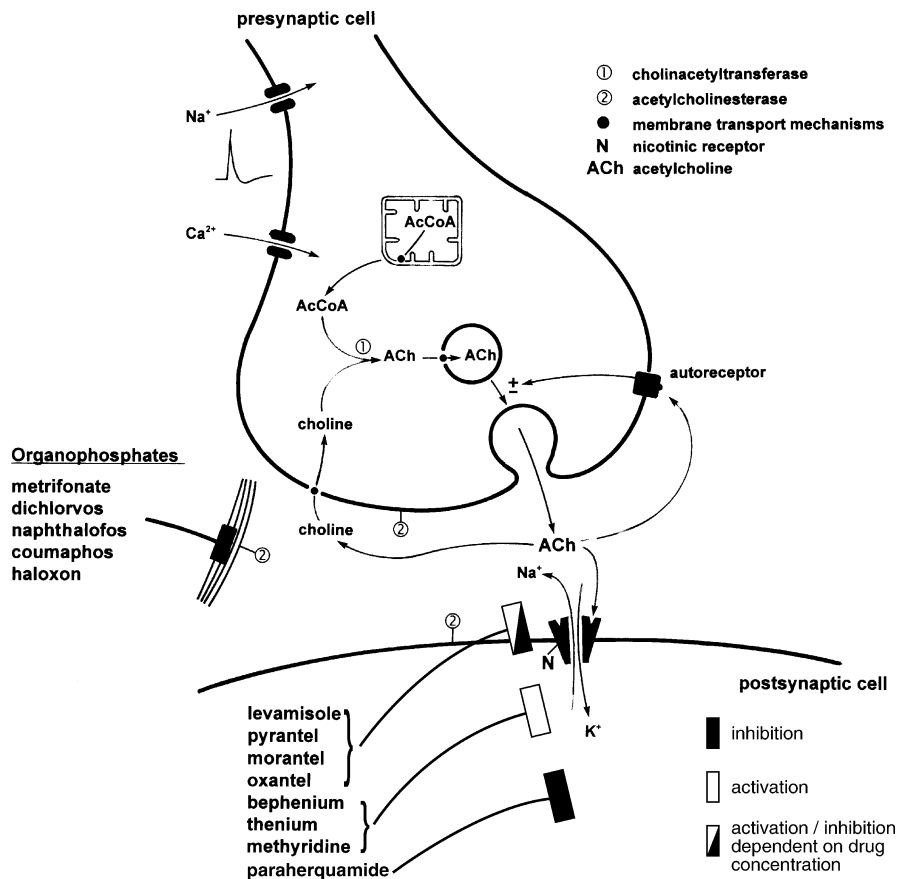

**Acetylcholine-Neurotransmission-Affecting Drugs. Figure 1** Model of the action of drugs interfering with acetylcholine-mediated neurotransmission.

The antitrepatodal activity of metrifonate is directed against →*Schistosoma haematobium*, and is only slightly active against →*S. mansoni* and →*S. japonicum*. Metrifonate is one of the drugs recommended by the WHO for the treatment of urinary schistosomiasis and present in the current Model List of Essential Drugs. For use in ruminants organophosphates had been available only in a limited number of countries. They are generally not as effective as the broad-spectrum anthelmintics and also have a lower therapeutic index. Haloxon, trichlorphon, coumaphos, naphthalophos and crufomate had been used in cattle, haloxon in sheep, dichlorvos in pigs, dichlorvos and trichlorphon in horses, and coumaphos in poultry.

### Molecular Interactions

Metrifonate is unstable in aqueous solutions, and a spontaneous, nonenzymatic transformation into various compounds takes place. One of the degradation products is dichlorvos, which exerts high biological activity. Acetylcholinesterase (AChE) from helminths as target for organophosphates was first explored in the late 1950s. Metrifonate has *in vitro* activity against →*Ascaris*

*lumbricoides* by the inhibition of AChE and cholinesterases resulting in an impairment of the action of the neurotransmitter acetylcholine (Fig. 1). AChE in →*nematodes* is inhibited at very low concentrations of  $10^{-13}$  M. This leads to an indirect permanent stimulation of excitatory neuromuscular transmission mediated by acetylcholine, followed by a continuous depolarization of the postsynaptic junction resulting in a spastic paralysis. In general, a complete paralysis of the oral sucker is induced at lower metrifonate concentrations than those required to produce complete paralysis of the body musculature. The prolonged paralysis of the intestinal musculature leads to an interruption of peristaltic movements and a starvation of the parasite. The differences in metrifonate susceptibility among schistosome species are explained by differences in the amount of AChE located on the surface of adult schistosomes. Thus, *Schistosoma haematobium* teguments contain up to 20 times, and *S. bovis* teguments up to 6.9 times, higher AChE activity than *S. mansoni* teguments. These quantitative differences correlate well with the relative sensitivities of these species to metrifonate. There is presumably an association of the





**Resistance**

Until now resistance against metrifonate is not known. However, against coumaphos and naphthalophos there are resistant →*Haemonchus contortus* strains in sheep and goats which lead to the ineffectivity of these organophosphates.

**Ethanolamines****Important Compounds**

Bephenium, thenium, methyridine.

**Synonyms**

Bephenium: Alcopar, Francin.

Thenium: Bancaris, Canopar; in: Ancaris, Thenatol.

Methyridine: Dekelmin, Mintic, Promintic.

**Clinical Relevance**

The antinematodal activity of bephenium is directed against *Ascaris lumbricoides*, →*Ancylostoma duodenale*, →*Trichostrongylus*.

**Molecular Interactions**

Several drugs belong to the class of ethanolamines such as bephenium, thenium, and methyridine. They have structural similarity to acetylcholine or nicotine and act as agonists of the acetylcholine receptor (Fig. 1) by binding to the acetylcholine receptors in the nerve cords of the nematodes. The compounds are not inactivated by AChEsterase. The result of the agonistic activity is the induction of depolarization and a permanent muscle contraction or spastic paralysis in the worms. The specific toxicity of these compounds is explained by the greater affinity to the parasite's receptors compared to the host receptors. At high concentrations they are also toxic for the host.

**Pyrantel, Morantel, Oxantel, Levamisole, Tetramisole****Synonyms**

Pyrantel pamoate: in Antiminth, Banminth, Cobantril, Combantrin, Felex, Helmex, Imathal, Nemex, Piranver, Pyraminth, Strongid T; in: Dosalid, Trivexan, Welpan. Pyrantel tartrate: in Banminth, Exhelm, Nemex, Pyreguan, Strongid.

Morantel: in Banminth II, Ibantic, Paratec; rumatel; in: Banminth D, Equiban.

Oxantel pamoate in: Quantrel.

Levamisole: Anthelpor, Aviverm, Bionem, Cevasol, Chronomintic, Citarin-L, Cyverm, Dilarvon, Duphamisole, Ketrax, Levadin, Levamisol "Virbac" 10%, Levipor, Levacide, Levasole, Narpenol 5, Nemacide, Nilvern, Ripercol L, Solaskil; in: Ambex, Nilvax, Nilzan, Spectril. Tetramisole: Anthelvet, Ascardil, Citarin, Nemicide, Ripercol, Spartakon.

**Clinical Relevance**

Pyrantel has some anticestodal activity. It is effective against →tapeworms in horses in field trials, but the efficacy against *Anoplocephala perfoliata* is uncertain. However, pyrantel and levamisole are mainly used in the treatment of nematode infections in human and veterinary medicine (→*Microtubule-Function-Affecting Drugs/*Table 1). In addition, levamisole has microfilaricidal activity as shown in *Litomosoides carinii* infected *Mastomys coucha*. There is also microfilaricidal efficacy against →*Wuchereria bancrofti* and →*Brugia malayi* in man (→*Inhibitory-Neurotransmission-Affecting Drugs/*Table 1). Of interest is the topical application (eye drops) of levamisole. Levamisole has no effect against microfilariae of →*Onchocerca volvulus*. The side effects are similar to that of DEC treatment. Embryotoxic activity is observed in different filarial infections.

**Molecular Interactions**

The mode of action of these drugs relies on their anticholinergic activity. Levamisole is chemically an imidazothiazole, while pyrantel, morantel, and oxantel are tetrahydropyrimidine derivatives. They are simultaneously agonists and antagonists of the nematode ACh-receptors. Pyrantel acts as a nicotinic agonist on the acetylcholine receptor in the nematode *Ascaris suum* (Fig. 1). It induces a depolarization and an increase in input conductance of the muscle membrane due to sodium and potassium. Pyrantel leads to a spastic paralysis of →*Angiostrongylus cantonensis*. Levamisole is taken up by the nematodes via the cuticula, whereas the uptake of pyrantel and morantel occurs via the oral route (Fig. 3). In patch-clamp studies these nicotinic anthelmintics open cation channels nonselectively. Each channel has a characteristic conductance. There are variations of conductance between channels recorded from different patches in the range 19–60 pS. The mean open time of the channels varies with the anthelmintic in the range of 0.5–2.5 ms. These nicotinic anthelmintics act on the receptor with properties similar to, but not identical with, the nicotinic receptors in mammalian and vertebrate hosts because of pharmacological differences. Indeed, there is no significant action of levamisole on host muscle.

The antagonistic effects of levamisole, pyrantel, morantel, and oxantel may be explained by the fact that these molecules are too large to pass through the nicotinic acetylcholine receptor channel. However, they pass through the extracellular opening of the channel and lead to a blockage at the so-called middle ring of the channels. Thus, the middle ring of ACh-channel acts as a bottleneck for passing molecules. Thus levamisole, pyrantel, oxantel, and morantel induce a voltage-sensitive channel block at the nicotinic receptors in *A. suum* at higher concentrations.

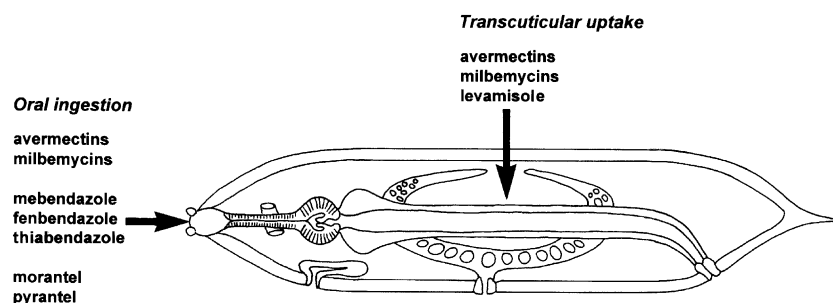

**Acetylcholine-Neurotransmission-Affecting Drugs.** Figure 3 Route of uptake of anthelmintics by nematodes (representation of the morphology of a sexually mature female worm according to Cox (1996) In: Cox FEG (ed) Modern Parasitology, Blackwell Science, 2nd edition).

The antifilaricidal action of levamisole relies presumably on an immunomodulatory effect. Thereby, cell-mediated immunity is stimulated, resulting in a generally depressed cellular response in microfilariaemic hosts. The levamisole-dependent immunostimulation is observed at low doses. So far there are no experimental data on enhanced  $\rightarrow$ immune reactions after levamisole treatment. There is only one report on enhanced filarial antigen-induced inhibition of the migration of macrophages in *B. malayi* infected *Mastomys coucha*.

Besides antiparasitic activities levamisole exerts antitumor activity.

### Resistance Against Levamisole

Resistance against levamisole occurs in a variety of nematodes in sheep, goats, cattle, and swine. The mode of resistance against levamisole is yet unclear. The heterogeneity in the types of nicotinic receptors are thought to facilitate the development of anthelmintic resistance against nicotinic drugs and perhaps to other anthelmintics that act on membrane ion channels. Thus, in *Oesophagostomum dendatum* up to four nicotinic receptor types are present. The  $\alpha$ -chains of the nicotinic ACh-receptor from susceptible and resistant *Trichostrongylus colubriformis* and *H. contortus* show no difference in amino acid sequence. There are different effects on the hatching of eggs between levamisole/morantel-susceptible, levamisole/morantel-resistant and morantel-resistant strains of *H. contortus* and *T. colubriformis* in the presence of levamisole, morantel, or pyrantel. Compared to adult susceptible *H. contortus*, five- to sixfold higher concentrations of ACh and other nicotinic agonists are necessary to cause equivalent contractions in levamisole/morantel-resistant worms. It is assumed that levamisole/morantel resistance is due to a reduced number or sensitivity of cholinergic receptors in resistant *H. contortus*. Levamisole-resistant mutants of  $\rightarrow$  *Caenorhabditis elegans* lack ACh-receptors and there is no response to the nicotinic agonists acetylcholine, nicotine, carbamyl chloride, or levamisole, which in

susceptible *C. elegans* cause contractions. The binding of cholinergic agonists varies between levamisole-susceptible and levamisole-resistant *C. elegans*.

### Paraherquamide

#### Clinical Relevance

Paraherquamide is an oxindol alkaloid metabolite of *Penicillium paraherquei*. It has antiparasitic activity and was first reported in rodent models. It is highly efficacious at a single oral treatment at dosages above 0.5 mg/kg against adult trichostrongylides in sheep and in addition against L4 larvae of *Cooperia* spp. Moreover, it is effective against ivermectin- and benzimidazole resistant *Haemonchus* and *Trichostrongylus* strains. In calves paraherquamide is effective against adult stages of nine common gastrointestinal and lung nematodes at single oral dosages of 0.5, 1.0, 2.0 or 4.0 mg/kg. However, *Cooperia punctata*, the dose-limiting species, was affected only at the highest dosage of 4.0 mg/kg to 89%. The compound is not toxic in ruminants up to a dosage of 10 mg/kg, but three dogs given an oral dose of 10 mg/kg had severe intoxications within 30 minutes of dosing and two animals died within 2 hours. On the basis of available data, for a broad-spectrum therapeutic paraherquamide has a therapeutic index of less than 3 at the dosage of 4 mg/kg and is thus inferior to ivermectin. As a narrow spectrum therapeutic used at a dosage of 0.3 mg/kg paraherquamide has a therapeutic index of 33 and could be thus useful as an antiparasitic agent if used in combination with an integrated approach to control resistant parasites.

### Molecular Interactions

Paraherquamide is an extremely potent competitor at the  $\alpha$ -bungarotoxin binding site at the nicotinic acetylcholine receptor in insects. It is also a competitor at the phenothiazine binding site. However, the real mode of action in nematodes has to be elucidated.

## Acetyl-CoA

→Energy Metabolism.

## Achroia grisella

Small species of the butterfly group moths, that parasitize in stocks of bees.

## Achteres

Genus of ectoparasitic crustaceans attached to fish skin, e.g., *A. percarum* on perch.

## Achtheinus

Genus of caligid ectoparasites (crustaceans) on fish.

## Acidocalcisomes

Acidic  $\text{Ca}^{2+}$  storage compartment in trypanosomatids, e.g., *Leishmania mexicana*, *Trypanosoma cruzi*, and →Apicomplexa (→*Toxoplasma gondii*). They are also rich in phosphorous,  $\text{Ca}^{2+}$ ,  $\text{Mg}^{2+}$ , and  $\text{Zn}^{2+}$  and have a number of pumps and exchangers involved in their homeostasis.

## Acini

Grape-like arranged salivary glands of →Ticks.

## Acquired Immune Deficiency Syndrome

→AIDS.

## Acquired Immunity

→Immune Responses, see, e.g., →Malaria, →Schistosomiasis, →Trichomoniasis.

## Acquired Immunodeficiency Syndrome (AIDS)

Disease due to infection with HI-virus, which supports development of →opportunistic agents.

## Acridinorange

Fluorescent stain for nucleic acids.

## Acrodermatitis

A. chronica atrophicans is a symptom of phase three of the tick-transmitted →lyme disease or borreliosis.

## Acrosom

Anterior peak of some →spermatozoa (e.g., →microgametes of →Coccidia have a perforatorium, that is lacking in →Platyhelminthes, →Nematodes and →Acanthocephala).

## Actin

→Cytoskeleton, motility in →Apicomplexa, muscles of metazoans.

## Actinocephalus

→Gregarines.

## Actinomycin

Compound to block nuclear spindle apparatus.

## Actinopilin

The setae of one progressive group of →mites (Actinotrichida) possess an axis of this light-breaking material.

## Actions of Drugs

→Drugs.

## Activation Factors

→Cytokines.

## Acuaria

Nematodes in the esophagus of the dove.

## Acute Dermatolymphangitis

→Lymphatic filariosis, →*Wuchereria bancrofti*, →*Brugia malayi*.

## Adaptation

→Local Adaptation.

## ADCC

Antibody-dependent cytotoxicity (→Immune Responses).

## ADCL

→Anergic Diffuse Cutaneous Leishmaniasis, a syndrome of the New World, →Leishmaniasis.

## Adeleidea

Systematic group of the →Coccidia now containing the genera *Klossia* (e.g., →*K. helicina*) and →*Klossiella* (e.g., *K. equi*).

## Adelina cryptocerci

→Adeleidea, →Chromosomes.

## Adelina deronis

→Coccidia.

## Adenolymphangitis

→Lymphatic filariosis.

## Adenophorea

### Synonym

→Asphasmidea.

### Classification

Class of →Nematodes.

### General Information

→Phasmids are generally absent; →amphids are postlabial and variable in shape, cephalic organs

setiform to papilloid; setae and hypodermal glands usually present, hypodermal cells uninucleate; excretory organ, if present, single-celled; caudal glands mostly present; usually two testes in males; →[cuticle](#) four-layered.

## Adhesion Proteins

→[Knobs](#), →[Coccidia](#), penetration.

## ADI

### Synonym

→[Acceptable Daily Intake](#).

## Adjuvant

To increase the immunogenicity of an antigen, various adjuvants are available. Freund's adjuvant, an oil emulsion of heat-killed *Mycobacterium tuberculosis*, saponins and various other formulations have commonly been used in experimental animal models. Because of possibly severe local and systemic reactions, they are considered unsafe for use in people and their use in animals is now restricted. Solely aluminium hydroxides and aluminium phosphate are registered for use in people.

## Aedeagus

Copulatory apparatus in →[Mites](#) for injecting sperms.

## Aedes

→[Diptera](#), →[Filiariidae](#), →[Mosquitoes](#), →[Insects](#).

## Aedes albopictus

Asian species of mosquitoes - so-called tiger mosquito – actually spreading worldwide (vector of dengue fever virus, West Nile virus). →[Diptera](#).

## Aega

→[Crustacea](#).

## Aegyptianella pullorum

Bacterium transmitted by the fowl tick →[Argas persicus](#) to chicken.

## Aelurostrongylus abstrusus

### Name

Greek: *ailouros* = cat, *strongylos* = cylindrical.

Metastrongylid nematode (up to 14 mm long as females) that parasitizes worldwide in the branchioles and alveoles of cat lung (high prevalence rates: up to 90%). Intermediate hosts are snails; larvae become also transported by rodents, frogs, reptiles. →[Respiratory Diseases, Animals](#), →[Nematocidal Drugs](#).

## Aerobic Metabolism

→[Energy Metabolism](#).

## Aeromonas hirudinis

→[Leeches](#).

## Aeropyls

Pores in the eggs of →Lice.

## Aerotolerant Anaerobism

→Trichomonadida.

## AFC

Antibody-forming cell (e.g., plasma cell, B-lymphocyte).

## African Horse Sickness

Disease due to a virus (AHSV), which becomes transmitted by →Culicoides spp. (e.g., *C. imicola*) in South Africa.

## African Swine Fever

Caused by the →ASF virus (ungrouped), African swine fever is an acute, contagious disease leading to high mortality in domestic pigs. It is maintained in wild pigs, particularly warthogs (*Phacochoerus* spp.), and in the tick *Ornithodoros porcinus*. It has been reported that infected male *O. porcinus* can infect uninfected females during mating. Warthogs are usually not severely affected, but it can be considered one of the most serious diseases of domestic swine, where it can be transmitted by contact alone and has caused severe economic losses after introduction into European countries.

## African Trypanosomiasis

Unstained wet blood preparations, chancre fluid, CSF or lymph node aspirate can be used for the demonstration of motile trypanosomes. Giemsa-stained slides

should also be prepared from the same material. With native blood samples it will be usually possible to demonstrate trypanosomes of *Trypanosoma brucei rhodesiense*, but less frequently those of *T. b. gambiense* since parasitaemia is usually much lower with this parasite. Here, concentration techniques may be successful, such as blood centrifugation and subsequent examination of the buffy coat, also in the form of the quantitative buffy coat technique (QBC). Mini anion-exchange and centrifugation is another useful method.

Antibody detection methods proved to be too insensitive or unspecific for a reliable diagnosis of African trypanosomiasis.

## Agamermis decaudata

Species of free-living nematodes, the larvae of which are parasitic in grasshoppers and thus become transported to other biotopes.

## Agamodistomum suis

Diplostomal trematode species of pigs, which are thought to represent mesocercaria of →*Alaria allata*. They are also described as →Duncker's muscle fluke.

## Agamogony

Asexual reproduction (e.g., →Schizogony and →Sporogony in →Coccidia).

## Age Related Prevalence

Prevalence rate of parasites in a host is mostly dependent on its age, i.e., it increases with the time of exposition e.g., in →*Clonorchis sinensis* and hookworms. In soil-transmitted nematodes, however, the prevalence is high beginning after the first year of host's life. In other parasites (e.g., in coccidians), infections occur mainly in the first weeks of life.

## Agents of Disease

→Prions, viruses, bacteria, →fungi, parasites (plants, animals).

## Aggregata eberthi

### Classification

Species of →Coccidia.

### Life Cycle

Fig. 1 (page 53).

## Aggregation-Attachment Pheromones

Type of →pheromones, e.g., produced by the males of the metastriate genus →*Amblyomma* during the course of feeding. →Ticks/Reproduction, →Ticks/Host Finding.

## AHSV

→African Horse Sickness virus.

## AIDS

Immuno-suppression in AIDS patients or other reasons lead to an increase in the growth rate of so-called →opportunistic agents.

## Airport Malaria

Malaria due to bites of imported, infected *Anopheles* females at airports (in aircraft, suitcases, containers, etc.). Also named: baggage – or taxi malaria.

## ALA

Amoebic liver abscess; →*Entamoeba histolytica*.

## Alae

Modification of the →cuticle in →Nematodes: keel-like thickenings which follow the lateral lines and support undulating locomotion (→Nematodes/Fig. 14C, →Nematodes/Integument).

## Alaria allata

Trematode species (2.5–6 × 0.5–2 mm) of wild canids, lives in the small intestine and reaches prevalence rates of up to 30%. First intermediate hosts: snails (production of cercariae), paratenic hosts (e.g., pigs, amphibia, reptiles with formation of mesocercariae), final hosts harbour metacercariae in lung, adults in intestine (→*Alaria canis*).

## Alaria canis

### Synonym

*Alaria americana*.

### Classification

Species of →Digenea.

### Life Cycle

Fig. 1 (page 54).

## Albendazole

Macrocyclic lactone, →Nematocidal Drugs.

## Aleppo Button

Badly healing skin lesion: a symptom of cutaneous →leishmaniasis, named after Aleppo, a town in the Middle East (Syria).

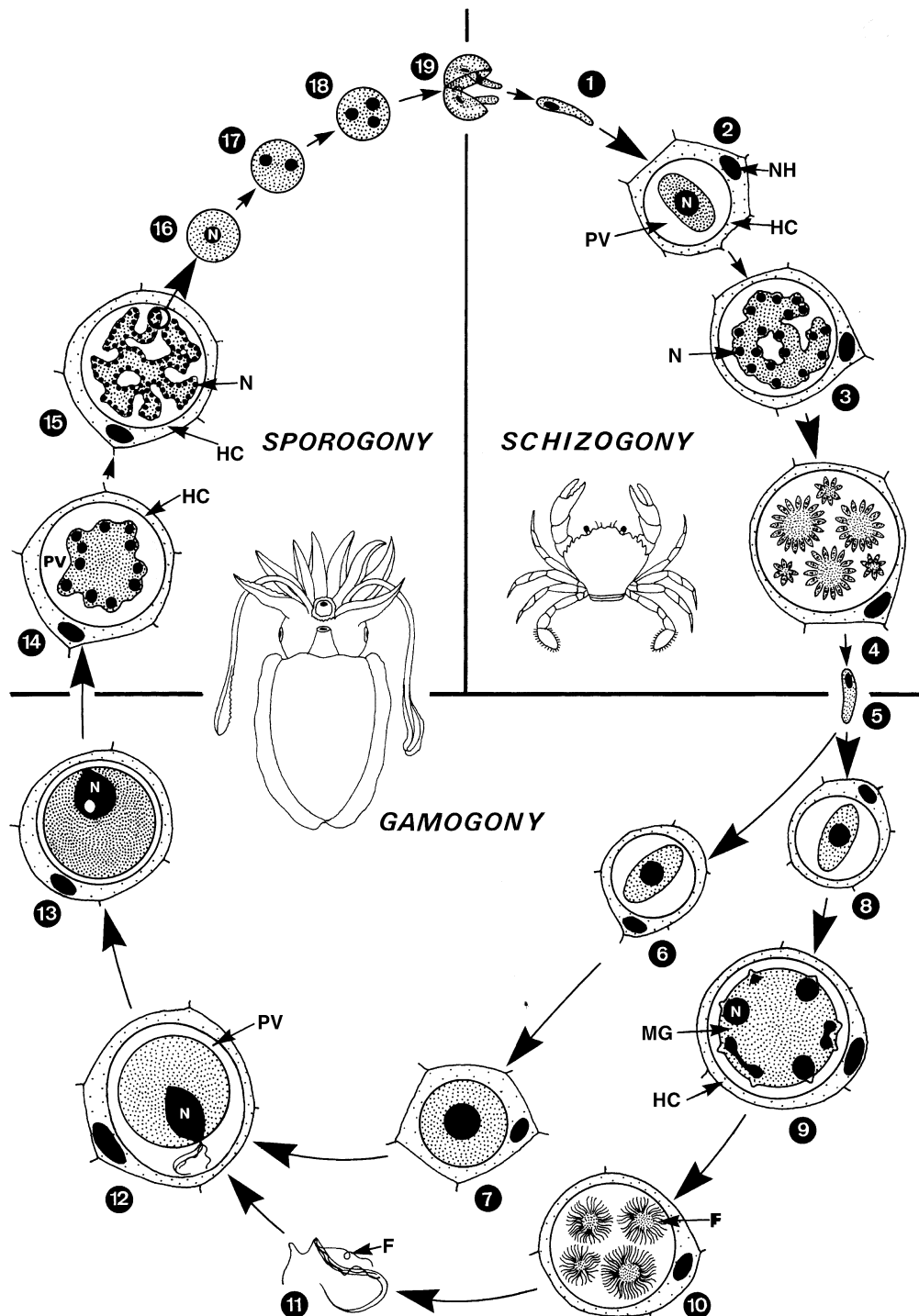

**Aggregata eberthi.** Figure 1 Life cycle of *Aggregata eberthi* in its hosts. 1-5 After oral uptake of sporocysts (19) by the crab (*Portunus* sp.) the sporozoites (1) are set free, leave the intestine, and enter cells of the connective tissues surrounding the gut; inside a →parasitophorous vacuole (PV) schizonts (3) produce 7-9 μm long, motile merozoites (4, 5). 6-11 As soon as the crab has been eaten by the cuttlefish *Sepia officinalis* (final host), the merozoites penetrate through the gut wall into cells of the submucosa. There they grow into macrogametes (6, 7) or →microgametes (9). The latter produce numerous biflagellate →microgametes (10, 11), which are about 30 μm in length and have an additional →recurrent flagellum. 12 Fertilization of the →macrogamete (200 μm in diameter). 13 →Zygote, surrounded by a very smooth →oocyst wall. 14-19 During →sporogony many globular sporocysts (16) are formed inside the smooth-walled oocyst. Each →sporocyst produces three sporozoites: large numbers of sporocysts are found within the feces of the cuttlefish (or within necrotic pieces of its gut). Crabs are again infected when ingesting such sporocysts. F, flagellum of microgamete; HC, host cell; MG, microgamete; N, nucleus; NH, nucleus of the host cell; PV, parasitophorous vacuole.



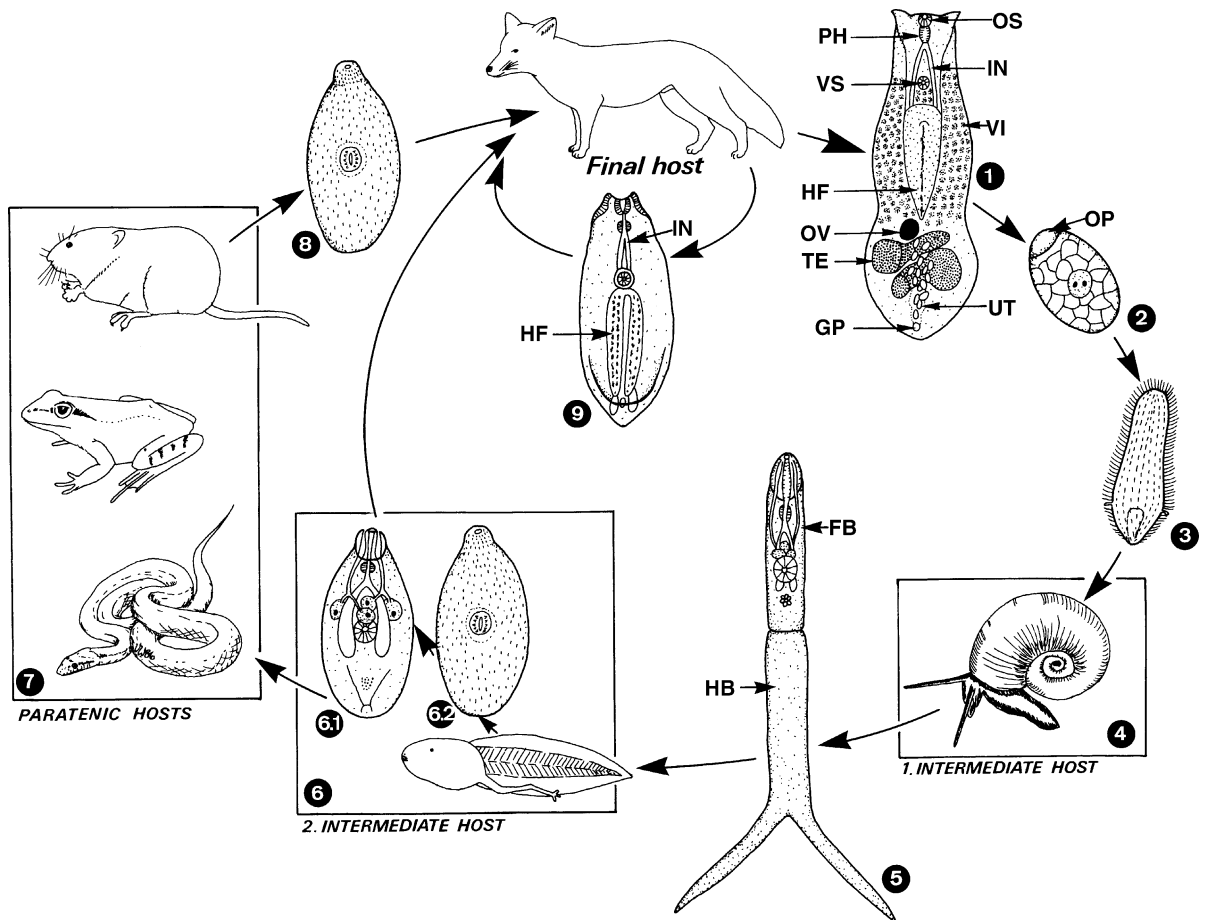

**Alaria canis.** Figure 1 Life cycle of *Alaria canis* (*A. americana*). 1 The adults (2.5–4.2 mm long) live in the anterior third of the small intestine of the final hosts (canids). 2 The operculate eggs are unembryonated when laid. 3 Larvae (miracidia) hatch in about 2 weeks after reaching water. 4 Miracidia swim actively and enter several species of helisomid snail (first → **intermediate host**), inside which mother → **sporocyst** and daughter sporocyst are produced. The latter give rise to → **cercariae**. 5 The → **furcocercous cercariae** leave the snail during daylight hours and swim to the water surface, where they hang upside down. 6 If tadpoles (as intermediate hosts of the second type) pass by, the cercariae penetrate the skin. In about 2 weeks the cercariae become transformed into → **mesocercariae** (6.1, 6.2 show surface view). 7–9 Two weeks after infection the mesocercariae are infectious for a series of paratenic hosts, or directly for the final host (canids) if this eats an infected tadpole (or an adult frog after its → **metamorphosis**). Inside the → **paratenic host**, the mesocercariae are accumulated (8) in various tissues without further development. Large numbers of mesocercariae are very pathogenic for their hosts. If humans become accidentally infected, severe damage or death may occur. Mesocercariae which have reached the intestine of the final host penetrate into the body cavity and pass through the diaphragm into the lungs by the end of 2–3 weeks. Here, they transform into → **diplostomulae** (→ **metacercariae**) in about 5–6 weeks. The diplostomulae migrate up the trachea and are finally swallowed. Inside the intestine they mature in about 4 weeks and cause severe enteritis. *FB*, forebody; *FT*, forked tail; *GP*, genital pore; *HB*, hindbody; *HF*, holdfast organ; *IN*, intestine; *OP*, → **operculum**; *OS*, oral sucker; *OV*, ovary; *PH*, pharynx; *TE*, → **testis**; *UT*, uterus with eggs; *VI*, → **vitellarium**; *VS*, ventral sucker.

## Algid Malaria

Patent → **malaria** also possible in → *Plasmodium falciparum* with progressing multiplication of parasites but without fever. Thus this form of disease is often misdiagnosed.

## Alimentary System Diseases, Animals

Gastrointestinal parasites affect their hosts, both directly and indirectly, through a wide variety of mechanisms. The diseases are associated mainly with → **anorexia**, loss of productivity, and → **diarrhoea** (→ **Clinical Pathology**,

Animals). The characteristic changes in blood constituents are →[hypoalbuminaemia](#) and →[anaemia](#) – for parasites inducing loss of blood. Abomasal parasitism is associated with characteristic increases in the concentration of plasma pepsinogen and liver parasitism with increases in the levels of liver enzymes.

The lesions caused by important parasites of domestic animals have been described many times and will not be dealt with in detail. Briefly, lesions may be almost negligible, e.g., in *Moniezia* infections in ruminants. They may also be confined to the point of attachment of the parasite, as with the tapeworm *Anoplocephala* in horses or the acantocaphalan *Macrocanthorhynchus hirudinaceus* in the pig. At the other extreme, lesions caused by some parasites may cover entire parts of the gastrointestinal tract such as during infections with →[Ostertagia](#) in the abomasum, →[Strongyloides](#) in the small intestine, or →[Trichuris](#) in the large bowel. Finally, the liver fluke →[Fasciola hepatica](#) causes hepatic →[necrosis](#) and haemorrhages during migration, and erosions of the biliary mucosa when it reaches the bile duct.

It is not always possible to establish a link between the severity of the lesions and either the impaired physiology of an organ, or the secondary manifestations of disease, such as anorexia, →[productivity loss](#), diarrhoea, or haematological changes. For example, lambs infected with →[Haemonchus contortus](#) and given a low-protein diet show more severe clinical signs of →[weight loss](#), anaemia, and loss of appetite than others given a normal diet, despite similar levels of blood loss. Dietary protein supplementation may not, however, be successful in animals with concurrent abomasal and intestinal infections in which compensatory digestion and an increase in intestinal absorption of nutrients depend upon the integrity of the latter organ. On the other hand, larval challenge of immune animals may cause impaired production despite low parasite burdens. It is important to consider these nutritional and immunological factors during any field observations. They may well account for some of the conflicting reports on the effect of parasitism. A genetically determined variation in the susceptibility of cattle and sheep to certain →[helminth](#) infections has also been demonstrated. Inherited resistance, as assessed by faecal egg output, worm burdens, or clinical symptoms of disease, has been described, e.g., in sheep or cattle infected with *Ostertagia* spp., *Haemonchus contortus*, *Cooperia* spp. and →[Trichostrongylus](#) spp. Finally, the interaction between parasitism and the physiological condition of the ewe is well documented: the postparturient rise in worm egg output is attributed to a loss of resistance associated with late pregnancy and lactation. The common clinical signs and pathology of the parasitic diseases of the alimentary tract are summarized in: →[Alimentary System Diseases, Ruminants](#), →[Alimentary](#)

[System Diseases, Horses](#), →[Alimentary System Diseases, Swine](#), →[Alimentary System Diseases, Carnivores](#).

Therapy and other measurements are presented in the chapters on control and disease control and under →[Drugs](#).

## Alimentary System Diseases, Carnivores

The common clinical signs and pathology of the parasitic diseases of the gastrointestinal tract of carnivores are summarized in [Table 1](#).

### Protozoal Enteritis

Coccidiosis (*Coccidiosis, animals*) and cryptosporidiosis have been reported in dogs and cats. *Giardia* spp. occurs in dogs and cats, and giardiasis may represent an important problem in these hosts. It causes →[anorexia](#), depression, and a mild recurring →[diarrhoea](#) consisting of soft, light-coloured stools with a characteristic “oatmeal” texture, frequently containing mucus. Growth retardation and cachexia may occur. The mechanism by which giardial →[malabsorption](#) and diarrhoea occurs is unclear. Epithelial damage, increased turnover of epithelial cells, villous shortening, and disaccharidase deficiency have all been reported as manifestations of giardiasis. →[Entamoeba histolytica](#) is the cause of →[entamoebiasis](#) in humans and among domestic animals. The disease which occurs rarely in dogs is characterized by diarrhoea.

### Gastrointestinal Helminthosis

#### Oesophagus

→[Spirocerca lupi](#), the oesophageal worm, is a parasite usually associated with the formation of →[nodules](#) in the oesophageal wall. Occasionally, however, it may be found in gastric nodules in cats. Most infected dogs are not clinically affected and the infection is only detected at necropsy. Signs of oesophageal involvement include anorexia, →[vomiting](#), dysphagia, and bloodstained regurgitus. There is a strong evidence of a causal relationship between *Spirocerca* and oesophageal fibrosarcomas or osteosarcomas. Ventral spondylitis of caudal thoracic vertebrae is also observed, the cause might be migrating worms inducing periosteal irritation.

#### Stomach

The presence of parasites in the stomach of dogs and cats does not commonly produce signs, except in severe infestations. The overall incidence of these parasites is low. Several →[nematodes](#) have been identified in the stomachs of dogs, cats, and wild carnivora:

**Alimentary System Diseases, Carnivores. Table 1** Gastrointestinal parasitic diseases of carnivores (according to Vercruyse and De Bont)

Parasite	Host	Clinical signs and pathology <sup>a</sup>										
		1	2	3	4	5	6	7	8	9	10	
<b>Oesophagus</b> <i>Spirocerca lupi</i>	Dog	+	+	+					±			Dysphagia haematomesis
<b>Stomach</b> <i>Gnathostoma spinigerum</i> <i>Ollulanus tricuspis</i> <i>Physaloptera</i> spp.	Cat, dog Cat Dog, Cat	+		±						+		Anophagia Regurgitation
<b>Small intestine</b> Protozoa <i>Cryptosporidium</i> <i>Cystoisospora</i> spp. <i>Hammondia heydorni</i> * <i>Toxoplasma gondii</i> <i>Entamoeba histolytica</i> <i>Giardia</i> spp.	Dog, cat Dog, cat Dog Cat Dog Dog, cat				+						±	Abortion in <i>N. caninum</i> Ocular lesions
<b>Cestoda</b> <i>Taenia</i> spp. <i>Echinococcus</i> spp. <i>Mesocestoides</i> spp. <i>Dipylidium caninum</i>	Dog, cat Dog, cat											Perianal itching (dog) Perianal itching (dog)
<b>Nematoda</b> <i>Ancylostoma</i> spp. <i>Ancylostoma tubaeforme</i> <i>Uncinaria stenocephala</i> <i>Strongyloides stercoralis</i> <i>Toxocara canis</i> <i>Toxocara cati</i> <i>Toxascaris leonina</i>	Dog Cat Dog Dog Dog Cat Dog, cat	+	+		+				++		+	Epistaxis Pot-bellied
<b>Large intestine</b> <i>Trichuris vulpis</i>	Dog	+	+		+	+			+			

<sup>a</sup> Clinical signs and pathology: 1, →Weight Loss; 2, →Anorexia; 3, →Vomiting; 4, →Diarrhoea; 5, →Dehydration; 6, →Unthriftiness;

7, →Anaemia; 8, →Abdominal pain; 9, →Hypoalbuminaemia; 10, Others

Occurrence of signs: ±, rare; +, common; ++, very common

\* Probably identical with →*Neospora caninum*

*Cylicospirura*, *Cyathospirura*, *Spirura*, *Physaloptera* spp., →*Gnathostoma spinigerum*, and *Ollulanus tricuspis*. Only the latter three parasites are likely to cause signs of gastric parasitism. *Physaloptera* spp. inhabit the stomach and proximal duodenum of many carnivores and may be a cause of vomiting and chronic gastritis. Regurgitation may occur, presumably because of the oesophagitis induced by vomiting. Adults of *G. spinigerum* are found in groups up to 10 in cysts within the gastric mucosa of cats and dogs. The cysts may be 2 cm in diameter, and communicate with the gastric lumen by small openings. Gnathostomosis has been associated with illness and death. Symptoms include anophagia, occasional vomiting, →abdominal pain, and loss of weight.

*Ollulanus tricuspis* inhabits the stomach of cats. Although most infections are asymptomatic, *O. tricuspis* should be included in the differential diagnosis for vomiting in cats, especially when vomiting is post-prandial.

### Small Intestine

Several →trematodes cause infections in carnivores. →*Schistosoma japonicum* live within the mesenteric and hepatic portal veins of dogs (→*Schistosomiasis, Animals Ruminants*).

Many genera of trematodes (*Apophallus*, *Heterophyes*, *Alaria*, *Nanophyetus*, and others) are parasitic in dogs and cats throughout the world, but they are only rarely of any clinical consequence. →*Nanophyetus*

*salmincola* is important as a vector of the highly pathogenic *Neorickettsia helminthoeca*, the cause of “→salmon poisoning” in dogs, a disease with a high mortality rate.

Dogs may be parasitized by a great number of →cestodes. Some common species are *Taenia hydatigena*, *T. pisiformis*, *T. ovis*, →*Taenia multiceps*, *T. serialis*, →*Dipylidium caninum*, →*Echinococcus* spp., →*Mesocestoides* spp., and *Spirometra* spp. Two species occur frequently in cats: →*Taenia taeniaeformis* and *Dipylidium caninum*.

In most cases there are few, if any, clinical symptoms. Infections have been associated with diarrhoea and failure to thrive, but concomitant gastrointestinal nematode parasitism may often be of greater significance. The passage through the rectum and anus of the gravid segments of *Taenia* and *Dipylidium caninum* produces irritation in dogs, but not in cats. The proglottides passing through the rectum, or lodging in the anal glands, frequently cause the dog to scoot.

Strongyloidosis in dogs is caused by →*Strongyloides stercoralis*. Though not common, infection in young animals may have severe consequences. There is enteritis with erosion of the mucosa of the small intestine and haemorrhages. Bloody diarrhoea occurs in heavy infections. →Dehydration develops rapidly, and death may occur.

There are four hookworm species that commonly affect dogs and cats. →*Ancylostoma caninum* and *A. tubaeforme* are the most pathogenic species of dogs and cats, respectively. *A. braziliense* is another hookworm parasite of dogs and cats and is not very pathogenic. *Uncinaria stenocephala* is mainly a hookworm of dogs; in cats it is much less common. *U. stenocephala* is the least pathogenic of the →hookworms that affect dogs and cats. With *A. caninum*, disease results from blood loss into the bowel which leads to iron deficiency, →anaemia (hypochromic, microcytic). In →chronic infections there is emaciation, poor appetite, and pica and the animals are frail. There is some diarrhoea and the faeces are dark and sometimes blood-streaked.

With respect to ascarid infections →*Toxocara canis* is by far the commonest roundworm of dogs. It is not highly pathogenic and the effects of infection are often overstated. During larval migration various tissues (liver, lung, heart, kidney) may show granulomatous lesions. The pulmonary phase may be lethal in pups infected heavily before birth; death occurring within a week after birth. This is the most severe effect of *T. canis* infection. Once the worms have become adults in the small intestine the only clinical signs are those of pot-bellied abdomen, light diarrhoea, and failure to thrive. Adult worms are often passed in the faeces or vomited. The other ascarid of the dog, and rarely the

cat, *Toxascaris leonina*, is non-migratory and of little pathological importance.

→*Toxocara cati*, the ascarid of cats, is endemic in all countries. As for infections with *T. canis*, many cases remain asymptomatic.

The Acanthocephalan *Onicola canis* occurs in the small intestine of wild carnivores and occasionally of dogs and cats. The lesions are the same as those described for *Macrocanthorhynchus hirudinaceus* in swine (→Alimentary System Diseases, Swine), although clinical manifestations are rare.

### Caecum, Colon, Rectum, Anus

The most important species are *T. vulpis* in dogs, and *T. campanula* and *T. serrata* in cats. →*Trichuris* is highly prevalent in all parts of the world but rarely causes clinical signs. Heavy infections associated with severe and often haemorrhagic typhlitis or typhlocolitis has been reported in dogs. Clinical manifestations include failure to thrive, →weight loss, abdominal pain, diarrhoea, dehydration, and terminal anaemia. In severe cases the faeces may be speckled with fresh blood. The lesions are caused by the adult worms boring tunnels into the mucosa of the large intestine.

### Liver

The commonest parasite of the liver of cats, and less frequently in dogs, is *Opisthorchis felineus*. The signs of infection are emaciation, jaundice, and ascites.

*Capillaria hepatica* occurs only rarely in the liver of cats and dogs, and infection remains inapparent.

### Therapy

→Chemotherapy, →Drugs.

---

## Alimentary System Diseases, Horses

The common clinical signs and pathology of the parasitic diseases of the gastrointestinal tract of horses are summarized in Table 1.

### Protozoal Enteritis

The only →*Eimeria* sp. occurring in horses, *Eimeria leuckarti* (→Coccidiosis, Animals) has been only sporadically reported to cause diarrhoea in young horses. *Cryptosporidium* has been reported in all domestic animals (→Cryptosporidiosis, Animals) including horses. In horses, symptoms have been particularly observed in animals with inherited or acquired immunodeficiency. *Giardia* spp. are usually non-pathogenic inhabitants of the small intestine of horses. However, they may cause

**Alimentary System Diseases, Horses. Table 1** Gastrointestinal parasitic diseases of horses (according to Vercruyse and De Bont)

Parasite	Clinical signs and pathology <sup>a</sup>						
	1	2	3	4	5	6	7
<b>Stomach</b>							
Protozoa							
<i>Cryptosporidium</i> spp.	+		+				
Nematoda							
<i>Draschia megastoma</i>	+						Skin lesions
<i>Habronema</i> spp.							
<i>Trichostrongylus axei</i>	+						
Arthropoda							
<i>Gasterophilus</i> spp.	+						
<b>Small intestine</b>							
Cestoda							
<i>Anoplocephala magna</i>	+		±				
Nematoda							
<i>Strongyloides westeri</i>	+		++				
<i>Parascaris equorum</i>	+	+	+	±			Pot-bellied, respiratory signs
<b>Large intestine</b>							
Trematoda							
<i>Gastrodiscus aegyptiacus</i>	+		±				Anaemia
Cestoda							
<i>Anoplocephala perfoliata</i>	+		±		±		Spasmodic colic, ileal impaction colic
<b>Nematoda</b>							
<i>Strongylus</i> spp. (adults)	+	+	+		±		
<i>Triodontophorus</i> spp.	+	+	+				
Cyathostominae	+	+	++	+	+	++	
<i>Oxyuris equi</i>	+						Anal pruritis

<sup>a</sup> Clinical signs and pathology: 1, →Loss in performance, →Weight Loss; 2, →Anorexia; 3, →Diarrhoea; 4, →Constipation; 5, →Abdominal Pain; 6, →Hypoalbuminaemia; 7, Others

Occurrence of signs: ±, rare; +, common; ++, very common

diseases under certain circumstances, such as in animals which are immunocompromised, malnourished, or very young.

## Gastrointestinal Infections

### Stomach

→*Trichostrongylus axei* occurs in the stomach of horses. The worm is rarely a pathogen on its own, most infections are chronic and mild. However, *T. axei* induces typical lesions in horses. The condition has been described as a *gastritis chronica hyperplastica et erosiva circumscripta* for the main lesion is a pad- or cushion-like thickening in the glandular part of the stomach.

The most common parasites of the equine stomach are larvae of botflies of the genus →*Gasterophilus*. The most common species which pass to the stomach and settle on the gastric mucosa are *G. intestinalis* followed by *G. haemorrhoidalis*. Despite the dramatic

appearance of a heavy bot infestation, its true veterinary significance is unclear. The parasites may produce significant gastric lesions, but primarily in the non-glandular part of the stomach which plays little role in digestion. This is possibly the reason why the vast majority of infections remain asymptomatic. Yawning and unsatisfactory performance are described as common signs. Erratic movements of the larvae into the abdomen (with or without peritonitis) are described.

The spiruroid →nematodes *Habronema majus*, *H. muscae*, and *Draschia megastoma* are also parasitic in the stomach of equidae. →*Habronema* species lie on the mucosal surface while *Draschia* burrows in the submucosa to produce large, tumour-like →nodules. *D. megastoma* is therefore the most pathogenic of the →stomach worms, although clinical signs remain inapparent in most cases. The parasite is often incorrectly blamed for the disease and death of the host because of the very impressive character of the lesions it produces.

### Small Intestine

The →cestodes found in the small intestine are →*Anoplocephala magna* and *Paranoplocephala mamillana*. In most cases they induce few, if any, clinical symptoms. The only →*Strongyloides* spp. in horses is *Strongyloides westeri* (→*Strongyloidosis, Animals/Ruminants*). Clinical outbreaks principally affect young suckling foals. Signs include →anorexia, loss of weight, coughing, →diarrhoea (rarely haemorrhagic), →dehydration, and slight to moderate →anaemia. Severe infections may be fatal. The ascarid →*Parascaris equorum* is a common parasite in young horses. Both the parasitic migration through the lungs and the intestinal phase of the life cycle may be associated with clinical signs. Symptoms include lethargy, loss of appetite, coughing, nasal discharge, and decreased weight gain. In the rare severe infections the intestinal phase may cause impaction, rupture, peritonitis, intussusception, and formation of abscesses.

### Caecum, Colon, Rectum, Anus

Members of the trematode genus *Gastrodiscus* may be found in the colon of horses and swine, but they are of little clinical significance. However, the immature trematode has been reported to cause a severe and hyperacute, possibly fatal colitis in horses.

The cestode *Anoplocephala perfoliata* is commonly found in the distal small intestine, caecum, and proximal large intestine. A significant number of the parasites often accumulates at the ileocaecal junction and may produce marked lesions there. *A. perfoliata* is a significant risk factor for spasmodic colic and ileal impaction colic in the horse. The risk of spasmodic colic increases with infection intensity.

Members of the Strongylidae are abundant and common nematode parasites of the caecum and colon in Equidae. There are 55 species of strongyles, with fewer than 20 commonly found in horses, usually as mixed infections. Therefore, the clinical signs can be considered to be caused by all the worm species collectively. Specific clinical signs may arise due to the larval stages of the *Strongylus* spp. These are described in the section on the cardiovascular system. Adult large strongyles are inhabitants of the large intestine. They feed by attaching to the glandular epithelium and drawing a plug of mucosa into the buccal capsule. Incidental damage to blood vessels in the plug results in bleeding. Some, as seen with clusters of *Triodontophorus* spp., cause deep ulcers. The damage thus caused results in the formation of crater-like ulcers which may extend deep into the gut wall. These lesions are believed to be the cause of anaemia, failure to thrive, and poor performance. The colitis and typhlitis do not often lead to diarrhoea. The adults of the Cyathostominae feed mainly on intestinal contents and are of little pathogenic significance. *Cyathostoma*-associated clinical disease is

attributed to the synchronous emergence of large numbers of previously inhibited third- and fourth-stage larvae from the large intestinal wall, resulting in physical disruption of the mucosa and typhlitis/colitis. Animals sometimes develop a fatal syndrome (winter cyathostomiasis) characterized by sudden onset of diarrhoea, mild colic signs, failure to thrive or cachexia, and →hypoalbuminaemia. Emaciation possibly results from the anorexia, the reduction of absorptive function, and the loss of protein through the disrupted intestine. A reduced level of ileocaeco-colic motility was recorded in ponies experimentally infected with a mixture of strongyles, predominantly cyathostomes. It was argued that this would reduce propulsion of ingesta, and cause loss of appetite and weight. Additional mechanisms which may contribute to the occurrence of cyathostome-associated colic include intestinal mucosal →oedema and/or vasoconstriction induced by the local production of vasoactive substances in response to the presence of cyathostome mucosal stages.

The only oxyurid of importance is *Oxyuris equi*, the large →pinworm of horses. It is never regarded as a serious pathogen. The chief feature of oxyuriasis in equines is the →anal pruritus produced by the egg-laying females. The irritation caused by the anal pruritus produces restlessness and improper feeding. The animal rubs the base of its tail against any suitable object, causing the hairs to break off and the tail to acquire an ungroomed “rat-tailed” appearance.

### Liver

A variety of cestodes, nematodes, and →trematodes produce inflammation of the liver and bile ducts, but they are of minor importance in horses. *Parascaris equorum*, *Strongylus equinus*, and *S. edentatus* migrate through the liver, but only *S. edentatus* has been associated with transient colic. *Echinococcus granulosus* is commonly found in the liver. Although they may involve a large amount of tissue, hydatid infections appear to be well tolerated. →*Fasciola hepatica* is occasionally found in the equine liver. Heavy infections are rare and are usually discovered only during post-mortem examination.

### Abdominal Cavity

Most of the parasites found in the peritoneal cavity have their final habitat elsewhere and passage through the peritoneum occurs in the normal course of migration, or by accident. Parasites normally migrating through the peritoneal cavity are the immature *Fasciola hepatica*, *Strongylus edentatus*, and *Strongylus equinus*. They can cause acute and chronic peritonitis.

Examples of accidental passages are those of *Parascaris equorum* and *Gasterophilus*, which enter the cavity through intestinal or gastric perforations.

**Therapy**

→Chemotherapy, →Nematocidal Drugs, →Cestodocidal Drugs.

## Alimentary System Diseases, Ruminants

The common clinical signs and pathology of the parasitic diseases of the gastrointestinal tract of ruminants are summarized in Table 1.

**Protozoal Enteritis**

Coccidiosis (→Coccidiosis, Animals) and Cryptosporidiosis (→Cryptosporidiosis, Animals) are very common diseases in young ruminants. *Cryptosporidium parvum* is frequently observed in calves and lambs of 1–4 weeks of age. Watery diarrhoea, sometimes with blood, is very typical and animals may dehydrate and show retarded growth. Morbidity is high but mortality is low in most cases. However, lethal cryptosporidiosis has been reported, possibly related to strain-specific virulence. *C. parvum* is not host specific and may also infect humans where severe disease may occur in immunocompromised individuals. Other *Cryptosporidium* spp. have been described in ruminants; however, these appear to be of no or very limited clinical significance.

Many *Eimeria* spp. have been identified in ruminants; however, only few are of clinical importance. Depending on the infection pressure *Eimeria bovis* or *E. zuernii* may induce subclinical disease or moderate to severe, sometimes haemorrhagic, diarrhoea in calves. Lesions are mainly found in the large intestine. Watery diarrhoea related to infection of the small intestine with *E. alabamensis* has been repeatedly reported in grazing calves. In sheep, *E. ovinoidalis*, *E. bakuensis*, and *E. ahsata* are considered particularly pathogenic; in goats, *E. ninakohlyakimovae* and *E. arloingi* are the most pathogenic species. Dehydration and hypoproteinaemia are typical signs of coccidiosis; fever and anorexia may be observed in severe cases. Disease symptoms are generally seen before oocysts are shed which makes specific diagnosis difficult. Coccidiosis-related mortality is variable but usually low. Recovering calves may show retarded growth. Cryptosporidiosis and coccidiosis are self-limiting diseases and generally disappear after 2–14 days. Drugs for therapy are available (toltrazuril, diclazuril), but effective control depends on strategic measures (improvement of hygiene, disinfection, and metaphylactic/prophylactic treatment). *Giardia* spp. are usually non-pathogenic inhabitants of the intestine of cattle, sheep, and goats. However, they may cause diseases under certain circumstances, such as in

animals which are immunocompromised, malnourished, or very young.

**Gastrointestinal Helminthosis****Abomasum**

Various infections of the abomasum have been reported of which →Ostertagiosis is probably the most important disease in grazing sheep and cattle in temperate climatic zones throughout the world. It causes subclinical losses of production and disease. The clinical disease is characterized by →diarrhoea, →weight loss, decreased production, rough hair coats, partial →anorexia, mild →anaemia, →hypoalbuminaemia, →dehydration, and in some cases death. →*Ostertagia ostertagi* in cattle and *O. (Teledorsagia) circumcincta* in sheep and goats are the most important species.

→Haemonchosis is a common and severe disease of the ruminant abomasum in many parts of the world. →*Haemonchus contortus* infects mainly sheep and goats, while *H. placei* occurs mainly in cattle. The pathogenesis of *Haemonchus* infection is the results of anaemia and hypoproteinaemia caused by the blood-sucking activity of the parasite.

→*Trichostrongylus axei* lives in the abomasum of cattle, sheep, and goats. In ruminants, *T. axei* infections are usually part of a mixed abomasal helminthosis and its effects cannot be dissociated from those of other worm species. The worm is rarely a pathogen on its own, as most infections are mild. Animals experimentally infected with large numbers of *T. axei* show a decrease of blood albumin, haemoconcentration, and a rise in serum pepsinogen. The clinical signs include diarrhoea, anorexia, progressive emaciation, listlessness, and weakness.

The pathogenesis of *M. digitatus* resembles that of *H. placei*. A drop in haematocrit to less than 20% has been reported in cattle infected with more than 1000 worms.

**Small Intestine**

Paramphistome infections may cause significant intestinal problems in ruminants (→Paramphistomosis). The adult worms live in the rumen, but the pathological effects of infection are caused by the immature stages within the small intestine. The most pathogenic species are thought to be *Paramphistomum microbothrium*, *P. ichikawai*, →*P. cervi*, *Cotylophoron cotylophoron*, and various species of *Gastrothylax*, *Fishoederius*, and *Calicophoron* (→Digenea).

Schistosomes live within the mesenteric and hepatic portal veins of ruminants. Although →*Schistosoma* infections in ruminants are highly prevalent in certain regions, the general level of infestation is often too low to cause clinical disease or losses in productivity. Levels sufficiently high to cause outbreaks of clinical schistosomosis do occur occasionally and infestation





**Alimentary System Diseases, Ruminants. Table 1** Gastrointestinal parasitic diseases of ruminants (according to Vercruyse and De Bont) (Continued)

Parasite	Host <sup>a</sup>	Clinical signs and pathology <sup>b</sup>									
		1	2	3	4	5	6	7	8	9	10
<i>Trichuris</i> <i>T. discolor</i> , <i>T. globulosa</i> <i>T. ovis</i>	C S, G	+	+				+			+	

<sup>a</sup> Host: C, cattle; S, sheep; G, goats

<sup>b</sup> Clinical signs and pathology: 1, →Anorexia; 2, →Diarrhoea; 3, →Oedema; 4, →Dehydration; 5, →Pale Mucosa; 6, →Productivity Loss; 7, →Death; 8, →Anaemia; 9, →Hypoalbuminaemia; 10, →Pepsinogen Increase

Occurrence of signs: ±, rare; +, common; ++, very common

becomes manifest either as an intestinal syndrome which is usually self-limiting, or as a chronic hepatic syndrome, which is usually progressive (Schistosomiasis, Animals). The intestinal syndrome is caused by the deposition of large numbers of eggs in the intestinal wall and usually follows a heavy infestation in a susceptible animal, i.e., an animal in which the capacity of the host to suppress the egg laying of the parasite has not been stimulated by previous infestations. This has been reported among cattle, sheep, and goats infected with either *S. bovis* or by *S. matthei*. As the faecal egg counts rise sharply with the onset of egg production the animal develops a mucoid and then haemorrhagic diarrhoea, accompanied by anorexia, loss of condition, general weakness and dullness, roughness of coat, hypoalbuminaemia, and paleness of mucous membranes. Death may occur 1 or 2 months after the onset of clinical signs. In most cases, the animal makes a spontaneous but slow recovery. The primary cause of the diarrhoea is the passage of large numbers of eggs through the wall of the intestine. The anaemia is usually due to an increased rate of red cell removal from the circulation; while haemodilution and the inability to mount a sufficiently effective erythropoietic response are of secondary importance. The underlying cause of the hypoalbuminaemia is hypercatabolism of albumin due to substantial loss of protein in the gastrointestinal tract.

In ruminants the more common and widely distributed intestinal →Cestodes are →*Moniezia expansa*, *M. benedeni*, *Thyzanietzia (Helicometra) giardi*, *Stilesia globipunctata*, and →*Avitellina* spp. These →tapeworms live in the middle third of the small intestine. They are generally of minor pathological importance and only produce harmful effects on the host in rare circumstances. The host–parasite relationship is so well adjusted that there is a surprising absence of apparent pathogenicity, even in such heavy infestations that the passage of intestinal contents may be impeded by the worms and, in most cases there are few, if any, clinical symptoms. Infections have been associated with diarrhoea and ill

thriving, but concomitant gastrointestinal nematode parasitism may often be of greater significance. In sheep *S. globipunctata* infections may cause signs of enteritis. The pathogenesis of this parasite is associated with the immature stages, which enter the mucosa of the intestine and induce the formation of →nodules.

Several nematode species cause severe gastrointestinal diseases such as →Strongyloidosis, →Trichostrongylosis, →Cooperiosis, and →Nematodirosis. Hookworm infections are caused by the two ancylostomatids occurring in cattle *Bunostomum phlebotomum*, and the little known *Agriostomum vryburgi*. Two species occur in sheep and goats: *Bunostomum trigonocephalum* and *Gaigeria pachyscelis*. Apart from the little damage to the mucosa of the small intestine caused by the bites, the entire pathogenesis of these worms is attributable to blood-sucking, which begins when larvae enter the adult stage. In addition to the withdrawal of great quantities of blood by the parasites, the feeding sites continue to bleed for several minutes after the worms have moved to another area. The signs are those of a rapid loss of blood: pale mucosae, hydraemia, sometimes →oedema, lassitude, and loss of weight. The faeces are often diarrhoeic and contain bloody mucus, or may be tarry in character.

The anaemia that develops is first normocytic and normochromic, but later becomes microcytic hypochromic as the animal becomes iron deficient. Other pathological changes recorded are hypoproteinaemia, hypocalcaemia, hyperglycemia, and →eosinophilia. The lowered plasma protein levels may be caused by both a compensatory replacement of haemoglobin at the expense of circulating plasma proteins and the loss of blood taken by the parasites. The non-specific loss of body fluid by leakage would account for the lowered plasma calcium values; the calcium associated with plasma albumin being lost with the protein.

*Toxocara vitulorum*, the pathogenic ascarid of large ruminants, is most commonly found in buffalo and cattle calves of less than 4 months of age. Infection occurs through ingestion of larvae with the milk from the mother. The clinical signs in calves relate primarily

to the bulk of parasites in the small intestine, which impedes the passage of ingesta and impairs the assimilation of food. The clinical signs include anorexia, diarrhoea or →constipation, dehydration, steatorrhoea, →abdominal pain, and a butyric odour of the breath.

### Caecum, Colon, Rectum, Anus

→*Trichuris* spp., the whipworms, inhabit the caecum and occasionally the colon of ruminants (→*Trichuriasis, Animals*). Members of the genus →*Oesophagostomum* infect cattle, sheep, and goats (→*Oesophagostomosis*).

→*Chabertia ovina* is found in the colon of sheep, cattle, goats, and deer throughout the world. Infections are usually light in intensity, and outbreaks of clinical disease are sporadic. Disease in sheep is associated with the presence of fifth stage and adult worms in the colon. Affected animals have a severe diarrhoea, sometimes blackened by blood. Ill thriving has been reported. The adults penetrate the muscularis mucosae and take a plug of mucosa into the buccal capsule; minor haemorrhage may be related to physical trauma to the mucosa but this blood loss is insufficient to induce anaemia in natural infections. More significant is the loss of plasma protein from the mucosa, which may cause hypoalbuminaemia and weight loss.

### Liver

The common clinical signs and pathology of the parasitic diseases of the liver of ruminants are summarized in Table 2.

A variety of →cestodes, →nematodes, and →trematodes produce inflammation of the liver and the bile ducts. Some of the parasites produce hepatic lesions in the course of their natural or accidental migration to their final habitat in the guts. The traumatic lesions produced by such larvae rarely cause disease, and are mostly found incidentally during post-mortem examination. Very heavy infections in sheep with the oncospheres of *Cysticercus tenuicollis* may induce severe haemorrhagic migration tracts in the liver.

Animals are weak, show abdominal pain, and have an enlarged, often palpable liver. Death may occur.

The most important parasites of the liver are those which have their final habitat in this organ.

### Trematodes

A variety of trematodes are very important parasites of the liver of animals. They belong to the families Fasciolidae (→*Fasciola hepatica*, →*F. gigantica*, and →*Fascioloides magna*), Dicrocoeliidae (→*Dicrocoelium dendriticum*, *D. hospes*), and Paramphistomatidae (*Gigantocotyle explanatum*).

*Fasciola hepatica*, the common liver fluke, is the most widespread and important of the group. *F. gigantica* occurs in the tropics. It occurs mainly in sheep and cattle, but a patent infection can develop in horses, pigs, wild animals, and in humans. The pathogenesis of fasciolosis is attributable in part to the invasive stages in the liver and in part to the blood feeding by the adults in the bile ducts. The process in all hosts shows close similarities, but considerable variation in severity occurs (→*Fasciolosis, Animals*).

The host range of *Fascioloides magna* includes cattle, bison, sheep, goat, and horse but it is only recognized as a pathogen of sheep. In sheep this parasite wanders continuously in the liver and causes extensive parenchymal destruction. Even a few →flukes may kill a sheep. *Dicrocoelium*, as with many →liver flukes, has a wide host range including both sheep and cattle. The pathological changes in the liver are less severe than those seen in *F. hepatica* infection (→*Fasciolosis, Animals*) and even in heavy infections there may be no clinical signs.

A chronic hepatic syndrome has been described in cattle infected with *Schistosoma matthei*. This syndrome is less common than the intestinal syndrome (see above). It is characterized by progressive hepatic fibrosis and may be manifested clinically as chronic hepatic insufficiency, with loss of condition, or as acute terminal hepatic failure, which often provokes nervous signs as ataxia or mania. The established condition is

**Alimentary System Diseases, Ruminants. Table 2** Parasitic diseases of the liver (ruminants) (according to Vercauysse and De Bont)

Parasite	Clinical signs
<i>Dicrocoelium</i> spp.	Loss of condition
<i>Fasciola hepatica</i> , <i>F. gigantica</i>	Acute (sheep): anorexia, distended abdomen pain, death. Mild: hypoalbuminaemia, hyperglobulinaemia eosinophilia, light anaemia. Chronic: loss of appetite, pale mucosae, oedema, productivity loss, Hypoalbuminaemia, anaemia, SGOT, $\gamma$ -GT rise
<i>Fascioloides magna</i>	Sheep: weakness, death
<i>Gigantocotyle explanatum</i>	Decreased production, enlargement of bile ducts, inflammatory reactions
<i>Schistosoma</i> spp.	Loss of condition, diarrhoea

invariably fatal. The syndrome is of immunological origin and apparently depends on the ability of the ox to limit the infestations by destruction of adult parasites. It is probably initiated by an immunological reaction in the hepatic portal veins to antigen released by dead or dying worms in the portal system. The lesion is analogous to Symmer's pipestem fibrosis in man.

*Gygentocotyle explanatum* occurs in the bile ducts of ruminants in Asia. Heavy infections induce inflammatory reactions, with enlargement of the bile ducts. Decreased production has been reported.

### Cestodes

*Thysanosoma actinoides* and *Stilesia hepatica* are parasites of the bile ducts of ruminants. They are both practically non-pathogenic.

### Abdominal Cavity

Most of the parasites found in the peritoneal cavity have their final habitat elsewhere and passage through the peritoneum occurs in the normal course of migration, or by accident. The only parasite of importance is *Fasciola hepatica* as it can cause acute and chronic peritonitis.

Other parasites, such as the commonly seen →*Setaria*, use the peritoneal cavity as their final habitat. All members of this genus live as well-adjusted parasites in their normal host and do not cause peritoneal lesions.

### Therapy

→Chemotherapy, →Trematocidal Drugs, →Cestodocidal Drugs, →Nematocidal Drugs.

---

## Alimentary System Diseases, Swine

The common clinical signs and pathology of the parasitic diseases of the gastrointestinal tract of swine are summarized in Table 1.

### Protozoal Enteritis

Coccidiosis (→Coccidiosis, Animals) and Cryptosporidiosis (→Cryptosporidiosis, Animals) have been reported in pigs. Although it is possible to experimentally induce clinical cryptosporidiosis in piglets this pathogen appears to be of little significance under natural conditions. Pigs serve as hosts for a number of coccidia species of the genus *Eimeria*. Oocysts of *Eimeria* are frequently found in adult pigs, particularly sows, but are only rarely associated with clinical disease or reduced performance. In contrast, *Isospora suis* is now widely accepted as a major cause of enteritis in

suckling piglets. Prevalence is very high in young piglets and generally peaks in the second or third week after birth. Even moderate infection levels can induce diarrhoea in suckling pigs. Due to the short prepatency of around 5 days, rapid sporulation in the environment and high reproductive potential *I. suis* spreads rapidly within a litter and across farrowing crates. Faeces is of pasty to watery consistency, gray to yellow, and has a typical odour. Although mortality is low the economic loss may be considerable due to impairment of piglet performance which may continue after weaning in recovered animals. →*Balantidium coli* occurs in the large bowel in pigs and sometimes other mammals. It is normally present as a commensal in the lumen but is capable of invasion of tissues injured by other diseases (e.g., →*Trichuris* infection, see below).

### Gastrointestinal Helminthosis

#### Stomach

There are several helminths that possibly live in the stomach of swine. In contrast to ruminants, →*Trichostrongylus axei* occurs rarely in pigs (→Trichostrongylosis). →*Hyostrongylus rubidus* is the most important parasite of the stomach of swine but very rare under conventional keeping conditions. This trichostrongylid nematode produces lesions resembling those caused by →*Ostertagia* in ruminants, but with less severe consequences. Listlessness, thirst, →anorexia, →anaemia, →diarrhoea, and reduced weight gains may occur. Under field conditions hyostrongylosis is associated with the "thin-sow syndrome." Parasite or host strain differences may account for some of the variations recorded in the literature regarding the effects of experimental *H. rubidus* infections on swine health and performance.

*Gnathostoma hispidum* live deep in the gastric mucosa where they may cause severe ulceration. Migrating larvae may be found in the liver where they leave necrotic tracks. *Physocephalus sexalatus* and *Ascarops strongylina* may be found free in the lumen or partly embedded in the mucosa. *Simonsia paradoxa* female worms form palpable →nodules in mucosal crypts. Clinical signs of acute or chronic gastritis, and occasional ulceration have only been observed in the rare heavy infections.

#### Small Intestine

The trematode →*Schistosoma japonicum* lives within the mesenteric and hepatic portal veins of pigs (→Schistosomiasis, Animals).

Strongyloidosis caused by →*Strongyloides ransomi* occurs in swine. Clinical outbreaks principally affect piglets. Signs include anorexia, loss of weight, diarrhoea (rarely haemorrhagic), →dehydration, and slight to moderate anaemia. Severe infections may be fatal.

**Alimentary System Diseases, Swine. Table 1** Gastrointestinal parasitic diseases of swine (according to Vercruysse and De Bont)

Parasite	Clinical signs and pathology <sup>a</sup>						
	1	2	3	4	5	6	7
<b>Stomach</b>							
Nematoda							
<i>Hyostrongylus rubidus</i>	+	+				+	+
<i>Spirurid infections</i>	+	+					
<b>Small intestine</b>							
Protozoa							
<i>Isospora suis</i>	+	+	++	+	+		
<i>Cryptosporidium</i> spp.	+	+	++	+			
Nematoda							
<i>Strongyloides ransomi</i>	+	+	+			+	+
<i>Ascaris suum</i>	+	+	+	+			+
<b>Large intestine</b>							
Protozoa							
<i>Balantidium coli</i>			+				
Nematoda							
<i>Oesophagostomum dentatum</i>	+	+	+			+	+
<i>O. quadrispinulatum</i>							
<i>Trichuris suis</i>	+	+	+		+	+	+

<sup>a</sup> Clinical signs and pathology: 1, →Loss in performance, →Weight Loss; 2, →Anorexia; 3, →Diarrhoea; 4, →Constipation; 5, →Abdominal Pain; 6, →Hypoalbuminaemia; 7, Others

Occurrence of signs: ±, rare; +, common; ++, very common

→Hookworms of the genus →*Globocephalus* appear to be of little significance in swine (→Alimentary System Diseases, Ruminants).

*Ascaris suum* is a very common parasite of pigs. Its importance is related both to the sometimes very significant lesions caused by larvae during migration through the liver and lungs, and to the effects of adult worms in the small intestine. In the liver, the travelling larva causes intralobular →necrosis and a granulation reaction known as “milk spots.” However, these lesions are not associated with symptoms. In the ordinary moderate infections, adults have no defined pathogenesis. In heavy infection, there is experimental evidence of reduction in growth rate, diarrhoea, and ill thriving. Intestinal obstruction is rare.

The Acanthocephalan *Macrocanthorynchus hirudinaceus* is the thorny-headed worm of swine, which infects the small intestine. The worm causes trauma at the site of attachment with its thorny →proboscis. The proboscis may penetrate as far as the serous coat, and nodules of up to 1 cm in diameter may be visible on the serosal surface of the gut. They occasionally perforate, causing peritonitis. Severely infected pigs may suffer ill thriving and anaemia. The latter is probably related to the loss of plasma protein and to the haemorrhages from numerous ulcerative lesions. The pigs often show signs of acute →abdominal pain during these infections.

### Caecum, Colon, Rectum, Anus

The →whipworm *Trichuris suis* inhabits the caecum of pigs. Heavy infections associated with severe and often haemorrhagic typhlitis or typhocolitis has been reported. Clinical manifestations include anorexia, dysentery, dehydration, →weight loss, and terminal anaemia. In severe cases the faeces may be markedly haemorrhagic or even all blood. The lesions are caused by the adult worms boring tunnels into the mucosa of the large intestine. Penetration of the mucosa by the parasites produce nodules in the intestinal wall (→Alimentary System Diseases, Carnivores). It has been shown that concurrent infections with *T. suis* enhances the ability of opportunistic bacteria to multiply and cause disease and pathology.

→Oesophagostomosis has been reported in pigs. The two common species found in pigs are *O. quadrispinulatum* and *O. dentatum*. Although the parasites themselves are generally highly prevalent, clinical →oesophagostomosis is not common in pigs. The “thin-sow-syndrome” has been associated with oesophagostomosis. At necropsy distinct nodules caused by the histotropic larvae are a common observation.

### Liver

The most important parasitic condition affecting the liver of pigs is the “milk spots” caused by the passage

of ascarid larvae (see supra). The pathogenesis of →*Stephanurus dentatus* infections (→[Urinary System Diseases, Animals](#)) is primarily related to the damage caused by the larvae during their migration through the liver. Hepatitis cysticercosa, resulting from the migration of *Cysticercus tenuicollis*, may be rarely observed in pigs (→[Alimentary System Diseases, Ruminants](#)).

→*Fasciola hepatica* has been found in pigs, but infections are very rare. Hepatic schistosomiasis occur in swine infected with *S. japonicum*. The lesions resemble those observed in cattle (→[Alimentary System Diseases, Ruminants](#)).

The opisthorchid →[flukes](#) (*Opisthorchis felineus*, →*Clonorchis sinensis*) are normally parasitic in the bile ducts of carnivores. However, they may also occur in swine and humans. The signs of heavy infection are emaciation, jaundice, and ascites.

### Abdominal Cavity

Most of the parasites found in the peritoneal cavity have their final habitat elsewhere and passage through the peritoneum occurs in the normal course of migration, or by accident. Parasites normally migrating through the peritoneal cavity are the immature *Fasciola hepatica* and *Stephanurus dentatus*. Both can cause acute and chronic peritonitis.

### Therapy

→[Chemotherapy](#), →[Trematocidal Drugs](#), →[Cestodocidal Drugs](#), →[Nematocidal Drugs](#).

---

## Allantosoma

Genus of suctorian ciliates attached to the intestinal wall of horses.

---

## Allergen

Substance (e.g., house dust) or portions of an animal (e.g., mite), that cause an increased immune-reaction in humans.

---

## Allergy

Increased immune reactivity of humans on repeated contact with allergenic substances.

---

## Allethrin

### Chemical Class

Pyrethroid (type I). →[Arthropodicidal Drugs](#).

### Mode of Action

Open state voltage-gated sodium channel blocker. →[Ectoparasiticides – Blockers/Modulators of Voltage-Gated Sodium Channels](#).

---

## Allochthony

The Greek terms *allos* = foreign and *cthonos* = home/place are used to characterize species which invade a new region/new hosts and often do not stay.

---

## Alloiozona

Genus of symbiotic ciliates in the caecum and colon of horses.

---

## Allopathy

→[Speciation](#).

---

## Allopatric Speciation

From Greek: *allos* = alien, Latin: *patria* = homeland. This term describes the formation/occurrence of related species in different regions/biotopes. →[Speciation](#).

---

## Allopurinol

→[Leishmaniacidal drugs](#), agent against Leishmaniasis (dogs).

## Alloscutum

Dorsal region posterior to the →scutum in ixodid ticks.

## Alloxenic Speciation

→Speciation.

## Alopecia

Clinical and pathological symptoms (e.g., loss of hair) of infections with skin parasites (→Skin Diseases, Animals, →Demodicosis, Man, →Acariosis, Animals, →Lice).

## Alphamethrin (Alpha-Cypermethrin, A-Cypermethrin)

### Chemical Class

Pyrethroid (type II,  $\alpha$ -CN-pyrethroids).

### Mode of Action

Open state voltage-gated sodium channel blocker.  
→Ectoparasiticides – Blockers/Modulators of Voltage-Gated Sodium Channels, →Arthropodicidal Drugs.

## Aluminium Hydroxide

The only adjuvant for vaccines licensed for use in humans.

## Alveococcosis

→Echinococcosis due to infection with →Echinococcus multilocularis.

## Alveococcus

→Echinococcus.

## Alveolar Cyst

→Echinococcus/Fig. 1. Formation and growth see →Echinococcus/Fig. 5.

## Alveolata

New phylum of protozoans comprising the subphyla Apicomplexa (Sporozoa), Dinoflagellata and Ciliophora. →Classification/New System.

## AMA

Apical membrane antigen.

## Amandibulata

### Synonym

→Chelicerata.

### Classification

Subphylum of →Arthropoda. Arthropods (e.g., →Spiders, →Scorpions, →Ticks, →Mites) that lack antennae and mandibles and are commonly placed in the subphylum Amandibulata. Others prefer the term Chelicerata, thus named because the first postoral appendages become feeding organs called →chelicerae (→Arthropoda/System).

## Amastigotes

Intracellularly parasitic developmental stage of, e.g., →Leishmania species, the very short flagellum (invisible

in light microscopy), does not rise above the surface of the parasite (→[Flagella](#)). These amastigotes are also called →[micromastigotes](#).

---

## Ambiphrya

Sessile ciliates on skin and gills of fish.

---

## Amblyomma

### Name

Greek: *amblys* = not sharp rounded, *omma* = eye.

### Classification

Genus of ixodid →[ticks](#); see also →[Aggregation-Attachment Pheromones](#).

### General Information

Genus of hard →[ticks](#), which comprises about 100 species, the most important of which are found in Africa south of the Sahara and in the New World in tropical and subtropical humid regions (not in Europe). Important species are the Bont tick *A. hebraeum* (nicely coloured) in South Africa, *A. variegatum* (Tropical bont tick) in East Central Africa, *A. pomposum* (Highland bont tick) in western Central Africa, *A. americanum* (Lone star tick) in the USA, Eastern Coast until Central Texas, *A. maculatum* (Gulf Coast tick) in the southern states of the USA, and *A. cajennense* (Cayenne tick) from Texas to Argentina. All *Amblyomma* spp. involve 3 hosts. Their sucking always induces painful skin lesions, necroses, itching, ulcers, granulomas (e.g., *A. cajennense* in horses). Also humans are attacked by larvae and nymphs when walking on cattle meadows. Loss of weight is enormous, if large amounts of ticks suck at cattle. *A. hebraeum* needs at least 171 days for one generation, it produces nearly 20,000 eggs per female and each stage may starve for more than 6 months. Thus they are absolute competitive ectoparasites. As vectors they are known to transmit stages of *Ehrlichia* spp., *Rickettsia rickettsii*, *Cowdria ruminantium*, *Coxiella burnetii*, *Hepatozoon americanum* (*A. americanum*), *Theileria mutans* (*A. variegatum*, *A. hebraeum*), *Cytauzoon felis* = *Theileria* (*A. variabilis*).

### Disease

→[Heartwater](#), →[Tularemia](#).

---

## Amblyospora

### Classification

Genus of →[Microsporidia](#).

### Life Cycle

Fig. 1 (page 69).

---

## Amebae

→[Amoebae](#).

---

## American Trypanosomiasis (Chagas Disease)

In the acute stage of →[Chagas Disease](#), the direct examination of anticoagulated blood or its buffy coat will usually reveal the presence of motile trypanosomes. Giemsa-stained thin or thick blood films are useful for confirmation. Direct visualization of trypanosomes is much more difficult in the chronic stage of the disease, where culture in NNN medium, blood inoculation into mice or xenodiagnosis with uninfected reduviid bugs are used to propagate the causative parasite which then becomes detectable by microscopic examination. Where appropriate facilities are available, PCR may be useful for detecting *T. cruzi* in blood.

For epidemiological or individual screening, the indirect fluorescent antibody test (IFAT) proved to be highly sensitive. However, cross-reactivity with *Leishmania* spp. co-endemic with *T. cruzi* in various areas of Latin America limits the usefulness of the IFAT.

---

## Amidines

Used as →[arthropodicidal drugs](#) and agents against Babesiosis.

---

## Amidostomum

Genus of trichostrongylid, →[nematodes](#) of birds.

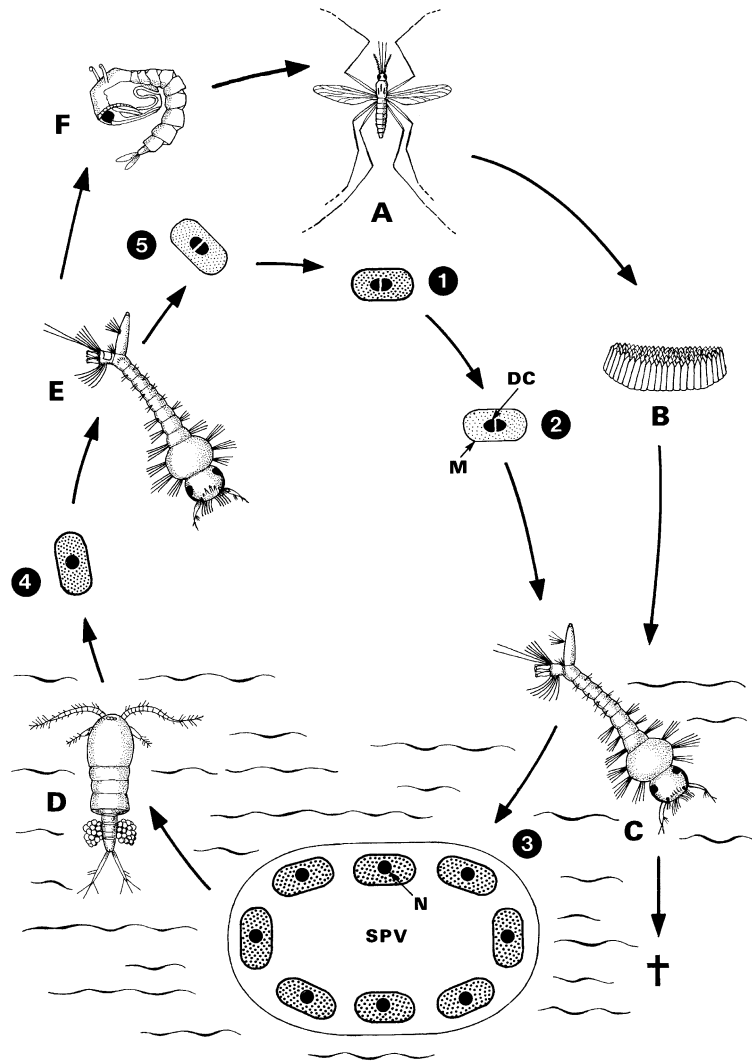

**Amblyospora.** Figure 1 Life cycle of *Amblyospora* species using different  $\rightarrow$  *Culex* stages (A, B, C, E, F) and copepods (D) as hosts. 1 Inside adult female  $\rightarrow$  mosquitoes (A) diplocaryotic  $\rightarrow$  spores are formed (dense wall) which are transovarially transmitted to the eggs (B) and to the developing larvae (C) of the insect. 2, 3 Inside the larvae diplocaryotic  $\rightarrow$  meronts (DC, M) reproduce and finally give rise to unicaryotic (N)  $\rightarrow$  meiospores – eight within a sporophorous vesicle. During this process most larvae die, thus setting free the meiospores which are ingested by another host, i.e., by a copepod (D). 4 Within the copepod, finally, uninucleate spores are formed from meronts. 5 When such uninucleate spores are swallowed by larvae of mosquitoes, various generations of diplocaryotic meronts are formed and persist in the pupae and adults of the insect. In the adult  $\rightarrow$  mosquitoes, finally, new diplocaryotic spores are produced (1). DC,  $\rightarrow$  diplocaryon; M, meront; MS, meiospore; N, nucleus; SPV,  $\rightarrow$  sporophorous vacuole.

## Amino Acids

Like all other organisms, parasitic protozoa and helminths require the basic set of 20 amino acids for their protein synthesis, formation of other biomolecules, and, to a lesser extent, for energy production. The majority of these amino acids are essential for the parasite and have to be obtained from the diet or from exogenous proteins. Ingested proteins are hydrolyzed within specialized

organelles (lysosomes, lysosome-like organelles, and other specialized vacuoles) into their constituent amino acids by the concerted action of specific proteinases and peptidases. In nematodes and trematodes, protein digestion is accomplished in the gut lumen. The amino acid metabolism of parasites resembles that of higher animals, but there are differences regarding the properties of the enzymes involved, the relative importance of the various pathways and the occurrence of a variety of unusual metabolic routes. The unique properties of amino acid metabolism found in protozoan parasites are often



determined by secondary gene loss and lateral gene transfer, primarily from bacterial lineages.

### Biosyntheses and Interconversions

The carbon skeletons of glycine, alanine, serine, aspartate, and cysteine are derived primarily from glycolytic or Krebs cycle intermediates, while the  $\alpha$ -amino groups are usually furnished by transamination reactions from glutamate. The latter amino acid is formed from ammonia and the Krebs cycle intermediate,  $\alpha$ -ketoglutarate. Other amino acids are produced by amino acid interconversions, a capacity in which parasites can differ greatly from their hosts. An unusual metabolic feature of some protozoa is the conversion of arginine to ornithine, ammonia, and  $\text{CO}_2$  by a

route called arginine dihydrolase pathway (Fig. 1). In eukaryotic organisms, this pathway has been reported to be present only in *Giardia*, trichomonads, and a green alga, in which it may serve as an energy source but also for ornithine production for further biosynthesis of polyamines (Fig. 1). Cysteine can be synthesized in most parasites from methionine, with the exception of *Giardia* which is absolutely dependent on an exogenous supply of this amino acid for survival and growth. Examples for more profound differences in sulphur compound metabolism between parasites and their mammalian hosts are the exclusively bacterial enzyme methionine  $\gamma$ -lyase catabolizing methionine and cystathionine in certain anaerobic protozoa, and the novel type of cystathionine  $\beta$ -synthases of trichomonads and nematodes involved in cysteine synthesis from

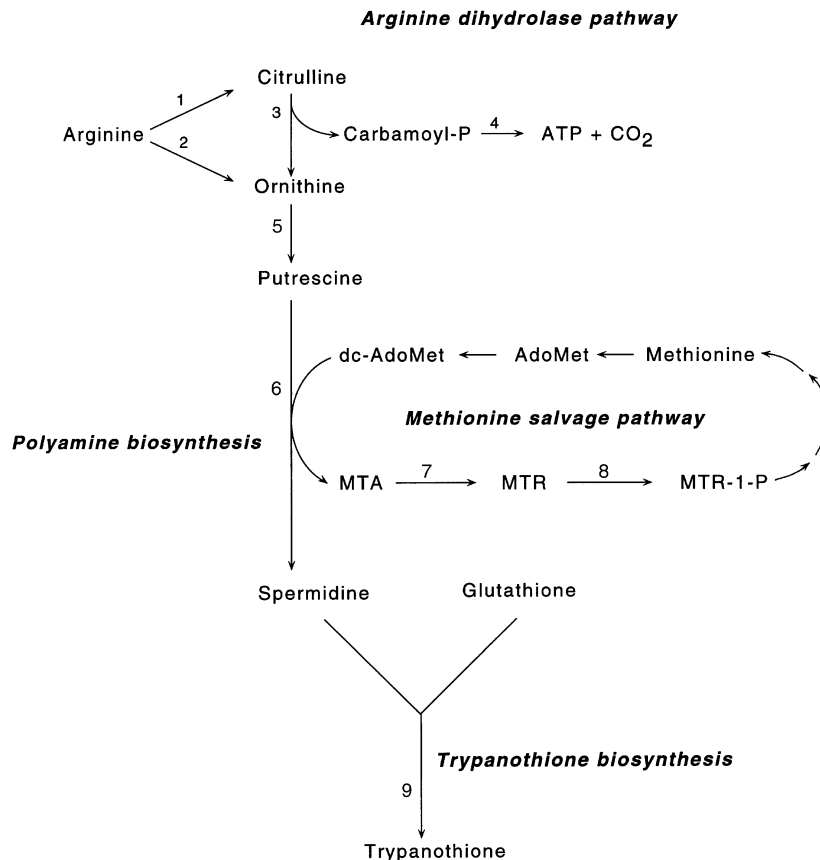

**Amino Acids. Figure 1** Interrelationships between the arginine dihydrolase pathway, methionine recycling and biosynthetic routes for polyamines and trypanothione in protozoan parasites. The arginine dihydrolase pathway is unique to *Giardia* and trichomonads and is used for energy generation and polyamine biosynthesis. Certain protozoa utilize a mechanism for methionine recycling during polyamine biosynthesis that is modified from that present in other eukaryotes. In this pathway, the intermediate MTA is converted in a 2-step reaction to MTR-1-P involving the microbial enzymes MTA nucleosidase and MTR kinase. In other eukaryotes, MTA is converted to MTR-1-P in one step by a phosphorylase. Trypanothione biosynthesis occurs only in trypanosomatids. 1, Arginine deiminase; 2, arginase; 3, ornithine carbamoyltransferase; 4, carbamoylphosphate kinase; 5, ornithine decarboxylase; 6, spermidine synthase; 7, 5'-methylthioadenosine (MTA) nucleosidase; 8, 5-decarboxylated AdoMet; MTA, methylthioadenosine; MTR, methylthioribose; MTR-1-P, methylthioribose-1-phosphate.

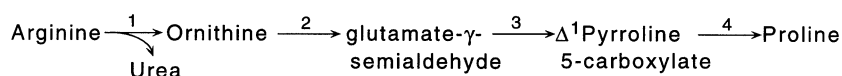

**Amino Acids. Figure 2** The proline biosynthetic pathway in trematodes. 1, Arginase; 2, ornithine aminotransferase; 3, spontaneous reaction; 4, pyrroline 5-carboxylate reductase.

homocysteine and in cysteine degradation. *Giardia*, *Entamoeba histolytica*, and *Plasmodium falciparum* possess a unique pathway for methionine recycling from methylthioadenosine produced from decarboxylated S-adenosylmethionine (Fig. 1). This process serves to conserve the essential amino acid for polyamine and other biosyntheses and involves enzymes, which are otherwise only found in prokaryotes. A unique feature of *Plasmodium* and other apicomplexan parasites is their ability to synthesize chorismate (shikimate pathway), the pivotal precursor in bacteria, fungi, and plants for the biosynthesis of aromatic amino acids. However, on the basis of gene similarity searches, no evidence was found for a role of chorismate in the synthesis of phenylalanine, tyrosine, and tryptophan in the malaria parasite. Other unusual routes of amino acid interconversions can occur during catabolism. Examples are procyclic *Trypanosoma brucei*, *T. cruzi* epimastigotes and *Leishmania* promastigotes which possess high rates of proline oxidation resulting in the formation of succinate mainly (Energy Metabolism). *T. brucei* procyclic culture forms catabolize threonine to form equimolar amounts of glycine and acetyl-CoA. The latter compound can be excreted as free acetate or used as a carbon source for lipid synthesis.

The large quantities of proline produced by *Fasciola hepatica*, schistosomes, and other trematodes correlate with an extremely active proline pathway in these helminths. In contrast to higher organisms, in which glutamate serves as the precursor for proline synthesis, the liver fluke and schistosomes use host-derived arginine as preferred substrate for the production of this amino acid (Fig. 2). The enzymes involved in the proline pathway of helminths are several times more active than in mammalian tissues. This, together with the absence of proline oxidase, aids in explaining the excessive levels of proline produced by certain helminths that have been implicated in the pathogenesis of trematode infections, including bile duct hyperplasia in fasciolosis and fibrosis in schistosomiasis.

### Catabolism

Like higher animals, the first step in amino acid catabolism in parasites is often the removal of the  $\alpha$ -amino nitrogen mediated primarily by transamination and deamination reactions. The ammonia arising from these reactions constitutes a major portion of the

total excretory nitrogen in endoparasites. While in most terrestrial vertebrates the  $\alpha$ -amino nitrogen is finally converted into urea by the urea cycle, the presence of this pathway in parasites appears doubtful. The small amounts of urea produced by helminths possibly derive from the cleavage of dietary arginine. In addition to ammonia, many parasites excrete a substantial amount of their amino nitrogen in the form of amino acids, primarily as alanine and proline. This metabolic strategy is also common in free-living protozoa and invertebrates but is unusual in higher animals, where oxidative degradation with associated energy production is the preferred strategy for amino acid breakdown. Larval and adult helminths were also found to excrete amines as end products of amino acid metabolism. The formation of these compounds, which includes various alkylamines and ethanolamine, appears to be catalyzed by unusual and as yet unknown enzymatic mechanisms. Certain amino acids can serve as important energy sources for parasites, including proline for insect stage trypanosomatids, arginine for anaerobic protozoa, and glutamine for filarial parasites (see above). In all these processes, substrate oxidation is incomplete and results, besides some CO<sub>2</sub>, in the formation of partially oxidized end products.

### Precursor Function

Except in being the building blocks for protein synthesis, the capability of parasites to use amino acids as precursors for synthetic purposes is rather limited. An example is the absence of the pathways for the *de novo* synthesis of purines in parasites for which glycine and aspartate are major precursors. Although amino acid-derived neurotransmitters and neurohormones are widely distributed among helminths, little is known about their synthesis in these organisms. Most of the neurophysiologically active substances found in worm tissues, such as histamine, serotonin (5-hydroxytryptamine), and catecholamines may be primarily of host origin.

## Aminosidine

Compound, →Leishmanicidal Drugs.

## Amitraz

### Chemical Class

Amidine (formamitidine) → [Arthropodicidal Drugs](#).

### Mode of Action

Octopamine receptor agonist → [Ectoparasiticides – Modulators/Agonists of Aminergic Transmission](#).

## Ammonia

→ [Amino Acids](#).

## Amocarzine

→ [Nematocidal Drugs](#), agents against nematodes.

## Amodiaquine

→ [Coccidiocidal drugs](#), → [Anticoccidial Drugs](#).

## Amoebae

### Synonym

Amoebida.

### Classification

Order of → [Protozoa](#) (new phylum Amoebozoa).

### General Information

Among the → [Sarcodina](#) (→ [Rhizopoda](#)), only the amoebae are of parasitological interest. Amoebae are characterized by the presence of an endo- and ectocyttoplasm, and by their locomotion and reeding as consequences of the formation of → [pseudopodia](#) (→ [Trichomonadida](#)/ [Fig. 2](#)). These family-specific formations originate from the outward flow of → [cytoplasm](#) and push the → [cell membrane](#) ahead in the direction of flow; amoebic stages

cannot swim, but creep around the substratum or the intestine (or vessels) of a parasitized host. Some of the amoebae, however, may become flagellated during their life cycles ([Fig. 1](#), page 73).

Most members of the order Amoebida are free-living, although some are facultative ([Table 1](#), page 74) or accidental ([Figs. 1–8](#)) pathogens; others live regularly as parasites. Reproduction of the parasitic species occurs by asexual binary or multiple division (→ [Cell Multiplication](#)); sexual stages have not been described. **Transmission** occurs by oral uptake of fresh → [trophozoites](#) or by ingestion of cysts (if present), the wall of which is excreted by the trophozoites ([Figs. 1–8](#), see pages 73, 75–77).

### Systematics

Order: Amoebida.

Family: Entamoebidae.

Genus: *Endolimax*.

Genus: *Iodamoeba* (*Pseudolimax*).

Genus: → [Entamoeba](#)/[Fig. 5](#)

Family: Hartmannellidae

Genus: → [Acanthamoeba](#) ([Figs. 1, 2, 4](#))

Genus: *Hartmannella*.

Family: Amoebidae.

Genus: *Amoeba* ([Fig. 3](#)).

Genus: *Chaos*.

Order: Schizopyrenida.

Family: Vahlkampfiidae.

Genus: *Naegleria* ([Fig. 1](#))

Genus: → [Vahlkampfia](#).

### Important Species

[Table 1](#) (page 74).

### Life Cycle

[Fig. 1](#) (page 73).

### Diseases

→ [Naegleriasis](#), → [Amoebiasis](#), → [Acanthamoebiasis](#), → [PAME](#), → [GAE](#).

## Amoebapora A

This is a protein of *Entamoeba histolytica*, which may initiate openings in membranes of endothelial cells of the host. Its structure belongs to the archetypes of saposin-like proteins. Similar proteins have been found in porcine and human cytotoxic lymphocytes and have been described as “natural killer lysine” and “granulolysin”, respectively.

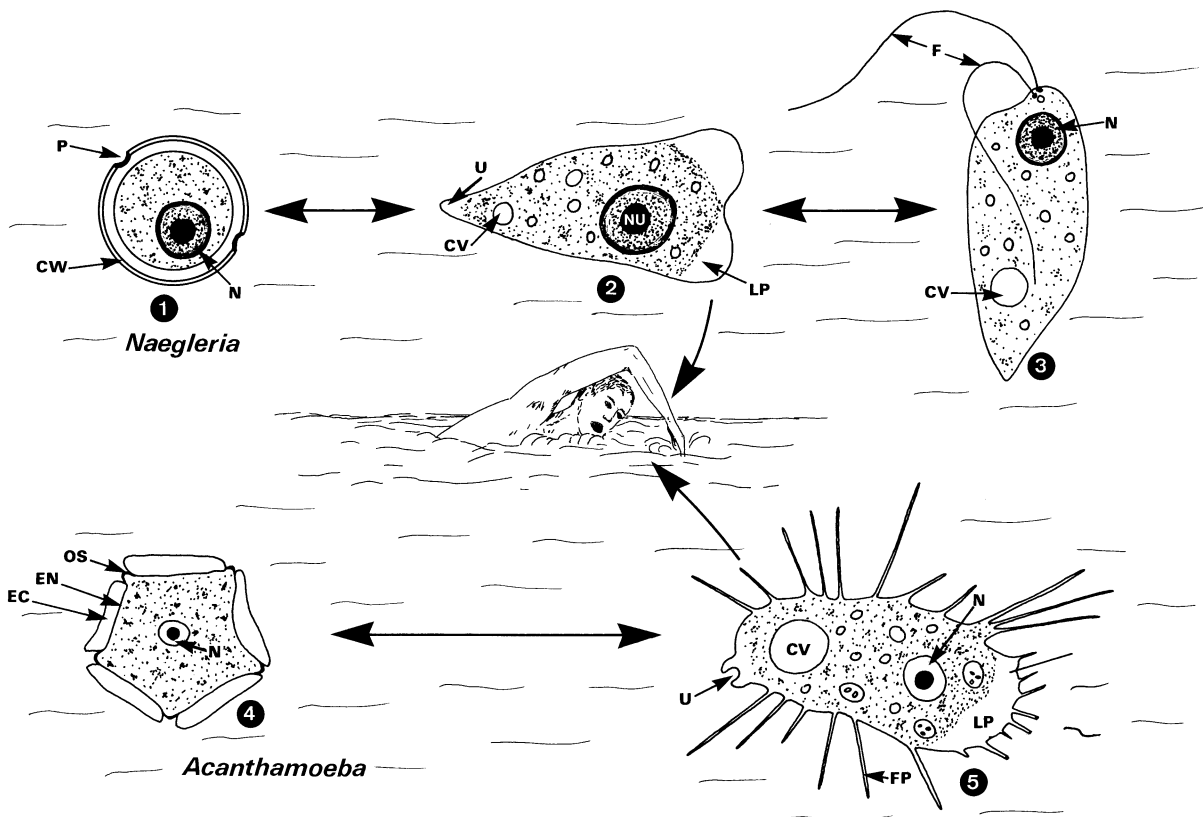

**Amoebae.** Figure 1 Developmental stages of two species from →soil amoeba which (under undefined conditions) may become pathogenic to man. 1–3 *Naegleria* spp. (e.g., *N. gruberi*). 1 Cyst. 2 Amoeboid stage (probably infectious for man via the olfactory pathways) is able to produce a cyst wall. 3 Flagellated stage: under certain physiological conditions, the amoeboid form undergoes transformation into flagellated stages, which do not feed or divide. 4, 5 →*Acanthamoeba castellanii* (syn. some *Hartmannella* species). The life cycle comprises cysts (4) and free amoeboid stages (5), which may become pathogenic to man. CV, →contractile vacuole; CW, cyst wall; EC, ectocyst; EN, endocyst; F, flagellum; FP, filopodium; LP, lobopodium; N, nucleus; NU, →nucleolus; OS, ostiole; P, plug of CW; U, uroid (for size see Table 1, page 74).

## Amoebapore

A polypeptid that is excreted by →trophozoites of →*Entamoeba histolytica*. It comes in contact with host cell membranes and initiates the formation of ion channels. This introduces the lysis of these cells and thus opens the entry of the amoeba into the intestinal wall. Recently, it was also found in →*Acanthamoeba* and →*Naegleria*.

## Amoebiasis

### Synonyms

Amoebic dysentery; →*Entamoeba histolytica* infection.

### Distribution

Fig. 1 (page 78).

### Pathology

Infectious disease caused by the amoeba →*Entamoeba histolytica* which may be commensal in the gut for long periods of time, or it may invade the mucosa soon after infection. The dose of infection, the strain of →amoebae, the nutritional state of the patient, and the nature of the intestinal flora are likely to be determinants of the development of disease. Axenic animals with an intestine free of bacteria do not appear to develop invasive amoebic infection. Some strains of amoebae are more pathogenic and appear to share isoenzyme or genomic patterns, described as zymodemes or →schizodemes. Although multiple pathogenic mechanisms of *E. histolytica* have been described, none have been definitively linked with pathogenicity. The amoebic →trophozoites are best demonstrated with

**Amoebae. Table 1** Important amoebes

Species	Size of trophozoites (µm)	Host/Habitat	General number of nuclei in cysts	Pathogenicity
<i>Entamoeba coli</i>	20–5	Humans/Colon	8	–
<i>E. hartmanni</i>	5–12	Humans/Colon	4	–
<i>E. histolytica</i> Minuta stage Magna stage	10–18 20–50	Humans/Colon, Extraintestinally in liver, lung, brain	4 No cysts	+/- +
<i>E. dispar</i>	10–18	Humans/Intestine	4	–
<i>E. polecki</i> <sup>a</sup>	10–20	Humans, pigs/Colon	1	-/+
<i>E. suis</i> <sup>a</sup>	5–25	Pigs/Colon	1	–
<i>E. gingivalis</i>	10–20	Humans/Mouth	No cysts	–
<i>E. gallinarum</i>	9–25	Chickens/Cecum	8	–
<i>E. anatis</i>	10–20	Ducks/Intestine	4	+
<i>E. bovis</i>	5–20	Cattle/Rumen	1	–
<i>E. invadens</i>	9–38	Reptiles/Colon	4	+
<i>Malpighamoeba mellificae</i>	2.5–4.5	Bees/Intestine	2	+
<i>Endolimax nana</i>	6–15	Humans/Colon	4	–
<i>Iodamoeba bütschlii</i>	8–20	Humans, pigs/Colon	1	–
<i>Naegleria gruberi</i>	22	Humans/Brain	1	+
<i>N. fowleri</i>	20	Humans/Brain	1	+
<i>Acanthamoeba</i> spp.	40	Humans/Brain	1	+
<i>A. castellanii</i>	25–40	Humans/Eyes, brain	1	+
<i>Balamuthia mandrillaris</i>	12–60	AIDS-patients/Brain	?	+

<sup>a</sup> Some authors keep them for synonyms

the periodic acid Schiff (PAS) technique (→[Pathology/ Fig. 4C,D](#)) because most trophozoites contain →[glycogen](#). Also, their →[cytoplasm](#) stains more distinctly with →[Giemsa](#) or eosin than the smaller macrophages. They adhere to the intestinal epithelium and generally invade in areas where the intestinal mucus appears depleted. The amoebae fan out in the lamina propria and submucosa, giving rise to “flask-shaped” ulcers (→[Pathology/ Fig. 4A](#)). The histolytic nature of the amoebae is suggested by the lysis of the surrounding cells, seen light microscopically by lysis of the nuclei and by ultrastructural changes in the cytoplasm. However, the clear space around individual amoebae is largely a fixation artifact. Neutrophils are attracted by the amoebae and are degranulated and lysed (→[Pathology/ Fig. 4B](#)). This release of neutrophil granules may contribute to tissue destruction. The absence of neutrophils around the ulcers is notable. The absence of fecal leukocytes with positive results of a guaiac test for blood is a useful diagnostic finding. However, eosinophilic leukocytes are often seen histologically and →[Charcot-Leyden crystals](#) may be found in the stool. The magna-stages phagocytose red blood cells and cell debris which distinguishes *E. histolytica*

from nonpathogenic amoebae. Intestinal ulcers may extend through the muscularis (→[Pathology/ Fig. 4C](#)) and lead to intestinal perforations. This complication is made more likely by the administration of anti-inflammatory corticosteroids which can occur if an erroneous diagnosis of inflammatory bowel disease has been made. However →[AIDS](#) patients do not appear to be especially susceptible to recrudescences.

The amoebae often invade the veins in the submucosa of the gut (→[Pathology/ Fig. 21B](#)) and are transported to the liver and rarely other organs (lung, brain, skin), where they may set up foci of infection. Liver abscesses may reach a size of several centimeters. They usually develop in the right side according to the laminar flow of the portal vein drainage from the colon. The amoebae colonize, lyse, and digest the liver cells, giving rise first to amoebic hepatitis (→[Pathology/ Fig. 4D](#)). Only when the focus of destroyed liver →[parenchyma](#) is too large for the lysed debris to be absorbed into the lymphatic and venous circulation will an →[abscess](#) result. The center of the abscess is formed by brownish, semiliquid fluid which is said to resemble “anchovy paste”. A liver abscess may extend through the diaphragm into pleura and lung with the abscess

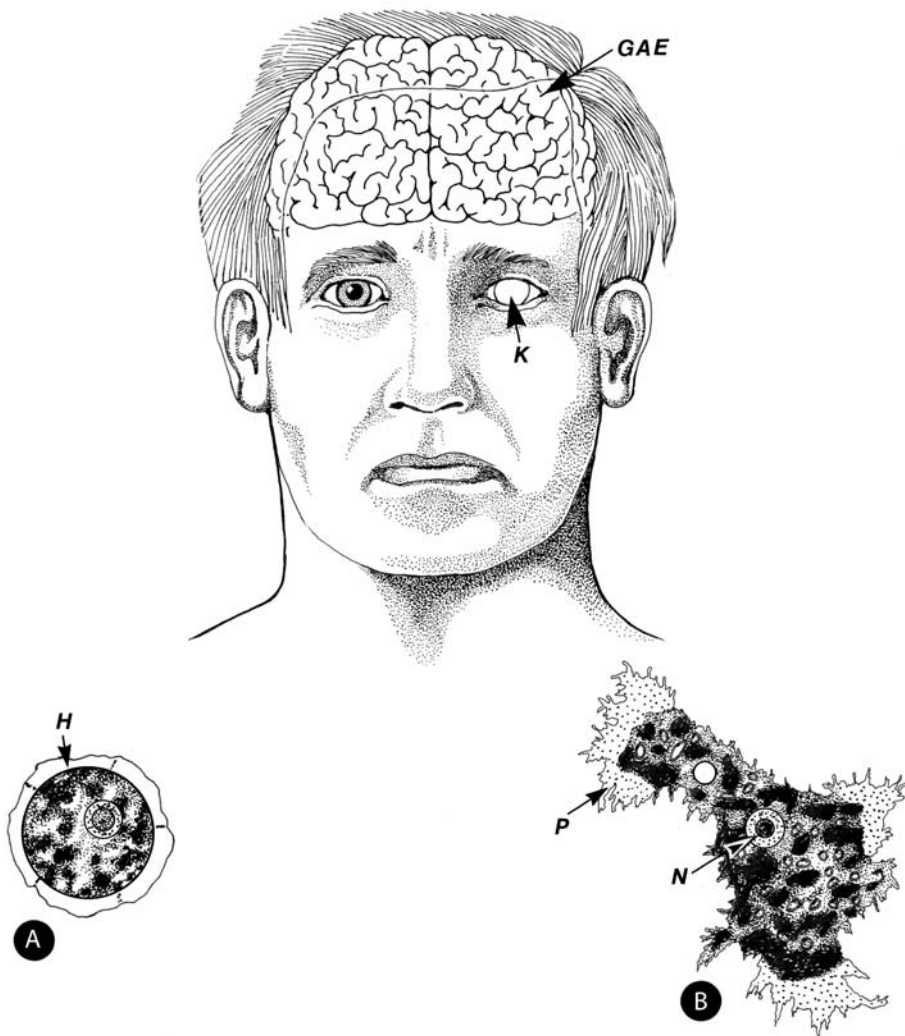

**Amoebae. Figure 2** Cyst (A), amoeboid stage (B) and symptoms of infection with *Acanthamoeba castellanii*. *GAE*, Granulomatous amoebic encephalitis; *H*, cyst wall; *K*, Keratitis in eye; *N*, Nucleus; *P*, pseudopodia.



**Amoebae. Figure 3** Free-living *Amoeba proteus*.

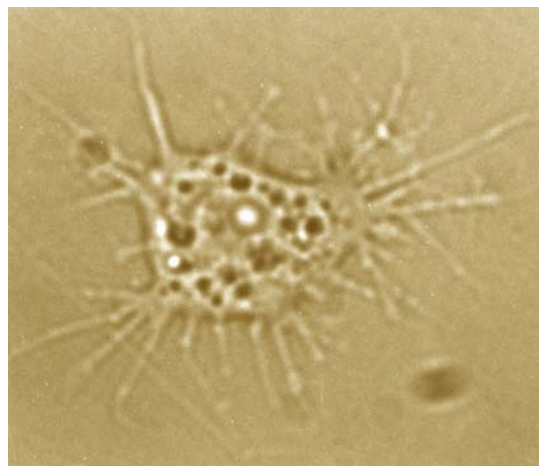

**Amoebae. Figure 4** Amoeboid stage of *Acanthamoeba castellanii*; note the filipod protrusions.

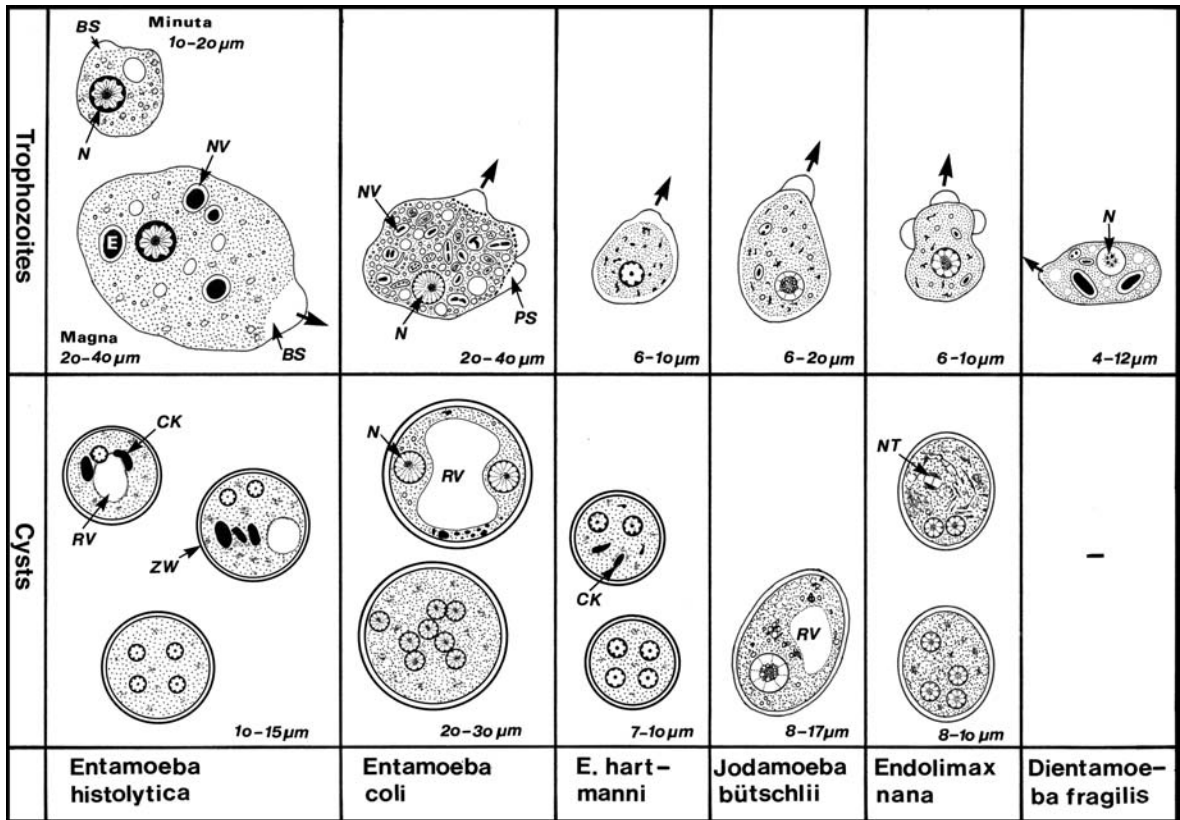

**Amoebae. Figure 5** Diagrammatic representation of the stages of infectious amoeba. BS, single pseudopodium; CK, chromatin body; N, nucleus; NT, nucleus in division; NV, residual vacuole; PS, pseudopodium; RV, reserve vacuole; ZW, cyst wall.

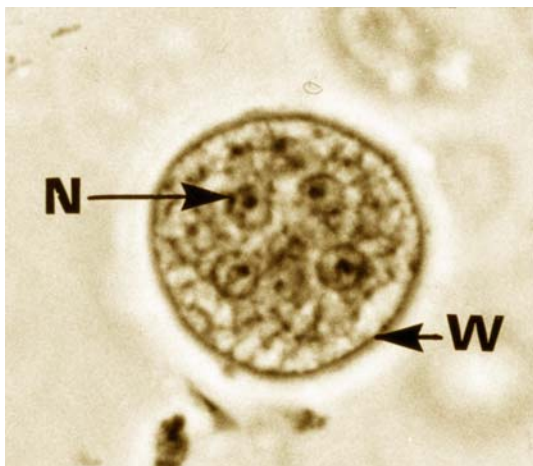

**Amoebae. Figure 6** Cyst of *Entamoeba histolytica*. N, nucleus; W, wall.

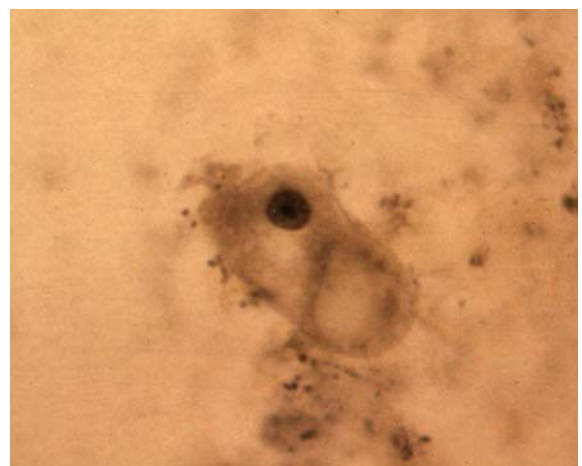

**Amoebae. Figure 7** Minuta-form of *Entamoeba histolytica*.

material being coughed up. Older abscesses are surrounded by fibrinous chronic →inflammatory-reaction products or by fibrosis. The amoebic trophozoites are found in the periphery of the abscess between the liver cells, best identified in PAS-stained sections

(→Pathology/Fig. 4D). The delicate nuclei of the trophozoites are shown with hematoxylin and eosin, but they stain less intensely than the nuclei of macrophages from which they need to be distinguished. Amoebic cysts are found only in the stools and not in the tissues. Invasive



**Amoebae. Figure 8** Magna-form of *Entamoeba histolytica*.

amoebiasis is enhanced by immunosuppression of whatever cause, e.g., by corticosteroid administration, as mentioned above, and in patients with AIDS. *Entamoeba histolytica* infections also occur in extraintestinal sites, penile infections following anal intercourse, infections of the cervix uteri, and the buccal mucosa.

### Immune Responses

Intestinal amoebiasis is characterized by fulminant diarrhea and intestinal hemorrhage. The associated disruption of the intestinal epithelium allows hematogenous dissemination of the parasite leading to →granuloma formation most commonly found in the liver. Survival of amoebic trophozoites may be favored by a transient immunosuppression associated with hepatic infections. The downregulation of the host's immune response involves macrophage effector and accessory cell functions as well as T cell functions (→Immune Responses).

### Innate Immunity

SCID mice infected with *E. histolytica* were used as a model of amoebic liver abscess formation and to study the functional role of neutrophils *in vivo*. Neutrophil-depleted animals developed significantly larger liver abscesses at early stages of infection, which lacked the prominent inflammatory cell ring observed in control SCID mice. These findings suggest a protective role of neutrophils in the early →host response to amoebic infection in the liver (→Innate Immunity). *E. histolytica* lipopeptidophosphoglycan initiates an innate immune response by interacting with TLR2 and TLR4 and that, through NF-κB activation, it can regulate an early proinflammatory response followed by an anti-inflammatory response.

### B Cells and Antibodies

A majority of *E. histolytica* isolates were found to be lysed by the alternative complement pathway *in vitro* in the absence of specific antibodies. A protective role of specific antibodies is suggested by experiments using passive immunization protocols of SCID mice. It could be shown that serum or purified antibodies from patients with amoebic liver abscesses were able to significantly reduce the mean abscess size in the experimental animals when applied 24 hours before intrahepatic infection with *E. histolytica*. In addition, specific antibodies against the serine-rich *E. histolytica* protein (SREHP) prevented amoebic liver abscesses in SCID mice. Furthermore, →vaccination with the immunodominant galactose/N-acetylgalactosamine-inhibitable lectin of *E. histolytica* induced protective immunity to amoebic liver abscesses at least in some animals, while in others of the same species exacerbation of disease was observed after vaccination. Lotter et al. recently showed that protective immunity is due to the development of an antibody response to a region of 25 amino acid residues of the lectin, while exacerbation of the disease is caused by antibodies against the NH<sub>2</sub>-terminal region of the lectin. These findings might be of clinical relevance, since individuals who are colonized with *E. histolytica* but resistant to invasive disease have a high prevalence of antibodies to the protective epitope.

### T Cells

There is good evidence suggesting that cell mediated immunity is centrally involved in the defense against *E. histolytica*. Human and mouse macrophages activated with IFN-γ are able to kill trophozoites in a contact-dependent manner. This killing involves both oxidative and nonoxidative mechanisms. With mouse macrophages it has been demonstrated that one of the principal effector molecules is →nitric oxide (NO). The responsible induction of iNOS is enhanced by →TNF produced in an autocrine fashion by stimulated macrophages. The requirement for macrophage activation suggests that a Th1-type immune response might be necessary for an efficient immune response against amoebae. In line with this, T cells from patients with treated amoebic liver abscesses secreted macrophage activating cytokines leading to amoebic killing. IL-2 and IFN-γ production of T cells can be induced by galactose/N-acetylgalactosamine-inhibitable lectin, an immunodominant molecule of *E. histolytica*. The analysis of cytokine production patterns in gerbils infected with *E. histolytica* showed that resistance to reinfection correlated with a Th1-like response.

### Evasion Mechanisms

Patients infected with *E. histolytica* generate specific IgGs that often do not prevent invasive or recurrent infection. One mechanism by which the



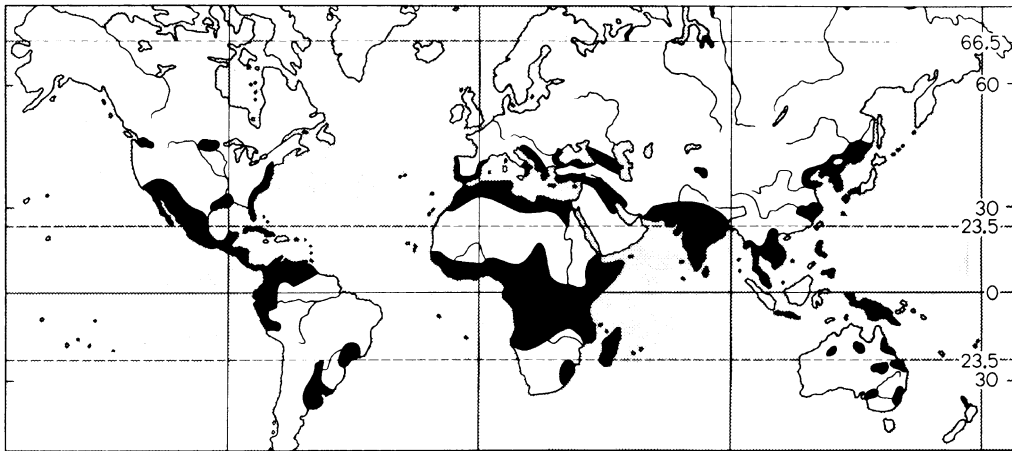

**Amoebiasis. Figure 1** Distribution map of amoebic dysentery.

parasite might avoid binding of the specific antibodies is the production of extracellular cysteine proteases. It has been shown that these proteases cleave IgGs near their hinge region resulting in fragments binding less efficiently to *E. histolytica* trophozoites (→**Evasion Mechanisms**).

The invasion and disease associated with *E. histolytica* has long been connected with suppression of host cellular immunity. Several studies have begun to clarify, at the cellular level, the dampening effects which *E. histolytica* exerts on immune cell and effector cell functions. Although, as discussed above, macrophages are potent cells for amoebicidal activity, the cytotoxic activity of abscess-derived macrophages is reduced during acute hepatic amoebiasis, while macrophages distal from the site of infection are in a heightened state of activity. Obviously, macrophage suppression is a local event, most likely mediated by direct exposure to the parasite or its products. It has been shown that soluble amoebic proteins (SAP) decreased the IFN- $\gamma$ -induced upregulation of MHC class II molecules on murine macrophages. This inhibitory effect, which is mediated at the transcriptional level, involves the production of prostaglandin E2 (PGE2). The fact that inhibition of PGE2 synthesis by indomethacin reversed SAP-mediated suppression of MHC class II expression by 60%, establishes that PGE2 induction is the main but not the only mechanism involved. Thus, PGE2 and related products, which may also be produced by *E. histolytica* trophozoites themselves, could indirectly inhibit T cell receptor recognition of parasite antigens. In addition, pretreatment of macrophages with SAP results in suppression of TNF and →**nitric oxide** synthesis. While addition of indomethacin restored TNF production, it had no effect on iNOS mRNA levels or NO production. Thus, *E. histolytica* appears to have the ability to inhibit different macrophage functions by separate pathways.

To date, T cell deficiencies in amoebiasis are less well characterized. However, the reduced delayed-type →**hypersensitivity** reaction during acute amoebiasis seen in patients as well as the reduced mitogenic response of purified T cells *in vitro* argue for a relative paucity of T cells mediating defensive responses against amoebae. A major phosphorylated, lipid-containing glycoconjugate surface molecule of *E. histolytica* may function similarly to →**lipophosphoglycan** (LPG) of →**Leishmania** by inhibiting PKC signal transduction. Other amoebic molecules with potential suppressive roles include a 220 kDa lectin, which induces the production of IL-4 and IL-10.

**Main clinical symptoms:** →**Abdominal pain**, bloody-slimy →**diarrhoea**, liver dysfunction in case of liver abscess (Fig. 2).

**Incubation period:** 2–21 days.

**Prepatent period:** 2–7 days.

**Patent period:** Years.



**Amoebiasis. Figure 2** Human liver with *Entamoeba*-abscesses (amoebomas).

**Diagnosis:** Microscopical determination of cysts in fecal samples, →[Serology](#).

**Prophylaxis:** Avoidance of uncooked food/water in endemic regions.

**Therapy:** Treatment see →[Antidiarrhoeal and Antitrichomoniasis Drugs](#).

## Amoebic Colitis

The process develops as follows:

1. Magna forms of →[Entamoeba histolytica](#) adhere to colonic mucus via Gal/GalNAc lectin (Galactose/N-acetyl-D-galactosamine).
2. Cysteine that is excreted by the amoebae degrades the colonic mucus.
3. The amoebae excrete the protein amoebapore initiating contact dependent apoptotic and necrotic killing of host cells.
4. Amoebic cysteine proteinases activate pre-interleucin 1-β inside the intestinal cells resulting in the occurrence of inflammatory cytokines, which contribute to tissue damage and thus production of hollows.
5. Amoebic invasion in the hollows and lateral spreading produces flask-shaped ulcers with rather low inflammation.

## Amoebic Infections

Several species of →[amoebae](#) (e.g., →[Entamoeba histolytica](#) causing →[Amoebiasis](#)) give rise to infections of the intestinal lumen (→[Protozoan Infections, Man/Table 1](#)). Most are commensal, feeding on bacteria, and producing neither lesions nor functional abnormalities. However, *Dientamoeba fragilis* does give rise to diarrhea often accompanied by →[eosinophilia](#) in both the stool and blood but without apparent tissue invasion. Its transmission in the absence of a cyst has been linked circumstantially to the nematode →[Enterobius vermicularis](#).

### Therapy

→[Antidiarrhoeal and Antitrichomoniasis Drugs](#).

## Amoebocides

→[Antidiarrhoeal and antitrichomoniasis drugs](#), agents against Amoebiasis.

## Amoeboflagellates

Group of protozoan parasites, that show a flagellum in some developmental stages, e.g., →[Histomonas meleagridis](#), →[Naegleria gruberi](#), →[Amoebae](#), →[Dientamoeba](#).

## Amoeboma

→[Abscess](#) caused by →[amoebae](#) (→[Entamoeba histolytica/Life Cycle](#)).

## Amoebotaenia

Genus of cyclophyllid →[tapeworms of birds](#).

## Amoebotaenia cuneata

Tapeworm (2–4 mm long) in chicken and other birds with earthworms as intermediate hosts; it belongs to the family Dilepididae.

## Amoebozoa

### Name

From Greek: *amoibos* = changing, *animan* = soon. New phylum of protozoans.

## Amphids

→[Adenophorea](#).

## Amphilina foliacea

### Classification

Species of →[cestodes](#).

**Life Cycle**

Fig. 1.

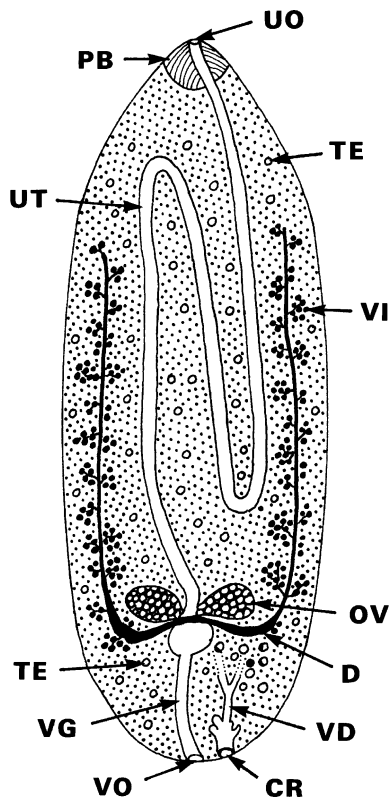
**AMPHILINOIDEA**

**Amphilina foliacea.** Figure 1 Diagrammatic representation of different groups of adult monozoic →tapeworms. *Amphilina foliacea* (about 2 cm long) from the body cavity of sturgeons (*Acipenser* sp.); eggs are swallowed by small crustaceans, where the →procercoid is formed. When the →intermediate host is ingested by the final hosts, the pleocercoid develops, reaching maturity in a few days (⇒neoteny). AH, adhesion zone; CR, →cirrus; D, duct of →vitelline glands; DB, →dense bodies in the vitelline system; GA, genital atrium (joint pore of UT and VE); OV, ovary; PB, →proboscis; SU, sucker; TE, testes; UO, opening of the uterus; UT, uterus; VD, vas deferens; VG, vagina; VI, vitelline glands; VO, opening of vagina; Z, interruption (animals are longer).

**Amphilinidea**

→Cestodaria.

**Amphistoma****Name**

Greek: *amphi* = at both sides, *stoma* = mouth (= 2 suckers).

**Amphistostomida**

Order of trematodes, with suckers at both poles, e.g., →*Paramphistomum cervi* of ruminants.

**Amphotericin**

→Leishmanicidal drugs, agents against Leishmaniasis.

**Amprolium**

Thiamin analogue drug, blocking the thiamin transport in chicken-coccidia (*Eimeria*), →Coccidiocidal Drugs.

**Amyloodinium**

Genus of flagellated protozoans, which after attachment to skin redraw the flagella and form root-like pseudopodia that penetrate deep into the skin and gills of salt water fish thus introducing openings for bacterial superinfections, which may lead to death (Fig. 1).



**Amyloodinium.** Figure 1 LM of a sessile *A. ocellatum* – stage from a coral fish.

## Amylopectin

→Reserve Granules, e.g. in →Coccidia, →Energy Metabolism.

## Anaemia

Clinical symptom due to infections with e.g., →Hookworms, →Babesia and Plasmodium species, →Gastrodiscus aegyptiacus (→trematodes in horses), →Fascioliasis, Man, →Fasciolosis, Animals, →Schistosomiasis, Man, →Schistosomiasis, Animals, →Diphyllobothriasis, →Ascaridia galli, blood sucking of →fleas, →mites (e.g., Dermanyssus).

## Anaerobic Glycolysis

→Energy Metabolism.

## Anaerobic Respiration

→Energy Metabolism.

## Anal Pruritus

Skin reaction in humans and horses due to infections with pinworms (→Enterobius vermicularis, →Oxyuris equi) (→Alimentary System Diseases, Horses).

## Analgidae

Family of skin and feather mites of birds.

## Anamnesis

Phenomenon (also called memory response) in animals that have the capacity to synthesize immunoglobulins (e.g., mammals).

## Anaphylactic Shock

Hypersensitivity-shock-reaction due to repeated setting free of masses of parasitic antigens inside a host (→Echinococcosis), fly larvae (→Myiasis, Animals, →Myiasis, Man).

## Anaphylaxis

Type 1 of immediate hypersensitivity (occurs within minutes after the introduction of an antigen into a previously sensitized host).

## Anaplasma marginale

Bacterium transmitted by Boophilus-, Rhipicephalus-, and Dermacentor-ticks introducing the anaplasmosis of cattle.

## Anaplasmosis

Disease in bovines or dogs due to tick-transmitted Anaplasma-stages (→Tick Bites: Effects in Animals).

## Anapolytic

Mode of detachment of proglottids. →Eucestoda.

## Anaticola

Genus of mallophaga (→Lice).

## Anatoecus

Genus of →mallophaga on feathers of birds.

## Anautogeny

Inability of female →mosquitoes (e.g., most →Culicidae) to produce eggs without preceding blood meal.

## Ancylostoma caninum

→Nematodes. Hookworm of dogs, may cause →larva migrans in human skin (Figs. 1–5).

## Ancylostoma duodenale

→Hookworms of humans.

## Ancylostoma Species

### Name

Greek: *ancylos* = hook, *stoma* = mouth.

Intestinal nematodes of man and animals, →Hookworms, →*Necator*, →*Uncinaria*, →*Bunostomum*, →*Globocephalus*.



*Ancylostoma caninum*. Figure 1 Mouth of *Ancylostoma caninum*.



*Ancylostoma caninum*. Figure 2 Mouth of *Ancylostoma duodenale* of humans.

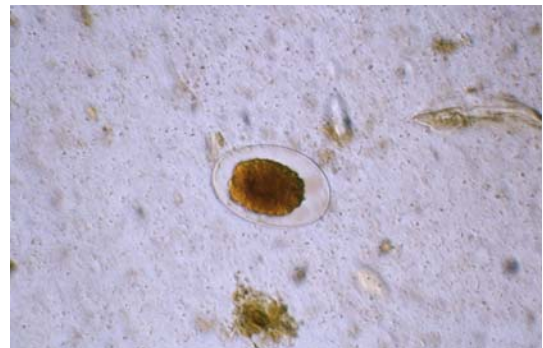

*Ancylostoma caninum*. Figure 3 Egg of *Ancylostoma* sp.



*Ancylostoma caninum*. Figure 4 Infectious larva 3 of *Ancylostoma duodenale*.



**Ancylostoma caninum.** Figure 5 Section of a dog's intestine filled with adult hookworms and masses of blood that passed through their guts.

## Ancylostomiasis

### Synonym

→ [Hookworm](#) infection (→ [Hookworm/Disease](#)). Soil-transmitted helminthic infection (→ [Nematocidal Drugs, Man/Table 1](#)).

## Ancyrin

Protein to connect proteins of the → [cytoskeleton](#) and → [cell membrane](#) in red blood cells.

## Ancyrocephalus paradoxus

Monogenean species parasitic on gills of perch.

## Anderson and May Model

→ [Mathematical Models of Vector-Borne Diseases](#).

## Androgyny

→ [Hermaphroditism](#). The stages look like females but the genital systems are male.

## Anemia

→ [Anaemia](#).

## Anepitheliocystidia

→ [Digenea](#).

## Anergic Diffuse Cutaneous Leishmaniasis (ADCL)

Syndrome of the New World, → [Leishmaniasis](#).

## Angiostrongylosis

**Abdominal Angiostrongylosis** is an accidental parasitosis of man by *Angiostrongylus costaricensis* – a species usually found in rats, acquired by eating third stage larvae from slugs or their mucus left on unwashed vegetables. Most of the cases have been found in the Americas, and only a few in Africa. The larvae enter the intestinal wall and migrate to the arteries of the ileocolic region where they become adult (→ [Pathology/Fig. 23B](#)). The eggs are deposited in the vessel; and are propelled into the intestinal mucosa where they give rise to an intense granulomatous inflammation with eosinophils and fibrosis. Most of the eggs degenerate; although larvae are occasionally seen in the tissues, they have not been found in the stool where they are shed by the natural host (→ [Pathology/Fig. 29A–D](#)). Many of the arterioles containing adults become thrombosed after the worms die. The lesions may simulate appendicitis or give rise to large inflammatory ileocolic masses which can cause intestinal obstruction and must be resected surgically. **Cerebral angiostrongylosis** is due to infection with → [Angiostrongylus cantonensis](#) (see Fig. 1). showing the following-signs:

**Main clinical symptoms:** →Eosinophilic meningoencephalitis, paralysis.

**Incubation period:** 2–3 weeks.

**Prepatent period:** Larvae are found within 2 days in the brain.

**Patent period:** Months until the larvae die.

**Diagnosis:** Serodiagnostic methods.

**Prophylaxis:** Avoid eating raw food (meat, snails, crabs).

**Therapy:** Treatment see →Nematocidal Drugs, Man.

## Classification

Species of →Nematodes.

## General Information

*A. cantonensis* is an accidental human parasite, normally found in rats (Fig. 1). The worm is acquired by eating undercooked snails or freshwater →crustacea, the intermediate hosts, or fresh vegetables contaminated with larvae in the slime of snails, slugs, or land planaria. The larvae migrate to the meninges and may be found in the spinal fluid. They wander through the brain and occasionally the eye, where they give rise to an acute →inflammatory reaction rich in eosinophils. The meninges may show the main lesions, or the cerebral cortex may be involved with worm tracks, hemorrhages, and large eosinophilic abscesses containing Charcot-Leyden crystals around dead worms.

## Angiostrongylus cantonensis

### Synonym

→*Parastrongylus cantonensis*.

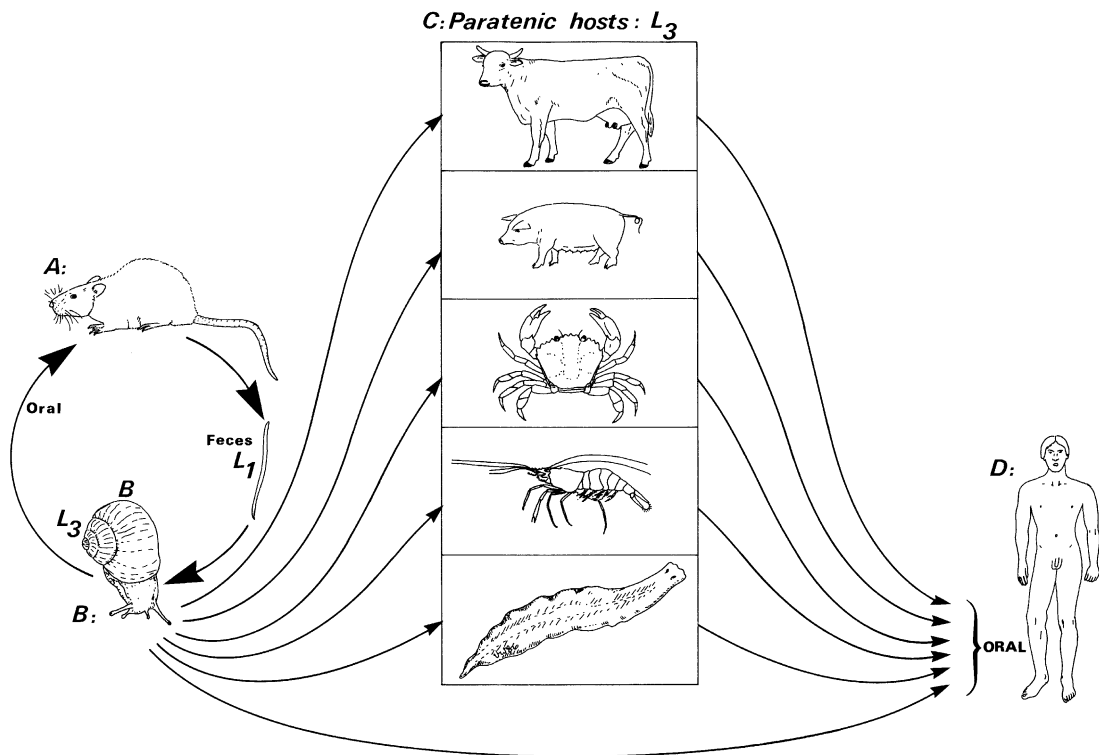

**Angiostrongylus cantonensis. Figure 1** Life cycle of *Parastrongylus* (= →*Angiostrongylus*) *cantonensis*. **A** Final hosts are rats, where the adult worms (male 19 mm, female 25 mm long) live mainly in the pulmonary arteries. There, the eggs are laid and carried to the pulmonary capillaries, where the first-stage larvae develop within 6 days; these break into the air spaces, migrate up the trachea, are swallowed, and finally passed with the feces. **B** A number of molluscs serve as intermediate hosts, within which the infectious third larval stage (L<sub>3</sub>) is formed after two molts. If a rat swallows such intermediate hosts containing infectious L<sub>3</sub> (after about 4 weeks), the larvae migrate to the rat's brain, which they leave 4 weeks after ingestion, having undergone another →molt. About 6 weeks after infection (prepatent period) maturation finally occurs in the pulmonary arteries. **C** A number of animals are involved in the life cycle as paratenic hosts bearing accumulations of infectious larvae. **D** Humans become infected when eating intermediate (B) or →paratenic host tissues (C) containing third-stage larvae. In man these larvae migrate to the capillaries of the meninges, there inducing an →eosinophilic meningoencephalitis. The larvae never become mature worms in man, but eventually die within eosinophilic granulomas.

When the worms are near adulthood, they migrate to the branches of the pulmonary artery. In rats, the natural host, eggs and larvae are produced with little inflammation, but in humans the cycle ends as the worms die in the pulmonary arteries.

### Life Cycle

Fig. 1.

## Angiostrongylus costaricensis

### Synonym

*Morerastrongylus costaricensis*.

### Geographic Distribution

South from Texas to Brazil.

### Classification

Species of nematodes.

### General Information

This roundworm has domestic rats (*Rattus rattus*) and cotton rats (*Sigmodon hispidus*) as final hosts, which become infected by feeding smooth snails (e.g., *Vaginulus plebeius*). In rats the worms (reaching as females a size of 28–42 mm × 0.35 mm) live in the mesenteric arteries in the caecal region. Their eggs and larvae are found in the wall of the intestine (without inflammatory reaction); the larvae leave the intestine within the faeces. The intermediate hosts (snails) feed these larvae, which develop into the infectious larvae 3.

Humans (especially children) become infected when in contact (eating, playing) with such snails. The mesenteric arteries are the places of development of the worms (until maturity). Inflammation reactions are common. →[Angiostrongylosis](#).

Similar reactions are produced by related worms, e.g., by *A. malaysiensis* in monkeys, by *A. mackerrase* (leading to eosinophilic meningitis) in rodents and humans in Australia or by *A. vasorum* (about 25 mm long, living in the arteria pulmonalis of dogs and foxes) in Europe (with a prevalence rate of 40% in foxes), Asia, Africa and South America. →[Aelurostrongylus abstrusus](#) is found in the bronchioles of cats.

### Treatment

→[Nematocidal Drugs](#).

## Angiostrongylus Species

### Name

Greek: *angeion* = bottle, *strongylos* = round, cylindrical.

→*A. cantonensis*, →*A. costaricensis*, with *A. mackerrase* in Australia, *A. malaysiense* in Asia or *A. vasorum* (foxes, dogs – worldwide).

## Angiostrongylus vasorum

The adults of these worms live in the pulmonary arteries of dogs, foxes, and other canids. The females excrete eggs which give rise to the larva 1, that leaves the final host by means of a penetration of the lung blood capillaries. Thus they reach the trachea, pass to the pharynx, and when arriving in the mouth, they are swallowed and leave the host via faeces.

If molluscs (e.g., snails) take up such faeces the larva 3 develops within 16 days. Frogs (e.g., *Rana temporaria*) may become paratenic hosts when feeding such infected intermediate hosts. As soon as the final hosts have taken up L<sub>3</sub>-containing hosts, the L<sub>3</sub> is set free in the intestine, enters the gut wall, and moults twice inside the abdominal lymph nodes. The preadult worms reach via liver the right ventricle and settle finally inside the pulmonary artery, where maturity is reached within 40–60 days. The **disease** is associated with coughing, dyspnoea, exercise intolerance, vomiting, abdominal pain, weight loss, neurological signs, heart failure, sudden death →[Nematocidal Drugs](#).

## Anguillicola crassus

Blood-sucking →[Nematode](#) in the swim bladder of, e.g., eels and other fish (Fig. 1, page 86).

## Anilocra

→[Crustacea](#).





**Anguillicola crassus.** Figure 1 Male and female of *A. crassus* in the swim bladder of an eel.

## Animal Reservoirs

Animals containing identical stages of parasites as found in humans, but symptoms of disease are mostly less strong, so that these animals are often the source for human infections.

## Anisakiasis

Anisakiasis comprises accidental human infection; with a variety of [→nematodes](#) normally infecting marine fish (salmon, herring), which was consumed raw, marinated, or undercooked ([→Anisakis](#)). The worms are often expelled or vomited. Occasionally they penetrate the gastric or intestinal wall where they give rise to an eosinophilic [→abscess](#), or in the omentum, or peritoneal lining associated with an adult nematode that may still be alive or dead ([→Pathology/Fig. 28D](#)). The specimens are often recovered surgically after an abrupt onset of severe abdominal discomfort. The structures of the worm may be well preserved in acute cases or may have degenerated after an illness of a few days.

**Main clinical symptoms:** [→Abdominal pain](#), intermittent [→diarrhoea](#), loss of weight.

**Incubation period:** 1 hour–1 week.

**Prepatent period:** Larvae are present from the moment of oral uptake.

**Patent period:** Weeks until the worms have been killed within granulomas.

**Diagnosis:** Gastroscopical methods.

**Prophylaxis:** Avoid eating raw fish (saltwater).

**Therapy:** Treatment see [→Nematocidal Drugs, Man](#).

## Anisakis

Genus of roundworms ([→Nematodes; Figs. 1–3](#), pages 87, 88).

### Disease

[→Anisakiasis](#).

## Anisogametes

[→Gametes](#) of different sexes that vary in size and shape occurring, e.g., in [→Apicomplexa](#) (e.g., [→Gregarines/Fig. 1](#)) while [→Coccidia](#) (e.g., [→Plasmodium](#), [→Eimeria](#)) have macro- and [→microgametes](#).

## Anisus

Genus of snails, intermediate hosts of [→Paramphistomum](#).

## Annelida

### Classification

Phylum of [→Metazoa](#).

### General Information

The annelids were named with respect to their outer annulated appearance, which apart from Hirudinea corresponds to an inner, more or less homonomous segmentation. Most of the annelids are free-living species; blood-sucking ectoparasites are mainly found among the members of the subclass Hirudinea ([→Leeches](#)).

### System

The classification of the Annelida is still in discussion, however, the following groups are widely accepted:

Phylum: Annelida.

Class: Polychaeta (mainly free-living).

Class: [→Myzostomida](#) (parasites of Crinoidea).

Class: Clitellata.

Subclass: Oligochaeta (mostly free-living).

Subclass: Hirudinea (some parasitic species).

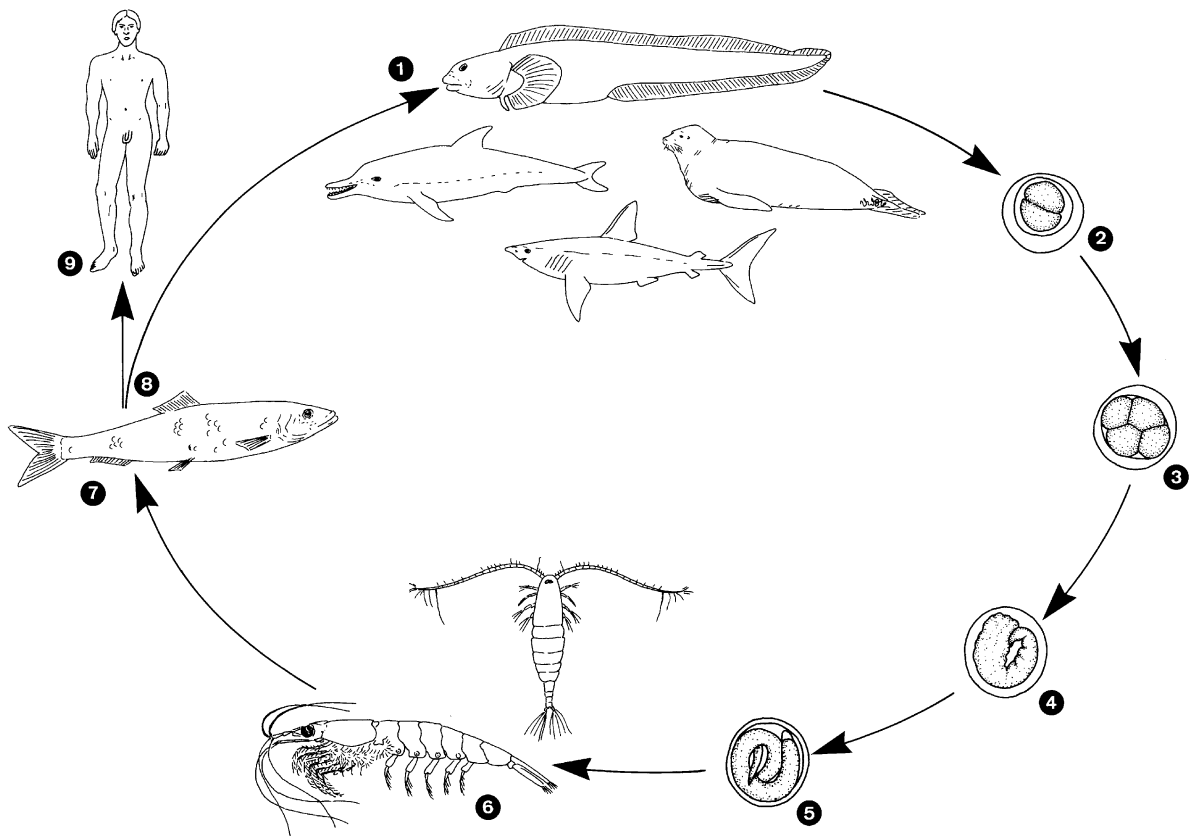

**Anisakis.** Figure 1 Life cycle of marine ascarids (e.g., →*Contracaecum* spp., *Phocanema* sp. = *Terranova*, →*Pseudoterranova* sp., *Anisakis* sp.). 1 Adult worms live in the intestine of fishes or sea mammals, respectively (final hosts). 2 Eggs are unembryonated when fecally excreted. 3–5 Formation of L<sub>1</sub> and L<sub>2</sub> apparently occurs inside the eggs floating in the water. 6 Apparently a wide range of small marine crustaceans may act as intermediate hosts when ingesting infectious eggs. Inside the →intermediate host the L<sub>3</sub> is formed (in some species free L<sub>3</sub> have also been suggested). 7 When these L<sub>3</sub>-bearing crustaceans are swallowed by a wide range of fish, the third-stage larvae are spirally encapsulated and thus accumulated inside various organs, including muscles, without further development. Some authors believe that development to L<sub>4</sub> occurs. When there is no further →molt, these fish must be considered as transport- or paratenic hosts. In addition, accumulation of L<sub>3</sub> often occurs in carnivorous fish species. 8 Infection of final hosts occurs by oral uptake of infected fish. Inside the stomach and intestine, ulcerations (by embedded groups of larvae and preadults) and even perforation of the intestinal wall have been described. 9 Humans who can be accidentally infected by eating raw or insufficiently cooked meat of infected fish (e.g., green herring) may become some sort of →paratenic host and suffer from an acute →anisakiasis as a result of the penetration of larvae into the walls of the stomach and/or intestine; this can lead to death. Over the last 50 years, the specific name of “codworm” or “sealworm” has changed several times. Once it was called *Ascaris decipiens* (*decipiens* means deceiving); it later became →*Porrocaecum decipiens*, then *Terranova decipiens*. Myers created a new genus for this worm, proposing the name *Phocanema decipiens*, but reexamination of the concept and validity of anisakid in general led to the conclusion that *Phocanema* was a synonym of *Pseudoterranova* Mosgovoi, 1951. This criterion has been gradually accepted and *Pseudoterranova decipiens* is found in current literature. *Terranova* sp. larva Type A, as referred to in Japanese literature, is definitely the third-stage larva of this *P. decipiens*, which is commonly called →codworm. Similarly, various names have been applied to the human disease caused by codworm. Margolis suggested restriction of ‘anisakiasis’ to denote infection with anisakid larvae of the genus *Anisakis*, using “nonspecific anisakiasis” when the larva has not been identified to genus or as a collective term for infection with anisakid larva, and “phocanemal (or terranoval) anisakiasis” for infections with larvae of genus *Phocanema*. But the genus *Terranova* is now restricted to the parasites of elasmobranchs, teleosts, and aquatic reptiles, and the genus *Phocanema* has been abandoned. However, “pseudoterranoval anisakiasis” would be an impractical name for clinicians, so the term “codworm anisakiasis” is preferred.

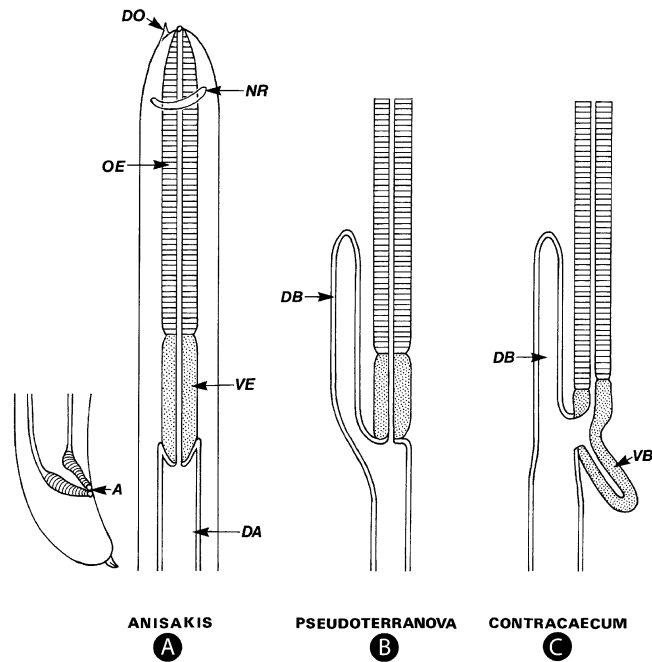

**Anisakis. Figure 2** Schematic representation of diagnostically useful intestinal features of human pathogenic marine anisakids (A–C). *A*, anus; *DA*, intestine; *DB*, intestinal enlargement; *DO*, thorn; *NR*, nerve ring; *OE*, esophagus; *VB*, enlargement of →ventriculus; *VE*, ventriculus.



**Anisakis. Figure 3** Ice fish (*Macrourus* sp.) from the Antarctic sea, the liver of which is filled with anisakid larvae.

## Anocentor

Genus of hard →ticks. *Anocentor* (syn. *Dermacentor*) *nitens* (the tropical horse tick) is found in Latin America. It is a one-host tick, e.g., all stages stay on its first host.

## Anopheles

→Diptera, →Filiariidae, →Mosquitoes.

## Anoplocephala magna, A. perfoliata

Tapeworm of horses, →Eucestoda, →Alimentary System Diseases, Horses.

## Annual Transmission Potential (ATP)

A factor that determines the burden of infection in a human community (e.g., in →onchocerciasis it is determined by the number of infectious larvae transmitted per year by the biting black fly vector (→*Simulium* species).

## Anoplocephaloides mamillana

Syn. *Paranoplocephala mamillana/is*, a 1–4 cm × 4–6 mm tapeworm of horses, which has its seat in the anterior small intestine (occasionally in the stomach).

## Anoplura

From Greek: *anoplos* = unarmed, *ura* = tail. Blood-sucking →lice.

## Anopluridosis

Disease due to infestation with →lice; see Table 1 (page 90).

## Anorexia

Clinical symptom (=reduction in voluntary food intake) in animals due to parasitic infections (→Alimentary System Diseases, →Clinical Pathology, Animals).

## Antarctophthirus ogmorhini

Louse from the Weddell-seal *Leptonychotes weddelli* reaching a size of about 4 mm in length (Fig. 1, page 91). The eggs, which have a single opening (spiraculum) in the cover (operculum) of the egg (Fig. 2, page 91).

## Anthelmintic Drugs

→Nematocidal Drugs, →Trematocidal Drugs, →Cestodocidal Drugs.

## Anthelmintic, Anthelminthic

Describes a reaction or compound that acts against worms (Greek: *anti* = against, *helminthes* = worms).

## Anthroponoses

Diseases affecting only humans. The major representatives of parasitic anthroponoses are listed in Table 1 (page 92).

## Therapy

→Chemotherapy, →Drugs.

## Anthroponosis

Disease, the agents of which are transmitted by man or vectors exclusively from man to man (e.g., →malaria, →louseborne spotted fever) see below (Table 1, page 92).

## Anthropophagic

→Mosquitoes that feed predominantly on humans (e.g., several →*Anopheles* species) are referred to as anthropophagic. However, hungry females also choose other hosts in case of absence of their favourites.

## Anthropozoonoses

### Synonym

→Zooanthroponoses (see also Table 1, pages 92–94).

### General Information

Diseases affecting both man and other animals. The major representatives of parasitic →zoonoses are listed in Table 1 (see pages 92–94).

### Therapy

→Chemotherapy, →Drugs.

## Anti Parasitic Sexual Mate Choice

→Behavior.

## Anti Parasitic Social Mate Choice

→Behavior.

**Anopluridosis. Table 1** Sucking animal lice and control measurements (according to Hansen and Londershausen)

Parasite	Host	Vector for	Symptoms	Country	Therapy		
					Products	Application	Compounds
<i>Linognathus setosus</i>	Dog	–	Blood loss, itching, secondary infections, urticaria	Worldwide	Advantage™ (Bayer)	Spot-on	Imidacloprid
					Bolfo™ Flohschutz-Puder (Bayer)	Dermal powder	Propoxur
					Mycodex™ Pet Shampoo, Carbaryl (Pfizer)	Shampoo	Carbaryl
<i>Haematopinus eurysternus</i>	Cattle	–	Blood loss, irritation	Worldwide	Rabon™ 3% Dust (Agri Labs)	Self-treating Dust Bags	Tetrachlorvinphos
					Warbex Famphur Pour-on For Cattle™ (Mallinckrodt)	Pour-on	Famphur
					Tiguvon™ Cattle Insecticide Pour on (Bayer Corp.)	Pour-on	Fenthion
					Ivomec™ 1% Injection For Cattle (Merial)	Injection	Ivermectin
					Dectomax™ (Pfizer Animal Health)	Injection	Doramectin
					Asuntol™ -Puder 1% (Bayer)	Dermal powder	Coumaphos
					Cydectin™ (Bayer)	Injection	Moxidectin
<i>Linognathus vituli</i>	Cattle	–	Blood loss, irritation	Worldwide	Rabon™ 3% Dust (Agri Labs)	Self-treating Dust Bags	Tetrachlorvinphos
					Warbex Famphur Pour-on For Cattle™ (Mallinckrodt)	Pour-on	Famphur
					Tiguvon™ Cattle Insecticide Pour on (Bayer Corp.)	Pour-on	Fenthion
					Ivomec™ 1% Injection For Cattle (Merial)	Injection	Ivermectin
					Dectomax™ (Pfizer Animal Health)	Injection	Doramectin
					Asuntol™ -Puder 1% (Bayer)	Dermal powder	Coumaphos
					Cydectin™ (Bayer)	Injection	Moxidectin
<i>Solenopotes capillatus</i>	Cattle	–	Smallest cattle-sucking lice, blood loss, irritation	Worldwide	Rabon™ 3% Dust (Agri Labs)	Self-treating Dust Bags	Tetrachlorvinphos
					Warbex Famphur Pour-on For Cattle™ (Mallinckrodt)	Pour-on	Famphur
					Tiguvon™ Cattle Insecticide Pour on (Bayer Corp.)	Pour-on	Fenthion
					Ivomec™ 1% Injection For Cattle (Merial)	Injection	Ivermectin

**Anopluridosis. Table 1** Sucking animal lice and control measurements (according to Hansen and Londershausen) (Continued)

Parasite	Host	Vector for	Symptoms	Country	Therapy		
					Products	Application	Compounds
					Dectomax™ (Pfizer)	Injection	Doramectin
					Cydectin™ (Bayer)	Injection	Moxidectin
<i>Linognathus ovillus</i>	Sheep	–	Blood loss, irritation	Scotland			
<i>Linognathus oviformis</i>	Sheep, Goat	–		Outside Europe wide spread			
<i>Linognathus pedalis</i>	Sheep, Goat	–		Worldwide, but outside Europe			
<i>Linognathus stenopsis</i>	Goat	–		Worldwide			
<i>Haematopinus asini macrocephalus</i>	Horse	–	Strong concern, itching	Worldwide			
<i>Haemotopinus suis</i>	Pig	Classical swine fever (hog cholera), Swine pox virus	Blood loss, host-specific, all ages, severe itching, irritation, concern, loss of appetite	Worldwide	Rabon™ 3% Dust (Agri Labs) Neguvon™ (Bayer): No treatment during migration Ivomec™ 0.27% Sterile Solution (Merial) Point-Guard™ Miticide/Insecticide Asunto™-Puder 1% (Bayer)	Self-treating Dust Bags Wash or Spray Injection Pour-on Dermal powder	Tetrachlorvinphos Trichlorfon/ Metrifonate Ivermectin Amitraz Coumaphos



**Antarctophthirus ogmorhini. Figure 1** Adult louse *Antarctophthirus ogmorhini* attached to a hair of the seal by the two posterior larger claws.

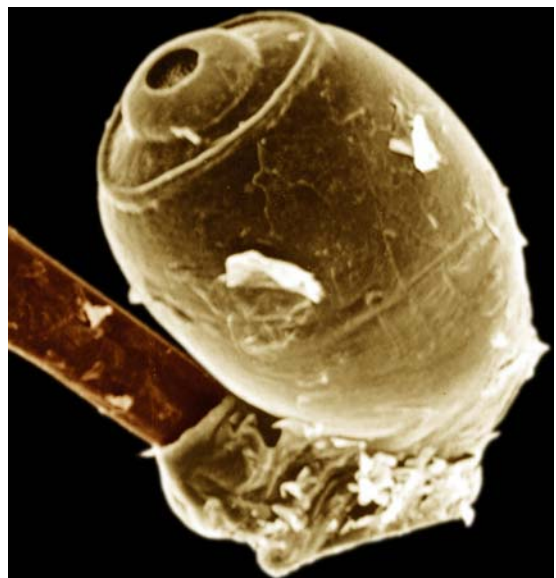

**Antarctophthirus ogmorhini. Figure 2** SEM of an egg of *A. ogmorhini* being clued at a host's hair.

**Anthroponoses. Table 1** Important parasitoses which are usually restricted to humans as vertebrate hosts

Parasite species	Infective stage	Mode of infection	Other obligatory hosts	Disease
<b>Protozoa</b>				
<i>Trypanosoma gambiense</i>	Metacyclic trypanosome	Bite of <i>Glossina</i> spp.	<i>Glossina</i> spp.	Sleeping sickness (Gambian)
<i>Trichomonas vaginalis</i>	Trophozoite	Mainly sexual intercourse	None	Human trichomoniasis
<i>Hartmanella</i> spp. <i>Acanthamoeba</i> spp. <i>Naegleria</i> spp.	Vegetative forms (cysts?)	Entry through nasal mucosa	None	Amoebic meningoencephalitis
<i>Plasmodium falciparum</i>	Sporozoite	Bite of <i>Anopheles</i> spp.	<i>Anopheles</i> spp.	Falciparum malaria
<i>Plasmodium ovale</i>	Sporozoite	Bite of <i>Anopheles</i> spp.	<i>Anopheles</i> spp.	Ovale malaria
<i>Plasmodium vivax</i>	Sporozoite	Bite of <i>Anopheles</i> spp.	<i>Anopheles</i> spp.	Vivax malaria
<b>Trematodes</b>				
<i>Schistosoma haematobium</i>	Cercaria	Transdermal invasion	<i>Bulinus</i> spp.	Urinary schistosomiasis (bilharzia)
<i>Schistosoma intercalatum</i>	Cercaria	Transdermal invasion	<i>Bulinus</i> spp.	Schistosomiasis intercalatum
<i>Schistosoma mansoni</i>	Cercaria	Transdermal invasion	<i>Biomphalaria</i> spp.	Mansonian schistosomiasis
<b>Nematodes</b>				
<i>Ascaris lumbricoides</i>	Eggs containing 2nd-stage larva	Ingestion	None	Human ascariasis
<i>Enterobius vermicularis</i>	Eggs, larvae entering anus	Ingestion	None	Human pinworm infection
<i>Trichuris trichiura</i>	Embryonated egg	Ingestion	None	Human trichuriasis
<i>Ancylostoma duodenale</i> <i>Necator americanus</i>	Strongyloform larva	Transdermal invasion	None	Human ancylostomiasis
<i>Wuchereria bancrofti</i>	Filiariform 3rd-stage larva	Mosquito bite	Mosquitos ( <i>Culex</i> , <i>Aedes</i> , <i>Anopheles</i> , <i>Mansonia</i> spp.)	Lymphatic (bancroftian) filariasis
<i>Onchocerca volvulus</i>	Filiariform 3rd-stage larva	Blackfly bite	<i>Simulium</i> spp.	Onchocerciasis

**Anthroozoonoses. Table 1** Important zoonotic and anthroozoonotic parasitoses (according to Wernsdorfer)

Parasite species	Principal hosts (besides humans)	Infective stage	Mode of infection	Other obligatory hosts	Disease
<b>Protozoa</b>					
<i>Leishmania donovani</i>	Various domestic animals	Promastigote	Sand fly bite	<i>Phlebotomus</i> spp.	Visceral leishmaniasis (Kala-azar)
<i>Leishmania tropica</i>	Dogs	Promastigote	Sand fly bite	<i>Phlebotomus</i> spp.	Oriental sore
<i>Leishmania brasiliensis</i>	Dogs	Promastigote	Sand fly bite	<i>Phlebotomus</i> spp.	Mucocutaneous leishmaniasis (Espundia)

**Anthrozooses. Table 1** Important zoonotic and anthrozootic parasitoses (according to Wernsdorfer) (Continued)

Parasite species	Principal hosts (besides humans)	Infective stage	Mode of infection	Other obligatory hosts	Disease
<i>Trypanosoma rhodesiense</i>	Wild and domestic mammals	Metacyclic trypanosome	<i>Glossina</i> bite	<i>Glossina</i> spp.	Sleeping sickness (Rhodesian)
<i>Trypanosoma cruzi</i>	Wild and domestic mammals	Metacyclic trypanosome	Invasion through bite wound from reduviid feces	Reduviid bugs ( <i>Triatoma</i> , <i>Panstrongylus</i> , <i>Rhodnius</i> spp.)	Chagas disease
<i>Giardia duodenalis</i>	Wild and domestic mammals	Cyst	Ingestion	None	Lambliasis (Giardiasis)
<i>Balantidium coli</i>	Pigs	Cyst	Ingestion	None	Balantidiosis (dysentery)
<i>Entamoeba histolytica</i>	Various mammals	Cyst	Ingestion	None	Amoebiasis (dysentery and amoebic abscesses)
<i>Toxoplasma gondii</i>	Domestic mammals	Oocyst, bradyzoite	Ingestion and transplacental	None	Toxoplasmosis
<i>Babesia bigemina</i>	Cattle	Sporozoite	Tick bite	Ticks (especially <i>Boophilus</i> spp.)	Texas cattle fever, babesiosis
<i>Babesia canis</i>	Dogs	Sporozoite	Tick bite	Ticks (various spp.)	Canine babesiosis
<i>Plasmodium malariae</i>	<i>Pan troglodytes</i>	Sporozoite	Bite of <i>Anopheles</i> spp.	<i>Anopheles</i> spp.	Quartan malaria
<b>Trematodes</b>					
<i>Fasciola hepatica</i>	Sheep, cattle	Metacercaria	Ingestion	Aquatic snails ( <i>Lymnaea</i> , <i>Succinea</i> , <i>Fossaria</i> , <i>Praticolella</i> spp.)	Fascioliasis (liver rot of sheep and cattle)
<i>Fasciolopsis buski</i>	Pigs	Metacercaria	Ingestion	Aquatic snails ( <i>Planorbis</i> and <i>Segmentina</i> spp.)	Fasciolopsiasis
<i>Dicrocoelium dendriticum</i>	Various domestic mammals	Xiphidiocercaria	Ingestion with ants	Land snails (mainly <i>Cionella</i> spp.) followed by ants (mainly <i>Formica fusca</i> )	Dicrocoeliasis
<i>Opisthorchis felinus</i>	Felines	Cercaria	Ingestion	Aquatic snails ( <i>Bithynia</i> spp.) followed by cyprinid fish	Opisthorchiasis
<i>Clonorchis sinensis</i>	Canines, felines	Cercaria	Ingestion	Various aquatic snail species, followed by cyprinid fish	Clonorchiasis
<i>Paragonimus westermanni</i>	Cats	Metacercaria	Ingestion	Molluscs ( <i>Semisulcospira</i> , <i>Tarebia</i> , <i>Brotia</i> spp.), followed by crustaceans (mainly freshwater crabs)	Paragonimiasis
<i>Paragonimus kelliotti</i>	Canines, felines and other mammals	Metacercaria	Ingestion	Aquatic snails followed by crayfish	Paragonimiasis
<i>Schistosoma japonicum</i>	Wild and domestic mammals	Cercaria	Transdermal invasion	<i>Oncomelania</i> spp.	Japanese schistosomiasis



**Anthropozoonoses. Table 1** Important zoonanthropotic and anthropozoonotic parasitoses (according to Wernsdorfer) (Continued)

Parasite species	Principal hosts (besides humans)	Infective stage	Mode of infection	Other obligatory hosts	Disease
<b>Cestodes</b>					
<i>Diphyllobothrium</i> spp.	Canines, felines and other fish eaters	Proceroid	Ingestion	Copepods (e.g., <i>Diaptomus</i> spp.), followed by fish	Fish tapeworm infection
<i>Taenia solium</i>	Pigs (adult worm), cysticercus also in other animals	Egg and cysticercus	Ingestion	No obligatory host species alternation	Cysticercosis cellulosae and pig tapeworm infection
<i>Taenia saginata</i>	Cattle (cysticercus), humans (adult worm)	Cysticercus	Ingestion	Humans (adult worm), cattle (cysticercus)	Taeniasis saginata (cattle tapeworm infection)
<i>Echinococcus granulosus</i>	Canines (adult worm), various mammals (hydatid cysts)	Egg and hydatid larva	Ingestion	Canines (adult worm), various mammals (hydatid cysts)	Hydatid disease
<i>E. multilocularis</i>	Fox, dogs, mice	Egg for man, alveolar cyst for fox	Ingestion	Mice, many animals	Alveolar disease
<i>Hymenolepis nana</i>	Rodents	Egg	Ingestion	None	Hymenolepiasis nana
<i>Hymenolepis diminuta</i>	Rodents	Cysticercoid larva	Ingestion with infected roach	Roaches ( <i>Tembrio</i> , <i>Pyralis</i> , <i>Anisobolis</i> spp., etc.)	Hymenolepiasis diminuta
<b>Nematodes</b>					
<i>Angiostrongylus cantonensis</i>	Rats	3rd-stage ensheathed larva	Ingestion with infected slug or snail	Slugs and aquatic snails	Human angiostrongyliasis (eosinophil meningoencephalitis)
<i>Ascaris lumbricoides</i>	Various vertebrates	Egg with 2nd-stage larva	Ingestion	None	Ascariasis
<i>Toxocara canis</i> <i>Toxocara cati</i>	Canines Felines	Embryonated egg or 2nd-stage larva	Ingestion	None	Human visceral larva migrans
<i>Anisakis</i> spp.	Marine mammals and birds	3rd-stage larva	Ingestion of fishmeat	Insufficiently known, mostly fish	Human anisakis infection (due to 3rd-stage larvae)
<i>Trichinella spiralis</i>	Various mammals	Infective larva	Ingestion	None	Trichinellosis
<i>Gnathostoma spinigerum</i>	Canines and felines	3rd-stage larva	Ingestion	<i>Cyclops</i> spp., followed by fish, frogs or snakes	Gnathostomiasis
<i>Capillaria hepatica</i>	Various mammals	Embryonated egg, after passage through "transport" host	Ingestion	Only "transport" host	Capillariosis, human visceral larva migrans
<i>Strongyloides stercoralis</i>	Various mammals	Filariform larva	Transdermal penetration	None	Strongyloidosis of humans and sheep
<i>Dracunculus medinensis</i>	Canines, felines, equines, monkeys	3rd-stage larva	Ingestion (with <i>Cyclops</i> )	<i>Cyclops</i> spp.	Guinea worm disease
<i>Brugia malayi</i>	Felines and non-human primates	Filariform 3rd-stage larva	Mosquito bite	Mosquitos (usually <i>Anopheles</i> and <i>Mansonia</i> spp.)	Lymphatic (Brugian) filariasis
<i>Loa loa</i>	Baboons	3rd-stage larva	Tabanid bite	Tabanids ( <i>Chrysops</i> spp.)	Loiasis

## Antibiotica

General term to describe drugs acting in various ways on bacteria (e.g., they may have bacteriostatic (tetracyclines) or bacteriocidal (e.g., penicillines) activities. See →[Lyme Disease](#), →[Streptothricosis](#), →[Borreliosis](#), →[Rickettsiae](#).

## Antibody

### Synonym

Immunoglobulin (Ig).

### General Information

The function of antibodies is to remove antigen from the system and to support an effective immune response. Circulating antibodies which are detected in serodiagnostic systems are secreted by antibody-forming cells (plasma cells) after contact between B cells and antigen. They circulate freely throughout the blood and lymph. Antibodies are bifunctional molecules with antigen-binding sites (Fab fragment) and a region which is involved in other aspects of the immune regulation (Fc fragment). In most higher mammals and man, four of the five immunoglobulin classes of molecules are involved in the humoral immune response to parasites: IgG, IgM, IgA, and IgE.

### Classes

Each immunoglobulin class differs in the heavy-chain polypeptides which determine its function at particular stages of the maturation of the immune response. IgM class antibodies are predominately antibodies of the early immune response and are distributed to a high degree intravascularly. A specific IgM class antibody response is indicative for an acute infection mainly with protozoan parasites. IgM serodiagnostic tests are used to discriminate between acute/recent and latent infections with *Toxoplasma*, *Trypanosoma cruzi*, and →[Babesia](#). In contrast, during the early phase of West →[African trypanosomiasis](#) specific IgM antibodies may be undetectable in spite of a rising total serum IgM concentration. In helminthic infections diagnostic IgM class antibodies do not necessarily precede an IgG response. This may be due either to a “diagnostic window” as seen 4–6 weeks after *Trichinella*-infection or, e.g., to the late onset and long-term persistence of gut-associated IgM antibodies after →[Schistosoma](#)-infection. The human IgG, which can be subdivided into the four

subclasses IgG1–IgG4, is the major antibody of the primary and secondary immune response and the major serum immunoglobulin. In chronic →[helminth](#) infections elevated IgG and IgE specific responses develop. The prominent IgG subclasses recognizing parasite-specific antigens are IgG4 > IgG1 > IgG3, rarely IgG2. A high IgG4 response may indicate a successful parasite infection. The detection of parasite-specific IgG4 is essential for a species specific diagnosis of →[Onchocerca volvulus](#), →[Wuchereria bancrofti](#), →[Strongyloides](#), →[Ascaris](#), and →[Echinococcus](#). IgG molecules of all subclasses can cross the placenta. Only the detection of specific IgM and/or IgA in the serum of the fetus or newborn is of relevance for the serological diagnosis of congenital infection with *Toxoplasma*, *Trypanosoma cruzi*, or →[Leishmania](#). IgM and IgG1-3 antibody classes are able to activate the complement cascade, but not IgG4, IgA, and IgE. IgA is the predominant immunoglobulin in seromucous secretion, IgA1 being the predominant subclass in the serum. IgA antibodies are of additional value as markers for an acute infection as documented for toxoplasmosis. An elevation of total serum IgE, but not necessarily specific IgE class antibodies, is often related to infections with helminth parasites and may indicate an active disease. In contrast, protozoan parasites do not induce a significant IgE class antibody response. Specific IgE is not a reliable diagnostic marker for acute *Toxoplasma*-infection due to many non- or low-responders within the population.

### Molecular Weights

IgM app. 970 000 daltons; IgG app. 146 000 daltons, IgA app. 160 000 daltons, IgE app. 188 000 daltons, IgD app. 184 000 daltons.

### Binding Sites and Affinity

Antibodies are highly specialized in recognizing small regions of antigens but occasionally recognize similar epitopes on other related or unrelated molecules (cross-reaction). The binding between the antibody and the epitope of the antigen is non-covalent. The strength of bond between an antibody-combining site with an antigen is characterized as antibody affinity, the strength with which a multivalent antibody binds a multivalent antigen as antibody avidity. The antibody affinity/avidity to many antigens increases during an immune response and determines the biological effectiveness of the antibody. High-affinity antibodies are superior to low-affinity antibodies in respect to many biological reactions (e.g., haemagglutination, complement fixation) and in achieving antigen-binding more effectively even at low antigen concentration. Today, this immunological mechanism is utilized for the differential diagnosis of a recent and latent *Toxoplasma*-infection in man.

### Half Lives

The half-life of antibodies differs according to the antibody classes. It is high for IgG (21 days), medium for IgM (10 days) and low for IgA, and IgE (6–2 days). The complexed antibody is catabolized before clearance.

### Biological Activity

In general, a primary antibody response can be divided into four phases: a first period when no antibodies are detectable, followed by an immune response of primarily IgM antibodies with a progressive change to IgG antibodies and an increasing antibody titer. The plateau phase with stable antibody titers is followed by an antibody decline. During →chronic infections, when the parasite is established at its permanent habitat, antibody production is mainly stimulated by circulating (excretory-secretory) antigens. The antibody secretion by B cells continues as long as the antigen(s) persists. Persisting antigen may increase the strength of the immune response. The primary antibody response is not only influenced by the nature of the antigen, its dose and infection route but also by the genetic background of a host. The time of antibody maturation and the final antibody concentration can vary considerably in individuals. Especially low responders or people with a recently contracted infection or patients from low endemic areas may not be detected in all serological test systems. Seroepidemiological studies in *L. infantum*-infected dogs indicate that a high sensitivity of the IFAT is reached only after an →incubation period of 8–9 months when first clinical symptoms occur. A complete antibody clearance is only possible after a complete elimination of the parasite (blood parasites after therapy) or its antigenic epitopes. Also, antigenic epitopes may be hidden by “walling off” in the host tissue (*Echinococcus*, →*Cysticercus*). However, after elimination of the antigen specific lymphocytes remain in circulation and may respond to a subsequent challenge (immunological memory). A challenge by antigens released after surgical or therapeutical measures (*Echinococcus*, *Cysticercus*) or reinfection induces a →secondary antibody production with a steep increase of mainly IgG class antibodies.

### Clinical Relevance

Generally, the presence of circulating antibodies indicates the recognition of a foreign antigen. In parasitic infections →antibody detection does not correlate with disease, protective immunity or the parasite load. The serum antibodies are the most important defence mechanism of the host against extracellular parasitic forms in

blood and body fluids like →*Trypanosoma*, *Toxoplasma*, →*Plasmodium*, or *Babesia* during acute infection. Symptomatic individuals normally present high antibody levels whereas asymptomatic carriers show a low antibody concentration. Antibodies in individuals without clinical symptoms may indicate an abortive infection as described for *E. multilocularis* or an infection with a long latency/incubation period. A correlation between cyst burden and antibody detection is known for porcine and human →cysticercosis (→*Taenia solium*). →Cysticercosis or →echinococcosis in asymptomatic or symptomatic patients is not excluded by negative test results. An assessment of the parasite load is not possible by conventional serological test systems. Recent developments indicate that specific antibody assays are useful for the determination of the egg-load after *Schistosoma*-infection. However, a better quantitation is by direct and indirect immunoassays which measure circulating parasitic antigens in body fluids. The quality of antibodies induced after natural infection or vaccination may differ in many aspects. It has to be considered that post-vaccination antibodies may not be detectable in conventional test systems. An evaluation of parasitic treatment is difficult by →serology. Only a complete parasitological cure is confirmed by negative serological results. Antibody disappearance is described for hepatic fascioliasis in humans 6–12 months after specific therapy and goats 1–5 months after therapy. In patients with Chagas’ disease humoral response may persist for years after a negative result in direct parasite examination. This is also true for schistosomiasis, echinococcosis, cysticercosis, and filariasis. However, there are promising results that a follow-up of the antibody response to selected antigen(s) may be efficient in post-therapeutic monitoring.

In parasitic infections the antibody isotype profiles may vary with time and the clinical manifestation. Differences in the IgG isotype pattern of the paired sera from mother and newborn add to the diagnosis of congenital toxoplasmosis. Congenital toxoplasmosis or congenital infection with *Trypanosoma cruzi* is proven by the demonstration of specific IgM and/or IgA antibodies in the newborn serum.

## Antibody-Dependent Cellular Cytotoxicity (ADCC)

Destruction of the target cell by release of toxic molecules by the effector cell.

## Antibody-Dependent Cellular Inhibition (ADCI)

An assay measuring (e.g., in malaria) the cooperation between antibodies and monocytes.

## Antibody Detection

→ Serology.

## Anticoccidial Drugs

→ Coccidiocidal Drugs.

## Antidiarrhoeal and Antitrichomoniasis Drugs

### Drugs Acting on Giardiasis

→ *Giardia lamblia* (syn. *G. intestinalis*, *G. duodenalis*) is distributed worldwide and has been identified in humans and domestic livestock, particularly in young animals such as calves, lambs, piglets, and foals and birds. The flagellate (with four pairs of → flagella) living in the small intestine may produce acute or chronic enteritis with profuse and heavy diarrhea and growth rate reduction in mammals and birds. *Giardia* spp. infections in animals may pose a serious zoonotic threat to humans. Humans may acquire infection either through waterborne transmission by *Giardia* cysts occurring in the drinking water contaminated with infectious feces or by direct contact with contaminated feces. Although quinacrine and furazolidone resistance have been induced in *G. duodenalis* → trophozoites, the substituted acridine dye derivative quinacrine can be of value in humans suffering from giardiasis, mainly in patients showing reduced response to 5-nitroimidazoles. However, quinacrine may cause exacerbation of psoriasis, ocular toxicity, and toxic psychoses, or distinctly enhance toxicity of 8-aminoquinolines, e.g., primaquine (→ Malariacidal Drugs).

**Benzimidazole carbamates** such as mebendazole, fenbendazole, or albendazole may exhibit the most pronounced activity against *Giardia* infections in man, farm animals, and dogs; however, repeat treatments may be necessary to eliminate parasites in reinfected farm animals. Currently used drugs in *Giardia*-infected humans are summarized in Table 1. The **control** and **prevention** of *Giardia* should be directed at young animals. They are highly susceptible to the parasite and show a markedly higher output of cysts than adult animals. Control measures for humans should be centered on environmental and personal → hygiene issues such as routine hand-washing, control of insects to prevent their contact with infected stools. **Iodine** seems to be an effective disinfectant for drinking water; filtration systems are also recommended (drawbacks may be clogging and safe removal of contaminated filters); killing of *Giardia* cysts by boiling the water is most effective but will cost energy. The chances of a protective vaccine against giardiasis are poor.

### Drugs Acting on Trichomoniasis in Humans and Cattle

→ *Trichomonas vaginalis* (motile trophozoite) is a common pathogen of the urogenital system in men and women but is uncommon in preadolescent girls. A frequent transfer of this flagellate is due to sexual intercourse, which explains the need for a therapy of both partners. In childbearing women, there may be an overall prevalence of 30%, which is significantly higher than that in men (5% or more). Very frequently *T. vaginalis* infection is asymptomatic, especially so in the male. Clinical signs may develop if parasites cause degeneration and desquamation of the vaginal epithelium followed by inflammation of the vagina and vulva and a leucocytic discharge may be evident. Topical treatment can be tried with clotrimazole or pimarcin but appears to be of little value because these drugs lack systemic action, which is essential in cryptic infection of men. Current **therapeutic drugs** with good systemic activity against *T. vaginalis* infections, are the well-tolerated **5-nitroimidazoles** metronidazole, ornidazole, tinidazole, and others showing high cure rates even after a single dosing (Table 1). These drugs may differ somewhat in their pharmacologic properties but not so in efficacy or toxicity. They have a wide spectrum of activity, including → *Entamoeba histolytica*, *G. lamblia*, *Balantidium coli*, and anaerobic bacterial infections. Drug resistance of *T. vaginalis* strains has been reported infrequently. This step forward in the 5-nitroimidazole-therapy becomes apparent when comparing the list of more than 170 different treatment regimens with exotic compounds like picric acid and mercuric

**Antidiarrhoeal and Antitrichomoniasis Drugs. Table 1** Drugs acting on *Giardia*, *Trichomonas*, Amoebae, and *Balantidium* in humans

DISEASE Nonproprietary name (chemical group)	Brand name other information	Adult dosage/*pediatric dosage (mg/kg b.w., or total dose/individual, oral route), miscellaneous comments
<b>GIARDIASIS</b>		
<i>Giardia lamblia</i> may contaminate drinking water, which is a common source of infection for humans and mammals; flagellated trophozoites attach by their 'suckers' to the surface of mucosa of small intestine, producing partial villous atrophy of the duodenum or jejunum; the ovoid cyst is passed in feces and has a very distinctive form; although <i>G. lamblia</i> is commensal in many individuals, it may be particularly pathogenic in debilitated and immunosuppressed patients, and is a common cause of diarrhea and a malabsorption syndrome characterized by excessive amounts of fat in the stool (steatorrhea) in travellers.		
<b>metronidazole</b> (5-nitroimidazole)	Flagyl, Clont, others	250 mg tid × 5d; *15 mg/kg/d in 3 doses × 5d (not licensed in the USA but considered investigational for this condition by the FDA)
<b>nitazoxanide</b>	Alinia	500 mg bid × 3; *1–3 yrs: 100 mg q12 × 3d; 4–11 yrs: 200 mg q12 × 3d
<b>tinidazole</b> (5-nitroimidazole)	Fasigyn, others	2 gr once; *50 mg/kg once (max. 2 g) treatment should be followed by administration of iodoquinol or paromomycin in doses as used to treat asymptomatic amoebiasis (see below)
<b>furazolidone</b> (nitrofurantoin)	Furoxone, others	100 mg qid × 7–10d; *6 mg/kg/d in 4 doses × 7–10d toxic effects may be serious and common, hypersensitivity reactions (urticaria)
<b>paromomycin</b> (aminoglycoside)	Humatin	25–35 mg/kg/d in 3 doses × 7d (use of drug may be suitable in pregnancy as it is not absorbed)
<b>TRICHOMONIASIS</b>		
Motile trophozoites of <i>Trichomonas vaginalis</i> can be found in the foamy vaginal discharge of trichomonal vaginitis; the creamy discharge is often secondarily infected with the yeast <i>Candida albicans</i> ; infection is transmitted by sexual intercourse; asymptomatic infection in the male (and therefore not treated) may be often a source of trichomonal infection in the female partner; for this reason sexual partners should be treated simultaneously; metronidazole-resistant strains have been reported, and enhanced doses of the drug for longer periods or use of tinidazole may be effective against these strains In cattle the <i>Tritrichomonas foetus</i> infection of the cow often leads to an abortion and sterility; infection is transmitted by coitus; in birds, particularly in pigeons, heavy <i>Trichomonas gallinae</i> infections may lead to high mortality caused by necrotic lesions in the mouth, crop, and the esophagus with extension to the bones of the skull, the liver, and elsewhere		
<b>metronidazole</b> (5-nitroimidazole)	Flagyl, Clont, others	2 g once; or 250 tid or 375 mg bid × 7d; *15 mg/kg/d in 3 doses × 7d
<b>tinidazole</b> (5-nitroimidazole)	Fasigyn, others	2 g once; *50 mg/kg once (max. 2 g) (the drug seems to be better tolerated than metronidazole, it is not marketed in USA)
<b>AMOEBIASIS</b>		
<i>Entamoeba histolytica</i> infection occurs by oral uptake of cysts, which are quite refractory to environment; the cysts are ingested with drinking water or food, which is not readily prepared or thoroughly cooked; as the disease is not characterized by a certain incubation time it is difficult to determine the onset of the amoebiasis; fever and feces containing blood and foamy fluid may be indications for acute amoebiasis; treatment should be started immediately after diagnosis has been made to avoid colonization of the liver by so-called "magna-forms" (tissue stages causing necrosis of liver parenchyma followed by formation of an abscess); large liver abscesses should be aspirated prior to treatment; there is no drug resistance in amoebiasis		
<b>ASYMPTOMATIC CASES</b>		
Asymptomatic carriers extruding cysts (quadrinucleate form) in the feces are an important source of infection; there are no therapeutic drugs, which may affect cysts; <b>luminal drugs</b> act directly (by contact) on (uninucleated) trophozoites of <i>E. histolytica</i> living in the lumen of large intestine; paromomycin may also act by modifying intestinal bacterial flora.		
<b>diiodohydroxyquinoline</b> (8-hydroxyquinoline)	Iodoxin, others (drug of choice)	650 mg tid × 20 d; *30–40 mg/kg/d (max. 2 g) in 3 doses × 20 d; toxic effect maybe SMNO (= subacute myelo optic neuropathy) after high doses and for long periods
<b>paromomycin</b> (aminoglycoside)	Humatin (drug choice)	25–35 mg/kg/d in 3 doses × 7d (may be useful in pregnancy as it is not absorbed); *25–35 mg/kg/d in 3 doses
<b>diloxanide furoate</b> (dichloroacetamide)	Furamide (alternative drug)	500 mg tid × 10d; *20mg/kg/d in 3 doses × 10d remarkably safe drug for treatment of carriers
<b>MILD TO MODERATE INTESTINAL DISEASE</b>		
Uninucleated trophozoites of <i>E. histolytica</i> invade the intestinal epithelium, principally in the cecum and the ascending colon causing lytic necrosis of tissues; 5-nitroimidazoles are well absorbed from the intestine and exhibit a marked systemic effect on extraintestinal amoebiasis		

**Antidiarrhoeal and Antitrichomoniasis Drugs. Table 1** Drugs acting on *Giardia*, *Trichomonas*, Amoebae, and *Balantidium* in humans (Continued)

DISEASE Nonproprietary name (chemical group)	Brand name other information	Adult dosage/*pediatric dosage (mg/kg b.w., or total dose/individual, oral route), miscellaneous comments
<b>metronidazole</b> (5-nitroimidazole)	Flagyl, Clont, others (drug of choice)	500–750 mg tid × 10d; *35–50 mg/kg/d in 3 doses × 10d
<b>tinidazole</b> (5-nitroimidazole)	Fasigyn (drug of choice)	2 g/d × 3 d; *50 mg/kg (max. 2 g) qd × 3 d (drug may be better tolerated than metronidazole; it is not marketed in the USA)
<b>ornidazole</b>	Tiberall	2 g once a day × 3d; amoebicidal activity of ornidazole is similar to that of other 5-nitroimidazole, not licensed in the USA
<b>SEVERE INTESTINAL DISEASE, EXTRAINTESTINAL AMOEBIASIS (HEPATIC ABSCESS)</b> In fulminating amoebic dysentery with loose feces, containing mucus and blood, the ameba penetrate more deeply into the intestinal wall thereby damaging all layers of the intestinal wall resulting in confluent ulceration; ameba may pass into the lymphatics or mesenteric venules and invade other tissues of the body, especially the liver, but also skin or genital organs; the most common form is a large single abscess in the right lobe of liver		
<b>metronidazole</b>	Flagyl (drug of choice)	750 mg tid × 10d; *35–50 mg/kg/d in 3 doses × 10d
<b>tinidazole</b>	Flasigyn	2g once daily × 5d; *50 mg/kg/day (max. 2g) × 5d
<b>ornidazole</b> (5-nitroimidazole)	Tiberall	2 g once a day × 3d; amoebicidal activity of ornidazole is similar to that of other 5-nitroimidazole; (not licensed in the USA)
<b>AMOEBIC INFECTIONS OF CENTRAL NERVOUS SYSTEM (CNS) AND THE EYE</b> Free-living aquatic amoeba such as <i>Naegleria</i> spp., <i>Acanthamoeba</i> spp., and <i>Balamuthia mandrillaris</i> may cause various CN disorders, which may be fatal; <i>N. fowleri</i> causes a rapidly fatal infection known as ‘primary amoebic meningoencephalitis’ (PAM); most patients with naeglerial infection have had a history of recent swimming in fresh water during hot summer weather; a number of <i>Acanthamoeba</i> species may produce a chronic CNS infection called ‘granulomatous amoebic encephalitis’ (GAE) or an eye infection characterized by a chronic progressive ulcerative keratitis; <i>B. mandrillaris</i> also causes GAE; unlike naeglerial infection, GAE does not appear to be associated with swimming; infections are often seen in individuals debilitated or immunocompromized including patients with AIDS; diagnosis is made by microscopic identification of living or stained amoeba trophozoites in CSF (Giemsa stained spinal fluid smears) or corneal scrapings, and motile amoeba (trophozoites) can be readily seen in wet-mount preparations; <b>chemotherapy</b> of PAM and GAE is problematic; almost all cases of PAM and GAE have been fatal because of the foudroyant course of PAM and lack of an effective causative treatment; considerable toxic amphotericin B seems to be the only drug with clinical efficacy		
<b>amphotericin B</b> (polyene antibiotic)	Amphotericin B powder	there are some known survivors of <b>PAM</b> , children from Australia, the UK, India, and the USA treated with amphotericin B: 1–(1.5) mg/kg/d × 3 d i.v. followed by 1mg/kg/d × 6 d i.v. or longer (additional amphotericin B given intrathecally plus miconazole or rifampicin i.v.)
<b>miconazole</b>	Daktar, solution for injection	<b>GAE</b> caused by <i>Acanthamoeba</i> has been successfully treated by total excision granulomatous brain tumor and administration of ketoconazole, <i>Acanthamoeba</i> meningitis with penicillin and chloramphenicol; <i>Acanthamoeba</i> and <i>Balamuthia</i> form cysts in tissues; thus, a potential effective drug for GAE must be capable of damaging cysts and trophozoites to prevent relapse after course of treatment; strains of <i>Acanthamoeba</i> isolated from fatal GAE cases were susceptible to pentamidine, ketoconazole, flucytosine <i>in vitro</i> ; today, <i>Acanthamoeba keratitis</i> can be managed by medical treatment alone, if diagnosis has been made soon enough; successful regimens may be topical propamidine, miconazole, and neosporin with epithelial debridement (removal of infected tissue from the lesion to expose intact tissue) or clotrimazole, systemic ketoconazole or itraconazole with topical miconazole and surgical debridement
<b>ketoconazole</b> (azoles)	Nizoral	
<b>flucytosine</b> (pyrimidinone analog) various topical formulations of azoles and other drugs for <i>Acanthamoeba</i> keratitis	Ancobon	
<b>BALANTIDIASIS</b> <i>Balantidium coli</i> (a ciliate) is a common commensal of the large intestine of wild and domestic pigs, but it can be pathogenic to humans and primates in which it produces various clinical forms (asymptomatic carrier condition, acute cases with fulminant diarrhea or chronic cases: diarrhea changes with constipation); however human infections are infrequent and pigs act as the main reservoir for human infections; motile flagellated trophozoites can invade the submucosa of large intestine		

**Antidiarrhoeal and Antitrichomoniasis Drugs. Table 1** Drugs acting on *Giardia*, *Trichomonas*, Amoebae, and *Balantidium* in humans (Continued)

DISEASE Nonproprietary name (chemical group)	Brand name other information	Adult dosage/*pediatric dosage (mg/kg b.w., or total dose/individual, oral route), miscellaneous comments
causing an ulcerative enteritis in severe cases; trophozoites and cysts are passed in the feces and can readily be found in fresh wet-mount preparations; the main endemic areas are in the tropical and subtropical areas and where there is close contact between humans and pigs; humans become infected by ingestion of cyst-contaminated food and water		
tetracycline (tetracyclines)	various	500 mg qid × 10 d; *40mg/kg/d (max. 2 g) in 4 doses × 10 d; use of tetracyclines is contraindicated in pregnancy and children <8 years of age; they discolor teeth in growing children; (not licensed in the USA but considered investigational for this condition by the FDA)
metronidazole (5-nitroimidazole)	Flagyl (drug of choice)	750 mg tid × 5 d; *35–50 mg/kg/d in 3 doses × 5 d (not licensed in the USA but considered investigational for this condition by the FDA)
diiodohydroxyquinoline (8-hydroxyquinoline)	Iodoxin alternative drug	650 mg tid × 20 d; *40 mg/kg/d in 3 doses × 20 d (not licensed in the USA but considered investigational for this condition by the FDA)

**Abbreviations:** the letter d stands for day (days); qd = daily (quaque die); bid = twice daily; tid = three times per day; qid = four times per day (quarter in die); p.c. (post cibum) = after meals

**Dosages** listed in the table refer to information from manufacturer or literature (e.g., Medical Letter 46, 2004)

Data given in this Table have no claim to full information

chloride cited in a book on trichomoniasis published about 50 years ago.

Also other flagellates may occur in the digestive tract or in the reproductive system being potential pathogens for diseases in mammals (monkeys, dogs, cats, zoo animals, or ruminants), and birds. → *Trichomonas foetus* with three anterior flagella may be of significance in the veterinary medicine causing an → abortion in cows followed by prolonged, and at times permanent, sterility or a closed pyometra (purulent endometritis). In the bull, the principal infection site is the preputial cavity. *A. T. foetus* infection is transmitted during coitus or by artificial insemination, and by gynecological examination of cows. The major control measure for trichomoniasis in cattle is the use of artificial insemination. The administration of **5-nitroimidazoles** like metronidazole or tinidazole is probably the most effective and expensive therapy for most of these protozoan infections. However, in some countries the use of 5-nitroimidazoles in food animals is now subject to regulatory actions of government agencies. The aim is to remove drugs of this chemical group from the market because of potentially cancerogenic action in rodents. Benign epithelial tumors (adenoma) have been observed in mice after being treated with high daily doses of metronidazole and others 5-nitroimidazoles administered for prolonged periods such as 6 months or so.

### Drugs Acting on Histomoniasis (Blackhead Disease) of Birds

*Histomonas meleagridis* is found in the ceca and liver of various birds (turkey, chicken, peafowl, guinea fowl, pheasant, partridge). The organism is probably transmitted by ingestion of cysts and/or anal contact to

fresh feces. The amoeboid stage of the flagellate may cause enterohepatitis in turkeys (or chickens) under range or yard management and thus high economic losses in the turkey industry. Control of enterohepatitis consists of good husbandry and preventive medication; contact between turkeys and chickens must be avoided, and regular treatment of all birds with anthelmintics should be performed to reduce the incidence of *H. gallinarum*, which apparently suppresses the immune system. Drugs used as additives in-feed and/or therapeutic drugs in-water belong to different chemical groups. Various **5-nitroimidazoles** such as dimetridazole, ronidazole, carnidazole, or ipronidazole may be used in-feed (the latter drug at dose levels between 50–85 ppm, withdrawal time 6 days, EC directives, 1999). Nifursol (use level in-feed, 50–75 ppm, withdrawal time 5 days, EC directives, 1999) or furazolidone, and others belong to the group of **5-nitrofuranes**. However, in various countries there are increasingly legislative restrictions concerning the use of additives in-feed for the prevention of histomoniasis because of potential cancerogenicity of these drugs in rodents.

### Drugs Acting on Intestinal and Extraintestinal Amoebiasis of Humans

*Entamoeba histolytica* in humans, monkeys, dogs, cats, and zoo-animals may produce acute or chronic enteritis associated with profuse and heavy diarrhea. Acute → amoebiasis must be differentiated from the chronic form. The use of amoebicidal drugs in the treatment of patients with various clinical forms of amoebiasis (Table 1) has contributed to reduction of → morbidity and mortality of the disease. Luminal drugs are used to treat asymptomatic carriers passing cysts of

*E. histolytica* in stool being an important source of infection. Various drugs are available for patients with invasive intestinal amoebiasis associated with ulceration of deep layers of the intestinal wall of cecum and colon (Table 1). The same agents (e.g., 5-nitroimidazoles) can be used in treating invasive extraintestinal amoebiasis, involving liver, skin, and other organs. Systemic amoebicides currently seldom used because of their high toxicity or only limited action (e.g., chloroquine) are emitine and dehydroemitine (alkaloids), which act in the liver, and intestinal wall (other tissues), and chloroquine, which acts in the liver only. Emitine and dehydroemitine administered intramuscularly are fairly toxic drugs producing cardiac arrhythmia, and asystole, but also adverse effects of the central nervous system (CNS).

### Drugs Acting on Amoebic CNS Diseases and Amoebic Keratitis

A number of free-living opportunistic →[amoebae](#) are known to be potential pathogens for humans. →[Acanthamoeba](#) spp., →[Balamuthia mandrillaris](#), and →[Naegleria fowleri](#) can cause lethal infections particularly in children having close contact with water. Their distribution is worldwide in fresh water and soil. The protozoans live preferably in aquatic habitats where they feed on bacteria (e.g., in warm lakes or swimming pools). Infection by *N. fowleri* is acquired by intranasal absorption of amoebae (flagellates or cysts); trophozoites invade the nasal mucosa, cribriform plate, and olfactory bulbs of the brain (cysts are absent in infected tissues). *Acanthamoeba* spp., and *B. mandrillaris* may infect man via nasal mucosa causing fatal CNS disease or by direct invasion of the cornea through lesions of the eye or the wearing of contaminated contact lenses of healthy persons producing *Acanthamoeba* keratitis. Primary amoebic →[meningoencephalitis](#) (PAM) due to *N. fowleri* is usually diagnosed after death of patient and is characterized by an acute, hemorrhagic, necrosing meningoencephalitis. *Acanthamoeba* spp. and *B. mandrillaris* cause focal granulomatous amoebic →[encephalitis](#) (→[GAE](#)) and trophozoites and cysts occur in most infected tissues. **Chemotherapy** of PAM and GAE is problematic and only a few cases have been treated successfully with the highly toxic polyene antibiotic amphotericin B (Table 1). *Acanthamoeba* keratitis, which increasingly occurs in immunocompromized patients, can be treated with success if it is diagnosed at an early stage. Various drugs (dibromopropamide, neomycin azoles, alone or in combination) have been administered topically as ointments and drops (see Table 1).

### Drugs Acting on Balantidiasis

→[Balantidium coli](#), which possesses →[cilia](#) for locomotion, is a natural inhabitant of the digestive tract of mammals

and widespread in swine; the vegetative forms of *Balantidium* (man, monkeys and pigs) may produce acute or chronic enteritis with profuse and heavy diarrhea. Good hygiene and sanitation may prevent infections, which are associated with close contact to pigs. Acute *B. coli* infections may be treated with **tetracycline**. Alternative drugs may be the 5-nitroimidazole **metronidazole** (Table 1). In many countries its use in food animals is now subject to regulatory actions of government agencies; the aim is to remove drugs of this chemical group from the market because of their potentially cancerogenic action in rodents after prolonged administration.

## Antifolates

Drugs acting against folate production, e.g., in malaria parasites, →[Malaria Drugs](#).

## Antigen Presentation

→[Immune Responses](#).

## Antigenic Variation

→[Surface Coat/Antigenic Variation](#).

## Antigens

### Synonym

Immunogens.

### Introduction

Antigens are molecules – proteins, peptides, carbohydrates, nucleic acids, lipids, or any other compound - that induce the production of antibodies and bind to antibodies. Parasites may present a great quantity and variety of antigens to the host that change with time as a consequence of maturation through different life-cycle stages. Parasitic antigens may be divided into several categories: diagnostic, protective, pathologic. An antigen acts as immunogen when it is able to induce



an immune response (immunogenicity). In general, different antibodies are produced to an antigen which bind to different epitopes. The hosts' immune response depends on the presentation, quantity, and kind, of [→circulating antigen](#). Cross-reacting epitopes exist between the different stages of the same species, and between different species of the same genus. In [→helminth](#) infections there is a high degree of cross-reactivity between species and genus. The antigens of helminths commonly exposed to the immune system are excretory and/or secretory (E/S) antigens or surface molecules (somatic antigen). Antigens of [→Protozoa](#) have a lower degree of variability between species and their immunogens are mainly surface antigens. For each parasite the diagnostic potency of surface, E/S, and somatic antigens has to be evaluated in regard to their effectiveness in a specific test system.

### Antigen Processing

Due to the often complicated life cycle of parasites, including vector transmission, it may be difficult to maintain helminth parasites in laboratory animals or *in vitro*. In practice it is impossible to recover large quantities of antigen from each pathogen species. It is a common laboratory practice to select one single, highly cross-reacting species for antibody screening within a whole genus ([→Brugia malayi](#) for filariasis, [→Schistosoma mansoni](#) for schistosomiasis, *Leishmania donovani/infantum* for leishmaniasis, [→Plasmodium falciparum](#) for [→malaria](#)). Until recently the primary source of antigen for most of the serological assays was parasite maintained *in vivo* (helminths) or in continuous *in vitro* culture systems (Protozoa). Complete cells, fragments, or cryosections of parasites (cellular antigens) are used as antigen in IFAT, DT, and agglutination test. Crude or purified soluble extract antigens or culture-derived E/S antigens are utilized in other test systems like [→ELISA](#), IHAT, CFT, CIEP, and gel precipitation. Today, new technologies which allow the construction of synthetic peptides, recombinant proteins, or DNA-based immunization have opened up the possibility for large-scale production of defined antigens or specific antibodies. However, for each preparation the diagnostic potency must be proven. It could be shown that a single antigen or a monoclonal antibody may be satisfactory for individual diagnosis but not for screening purposes. A combination of several defined antigens may improve the sensitivity, a polyclonal antibody, the binding capacity of a test system.

### Antigen Assays

[→Immunoassays](#) for antigen detection are increasingly developed. Urinary antigen detection is of diagnostic interest for parasites with developing stages associated

to the genito-urinary tract ([→Schistosoma haematobium](#), [→Trichomonas vaginalis](#)) or parasitic antigens excreted during the acute or [→chronic infection](#) stage in urine ([→Wuchereria bancrofti](#), *Trypanosoma cruzi*). Circulating antigen detection is useful for a quantification of blood parasites ([→Trypanosoma](#) spp., microfilariae) or detection of E/S antigens ([→Schistosoma](#) spp.). It may provide information on the presence and/or activity of the parasite. Antigen detection in stool specimens enables a species-specific diagnosis which is impossible after microscopic examination ([→Entamoeba histolytica/dispar](#), [→Echinococcus](#) spp.).

### Clinical Relevance

Many stage-specific antigens of different parasites have been characterized so far and some of them are already applied in serodiagnostic test systems. A tachyzoite-specific, recombinant surface antigen (P30) is of proven diagnostic value for the detection of *Toxoplasma* antibodies. Species-specific antigens of *Echinococcus multilocularis* like Em18 or the recombinant antigen Em2 are in use for the serological differentiation of infection with the alveolar or cystic form. ELISAs with improved specificity by use of recombinant antigens were developed for parasitic infections like Chagas' disease, leishmaniasis, [→Strongyloides](#), and many others. Defined glycoproteins of the cyst fluid from [→Taenia solium](#) are highly specific and allow the identification of patients with [→cysticercosis](#) by use of the WB. The seroreactivity to a specific antigen as indication for active infection was described for [→visceral leishmaniasis](#) and amoebiasis. The detection of one or both genus-specific *Schistosoma*-antigens (circulating anodic, CAA, and cathodic, CCA, antigens) indicate an active schistosomiasis. A positive correlation between *Schistosoma haematobium* egg excretion and levels of CAAs was reported. The level of complexed antigen in serum is a good indication for the microfilarial load in [→Bancroftian filariasis](#).

Not only a quantification of the parasite load but also a discrimination between recent and past infection is possible by urinary antigen detection. A better discrimination between acute and congenital-infected patients was reported for Chagas' disease. The [→immunodiagnosis](#) of intestinal parasitic infection has advanced significantly through the development of coproantigen detection methods. Commercial ELISA systems which use monoclonal antibodies for the detection of fecal parasitic antigens like *E. histolytica/dispar*, *Giardia lamblia*/*G. intestinalis* and/or *Cryptosporidium* spp. are now available and are going to replace microscopic examination in many laboratories. However, the specificity, sensitivity, and clinical value of the available tests are still under investigation.

The detection of *Echinococcus*-antigen in fecal samples of the dog (*E. granulosus*) or fox (*E. multilocularis*) by use of polyclonal antibodies may become an important diagnostic tool in veterinary medicine.

## Antimony Compounds

Drugs acting, e.g., against trypanosomiasis (e.g., antimony potassium tartrate), → [Trypanocidal Drugs](#).

## Antiparasitics

Compounds (natural or chemical) acting against parasites, e.g., → [Nematocidal Drugs](#) = agents against nematodes.

## Antricola

Genus of → [argasid ticks](#) (e.g., *A. coprophilus*, *A. marginatus*), which feed on bats in Central America and in USA.

## Aonchotheca

Synonym for the genus name → [Capillaria](#).

## Apanteles

Genus of Ichneumonoidea (e.g., *A. melanoscelus*), which are used in the USA as biocontrol of gypsy moth larvae.

## Apatemon gracilis

2 mm-sized trematode (syn. *Strigea gracilis*) living in the small intestine of geese, ducks, etc. → [Digenea](#).

## APC

Antigen-presenting cell.

## Aphaniptera

The term means animals with hidden/lost wings, see → [Fleas](#).

## Aphanipteridosis

Disease due to → [flea](#) bites.

## Aphanipteriosis

→ [Fleas](#), → [Siphonapteridosis](#).

## Apical Cap

→ [Apicomplexa](#).

## Apical Complex

→ [Apicomplexa](#), organelles at the apical cell pole.

## Apical Organ

→ [Acanthocephala](#).

## Apicomplexa

### Synonym

→ [Sporozoa](#).

## Classification

Subphylum of →*Alveolata* (new system), Phylum of →*Protozoa* (old system).

## General Information

Members of this phylum are characterized by the occurrence of the name-giving sporocysts (and/or oocysts) which produce the infectious sporozoites. The life cycles comprise a regular alternation of different sexual and/or asexual generations (→*Coccidia*). Although several multinucleate stages occur during the reproduction of individuals of the different species (→*Plasmodium*/Fig. 2), the typical sporozoan cell is uninucleate. With respect to fine structure the Sporozoa are a relatively uniform group, being provided with a typical →*apical complex* (→*Pellicle*/Figs. 3–5).

## System

Due to these fine structural features, several groups of parasites have been added to, or excluded from, the Sporozoa. This led to the systematic concept of Levine et al., which is, however, not generally accepted. Thus, the authors of this chapter do not support the addition of the class →*Perkinsea*, since the fine structure is not identical with that of other sporozoans. Furthermore, we find it necessary to include the →*Piroplasma* (→*Babesia*/Fig. 1, →*Theileria*/Fig. 1) and all blood-parasitizing members of the →*Adeleidea* (genera →*Karyolysus*, →*Hepatozoon*, →*Haemogregarina*, →*Leucocytozoon simondii*/Fig. 1, →*Karyolysus lacertae*

Fig. 1, →*Hepatozoon*/Fig. 1) in the Haemosporida. Thus, in our opinion the following system better reflects the biological and morphological relations among the members of the Sporozoa (Fig. 1).

## Surface Coat

The major surface proteins of →*Plasmodium* merozoites or →*Toxoplasma gondii* tachyzoites have been shown to be GPI-anchored (→*Glycosylphosphatidylinositols*). The Circumsporozoite protein (→*CSP*) of sporozoites and the →*ookinete* surface proteins have the primary sequence requirements for →*GPI* anchoring, although the latter has not been formally demonstrated due to the low amount of material available for study. Although the trimannosyl-glucosaminyl core is common with kinetoplastids, the structure of the GPI anchors differs from the trypanosomes, and among apicomplexans, by the sugar ornamentation of the glycanic core, and it does not undergo remodeling after addition to the protein.

The GPI anchor of *Plasmodium* has been shown to be a strong immunomodulator responsible for signal transduction in cells of the vertebrate host.

The →*MSP1* of *Plasmodium* merozoites undergoes proteolytic processing before reinvasion, and shedding of the cell coat described during invasion coincides with the removal of most of the protein except the C-terminal 19 kDa that is internalized with the parasite inside the red blood cell. In sporozoites, the CSP is deposited on the substrate during motility on serum albumin-coated surfaces, or is capped and shed when bound to specific antibodies. The mechanism of

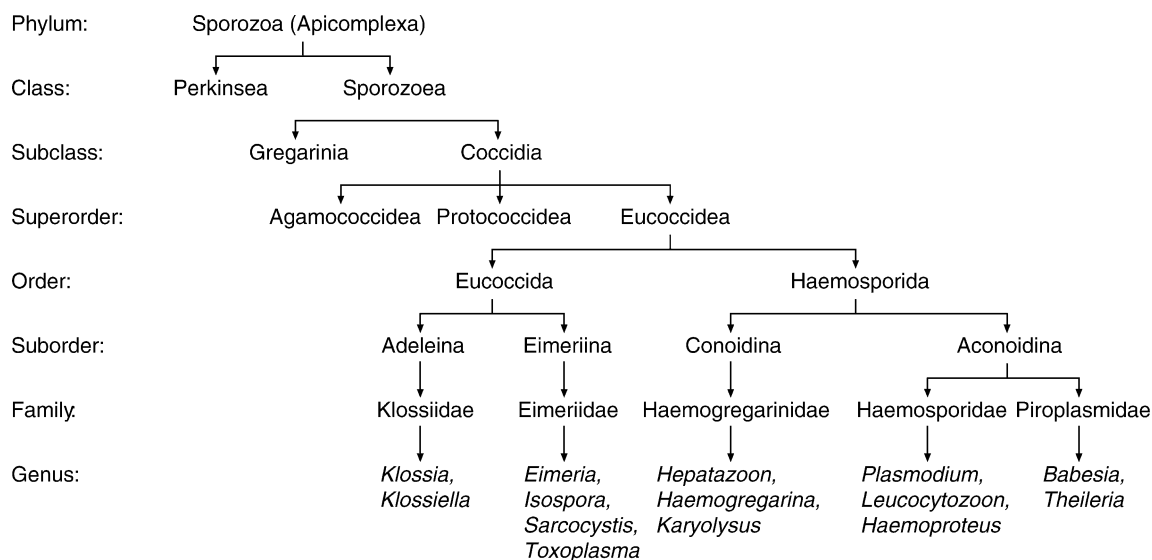

**Apicomplexa. Figure 1** Overview of groups among Sporozoa (Apicomplexa/Alveolata) (according to Mehlhorn and Schein). Recent molecular biologically obtained data indicate that it is necessary to exclude →*Toxoplasma*, →*Sarcocystis*, and →*Isospora* from Eimeriidae and to include them into a newly created sister family (Sarcocystidae). Furthermore Perkinsea are surely no longer Apicomplexa but dinoflagellates. The genus *Cryptosporidium* probably belongs to the group of Gregarines.

shedding (release of proteins, cleavage of the anchor, or removal of lipids associated with the coat) is not elucidated. As described below, the contribution of GPI-anchored proteins to Apicomplexan motility is not known; in addition, exocytosed microneme protein are transiently inserted into the →**plasmalemma** of the parasites during motility and at the invasion stage and may therefore be part of the glycocalyx during a short period of the parasite cycle.

## Motility

As described by many investigators, motility of Apicomplexan zoites can be subdivided into 3 types which are, respectively, gliding, twisting, and bending. Only the first type leads to active displacement of the →**zoite**, the 2 others being involved in changing the direction of motion. →**Gliding motility** is very uncommon among eukaryotic cells; it is clearly different from amoeboid locomotion and involves a unique molecular assembly of proteins originating from several compartments of the zoite.

In all cases, gliding motility has been described as the backward translocation of a “junction” between a substrate and the zoite surface along the latter’s longitudinal axis. The substrate could be detected by small latex beads which, in the case of the gregarine, were translocated and accumulated at the posterior extremity of the organism. The experiments clearly demonstrated that the gliding motility of Apicomplexan zoites was a relative phenomenon in which the moving partner could be the zoite or the substrate depending on their respective size. Physiological studies of these

models and others have shown that gliding was temperature- and cytochalasin D-sensitive, this last property being interpreted as a clue to the participation of →**actin** in zoite motility. Indeed, in *T. gondii*, the direct involvement of actin in motility has been demonstrated and →**myosin** is also implicated, both molecules being found between the plasmalemma and the inner complex of zoites.

The parasite surface molecules involved in motility are essentially derived from the exocytosis of micronemes. Indeed, the resident surface proteins being GPI-anchored, they cannot transduce directly a mechanical force originating from the acto-myosin motor located below the plasma membrane. Instead, transmembrane proteins initially located in micronemes are translocated on the parasited surface by exocytosis at the parasite apical area and operate this transduction. Very elegant genetic studies in *P. berghei* have demonstrated the critical role of a highly conserved microneme protein TRAP in the gliding motility of sporozoites. These findings, together with other investigations in *T. gondii* have led to the description of the molecular assembly responsible for gliding motility. The TRAP family proteins are inserted into the plasma membrane and their cytoplasmic C-terminus sequence interact via an aldolase and triggers the polymerization of short actin filaments that are propelled by resident myosin molecules that are attached to underlying inner membrane complex. This antero-posterior translocation of a transmembrane protein interacting with the substrate via its N-terminus is responsible for the gliding motility (Fig. 2).

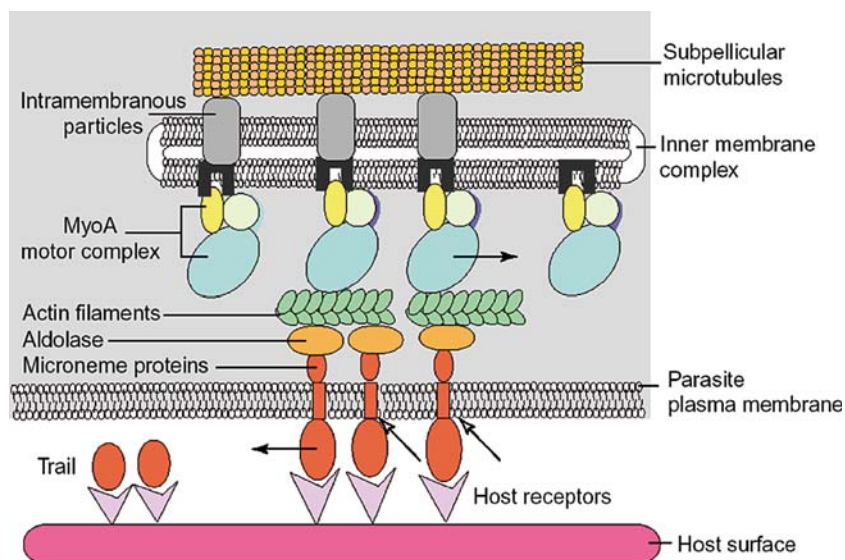

**Apicomplexa. Figure 2** Schematic drawing of the mechanism of zoite motility in Apicomplexa. The myosin motor (myoA motor complex) is associated with the inner membrane complex, oriented by the subpellicular microtubules. Microneme proteins become inserted in the plasmalemma and associate with short actin filaments through an aldolase. The actin-aldolase-microneme protein complexes are translocated by the myosin motor while interacting with the substrate, resulting in gliding motility. (After Soldati and Meissner, *Current Opinion in Cell Biology*, 16, 32–40, 2004, modified).

The nature of the interaction between the zoite and the substrate is entirely unknown. A classical →receptor-ligand interaction is unlikely since gliding motility has also been observed on glass or on liquid-liquid interfaces and it thus appears that zoites may use physical properties of interfaces and surface tension to interact with substrates.

The →orientation of motility, along the zoite axis, and its exclusive forward directionality can be related to morphological characteristics of zoites, although no experimental demonstration of a relation between structures and motility has yet been obtained. Indeed, freeze fracture has demonstrated highly organized structures within the →pellicle of Apicomplexan zoites: although the outer layer (cytoplasmic membrane) shows little differentiation, the inner membrane complex, which is made of 2 closely apposed membranes underlying the plasmalemma, is highly organized. This inner complex is in fact a continuous layer of rectangular flattened vesicles (plates) arranged in longitudinal rows except at the anterior extremity where a truncated conical plate (→Apical Cap) is found (Fig. 3). The intramembranous particles of both membranes of the inner complex are arranged in a dense array of parallel longitudinal lines. Lines of higher particle density are found over the subpellicular microtubules which extend longitudinally under the inner complex (Fig. 4). Similar structures have been observed in all Apicomplexan zoites described so far. This highly organized longitudinal pattern is likely to provide the template for the translocation of the TRAP Proteins. A correlation between these morphological features and the actomyosin motor of motility remains to be established.

Another phenomenon has been described on apicomplexan zoites which also concerns the surface interactions between these organisms and their surroundings. When zoites are presented with a variety of ligands interacting with their surface (cationized ferritin, surface antigen-specific antibodies), they are at first entirely covered with the ligand but they are able to cap it on their posterior extremity and shed it into the medium. This →capping phenomenon shares many common features with gliding motility (polarity, temperature, and cytochalasin D sensitivity) although, as mentioned above, the way GPI-anchored proteins can be moved by the actomyosin motor is unknown.

If one considers motility of parasites as the way of homing to their host (host cell in the present case), one would then wonder whether any signal or tropism guides the zoite to its definitive location, which is usually extremely specific. No such phenomenon has been described so far concerning Apicomplexans and in most cases, homing to the vicinity of the target cell seems to be passive; the zoites being driven either by the digestive or the circulatory route depending on the inoculation site. Gliding motility seems to be operational within a short range and to allow accidental contact between zoite and host cell when the organism has been passively carried close to the site of interaction. In the case of malaria sporozoites, the high specificity of recognition between hepatocyte surface proteoglycans and parasite surface proteins seems to be a major cause of organ targeting, probably by inducing binding of sporozoites to the hepatocytes when they are carried in the vicinity of these cells by the bloodstream.



**Apicomplexa. Figure 3** Freeze fracture replica of second generation merozoites of the chicken →*Coccidia Eimeria necatrix*. Three fracture planes are found in the →pellicle, corresponding to the 3 membranes (*e*, plasmalemma; *m* and *i*, inner membrane complex). The inner membrane complex is made of continuous rows of longitudinal plates containing longitudinal arrays of intramembranous particles. (bar = 1 μm; Dubremetz and Torpier, original).

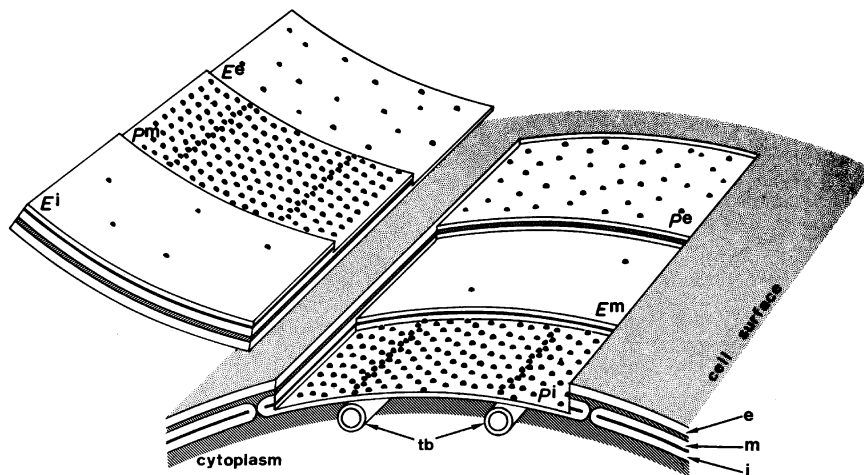

**Apicomplexa. Figure 4** Schematic diagram of the organization of the →pellicle of Apicomplexan zoites as revealed by freeze fracture. Three fracture planes lead to three pairs of complementary fracture faces named according to the conventional nomenclature (*E*, external face; *P*, proplasmic face). Longitudinal arrays of intramembrane particles are found in the *P* faces of the inner membrane complex; lines of higher particle density overlay →subpellicular microtubules (*e*, plasmalemma; *m* and *i*, inner complex; *t*, microtubule).

### Host Cell Recognition

Regarding the host cell recognition process, 2 groups seem to exist among Sporozoa: one in which a highly specific recognition step occurs which concerns the blood parasites (Hemosporidia, →Piroplasms), and another in which little if any specific recognition of the host cell concerning the Coccidia can be demonstrated. This difference is better understood when one realizes that a *Plasmodium* →merozoite is only able to invade the red blood cells of an extremely narrow range of hosts whereas a *T. gondii* tachyzoite readily invades almost any type of cells it gets in contact with. The difference between the 2 groups could also be interpreted as the need for receptor-ligand-mediated adhesion as a prerequisite to invasion by blood parasites whereas this step would be unnecessary to Coccidia whose host cell and tissue specificity *in situ* could be due to other mechanisms. However, another possibility is that binding always occurs before invasion but its specificity varies depending on the parasite and allows a variable range of invasion that may or may not need further specific interaction to determine development or escape and search for a more suitable host cell. Although the surface proteins of the invasive stages seem to be involved in the recognition binding to the host cell, the →micronemes proteins which are translocated on the surface of the parasite appear to be essential in parasite–host cell interaction in all Apicomplexa. The present status of knowledge does not clearly differentiate between recognition binding and motility of Apicomplexan zoites.

In the case of blood parasites (*Plasmodium*, →*Babesia*), receptor–ligand types of interaction have been shown to occur between zoites and erythrocytes.

These events seem to be involved in the adhesion of the parasite to its target cell which holds the partners together after accidental contact and allows invasion to proceed. Phase contrast microscopic observations of red blood cell invasion by merozoites of *P. knowlesi* or →*P. falciparum* have shown that initial contact could occur between any 2 points of the surfaces of the 2 cells. Then the merozoite reorients itself in such a way that its apical end faces the erythrocyte membrane. →Moving junction formation and invasion then occur. Reorientation has been suggested to be effected by a gradient of receptors directed towards the apical end of the zoite. The respective part of receptor-mediated interaction in initial contact, reorientation, and moving junction formation is still unclear because of the difficulty of manipulating these different events *in vitro*. Thus the following applies to these interactions as a whole and we will only describe the *P. falciparum* model.

Recognition events concern interactions between merozoite receptors and erythrocytic ligands. Soluble molecules acting as bridges between both surfaces may also be involved. Most of the data obtained on these interactions come from *in vitro* experiments in which a *P. falciparum* culture was subjected to various treatments (use of variant red cell phenotypes, enzymatic alteration of erythrocyte surface, competition with soluble molecules) or from affinity of parasite molecules for erythrocytes (erythrocyte-binding antigens) or erythrocyte fractions (Glycophorin).

Concerning the erythrocyte, →Glycophorin A (major sialoglycoprotein) is the major ligand in interaction with merozoites. More precisely, O-linked sialylated polysaccharides of the molecule seem to be directly involved in recognition. However, in addition, sialic

acid-independent recognition and invasion can occur in certain strains, which suggests the existence of alternate pathways allowing the parasite to survive if one way fails to operate.

The main merozoite receptors described so far are molecules having affinity for the erythrocyte surface that were initially described as →erythrocyte-binding antigens (EBA). These molecules are located in micronemes and are translocated in a transmembrane orientation on the merozoite surface where they play a major role in host cell recognition-invasion. A highly conserved family of →EBA proteins expressed in the merozoite stages of various *Plasmodium* has been characterized; they all contain a conserved N-terminal cystein-rich domain that is involved in recognition. As for most microneme proteins, the way these proteins stored in the lumen of an organelle become transmembrane in the parasite surface is unknown.

Although *P. knowlesi* shares a part of its erythrocyte host range with *P. falciparum*, the recognition events seem to be distinct from the ones involved for the latter species. The →Duffy blood group antigen has been described to play a key role in *P. knowlesi* invasion, in association with the DBL, which is a member of the erythrocyte-binding ligands EBL. The Duffy antigen is also involved in *P. vivax* invasion.

The role of →merozoite surface proteins in erythrocyte invasion is unclear; the major merozoite surface protein (MSP1) may participate in initial binding, and antibodies that inhibit its proteolytic cleavage occurring during invasion block cell entry, but the receptor for this interaction is unknown. This surface protein may be acting as an early ligand of low affinity that allows close contact between both partners and is then strengthened by the EBL–glycophorin interaction.

Whether the receptor-ligand recognition that precedes invasion is maintained in the moving junction that powers invasion is unknown; however, observations on the interaction between *P. knowlesi* and Duffy negative red cells where the junction does not form suggest that the DBL protein may be involved in the junction.

In the →sporozoite stage of the malarial parasite life cycle, receptor-ligand recognition has been postulated to drive the interaction with the target cell, which is the hepatocyte. Although *Plasmodium* sporozoites have been shown to invade a rather large range of cells *in vitro*, their very efficient homing to the hepatocytes *in vivo* is probably driven by the affinity between the circumsporozoite surface protein CSP and the hepatocyte surface heparan sulfate proteoglycans.

Another system of recognition, which is found in *Plasmodium* sporozoites and is conserved in many Apicomplexa is the →TRAP microneme protein family. In *Plasmodium* sporozoites, this protein also binds sulfated sugar-containing domains on the hepatocyte surface. *Toxoplasma gondii* and *Eimeria tenella* contain

TRAP-like proteins in their micronemes, but their putative receptors have not been identified.

Micronemes of *T. gondii*, *Cryptosporidium*, and *Sarcocystis* also contain proteins with cell-binding properties, some of which with lectin features, that probably play a role in host cell recognition, although yet unidentified.

## Host Cell Invasion

Due to their medical significance, →host cell invasion by Apicomplexan zoites has mainly been studied with malaria parasites and *T. gondii* to a lesser extent with the Coccidia and *Eimeria*, *Sarcocystis* or with piroplasmids.

In all cases in which invasion has been described in detail, Apicomplexan zoites enter the host cell apical end first, i.e., the area where the so-called apical complex is located and especially where the rhoptry ducts reach the zoite membrane. The zoite then gains access into an intracellular compartment surrounded by a membrane which is continuous with the host cell plasmalemma during invasion. The fate of that membrane has long been controversial since some authors have described its disintegration during the invasion, arguing that the →parasitophorous vacuole appeared later around the cytoplasmic parasite. These conclusions were based on preparation artifacts due to the peculiar nature of the developing parasitophorous vacuole membrane which is poorly stabilized by the electron microscope preparation.

A very precise description of invasion has been given for *P. knowlesi*, this species being more amenable to experimental study of invasion than any other malarial parasite because of the relatively long shelf life of its merozoites. The initial step of internalization is a close contact between the apical end of the merozoite and the red blood cell plasmalemma. This latter becomes thicker on its inner side under this contact. Initiated as a segment of a sphere, this “junction” turns into a ring which moves backward on the zoite surface, whereas the host membrane area previously involved in the junction becomes the developing parasitophorous vacuole. The ring travels along the zoite to its posterior end where the junction ends up as a segment of a sphere, at which level the vacuole closes and separates from the host plasmalemma. The →surface coat of the merozoite has been shown to be “shaved off” at the level of the junction as this latter went along the zoite surface.

Associated with this process are the formation of vesicles facing the zoite apex on the cytoplasmic side of the developing parasitophorous vacuole, and a clear decrease in the electron density of the rhoptry contents. The →rhoptries open at the tip of the zoite and their contents are in contact with the parasitophorous vacuole membrane. Freeze fracture electron microscopy has shown a total depletion of intramembranous particles

of the developing parasitophorous vacuole compared to the erythrocyte plasmalemma, which indicated a very low proteinic content for this membrane. A second observation was that the moving junction had a peculiar freeze fracture structure as a rhomboedric network of “particles” in the erythrocytic side, which indicated that the junction was more than a close apposition of membranes but that the internal structure of the host →cell membrane was altered at this level.

From a physiological point of view, the major finding was that cytochalasin D inhibited the invasion, although the junction was initiated at the apex of the zoite and some vesicles appeared on the cytoplasmic side of the junction indicating that the actin motor was not needed for junction formation and rhoptry exocytosis, but essential for entry. Protease inhibitors were also found to block the phenomenon, which suggests that proteases may be involved in the process.

→Host cell invasion by Coccidia has been studied both *in vitro* and *in vivo*. Because of the larger size of the zoites and the more complex organization of the host cells, the results obtained by electron microscopy were not as clear as for *Plasmodium*. Moreover, the host cells chosen for experimental studies were in some cases professional phagocytes (monocytes, macrophages), which raised additional questions concerning the active part played by zoites in entry. It is now clearly demonstrated that host cell invasion by Coccidia proceeds as described for *Plasmodium*, i.e., by a moving junction gliding backward on the zoite which enters a parasitophorous vacuole, the membrane of which is

continuous with the plasmalemma of the host cell but depleted of intramembranous particles (Figs. 5–7). The freeze fracture features of the moving junction are identical to the ones found on red blood cell membranes in *Plasmodium*.

Abundant membrane whorls are found in the parasitophorous vacuole or in “empty rhoptries” and vesicles are found on the cytoplasmic side of the parasitophorous vacuole, especially when invasion is blocked by cytochalasin, these vesicles contain rhoptry proteins.

Thus, the invasion process is conserved in all intracellular Apicomplexa, characterized by a moving junction and the development of the parasitophorous vacuole. The moving junction components have been recently identified in *T. gondii*: it contains proteins exocytosed from both the micronemes (AMA1) and from the anterior part of the rhoptries (rhoptry neck, RON proteins). These proteins are associated in a transmembrane complex at the junction level. This complex is believed to be moved by the parasite actomyosin motor on the parasite side, and to attach to host cell receptors or cytoskeleton. Another possibility is that the complex itself is anchored in the host cell membrane, avoiding the need for a specific receptor. A schematic view of the invasion process is shown in Fig. 8 (page 111).

The origin of the parasitophorous vacuole membrane is still controversial. The respective contributions (qualitative and quantitative) of the host cell plasma membrane and of rhoptry products are not fully determined, although both are probably involved. Ward et al., using fluorescent lipids or electrophysiological

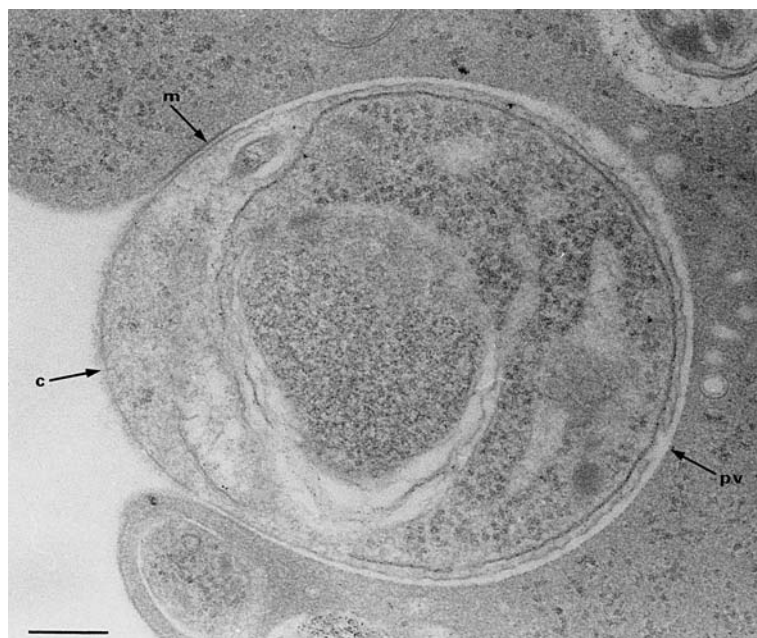

**Apicomplexa. Figure 5** Invasion of a mouse reticulocyte (R) by a merozoite of *Plasmodium yoelii nigeriensis* (c, merozoite cell coat; m, moving junction; pv, developing parasitophorous vacuole. bar = 0.2  $\mu$ m; courtesy of G. Prensier, original).



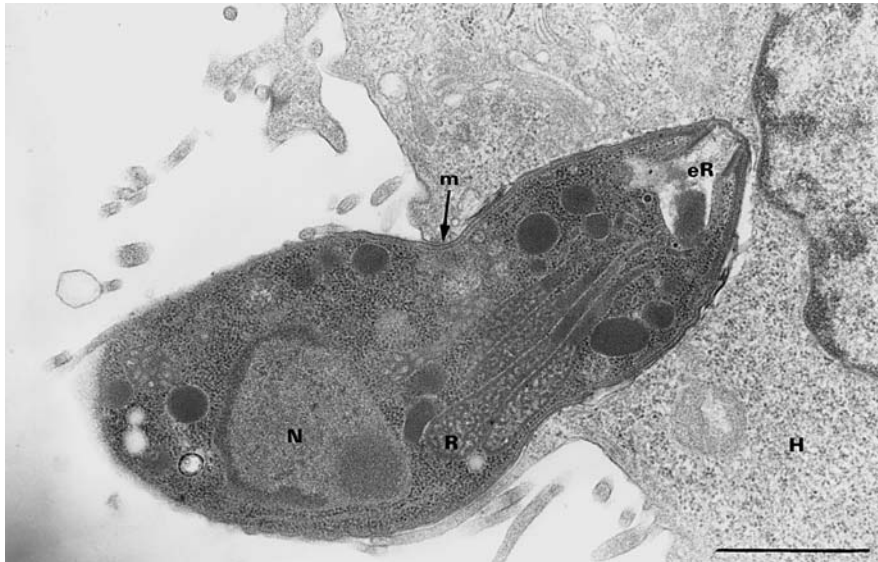

**Apicomplexa. Figure 6** Invasion of HeLa cell (H) *in vitro* by a tachyzoite of *Toxoplasma gondii* (R, rhoptry; eR, empty rhoptry; N, nucleus; m, moving junction. bar = 1  $\mu$ m; Ferreira and Dubremetz, original).

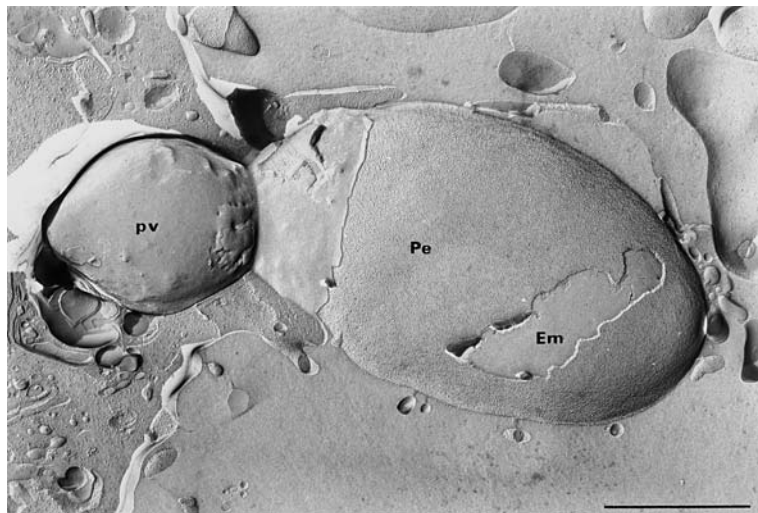

**Apicomplexa. Figure 7** Freeze fracture of the invasion of HeLa cell *in vitro* by a tachyzoite of *Toxoplasma gondii*. The developing parasitophorous vacuole (pv) is devoid of intramembrane particles (Pe, zoite plasmalemma; H, host cell  $\rightarrow$  cytoplasm. bar = 1  $\mu$ m; Dubremetz, Ferreira, and Torpier, original).

procedures, have shown in both *P. knowlesi* and *T. gondii* that host cell membrane components (essentially lipids) contribute a major part of the early parasitophorous membrane.

The contribution of the apical secretory organelles to invasion is essential. They undergo sequential exocytosis during the process. Micronemes release proteins involved in motility recognition adhesion, at an early stage of interaction. Rhoptries then contribute components of the moving junction (RON proteins, exclusively located in the neck of the organelle) followed by

proteins (and lipids) which are integrated into the parasitophorous vacuole membrane (ROP proteins, derived from the posterior part of the organelle). They contribute enzymes such as proteases or phospholipases that can modify the host cell plasmalemma and facilitate vacuole formation (e.g., the cleavage of the erythrocyte protein band 3 by a serine protease of *Plasmodium* is believed to lead to disorganization of the spectrin network of the red blood cell as a prerequisite to red cell invasion). In addition, some rhoptry proteins are released in the host cell and at least

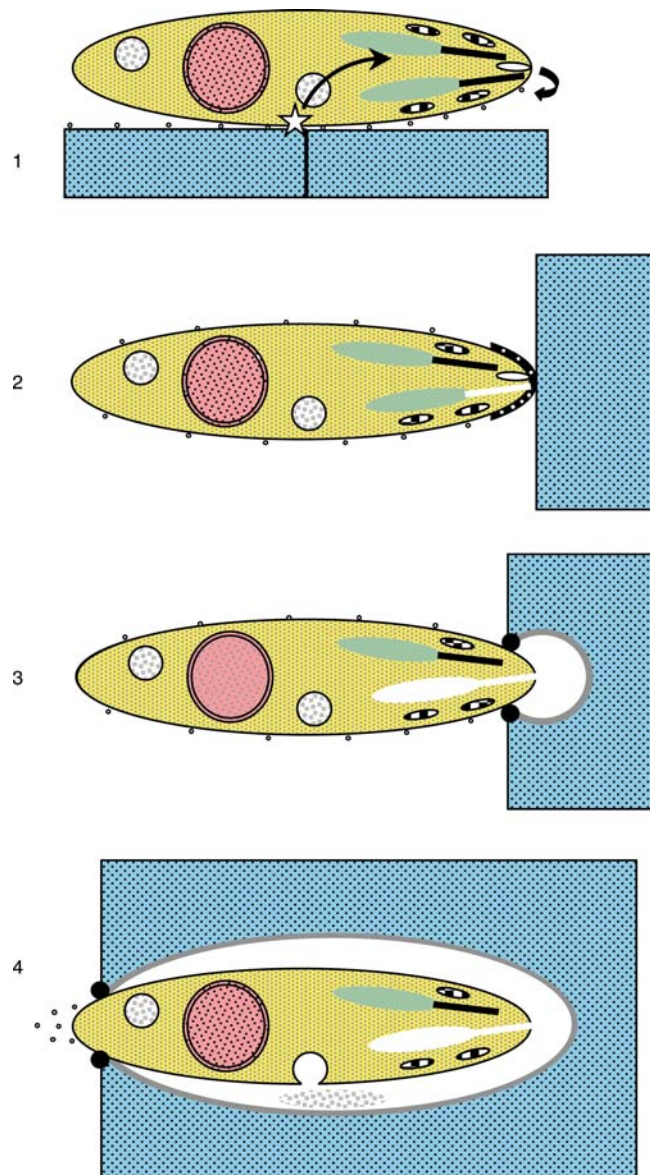

**Apicomplexa. Figure 8** Schematic drawing of the successive steps of Apicomplexa invasion. 1 A zoite glides on a host-cell surface using microneme proteins exocytosed apically (curved arrow); a signal is transduced from the surface (star, arrow) to the apex. 2 The signal induces reorientation, apical binding to the host cell, rhoptry neck exocytosis, formation of the moving junction from microneme and rhoptry neck proteins. The bulk of micronemal material is capped behind the moving junction. 3 Rhoptries are exocytosed while the moving junction glides backward and the parasitophorous vacuole starts expanding. Rhoptry material is integrated in the vacuole membrane. 4 The vacuole keeps expanding, getting most of its lipids from the host cell plasmalemma. The junction reaches the posterior end of the parasite and eventually seals the vacuole. Dense granules are exocytosed in the vacuolar space. (After Dubremetz et al., *Int J Parasitol*, 28, 1009–1011, 1998, modified).

2 of them in *T. gondii* are targeted to the host nucleus where they modulate the host cell transcription. Dense granules are exocytosed into the vacuole after invasion and their role is not well understood, yet they are probably involved in rendering the vacuole contents and membrane efficient to sustain parasite metabolic needs. In *P. falciparum*, a →dense granule protein (RESA)

is translocated under the erythrocyte membrane and associates with spectrin.

A peculiar process has been described for the piroplasm →*Theileria*: invasion of mononuclear lymphocytes by sporozoites seems to involve a zipper mechanism in a receptor-mediated →endocytosis due to specific receptors on the zoite surface. These

findings are very unique among Apicomplexa and may represent an exception to the moving junction process. In addition, in this model, as in the other piroplasm *Babesia* (which invades red cells in a manner very similar to *Plasmodium*), the vacuole membrane is disintegrated after invasion and the parasite develops in the cytoplasm of the host cell.

---

## Apicoplast

The putative origin of this characteristic organelle now called apicoplast, was and is, still highly disputed. The original description of two membranes as border of the organelle led to the former name “double-walled organelle or vesicle”. However, recently authors described 3 and 4 membranes as limiting system of the apicoplast in different coccidian species.

Since the number of wall membranes is a strong indicator to distinguish primary (with two membranes) from secondary (with 3–4 membranes) plastids, the exact clarification of the apicoplast’s border is essential.

The appearance of membranes on electron micrographs is, however, a tricky thing. Only long series of serial sections elucidate, whether infoldings of the inner membrane of a double-walled organelle would let appear – erroneously – 3 or even 4 membranes. Recent serial sections done by Köhler (2005/2006) in the editor’s laboratory clearly indicate at least in *Toxoplasma gondii*, that there are in several apicoplasts only 2 membranes, the inner of which undergoes a variety of infoldings. Whether the described triple-membrane arrangement in malarial parasites is consistent, whether it is the result of an artificial ultra-thin sectioning or whether it is due to a reduction of a further membrane during evolution, remains unclear. In any case, however, the apicoplast contains besides its activities in protein translation, fatty acid and isoprenoid synthesis as well as in iron-sulfur biogenesis typical plant-specific metabolic pathways, which are not found in mammalian cells. This gives a hint that there might be ancestors of the apicoplast in the group of small unicellular algae.

---

## Apiosoma

Genus of about 0.1–1.0 mm sized ciliates (syn. *Glossatella*), which parasitize at inflamed skin of fish (Fig. 1). → Ciliophora.

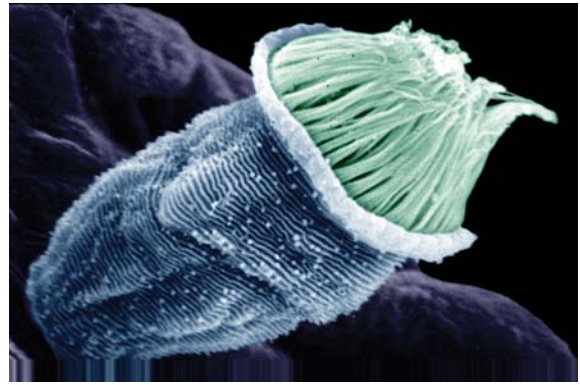

**Apiosoma.** Figure 1 SEM of a sessile stage of *Apiosoma* sp.

---

## Apolysis

Detachment of →proglottids from the →strobila of →Cestodes, →Eucestoda, or cuticle from →arthropoda.

---

## Apomorphic Character

→Phylogeny.

---

## Apomorphy

A derived character state.

---

## Aponomma

Genus of hard →ticks, the species of which feed in warmer countries at the surface of reptiles.

---

## Apophallus muehlingi

### Classification

Species of →Digenea.

### Life Cycle

Fig. 1.

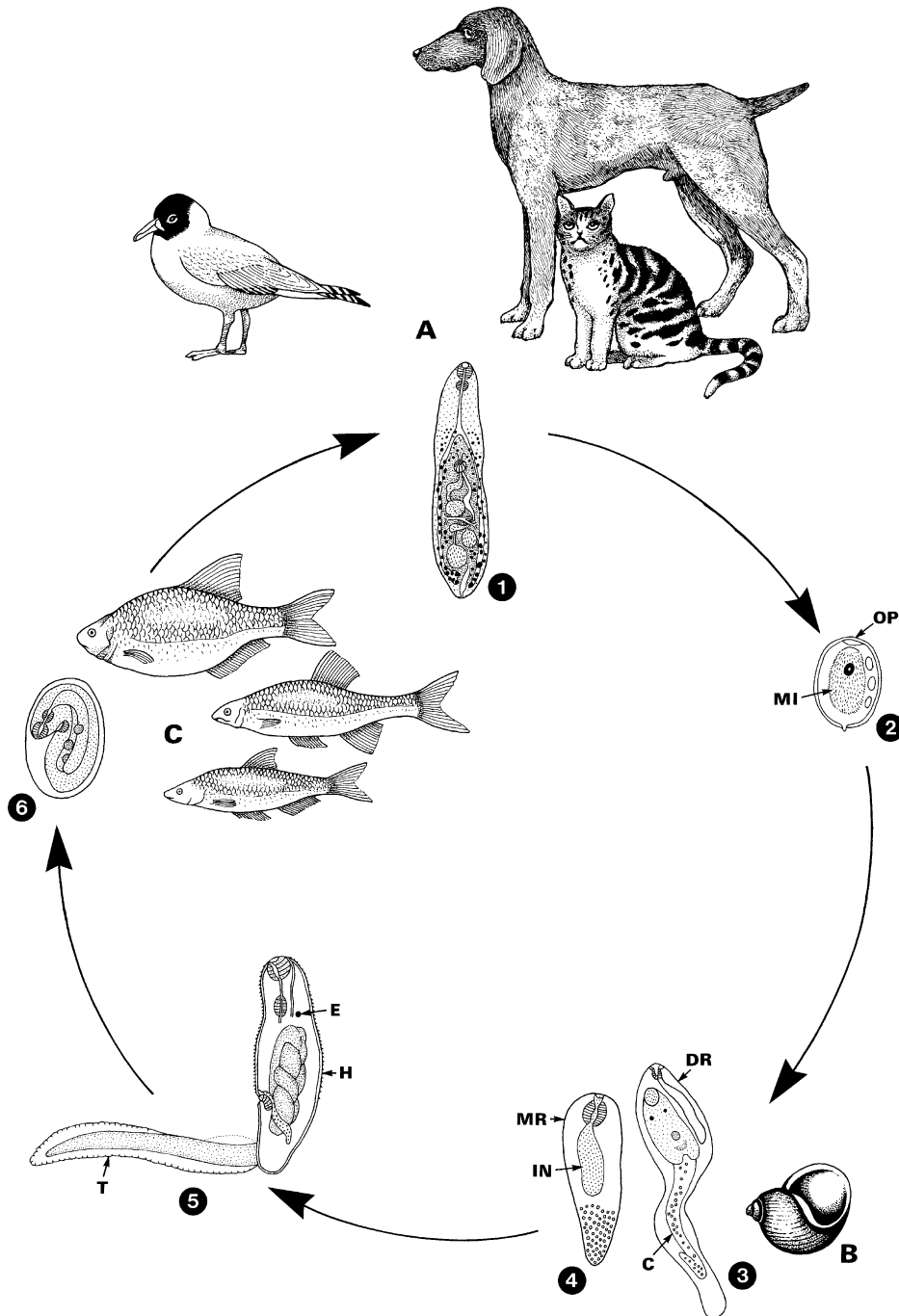

**Apophallus muehlingi.** Figure 1 Life cycle of the digenean *Apophallus muehlingi* that parasitizes in the intestine of several fish-eating animals (A) according to Odening 1970 (especially in the region of the Eastern Sea and Black Sea). 1 Adult worm (about 0.8 mm long). 2 Operculated and fully embryonated eggs ( $34 \mu\text{m} \times 28 \mu\text{m}$ ) are set free with the feces of the hosts. The  $\rightarrow$ miracidium does not leave the egg until it is eaten by fresh water or brackish water snails (B,  $\rightarrow$ *Lithoglyphus naticoides*). 3-6 Inside the snails reproduction occurs via  $650 \mu\text{m} \times 140 \mu\text{m}$ -sized  $\rightarrow$ rediae (3, 4), within which tailed  $\rightarrow$ cercariae (5) with eyespots are formed. These stages including tails up to 700  $\mu\text{m}$  in size leave the snails and penetrate into cyprinid fish (C), in whose fins they become encysted as  $\rightarrow$ metacercariae (6). When such infected fish are eaten by the final hosts, the metacercariae leave the cysts in their intestine and mature to adult worms within 7 days, e.g., in *Larus*-sea birds. C, cercaria; DR, redia with 6–12 cercarial embryos; E, eyespot; H, head of cercaria; IN, intestine; MI, miracidium; MR, mother redia; OP,  $\rightarrow$ operculum; T, tail of  $\rightarrow$ cercaria.

## Apoptosis

Metazoa are known to possess a sophisticated machinery of programmed cell death (PCD), which limits the life span of cells and prohibits cell exaggeration leading to tumors. Recently PCD has also been found in parasitic protozoans, e.g., in trypanosomes, malaria parasites, leishmanian species, trichomonads. As apoptotic markers had been described: chromatin condensation, DNA fragmentation, externalization of phosphatidylserine, and caspase-like activities. This way of self-limitation in protozoans is much less complex than in metazoan. It brings the advantage to these parasites, that they do not lose their hosts by killing them, before a small part of the population has been transferred to the next host. Thus the parasite density in a host does not rely exclusively on the host's immune system. Since the apoptosis of protozoans is different from that of metazoans, it might be used as target for new chemotherapeutics.

However, intracellular parasites have also developed methods to survive by maintaining their host cell, if the natural response of the infected cells is leading to the reaction to commit apoptosis and thus to deprive the invader of the opportunity to multiply and to disseminate. Such protection from apoptosis is found, e.g., in cells parasitized, e.g., by →*Toxoplasma gondii*, →*Leishmania* spp. or →*Theileria* stages. The latter even stimulate their host cells (lymphocytes) to constantly repeated divisions like that of tumor cells.

## Apparent Infection

Infection followed by symptoms of disease.

## Application

Mode of treatment or mode of experimental infection, e.g., orally, intramuscularly, subcutaneously, intraperitoneally, etc.

## Apterygota

Subclass of →insects characterized by the absence of wings.

## Arachnology

Comprises the knowledge of spiders (Greek: *arachne*), mites, ticks, scorpions which are united in the systematic unit Chelicerata within the phylum Arthropoda.

## Araneidae

Family of spiders: the bites of some of them are poisonous for humans: e.g., *Latrodectes mactans* (Black widow of the Americas, Europe), *Loxosceles* species (Brown recluse spider (Americas), Australian red back funnel spider (*Latrodectus hasselti*), etc.).

## Arboviruses

### General Information

Arboviruses (=arthropod-borne) is a collective name for those viruses which (1) replicate in certain arthropods as well as (2) in certain vertebrates and which are (3) transmitted by bloodsucking arthropods between their vertebrate hosts with the saliva during their blood meals. The biological (=cyclic) transmission with replication of the virus in the arthropod is a crucial criterion. A virus adhering to the mouthparts of a bloodsucking arthropod and transmitted mechanically without prior replication in the salivary glands is not an arbovirus. Thus, arbovirus is only an ecological and biological term without any phylogenetic relevance (Fig. 1).

### System

Arboviruses are to be found in different virus families: among double-stranded DNA viruses (Asfarviridae →African swine fever virus), among double-stranded →RNA viruses (→Reoviridae: Orbivirus, Coltivirus, Seadornavirus), among negative-sense single-stranded RNA viruses (→Rhabdoviridae: Vesiculovirus, Epimerovirus; →Orthomyxoviridae: Thogoto-like viruses; →Bunyaviridae: Bunyavirus, Nairovirus, Phlebovirus), and among positive-sense single-stranded RNA viruses →Flaviviridae →Flavivirus; →Togaviridae: Alphavirus). Altogether about 600 viruses have been assigned to the arboviruses, some of them were withdrawn later, but in most of them the above-mentioned criteria could be proved, in some (which have been isolated either from arthropods or from vertebrates only) the arbovirus nature has been concluded from close antigenic relationships to other confirmed arboviruses. Most arboviruses

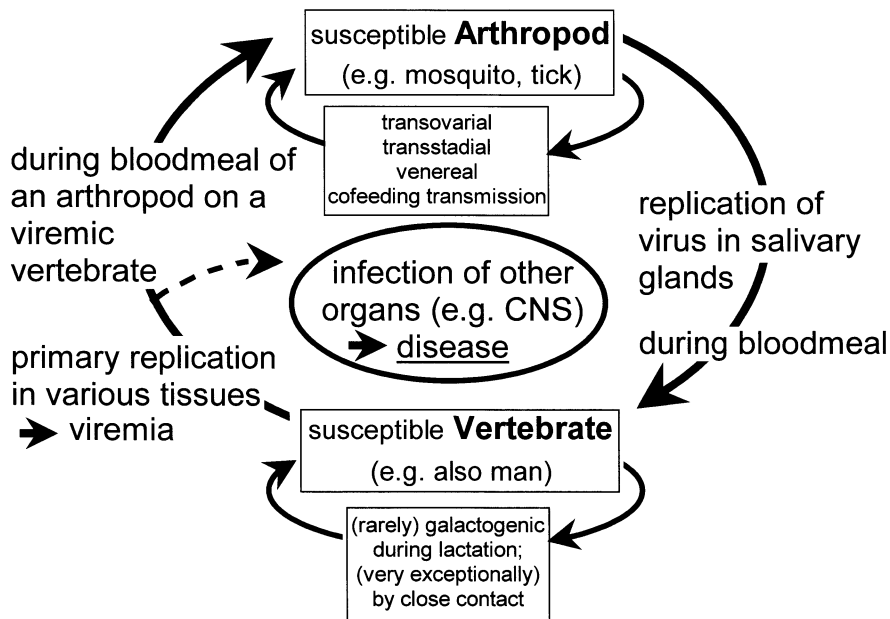

**Arboviruses. Figure 1** Arbovirus cycles.

are to be found among the →*Reoviridae* (about 150 species), *Bunyaviridae* (about 200 species), →*Flaviviridae* (about 60 species) and →*Togaviridae* (about 30 species). Among the other families (apart from the family *Asfarviridae*) arboviruses are more or less exceptional. [Table 1](#) gives an overview of the genera of those virus families (also) comprising arboviruses.

Some of the viruses called “species” have turned out or will turn out to represent only slightly different strains of other “species,” on the other hand, there is no doubt that a large number of arboviruses still remains to be detected. Moreover, one can hardly doubt that – besides many arboviruses without any medical significance – viruses causing (known or unknown) diseases in man and/or animals will also be discovered. It is difficult to estimate how many arboviruses may exist – possibly several thousand. Thus arboviruses will continue to form an important challenge to virologists as well as to parasitologists. The tables →*Arboviruses L-X* (→*ASF Viruses*, →*Asfarviridae*, →*Bunyaviridae*, →*Flavivirus*, →*Orthomyxoviridae*, →*Reoviridae*, →*Rhabdoviridae*, →*Togaviridae*) list selected species of arboviruses with indication of hosts, distribution, and diseases in man and animals. These tables include all arboviruses causing diseases of major significance and/or prevalence and representatives of all families. Most remaining species are poorly known. Some of them apparently cause febrile illness in man (and animals), but many have so far (under natural conditions) not yet been correlated to any symptoms in man or animals (which does not necessarily mean that they are strictly apathogenic, of course).

It should be noted that the concept of species, genera, and families in virology is quite different from that in other biological disciplines and that a real phylogenetic system of viruses does not and will not exist for principal reasons. Viruses derive from living organisms, thus similar viruses may have quite different and independent origins, although evolution, following the well-known factors of mutation, selection, isolation, etc., does occur to a certain extent within certain taxonomic entities, of course, so that monophyla do also exist at various levels among viruses. Most virus families and at least many virus genera are, however, not monophyla but assemblies of members with a high degree of (genomic) similarities and, in many cases, of similar, but independent origins. It has been suggested that at least most arboviruses derive from their arthropod hosts. This assumption is supported by the fact that arboviruses usually do not cause disease or life-threatening damage in their arthropod hosts (exceptions exist, particularly among *Togaviridae*), but often cause more or less serious harm in their vertebrate hosts.

## Important Families

Table 1.

## Distribution

Arboviruses occur in all continents, even in high latitudes where →*mosquitoes* may develop large populations. Moreover, seabirds flying far into the north may act as hosts of tick-borne viruses. It is, however, striking that the number of arboviruses endemic to a

**Arboviruses. Table 1** Virus families containing arboviruses

Family	Characterization	Genera representing Arboviruses	Main arthropod hosts	Genera other than arboviruses (hosts in brackets)
Asfarviridae	ds-DNA viruses, spherical, with envelope, 175–15 nm	Asfivirus	Ceratopogonidae	
Reoviridae	ds-RNA viruses, icosahedral, without envelope, 60–80 nm	Orbivirus	Ceratopogonidae Phlebotominae Culicidae Ixodidae	Orthoreovirus (vertebrates) Rotavirus (vertebrates) Aquareovirus (vertebrates) Cypovirus (invertebrates) Phytoreovirus (plants) Fijivirus (plants) Oryzavirus (plants)
		Coltivirus	Ixodidae	Idoreovirus (invertebrates)
		Seadornavirus	Culicidae	Mycoreovirus (fungi)
Rhabdoviridae	negative-sense, non-segmented, ss-RNA viruses, rod-shaped, with envelope, 100–430 × 45–100 nm	Vesiculovirus	Culicidae Phlebotominae	Lyssavirus (vertebrates) Cytorhabdovirus (plants)
		Ephemerovirus	Culicidae Phlebotominae	Nucleorhabdovirus (plants)
Orthomyxoviridae	negative-sense, segmented, ss-RNA, spherical or filamentous, with envelope, 80–120 nm	Thogotovirus	Ixodidae	Influenzavirus A (vertebrates) Influenzavirus B (vertebrates) Influenzavirus C (vertebrates) Isavirus (vertebrates)
Bunyaviridae	negative-sense, segmented, ss-RNA, spherical, with envelope, 80–120 nm	Orthobunyavirus	Culicidae Ixodidae	Hantavirus (vertebrates) Tospovirus (plants)
		Nairovirus	Ixodidae Argasidae	
		Phlebovirus	Phlebotominae Culicidae Ixodidae	
Flaviviridae	positive-sense non-segmented ss-RNA, spherical, with envelope, 40–50 nm	Flavivirus	Ixodidae Culicidae	Pestivirus (vertebrates) Hepacivirus (vertebrates)
Togaviridae	positive-sense non-segmented ss-RNA, spherical, with envelope, 70 nm	Alphavirus	Culicidae	Rubivirus (vertebrates)

certain geographic region increases towards the equator, and the subtropical and particularly tropical regions harbour by far the largest number of arboviruses.

In Europe more than 60 arboviruses have been isolated, among these there are also 6 phleboviruses which are transmitted by sand flies; they cause Papataci fevers or reningitis which occur in Southern Europe. Even on a Europe-wide scale the →[tick-borne encephalitis](#) virus remains the most important arbovirus, but a few others may also lead to diseases of the Central nervous system.

Central Europe harbours (at least during certain periods in certain years) 11 arboviruses. Of these 6 are tick-borne: Tribec, Lipovnik, Eyach, Uukuniemi, Bhanja, and Tick-borne Encephalitis (→[TBE](#)); all of them are transmitted by ixodid →[ticks](#), mainly *Ixodes ricinus*. Four viruses are transmitted by mosquitoes:

Calovo, Tahyna, Lednice, West Nile. Calovo is transmitted by Anophelinae, the others by Culicinae. Tribeé, Lipovnik, Eyach, Uukuniemi, TBE, Calovo, Tahyna, and (at least partially) Lednice are probably endemic to Central Europe and also hibernate in this part of Europe. Some arboviruses, (e.g., Usutu virus) are most probably more or less regularly introduced by migrating birds to Central Europe and may get established for longer periods. Although at least Tahyna and Calovo viruses are endemic (in the sense of occurring in the area throughout the year), it has to be questioned whether Central Europe harbours autochthonous mosquito-borne viruses in the strict biogeographic sense. Of these 11 viruses 9 may cause diseases in man, the most important of them being tick-borne encephalitis virus which claims many severe cases every year, sometimes sporadically even deaths. (Before the

development of a vaccine and the broad application in the human population in some parts (particularly Austria the importance of TBE in Central Europe was much higher.) The other viruses cause febrile illnesses of various clinical symptoms (Tables → [Bunyaviridae](#), → [Flavivirus](#), → [Reoviridae](#), → [Togaviridae](#)).

Due to the complexity of the synecological systems in which arboviruses circulate (see below) preconditions for the maintenance of the virus cycle are usually fulfilled in limited areas only. These areas are called foci to which the viruses are endemic. (The terms “endemic” and “endemisms” have different meanings in biology and medicine. In biology “endemic” means “restricted to a certain biotope or region, mountain range, island, etc.” In medicine “endemic” is more or less a synonym of “autochthonous”). Thus, amplification of a focus is usually difficult. Formation of new foci requires suitable ecological conditions. New and dispersed foci may be established by introduction of virus into a suitable biocoenosis by migrating viremic birds or by larger mammals, in particular man may also act as an amplifier host. → [Dengue](#) and → [Yellow fever](#) are impressive examples of how the migrating species *Homo sapiens* has established numerous new foci of these arbovirus infections in many tropical and subtropical parts of the world. During the 18th and 19th centuries Yellow fever virus was introduced to several towns in the South of Europe (Spain, Portugal, Italy, France) and was established for shorter periods. In the 20th century Dengue I virus was introduced to Greece where it led to a major epidemic in 1928. Bluetongue viruses were introduced and caused heavy epidemics among livestock in Southern and Central Europe. Principally, this anthropogenic dispersal of arbovirus infections plays an important role in all arbovirus cycles in which man is the main vertebrate host (see below [Fig. 2](#)).

## Vectors

The following arthropod families comprise vectors of arboviruses: → [Ixodidae](#) (hard → [ticks](#)), → [Argasidae](#) (soft ticks), Culicidae/Culicinae, → [Culicidae](#)/ Anophelinae (→ [Mosquitoes](#)), Psychodidae/Phlebotominae (→ [Sand Flies](#)), and → [Ceratopogonidae](#) (gnats). Moreover, arboviruses have been isolated from some other arthropod-families (→ [Mites](#), → [Bugs](#), → [Fleas](#), → [Blackflies](#), Horseflies); it is, however, not clear whether (some of) these may (additionally) act as (natural) hosts and biological vectors.

## Life Cycle

[Fig. 1](#) shows the basic structure of an arbovirus cycle. Principally 2 ways can be differentiated: usually the virus is transmitted by bloodsucking arthropods (the vector and arthropod host) to a vertebrate in which it leads to viremia. During this period, which usually lasts

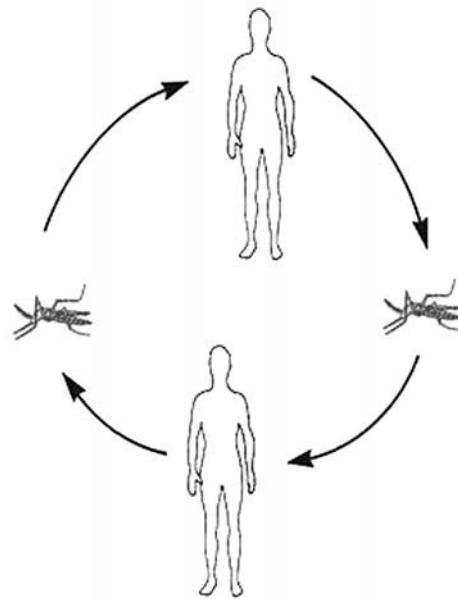

**Arboviruses. Figure 2** Arbovirus transmission cycle involving human as natural hosts (e.g., urban transmission cycle of yellow fever).

only a few days, the virus may be taken up by another bloodsucking arthropod. The vertebrate may or may not become ill shortly before, during, or (particularly) after the viremia. Also, man may be integrated into this form of an arbovirus cycle and may develop disease. In several arbovirus cycles man is even the only vertebrate host maintaining the virus cycle (e.g., dengue, urban yellow fever, Chikungunya), in others man is a dead end of the virus cycle regardless of whether he may develop disease or not. Besides this typical form of an arbovirus cycle there is another one in which the virus may “remain” in its arthropod host being transmitted vertically - transovarially - to the next generation and then transstadially throughout the larval (and pupal) stages to the adults. Moreover, a sexual (“venereal”) transmission from male to female and vice versa during copulation has also been found in some arboviruses and may occur more often. → [Transovarial transmission](#) has been established only in a comparatively small number of arboviruses; one may, however, assume that it will principally occur in most (if not all) arboviruses, regardless of whether they are transmitted by ticks, mosquitoes, → [sand flies](#), or gnats.

An unusual mode of infection has been described in ticks: uninfected ticks feeding simultaneously with infected ticks on the same host may become infected, despite the absence of a true viremia of the host, by uptake of virus released by the infected ticks, most probably after replication in certain cells of the skin. This mechanism, which is not yet fully understood, might possibly be of greater significance in arboviruses.



Virus ingested during a blood meal first infects epithelial cells lining the midgut; subsequently it is released into the hematocele from where the salivary glands as well as the ovaries can be infected. The susceptibility of the midgut epithelium is the primary determinant for the vector competence of an arthropod. Infection of the salivary glands may take place after secondary amplification in other cells (tissues) or without secondary amplification. The period between the ingestion of virus during a blood meal and the salivary secretion is called extrinsic →incubation period (EIP). This interval must not exceed the lifespan of an arthropod acting as a potential vector. In some alphavirus species the tissue of the midgut is damaged so heavily by the infection that it becomes “perforated,” which enables the virus to enter the haematocoel and thus to rapidly infect the salivary glands. This leads to an unusually short extrinsic incubation period.

Temperature is of great influence on the length of the EIP, which usually lasts a few days; increased temperature may lead to shortening of EIP and/or to an increase of viral replication and in this way to an increase in transmission rates. Co-infections with other pathogens may also have an influence, e.g., microfilariae penetrating the midgut epithelium cause lesions which facilitate the virus transfer to the haematocoel. Virus transfer from a mosquito to the vertebrate mainly occurs during probing of the host tissues with the mouthparts in order to find a small vessel. Therefore the first replication takes place in extravascular tissues. In viruses transmitted by ticks, which are →pool feeders, there is a comparable situation. Other factors influencing the capacity of a given arthropod species for the virus cycle are virus amount in salivary glands, number of generations, population densities and population dynamics, frequency and duration of blood meal, horizontal and vertical distribution, →circadian rhythms, and host spectrum. From all these factors the number of individuals capable of transmission in a given biocoenosis results as a key parameter.

Vertebrate hosts of arboviruses comprise numerous mammals on the one hand and birds on the other hand; moreover in a few cases reptiles or amphibians are (or may be) of importance. The suitability of a given vertebrate species to act as a host significant to the maintenance of the cycle depends on several factors, the most important being virus concentrations reached during viremia and length of viremia as a crucial prerequisite to successfully infect a sufficiently high number of vectors. Other parameters are population density, population dynamics, reproduction rates and life expectation, degree of (homologous and heterologous) immunisation in a population, horizontal and vertical activity, circadian rhythm, and spectrum of bloodsucking parasites; from these parameters the number of susceptible and finally the number of viremic vertebrate hosts results.

Taking all these factors into consideration from the perspective of the arthropods on the one hand and of the vertebrates on the other hand, a very complex and rather vulnerable synecological system results.

In arboviruses occurring in temperate zones an important ecological problem in the virus cycle results from winter and thus →hibernation. This can be overcome by several mechanisms: →vertical transmission in the arthropod host, survival in hibernating (larval or adult) stages of arthropods, →chronic infection in vertebrate hosts with persisting or recrudescing viremia (e.g., in heterothermic mammals like →bats and hedgehogs), or regular introduction by migrating birds (with a prolonged viremia) from tropical regions. Hibernation of tick-borne viruses is usually easily achieved by persistence of the virus in the larvae or nymphs and by →transstadial transmission. In some mosquito-borne viruses overwintering is also possible in adult mosquitoes (e.g., →*Anopheles* spp., *Culiseta* spp., →*Culex* spp. hibernating as adults).

Although vertical, transovarial (and sexual) transmission are biologically remarkable phenomena and important mechanisms, it seems, unlikely that maintenance of virus in a certain biocoenosis can be achieved by such modes without regular participation of mammals in the virus circulation.

Under certain circumstances an arbovirus can also be transmitted from one vertebrate to another. A natural way is the →galactogenic transmission during lactation to the progeny or (in case of animals whose milk is used) to man (Fig. 3). In tick-borne encephalitis smaller outbreaks in the human population due to consumption of raw, infective milk have been described. Virus in the milk is found only during the viremic stage of the lactating animal.

Contact with injured (living or killed) animals can also lead to infection as it has been known from arboviruses with vertebrate hosts which are hunted or slaughtered. This is of particular importance in the transmission of Rift Valley fever, Crimean Congo hemorrhagic fever, or Alkhumra hemorrhagic fever to man.

Finally there are also a few viruses which have never been isolated from an arthropod and which are apparently transmitted between their vertebrate hosts by close contact only (e.g., Modoc, Rio Bravo). These viruses are not arboviruses by definition; they have, however, been included due to their close antigenic relationship to other viruses which present all characters of a real arbovirus.

From the viewpoint of host capacity for arbovirus circulation, vertebrates can be assigned to 3 groups: (1) species which are not susceptible (natural resistance; e.g., due to the lack of receptors) at all and in which, therefore, no virus replication will take place; (2) species which are susceptible but will develop only

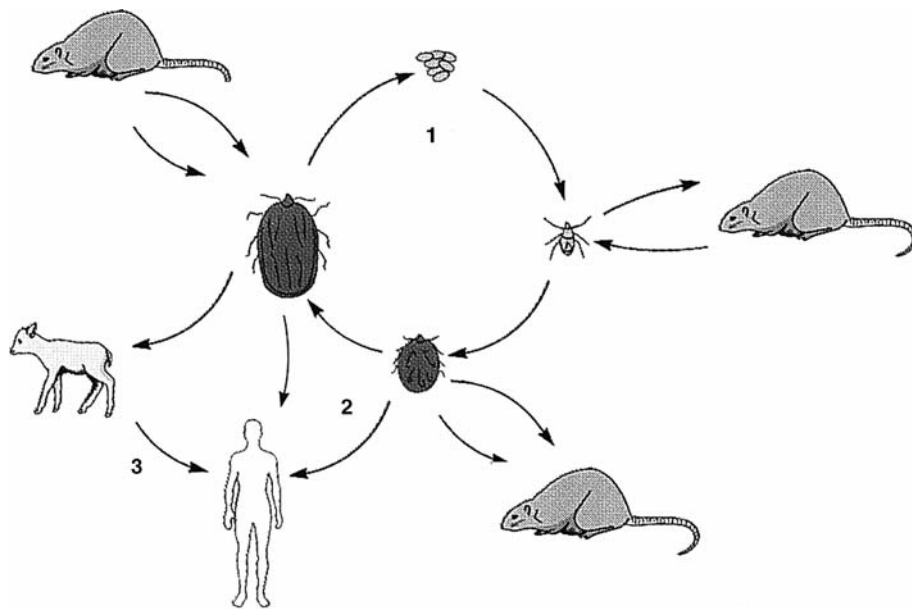

**Arboviruses. Figure 3** Transmission cycle of an arbovirus (tick-borne encephalitis virus) with humans as dead-end hosts. **1.** natural transmission cycle between rodents and ticks; **2.** natural transmission from vector (ticks) to humans; **3.** unusual transmission from one dead-end host (goat) to humans by milk.

a low (and/or short) viremia which is not sufficient for a successful infection of arthropod dead-end hosts. These species are therefore of no significance for the maintenance of the virus cycle; (3) species which are susceptible and will develop a viremia sufficiently high and long to infect arthropods (natural vertebrate hosts). These are the species maintaining the virus cycle. Apart from the intensity and duration of viremia, species of groups (2) and (3) may, but need not necessarily, develop a disease. Usually those vertebrates which are essential for the maintenance of the cycle will not develop (a life-threatening) disease; in many cases they do not even show any symptoms. This seems to be in good agreement with general considerations on parasites; one must, however, take into consideration that a vertebrate infected with a virus will develop immunity which prevents reinfection. Thus a vertebrate host can contribute to the virus cycle directly during its viremic stage only for a very short period. After that (apart from very rare →Chronic infections with persisting or relapsing viremia) the vertebrate will not be a source of infection. Nevertheless, it may contribute indirectly to the virus circulation by acting as a host for arthropods which maintain the circulation (e.g., ticks will reach higher populations if hosts are abundant). Therefore vertebrate species developing severe disease with a high mortality may also act as maintaining hosts, particularly if they have high population densities with a sufficient percentage of non-immune individuals. Dengue and Yellow fever are good examples; in urban areas with circulation between *Culicidae* (*Aedes*

*aegypti*) on the one hand and man on the otherhand, man will develop serious disease. In many cases those vertebrate species which suffer from life-threatening arbovirus infections (e.g., horses infected with EEE or WEE) do not develop sufficiently high viremia to be of any importance for the virus cycle.

### Syndromes

Out of the 600 arboviruses described so far about 150 have proved to be pathogenic for man. In some infections only antibodies, but no symptoms were found thus at least indicating that man is susceptible. The syndromes caused by arbovirus infections can be roughly divided into (1) febrile illnesses, usually with headache, rash, with or without arthralgia and polyarthrititis (Dengue, West Nile, Chikungunya, Mayaro, Ockelbo, O'nyong-nyong, Ross River, Semliki, Sindbis, and many others), sometimes, however, also with neurological symptoms (e.g., in recent outbreaks of West Nile infections); (2) haemorrhagic fever (→Crimean-Congo haemorrhagic fever, →Omsk haemorrhagic fever, →Kyasanur Forest disease, Dengue, Yellow fever, Rift Valley fever, Alkhumra fever, garissa fever); (3) neurological disorders with meningitis and →encephalitis (Kyasanur Forest disease, Powassan, tick-borne encephalitis, →Eastern equine encephalitis, Venezuelan equine encephalitis, Western equine encephalitis, and others).

Arbovirus infections have a tremendous impact on human health throughout the world. Every year millions

of people become infected by arboviruses, many hundreds of thousands of whom develop diseases. Every year smaller or larger epidemics – e.g., due to Dengue viruses, Yellow fever virus, Chikungunya virus, Japanese encephalitis virus, Rift Valley virus, etc., with a varying number of deaths – are reported. Also the economic loss in livestock due to arbovirus infections is serious. Several arbovirus infections have been of considerable influence on human history. Yellow fever (which was most likely introduced to America during the dark era of transports of slaves from Africa) led to a defeat of the French army on the Caribees at the beginning of the 19th century so that Napoleon was forced to sell Louisiana to the USA, thus putting an end to French colonial strategies and influence in North America. Later in the 1880s, Yellow fever thwarted the construction of the Panama canal and led to a financial disaster and condemnation and the sentencing of the famous French engineers A.G. Eiffel and F. Lesseps. Only at the beginning of the 20th century, after it had generally been accepted that Yellow fever is transmitted by mosquitoes, mainly *Aedes aegypti*, and that mosquito control is crucial for fighting against Yellow fever, the Panama canal could be built.

### Therapy

There are no specific drugs for treatment of any arbovirus infection, only symptomatic treatment is possible.

### Vaccines

There are only three arboviruses against which vaccines are available and in general use: Tick-borne encephalitis virus (inactivated virus propagated in chicken cells), Japanese encephalitis virus (inactivated virus propagated in mouse CNS or in hamster kidneys or – in China – a living attenuated strain) and Yellow fever virus (attenuated strains). In addition, several “noncommercial” vaccines against a few arboviruses have been in use to protect laboratory and veterinary workers (e.g., against Rift Valley fever, Eastern, Western and Venezuelan equine encephalitis). These are usually inactivated vaccines, but also living vaccines (e.g., VEE) are in use. Moreover, a vaccine (attenuated strain) against Dengue has been developed and is now tested in field trials.

---

## Archaeopsylla erinacei

Flea of hedgehog, →Fleas.

---

## Archezoa

Subkingdom 1 according to 2000's classification being characterized by unicellular eukaryotic, phagotrophic, nonphotosynthetic organisms without cell walls. It includes the phylum Metamonada with its families Diplomonadidae, Enteromonadidae, and Retortamonadidae.

---

## Archiacanthocephala

→Acanthocephala.

---

## Archigetes Species

### Classification

Genus of →Eucestoda.

### Life Cycle

Fig. 1 (page 121).

---

## Argas

### Classification

Genus of →Ticks.

### Important Species

Table 1 (page 121).

### Life Cycle

Figs. 1–3 (pages 122–123).

---

## Argasidae

### Synonym

Soft →ticks, leather ticks.

### Classification

Family of →Ticks (genera →Argas, →Ornithodoros).  
→Acarina.

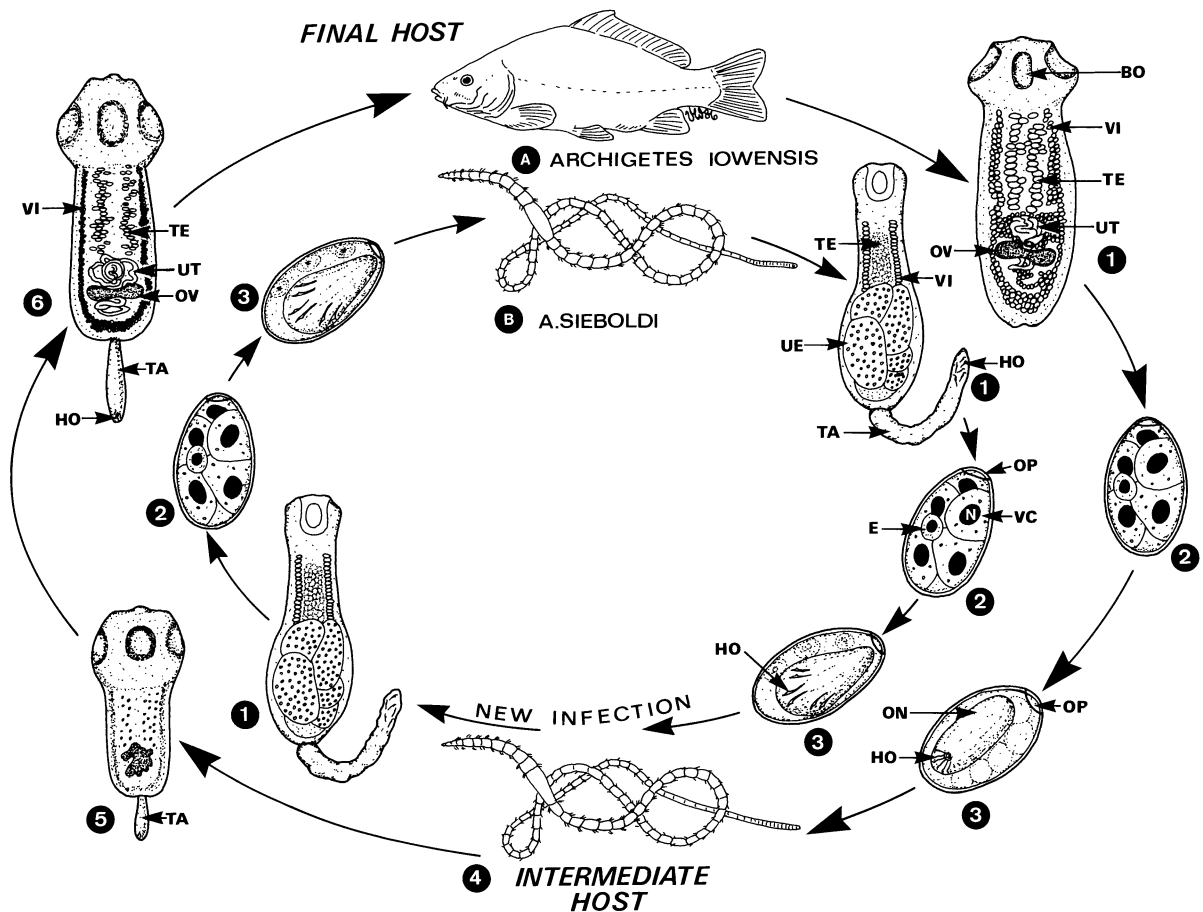

**Archigetes Species. Figure 1 A, B** Life cycles of *Archigetes iowensis* (A) and *A. sieboldi* (B) according to Mackiewicz and others. 1 The monoecious sexually mature stages live in the intestine of many fish species (A) or in the body cavity of oligochaetes (=annelids; *Limnodrilus*, *Tubifex*). According to some authors, *A. sieboldi* should also form fertile stages in fish hosts. 2 Unembryonated eggs enter the water with the feces (A) or after death of the oligochaete (B). 3 Embryonation is completed after about 14–16 days in water of about 18–22°C, leading to the formation of an →*oncosphaera* (ON). These eggs are infective for the next host. In *A. sieboldi* the development (1–3) is repeated in another oligochaete (i.e., indirect development). Since the sexually mature stages are proceroids, this development is progenetic. 4–6 In *A. iowensis* an →*intermediate host* is obligatorily involved; this may also occur (according to recent articles) in *A. sieboldi* if fish are used as final hosts. When oligochaetes swallow infective eggs, the oncosphere escapes from the egg and penetrates into the body cavity. Each oncosphere develops into a →*proceroid* larva at this site. Each proceroid forms complete reproductive organs within 60 days (6). When such proceroids are eaten by a final host, the larva loses its →*cercomer*, becomes adult, and starts production of sperms and →*oocytes*. After copulation eggs are passed with the host feces. BO, →*bothrium* (acetabular sucker); E, egg cell; HO, hooks of oncosphaera; N, nucleus; ON, oncosphaera; OP, →*operculum*; OV, ovary; TA, tail; TE, →*testis*; UE, uterus (gravid) filled with eggs; UT, uterus; VC, vitellary cell; VI, vitellary glands (→*Vitellarium*).

**Argas. Table 1** Important species of the genus *Argas*

Species	Length (mm) of unfed adults	Hosts during development	Main hosts	Disease (pathogens)	Type of bite-transmitted pathogens
<i>Argas persicus</i>	f 5.5–11 m 5.5–8	Many	Chickens	Fowl spirochaetosis ( <i>Borrelia anserina</i> )	S
<i>A. reflexus</i>	5–8	Many	Pigeons	<i>Borrelia anserina</i>	S

m = male, f = female, S, *spirochaeta*

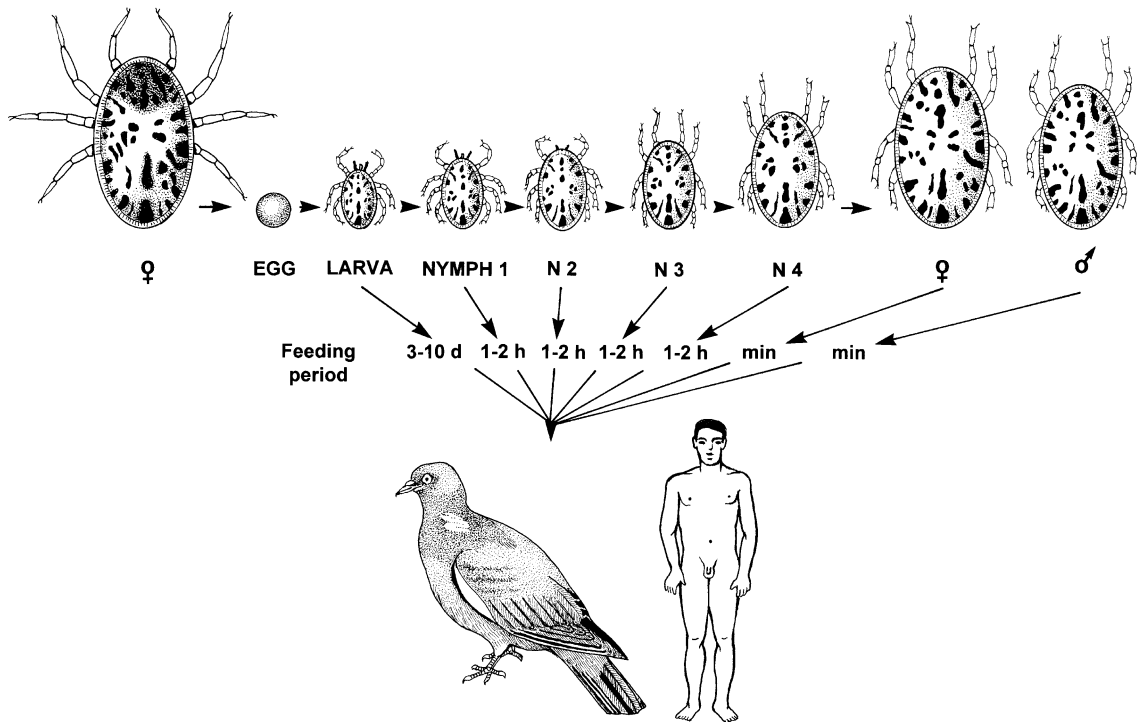

**Argas. Figure 1** Developmental stages in the life cycle of the soft tick *Argas* spp., which need about 3–36 months to mature (depending on the temperature). Except for larvae, which suck blood for 3–10 days, all stages feed several times but only for short periods (e.g., adults often only for a few minutes, but always at night).



**Argas. Figure 2** *Argas* specimens, dorsal and ventral side.

### Characteristics

Capitulum not visible from dorsal (except for larvae), the openings of the respiratory system (→*stigmata*) are situated laterally between the pairs of legs III and IV.

### Argasidiosis

Disease due to Argasid →*ticks* (see [Table 1](#), pages 121, 123).



**Argas.** Figure 3 Scanning electron microscopy of the ventral side of *Argas persicus*.

## Argulus

Genus of the class →[Branchiura](#) of the crustaceans; the specimens reach 6–22 mm in length and parasitize (they suck blood and lick digested epidermis) fresh- and saltwater fish. The females of the species →[A. foliaceus](#) (carp; Fig. 1), and *A. coregoni* (salmon) may swim and deposit their eggs at the bottom of the habitat. As opposed to →[nauplius](#) larvae, young adults hatch from

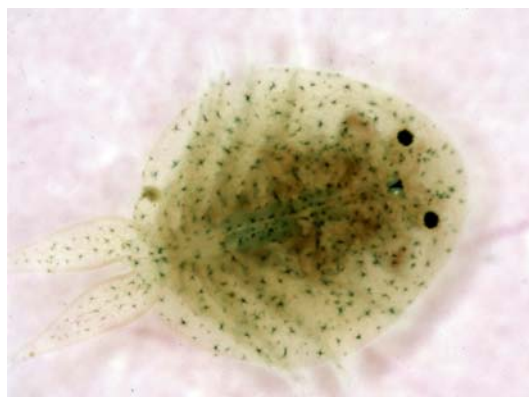

**Argulus.** Figure 1 Carp louse (*Argulus foliaceus*), LM of dorsal side.

the eggs. During sucking *Argulus* species may transmit a broad spectrum of viruses and bacteria.

## Argulus foliaceus

→[Crustacea](#).

## Arista

Long hair with sensilla fixed at the third segment of the antenna of brachyceran flies.

**Argasidiosis. Table 1** Argasid (soft) ticks<sup>1</sup> and Control Measurements

Parasite	Host	Vector for	Symptoms	Country	Therapy		
					Products	Application	Compounds
<i>Otobius megnini</i> (Spinose ear tick)	Cattle, Dog, Horse, Sheep, Man	Tularemia ( <i>Francisella tularensis</i> ), Q-fever ( <i>Coxiella burnetii</i> ), <i>Rickettsia rickettsii</i> (Rocky Mountain spotted fever), Colorado tick fever virus	Ear inflammation, tick paralysis	America, Southern Africa, India	Tactic™ E.C. (Intervet)	Spray or Dip	Amitraz
<i>Ornithodoros moubata</i>	Ruminants, Pig, Man	Q-fever ( <i>Coxiella burnetii</i> ), Spirochaetosis, Relapsing or African swine fever (virus)	Blood loss, dermatitis	Africa			
<i>Argas</i> sp.	Birds, Humans, many other	Fowl Spirochaetosis ( <i>Borrelia anserina</i> )	Blood loss, dermatitis	World-wide	Blattanex® (Bayer)	Spray	Azamethiphos

<sup>1</sup> Genus *Argas*; room treatment: Blattanex™ (Bayer)



**Argulus.** Figure 2 Carp louse; SEM of ventral side.

## Armilliferidae

→ [Pentastomida](#).

### Morphology

Fig. 1.

## Aromatic diaminidines

→ [Leishmaniacidal Drugs](#) = agents against leishmaniasis.

## Arprinocid

An analogue of purin, stops the hypoxanthin transport in chicken coccidians, → [Coccidiocidal Drugs](#).

## Arrested Larvae

Delayed development (→ [Hypobiosis](#)). In autumn trichostrongylid larvae stop further development inside



**Armilliferidae.** Figure 1 Adult pentastomid *Armillifer armillatus* from lungs of snakes. The pentastomid larvae may penetrate into different organs of humans, if eggs within faeces of snakes are swallowed.

the tissues of their hosts. In spring these arrested larvae resume their development to become adults.

## Artemisinin

→ [Malariaicidal Drugs](#) = agents against protozoal diseases.

## Arteritis

→ [Cardiovascular System Diseases, Animals](#).

## Artesunate

→ [Malariaicidal Drugs](#) = agents against protozoal diseases.

## Arthemether

A methyl ether derivative of artemisinin that is active against malaria and schistosomiasis, → [Malariaicidal Drugs](#).

## Arthropoda

### Name

Greek: *arthron* = segment, *pus, podos* = foot.

## Classification

Phylum of →Metazoa.

## General Information

The metameric arthropods are named with respect to their segmented legs (→Acarina, →Mites) which probably derive from locomotory appendages similar to the parapodia of recent polychaetes. The chitin-protein exoskeleton is common to all groups of arthropods, is secreted by chitogenous cells of the epidermis (hypodermis) beneath it, and not only covers the external surface, but also passes through the mouth into the anterior part of the intestine (→Stomodaeum) and through the anus into the rectal part of the alimentary system (→Proctodaeum). The exoskeleton in the form of chitinous plates (sclerites) covers the metamericly arranged segments of the animal. The single plates are connected by fine membranous elements, thus allowing movements and body flexing by means of the strong inner muscular systems and the hydrostatic pressure of the body fluid. The chitinous cover would hinder growth of the arthropods; thus, it is cast off periodically and a new larger exoskeleton is formed during →molt (→Ecdysis). Most arthropods are monoecious; copulation and internal fertilization are characteristic of the majority of species. Ontogenesis proceeds in all parasitic forms as →metamorphosis involving at least one and sometimes several larval (nymphal) stages. The circulatory system is open with a primitive dorsal heart; respiratory systems of various kinds (gills, trachea, lungs, etc.) may occur, just as different forms of the excretory tract (Malpighian tubules, coxal and antennal glands, etc., →Insects/Fig. 6, →Mites/Fig. 7).

Arthropods have traditionally been divided into two subphyla. Those with antennae have been placed within the subphylum →Mandibulata, thus named because the first postoral appendages are mandibles. Those that lack antennae and mandibles are commonly placed in the subphylum →Amandibulata (others prefer the term →Chelicerata, thus named because the first postoral appendages become feeding organs called →chelicerae).

## System

Recent classifications of the arthropods are under discussion (especially the rank of different taxonomic groups). However, the following groups are accepted *in toto*:

Phylum: Arthropoda.

Subphylum: Trilobitomorpha (the fossil trilobites).

Subphylum: →Chelicerata.

Class: Merostomata (horseshoe crabs and fossil eurypterids).

Class: Arachnida (including orders Araneae = →spiders, →scorpions, →Acarina = →ticks, →mites, etc.).

Class: Pycnogonida (= Pantopoda, sea spiders).

Subphylum: Tracheata.

Class: Chilopoda.

Class: Progoneata.

Class: Insecta (Hexapoda).

Subphylum: Diantennata (Branchiata).

Class: →Crustacea.

## Intestine and Food Uptake

The structure of the intestine and its appendages varies considerably among the various arthropod taxa, depending on their different ways of living and feeding. Even when they feed in the same way (e.g., blood-sucking), different (though convergent) structures, methods, and strategies have developed in →insects, →mites and →ticks.

## Arthropodicidal Drugs

### General Information

Much of the increase in animal productivity as well as prevention and treatment of parasitic diseases over the past half century has been due to more efficacious and economical control of arthropods through the use of synthetical chemical compounds.

Chemical control of parasitic arthropods is a critical resource for worldwide food production as well as human or animal health. There is little doubt that it will remain so for the foreseeable future, but it is also important that progress be made to sustain and enhance its contribution. Achieving this progress depends to a great extent on the synthesis of new parasiticides, a field in research-orientated life science companies that is still highly dynamic.

In the livestock- and companion animal field the demand for chemical control measures has grown with increasing animal numbers and the world wide increase in consumption of meat (Fig. 1).

Arthropod attack causes a variety of damaging effects including reduction in feed efficiency, growth rate, milk and wool production. In addition to lower quantities of finished products, their quality is also impaired and parasite infestation contributes to a loss of general condition and an increase in susceptibility to secondary infections or further parasite attack.

While the level of parasite infestation is generally less severe in pets than in livestock species, the main health concern with dogs and cats is the danger of transmission of →fleas, worms, and tick borne diseases to human beings.

The importance of drugs to control arthropods is reflected by the market development for →insecticides, acaricides and endectocidals displaying activity against some arthropods, and various helminths (avermectinoid drugs).



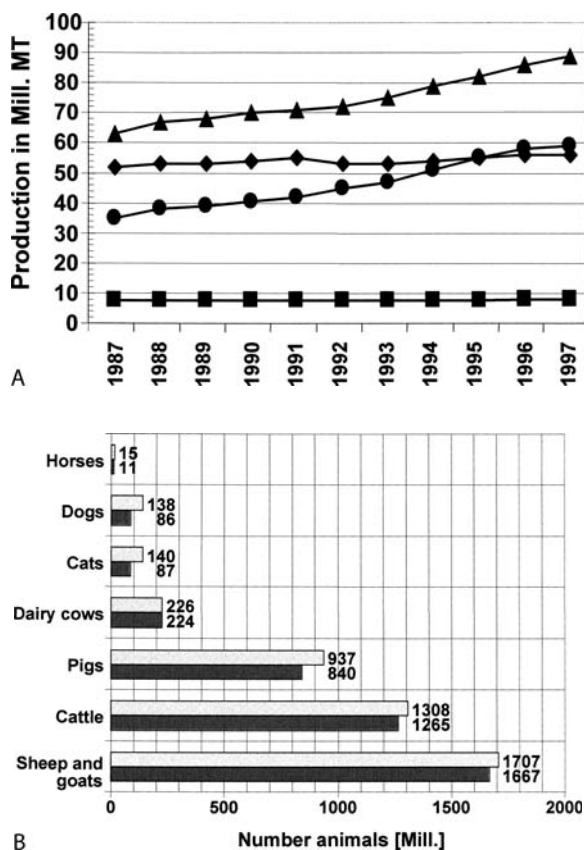

**Arthropodicidal Drugs.** Figure 1 A Development of worldwide production capacities of meat between 1986 and 1997. (◆) Beef and veal; (■) mutton and lamb; (▲) pork; (●) poultry. B Standing animal populations between 1987 and 1997.

Arthropodicidal products currently account for around 14% the world animal health market, which has a value of about US\$ 17 billion (including feed additives). The performance of arthropodicidal drugs has been notable in recent years, while others have been static or declining. This sector has continually expanded worldwide. An amount of US\$ 1,600 Million was spent in 1993 for livestock- and companion animal drugs useful for the treatment of parasitic arthropods (insecticides, acaricides and endectocides without environmental health insecticides). In 1998 the corresponding value increased by about 40% to US\$ 2,300 Million. This trend looks yet to continue and it is expected that the market may increase by 12% until 2002.

In terms of volume the growth rate for livestock arthropodicides is expected to be low. In context, however, with the introduction of new highly innovative drugs against ectoparasiticides of dogs and cats, such as advantage<sup>®</sup> (imidacloprid), program<sup>®</sup> (lufenuron), and frontline<sup>®</sup> (fipronil), a significant expansion is expected in the field of pets.

## Resistance

The spectrum of parasite resistance is one of the major problems affecting the usage of arthropodicidal drugs.

In some regions the development of this trait has rendered compounds practically useless. One solution is to put more effort into careful promotion of the proper use and rotation or combination of compound used in parasite control in order to prolong the life cycle of the products on the market.

Another possibility, and probably the best long term strategy is to increase the search for drugs displaying an alternative →mode of action not interfering with the resistance mechanisms already developed in relevant arthropod pests. Good examples in the area of pets are again imidacloprid, lufenuron and fipronil which act on the nicotinic acetylcholin receptor, chitinbiosynthesis and  $\gamma$ -aminobutyric acid receptor, respectively.

## Improvement of Chemical Product Quality

Particularly in livestock the world trend has now moved firmly away from purely quantitative considerations towards quality of products. Concerns about critical side effects of arthropodicidal compounds which affect the classical targets (acylcholinesterase: organophosphates, carbamates; sodium channel: DDT, pyrethroids; GABA-aminobutyric acid gated chloride channel: chlorinated hydrocarbons) have led the regulatory agencies to demand additionally information and studies in order to define more clearly product efficacy, safety, residue profile and quality. Accompanied by the increasing levels of funding used for regulatory compliance the improvement and innovation in delivery formulations of existing chemical classes was and will be a preferable method for expanding product ranges. Good examples are the development of easy to apply pyrethroid pour on's and spot on's (application of an arthropodicidal drug along the backbone of an animal, or as a spot on in one place) which have considerably infringed the share of environmentally less favourable dips and sprays.

Increasing expenditure on development have led to a tendency to exploit drug properties also by combining different compounds in one product, thereby providing a broader range of activity within one treatment. In particular the combination of anthelmintic with arthropodicidal drugs such as levamisole and famphur to "produce" activity against →stomach worms, →lung worms, cattle grubs and →lice or the combination of insect growth regulators with avermectinoid drugs against intestinal worms and flea larvae are of significant interest in this context (Table 1).

## Formulation and Delivery Systems

The ease of delivering an arthropodicidal drug has become almost as important in terms of it's consumer acceptance as is it's activity against parasites. With the

increasing levels of funding needed to develop new drugs, the improvement in formulation of existing drugs is fast becoming an important method to expand product ranges.

The future trend of innovative delivery systems will probably focus on stress reduction and improvement of convenience. Losses in weight gain and growth performance as well as costs for handling of livestock species can almost reach the spending on medication. Therefore systems which extend the delivery time such as tablets, boluses or other controlled release devices, will reduce handling frequency and may open up possibilities for new administration technologies (Table 2).

As miniaturisation of electronic devices continues to advance one innovative example might be the

development of new bolus types that will release ectoparasiticides, for example insect growth regulators, self- or externally triggered over a long period of time. By eliminating larval development in the pasture and reducing re-infestation such products might play an important role in the strategic management of fly control programs.

Another step forward could be the development of more advanced topical applications such as pour ons or spot ons involving for example micro-encapsulation technology for livestock and pets.

Wash-off resistance and decreased dermal penetration of adulticidal drugs such as pyrethroids or others will further stimulate the usage of this easy and stress minimising application.

**Arthropodicidal Drugs. Table 1** Combination products with arthropodicidal drugs (according to Hansen and Londershausen)

Example of combination	Main indications	Formulation/ Application
<b>Large animal use</b>		
Abamectin/Praziquantel	Control of round- and tapeworms as wells as bots in horses	Paste
Amitraz/Diazinon	Sheep ectoparasites: flies, keds, lice, ticks	Dip
Cypermethrin/Chlorfenvinphos	Broad tick activity for various host animals, catt lice and flies	Dip/Spray
Cypermethrin/Rotenone	Longterm protection for sheep against itchmite and lice	Dip
<b>Small animal use</b>		
Lufenuron/Milbemycin-oxime	Canine helminths and immature flea stages	Tablet
Permethrin/Pyriproxyfen	Larval development stages and adult fleas	Spray
Propoxur/Flumethrin	Control of adult fleas and ticks	Collar
Propoxur/Methoprene	Environmental control of flea development stages	Spray
Pyrethrin/S-Methoprene	Control of fleas and ticks	Spray

**Arthropodicidal Drugs. Table 2** Delivery systems of arthropodicidal drugs (according to Turberg and Londershausen)

Method of application	Typical examples of actives or chemical classes used
<b>Major topical formulations</b>	
Collar	Propoxur, Amitraz, Permethrin, Flumethrin, Diazinon, Deltamethrin, Methoprene
Dips	Organophosphates, Pyrethroids
Pour-ons	Avermectins, Milbemycins, Pyrethroids, Metaflumizone, Amitraz
Spot-ons	Fenthion, Fipronil, Imidacloprid, Permethrin Amitraz, Carbamates, Organophosphates, Pyrethroids
Sprays/Jetting fluids/Mist sprays	
<b>Other topical formulations</b>	
Aerosols	Organophosphates, Pyrethroids, Carbamates
Dust bags/Back-rubbers/Dusts	
Eartags/Strips	
Foams/Shampoos	
Ointments	
Powders	
Washes	
<b>Oral formulations</b>	
Boluses	Methoprene, Avermectins, Milbemycins
Tablets	
<b>Injection</b>	
	Avermectins, Milbemycins

## Classes of Chemical Compounds

A wide variety of ectoparasites are relevant for livestock and pets. These resolve into a relatively small number of major problems with a wide variety of products, ingredients and formulation for their control. For information on →repellents and →synergists please refer to the respective entries.

Arthropodicidal drugs can be divided into different groups according to their structure and mode of action (Table 3) assuming that similar chemical structure leads to the same basic mode of action. This certainly is a much too simplified view which doesn't reflect realistically an overall biological activity. Biological effects result from the superimposition of primary mode of action, pharmacokinetic behavior, degradation and excretion driven by the physicochemical parameters of drugs. Chemical compounds may display significantly different properties in this respect, even if they basically belong to the same chemical class.

### Organochlorides

#### Important Compounds

Bromocyclen, chlordane, DDT, lindane (gamma benzene hexachloride), methoxychlor.

#### General Information

Lindane and several cyclodienes were demonstrated to stimulate the central nervous system by influencing synaptic transmission and causing hyperexcitation. In the 1980s it was shown that these compounds block the (GABA)-influenced  $Cl^-$  current in neurons by binding to the GABA receptor chloride channel. In a set of elegant

experiments this theory has been confirmed by showing that target site insensitivity to cyclodienes was associated with a resistance gene (Rdl = resistance to dieldrin) which codes for a GABA receptor subunit in *Drosophila melanogaster*. The responsible point mutation in the membrane spanning region M2 could be identified by cloning of the M2 region with degenerated PCR primers amongst others in a variety of resistant dipteran flies.

Chlorinated hydrocarbons applied in sprays or dips once were common products for example in the treatment of myiasis and lice infestation in cattle and other species. Nowadays organochlorides such as chlordane, lindane are no longer approved for veterinary use in many countries, particularly because of their long persistence in the environment. Occasionally compounds like bromocyclen or methoxychlor are used against →mange mites biting and sucking lice and flies such as *Melophagus* or *Hippobosca* species.

### Organophosphates/Carbamates

#### Important Compounds

Azamethiphos, bendiocarb, bromopropylate, carbaryl, chlorfenvinphos, chlorpyrifos, coumaphos, cythioate, diazinon, dichlorvos, dicrotophos, dioxathion, ethion, famphur, fenchlorphos, fenitrothion, fenthion, heptenophos, iodofenphos, malathion, methomyl, phosmet, phoxim, pirimiphos, promacyl, propetamphos, propoxur, temephos, tetrachlorvinphos, trichlorfon.

#### General Information

The concept that toxicity to insects and →ticks by organophosphates and carbamates results from inhibition

**Arthropodicidal Drugs. Table 3** Major arthropodicidal chemical classes used in veterinary medicine (according to Turberg and Londershausen)

Chemical class/examples	Mode of action	Chronology of discovery for veterinary use*
Chlorinated hydrocarbons DDT Cyclodienes, Lindane	Voltage dependent sodium channel GABA-gated chloride channel	1943 ~1945–1959
Organophosphates	Acetylcholinesterase	~1950–1965
Carbamates	Acetylcholinesterase	~1960–1970
Pyrethroids	Voltage dependent sodium channel	~1970–1985
Amidines	Sites responsive to biogenic amines (Octopamine receptors, monoamine oxidases)	~1975–1980
Avermectins / Milbemycins	Glu-gated chloride channel	~1981–1998**
Insect growth regulators Cyromazine Benzoylphenylureas	Interference with cuticle sclerotization Inhibit cuticle deposition/chitin biosynthesis	1979 ~1985–1995
Juvenoids	Mimic juvenile hormone effects	~1988–1996
Arylpyrazole (Fipronil)	GABA-gated chloride channel	1994**
Chloronicotinyles (Imidacloprid)	Nicotinic acetylcholin receptor	1996**

\* Area of entry date based on the introduction of important actives of the respective chemical class into veterinary market

\*\* The discovery and development of further products can be expected due to intensive research efforts in various veterinary companies

of acetylcholinesterase (AChE) was proven to be useful in correlating structure with activity for various compounds from both chemical classes, although some disagreement exists as to the exact mode by which AChE-inhibitors kill ectoparasites.

Organophosphates and carbamates have a wide range of activities against various arthropods, involving blowfly larvae, →keds, lice, fleas, →mites and ticks in companion and livestock animals. Products with almost any application type have been developed ranging from dips, sprays and pour on's to ear tags and collars. Organophosphates in particular have been popular due to their rapid onset of activity, but in recent years concerns have been raised regarding environmental effects and some adverse reactions. In contrast to organophosphates the carbamylation of AChE by carbaryl and propoxur results in a reversible inhibition of AChE whereas organophosphates inhibit AChE almost irreversibly. The somewhat lower safety level compared to other insecticides has limited their use on older animals (>3 months) and the development of resistance nowadays restricts their applicability significantly. This problem is especially important in such sectors as the ear tag application.

## Pyrethroids and DDT

### Important Compounds

Alphamethrin, bioallethrin, cyfluthrin, (beta-)cyfluthrin, cyhalothrin, cypermethrin, deltamethrin, fenvalerate, flucythrinate, flumethrin, (tau-)fluvalinate, permethrin, phenothrin, resmethrin, tetramethrin.

### General Information

The symptoms of pyrethroid and DDT poisoning in insects are characterised by different forms of hyperexcitation caused by repetitive discharge of the nervous systems. In patch clamp investigations of single sodium channel currents it has been demonstrated, that under the influence of pyrethroids and DDT individual channels are modified to remain open for an unphysiological long period of time. The symptoms of intoxication differ somewhat between type II and type I pyrethroids based on the presence or absence of a cyano group at the á-position. Taking into account this structural as well as pharmacokinetic differences between various pyrethroids, the basic mechanism of action at the channel and cellular level is the modulation of the gating kinetics of individual sodium channels.

Since natural pyrethroids are not stable enough under atmospheric influences, the use of synthetic pyrethroids in animal health has become an important method to control arthropod pests such as flies and ticks. Various pyrethroids have been developed for animal health indications expressing more or less pronounced broad spectrum activity against ectoparasites. In this context the relation between dosage and occurrence of adverse drug reactions of the host animal became relevant in differentiating the range of optimal use for these pyrethroids.

## Amidines

### Important Compounds

Amitraz, cymiazole.

### General Information

The formamidines are structurally related to octopamine. Since they mimic the action of this phenolamine in a number of insect preparations it was concluded that these compounds act via effects on octopamine sensitive adenylate cyclase (octopamine-receptors). In addition formamidines are reasonable potent inhibitors of monoamine oxidase (MAO) in cattle ticks and mammals. However MAO activity in insect nervous tissue is low and no consistent similarities or structure activity relationship have been observed between the biological effects of known MAO inhibitors and those caused by amidines in insects and ticks. It still remains to be established whether this action is causative of any of the various responses of veterinary or agricultural important insects and acarines.

Numerous biochemical targets have been suggested for formamidines, however on the basis of current knowledge the action on sites responsive to biogenic amines seem to be most likely. In animal health formamidines, in particular amitraz, displays a high acaricidal activity and offers an alternative to control organophosphorus and/or organochlorine and/or pyrethroid resistant ticks and mange mites of cattle, sheep and pigs.

Amitraz causes ticks to withdraw their mouthparts rapidly and fall off the host animal, which from the viewpoint of practical control of tick-borne diseases is highly desirable.

## Avermectins/Milbemycins

### Important Compounds

Abamectin, doramectin, eprinomectin, ivermectin, selamectin, moxidectin, milbemycin-oxime.

### General Information

Avermectins, milbemycins and their active derivatives inactivate →nematodes, arachnids and some insects by disrupting their nerve transmission. Most of the studies have been performed with ivermectin.

In GABA sensitive fibres from insect skeletal muscles ivermectin induced increased chloride conductance which was reversible at low concentrations (nM range) but irreversible in µM range. GABA insensitive muscle fibres produced only irreversible responses to ivermectin, particularly the drug inhibited chloride conductance gated by →glutamate receptors in locust muscle fibres. These and other investigations led to the conclusion that this class of compounds act through their effects on glutamate gated chloride channels.

The activity against arthropods varies to some extent depending on the milbemycin or avermectin type of drug and the delivery method.

## Insect Growth Regulators

Insect or acarid growth regulators may provide a complementary method to parasite control relying on adulticide drugs. Growth regulators often have a favourable safety margin which enables them to be used also in systemic applications either as in-feed products, boluses or tablets.

After uptake their presence in manure, body fluid or skin interrupts the life cycle of various ectoparasites. Growth regulators display their mode of action either by preventing development of eggs, larvae or nymphs (e.g., tick → *Boophilus microplus*) directly on contact or by interfering with egg development and hatching after being ingested during feeding of adult females (e.g., flea: → *Ctenocephalides felis*).

Since growth regulators only operate on a specific part of the → *ectoparasite* life cycle they usually have little direct effect on the adult parasite population and achieve control after a longer period of time when compared to fast acting neuroactive compounds.

Growth regulators provide a valuable tool for long term control when used in conjunction with other arthropodicides which clear the host from adult parasite and final larval stages.

### Triazine

The drug Cyromazine is an insect growth regulator which is still used to control blow fly strike and fly development in poultry manure. Cyromazine interferes with moulting and pupation and causes reduced growth of treated larvae. A direct effect on → *chitin* biosynthesis has not been confirmed, but evidence has been presented that interference with → *cuticle* sclerotisation and elasticity might be responsible for the antiparasitic effect of this substance.

### Benzoylphenylureas

Important drugs are diflubenzuron, fluazuron, lufenuron, and triflumuron.

The exoskeleton of arthropods consists of different layers, of which typically the procuticle contains the amino sugar polysaccharide chitin, a major component of insect cuticle.

Nucleoside peptide antibiotics and benzoylphenylureas (BPUs) are the major groups of compounds acting primarily at chitin synthesis as target site.

For animal health indications only BPUs have been developed and commercialised internationally. Original studies of the mode of action of BPUs have implicated that synthesis and deposition of chitin are disturbed after application of BPUs.

Since these findings several hypotheses for their mode of action have been proposed, but the underlying biochemical mechanism still remains unclear. So far inhibition of precursor transport, proteolytic activation of chitin synthase zymogen, direct inhibition of chitin synthase, indirect hormonal effects and effects on cell membranes in combination with vesicle transport have been discussed as the primary mode of action.

The inhibition of cuticle deposition after BPU treatment results in death of larvae, pupae and non viable adults. In addition egg development and hatching are interrupted if particular systemically active BPUs are ingested during feeding of female ticks (fluazuron) or fleas (lufenuron). Even if growth regulators require more time to reduce ectoparasite populations they are useful tools, particularly in combination with compounds displaying an alternative mode of action, to control different life stages of ectoparasites.

### Juvenoids

Important drugs are fenoxycarb, hydroprene, methoprene, and pyriproxyfen.

The development of arthropod parasites comprises an orderly series of stages in the course of which they become transformed from larval stages into an adult. This process involves a series of moults and a → *metamorphosis* which can be disturbed with drugs which act similarly to insect → *juvenile hormones*.

The main effects contributing to insect control often depend on the target pest and the timing of application.

In the veterinary field juvenoids are particularly useful in controlling flea development either used in topical on-animal applications or in sprays to prevent hatching of fleas from companion animal surroundings.

→ *Hygiene* pests such as various species of → *mosquitoes*, house flies and to a lesser extent cockroaches can be controlled with juvenoids, too. Due to their improved stability particularly fenoxycarb and pyriproxyfen are useful for these indications.

The exact mode of action of juvenoids has not been resolved so far. A number of factors other than receptor binding may influence the activity of a juvenoid significantly when applied at a sensitive stage in growth. Penetration through the cuticle and transport to the target tissue, rates of degradation and excretion, inhibition of the juvenile hormone (JH) degradation system as well as competitive binding to JH carrier proteins are still under evaluation.

### Arylpyrazoles

#### Important Compound

Fipronil.

#### General Information

γ-Aminobutyric acid (GABA) is a major inhibitory transmitter at the neuromuscular junction not only in nematodes but also in insects and most likely in acarines, too. Upon binding of GABA to its receptor a rapid influx of chloride into the cell is induced which results in a hyperpolarisation of the membrane potential. In most cases an inhibitory effect on the respective cell is the consequence of this GABA activity. In vertebrates two subtypes have been identified. GABA<sub>A</sub> receptors which form a ligand gated chloride channel as well as contain modulatory sites for various drugs; and GABA<sub>B</sub> receptors, G-proteins which display various effects on calcium and potassium channels.

Most GABA receptors in insects resemble GABA<sub>A</sub> subtype, but they are clearly distinct from the vertebrate GABA<sub>A</sub> receptors. The GABA receptor is an important target for some older arthropodicides such as lindane cyclodiens but is also affected by fipronil, a new insecticide and acaricide which belongs to the chemical class of arylpyrazoles. This has been recently confirmed by cloning of a *Drosophila* GABA-gated chloride channel subunit using genetic mapping of a mutation which causes resistance against dieldrin (RdI). Fipronil was developed as an agrochemical and veterinary arthropodicide. In the veterinary field the compound is used for the treatment of fleas in dog and cats and ticks in dogs.

### Chloronicotinyles

#### Important Compound

Imidacloprid.

#### General Information

Cholinergic →[synapses](#) play a critical role in transmission in arthropods and nematodes. Recently a new drug, imidacloprid, was discovered displaying a new mode of action. Insecticides of this type act as agonists at the nicotinic acetylcholin receptor (nAChR) as was demonstrated by electrophysiological techniques and biochemical competition assays. The compound is highly effective against target insects, such as fleas or cockroaches but has virtually no effect on the mammalian nervous system. This might be explained by the fact that imidacloprid is not absorbed into the host animal bloodstream or internal organs and nAChRs from mammalian sources are much less or not at all sensitive to the agonistic action of insecticidal chloronicotinyles. In this context the fast killing of adult fleas on dogs and cats on contact not only prevents re-infestation for a long period of time (at least 4 weeks) but also significantly reduces the occurrence of flea →[allergy](#) dermatitis caused by flea saliva allergens.

### Rotenone

Rotenone is a natural product derived from plant roots of *Derris* and *Lonchocarpus*. This drug is a highly effective inhibitor of complex I of the →[mitochondrial respiratory chain](#) and inhibits NADH cytochrome c-reductase in nmole per mg protein range. The drug has largely been replaced by modern compounds, but is still used in combination products against ear mites and demodectic mange.

### Benzylbenzoate

Benzylbenzoate is an old acaricidal drug which is useful for the treatment of sarcoptic mites in dogs.

### Sulphur

Due to the availability of new and safer products nowadays the use of sulphur for mite treatment has been largely banned not only because of toxicological but also pollution concerns.

## Arthur's Phenomenon

→[Gametes](#).

## Arthus Reaction

Allergic immediate reaction with severe tissue inflammation, →[oedema](#), hemorrhages and →[necrosis](#) named after the Swiss microbiologist M. Arthus (1862–1935).

## Articles

Segments of the legs or palps in ticks and mites.

## Articulation Pain

Leading symptom in vector – transmitted diseases: →[Borreliosis](#), →[Chikungunya](#), →[Dengue Fever](#).

## Ascariasis, Man

### Pathology

Ascariasis is an infection with →[Ascaris lumbricoides](#), a large, lumen-dwelling nematode contracted by the ingestion of its larva via eggs (→[Ascaris](#)/[Fig. 1](#)). The larvae penetrate the small intestine wall and migrate through the lymphatics and blood stream to the liver, and then to the lungs where they enter the alveoli. There they pause for at least 2–3 weeks and →[molt](#), giving rise to allergic bronchopneumonia in previously infected and sensitized individuals. Later, they wander up the bronchi and trachea, giving rise to bronchitis with bronchospasm, →[urticaria](#), and occasionally, larvae in the sputum. Most larvae are swallowed and grow to adulthood in the small intestine. The adult worms are up to 30 cm long and 4 mm wide, and give rise to mechanical problems because of their size and, especially in children to a severe nutritional drain, because of the worm number and mass. A temperature elevation to 39 °C, certain drugs, and some unknown influences may cause the worms to congregate, sometimes resulting in intestinal obstruction and migration out of the gut into the bile duct, esophagus, mouth, pancreatic duct or appendix, and occasionally

the liver. The migration leaves necrotic tracts in the liver with hypersensitive inflammation produced by adults and eggs (→Pathology/Fig. 27A). Adult worms may perforate the intestine and pass out of the gut, leading to peritonitis.

### Targets for Intervention

Eggs of *Ascaris lumbricoides* are not immediately infective after leaving the infected host. They require a holding period in a suitable environment and become infective once second-stage larvae have developed in the eggs. Fig. 1 shows the carrier and the infection cycle as targets of intervention. Control may be achieved by the detection and treatment of infected persons, safe disposal of feces, and improving agricultural →hygiene and food hygiene.

**Main clinical symptoms:** →Eosinophilia, →abdominal pain, →vomiting, enteritis, ileus verminosus

**Incubation period:** Lung: 7 days, intestine: 3 weeks (however 85% of the patients remain symptomless)

**Prepatent period:** 2 months

**Patent period:** 9–15 months

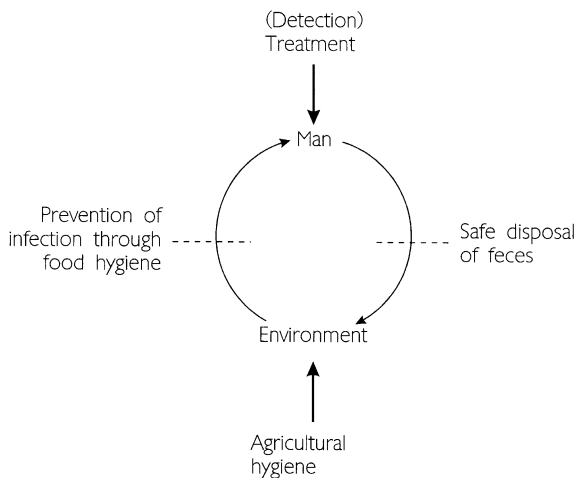

**Ascariasis, Man. Figure 1** Targets and approaches for the control of ascariasis.

**Ascaris. Table 1** Important species of the genus *Ascaris*

Species	Length of adult worms (mm)		Size of eggs (or larvae) (μm)	Final host/Habitat	Intermediate host	Prepatent period in final host (weeks)
	f	m				
<i>Ascaris lumbricoides</i>	200–410	150–250	50–75 × 40–50	Humans, pigs/Small intestine	–	6–11
<i>A. suum</i>	200–300	150–250	65–85 × 40–60	Pigs, Humans/Small intestine	–	6–11

f = female, m = male

**Diagnosis:** Microscopic determination of eggs in fecal samples (→Ascaris/Fig. 1)

**Prophylaxis:** Avoid eating uncooked vegetables and avoid human feces.

**Therapy:** Treatment see →Nematocidal Drugs, Man

## Ascaridia galli

### Classification

→Nematodes.

### General Information

Specimens of this and related species grow up as females to a length of up to 12 cm inside the intestine of chicken and doves. A related species in turkeys leads to necrosis of the intestinal wall. The life cycle is monoxenous, i.e., the infection runs from bird to bird by ingestion of the 80 μm × 50 μm-sized eggs. Each of which develops an infectious larva within 8–10 days after being excreted with the feces. The larvae – when hatched from the egg inside the intestine – enter the intestine wall for 3 weeks. After a total of 5–8 weeks maturity is reached and egg production starts. Pathogenesis is considerable, since bacteria superinfect the intestinal wall lesions. Anemia is common.

### Treatment

→Nematocidal Drugs.

## Ascaris

### Classification

Genus of →Nematodes.

### Important Species

Table 1.

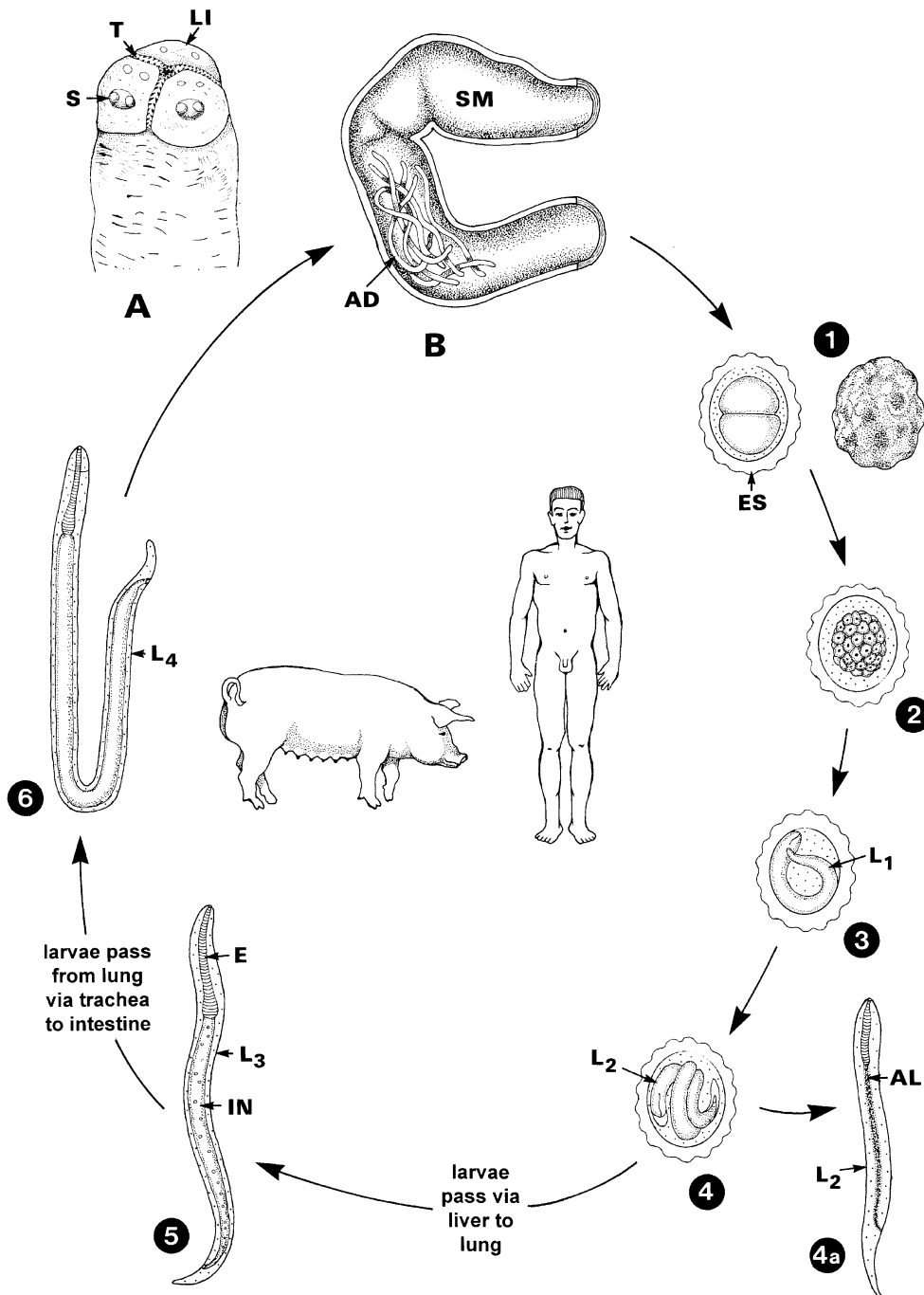

**Ascaris. Figure 1** Life cycle of ascarid worms (e.g., → *Ascaris lumbricoides*, *A. suum*) of man and swine. 1–2 Adult worms (male 15–25 × 0.3 cm; female 25–40 × 0.5 cm) live in the small intestine of their hosts and feed (in general) on the liquid contents of the gut. Fertilized eggs are ovoid to spherical (45–75 × 35–50 μm), are surrounded by a thick, lumpy, mammilated shell and are usually uncleaved when passed in the feces (2). The shells of unfertilized eggs are thinner. 3–6 On the soil a period of about 10–40 days (dependent on the temperature) is needed to develop the second larval stage (L<sub>2</sub>) inside the egg (some authors describe development until L<sub>3</sub>). 7–8 After oral uptake of infectious eggs, the larvae hatch in the intestine (in 3–4 h), enter the intestinal wall, pass through the liver and via heart to the lung, where finally the L<sub>3</sub> is formed. These third larval stages break into the air spaces of the lung and move up the trachea to the pharynx, where they are swallowed. In the intestine (reached around the 8th day after infection) the worms → molt twice and mature, starting eight weeks after infection (prepatent period). This peculiar migration is considered as → phylogenetic reminiscence. **A** anterior end; **B** intestine; **AD**, adult worm; **AL**, anlage of intestine; **E**, esophagus; **ES**, egg shell; **IN**, intestine; **L**<sub>1–4</sub>, larval stages; **LI**, lip; **S**, sensory organ; **SM**, small intestine.



**Life Cycle**

Fig. 1.

**Disease**→[Ascariasis, Man](#), →[Respiratory System Diseases, Animals](#).**Ascaris lumbricoides**

*Ascaris* was recently shown to possess hemoglobin. While the hemoglobin of the body wall resembles vertebrate myoglobin (~40.6 kDa), that of the perienteric fluid is an octomer (328 kDa) and has the highest affinity for oxygen of any known hemoglobins.

**Life Cycle**

*Ascaris*/Fig. 1. Human round worm, →[Ascaris](#), →[Nematodes](#).

**Ascaris suum****Name**

Greek: *ascaris* = worm; latin: *sus* = pig.

Important roundworm of pigs, →[Alimentary System Diseases](#), Swine; eggs are used to settle symptoms of Morbus-Crohn.

**Ascarops**

Genus of the worldwide occurring nematode family Spiroceridae. The species (e.g., *Ascarops strongylina*) lives in the stomach of their hosts, suck their blood, lead to weight loss, anaemia, and bloody diarrhoea. The larvae 3 are found inside beetles, which are taken up with the food.

**Incubation period:** 10–13 days.

**Prepatent period:** 6 weeks.

**Therapy:** →[Nematocidal Drugs](#).

**Ascarops strongylina**

Spirocerid nematode (thick stomach worm) of swine reaching as female a size of up to 20 cm. Coprophagic beetles are intermediate hosts. The larvae 3 may also become included into transport hosts such as small

mammals, birds, etc. The female and male worms live on the surface of the mucocutaneous layer of the stomach and may introduce haemorrhagic inflammations.

**Treatment**

→[Doramectin](#), →[Ivermectin](#), →[Nematocidal Drugs](#).

**Ascetospora**

Phylum of intracellular protozoan organisms that parasitize in Turbellaria, annelids, molluscs, and crustaceans. They include two classes (Haplosporea and Paramyxia) and do not possess polar capsules or polar filaments. The sporoplasms leave the capsule via pores of after bursting of the shell. Genera: e.g., *Haplosporidium*, *Marteilia*, *Bonamia*.

**Ascogregarina taiwanensis**

This species (syn. *Ascocystis*, *Monocystis*, *Lankesteria*) is an aseptate gregarine species which parasitizes in *Aedes* and *Phlebotomus* spp. (among other insects), where it is always found in the midgut and →[Malpighian tubes](#).

**ASF Viruses****General Information**

Among the →[arboviruses](#) there is a group containing double-stranded DNA. These spherical viruses with an envelope are also called African swine fever-like (ASF) viruses.

**Important Species**

Table 1 (page 135).

**Asfarviridae****Classification**

Family of double-stranded DNA viruses with one genus with one species: Table 1.

**ASF Viruses. Table 1** Arboviruses I. Double-stranded DNA viruses: African Swine Fever-like viruses (unnamed family) (spherical, with envelope)

Genus (group)	Species (selected)	Arthropod host	(Main) Vertebrate hosts	Distribution	Disease in man	Disease in animals
African swine fever-like viruses	African swine fever viruses	Argasidae ( <i>Ornithodoros</i> )	Domestic and wild swine, wart hogs, bush pigs, grant forest hogs	Africa	–	+ (depending on strain)

## Asphasmeida

### Synonym

→ Adenophorea.

### Classification

Group of → nematodes.

## Aspiculuris

Genus of oxyurid nematodes of rodents in laboratories, e.g., *A. tetraptera*, which (like *Syphacia muris* and *S. obvelata*) lives in the colon and caecum. In contrast to the quick development of the larvae in the human oxyurid → *Enterobius vermicularis*, *Syphacia* and in *Aspiculuris*, the development of the *Aspiculuris* – larvae inside the excreted eggs is slow and needs 5–7 days.

## Aspidobothrea

### Synonym

→ Aspidogastrea.

### Classification

Group of → Platyhelminthes.

### Morphology

Fig. 1.

## Aspidogaster conchicola

→ Aspidogastrea.

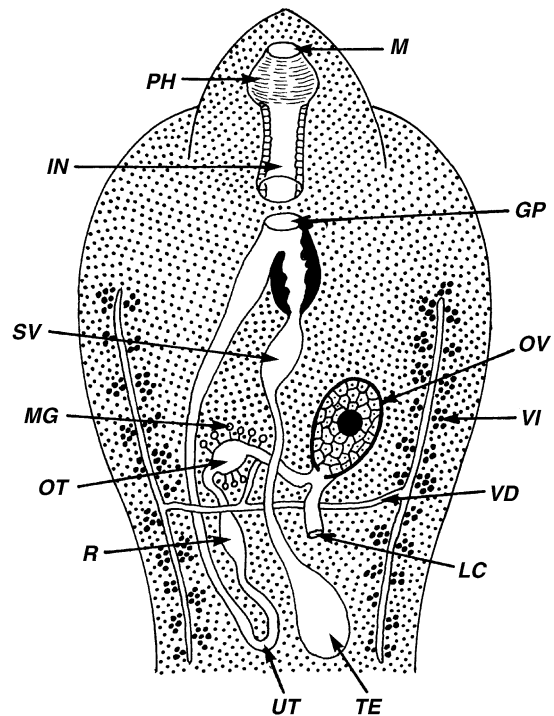

**Aspidobothrea. Figure 1** Diagrammatic representations of reproductive systems (after Rohde). GP, genital pore; IN, intestine (digrammatically interrupted); LC, Laurer's channel; U, mouth; MG, → Mehlis' glands; OT, → ootype; OV, ovary; PH, pharynx; R, → receptaculum seminis; SV, seminal vesicle; TE, → testis; UT, uterus; VD, vitelloduct; VI, → vitellarium.

## Aspidogastrea

### Synonym

→ Aspidobothrea.

### Classification

Class of → Platyhelminthes.

### General Information

The Aspidogastrea is a relatively small group, which is characterized by a very large hookless holdfast organ

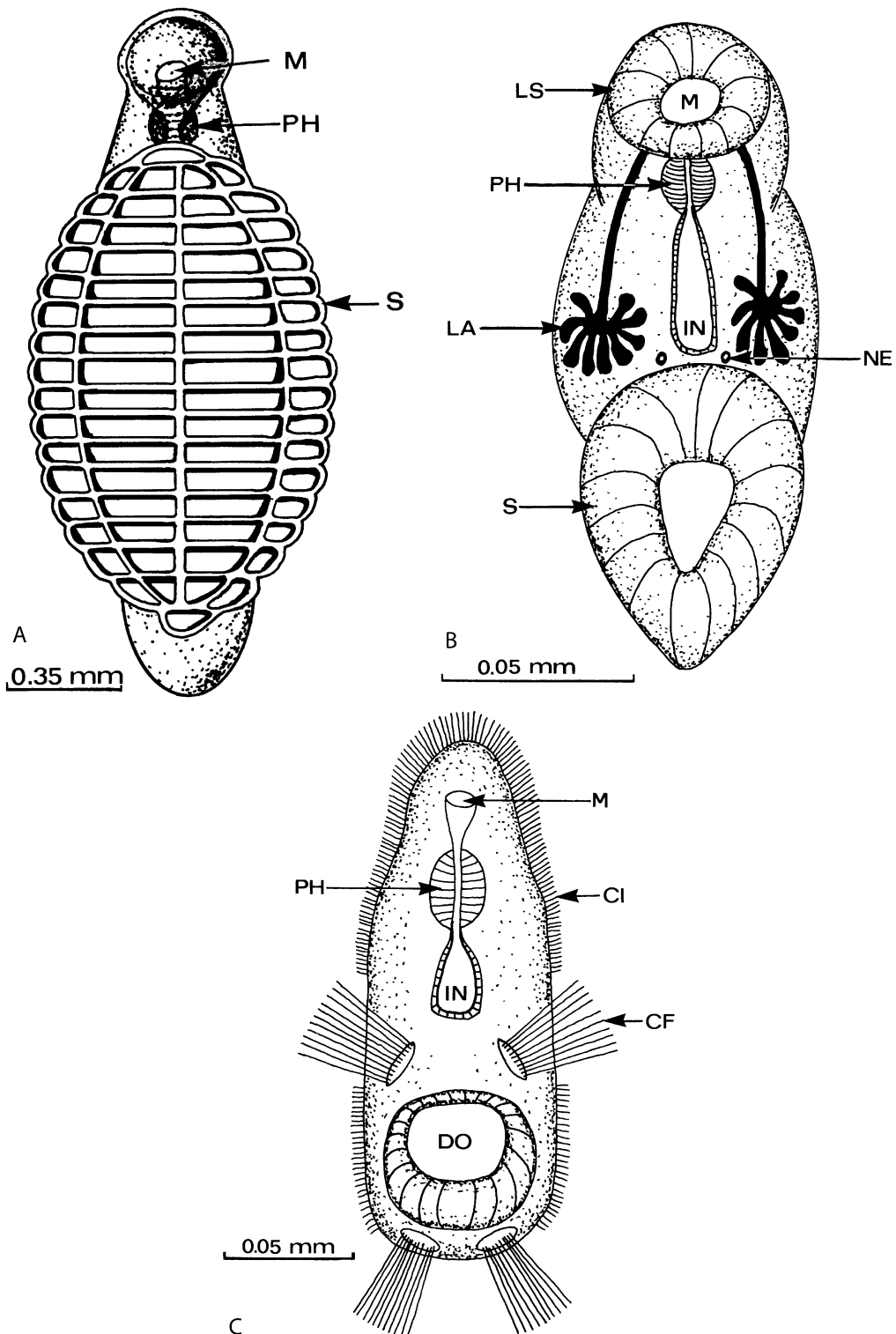

**Aspidogastrea.** Figure 1 A–C Life cycle stages of Aspidogastrea (seen from ventral side). **A, B.** → *Aspidogaster conchicola*. **A.** Adult worm (2–3 mm long) from kidney of clams (Lamellibranchiata, Unionidae) or from the intestine of snails, fish, and reptiles. Excreted operculated eggs are embryonated and contain a creeping, nonciliated larva (B), which grows to the adult stage by gradual transformation. **C.** → *Multicotyle purvis*, ciliated free-swimming larva; adults reach 10 mm in length and occur inside the pallial complex of snails (*Pila*) or in the intestine of snail-eating turtles. *CF*, ciliated field; *CI*, → cilia; *DO*, development of → opisthaptor; *IN*, intestine; *LA*, lateral larval glands; *LS*, larval anterior sucker; *M*, mouth; *NE*, nephridioporus (seen from ventral side since it opens dorsally); *S*, ventral sucker (= Baer's disc).

**Aspidogastrea. Table 1** Some common species of the Aspidogastrea (syn. Aspidobothrea)

Species	Length (mm)	Host	Habitat
<i>Aspidogaster conchicola</i>	3	Freshwater clams Reptiles Fish Snails	Pericardial cavity Intestine Intestine Visceral mass
<i>Lophotaspis vallei</i>	5	Marine turtles Snails Clams	Esophagus, stomach Mantle cavity Pericardial cavity
<i>Multicotyle purvisi</i>	10	Snails Turtles	Pallial complex Intestine
<i>Stichocotyle nephropis</i>	115	Lobsters Rays	Wall of intestine Bile bladder
<i>Macraspis elegans</i>	15	Ratfish	Bile bladder
<i>Cotylaspis insignis</i>	2	Freshwater clams	Kidney, mantle cavity
<i>Cotylogasteroides occidentalis</i>	2	Freshwater clams Snails Fish	Gill cavity Mantle cavity Intestine
<i>Rugogaster hydrolagi</i>	15	Ratfish	Rectal gland

(ventral or Baer's disc, →[opisthaptor](#)), which, in adult worms, covers nearly the whole ventral side (Fig. 1A). The Aspidogastrea are typically endoparasites of many molluscs, elasmobranchs, teleosts, turtles, or decapod crustaceans (Table 1) and are not host-specific. Their development occurs as →[metamorphosis](#) via larval stages (Fig. 1B, C); in general no →[intermediate host](#) is needed; however, larvae may continue their development in different hosts. With respect to host specificity, their parasitism is apparently not very specialized, since it is not uncommon to find an aspidogastrea in the gut of a fish, although it may normally parasitize a mollusc.

### Important Species

Table 1.

### Life Cycle

Fig. 1A–C.

### Morphology

In the →[cotylodidum](#) larva as well as the adult worms the external surface of the tegumental membrane shows a PAS-positive, filamentous surface coat, e.g., in adult *Aspidogaster conchicola* – a parasite of freshwater clams of the genera *Unio*, *Anodonta* and *Gonidea* – it has a thickness between 100 and 300 nm. The sexual organs are diagrammatically depicted in Fig. 1 of →[Aspidobothrea](#) (syn. Aspidogastrea).

## Astigmata

→[Acarina](#).

## Atopic Reactions

Clinical symptoms of allergic →[hypersensitivity](#) reactions of type 1 (e.g., rhinitis, asthmatic symptoms, eczema) due to contacts e.g., with dust →[mites](#).

## Atovaquone

Compound for babesiosis, toxoplasmosis, malaria treatment, see →[Malariaicidal Drugs](#), agents against protozoal diseases.

## ATP Synthesis

→[Energy Metabolism](#).

---

## Atractis

Genus of oxyurid nematodes in lizards and tortoises.

---

## Attached Flagellum

→Undulating membrane of →trichomonads and →trypanosomes.

---

## Attractans

Compounds or odour that attract blood-sucking or mating arthropods respectively eyeless species (e.g. some ticks, termites).

---

## Auchmeromyia

The calliphorid fly *A. senegalensis* (syn. *A. luteola*) belongs to those flies introducing →myiasis (Figs. 1, 2, page 139). Its common name is Congo floor maggot; it does not burrow in the skin, but it sucks blood at sleeping humans or animals. This activity is referred to as “sanguinivorous myiasis.”

---

## Auditory Ability

The males of many →Culicidae are able to “hear” the wing beat of females (about 250–350 Hz) via the scolopids of the Johnston organ at the 2nd segment of the antennae and are thus attracted. Females are unable to percept the wing beat of males (250–500 Hz) and thus unable to avoid them, as is claimed by producers of piping apparatuses to repel biting females.

---

## Australamphilina elongata

Species of →Cestodaria within the body cavity of the Australian tortoise *Chelodina longicollis*.

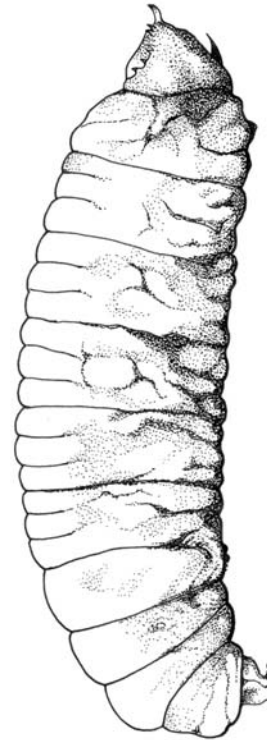

**Auchmeromyia.** Figure 1 *Auchmeromyia senegalensis*; blood sucking larva.

---

## Austrobilharzia

Genus of schistosomatid trematodes, →Digenea.

---

## Austroconops

Genus of →Ceratopogonidae. The only species of this genus (*A. macmillanii*) bites during daytime in Western Australian humans and animals.

---

## Austrosimulium

Genus of blood-sucking simuliid Nematocera in Australia and New Zealand, vectors of onchocerciasis (e.g., *Onchocerca* of cattle).

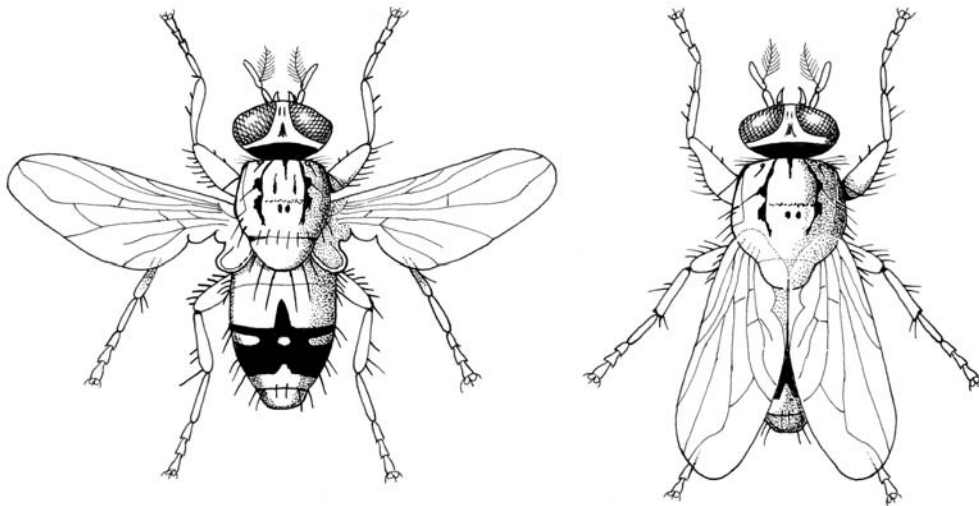

**Auchmeromyia.** Figure 2 *Auchmeromyia senegalensis*; adult fly with folded and unfolded wings.

## Autochthony

Name derives from the Greek terms *chtono* = place and *autos* = self. It means that a plant/animal/parasite develops at a given place since long and has not been imported recently from another region. For example, the tick *Ixodes ricinus* is autochthonous in Germany, *Dermacentor reticulatus* is allochthonous (→ [Allochthony](#)).

## Autocid Method

→ [Sterile Male Technique](#).

## Autoclavation

→ [Sterilization](#) of equipment by hot steam at 121 °C.

## Autogamy

Fusion of gametes originating from one individual (e.g., in *Taenia* – tapeworms).

## Autogeny

Egg production in some female → [Culicidae](#) (e.g., genus *Toxorhynchites*) without preceding blood meal.

## Autoimmunity

→ [Chagas' Disease](#), [Man/Immune Responses](#).

## Autoinfection

Reinfection of the same host, within which the parasite had grown up. → [Cryptosporidium Species](#), → [Strongyloides](#), → [Hymenolepidae](#), → [Taenia solium](#), → [Enterobius vermicularis](#).

## Autolysosome

Type of secondary → [lysosome](#) which is involved in the disintegration of cellular waste material, thus providing the function of disposal of debris.

## Avarita

Subgenus of the genus → *Culicoides*, e.g., with the species *C. imicola* and *C. brevitarsis*, *C. actoni*, *C. obsoletus*, which are all proven vectors of bluetongue virus.

## Avermectines

→ Nematocidal Drugs, → Arthropodicidal Drugs.

## Avian Spirochaetosis

Disease due to spirochaetan bacteria transmitted by the bite of → *Argas* → ticks (→ Tick Bites: Effects in Animals).

## Avicenna

Abu Ali El-Hosein Ben Abdullah Ibn Sina (870–1037), Arabian physician and philosopher. His famous books *Canon medicinae* and *De animalibus* describe diseases of humans, respectively of animals. He is honoured by the French name “Fil d’Avicenne” for → *Dracunculus medinensis*.

## Avioserpens

Genus of dracunculid nematodes.

## Avitellina

Genus of → Eucestoda.

### Morphology

Fig. 1.

## AVL

American visceral → leishmaniasis.

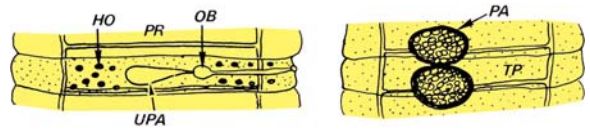

**Avitellina.** **Figure 1** Diagrammatic representations of young (left) and terminal proglottids (TP) of *Avitellina* sp.; HO, testis; OB, oogenotop; PA, paruterine organ; PR, cross running excretory channel; TP, terminal proglottis; UPA, anlagen of PA.

## Avoidance of Parasitized Prey

→ Behavior.

## Axenic Cultures

*In vitro* cultures of parasites without addition of any feeder cells (Greek: *a* = not, *xenos* = foreign).

## Axon

Efferent protrusion of a nerve cell, see → Platyhelminthes/Nervous System.

## Axoneme

Microtubular elements inside flagellum or running through the → cytoplasm, e.g., of → *Giardia* and → *Trypanosoma* stages.

## Axostylata

New phylum of protozoans comprising the class is Parabasalea with the families Trichomonadidae (→ *Trichomonas*) and Monocercomonadidae (→ *Histomonas*).

---

## Axostyle

Element for stabilization consisting of one or more rows of microtubuli (e.g., → *Trichomonas*, → *Oxymonadida*).

---

## Azamethiphos

### Chemical Class

Organophosphorous compounds (monothiophosphate).

### Mode of Action

Acetylcholine esterase inhibitor. → *Ectoparasitocides – Agonists and Antagonists of Cholinergic Transmission*.

---

## Azanidazole

→ *Antidiarrhoeal and antitrichomoniasis drugs* = agents against protozoal diseases.

---

## Azathioprine

→ *Trypanocidal Drugs*.

---

## Azithromycin

Agent against protozoal diseases.

---

## Azygia lucii

Trematode in the oesophagus and stomach of fresh water fish (5.5 cm × 1–5 mm), miracidium without cilia; intermediate hosts are *Lymnaea*-snails.





---

## Babès, Victor (1854–1926)

Rumanian pathologist, 1888 discoverer of →*Babesia* spp.

---

## Babesia

### Classification

Genus of →*Piroplasm*s (Alveolata, Apicomplexa).

### General Information

The tickborne protozoans of the genus *Babesia* are unpigmented protozoans that multiply in the red blood cells of many vertebrate hosts. Several species of *Babesia* give rise to natural infections in humans, cattle, other domestic animals, and field mice, on which one stage of the ixodid →tick normally feeds.

### Important Species

Table 1 (page 144).

### Life Cycle

Fig. 1 (page 145).

### Morphology

→Pellicle/Fig. 1; Figs. 2, 3 (page 146).

### Reproduction

→Gametes/Fig. 5, →Cell Multiplication.

### Disease

→Babesiacidal Drugs, →Babesiosis, Animals, →Babesiosis, Man, →Texas Fever, →Tick Fever.

---

## Babesiacidal Drugs

See Table 1 (page 147–149).

### Economic Importance

Members of the genus →*Babesia* occur throughout the world and may cause a wide range of clinical syndromes in most domestic animals and humans due to differences in virulence within each *Babesia* species. They are transmitted by hard →ticks (→Ixodidae) during blood meals, and may produce diseases in their hosts, which are characterized by an acute febrile reaction, jaundice, hemolytic anemia, hemoglobinuria, and variable mortality. The babesiosis is of major economic importance in cattle because the majority of about 1.2 billion cattle in the world are potentially exposed to *Babesia* spp. because of the extensive husbandry methods employed in raising these animals. *Babesia* spp. infections may also occur by the frequent introduction of *Babesia*-free animals into *Babesia*-enzootic areas, and by introduction of tick vectors and *Babesia* spp. into clean zones. The greatest economic loss is due to *Babesia* spp. infections in cattle, particularly in the USA, Australia (State of Queensland), South Africa, and South America. Indigenous animals are normally protected from babesiosis in early life by premunition resulting from continuous reinfection. In regions with enzootic stability babesiosis is not a disease problem, and control measures are not necessary. In these zones calves are still protected by maternal antibodies which they had received through the colostrum. Subsequently the animals remain carriers by repeated natural infections.

### Epizootiology and Enzootic Stability of Bovine Babesiosis

The idea of maintaining enzootic stability is to allow limited challenge of the parasite and the tick to cattle without producing disease or loss of production. The immune status of a herd can be monitored serologically, and in cases where more than 50% of cattle show no antibabesial serum titres the whole herd should be vaccinated. Thus, the efficient application of vaccination procedures depends considerably on the →epizootiology of babesiosis, and involves knowledge of the complex interaction of the host, *Babesia* parasite, and vector. The aim of premunization [see Premunization and Use of Antibabesial Drugs (Chemoimmunization)] or immunization with live blood-derived vaccines of attenuated strains of *B. bovis* and *B. bigemina* is to maintain herd

**Babesia.** Table 1 Important species of the genus *Babesia*

Species	Vector		Vertebrate host	Size in erythrocytes ( $\mu\text{m}$ )	Geographic distribution
	Species	Stage			
<b>Significant large <i>Babesia</i> species</b>					
<i>B. bigemina</i>	<i>Boophilus</i> spp.	Nymphs, adults	Cattle, water buffaloe, wild ruminants	$5 \times 2$	Southern Europe, America, Africa, Asia, Australia
<i>B. bovis</i>	<i>Boophilus</i> spp., <i>Ixodes</i> spp., <i>Rhipicephalus bursa</i>	Larvae	Cattle, water buffaloe, wild ruminants	$2.5 \times 1.5$	Southern Europe, America, Africa, Asia, Australia
<i>B. divergens</i>	<i>Ixodes ricinus</i>	Larvae	Cattle, wild ruminants, <b>humans</b>	$1.5 \times 0.5$	Europe
<i>B. major</i>	<i>Haemaphysalis punctata</i>	Adults	Cattle	$3 \times 1.5$	Western and Southern Europe, Great Britain, Northwestern Africa
<i>B. motasi</i>	<i>Haemaphysalis</i> spp., <i>Rhipicephalus bursa</i>	Adults	Sheep, goats	$4 \times 2.5$	Southern Europe, Middle East, Southern Russia, Africa, Asia
<i>B. ovis</i>	<i>Rhipicephalus bursa</i>	Adults	Sheep, goats	$2 \times 1$	Southern Europe, Middle East, Southern Russia, Africa, Asia
<i>B. caballi</i> <sup>2</sup>	<i>Hyalomma</i> spp., <i>Dermacentor</i> spp., <i>Rhipicephalus</i> spp.	Adults	Horses, mules, donkeys, <i>Equus burchelli</i>	$4 \times 2.5$	Europe, Asia, Africa, America, Australia
<i>B. canis</i> <sup>1</sup>	<i>Rhipicephalus sanguineus</i> , <i>Haemaphysalis leachi</i> , <i>Dermacentor reticulatus</i>	Nymphs, adults	Dogs, other wild canines, fox	$5 \times 2.5$	Europe, Asia, Africa, America, Australia
<i>B. trautmanni</i>	<i>Rhipicephalus</i> spp.	?	Pigs	$4 \times 2.5$	Southern Europe, Africa
<i>B. herpailuri</i>	?	?	<i>Felis sylvestris</i>	$3 \times 2.2$	Southern America
<i>B. pantherae</i>	?	?	<i>F. sylvestris</i> , <i>Panthera leo</i>	$2.5 \times 1.5$	Africa
<b>Small <i>Babesia</i> species of doubtful systematic position<sup>2</sup></b>					
<i>B.</i> (syn. <i>Microbabesia</i> ) <i>gibsoni</i>	<i>Haemaphysalis bispinosa</i> , <i>Rhipicephalus sanguineus</i>	All stages	Canidae including dogs, fox, and other wild canines	1.2–2.1	Asia, Africa, India, Japan
<i>B. microti</i> group	<i>Dermacentor</i> spp., <i>Rhipicephalus</i> spp., <i>Ixodes</i> spp.	Larvae to nymphs	Rodents, <b>humans</b>	1.5–2	Europe, North America
<i>B. felis</i> (syn. <i>Achromaticus felis</i> )	<i>Haemaphysalis leachi</i>	?	Felidae including <i>Panthera leo</i> , <i>Felis sylvestris</i>	1.5–2	Africa
<i>B.</i> (syn. <i>Achromaticus</i> ) <i>rodhaini</i> = <i>B. quadrigemina</i>	?	?	Mice	1.5–2	Europe

<sup>1</sup> *Babesia canis* is now subdivided into 3 subspecies: *B. canis canis* (in Europe; transmitted by *Dermacentor reticulatus*), *B. canis vogeli* (transmitted by *Rhipicephalus sanguineus* in the tropics and the subtropics), and *B. canis rossii* (very pathogenous in South Africa; transmitted by *Haemaphysalis leachi*)

<sup>2</sup> *B. equi* of horses was transferred to the theilerians

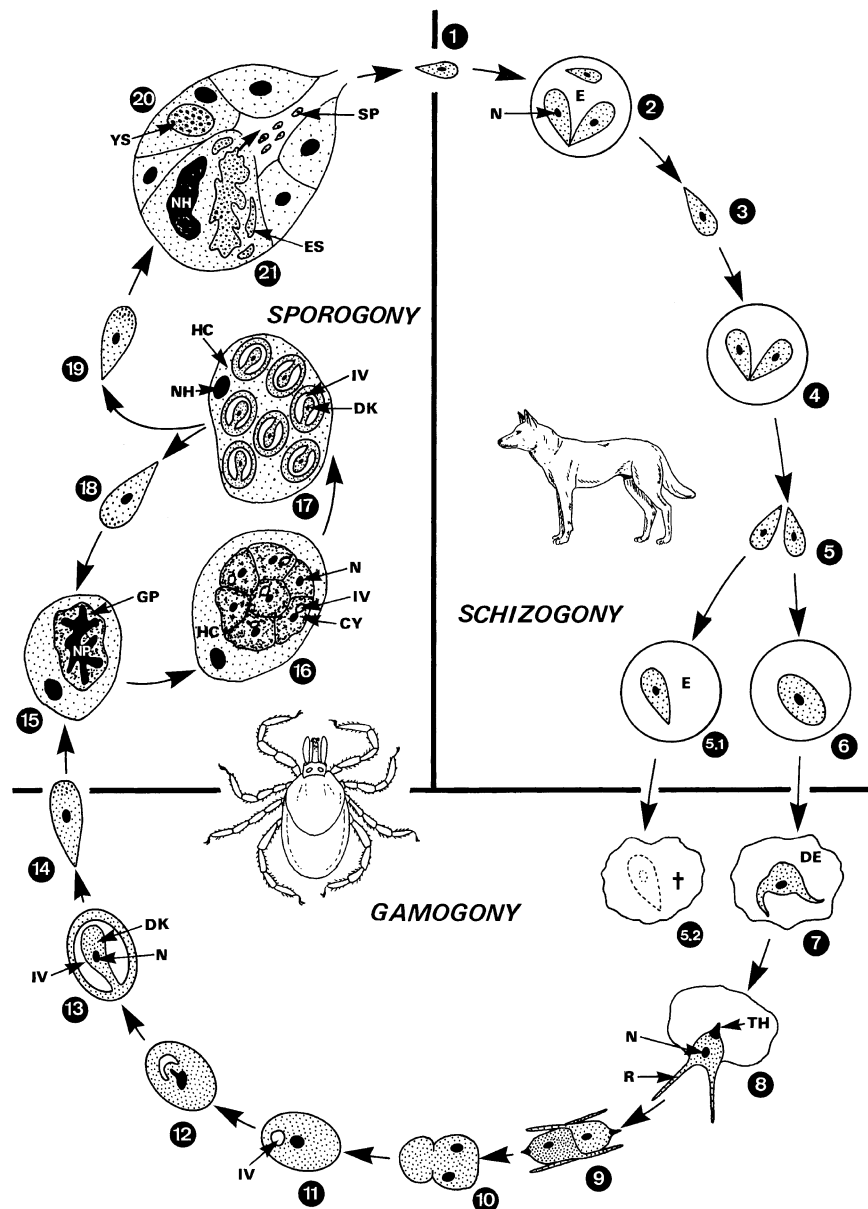

**Babesia.** Figure 1 Life cycle of *Babesia canis* (for other species see Table 1). 1 Sporozoites in saliva of feeding tick. 2–5 Asexual reproduction in erythrocytes of vertebrate host (dog) by →binary fission, producing merozoites (5) which enter other erythrocytes. When merozoites are ingested by a tick (5.1), they become digested inside the gut (5.2). 6 Some merozoites become ovoid gamonts. 7, 8 After ingestion into the tick's intestinal cells the ovoid gamonts form protrusions and thus appear as →ray-bodies (8). Fusion of 2 uninucleate ray-bodies (gametes). 10 Formation of a →zygote. 11–14 Formation of a single →kinete from a zygote inside the inner vacuole. The kinete leaves the intestinal cell and enters cells of various organs (including the eggs) of the vector ticks. 15–18 Formation of several kinetes (sporokinetes). This process is repeated (15–18) and also proceeds in eggs of ticks. The infection is thus transmitted to the next generation of ticks (i.e., transovarial transmission). 19–21 Some of the kinetes penetrate cells of the salivary glands, where a large multinuclear sporont (YS, ES) is formed (inside hypertrophic host cells) finally giving rise to thousands of small sporozoites (SP), which are injected during the feeding act (i.e., →transstadial transmission). CY, →cytomere (uninucleate); DE, digested erythrocyte; DK, developing kinete; E, erythrocyte; ES, enlarged sporont (forming sporozoites); GP, growing parasite (polymorphic stage); HC, nucleus of host cell; IV, inner vacuole; N, nucleus; NH, nucleus of host cell; R, ray-like protrusion; SP, →sporozoite; T, thorn-like apical structure; YS, young sporont.

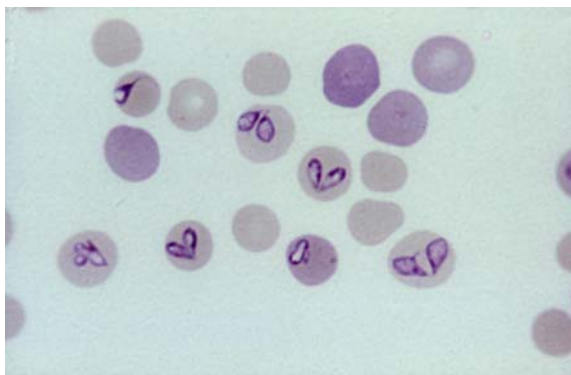

**Babesia.** Figure 2 Bloodsmear of dog showing *Babesia canis* stages (type of large babesias).

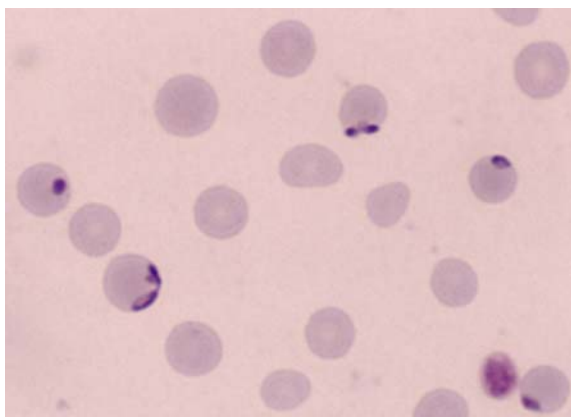

**Babesia.** Figure 3 Bloodsmear of a jird showing *Babesia divergens* stages at the periphery of red blood cells (type of small babesias).

immunity, and thus the balance between host and vector. In various countries the idea of reestablishing areas of enzootic stability has strongly been supported, particularly after the introduction of “tick-resistant” cattle, and the occurrence of increasing failures of chemical control measures.

### Strategic Tick Control in Areas with Enzootic Instability of Babesiasis

Attempts at controlling babesiasis in districts with enzootic instability (i.e., where less than 90% of cattle show premunition) can be directed against the tick vector (for more details see control of →ticks, and application techniques). There are one-host ticks (e.g., →*Boophilus* spp.), two-host ticks, and three-host ticks (e.g., →*Rhipicephalus* spp., →*Haemaphysalis* spp.; *Ixodes ricinus*) which can be controlled by aggressive or strategic dipping (this latter method may involve three dippings in the dry season and is used for example in Australia) plus pasture improvement and/or pasture

spelling at intervals of 8–10 weeks in summer or early autumn. Aggressive dipping is still imperative in areas where, in addition to babesiosis, →East Coast Fever, heart water due to *Cowdria ruminantium* infection, and →anaplasmosis (*Anaplasma centrale* and *A. marginale*) occur. This method involves acaricide administration at regular intervals, either throughout the year or during tick seasons, with the aim of eliminating the tick vector. The application of acaricide can be done in any of three ways. These may be (1) a plunge bath, communal dip, or dip on large farms; (2) a spray-race (system of pipes fitted with spraying nozzles) on large farms, or (3) a hand-spraying system consisting of a large water container and a hand-pump or small motor-pump. The strategic dipping system, i.e., administration of an acaricide at certain time intervals, may lead to temporarily unstable situations since transmission of *Babesia* spp. and *Anaplasma* spp. is not completely interrupted; in this case an additional vaccination against both organisms is advisable.

### Tick Control in Livestock to Prevent Babesiosis

Today, the only conventional control measure against argasid and ixodid ticks is the use of acaricides for animals at risk. Pesticides belong to different chemical groups such as chlorinated hydrocarbons, organophosphates, carbamates, diamidines, synthetic pyrethroids, and avermectins. Drugs of these groups have different mode and site of actions. For instance the growth regulator **fluazuron** inhibits the →chitin formation in ticks. Its effect results in reduced production of viable eggs in engorged females and may reduce pasture contamination.

Acaricidal control of vectors to protect animals from disease has been applied in many countries although with only limited success, as ticks rapidly developed resistance to pesticides and acaricides (→Ectoparasitocidal Drugs, →Arthropodicidal Drugs). However, acaricide treatment continues to be necessary although drug tolerance of ticks to most agents, except the macrolytic lactones, is common. In the field, there may occur tremendous economic losses due to breakdown of dipping systems in various regions, the increasing cost of acaricides often beyond the means of many farmers, and the lack of veterinary infrastructure in many countries have made the eradication of tick vectors impossible.

**Closantel** used for the control of helminthic infections (→Nematocidal Drugs, Animals, →Trematodocidal Drugs) of sheep and cattle, and larval stages of nasal bot fly (→*Oestrus ovis*) of sheep has been shown to have a marked effect also on →fecundity and egg viability of ticks. The strongly plasma-bound drug is ingested by ticks while feeding and probably affects their mitochondrial energy production by inhibiting oxidative phosphorylation and thereby adenosin triphosphate synthesis. Thus closantel may play a role in tick control

**Babesiacidal Drugs. Table 1** Babesiacidal drugs used in domestic animals

Chemical group (approx. dose, mg/kg b.w., route, animal)	Nonproprietary name, *brand name (company, manufacturer)	Characteristics and miscellaneous comments
<b>AZO-NAPHTHALENE DYES</b>		
(cattle, 2–3, i.v.; dog, 10, 1% solution, i.v.) <sup>a</sup> 1909	<b>Trypan blue</b> (syn. Congo blue, Niagara blue) *Trypan Blue SS (Centaur Lab., S.-Africa): discontinued	first specific drug with activity against <i>B. bigemina</i> and other large species; i.v. application leads to blue staining of meat, body secretions and milk (today, largely replaced by diamidines); discoloration of mucous membranes and plasma interferes with clinical and laboratory parameters; there are severe local reactions after extravascular injection; drug can be used in treating <i>B. canis</i> infection in dog but relapse may occur; diminazene may sterilize infection.
<b>ACRIDINE DERIVATIVES</b>		
(cattle, 4.4 ml/100 kg, 5% solution, i.v.) <sup>a</sup> 1919	*Acriflavine HCl *Euflavine HCl *Gonacrine HCl (Merial, others) (no longer in use as antibabesial drugs)	is active against <i>B. bigemina</i> and other large <i>Babesia</i> spp.; like trypan blue, it proves less effective against <i>B. bovis</i> ; i.v. administration limits its use under field conditions; drug is relatively well tolerated at recommended dose; discoloration of tissues is less pronounced than that caused by trypan blue.
<b>Urea derivatives</b> (quinolone derivative) (cattle, 1–2 ml/100 kg, 5% Acaprin solution, 1–2 injections, 24 h interval, s.c.; dogs, 0.25 ml/5 kg, 0.5% Acaprin solution, s.c.) <sup>a</sup> 1935	<b>Quinuronium sulfate</b> *Acaprin (Bayer) *Ludobal (Bayer) *Babesan *Akiron, Pirevan, Piroplasmim, and others (various manufacturers in India and China)	for many years the drug of choice in treating bovine babesiosis ( <i>B. bigemina</i> , <i>B. bovis</i> , <i>B. divergens</i> ); it is active against large <i>Babesia</i> spp. of swine, horse, and dog; drug has a low therapeutic index and may stimulate parasympathetic nervous system (excessive salivation, frequent urination, or dyspnea caused by anticholinesterase activity; antidotes are atropine or epinephrine; in fatal cases volvulus of jejunum has been observed, which may result from hyperperistalsis); its mode of action is uncertain; action of drug on <i>B. felis</i> see text.
<b>DIAMIDINES</b>		
Carbanilides (cattle, 5–10, i.m.; horses 8, i.m.) <sup>a</sup> 1964	<b>Amicarbalide</b> diisethionate *Diampron (Merial)	is effective against <i>B. bigemina</i> , <i>B. caballi</i> , <i>B. motasi</i> but there are differences in efficacy against large <i>Babesia</i> spp.; its effect on small <i>Babesia</i> spp. is less pronounced (clinical remission only).
(cattle, 1.2–2.4, s.c.; horse, 2–2.4, i.m.; 2 injections, 24 h interval; dog 5–6, i.m. 1–2 injections, 24 h interval) <sup>a</sup> 1969	<b>Imidocarb</b> dipropionate *Imizol, *Carbesia (Schering-Plough AH) *Forray-65 (Bayer, SA)	is effective in preventing and treating bovine babesiosis without interfering with development of immunity; protection period may last for several weeks depending on dose used; drug shows efficacy against <i>B. canis</i> infections, and equine babesiosis. Fine-structural alterations of <i>B. herpailuri</i> in cats treated with the drug were less pronounced and resulted in widening of subpellicular endoplasmic reticulum and perinuclear; drug is very slowly eliminated; bile is an important route of excretion; there is a long preslaughter withdrawal period (cattle; sheep) for edible tissues and milk of approx. 90 days and 21 days, respectively; data on toxicity are somewhat erratic; there is a wide range of individual animal tolerance to the drug; side effects are due to anticholinesterase activity, and fatal toxicosis is usually associated with renal disorder (necrosis), edema, hydrothorax, hydroperitoneum, and pulmonary congestion; mortality in equines (which can occur at 4 mg/kg or higher doses) is attributed to acute tubular renal necrosis; mechanism of drug action is known (possibly interferes with nucleic acid synthesis, see diminazene ↓); excess of polyamines (e.g., spermidine) can nullify trypanocidal activity of imidocarb and amicarbalide; the diamidine imidocarb also proved active against <i>Trypanosoma brucei</i> mouse infection, and <i>Anaplasma marginale</i> infection in cattle at 3 mg/kg b.w. (elimination of parasites is not achieved).

**Babesiacidal Drugs. Table 1** Babesiacidal drugs used in domestic animals (Continued)

Chemical group (approx. dose, mg/kg b.w., route, animal)	Nonproprietary name, *brand name (company, manufacturer)	Characteristics and miscellaneous comments
<b>AROMATIC DIAMIDINES</b>		
(dog, 5–10, i.m., 15, s.c. 1–2 injections, 24 h (48 h: s.c.) interval; horse, 8, i.m., 1–2 injections, 24 h interval) <sup>a</sup> 1939	<b>Phenamidine</b> diisethionate *Lomidine (Merial) *Oxopirvedine (Merieux) *Phenamidine (Virbac, SA)	is used mainly in treating canine and equine babesiosis; it has also been used successfully in <i>B. bigemina</i> infections; frequent relapses may occur in <i>B. gibsoni</i> infections in dogs; drug can be used for eradicating carrier infections in horses; side effects of drug are similar to those noticed with pentamidine; it is well tolerated at recommended dose although s.c. injections may lead to moderate swelling (necrosis, mainly in horses); drug may cause transient immunosuppression in dogs; mechanism of drug action is uncertain but may be similar to that of pentamidine and diminazene (→ <a href="#">Trypanocidal Drugs, Animals</a> ).
(experimental drug, approved for use in humans only; cattle, 1–5, s.c. <sup>a</sup> 1939	<b>Pentamidine</b> diisethionate *Lomidine (Merial)	is reported to be effective against <i>B. bigemina</i> allowing carrier state to persist in chemoimmunization (see text); drug is active against <i>B. canis</i> and <i>B. gibsoni</i> infections in dogs; relapses occurred with <i>B. gibsoni</i> at 16.5 mg/kg i.m.; common side effects are vomiting (dogs), nausea, hypotension, tachycardia, and pain at injection site; it may affect <i>B. microti</i> infections in man (see text); pentamidine is highly active in treating early stage of <i>T. b. gambiense</i> infection in man (→ <a href="#">Trypanocidal Drugs, Man</a> ).
<sup>3</sup> (3.5, i.m., cattle, horse) <sup>a</sup> 1955	<b>Diminazene</b> aceturate <sup>3c</sup> *Berenil (Intervet), not recommended for use in dog *Ganaseg (Novartis, Brasil and elsewhere)	is highly active against bovine, ovine, porcine, equine, and canine babesiosis; small <i>Babesia</i> spp. are generally more refractory to treatment than large ones; it can be used in chemoimmunization programs, moderating clinical signs and allowing development of premunition (see text); there are various treatment regimens for eliminating babesiosis in cattle, horses, and dogs: in most cases recommended dose has been varied, e.g., 5 mg/kg, twice in 24 h interval to eradicate <i>Babesia</i> spp. infections in horses, or 1.75 mg/kg twice in 24 h interval to reduce or avoid neurotoxic side effects in dogs (e.g., ataxia, opisthotonus, nystagmus, extensor rigidity, coma, and even death); however, there seems to be a wide range of individual animal tolerance to the drug; it is well tolerated in equines at recommended dose, but higher doses may cause severe side effects; in camels there may be mortality at recommended dose but ruminants tolerate the drug at higher doses (7–10 mg/kg); preslaughter withdrawal period (cattle; sheep) for edible tissues and milk is at least 21 days and 3 days, respectively; diminazene was shown to be active against <i>B. microti</i> infections in humans (see text); for its activity against African trypanosomes in animals and humans see → <a href="#">Trypanocidal Drugs, Animals</a> and → <a href="#">Trypanocidal Drugs, Man</a> , respectively.
<b>8-AMINO-QUINOLINES</b>		
(experimental drug approved for use in humans only)	<b>Primaquine</b> diphosphate *Primaquine (Bayer) *Neo-Quipenyl *Neo-Plasmochin, others	is active against <i>B. felis</i> (base 0.5 mg/kg, i.m., or p.o. repeated doses well tolerated); maximum tolerated dose of base was 1 mg/kg, higher doses caused mortality; standard antibabesial drugs proved ineffective against <i>B. felis</i> ; for its action on exoerythrocytic stages of <i>P. vivax</i> see → <a href="#">Malaricidal Drugs</a> (Malaria antirelapse drug).

**Babesiacidal Drugs. Table 1** Babesiacidal drugs used in domestic animals (Continued)

Chemical group (approx. dose, mg/kg b.w., route, animal)	Nonproprietary name, *brand name (company, manufacturer)	Characteristics and miscellaneous comments
<b>TETRACYCLINES</b>		
(long-acting preparation)	<b>Oxytetracycline</b> *Terramycin, LA (Pfizer AH)	<i>B. divergens</i> field infections in cattle could be controlled by continuous administration of 20 mg/kg every 4 days during natural exposure on grazing heavily infested with <i>Ixodes ricinus</i> ; no parasites were seen in treated cattle in comparison with untreated animals which developed a patent parasitemia; the antibiotic seems to be useful in chemoimmunization (see text) against bovine babesiosis allowing development of premunition.
<b>TETRACYCLINES</b>		
	<b>Chlortetracycline</b> *Aureomycin, others (many manufacturers)	was shown to control parasitemia in the early course of <i>B. equi</i> infection; antibabesial activity was demonstrated by six daily injections of 0.5, 2.5, and 2.6 mg/kg; the antibiotic proved active against <i>T. parva</i> (→ <a href="#">Theileriacidal Drugs</a> )
<b>MACROLIDE ANTIBIOTICS</b>		
	<b>Clindamycin</b> (Pfizer, others) in combination with <b>vancomycin</b> HCl (glycopolypeptide) (Eli Lilly, others) (approved drugs, but considered investigational for this condition)	single drug, and clindamycin + quinine were shown to be effective in treating experimental <i>B. microti</i> infection in hamsters; clindamycin/vancomycin combination has successfully been used in eradicating parasitemia and bringing about remission of <i>B. microti</i> infections in humans; for more details on standard therapy of human babesiosis see text; side effects caused by clindamycin may be allergic reactions, diarrhea (enterocolitis), hepatotoxicity, occasionally hypotension, ECG changes; vancomycin may reduce antibiotic-associated colitis
<b>HYDROXYNAPHTHOQUINONES</b>		
	<b>Parvaquone</b> *Clexon (experimental drug)	antitheilerial drugs (→ <a href="#">Theileriacidal Drugs</a> ) had shown some efficacy against <i>B. equi</i> (belongs to small <i>Babesia</i> spp.) in horses; for more details on <i>Theileria</i> -like characteristics of small babesias see text; in splenectomised horses given at 5 mg/kg b.w. 4 times at 48 h intervals the parasitemia was eliminated.

Doses listed refer to recommended dose of the manufacturer and/or to literature and websites on the subject

<sup>a</sup> First practical (commercial) application (approx. year)

Data given in the table have no claim to full information

strategies, due to its effect on tick reproductive cycle being greatest at time of dosing. Current alternative control measures and their effective use in the field are still of minor importance. →[Biological control](#) of ticks with living antagonists distributed by man to lower pest (parasite) populations may lead to their reduction and so to acceptable subclinical densities. In the field, however, the use of biological agents as formulations (products) of viruses, bacteria, fungus, protozoans (e.g., →[microsporidia](#)), →[nematodes](#), and insects, or →[pheromones](#), are very much limited and less promising in their effects today. A more successful control measure against widely distributed *Boophilus* spp. and other tick species seems to be the immunization of cattle with recently developed antitick vaccines. The antigens of interest against ticks are native or recombinant proteins located in the gut cells' plasmatic

membrane. They are called “novel, concealed, or occult antigens” causing lesions in the tick's intestine, thereby, reducing the fecundity of ticks. Other putative antigens seem to be located in cells of the salivary glands preventing feeding of the ticks and thus depressing their fertility.

### Control of Babesiosis by Various Application Techniques of Acaricides

Acaricides can be applied to animals by different application techniques. When treating animals for external parasites it is important that agents not absorbed through the skin, or from the digestive tract, or parenteral injection be so applied that contact with the parasite will occur. Dips and sprays generally are suited for treating



most animals (especially herds) except when temperatures are below freezing or extremely thirsty animals are to be treated. Systemic drugs, usually the organophosphates and macrocyclic lactones (ivermectin, moxidectin, doramectin, and eprinomectin) are applied as pour-ons, spot-ons, injectables, sprays, and feed additives, or via dipping vats (tanks). These agents gain access to the host circulatory system and are then distributed throughout the body. **Dipping** probably offers the best means and most cost-effective method of tick control for cattle in tropical areas, and for dogs (is less frequently used for cats). Dipping with acaricides has the advantage of thorough coverage of the skin, coat, and head of cattle (if deep tanks are used). When using such agents caution must be exercised to prevent contaminating humans and their food supply and environment.

### **Premunization and Use of Antibabesial Drugs (Chemoimmunization)**

Bovines of an enzootic area commonly acquire a so-called infection-immunity or **premunition** against babesiosis in the first six months of life. As a result, most of the cattle of enzootic areas are carriers of a few parasites and will therefore develop a certain degree of protective immunity against local *Babesia* strains without showing signs of disease. In contrast, elimination of the infection by curative agents is soon followed by loss of resistance to the parasite in most hosts. Cattle introduced from areas free of babesia or with parasites of different antigenic strains, may acquire babesiosis and die. **Premunization** (artificial induction of premunition) has allowed the introduction of quality cattle into enzootic areas of Australia, USA, Latin America, and elsewhere. Animals introduced are injected with blood from babesia carriers and monitored for the presence of fever and parasitemia. Soon after clinical signs are apparent, animals are treated with subcurative doses of diminazene aceturate or imidocarb dipropionate (Table 1), thereby killing enough parasites to prevent an outbreak of disease but allowing some surviving parasites to induce protective immunity to natural challenges in hosts. Animals can be injected simultaneously with a standardized dose (several million organisms of each species per animal) of *B. bigemina*, *B. bovis*, and *Anaplasma marginale* (*Rickettsia* species) derived from blood of donor bovines often splenectomized. They are then treated well timed with Imidocarb or with long-acting tetracyclines, which are active against both *Babesia* and *Anaplasma*. Premunization has several drawbacks. The main obstacles, like the occurrence of hemolytic disease in newborn calves (antibodies against erythrocyteisoantigens), transmission of other blood-borne pathogens (e.g., leukosis virus), or storage and transportation problems of the

'vaccines', have largely been overcome but some problems remain. Thus premunization prevents eradication of the parasites, may cause economic losses (outbreak of disease or occurrence of mortality in herds), may induce a variable resistance status in cattle, and is expensive. On the other hand there may be some advantages concerning premunization. Thus its application is still needed in large enzootic areas because refinements to the system of immunization with attenuated parasites are not yet satisfactory with regard to tolerability of vaccines. Occasionally there are adverse effects such as →**abortion**, hemolytic neonatal disease, or induction of severe babesiosis. The safety of blood derived vaccines is not always guaranteed and transmission of other hematogenous infections cannot be absolutely excluded. This may also be true for the stability of vaccines. They may fail to induce strong herd immunity because of instability of vaccinal parasites or changes in selection of field strains, or prolongation of vaccine shelf life beyond expiration date. Intolerability of vaccines may be shock and disturbances of the blood-clotting mechanisms, and calcium balance.

### **Chemotherapy of Babesiosis in Animals**

The elimination of babesias (Table 1) in cattle or horses may play an important role for those animals which have a low-grade infection premunition. In these cases it must be guaranteed that carrier animals are free from infection before being imported into *Babesia*-free areas. However, when drugs are used therapeutically in endemic regions the aim is to promote clinical recovery only, and to allow some parasites to survive, reestablishing premunition. Thus, instead of the chemoimmunization programs (see Premunization and Use of Antibabesial Drugs) that are used in districts with enzootic stability or instability, in countries where babesias are rare the so-called diagnosis-treatment method is employed. There are several drugs in use, all of which are "oldtimers" and are more or less afflicted with adverse effects involving long withdrawal periods for meat and other edible tissues. Drugs commonly used in treating acute ovine or porcine babesiosis are quinuronium sulfate, imidocarb, and diminazene, which have sufficient efficacy against clinical attacks. Infections with *Babesia* spp. in sheep, goat, and swine must be treated with somewhat higher doses than those normally recommended in cattle. Repeated administration of drugs may be necessary to cure *B. ovis* infections (for details regarding activity and toxicity of antibabesial drugs see Table 1, →**Trypanocidal Drugs, Animals**; for pharmacokinetics of diminazene diacetate and ethidium bromide see →**Trypanocidal Drugs, Animals/Pharmacokinetics of Trypanocides and Chemical Residues in Edible Tissues and Milk**). The effect of an antibabesial drug may vary and can be modified by the

severity of the disease, the dosage used, the timing of treatment in the course of infection, and the length of time that the drug is present to affect the parasite. As a rule, large *Babesia* spp. are distinctly more susceptible to chemotherapeutic agents than are the small ones. In general, small babesia respond variably to antibabesial drugs. **Sterilization of infection**, i.e., complete elimination of parasites, is usually not achieved with small *Babesia* spp. possibly due to adherence of parasites to capillary walls and consequent obstruction of blood flow. There may be differences in relation and metabolism between small and large *Babesia* spp., and as a result the target and biochemical mode of action of drugs differ. Recovery of ill animals can be achieved if specific and effective treatment is given prior to the onset of severe anemia or disorders of the nervous system, i.e., in the early course of infection. Prognosis is poor for those animals already showing cerebral signs; these are caused by clumps of parasitized erythrocytes blocking capillary blood vessels of cerebral cortex. In severe cases the aim of supportive treatment (e.g., blood transfusion, fluid therapy) is to reduce the occurrence of shock and disturbances of the blood-clotting mechanisms and calcium balance.

### Elimination of Babesia in Horses

Equine babesiosis is widespread; severe clinical disease and mortality may occur occasionally. Therefore, the elimination of carrier infection in horses being shipped from endemic zones to *Babesia*-free areas gains increasing importance. Various drugs may be used for clearing *Babesia caballi* infections. Amicarbalide (8.8 mg/kg b.w., × 2, 24 h interval), imidocarb (1–2 mg/kg b.w., × 2, 24 h interval), diminazene (5 mg/kg b.w., × 2, 24 h interval), and phenamidine (8.8 mg/kg b.w., × 2, 24 h interval) may show sufficient action. *B. equi* (small species) has recently been transferred to the genus →*Theileria* (see also Table 1: parvaquone).

### Elimination of Babesia in Dogs and Cats

Canine babesiosis is becoming increasingly widespread in the USA, Europe, Africa (*B. canis*), and Asia (*B. gibsoni*). The disease can be treated with a few antibabesial drugs causing more or less toxic side effects, such as diminazene (which is not recommended for use in dogs by the manufacturer, Table 1), imidocarb, amicarbalide, phenamidine, and trypan blue. *B. canis* may cause uncomplicated infections (fever, depression, acute hemolysis with a mild to severe anemia, pale mucous membranes, and splenomegaly), or complicated ones (coagulopathy, hepatopathy, immune-mediated hemolytic anemia, renal failure, cerebral signs, pulmonary →*edema*, and shock). The specific therapy (if started too late, or in case of complicated infection per se) must be combined with supportive treatment

(fluid infusion followed by blood transfusion, liver protectants, diuretics, vitamin B complexes, prednisolone). In general, drugs are distinctly less active against *B. gibsoni* than against *B. canis*. Relapses in *B. gibsoni* infections are common, and may also occur after administering markedly higher doses than those recommended. Thus, diminazene in doses of 7–10 mg/kg b.w. only suppresses parasitemia, but these doses and even lower ones may cause severe side effects and occasionally mortality in dogs (Raether unpublished). *B. felis* infection, which may cause anemia and icterus in the domestic cat, has been reported to respond to trypan blue and quinuronium. These results are inconsistent with those of Potgieter who found that all known antibabesial drugs failed to affect *B. felis*; successful treatment was achieved in using primaquine diphosphate. Concerning differential diagnosis of feline babesiosis →*Cytauxzoon felis* infection (*Theileria* species) should be considered; it may occur in North America and parasitize lymphocytes and erythrocytes of cats.

### Chemoprophylaxis of Babesiosis in Animals

The aim of →*chemoprophylaxis* is to protect susceptible animals from clinical signs of babesiosis caused by natural tick infection, or to moderate the clinical course of infection in immunization programs (see Premunization and Use of Babesiocidal Drugs). The administration of drugs like **diminazene**, **imidocarb**, or **oxytetracycline** (Table 1) should allow the development of premunition. Imidocarb, which exhibits a fairly long effect on *Babesia* spp. in cattle (4–12 weeks at 2 mg/kg b.w., depending on *Babesia* species, and infection pressure), can also be used for short-term protection of susceptible animals after their introduction into *Babesia*-infected areas.

A single subcutaneous dose of 2.4 mg/kg b.w. **imidocarb** may protect dogs from *B. canis* infections for about 4 weeks. However, controversy exists concerning the duration of its prophylactic efficacy. So in Beagle dogs experimentally infected with *B. canis* (merozoites), a single dose of 6 mg/kg b.w. resulted in a 2-week protection period only. In enzootic *Babesia* areas, dogs can also be protected by long acting acaricides applied in 4-day-intervals, or by application of inactivated vaccines (e.g., Pirodog®). Although these vaccines allow *Babesia* infections under high infection pressure they may prevent infected dogs from mortality.

### Resistance

Although →*malaria* and babesiosis have many similarities, and their causative agents are related, resistance of *Babesia* and malaria parasites to drugs differs markedly. While resistance of *P. falciparum* to drugs has probably become the most important threat to effective →*control of malaria*, drug resistance in large

*Babesia* spp. seems to be a minor problem in the chemotherapy of babesiosis. Resistance to babesiacidal drugs can be induced experimentally. Thus *in vitro* micro-titres tests (96-well flat-bottom plates) may be used to assess drug responsiveness of *B. bovis* or *B. bigemina* to various antibabesial compounds, thereby selecting drug-adapted lines by the presence of sub-inhibitory drug concentrations. Under field conditions drug resistance in *Babesia* spp. may emerge if drugs are used prophylactically or in chemoimmunization programs. Using such dose regimes it is likely that subtherapeutic, low concentrations of the drug are in temporary or permanent contact with the parasites, thereby causing selection of drug-resistant organisms. However, it must be emphasized that the innate poor response of small *Babesia* spp. (e.g., *B. bovis*, *B. ovis*, *B. gibsoni*, *B. felis*, *B. microti*) to antibabesial drugs should be distinguished from an acquired drug resistance occasionally occurring in large babesias. Compared to the greater drug sensitivity of large *Babesia* spp., the varied action of drugs against small forms (→“Natural Resistance”) may well be connected with differences in their relation. Small species undergoing →schizogony in lymphocytes (e.g., *B. microti*) appear in their fine structure very similar to *Theileria* spp. Molecular analyses of the small subunit ribosomal RNA genes (rDNA) suggest that small *Babesia* spp. may have a close relation to *Theileria* spp. There were a number of reasons why *B. equi* was transferred to the genus *Theileria*.

### Chemotherapy of Human Babesiosis

Since the first description of human babesiosis in 1957 in a splenectomized patient in Yugoslavia there have been several case reports from the USA, Europe, and other countries on babesiosis in man. The acquisition of human babesiosis may depend on contact with subadult stages of certain *Ixodes* ticks, e.g., *I. dammini* (its main host is white-footed mouse, *Peromyscus leucopus*), and *I. ricinus* possibly transmitting *Babesia microti* (a rodent piroplasm) and *B. divergens* (a parasite of cattle), respectively. *B. gibsoni* is a parasite of dogs, and WA-1, a *B. gibsoni*-like piroplasm, has been documented in residents along the Pacific Coast of the USA, and may infect humans in Taiwan and South Africa too. The host (vector/tick) of WA-1 and its reservoir are still unknown. Although closely related to *B. gibsoni*, WA-1 should not infect dogs. However, it is highly pathogenic for most rodents. In humans WA-1 and *B. microti* may cause a similar course of infection and symptoms. Apparent **clinical signs** are parasitemia (intraerythrocytic parasites show characteristic tetrad forms), fever, rigors, cough, headache, vomiting, anorexia, and dark-colored urine. Spleen-intact humans infected with *B. microti* or WA-1 may well respond to a combination of **clindamycin**

(macrolide antibiotic) and **quinine** (*chinchona* alkaloid, Table 1, →Malaria Drugs/Malaria of Human) although quinine proved to be totally ineffective against *B. microti*. In many areas of Europe, the enzootic cycle of *B. microti* may obviously depend on uniquely mouse-specific tick, *I. trianguliceps*. Possibly for that reason this species is not transmitted to humans, or its European strains are not pathogenic to humans. Reported cases of human babesiosis in Europe are due to *B. divergens* and chiefly occur in farmers and other persons frequently in contact with cattle. As a rule, *B. divergens* infections in man show rapid increasing parasitemia, and damage of large numbers of infected red cells causing massive hemoglobinuria, intravascular hemolysis, and renal failure. Therefore an early start of specific treatment is important for any patients infected with *B. divergens*. The treatment of choice seems to be the immediate administration of clindamycin (adult dosage: 1.2 g, 2×/d IV or 600 mg, 3×/d PO × 7d) plus quinine (650 mg, 3×/d PO × 7d; all doses cited are from Medical Letter, 2004; pediatric dosage for both drugs see there). Chemotherapy is followed by a massive exchange transfusion to reduce parasitemia, i.e., to remove physically large numbers of infected red cells and prevent extensive hemolysis and renal failure. Exchange transfusion may be used as an alternative or in addition to chemotherapy relying on relatively toxic drugs. However, this therapy with its attendant risks should be reserved for heavily parasitized and seriously ill patients only. Symptomatic and other supportive care should be associated with specific treatment. Clindamycin plus quinine treatment proved to be insufficient in immunosuppressed patients or in HIV infected ones. Therefore, in foudroyant infection courses massive blood exchange may be lifesaving or application of **atovaquone** plus **azithromycin** (Medical Letter 2004) as was recently shown.

**Pentamidine isethionate** (a trypanocide, see →Trypanocidal Drugs, Man) has shown good activity against *B. microti* but failed to eliminate parasites from blood completely. **Diminazene aceturate** (Table 1 and →Trypanocidal Drugs, Animals), an aromatic diamidine like pentamidine and approved for use in animals only, has also been tested in humans. The drug was successful in treating a *B. microti* infection, which did not respond to therapy with oral chloroquine phosphate. The infection was eliminated, but the patient developed acute idiopathic polyneuritis, probably related to the diminazene therapy.

---

## Babesians

Members of →*Babesia* species, →Tick Bites: Effects in Animals.

## Babesiosis, Animals

### Synonym

→ Piroplasmosis, → Texas Fever, Meadow Red, → Red-water Disease, → Cardiovascular System Diseases.

### General Information

Babesiosis is caused by infection with species of tickborne, intraerythrocytic and generally host-specific protozoan parasites of the genus → *Babesia*. It occurs in a wide variety of vertebrate hosts and has a very wide distribution around the world. The two major factors involved in the pathogenesis of babesiosis are the release of pharmacologically active agents and intravascular haemolysis. The relative importance of each varies with the species of → *Babesia*, e.g., the pathogenesis of *B. bigemina* is almost entirely related to haemolysis while with *B. bovis* the release of proteolytic enzymes which directly or indirectly affect the microcirculation and the viscosity of blood is the most important. Effects on the microcirculation include vasodilatation and increased vascular permeability, leading to hypotension and → oedema. Higher viscosity and coagulability of blood and increased stickiness of the membrane of blood cells cause aggregation of cells in capillaries and obstruction of the blood flow. This may lead to congestion and degenerative changes in the spleen, lymph nodes, kidneys and brain. Whatever the species involved, the disease may follow acute, subacute or chronic courses, and there may be great variation in the clinical manifestations of infection.

### Pathology

#### Cattle

Various species of *Babesia* (*B. bovis*, *B. bigemina*, *B. divergens* and *B. yakimovi*) are transmitted by → ticks into wild and domesticated cattle. Large numbers of ruminants are killed by this parasite in tropical and subtropical areas of Australia, South America, Southern USA, and Africa where the parasites are endemic. The fight against babesiosis is a major economic factor in these areas. *B. bovis* infection is probably the most important cause of "tick fevers" of cattle. The fact that some breeds of *Bos indicus* are relatively resistant to the effects of this parasite has led to the suggestion that the organism evolved in these breeds. Young cattle have pronounced resistance to severe infection. The first clinical signs are fever (>40°C), loss of appetite and listlessness. → Anaemia and → haemoglobinuria (→ Redwater) follow, and signs of jaundice develop. Diarrhoea is common and pregnant cows may abort. A form of "cerebral babesiosis" develops in some animals with such clinical signs as hyperaesthesia,

nystagmus, grinding of teeth, circling, head pressing, mania, ataxia and convulsion. In terminal cases muscle tremors and wasting may appear, followed by coma and death. At post-mortem examination the blood appears to be thin and watery, and there is haemoglobinuria. All connective and fat tissues are oedematous and show evidence of icterus. The spleen is characteristically enlarged. The liver is swollen and the gall-bladder distended. In cases of cerebral babesiosis the grey matter of the brain is congested and shows a typical red discolouration. Infection with *B. bigemina* causes similar but usually less severe clinical signs than infections with *B. bovis*, though acute anaemia and death also occur. The pathogenesis is here almost entirely related to a rapid haemolysis, with signs of haemoglobinuria and jaundice. There is no cerebral involvement. *B. divergens* and *B. major* are considered less pathogenic than other species in the tropics. In temperate regions, *B. divergens* causes the most severe signs and may be responsible for heavy economical losses. Clinical signs include fever, anaemia, → bilirubinuria and haemoglobinuria. Diarrhoea, icterus, nervous signs and → abortion may also occur in severe cases.

#### Horses

The horse parasite *Babesia equi* has recently been redescribed as *Theileria equi*. The only *Babesia* spp. which occurs in horses is *B. caballi*. The pathogenesis and clinical signs of infection are similar to those described above for other *Babesia* spp., i.e., that of an haemolytic anaemia which is compounded by phagocytosis of erythrocytes by macrophages. However, most infected animals are not clinically affected. Equine babesiosis is an important reason for the restriction of movements of horses between some countries.

#### Dogs

*Babesia canis* infection is a common cause of death in dogs. The pathogenesis resembles that of *B. bovis* in that mechanisms other than a haemolytic anaemia appear to be involved. However, in contrast with other animals, infection is more frequent in young dogs than in older animals. The clinical picture of dogs suffering from babesiosis is diverse and may follow a hyperacute, acute, or chronic course. Experimental infection of dogs with *B. canis* isolates from geographically different areas reveals different pathology which suggest that the aetiology of the disease caused by these isolates is different. Mildly affected animals develop anaemia and fever, are lethargic and have poor appetite. They show no visible signs of jaundice or haemoglobinuria and recover after a few days. More severe cases show a wide variety of signs, including severe depression, salivation, → vomiting, diarrhoea, jaundice and haemoglobinuria or haematuria. Pulmonary involvement

occurs frequently with quickened respirations and frothy blood-stained spittle. →Anorexia and →weight loss may be persistent. Nervous signs may occur. Infections with *B. gibsoni* are less severe and often resemble an uncomplicated haemolytic anaemia.

### Other Species

In most cases, babesial infections of other vertebrate host species are mild or clinically inapparent. However, severe reactions have been described, e.g., during *B. perroncitoi* infections in pigs and *B. felis* infections in cats.

### Vaccination

The ticks responsible for transmission of cattle babesiosis are, particularly in Australia, resistant against most of the commercial acaricides, so that vaccination against the parasite is the only means of fighting the disease. It has been known for a long time that cattle can develop a prominent and long-lasting premunition against the parasite after recovery from babesia infection. From 1897 until the mid-1960s blood from recovered cattle was used as a simple blood vaccine. More recently this live vaccine was refined by making the *B. bovis* parasite less virulent, passing it through splenectomized calves, and diluting the erythrocytes in a cell-free, plasma-like medium. This live vaccine was mainly produced and used in Australia but was also and still is used in Africa. About  $10^7$  parasites are administered per vaccination. The vaccine has a short half-life of about 6 days and, like most live vaccines, its quality can vary batch to batch. Live vaccines prepared in splenectomized calves are used with success in Israel against *Babesia bovis*, *B. bigemina* and *Anaplasma centrale*. They have been proven to be better than vaccines prepared from tissue cultures. The vaccines are stored and dispatched to the field in a concentrated frozen state. The extensive use of the same type of vaccine in Australia from 1959 to 1996, with 27 million doses has been recently reviewed by Callow et al. in 1997 with favourable results. However, this dependence of cold chain facilities is an insurmountable difficulty for poor and tropical areas of Africa and South America in the use of attenuated live vaccines. The search for alternative vaccines has been developed, such as attempts to use irradiated parasites with  $^{60}\text{Cobalt}$  with satisfactory results. Efforts to produce parasite extracts or fractions to be used as vaccines have also failed. A breakthrough in the search for a defined vaccine came when it became possible to produce *B. bovis* in a candle-jaw culture system used for growing →*Plasmodium falciparum*. Parasites and culture supernatant, which contains soluble parasite exo-antigens, became available in large quantities and both produced protective immunity in cattle. Lately

purified *B. bovis* antigens have been successfully used in animal vaccination trials with reference to the ability to induce protection against heterologous strains challenge. These types of vaccines have been used also in tropical areas of India and Brazil with success. However, antigen →polymorphism of exo-antigens is a limiting factor for generalization of commercially available vaccines of this type.

There is only a vaccine against *B. canis* commercially available (Pirodog®) based on culture-derived antigens. Vaccination, however, has to be repeated regularly and induces poor protection against heterologous *B. canis* parasites.

A second generation of controlled babesiosis vaccines by gene technology methods is being intensively pursued in various laboratories. A large number of antigens to be used in subunit vaccines have been identified and cloned. However, again, antigenic polymorphism and lack of knowledge on the immune effector mechanisms responsible for protection are limiting factors for preparing practically useful recombinant or synthetic vaccines which can be used in mass vaccinations.

A 37 kDa glycoprotein of *B. bigemina* has been recently identified as the major component of a protective fraction obtained from cultures of these parasites.

### Therapy

→Babesiacidal Drugs.

---

## Babesiosis, Man

### Synonym

→Piroplasmosis.

### General Information

Babesiosis is usually contracted accidentally from the bite of an ixodid tick which transmits →*Babesia* spp., an unpigmented protozoan multiplying in the red blood cell, usually in an asplenic individual. Several species of →*Babesia* give rise to natural infections in cattle, other domestic animals, and field mice, on which one stage of the →ticks normally feeds (→*Babesiosis, Animals*). Transmission to man occurs in the next stage. *Ixodes dammini* and *I. ricinus* are the principal vectors of *Babesia microti* which is zoonotic in New York State and Massachusetts. *Ixodes ricinus* transmits *B. divergens*. Most European cases of human babesiosis are caused by →*Babesia divergens*. In humans the *Babesia* spp. undergo →binary fission and often are

located at the periphery of mature red blood cells, which are destroyed without production of insoluble →pigment.

### Pathology

Bilirubinemia, jaundice, hemoglobinuria, fever, and hematuria often accompany heavy infections of humans with *B. divergens* of cattle or *B. microti* of rodents. However, many infections appear to pass asymptotically. The infection is lethal in splenectomized individuals but it is very rare and is restricted to small isolated endemic areas.

**Main clinical symptoms:** Abdominal symptoms, →diarrhoea, continuous fevers of 40–41°C, →anaemia, death.

**Incubation period:** 1–4 weeks.

**Prepatent period:** 1 week.

**Patent period:** 1 year.

**Diagnosis:** Microscopical determination of blood stages in →Giemsa-stained smear preparations (pigment does never occur), →Serology.

**Prophylaxis:** Avoid the bite of ticks.

**Therapy:** Treatment see →Babesiacidal Drugs, combined with blood transfusions.

## Babesiosoma

→*Babesia*-like parasites in red blood cells of amphibia.

## Baccalaureus japonicus

Cirriped parasite (like →*Sacculina*) in/on coelenterates and echinoderms.

## Bacillary Cells

→Nematodes, →*Trichinella spiralis*.

## Bacillus sphaericus

→Mosquitoes.

## Bacillus thuringiensis

→Spores and proteinous crystalline structures (of the serotype H 14) kill the larvae of →mosquitoes. After swallowing these components toxins are produced, the intestinal wall is ruptured and the development of the bacteria proceeds in the body cavity (→Blackflies/Control, →Disease Control, Methods).

## Bacot, Arthur William (†1922)

English biologist (Fig. 1), discoverer (1910) of the life cycle of the plague bacillus in the pest flea *Xenopsylla cheopis*. During World War I, he described the agents of the Trench Fever (*Rickettsia wolhynica*). He died in 1922 from louseborne spotted fever (*Rickettsia prowazeki*).



Bacot, Arthur William (†1922). Figure 1 Arthur W. Bacot in his mid-years as director of the Lister Institute in London.

## Bacteria

→Nematodes, →*Glossina*, →Diptera, →Mosquitoes, →*Bacillus sphaericus*, →*B. thuringiensis*, →*Wolbachia* Species, →*Pseudomonas hirudinis*.

## Baer's Disk

### Synonym

→Opisthaptor.

Named by Baer (Swiss biologist). Hookless holdfast organ of →*Aspidobothrea*; in adultworms it covers nearly the whole ventral side.

## Baermann, Gustav Karl Theodor Friedrich (1877–1950)

German physician, discoverer of the Baermann-funnel to separate worm larvae from faeces.

## Baermann's Larval Technique

Method to eliminate, e.g., lungworm larvae from faeces (Fig. 1). Larvae in lamp-heated faeces wander to the aqueous side at the bottom and fall into the water, from where they are taken and studied by light microscope.

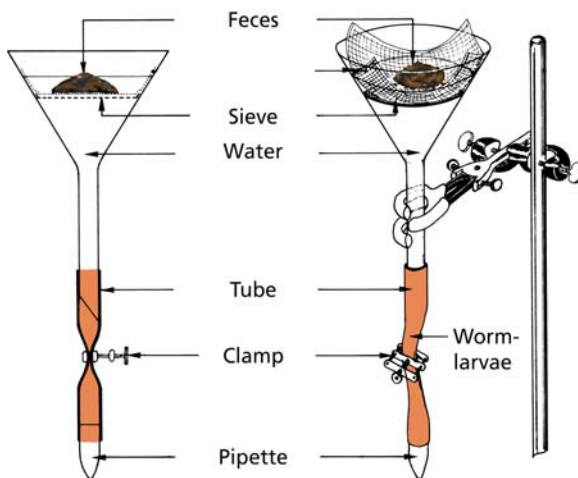

**Baermann's Larval Technique.** Figure 1 DR of 2 aspects of the Baermann-funnel which is used to obtain living larvae from faeces.

## Baggage Malaria

Other term for →airport malaria.

## Baker's Itch

Allergy due to →mites.

## Balamuthia mandrillaris

→Amoebae, →GAE.

## Balantidiasis, Man

Disease due to infections with the porcine ciliate →*Balantidium coli* via oral uptake of cysts from feces.

**Main clinical symptoms:** →Diarrhoea, nausea, obstipation.

**Incubation period:** Days to weeks.

**Prepatent period:** 4 days to weeks.

**Patent period:** Years.

**Diagnosis:** Microscopic determination of cysts and →trophozoites in fecal smears (Fig. 1).

**Prophylaxis:** Avoid contact with human or pork feces.

**Therapy:** Treatment see →Antidiarrheal and Antitrichomoniasis Drugs.

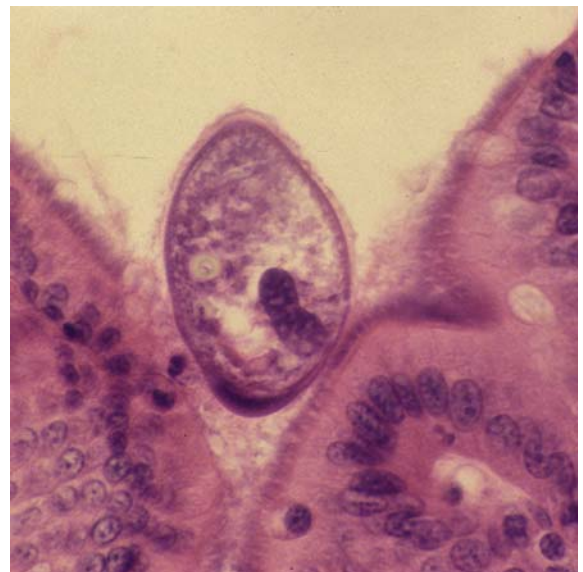

**Balantidiasis, Man.** Figure 1 Trophozoite of *Balantidium coli* at the intestinal wall.

## Balantidium

### Name

Greek: *balantion* = sack, *kolon* = terminal intestine.

Genus of trichostomatid ciliates (Ciliophores), the species of which live in the gut of many host species (e.g., →*Balantidium coli* in pigs and humans, *B. depressum* in a mollusc (*Pila*), *B. caviae* in guinea pigs, and many species in freshwater and saltwater fish or in amphibia). Their size is often rather large (50 × 70 μm), they are characterized by an anterior vestibulum, a cystostome-cytopharyngeal complex, several contractile vacuoles, a spherical small micronucleus besides a half-moon-shaped macronucleus and the lack of typical mitochondria. However, they possess hydrogenosomes.

## Balantidium coli

### Classification

Species of →Ciliophora.

### General Information

The ciliate *Balantidium coli*, 50–200 μm in length (Fig. 2, page 158) lives in the lumen of the colon of humans, pigs, rodents, and many mammals but is often invasive, forming deep ulcers with undermining margins. The balantidia are found in these ulcers and extend the →ulcer base to the muscularis and occasionally beyond, leading to perforation. The →inflammatory reaction is neutrophilic, but whether it is due to the ciliates or the accompanying bacteria is not known.

### Life Cycle

Fig. 1.

### Disease

→Balantidiasis, Man, →Balantidiosis, Animals.

## Balantidiosis, Animals

→*Balantidium coli*, →Alimentary System Diseases, Swine.

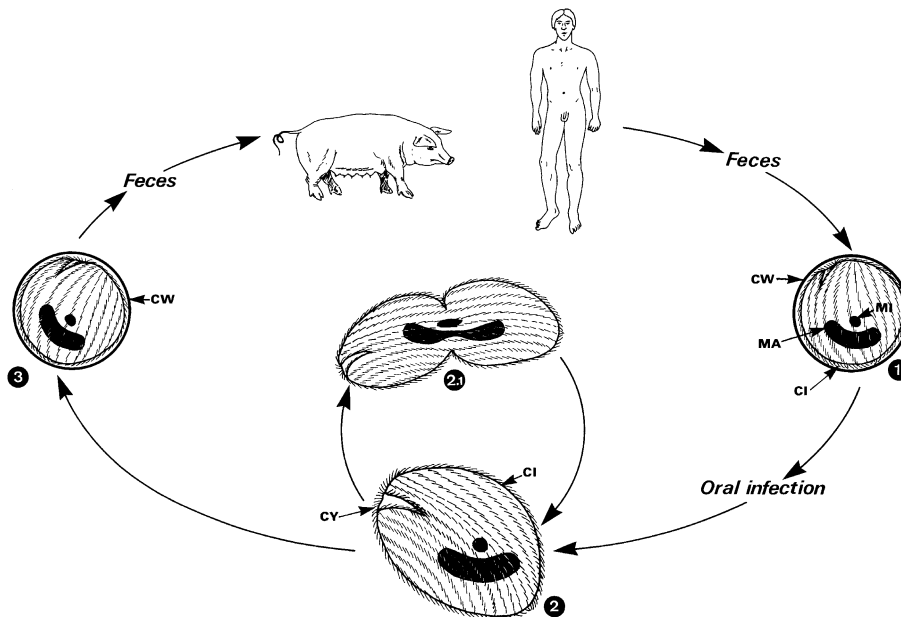

**Balantidium coli.** **Figure 1** Life cycle of *Balantidium coli* in the cecum and colon of humans, pigs, rodents, and many mammals. 1 Cysts of 40–60 μm diameter are excreted with the feces. The →macronucleus of this species is sausage-shaped. 2 Cysts are orally ingested with food by the new host. In the intestine the →trophozoites hatch from the cysts and grow to a size of 150 × 100 μm. 2.1 The trophozoite is reproduced by repeated transverse binary fissions. →Conjugation has been observed, but may occur only rarely in man. In mammals the trophozoites may initiate lesions and ulcers of the intestine. 3 Encystment is initiated by →dehydration of feces as they pass posteriad in the rectum. Trophozoites may also encyst after being passed in feces. CI, →cilia; CW, cyst wall; CY, cytopharynx; MA, macronucleus; MI, →micronucleus (for other species of →Ciliophora see →Ciliophora/Table 1).





**Balantidium coli.** Figure 2 Fresh preparation of a trophozoite of *Balantidium coli* of pigs. The cilia are invisible due to movement.

## BALF

Abbreviation for bronchoalveolar fluid obtained by lavage in order to detect *Pneumocystis* stages.

## Bancroft, Joseph

Irish scientist and physician (Fig. 1; 1836–1894), who discovered the adults of →*Wuchereria bancrofti* in a muscle abscess of humans (1876).

## Bancroftian filariasis

→Filaridae.

## Barbulanympha

Genus of the protozoan order →*Hypermastigina* living in the intestine of cockroaches. →Gametes/Fig. 24.



**Bancroft, Joseph.** Figure 1 Dr. Joseph Bancroft, discoverer of the adult stages of the *Wuchereria filariae*.

## Bartonellosis

Disease due to an infection, e.g., with the bacterium →*Bartonella bacilliformis* being transmitted by →sand flies (phlebotomes); other names are →*Verruga peruana* or Carrion disease.

## Baruscapillaria

Synonym of *Capillaria obsignata*, a nematode of chicken and turkeys.

## Basal Bodies

→Flagella.

## Basis capituli

Apical region of →ticks, which is formed by the basal portions of the 2 pedipalps.

## Bats

→Vampire Bats.

## Bayliascaris procyonis

Ascarid nematode of racoons; life cycle compare →*Ascaris*; leads to →larva migrans in humans.

## Bay-Sore

Other name for chiclero's ulcer, a form of cutaneous →leishmaniasis.

## B-Cells

→Immune Responses.

## BCG

Bacille Calmette-Guérin.

## BDCL

Borderline disseminated cutaneous leishmaniasis.

## Bdellonyssus

### Name

Greek: *bdallein* = sucking.

Genus of mites, synonymous with →*Ornithonyssus* and →*Liponyssus*.

## Beauveria

Genus of entomopathogenic fungi, the species of which are used as biological insecticides to control growth of anophelid mosquitoes. If adult mosquitoes get contact with conidia of *Beauveria*, they die within 24 hours.

## Bee Dysentery

Infectious disease of bees caused by the microsporidian species →*Nosema apis*, see also →Nosematosis.

## Bee Mites

→*Varroa jacobsoni* (syn. *V. destructor*), →*Acarapis woodi*.

## Behavioral Alternations

→Behavior.

## Behavioral Fever

→Behavior.

## Behavior

### General Information

Parasites have evolved a wide range of subtle and sensitive mechanisms for locating and invading their hosts, for avoiding and resisting host defense systems and for acquiring resources that are not given to them voluntarily.

In response, the host has evolved remarkable defense strategies to avoid becoming infected and if they fail, to reduce the detrimental impact of the parasites on their individual bodies but also to improve the gene pool of their offspring by choosing mates with high resistance

against parasites. In the context of parasite-driven sexual selection it is interesting to note that, according to the →Red Queen Hypothesis, the advantage of sex and recombination – compared to parthenogenetic reproduction – is, for the host, the means for producing rare offspring that may escape infection and, for the parasite, the means for tracking these genotypes as they become common. Consequently, the evolutionary arms race between parasite and host is getting increasingly sophisticated.

In most of these host–parasite interactions, behavioral aspects play an important role. It is noteworthy, however, that the word behavior is used in different senses. If parasites shed their →glycocalyx, which has become loaded with antibodies, or when they switch the genes involved in their antigenetic variance, these actions are named behavior by certain authors. The scope of this chapter does not include such physiological actions and responses but is rather confined to activities that are carried out by the whole parasite or host body, or at least by certain external extremities or organs of it.

For many years the well-known behavioral changes displayed by ants infected with →*Dicrocoelium dendriticum* have fascinated parasitologists and behavioral ecologists. A vast number of papers reporting behavioral alterations in various infected hosts, mainly intermediate hosts, have appeared since then. Parasitologists were eager to detect the physiological mechanisms behind the abnormal behavior but unfortunately they were not all that successful, except for a few cases where agents such as the neurotransmitter →serotonin could be named as being involved in the behavioral change. Behaviorists on the other hand were keen on debating the theoretical aspects of the phenomenon. In a recent review on parasite transmission authors succeeded in combining both approaches and also suggest criteria for the differentiation between adaptive behavioral changes and such alterations which are just pathological side effects of infection, reflecting, for instance, an altered →energy metabolism.

As pointed out in a review by Poulin, researchers often use the “adaptation” label for host behavioral changes, based on their intuition. He suggests that altered host behaviors following infection can only be considered adaptive in an evolutionary sense if they satisfy certain conditions: (1) they must be complex; (2) they must show signs of purposive design; (3) they are more likely to be adaptations if they have arisen independently in several lineages of hosts or parasites; and (4) they must be shown to increase the fitness of either the host or the parasite.

A landmark paper which opened an entirely new line of research appeared in 1982: →Hamilton and Zuk's hypothesis that there should be a relationship between a

species' parasite load and its sexual showiness such as a colorful plumage. In female →mate choice, an individual male's resistance to parasites should be expressed in exterior secondary sexual characters which would allow a female to select parasite-resistant genes for her kin (parasite-mediated sexual selection). Subsequently, this novel concept has been manifoldly confirmed and partly disputed.

The present chapter – written from the host-parasite-interactions viewpoint of its author – aims to describe parasitological items involving the behavior of hosts and parasites, and to focus on new trends in the subject which have come up within the past few years. Such aspects that do fit into the scope of this review but are treated in other chapters have not been considered here.

### Alterations of Host's Behavior Facilitating Parasite Transmission

Concerning trophically transmitted parasites in their intermediate hosts a few, rather early, descriptions provided conspicuous and astonishing examples of behavioral changes in a host. For instance, there was the discovery of the life cycle of →*Dicrocoelium dendriticum* in which a specialized metacercarial stage, the →brain worm, induces an ant to seek an exposed position on a blade of grass where it stays, thus making itself vulnerable to predation by grazing ungulates. Sporocysts of *Leucochloridium* spp. were shown to mimic animals serving as food-items of warblers, the final bird hosts of the parasite, by forcing the snail intermediate host's tentacles to change size and shape, attain a showy color and perform pulsating movements. Later on, the literature on the behavior of parasitized intermediate hosts of parasites transmitted to final hosts via the food chain became very voluminous. Mostly authors were tempted to assume that alterations in ranging, foraging, cryptic, or antipredator behavior followed a purposive design, either benefiting the parasite in its transmission or the host (which is less frequently postulated).

Theoretically, the parasite can manipulate its host's behavior directly or it can influence its decision-making by imposing a constraint or stress, for instance by causing a drain of energy. Hunger-induced decrease of antipredator behavior induced by a parasite seems to be very common. In 3-spined sticklebacks (*Gasterosteus aculeatus*) infected by *Schistocephalus solidus* the energy flow into the large plerocercoids parasitizing in the peritoneal cavity of the fish result in higher energetic requirements and a higher oxygen demand. Consequently, time spent feeding away from a shelter is prolonged, combined with a reduced aversion to the risk of predation and a shift in habitat preference

emerging to the surface of the water where the availability of oxygen is best.

*Toxoplasma gondii*, for instance, is known to induce various behavioral alterations in its rodent intermediate hosts, but they do not seem to be driven by hunger. In addition to memory impairment, the propensity to explore novel stimuli in their environment is higher than in uninfected individuals. Infected rats are more active and more easily trapped. Interestingly, this altered perception of predation risk can be prevented not just by anti-*T. gondii* drugs but also by antipsychotic drugs.

In human patients (accidental hosts of *T. gondii*) latent toxoplasmosis, i.e., the lifelong presence of *Toxoplasma* cysts in neural and muscular tissues, leads to a prolongation of reaction times and reduced concentration, and accordingly such infected subjects have a higher risk of committing an accident than toxoplasmosis-negative subjects.

Among the trophically transmitted parasites acanthocephalans offer several good examples of complex and purposive alterations in the behavior of the host, leading to an increased probability that the larvae of the parasites will be transmitted to their final hosts. According to the often-quoted papers by Bethel and Holmes, the altered behavior of *Gammarus lacustris* only becomes apparent when the larvae of *Polydora paradoxus* reach their infectivity to the definitive host. Gammarids infected with infectious cystacanths of this species respond to disturbance by approaching the water surface and clinging to solid objects. Uninfected conspecifics are less sensitive to disturbance; when they are disturbed, they dive toward the bottom and burrow themselves into the mud. Later on Helluy and Holmes, after experimenting with different neurotransmitters known to play a role in crustacean behavior, offered an explanation of the altered behavior. They succeeded in demonstrating that the clinging behavior is influenced by serotonin, the injection of which also induced the same behavior in uninfected gammarids as in infected individuals.

Among acanthocephalans the induced abnormal behavior is often combined with a conspicuous orange or yellow color of the cystacanths, which is visible through the cuticle of the crustacean intermediate host, making the alteration more complex and purposive in terms of an increased predation probability by a final host; this has been demonstrated for several acanthocephalan species. In *Caecidotea intermedius* (formerly *Asellus intermedius*), infected with *Acanthocephalus dirus*, it could be shown that the decreased antipredator behavior of the infected isopods was obviously not simply due to increased energy demands since the time spent away from a refuge, when a predator was present, was not related to the location of the food offered.

The literature on behavioral changes of intermediate hosts of trophically transmitted parasites promoting their transmission to suitable final hosts – often referred to as favorization – has become rather voluminous.

Regarding behavioral alterations of final hosts of parasites and of parasites with monoxenic life cycles little information is available.

Mice subclinically infected with the monoxenic coccidian *Eimeria vermiformis* spent a significantly greater amount of time near to a source of cat odors and generally showed less predator-induced fear compared to uninfected controls. The altered behavior could not be modulated by treatment of the mice with morphine. Interestingly, in this case the resulting increased vulnerability of the infected mice to predation is not beneficial to the parasite which uses mice as the only host. Thus, behavioral changes do not always have to show a purposive direction that increases the probability of transmission of a parasite.

Often infected hosts are subjected to neuromodulatory responses leading to reduced spatial learning (mice infected with the monoxenic nematode *Heligmosomoides polygyrus*). Also, *Schistosoma mansoni* infection in humans and animals induces abnormal neurobehavioral responses, following granuloma formation. In infected mice the exploratory activity and the pain response on the host plate are markedly altered. Also increased sniffing and grooming of the infected mice can be noted. In malnourished schoolchildren the degree of infection with *Ascaris lumbricoides* was correlated with varying cognitive behaviors.

Human adults infected with *Dracunculus medinensis* revealed lowered sexual activity and poor maternal attention (in females).

All these behavioral changes seem to be side effects of pathology reflecting incomplete reciprocal host–parasite adaptations and thus cannot be considered adaptive in an evolutionary sense.

**Nontrophically transmitted parasites** may manipulate host behavior in a way aiming at an altered habitat preference benefiting their life cycle requirements. Mermithid nematodes as well as Nematomorpha are capable of driving their terrestrial hosts into water where the parasites can complete their life cycles as free-living adults. Nematomorphs achieve this by altering host transmitters, but the mechanisms used by mermithids have remained less understood. The supralittoral marine amphipod *Talorchestia quoyana* when infected with the mermithid *Thaumamermis zealandica*, seeks water-saturated sand where it burrows more deeply than uninfected individuals. An increase of host haemolymph osmolarity seems to induce “thirst” explaining why parasitized amphipods seek wet substrates.

Concerning **parasites transmitted by bloodsucking vectors**, behavioral changes affecting the vertebrate hosts as well as the arthropod vectors have been described.

Oxen infected with →*Trypanosoma congolense* were about 70% more attractive to the →*Glossina pallidipes* vector than uninfected controls or controls infected with *T. vivax*; and the feeding success of the →tsetse flies on the oxen infected with *T. congolense* was approximately 60% greater than on oxen of the other 2 groups. Both differences were discussed in relation to reduced antifly movements and vasodilatation induced by *T. congolense* in the mammalian host. The transmission of the parasite, however, also seems to be promoted by behavioral changes affecting the insect vector. →Epimastigotes of *T. congolense* attach themselves by means of →hemidesmosomes to the labral mechanoreceptors of the vector, thus impairing the sensory function and feeding behavior of the infected flies. The impairment of normal receptor function, plus the accumulation of trypanosomes in the labrum, also decreases the flow within the food canal. Infected flies probe more frequently and take longer to engorge than uninfected flies. These features have been calculated to increase the transmission rates for the parasites.

Furthermore, infection of →"kissing bugs" (Reduviidae) with *T. cruzi* reduced the time to detect potential hosts in comparison to control insects. Infected bugs bit about twice as often as uninfected nymphs and defecated 8 minutes after the last blood meal whereas uninfected individuals needed 11 minutes. And from mosquitos infected with *Plasmodium* spp. we know that appetite for blood is stimulated by the infection in themselves and their vertebrate hosts.

### **Castration, Sexual Reversal, Sex Ratio Distortion**

As already mentioned, parasitized hosts are often restricted in their mating behavior and in many cases do not show any sexual behavior at all, which may result from partial or complete castration, more frequently affecting intermediate hosts than final hosts. Castrated, nonreproducing males, like green crabs (*Carcinus maenas*) infected by the monoxenic rhizocephalan barnacle *Sacculina carcini*, tend to become feminized in their phenotype.

But in other host–parasite associations, best described from gammarid crustaceans, feminized males behave as genetic females and can even produce offspring. Once thought to be a rare phenomenon, sex-ratio distortion by parasites is now known to be common in many (mostly arthropod) vertebrates.

Among microsporidians many species undergo partly or even solely vertical transmission. This means that the parasite is transovarially transmitted in the cytoplasm of the eggs from mother to offspring. Infected male embryos become feminized which increases the transmission base to future host generations

by converting males, which cannot transmit the parasite in their sperm, into females. Due to such female-biased broods combined with a high prevalence of the microsporidians, eventually host populations should collapse due to a lack of males. However, feminized males are larger than true females and accordingly are less accepted as sexual mates than the latter. Furthermore, as described from *Gammarus duebeni* infected with *Nosema granulosis*, male (uninfected) amphipods provide uninfected, high fecundity females with more sperm than infected females.

These findings again demonstrate that parasites manipulate host behavior in order to promote their transmission, while the hosts' counter measures aim at the selection of good genes useful in resisting future parasite attacks against their progeny (good genes benefits mating, antiparasitic sexual mate choice, see below).

### **Behavior of the Host in Avoiding, Expelling or Eliminating Parasites**

#### **Change of Habitat**

Many examples reveal how mammals temporarily change their location in response to attacks by flying insects, e.g., when reindeer enter water or scrub. A special kind of change in habitat preference in response to parasite attack appears to be roost-switching of hosts that live in groups. →Bats change their day roost in response to a severe →ectoparasite attack. High ectoparasite levels were correlated with lower body weights in lactating females. Thus roost-switching might be an important strategy for decreasing ectoparasite loads by interrupting the reproductive cycles of those parasites that spend at least part of their life cycle on the walls of the cave.

#### **Escape and Defence Behavior**

Evasive actions of hosts following attacks of ectoparasites have been described from many hosts. The effectiveness of such actions has been demonstrated. A very interesting study was carried out by Laitinen et al. Brown trout (*Salmo trutta*) and roach (*Rutilus rutilus*) were exposed to furcocercariae of a →*Diplostomum* sp. that infects the eyes of fishes and to →xiphidiocercariae of a →*Plagiorchis* sp. that employs insects as second intermediate hosts. Swimming activity increased significantly in the roach exposed to *Diplostomum* →cercariae, even at very low densities, and remained high for 24–36 hours after exposure. Brown trout showed no response to low cercarial numbers but responded significantly at high exposure densities. The increase in activity peaked at 2 hours and returned to pre-exposure levels within 5–6 hours. In contrast, exposure to the cercariae of *P. elegans* did not elicit a response in either fish. This difference in the evasive behavior of the host could be due to the adherence and penetration activity of the

*Diplostomum* cercariae on the fish. On the other hand, related host species may differ in their success in preventing attacks of ectoparasites, perhaps reflecting different ecological strategies. Tadpoles of *Bufo* and *Rana* species can also make explosive movements when they sense cercariae contacting their skin. Because *Bufo* (toad) tadpoles are unpalatable to many predators they obviously have a different trade-off between predation and infection risk than *Rana* (frog) tadpoles and can afford to make more conspicuous evasive maneuvers than the latter which can be demonstrated in the laboratory. Species-specific differences in antiparasitic behavior are also known from higher vertebrates. In cage experiments with 6 species of herons and one ibis, →mosquitoes preferably fed on 2 of the heron species. When the birds were prevented from moving (most of their defensive behavior was directed toward protecting the legs and the feet) similar numbers of mosquitoes engorged on all the bird species.

### Hygienic Behavior

Localized defecation sites as a tactic to avoid (re-) infection by gastrointestinal tract parasites are practiced by many herbivorous as well as by carnivorous hosts such as racoons. But it remains under discussion to which extent the habit to deposit feces at latrine sites is a parasite avoidance measure or whether it also has a social function.

### Avoidance of Parasite Transmission by Choosing Uninfected Sexual Mates

The parasite avoidance hypothesis, which applies to horizontally transmitted parasites (ectoparasites, venereal diseases, and directly transmitted microparasites), suggests that females reduce the probability of catching parasites by direct transmission if they choose parasite-free males. The mate's sexual ornament, its odors or acoustic signals may serve as cues in decision-making according to the hypothesis of Hamilton and Zuk (good genes benefits mating; see below).

### Distinction and Avoidance of Infected Food

Since many parasites that are transmitted to their subsequent hosts through predation strongly reduce the fitness or even the survival of these hosts, the hosts should theoretically try to recognize and avoid infected prey individuals or to exclude particular prey species entirely from their diet when alternative prey is available. In different trials, sticklebacks constantly, and under all conditions tested, consume copepods infected with the tapeworm *Schistocephalus solidus* in preference to uninfected specimens. The infected copepods were more active and easier to catch. In this case, the procercoid of the parasite inside the copepod was visually inconspicuous, but still one should expect that the pronounced pathogenicity displayed by this tapeworm

in sticklebacks would have led to discriminative feeding behavior. If female sticklebacks avoid mating with parasitized males why do they accept parasitized prey? was the question that Bakker asked. He was amazed that sticklebacks did not even avoid gammarids that were marked by the shiny, orange-colored, infected larvae of the acanthocephalan *Pomphorhynchus laevis*. On the contrary, the infected gammarids were preferentially preyed upon because they possessed the conspicuous color mark that was visible through their transparent cuticle and because of their diminished photophobic behavior. This again contrasts with the high discriminating value of small dark spots (metacercariae) on the surface of fish when these fish species choose sexual mates or mates to school with. As far as can be ascertained, no positive report on the avoidance of infected prey or food by animal hosts exists. There has been some debate about an assumed trade-off between the energy gain of ingesting the easily accessible infected prey and the subsequent costs of reduced fitness. But regarding the transmission of *Leucochloridium* digeneans, the sporocyst of the parasite inside the snail's tentacle is the prey, not the snail or the tentacle. Thus, in this case no energetic trade-off could justify the uptake of this (apparent) prey.

### Antiparasitic Social Mate Choice

Sexual mate choice under the auspices of parasitism has received plenty of attention but many other forms of →partner choice exist where parasitism plays a role. Banded killifish, *Fundulus diaphanus*, were presented individually with a choice of "shoaling" with either of 2 conspecific stimulus shoals, the one consisting of fish with externally visible black spots (melanized metacercariae of *Crassiphiala bulboglossa*), the other consisting of fish without such spots. Both parasitized and unparasitized test fish significantly preferred to shoal with unparasitized stimulus shoals rather than parasitized ones. It was also shown in another experiment that killifish used black spots as an indicator for the presence of parasites when making their shoal choice. Thus, although in the case described metacercariae cannot spread from one fish to another, the decision of the fish should be interpreted as a parasite-avoidance behavior. Probably many ectoparasites that do have the ability to spread from host to host within a shoal are visually detectable by the respective fish. Furthermore, the parasitized shoal must have been exposed to the parasites and the exposure might be continuous.

### Measures to Eliminate Parasites that have Become Established

If an infection could not be prevented, the parasites can be attacked or removed by the host's behavior.

The physical removal of ectoparasites by the hosts has been well studied. Tools available for this task are,

for instance, comblike cleaning claws existing in several families of birds such as herons, and in certain marsupial and lemuriform mammals. House mice (*Mus domesticus*), for instance, have specialized lower incisors (teeth) which are capable of lateral closure and can thus effectively comb ectoparasites (such as the anopluran louse, → *Polyplax serrata*) away from the fur. Most stages of this common louse aggregate on the anterior body (mainly the head) where self-grooming is difficult. If, however, grooming is prevented by placing a collar around the neck of the mouse, → lice and their eggs spread across the whole body, and the number of lice may increase from 100 to more than 1,000 within 4 weeks. Within 24 hours of being permitted to self-groom the number of lice and their distribution begin to return to normal. Furthermore, recent studies have revealed the adaptive significance of avian beak morphology for ectoparasite control. The shape of a bird's beak used to be interpreted in relation to its role in feeding but now it is acknowledged to play an important role in preening. Amputation experiments were carried out with domestic pigeons. When the tips, obviously an important tool in preening, of the bills were removed (which did not prevent the birds from feeding) the populations of lice in their plumage increased rapidly.

Until recently we knew rather little about the time terrestrial animals devote to grooming. Cotgreave and Clayton published data on 62 bird species. On average, the birds spent 9.2% of the day in maintenance activities, mainly grooming (92.6%). Interestingly, bird species known to harbor a large number of lice spend more time grooming than do host species with few lice; the time spent on preening can also be experimentally manipulated by loading ectoparasites onto them. Of course, as one may expect, parasites have also adapted to grooming and can even utilize it for their transmission, as is shown in the case of the nematode *Heligmosomoides polygyrus* in the mouse host. After infective larvae have been placed on individually housed mice, significantly higher numbers of adult worms were recovered from the small intestines of the mice that were allowed to self-groom than were recovered from those mice that had been fitted with collars to prevent self-grooming. When larvae were placed on a single mouse housed with 3 other untreated mice, the latter became infected, suggesting that allogrooming may also be important in parasite transmission.

Following transcontinental introductions of parasites, hosts that have not undergone coevolution with the invasive parasite may become colonized and seriously harmed due to a lack of parasite removal behavior. In hives of the Asian honey bee *Apis cerana* serving as the natural host of the mite *Varroa destructor* (syn. *jacobsoni*), most of the infected worker brood is

removed from the colony, and bees also pick up mites from their bodies. In contrast, in hives of the naive novel host *Apis mellifera* (European honey bee) infected brood is not efficiently recognized and eliminated and the grooming behavior of the workers is comparatively low.

### Self-Medication

Many host species have been found to use substances (mainly plants) from their environment that are deliberately swallowed or otherwise contacted under certain circumstances. Several substances investigated seem to have detrimental effects to the parasites, and in certain cases it even seems that the use of the drugs leads to improved host fitness. Huffman correlated quantitative measures of the health of chimpanzees with observations of leaf-swallowing in an African national park. There was a significant relationship between the presence of whole leaves of certain plants and worms of adult → *Oesophagostomum stephanostomum* in the dung of the apes. But later on other controversial results and discussions about the medical properties of such plants ingested by chimpanzees came up and it appeared that swallowing unchewed rough leaves rather than the drugs in them was the causative agent of the self-cure.

### Behavioral Fever

Poikilothermic hosts affected by endoparasites may raise their body temperature by choosing warm and sunny microhabitats in order to improve the function of their immune system. In addition to generating behavioral fever, infected host individuals may prefer microhabitats with a lower temperature than their uninfected mates, slowing down the development of the parasites (digeneans in snails). But thus far only little and controversial literature on this subject exists. In addition, parasites are also known to manipulate their host's behavior making them select certain sites. So the distinction between both phenomena may not be easy to elucidate and further study of this topic is needed.

### Host Sexual Mate Choice as an Antiparasitic Selective Mechanism

#### General Aspects

At breeding time, conspecifics of one sex normally compete intensively for being chosen by the other sex. Mostly, the females choose and many studies have shown that they use male signals as a basis of their choice. Hamilton and Zuk postulated that secondary sexual characteristics may allow females to select

healthy, vigorous males resistant to common and harmful parasites and thus pass resistance genes on to their offspring. Thus, one of the most substantial benefits of sexual reproduction itself could be that it allows animals to rapidly react to changing environmental selection pressures such as coevolving parasites. Indeed it appears as if sexual reproduction itself is favored by selection resulting from host–parasite interactions. In different populations of a →dioecious freshwater snail, showing both sexual and parthenogenic reproduction, the frequency of males was used to estimate the degree of sexual reproduction in each population. The male frequency was significantly positively correlated with the frequency of 2 digenetic →trematodes in the snails. Since the proportion of males infected was not significantly different from that of the females, this interesting result did not appear to be an artifact. The result suggests that parasitism potentially functions as a means of frequency-dependent selection which favors the maintenance of sex. Therefore sex and recombination seems to be a definite strategy of hosts in the evolution of their resistance toward parasites. One may conclude that heritable variation in parasite resistance is maintained by coevolutionary cycles between host and parasite genotypes.

### Female's Choice

Among birds, ornamental characteristics, for instance of the plumage, are often related to sexual mating. So when females pick partners to mate with, they may make their decision according to the impression they get of an ornamentation that has been directly altered by parasites, i.e., by the optical presence of the parasites themselves on the host or by marks created by their activity. For example, female saga grouse (*Centrocercus urophasianus*) appear to reject lousy males because their airsacs, inflated during courtship, have many small black hematomas caused by the lice infestation. Males with artificial hematomas applied with a pen are also rejected by females.

More common, however, seem to be indirect adverse effects of parasites on male secondary sexual characteristics, leading to the female's preference for unparasitized males. Among captive flocks of red jungle fowl (*Gallus gallus*), roosters experimentally infected with intestinal nematodes (→*Ascaridia galli*), revealed duller →combs and eyes, shorter combs and tail feathers, and paler hackle feathers upon reaching sexual maturity than did the roosters of a control group. In experimental mate choice tests, two-thirds of the females preferred unparasitized rather than parasitized roosters. Moreover, the hens made their choices according to features indirectly caused by the parasites and not according to nonsexually selected characteristics such as bill size, as evidenced by other tests.

Among many passerine birds, female mate preferences for a shiny, colorful ornamentation such as red breast are well-documented. Among yellow-hammers (*Emberiza citrinella*), for instance, male intensity of infection by the hemoprotozoan *Haemoproteus coatneyi* is reliably revealed by the bright or pale male's yellow plumage. But inconspicuous features like the size of a certain spot can also mediate mate choice. In addition, all signals seem to play a role in territorial behavior appealing to the own sex.

Acoustic cues may reflect the health and vigor of mates and competitors. Among birds, the receivers of songs can gain information relevant to mate choice and to male–male competition from the complexity, duration, and frequency of the song. Furthermore, male parasite loads were found to be correlated with the speed of an acoustic response to an intruder and the structure of the call.

Among fish too, the intensity of the red coloration as a sexually dimorphic characteristic shows relationships with parasite intensities; and in sticklebacks (*Gasterosteus aculeatus*), the role played by male coloration in mate choice and the avoidance of parasitized males has been evidenced.

Breeding tubercles, the sexual ornamentation of many fish species, are induced by several androgens and at least one estrogen. Interestingly, among male roach and other cyprinids it was observed that the more heavily they were infected the fewer breeding tubercles they had. It was concluded that a female could potentially decode these differences in ornamentation in order to gain a sort of clinical picture of the male as her choice of mate. The few data available from male reptiles involving infection by →*Plasmodium* spp. also show alterations in sexually dimorphic coloration combined with less courtship and territorial behavior, which negatively influences the female's choice of mate.

Interestingly, among mammals, odors seem to have the potential for decoding complex information, and this also seems to be true for major histocompatibility complex (MHC)-linked odor components: glycoproteins encoded by MHC loci under the influence of bacteria may simply degenerate to waste products small enough to become evaporating molecules in urine and feces. Urine odors of male mice (experimentally subclinically) infected with coccidians or helminths were offered to female mice in choice experiments. The females showed an overwhelming preference for the odors of the nonparasitized males.

Concerning insects, the few studies that have been conducted also suggest that certain courtship songs are indicators of male quality, and females (of crickets) responded most positively to the songs of males that proved to have high encapsulation abilities (a measure of immunity).



Interestingly, sexual signaling may be dishonest as shown from mealworm beetles. Males, when perceiving a threat to survival, may divert resources into attractiveness traits in order to maximize mating prior to death or parasitic castration which is dishonest with respect to the male's current condition.

As discussed by Wedekind, there are a lot of theories and hypotheses about benefits relating to resistance genes and choosy females. But there is a general consent about the assumption that the maintenance of conspicuous secondary sexual characters is costly to the immune system demonstrating that a vigorous male can bear the cost of the immunosuppressant effects of androgens. Exaggerated ornamentation decreases immunocompetence. On the other hand, the bright yellows, oranges, and reds exhibited by many bichromatic birds are the products of carotenoid pigments, which are known to have health benefits. Therefore, bright colors may also be indicative of a bird's access to a superior diet or of its superior foraging ability. Testosterone is associated with a suppressed immune system in many vertebrates and the sexes differ accordingly in the blood parameters involved in immunity. The comb length of red jungle fowl, for instance, is positively correlated with the plasma testosterone level but negatively correlated with the number of lymphocytes in the blood. Male house sparrows with pronounced secondary sexual characters have a smaller bursa of Fabricius and thus lower current levels of immune response than do males with less conspicuous ornamentation. However, males in good physical condition had a relatively small bursa of Fabricius. Furthermore, in *Plasmodium*-infected lizards infected males have lower levels of plasma testosterone and higher levels of the stress hormone corticosterone. However, when the plasma corticosterone level in uninfected lizards was experimentally raised, the animals showed decreases in testosterone level and other accompanying pathological features as are found in infected males in the wild. All these morphological and physiological findings support the idea that only individuals in good health, such as uninfected ones, can afford the handicap of raised androgen levels.

### Male's Choice

Since the selection of females by males is less common than vice versa, the existing mechanisms signaling the health of females are little investigated. In pipefish (*Syngnathus typhle*) males are the choosy sex. They were shown to differentiate between uninfected females and those infected by metacercariae of *Cryptocotyle* sp., which induces visible black spots in the skin of the fish. Since there was also a negative correlation between parasite load and female *fecundity*, males mating with unparasitized females may benefit

directly by fertilizing more eggs. But the importance of the intraspecific assessment of genetic resistance against the parasites should also work in this example. In species with predominantly female mate choice, males were found to be choosy to a certain extent. This was first demonstrated from male laboratory mice showing a preference for uninfected females rather than for those infected with *Trichinella spiralis*. But the apparent preference was interpreted in relation to parasite-induced changes in female ability for conception. It was also reported that male mice can discriminate between the odors of nonparasitized females and those infected by *Heligmosomoides polygyrus*, and that they find the odors of parasitized estrous females aversive. Meanwhile, we also know about male birds performing similar discriminations.

### Sexual Mate Choice by Infected Hosts

The evolution of mating systems useful in the search for good genes should not only consider the parasite load of the mate being selected but also the parasite burden of the choosy mate, whether this is a male or a female. So far models of parasite-mediated sexual selection have neglected the potential effects of parasites on the ability of their hosts to choose mates. The reports on this subject that are available show that infected mates are less choosy compared to their conspecifics which is often combined with an impairment of other mating behaviors. Thus, behavioral changes of infected hosts may be pathological side effects of infection. Due to an alteration in energy metabolism or hormone levels, for instance, one should always expect an impact on mating behavior. The reduced courtship and territorial behavior (combined with smaller testes and lowered plasma testosterone levels) as shown for instance by male fence lizards infected with *P. mexicanum* should lead to less success in the choice of mate on the part of the infected hosts and thus work as a driving force in the evolutionary arms race between parasites and their hosts.

### Parasite Mating Behaviors

Since the mating systems of the hosts and apparently even sex itself are parasite-driven, one might expect that parasites also show heritable variation in their adaptation to their hosts and that they compete for sexual mates with good genes useful for a parasitic life style.

This seems to be true but so far it is difficult or too early to recognize patterns other than general preference for mates with a high reproductive potential. In the copepod *Lernaeocera branchialis* on flounders male mate choice has been studied. It depended on the sex ratios of the parasite on its hosts and on the age and

mating status of females. At most sex ratios, males preferred the stages →[chalimus](#) 4 and virgin adult females. Mated females were less attractive but were chosen more frequently at strong male-biased sex ratios.

From schistosomes three findings were described: the existence of a specific male mate preference system, the existence of mating competition and the possibility of change of mate. The principal factor in male mate preference is female fecundity. Thus, paired males prefer remaining with developed and fecund females rather than changing to young immature females. Change of mate does occur when a heterospecific female (in mixed infections) can be exchanged for a conspecific female. When there is a surplus of females, the male is faithful and stays with its reproducing mate and arriving virgins do not become fertilized. However, in infections with a greater number of males compared to females, competitive male mate choice does seem to occur, i.e., unpaired males seem to compete for females.

Meanwhile, parasite mating behaviors are known from several additional host–parasite associations. The general pattern is male–male mating competition for females having a high fecundity potential. Females do not seem to play an active role in mate choice. In acanthocephalans female worms do not even possess a genital ganglion. Following copulation they become locked by a copulatory cap imposed on their vagina by male excretion preventing further fertilizations until the eggs are discharged. Interestingly, inferior (smaller) males were also found to carry copulatory caps deriving from superior males (→[Selfish Gene Hypothesis](#)). Furthermore, the size of the male testes is modulated by the quantitative presence of mates and competitors. In female-biased infrapopulations the testes are small. In contrast, under competition by a surplus of males worms make the largest testes, probably reflecting upregulation of sperm production.

Data are also available from hermaphrodites with mixed mating systems. Among tapeworms, for instance, partners can modify their rate of cross-fertilization over selfing according to the fecundity potential of the partner. It was shown for *Schistocephalus solidus* that outcrossed offspring achieved both a higher infection success and a higher weight in the copepod, and a higher number of parasites per host in both intermediate hosts (copepod, stickleback), but only under competition. Accordingly, a general preference for cross-fertilization over selfing is practiced but the genetic benefits from outcrossing do not necessarily outweigh the costs of mating with a relatively small individual which has a low fecundity prospect. Furthermore, there seems to be a conflict over who is allowed to give how much sperm, since the opportunity to fertilize a partner's eggs is more attractive in terms of saving energy than getting their own eggs fertilized.

## Beltranmyia

Subgenus of →[Culicoides](#) with the common British species *C. circumscriptus*.

## Bendiocarb

### Chemical Class

Carbamate.

### Mode of Action

Acetylcholine esterase inhibitor. →[Ectoparasiticides – Agonists and Antagonists of Cholinergic Transmission](#).

## Beneden, Peter Joseph van (1804–1884)

Belgian physician, famous describer of tapeworms, honoured by application of species names (e.g., *Moniezia benedeni*).

## Benedenia melleni

Monogenean trematode parasitic on the pacific puffer fish, angle fish, etc. It is also found on the conjunctiva of their hosts.

## Benign Malaria

Malaria due to infection with *Plasmodium vivax*, *P. ovale* (benign malaria tertiana), or *P. malariae*, which can be survived in contrast to malign (= bad) malaria tertiana due to →[Plasmodium falciparum](#).

## Benign Theileriosis

Disease in cattle due to infection with *Theileria mutans* (→[Theileriosis](#)).

## Benzimidazoles

Group of compounds acting against nematodes,  
→[Nematocides](#).

## Berlese, Antonio (1846–1927)

Italian entomologist, famous for his books on insects and mites. Inventor of a funnel to collect insects from fallen leaves or detritus material.

## Berlese's Organ

Invagination of the fourth abdominal segment of the bed bug →[Cimex lectularius](#), which represents the fertilisation pocket. This entrance is also called →[Ribaga's organ](#).

## Bernoulli Trial

→[Mathematical Models of Vector-Borne Diseases](#).

## Besnoitia

Genus of →[Coccidia](#)/[Table 5](#); named in honor of Prof. C. Besnoit, Toulouse, France.

## Besnoitia besnoiti

### Classification

Genus of →[Coccidia](#); Figs. 1–3.

### Disease

→[Skin Diseases, Animals](#).

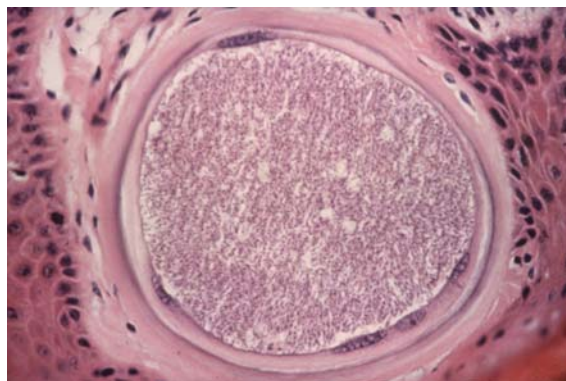

**Besnoitia besnoiti. Figure 1** Section through a cyst of *Besnoitia besnoiti* in the skin of a cow. Note that the host cell has become several nuclei (blue) and is widely surrounded by a thick layer of filaments.

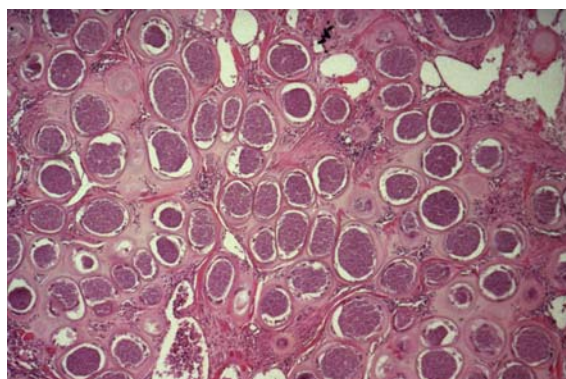

**Besnoitia besnoiti. Figure 2** LM of a section through the skin of a heavily infected cow showing numerous *Besnoitia besnoiti* cysts.



**Besnoitia besnoiti. Figure 3** Horny skin due to infection with *Besnoitia* cysts.

## Besnoitiosis

Disease in cattle and goats due to → *Besnoitia besnoitii* Figs. 1–3 with formation of tissue cysts inside skin (and eye) leading to the so-called elephant-skin. Transmission by body contact; life cycle unclear (→ [Skin Diseases, Animals/Protozoa](#), → [Coccidia](#)).

## Betacyfluthrin

### Chemical Class

Pyrethroid (type II, α-CN-pyrethroids).

### Mode of Action

Open state voltage-gated sodium channel blocker. → [Ectoparasiticides – Blockers/Modulators of Voltage-Gated Sodium Channels](#).

## Biacetabulum meridianum

Caryophyllidean cestode from catostomid fish.

## Bilharz, Theodor (1825–1862)

German physician and zoologist; he discovered in Egypt the pairs of the male and female blood flukes, formerly called *Bilharzia* – now *Schistosoma*. He died from typhus in Cairo.

## Bilharziella polonica

→ [Digenea](#), → [Schistosoma](#).

## Bilharziomas

Granulomatous and fibrotic lesions that develop around egg masses of schistosomes in organs (e.g., liver) away from the mucosa.

## Bilharziosis

### Synonym

→ [Schistosomiasis, Man](#).

The name was given in honour of Theodor → [Bilharz](#) (1825–1862), a German physician who discovered the → *Schistosoma* worms in Egypt in 1851–1852 and described them originally as → *Diplostomum*.

## Bilirubinuria

Clinical symptom in hosts infected, e.g., with → *Babesia* species or *Theileria equi* (→ [Piroplasmea](#)).

## Binary Fission

The most basic type of → [Cell Multiplication](#) is binary fission, which always produces 2 daughter cells and needs a preceding duplication of the organelles of the mother cell (→ [Cell Multiplication/Figs. 1, 2](#)).

## Bioallethrin

### Chemical Class

Pyrethroid (type I).

### Mode of Action

Open state voltage-gated sodium channel blocker. → [Ectoparasiticides – Blockers/Modulators of Voltage-Gated Sodium Channels](#).

## Biocid

Compound which acts apart from a body (e.g., on the floor) against pests.

## Biocoenosis

From Greek: *bios* = life and *koinos* = together. Biocoenosis was created by K. Möbius (1877) to characterize species living close together in a biotope and/or host.

## Bioenergetics

### Synonym

→Energy Metabolism.

## Biological Control

Arising from →*Bacillus thuringensis* or breeding of gambusian fish to control development of →mosquitoes. →*Apanteles*, →*Tiphia popilliavora*.

## Biological Methods

→Disease Control, Methods.

## Biological Systems

→Disease Control, Strategies.

## Biomphalaria

Genus of snails, that are vectors of →*Schistosoma* spp.

## Bithynia

Genus of snails, intermediate hosts of →*Prosthogonimus*-trematodes.

## Black Disease

Disease due to combined infection with the trematode →*Fasciola hepatica* and the bacterium *Clostridium novji* type B.

## Black Sickness

→Visceral Leishmaniasis.

## Blackflies

### Synonyms

→Simuliidae.

### Classification

Family of →Insects, order →Diptera.

### General Information

Fossil blackflies are about 170 million years old. Of the approximately 1,600 blackfly species, only about 900 are man-biting species. Only female blackflies suck blood, demoralizing the host by their painful bites. Since the larvae develop only in flowing water, attacks by adults regularly occur there, and after mass attacks by adults these can even induce panic reactions in herds of cattle. Black flies transmit protozoan blood parasites to birds but are mainly known as vectors of filarial helminths, especially →*Onchocerciasis* (→River Blindness).

Blackflies are holometabolous insects; larvae and pupae live aquatically. Adults are small, stout-bodied, humpbacked →Diptera (Figs. 1, 2). The best identification criteria are little drops of blood on the legs near flowing waters, accompanied by strong itching reactions. Despite the name, many neotropical species are not black but yellow or orange. Especially larvae and pupae can easily be identified, both anchored to immersed substrate in flowing water, larvae with the end of the abdomen, which has a “Coke”-bottle-like

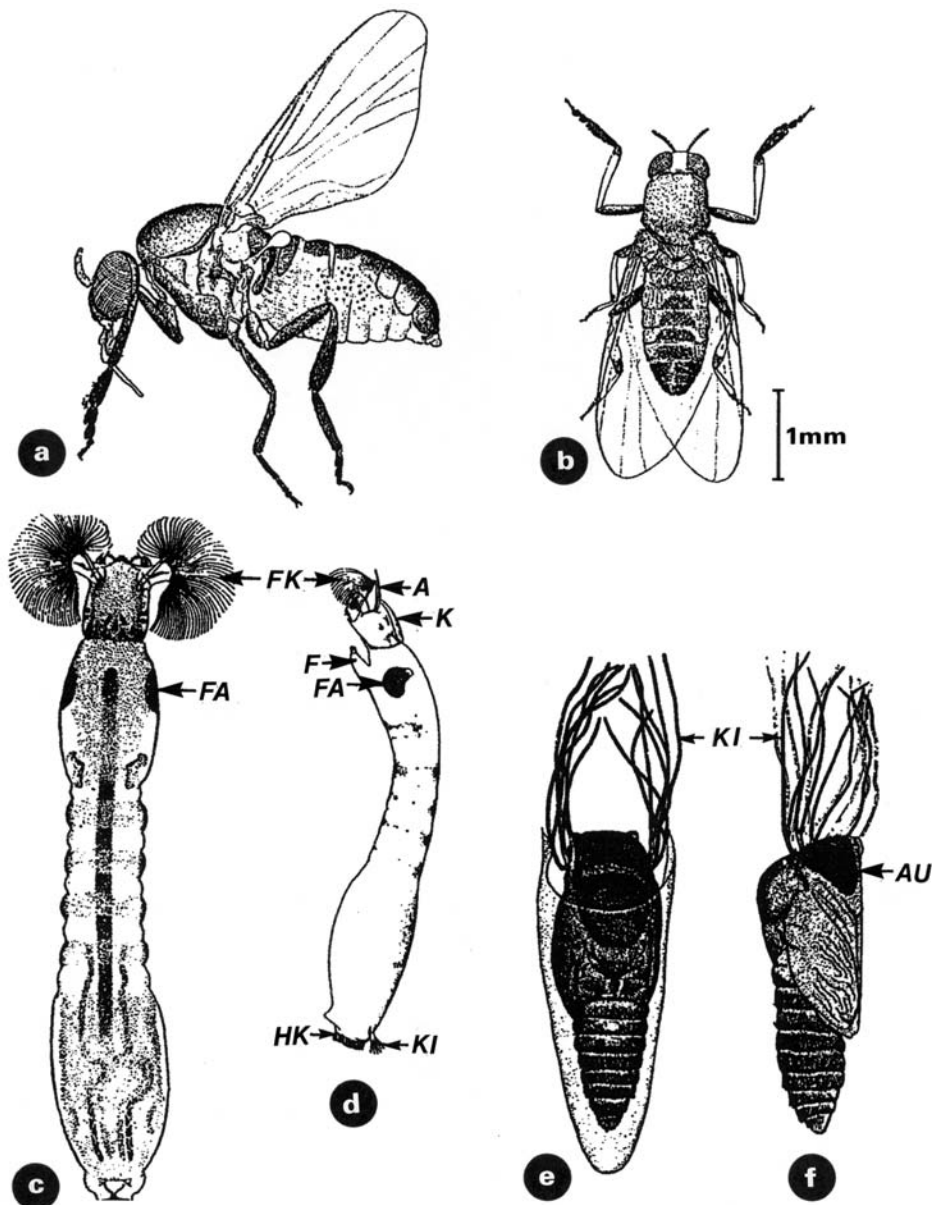

**Blackflies.** Figure 1 Life cycle stages of *Simulium* sp. (a)/(b) adult female; (c)/(d) larvae seen dorsally and ventrally; (e)/(f) pupae; A, antenna; AU, eye anlage; F, foot protrusion; FA, anlage of wing; FK, filter fan; H, hooks; K, head; KI, gills.

appearance; pupae with the shoe- or slipper-shaped →cocoon, out of which the spiracular gills emerge.

### Distribution

Blackflies are cosmopolitans. They occur in all geographical regions, but only if flowing water is present.

### Morphology

The adult blackflies are 1.5–4 mm long, having no large scales on wings and a body like many →mosquitoes. The head is short, possessing well-developed eyes.

The 9-12 (mainly 11) segments of the short antennae are cylindrical. The →proboscis of the mouthparts is shorter than the height of the head and consists of the posterior labium enclosing 6 stylets (labrum, paired mandibles, paired maxillary laciniae, hypopharynx). The food channel is located between the labrum and the mandibles, the salivary channel between the latter and the hypopharynx. The 5-segmented maxillary palps are longer than the proboscis, containing a large carbon dioxide-sensory pit organ. Males and females can be separated according to the weaker developed and untoothed mouthparts of males, but much better by the compound eyes which are larger in males, leaving no



**Blackflies. Figure 2** SEM of a female black fly (*Simulium damnosum*).

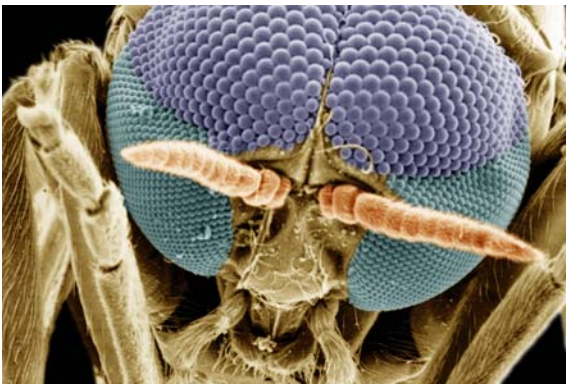

**Blackflies. Figure 3** SEM of a male of *Simulium damnosum* showing two types of eye-ommatidia.

space between them on the frons. In addition, males possess greatly enlarged upper ommatidia (Fig. 3).

The wings are short and broadened by a large anal lobe. The first abdominal tergite forms a prominent scale, bordered by fine hairs.

In the elongated larvae, which measure 4–12 mm in the final →instar, the head capsule is rarely fully sclerotized. The thorax is broader than the anterior abdomen and not sharply separated from it. The abdomen increases in diameter towards the posterior end, giving the larvae a slightly bottle-like appearance. This expansion is more strongly developed in larvae of fast than of slowly flowing waters. The abdomen ends in a →proleg (pseudopodium), possessing many minute hooks, by which the larvae anchor to a pad of silk, secreted by salivary glands which run through the whole body. The thoracic proleg also possesses such hooks. A pair of cephalic fans, covered with a sticky secretion produced by the cibarial glands, is used for filtering food from the water.

The →pupa is protected by a →cocoon and possesses paired thoracal spiracular gills, which act as a gill →plastron, i.e., air remains at the →cuticle and the gas exchange occurs at the air–water interface. The pupa anchors within the cocoon byhooks.

### Genetics

In natural populations it is very difficult to recognize the different species. For very similar species the term “group” is used, e.g., the *Simulium neavei* group, for sibling species, which cannot be distinguished according to morphological but only by other criteria the term “complex”, e.g., the →*Simulium damnosum* complex. Nonmorphological criteria are offered by the banding pattern of large polytene →chromosomes in the nuclei of the larval →salivary gland cells and sometimes of the Malpighian tubules of adults.

### Reproduction

Breeding of blackflies in the laboratory is difficult, but possible for some species. Whereas the larval habitat can be established relatively easily, in most species adults do not mate or suck blood.

Meeting of males and females occurs by chance or when females enter a swarm of males, both near breeding places or hosts. Since in males the copulatory organs do not rotate after emergence as in mosquitoes, copulation, i.e., the transfer of a →spermatophore, occurs on the ground. Presumably one copulation is sufficient to inseminate all eggs. Females lay batches of about 200–800 eggs (0.1–0.4 mm long) mainly late in the day and often on just submerging substrates. In most species females are gonotrophically concordant, i.e., a blood meal is required for the development of each batch of mature eggs, but there are also autogenic species or populations laying at least the first batch of eggs without a blood meal. The number of blood meals and egg depositions determines the possibility of transmission of disease. The parous state can be determined according to changes in the ovarioles. Usually the gonotrophic cycle is completed within 3–7 days and can be repeated several times since females in nature can live up to 3–4 weeks.

### Life Cycle

An adaptation to unfavorable conditions is the diapause or aestivation phase of the egg. Hatching occurs after several months in spring or after droughts for up to 2 years. Normally in tropical regions embryonic development lasts up to 2 days. Also larvae can survive the winter by a production of cryoprotectants to reduce the supercooling point. Larvae develop in every kind of running water, filtering microorganisms from the water, especially bacteria and diatoms. If larvae wish to settle on another place, they spin a silk thread, detach

from the pad of silk and drift downstream. Usually they settle on submerged substrates near the surface of the water, i.e., in a region with high oxygen tension. Short distances are covered in a looping manner detaching and anchoring alternatively with the hooks on the abdominal and thoracic proleg. The total duration of larval development varies greatly since the number of larval instars varies from 6 to 11 instars (commonly 7), even within a species, and since the development is temperature-dependent and can be retarded by the winter. In the tropics, larval development lasts from 4 to 10 days. Then the mature larva, which is actually a pharate pupa with the skin of the final larval instar, spins a slipper-shaped cocoon, orientating the open end downstream. The development of the inactive pupa usually lasts between 3 and 10 days. During the day adults emerge from the cocoon in an air bubble which brings them to the surface of the water. The whole developmental cycle (egg to egg) can be completed within less than 2 weeks, but up to several months in diapausing species (→[Diptera/](#)Fig. 1).

### Transmission/Dispersal

Especially females searching for hosts and breeding sites fly long distances (15–35 km in mark-and-recapture investigations), but when assisted by wind, up to 600 km can be covered.

### Feeding Behavior and Transmission of Disease

Host odours induce long-range attraction, followed by →[orientation](#) to the carbon dioxide source and then a visual orientation to the preferred region of the host. Simuliids usually bite during the day near running waters, showing species-specific peak diurnal biting activities and preferences to specific parts of the body of the host. In the Amazon basin 400–500 and in New Zealand up to 1000 blackflies settled to bite a man in one hour. Usually the blackflies need 3 to 6 minutes to engorge their own weight in blood. Simuliids are →[pool feeders](#), opening capillaries in a depth down to half a millimeter. The blood is pumped directly into the midgut. Sugar liquids are at first directed into the crop for →[sterilization](#) and then into the midgut.

Simuliids transmit filarial helminths and – mechanically – →[myxomatosis virus](#) of rabbits. Onchocerciasis is caused by the filarial →[helminth](#) →[Onchocerca volvulus](#) and is common in tropical Western and Equatorial Africa, South America, and Yemen.

### Interaction of Vector and Parasite

When the simuliids suck blood from an infected human, microfilariae of *Onchocerca volvulus* are ingested, which penetrate the →[peritrophic membranes](#) and the intestinal wall. In the hemocoel they migrate to the

thoracic flight muscles, in which they grow and molt twice within 6–9 days. The infective L3 larvae migrate to the labium. Movements of maxillae and mandibles during piercing of the skin and the increase of temperature by the blood induce the penetration of the L3 via the soft parts of the labium.

Only rarely have effects of the parasite on the vector been investigated. The penetration of the gut wall and of the cuticle before transmission does not seem to induce a strong decrease of longevity. However, →[immune reactions](#) and reproduction rate are reduced.

### Prophylaxis

Since the adults are active outdoors and during the day, only →[repellents](#) can be applied to clothing. In addition, people should not be near the water during the various local peaks of biting activity.

### Control

→[Insecticides](#) could be used against adults, but such an outdoor use is nearly impracticable. The better way is a control of the larvae. In a major project, the Onchocerciasis Control Program (OCP) in West Africa, →[Bacillus thuringiensis](#) H-14 is also used, meanwhile in rotation with 6 chemical insecticides (phoxim, temephos pyraclophos, etofenprox, permethrin, carbosulfan). After 14 years of larviciding some residual foci remain to be treated, and neighboring countries have established a similar program, the African Program for Onchocerciasis Control (APOC) using not only →[larvicides](#), but also the microfilaricide ivermectin for treatment of humans.

In the OCP countries, the human populations are well informed about the transmission of →[Onchocerca](#), but much less so in the APOC region and South America.

---

## Blackhead Disease

### Symptom

The crest appears black – due to the infection with the amoeboflagellate.

### General Information

→[Histomonas meleagridis](#) in many species of turkeys, chicken or other birds. The parasitic stages (Fig. 1) reach a size of 10–30 μm, some appear with one flagellum others without flagellum, as spherical stage or as slightly amoeboid stage. Stages with two nuclei are apparently in the phase of division (Fig. 1, right below). Recently cyst-like stages also had been



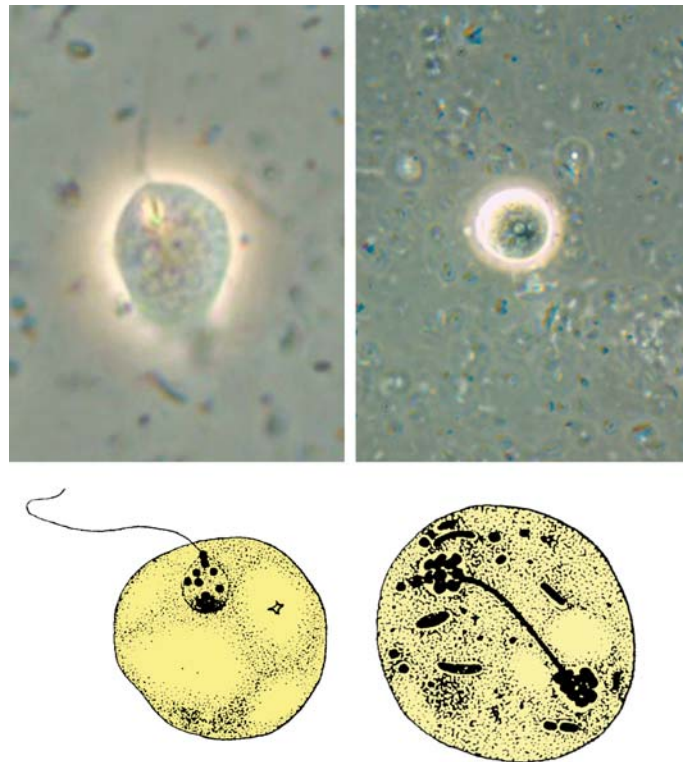

**Blackhead Disease. Figure 1** Light micrographs and drawings of uniflagellated and amoeboid stages, of which one is apparently in division (right below) showing two nuclei.

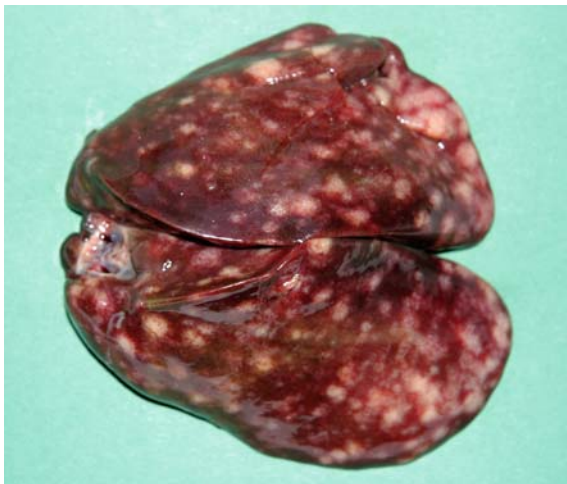

**Blackhead Disease. Figure 2** Liver of an infected turkey showing complete necrosis.

described. The (rarely) reported stages with 2–4 flagella are probably not *Histomonas* but due to co-infections with other flagellates.

The mode of infection with *Histomonas* stages is not yet completely clarified. The most reasonable way is the oral uptake of cyst stages, which may develop

from the uniflagellated or amoeboid stages in the rectum of the hosts. The quick common start of histomoniasis in a group of birds does underlie this possibility. The contamination of the anal region of the birds with trophozoites is, of course, also possible, when birds place themselves on faeces of infected birds. The most unlikely way of infection is due to eggs of the nematode *Heterakis gallinae*. In this case the unicellular parasite has to penetrate actively into the vagina of the female worm, and swim against the stream of excreted eggs up to the place where the worm oocytes are not yet fertilised, since later a thick egg wall will hinder any penetration. The reported “4 years – infectivity” of *H. gallinae* – eggs is probably related to the fact that the fluid of stored eggs were contaminated with cysts of *Histomonas*.

### Pathology

Apparently the amoebic stages enter the intestinal wall, reach the liver, and introduce there huge necrosis (Fig. 2) due to repeated binary fissions of the amoebic stages (Fig. 1, right below).

**Main clinical symptoms:** →Diarrhoea, →anaemia, black crest, general weakening, death.

**Incubation period:** 2 days.

**Patent period:** Several months up to lifelong.

**Diagnosis:** Microscopic determination of trophozoites in fresh faeces, occurrence of cysts.

**Prophylaxis:** Separation of young from older animals.

**Therapy:** Oral application of different nitro-imidazoles (→Antidiarrhoeal and Antitrichomoniasis Drugs).

## Morphology

Figs. 1, 2A–E, 3 (page 176), →Cell Multiplication/Fig. 2A.

## Bladder Worm

→Cysticercus of →tapeworms.

## Blastocrithidia triatomae

### Classification

Species of →Trypanosomatidae.

### Life Cycle

Fig. 1.

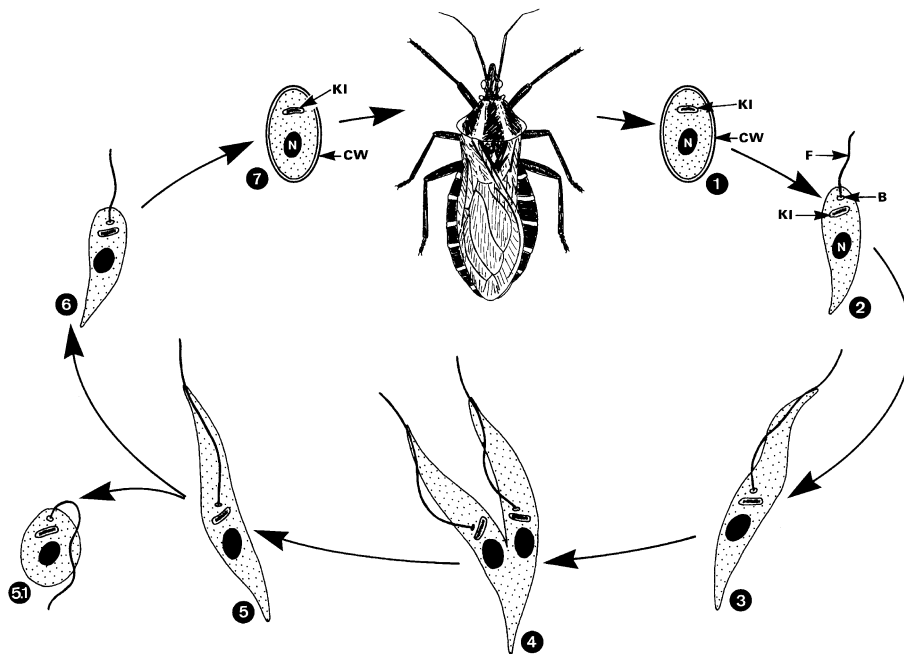

**Blastocrithidia triatomae.** Figure 1 Life cycle of *Blastocrithidia triatomae* inside its host (the reduviid bug → *Triatoma infestans*, which may be a vector of *Trypanosoma cruzi*). 1 The bug ingests feces containing cysts. 2 Excystation inside the midgut within 12–48 h after uptake. 3–5.1 Development (by →binary fission) of pro-, epi- and sphaeromastigotes inside the whole gut. 6, 7 →Encystation inside the rectum (6 days p.i.). After unequal divisions, the smaller daughter cell remains attached to the flagellum of the other cells and encysts. The cysts are often attached “straphanger-like” along the →flagellum of nonencysted flagellates. After 14–21 days cysts are excreted within the feces of the bug. B, basal body; CW, →cyst wall; F, flagellum; KI, →kinetoplast; N, nucleus.

## Blastocystis hominis

### General Information

*Blastocystis hominis* is an organism of uncertain affinities living in the intestine of humans and probably other hosts (Figs. 1, 2). Other species of *Blastocystis* exist in many animals, some of them may also occur in humans (Fig. 1, page 176). Studies indicate that whatever symptoms are present can be attributed to unrecognized concomitant pathogens such as →*Entamoeba histolytica*, →*Giardia* sp. or →*Dientamoeba* sp. These symptoms disappear after appropriate treatment, whereas *B. hominis* persists. No lesions have been recognized.

### Life Cycle

Fig. 2 (page 177).

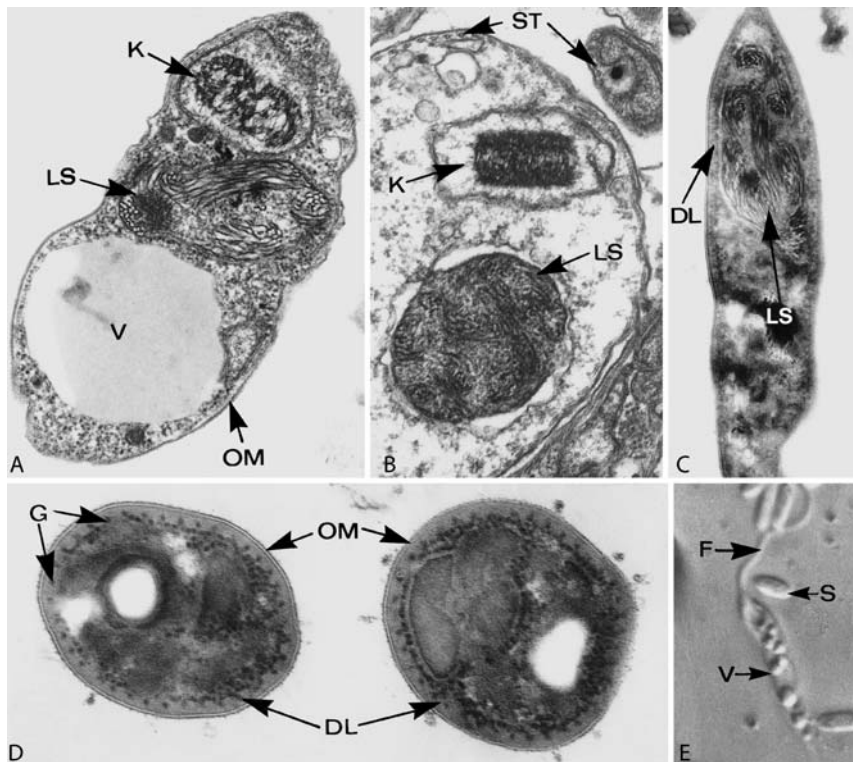

**Blastocritithidia triatomae.** Figure 2 A–E Cyst formation with increasing (A, E) desiccation in *Blastocritithidia triatomae* (see life cycle). Note that the nucleus has a labyrinthine pattern (LS). The cyst wall consists of a dense layer (DL) below the →cell membrane (OM). Cysts (D) are attached (straphanger-like) to the →flagella of mastigote stages (E). (A, B, C ×22,000, D ×33,000; E ×2,000). DL, dense layer; F, flagellum; G, large granules; K, →kinetoplast; LS, labyrinthine structure of the nucleus; OM, cell membrane; S, straphanger-like cysts; ST, →subpellicular microtubules; V, vacuole.



**Blastocritithidia triatomae.** Figure 3 LM of cysts and a flagellate stage.

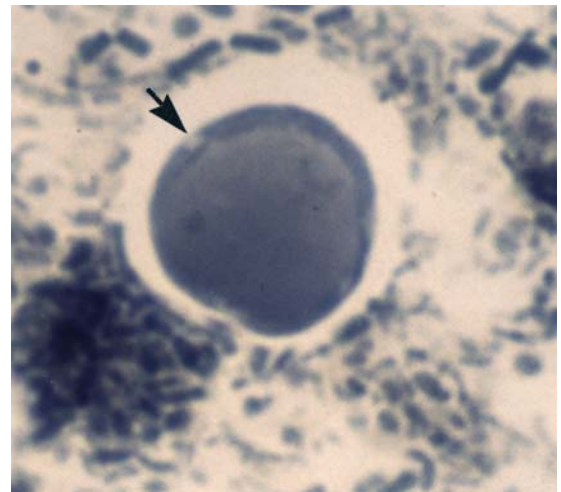

**Blastocystis hominis.** Figure 1 Light micrograph of a vacuolar stage of *B. hominis*. Arrow points to a nucleus.

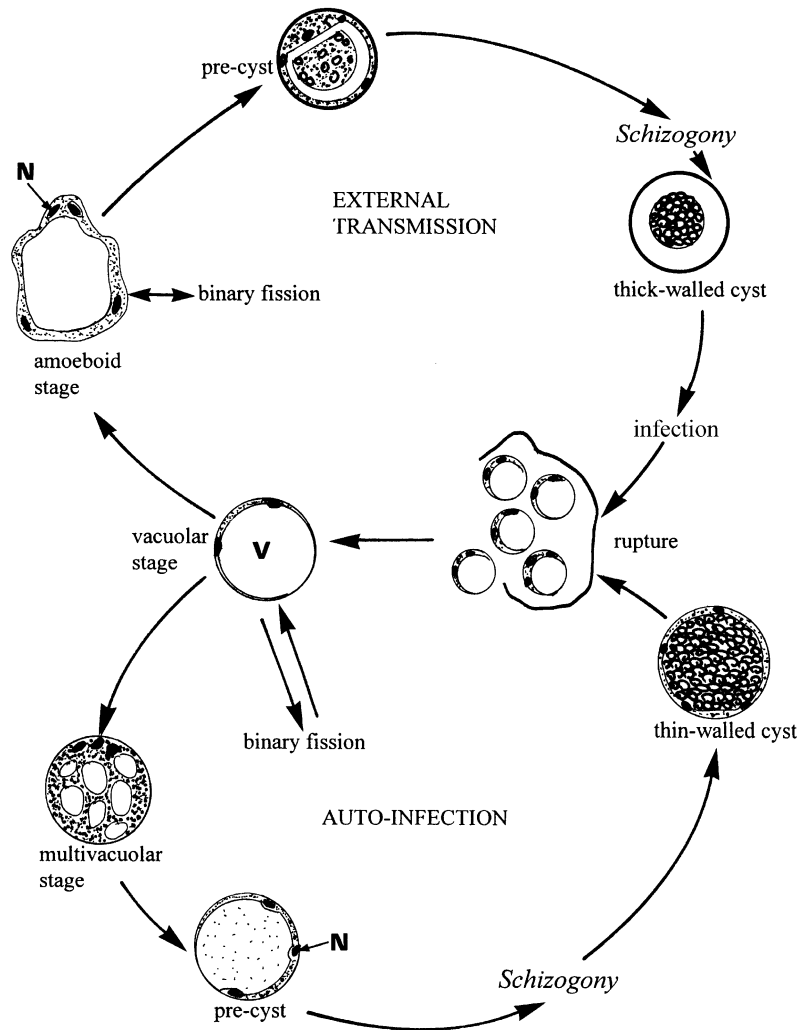

**Blastocystis hominis.** Figure 2 → *Blastocystis hominis*. Diagrammatic representation of the follow-up of the different life cycle stages. The infection occurs during oral uptake of cyst stages which had been excreted with the feces. *N*, nucleus; *V*, vacuole.

### Disease

→ *Blastocystosis*, Man.

**Prophylaxis:** Avoid contact with human feces.

**Therapy:** Curative treatment unknown; see → *Treatment of Opportunistic Agents*.

## Blastocystosis, Man

Disease due to infection with → *Blastocystis hominis* cysts from human or animal feces.

**Main clinical symptoms:** Nausea, → *diarrhoea*, → *abdo-minal pain*.

**Incubation period:** Days to weeks.

**Prepatent period:** 2–3 days to weeks.

**Patent period:** 2–3 weeks.

**Diagnosis:** Microscopic determination of cysts in fecal samples.

## Blepharoplast

Archaic term for → *kinetoplast*. See also → *Mitochondria*.

## Blepharoprosthium

→ *Concrement Vacuole*.

## Blindness

→*Filariidae*, →*Onchocerca volvulus*.

## Blue Tongue Disease (BTD)

### Synonym

Ovine catarrhal fever.

### Name

French: *fièvre catarrhale du mouton*; Spanish: *lengua azul*; Africans: *bloutang*.

Disease that occurs in wild and stock ruminants due to infections with BTD virus that is transmitted in Africa mainly by →*Culicoides imicola*, in Central Europe (new) by *C. obsoletus*, in the USA by *C. variipennis*, and in Australia by the *C. schultzei* group.

**Symptoms of disease** are: the name-giving blue tongue due to cyanosis (rather rare), severe nasal discharge, subcutaneous hyperaemia, petechiae, lachrymation, facial, mouth, udder and lung oedema, swollen lymph nodes, typical foot lesions leading to general stiffness, abortion, torticollis, death.

## Bluebottles

→*Calliphora*.

## Blue Tongue Virus (BTV)

This is a so-called orbivirus within the family Reoviridae, which possesses double-stranded RNA with about 10–12 genome segments. BTV is transmitted during the bite of the very tiny females of insect family →*Ceratopogonidae*. The most important symptom of the disease in ruminants are haemorrhages in the mouth (i.e., leading to a blue tongue), on the surface of the udder and between the claws introducing painful and stiff movements of cattle. The disease which is common and symptomless in South African game animals leads to 24 different blood serotypes. Although the disease is not contagious it led since its first arrival (1998) in South Europe, to the death of more than one million sheep and also many specimens of cattle. Just recently (2006) it arrived also in Northern Europe (North France, Belgium, Netherlands, Germany).

## Bodonids

Member of the flagellated protozoan family Bodonidae. *Ichthyobodo* (syn. *Costia*) *necatix* and *Trypanoplasma borreli* are important fish parasites.

## Body Cover

### Synonym

→*Integument*, →*Cuticle*, Skin.

### General Information

The parasite–host interface is the place where nutrients are taken up and is the site of the attacks of the host's defense system. In the parasitic →*Metazoa* considered in this book, two main types of body cover exist:

- An acellular filamentous →*cuticle* (excreted by an underlying cellularly organized hypodermis) is found, e.g., in →*nematodes*, →*pentastomids*, and in arthropods (→*Ticks*, →*Mites*, →*Insects*).
- A syncytial cytoplasmic →*tegument*, where giant nuclei or nuclear fragments may occur, covers the surface of larval monogeneans, →*digeneans*, →*cestodes* and →*acanthocephalans*, whereas the tegument (i.e., →*neodermis* = new skin) of adult parasitic →*platyhelminths* lacks nuclei (→*Platyhelminthes*/Figs. 11, 12).

The surface of both types of outer body cover (cuticle or tegument) may be lined by more or less thick layer(s) of carbohydrates, mucopolysaccharides, or even membranous material depending on the species and the site of parasitism.

The →*surface coat*, which fulfills its tasks in defense against environmental influences while covering “normal” and parasitic cells, is thought to be the ancestor of all cuticular systems (→*Cuticle*) of the whole animal and plant world. Apparently during evolution the →*glycocalyx* while situated between body- and/or cell protrusions (e.g., →*microvilli*, protuberances) became fortified by enclosure of fibers of →*collagen*, →*chitin*, cellulose, and/or calcium carbonate components, etc. Thus, the original protection system received a second function, i.e., the preservation of the body shape as system belonging to the exoskeleton. However, the uptake of nutrients through this increasing outer surface remained possible using a variety of mechanisms and carrier systems (→*Membrane Transport*; →*Endocytosis*). Thus, for example, schistosomes are able to take in huge amounts of glucose through their surface

membranes, and →[nematodes](#) may also become hidden by several drugs as a result of cuticular uptake.

## Bolbosoma

Genus of polymorphid acanthocephalans; most species of this genus (as well as those of the genus *Corynosoma*) live in the intestine of aquatic birds and marine mammals, but a few are also found in humans. The specimens of this genus possess spines not only at the proboscis but also along the trunk.

## Bolus

Small container to be placed into a host (beneath skin, inside stomach) that releases drugs at given intervals (e.g., by corrosion of metal enclosures). Boluses are often used in grazing animals.

## Bonamia Species

Intracellular parasites of oysters belonging to the protozoan phylum →[Ascetospora](#).

## Boophilus

### Name

Greek: *bos* = cattle, *philein* = loving.

### General Information

Genus of hard →[ticks](#) (Fig. 1) of ruminants (wild and farm). The species apparently originated from Africa, however, are now spread all over the world. Most important species are *B. microplus*, *B. decoloratus*, and *B. annulatus*. They are one-host ticks, which need only about 3 weeks until the females drop down to floor. 5 days later the females depone about 2000–4500 eggs, which need about 3–6 weeks (temperature-dependent) until the larvae hatch. The period of egg deposition can be stretched up to 120 days. The larvae may starve without host for 90 days (summer) or up to 180 days (winter). Due to their life cycle *Boophilus* sp. mainly



**Boophilus.** **Figure 1** *Boophilus microplus*. Engorged females of this one-host cattle tick species laying eggs. This species is found in Australia, Asia, Latin America, East Africa. The development on cattle needs 3 weeks, egg excretion (on the soil) takes 1–2 weeks. Thus 5–6 generations develop per year and may transmit →[Babesia](#) parasites of cattle. The name comes from Latin *bos* = ox, cow, and Greek *philein* = friend, loving.

transmit agents of disease, which enter the eggs of the ticks (e.g., viruses, →[Babesia](#), [Anaplasma](#)).

## Booponus

Genus of calliphorid flies in the Philippines that induce myiasis in the feet of cattle (e.g., *B. intosa*).

## Bore Organ

→[Linguatula serrata](#).

## Borrelia

The species of this genus are gram-negative bacteria with a species-specific length of 5–15 μm and 0.2–0.5 μm in width (thus they are thicker as *Treponema* spp.). They show only a few windings (Figs. 1–3) and possess – unique in bacteria – a linear chromosome. The genes for membrane proteins are situated on their circular and linear plasmids.

They may become cultured in artificial media and need a time of about 18 hours for duplication. Some

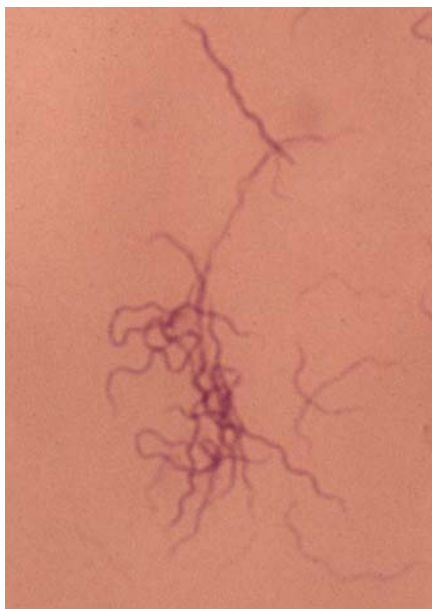

**Borrelia.** Figure 1 LM of *Borrelia burgdorferi*.



**Borrelia.** Figure 3 SEM of *Borrelia burgdorferi* from culture.



**Borrelia.** Figure 2 SEM of the bacteria stage of *Borrelia burgdorferi* on the surface of a tick intestinal cell.

species are apathogens, others are agents of important human diseases and are transmitted by bloodsucking arthropods.

Examples are agents of:

- Endemic and epidemic relapsing fevers transmitted by →lice: *Borrelia berbera* (North Africa), *Borrelia*

*carteri* (India), *Borrelia hispanica* (Spain), *Borrelia recurrentis* (syn. *Borrelia obermeieri*) (Africa, South America, East Asia), *Borrelia turricatae* (Central America), *Borrelia venezuelensis* (South America).

- Relapsing fever transmitted by →*Ornithodoros* ticks: *Borrelia caucasica* (Near East), *Borrelia duttoni* (Central and South Africa, Madagascar), *Borrelia parkeri* (Western USA).
- Tick- or →Lyme-borreliosis transmitted by →*Ixodes* and →*Dermacentor* ticks. *Borrelia burgdorferi* sensu lato (Europe, USA, Japan, including, e.g., *Borrelia burgdorferi* sensu strictu, *Borrelia afzelii*, *Borrelia garinii*, *Borrelia spielmani*). In Europe all types are found, in USA occur mainly *S. burgdorferi* s.s. and in Japan *Borrelia garinii* and *Borrelia afzelii*.
- *Borrelia vincentii* is apathogenic in the respiratory tractus (syn. *Treponema*).
- *Borrelia refringens* (syn. *Treponema*) is apathogenic in the sexual tractus.

→Lyme Disease, →Relapsing Fever, →Tick Bites, →Ticks as Vectors of Agents of Diseases, Man.

---

## **Borrelia burgdorferi**

Bacterium transmitted by →Ticks (→Lyme Disease).

## Borrelia recurrentis

Bacterium transmitted by →lice.

## Borreliosis

→Ixodes Species, →Lyme Disease, →Ticks as Vectors of Agents of Diseases, Man.

## Bosch-Yaws

Local name for multiple skin lesions in cutaneous →leishmaniasis due to *Leishmania guyanensis* in South America.

Similar forms are called →pian bois and →forest yaws. The sandfly vectors are *Lutzomyia umbratilis*, *L. anduzei* and *L. whithmani*.

## Bosses

Modification (elevations) of the →body cover, e.g., in many →nematodes and male schistosomes (eventually provided with hooks). →Nematodes/Integument, →Platyhelminthes/Integument.

## Botfly

Fly, the larvae of which cause myiasis in humans or animals, e.g., →*Dermatobia hominis* (→Myiasis, Animals, →Myiasis, Man).

## Bothriocephalus

Genus of the cestode family Bothriocephalidae, often found in freshwater fish in the USA (e.g., the gravid →proglottids of *Bothriocephalus scorpii* possess two ovaries and two uteri which are situated at their anterior and posterior poles).

## Bothriocephalus acheilognathi

### Name

Greek: *bothrion* = invagination, groove; *kephalon* = head; *a* = lacking; *cheilos* = lip; *gnathos* = jaw.

### General Information

This tapeworm (→*Bothriocephalus*/Fig. 1) originates from East Asia, from where it was imported with the grassfish *Ctenopharyngodon idella* to Europe, New Zealand, and USA. According to some authors it is a synonym of *B. gowkongensis*, which is now found in Cyprinid fish cultures with high pathogenicity. The adult worm reaches a length of 8–31 cm and a terminal width of about 2–4 mm. The scolex is heartlike and has 2 bothria as suckers. The operculated eggs are thin-shelled (50 × 30 μm) and contain already the coracidium larva, when leaving the proglottids. After infection it takes 12–20 days until the tapeworm is mature inside the fish intestine. A related species is: *B. claviceps* in the eel (reaching a length of 55 cm and a width of 3 mm).

## Bothrium

→Archigetes Species.

## Bouba

Local name for mucocutaneous and cutaneous forms of →leishmaniasis in South America due to *Leishmania braziliense* and *L. peruviana*. Vectors are *Psychodopygus wellcomei* (syn. *Lutzomyia*). Other names are →espundia, buba.

## Boutonneuse Fever

Boutonneuse fever is caused by *Rickettsia conori*, which is widespread in Africa, the Mediterranean region, and parts of Southeast Asia. The tick bite lesion takes on a black, button-like appearance (hence the name), with a central dark necrotic area. A large number of tick species appear able to transmit the disease, which can also be acquired by contact with tick tissues when the tick is crushed, for instance when *Rhipicephalus sanguineus* is removed from dogs.



**Therapy**

Application of antibiotics.

**Related Entries**

→Rocky Mountain Spotted Fever, →Tick Typhus.

**Bovicola bovis**

→Lice.

**Brachiola**

Genus of microsporidians with a diplocaryotic arrangement of the sporoplasm inside the spore. In humans three species have been recorded: *Brachiola vesicularum* (spores measure  $2.7 \times 2.0 \mu\text{m}$ ), *B. connori* and *B. algerae*, which formerly were called *Nosema algerae* respectively *N. connori*.

**Brachiola vesicularum**

→Microsporidia.

**Brachycera**

→Diptera.

**Brachylaemus erinacei**

3.5 mm long trematode in the intestine of hedgehogs.

**Bradyzoites****Name**

Greek: *bradys* = slow, *zoon* = animal.

Slowly by →endodyogeny reproducing unicellular stages in tissue-cysts of, e.g., →*Toxoplasma gondii*.

**Brain Worm**

Metacercaria of the liver fluke *Dicrocoelium* that has entered the subesophageal ganglion (brain) of the second →intermediate host (ant). Such →metacercariae initiate a change in the behavior of the ants such that they stay overnight outside of their state, anchored at grass, and thus become an easy prey for feeding ruminants.

**Branchiura**

A class of lower →crustaceans which include ectoparasites (order Argulidae, e.g., →*Argulus* species, carp →lice) which suck blood and body fluid at the skin of fish. →*Argulus*/Figs. 1, 2.

**Braula**

Genus of the family Braulidae (lice of bees). *B. coeca* (Fig. 1) of the honey bee is rather small (1.5 mm long) and has no wings. They live mainly as commensals on

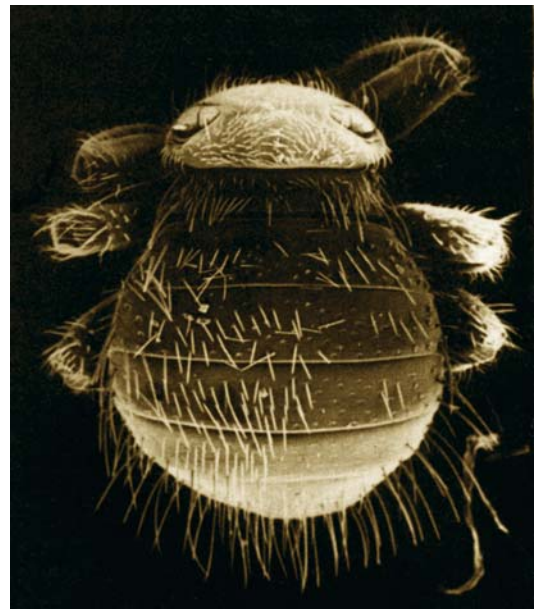

**Braula. Figure 1** Scanning electron micrograph of the bee louse *Braula coeca*.

the thorax and mouthparts of their host. They deposit their eggs inside the brood chambers of the bees. Their larvae eat the food of the bee larvae and thus may have effects on the quality of honey. They possess only 2 ommatids as eyes.

## Brill-Zinsser-Disease

Disease due to *Rickettsia prowazeki* (being louse-transmitted and later endogeneously reactivated).

## Bromocyclene

### Chemical Class

Organohalogenide (organochlorine compound, cyclo-diene).

### Mode of Action

GABA-gated chloride channel antagonist. → [Ectoparasitocides – Antagonists and Modulators of Chloride Channels](#).

## Bromopropylate

### Chemical Class

Organohalogenide (organobromine compound).

### Mode of Action

Acetylcholine esterase inhibitor. → [Ectoparasitocides – Agonists and Antagonists of Cholinergic Transmission](#).

## Bronchoalveolar Lavage

Method to obtain fluid from lung in order to diagnose → [Pneumocystis carinii](#) stages. → [BALF](#), → [Pneumocystosis](#).

## Brood Capsules

→ [Echinococcus/Life Cycle](#).

## Brood Parasitism

→ [Behavior](#).

## Brown-Brenn Stain

→ [Microsporidiosis](#).

## Bruce, David, Sir (1855–1931)

English military physician (Fig. 1), discoverer of the life cycle of trypanosomiasis (→ [Trypanosoma brucei](#)), discoverer (1883) of the agent of the Malta-fever within milk (now-called “Brucellosis”) and of the trypanosomes that lead to the animal Nagana (1894–1897).



**Bruce, David, Sir (1855–1931).** **Figure 1** Sir David Bruce, discoverer of the Malta fever of goats (brucellosis) and the transmission of Nagana fever.

## Brugia

See [Table 1](#). → [Filaridae](#).

**Brugia. Table 1** Comparison: characteristics of *Brugia malayi* and *Brugia timori*

	<i>Brugia malayi</i>	<i>Brugia timori</i>
<b>Microfilariae</b>		
Mean length	220 µm	310 µm
Cephalic space	Length to width ratio = 2:1	Length to width ratio = 3:1
Sheath	Stained pink with Giemsa	Stained pale pink with Giemsa
Terminal nuclei	4–5 in a single row	5–8 in a single row
Mean length of anlagen of organs	31 µm	60 µm
<b>Adult worms</b>		
Females	Body length to ovijector length ratio = 360:1	Body length to ovijector length ratio = 170:1
Male adanal papillae	3–4 on a side, regularly spaced	3–5 on a side, irregularly spaced
<b>Ecology</b>	Various ecotypes (anthropophilic or zoophilic); transmitted by <i>Anopheles</i> or <i>Mansonia</i> spp.	One ecotype (anthropophilic); transmitted by <i>Anopheles</i>
<b>Geographic distribution</b>	India, Southeast Asia	Lesser Sunda archipelago, East Timor

## Brugia malayi

→Nematodes, →Filariidae, →Brugia.

## BTD

→Blue Tongue Disease (BTB).

## Brugiasis, Man

Disease due to infection with the filarial worm →*Brugia malayi*.

**Main clinical symptoms:** see →Elephantiasis Tropical, →Filariasis Lymphatic Tropical.

**Incubation period:** 30–60 days.

**Prepatent period:** 50–90 days.

**Patent period:** 8–10 years.

**Diagnosis:** see →Filariasis, Lymphatic, Tropical.

**Prophylaxis:** Avoidance of mosquito bites.

**Therapy:** Treatment see →Nematocidal Drugs, Man.

## Buba

→Bouba.

## Buccal Capsules

At the anterior end of nematodes (e.g., →Hookworms, *Camallanus species*) toothed depressions are formed which are used as suckers to get blood and/or body fluids from their hosts.

## BSE

Bovine spongious encephalopathy in cattle due to →prions, which apparently are transmitted to many hosts via oral uptake of infected brain (nerves) or contaminated fly larvae and other destruent(?). Transmission to man is introducing the new Creutzfeldt-Jakob-Disease (CJD).

### Therapy

Unknown.

## Bucephalus

Genus of marine fish trematodes (e.g., *B. cuculus*), the species of which form branched sporocysts (e.g., in the American oyster *Crassostrea virginica*).

## Budd-Chiari-Syndrome

Symptom due to alveolar echinococcosis.

## Buffon, Georges-Louis Leclerc, Compte de (1707–1788)

Director of the Royal Garden at Paris (1739), describer of the large liver fluke *Strobilocercus (Fasciola) fasciolaris (hepatica)*.

## Bugs

### Classification

Order of →insects.

### Synonyms

→Rhynchota, →Hemiptera.

**Bugs. Table 1** Some common parasitic bugs

Family/Species	Length (mm)	Hosts	Transmitted pathogens
<b>Reduviidae</b>			
<i>Rhodnius prolixus</i>	30	<b>Humans</b> , many animals	<i>Trypanosoma cruzi</i>
<i>Triatoma infestans</i>	30	<b>Humans</b> , many animals	<i>Trypanosoma cruzi</i>
<i>Panstrongylus megistus</i>	30	<b>Humans</b> , many animals	<i>Trypanosoma cruzi</i>
<i>Reduvius personatus</i>	18	Insects, <b>humans</b>	–
<b>Cimicidae</b>			
<i>Cimex lectularius</i>	5–6	<b>Humans</b> , mammals, birds	Eventual mechanical transmission
<i>C. hemipterus</i>	6–7	<b>Humans</b> , mammals, birds	Eventual mechanical transmission
<i>Oeciacus hirundinis</i>	2–3	Swallows, <b>humans</b>	Eventual mechanical transmission
<i>Leptocimex boueti</i>	3–4	Bats, <b>humans</b>	Eventual mechanical transmission

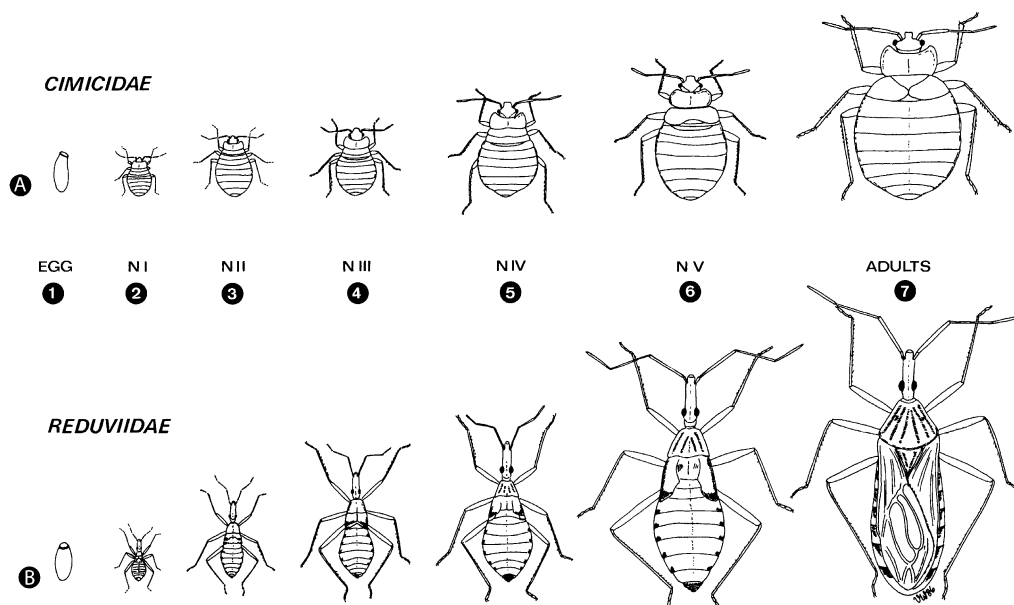

**Bugs. Figure 1** Life-cycle stages of the wingless Cimicidae (A, →*Cimex lectularius*, bedbug) and the Reduviidae (B, →*Rhodnius prolixus*) in dorsal view. 1 The eggs are laid in batches by *Cimex* and mostly singly by *Rhodnius* in the crevices of bed frames, walls, or similar household sites. 2 The larvae (nymphs I) which hatch from the eggs are wingless and feed (as do all other stages) by sucking the blood of humans, and also many other mammals. 3–7 5 molts of the nymphal instars are needed to reach the sexually mature female or male stage (7); in Reduviidae typical fore- and hindwings are eventually formed, but Cimicidae remain wingless in all stages.



**Bugs. Figure 2** SEM micograph of the ventral side of a reduviid bug showing the attached, but protrudible sucking tube.  $\times 30$ .



**Bugs. Figure 3** Light micrograph of a female bedbug (*Cimex lectularius*) with 2 eggs.



**Bugs. Figure 4** Light micrograph of the predator bug *Reduvius personatus*, which may bite painfully humans, too.

## General Information

Among the 30,000 species of bugs of the suborder [→Heteroptera](#), 2 families have obtained medical importance due to their periodic bloodsucking activity which allows transmission of pathogens ([Table 1](#), page 185): the [→Reduviidae](#) (predacious bugs) including the [→Triatominae](#) ([→Kissing Bugs](#)) with wings, and the [→Cimicidae](#) (bedbugs, [Fig. 1A](#), page 185) without wings. Both groups are dorso-ventrally flattened bugs and feed on the blood of their hosts by means of their stylet-like mouthparts, which are included inside an eversible [→proboscis](#) ([Fig. 2](#)) located at the tip of their head; furthermore, “stinking glands” which open behind the third to the sixth abdominal tergite (in juvenile bugs) or alongside the metathorax (in adults) are characteristic. The [→hemimetabolous development](#) of the Rhynchota includes 5 nymphal instars ([Fig. 1B](#), page 185).

## Life Cycle

[Fig. 1](#).

## Important Species

[Table 1](#), [Figs. 3, 4](#).

---

## Bulinus

Genus of snails, intermediate hosts of schistosomes of cattle.

---

## Bulla

Anchoring device of lernaepodoid crustaceans (like [→Salmincola](#)) representing solidified secretions from the head and maxillary glands. The maxillae of these parasites are often fused to the bulla.

---

## Bullis Fever

Disease due to transmission of agents by the tick *Amblyomma americanum*.

## Bunodera

Genus of fish trematodes. → [Digenea](#).

## Bunodera inconstans

Intestinal fish trematode. → [Behavior](#).

## Bunostomum

→ [Hookworms](#), → [Nematodes](#).

## Bunyaviridae

### Classification

Family of → [RNA Viruses](#), mainly transmitted by arthropods (→ [Arboviruses](#)).

### General Information

Negative-sense single-stranded tripartite → [RNA viruses](#) (spherical, with envelope); about 200 species.

### Important Species

[Table 1 \(Bunyavirus\)](#), page 188–190.

[Table 2 \(Nairovirus\)](#), page 191.

[Table 3 \(Phlebovirus\)](#), page 191, 192.

## Buparvaquone

Compound that belongs to the hydroxynaphthochinone group.

→ [Babesiocidal Drugs](#); → [Theileriacidal Drugs](#); it blocks the electron transport in theilerian “mitochondria.”

## Buphagus

→ [Ticks](#).

## Burkea eisenia

Microsporidian parasite of muscles of earthworms.

## Burkitt's Lymphoma

Childhood disease due to infections with the Epstein-Barr-virus causing tumors only in regions where malaria is endemic, while the virus occurs worldwide. Thus the outbreak of such lymphoma tumors are probably related with a malaria-induced immunosuppression.

## Bursa copulatrix

The bursa is a lobular modification of the male posterior end in some groups of → [nematodes](#) which is highly elaborated in strongylid nematodes (Fig. 1, page 192). During copulation the bursa surrounds the vulvar region of the female worm (→ [Nematodes/Reproductive Organs](#)).

## Bütschli, Johann Adam Otto (1848–1920)

Swiss zoologist, discoverer of many pathogenic protozoans.

## Bütschliidae

Family of ciliates that live inside the intestine of mammals.

## Buxtonella

→ [Ciliophora](#).

**Bunyaviridae. Table 1** Arboviruses II. Negative sense, single-stranded tripartite RNA viruses: Family Bunyaviridae, genus Orthobunyavirus

Serogroup (no. of known members)	Species (selected)	Arthropod host	(Main) vertebrate hosts	Distribution	Disease in man	Disease in animals
Acara (2)	Acara	Culicidae ( <i>Culex</i> )	Rodents (?)	Brazil, Panama		
Akabane (4)	Akabane	Culicidae ( <i>Aedes</i> , <i>Culex</i> ), Ceratopogonidae (Culicoides)	Cattle, sheep	Africa, Asia, Australia		Congenital anomalies in cattle, sheep, goat
Alajuela (2)	Alajuela	Culicidae	?	South America		
Anopheles A (4)	Anopheles A	Culicidae ( <i>Anopheles</i> )	Vertebrates (?)	Kolumbien	Fever	
Anopheles B (2)	Anopheles B	Culicidae ( <i>Anopheles</i> )	?	Kolumbien		
Bakau (5)	Bakau	Culicidae ( <i>Culex</i> )	Monkeys (?)	Malaysia		
Batama (1)	Batama	?	Birds	Central African Republic		
Benevides (1)	Benevides	Culicidae ( <i>Culex</i> )	Rodents (?)	Brazil		
Bertioga (5)	Bertioga	Culicidae (?)	?	Brazil		
Bimiti (1)	Bimiti	Culicidae ( <i>Culex portesi</i> )	Rodents (?)	South America		
Botambi (1)	Botambi	Culicidae ( <i>Culex quiarti</i> )	?	Central African Republic		
Bunyamwera (23)	Bunyamwera	Culicidae ( <i>Aedes</i> )	Monkeys, domestic animals (?)	Africa	Fever, meningitis, encephalitis	
	Cache Valley	Culicidae ( <i>Culiseta</i> , <i>Aedes</i> , <i>Anopheles</i> )	Domestic ungulates	North America, Central America, South America	Fever, encephalitis	
	Calovo	Culicidae ( <i>Anopheles</i> )	Cattle, swine	Asia, Europe	Fever	
	Fort Sherman	Culicidae	?	North America	Fever	
	Garissa	Culicidae	?	Africa	Hemorrhagic fever	
	Germiston	Culicidae ( <i>Culex rubinotus</i> )	Rodents (?)	Africa	Fever	
	Ilesha	Culicidae ( <i>Anopheles</i> )	Man (?)	Central Africa, West Africa	Fever	
	Ngari	Culicidae ( <i>Aedes</i> , <i>Anopheles</i> )	?	Africa	Fever	
	Shokwe	Culicidae ( <i>Aedes</i> , <i>Anopheles</i> , <i>Mansonia</i> )	Rodents (?)	Africa	Fever	
	Tensaw	Culicidae ( <i>Aedes</i> , <i>Anopheles</i> , <i>Mansonia</i> , <i>Psorophora</i> )	?	Southern USA	Fever, encephalitis	
Bwamba (2)	Bwamba	Culicidae ( <i>Anopheles</i> )	Man (?), domestic ungulates (?)	Africa	Fever	
	Pongola	Culicidae ( <i>Aedes</i> , <i>Anopheles</i> , <i>Mansonia</i> )	Domestic ungulates, cattle, sheep, goat	Africa		
California (13)	California encephalitis	Culicidae ( <i>Aedes</i> )	Rodents, rabbits	North America	Fever	

	Guaroa	Culicidae (?)	?			Columbia, Brazil	Fever, encephalitis (?)	
	Inkoo	Culicidae	Rodents			Europe, Asia	Fever	
	Jamestown Canyon	Culicidae ( <i>Culiseta</i> )	Rodents			North America	Fever, encephalitis	
	La Crosse	Culicidae ( <i>Aedes</i> )	Chipmunks, squirrels			North America	Fever, La Crosse encephalitis	
	Snowshoe Hare	Culicidae ( <i>Aedes</i> )	Hares			North America, Asia, Europe	Fever, encephalitis	
	Tahyna	Culicidae ( <i>Aedes</i> )	Lagomorphs, swine			Asia, Europe	Fever, meningitis	
Capim (1)	Capim	Culicidae ( <i>Culex</i> )	Rodents			Brazil		
Caraparu (5)	Caraparu	Culicidae ( <i>Culex</i> )	Rodents			South America	Fever	
Catu (1)	Catu	Culicidae ( <i>Culex</i> )	Rodents			South America	Fever	
Estero Real (1)	Estero Real	Ixodidae	?			South America		
Gamboa (2)	Gamboa	Culicidae ( <i>Aedomyia</i> )	?			Panama		
Guajara (1)	Guajara	Culicidae ( <i>Culex</i> )	Rodents			Brazil		
Guama (1)	Guama	Culicidae ( <i>Culex, Mansonia</i> )	Rodents			Central America, South America	Fever	
Guaroa (1)	Guaroa	Culicidae ( <i>Anopheles</i> )	Man (?)			Colombia, Brazil		
Kaeng Khoi (1)	Kaeng Khoi	( <i>Cimex</i> )	Bats			Thailand		
Kaikalur (1)	Kaikalur	Culicidae ( <i>Culex</i> )	?			India		
Kairi (1)	Kairi	Culicidae ( <i>Aedes, Anopheles, Wyeomyia, Psorophora, Culex</i> )	Domestic ungulates (?), rodents (?)			Trinidad, Brazil, Colombia		
Koongol (2)	Koongol	Culicidae ( <i>Culex</i> )	?			Australia, New Guinea		
Madrid (1)	Madrid	Culicidae ( <i>Culex</i> )	Rodents (?)			Panama	Fever	
Main Drain (1)	Main Drain	Culicidae ( <i>Culex, Psorophora</i> ), Ceratopogonidae ( <i>Culiseta</i> )	Rodents			Western USA		
Manzanilla (5)	Manzanilla	?	?			Trinidad, Colombia		
Marituba (5)	Marituba	Culicidae ( <i>Culex</i> )	Marsupials (?)			Brazil	Fever	
	Murutucu	Culicidae ( <i>Culex</i> )	Rodents			Brazil, French Guiana	Fever	
	Nepuyo	Culicidae ( <i>Culex</i> )	Rodents			Central America, South America	Fever	
	Restan	Culicidae ( <i>Culex</i> ?)	?			Trinidad, Surinam	Fever	
Minatitlan (2)	Minatitlan	?	?			Mexico, Guatemala		
M'Poko (2)	M'Poko	Culicidae ( <i>Culex</i> )	Birds (?)			Central African Republic		



**Bunyaviridae. Table 1** Arboviruses II. Negative sense, single-stranded tripartite RNA viruses: Family Bunyaviridae, genus Orthobunyavirus (Continued)

Serogroup (no. of known members)	Species (selected)	Arthropod host	(Main) vertebrate hosts	Distribution	Disease in man	Disease in animals
Nyando (2)	Nyando	Culicidae ( <i>Anopheles</i> , <i>Aedes</i> )	?	Africa	Fever	
Olifantsvlei (4)	Olifantsvlei	Culicidae ( <i>Culex</i> , <i>Mansonia</i> )	?	South Africa, East Africa		
Oriboca (2)	Itaqui	Culicidae ( <i>Culex</i> )	Rodents	Brazil	Fever	
	Oriboca	Culicidae ( <i>Culex</i> , <i>Mansonia</i> , <i>Psorophora</i> )	Rodents, marsupials	Brazil, Trinidad, Suriname	Fever	
Oropouche (4)	Oropouche	Culicidae, Ceratopogonidae	Monkeys, sloths	South America	Oropouche fever	
Patois (5)	Patois	Culicidae ( <i>Culex</i> )	Rodents	Central America		
Sathuperi (2)	Sathuperi	Culicidae ( <i>Culex</i> ), Ceratopogonidae ( <i>Culicoides</i> )	Cattle	India, Nigeria		
Shamonda (3)	Shamonda	Ceratopogonidae ( <i>Culicoides</i> )	Cattle	Nigeria		
Shumi (3)	Shumi	Culicidae ( <i>Culex</i> )	Cattle, sheep	Nigeria, South Africa	Fever	
	Aino	Culicidae ( <i>Culex</i> ), Ceratopogonidae ( <i>Culicoides</i> )	Cattle, sheep	Australia, Japan		Stillbirth, abortion in cattle
Simbu (1)	Simbu	Culicidae ( <i>Aedes</i> )	?	Africa		
Tacatuma (4)	Tacatuma	Culicidae ( <i>Haemagogus</i> , <i>Anopheles</i> )	Rodents	Brazil, French Guiana		
Tete (5)	Bahig	Ixodidae ( <i>Hyalomma</i> )	Birds	Europe, Northern Africa		
	Matruh	Ixodidae ( <i>Hyalomma</i> )	Birds	Europe, Northern Africa		
	Thimiri (1)	?	Birds	India, Egypt		
Timboteua (1)	Timboteua	?	Rodents (?)	Brazil		
Turlock (5)	Lednice	Culicidae ( <i>Culex modestus</i> )	Water birds	Czech Republic, Romania		
	Sedlec	?	Birds (?)	Czech Republic		
Wyomeyia (6)	Wyomeyia	Culicidae ( <i>Wyomyia</i> , <i>Aedes</i> , <i>Psorophora</i> )	?	South America		
Zegla (1)	Zegla	?	Marsupials	Central America		
Tentative (4)	Leanyer	Culicidae	?			
Unassigned	Bhanja	Ixodidae	?	Europe	Fever, encephalitis	

**Bunyaviridae. Table 2** Arboviruses III. Negative sense, single-stranded tripartite RNA viruses: Family Bunyaviridae, genus Nairovirus

Serogroup (no. of known members)	Species (selected)	Arthropod host	(Main) vertebrate hosts	Distribution	Disease in man	Disease in animals
Crimean-Congo (3)	Crimean-Congo	Ixodidae ( <i>Hyalomma</i> )	Various mammals, migrating birds (?)	Europe, Asia, Africa	Crimean-Congo hemorrhagic fever	
Dera Ghazi Khan (6)	Dera Ghazi Khan	Ixodidae ( <i>Hyalomma</i> )	?	Pakistan		
Hughes (10)	Soldado	Ixodidae ( <i>Ornithodoros</i> )	Birds	Europe, Africa, Trinidad, Seychelles		Illness in juvenile seabirds and chickens
	Puffin Island	Ixodidae	Birds	Europe		
Dugbe (3)	Dugbe	Ixodidae ( <i>Amblyomma</i> , <i>Hyalomma</i> , <i>Boophilus</i> )	Cattle, rodents	Africa	Fever	
	Ganjam	Ixodidae ( <i>Haemaphysalis</i> ) Culicidae ( <i>Culex</i> ?)	Sheep (?)	India	Fever	Febrile illness
	Nairobi Sheep Disease	Ceratopogonidae ( <i>Culicoides</i> ), Ixodidae ( <i>Rhipicephalus</i> )	Sheep, goat	Kenya, Uganda	Fever	Nairobi sheep disease (intestinal hemorrhagics, nephritis)
Qalyub (4)	Qalyub	Ixodidae ( <i>Ornithodoros</i> )	?	Egypt		
Sakhalin (7)	Avalon	Ixodidae ( <i>Ixodes</i> )	Birds	Russia, Canada	Cervical adenitis (?)	
	Clo Mor	Ixodidae ( <i>Ixodes</i> )	Birds	Great Britain		
Thiafora (2)	Erve	?	Rodents	France, Germany (?)	Hemorrhagic CNS infection (?)	

**Bunyaviridae. Table 3** Arboviruses IV. Negative sense, single-stranded tripartite RNA viruses: Family Bunyaviridae, genus Phlebovirus

Group (no. of members)	Species (selected)	Arthropod host	(Main) vertebrate hosts	Distribution	Disease in man	Disease in animals
Bujaru (2)	Bujaru	?	Rodents (?)	Brazil		
Candiru (6)	Candiru	?	?	Brazil	Fever	
Chilibre (2)	Chilibre	Phlebotominae ( <i>Lutzomyia</i> )	?	Panama		
Frijoles (2)	Frijoles	Phlebotominae ( <i>Lutzomyia</i> )	?	Panama		
Punta Toro (2)	Punta Toro	Phlebotominae ( <i>Lutzomyia</i> )	?	Panama	Fever	
Rift Valley (3)	Rift Valley Fever	Culicidae ( <i>Aedes</i> , <i>Culex</i> )	Cattle, sheep, goat, antelopes, rodents	Africa, Arabia, Jemen	Rift Valley fever, (hemorrhagic fever, encephalitis, retinitis)	Febrile illness, hepatitis, hepatic necrosis, stillbirths

**Bunyaviridae. Table 3** Arboviruses IV. Negative sense, single-stranded tripartite RNA viruses: Family Bunyaviridae, genus Phlebovirus (Continued)

Group (no. of members)	Species (selected)	Arthropod host	(Main) vertebrate hosts	Distribution	Disease in man	Disease in animals
Salehabad (2)	Arbia	Phlebotominae ( <i>Phlebotomus</i> )	?	Iran, Pakistan, Bangladesh		
Sandfly fever Naples (4)	Sandfly Fever Naples	Phlebotominae ( <i>Phlebotomus</i> , <i>Seregentomyia</i> )	Man (?)	Southern Europe, Northern Africa, Middle Asia	Pappataci fever	
	Toscana	Phlebotominae ( <i>Phlebotomus</i> )	Man (?)	Europe, Northern Africa	Meningitis	
Uukuniemi (13)	Grand Arbaud	Ixodidae ( <i>Argas</i> )	?	Southern France		
	Ponteves	Ixodidae ( <i>Argas</i> )	?	Southern France		
	St. Abb's Head	Ixodidae ( <i>Ixodes</i> )	Sea birds	Europe		Illness in juvenile sea birds
	Uukuniemi	Ixodidae ( <i>Ixodes</i> )	Passerine birds, sea birds	Europe, Asia	Fever (?)	
	Zaliv Terpeniya	Ixodidae ( <i>Ixodes</i> )	Birds	Russia		
Unassigned (16)	Sandfly Fever Sicilian	Phlebotominae ( <i>Phlebotomus</i> , <i>Seregentomyia</i> )	Man (?)	Southern Europe, Northern Africa, Middle Asia	Papataci fever	
	Sandfly Fever Kios	Phlebotominae ( <i>Phlebotomus</i> )	?	Southern Europe	Meningitis	

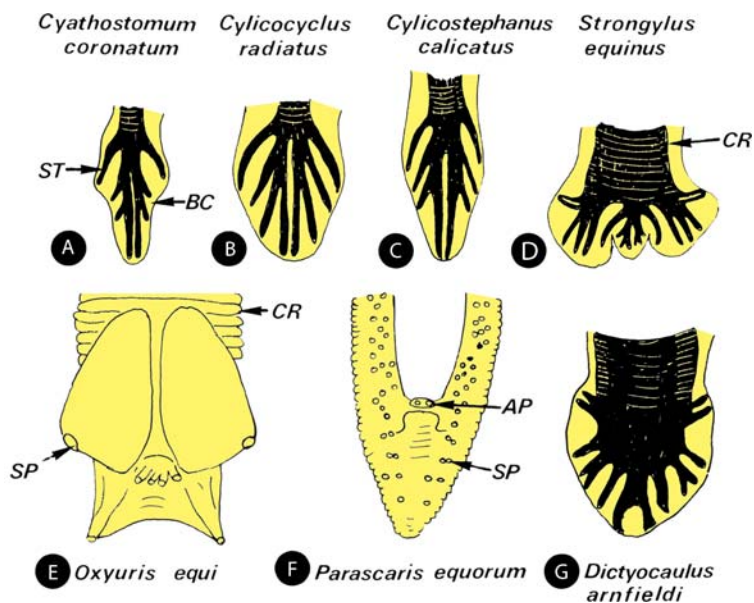
**Bursa copulatrix. Figure 1** DR of the terminal ends of male worms of different nematode species of horses, which are characterized by their means for copulation. AP, anal papillae; BC, bursa copulatrix; CR, cuticular rings; SP, sense papillae; ST, stabilizations of the BC (rays).

## Caenorhabditis elegans

Free-living small-sized (1.3 mm in length) nematode, which is now one of the most often cultured specimens for laboratory experiments. The Nobel prize winners of the year 2006 worked with the RNA of this fully sequenced worm with a constant number of 959 cells (→*Eutely*) and about 19,000 genes. Most of the animals are hermaphrodites, which fertilize themselves. They are females, which as adults may produce sperms for a limited period. Males are rare, but they may copulate with the hermaphroditic females.

## Calabar Swelling

→*Oedema* due to infection with wandering →*Loa loa* stages in human skin, →*Filariidae*, →*Loiasis*.

## Calcareous Corpuscles

The →*tegument* and parenchymal cells of adult and in particular larval →*tapeworms* contain these significant corpuscles (Fig. 1), which may be used for diagnosis (→*Cestodes/Tegument*). They are composed of an organic base coupled with inorganic substances, such as potassium, sodium, magnesium, calcium, phosphate, and sulfate in different →*Cysticercus* larvae. In adult tapeworms CaO, MgO, P<sub>2</sub>O<sub>5</sub>, and CO<sub>2</sub> were determined. The organic base of the corpuscles includes DNA, RNA, proteins, and →*glycogen*. The function of these organelles, which (after KOH isolation) in electron microscopy appear as concentrically lamellated platelets, is not quite clear. Since they are mainly produced in the absence of oxygen, they were thought to buffer anaerobically produced acids. It has also been suggested that they are a reservoir for inorganic ions. It was recently reported that calcareous corpuscles are

also formed in the excretory canals of cysticerci of →*Taenia solium* indicating their possible contribution in osmoregulation and protection against calcification.

## Calicophoron

Genus of flukes related to →*Paramphistomum*, e.g., *Calicophoron* (syn. *Paramphistomum*) *daubneyi* in deers.

## Caligus

→*Crustacea*.

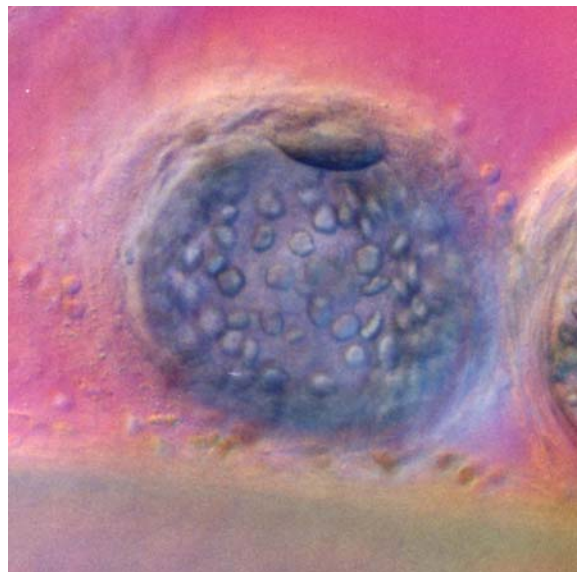

**Calcareous Corpuscles. Figure 1** Calcareous corpuscles inside a protoscolex within an *Echinococcus* brood capsule.

## Calliphora

### Name

Greek: *kalos* = beautiful, *phorein* = porting, showing.

Genus of →*Diptera*, belonging to the fly family Calliphoridae appearing with black thorax and steely dark-blue, bluish-violet, or blue-black, slightly metallic abdomen. This group of flies is also called “bluebottles” reaching a length of 10–14 mm as adults. In Europe occur *C. vicina* (syn. *erythrocephala*) (Fig. 1), and *C. vomitoria*, also named “blue flesh flies.” The eggs are ovoid and appear white (Fig. 2).

## Callitroga

Genus of flies, the larvae of which penetrate human skin leading to →*myiasis*. The species *C. americana* is synonym to *Cochliomyia hominivorax*. The common name for this group of flies is “screwworms” or “-flies”. →*Diptera*.

## Calpain

This product is released by the skin – penetrating cercariae of →*schistosomes*. It is postulated to lead to a Th1 cytokine production, which may introduce protection of the host.



**Calliphora.** Figure 1 LM of an adult *Calliphora erythrocephala* fly.



**Calliphora.** Figure 2 LM of *Calliphora* eggs close to the border of a 10-cent coin.

## Calreticulin

This is a calcium-binding protein (e.g., of →*trypanosomes*), which is suggested to modulate the vertebrate complement system and provides an effective immune-escape mechanism for, e.g., *T. cruzi*. Since it also inhibits angiogenesis it might protect the host from ongoing neoplastic aggressions.

## Calyptospora

→*Coccidia*; Genus of parasites of fish, e.g., *C. funduli* is found in Cyprinodontidae and Atherinidae and needs intermediate hosts (shrimps) to complete the life cycle.

## Camallanus

Genus of →*nematodes*. Several of these red appearing species (e.g., *C. cotti*) live in the hind gut of fish and parasitize by blood sucking (Fig. 1). Since they possess a fortified buccal capsule (Fig. 2), they are also called “fraise-head-worm.” Males reach 3–4 mm in length, females grow up to 7–12 mm, hang out of the anus, and



**Camallanus.** Figure 1 The posterior end of a female *Camallanus* hangs out of the anus of its host (*Papiliochromis* sp.).



**Camallanus.** Figure 2 LM of the buccal capsules of a *Camallanus* – nematode.

excrete larva – containing eggs into the water (Fig. 1). These eggs are taken up by intermediate hosts (small crustaceans), within which the infectious larva 3 develops. The infection of the fish (final host) occurs by feeding such intermediate hosts.

### Symptoms of Disease

Apathy, anaemia, slow growing, disturbance of bone formation, death due to bacterial superinfections.

### Therapy

Medical bath containing compounds such as emamectine (Nematol<sup>®</sup>) or mosquito-larvae that had been traced with levamisole or fenbendazole (~50 mg/kg food).

## Campylobacter coli

Bacterium, the presence of which facilitates in pigs the mucosae invasion of the ciliate → *Balantidium coli*.

## Canalis gynaecophorous

In →schistosomes the dorso-ventrally flattened male forms a groove, within which the tiny female – appearing circular in diameter – is hidden. This partnership keeps for the whole lifespan.

## Candiru Fish

### Synonym

→Vampire Fish.

## Canine Parasitic Zoonoses

Often neglected diseases, since dog owner do not know the existence of such parasites. Risks are especially during contacts with stray dogs.

## Capacitation

The last stage of spermiogenesis in →ticks, leading to mature sperms (→Ticks/Spermatogenesis and Fertilization).

## Caparinia

→Mites.

## Capillaria aerophila

→Nematodes, →Respiratory System Diseases, Horses, Swine, Carnivores.

## Capillaria Species

### Name

Latin: *capillus* = hair.

### Classification

Genus of →Nematodes.

### Important Species

Table 1, others in ruminants.

### Life Cycle

Fig. 1.

### Disease

→Capillariosis, →Capillariasis.

intestine of people who are believed to have been infected by eating raw freshwater fish. →Autoinfection with larvae appears to explain the intensity of the infection. Severe protein-wasting enteropathy with edematous jejunal walls but with little inflammation and an inconstant presence of eosinophils are considered characteristic. →Malabsorption with voluminous diarrhea, followed by emaciation, and hypoproteinemic edema, often precedes a fatal outcome after an illness of 2 weeks to 2 months.

### Therapy

→Nematocidal Drugs, Man.

## Capillariasis

Capillariasis is diagnosed by finding the distinctive →*Trichuris*-like eggs either in the liver (→*Capillaria* species) or in the feces (*C. philippinensis*). In *C. hepatica* infection the embryonated eggs are ingested with soil, and the larvae mature in the liver where adults lay their eggs. They have been found in a number of humans, surrounded by fibrosis. Because *C. hepatica* is normally found in rats, the adults die in humans. Infection with *C. philippinensis* has been described in Thailand and the Philippines. Large numbers of →viviparous adults, larvae, and eggs have been found in the lumen and mucosa of the small

## Capillariosis

→*Capillaria* species, syn. →Capillariasis.

## Capitulum

Anterior part of →ticks and →mites – also called gnathosoma – which presents 2 pairs of mouthparts (cheliceres, pedipalps).

## Capping

→Coccidia, motility, →Locomotory Systems.

**Capillaria Species. Table 1** Important species of the genus *Capillaria*

Species	Length of adult worms (mm)		Size of eggs (or larvae) (µm)	Final host/Habitat	Intermediate host	Prepatent period in final host (weeks)
	f	m				
<i>C. aerophila</i>	30	25	70 × 35	Cats, dogs, hedgehogs/ Lung	–	4–6
<i>Capillaria annulata</i>	10–50	10–25	60–62 × 24–27	Chickens/Pharynx	Earthworms	3
<i>C. hepatica</i>	100	15–30	50 × 35	Lagomorpha, rodents, <b>humans</b> /Liver	–	21–28 (remain in liver)
<i>C. philippinensis</i>	45	3	50 × 35	Birds, <b>humans</b> /Small intestine	Fish, crustaceans	?

f = female, m = male

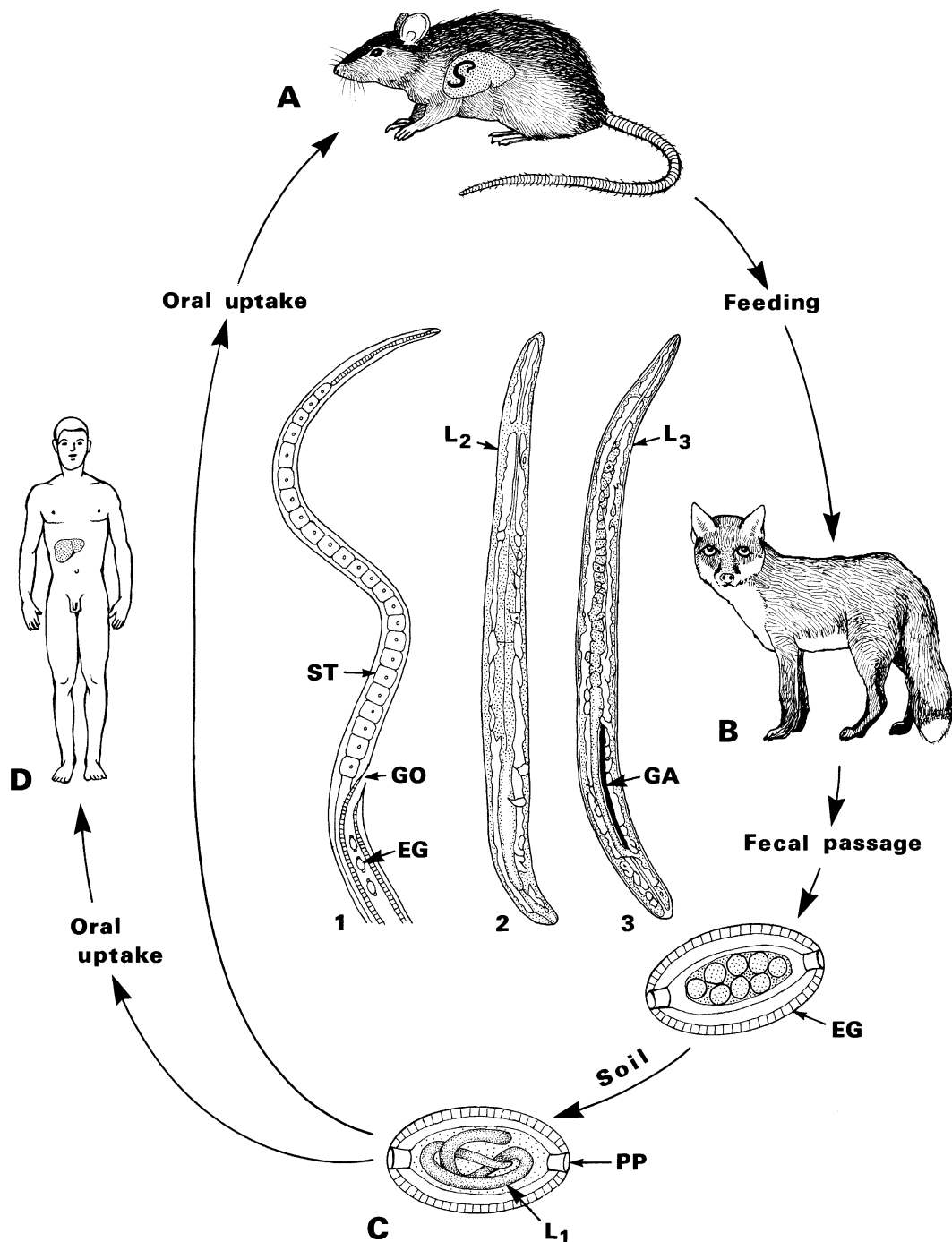

**Capillaria Species. Figure 1 A–D** Life cycle of *Capillaria hepatica*. **A** Adults (male 15–30 × 0.06 mm, female 100 × 0.2 mm) live in liver → **parenchyma** of their final hosts (rodents and a variety of other mammals). Here the females (**1**) deposit their typical eggs (EG), which measure 45–60 × 30 μm and are characterized by two → **polar plugs** (PP). **B** The unembryonated eggs have no means of egress until eaten by a predator (mainly foxes, dogs) or until the liver decomposes after death of the final host. In the first case the eggs merely pass through the intestine of the predator and are excreted with the feces. **C** Embryonation occurs on the soil and depends on a favorable combination of temperature, moisture, and oxygen. At room temperature about 4–5 weeks are needed until the first-stage larva (L<sub>1</sub>) is formed (which may survive for more than 1 year). **D** Infection of final hosts (A; mice and erroneously man) occurs by swallowing of fully developed eggs. After hatching in the cecum the L<sub>1</sub> reaches (via the intestinal wall and portal vein) the liver within 2 days. There, the next 2 larval stages (2, 3) are formed by molts; maturity is acquired 21–28 days after infection (prepatent period). The lifespan of males is about 40 days and that of females about 60 days (patent period). The eggs, however, persist until the death of the final host. EG, egg; GA, genital anlagen; GO, genital opening; L, larva; PP, → **polar plug**; ST, stichosomal cell of esophagus.



## Carallobothrium fimbriatum

Species of proteocephalan cestodes (parasitic in fish intestine).

## Carbamates

→Ectoparasiticides, →Arthropodicidal Drugs (e.g., Pro-poxur).

## Carbaryl

### Chemical Class

Carbamate.

### Mode of Action

Acetylcholine esterase inhibitor. →Ectoparasiticides – Agonists and Antagonists of Cholinergic Transmission.

## Carbohydrate

→Energy Metabolism.

## Carchesium

→Ciliophora.

## Carcinogenesis

Some worms may introduce development of tumors in organs of their hosts, e.g., in liver →*Clonorchis*, →*Opisthorchis*, in liver and bladder →*Schistosoma*, in lung →*Paragonimus*, in brain →*Acanthamoeba*.

## Card Agglutination Test (CATT)

Antibody detection test for →trypanosomiasis.

## Cardiovascular System Diseases, Animals

### Blood Disease, Animals (Parasitaemias)

Haemoprotozoal diseases (→*Babesiosis*, *Animals*, →*Trypanosomiasis*, *Animals*, →*Theileriosis* and →*Leishmaniasis*, *Animals*) are caused by infections which localize either in the blood alone or in the blood and solid tissues. Blood infections affect primarily the microcirculation. However, more important are the lesions caused in solid tissues and organs. They are attributable either to systematic malfunction of the circulation or to disturbances in the microcirculation of a specific organ. An important common feature in all the pathogenesis is the release of large amounts of antigens into the plasma. The interactions of these antigens with the host's immunological responses result also in mechanisms of tissue destruction.

The clinical signs are non-specific and consist of fever, lethargy, weakness, and emaciation. Parasitaemias are often associated with →*anaemia*, leucopenia, →*oedema*, and hemorrhages (Table 1).

### Heart

Most parasites which form cysts in striated muscles may also invade the myocardium. Such cysts include the tiny tubular sarcocysts formed by the protozoan →*Sarcocystis*, the metacystodes of the →*Taeniidae* (cysticerci and hydatid cysts), or the encysted larvae of the nematode →*Trichinella spiralis*. These infections generally produce few or no symptoms and in most cases the cysts are found incidentally on post-mortem examination of the cardiac muscle. However, in the unusual event of a massive infection death may occur after a febrile course.

The pathognomonic lesion in *Gedoelestia*-fly larva infection (→*Uitpeuloog*) is a thrombo-endophlebitis which varies in intensity, location, and distribution and is frequently accompanied by thromboendoarteritis. In sheep coronary →*thrombosis* causes myocarditis or myomalacia cordis with sudden death as the sequel.

*Trypanosoma cruzi* is the cause of human trypanosomiasis in South America (→*Chagas' Disease*, *Man*). It also develops and causes disease in cats, dogs, and pigs which, together with numerous wild animals act as →*reservoir* hosts for the parasite. *T. cruzi* multiply within the →*cytoplasm* of the cells of their mammalian host, particularly those in the skeletal and cardiac muscles (amastigote form). The heart is particularly affected, with development of multifocal to diffuse severe granulomatous myocarditis. In dogs non-specific clinical signs such as →*weight loss*,

**Cardiovascular System Diseases, Animals. Table 1** Parasites of the haematopoietic system (according to Vercruyse and De Bont)

Parasite	Host	Location	Clinical presentation	Principal lesions
<b>Babesia</b>				
<i>B. bigemina</i>	Cattle	Red blood cells	Fever, malaise, loss of appetite, listlessness, anaemia haemoglobinuria, icterus	Findings of acute intravascular haemolytic crisis: capillary congestion of most organs, splenomegaly
<i>B. bovis</i>	Cattle		<i>B. bovis</i> , <i>B. canis</i> : nervous symptoms	<i>B. bovis</i> , <i>B. canis</i> : congestion grey matter throughout the brain
<i>B. divergens</i>	Cattle			
<i>B. major</i>	Cattle			
<i>B. caballi</i>	Horse			
<i>B. canis</i>	Dog			
<i>B. gibsoni</i>	Dog			
<i>B. felis</i>	Cat			
<b>Leishmania</b>				
<i>L. infantum</i>	Dog	Monocyte-macrophage system (visceral and cutaneous)	Lymphadenomegaly, anaemia, splenomegaly, dry exfoliative dermatitis, ulcerations, weight loss, onychogryphosis, ocular signs, anorexia	Haemo-lymphatic hypertrophy with macrophage proliferation and focal granulomas
<b>Theileria</b>				
<i>T. parva</i>	Cattle	Lymphocytes (lymphoblasts), erythrocytes	E C F: fever, dullness, listlessness, anorexia, hyperplasia lymph nodes, salivation, lacrimation diarrhoea, watery cough and dyspnea	Lymphoid hyperplasia, splenomegaly, petechial haemorrhages over most of the serous and mucous surfaces, interlobular oedema, emphysema and hyperaemia of the lungs
<i>T. annulata</i>	Cattle			
<i>T. lawrencei</i>	Cattle			
<i>T. mutans</i>	Cattle			
<i>T. hirci</i>	Sheep, goats			
<i>T. equi</i>	Horse			
<b>Trypanosoma</b>				
<i>T. congolense</i>	Ruminants	Bloodplasma, perivascular tissues	Acute: severe symptoms and death after 3 weeks Chronic: remittent fever, anaemia and progressive emaciation. Less common: watery diarrhoea, abortion, stillbirths, corneal opacity, bottle jaw	Generalized lymphadenopathia, heart is flabby, liver and spleen are enlarged
<i>T. vivax</i>	Ruminants, Horses			
<i>T. evansi</i>	Horses, Dogs			
<i>T. brucei</i>	Equines, Ruminants, Dogs, cats			
<i>T. simiae</i>	Pigs			

ECF = East Coast Fever

lymphadenomegaly, →diarrhoea, and →anorexia are generally accompanied by signs referable to cardiac dysfunction, such as tachycardia, ascites, weak pulse, lethargy, and hepatomegaly.

### Vasculitis

The tachyzoite stage of *Toxoplasma gondii* invades many host cell types including vascular endothelium. Perivascular infiltration, e.g., in the brain is a common feature in

toxoplasmosis-related inflammation. High infective doses of pathogenic *Sarcocystis* spp. (e.g., *S. cruzi*, *S. miescheriana*) may cause multiple haemorrhages in the intermediate host. The pathogenesis is not completely resolved but it appears that both mechanical destruction of the endothelial lining by the intracellularly developing parasite and alteration of blood coagulation are involved.

Haemoprotozoa (→ Cardiovascular System Diseases, Animals/Parasitaemia, → *Babesia*, → *Theileria*, → *Leishmania*, → *Trypanosoma*) do not only destroy host cells but also induce occlusion of capillaries and immune complex formation. This leads to necrosis and inflammation in various tissues. Severe, often lethal, disease results from organ malfunction, however, the clinical picture may be quite variable, depending on the main localization of impairment of microcirculation. Moreover, generalized disorder of circulation and acute shock are possible consequences of haemoprotozoan infection.

### Arteries

Parasitic →arteriitis is a very common form of arterial disease in animals (Table 2). The lesions are characterized by →inflammatory reaction and thickening of the arterial wall, often accompanied by endothelial damage and thrombosis. Thrombi may partially or completely occlude the artery and emboli arising from pieces of thrombi that have broken loose may occlude vessels distal to the site where parasites have lodged. Rupture of arteries as a result of parasitic lesions is rare. The 2 helminth species which cause by far the most severe damage to arteries are →*Strongylus vulgaris* in horses and →*Dirofilaria immitis* in dogs. Other species eliciting varying degrees of arteriitis are *Onchocerca armillata* in cattle, *Elaeophora schneideri* in sheep, *Angiostrongylus vasorum* and →*Spirocerca lupi* in dogs, and *Aelurostrongylus abstrusus* in cats.

*Strongylus vulgaris* is often referred to as the most important parasite of horses. It is widely distributed

**Cardiovascular System Diseases, Animals. Table 2** Parasites inducing myocarditis and vasculitis (according to Vercruyse and De Bont)

Parasite	Host	Location	Clinical presentation	Principal lesions
<b>Nematoda</b>				
<i>Angiostrongylus vasorum</i>	Dog, fox	Pulmonary artery	Dyspnea	Granulomatous interstitial pneumonia, endarteriitis
<i>Dirofilaria immitis</i>	Dogs, rarely other hosts	Pulmonary arteries and chambers of the right heart	Deep soft chest cough, loss of exercise tolerance, emaciation	Intense endovascular reaction of the pulmonary arteries sometimes in hepatic veins
<i>Elaeophora schneideri</i>	Sheep, deer, elk	Cephalic arteries	Hyperplasia and occlusion of cephalic and other arteries, microfilariae cause dermal lesions	Mild intimal sclerosis to prominent fibrous thickening of the vessel wall
<i>Onchocerca armillata</i>	Cattle	Thoracic aorta	Microfilariae cause epileptiform signs and ophthalmia	Nodules, roughening, and calcifications in the aortic walls
<i>Spirocerca lupi</i>	Dog	Aorta	Usually no clinical signs during the prepatent phase	Local thickening of the intima and media of the aorta
<i>Strongylus vulgaris</i>	Equines	Anterior mesenteric artery and the adjacent aorta and other trunks	Pyrexia, anorexia, weight loss, dullness, colic, and death in severe infections, otherwise varying pyrexia, colic, diarrhoea	Verminous arteritis, thrombus formation, infarction of colon and caecum
<b>Protozoa</b>				
<i>Trypanosoma cruzi</i>	Man, wild mammals, dog, cat, pig	Amastigote forms preference for skeletal and cardiac muscle	Systemic disease, cardiac dysfunction as tachycardia ascitis, weak pulse, lethargy	Heart: mild multifocal to diffuse severe granulomatous myocarditis
<b>Trematoda</b>				
<i>Schistosoma curassoni</i> , <i>S. bovis</i> , <i>S. mattheei</i>	Ruminants  Ruminants, horses	Mainly mesenteric and portal veins	Mucoid and haemorrhagic diarrhoea, anorexia, loss of condition, general weakness, anaemia, hypoalbuminaemia	Granulomatous lesions in intestine and liver

and infects horses of all ages, fatal natural infection having been observed in foals as early as 21 days after birth. The pathogenesis of *S. vulgaris* infection is associated with the larval migration of the parasite through the tissues of the host. Third-stage infective larvae ingested by the grazing animal penetrate the wall of the intestine, moult in the submucosa to become fourth-stage larvae, and invade terminal branches of intestinal arteries to begin their migration. This penetration and early migration of larvae results in inflammatory reactions and small haemorrhages throughout the intestinal wall. This coincides with the rise in body temperature detected 5–7 days after heavy infections. The temperature reaction generally subsides as the fourth-stage larvae migrate in the intima of the mesenteric arteries causing inflammatory reactions and mural thrombi. By 2–3 weeks post-infection the larvae reach the cranial mesenteric artery where they remain for several months. They moult to become fifth-stage larvae and eventually return to the lumen of the large intestine where they complete their maturation and start producing eggs 6–7 months after infection. During their long stay in the cranial mesenteric artery, the larvae induce a severe fibrinous inflammatory reaction which can involve all layers of the arterial wall (verminous arteritis). In [→chronic infections](#), the wall of the artery becomes thickened and the lumen partly occluded by thrombi, cellular debris, and larvae which remain firmly attached to the intima. Clinical signs in animals include dullness, progressive weight loss, and varying degrees of pyrexia, often with intermittent abdominal discomfort. At post mortem, aneurysmal dilatation of the artery may sometimes be observed. Larval migration of *S. vulgaris* was generally recognized as a major etiological factor of equine colic, although its incidence is decreasing due to the availability of efficient anthelmintics. Acute colic due to thromboembolic infarction of the caecum or large intestine is a well-documented complication of verminous enteritis. Colic signs have also been observed in early massive infections, before verminous lesions develop in the cranial mesenteric artery. Possible mechanisms for colic include damage to and impairment of nervous innervation to the intestine by migrating larvae, release of toxins by degenerating larvae, and [→hypersensitivity](#) or allergic reactions to *S. vulgaris*. A diarrhoeic syndrome in field cases of verminous arteritis has also been described. The pathophysiology is poorly understood but it may be a response to altered intestinal circulation, local irritation, and/or severe ulceration of the mucosa of the caecum and colon caused by thromboembolism. Clinical signs and lesions have been associated with aberrant larval migration in the aorta, coronary, iliac, spermatic and renal arteries, and in the heart, kidney, brain, and spinal cord.

The filarial worm *Dirofilaria immitis*, or “[→heartworm](#),” is an important parasite of the dog. The adult worms are 12–30 cm long and live in the right ventricle of the heart and in the pulmonary arteries. Most cases with light infection remain asymptomatic. In heavier infestations, the presence of large numbers of heartworms does both mechanically interfere with the circulation through the right heart and lungs, and induces endarteritis with severe intravascular changes. Such heavy infection invariably leads to circulatory and respiratory distress. The mechanical interference with the circulation through the right heart generally causes a compensatory hypertrophy of the right ventricle. At the same time, adult worms and juveniles spread within the pulmonary arterial system and cause inflammatory reactions. They also induce the development of typical myointimal proliferative lesions which gradually reduce the lumen of small pulmonary arteries, leading to pulmonary hypertension. Endothelial damage, with thrombosis and thromboembolism has sometimes been reported. Chronic infections eventually lead to insufficiency of the right heart, which results in passive congestion of the liver, spleen, and lungs, ascites and peripheral oedema. The onset of clinical signs of dirofilariasis is insidious and may go unrecognized until substantial vascular damage has occurred. A deep, usually soft chest cough is a common early sign. Coughing may be aggravated by exercise, severe coughing being sometimes accompanied by hemoptysis, a sign highly suggestive of heartworm infection. In the late stages some dogs display characteristic respiratory movements: the rib cage remains expanded, and there is an extra inspiratory effort. The very poor exercise tolerance is a consistent clinical finding in advanced cases. Dogs which are suddenly forced to exercise may rapidly become ataxic or experience syncope. Emaciation develops gradually. The final stage of congestive failure of the right heart is only seen in a small proportion of affected dogs. A relative infrequent complication of *Dirofilaria immitis* heavy infestations is the occurrence of pulmonary embolism by adult worms – or worms killed by chemotherapy – which occlude small pulmonary arteries and cause infarction. Also described in very heavy infections is the “liver failure syndrome” caused by worms which have invaded the vena cava and hepatic veins. The cause of the distribution is not known but it may be related to overcrowding in the normal pulmonary arterial habitat. The syndrome is characterized by sudden onset of weakness, anorexia, [→bilirubinuria](#), [→haemoglobinuria](#), Haemoglobinaemia, and [→anaemia](#). The anaemia develops due to disseminated intravascular coagulation and fragmentation of red cells. Azotaemia develops, and death usually occurs in 1–3 days. Another possible complication of *Dirofilaria* infection is [→immune complex](#) [→glomerulonephritis](#). [→Microfilaria](#) are usually

of little consequence for the dog. If microfilariae block the arterioles of the skin there is →erythema, →pruritus, and loss of hair. This effect may however be due to concurrent dipetalonemiasis. Infections with *D. immitis* have also been reported in the cat, wild Canidae and Felidae, and rarely in humans.

*Onchocerca armillata* and *Elaeophora schneideri* are another 2 filarial parasite species which live in large blood vessels, produce microfilariae, and have biting insects as obligate intermediate hosts. *O. armillata* is focally highly prevalent in ruminants in Africa and Asia. In cattle it produces striking lesions in the intima and media of the thoracic aorta: tunnels, →nodules, Roughening, and calcifications. However, the only cardiovascular disturbances that have been reported appear to be slight aneurysmal changes, despite the presence in the aortic wall of worms which may be up to 70 cm long. Other symptoms, such as repetitive episodes of collapse and tetanic convulsions, periodic ophthalmic, and even →blindness sometimes observed in heavily infected animals have been attributed to the microfilariae. *E. schneideri* is common in wild ruminants and sheep in northern America. The adult worms live in the cephalic arteries of the host, while microfilariae are found in the skin, mainly in the head region. In elk and moose, the infection often causes inflammatory reactions and thrombosis of the cephalic arteries, which may lead to obstruction and ischaemic →necrosis. The disease, if not fatal, may induce various neurologic signs such as blindness, and necrotizing lesions in the skin of the head. In sheep, arterial lesions are minimal or absent, but hypersensitivity to microfilariae often results in severe exudative dermatitis, primarily over the head.

*Angiostrongylus vasorum* and *Aelurostrongylus abstrusus* are small metastrongyle worms. The adult *A. vasorum* lives in the pulmonary artery and right ventricle of the dog where it causes a proliferative endarteritis and thrombosis in pulmonary arteries comparable to that induced by *D. immitis*. *A. abstrusus* is a lungworm of cats. In addition to causing pulmonary nodules, it is believed to incite the smooth muscle hypertrophy and medial →hyperplasia of the pulmonary arteries which may focally be observed in up to 70% of cats. The respiratory clinical signs of these 2 infections are described in →Respiratory System Diseases, Horses, Swine, Carnivores.

The spiruroid worm *Spirocerca lupi* is primarily a parasite of dogs. The major clinical signs of spirocercosis are associated with the presence of adult worms in the oesophagus. They are described in →Alimentary System Diseases, Carnivores. However, significant lesions are also caused by the migrating larvae which spend about 3 months in the adventitia and media of the aorta. Aortic lesions include the formation of small

nodules containing larvae, thickening of the intima and media, and deposition of atheromatous plaques. Weakness of the aortic wall and partial rupture of the layers sometimes leads to the development of shallow aneurysmal pouches, with possible rupture, and fatal hemorrhage. In most cases, aortic lesions do not produce any clinical signs.

### Veins

Schistosomes are important parasites of the venous vascular system of vertebrates (Table 2). In Africa, *Schistosoma bovis*, *S. mattheei*, and *S. curassoni* occur commonly in ruminants, and *S. rhodhaini* has been reported to infect dogs. In Asia, *S. indicum*, →*S. spindale*, and *S. nasale* occur in a variety of domesticated animals including cattle, water buffalo, sheep, goat, and horse. *S. incognitum* has been reported in pigs, dogs, sheep, goats, and occasionally cattle. Finally, →*S. japonicum* is an important →zoonosis in Southeast Asia. In China, dogs, goats, rabbits, cattle, sheep, pigs, horses, and water buffaloes have all been found to harbour the infection (→Schistosomiasis, Animals). All these parasites live in the mesenteric and hepatic veins of the host, except for *S. nasale* which is found in the veins of the nasal tissue. The presence of adult worms in the veins does not induce reactions from the host, except when dead worms are occasionally blocked into small veins of the intestine or swept into the liver where they give rise to focal inflammatory reactions (phlebitis) and lymphoid nodules. Such lesions are only of clinical consequence after chemotherapy. Schistosomes are relatively large worms (>10 mm) and the sudden accumulation of considerable numbers of them (up to several tens of thousands) in the portal veins may cause diffuse phlebitis and extensive thrombosis. The pathogenesis of schistosome infection is mainly caused by the migration of millions of eggs through the intestinal wall, and their accumulation in the liver. These clinical syndromes are discussed under →Alimentary System Diseases, Ruminants.

### Lymphatic Vessels

Filariid worms of the genus →*Brugia* parasitize the lymphatic system of dogs and cats in tropical areas. They do not usually cause lymphoedema and elephantiasis as in humans. *Dracunculus insignis* may occasionally infect dogs in North America, causing obstruction and inflammation of the lymphatic vessels, leading to lymphoedema.

### Therapy

→Chemotherapy, →Drugs.

## Carnidazole

Compound belonging to the group of →nitroimidazoles acting against specimens of the genera *Giardia*, *Trichomonas*, *Entamoeba*, see →Antidiarrhoeal and Antitrichomoniasis Drugs.

## Caryocyst

Characteristic →tissue-cyst of →Caryospora species.

## Caryophyllaeus laticeps

### Classification

Monozoic tapeworm belonging to the group →Eucestoda in →Cestodes (→*Amphilina foliacea*).

### Morphology

Fig. 1.

## Caryospora Species

### Classification

Genus of →Coccidia.

### Life Cycle

Figs. 1, 2 (page 204, 205).

## Casinaria texana

Ichneumonid insect used for biological control of pests.

## Castration

Some parasites castrate their hosts due to chemical or mechanical measurements, e.g., the digeneans *Parorchis* and *Zoogonus* do it in their intermediate hosts (= snails), see →Behavior/Castration.

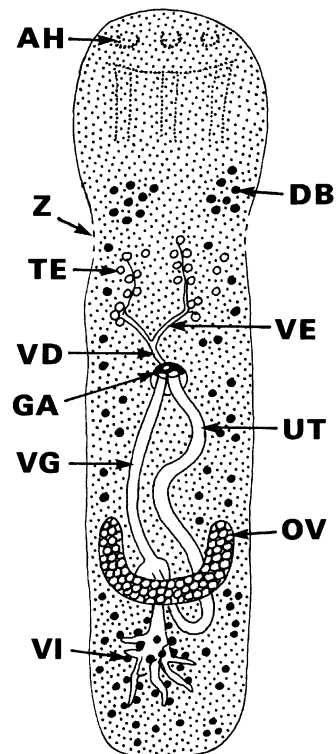

**Caryophyllaeus laticeps.** Figure 1 Diagrammatic representation of the adult monozoic →tapeworm *Caryophyllaeus laticeps* (3 cm long) from the intestine of cyprinid and catostomid fish; intermediate hosts are aquatic annelids (*Tubifex* sp.); paratenic hosts are possible. AH, adhesion zone; DB, →dense bodies in the vitelline system; GA, genital atrium (joint pore of UT and VE); OV, ovary; TE, testes; UT, uterus; VD, vas deferens; VE, vas efferens; VG, vagina; VI, vitelline glands; Z, interruption (animals are longer).

## Catatropis verrucosa

This species (1–6 × 0.7–2 mm), which has no ventral sucker, lives in the caeca of ducks and other waterbirds. The eggs show polar filaments. High infection rates may introduce ulcerative typhlitis. Common in Europe, Africa, Asia, and North America.

## Catecholamines

→Nervous System of Platyhelminthes.

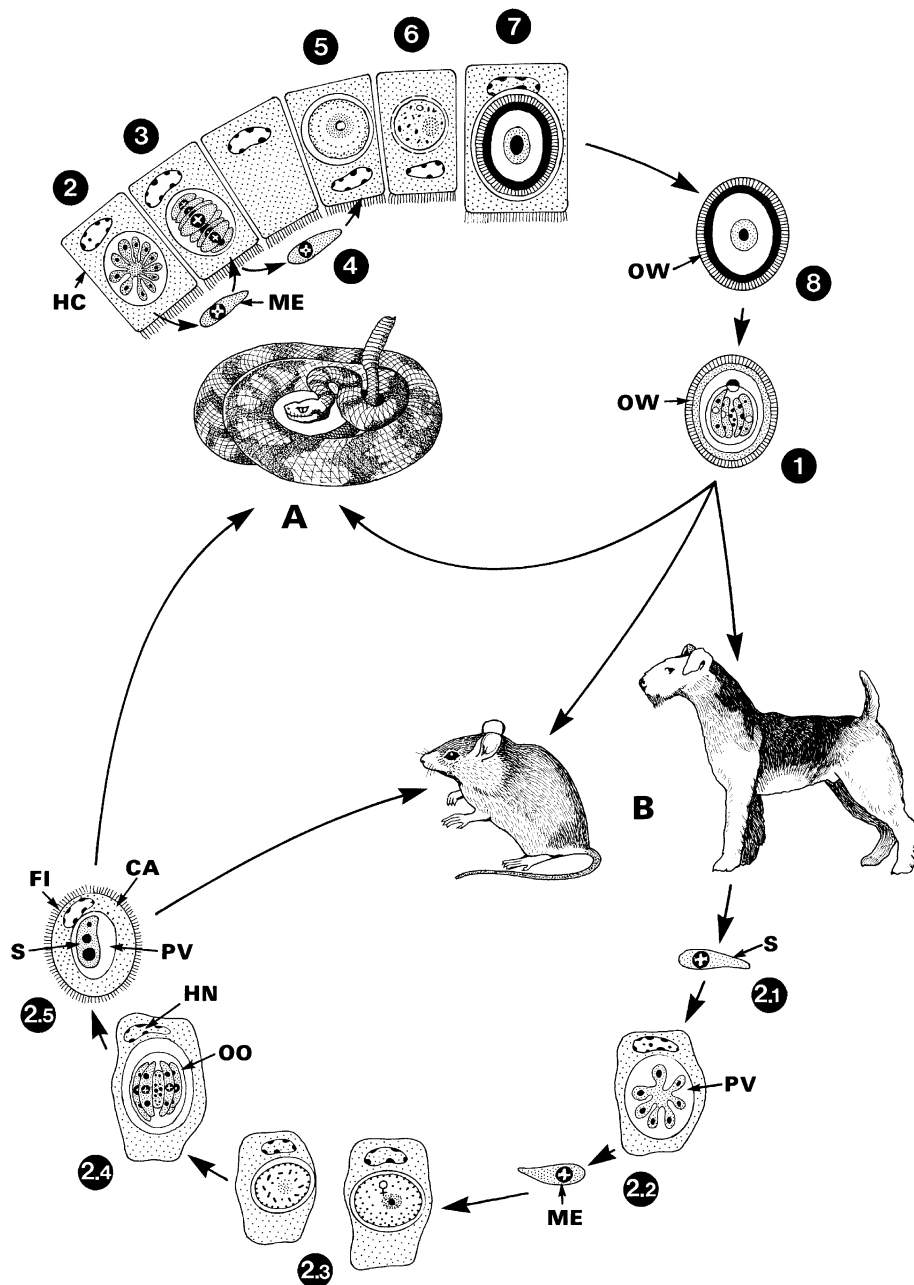

**Caryospora Species. Figure 1** Life cycle of *Caryospora bigenetica* (according to C. Sunderman). **A** First type of final host (rattlesnake). 1 The sporulated →oocyst contains a single →sporocyst with 8 sporozoites. 2–4 After oral infection with oocysts 2 generations of schizonts are formed inside the intestinal epithelium. 5/6 Male and female gamonts are formed and later →gametes occur. The male →gamont (G) forms numerous gametes. 7/8 After fertilization a thick-walled oocyst is formed inside the host cell and becomes free within the feces. While sporulating on the ground a single sporocyst with 8 sporozoites is formed inside each oocyst. **B** Second type of final host (mice, cotton rats, dogs). 2.1–2.4 Repetition of the schizogonic and gamogonic development (described in 1–8). The →sporulation of oocysts may occur in skin regions (2.4). 2.5 Sporozoites that were set free from their sporocysts while still inside the skin of their hosts enter other host cells and induce formation of so-called caryocysts, i.e., cells being surrounded by fibrillar material. Those caryocysts are infectious for both host types (if taken up orally). Furthermore these caryocysts are infectious for hosts of the second type during close skin contacts. CA, →caryocyst; FI, filamentous material; HC, host cell; ME, →merozoite; OO, →oocyst; OW, oocyst wall; PV, →parasitophorous vacuole; S, →sporozoite.

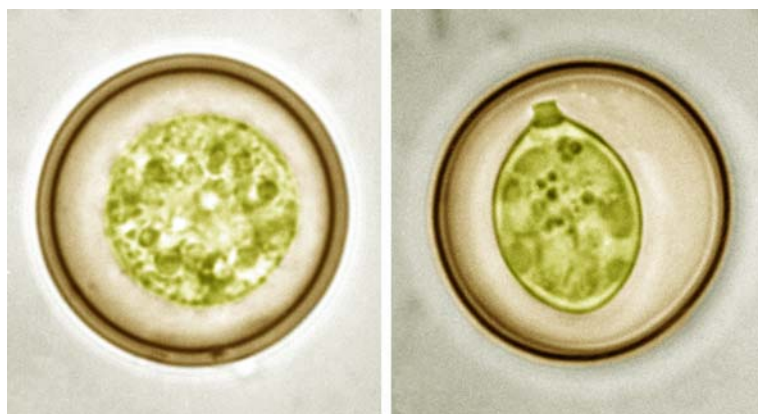

**Caryospora Species. Figure 2** Unsporulated and sporulated (right) oocyst.

## CD-36 Gene

Polymorphism of this gene is often linked to a high susceptibility to severe malaria. Similar effects are described due to polymorphism of the genes of the TNF -  $\lambda$  promoter or the genes for the interferon receptor I.

## CD4<sup>+</sup>-Cells

Memory cells, CT-helper-cells, which inform upon an infection the B-lymphatic system to produce antibodies.

## CDC

Centers for Disease Control and Prevention.

## Cediopsylla simplex

New World flea.

## Celation

From Latin: *celatio* = secrecy. Phase of virus inside insect vector, during which a transmission is not possible.

## Cell

Cells are the basic units of life. It was recognized by Virchow in 1855 that they are the smallest units capable of maintaining the continuity of life or, as he expressed it, *Omnis cellula e cellula* (every cell derives from a cell). Organic matter on earth exists in the following forms: various types of cells; short sequences of stable proteins ( $\rightarrow$ Prions); extracellular genomes (viroids, or naked RNA molecules); and protein capsules, or capsids, containing relatively short molecules of DNA or RNA often surrounded by an additional membrane (bacteriophages and viruses). Prions, viroids, phages, and viruses lack their own metabolism and the ability to reproduce independently, whereas all types of cells are true living systems with metabolic ability ( $\rightarrow$ Metabolism) and the capacity for independent reproduction ( $\rightarrow$ Cell Multiplication). All cells share the following attributes:

- They are enclosed by a  $\rightarrow$ cell membrane.
- Their systems of reproduction use DNA for information storage and RNA for directing cellular organization.
- Their genomes may undergo accidental change (i.e., they mutate).
- They can use chemical-bond energy or light energy (autotrophic organisms) to run their metabolic systems.
- They can detect and respond to environmental signals; and they can receive, recognize, and transmit signals and impulses.

They may also be motile and, in the case of eukaryotes, may have a flowing  $\rightarrow$ cytoplasm. Two basic types of true cells are distinguishable:  $\rightarrow$ prokaryotes and  $\rightarrow$ eukaryotes. There are no transitional forms in existence today and thus these 2 forms are quite distinct.



## Cell Anus

### Synonym

→Cytopyge.

### Definiton

Special place for →exocytosis developed by many →Protozoa.

## Cell Division

→Cell Multiplication.

## Cell Junctions

Membrane-bound structures exist that mediate the joining of cells. These are needed for fusion of →gametes and similar structures and are also found at places where →flagella are attached to the surfaces of →protozoa. The undulating membranes and recurrent flagella of trypanosomes and →trichomonads are joined to the cell by means of such cell junctions. Cell junctions also play a role in the attachment of many parasites to the surfaces of host cells. For example, trypanosomes use junctions for attachment to the vector's intestine. Another example is the →moving junction that is formed during cell penetration of Apicomplexa (→Apicomplexa/Fig. 8).

## Cell Membrane

### Synonym

Unit membrane; →plasmalemma.

### General Information

All cells are surrounded by a 5–10 nm thick cell membrane (→Pellicle/Fig. 1G, →Surface Coat/Fig. 2). In living cells this membrane always forms a closed sac or vesicle. The membrane is composed of species-specific amounts of various proteins and a double layer of lipids. It is physiologically and morphologically

asymmetric, presenting a p face (directed towards the →cytoplasm) and an external e face. High magnification electron microscopy reveals that it is composed of 3 layers (trilaminar) (→Pellicle/Fig. 1G). It is semipermeable, i.e., only certain types of molecules may cross it. Several models have been created to explain how this biomembrane functions. The most widely accepted is the fluid mosaic model of Singer and Nicolson in which it is proposed that the membrane consists of a double layer of lipid molecules within which proteins and other components float like icebergs. At least some of the proteins may be structured to form pores. The membranes expand by additive inclusion of vesicles formed inside the cytoplasm and shrink by formation of endocytotic vesicles. The functions of the cell membrane are various and include transport processes such as uptake (→Membrane Transport, →Endocytosis), →secretion of substances, cell recognition, and joining of cells (→Cell Junctions).

## Cell Multiplication

In the →Protozoa different ways of cell multiplication have been developed during phylogeny.

### Binary Fission

The most basic type of multiplication is →binary fission, which always produces 2 daughter cells and needs a preceding duplication of the organelles of the mother cell (Figs. 1, 2). Since the axis of →cell division is fixed in the different groups within the Protozoa different types can be distinguished:

- Irregular division. In microsporidians (e.g., →Nosema, cf. life cycles) binary fissions occur after nuclear divisions. In these cases the →cytoplasm is divided irregularly and different-sized daughter cells are formed, which, however, obtain a similar shape after feeding.
- Amoeba-like division (Fig. 1A). In rhizopods (e.g., →Entamoeba histolytica, →Acanthamoeba) the cell division is more or less irregular with respect to the cytoplasm; however, the constriction always occurs perpendicular to the spindle axis.
- Longitudinal division (Fig. 1B–D). In flagellates (e.g., diplomonadids, →trichomonads, trypanosomatids) and sporozoans (e.g., →Coccidia) the axis of binary cell division runs longitudinally. Flagellates determine the polarity of the division axis by the initial duplication of the →basal bodies of the →flagella (Fig. 2). Binary fission is found in only a

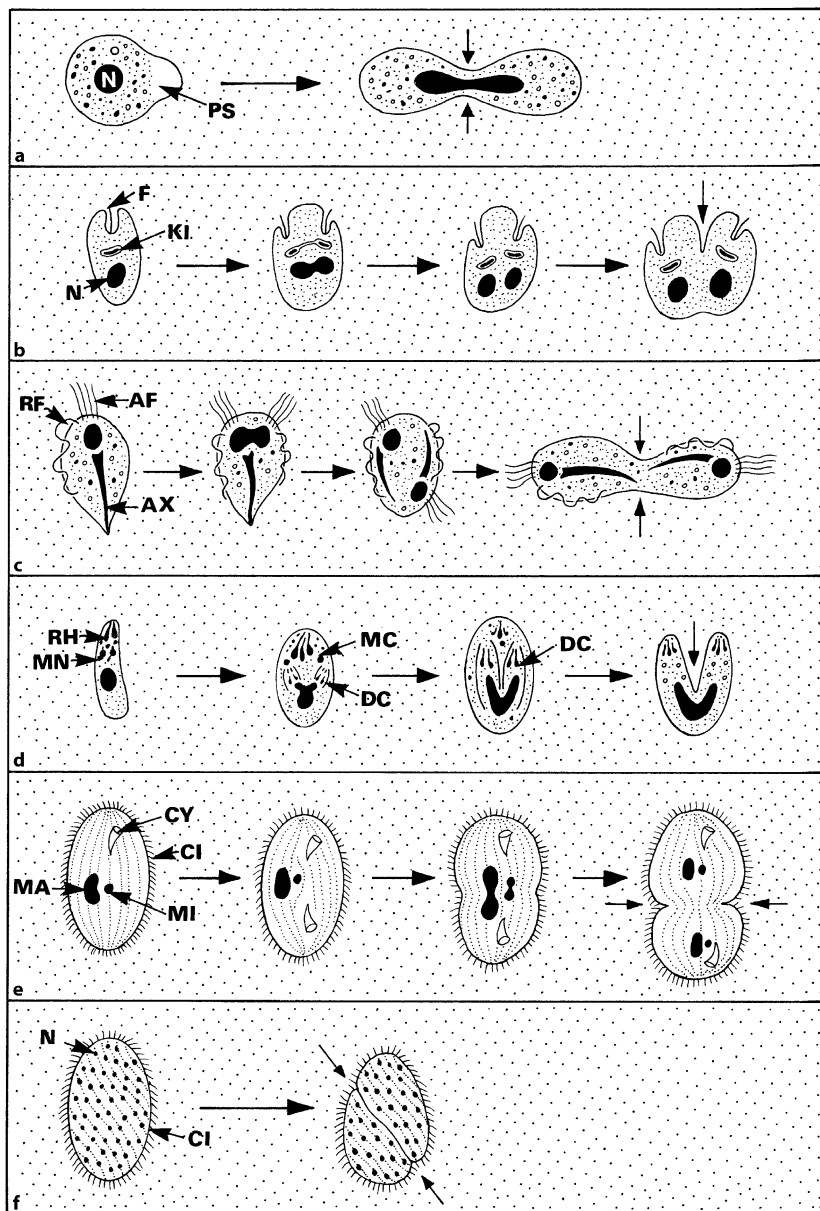

**Cell Multiplication. Figure 1 A–F** Diagrammatic representation of different types of binary fission (invaginations are shown by small arrows). **A** Ameba type: division without fixed axis. **B** Trypanosomatid type (here →*Leishmania*): longitudinal division. **C** Trichomonad type (here *T. vaginalis*, note that it is only a longitudinal division at the beginning). **D** Endodyogeny of tissue-cyst-forming coccidia (e.g., *Toxoplasma*, →*Sarcocystis*): inner development of daughter cells. **E** Ciliata type (e.g., *Balantidium*): cross-division. **F** →*Opalina* type: oblique division. *AF*, anterior free →flagellum; *AX*, →axostyle; *B*, →basal body of flagellum; *CI*, cilium; *CY*, cytopharynx; *DC*, daughter cell; *F*, short flagellum in a pocket; *KI*, →kinetoplast; *MA*, →macronucleus; *MC*, mother cell; *MI*, →micronucleus; *MN*, →micronemes; *N*, nucleus; *PS*, pale pseudopodium; *RF*, →recurrent flagellum; *RH*, →rhoptries.

few species of the →*Sporozoa*, e.g., blood merozoites of →*piroplasm*s divide in this way. A peculiar longitudinal division is the →*endodyogeny* of those →*coccidia* that form tissue cysts (Figs. 1D, 4). Inside a mother cell 2 daughter cells are formed arching over

the 2 angles of the dividing nucleus. The daughter cells produce their inner 2 pellicular membranes *de novo* (using membranes of the →*endoplasmic reticulum*) and take over the outer membrane of the mother cell's →*pellicle*; the 2 inner ones disintegrate

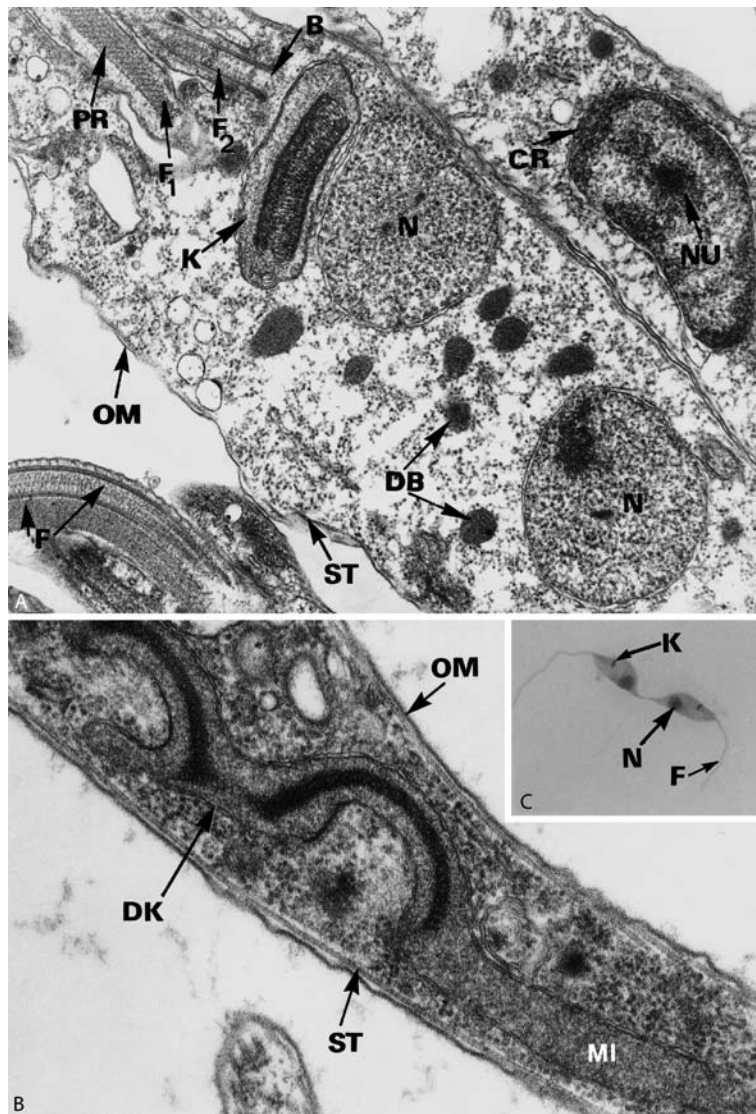

**Cell Multiplication. Figure 2A–C** Binary longitudinal divisions in trypanosomes (A, B transmission electron micrographs; C light micrograph). **A** → *Blastocrithidia triatomae*; note that the basal bodies of the flagella (F1, F2) and the nuclei are already divided. ×24,000. **B** → *Trypanosoma vivax*; trypomastigote from blood during reduplication of the kinetoplast. ×22,000. **C** → *Crithidia* sp. from cultures; late binary fission. ×1,200. **B**, basal body of flagellum; **CR**, chromatin; **DB**, → dense bodies; **DK**, dividing kinetoplast; **F**, flagellum; **K**, → kinetoplast; **MI**, mitochondrion; **N**, nucleus; **NU**, → nucleolus; **OM**, outer surface (→ Cell Membrane); **PR**, → paraxial rod of flagellum; **ST**, → subpellicular microtubules.

(Fig. 5A). In → trichomonads the axis of all cell divisions is longitudinal, but only at the beginning (Fig. 1C) when the flagellar basal bodies and the nucleus are reduplicated; later on the divided nuclei wander below the surface membrane into opposite positions, and finally an oblique or even transverse cytoplasmic division appears (Fig. 1C).

- Oblique division (Fig. 1F). In → opalinids (see life cycles), which are characterized by oblique rows of → cilia, binary fission occurs during the sexual and

asexual developmental phases. The axis of the cytoplasmic division initially runs longitudinally, but soon becomes parallel to the oblique rows of cilia. It is thus intermediate between the longitudinal fission of flagellates and the transverse division of ciliates.

- Transverse (cross) divisions (Fig. 1E). In ciliates (e. g., → *Balantidium*, → *Ichthyophthirius*) binary fission starts with the duplication of the cytostomal kinetosomes (basal bodies) and is followed by the division

of the →macronucleus and →micronucleus. The axis of cytoplasmic division runs perpendicular to the axis of the nuclear spindles (Fig. 1E); cell constriction may occur simultaneously or with some time lag. Since this division proceeds across the rows of cilia, it is also described as homothetogenic fission.

### Rosette-like Multiplication

If there is incomplete or delayed division of the cytoplasm the newly formed nuclei may initiate a new division, thus giving rise to a more or less simultaneous development of more than 2 parasitic protozoans that remain attached at their posterior poles. This may be repeated and the whole bulk appears as a →rosette; under light microscopy this was misinterpreted as a stage of multiple division. Such rosettes are frequently found in trichomonads and trypanosomes (especially in cultured forms), and are also relatively common in →*Toxoplasma gondii* during the acute phase of infection when endodyogenies are often repeated inside →parasitophorous vacuoles of macrophages and reticuloendothelial cells. However, in cultures of trypanosomatids most of the rosette-like stages are artefacts, while during movements they became irreversibly tied with their flagella (Fig. 3).

### Multiple Divisions

→Multiple divisions are characteristic of amebae, sporozoans, and →microsporidia, but are rarely observed in the other parasitic protozoan groups. The formation of



**Cell Multiplication. Figure 3** SEM-micrograph of a cluster of cultured →promastigotes of →*Leishmania major* being closely tied with their flagellum. This stage – in light microscope – may be kept for a rosette-like developing stage. ×3,000.

daughter cells may be initiated by three main types of mother cells.

- Multinuclear type. Daughter-cell formation starts at the end of a phase of repeated nuclear divisions (Figs. 3, 4B, 5B). In this way multinucleate plasmodia occur (Fig. 4A–C), which for example led to the naming of the genus →*Plasmodium*. Such multinucleate stages are found in the life cycles of →*Entamoeba histolytica*, in schizonts and sporonts of →gregarines and of some coccidia (Figs. 4B, 5B, 6), in all gamonts of gregarines, but only in →microgamonts of some coccidia (e.g., Fig. 3C), and in some developmental stages of myxosporidia. In these cases the cytoplasm may be divided evenly or not (but always in a species-specific pattern). In eimerian and theilerian schizonts (Fig. 4B), and in sporonts of →hemosporidia and of some piroplasms, daughter-cell formation is connected with the last →nuclear division, thus giving rise to endodyogeny-like features (Fig. 5A) when producing merozoites or sporozoites. In eimerian microgamonts in general a single microgamete is formed from each nucleus (leaving, however, an electron lucent remnant of the karyoplasm). Only occasionally do 2 →microgametes originate from such a microgamont's nucleus.
- Uninuclear type. Daughter-cell formation starts without a preceding phase of nuclear divisions. However, in most cases the nucleus of the parasitic stage has grown considerably and is provided with a lobulated surface (Figs. 4D, E, 5C). During the final division of this eventual giant nucleus, daughter-cell formation takes place simultaneously, incorporating portions of the nucleus, the chromosomal components of which had apparently been increased by preceding endomitosis. Such a splitting process occurs during the →schizogony of →sarcosporidia (Fig. 5C) and has been described as →endopolygeny. The microgamonts of some *Sarcocystis* spp. and of *Plasmodium* spp. produce their microgametes in this way (Fig. 4D,E). A similar simultaneous process is found in sporonts of some piroplasms during the mass production of sporozoites.
- Intermediate type (Fig. 4F). In these cases a large mother cell with a lobated giant nucleus is divided into numerous uninuclear cytomeres; the single limiting membrane of these stages originates from the surface membrane of the original cell or from the endoplasmic reticulum. Such cytomeres are regularly formed in schizonts of some →*Eimeria* and →*Globidium* spp. (e.g., *E. tenella*, Fig. 4F), and in sporonts of →*Babesia* spp., →*Theileria* spp., *Plasmodium* spp., and →*Hepatozoon* spp. The uninuclear cytomeres ultimately produce the daughter cells at once (Fig. 4F), giving rise alternatively to

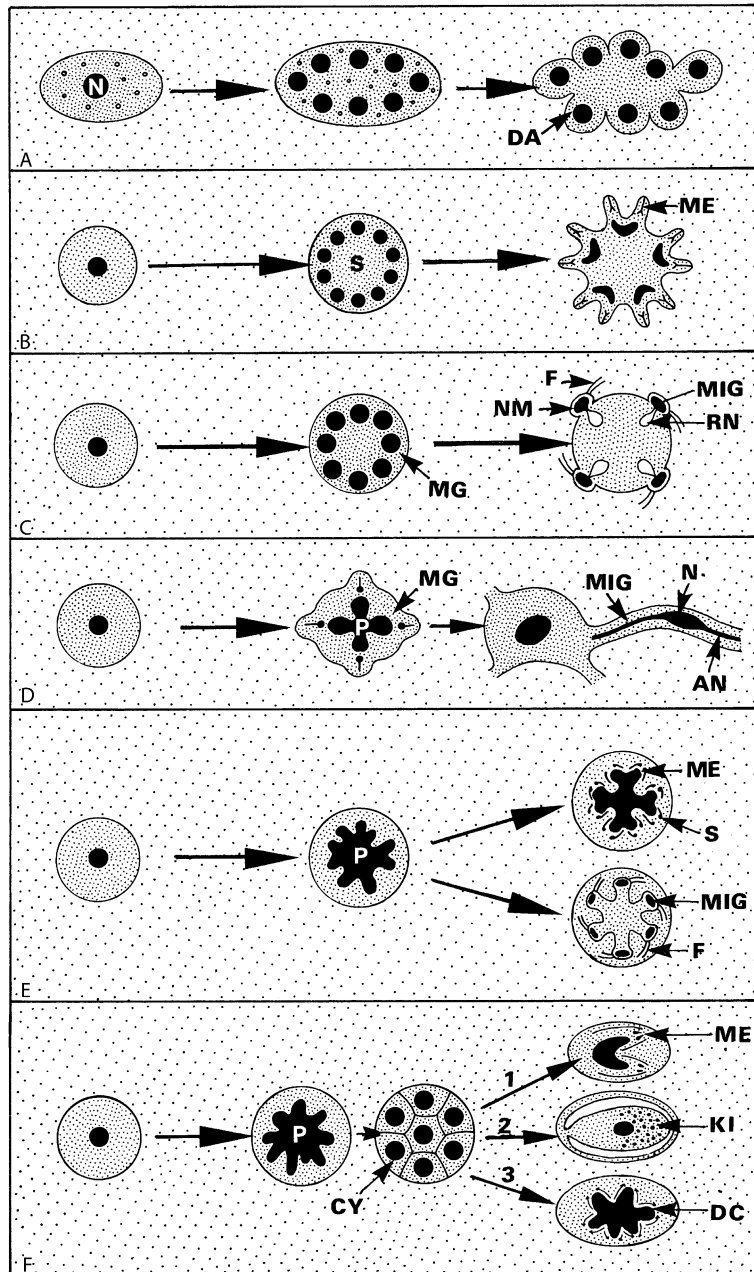

**Cell Multiplication. Figure 4 A–F** Diagrammatic representation of multiple divisions. **A** *Amoeba* spp.; formation of vegetative stages after excystation. **B** Formation of merozoites by schizonts of species of *Eimeria*, *Plasmodium*, *Theileria*, etc. **C** Formation of microgametes, e.g., *Eimeria* spp. **D** Formation of microgametes of *Plasmodium* spp. and other hemosporidia (e.g., “exflagellation”). **E** *Sarcocystis* spp.; formation of merozoites by schizonts (1) and of microgametes by microgamonts (2). **F** Formation of cytomeres. These may each develop: (1) 2 merozoites (some *Eimeria* spp.) (2) a single kinete (*Babesia* spp.) (3) many parasitic stages of the life cycle of various coccidians, i.e., merozoites of *Globidium* spp. or sporozoites of species of *Plasmodium*, *Babesia*, and *Theileria*. AN, →axoneme (flagellum of MIG); CY, →cytomere; DA, daughter ameba; DC, daughter cell; F, flagellum; KI, kinete; ME, →merozoite anlage; MG, microgamont; MIG, microgamete; N, nucleus; NM, nucleus of microgamete (dense part); PN, polymorphous, multilobulated nucleus; RN, residual nucleus (light part); S, →schizont.

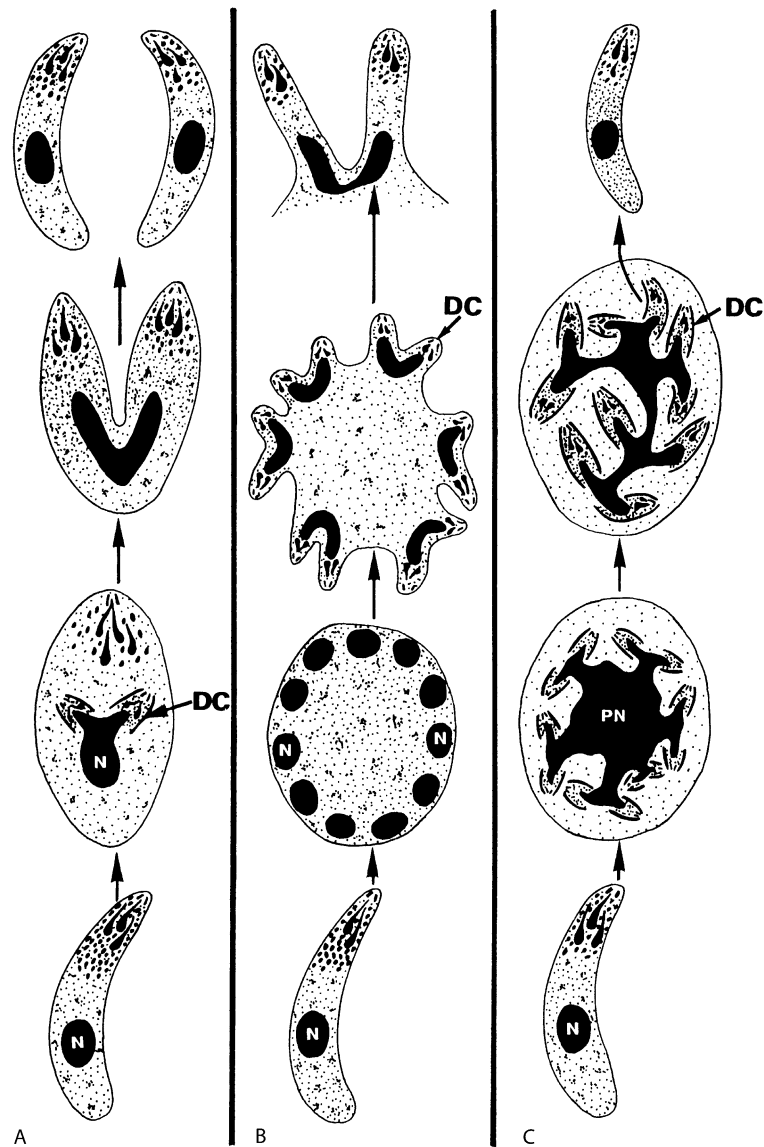

**Cell Multiplication. Figure 5 A–C** A sexual reproduction in coccidia. **A** →**Endodyogeny** (e.g., in tissue-cysts of *Toxoplasma*, *Sarcocystis*, →*Besnoitia*, →*Frenkelia*). **B** →**Schizogony** (ectotype) or →**sporogony** along the surface of cytomeres (or sporonts) as found in many Coccidia (e.g., *Eimeria*, *Globidium*, *Plasmodium*, *Theileria*, *Babesia*). **C** →**Endopolygeny** (e.g., schizonts of *Sarcocystis* spp.) produce the daughter cells at once around the lobulated giant nucleus. *DC*, daughter-cell anlage; *N*, nucleus; *PN*, polymorphous (polyploid) giant nucleus.

2 merozoites (*Eimeria* spp.), to a single →**kinete** (*Babesia* spp., *Theileria* spp.), or to many merozoites (*Globidium* spp.) or sporozoites (*Plasmodium* spp., *Babesia* spp., *Theileria* spp.). Cytomeres join each other in →**Myxozoa**.

## Cellular Immune Reponse

→**Immunity**.

## Cement Glands

Cement glands are significant accessory organs (1–8 in number) in →**Acanthocephala**. In addition, Eoacanthocephalans have a separate cement reservoir. The vasa efferentia fuse to form a vas deferens, which fuses with one or several ducts of the cement gland(s) to form a genital canal. The cement locks the female vagina after copulation until the first embryonated eggs are released, and forms typical copulatory caps on the posterior tips of inseminated females (→**Acanthocephala/Reproductive Organs**).

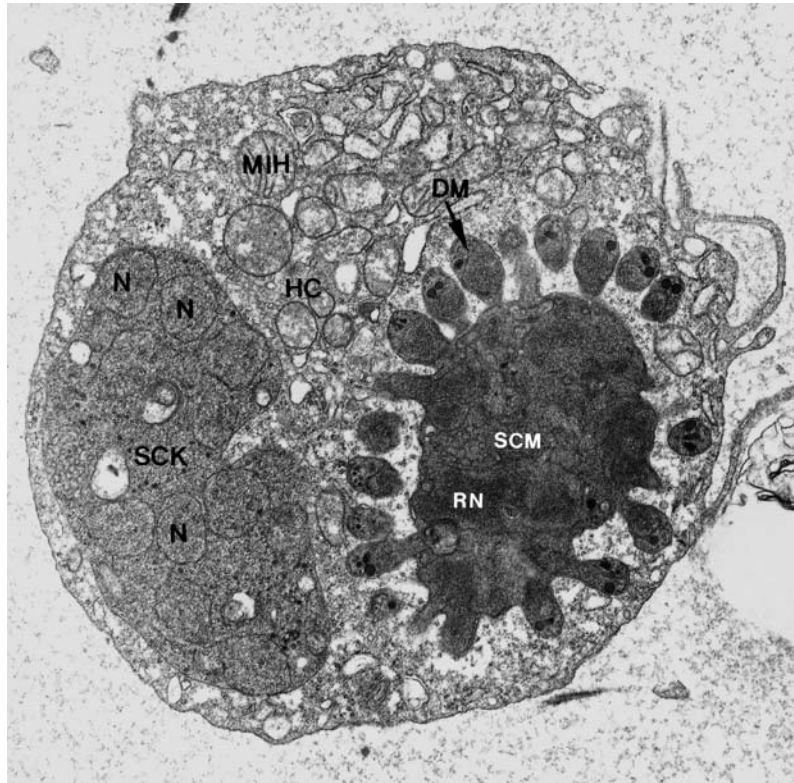

**Cell Multiplication. Figure 6** Asexual reproduction in coccidian blood parasites – TEM-micrograph of a section through a lymphoblastic cattle cell containing directly in the cytoplasm a macro- and a microschizont (i.e., Koch's bodies) of the piroplasm parasite → *Theileria annulata*. The macroschizont is cut during the phase of nuclear reproduction – the microschizont during formation of merozoites at the periphery. ×8,000. *DM*, developing merozoite; *HC*, host cell cytoplasm; *MIH*, mitochondrion of the host cell; *N*, nucleus; *RN*, residual nucleus; *SCK*, macroschizont; *SCM*, microschizont.

## Centriole

This cell organelle consists of a hollow tube of a length of 0.3–0.6 μm and a diameter of about 0.2 μm. It is formed by 9 concentrically arranged triplets of short →microtubules (also seen in the basal body of →cilia). A pair of these centrioles (being arranged perpendicularly to each other) form the so-called centrosome, which is thought to function as a microtubuli organizing center (→MTOC) of the spindle apparatus during →nuclear divisions. Centrioles thus reduplicate before cell/nuclear divisions. In →Coccidia so-called centriole-like structures consisting of 9 single outer microtubules and a central one with apparently similar functions occur.

## Centrocestus cuspidatus

Digenetic trematode in the intestine of *Milyus parasiticus*; similar species occur in fish as well in cats, dogs, and humans.

## Centrocones

Evaginations of the nuclear membrane during →nuclear divisions of →Coccidia.

## Centromer

→Cytoskeleton, →Nuclear Division.

## Cepaea

Genus of snails, intermediate hosts of →*Dicrocoelium trematodes*.

## Cephalobaenidae

→Pentastomida.

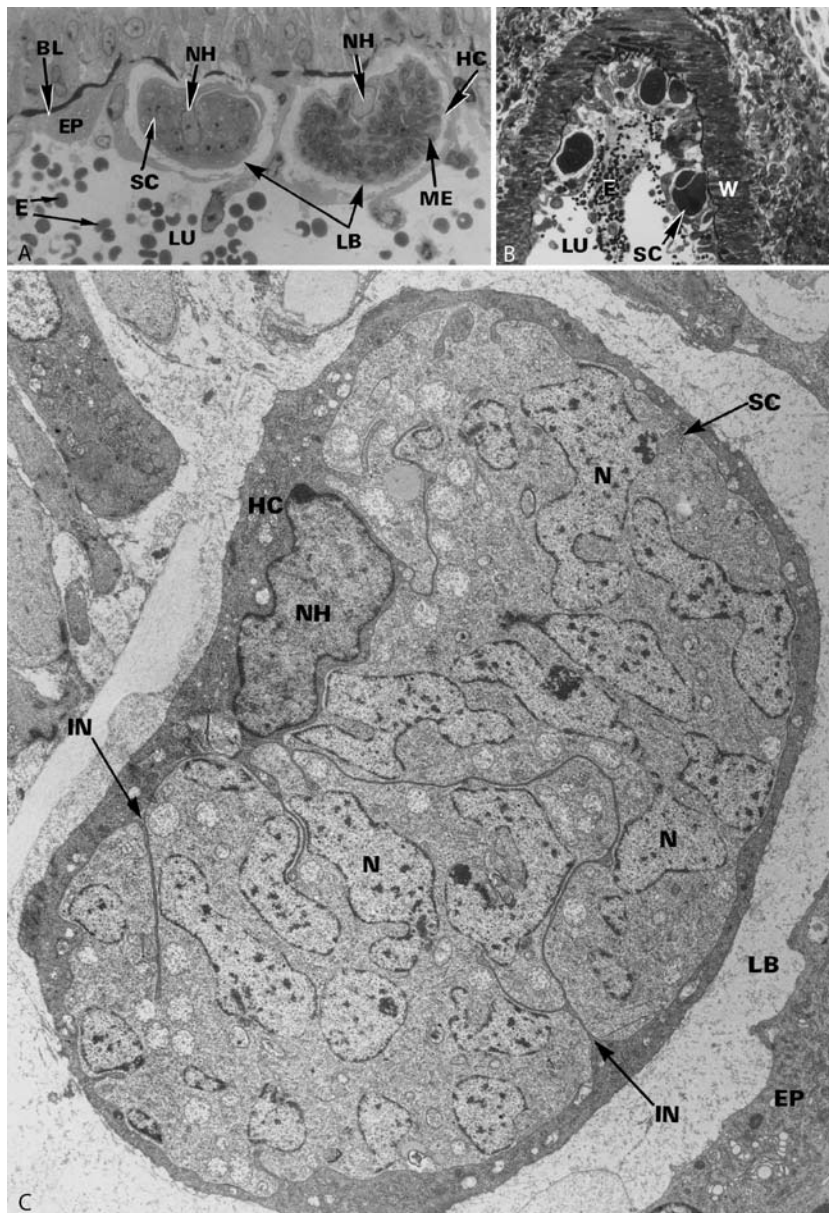

**Cell Multiplication.** Figure 7 A–C Asexual reproduction by →endopolygony in →*Sarcocystis arieticanis* schizonts (from sheep). A, B Light micrographs of schizonts, which are situated within epithelial cells of branches of blood vessels. (A ×600, B ×80). C Transmission electron micrograph of a schizont, the surface of which has deep invaginations (IN); note the large lobulated nuclear system. ×4,800. BL, basal lamina; E, erythrocytes; EP, epithelium; HC, host cell; IN, invagination; LB, lumen of a branch of LU; LU, lumen of a blood vessel; ME, merozoite; N, nucleus, NH, nucleus of a host cell; SC, schizont; W, wall of an arteriole.

## Cephalobidae

### Name

Greek: *kephalon* = head, *lobos* = lobe.

Genus of free-living nematodes, some species of which may become parasitic in vertebrates when taken up as adult or larva via food, e.g., →*Halicephalobus*.

## Cephalothorax

Caput and thorax are combined in →*Pentastomida*, several crustaceans, and in some →*Chelicerata* to a functional complex, so that there is no visible border between the former tagmata.



## Cephemyiidae

Family of →Diptera. These flies (belonging to the group of Oestridae) excrete while flying their (15–100) eggs (Fig. 1) in the nostrils of deer, where they grow up and may block breathing. *Cephemyia stimulator* reaches a length of 14–16 mm and shows a yellowish, bee-like appearance (with long hairs and black bandings) in moderate zones of Europe until East Asia.

## Ceramide

→Glycosylphosphatidylinositols.

## Ceratophyllus gallinae

→Fleas.

## Ceratopogonidae

### Name

Greek: *keras* = horn, *pogon* = beard.

### Synonyms

Heleidae, biting midges, sand flies of the Caribbean Islands, punkies in the USA, trivial: no-see-ums.



**Cephemyiidae.** Figure 1 Larvae of *Cephemyia* sp. from the pharyngeal/nostril region of a deer.

## General Information

This family of →Diptera comprises 4 genera: *Culicoides*, *Leptoconops*, *Lasiohelea*, and *Austroconops* (Figs. 1–3). *Culicoides* is the most widespread and abundant with 800 species (Table 1). There are fewer species (120) of *Leptoconops*, but they are widely distributed and their bite is even more painful than that of *Culicoides*. The genus *Lasiohelea* is as widely distributed as *Leptoconops* with relatively few species (150). Only one species is known of *Austroconops* (*A. macmillanii*) in Australia.

The size of the bloodsucking females of all species/genera is very small; several do not reach a length of even one mm. Their behaviour, their sucking activities, and their habitats = brood places vary considerably – even among the species of a genus.

## Mating

In general mating occurs prior to bloodmeal, which is in general necessary to lay eggs. However, there are



**Ceratopogonidae.** Figure 1 LM of a female *Culicoides obsoletus*.

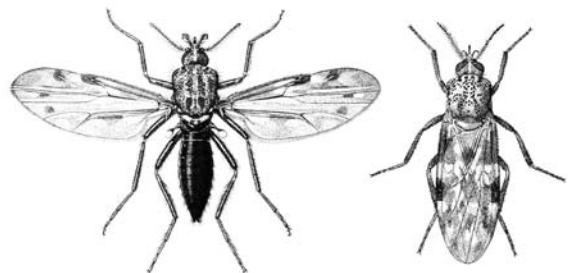

**Ceratopogonidae.** Figure 2 Diagrammatic representation (DR) of female midges with and without spread wings; the dark spots of wings are used for diagnosis.

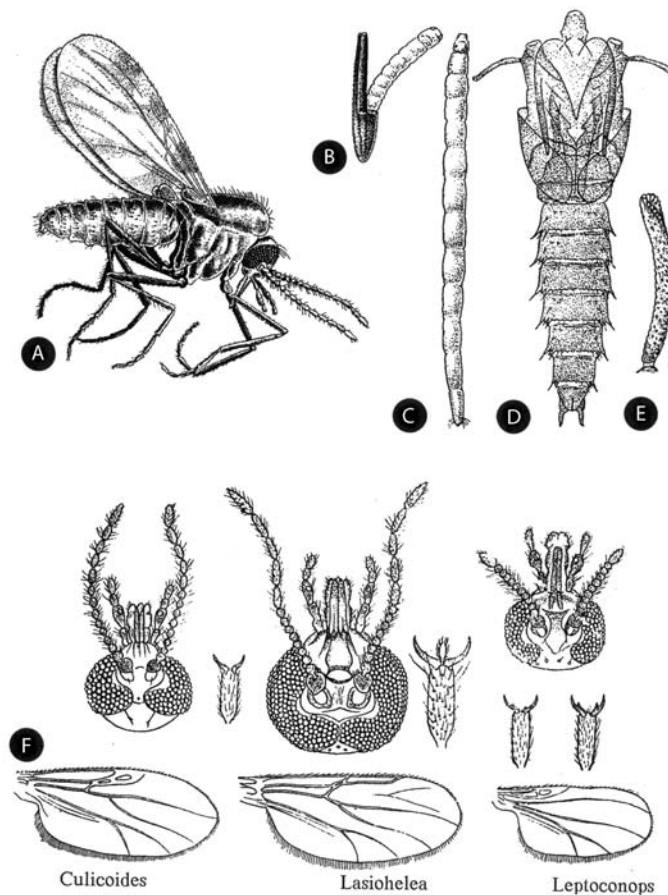

**Ceratopogonidae. Figure 3** DR of development stages of midges. **A** Female of *Culicoides obsoletus*; **B** Larva leaving the egg; **C** Larva; **D** Puparium; **E** Breathing siphon of puparium (enlarged); **F** Characteristics for genus diagnosis.

species which are apparently parthenogenetic (e.g., *C. circumscriptus*). Males of most species form swarms.

### Blood Meals

Most species have preferences for hosts; e.g., humans are heavily attacked by *C. impunctatus*, while others prefer birds, cattle, deer, etc. However, in case of hunger they may switch to other hosts. There are also preferences with respect to the biting spot (leg, arm shaded underside of cattle, etc.).

### Eggs

The numbers of eggs produced and laid in batches of less than 100 depend on the amount of blood taken up.

### Breeding Sites

Their eggs are – depending on the species – deposited at definite places. For example, *C. imicola* and *C. dewulfi* breed in dung of cattle and horses, *C. pulicaris* is found in swamps/soil, *C. maritimus* uses salt marsh, while the European *C. obsoletus* group breeds hidden in straw of

tree leaves or *C. fagineus* are restricted to tree holes. *Leptoconops bequaerti* also breeds in pure sand hidden in holes during tides. The larvae of all 3 genera differ in shape (Fig. 3).

### Length of Life Cycle

This depends on the temperatures. Many temperate species have either 1 or 2 generations per year. Others – as *C. obsoletus* in Europe may occur from March until end of October. In general, the temperate species overwinter as larva 4 and pupate in the following year. However, in warm countries *C. pulicaris*, *C. obsoletus* in South Italy or in the tropics may occur throughout the year.

In general, adult females of culicoids do not live longer than 3–4 weeks. However, *C. obsoletus* specimens were found to survive often up to 3.5 months.

### Daily Activity

Most species of *Leptoconops* and a few of *Culicoides* are diurnal, while most *Culicoides* are crepuscular species showing great activity at dawn and dusk (e.g., *C. imicola*,

*C. obsoletus*). However, some (e.g., *C. grahamii*) are also active throughout the night, others only in the night. Since these insects are all very small they can be driven away easily even by winds with a maximum speed of 5–8 km/hour. Thus potentially infected midges can spread over long distances within a single night.

### Vectors

Ceratopogonids are known vectors of viruses and bacteria such as →*Franciscella tularensis*. Recently outbreaks of →Blue tongue virus disease occurred in Europe involving serotypes 1, 2, 4, 9, 16, and most recently in Germany (2006) serotype 8. The viruses may survive for more than 150 days inside the defense cells of ruminants. Especially the so-called T-cells may contain these viruses for long and initiate new transmission to the new generation.

## Ceratopogonidosis

Disease due to bite of →midges (Table 1).

## Cercariae

The characteristic developmental stages of digenean →trematodes initiating infection of the next host in the life cycle (→Digenea/Life Cycle).

## Cercarial Dermatitis

Allergic skin reaction due to penetration of cercariae of bird schistosomes like *Trichobilharzia*, *Dentrobilharzia*, *Orzithobilharzia*, *Gigantobilharzia*, *Macrobilharzia*,

*Bilharzia* into the skin of humans during bathing in lakes or rivers with intermediate hosts (snails) of those bird schistosomes. The most significant symptoms are: formation of reddish pustules and intensive itching.

## Cercarien-Hüllenreaktion

→Skin Diseases, Animals/Integument, →Serology.

## Cercomer

→Archigetes Species.

## Cercomeromorpha

A group of parasitic →Platyhelminthes comprising 4 classes: →Monogenea, →Amphiliinidea, →Gyrocotylidea and →Cestoda.

## Cercopithifilaria

Genus belonging to the nematode family Onchocercinae. *C. grassi* is found in the connective tissues of subcutis and muscles of dogs in South Europe, Africa, and South America. The vector is the brown dog tick *Rhipicephalus sanguineus*.

Ceratopogonidosis. Table 1 Midges and Control Measurements

Parasite	Host	Vector for	Symptoms	Country	Therapy/Protection		
					Products	Application	Compounds
<i>Culicoides</i> spp. (biting midges, no-see-ums or punkies)	Ruminants, Horse	Bluetongue virus (Cattle, Sheep), African Horse sickness virus, <i>Onchocerca cervicalis</i> (Horse)	Edema, allergic reactions. Skin nodules	Worldwide	Butox™ Bayofly™	Spray	Pyrethroids
<i>Forcipomyia taiwana</i>	Humans	Japanese-B-encephalitis virus	Encephalitis	Asia	Repellants	Spray	Deet, Picaridin

## Cerebral Ganglion

→ [Insects](#).

## Cerebral Malaria

→ [Plasmodium](#), → [Malaria](#).

## Cerebrospinal Fluid – CSF

Puncture of CSF and its microscopical investigation is an effective way to diagnose stained or living *Naegleria* amoebae in cases of PAM (Primary amoebic meningitis).

## Cestodaria

### Classification

Subclass of → [Cestodes](#).

### General Information

Cestodaria are monozoic hermaphroditic worms which are not subdivided and include only a single set of male and female reproductive organs (→ [Eucestoda](#)/Fig. 2). Their → [holdfast organs](#) (if present at all) are not very well developed (→ [Amphilina foliaceae](#)/Fig. 1), but allow them to inhabit the intestine or the coelom of their hosts. In ontogenesis a 10-hooked → [lycophora](#) larva is involved. With respect to body organization and life cycles 2 orders can be distinguished: → [Amphiliinidea](#) and → [Gyrocotylidea](#) (→ [Amphilina foliaceae](#)/Fig. 1, → [Gyrocotyle](#)/Fig. 1). Members of the Amphiliinidea are parasitic in the coelom of sturgeons, other primitive fish, and tortoises, usually reaching a size of 2–8 cm (but up to 38 cm in species of *Gigantolina*). These ribbon-like monozoic and monoecious worms have their genital pores (vagina, male → [cirrus](#)) at the posterior end (→ [Amphilina foliaceae](#)/Fig. 1), but in the female the uterus opens at the anterior end. The parent worms bore through the body wall of the fish host to lay their eggs. Inside excreted eggs a larva (lycophora) is formed, the surface of which may be ciliated (→ [Amphilina foliaceae](#) of the European sturgeon) or not (*Gephyrolina paragonopora* of siluroid fish); the larva can reach a length of about 100 µm and has 10 hooks at the

posterior end. In *A. foliaceae* the egg must be swallowed by an → [intermediate host](#) (an amphipod crustacean), inside which the lycophora hatches, sheds its ciliated epidermis, and finally enters the hemocoel. Inside the body cavity of the intermediate host the lycophora elongates and attains the appearance of a → [proceroid](#) and a → [plerocercoid](#). When the amphipod host is ingested by a sturgeon, the plerocercoid burrows through the intestinal wall of the final host, and enters the body cavity, where it attains sexual maturity.

Members of the order Gyrocotylidea primarily inhabit the intestines of marine chimaerid fish, being attached to the wall by their posterior → [rosette](#). They reach a length of up to 25 cm and have all 3 genital pores at their apical pole (→ [Gyrocotyle](#)/Fig. 1). Inside the fecally passed, operculated eggs, the 10-hooked lycophora larva develops within 30 days. In → [Gyrocotyle urna](#) the lycophora is ciliated (but not in other species) and leaves the egg shell. An intermediate host is not yet known, and apparently not necessary, since 3-5-mm-long proceroid-like larvae with a well-formed typical terminal rosette have been found in several host fish.

## Cestode Infections

### General Information

→ [Cestodes](#) live as intestinal parasites firmly attached to the mucosa of the gut in their definitive hosts where they can live for years (e.g., → [Taeniasis, Animals](#), → [Taeniasis, Man](#)). Gravid → [proglottids](#) or eggs are released in the feces and ingestion of eggs by susceptible intermediate hosts results in the release of larvae, also called oncospheres within the gastrointestinal tract. The oncospheres penetrate the intestinal mucosa and migrate into tissues of the host where they can develop into mature metacestodes (e.g., → [Cysticercosis](#), → [Echinococcosis](#)). Important cestode infections are listed in → [Platyhelminthic Infections, Man, Pathology](#).

### Immune Responses

While relatively little is known on immunity against the adult → [tapeworms](#) in the gut, mechanisms of host–parasite interactions and the immune response have been extensively studied for the tissue stages. In larval cestode infections the intermediate mammalian host harboring egg-derived metacestodes in the tissues becomes completely immune to reinfection with eggs. In contrast, autoinfections with eggs occur in the case of → [Taenia solium](#) when the host is initially infected with metacestode-derived adult tapeworms in the gut lumen.

**Therapy**

→Cestocidal Drugs.

**Cestodes**

**Name**

Greek: *keistos* = band, belt.

**Synonym**

→Tapeworms.

**Classification**

Class of →Platyhelminthes.

**General Information**

All members of the class Cestoidea live as parasites, are extremely dorsoventrally flattened, may reach a length

of several meters in some species and thus are called tapeworms. In general, the adults inhabit the intestines of their hosts, being anchored to the intestinal wall by means of type-specific →holdfast organs (Fig. 1). Their principal body organization corresponds to that of →trematodes with the exception of the lack of an intestine; thus all nutrients have to be taken up through the syncytial →tegument (Figs. 1, 3–5). The ontogenesis of the cestoda proceeds in most species as →metamorphosis employing different larval stages (Fig. 2). In relatively rare cases (e.g., →*Echinococcus* spp.; Fig. 2), an alternation of different generations is involved in the life cycle; however, all tapeworm need an alternation of hosts (see →Eucestoda/Table 1). The classification of the class Cestoda is far from being solved (cf. →Classification); however, most systems accept 2 subclasses which are differentiated with respect to the number of larval hooks. The medically unimportant →Cestodaria form 10 larval hooks and are thus described as →decacanth, whereas the larvae of the →Eucestoda have only six hooks (→Hexacanth).

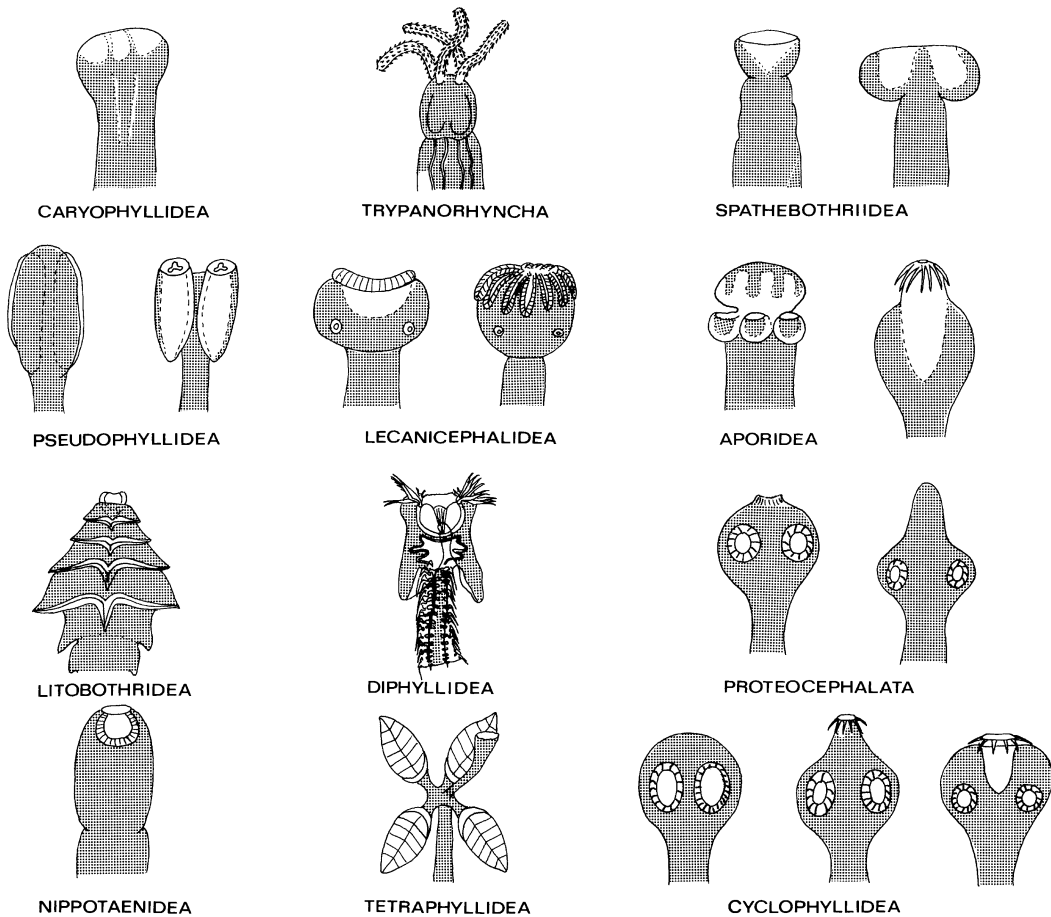

**Cestodes. Figure 1** Diagrammatic representation of scolices in different orders of tapeworms.

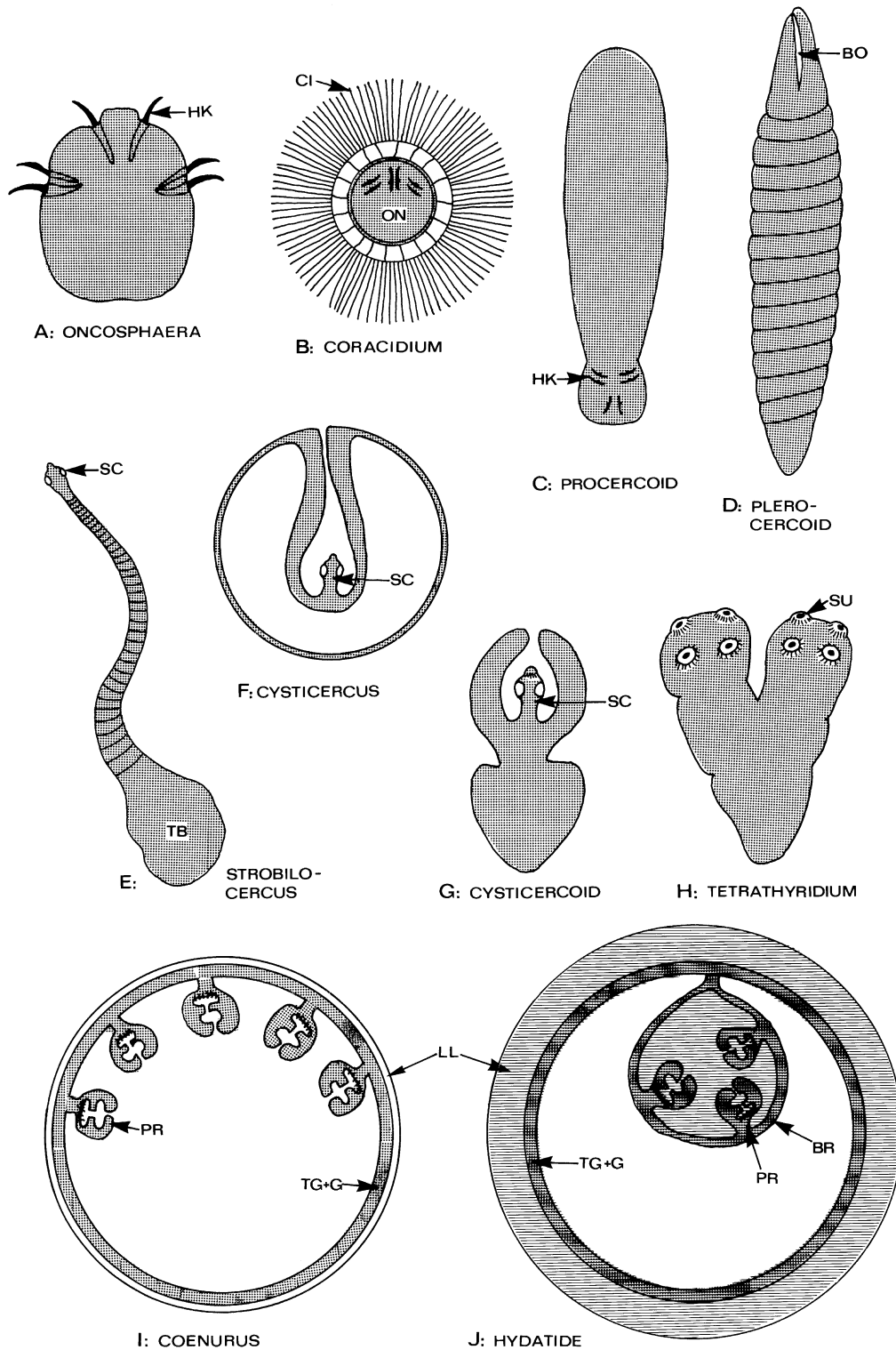

**Cestodes. Figure 2 A–J** Different larval stages of Eucestoda. *BO*, bothria (sucking grooves); *BR*, brood capsules; *CI*, cilia; *G*, germinative layer (consisting of undifferentiated cells inside *TG*); *HK*, hooks of oncosphaera; *LL*, laminar layer (not cellular); *ON*, oncosphaera; *PR*, protoscolices; *SC*, scolex; *SU*, sucker; *TB*, terminal bladder; *TG*, tegument.

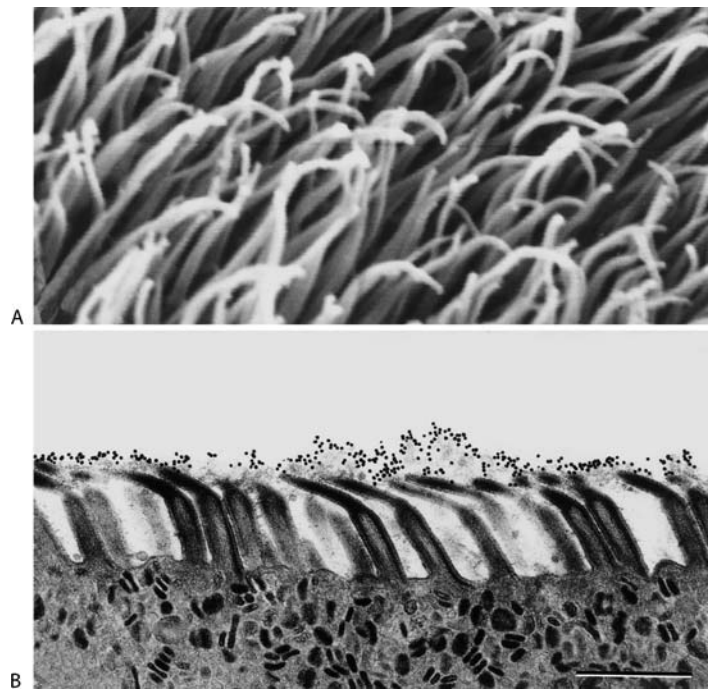

**Cestodes. Figure 3 A, B** Microtriches at the surface of the tapeworm *Hymenolepis microstoma* after incubation of intact worms with lectin-gold conjugates. Bars 0.5 µm. **A** The surface coat of the electron-dense spines of the microtriches is densely covered with SBA gold. Only a few granules are present at the proximal part of the microtriches. This pattern of lectin binding was also found with other lectins and in other species, notably *H. nana*. **B** In the anterior parts of the *strobila* where the *proglottids* grow, a filamentous layer can be observed on top of the microtriches which binds SBA gold strongly.

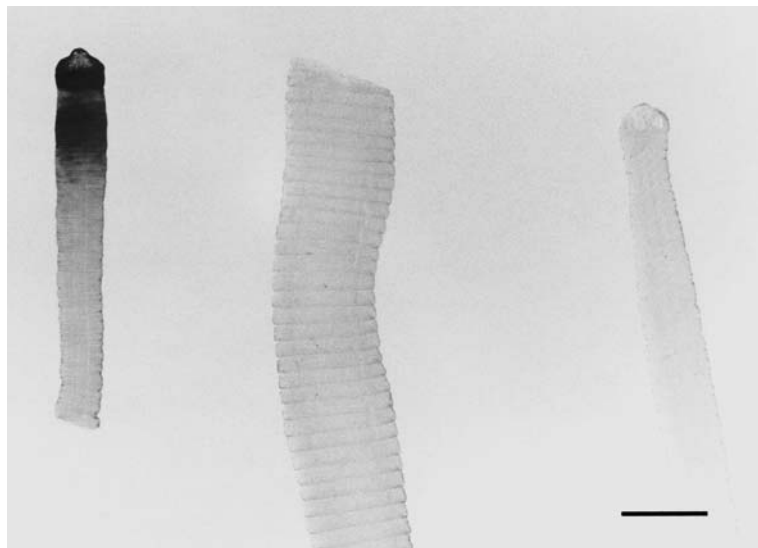

**Cestodes. Figure 4** *Hymenolepis diminuta* after incubation of the intact worm with SBA gold. Only the anterior parts are covered with SBA gold. Bar 0.5 mm.

### System

Phylum: Platyhelminthes

Class: Cestoidea

Subclass: *Cestodaria*

Order: *Amphilinidea*

Order: *Gyrocotylidea*

Subclass: *Eucestoda*

Order: *Caryophyllidea*

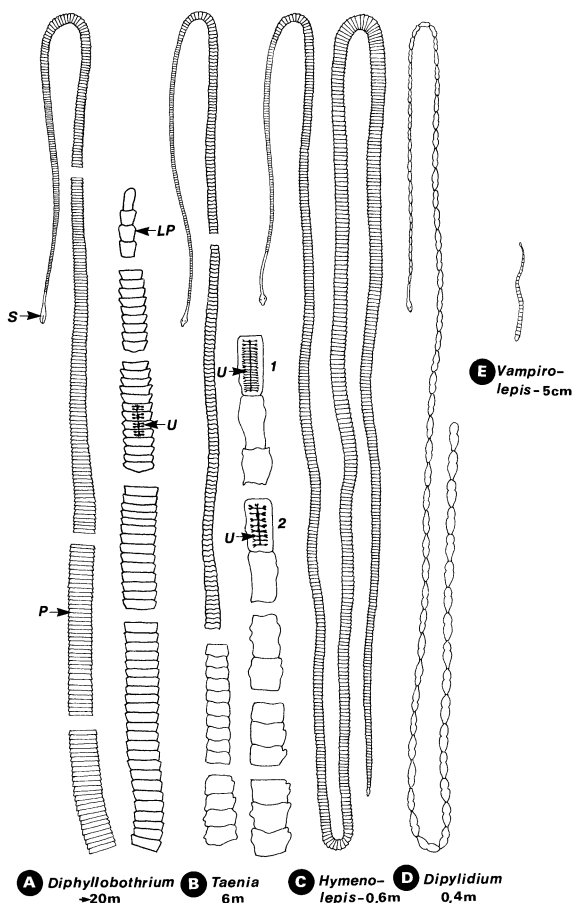

**Cestodes. Figure 5** Diagrammatic representation of 5 tapeworms. LP, Empty proglottids; P, Proglottids; S, Scolex; U, Uterus with eggs.

Order: [Trypanorhyncha](#)  
 Order: Spathebothriidea  
 Order: [Pseudophyllidea](#)  
   Family: Diphyllbothriidae  
   Family: Schistocephalidae  
 Order: Lecanicephalidea  
 Order: Aporidae  
 Order: Tetraphyllidea  
 Order: Diphyllidea  
 Order: Litobothriidea  
 Order: Proteocephalata  
 Order: Nippotaeniidea  
 Order: Cyclophyllidea  
   Family: Dioecocestidae  
   Family: [Hymenolepidae](#)  
   Family: [Taeniidae](#)  
   Family: Mesocestoididae  
   Family: Dilepidiidae  
   Family: Davaineidae  
   Family: Anoplocephalidae  
   Family: Dipylidae

## Important Species

→ [Eucestoda/Table 1.](#)

## Integument

In cestodes a gut is lacking. Therefore, nutritional uptake has to be mediated completely by the tegument surface. Moreover, the tegument has to resist the attack of digestive enzymes and protect against the immune responses of the host. Tapeworms may be affected by the immune response of their host. Initially, destrobilized worms are not permanently damaged, but will recover if they are transplanted into nonimmune hosts. It has been assumed that inactivation of proteases and lipase occurs on the surface of the tegument.

The external tegumentary membrane covering the [microtriches](#) has a [surface coat](#) which is a highly dynamic structure. Using [<sup>3</sup>H]-galactose as a label it was shown that the surface coat had a turnover rate of about 6–8 hours in [Hymenolepis diminuta](#). Autoradiographic investigations revealed that the constituents of the surface coat are synthesized by the endoplasmic reticulum and Golgi complexes of the perikarya and that they are transported to the apical part of the tegument. Histochemical methods demonstrated the presence of carbohydrates and negatively charged compounds in the surface coat. Biochemical investigations revealed a variety of glycoconjugates in tegumental extracts of [Hymenolepis diminuta](#) and [Spirometra mansonioides](#) which are assumed to take part in the replenishment of the surface coat.

Extracted surface material and *in vivo* products of larvae of [Taenia taeniaeformis](#) have been shown to contain a sulfated glycoconjugate. Its oligosaccharide chains contain glucosamine, galactose, and glucose at proportions of 4:4:1. This glycoconjugate is secreted and able to activate the complement cascade *in vitro*. It is assumed that it lowers the complement level in the surroundings of the parasite and thus prevents activation of complement at the external tegumentary membrane.

Gold-labeled lectins have been used to localize, by light and electron microscope, terminal sugar residues of the [surface coat](#) of [Hymenolepis nana](#), [H. microstoma](#), and [H. diminuta](#) (Figs. 3, 4). Light microscopic sections of [Hymenolepis microstoma](#) were labeled with lectin-gold conjugates. It was shown that the tegument binds wheatgerm agglutinin (WGA) and soybean agglutinin (SBA) strongly, but peanut agglutinin (PNA) and Concanavalin A less intensely. Electron microscopic investigations of [H. microstoma](#) and [H. nana](#) demonstrated that WGA, succinylated WGA, SBA, [Abrus precatorius](#) agglutinin (APA), PNA and, to a lesser extent, Concanavalin A were preferentially bound to the spines of the microtriches, which indicated that the surface of these species had exposed [N-acetylglucosamine](#), galactose, and perhaps glucose



and/or mannose residues. *Ulex europaeus* (UEA) 1 and *Dolichos biflorus* agglutinin (DBA) were not adsorbed, which means that terminal L-fucose and N-acetylgalactosamine residues seem to be absent. Specificity was controlled by competition with the respective sugars or sugar derivatives. Lectin-gold particles adsorbed mainly to the surface of the electron-dense spines. Only a few particles were found at the proximal part of the microtriches. This binding pattern does not appear to be the result of →capping, since similar results were obtained with worms which had been fixed with glutaraldehyde prior to incubation. The →carbohydrate constituents of the surface coat seem to be of parasite origin and do not represent adherent intestinal mucus from the host. The latter readily adsorbed UEA 1- and DBA-gold particles which were not bound by the tapeworm surface.

*H. nana* inhabits the posterior part of the ileum of the mouse, whereas *H. microstoma* is attached in the bile duct and extends into the intestine. Nevertheless, no differences were observed in the lectin-binding pattern of both species. However, the rat tapeworm, *H. diminuta*, differs markedly from these 2 species. It is expelled by normal mice 8–13 days after infection by unknown mechanisms, but it is able to develop in immunodepressed mice. In this species lectins specific for N-acetylglucosamine and galactose are adsorbed only at the scolex and adjacent parts but not on the strobila. The same lectins are adsorbed by the whole tegumental surface of *H. nana* and *H. microstoma*. The immune system of the mouse above all destroys the strobila of *H. diminuta* and leaves the scolex region intact. Destrobilated worms may survive for at least a few days. Therefore, it is tempting to assume that the glycoconjugates which are present in this region might be responsible for the resistance to →immune reactions of the host. A striking difference in the polysaccharide content of 2 species appears to be in accordance with this assumption. A polysaccharide which is present in larger amounts in a resistant species, *H. microstoma*, appears only in traces in *H. diminuta* which is eliminated by the mouse. No protein or uronic acids were demonstrated. Negative charges are due to acetyl groups.

Befus was able to demonstrate the C3 component of complement on the surface of *H. diminuta* in the mouse, but found it inconsistently and only in small amounts in *H. microstoma*. Contrary to these results, other groups found that only small amounts of C3 were deposited on the surface of *H. diminuta* *in vivo*, whereas *in vitro* C3 was bound in large amounts. Mouse complement proved unable to lyse the tegumental membrane of the rat tapeworm. However, that and human sera are able to destroy the surface of the tegument of *H. diminuta* in a few minutes. Therefore, the complement system of the mouse cannot be responsible for the elimination of *H. diminuta* from its gut, and it appears more likely that this is effected by cellular mechanisms.

## Diseases

→Taeniasis, Animals, →Taeniasis, Man, →Cysticercosis, →Echinococcosis, →Cestode Infections.

---

## Cestodocidal Drugs

Tables 1, 2.

### Economic Importance and Epizootiology

→Tapeworms, which belong to the phylum Platyhelminthes, are hermaphroditic, endoparasitic, elongate, flatworms without a body cavity or alimentary tract, a few millimeters to several meters in length. As a rule economic loss, resulting from cestode infections is less severe than that due to trematode or nematode infections. Adult stages of tapeworms living in the alimentary tract of the final host are remarkably benign although adults may be up to 8 or 15 m in length (e.g., *Taenia saginata*, *Diphyllobothrium latum*). The scolex of the strobilate stage in eucestodes is provided with →holdfast organs (suckers = acetabula), which may be armed with hooks and a rostellum with 2 rows of hooks. Transmission of many important cestodes in livestock, such as *Taenia* spp. and *Echinococcus* spp., usually involves “predator–prey” relationships between carnivores or omnivores (e.g., man) acting as final hosts and herbivores (food animals, occasionally man) serving as intermediate hosts. Food animals like ruminants and horses may also acquire adult tapeworms (*Moniezia* spp. or *Anoplocephala* spp.) by ingestion of arthropod intermediate hosts (mites of the family Oribatidae) with herbage. Large numbers of *A. perfoliata* and *A. magna* may cause clinical signs in horses and donkeys, e.g., catarrhal or hemorrhagic enteritis, ulcerative lesions, and occasionally perforation of the intestine. Although lambs, kids, and calves under 6 months of age may be substantially infected with *Moniezia* spp.; pathogenic effects of these tapeworm infections appear to vary considerably. Major economic impact may result from zoonotic infections caused by members of the family of Taeniidae (*Taenia* spp., *Echinococcus* spp.). Close contact of humans, dogs, and foxes (final hosts) with feedlot cattle and other ruminants, rodents, and by chance, humans, acting as intermediate hosts can lead to larval tapeworm infections. Thus, humans infected with *T. saginata* may pass thousands of eggs daily, which may be transmitted to cattle directly in feed or water or via pasture. Pigs running loose scavenging for food and with easy access to human feces may become infected by ingestion of gravid proglottids. Invertebrates such as blowflies, beetles, or earthworms may disperse *Taenia* spp. eggs, and they will remain viable for about 6 months.

**Cestodocidal Drugs. Table 1** Drugs used against cestode infections of domestic animals

CHEMICAL GROUP nonproprietary name of active substance (single oral dose, mg/kg body weight = b.w.), other information	*DRUG PRODUCT dose form (formulation), withdrawal time (WT) days (d) before slaughter, manufacturer, supplier, other information	CHARACTERISTICS: miscellaneous comments on pharmacokinetics, metabolism, mode of action, toxicity, and contraindications
<b>ALKALOIDS</b>		
<b>arecoline</b> hydrobromide (1–1.5; repeated administration may be necessary) in veterinary use since 1921 (discontinued in the 1990s)	drug products are now disapproved in the USA, Australia, European countries, elsewhere; bitter-tasting powder; addition of sucrose (15%) is recommended; may be given as 1.5% solution	it may still serve as a diagnostic drug for cestode infections in dogs ( <i>Echinococcus</i> spp., <i>Taenia</i> spp.); it has strong parasymphomimetic actions causing increased peristalsis so that the paralyzed worm looses its attachment to intestinal mucosa and
is expelled live and intact; its action on <i>E. granulosus</i> is variable but it shows good efficacy against <i>Taenia ovis</i> , <i>T. pisiformis</i> (other <i>Taenia</i> spp.), and <i>Dipylidium caninum</i> if the purging effect occurs sufficiently (onset of catharsis usually occurs 15 minutes after administration but some dogs may not defecate); the drug should not be used in cats, pregnant bitches, or in pups less than 6 months of age; its safety margin is narrow; atropine sulfate (0.04 mg/kg) may be used as antidote (does not interfere with the cestocidal action of arecoline)		
<b>arecoline</b> acetarsol (5) (tasteless, odorless, white powder; was formulated into scored tablets)	drug products (e.g., *Nemural, others) are now disapproved in the USA, Australia, European countries, elsewhere	its action is similar to that of the arecoline hydrobromide; following ingestion of tablet the complex hydrolyzes in stomach releasing
active arecoline which causes increased peristalsis, detachment of paralyzed worm and its expulsion (onset of catharsis usually occurred 30 minutes after administration); pups less than 3 months of age and cats less than 6 months of age should not be treated; arecoline acetarsol was not well tolerated (frequently vomiting, rarely salivation, restlessness, labored breathing, ataxia)		
<b>INORGANIC COMPOUNDS</b>		
<b>tin compounds</b> (mixture of metallic tin, tin oxide, or di-butyl-tin dilaureate chloride) were used several decades ago as anticestodals for humans; it has been assumed that anticestodal action of tin compounds may be due to coating tapeworm's integument (cuticle) with a thin layer of tin particles, which renders tapeworm strobila susceptible to digestion; tin preparations exhibited a moderate cestocidal activity (70–90%) against <i>Taenia</i> spp. in humans (dose regimen: once a day over a period of several days); di- <i>n</i> -butyl tin dilaureate (100–125 mg/kg b.w., given in-feed) has been used (may still used occasionally elsewhere) in poultry flocks and in cage birds; today the cheap compound has been replaced by niclosamide and other anticestodals; di- <i>n</i> -butyl tin laureate was highly effective against <i>Railletina</i> spp. but not so against <i>Choanotaenia</i> spp. and <i>Davainea proglottina</i> (variable effects); it was well tolerated at recommended dose but could cause a temporary drop in egg production		
<b>lead arsenate</b> was first used as an insecticidal drug, and has been found by chance to be effective also against tapeworms of sheep; for a long time it had been used worldwide as an inexpensive anticestodal drug with almost 100% effectiveness against <i>Moniezia</i> infections in lambs, kids, and calves (single dose in capsules: 0.5 mg/kg b.w.: calves, kids < 3 months of age; 1g/head: lambs > 2 months age, calves > 3 months age); its safety margin was low, and 2 g/head daily for 2 days (or 1g daily for 6 days) caused mortality in sheep (profuse diarrhea, oliguria, extreme weakness, enhanced permeability of capillary, and resulting shock); the drug was contraindicated in poultry		
<b>PHENOL DERIVATIVES</b>		
<b>dichlorophene/ toluene</b> (single dose per os: 220/264 mg/kg b. w. dog, cat,) (divided dose per os: 100/ 120 mg/5 pound b.w. = 20/24 mg/pound daily for 6 days)	*Vermiplex, *Tri-plex, (Schering- Plough), *Anaplex Caps (Boehringer Ingelheim) *Difolin Capsules (Fort Dodge AH), all capsules, many other sponsors (all USA)	several drug products containing <i>dichlorophene/toluene</i> may still have rather wide use in small animal practice, <b>approved indications</b> (dogs/cats): for removal of ascarids ( <i>Toxocara canis</i> , <i>Toxascaris</i>
<i>leonina</i> ) and hookworms ( <i>Ancylostoma caninum</i> , <i>Uncinaria stenocephala</i> ) and as an aid in removing tapeworms ( <i>Taenia pisiformis</i> , <i>Dipylidium caninum</i> , and <i>Echinococcus granulosus</i> ); <b>limitations</b> (dogs/cats): withhold solid foods and milk for at least 12 hours prior to medication and for 4 hours afterward, repeat treatment in 2–4 weeks in animals subject to reinfection; <b>dichlorophene</b> products (as sole active ingredient) are no longer available; they gave an alternative to arecoline that was unpleasant in use; dichlorophene (introduced in 1946) is chemically similar to niclosamide (both are phenol derivatives) it has bactericidal, fungicidal, and anticestodal activity; its anticestodal spectrum includes variable efficacy (only destrobilating action) against <i>Taenia</i> spp. (±72% efficacy) and <i>Dipylidium caninum</i> (±85% efficacy) in dogs and cats; its efficacy against <i>E. granulosus</i> is variable; it has limited efficacy against <i>Moniezia</i> spp. and <i>Thysanosoma</i> in sheep (therapeutic dose sheep: 200 mg/kg b.w.); dichlorophene shows low toxicity (LD50 in rats 2.6 g/kg); this is due to poor absorption of the drug from the alimentary tract; however, drug may be toxic in cats; adverse effects are vomiting and colic diarrhea;		

**Cestodocidal Drugs. Table 1** Drugs used against cestode infections of domestic animals (Continued)

CHEMICAL GROUP nonproprietary name of active substance (single oral dose, mg/kg body weight = b.w.), other information	*DRUG PRODUCT dose form (formulation), withdrawal time (WT) days (d) before slaughter, manufacturer, supplier, other information	CHARACTERISTICS: miscellaneous comments on pharmacokinetics, metabolism, mode of action, toxicity, and contraindications
<p><b>toluene</b> (a hydrocarbon obtained from coal tars or methylbenzene) is only available in combination with <i>dichlorophene</i>; it has efficacy against GI nematodes as ascarids (~98% efficacy), hookworms (~95% efficacy) and whipworms (~40% efficacy: not approved indication) of dogs and cats; usually it is fairly well tolerated in therapeutic doses; at 5 times the therapeutic dose; adverse effects may occur in older animals as vomiting, muscular tremor, and ataxia</p>		
<p><b>bithionol</b> (~200 per os cats, dogs, sheep, goats, quail) (~200, 2 times in 4-day intervals, chicken) (~600 geese) <b>bithionol sulfoxide</b> (sulfene, syn. sulphene)</p>	<p>preparations of the drug and its derivatives may still be used outside North America, Europe, Australia, elsewhere; earlier known as *Bithin, others; poultry: in-feed, other animals capsules, tablets, or boluses</p>	<p><i>bithionol</i> is a phenolic compound which may be used for treatment of common cestodes in dogs, cats (little efficacy against <i>D. caninum</i>), poultry (<i>Raillietina</i> spp., <i>Choanotaenia</i> in chickens, geese, quail), and <i>Moniezia</i>, <i>Thysanosoma</i>, and</p>
<p><i>Paramphistomum</i> (~85% efficacy) in ruminants; it is well tolerated in these animals but may stimulate purgation in dogs and cats; in contrast to bithionol, <i>bithionol sulfoxide</i> has the advantage of a lower therapeutic dose (60 mg/kg) against adult cestodes (adults are expelled intact); its antitrematodal efficacy against liver flukes in sheep and cattle is superior to that of the parent compound</p>		
<p>HEXYLOXY-NAPHTHAMIDINES <b>bunamidine</b> hydrochloride (BUH) (25–50 dog, cat) dog and cat, no use class stated or implied</p>	<p>*Scolaban 400 (Schering-Plough AH, USA), coated tablet containing 400 mg BUH do not crush tablet (cf. limitations \)</p>	<p>has been used worldwide after its introduction in 1965 against tapeworm infections of dogs and cats; it quickly replaced arecoline and dichlorophene for routine</p>
<p>treatment of cestode infections in cats and dogs; *Scolaban is approved in the USA (elsewhere ?); BUH is active against <i>Taenia</i> spp., <i>Dipylidium caninum</i> (effect varies), <i>Spirometra</i> spp., and <i>Echinococcus granulosus</i> in cats and dogs; for some years it was the drug of choice against <i>E. granulosus</i> (50 mg/kg, repeated after 48 hours empty stomach); however, its effect on <i>Echinococcus</i> is not 100% and allows some worms to survive; about 10 years after its introduction, it was replaced in hydatid control schemes by <i>praziquantel</i>; BUH exhibits activity against <i>Moniezia expansa</i> in sheep, and shows variable efficacy against ascarids in dogs and cats (not approved indications); <b>approved indications</b>: is intended for oral administration to dogs for the treatment of <i>D. caninum</i>, <i>T. pisiformis</i>, and <i>E. granulosus</i>, and to cats for the treatment of <i>D. caninum</i> and <i>T. taeniaeformis</i>; <b>limitations</b>: oral tablet should not be crushed, mixed with food, or dissolved in liquid (dogs, cats), repeat treatments should not be given to dogs and cat within 14 days, BUH should not be given to male dogs within 28 days prior to their use for breeding, do not administer to dogs and cats having known heart conditions; for use only by or on the order of a licensed veterinarian; <b>mode of action</b>: BUH acts as taeniocide; it affects tegument of <i>Hymenolepis nana</i> causing disruption of the outer layer, which leads to decrease in the rate of glucose uptake and an increase in the rate of glucose efflux; damaged outer layer allows digestion of the worm in the host; <b>tolerability and adverse effects</b>: it is relatively well tolerated at recommended dose; side effects are transient diarrhea and occasional vomiting: crushed tablet may cause irritation of oral and stomach mucosa, and thus enhanced drug levels in blood plasma producing unexpected toxic effects; detoxification of drug likely occurs in the liver; cases of sudden death have occasionally been seen in dogs without evidence of hepatic dysfunction; liver disorders may lead to higher levels of BUH in the circulation; in excited dogs, high levels of epinephrine may then cause ventricular fibrillation in heart sensitized by BUH to endogenous catecholamines; excitement and exertion should be avoided after treatment; reduced spermatogenesis was found in dogs but not in cats; the drug is well tolerated in bitches (all stages of pregnancy); <b>bunamidine hydroxynaphthoate</b> (25–50 mg/kg b.w. per os: *Buban) has been used in the UK as a drench for control of tapeworm infections in sheep and goats; the salt (insoluble in water and less irritant to mucous membranes than the hydrochloride) exhibits marked efficacy against <i>Moniezia expansa</i> and <i>M. benedeni</i> in naturally infected sheep and goats; metaphylactic treatment (single dose) was during spring/summer and in autumn when reinfection occurred; the drug was tolerated in sheep and goats at twice the recommended dose; given in feed, it showed variable activity against <i>Taenia</i> spp. in dogs; it was tested in <i>poultry</i> with natural infection of <i>Raillietina</i> spp. and <i>Amoebotaenia sphenoides</i> and was found to be highly active at 400 mg base/kg per os</p>		
<p>SALICYLANILIDES *1 <b>niclosamide</b> (mono-hydrate) (NIC) <i>Australian market</i>, elsewhere: drug combinations only, doses for oral <i>tablets</i>:</p>	<p>1*Mansonil drench (Bayer Australia) for control of tapeworms and immature stomach fluke of sheep and lambs, powder/liquid</p>	<p>announced in 1958 and introduced into the market in 1960; since then it has been used worldwide against tapeworm infections of animals and humans, good</p>

**Cestodocidal Drugs. Table 1** Drugs used against cestode infections of domestic animals (Continued)

CHEMICAL GROUP nonproprietary name of active substance (single oral dose, mg/kg body weight = b.w.), other information	*DRUG PRODUCT dose form (formulation), withdrawal time (WT) days (d) before slaughter, manufacturer, supplier, other information	CHARACTERISTICS: miscellaneous comments on pharmacokinetics, metabolism, mode of action, toxicity, and contraindications
<p><b>NIC/levamisole HCl (LEV):</b> e.g., *Ambex (Bomac): (100/4.25 LEV base dog cats)</p> <p><b>NIC/pyrantel pamoate (PYR):</b> e.g., *Troy All Wormer (Troy Labs.): (100/14.4 dog) (60/23 cat, kittens)</p> <p><b>approved indications:</b> for the control of roundworms, hookworms and tapeworms (except <i>E. granulosus</i>) in dogs and cats (do not overdose)</p>	<p>(790 g/kg NIC: 5mL/10kg b.w.) NIC is combined with nematocidal drugs (drug form: tablets, paste) to have an advantage in that both nematodes and cestodes can be treated in dogs and cats (for further information on dosages, drug products, sponsors, suppliers, companies, and characteristics of these drug combinations cf. → <a href="#">Nematocidal Drugs, Animals/Table 5</a>)</p>	<p>tolerability, a wide safety margin, and excellent efficacy against <i>Taenia</i> spp. infections of mammals have accounted for its widespread use as a taeniocide in human and veterinary medicine; now, it has largely been replaced in all fields by praziquantel that shows superior cestocidal action compared to niclosamide; NIC may be also used as a molluscicide for the control of freshwater snails, which serve as an intermediate host for</p>
<p>trematodes e.g., <i>Schistosoma</i> spp. (cf. → <a href="#">Trematodocidal Drugs</a>); NIC is highly active against tapeworm infections in dogs, cats, ruminants, and poultry; it shows marked activity against <i>Taenia</i> spp. but erratic activity against <i>Dipylidium caninum</i>, <i>Mesocostoides corti</i>, and poor efficacy against <i>M. lineatus</i> and <i>Echinococcus granulosus</i> in dogs; immature stages of <i>E. granulosus</i> may be susceptible to 50 mg/kg b.w. given on 2 consecutive days; the drug exhibits excellent activity against adult stages of <i>Moniezia</i> spp., <i>Thysanosoma actinoides</i> (fringed tapeworm), <i>Thysaniezia giardi</i> and <i>Avitellina</i> spp. in ruminants; it was widely used against infections of anoplocephalids in horses (80–100 mg/kg b.w.) and may still be used for control of <i>Hymenolepis</i> spp. and <i>Raillietina</i> spp. infections of birds (100 mg/kg); it also affects cestode and skin fluke (<i>Gyrodactylus</i>, 0.1mg/L, water-bath for 60 minutes) infections of fish (<i>Bothriocephalus</i>: 40 mg/kg daily for 3 days, or 0.5% medicated feed); <b>mode of action:</b> niclosamide inhibits the formation of mitochondrial energy, i.e., oxidative phosphorylation; in susceptible adult stages uptake of oxygen and glucose is blocked; its major action takes place in the scolex and proximal segments; drug produces spastic and/or paralytic action <i>in vitro</i> on various preparations of helminths (e.g., <i>D. caninum</i>, <i>F. hepatica</i>); <b>tolerability:</b> it is a very safe drug (poor gastrointestinal absorption) also during pregnancy and lactation in cattle and sheep; dogs and cats appear to be more sensitive to the drug although twice the normal dose is well tolerated; <b>derivatives</b> have been prepared mainly by Russians as various salts and esters; among them the piperazine salt <i>phenolsulfonphthalein</i> (PSP) is approx. 2 times more effective against <i>Moniezia expansa</i> in lambs than the parent drug; in countries of the earlier USSR it may still be used in animals and humans; <b>limitations:</b> it should not be used in combination with <i>organophosphate</i> compounds (enhanced toxic effects)</p>		
<p><b>resorantel</b> (65 mg/kg b.w., per os: drench), chemically a 4'-bromo-γ-resorcylanilide (*Terenol discontinued in member states of European Union, may still commercially available in parts of Europe and Russia) was highly effective (95–100%) against various cestodes such as <i>Moniezia</i> spp. infections in sheep and cattle, <i>Thysaniezia giardi</i> and <i>Avitellina</i> spp. infections in sheep; the drug showed also good efficacy (90%) against mature and immature stages of <i>Paramphistomum cervi</i> (rumen fluke) in cattle, sheep, and goats; there was slight, transient diarrhea following treatment at recommended dose; the drug was excreted quite rapidly (total residues 3 days after treatment was about 0.1% of total)</p>		
<p><b>nitroscanate</b>, chemically a substituted diphenylether, introduced for use in dogs in 1973 (50 mg/kg b.w., per os tablets: micronized particles, earlier *Lopatol (Novartis), others, no longer available in Germany but available in Switzerland, not approved in the USA, Australia, elsewhere, for other information cf. → <a href="#">Nematocidal Drugs, Animals/Table 5</a>); it is a broad-spectrum compound with activity against roundworms (<i>Toxocara canis</i>, <i>Toxascaris leonina</i>), hookworms (<i>Ancylostoma caninum</i>, <i>Uncinaria stenocephala</i>), and tapeworms (<i>Taenia</i> spp., and <i>Dipylidium caninum</i>) of dogs; its action on whipworms is poor and that on <i>E. granulosus</i> is somewhat erratic at recommended dose; even at repeated doses of 200 mg/kg, total elimination of adult <i>E. granulosus</i> is not always achieved; therefore it is not recommended against these worms; the drug is poorly absorbed from gastrointestinal tract but irritates gut's mucosa resulting in relatively high incidence of vomiting (10–20% of treated dogs) within 3–5 hours after treatment; fasting, 12–24 hours prior to treatment followed by a small quantity of food thereafter will markedly reduce vomiting; nitroscanate should not be used in cats, as it frequently provokes adverse side effects at therapeutic dose; mode of action in cestodes appears to be an uncoupler of oxidative phosphorylation (the drug inhibits ATP synthesis in <i>Fasciola hepatica</i>)</p>		
<p><b>PYRAZINOISOQUINOLINES</b> <b>praziquantel (PZQ)</b> *1 (5–10 per os, s.c., i.m. dog, cat, dose may vary depending on b.w. and age of animal) (20–25 wild carnivores per os, s. c., i.m.: <i>Joyeuxiella pasqualei</i> or <i>Dipylidium</i> sp.)</p>	<p>1*Droncit (Bayer, USA, Australia, Germany, elsewhere) tablets, solution for injection for cat and dogs; spot-on for cats, other drug products in Germany, Australia;</p>	<p>PZQ was introduced in 1975 for treatment of cestode infections in cats, and dogs; it is also the drug of choice for treatment of intestinal tapeworm infections of man (cf. Table 2) and</p>

**Cestodocidal Drugs. Table 1** Drugs used against cestode infections of domestic animals (Continued)

CHEMICAL GROUP nonproprietary name of active substance (single oral dose, mg/kg body weight = b.w.), other information	*DRUG PRODUCT dose form (formulation), withdrawal time (WT) days (d) before slaughter, manufacturer, supplier, other information	CHARACTERISTICS: miscellaneous comments on pharmacokinetics, metabolism, mode of action, toxicity, and contraindications
*2 (3.75 as drench, sheep)	2*Cestocur (Bayer), oral liquid (drench) for sheep, WT: sheep 0d, milk 0d Germany; WT: sheep 3d Australia	human schistosomiasis (cf. → <a href="#">Trematodocidal Drugs/Table 2</a> ); <i>Taenia</i> spp. and <i>Diphyllobothrium</i> spp. infections in humans may be
<p>eliminated by oral doses of 10 and 25 mg/kg, respectively; PZQ has no action on nematodes; the drug is extremely active after a single oral, subcutaneous (being less effective), or intramuscular dose (route may depend on cestode species) against juvenile and adult tapeworms of carnivores such as <i>Taenia</i> spp., <i>Dipylidium caninum</i>, <i>Diphyllobothrium latum</i>, <i>Spirometra</i> spp. (<i>S. mansonioides</i>, <i>S. erinacei</i>), <i>Mesocestoides corti</i>, <i>Echinococcus granulosus</i>, and <i>E. multilocularis</i> (i.m. injection is recommended in case of <i>Echinococcus</i> infection); for removal of adult <i>Spirometra</i> spp., <i>D. latum</i> it is necessary to enhance the PZQ dose (25 mg/kg b.w. once a day for 2 days); the drug exhibits also high efficacy against tapeworms of ruminants, e.g., <i>Moniezia</i>, or “bile duct” cestodes as <i>Thysanosoma actinoides</i> and <i>Stilesia hepatica</i> or <i>Avitellina</i> in sheep, goats (10–15 mg/kg b.w., single dose not approved), or cestodes of birds, snakes, and fish; it is also active against certain flukes of sheep (e.g., <i>Eurytrema pancreaticum</i>) or intestinal fluke <i>Fasciolopsis buski</i> of swine (50–70 mg/kg and 30 mg/kg b.w., respectively, single dose not approved) or skin fluke of fish (<i>Gyrodactylus aculeatus</i>: 10 mg/L water-bath for 2–3 hours); PZQ has some <i>ovicidal</i> action on <i>E. granulosus</i> eggs released from the proglottid; however, eggs located in the proglottids are not affected by the drug (this limits epidemiological value of its <i>ovicidal</i> effect); <b>action on tissue stages</b> (metacestodes in liver, lungs, brain, elsewhere ) residing in various intermediate hosts: activity of PZQ against larval forms (hydatid cysts) of the dog tapeworm <i>E. granulosus</i> is variable and benzimidazole carbamates (<i>mebendazole</i>, <i>albendazole</i>) prove to be more active against hydatids in sheep or man following long-term administration of these drugs; in cattle and sheep its action on larval stages (<i>Cysticercus</i>) of most <i>Taenia</i> spp. is about 100%; this is also true for the larval stage of the human tapeworm <i>T. saginata</i> in cattle; <b>pharmacokinetics</b>: there is almost complete absorption from the alimentary tract following oral administration; PZQ is conveyed throughout the body and reaches high plasma levels in tissues of almost all organs; this puts it in a position to be in close contact with larval and adult stages of cestodes that have highly varied locations in the host; its major pathway of biotransformation is the liver; inactive drug metabolites are excreted mainly by the liver into bile and then feces; <b>mode of action</b>: the drug is rapidly taken up by cestodes and trematodes; however, uptake of PZQ is no guarantee of therapeutic activity (e.g., <i>F. hepatica</i> is unaffected by the drug); action of PZQ results in a rapid vacuolization of tegumental layer in the growth zone of the neck region of cestodes; vacuolization leads to disruption of the apical tegument layer (molecular mechanism leading to these alterations is not yet well understood); contraction (spastic and/or paralytic) of parasite musculature depends on drug concentrations used in isolated host tissue preparations; contraction of <i>Hymenolepis diminuta</i> muscle depends on endogenous Ca<sup>2+</sup> (as in vertebrate skeletal muscle); contraction of <i>Schistosoma mansoni</i> muscle depends on uptake of external Ca<sup>2+</sup> (as in vertebrate smooth muscle); <b>tolerability</b>: it is a safe drug after the oral or parenteral route; there is a wide margin of safety for PZQ as shown in acute and chronic toxicity studies in mice, rats, rabbits, and dogs; up to 5 times the recommended dose PZQ is tolerated without adverse effects in cats and dogs, 10-fold overdose may cause transitory vomiting and sign of depression; there was no evidence for embryotoxicity or teratogenicity in reproduction studies performed in rats, rabbits, cats, and dogs; the use of PZQ in breeding and pregnant animal is safe</p>		
<p><b>praziquantel</b> (PZQ) / antinematodal drugs so called “allwormer” = drug combination with 2; 3; or 4 active nematocidal ingredients and PZQ for use in dogs and cats; for drug products cf. <b>pyrantel</b>, <b>fenbendazole</b>, <b>oxfendazole</b>, <b>oxibendazole</b>, <b>febantel</b>, <b>abamectin</b>, <b>milbemycin oxime</b>, <b>emodepside</b>: →<a href="#">Nematocidal Drugs</a>, →<a href="#">Animals/Table 5</a></p>	<p>drug products containing active nematocidal ingredients and PZQ for use in <i>sheep</i> and <i>lambs</i> cf. <b>fenbendazole</b>, <b>abamectin</b>, <b>moxidectin</b> (→<a href="#">Nematocidal Drugs, Animals/Table 1</a>); drug products containing active nematocidal ingredients and PZQ for use in <i>horse</i> cf. <b>pyrantel</b>, <b>ivermectin</b>, <b>abamectin</b>, <b>moxidectin</b> (→<a href="#">Nematocidal Drugs, Animals/Table 3</a>); *First Drench (Virbac Australia), liquid, WT 3d: <b>levamisole HCl</b>/ PZQ (7.5/3.8 mg/kg b.w.)</p>	<p>BZs (e.g., fenbendazole) and pyrantel affect certain flukes (cf. →<a href="#">Trematodocidal Drugs/Table 1</a>) and cestodes; BZs may have good activity against <i>Taenia</i> spp. but not so against <i>Dipylidium caninum</i> in cats and dogs (cf. BZs ↓); pyrantel pamoate exhibits activity against the ileocecal tapeworm <i>Anoplocephala perfoliata</i> of horse at 2 times the recommended dose (13.2 mg/kg b.w.); the drug is inactive against common</p>
<p>tapeworms in cats and dogs; a so called “allwormer” may contain a <i>macrocyclic lactone</i> (e.g., ivermectin, milbemycin oxime, or abamectin), BZ (e.g., fenbendazole, oxfendazole, or oxibendazole), pyrantel pamoate, praziquantel, and an <i>ectoparasiticide</i> (e.g., fipronil, imidacloprid, and/or s-methoprene or lufenuron); this group of drug products may involve a broad range of indications as relevant external and internal parasites (including prevention of heartworm disease) in cats and dogs, thus a single application of such kit-products may control not only all &lt;11&gt; gastrointestinal worms but also</p>		

**Cestodocidal Drugs. Table 1** Drugs used against cestode infections of domestic animals (Continued)

CHEMICAL GROUP nonproprietary name of active substance (single oral dose, mg/kg body weight = b.w.), other information	*DRUG PRODUCT dose form (formulation), withdrawal time (WT) days (d) before slaughter, manufacturer, supplier, other information	CHARACTERISTICS: miscellaneous comments on pharmacokinetics, metabolism, mode of action, toxicity, and contraindications
common ectoparasites (fleas, ticks, and/or biting lice) of dogs; an example for an allwormer is <*The Complete Parasite Control Kit for Dogs 10–25 kg, Bayer, Australia> (active constituents: 0.8 g/L ivermectin, 100 g/L imidacloprid, 250 mg/Tb febantel, 50 mg/Tb praziquantel, 49.8 mg/Tb pyrantel as pamoate /embonate salt, formulations: topical solution and oral tablet) for the treatment and prevention of heartworms, fleas, and all “11” gastrointestinal worms; an allwormer may have various limitations/ contraindications concerning the indication <prevention of heartworm disease> in regions where <i>Dirofilaria immitis</i> is endemic (for details cf. →Nematocidal Drugs, Animals/Table 5/pyrantel)		
HYDROPYRAZINOBENZAZEPINE <b>epsiprantel (ESP)</b> (5–5.5 dog, excluding under 7 weeks of age) (2.75 cat, excluding under 7 weeks of age) ( <i>Echinococcus granulosus</i> : 7.5, not approved dose)	*Cestex (Pfizer AH, USA, Australia), oral tablets (various specifications: 12.5, 25, 50 or 100 mg/kg b.w. of epsiprantel) <b>ESP/pyrantel</b> pamoate: cf. →Nematocidal Drugs, →Animals/ Table 5/pyrantel	chemically related to praziquantel (PZQ); since 1989 on the market (first USA, early 1990s Canada and Taiwan); unlike PZQ, it is poorly absorbed from the gastrointestinal tract and there seem to be no detectable metabolites in the urine of dogs; this puts the compound in a position to be in contact with
tapeworms of the alimentary tract for a longer time; ESP is used for removal of common cestodes of dogs ( <i>Dipylidium caninum</i> , <i>Taenia pisiformis</i> ), and cestodes of cats ( <i>D. caninum</i> , <i>T. taeniaeformis</i> : tapeworm segments may appear in feces for 2–3 days following treatment); if exposure to infected intermediate hosts is not controlled reinfection will be likely and so retreatment necessary; therefore, in cases of <i>D. caninum</i> infections an additional flea control program should be applied; immature/adult stages of <i>Echinococcus granulosus</i> are not completely eliminated by ESP (immature: 94, mature: 99% at regular dosage of 5 mg/kg b.w.); total elimination of mature worms may be achieved with 7.5 mg/kg b.w.; there are no information on efficacy against other GI tapeworms in livestock; due to its low absorption from GI tract it is not likely that ESP may affect larval cestodes or flukes residing in liver or lungs; <b>mode of action</b> may be similar to that of PZQ; ESP may disturb regulation of Ca <sup>2+</sup> and other cations leading to disintegration and lysis of tapeworm’s tegument (cuticle) and digestion of the worm by the host; <b>limitations</b> : for oral use only as a single dose, do not use in animals less than 7 weeks of age; safety of use in pregnant or breeding animals has not been established; federal law restricts this drug to use by or on the order of a licensed veterinarian (USA., elsewhere); pregnant animals may be treated at mating, before birth of puppies or kittens and then every 3 months; <b>tolerability</b> : the drug is claimed to have a wide safety margin in dogs and cats; at 5 times the regular dose (once daily for 3 days) no adverse effects were observed; at 40 times the regular dose (once daily for 4 days) only slight clinical signs were seen		
BENZIMIDAZOLE CARBAMATES <b>listed doses</b> of benzimidazole carbamates (BZs) refer to <i>experimental studies</i> published in literature; BZs are primarily used for their efficacy against nematodes (→Nematocidal Drugs, Animals/Tables 1, 3–5); some of them are also effective against certain cestodes in animals like mebendazole (MBZ), fenbendazole (FBZ), oxfendazole (OFZ), albendazole (ABZ), or cambendazole (CBZ); BZs exhibit no activity against the common tapeworm <i>Dipylidium caninum</i> of cats and dogs; BZs have a wide margin of safety in livestock but their use is contraindicated (heavy incompatibility) within 7 days of a bromsalans flukicide administration in cattle (→Nematocidal Drugs, Animals/Table 1)		
DOG AND CATS (adult stage or intestinal tapeworm, larval stage) <i>M. corti</i> intermediate stage (tetrathyridium) of <i>M. corti</i> can infect dogs (final host)	<i>Taenia</i> spp. of cats and dogs, good efficacy: MBZ (22, daily for 5 days), or: FBZ (50 daily for 3 days) <i>Echinococcus granulosus</i> in dogs, efficacy against adult stages: MBZ (20, 2 doses every 2 days) <i>Mesocostoides corti</i> in dogs, efficacy against adult stages: ABZ (50 every 12 hours, 4 treatments, or 100 × 1) <i>Mesocostoides corti</i> larval stage (tetrathyridium) in dogs FBZ (100 twice daily for 14–60 days: 5 of 6 infected dogs were cleared); MBZ is also effective against tetrathyridia of <i>M. corti</i> in dogs	
RUMINANTS and CHICKENS (adult stage or intestinal tapeworm)	<i>Moniezia</i> spp. infection in cattle/sheep, good efficacy at * regular dose: ABZ (*10/*7.5), OFZ (*5), at enhanced dose FBZ (15), MBZ (20) <i>Thysanosoma actinoides</i> in sheep, efficacy against adult stages: FBZ (10) <i>Railletina tetragona</i> in chicken, good efficacy: OFZ (7.5 adults, 10 immature stages)	

**Cestodocidal Drugs. Table 1** Drugs used against cestode infections of domestic animals (Continued)

CHEMICAL GROUP nonproprietary name of active substance (single oral dose, mg/kg body weight = b.w.), other information	*DRUG PRODUCT dose form (formulation), withdrawal time (WT) days (d) before slaughter, manufacturer, supplier, other information	CHARACTERISTICS: miscellaneous comments on pharmacokinetics, metabolism, mode of action, toxicity, and contraindications
(larval stage of tapeworm in intermediate host)	<i>Cysticercus bovis</i> (larval stage of human tapeworm <i>Taenia saginata</i> ), marginal effect MBZ (5 daily for 10 days); marked (approx. total) reduction of cysts in beef tissue: FBZ (50), CBZ (35) <i>Cysticercus cellulosae</i> (larval stage of human tapeworm <i>Taenia solium</i> ) reduction of cysts in pork: OFZ (single dose, cf. Gonzalez et al., 1996: <i>Am J Trop Med Hyg</i> 54: 391–394)	
HORSE (adult stage or intestinal tapeworm)	drug combinations containing macrocyclic lactones (ivermectin, abamectin or moxidectin) and praziquantel are approved for treatment of equine cestode infections caused by <i>Anoplocephala perfoliata</i> , <i>A. magna</i> , or <i>Paranoplocephala</i> <i>mammillana</i> , however, none of BZs products have been labeled for this indication, likely because of their insufficient efficacy against equine tapeworms at regular dose; enhanced dose MBZ (20) and FBZ was shown to be effective against <i>Anoplocephala</i> spp.	
LABORATORY ANIMALS (larval stage of tapeworm in intermediate host)	<i>Taenia cysticerci</i> in rabbits and pigs, marked (approx. total) reduction of visceral cysts: MBZ (25 daily for 5 days) <i>Echinococcus granulosus</i> , hydatid cysts in mice, marked (approx. total) reduction of visceral cysts: MBZ (150 intraperitoneally for 3 days) or FBZ (500 ppm in-feed for 18 weeks)	
ANTIBIOTICS <b>paromomycin</b> (isolated in 1955, *Humatin) is a fermentation product of <i>Streptomyces rimosus</i> var. <i>paromomycinus</i> and commercially supplied as its neutral sulfate salt; first use as a cestocide was in Italy in 1963; in experimental studies, the antibiotic was shown to exhibit a promising effect against <i>T. taeniaeformis</i> in cats but not so against <i>Hymenolepis</i> spp. in rats and mice; in humans it proved to be effective against <i>Taenia saginata</i> and <i>T. solium</i> at doses of (40) for 5 days, or at (75); <i>Hymenolepis nana</i> infection in man was completely cured at doses of (40) for 7 days; its further use became limited because of the availability of modern drugs with simple regimens for patients; (cf. Table 2, praziquantel); paromomycin is poorly absorbed from GI tract (<1% of oral dose and is subsequently excreted unchanged in urine); it is little known about the structure-activity relationship concerning antibacterial action of paromomycin and not its anticestodal efficacy; destruction of the basic functions of active molecule by N-acylation of primary amino groups results in complete loss of activity; its anticestodal action ( <i>T. saginata</i> ) may be based on fine-structural changes of the tegumental membrane making the tapeworm susceptible to digestive system of host; *Humatin (Parke-Davis, others) may be currently used for the treatment of asymptomatic <i>Entamoeba histolytica</i> infection of humans (cf. → Antidiarrhoeal and Antitrichomoniasis Drugs/Table 1); it shows activity against gram-positive and gram-negative bacteria and may cause slight diarrhea after recommended dosage regimen		

Data of drug products (approved labels) listed in this table refer to information from literature, manufacturer, supplier, and websites such as the European Medicines Agency (EMA), Committee for Veterinary Medicinal Products (CVMP), the U.S. Food and Drug Administration (FDA), Center for Veterinary Medicine (CVM), the Australian Pesticides and Veterinary Medicines Authority (APVMA) and associated Infopest (search for products), VETIDATA, Leipzig, Germany, and Clini Pharm, Clini Tox (CPT), Zurich, Switzerland

Data given in this table have no claim to full information

Cysticerci such as *Cysticercus bovis* (infectious stage of *T. saginata*) or *C. cellulosae* (infectious stage of *T. solium*) develop primarily in skeletal and cardiac muscle. **Neurocysticercosis** of humans may occur by ingestion of *T. solium* eggs with contaminated food or by **autoinfection**. Autoinfection is possible if eggs are released in the upper intestine, and regurgitated into the stomach. Oncospheres released from digested eggs then reenter the intestine where they initiate the life cycle.

Economic loss in livestock may result also from condemnation of carcasses or offal as unsuitable for human consumption at the abattoirs. For instance, *C. bovis* in the musculature of cattle becomes infective about 10 weeks after infections and remains viable for

up to 9 months. Humans become infected by the ingestion of raw or undercooked infected beef (Table 2). Despite the availability of more sensitive and specific immunodiagnostic tests (recombinant antigens, PCR techniques) their role for routine diagnosis of cysticercosis in cattle will be very limited. Such tests could be used, however, on a herd basis to find out whether a herd is free of cysticerci or infected. This would be a valuable approach in → epizootiology of → cysticercosis. Today there are no effective drugs, which may be used economically in the treatment of → metacestode infections in livestock. **Prophylactic measures** should therefore always involve treatment of infected persons and management adjustments such as proper meat inspection. However,

**Cestodocidal Drugs. Table 2** Drugs used against cestode infections in humans

PARASITE DISEASE distribution, pathology	Stage affected (location), morphology of egg	Chemical class other information (1*, 2* etc. refer to linked chemicals and comments)	Nonproprietary name adult dosage (♦ = pediatric dosage) (oral route), d = days, comments	Miscellaneous comments
<b>INTESTINAL TAPEWORMS:</b> adult worms consist of a head (scolex), a neck (growth region), and a strobila (series of proglottids)				
<b>DIPHYLLOBOTHRIASIS:</b> first intermediate host is a copepod, second intermediate host are various freshwater fishes due to lack of specificity of the plerocercoid (sparganum lacking a bladder, see sparganosis); man becomes infected by ingestion of raw or undercooked fish-intermediate host containing plerocercoids; adult tapeworm may live for 25 years or longer in humans and may cause rarely vitamin B12 deficiency (due to absorption of B12 by the worm) and megaloblastic anemia; <i>D. latum</i> eggs (small knob at end, opposite the operculum) may be confused with those of <i>Paragonimus westermani</i> (cf. → Trematodocidal Drugs/Table 2)				
<i>Diphyllobothrium latum</i> (fish tapeworm), common where cold, clear lakes are abundant; occurs in N Europe, N America, Japan in fish-eating mammals, and man	<b>adult</b> (5–15 m long) (upper half of intestine) <b>eggs</b> (unembryonated, ovoid, operculate, pass in feces into water)	1* <b>pyrazino-isoquinolines</b> contraindicated in ocular cysticercosis 2* <b>halogenated salicylanilides</b> (availability problems)	1* <b>praziquantel</b> ( <i>drug of choice</i> ) (5–10 mg/kg once, and ♦) <i>alternative:</i> 2* <b>niclosamide</b> (2 g once) (♦50 mg/kg once)	1*safe and well tolerated, occasionally skin rashes 2*safe drug, also in pregnant or debilitated patient; occasionally abdominal pain, and pruritus
<i>Dipylidium caninum</i> (dog tapeworm)	humans become infected by swallowing fleas containing infective larval stages (cysticercoids)			
distribution worldwide; infrequent in humans, pathogenic effects are unknown; infection is due to close contact with infected dogs and their fleas	<b>adult</b> (approx. 50 cm long) (small intestine) <b>eggs</b> (thin-shelled, small, spherical; contain 6-hooked onchosphere) pass in feces (typical egg packets each contains up to 15 eggs)	1* <b>pyrazino-isoquinolines</b> 2* <b>salicylanilides</b> (availability problems)	1* <b>praziquantel</b> ( <i>drug of choice</i> ) (5–10 mg/kg once, and ♦) <i>alternative:</i> 2* <b>niclosamide</b> (2 g once) (♦50 mg/kg once)	definite hosts (dogs, cats) should be regularly treated to avoid infection in humans (especially in children); eradication of fleas (pets carpets, rugs, and other sites) is needed
<b>HYMENOLEPIASIS:</b> humans become usually infected by ingestion of embryonated eggs (contaminated food and water); human infection also is possible by ingestion of arthropods (e.g., beetles) containing the infective larval stage (cysticercoid)				
<i>Hymenolepis nana</i> (dwarf tapeworm) occurs worldwide; infects simian primates, rodents, man; oncosphere can hatch also from embryonated egg within GI tract causing <i>autoinfection</i> ; this render eradication difficult; amounts of cysticercoids may damage intestinal mucosa and produce diarrhea	<b>adult</b> (approx. 2–4 cm long) (lumen of small intestine; oncosphere develops in lamina propria of a villus to preadult cysticercoid) <b>eggs</b> (small, thin-shelled, spherical to subspherical, 6-hooked larva surrounded by a membrane with 2 polar “knobs” from which 4–8 filaments arise, pass in feces)	1* <b>pyrazino-isoquinolines</b> 2* <b>salicylanilides</b> 3* <b>aminoglycoside</b> (<1% of dose is absorbed from gut, excreted unchanged in urine) 4*//5- <b>nitrothiazole benzamide</b> (first described in 1984 as a human cestodocidal drug)	1* <b>praziquantel</b> ( <i>drug of choice</i> ) (25 mg/kg once, and ♦) <i>alternative:</i> 2* <b>niclosamide</b> (2 g × 1d; 1 g × 6d) 3* <b>paromomycin</b> minimal side effects 4* <b>nitazoxanide</b> (500 mg × 3d) (tablet = 500 mg) (investigational drug)	1* e.g., Biltricide is active against both juvenile and adult stages e.g., 2*Yomesan acts only against adults and mature cysticercoids, therefore treatment for 5–7 days 3*(40 mg/kg/d for 7d) may cause total elimination of worm burden



**Cestodocidal Drugs. Table 2** Drugs used against cestode infections in humans (Continued)

PARASITE DISEASE distribution, pathology	Stage affected (location), morphology of egg	Chemical class other information (1*, 2* etc. refer to linked chemicals and comments)	Nonproprietary name adult dosage (♦ = pediatric dosage) (oral route), d = days, comments	Miscellaneous comments
<p><b>4* nitazoxanide:</b> there have been several reports on preclinical and clinical studies evaluating the activity of the drug against a broad spectrum of intestinal and extraintestinal parasitic infections including cryptosporidiosis, giardiasis, amebiasis, microsporidiosis, equine myeloencephalitis caused by <i>Sarcocystis neurona</i> (approved drug for horses = brand-name Navigator, IDEXX Pharmaceuticals, USA), ascariasis, fascioliasis, and other intestinal infections caused by protozoa such as <i>Balantidium coli</i>, <i>Blastocystis hominis</i>, <i>Isospora belli</i>, or helminths as whipworms, hookworms, and threadworm <i>Strongyloides stercoralis</i> (cf. Raether W, Hanel H (2003) Parasitol Res 90: S19-S39)</p>				
<i>H. diminuta</i> (rat tapeworm) occurs worldwide; common parasite of rats, may occasionally infect man	<b>adult</b> (20–60 cm long) (small intestine) <b>eggs</b> (large, thick-shelled, spherical, 6-hooked oncosphere, pass in feces)	<b>pyrazino-isoquinolines salicylanilides</b> (availability problems)	<b>praziquantel</b> ( <i>drug of choice</i> ) (25 mg/kg once) <i>alternative:</i> <b>niclosamide</b> (2g × 1d; 1g × 5–7d)	clinical manifestations are inconspicuous (unknown)
<p>sometimes there may be diagnostic problems concerning confusion with <i>H. nana</i> eggs: oncosphere of <i>H. diminuta</i> is surrounded by a membrane without polar filaments and separated considerably from outer shell; rodent control and protection of food from insect intermediate hosts may prevent infection (infection may be acquired by accidental ingestion of infected beetles present in various grain products)</p>				
<p><b>TAENIASIS:</b> humans become infected by ingestion of raw or undercooked muscles (beef or pork) containing infective cysticercus; <i>diagnostic problems:</i> eggs of human and animal taeniid species (<i>Taenia</i> and <i>Echinococcus</i> spp.) are all indistinguishable from each other; <i>T. saginata</i> and <i>T. solium</i> diagnostic is usually done by examination of gravid proglottids injected with India ink or stained by permanent stains to visualize characteristic number of lateral uterine branches (<i>T. saginata</i>: 15–30, and <i>T. solium</i>: 7–13); some pollen grains found in feces may closely resemble eggs of <i>Taenia</i> spp.; taeniid egg contains a characteristic 6-hooked embryo (oncosphere); caution should be used in handling unidentified gravid (mature) taeniid proglottids since <i>T. solium</i> and <i>Echinococcus</i> spp. eggs are infective to humans; they can cause larval tapeworm infections of brain, liver, lungs, and other organs (cf. larval tapeworm infections ↓)</p>				
<i>Taenia saginata</i> (beef tapeworm), worldwide distribution (parallels stock keeping); adult worm causes no distinct lesions; cattle act as intermediate host	<b>adult</b> (up to 8 m long) (upper half of small intestine) <b>eggs</b> (embryonated spherical, yellow-brown, thick shell striated radially, 30–44µ Ø, pass in feces)	1* <b>pyrazino-isoquinolines</b> 2* <b>salicylanilides</b> (availability problems) 3* <b>benzimidazole carbamates</b>	1* <b>praziquantel</b> ( <i>drug of choice</i> ) (5–10 mg/kg once and ♦) <i>alternative:</i> 2* <b>niclosamide</b> (2g once) 3* <b>mebendazole</b> , Vermox (200 mg BID × 3d)	in most cases there are no clinical signs; on an individual level, infection can be prevented by thorough cooking of meat or by freezing meat at –18°C for 7d
<i>T. solium</i> (pork tapeworm), worldwide distribution (parallels pig keeping); pigs and humans act as intermediate host; they become infected with embryonated eggs by ingestion of contaminated food or by <i>autoinfection</i>	<b>adult</b> (up to 6 m long) (small intestine) <b>eggs</b> (morphology cf. “Taeniasis”, and <i>T. saginata</i> ↑, pass in feces; egg of <i>T. solium</i> may be infective to humans and can cause cysticercosis)	1* <b>pyrazino-isoquinolines</b> (1* has a moderate effect on larval stages) 2* <b>salicylanilides</b> 3* <b>benzimidazole carbamates</b>	1* <b>praziquantel</b> ( <i>drug of choice</i> ) (5–10 mg/kg once and ♦) <i>alternative:</i> 2* <b>niclosamide</b> (2 g once) 3* <b>mebendazole</b> (200 mg BID × 3d)	2* has no ovicidal action on larvated egg; larva liberated from a shed gravid segment in upper intestine can cause cysticercosis; do not use a purgative; an enhanced peristalsis increases risk of cysticercosis
<p><b>LARVAL TAPEWORMS:</b> there are 2 types of larvae invading human tissues, (1) larva with a bladder, and (2) larva lacking a bladder (sparganum)</p> <p><b>LARVAL CESTODE DISEASES:</b> man may be infected by ingestion of an oncosphere-containing (embryonated) egg or by ingestion of a larval stage belonging to the genus <i>Spirometra</i> (cf. sparganosis ↓)</p> <p><b>CYSTICERCOSIS, NEUROCYSTICERCOSIS</b> contaminated food containing <i>T. solium</i> eggs may infect humans during meal; <i>autoinfection</i> is possible; cysticerci with a fibrous tissue capsule may undergo calcification and release antigens that can cause inflammatory reactions</p>				

**Cestodocidal Drugs. Table 2** Drugs used against cestode infections in humans (Continued)

PARASITE DISEASE distribution, pathology	Stage affected (location), morphology of egg	Chemical class other information (1*, 2* etc. refer to linked chemicals and comments)	Nonproprietary name adult dosage (♦ = pediatric dosage) (oral route), d = days, comments	Miscellaneous comments
<i>Taenia solium</i> (larva type: a single scolex invaginated into a bladder) cerebral cysticercosis may occur where pig keeping is done; (prevention of infection cf. "Taeniasis" ↑)	<b>cysticercus cellulosae</b> larva may reside in almost any tissue, often brain: larva tends to grow slowly to a large cyst that causes space-occupying lesions and/or hydrocephalus (larva in ventricle blocks CSF circulation)	<b>1*benzimidazole carbamates</b> 1*Eskazole, Albenza, others <b>2*pyrazino-isoquinolines</b> 2* Biltricide  experimental drugs: <i>mebendazole</i> <i>flubendazole</i>	<b>treatment of choice</b> (see below) <i>alternative:</i> 1* <b>albendazole</b> (ABZ) (400 mg BID × 8–30d, can be repeated as necessary) 2* <b>praziquantel</b> (PZQ) (50–100 mg/kg/d in 3 doses for × 30d)	<b>treatment of choice</b> (see below) <i>alternative:</i> 1* <b>albendazole</b> (ABZ) (♦15 mg/kg/d, <max.800 mg> in 2 doses × 8–30d; can be repeated as necessary) 2* <b>praziquantel</b> (PZQ) (♦50–100mg/kg/d in 3 doses for × 30d)
<b>treatment of choice of parenchymal cysticercosis:</b> Initial therapy for patients with inflamed parenchymal cysticercosis should focus on symptomatic treatment with anti-seizures medication; treatment of parenchymal cysticerci with ABZ or PZQ is controversial and characterized by various limitations: (1) patients with live parenchymal cysts and seizures should be treated with ABZ together with steroids (dexamethasone: 6 mg or prednisone: 40–60 mg daily) and an antiseizure medication; (2) patients with subarachnoid cysts or giant cysts in the fissures should be treated with ABZ for at least 30d; (3) patient with arachnoiditis, vasculitis, or cerebral edema: prednisone 60 mg/d or dexamethasone 4–6 mg/d together with ABZ or PZQ; <b>contraindication:</b> any cysticercocidal drug may produce irreversible pathologic alterations when used to treat <i>ocular or spinal cysts</i> even with concurrent use of steroids; (4) in case of obstructive hydrocephalus surgical intervention or cerebrospinal fluid (CSF) diversion is indicated (prednisone 40 mg/d may be given with surgery); surgical excision of accessible lesions is the only reliable means of cure and should include the use of anticonvulsant drugs; chemotherapy of neurocysticercosis is further discussed to define guidelines for use of drugs in inoperable patients				
COENURIASIS (infrequent): adult worm occurs in Canidae like dog, fox, coyote, and others (definitive hosts); herbivores serve as intermediate hosts as cattle, horse, sheep, wild herbivores, rarely man; latter becomes infected by ingestion of contaminated food containing embryonated eggs; human <i>Coenurus cerebralis</i> -disease mainly occurs in Africa; space-occupying larva usually invades brain				
<i>Taenia multiceps</i> (= <i>Multiceps multiceps</i> ) (larva type: multiple invaginated scoleces into a bladder), infrequent	<b>Coenurus cerebralis</b> , larval cyst contains several hundred proto-scoleces (central nervous system, usually brain)	Prevention is not possible (reservoir hosts include numerous species of wild carnivores)	drug medication is unknown against space-occupying lesions due to larva	only reliable means is excision of accessible cyst
CYSTIC HYDATID DISEASE (hydatidosis, or cystic echinococcosis = CE): <i>Echinococcus granulosus</i> larva-type is a <i>unilocular hydatid cyst</i> infection of intermediate host (usually sheep, other herbivores as cattle, horse, and occasionally man) is due to close contact with dogs and other canids (definitive hosts), which may be infected with large numbers of adult worms (3–6 mm long, with a single gravid proglottid that is longer than wide; it contains typical <i>Taenia</i> -like eggs); feces of dogs contain embryonated eggs infective to potential intermediate hosts (occasionally humans); cestode larval stage in human tissues is characterized by multiple daughter bladders or "brood capsules" with multiple invaginated protoscoleces budding from their walls (inner layer of germinal epithelium of cystic cavity); cyst content (materials) consisting of degenerated scoleces and debris in milky fluid of parent cyst is referred to as <i>hydatid sand</i> (calcareous corpuscles)				
<i>Echinococcus granulosus</i> (humans are an accidental intermediate host and are usually infected by handling an infected dog)	<b>hydatid cyst, unilocular</b> (solitary or multiple or oval masses on imaging, frequently seen in liver and lungs, but also other tissues)	<b>1*benzimidazole carbamates</b> mebendazole (40–50 mg/kg/d in 3 divided doses is less efficacious than albendazole in long-term regimen)	1* <b>albendazole</b> ( <i>drug of choice</i> ), (400 mg bid × 1–6 months) <b>praziquantel</b> preoperatively use cf. ↓	1*(♦15 mg/kg/d, <max. 800 mg> × 1–6 months); adverse effects include nausea, hepatotoxicity, neutropenia, rarely alopecia (long-term treatment)
sheep and cattle are common intermediate hosts of the larval stage; prevention of hydatidosis may be largely achieved if abattoir and disposal of infected offal are strictly controlled [for details cf. Raether W, Haelen H (2003) <i>Parasitol Res</i> 91: 412–438]; most ultrasound surveys of CE reveal that the zoonotic sheep strain of <i>E. granulosus</i> is likely the main cause of				

**Cestodocidal Drugs. Table 2** Drugs used against cestode infections in humans (Continued)

PARASITE DISEASE distribution, pathology	Stage affected (location), morphology of egg	Chemical class other information (1*, 2* etc. refer to linked chemicals and comments)	Nonproprietary name adult dosage (♦ = pediatric dosage) (oral route), d = days, comments	Miscellaneous comments
<p>human CE in remote rural areas; clinical symptoms and manifestations in CE patients are highly variable and often nonspecific; infected individuals may be asymptomatic for a long time, symptoms may result from release of antigenic material following cyst rupture and dissemination of viable scoleces (secondary infection); there is a great diversity of clinical manifestations and pathological alterations in liver and lungs and other organs; about 20–40% of CE patients have multiple cysts with involvement of several organs; total surgical resection of an hydatid cyst may be still considered the &lt;gold standard treatment&gt; for CE; medical treatment with benzimidazole drugs is currently used in nonsurgical cases or as supplementary treatment prior to and post-surgery to reduce the risk of secondary CE (intraoperative spillage of viable material) and recurrence; WHO recommends postoperative chemotherapy (in case of spillage of protoscoleces) for at least 1 month with albendazole (ABZ) or 3 months with mebendazole (MBZ); <b>praziquantel</b> (PZQ) may be useful preoperatively in case of cyst spillage during surgery; it has also been used (25 mg/kg/d) with ABZ for combined treatment of CE resulting in improved efficacy over ABZ alone (PZQ may increase serum concentrations of ABZ sulfoxide up to 4-fold); percutaneous aspiration-injection-reaspiration (PAIR) with ultrasound guidance plus ABZ treatment has been effective for management of hepatic CE; however, for PAIR there is no ideal agent that is both effective and safe; for optimum efficacy, scolecidal compounds require a 15 minutes “dwell time” within the cavity; relatively safe and effective are ethanol (70–95%), saline (15–20%) and cetrimide solution (formalin should never be used); severe, sometimes fatal chemical (sclerosing) cholangitis can result if there is communication between biliary tree and cyst; in summary, there is yet no formal consensus, as efficacy and safety of the methods require further evaluation to establish comprehensive guidelines for medical treatment of CE; ABZ and MBZ (teratogenic in laboratory animals) are listed as category C drugs in pregnancy in the USA (in Australia category D; B3): neither drug is absolutely contraindicated in pregnancy</p>				
<p>ALVEOLAR DISEASE (or alveolar echinococcosis = AE): <i>Echinococcus multilocularis</i> larva-type: <i>multilocular</i> or <i>alveolar multilocular</i> cyst large numbers of adult worms (3–5 mm long, morphology cf. <i>E. granulosus</i>, and eggs of taeniid type) primarily occurring in fox (definitive host, occasionally dogs, cats, and wolves); several microtine rodents serve as intermediate host (sylvatic cycle); major source of infrequent human infection is through fruits and vegetables contaminated with larvated eggs from fox feces; in infected humans, “metastasis” (branches) of the laminated membrane by the alveolar cyst resembles lesion of a neoplasm; lesions in the liver are usually membranous; in contrast to hydatid of <i>E. granulosus</i>, neither protoscoleces nor hydatid sand (calcareous corpuscles) are identifiably in human cysts</p>				
<p><i>Echinococcus multilocularis</i> (infrequent); <i>E. vogeli</i> (infrequent) causing <b>polycystic</b> echinococcosis</p>	<p>growth of <b>alveolar (multilocular) cyst</b> is peripheral and invasive; metastases are frequent (liver, adjacent tissue)</p>	<p><i>experimental drugs:</i> (flubendazole, fenbendazole, oxfendazole, amphotericin B <i>nitazoxanide</i>)</p>	<p><b>treatment</b> if early diagnosed, surgical excision of lesions is a reliable means of treatment</p>	<p>no therapy is fully effective against tumorlike growth of alveolar type of cyst</p>
<p>clinical manifestation produced by the alveolar larva of <i>E. multilocularis</i> are related to the extent of tumorlike lesions of the cyst; AE is characterized by a chronic course lasting for months or years; clinical symptoms are variably and usually only follow a long asymptomatic period (5–15 years); in liver, alveolar hydatid presents a mass-producing inflammatory process; metastasis in lungs may be seen as multiple small solid foci and pathological findings may be characterized by marked foreign-body reaction in bones; <b>treatment:</b> AE is difficult to treat; current treatment approach is preferable surgery, or secondarily benzimidazole chemotherapy; radical surgical resection of complete alveolar lesion(s), e.g., in right or left liver lobes, is the only potential curative treatment [cf. details Craig P (2003), <i>Curr Opin Dis</i> 16: 473-444]; <b>albendazole</b> (ABZ: 10–15 mg/kg/d: long-term treatment: 6.5 years) is the drug of choice for human AE in patients with nonresectable AE; ABZ may be a useful adjunct therapy to surgery; overall its use orally resulted in improved 10-year survival rates up to 80–83% compared to 6–25% for untreated historical controls [a WHO group recommended long-term treatment: 3–24 months: ABZ (10 mg/kg), mebendazole (40–50 mg/kg); high doses are necessary to affect larva →WHO Group Bull WHO, 74:231, 1996]; <b>nitazoxanide</b> (NTZ)-treated <i>in vitro</i> cultured metacestodes of <i>E. multilocularis</i> were nonviable when implanted into susceptible mice; as NTZ is much better absorbed than ABZ following oral administration it provides an attractive alternative for medical treatment of human AE</p>				
<p>SPARGANOSIS: <b>larva type:</b> solid-bodied larva lacking a bladder adult worm (pseudophyllidean tapeworm) occurs in cats, dogs, wild canids, or felids and is of little significance to definitive hosts; first intermediate host is a copepod, second one any vertebrate due to lack of specificity of the plerocercoid; humans become infected (1) by ingestion of a copepod (crustaceans) containing proceroids (first larval stage), (2) by ingestion of raw or undercooked flesh or organs of any vertebrate (amphibians, reptiles, mammals, particularly feral pigs raised for human consumption) containing plerocercoids (=sparganum, second larval stage, easily mistaken for nerves), or (3) by local application of flesh (poultice to wounds or to the eye) containing plerocercoids sparganum</p>				

**Cestodocidal Drugs. Table 2** Drugs used against cestode infections in humans (Continued)

PARASITE DISEASE distribution, pathology	Stage affected (location), morphology of egg	Chemical class other information (1*, 2* etc. refer to linked chemicals and comments)	Nonproprietary name adult dosage (♦ = pediatric dosage) (oral route), d = days, comments	Miscellaneous comments
<i>Spirometra</i> spp. (infrequent), life cycle is similar to that of <i>D. latum</i> (fish tapeworm of humans)	<b>proceroid</b> (migrate in subcutaneous and muscular tissue) <b>plerocercoid</b> (migrate in connective tissue of muscles, abdomen, hind legs; peritoneum, pleura)	there is no reliable chemotherapy ( <i>praziquantel</i> may show some larvicidal effects)	<i>treatment</i> is surgical prevention is difficult because of entrenched eating habits and other customs	larval worms cause during subcutaneous migration painful edema, urticaria, inflammation, fibrosis; spargana grow into irregular nodules of subcutaneous tissues

Abbreviation(s): BID = bis in die = twice a day

Dosages listed in the table refer to information from manufacturer, literature, and/or Medical Letter (2004) "Drugs for parasitic infections": The Medical Letter (publisher) 46 (issue 1189): e1–e12, New Rochelle, New York

Data given in this Table have no claim to full information

the latter measure is estimated to detect only about 50% of the infected carcasses. To kill cysticerci, beef carcasses must be frozen, e.g., for 6 days at  $-20^{\circ}\text{C}$ , or carcasses should be cooked. There are several reports that cattle and sheep (goats) can be successfully vaccinated against *T. ovis* and *T. saginata* (beef tapeworm) with recombinant antigens inducing high levels of protective immunity. This may give some hope for the commercial use of such vaccines against infection in the near future (cf. →Vaccination).

Through chemotherapy, complete elimination of *Echinococcus* spp. infections in dogs must be achieved because of the major agricultural and public health problems due to →hydatidosis in intermediate hosts. Primarily sheep but also other herbivores such as goats, cattle, horses, camels (pigs), and by chance humans serve as intermediate hosts. There are phylogenetic variations in *Echinococcus*, i.e., several strains of *E. granulosus* differing in their morphology and their isoenzyme patterns. Some of these strains appear to be specific for a particular →intermediate host and an endemic area. The horse strain does not appear to infect humans although the sheep strain does. Human hydatidosis (infectious stage of *E. granulosus*, cf. Table 2) is often associated with severe clinical signs, particularly if the brain (hydatid cyst with calcifications) or heart is involved. This is also true in human alveolar cyst formation caused by *E. multilocularis* and *E. vogeli* (Table 2). Hydatidosis in domestic animals rarely produces clinical signs despite heavy infections. Adult *E. granulosus*, only 3.5–5.6 mm in length, is principally harmless to the dog although large numbers of adults may cause enteritis. There has been substantial progress toward successful vaccination against *E. granulosus*; recombinant antigens from *E. granulosus* generated more than 95% protection against challenge in vaccinated sheep or dogs.

### Old Remedies and Modern Compounds with Cestocidal Activity

There are many old remedies showing some activity against adult tapeworms. Thus pumpkinseeds, powdered areca (fruits of betel palm, *Areca catechu*), koussou (flowers of an Abyssinian tree, *Hagenia abyssinica*), turpentine (oily mixture of exsudates from coniferous trees, especially longleaf pine), pomegranate root bark (tropical Asian and African tree, *Punica granatum*), and male fern (*Dryopteris filix-mas*) were used as anticestodal remedies. These and other plant products had been gradually replaced by arecoline (alkaloid obtained from seeds of betel palm), organic tin compounds, lead arsenate, or dichlorophene during the first half of this century. Since 1921, **arecoline** has been used in veterinary medicine for many years against *E. granulosus* and *Taenia* spp. in dogs. Because of its relative low efficacy and its severe side effects, it is no longer recommended as a therapeutic drug in dogs and cats. However, its strong parasympathomimetic action causes purging and thus partial removal of paralyzed worms from the intestine. This action makes arecoline a useful diagnostic agent, which may give valuable information on whether a group of dogs on a farm is infected with *Taenia* spp. or *Echinococcus* spp. or not.

Several "modern" **synthetic compounds** are in current use for the control of tapeworm infections preferably in pets (Table 1). Such drugs are for instance dichlorophene, bunamidine, niclosamide, resorantel, benzimidazole carbamates, nitroscanate, pyrantel (e.g., horses), praziquantel, and epsiprantel. They may exhibit good activity against adult stages of intestinal tapeworms while praziquantel (Table 2) and benzimidazole carbamates (mebendazole, albendazole) show action against larval stages of certain cestodes. Thus, mebendazole and albendazole may improve clinical

illness of →**hydatid disease** (*Echinococcus* spp.) in humans following long-term treatment.

### Drugs Acting on Adult Tapeworm Infections in Dogs and Cats

*Echinococcus* spp., *Dipylidium caninum* (highly active proglottids may cause anal irritation and thus scooting), *Diphyllobothrium latum*, and *Spirometra* spp. have public health implications (Table 2). Other cestode-species occurring in dogs and cats are *Taenia* and *Mesocestoides*. Routine treatment with effective cestocidal drugs at intervals less than the prepatent periods of the parasites should be used in working dogs to reduce the incidence of *Echinococcus* spp. infections, particularly in rural areas. Other control measures should also be considered to prevent hydatidosis in livestock and man, such as control of home slaughtering of small ruminants and consequent condemnation of infected viscera of infected animals, and quarantine regulations for dogs.

The majority of compounds recommended for treatment in dogs and cats (Table 1), such as bunamidine HCl, some benzimidazole carbamates (e.g., mebendazole, fenbendazole), niclosamide, praziquantel, and epsiprantel, prove highly effective against adult stages of *Taenia* spp. and *D. caninum*. The action of **niclosamide** is, however, somewhat erratic against *D. caninum*. **Bunamidine** appears to be the only drug that shows efficacy against *Spirometra* spp., particularly against *S. erinacei* in dogs and cats. Like praziquantel, it also exhibits activity against *Mesocestoides* spp. but requires a 10 times higher dosage than that drug. **Nitroscanate**, introduced in 1973 (not commercially available in Germany, USA, Australia) as a broad-spectrum agent for use in dogs, has marked activity against roundworms (*Toxocara canis*, *Toxascaris leonina*), hookworms (*Ancylostoma caninum*, *Uncinaria stenocephala*), and tapeworms (*Taenia* spp. and *D. caninum*). However, the drug is not recommended for use against *E. granulosus* infection since 100% elimination of adults and juvenile worms is not achievable. **Praziquantel** (Tables 1, 2) is a safe and highly active drug against a broad range of mature and immature tapeworms (including *Echinococcus* spp.), and most trematodes (particularly *Schistosoma* spp. cf. →**Trematodocidal Drugs**). **Epsiprantel** one of the latest cestocidal products on the market is chemically related to praziquantel. It exhibits good activity against common tapeworm infections in cats (*D. caninum* and *Taenia taeniaeformis*), and dogs (*T. pisiformis* and *D. caninum*), and shows an excellent action on adult *E. granulosus*. The drug is poorly absorbed from the gastrointestinal tract allowing the compound to be in contact with the parasites for a prolonged period.

There are numerous combinations of praziquantel with antinematodal compounds (cf. →**Nematocidal**

**Drugs, Animals**), e.g., **febantel/pyrantel/praziquantel** (Drontal Plus for dogs), an all wormer against intestinal nematodes and cestodes or **praziquantel/pyrantel** (Drontal for cats) has a high activity against *Ancylostoma caninum* and cestodes but only moderate activity against *Toxocara canis* and *Trichuris vulpis*. **Albendazole/praziquantel** may control various tapeworm infections (*Taenia* spp., *D. caninum*, *Echinococcus* spp.) and nematode infections (roundworms such as *Toxocara* spp., hookworms as *Ancylostoma* spp., the whipworm *Trichuris vulpis*, and *Strongyloides* spp.). **Ivermectin/praziquantel** may be used for heartworm prophylaxis (*Dirofilaria immitis*) and prevention of tapeworm infections in dogs (cf. pyrantel Table 1 for details).

### Drugs Acting on Adult and Larval Tapeworm Infection of Sheep and Cattle

There are several species (e.g., *Moniezia expansa*, *M. benedeni*, *Avitellina* spp., and *Thysaniezia giardi*) which occur in the intestine of sheep, goats, cattle, and other ruminants in most parts of the world. *Stilesia hepatica* and *Thysanosoma actinioides* (the fringed tapeworm) are found in the bile ducts of cattle, sheep, and wild ruminants (e.g., deer) in Africa and Asia, or in North and South America (*T. actinioides*). None of these relatively large species appears to be very pathogenic, and therefore there may only be economic return from treatment of lamb and calves if the administered compound is effective against both cestodes and nematodes. Such drugs include the **benzimidazole carbamates** (e.g., albendazole, oxfendazole); they exhibit good efficacy against various intestinal nematodes (→**Nematocidal Drugs, Animals**) and cestodes (Table 1) in food animals. **Niclosamide** exerts good activity against *Moniezia* spp. and *Avitellina* spp. in ruminants. **Albendazole**, **fenbendazole**, and **praziquantel** are effective against cestodes occurring in the bile ducts. However, enhanced doses (double and 4 times the recommended dose) of these drugs are necessary to eliminate the tapeworms.

High doses of praziquantel (20–40 times the recommended dose) are required to affect *T. saginata* or *T. hydatigena* **larval stages** in cattle and sheep; cost for treatment precludes, however, the use of praziquantel in the field. The same is true for albendazole showing action on larval *T. saginata* in cattle at 10 times the recommended dose. The mode of action of the **benzimidazole carbamates** is generally thought to be primarily due to alterations in microtubule polymerization via a direct binding of these compounds to parasite tubulin. Thus, the coadministration of **fenbendazole** and the phenylguanidine **netobimin** (a prodrug of albendazole, cf. →**Nematocidal Drugs, Animals**) has been shown to inhibit solidly the regenerative capacity of hydatid material in gerbils.

Recurrence of hydatid-cyst never took place when using coadministration of both drugs. Different effects have been observed after the administration of **praziquantel** in laboratory animals against larval stages of *Echinococcus*. Thus it affects protoscolexes of *E. multilocularis* but does not inhibit growth of cysts of both *E. multilocularis* and *E. granulosus*.

### Drugs Acting on Adult Tapeworm Infections in Horses and Donkeys

Clinical signs associated with tapeworms in equines are uncommon. Occasionally *Anoplocephala magna* and *Paranoplocephala mamillana* occurring in the small intestine and rarely stomach may cause catarrhal (rarely hemorrhagic) enteritis. *A. perfoliata* found in the large and small intestine is often localized near the ileocecal orifice and ulcerative lesions and edema may be produced where the scolexes are attached to the cecal wall. Clinical signs (e.g., diarrhea) are usually seen in autumn and spring when infected oribatid mites may be present in great numbers. Because of the low pathogenicity of these tapeworms, treatment should be considered carefully since use of a compound that acts only specifically is unlikely to be economic. It may be of value to use a compound that combines activity against both cestodes and nematodes. Thus, **pyrantel embonate** (an antinematodal agent, cf. →[Nematocidal Drugs, Animals](#)) has been found to have a distinct activity against *A. perfoliata* at twice the nematocidal dose. It is only variably active against *P. mamillana*. However, in confirmed cases of equine cestodiasis **praziquantel** (1 mg/kg: *P. mamillana*; 0.5 mg/kg: *A. perfoliata*) exhibited a marked effect against these tapeworms. **Fenbendazole** ( $3 \times 10\text{--}20$  mg/kg) and **mebendazole** (dosage see Table 1) also show action on equine tapeworms (cf. also →[Nematocidal Drugs, Animals](#)). However, widespread benzimidazole resistance of equine nematodes may limit the economic value of such a therapy. **Niclosamide** (80–100 mg/kg b.w., not approved indication, availability problems) had good activity against anoplocephalids of all ages. Combinations containing praziquantel and a macrocyclic lactone (ivermectin, abamectin, or moxidectin, cf. →[Nematocidal Drugs, Animals](#)) may be used for the prevention and control of infections caused by cestodes, nematodes, and *Gasterophilus* spp. (botflies).

### Drugs Acting on Adult Tapeworm Infections in Birds

In the poultry industry the meat production has increased continuously worldwide (cf. →[Coccidiocidal Drugs/Economic Importance](#)). In 2004, broiler meat production amounted to about 10 million metric tons in the USA and China, respectively (USDA, Vol. 08 NO. 45, 2005). In birds, losses due to moderate and

seldom heavier tapeworm infections may be diarrhea (enteritis), weight depression, emaciation, and rarely mortality. Free-range birds, e.g., those in backyard flocks, and cage birds in aviaries with earthen floors are often hosts to many species of tapeworms (e.g., →*Davainea proglottina*, *Raillietina* spp., *Cotugnia* spp., *Amoebotaenia cuneata*, *Choanotaenia infundibulum*, *Hymenolepis* spp., →*Fimbriaria* spp., and other cestodes). Their life cycles require the development of cysticercoids (larval stages) in a large number of intermediate hosts such as various copepods, snails, and insects. Modern husbandry methods may largely prevent access to the various intermediate hosts, thus preventing tapeworm infections in commercial poultry. Consequently, only little information is available about adequately tested compounds in birds. **Niclosamide** (250 mg/kg, per os) seems to be effective and safe in most cases (can be toxic to geese). **Praziquantel** (5–10 mg/kg) is effective against a wide range of immature and mature cestodes in poultry, waterbirds (ducks, geese), and game birds (pheasant, partridge). However, an economic return to its use seems to be questionable. **Benzimidazole carbamates** (fenbendazole, mebendazole, other compounds, →[Nematocidal Drugs, Animals](#)), exhibit variable actions on avian cestodes. Fenbendazole is somewhat erratically effective against *Davainea proglottina*, and the activity of mebendazole is limited to *Raillietina* and *Hymenolepis*.

### Drugs Acting on Adult and Larval Tapeworm Infections of Humans

Among the adult (intestinal) tapeworms in man, *T. solium* (pork tapeworm, common in Latin America) and *D. latum* (broad tapeworm or fish tapeworm, common in regions where freshwater fishes occur) are particularly important to human health. *T. solium* may cause →[cysticercosis](#) (Table 2) and *D. latum* pernicious anemia due to vitamin B<sub>12</sub> deficiency. Other adult tapeworm species affecting humans are *T. saginata* (beef tapeworm, worldwide distribution, approx. 60 million people currently infected), and *Hymenolepis nana* (dwarf tapeworm, infects not only man but also mice and rats). *T. saginata* may cause economic loss due to taeniasis or cysticercosis in cattle and *H. nana* play a role as →[zoonosis](#) since cross-infections between humans and rodents are possible. Mainly two drugs, the older **niclosamide** (a nitrosalicylanilide) and the newer **praziquantel** (pyrazinoisoquinoline) are used for elimination of these tapeworms from the intestinal tract (dosage, cf. Table 2). Old remedies (certain seeds from locally grown plants) or other drugs may still be in use (Tables 1, 2).

**Larval cestodes** of certain tapeworms lodge preferably in the central nervous system, or in the liver (lung or other organs). Thus the cysticercus of *T. solium* causes neurocysticercosis. The hydatid cyst of

*E. granulosus* produces cystic →**echinococcosis**, and that of *E. multilocularis* alveolar echinococcosis. *E. vogeli* causes polycystic echinococcosis in humans, and characteristics of *E. vogeli* metacestode are considered intermediate to those of *E. granulosus* and *E. multilocularis*. Because of the tumor-like growth and proliferation of larval stages, clinical manifestations and pathology are characterized by their great diversity of moderate to severe symptoms. **Treatment** of diseases caused by larval stages is based mainly on 3 measures focusing on symptomatic and causal therapy: (1) Palliative drugs (e.g., antiepileptics and corticosteroids) are used to control seizures and inflammation associated with tissue reactions caused by cestode larva. (2) Measures of palliative surgery are performed to drain CSF by placement of ventricular shunts, and those of causative surgery to remove solitary brain cysticerci or hydatid cyst from liver or lung. (3) Long-term chemotherapy (indicated if surgical resection of cyst is not possible) may result in complete and permanent disappearance of cyst if it is surrounded by minimal adventitial reactions. Patients with complicated cysts (multiple compartments and numerous daughter cysts) and surrounded by solid fibrous reactions appear to be considerably refractory to treatment (drugs used see [Table 2](#)). Children suffering from larval cestode infection usually respond more sensitively to chemotherapy than adults. **Albendazole** and **praziquantel** may be useful for affecting and eliminating living cysticerci in brain parenchyma and in the subarachnoidal space. **Antiepileptic drugs** are the treatment of choice for patients suffering from epileptic attacks caused by neurocysticercosis with calcifications. The administration of such drugs is indicated when seizures are the only manifestation of the disease and there is no imaging and immunological evidence of living parasites. **Corticosteroids** should be used simultaneously with chemotherapy (for 2 or 3 days prior to and during drug treatment) to reduce exacerbation of neurological symptoms. Any cysticercocidal drug may cause irreparable damage when used to treat ocular or spinal cysts, even when steroids are used. An ophthalmic examination must be carried out before treatment. **Surgical removal** of cystic echinococcosis (*E. granulosus*) appears to be the treatment of choice if cysts are large (>10cm Ø). When surgical excision cannot be performed because of general condition of the patient and the extent and location of the cyst, **long-term chemotherapy** should be performed either with **albendazole** (10 mg/kg, b.w.) or **mebendazole** (40–50 mg/kg, b.w.) for at least 3 months. These benzimidazole carbamates also inhibit the growth of larval *E. multilocularis*, reduce metastases, and may enhance both the quality and length of patient's survival. Sometimes they may be larvicidal after prolonged therapy but often recurrence may occur.

Alveolar hydatid disease (*E. multilocularis*) is often diagnosed too late so that lesion becomes inoperable. This may also be true for surgical resection of extensive lesions caused by polycystic echinococcosis (*E. vogeli*). Liver transplantation has been successfully performed on otherwise terminal cases. Often combination of surgery with chemotherapy (albendazole) is more likely to be successful in cases in which resection is difficult and usually incomplete. Postoperative chemotherapy should be done routinely for at least 2 years after radical surgery. Also prolonged follow-up of patients for at least 10 years with ultrasound or other imaging procedures is necessary to track down possible recurrence of cysts. Combined methods of percutaneous cyst puncture and drainage under ultrasound guidance can be carried out with or without injection of a protoscolicidal compound (e.g., 95% ethanol, or 20% sodium chloride solution). Thus liquid cyst content is aspirated (or drained), the chemical installed, and then re-aspirated (or drained). Secondary echinococcosis, which may be caused by accidental spill of cyst fluid during this procedure, can be minimized with simultaneous administration of albendazole or preoperative use of praziquantel. Ivermectin directly injected into hydatid cyst of *E. granulosus* has been found to damage viable protoscoleces in gerbils 6–8 weeks after injection. “Percutaneous drainage, i.e., aspiration-injection and re-aspiration” (= PAIR) should be performed only if cysts have no biliary communication. Otherwise, sclerosing cholangitis may occur when the chemical is installed. Therefore prior to PAIR, cyst fluid has to be investigated for the presence of bilirubin.

---

## CFT

Complement fixation text, →[Serology](#).

---

## Chabert, Philibert (1737–1814)

French veterinarian and describer of different worms.

---

## Chabertia

→[Nematodes](#), e.g., most common: *C. ovis* of sheep.

## Chagas, Carlos (1879–1934)

Brazilian physician and discoverer of the life cycle of  
→ *Trypanosoma cruzi*.

## Chagas' Disease, Animals

→ Cardiovascular System Diseases, Animals.

## Chagas' Disease, Man

### Pathology

→ *Trypanosoma cruzi* infection occurs in Central and South America and is transmitted by triatomid → bugs (→ Kissing Bugs). These hematophagous → hemiptera evacuate their intestinal contents containing the infection's metacyclic forms, while feeding, in order to ingest more blood. Metacyclic forms enter either the skin through the site of the bite, are inoculated by scratching the itching bite wound, or penetrate the mucosa of the conjunctiva or mouth. → Amastigotes multiply in adjacent muscle and fat cells in the dermis, producing an inflammatory → nodule, the chagoma, which is composed of parasitized cells, histiocytes, and a periphery of neutrophilic granulocytes. This chagoma may persist for several weeks. Trypanosomes are disseminated via the lymphatics, often enlarging the regional lymph nodes. Hematogenous dissemination follows and amastigotes parasitize many tissues, especially histiocytes, adipocytes, myocardial fibers, and autonomic ganglia in the gastrointestinal tract; this is accompanied by fever. The parasitized cells are usually destroyed (→ Pathology/Fig. 13D). When the infection is transmitted by blood transfusion it is particularly severe because it starts with the hematogenous phase of dissemination without any preceding immunization during the chagoma stage. However, the majority of patients with naturally acquired *T. cruzi* infection experience a benign or asymptomatic infection.

The most important lesions are in the heart, the esophagus, and the colon. The myocardium contains large → pseudocysts of amastigotes without surrounding inflammation (Fig. 1). Destroyed myocardial cells are also found, with lymphocyte, plasma cell, and macrophage infiltration often forming "microabscesses" that later heal by fibrosis (→ Pathology/Fig. 13D). During chronic Chagas' disease, which

may last for years, the heart usually undergoes marked hypertrophy (400–800 g) and dilatation. Mural thrombi are commonly found. Next to the apex of the left ventricle myocardial inflammation and fibrosis are often most advanced, and the ventricular wall may become so thin as to be transilluminable. After the Purkinje fibers are destroyed, conduction defects, such as arrhythmias, hypotension, tachycardia, right bundle branch block, and later bradycardia make their appearance. Myocardial failure responds poorly to digitalis and results in death, as does ventricular fibrillation. There are usually few amastigotes in the lesions of chronic Chagas' myocarditis, but the myocarditis with diffuse fibrosis still progresses. This has led to various hypotheses suggesting that delayed → hypersensitivity or → autoimmunity may participate in the pathogenesis. However, reviewing these, there is enough pathologic evidence to support a direct effect of *T. cruzi* on infected cells.

The autonomic ganglia of the esophagus and colon may be destroyed either by parasitization or by an undetermined process. The destruction leads to an interruption of the peristaltic wave and dilatation of the viscus proximal to the destroyed ganglia, often resulting in megaesophagus and megacolon.

Chagas' → encephalitis is seen especially in young children, with parasitization of neurons by amastigotes and destruction of even unparasitized cells. There is marked focal neuronal damage accompanied by lymphocytic infiltration and extending into the meninges. Death may occur after a disease course of only 1–2 months.

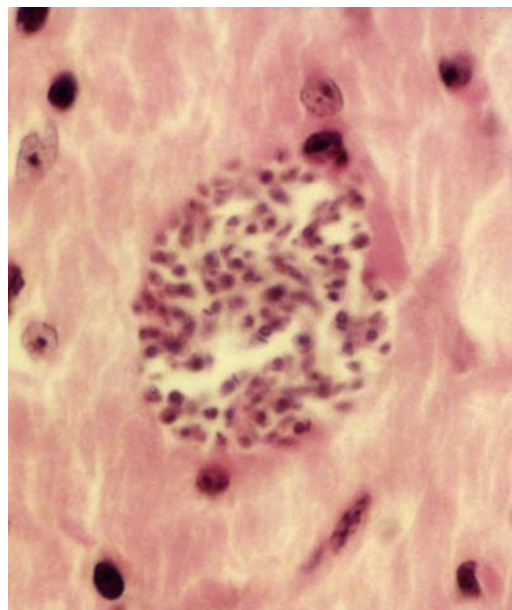

**Chagas' Disease, Man. Figure 1** Giemsa stained section through a muscle fiber with a pseudocyst of *Trypanosoma cruzi*.



There are many cases known of spontaneous cure and of chronic asymptomatic parasitemia lasting for 20–40 years without apparent progressive organ lesions. Minor lesions include the lipochagoma resulting from the destruction of adipocytes by trypanosomes, and a painful lipogranuloma which, if it occurs in the cheeks, interferes with eating.

Placental infection may occur and lead to →abortion. Sometimes the fetus becomes infected, resulting in encephalitis and death a few days or weeks after delivery.

## Immune Responses

*T. cruzi* is able to infect virtually any nucleated cells of mammals. In infected mammals *T. cruzi* can be found either as flagellated trypomastigote or as amastigote replicating inside of cells. Amastigotes can be found both within phagocytic →vacuoles as well as free in the →cytoplasm. After rupture of the host cell, amastigotes transform into →trypomastigotes, which are the most infective forms. The intracellular habit may be the reason why *T. cruzi* did not evolve mechanisms of adaptive genetic variation to alter expression of surface proteins such as occurring in African trypanosomes. In humans, the majority of infections with *T. cruzi* are thought to be asymptomatic. Chagas' disease typically represents a chronic disease, with a long-term interaction of the host's immune system and the parasite. Sterile immunity is seldom or never achieved and human *T. cruzi* infections are often dormant for decades. As in the case of *T. gondii*, reactivation has been described to occur during intentional immunosuppression for organ transplants or in →AIDS patients. Mouse models of *T. cruzi* infection have been used by many investigators to study both acute and →chronic infections to elucidate immune-response mechanisms leading to the control of the parasite or to autoimmune pathology. Differences in *T. cruzi* strains can greatly influence the immunological characteristics and disease outcome. In addition, inbred mouse strains have been classified as being susceptible or resistant to *T. cruzi* infection, but this responsiveness clearly depends on the parasite strain as well.

A typical feature of *T. cruzi* infections in mice is a profound suppression in multiple components of the immune system, which for example, can result in exacerbated viral infections (e.g., Murine leukemia virus). Likewise, virtually all immune-defense mechanisms appear to be involved in the control of *T. cruzi* infection and disease development.

## Innate Immunity

*T. cruzi* activates cells of the innate immune system by glycosylphosphatidylinositol and the Tc52-released protein as TLR2 agonists, glycoinositolphospholipid-containing

ceramide as TLR4 agonist, and unmethylated CpG motifs as potential TLR9 agonists. TLR2-deficient mice develop enhanced parasitemia and mice deficient for the TLR adaptor protein Myeloid Differentiation factor 88 (MyD88) display impaired production of pro-inflammatory cytokines and enhanced susceptibility. During the very early phase of infection NK cells are activated via IL-12 produced by macrophages in response to live, infective trypomastigotes. IFN- $\gamma$ , produced very early by activated NK cells has a protective effect on experimental *T. cruzi* infection *in vivo*. Both, neutralization of IFN- $\gamma$  or depletion of NK cells by mAb treatment rendered relative resistant mice more susceptible to the infection and increased parasitemia. However, IFN- $\gamma$  produced in the later phases of acute infection may not be relevant for protection.

As the acute infection progresses, polyclonal activation of essentially all peripheral lymphoid cell types is induced. One minor subset intensely expanded is the  $\gamma\delta$  T cells. Although the relevance of this subset for host protection is still uncertain, one study showed that  $\gamma\delta$ T cells are able to modulate the intensity of parasitemia, mortality, and tissue inflammation.

## B Cells and Antibodies

Polyclonal activation of B cells during the acute phase of infection leads to marked Ig production of all isotypes, but only a minor component of the Ig's appears to be parasite-specific. However, transfer of serum containing *T. cruzi*-specific antibodies mediated significant protection against the infection. In this regard, *T. cruzi* differs from other intracellular pathogens, in that humoral responses do play a protective role against circulating trypomastigotes. CD5<sup>+</sup> B1 cells may play an important regulatory role by their capacity to produce IL-10. It has been reported, that mice carrying the *xid* defect and therefore lacking B1 cells, showed an increased IFN- $\gamma$  production and were more resistant than the appropriate control mice.

## T Cells

A number of studies demonstrated that both CD4<sup>+</sup> and CD8<sup>+</sup> T cells were needed for parasitemia control and survival in acute infection. Elimination of CD4<sup>+</sup> T cells by antibody treatment or in MHC class II deficient mice resulted in markedly increased susceptibility to *T. cruzi* infection while athymic mice receiving syngeneic CD4<sup>+</sup> T cells were better able to contain parasitemia. The need for CD4<sup>+</sup> T cells has been attributed to the production of cytokines stimulating macrophages to kill intracellular parasites and/or to help in the production of protective parasite-lytic antibodies. Elimination of CD8<sup>+</sup> T cells by preventing MHC class I expression in gene-deficient mice or by treatment with mAb also resulted in markedly increased susceptibility to *T. cruzi* infection. Mice made deficient in both CD4<sup>+</sup> and CD8<sup>+</sup>

T cells are even more susceptible to increased parasitemia and death, which is consistent with a crucial role for IFN- $\gamma$  produced by both CD4<sup>+</sup> and CD8<sup>+</sup> T cells.

In contrast to other experimental parasitic infections, infection with *T. cruzi* does not result in a clear polarization of Th1 or Th2 cytokine responses, as both IFN- $\gamma$  and IL-10 were found to be produced simultaneously. Instead, separate Th1 and Th2 waves may occur at different stages of infection within the same resistant host and a higher amplitude and more rapid onset of a Th1-type response correlated with resistance.

At least in the Brazilian strain model of infection, most of the IFN- $\gamma$  appears to be produced from a very unusual subset of ab TCR<sup>+</sup>, NK1.1<sup>-</sup>, CD4<sup>-</sup> and CD8<sup>-</sup> (DN) T cells. However, for reasons unclear so far this cell population does not seem to play any major protective or inflammatory role in *T. cruzi* infection.

### Immunosuppression

The observation that effector mechanisms were impaired in mice infected with *T. cruzi* led to the search for soluble mediators of this deficiency. TGF- $\beta$ , which exerts suppressive effects on macrophages and T cells, was found to be released in a biologically active, processed form by cultured spleen cells from *T. cruzi*-infected mice already on day 8 postinfection. Since in most cases TGF- $\beta$  is produced in an inactive latent form, it was analyzed, how activation occurs in *T. cruzi* infection. Recent findings suggest, that *T. cruzi* trypomastigotes themselves have a potent enzyme capable of activating TGF- $\beta$ . Since administration of recombinant TGF- $\beta$  to resistant B6D2 F1 mice significantly increased both  $\rightarrow$ morbidity and mortality in these animals, TGF- $\beta$  induced and activated by *T. cruzi* may represent a novel mechanism for pathogenesis.

Another candidate for a mediator of macrophage inhibition is IL-10. Like the "host protective" IL-12, IL-10 can also be produced by macrophages in response to live infective trypomastigotes. Since *in vitro* IL-10 is able to inhibit the ability of macrophages to kill intracellular *T. cruzi*, it has been considered as a "parasite protective" cytokine. In line with this, administration of neutralizing anti-IL-10 mAb could block the development of acute disease in susceptible C57BL/6 mice. In addition, it has been established that infections with *T. cruzi* (strains  $\rightarrow$ CL or Tulahuen) trigger a significantly stronger IL-10 production in susceptible than in resistant mice. On the other hand, IL-10 may also possess protective effects, since IL-10 knockout mice infected with the Tulahuen strain showed accelerated mortality, as compared to wild type mice despite a reduced parasite load. In these IL-10-deficient mice, not only rIL-10 but also anti-IL-12 mAb reversed the susceptibility, leading to the conclusion, that IL-10 may prevent toxic immune responses characterized

by overproduction of IL-12 and IFN- $\gamma$ . However, Treg cells as a potential source of IL-10 and TGF- $\beta$  do not appear to play a major role in regulating CD8<sup>+</sup> T cell effector responses during the acute phase of infection, nor in the muscle of mice during chronic *T. cruzi* infection. A second mechanism of immunosuppression beside soluble mediators involves the induction of activation-induced programmed cell death,  $\rightarrow$ apoptosis. Selective triggering of CD4<sup>+</sup> T cell apoptosis has been described in experimental *T. cruzi* infection, which is mediated via the TCR-CD3 pathway and not via CD69 or Ly-6.

### Autoimmunity

There is strong evidence that much of the pathology of chronic Chagas disease, such as cardiac manifestations or peripheral neuropathy, is caused by autoimmune mechanisms. One antigen of *T. cruzi* (FL-160) has been implicated in molecular mimicry of nervous tissues. About 40% of persons with chronic *T. cruzi* infections had antibodies to the FL-160 antigen, and antibodies to 2 epitopes in this protein have been shown to bind to human sciatic nerve. Ribosomal P proteins of *T. cruzi* are also able to trigger antibody responses against host P proteins, which, interestingly, have previously been implicated as autoimmune targets in SLE patients. Furthermore, human T cells and antibodies reacting with  $\rightarrow$ myosin and most likely involved in the pathogenesis of Chagas cardiomyopathy may be triggered by a cross-reactive antigen of *T. cruzi*, which was identified recently.

### Vaccination

The approximately 12–20 million individuals in Central and South America infected with *T. cruzi* represent an important medico-social problem. Various chemotherapeutic drugs have become available but no vaccines have been developed. An important effort of Public Health Organization in Brazil, Uruguay, and Argentina has successfully controlled the domestic hemiptera vector  $\rightarrow$ *Triatoma infestans*, and transmission of Chagas' disease in these countries, is practically reduced to blood transfusion accidents. In other South and Central America countries anti-vector campaigns are successfully in progress. This success in transmission control considerably decreases the interest in vaccination against Chagas' disease. However, a large number of animal species from different orders of mammals are *T. cruzi* reservoirs in nature, including domestic animals like cats and dogs, which represent potential sources of infection for man. Thus, if available, vaccination would have a double interest: (1) Control of animal's sources of infection and (2) Protection of humans migrating in new eventual endemic areas will be possible in future in the Amazon Region. No evidence of  $\rightarrow$ antigenic variation has been found in *T. cruzi* as described for the African trypanosomes. However,

2 main lineages of parasites have been recently identified by molecular markers, one more frequent in human infections and the other in →[animal reservoirs](#). In both lineages, the parasite from the vector insect stage (Triatomidae) can be grown easily in liquid culture with semi-synthetic or defined medium while the vertebrate form can also easily grow in tissue culture using a variety of cells from mammals or birds. Thus, the preconditions for developing vaccines directly from parasites' materials are there, either for development of attenuated lines or chemical purification of antigen components.

About 90% of infected persons recover from the acute stage, but continue to have low parasitemias for an indefinite period of time without clinical signs. A small proportion of them later develop the chronic form of Chagas' disease, with chronic myocarditis or mega-esophagus or mega-column syndromes. In the asymptomatic period, carriers have antibodies to *T. cruzi* and this immune response has been considered responsible for resistance to challenge infections in experimental models and man.

Attempts have been made to develop live vaccines using parasites attenuated by chemical modification, by culture passage, and by x-ray irradiation. Most of these live vaccines have induced partial immunity but have also shown pathogenic side effects. Some authors have reported protection of laboratory animals immunized with subcellular fractions of *T. cruzi*. Others have described a 90-kilodalton glycoprotein which exists on the parasite's cell surface throughout the life cycle and which was partially protective in mice and in marmosets. An important objection to the use of natural sources of antigens from *T. cruzi* for vaccination is the description by different authors of molecular mimicry between *T. cruzi* antigens and different cell proteins from the human host with description of parasite-antigen driven human T-cell clones that react with cardiac myosin. Antibodies to ribosomal P proteins of *T. cruzi* have been shown to lead to cross-reaction with heart tissue and eventually be implicated in the induction of myocarditis. Because of these potential cross-reactions and consequent autoimmune pathologies, some authors consider that the development of a classical vaccination against Chagas' disease is not suitable. There are apparently 2 types of antibodies with different functional activities. Protective or complement-dependent "lytic" antibodies (LA) are associated with host resistance, whereas "conventional →[serology](#)" antibodies (CSA) are not. Chronically infected patients or animals have both LAs and CSAs, whereas experimentally immunized animals only have CSAs. However, it is not yet possible to decide whether a vaccine induces protection without knowing first if some of its components will not provoke autoimmune pathology with later manifestations as in natural infection.

Different groups have recently shown that CD8<sup>+</sup> T cells, IFN-gamma and macrophages play an essential role in the control of parasite multiplication in the acute phase. They have identified cytotoxic epitope in the trypanosome surface antigen 1 (TSA-1) and in trypanosome surface proteins members of the →[trans-sialidase](#) superfamily. Effective protection against the acute infection was obtained with immunization by plasmid DNA containing genes corresponding to these antigens.

**Main clinical symptoms:** Chagom at bite site, →[lymphadenitis](#), →[edema](#), fever, hepatosplenomegaly, cardiomegaly, aneurisms.

**Incubation period:** 5–20 days.

**Prepatent period:** 1–2 months.

**Patent period:** 20 years.

**Diagnosis:** Serologic tests, microscopic examination of blood smears, →[xenodiagnosis](#) using uninfected →[bugs](#), →[serology](#).

**Prophylaxis:** Avoid bites of triatomid bugs.

**Therapy:** Treatment see →[Trypanocidal Drugs, Man](#).

---

## Chagom

Initial sign (swelling of skin) of Chagas' disease.

---

## Chalimus

Larval stage of ectoparasitic copepods (→[Lepeophtheirus salmonis](#), →[Lemaecocera](#)).

---

## Chancere

Papular and later ulcerating lesion caused by African trypanosomes which are present extracellularly in the subcutaneous tissue at the site of the bite of the →[Tsetse fly](#) (→[Sleeping Sickness](#)).

---

## Charcot-Leyden Crystals

→[Pathology](#), →[Angiostrongylus cantonensis](#), →[Schistosomiasis, Animals](#), →[Schistosomiasis, Man](#), →[Paragonimiasis, Man](#), →[Sparganosis, Man](#); also found in →[Amoebiasis](#) and →[Angiostrongylosis, Trichuriasis](#).

## Chelae

Sharp claws at the tips of chelicerae of mites (→e.g., *Cheyletiella*) or spiders.

## Chelicerae

The first pair of appendages of →ticks and other arachnids; they consist of 3 segments starting from the very end of the →basis capituli. In ticks they become essentially modified and are used for grasping, piercing, cutting, etc. during food gathering or feeding.

## Chelicerata

### Synonym

→Amandibulata.

### Classification

Subphylum of →Arthropods. Arthropods that lack antennae and mandibles are commonly placed in the subphylum Chelicerata, thus named because the first anterior appendages become feeding organs called →chelicerae (→Arthropoda/System). The Chelicerata contain as parasitic group the economically and medically important order of →Acarina (→Ticks and →Mites), while the sister groups of →scorpions and →spiders may have a considerable medical impact as poisonous animals.

## Chemokines

→Cytokines that are involved in infectious diseases (e.g., like IL-9) being responsible for the induction and migration of subsets of leukocytes. This is a superfamily of low molecular weight (6–17 kDa) cytokines, which recruit distinct groups of leukocytes and activate them through increased adhesion, degranulation, and respiratory burst. Up to now 44 different chemokines are described plus 21 chemokine receptors. The chemokines represent excreted proteins consisting of 67–127 amino acids. Previously chemokines were grouped into inflammatory or homeostatic chemokines. Today however, it is shown, that at least some have double functions.

## Chemoprophylaxis

Administering a chemical agent to avoid the development or spread of a certain disease (→Chemotherapy).

## Chemotaxis

Movements of protozoans/cells due to attraction by chemical gradients; from Greek: *taxis* = position.

## Chemotherapy

### Definition

Drug application after appearance of clinical signs may eliminate or damage pathogens/parasite and lead to recovery of health in the patient.

### General Information

Chemotherapy (CT) and →chemoprophylaxis (CP) are experimental sciences dealing with drugs that selectively inhibit or destroy parasites or other pathogens. Thus, attention to selective toxicity of antiparasitic drugs is central to CP and CT, and useful chemotherapeutic agents should affect the parasite more adversely than the host. Until now, there is no completely safe drug. Knowledge of sources of drugs (pharmacognosy), action and fate in the body (pharmacodynamics), use in the treatment of disease (therapeutics), adverse effects (toxicology), and contraindications is a must to evaluate potential risks as well as possible benefits of drugs to the patient's well-being.

### Withdrawal Time of Drugs in Target Animals

Claims made by the drug manufacturer for a drug product in treatment of target animals consumed by humans (poultry, bovines, equines) must have been investigated and evaluated in the target animal, besides toxicological studies in rodents (rat, mouse) and other species. The latter are required to determine the ADI. The acceptable daily intake is the dose of a drug residue in edible tissues, like meat, various organs, fat, etc., that during the entire lifetime of a person seems to be without obvious risk to health on the basis of all toxicological data known at the time. The ADI for humans may be determined by applying a safety factor

of 1:100, or a safety factor of at least 1:1,000 in case of a teratogenic drug. Therapeutic claims made by the manufacturer must coincide with safety and tissue residue data for the drug approved by government regulatory agencies. The **preslaughter withdrawal time** refers to the interval from the time an animal is removed from medication until the permitted time of slaughter (→[Nematocidal Drugs, Animals/](#)Table 2). During this interval the residue of toxicological concern will reach a safe concentration as defined by the maximum residue limit (MRL). Recent workshops give guidance to the analytical approaches. There may be 3 **types of tolerances** in defining allowable concentrations of drug residues at the time of slaughter up to the time of consumption by humans. (1) The finite tolerance (measurable amount of drug residue permitted in food), (2) the negligible tolerance (insignificant amounts of residue, i.e., a small fraction of maximum ADI), or (3) the zero tolerance (no residue is permitted in feed or food because of extreme toxicity or because the drug is carcinogenic). Questions and answers concerning specific legislation of the establishment of MRLs in the European Union cf. website address <http://www.emea.eu.int/htmls/vet/>).

## Drugs

### General Information

Drug can be broadly defined as any chemical compound that affects living processes and is used in the diagnosis, prevention, treatment (cure) of disease(s), or for controlling or improving any physiological or pathological disorder or for relief of pain in animals and humans. A drug may have various names: one or more **chemical names** depending on rules of chemical nomenclature used: (1) usually one international nonproprietary name (**INN**), (2) one or more nonproprietary names, e.g., in different countries, and (3) usually several proprietary names or brand names of a drug product. Drug products are galenic, pharmaceutical, and/or medicinal preparations of drugs, e.g., various drug forms and dosage forms. These may be powders, tablets, pills, capsules, sustained-release boli, or several liquid preparations, e.g., mixtures, or emulsions for oral administration or medicated feed articles. Dosage forms for injections are ampules, multidose vials, large-volume capped bottles, and implants that may be hard, sterile pellets inserted under skin. The parenteral administration of such preparations may be done either by subcutaneous (s.c.), intramuscular (i.m.), intravenous (i.v.), intraperitoneal (i.p.), or intrathecal (i.e., into the subarachnoid space) injection. For application to skin surface several external preparations of drugs may be used such as liniments, lotions, ointments, creams, dusting powders, or aerosols, e.g., topical insecticides.

### Critical Use of Drugs in Concert with Other Control Measures

The administration of chemotherapeutic or chemoprophylactic agents can only be regarded as a suitable measure when individual cases or parts of the population or herds are treated under controlled conditions after a diagnosis has been made. Parasitism in the field is often a multifactorial problem. Thus, methods of control must include epizootiological/epidemiological and therefore ecological and economic aspects as well as consideration of the development of resistance to drugs by the parasites. Drug application is important but not the only control measure in a large-scale, complex **control strategy**. The aim of each of the measures that can be taken is to reduce or even completely eliminate the parasite population in its environment. However, the tasks, solutions, and objectives of a certain strategy require profound knowledge of the biology of the parasites and the →[epizootiology](#) or →[epidemiology](#) of parasitism. Thus, when planning and implementing programs of this type, account must be taken of the many different interactions between host and parasite on the one hand (mode of transmission and susceptibility of the population) and those between parasite and/or host and biotype on the other (e.g., pathogen reservoir). Knowledge of the **environmental factors** such as temperature, humidity, soil structure, and prevailing weather conditions, which are critical within the infection chain, are of practical importance for forecasting parasitic risk in certain areas.

In order for the chemotherapeutic agent administered to have its optimum effect against the parasites, the **time of treatment** must be adapted to the development cycle of the parasite. An example of this is the →[metaphylaxis](#) often practiced in veterinary medicine when the aim is to prevent the outbreak of disease in animals already infected, i.e., to kill off certain parasitic developmental stages in the host before serious damage occurs. The correct timing of the treatment in relation to the course of the infection is therefore critical for the success or failure of drug →[metaphylaxis](#).

As is well known, the acquired and often species-specific or even life-cycle-stage-specific **immunity** (→[Immune Responses](#)) of the host plays an important role in the elimination of parasites. It would be ideal if CT and immunoprophylaxis (→[Vaccination](#)) had a synergistic effect. However, drugs can suppress the development of immunity and the immune response of the host may not materialize. Thus, the lack of an immune response may result from starting treatment at the incorrect time in relation to the course of the infection. This may be true for instance when treatment and infection take place at the same time, or the treatment starts shortly after the infection, as a result of which the parasites are immediately eliminated (without antigenic effect).

In modern livestock farming in which large numbers of animals are reared and fattened in a confined space, continuous drug application must often be performed via the feed. This is because other preventive measures, such as methods for maintaining good [→hygiene](#) and disinfection ([→Disease Control](#)), have either not yet been developed or are as yet inadequate (such as reliable immunoprophylaxis or vaccination) against the high risk of parasitism that exists with this form of farming. Thus, without prophylactic medication, the rapidly increasing pressure of infection would lead to an outbreak of disease in a herd. Consequently, in the fattening of poultry feed additives such as [→coccidiocidal drugs](#) can control outbreaks of coccidiosis and therefore serious financial losses can be reduced to a minimum during the fattening period.

A few examples clearly show that prophylactic or therapeutic agents must not be used in a stereotyped fashion. Often their use must be adapted to varying relationships between the parasite and host populations and their environment; only then will a treatment campaign have the desired success. Flexible handling of the chemotherapeutics also considerably slows down the development and therefore the spread of drug-resistant parasites. Before the start of every course of treatment adverse effects of the chemotherapeutic agent must be taken into account in the treatment plan. They should be reduced to a minimum by varying the dosage regimen and the treatment intervals. Anaphylactic reaction to the drug used or the intrinsic toxicity of the drug including its toxic metabolites may induce a severe and life-threatening risk to a patient. This may be applied also to severe allergic reactions caused through toxic metabolic products of endoparasites released after the drug has killed parasites.

### Related Entries

[→Acanthocephalacidal Drugs](#), [→Antidiarrhoeal and Antitrichomoniasis Drugs](#), [→Arthropodicidal Drugs](#), [→Babesiacidal Drugs](#), [→Cestodocidal Drugs](#), [→Coccidiocidal Drugs](#), [→DNA-Synthesis-Affecting Drugs I](#), [→DNA-Synthesis-Affecting Drugs II](#), [→DNA-Synthesis-Affecting Drugs III](#), [→DNA-Synthesis-Affecting Drugs IV](#), [→DNA-Synthesis-Affecting Drugs V](#), [→Drugs](#), [→Drugs Against Sarcocystosis](#), [→Drugs Against Microsporidiosis](#), [→Ectoparasitocidal Drugs](#), [→Energy-Metabolism-Disturbing Drugs](#), [→Hem \(oglobin\) Interaction](#), [→Inhibitory-Neurotransmission-Affecting Drugs](#), [→Leishmaniacidal Drugs](#), [→Malariaicidal Drugs](#), [→Microtubule-Function-Affecting Drugs](#), [→Myxosporidiacidal Drugs](#), [→Nematocidal Drugs](#), [Animals](#), [→Nematocidal Drugs](#), [Man](#), [→Opportunistic Agents](#), [→Treatment of Opportunistic Agents](#), [→Theileriacidal Drugs](#), [→Trematodocidal Drugs](#), [→Trypanocidal Drugs](#), [Animals](#), [→Trypanocidal Drugs](#), [Man](#), [→Vaccination Against Protozoa](#).

## Cheyletiella parasitivorax

[→Mites](#) of rabbits.

## Cheyletiella Species

Species of the genus *Cheyletiella* reach a size of 0.2–0.5 mm parasitizing the hair of dogs (*C. yasguri*) and of foxes, cats (*C. blakei*), occasionally specimens are found even on humans. They are characterized by strong claws at the pedipalps (Fig. 1). The eggs (Fig. 2) are attached by filaments to hair. The total development (including egg – 1 larva – 2 nymphs) until adult males and females takes 3 weeks. Due to their feeding activity at the skin, infestations with such mites lead to a strong

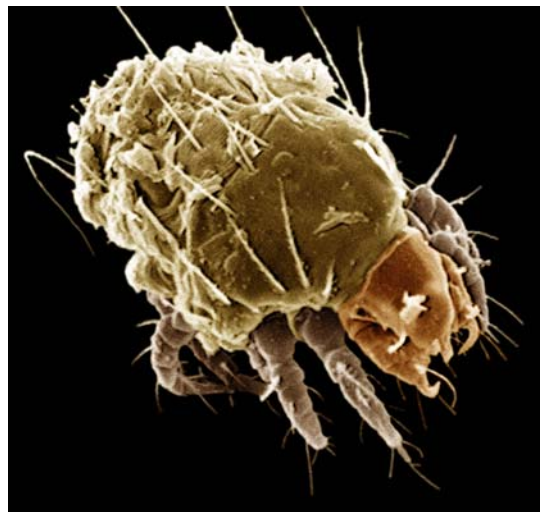

**Cheyletiella Species. Figure 1** SEM of *Cheyletiella yasguri*-mite.



**Cheyletiella Species. Figure 2** SEM of an egg of *Cheyletiella yasguri* being attached to a hair.

itching, to dermatitis, to loss of hair, allergic reactions, and bacterial superinfections. Often such small mites are covered by skin detritus, thus were not clearly seen and therefore called “walking dandruff.”

---

## Cheyletiellosis

→Mange, Animals/Cheyletiellosis.

---

## Chicleros Ear / Ulcer

Symptom due to →cutaneous leishmaniasis in South America.

---

## Chikungunya

Disease due to alphaviridae transmitted by bite of →*Aedes*-mosquitoes with considerable muscle and articulation pain.

---

## Chilodonella

Heart-shaped ciliate (e.g., *C. cyprini* of carps) of about 0.07 mm in size, which lives on the skin and gills of fish and leads to the production of slime and eventually to death due to the lack of oxygen. →Ciliophora.

---

## Chilomastix mesnili

→Diplomonadida, →Retortamonadida.

---

## Chirodiscoides caviae

### Name

Greek: *cheir* = hand, *diskoides* = disk-like.

Mite of the guinea pig fur, of which the first and second pair of legs are modified for clasping (Fig. 1). This mite



**Chirodiscoides caviae.** Figure 1 LM of a female.

(3–4 mm) is also called “static louse,” since it mainly remains in the fur, leading to itching.

---

## Chironomids

→Mosquitoes, non-biting group.

---

## Chitin

Chitin is a polysaccharide of *N*-acetylglucosamine (GlcNAc) residues joined by  $\beta(1 \rightarrow 4)$  glycosidic links that forms the cell walls of →fungi and the exoskeletons of →arthropods. In endoparasites, this polymer is a component of the nematode eggshell, the protective sheath of microfilariae and the cyst walls of →protozoa, but is also expressed at the cell surface of trichomonad species. Chitin is synthesized by the stepwise polymerization of GlcNAc from UDP-GlcNAc as catalyzed by chitin synthase. The straight chains of the chitin polymer are important for the maintenance of the structural integrity and protection of the organism from environmental, chemical and mechanical damages. As chitin synthesis and assembly do not occur in higher animals these processes serve as targets for antiparasite chemotherapy.

## Chitin Synthesis Inhibitors

Products that hinder molt of insect larvae (they are used e.g., to interrupt larval development of fleas).

## Chlordane

### Chemical Class

Organohalogenide (organochlorine compound, cyclo-diene).

### Mode of Action

GABA-gated chloride channel antagonist. → [Ectoparasitocides – Antagonists and Modulators of Chloride Channels](#).

## Chlordimeform

### Chemical Class

Amidine (formamidine).

### Mode of Action

Octopamine receptor agonist. → [Ectoparasitocides – Modulators/Agonists of Aminergic Transmission](#).

## Chlorfenvinphos

### Chemical Class

Organophosphorous compounds (organophosphate).

### Mode of Action

Acetylcholine esterase inhibitor. → [Ectoparasitocides – Agonists and Antagonists of Cholinergic Transmission](#).

## Chloride Cells

Cells with the function to withdraw salts (e.g., in insects, → [pentastomids](#)) from body fluids.

## Chloropyga

Other/new genus name for → [Cordylobia](#)-type species are *C. anthropophaga* (Tumbu fly) and *C. hominivorax* (New World screwworm).

## Chloroquine

→ [Malariacidal Drugs](#).

## Chlorpyrifos

### Chemical Class

Organophosphorous compounds (monothiophosphate).

### Mode of Action

Acetylcholine esterase inhibitor. → [Ectoparasitocides – Agonists and Antagonists of Cholinergic Transmission](#).

## Choanotaenia infundibulum

Tapeworm of chicken, turkey, which reaches a length of about 25 cm in the intestine. Intermediate hosts are beetles, flies, and grasshoppers.

## Cholangitis

Symptom in → [microsporidiosis](#), AIDS.

## Cholecystitis

Symptom in → [clonorchiasis](#), opisthorchiasis, microsporidiosis.



## Cholesterol

This protein, which is an essential component of host cell membranes was recently shown to be necessary for binding and internalization of *Leishmania* stages and the subsequent presentation of leishmanial antigens in infected macrophages. Cyclodextrin-based compounds modulate cholesterol levels.

## Chorioptes bovis

Mange mite of cattle (Fig. 1). All stages feed by eating skin particles thus inducing allergic skin reactions, mainly due to their excretions. Males reach a size of 300–450  $\mu\text{m}$ , females grow up to 600  $\mu\text{m}$ . The complete development needs about 3 weeks on their host. They may survive away from their host for up to 70 days. Since they occur mostly close to the claws, the disease is called “foot-mange,” which, however, has mostly not very severe symptoms.

## Chorioptic Mange

→Mange, Animals/Chorioptic Mange.



**Chorioptes bovis.** Figure 1 *Chorioptes bovis* from ventral.

## Chromatin Diminution

→Nucleic Acids, →Nematodes.

## Chromatoid Bodies

→*Entamoeba histolytica*.

## Chromosomal Diminution

In the nematode of the horse (→*Parascaris equorum*) and in some other →nematodes the large compound chromosome is divided into small portions during divisions of somatic cells, which then have different quantities of DNA, while this does not happen during formation of →gametes.

## Chromosomes

### Protozoa

In many protozoans the correct number of chromosomes is unknown due to the fact that the nuclei are very small and/or the chromosomes do not condense during the →nuclear division (e.g., in →*Coccidia*). The ploidy of the different parasitic protozoans is also only poorly understood. DNA-measurements of all life-cycle stages showed that the coccidian genera →*Eimeria*, →*Sarcocystis*, →*Plasmodium*, →*Theileria*, →*Babesia*, and several genera of the hypermastigotes (→*Barbulanympha*, →*Gametes*/Fig. 8) are haploid (except for the →zygote), while the trypanosomatid genera →*Trypanosoma* and →*Leishmania* are diploid (except for a few haploid stages in the vector). This diploidy is, however, probably only found in the maxichromosomes (cf. →*Gametes*/Fig. 7, →*Trypanosoma*). In some groups (e.g., trypanosomatids) the size of the chromosomes varies completely within an individual; thus this →polymorphism also poses problems in counting. The application of different methods (e.g., pulse field electrophoresis, counting of kinetochores in ultrathin sections, etc.), however, allow some conclusions to be drawn (Table 1). Indications for (sex) determination of →gametes are scarce and mostly lacking.

**Chromosomes. Table 1** Number of chromosomes in some parasitic protozoans

Number of chromosomes	Species	Stage	Systematic position
2	<i>Spirotrichonympha polygyra</i>	Trophozoite	Sarcomastigophora/ Hypermastigida
2	<i>Mattesia trogodermae</i>	Trophozoite	Sporozoa/Neo gregarina
3	<i>Gregarina blattarum</i>	Trophozoite	Sporozoa/Eugregarinida
3	<i>Coelotropha durchoni</i>	Trophozoite	Sporozoa/Coccidia
4	<i>Trichomonas caviae</i>	Trophozoite	Sarcomastigophora/ Trichomonadida
4	<i>Babesia divergens</i>	Merozoite	Sporozoa/Piroplasmea
4	<i>Theileria parva</i>	Merozoite	Sporozoa/Piroplasmea
4	<i>Klossia helicina</i>	Macrogamete	Sporozoa/Adeleidea
4	<i>Stylocephalus longicollis</i>	Trophozoite	Sporozoa/Eugregarinida
5	<i>Eimeria tenella</i>	Macrogamete	Sporozoa/Coccidia
Several mini-, 3 medium and 2 big chromosomes	<i>Giardia lamblia</i> (USA <sup>1</sup> )	Trophozoite	Sarcomastigophora/ Diplomonadida
5/6	<i>Entamoeba histolytica</i> <sup>2</sup>	Minuta-form	Sarcomastigophora/Amoebida
6	<i>Aggregates eberthi</i>	Macrogamete/ sporont	Sporozoa/Coccidia
8	<i>Adelina cryptocerci</i>	Sporozoite	Sporozoa/Gregarinida
8	<i>Toxoplasma gondii</i>	Bradyzoite	Sporozoa/Coccidia
12	<i>Zelleriella intermedia</i>	Trophozoite	Sarcomastigophora/Opalinida
12	<i>Spirotrichosoma normum</i>	Trophozoite	Sarcomastigophora/ Hypermastigida
12–16	<i>Pneumocystis carinii</i>	Trophozoite	unknown
14	<i>Plasmodium falciparum</i> , <i>P. berghei</i> , <i>P. chabaudi</i>	Merozoite/ gamont	Sporozoa/Haeosporidia
24	<i>Spirotrichosoma promagnum</i>	Trophozoite	Sarcomastigophora/ Hypermastigida
26	<i>Barbulanympha ufalula</i>	Trophozoite	Sarcomastigophora/ Hypermastigida
28	<i>Notila proteus</i>	Gamont	Sarcomastigophora/ Oxymonadina
48	<i>Spirotrichosoma paramagnum</i>	Trophozoite	Sarcomastigophora/ Hypermastigida
60	<i>Spirotrichosoma magnum</i>	Trophozoite	Sarcomastigophora/ Hypermastigida
100 mini-, 1–8 medium, 14 megabase chromosomes	<i>Trypanosoma brucei brucei</i>	Trypomastigote forms	Sarcomastigophora/ Kinetoplastida
no mini- <sup>3</sup> , 17 medium <sup>4</sup> , more than 23 big <sup>5</sup> chromosomes	<i>Leishmania major</i> and other species	Amastigote forms	Sarcomastigophora/ Kinetoplastida

<sup>1</sup> the Australian isolates possess a further medium sized chromosome<sup>2</sup> recent result of Willhoeft and Tannich using pulsed field gel electrophoresis indicate the existence of 31–35 chromosomes ranging from 0.3 to 2.2 Mb, and a functional ploidy; the haploid genome size is thought to be around 20 Mb<sup>3</sup> smaller than 150–200 Kb<sup>4</sup> 350–900 Kb<sup>5</sup> bigger than 1 Mb

## Metazoa

Fertile adult stages of most metazoan are diploid (=2n) apart from some digeneans and →ticks, which may be either haploid (n) or triploid (3n). →Sex determination—mostly occurs by formation of morphologically different →sex chromosomes. These differences, however, are

not very significant in some groups of parasites. Thus heterochromosomes could not be unequivocally identified in the karyotypes of schistosomes, and only after the use of the so-called C-band treatment an univalent sex chromosome has been discovered in the female of several schistosome species. Table 2 summarizes the

**Chromosomes. Table 2** Chromosome numbers of some metazoan parasites

Number of chromosomes (2n)	Species	Stage	Systematic position
1 (compound chromosome)	<i>Parascaris equorum</i>	Adults	Nematodes
4	<i>Strongyloides papillosus</i>	Adults	Nematodes
6	<i>Strongyloides stercoralis</i>	Adults	Nematodes
6	<i>Culex pipiens</i>	Adults	Diptera, Insecta
6	<i>Macracanthorhynchus hirudinaceus</i>	Adults	Acanthocephala
8	<i>Diplozoon paradoxum</i>	Adults	Monogenea, Platyhelminthes
8	<i>Davainea proglottina</i>	Adults	Cestodes, Platyhelminthes
8–12	<i>Gyrodactylus elegans</i>	Adults	Monogenea, Platyhelminthes
8	<i>Moniliformis moniliformis</i>	Adults	Acanthocephala
10	<i>Vampirolepis nana</i>	Adults	Cestodes, Platyhelminthes
11	<i>Paragonimus westermani</i>	Adults	Digenea, Platyhelminthes
12	<i>Fasciola hepatica</i>	Adults	Digenea, Platyhelminthes
12	<i>Hymenolepis species</i>	Adults	Cestodes, Platyhelminthes
14	<i>Schistosomatium douthitii</i>	Adults	Digenea, Platyhelminthes
16	<i>Fasciola gigantica</i>	Adults	Digenea, Platyhelminthes
16	<i>Schistosoma species</i>	Adults	Digenea, Platyhelminthes
16	<i>Paragonimus kellicotti</i>	Adults	Digenea, Platyhelminthes
16	<i>Taenia taeniaeformis</i>	Adults	Cestodes, Platyhelminthes
18	<i>Trichobilharzia species</i>	Adults	Digenea, Platyhelminthes
18	<i>Diphyllobothrium species</i>	Adults	Cestodes, Platyhelminthes
18	<i>Echinococcus species</i>	Adults	Cestodes, Platyhelminthes
20	<i>Heterobilharzia species</i>	Adults	Digenea, Platyhelminthes
20	<i>Dicrocoelium dendriticum</i>	Adults	Digenea, Platyhelminthes Cestodes, Platyhelminthes
20	<i>Taenia saginata</i>	Adults	
20	<i>Otobius megnini</i>	Adults	Acari, Chelicerata
21	<i>Rhipicephalus species</i> <i>Hyalomma species</i>	Male adults	Acari, Chelicerata
22	<i>Rhipicephalus species</i> <i>Hyalomma species</i>	Female adults	Acari, Chelicerata
12–32	<i>Ornithodoros species</i>	Adults	Acari, Chelicerata
24	<i>Argas brumpti</i>	Adults	Acari, Chelicerata
26	<i>Argas persicus</i>	Adults	Acari, Chelicerata
23–28	<i>Ixodes species</i>	Adults	Acari, Chelicerata
43	<i>Ascaris lumbricoides</i>	Male adults	Nematodes
48	<i>Ascaris lumbricoides</i>	Female adults	Nematodes

chromosome numbers of some selected species of metazoan parasites showing a rather large scale.

## Chronic Infections

Long persistent infections mostly occurring in natural hosts and characterized by regular fluctuations in the level of parasitemia (e.g., → *Plasmodium* sp., trypanosomiasis) or in the quantity of the parasitic load (e.g., filariae), → *Arboviruses*.

## Chronobiology

→ *Favorisation*.

## Chrysomia bezziana

→ *Diptera*. This fly the larvae of which are called Old World Screwworm initiates → *Myiasis*, *Man*.

## Chrysomya megacephala

Common blowfly, which in Asia is called Oriental latrine fly due to its feeding on filth material, animal carcasses, garbage, etc. The larvae may also cause →[myiasis](#) in humans as well as act as mechanical vectors of viruses, bacteria, and parasites.

## Chrysops Species

Genus of →[Diptera](#), belonging to the brachyceran family Tabanidae (e.g., *Chrysops caecutiens*, *C. relictus* in Europe). They are often beautifully coloured blood suckers (as females) of up to 1.5 cm in length and possess large, coloured eyes (Figs. 1, 2). Their sawing mouthparts cut wounds into the skin, which become filled by blood. Thus they are pool-feeders. Their bite is rather painful. They act as vectors of filariid worms (e.g., →[Loa loa](#)) or mechanical transmitters of viruses and bacteria.

## Chyluria

Symptom in →[lymphatic filariasis](#) due to *Wuchereria* or *Brugia* worms.

## CIC

Circulating immune complexes (→[Immune Responses](#)).

## Cilia

→[Flagella](#).

Cilia (sing. Cilium) although shorter possess the same internal structures (→[Axoneme](#)) as →[flagella](#), but show different (often coordinated) movements due to interconnecting structures at their →[basal bodies](#).



**Chrysops Species. Figure 1** Light micrograph of the dorsal side of *Chrysops* sp.



**Chrysops Species. Figure 2** Anterior front of *Chrysops* sp.

## Ciliophora

### Synonym

Ciliata.

### Classification

Phylum of →[Protozoa](#).

### Important Species

Table 1.

**Life Cycle**

→ *Balantidium coli*/Fig.1, → *Ichthyophthirius multifiliis*/Fig. 1, → *Apiosoma*/Fig. 1, 2, → *Cryptocaryon*/Fig. 1, 2.

**Cimicidae**

See Table 1.

**Cimex lectularius**

→ Bugs; bed bug of humans.

**Synonym**

Bedbugs (→ Bugs).

**Ciliophora. Table 1** Some important species of the Ciliophora

Species	Principal hosts	Habitat	Size (εμm)
<i>Balantidium coli</i>	<b>Humans</b> , pigs, monkeys	Colon	50–100 × 45
<i>Balantidium</i> sp.	Sheep	Intestine	45 × 35
<i>Buxtonella sulcata</i>	Ruminants	Cecum	50–130 × 60
<i>Nyctotherus</i> sp.	<b>Humans</b>	Intestine	26 × 10
<i>N. cordiformis</i>	Frogs	Rectum	60–200
<i>N. ovalis</i>	Cockroaches, millipedes	Colon	90–185
<i>Ichthyophthirius multifiliis</i>	Fish (fresh water)	Integument	50–500
<i>Cryptocaryon irritans</i>	Fish (salt water)	Integument	30–300
<i>Chilodonella cyprini</i>	Fish	Integument	40 × 15
<i>Trichodina</i> spp.	Fish	Skin	80 × 80
<i>Epistylis</i> spp.	Fish	Skin	30 × 10 (without stalk)
<i>Carchesium</i> spp.	Fish	Skin	30 × 10 (without stalk)
<i>Glossatella</i> spp.	Fish	Skin	35 × 9
<i>Apiosoma piscicola</i>	Fish	Skin	80 × 38
<i>Enchelys parasitica</i>	Salmonid fish	Skin	60 × 20

**Cimicidae. Table 1** List of the subfamilies and genera of Cimicidae

<b>Primicimicinae</b>	<i>Bucimex</i> (Chile: 1 species) <i>Primicimex</i> (USA, Mexico and Guatemala: 1 species)
<b>Cimicinae</b>	<i>Bertilia</i> (Argentina and Chile: 1 species) <i>Cimex</i> (Cosmopolitan: 21 species) <i>Oeciacus</i> (Nearctic region, western Palearctic region: 2 species) <i>Paracimex</i> (Oriental region, Southern Africa: 13 species) <i>Propicimex</i> (Argentina and Brazil: 2 species)
<b>Cacodminae</b>	<i>Aphrania</i> (Afrotropical region, South East Asia: 5 species) <i>Cacodmus</i> (Africa, Middle East, Oriental region: 10 species) <i>Crasscimex</i> (Tropical Africa, Madagascar, Cambodia: 3 species) <i>Leptocimex</i> (West Africa, Sudan, Middle East, Sri Lanka: 4 species) <i>Loxaspis</i> (Tropical Africa and South East Asia: 6 species) <i>Passicimex</i> (Tropical Africa: 1 species) <i>Stricticimex</i> (Afrotropical and Oriental regions, Egypt: 10 species)
<b>Afrocimicinae</b>	<i>Afrocimex</i> (Equatorial Africa: 3 species)
<b>Latrocimicinae</b>	<i>Latrocimex</i> (Brazil and Trinidad: 1 species)
<b>Haematosiphoninae</b>	<i>Camincimex</i> (Argentina and Uruguay: 1 species) <i>Cimexopsis</i> (Mid-Western and Eastern USA: 1 species) <i>Haematosiphon</i> (Southwestern USA, Mexico: 1 species) <i>Hesperocimex</i> (Nearctic region: 3 species) <i>Ornithocoris</i> (Southeastern USA, South America: 2 species) <i>Psitticimex</i> (Argentina: 1 species) <i>Synxenoderus</i> (Western USA: 1 species)

## Cinerin

### Chemical Class

Natural products (terpenoid).

### Mode of Action

Open state voltage-gated sodium channel blocker.  
 →Ectoparasitocides – Blockers/Modulators of Voltage-Gated Sodium Channels.

## Ciprofloxacin

Antibiotic that is used to treat →[cyclosporiasis](#) in humans that are intolerant to sulfonamides (500 mg twice daily for 7 days).

## Circadian Rhythms

Parasites act or are present at special habitats during fixed hours of the day; e.g., →[Enterobius](#) females migrate nocturnally from the rectum to the perianal region to lay their eggs; larvae of →[Loa loa](#) are found in the peripheral blood between 1 pm and 3 pm, while the microfilariae of →[Wuchereria bancrofti](#) are seen there between 9 pm and 11 pm in the evening. Some mosquito species feed at night, others exclusively during daytime.

## Circomyarian Muscle Type

→[Nematodes](#).

## Circular DNA

→[Kinetoplast DNA](#).

## Circulating Antigen

Elisa – tests have been developed to detect circulating anodic antigen (CAA) and circulating cathodic antigen (CCA) in serum and urine of patients with schistosomiasis. Both antigens are found in more than 90% of the infected people and even diagnosed in people, where stool controls remained negative.

## Circumsporozoite Protein

→[Malaria](#), →[CSP](#), →[Vaccination](#).

## Cirripedia

Group of lower →[Crustacea](#) (= Entomostraca). The larvae are free-living and swim by cilia. Some attach to rocks, ships etc., produce calcareous shells (e.g., genus *Balanus*) and live as filter organisms. Some (e.g., *Sacculina carcini*) become parasites by entering the body cavity of crabs (Fig. 1). Only an amorphous mass (= which contains and excretes the larvae) is seen outside of a parasitized host, which at its inner side is completely filled by tumor – like growing strands of undifferentiated cells. Thus this group with about 230 marine species is called Rhizocephala (from Greek: *rhiza* = root, *kephale* = head), Fig. 1.



**Cirripedia. Figure 1** *Sacculina carcini* below the “tail” of a brachyceran crustacean (= crab).

## Cirrus

Penis-like structure of Platyhelminthes (→[Platyhelminthes/Reproductive Organs](#)).

## Cittotaenia

→[Eucestoda](#).

## Civil Unrest

Movement of human populations due to different reasons thus spreading agents of diseases, →[epidemiology](#).

## CL

Abbreviation for →[Cutaneous Leishmaniasis](#).

## Clade

A group of organisms that are related by descent from a common ancestor.

## Cladogram

A cladistic representation of a phylogeny, whereby only the branching order is displayed (→[Phylogeny](#)).

## Classification

### General Information

“Nothing remains as it is.” This sentence is true in particular with respect to the recent situation of

taxonomy, which – since its beginnings – has tried to reflect relationships between taxa. The earlier classifications were based on morphological and developmental similarities; and individuals resembling each other were grouped together as a species, similar species as genera, and so on. So much information accumulated that finally 2 different kingdoms – plants and animals – arose among the eukaryotic organisms, the origin of which, however, remained under constant discussion. Nowadays, the use of molecular →[biological methods](#) delivers new and deeper insights into the genetic repertoire of organisms and thus other interpretations are called for. When considering the ideas actually discussed ([Fig. 1](#), page 255), that all recent organisms are a mixture of different hereditary lines, including the genomes of former autotrophic →[prokaryotes](#), heterotrophic prokaryotes, and heterotrophic eukaryotes, the border between animals and plants becomes obsolete. Thus the position of the different parasites in this living world has reached the point of new allocation, and discussion is going on about mono- and polyphyletid modes during the evolution of metazoans. When looking at →[spliced leader RNA](#), →[trans-splicing](#), which was originally described as a mechanism of gene expression in parasitic →[Kinetoplastida](#) and which is now also found in free-living and parasitic helminths, new possibilities ([Fig. 2](#), page 256) for explaining the radiation of early →[Metazoa](#) were seen by several authors. Since most of the results obtained are preliminary and, moreover, often contradictory, all recently proposed systematics remain hypothetical and will be changed in future. The old classifications that are being adapted in most parasitological textbooks are apparently scientifically wrong, but nevertheless useful for categorizing the knowledge. Thus the only groups that are today fairly stable are the species, the families, and the phyla, although even within them newly discussed strains or systematically unseated groups (such as →[Pneumocystis](#) or →[Blastocystis](#) with protozoan and fungal characteristics) are leading to disturbances. In order to provide a survey and the possibility of retrieving facts at a suggested place both systematic attempts – the new more-correct one and the old better-known one – are presented here one after the other, with special reference to parasitic groups.

### Old System

Regnum: Animalia<sup>1</sup>

Subregnum: →[Protozoa](#)

Subphylum: →[Mastigophora](#) (Flagellata)

Diplomonadida

Trichomonadida

Kinetoplastida

<sup>1</sup> Only groups/taxa with many parasites are cited

Retortamonadida  
 Oxymonadida  
 Hypermastigida  
 Proteromonadida  
 Subphylum: → [Opalinata](#)  
 Subphylum: → [Sarcodina](#) (e.g., Amoebae)  
 Phylum: → [Sporozoa](#) (Apicomplexa)  
   Gregarina<sup>2</sup>  
   Coccidia<sup>2</sup>  
 Phylum: → [Microspora](#)  
 Phylum: → [Myxozoa](#)  
 Phylum: → [Ciliophora](#)  
 Incertae sedis: *Pneumocystis*, *Blastocystis*  
 Subregnum: Metazoa  
 Phylum: Mesozoa  
 Phylum: → [Platyhelminthes](#)  
   Class: → [Aspidogastrea](#) (Aspidobothrea)  
   Class: Monogenea<sup>3</sup>  
   Class: Digenea<sup>4</sup>  
   Class: Cestoda<sup>5</sup>  
 Phylum: → [Acanthocephala](#)  
 Phylum: Nematoda<sup>6</sup>  
 Phylum: → [Pentastomida](#) (Tongueworms)  
 Phylum: → [Annelida](#) (e.g., leeches)  
 Phylum: Arthropoda<sup>7</sup>  
   Class: → [Acarina](#) (ticks and mites)  
   Class: Insecta  
   Class: Branchiata (→ [Crustacea](#))

## New System

Empire: → [Eukaryota](#)  
 Kingdom: Microspora  
   Phylum: Microspora  
 Kingdom: Mastigota  
 Subkingdom: Dimastigota  
   Superphylum Tetramastigota  
     Phylum: Retortamonada  
       Class: Retortamonadea  
       Class: Diplomonadea  
         Order: → [Diplomonadida](#)  
     Phylum: Axostylata  
       Class: Oxymonadea  
       Class: Parabasalea  
         Order: → [Trichomonadida](#)  
         Order: → [Hypermastigida](#)

<sup>2</sup> An overview of taxa is shown in → [Apicomplexa/](#)[Fig. 1](#)

<sup>3</sup> They were kept as primitive tapeworms. too

<sup>4</sup> Important families and species are shown in → [Digenea/](#)[Table1](#)

<sup>5</sup> Important families and species are shown in → [Eucestoda/](#)[Table1](#)

<sup>6</sup> Important families and species are shown in → [Nematodes/](#)[Table1](#)

<sup>7</sup> Important families and species are given in → [Ticks,](#)  
→ [Mites](#)

Superphylum: Metakaryota  
 Phylum: Euglenozoa  
   Subphylum: Euglenida  
   Subphylum: Kintetoplasta  
     Class: Bodonea  
     Class: Trypanosomatidea  
 Phylum: Heterolobosa  
 Phylum: Dictyostela  
 Phylum: Protostela  
 Phylum: Myxogastra  
 Phylum: Chromista  
   Subphylum: Heterokonta  
     Class: Opalineae  
     Class: Chrysomonadea  
 Phylum: → [Alveolata](#)  
   Subphylum: Dinoflagellata  
   Subphylum: → [Apicomplexa](#)  
     Class: Gregarina  
     Class: Coccidea  
       Order: Adeleida  
       Order: Eimeriida  
     Class: Haematozoa  
       Order: Haemosporida  
       Order: Piroplasmida  
   Subphylum: Ciliophora  
 Superclass: Postciliodesmatophora  
   Class: Spirotrichea  
 Superclass: Rhabdophora  
   Class: Litostomatea  
 Superclass: Cyrtophora  
   Subclass: Suctoria  
   Class: Oligohymenophorea  
     Order: Hymenostomatia  
   Phylum: Choanoflagellata  
   Phylum: Chlorophyta

## Metakaryota Incertae Sedis:

1. Amoebozoa  
   Lobosea  
   Filosea
2. Granuloreticulosa  
   Foraminifera
3. Actinopoda  
   Acantharea  
   Polycystinae  
   Phaeodarea  
   Heliozoa
4. → [Ascetospora](#)  
   Haplosporea  
   Paramyxia
5. Myxozoa

Kingdom: Metazoa  
 Phylum: Parazoa  
 Phylum: Cnidaria  
 Phylum: Ctenophora  
 Subkingdom: Bilateria  
 Phylum: Platyhelminthes



Phylum: Gnathostomulida  
 Phylum: Nemertini  
 Phylum: Mollusca  
 Phylum: Sipunculida  
 Phylum: Kamptozoa  
 Phylum: Echiura  
 Phylum: Annelida  
 Phylum: →[Arthropoda](#)  
 Phylum: Priapulida  
 Phylum: Loricifera  
 Phylum: Kinorhyn?ha  
 Phylum: Acanthocephala  
 Phylum: Rotatoria  
 Phylum: Nematomorpha  
 Phylum: Nematoda  
 Phylum: Gastrotricha  
 Phylum: Brachiopoda  
 Phylum: Bryozoa  
 Phylum: Phoronida  
 Phylum: Chaetognatha  
 Phylum: Pterobranchia  
 Phylum: Enteropneusta  
 Phylum: Echinodermata  
 Phylum: Chordata  
 Subphylum: Vertebrata

The following overview of the metazoan taxa waives any hierarchical arrangement of names:

#### **Metazoa**

Porifera  
 Epitheliozoa  
 Placozoa  
 Eumetazoa  
 Cnidaria  
 Acrosomata  
 Ctenophora  
 Bilateria  
 Spiralia  
 Plathelminthomorpha  
 Euspiralia  
 Radialia  
 “Tentaculata”  
 Deuterostomia (including the last 5 phyla of the upper system)

#### **New System of Parasitic Platyhelminthes According to Ehlers (Simplified)**

##### **Platyhelminthes**

Groups comprising the former Turbellaria

- Neodermata Ehlers, 1984
- Trematoda Rudolphi, 1808
- Aspidobothrii Burmeister, 1856

- Digenea von Beneden, 1858
- Cercomeromorphae Bychowsky, 1937
- Monogenea von Beneden, 1858
- Cestoda Gegenbaur, 1859
- Gyrocotylidae Poche, 1926
- Nephroposticophora Ehlers, 1984
- Amphilinidea Poche, 1922
- Cestoidea Rudolphi, 1808
- Caryophyllidea von Beneden, 1893
- Eucestoda Southwell, 1930

#### **New (Simplified, Selective) System of Protozoans (–2007)**

Regnum Eukaryota

##### 1. **Phylum: Metamonada**

**Classis:** Diplomonadea  
 Ordo: Diplomonadida  
 Ordo: Enteromonadida  
 Ordo: Retortamonadida

##### 2. **Phylum: Axostylata**

**Classis:** Parabasalea  
 Ordo: Trichomonadida

##### 3. **Phylum: Euglenozoa**

**Classis: Trypanosomatidea**  
 Ordo: Trypanosomatida  
 Ordo: Bodonida

##### 4. **Phylum: Alveolata**

###### 4.1 **Subphylum: Apicomplexa (Sporozoa)**

**Classis:** Coccidea  
 Ordo: Adeleida  
 Ordo: Eimeriida  
 Ordo: Cryptosporiida  
**Classis:** Haematozoa  
 Ordo: Haemosporida  
**Classis:** Piroplasmae  
 Ordo: Piroplasmida

###### 4.2 **Subphylum Dinoflagellata**

**Classis:** Dinoflagellidea

###### 4.3 **Subphylum Ciliophora**

##### 5. **Phylum: Amoebozoa**

**Classis:** Amoebida  
**Classis:** Acanthopoda

##### 6. **Phylum: Microspora**

**Classis:** Microsporea

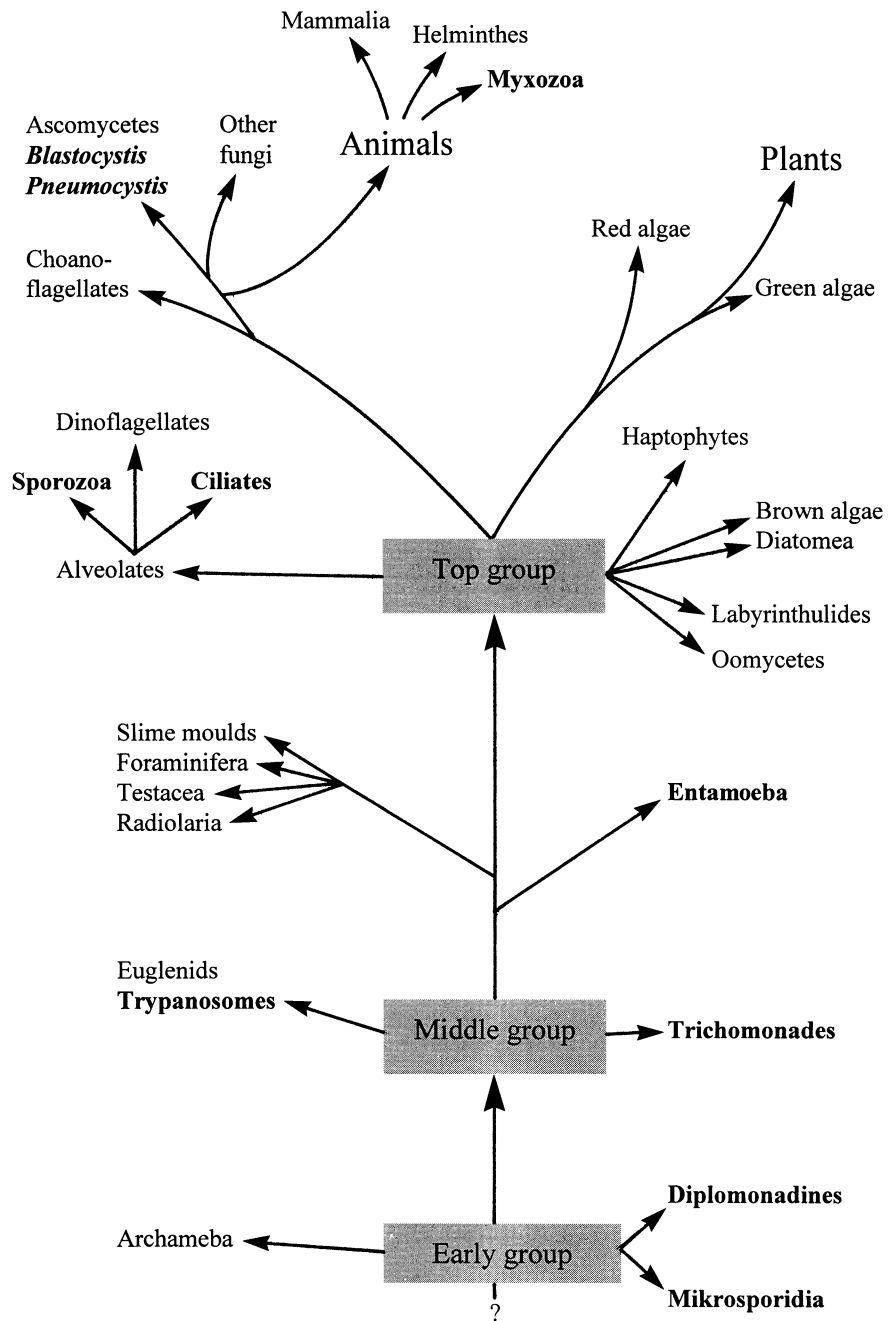

**Classification. Figure 1** Diagrammatic representation on recent ideas of origin and relationships of living organisms (according to Bardele, Tübingen).

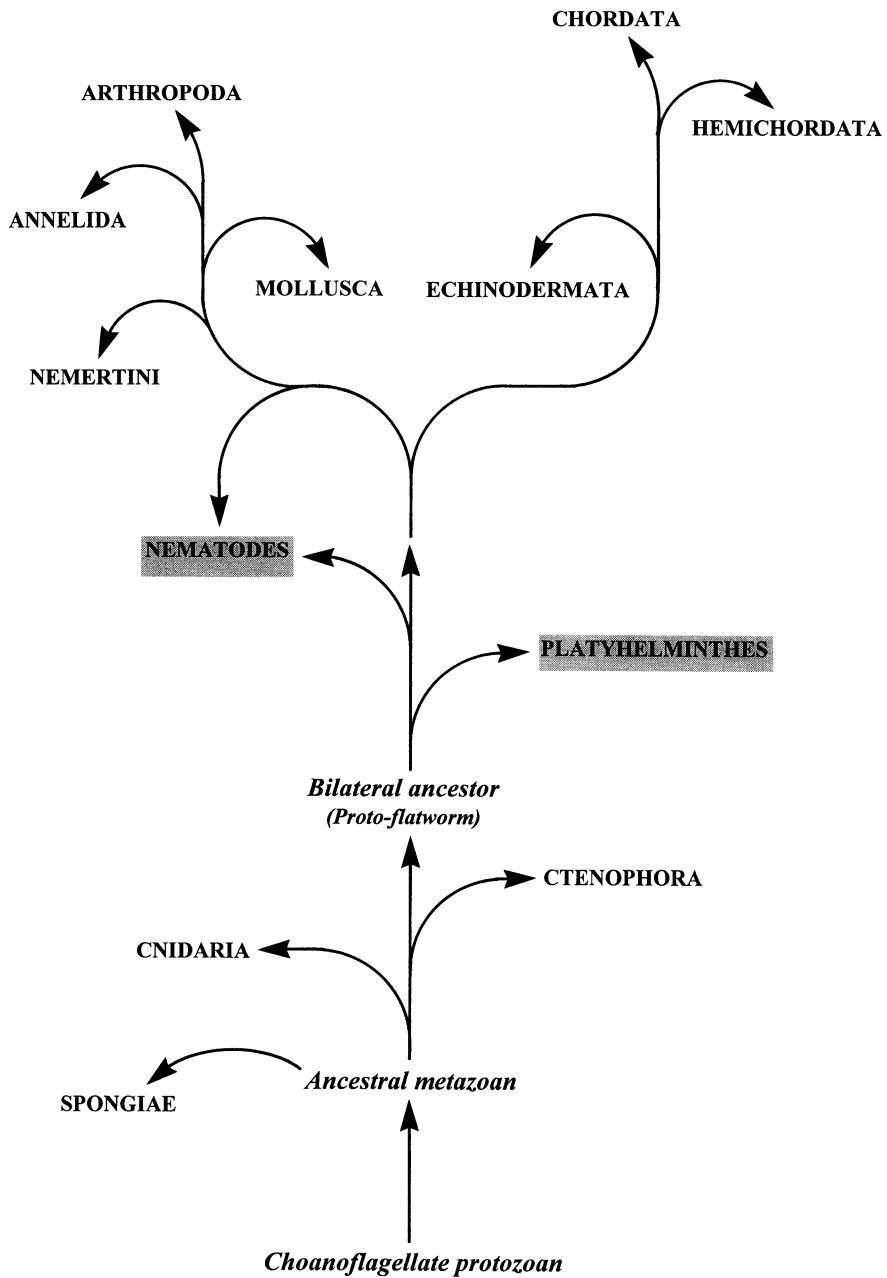

**Classification. Figure 2** Hypothetical monophyletic evolutionary scheme for the relationship of some early Metazoa and their progeny. This proposal illustrates a potential role for a flagellate ancestor of Metazoa (but not directly the Kinetoplastida) and a proto-flatworm as an ancestor of bilateral Metazoa. Boxed groups represent Metazoa known to have spliced leader →trans-splicing (according to Davis).

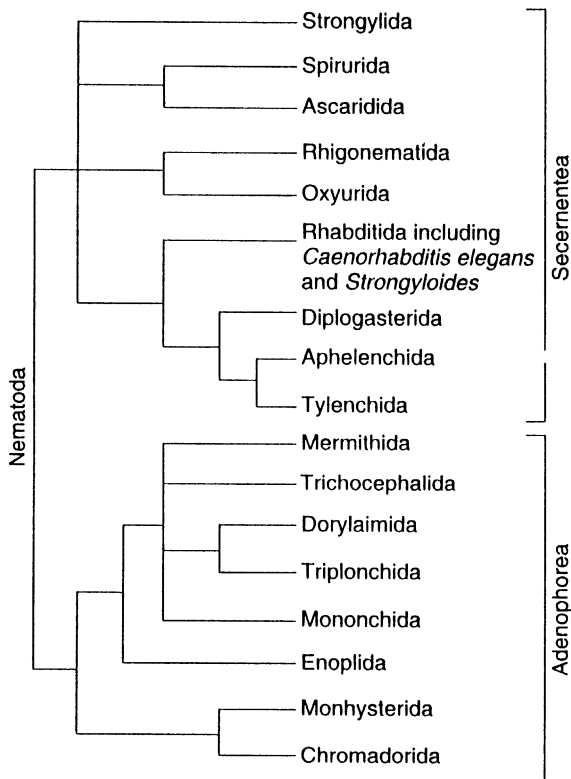

**Classification. Figure 3** A recent consensus → cladogram of the class/phylum Nematoda (as example).

## Clathrin-Coated Pits

→ Coated Pits.

## Clavus

Distal portion (fortified) of the triatomid bug wing.

## Clazuril

A triazine – derivative which blocks DNA-synthesis in coccidians. → Coccidiocidal Drugs.

## Clindamycin

Compound used together with sulfadimidin and trimethoprim to treat → neosporosis in dogs. → Coccidiocidal Drugs.

## Clinical Pathology, Animals

### General Information

It is difficult to give an estimate of the (economic) importance of parasitic diseases at the world level. Firstly, because the effect of a particular parasitic disease may vary completely from one region to another. Secondly, our knowledge of some parasitic infections is based primarily on experimental infections, which often differ from natural conditions. Finally, appropriate data are missing for a number of diseases. Some parasites are known to induce severe, sometimes highly fatal clinical syndromes, and have a recognized economical importance. Most of the others only produce subclinical, or even asymptomatic infections. However, it has now been established that such subclinical infections cause significant losses due to long-term effects on animal growth and productivity and increased susceptibility to other parasitic or bacterial/viral diseases.

Parasitism causes a wide variety of clinical and pathological changes. This is easy to understand as parasites occur in all organs of the host (Fig. 1). However, most signs are nonspecific and a clinical examination alone is often insufficient to establish an etiological diagnosis. The clinician is therefore dependent on other diagnostic methods such as laboratory examination of feces, blood, and urine.

The pathogenicity of a particular parasite population will depend on the “parasite load,” and on the major site of infection. The heavier the infection the more dramatic is the effect, although there is both, a lower and upper threshold. However, in the field many different factors contribute to determine the clinical outcome of a parasitic infection. Age and previous parasite experience increase resistance to infection with most parasites. It is also generally accepted that the plane of nutrition of the animal affects its overall response to the infection, either by affecting the rate of establishment of the parasite or modifying the effects of the infection. Finally, resistance to infection is often reduced by stressful conditions, such as during intercurrent diseases and around parturition (Fig. 2). Caution is needed when applying the results of experimental infections with individual parasites to the field situation in which animals normally acquire several parasite species

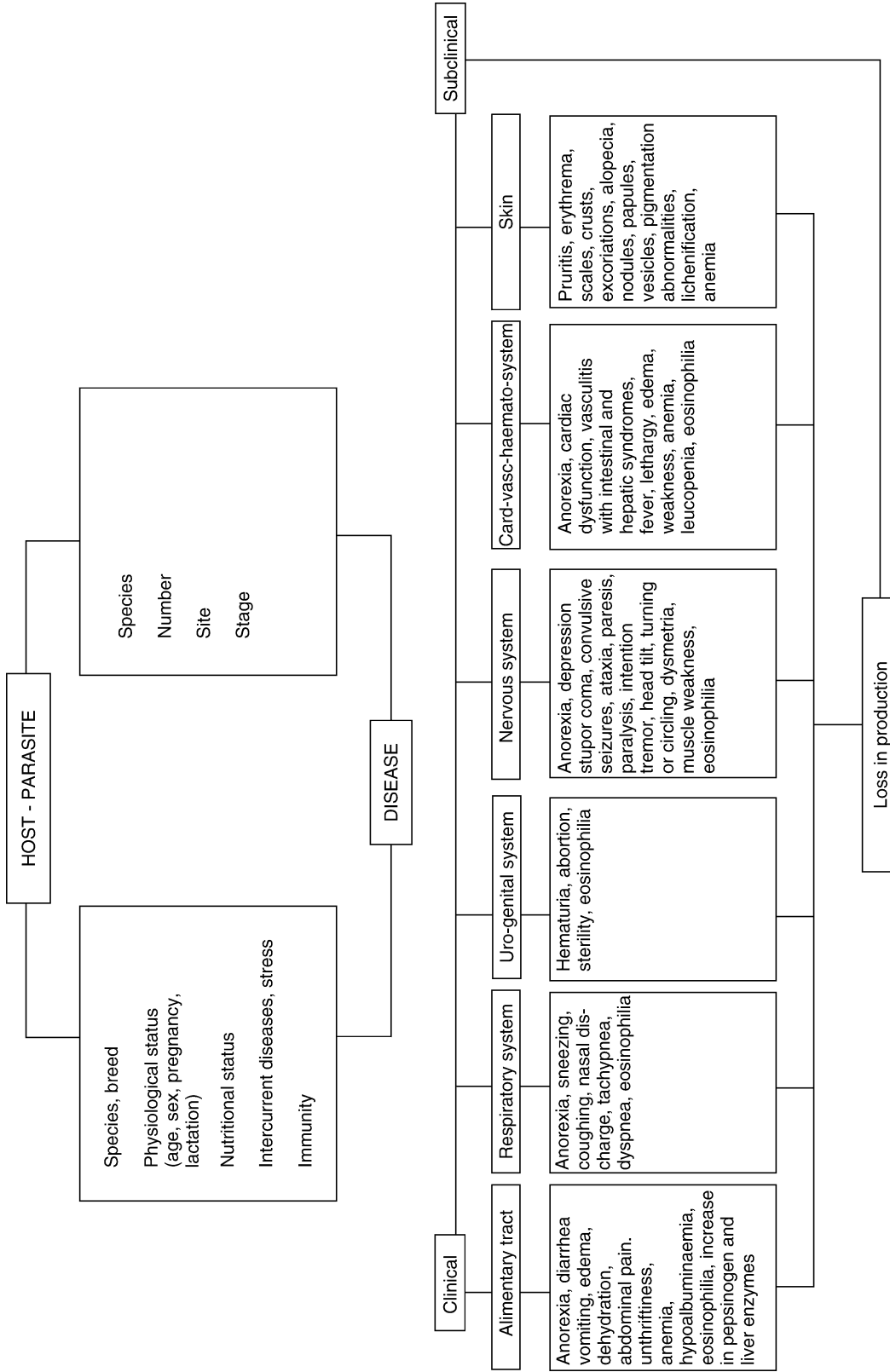

Clinical Pathology, Animals. **Figure 1** General outline of host-parasite relationships.

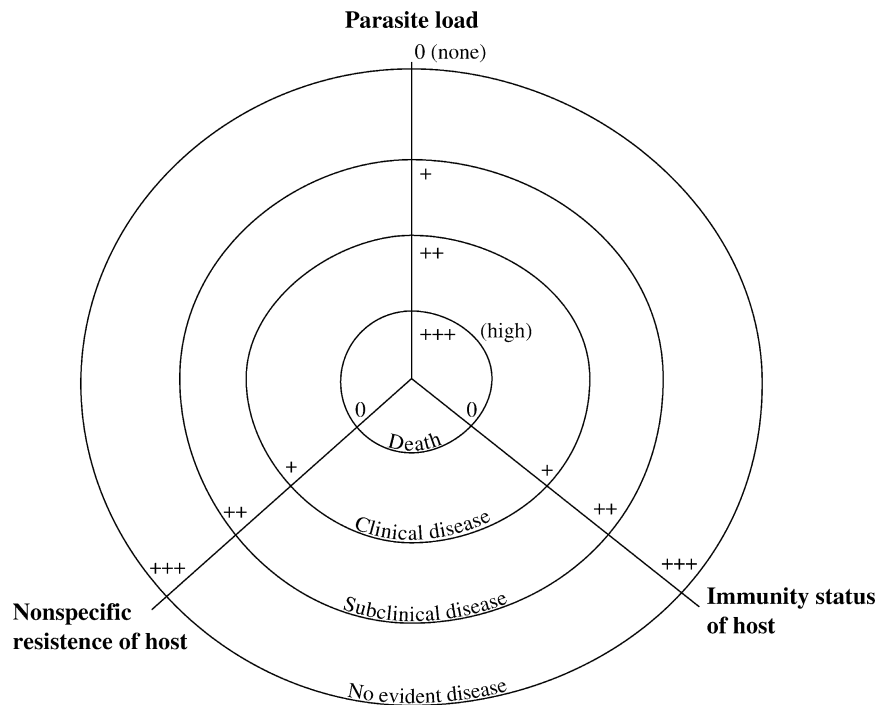

**Clinical Pathology, Animals. Figure 2** Relationship between parasite load, immunity, and non-specific resistance of host, and severity of disease.

concurrently. The combined pathophysiological effects of several parasite species may be greater than could be anticipated from the effects of monospecific infections.

### Anorexia

→Anorexia, or reduction in voluntary food intake, is a feature of many parasitic infections. The degree of appetite loss can vary considerably. In moderate to heavy infections, food intake can be reduced by 20% or more. It may be less obvious in lighter infections. The degree of appetite loss has been shown to vary not only with the level and duration of parasitism but also with the level of protein nutrition. Despite the obvious importance of loss of appetite in parasitized animals, it is still not known why it occurs. The subject has been reviewed by several authors who concluded that anorexia in parasitized animals is certainly complex and that a complete understanding may be difficult to obtain. Possible factors in gastrointestinal parasitism of ruminants are →abdominal pain, anatomical or chemical responses to infection, changes in protein digestion and in the availability of amino acids for absorption, changes in plasma levels of hormones (gastrin, cholecystokinin), alterations in the rate of passage of ingesta, or direct effects on the central nervous system.

### Production Losses

Parasites can have a range of effects on animal production. A reduction in growth rate, and even

losses of weight, are probably the most widely described effects of parasitism. It has been recorded for infections with →protozoa, →nematodes, →cestodes, →trematodes, and arthropods and it is best studied in cattle, sheep, and pigs. The effect on body weight is independent of the site of infection and the heavier the infection the more dramatic the effect. However, there is both a lower and upper threshold in intensity of infection where weight ceases to be affected. In the latter case, this is because of the early death of the animal. Finally, at equal worm burdens young animals or animals on a poor plane of nutrition are more severely affected than those maintained on a better diet, or adults. In addition to changes in body weight, alterations in body composition also occur. These can be of considerable importance when assessing the economic impact of parasitism. Most authors have found that infected animals had a higher percentage of water and a lower deposition of fat, protein, and skeletal calcium and phosphorus, compared with parasite-free controls. The reasons for impaired growth or loss of weight are complex. They have been studied more particularly in intestinal trichostrongylid infections. Because of the loss of appetite, the enteric losses of proteins and the increased rates of intestinal metabolism, there is a net movement of amino acid nitrogen from the muscles, and possibly the skin, to the liver and intestines. This decreases the availability of nitrogen for growth, milk, and wool production. The drop in appetite was responsible for

nearly 73% of the difference in live weight gain between calves infected with →*Ostertagia ostertagi* and control animals. Table 1 presents a list of gastrointestinal parasites with their effect upon body weight.

There has been considerable controversy regarding the effect of parasites on milk production and apparently conflicting results have been reported. Some studies have shown that anthelmintic treatment in early lactation is associated with an increased milk production of approximately 5% over the whole lactation, while other studies have not shown such an effect. Evaluation of such experiments is made difficult because of the impossibility of identifying those situations where subclinical infections of helminths are likely to cause depression in milk production. Very few experiments have been conducted to evaluate the direct effect of nematode parasitism on milk production. The administration to cows of 130,000 to 200,000 infective larvae of mixed trichostrongylid species, given once or over several weeks in early lactation, resulted in a reduced milk production of 1–3 kg/day. Ewes infected weekly (for 12 weeks, starting last 6 weeks of pregnancy) with 2,500 L3 larvae of →*Haemonchus contortus* produced 23% less milk than control animals, despite a similar feed intake. It has also been shown that arthropod parasites such as horn flies, stable flies, cattle grubs, and →mites can reduce milk production by up to 40%–60%.

Many helminths infections adversely affect the quantity and quality of wool. Wool growth can be reduced by up to 66% in some parasitic infections. The reduction in growth rate of wool is accompanied by decreases in staple length and fibre diameter. There are indications that these effects occur at levels of infection below the threshold normally considered to affect body weight.

### Reproductive Performance

The impact of parasitism on reproductive performance is of major economic importance. Parasites such as →*Toxoplasma gondii* in sheep and goats and →*Tritrichomonas foetus* and →*Neospora caninum* (syn. *Hammondia heydorni* ?) in cattle often induce →abortion. Preventive treatment of gastrointestinal trichostrongylosis or fasciolosis in ruminants may result in earlier breeding, higher pregnancy rates, and better birth weights.

---

## Clinostomum

Genus of bird, →Digenea.

---

## Clitellum

Belt-like zone in →Annelida (e.g., →*Hirudo medicinalis*, →leeches) that excretes mucous material, which is used to form the →cocoon around eggs.

---

## Cloaca

Common exit of intestine and male reproductive system (e.g., in →nematodes, Sauropsida), →Nematodes/Reproductive Organs.

---

## Clone

### Name

Greek: *klon* = *kladon* = offspring.

Population of protozoans that derived from a single cell by asexual reproduction. Thus all cells have an identical genetic appearance.

---

## Clonorchiasis

### Synonym

→Opisthorchiasis, Man.

---

## Clonorchis sinensis

### Synonyms

→Opisthorchis sinensis, Chinese liver fluke of humans.

### Morphology

Figs. 1–3.

### Life Cycle and Geographical Distribution

→Digenea/Fig. 8.



**Clonorchis sinensis. Figure 1** LM of an adult *Clonorchis sinensis* (coloured by carmin red), note the two posterior branched testes.



**Clonorchis sinensis. Figure 2** LM of a typical egg of *Clonorchis sinensis* with an operculum.

---

## CM

Cerebral malaria, →[Malaria](#).

---

## CoA Transferase

→[Energy Metabolism](#).

---

## Coated Pits

Many cells contain clathrin-coated pits that are involved in the receptor-mediated →[endocytosis](#) of macromolecules. The knowledge of coated pits in →[Protozoa](#) remains limited.



**Clonorchis sinensis. Figure 3** SEM of the ventral side of *Clonorchis sinensis*.



## Cobalamin Absorption

The vitamin B 12 (cobalamin) – absorption of the fish tapeworm (*→Diphyllobothrium latum*) leads in humans (especially in children) to a severe pernicious anaemia.

## Cobbold, Thomas Spencer (1826–1886)

English physician, famous helminthologist (e.g., author of *Treatise on the entozoa of man and animals*, 1879).

## Cobboldia

Genus of the family Gasterophilidae inducing myiasis in the stomach of elephants (e.g., *C. loxodontis*, *C. chrysidiformis*).

## Coccidia

### Classification

Subclass of *→Apicomplexa*.

### General Information

Apart from only a few species, the coccidia are intracellular parasites which have a life cycle consisting of 3 phases: *→schizogony* (asexual multiplication), *→gamogony* (sexual phase, which proceeds in general as *→oogamy* with macrogametes and *→microgametes*),

and *→sporogony* (the *→zygote* initiates another asexual reproduction leading to the production of numerous infectious sporozoites). In fecally transmitted species (*→Eimeria*/Fig. 1) the sporozoites are always included in resistant stages (oocysts and/or sporocysts), whereas in bite-transmitted groups (e.g., *→Plasmodium*/Fig. 2) oocysts are smooth and always located inside the vector.

Among the life cycles of the coccidia different types can be distinguished:

- **→Monoxenous development:** The whole development is restricted to the tissues of a host individual. The species may be strictly host-specific (using only a single host species, e.g., *→Isospora* spp., *→Eimeria* spp.) or not (e.g., *→Cryptosporidium* spp.) and are found in several host types.
- **Di-or→heteroxenous development:** Parasites belonging to this group have at least 2 different hosts during their life cycle: a final host (where the sexual phase proceeds), and an *→intermediate host* (with continuing asexual reproduction) or a *→paratenic host*, inside which no development occurs but only an accumulation of infectious stages (*→Cystoisospora* spp.). This alternation of hosts may be: facultative, e.g., *→Cystoisospora* spp., *→Toxoplasma gondii*, *→Neospora caninum*, or obligatory, e.g., *→Aggregata eberthi*, *→Hammondia* spp., *→Sarcocystis* spp., *→Frenkelia* spp., the *→Haemosporidia*, *→Piroplasms* and some species of the *→Adeleidea*. In some genera (*→Besnoitia*; *→Globidium*) the life cycles of the species are poorly understood, so their final classification remains doubtful.

### Important Species

Tables 1–7.

### Life Cycle

Figs. 1, 2 (page 267, 268), *→Eimeria*, *→Plasmodium*, *→Toxoplasma gondii*, *→Sarcocystis*.

### Diseases

*→Coccidiosis, Animals*, *→Coccidiosis, Man*.

**Coccidia. Table 1** Some common *Plasmodium* species

Species	Periodicity of fever	Vertebrate host	Vector/mosquitoes	Mortality
<i>Plasmodium falciparum</i>	48 h + irregular	<b>Humans</b>	<i>Anopheles</i> spp.	+
<i>P. vivax</i>	48 h	<b>Humans</b>	<i>Anopheles</i> spp.	–
<i>P. ovale</i>	48 h	<b>Humans</b>	<i>Anopheles</i> spp.	+/-
<i>P. malariae</i>	72 h	<b>Humans</b> , monkeys	<i>Anopheles</i> spp.	+/-
<i>P. knowlesi</i>	24 h	Asian monkeys, <b>humans</b>	<i>Anopheles</i> spp.	-/+
<i>P. coatneyi</i>	48 h	Asia monkeys, <b>humans</b>	<i>Anopheles</i> spp.	-/+
<i>P. cynomolgi</i>	48 h	Asian monkeys, <b>humans</b>	<i>Anopheles</i> spp.	–
<i>P. simium</i>	48 h	New World monkeys, <b>humans</b>	<i>Anopheles</i> spp.	–
<i>P. gallinaceum</i>	Irregular	Chickens	<i>Aedes</i> spp., <i>Culex</i> spp.	+
<i>P. juxtannucleare</i>	Irregular	Chickens	<i>Culex</i> spp.	+
<i>P. relictum</i>	12–36h	Pigeons	<i>Culex</i> spp., <i>Aedes</i> spp., <i>Anopheles</i> spp.	+
<i>P. cathemerium</i>	24/48 h	Sparrows, canaries	<i>Aedes</i> spp., <i>Culex</i> spp., <i>Anopheles</i> spp.	+
<i>P. berghei berghei</i>	24 h	Rodents	<i>Anopheles durenii</i>	-/+
<i>P. agamae</i>	Irregular	Lizards	<i>Lutzomyia</i> spp., <i>Culicoides</i> spp.	–
<i>P. wenyoni</i>	Irregular	Snakes	<i>Culex</i> spp.	–

+ = high; +/- = medium; – = none or low

**Coccidia. Table 2** Important *Isoospora* and *Cystoisospora* species

Species	Host/Habitat	Size of oocysts (µm)	Prepatent period	Pathogenicity
<i>Isoospora belli</i>	Humans/Small intestine	20–33 × 10–19	9–10	+
<i>I. suis</i>	Pigs/Small intestine	17–22 × 17–19	5–6	+
<i>I. serini</i>	Canaries/Intestine and its wall, liver, lung	12 × 10	9–10	+
<i>I. canaria</i>	Canaries/Intestine	13 × 10	4–5	-/+
<i>I. lacazei</i>	Sparrows/Intestine	22–35	7–8	–
<i>I. erinacei</i>	Hedgehogs/Small intestine	28–34 × 23–27	7–14	+
<i>Cystoisospora felis</i> <sup>1</sup>	Cats/Small intestine, Ileum	30–53 × 23–32	6–17	–
<i>C. ohioensis</i>	Dogs/Small intestine, cecum, colon	19–27 × 18–23	6	–
<i>C. canis</i>	Dogs/Small intestine, cecum	36–44 × 29–36	8–11	–
<i>C. burrowsi</i>	Canids/Small intestine, cecum, colon	21 × 18	6–9	+
<i>C. rivolta</i>	Cats/Small intestine, cecum, colon	22–36 × 21–27	5–7	–

<sup>1</sup> Some authors keep *Cystoisospora* synonym to *Levineia* or retain *Isoospora*

**Coccidia. Table 3** Important *Eimeria*-, *Tyzzeria*-, *Goussia*- and related species

Species	Host/Habitat	Oocyst size ( $\mu\text{m}$ )	Prepatent period (days)	Pathogenicity
	<b>Cattle</b>			
<i>E. bovis</i>	Posterior small intestine	23–34 $\times$ 17–23	15–21	+
<i>E. auburnensis</i>	Small intestine	36–42 $\times$ 19–26	17–20	+
<i>E. zuernii</i>	Small intestine	16–20 $\times$ 15–18	15–19	+
<i>E. ellipsoidalis</i>	Small intestine	18–26 $\times$ 13–18	8–13	+
	<b>Sheep</b>			
<i>E. faurei</i>	Small intestine	22–33 $\times$ 19–24	12–15	+
<i>E. intricata</i>	Small intestine, cecum	40–56 $\times$ 30–41	20–27	+
<i>E. ovina</i>	Small intestine	23–36 $\times$ 16–24	19	+
<i>E. ovinoidalis</i>	Colon	17–25 $\times$ 13–20	10–15	+
	<b>Goats</b>			
<i>E. arloingi</i>	Intestinal crypts	25–33 $\times$ 16–21	14–20	+
<i>E. ninakohlyakimovae</i>	Intestinal crypts	16–28 $\times$ 14–23	11–17	+
<i>E. christenseni</i>	Small intestine	34–41 $\times$ 23–38	14–23	+
	<b>Pigs</b>			
<i>E. scabra</i>	Small intestine	25–45 $\times$ 17–28	7–10	+
<i>E. suis</i>	Small intestine	13–20 $\times$ 11–15	10	+
	<b>Horses</b>			
<i>E. leuckarti</i>	Small intestine	70–90 $\times$ 50–69	31–37	–
	<b>Rabbits</b>			
<i>E. intestinalis</i>	Cecum, colon	23–32 $\times$ 15–20	10	+
<i>E. perforans</i>	Small intestine	16–28 $\times$ 12–16	4–6	+
<i>E. magna</i>	Small intestine	28–40 $\times$ 18–30	7–9	+
<i>E. stiedai</i>	Bile ducts	26–40 $\times$ 16–25	12–16	+
	<b>Rats</b>			
<i>E. contorta</i>	Whole intestine	18–27 $\times$ 15–21	6	–
<i>E. nieschulzi</i>	Small intestine	16–26 $\times$ 13–21	7–8	+
	<b>Mice</b>			
<i>E. falciparum</i>	Cecum, colon	16–21 $\times$ 11–17	4–5	+
<i>E. ferrisi</i>	Cecum	17–20 $\times$ 14–16	4–5	–
	<b>Chickens</b>			
<i>E. tenella</i>	Cecum	23 $\times$ 19 (mean)	6	+
<i>E. maxima</i>	Small intestine	30 $\times$ 20 (mean)	5	+
<i>E. necatrix</i>	Small intestine	22 $\times$ 17 (mean)	6	+
<i>E. praecox</i>	Small intestine	21 $\times$ 17 (mean)	4	–
	<b>Geese</b>			
<i>E. truncata</i>	Kidneys	15–22 $\times$ 11–16	5	+
<i>E. anseris</i>	Small intestine	16–23 $\times$ 13–18	7	+
<i>E. nocens</i>	Colon	25–33 $\times$ 17–24	9	+
	<b>Ducks</b>			
<i>Tyzzeria pernicioso</i>	Small intestine	10–13 $\times$ 9–10	6	+
<i>Eimeria danailovi</i>	Small intestine	19–22 $\times$ 11–14	7	+
	<b>Turkeys</b>			
<i>E. adenoides</i>	Colon, Cecum	25 $\times$ 17 (mean)	5	+
<i>E. meleagritidis</i>	Small intestine	20 $\times$ 17 (mean)	5	+
	<b>Pigeons</b>			
<i>E. labbeana</i>	Small intestine	15–18 $\times$ 14–16	6	+

**Coccidia. Table 3** Important *Eimeria*-, *Tyzzeria*-, *Goussia*- and related species (Continued)

Species	Host/Habitat	Oocyst size ( $\mu\text{m}$ )	Prepatent period (days)	Pathogenicity
<i>E. columbarum</i>	Small intestine	19–21 $\times$ 17–20	6	-/+
	<b>Fish (Gulf Killifish)</b>			
<i>Calyptospora funduli</i>	Liver	21 $\times$ 19 (mean)	?	+
	<b>Fish (Cyprinids)</b>			
<i>Goussia subepithelialis</i>	Intestine	18–21 (mean)	?	+
<i>G. carpelli</i>	Intestine	8–14 (mean)	12–19	+
	<b>Fish (Salmonids)</b>			
<i>G. truttae</i>	Pyloric sac, intestine Fish (Eels)	10–12 (mean)	?	+
<i>Epieimeria anguillae</i>	Intestine	10–14 (mean)	?	+

**Coccidia. Table 4** Important *Cyclospora*-species

Species	Host	Infected tissues	Oocyst size	Prepatent period
<i>Cyclospora cayetanensis</i>	<b>Humans</b> (AIDS patients)	Intestinal cells	8–10 $\mu\text{m}$	?
<i>Cyclospora caryolytica</i>	Mole ( <i>Talpa</i> )	Intestinal cells	8–12 $\mu\text{m}$	?
<i>Cyclospora viperae</i>	Snakes	Intestinal cells	9–12 $\mu\text{m}$	?

**Coccidia. Table 5** *Toxoplasma gondii* and related tissue-cyst-forming coccidia

Species	Intermediate hosts	Final hosts	Size of oocysts ( $\mu\text{m}$ )	Pathogenicity
<i>Toxoplasma gondii</i>	<b>Humans</b> and many animals	Cats	11–14 $\times$ 9–11	+
<i>Neospora caninum</i> <sup>c</sup>	Dogs, cats, lambs, calves, horses, jirds, guinea pigs	Dogs	10–12 $\times$ 10–11	+
<i>Hammondia heydorni</i>	Cattle, sheep, goats, roe deer, camels, guinea pigs	Dogs, foxes, coyotes	10–14 $\times$ 9–13	–
<i>H. hammondi</i>	Mice and other rodents	Cats	11–13 $\times$ 10–12	–
<i>Besnoitia wallacei</i>	Rodents	Cats	16–19 $\times$ 10–13	–
<i>B. darlingi</i>	Opossums, lizards	Cats	11–13 $\times$ 10–13	–
<i>B. besnoiti</i>	Cattle	Cats <sup>a</sup>	14–16 $\times$ 11–14 <sup>a</sup>	+
<i>B. jellisoni</i>	Mice, rodents	?	?	+
<i>Frenkelia microti</i>	European voles ( <i>Microtus agrestis</i> ), <i>Mus</i> , <i>Rattus</i>	European buzzards ( <i>Buteo buteo</i> )	Sporocysts 12 $\times$ 10	–
<i>F. glareoli</i>	Bank voles ( <i>Clethrionomys glareolus</i> )	European buzzards ( <i>Buteo buteo</i> )	12.5 $\times$ 8.8	+
<i>Caryospora</i> <sup>b</sup> <i>bigenetica</i>	?	Snakes, dogs, rodents	11–20 $\times$ 15–17	+
<i>C. colubri</i>	?	Snakes, rodents	17–20 $\times$ 18–20	+









<sup>a</sup> Results according to Peteshev et al. (1974); these findings, however, were not confirmed for the Berlin strain of Prof. Heydorn<sup>b</sup> The species of this genus have 2 types of final hosts<sup>c</sup> This species is probably synonymous to *Hammondia heydorni* representing a pathogenic strain that introduces under special conditions the described abortions in cattle and dogs

**Coccidia. Table 6** Some common species of the Adeleidea

Species	Host	Hosts/Habitat	Vector/Habitat	Mode of infection/transmission
<b>Significant Adeleidea</b>				
<i>Adelina deronis</i>	1	Oligochaetae ( <i>Derolimosia</i> )/ Body cavity	–	Oral uptake of oocysts/sporocysts
<i>A. cryptocerci</i>	1	Roaches ( <i>Cryptocercus</i> )/Fat body	–	Oral uptake of oocysts/sporocysts
<i>A. tribolii</i>	1	Red flour beetles ( <i>Tribolium</i> )/Hemocoel	–	Oral uptake of oocysts via cannibalism
<i>Klossia helicina</i>	1	Snails ( <i>Helix</i> , <i>Cepaea</i> , <i>Succinea</i> )/Kidney epithelium	–	Oral uptake of oocysts/sporocysts
<b>Adeleidea of doubtful systematic position</b>				
<i>Haemogregarina stepanowi</i>	2	Water tortoises ( <i>Emys orbicularis</i> )/Erythrocytes, bone marrow	Leeches ( <i>Placobdella</i> sp.)/ Intestine	Blood meal of vector
<i>Hepatozoon muris</i> (syn. <i>Perniciosum</i> )	2	Rats, mice/Liver cells, leukocytes	Rat mites ( <i>Echinolaelaps</i> sp.)/Hemocoel	Blood meal of vector
<i>H. erhardovae</i>	2	Bank voles ( <i>Clethrionomys</i> sp.)/Lung, leukocytes	Rat fleas/Hemocoel	Blood meal of vector
<i>H. aegypti</i>	2	Snakes ( <i>Spalerosophis diadema</i> )/Lung, erythrocytes	Mosquitoes ( <i>Culex pipiens</i> )/Body cavity	Blood meal of vector
<i>Karyolysus lacertae</i>	2	Lizard ( <i>Lacerta</i> sp.)/ Endothelial cell of blood vessels, erythrocytes	Mites ( <i>Liponyssus saurarorum</i> )/Gut epithelium, hemocoel, yolk	Feeding with shed oocysts or infected whole mites, which were infected during blood meal.

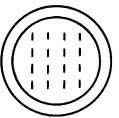
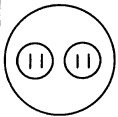
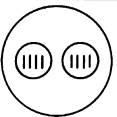
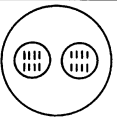
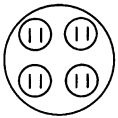
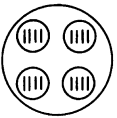
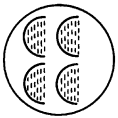
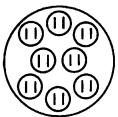
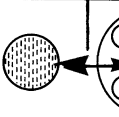
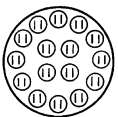
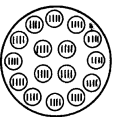
**Coccidia. Table 7** Some blood parasitizing genera of doubtful systematic position

Species	Host	Tissue	Vector	Mode of infection
<i>Lankesterella minima</i>	Frog ( <i>Rana esculenta</i> )	Sporozoites: red blood cells	Leech ( <i>Placobdella marginata</i> )	Mechanically during blood sucking, by eating the leech
<i>Atoxoplasma</i> spp.	Birds	Merozoites: RES Leukocytes	Mites, mosquitoes	Bite, by eating the vector
<i>Schellackia bolivari</i> (syn. <i>Lainsonia</i> , <i>Gordonella</i> )	Lizards	Merozoites: midgut Sporozoites: red blood cells	Mites	By eating the vector

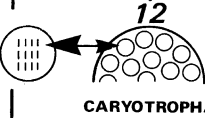
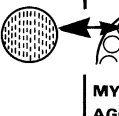
NUMBER OF SPOROCYSTS PER OOCYST	NUMBER OF SPOROZOITES PER SPOROCYST						
	1	2	3	4	8	16	n
0				 CRYPTOSPORIDIUM	 SCHELLACKIA TYZZERIA		 LANKESTERELLA
1				 MANTONELLA	 CARYOSPORA	 SILVATO-SHELLINA	
2		 CYCLOSPORA		 ISOSPORA TOXOPLASMA SARCOCYSTIS	 DORISIELLA		
4		 EIMERIA		 WENYONELLA			 ANGEIO-CYSTIS
8		 OCTO-SPORELLA				 YAKIMOVELLA	
16		 HOARELLA		 PYTHONELLA			
n	 BARROUXIA ECHINOSPORA	 MEROCYSTIS PSEUDO-KLOSSIA	 AGGREGATA (pro parte)		 12 CARYOTROPHA	 MYRIOSPORA AGGREGATA (pro parte)	

**Coccidia. Figure 1** Diagrammatic representation of numbers and relationships between oocysts, sporocysts, and sporozoites in different genera of Eimeriidae. In the genera without sporocysts the numbers of sporozoites per →oocyst are given. In the case of *Cryptosporidium* the smooth oocyst wall disappears and is transformed into the →sporocyst wall. Thus, this genus might also be placed in the second row, but it is probably more related to →gregarines. (After Levine 1973, modified.)

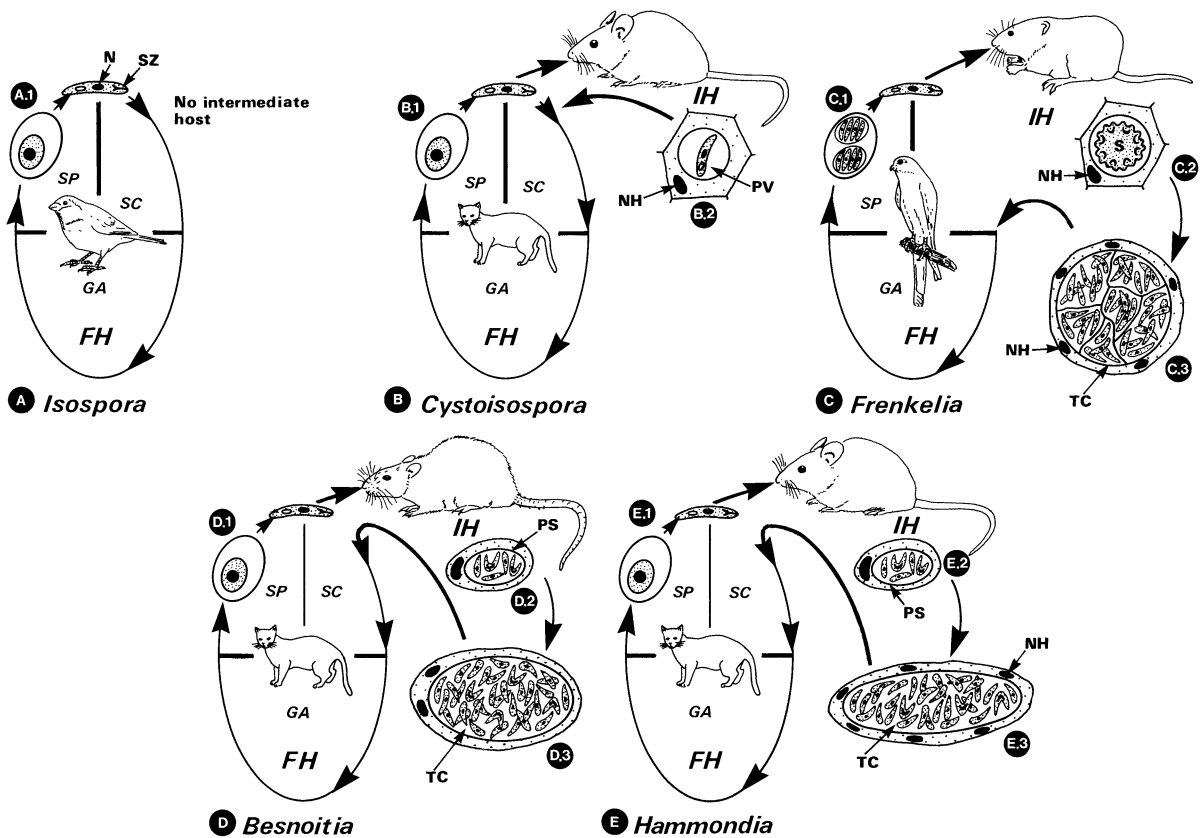

**Coccidia. Figure 2** Life cycles of different coccidian tissue-cyst-forming genera, the gamogony (GA) of which always occurs in the intestinal epithelial cells of final hosts (FH). **A** → *Isospora* (e.g., *I. serini* of canaries, *I. lacazei* of sparrows): homoxenous (i.e., one-host-type) cycle. Oocysts are excreted unsporulated (B1); after →sporulation (compare C1) they become infectious to other hosts of the same species. Schizogony (SC) is not restricted to epithelial intestinal cells, but also occurs in the gut wall and extraintestinally. **B** → *Cystoisospora* (e.g., *C. felis* and *C. rivolta* of cats, *C. ohioensis* of dogs): heteroxenous cycle. Oocysts are excreted unsporulated (B1). An intermediate host (B2) may facultatively be involved in addition to the typical development (SC, GA, SP) inside the intestine of the final host. Rodents and/or cattle are infected by oral ingestion of sporulated oocysts. The sporozoites (SP) enter numerous types of host cells, but remain there unchanged in a →parasitophorous vacuole (PV) until this cell is eaten by the final host. Since there is no parasitic development inside the intermediate host, it must be considered as a transport or →paratenic host. **C** → *Frenkelia* (e.g., *F. clethrionomyobuteonis*): heteroxenous cycle with an obligate alternation of final (hawk) and intermediate (bank vole) hosts (like → *Sarcocystis*). The oocysts are excreted fully sporulated (C1) and must be ingested by the intermediate host. Inside the liver cells (C2) typical schizonts (S) produce merozoites, which lead to formation of septated tissue cysts (TC) in brain and cord (C3). The cysts contain dividing merocytes and finally motile cyst merozoites (→ *Bradyzoites*). The latter are infectious to the final hosts, where they (when oral ingestion occurs) initiate gamogony inside the gut cells. **D** → *Besnoitia* (e.g., *B. wallacei*): obligatory 2-host cycle. Oocysts are excreted unsporulated by the final host cat (D1); after sporulation they must be ingested by intermediate hosts (rats, mice), where reproduction initially occurs by →endodyogeny in many cells (appearing as →pseudocysts; D2). Later, tissue-cysts (D3) are formed inside fibroblasts, leading to cysts that are often macroscopically visible. The latter exclusively contain cyst merozoites (never →metrocytes), which are infectious to final hosts when ingested. After experimental transmission, cyst merozoites of several → *Besnoitia* species repeat the developmental steps D2 and D3 in other intermediate hosts. **E** → *Hammondia* (e.g., *E. hammondi*): obligatory alternation of 2 hosts. Oocysts are excreted unsporulated (E1) by the final host cat; after sporulation they must be ingested by intermediate hosts (mice, rodents), where rapid asexual reproduction occurs in lymphoid cells (E2); this is followed by formation of tissue-cysts (TC) in striated muscles (E3). The cyst merozoites are finally infectious to final hosts (FH), where they initiate schizogony in epithelial cells (SC). This species is discussed as strain of → *T. gondii*. **Infection of final hosts (FH)** by their own excreted oocysts is only possible in the genera → *Isospora* and → *Cystoisospora*. FH, final host; GA, gamogony; IH, intermediate host; N, nucleus; NH, nucleus of the host cell; PS, pseudocyst; PV, parasitophorous vacuole; S, →schizont; SC, schizogony; SP, sporogony; SZ, →sporozoite; TC, →tissue cyst (for more details see Table 2 and Table 5 of →Coccidia).

## Coccidiosis, Man

Infectious diseases of the human small intestine caused by various →coccidians (→Isosporosis, Man, →Cyclosporiasis, →Cryptosporidiosis, Man, →Sarcosporidiosis, Man).

**Main clinical symptoms:** →Diarrhoea, →vomiting, loss of weight.

**Incubation period:** 2–13 days.

**Prepatent period:** 7–9 days.

**Patent period:** 2 weeks until 1–2 months (in case of →AIDS patients).

**Diagnosis:** Microscopical determination of oocysts in fecal samples.

**Prophylaxis:** Avoid contact with human feces.

**Therapy:** Treatment see →Coccidiocidal Drugs.

## Coccidiocidal Drugs

### Economic Importance

Most of the anticoccidials used for the control of →coccidia proper in livestock and poultry are approved by government agencies for the prevention of coccidiosis in chickens (Table 1, page 270). Despite the use of anticoccidials in continuous medication programs, global losses chiefly due to subclinical coccidiosis in broiler poultry is estimated at up to US\$750 million. The enormous expansion of broiler production over the last 16 years (e.g., in USA: 1991/2006 = 6.1/8.9 billion birds = plus 45.9%) has been reflected in the world market for anticoccidial drugs. In 1991 the total turnover per year was about US\$450 million. This figure includes in-feed anticoccidials (~80% ionophores) at about US\$370 million, in-water anticoccidials at US\$30–40 million, and biologicals at US\$25–30 million; the broiler market with about 80% of the total has been large enough to stimulate major screening and development programs in the American and European pharmaceutical industries. However, the rapid emergence of drug resistance can result in a short market life for some drugs (less than 6 months for buquinolate). However, high cost of obtaining government clearance, and the delays involved, have all discouraged pharmaceutical companies. Discovering, characterizing, developing, and registering a new drug may take 8–10 years. The risk of drug resistance may also jeopardize any hope of benefit from the high capital expenditure on registering a new anticoccidial. Several pharmaceutical companies have consequently taken a new approach and abandoned anticoccidial-screening programs although the use of

novel high-throughput screening methods would permit large numbers of compounds to be investigated within short periods of time. In future the most promising alternative to controlling coccidia infections with chemotherapy may be coccidiosis vaccines. As a result of public pressure against continuous medication, drug resistance problems, and the high cost of drug clearance vaccines, which are able to induce sufficient immunity (both humoral and cellular response) and thus provide flock protection against →morbidity and →mortality, would be an appropriate alternative.

### Epizootiology and Control Measures

The application of any control methods, whether hygienic, chemotherapeutic, or immunological, needs profound knowledge of the →epizootiology of various coccidiosis. The term coccidiosis is used to describe relatively nonpathogenic and usually mixed infections, whereas coccidiosis is a severe disease in the host. In papers related to human medicine the ending *iasis*, however, is used to indicate an acute phase of disease with severe clinical symptoms. Thus the parasitological literature may lead to confusion on the severity of the disease. Mixed infections, i.e., those where animals are infected with more than one species of coccidia, are very common and only some species are highly pathogenic. The severity of the disease is the result of the combined actions of the particular mixture of coccidia, the number of sporulated oocysts ingested with feed or water. However, it may be influenced also by the nutritional condition of the host, environmental and climatic factors (such as temperature, moisture, oxygen tension, and sunlight) and the management practices used. Crowding of animals due to intensive rearing, e.g., in the broiler industry where large numbers of chickens are kept in enormous houses, creates conditions favorable to sudden outbreaks of severe coccidiosis. Fecal debris may concentrate large numbers of oocysts, which can rapidly sporulate and become infective under warm and moist conditions. Severe coccidiosis is, therefore, mostly a “man-made” problem with domestic animals and is not a general problem in the wild or on pastures. When coccidiosis is suspected and oocysts are found, the species present should be identified. A periodic examination of feces for oocysts and a postmortem examination in a few animals will give valuable information on the status of infection.

Coccidiosis cannot be recognized clinically until tissue damage associated with second- or third-generation →schizogony occurs. When the disease is present, the **clinical signs** are catarrhalic or hemorrhagic enteritis. The severity of disease is often complicated by the presence of secondary bacterial infections. Moderately affected animals show poor weight gain or weight loss, weakness, and emaciation, severely affected animals



**Coccidiocidal Drugs. Table 1** Anticoccidial drugs used in the poultry industry

CHEMICAL GROUP nonproprietary name (oral dose: g/ton feed or ppm: part per million), other information	*BRAND NAMES (manufacturer, companies, distributors), WT, other information	COMMENTS on efficacy, mode of action, toxicity, limitations as withdrawal time before slaughter (WT in days = d), target species, indication(s), contraindications and other information
SULFONAMIDES (introduced around 1940) (approx. 120–250); <i>sulfadiazine</i> , <i>sulfadoxine</i> <i>sulfadimethoxine</i> <i>sulfadimidine</i> <i>sulfaguandinine</i> <i>sulfamethazine</i> <i>sulfaquinoxaline</i> <i>sulfamerazine</i> , and others	(*various brand names and suppliers)  <b>limitations:</b> do not use for <b>prevention</b> of coccidiosis recommended dose levels may vary and depend on drug and dose form (in feed or in water)	opened up the field for practical use; sulfonamides ( <i>sulfas</i> ) have a broad spectrum of activity against <i>Eimeria</i> spp. of the anterior and lower part of the intestine but only a moderate effect on <i>E. tenella</i> (residing in ceca) of chickens; in cattle, swine, and rabbits prophylactic feeding of <i>sulfaguandinine</i> , <i>sulfaquinoxaline</i> and others (not approved indication) may prevent clinical signs and reduce oocyst production thereby allowing development of protective immunity; drug resistance had limited their use as prophylactics in the past; sodium salts of sulfas are
usually water soluble and render them useful for <i>curative treatment</i> of coccidiosis in ruminants, swine, (game) birds, and dogs (withdrawal time may exceed 14 days in food-producing animals); sulfas are active against first- and second-generation schizonts and probably against sexual stages; their action seems to be coccidiocidal at higher doses and coccidiostatic at lower doses; higher doses used in therapy often cause toxicity (hemorrhagic syndrome, kidney damage, growth depression); sulfas interfere with cofactor synthesis, i.e., block dihydropteroate synthetase and hence synthesis of tetrahydrofolate (cofactor is required for cellular methylation reactions) in the early phases of folate synthesis; their action can be nullified by excess p-aminobenzoic acid (PABA); long-acting sulfas (e.g., sulfadoxine, sulfadimethoxine) combined with <i>diaminopyrimidines</i> (e.g., pyrimethamine; other related compounds are ormetoprim, diaveridine, pyrimethamine, and trimethoprim) are highly active antimalarials, anticoccidials, and antibacterials; these combinations may be useful for treating various types of protozoan infections such as toxoplasmosis, sarcocystosis, and neosporosis, various bacterial infections, and human malaria; diaminopyrimidines are dihydrofolate reductase/thymidylate synthase = DHFR/TS inhibitors showing synergistic effects with sulfas due to effects at different sites in the folate biosynthesis; <b>limitations:</b> sulfas, and combinations of sulfas with DHFR/TS inhibitors are not approved for <i>prevention</i> of coccidiosis in poultry or other animals under European Commission Guidelines (additives in feeding stuffs), and feed regulations of Food and Drug Administration (FDA) in the USA and elsewhere, except <i>ormetoprim</i> combined with <i>sulfadimethoxine</i> , the only DHFR/TS-sulfa combination presently available in the USA as an aid for the prevention of coccidiosis in poultry		
DIAMINOPYRIMIDINES <b>sulfadimethoxine/</b> <b>ormetoprim</b> *1 (113.5/68.1 chickens: broilers, replacements, Chukar partridges) (56.75/34.05 turkeys: not laying eggs for human consumption) (454/272.4 for 7d ducks excluding layers) *2 (113.5/68/22.7 chicken broilers)	1*Rofenaid 40 (feed as a sole ration) 2*Rofenaid Plus Roxarsone (Alpharma, USA), Type A medicated Articles (feed as a sole source of organic arsenic) WT: chickens, turkeys, ducks: 5d; Chukar partridges: not released into wild before 18 weeks and can only be used up to 8 weeks of age	1* <b>approved indications:</b> <i>chickens</i> (broilers, replacements) as an aid in prevention of coccidiosis caused by all <i>Eimeria</i> spp. namely, <i>E. tenella</i> , <i>E. necatrix</i> , <i>E. acervulina</i> , <i>E. brunetti</i> , <i>E. mivati</i> , and <i>E. maxima</i> and bacterial infections due to <i>Haemophilus</i> <i>gallinarum</i> (infectious coryza), <i>Escherichia coli</i> (colibacillosis), and <i>Pasteurella multocida</i> (fowl cholera); <b>turkeys:</b> as an aid in prevention of coccidiosis caused by all <i>Eimeria</i> spp. namely, <i>E. adenoeides</i> , <i>E. gallopavonis</i> , and <i>E. meleagrimitis</i> and bacterial infection due to <i>P. multocida</i>
(fowl cholera); <b>Chukar partridges:</b> for prevention of coccidiosis caused by <i>E. kofoidi</i> and <i>E. legionensis</i> , <b>limitations:</b> feed continuously to young birds up to 8 weeks of age as sole ration; <b>ducks:</b> as an aid in control of bacterial infections due to <i>E. coli</i> , <i>Riemerella anatipestifer</i> , and severe challenge of <i>P. multocida</i> (fowl cholera), <b>limitations:</b> feed as a sole ration for 7d, withdraw 5d before slaughter; medication should be started at the first signs of infection; not for breeding ducks, do not feed to ducks producing eggs for food; 2* <b>approved indications:</b> <i>chickens</i> (broilers) as an aid in prevention of coccidiosis caused by all <i>Eimeria</i> spp., namely <i>E. tenella</i> , <i>E. necatrix</i> , <i>E. acervulina</i> , <i>E. brunetti</i> , <i>E. mivati</i> , and <i>E. maxima</i> , and bacterial infections due to <i>H. gallinarum</i> (infectious coryza), <i>E. coli</i> (colibacillosis), and <i>P. multocida</i> (fowl cholera), growth promotion and feed efficiency, improving pigmentation, WT: 5d		
2,4-SUBSTITUTED AMINO BENZOIC METHYL ESTER <b>ethopabate</b> (cf. combination with amprolium ↓)	it has a good innate activity against <i>E. acervulina</i> but not so against <i>E. maxima</i> and <i>E. brunetti</i> (it has no activity against <i>E. tenella</i> ); drug is usually used only in combination with other anticoccidials (cf. amprolium); ethopabate (an aryl-amide containing one phenyl ring belonging to monocyclic aromatics) is a safe drug in mammals and birds; it is an analogue and thus competitor of PABA (p-aminobenzoic acid), which is required for the synthesis of folic acid by the parasite; ethopabate interferes (like sulfonamides) with the dihydropteroate synthetase reaction (conjugation of a pteridine moiety and PABA); however, PABA excess in medicated feed or water can nullify action of ethopabate	

**Coccidiocidal Drugs. Table 1** Anticoccidial drugs used in the poultry industry (Continued)

CHEMICAL GROUP nonproprietary name (oral dose: g/ton feed or ppm: part per million), other information	*BRAND NAMES (manufacturer, companies, distributors), WT, other information	COMMENTS
<b>PYRIDINOLES</b> <b>clopidol</b> *1 (113.5/227 chicken broilers, replacements), <b>clopidol/roxarsone</b> *2 (113.5/45.4) Coyden 25/3-Nitro (Merial USA), Type A medicated Articles, WT: chickens 5d	1*Lerbeck 25, Coyden 25 (Merial USA: Type A medicated Articles, WT: 5d, 1*Lerbeck Australia: oral powder WT: 0d), <i>limitations</i> : do not feed to chickens over 16 weeks of age	on efficacy, mode of action, toxicity, limitations as withdrawal time before slaughter (WT in days = d), target species, indication(s), contraindications and other information  first commercial use of drug products 1968; it arrests sporozoite and trophozoite development (= coccidiostatic effect: withdrawal of drug leads to relapse of infection); it is active against all <i>Eimeria</i> spp. in chickens but considerable problems have been reported with <i>E. acervulina</i> ; drug resistance problems limit its use to shuttle programs (e.g., last 1–3 weeks of broiler grow- out); it is synergistic when combined with chemically
related 4-hydroxy-quinolines; it is very safe for chickens and safe in mammals; <b>approved indications</b> : as an aid in prevention of coccidiosis caused by <i>E. tenella</i> , <i>E. necatrix</i> , <i>E. acervulina</i> , <i>E. maxima</i> , <i>E. brunetti</i> , and <i>E. mivati</i> ; *2: also growth promotion and feed efficiency, improved pigmentation); <i>limitations</i> (Coyden 25/3-Nitro): feed up to 16 weeks of age if intended for use as caged layers, feed continuously as the sole ration		
<b>4-HYDROXYQUINOLINES</b> <b>decoquinat</b> *1 (20–40) <b>decoquinat/roxarsone</b> (27.2/45.4) *3-Nitro/Deccox (Alpharma USA), Type A medicated Article, WT: chicken, broilers excl. layers, 5d	1*Deccox (Alpharma USA, Germany, and elsewhere), Type A medicated Article for chickens (broilers) <i>limitations</i> : chickens not laying eggs, cattle (not lactating), young sheep and goats (not lactating)	first commercial use: buquinolate 1967 (withdrawn), decoquinat 1970, methylbenzoate/clopidol 1974 (withdrawn); <i>buquinolate</i> was “commercially dead” within 6 months (sudden and dramatic appearance of drug resistance); hydroxyquinolines are almost entirely coccidiostatic against sporozoites and trophozoites of all <i>Eimeria</i> spp. in chickens (cf. clopidol); as single compounds they had only limited success: methylbenzoate
(10ppm and higher concentrations) proved ineffective against relevant <i>Eimeria</i> spp. due to serious and immediate development of drug resistance in the field; <b>mode of action</b> : hydroxy-quinolines target on energy metabolism: compounds block electron transport down the cytochrome chain in the mitochondria of coccidia and hence inhibit NADH oxidation and ATP synthesis as well; *1 <i>approved indications (chickens)</i> : for prevention of coccidiosis caused by <i>E. tenella</i> , <i>E. necatrix</i> , <i>E. acervulina</i> , <i>E. maxima</i> , <i>E. brunetti</i> , and <i>E. mivati</i> (*3-Nitro/Deccox: also growth promotion and feed efficiency, improved pigmentation); *1 ( <i>cattle</i> ): for prevention of coccidiosis in ruminating and nonruminating calves and cattle caused by <i>E. bovis</i> and <i>E. zuernii</i> ; ( <i>goats</i> ): for prevention of coccidiosis caused by <i>E. christenseni</i> and <i>E. ninakohlyakimovae</i> ; ( <i>sheep</i> ): for prevention of coccidiosis caused by <i>E. ovinoidalis</i> , <i>E. crandallis</i> , <i>E. parva</i> , <i>E. bakuensis</i> ; <i>general limitations</i> : bentonite should not be used in decoquinat feeds, and other limitations for use in ruminants concerning dosage regimens (cf. label) in various feed and duration of prophylactic treatment (feed at least 28 days during periods of exposure to coccidiosis or when it is likely to be a hazard)		
<b>NITROBENZAMIDES</b> <b>dinitolmide</b> (125, chicken broilers, pullets, turkeys), not to be fed on laying hens; drug products available in <i>Australia</i> , elsewhere	*CCD D.O.T.: CCD AH and Nutrition (Ridley AG), *DOT 125 Premix: (Provimi Australia), oral powder, premix, WT: 0d chicken (broilers, pullets) and turkeys	first commercial use: dinitolmide 1960, nitromide 1958 (withdrawn in the USA and elsewhere), aklomide 1965; drug arrests development of first- and second- generation schizonts and does not interfere with development of immunity; it is active against <i>Eimeria</i> <i>tenella</i> and <i>E. necatrix</i> but its effect against <i>E. acervulina</i> is limited; drug was combined with sulfanitrans or roxarsone to enhance coccidiostatic activity and growth promotion; it may chiefly be used in breeder or replacement chickens (up to 14 weeks of age); mode of action is unknown; <b>limitations</b> : do not use in laying hens (chicken, <i>turkeys</i> )
*1 <b>nitromide/sulfanitrans</b> (227/227 chickens), *2 <b>nitromide/ sulfanitrans/</b> <b>roxarsone</b> (227/22745.4 chicken) *1 <b>aklomide/sulfanitrans</b> (227/181 chickens) *2 <b>aklomide/sulfanitrans/</b> <b>roxarsone</b> (227/181/45.4 chicken)	1*Unistat 2; 2*Unistat 3 (Fort Dodge USA, elsewhere), Type A medicated feed, medicated feed WT: 5d 1*Novostat, 2*Novostat- 3 Type A medicated Article, Premix, others (all Fort Dodge USA)	is not currently marketed as a single agent; it was the first nitrobenzamide on the market and has same similar action on coccidia like dinitolmide; it may be used in breeders, broilers, and roasters; <b>approved indications</b> : as an aid in prevention of coccidiosis caused by <i>E. tenella</i> , <i>E. necatrix</i> , and <i>E. acervulina</i> (*2: also growth promotion and feed efficiency and improved pigmentation); <i>limitations</i> : not to be fed to laying chickens, and (*2) feed as a sole source of organic arsenic drug products can be used in breeders, broilers,

**Coccidiocidal Drugs. Table 1** Anticoccidial drugs used in the poultry industry (Continued)

CHEMICAL GROUP nonproprietary name (oral dose: g/ton feed or ppm: part per million), other information	*BRAND NAMES (manufacturer, companies, distributors), WT, other information	COMMENTS on efficacy, mode of action, toxicity, limitations as withdrawal time before slaughter (WT in days = d), target species, indication(s), contraindications and other information
and roasters and have similar activity against coccidia like dinitolmide and nitromide; approved indications and limitations (not to be fed to laying chickens, and (*2) feed as a sole source of organic arsenic) cf. nitromide†		
ORGANIC ARSENICALS <b>roxarsone</b> 1*(45.4 chicken, turkeys) <b>arsanilic acid</b> (90 chicken, turkey) Pro-Gen Plus Supplement (Fleming Labs, others, USA)	1*A.L. 3-Nitro (OZ-Biopharm, Alpharma, Australia) powder WT: chicken, turkeys 5d; 2*/3 Nitro/ BMD/ Monteban (Alpharma USA)	first commercial use of roxarsone 1946, and arsanilic acid 1949; primary indication of arsenicals like arsanilic acid, or roxarsone (3-nitro-4-hydroxyphenyl-arsonic acid) is growth promotion; <b>approved indication</b> (1*A.L. 3-Nitro Australia, or *Zoco or *Zuco Tablets for Poultry, Alpharma, USA, oral liquid, WT: chicken, turkey 5d): for growth promotion and improved feed conversion efficiency in chickens and turkeys; <b>limitations</b> : do not use in birds which are producing
or may in the future produce eggs or egg products for human consumption, do not use in ducks, geese, or dogs nor for any other purpose or in any manner contrary to the directions on this label, feed as a sole source of organic arsenic; roxarsone has been reported to have some activity against <i>E. tenella</i> and <i>E. brunetti</i> (as a single agent or in combination with nitrobenzamides); in the European Union arsenicals have been prohibited and withdrawn from market; roxarsone is also used in combination with other agents as narasin, antibiotics (e.g., bacitracin methylene disalicylate, \cf. 2*/3 Nitro/ BMD/ Monteban, Alpharma USA)		
CARBANALIDE DERIVATIVES <b>nicarbazin</b> (113.5–125 chicken, breeders, broilers, roasters) <b>limitations</b> : do not feed to laying hens	*Nicarbazin (Phibro AH, USA), Type A Medicated Article, WT: 4d *Keymix Keycarbazin (Internat. AH Products, others Australia), oral powder, premix, WT: 4d	nicarbazin (introduced in 1955) was the first agent with “broad-spectrum” activity against <i>Eimeria</i> spp. of chickens; it is an equimolar complex of dinitrocarbanilide and dimethylpyrimidinol and still used as a single agent in the USA, Australia, elsewhere
or in combination with polyether antibiotics (narasin, or maduramicin), roxarsone, or antibiotics (lincomycin, bacitracin, flavomycin in the USA, incl. roxarsone) for prevention and control of coccidiosis caused by <i>Eimeria</i> spp. (all relevant species) in broiler chickens; it shows synergistic effect with polyether antibiotics (cf. combination with narasin *Maxiban or maduramicin *Gromax); its action is primarily directed against developing second-generation <i>Eimeria</i> schizonts; it has approval for chickens only and may still be used in shuttle programs as starter feed preferably in winter or cooler months; this may be the reason why nicarbazin-resistant coccidia strains do not occur so frequently in poultry industry; however, there may be problems with side effects occurring during summer; it can cause increased sensitivity to heat stress, which may result in growth depression and even mortality in broilers; death may be due to cell degeneration processes in liver and kidneys; at recommended dose, the drug causes occasionally toxic effects in laying hens like reduced hatchability and interruption of egg laying; <b>mode of action</b> is not yet well understood and potential targets of selective toxicity in coccidia are unknown; <b>approved indications</b> (USA): aid in preventing outbreaks of cecal ( <i>E. tenella</i> ) and intestinal ( <i>E. acervulina</i> , <i>E. maxima</i> , <i>E. necatrix</i> , and <i>E. brunetti</i> ) coccidiosis; <b>limitations</b> : feed continuously as sole ration from time chicks are placed on litter until past the time when coccidiosis is ordinarily a hazard, do not use as a treatment for coccidiosis, do not use in flushing mashers		
THIAMINE ANALOGUES <b>amprolium</b> (APL) *1 (36.3–113.5, chicken broilers, replacements) *1 (113.5–227, chicken laying, 227: treatment) *1 (113.5–227 turkeys) *1 (159 pheasants growing), *1 (5mg/kg b.w. cattle for 21d)  *2 <b>amprolium</b> HCl (240 mg/ litre for 24 hours every fourth day as long as infection is likely: chickens, turkeys, ducks, pigeons)	*Amprovine: various products for prevention and treatment (Merial USA) 1*Type A medicated Article, poultry WT: 0d, cattle, calves 1d; or 9.6% solutions or 20% soluble powder (WT see above) for the treatment (amount see label) 2*Amprolium 200 Soluble Powder (200 g/kg APL HCl) (Australia), oral powder (drinking water), WT: 0d;	amprolium (introduced 1960) is structurally related to the vitamin thiamine and is soluble in water as HCl salt; its activity is primarily directed against first-generation schizonts of <i>Eimeria</i> spp. (prevents development of merozoites and thus reduces production of second-generation schizonts); there is some activity against gamonts (sexual stages); it may affect sporulation process in the oocyst (development of sporozoites); it is coccidiostatic at lower, and coccidiocidal at higher doses and is a very safe agent in poultry and mammals; APL-resistant <i>Eimeria</i> strains are prevalent in broiler chickens and floor-reared replacement pullets or turkeys, which limits its use in the field; APL is combined with

**Coccidiocidal Drugs. Table 1** Anticoccidial drugs used in the poultry industry (Continued)

CHEMICAL GROUP nonproprietary name (oral dose: g/ton feed or ppm: part per million), other information	*BRAND NAMES (manufacturer, companies, distributors), WT, other information	COMMENTS on efficacy, mode of action, toxicity, limitations as withdrawal time before slaughter (WT in days = d), target species, indication(s), contraindications and other information
*3 <b>amprolium/ethopabate</b> (125/8, chicken, turkey)	3*Keymix Keystat Powder Feed Additive (Internat. AH Products) 3* Amprolix Plus (Merial Australia), oral powder, premix in feed, WT: 0d	other agents (e.g., <i>ethopabate</i> or <i>roxarsone</i> ) to enhance anticoccidial activity; <b>approved indications</b> (USA): APL and combinations (APL/ethopabate; APL/ethopabate/roxarsone: available as feed additives or other dose forms) may be used in poultry (chicken broilers, broiler breeders, or replacement pullets: latter feed from day-old till 6–8 weeks of age), guinea fowl, turkeys (poult: from day-old till 6–8 weeks of age), ducks and pigeons for
*4 <b>amprolium/ethopabate/roxarsone</b> (113.5/3.6/45.4 chicken broilers)	4* Broiler PMX No.1620 (Merial USA), Type A medicated Article, WT: broiler 5d	the treatment and an aid in the prevention of coccidiosis caused by <i>Eimeria tenella</i> , <i>E. acervulina</i> (most strains are affected), <i>E. maxima</i> (affected to a lesser degree), <i>E. necatrix</i> , and <i>E. brunetti</i> , pathogen <i>Eimeria</i> spp. of turkeys and other species of ducks and pigeons (*4: in addition, growth promotion and feed efficiency, improved pigmentation); drug products may be used in turkey poult because of its good tolerability and encouraging immunity to develop, needed for satisfactory performance of replacement pullets and poult following withdrawal of agent; in <i>cattle</i> and <i>calves</i> *Amprovine is used as an aid in the treatment of coccidiosis caused by <i>E. bovis</i> and <i>E. zurnii</i> ; <b>mode of action</b> : in parasites, APL competitively inhibits uptake and active transport of thiamine (coccidia may be 50-fold more sensitive to the system than that of the host); thiamine pyrophosphate is a cofactor of several enzymes involved in decarboxylating processes playing a role in cofactor synthesis; APL cannot be pyrophosphorylated (lacks hydroxyethyl group); <b>limitations</b> (*3, *4): do not use in birds, which are producing or may in the future produce eggs or egg products for human consumption; (*4): feed as a sole source of organic arsenic
<b>QUINAZOLINONES</b>		
halofuginone (introduced 1976) was originally derived from a plant extract ( <i>Dichroa febrifuga</i> Lour); isolated <i>febrifugine</i> had an antimalarial and anticoccidial effect but a too narrow safety margin; structural variations of the alkaloid (previously performed by American Cyanamid) led to halofuginone; its mode of action is unknown; the alkaloid is <i>toxic to fish</i> and other aquatic species		
<b>halofuginone</b> Hydrobromide (HAL) *1 (2–3 chickens EC) *1 (2.72 chicken broilers, replacement cage layers, and replacement broiler breeders, USA) *1 (1.36–2.72 turkeys growing, USA) <b>halofuginone/roxarsone</b> *2 (2.72/ 22.7–45.4 chicken replacement broilers not over 20 weeks age, chicken, replacements for caged layers not over 16 weeks)	1*Stenorol (Huvepharma USA; Intervet Internat. Europe, elsewhere), Type A medicated article: chicken and turkeys (USA, Switzerland, elsewhere), chicken: replacement cage layers and replacement broiler breeders (EC = European Commission), WT may vary (USA cf. text →, Switzerland: 5d, EC: 5d) 2*/3-Nitro/Stenorol (Alpharma, Inc. USA), Type A medicated article: for chicken, WT: 5d	HAL is highly active against asexual stages of coccidia; it has a broad spectrum of activity against all pathogenic <i>Eimeria</i> spp. of chickens and turkeys; it affects asexual stages of coccidia, particularly merozoites during the first-generation schizogony maturation; drug action is both coccidiocidal and coccidiostatic but in case of <i>E. acervulina</i> not as strong as with other species; drug resistance may occur when drug is used for too long periods in straight medication programs; if used in shuttle (or rotation) programs and alternated with polyether antibiotics it will be more likely that field strains of coccidia remain sensitive to the agent; <b>approved indications</b> ( <i>chicken</i> broilers, replacement cage layers, and replacement broiler breeders, USA): for prevention of coccidiosis caused by <i>E. tenella</i> , <i>E. necatrix</i> , <i>E. acervulina</i> , <i>E. brunetti</i> , <i>E. mivati</i> / <i>E. mitis</i> ,
and <i>E. maxima</i> ; <b>limitations</b> (broilers: feed continuously as sole ration, withdraw 4 days before slaughter, do not feed to layers); <b>limitations</b> (replacement cage layers and replacement broiler breeder): feed continuously as sole ration to replacement cage laying chickens until 20 weeks of age, feed continuously as sole ration to replacement broiler breeder chickens until 16 weeks of age, withdraw 4d before slaughter, do not feed to laying chickens or water fowl; <b>approved indications</b> ( <i>turkey</i> growing USA): for prevention of coccidiosis in growing turkeys caused by <i>E. adenoides</i> , <i>E. meleagriditis</i> , and <i>E. gallopavonis</i> ; <b>limitations</b> : feed continuously as sole ration, withdraw 7d before slaughter, do not feed to layers or water fowl; <b>approved indications</b> ( <i>chicken</i> ) 2*/3-Nitro/Stenorol, cf. 2*): for prevention of coccidiosis caused by <i>E. tenella</i> , <i>E. necatrix</i> , <i>E. acervulina</i> , <i>E. brunetti</i> , <i>E. mivati</i> , and <i>E. maxima</i> , for increased rate of weight gain, improved feed efficiency, and improved pigmentation; <b>limitations</b> : feed continuously as sole ration to replacement cage laying chickens until 20 weeks of age, and to replacement broiler breeder chickens until 16 weeks of age, use as the sole source of organic arsenic; drug overdose or lack of water intake may result in leg weakness or paralysis, do not feed to laying chickens or waterfowl; <b>general limitations</b> : avoid contact with skin, eyes, or clothing, do not contaminate dams, rivers, streams, or other waterways with the chemical; <b>tolerability and metabolism</b> : at recommended dose, HAL is well-tolerated in chicken and turkeys; however, it is unpalatable at the recommended feed concentrations for anseriformes (ducks, geese, swans), water fowl, guinea fowls, partridges, or other game birds and rabbits; if fed continuously there is a drastic reduction in feed intake followed by serious toxic reactions and		

**Coccidiocidal Drugs. Table 1** Anticoccidial drugs used in the poultry industry (Continued)

CHEMICAL GROUP nonproprietary name (oral dose: g/ton feed or ppm: part per million), other information	*BRAND NAMES (manufacturer, companies, distributors), WT, other information	COMMENTS on efficacy, mode of action, toxicity, limitations as withdrawal time before slaughter (WT in days = d), target species, indication(s), contraindications and other information
occasionally mortality; other adverse effects may be associated with skin tears in chicken (HAL is an inhibitor of collagen type I synthesis in avian and mammalian fibroblasts thereby decreasing skin strength and increasing incidences of skin tears during processing); however, in shuttle programs, in which halofuginone is included in grower feed, it seems to maintain skin integrity in broilers; in toxicity studies on laying hens it was shown that HAL is transmitted to eggs (there were no adverse effects on egg production or egg quality); it irritates skin and eyes after contact (precaution should be taken during handling this agent)		
<b>GUANIDINE DERIVATIVES</b>		
robenidine (introduced 1972) is a synthetic anticoccidial derivative of guanidine; if not withdrawn 5 days before slaughter or used at higher than the recommended dose edible tissues and eggs of layers of medicated birds will have an unpleasant (medical) taste; mode of action of robenidine is believed to interfere with energy metabolism by inhibition of respiratory chain phosphorylation and ATPase activity in rat liver mitochondria; however, other guanidine derivatives lacking anticoccidial activity also share this inhibitory activity on oxidative phosphorylation process		
<b>robenidine</b> hydrochloride *1 (30–36 chicken broilers, fryers; EC: and turkeys growing) <b>robenidine/roxarsone</b> (30/22.5–45.4, chicken broilers, fryers) 2*Robenz Plus Roxarsone (Alpharma USA)	1*Cycostat 66G (Alpharma Australia; EC) for broiler chickens (Australia) and growing turkeys (up to 12 weeks of age) and <b>rabbis</b> (EC) 1*Robenz (Alpharma USA) for chickens (broiler and fryers): 1*/ 2*: all Type A medicated articles (WT: all 5d)	has broad anticoccidial spectrum of activity including <i>Eimeria</i> spp. of birds and mammals (EC approval for <b>rabbis</b> at 50-66ppm for prevention of coccidiosis caused by intestinal <i>Eimeria</i> spp. only); it affects late developing stages of first- and second-generation schizonts; it may have some activity against gamonts (sexual stages); its action is both first coccidiostatic and then coccidiocidal; <i>Eimeria</i> spp. may easily and quickly develop resistance to the agent; there were reports of unexpected outbreaks of drug resistance in the USA
and Canada within a year of its introduction in poultry farms; <b>approved indications</b> (USA): an aid in prevention of coccidiosis caused by <i>E. mivati</i> , <i>E. brunetti</i> , <i>E. tenella</i> , <i>E. acervulina</i> , <i>E. maxima</i> , and <i>E. necatrix</i> (EC: in addition <i>Eimeria</i> spp. of turkeys such as <i>E. adenoides</i> , <i>E. meleagritidis</i> , and <i>E. gallopavonis</i> ); <b>limitations</b> : do not feed to layers, feed continuously as the sole ration, Type C feed containing robenidine HCl must be fed within 50 days from the date of manufacture, do not use in Type B or Type C medicated feeds containing bentonite; 2*Robenz Plus: in addition: feed as a sole source of organic arsenic		
<b>POLYETHER IONOPHOROUS ANTIBIOTICS</b>		
(discovered in the early 1950s and anticoccidial activity recognized in late 1960s) are fermentation products of various <i>Streptomyces</i> spp. or <i>Actinomadura</i> sp. (maduramicin, semduramicin) containing mycelial biomass (maduramicin can be extracted into granular carrier); ionophores have different affinities to different cations; their mode of action is related to their ability to interact with physiologically important monovalent and divalent cations (e.g., Rb <sup>+</sup> , Na <sup>+</sup> , K <sup>+</sup> , Cs <sup>+</sup> , or Ca <sup>2+</sup> ) to form lipophilic complexes and transport so cations across biological membranes thereby destroying their cross-membrane gradients; sporozoites of <i>E. tenella</i> are killed after 12–24 hour-incubation in “solutions” of monensin, salinomycin and lasalocid, respectively, at very low concentrations (Raether W. et al. (1991) Parasitol Res 77: 386); ionophores also altered irreversible free <i>Eimeria tenella</i> merozoites and mature (first- and second- generation) schizonts or erythrocytic stages of various chloroquine-resistant strains of <i>Plasmodium berghei</i> <i>in vitro</i> ; <i>Eimeria</i> -infected chickens fed with polyether antibiotic-medicated feed show usually relatively high oocyst outputs in feces; this may be due to ionophores’ lack of activity against sporozoites <i>in vivo</i> ; broad-spectrum activity of polyether antibiotics against all pathogenic <i>Eimeria</i> spp. in poultry gave them continuing commercial success till mid- to late 1980s as first [Raether W. et. al. (1991) Parasitol Res 77: 386]; ionophore-resistant strains of chicken <i>Eimeria</i> spp. were documented in Europe, USA, and elsewhere; today, ionophore resistance is common though response of resistant strains to specific ionophores may be different; there may be side resistance between monovalent ionophores (e.g., salinomycin/monensin) or cross-resistance between monovalent and divalent ionophores (e.g., monensin/lasalocid); in general, side-resistance among monovalent ionophores is widespread because this group of compounds is frequent used in the poultry industry; however, <i>Eimeria</i> spp. of poultry will retain their susceptibility to monovalent and divalent polyether antibiotics if concerned drug products are used strategically in the field (e.g., rotation programs); ionophores are potential toxic for highly susceptible animals such as horses and other equines, their safety margin is narrow in birds and mammals; concurrent use of tiamulin (a macrolide antibiotic) and certain anticoccidial ionophores produces adverse effects in poultry, such as weight depression and mortality due to retarded elimination of the ionophores via feces; lasalocid, maduramicin, and semduramicin are compatible with tiamulin but most of the ionophores may interact with sulfonamides and erythromycin; dose-related toxicity is evident by weakness, leg paralysis, and sharp reduction of water intake; anticoccidial ionophores may be used as feed additives for preventing coccidiosis in poultry (rabbits: EC?; ruminants: USA, Australia, elsewhere) or as feed additives for improving feed conversion efficiency and/or weight gain in cattle or swine in the USA and elsewhere (an EU-wide ban on antibiotics as growth promoters in animal feed entered into effect on January 1, 2006; Commission Regulation, EC No. 600/2005, April 2005 concerning a new authorization for 10 years of a coccidiostatic as an additive in feedstuffs including certain polyether antibiotics, see also below)		

**Coccidiocidal Drugs. Table 1** Anticoccidial drugs used in the poultry industry (Continued)

CHEMICAL GROUP nonproprietary name (oral dose: g/ton feed or ppm: part per million), other information	*BRAND NAMES (manufacturer, companies, distributors), WT, other information	COMMENTS
<b>monensin-Na</b> (sodium) (MON) ●USA: (90–110 chicken broilers, replacements) (54–90 turkeys, no use class stated or implied) (73 Bobwhite quails, growing) ●Australia: (100–120 chicken broilers, replacements) ●EC (100–125 chicken broilers), (100–120 chicken replacements) (60–100 turkeys growing)	*Coban; *Elancoban, others (Elanco AH, Eli Lilly USA, Australia, EC), Type A medicated articles, others, WT: USA and Australia 0d, EC 3d, other drug products (in the USA: roxarsone or antibiotics combined with MON); <b>general limitations:</b> do not feed to laying chickens, do not allow horses, other equines, mature turkeys, or guinea fowl access to feed containing MON	on efficacy, mode of action, toxicity, limitations as withdrawal time before slaughter (WT in days = d), target species, indication(s), contraindications and other information  fermentation product of <i>Streptomyces cinnamomensis</i> (introduced in 1968); MON was the first ionophore used in poultry industry; <b>approved indications</b> (USA, elsewhere): as an aid in prevention of coccidiosis in chickens caused by <i>E. necatrix</i> , <i>E. tenella</i> , <i>E. acervulina</i> , <i>E. brunetti</i> , <i>E. mivati</i> , and <i>E. maxima</i> , in turkeys: <i>E. adenoides</i> , <i>E. meleagrimitis</i> , and <i>E. gallopavonis</i> , in growing bobwhite quail: <i>Eimeria dispersa</i> and <i>E. lettyae</i> ; <b>limitations:</b> feed continuously as sole ration as MON sodium, do not feed to chickens (and turkeys: EC) over 16 weeks of age; chicken broilers: in the absence of coccidiosis, the use of MON sodium with no withdrawal period may limit feed
intake resulting in reduced weight gain; feed continuously as the sole ration to growing turkeys from 1 day of age as MON sodium; <b>tolerability:</b> MON may produce poor feathering when feeding diets with low energy and low sulphur-containing amino acids; tiamulin interferes with metabolism of MON in chickens; at recommended doses MON may be toxic to guinea fowl and other avian species; horses are very sensitive to MON (LD 50%: horse 2–3 mg/kg b.w., cattle 25 mg/kg; chickens 200 mg/kg); <b>contraindication</b> MON will cause deaths in equines that ingest feed containing it		
<b>lasalocid-A-Na</b> (sodium) (LAS) ●USA (68–113 chicken broilers, fryers, turkeys growing), (113 Chukar partridges) ●EC (75–125 chicken broilers, replacements up to 16 weeks of age) (90–125 turkeys up to 12 weeks of age) ●Australia (75–100 chicken broilers, rearing replacement pullets, turkeys)	*Avatec (Alpharma EC, USA, Australia), Type A Medicated Article, others (medicated feed), WT: USA, Australia 0d, EC 5d; other drug products (in the USA: roxarsone or antibiotics combined with LAS) <b>limitations:</b> feed continuously as the sole ration, not to be added to feed consumed by hens producing fertile eggs or by game birds other than turkeys and Chukar partridges;	fermentation product of <i>Streptomyces lasaliensis</i> (introduced in 1974); it structurally differs from other ionophores and has strong affinity to <i>divalent</i> cations; metabolism of LAS appears to differ from that of monovalent ionophores, for its usage is associated with wet litter at the higher dosage levels and it is well tolerated when fed with tiamulin; at 75 ppm its activity against <i>E. acervulina</i> is unsatisfactory but good against <i>E. tenella</i> ; <i>E. tenella</i> strains resistant to monovalent ionophores may be controlled with LAS; in the USA (elsewhere), LAS is approved for the prevention and control of coccidiosis caused by various <i>Eimeria</i> spp. of <b>cattle</b> (excluding veal calves), <b>sheep</b> and young <b>domestic rabbit</b> (only <i>E. stiedae</i> ); it shows efficacy
against <i>Eimeria</i> spp. of sheep, cattle, and domestic rabbits ( <i>E. stiedae</i> ) may be used in the USA (e.g., *Bovatec, or *Avatec, others, various oral drug forms, cattle and sheep: also for improved feed efficiency and increased rate of weight gain: <b>approved indications in birds</b> (*Avatec, USA, elsewhere): for prevention of coccidiosis in chickens (broilers, fryers) caused by <i>E. necatrix</i> , <i>E. tenella</i> , <i>E. acervulina</i> , <i>E. brunetti</i> , <i>E. mitis</i> , ( <i>E. mivati</i> ), and <i>E. maxima</i> ; in turkeys (growing) <i>E. adenoides</i> , <i>E. meleagrimitis</i> , and <i>E. gallopavonis</i> ; and in Chukar partridges (up to 8 weeks of age) <i>E. legionensis</i> ; <b>contraindications:</b> not to be fed to horses or other equid species		
<b>salinomycin-Na</b> (sodium) (SAL) ●USA (40–60 chicken broilers, roasters, replacements, excluding layers), (50 quail, no use class stated or implied) ●EC (60–70 chicken broilers), (50: up to 12 weeks age replacements) ●Australia (60 chicken broilers, replacements, excluding layers)	*Bio-Cox (Alpharma USA, Australia) Type A Medicated Article, others (medicated feed), WT: USA, Australia 0d; other drug products (in USA: roxarsone or antibiotics combined with SAL) *Sacox 120; (Intervet EC), Type A Medicated Article (medicated feed), WT: EC 5d; other drug products	fermentation product of <i>Streptomyces albus</i> (introduced 1978); SAL is active against all pathogen <i>Eimeria</i> spp. of poultry and affects particularly developmental stages in the early and late phase of coccidia life cycle as sporozoites and late asexual stages (second/third schizont-generation); SAL has been reported to have a pronounced effect against <i>E. tenella</i> and <i>E. acervulina</i> (including against drug-resistant <i>Eimeria</i> spp. in the field); SAL is active against coccidia of the <b>domestic rabbit</b> (approval by EC, e.g., *Sacox 120: 20–25ppm); <b>tolerability:</b> at recommended dose, SAL is toxic for turkeys (particularly in adult birds: growth depression,
excitement followed by paralysis with head and legs extended, mortality), horses, and other equines; tiamulin interferes with metabolism of SAL in chickens and causes weight depression; <b>approved indications in birds</b> (*Bio-Cox, *Sacox, others): for prevention of coccidiosis in chickens (broilers, roasters, replacements) caused by <i>E. necatrix</i> , <i>E. tenella</i> , <i>E. acervulina</i> , <i>E. brunetti</i> , <i>E. mitis</i> , ( <i>E. mivati</i> ), and <i>E. maxima</i> ; and in quail: <i>E. dispersa</i> and <i>E. lettyae</i> ; approved indication as <b>growth promotor</b> (Australia, elsewhere): for improvement of productivity by stimulating the growth rate and increasing feed		

**Coccidiocidal Drugs. Table 1** Anticoccidial drugs used in the poultry industry (Continued)

CHEMICAL GROUP nonproprietary name (oral dose: g/ton feed or ppm: part per million), other information	*BRAND NAMES (manufacturer, companies, distributors), WT, other information	COMMENTS on efficacy, mode of action, toxicity, limitations as withdrawal time before slaughter (WT in days = d), target species, indication(s), contraindications and other information
conversion of grower (30–60ppm)/finisher (15–30ppm) <b>pigs</b> and <b>feedlot beef cattle</b> (15ppm), do not use in cows, which are producing, or may in the future produce milk or milk products for human consumption; <b>limitations</b> (USA, elsewhere): feed continuously as sole ration, do not feed to laying hens producing eggs for human consumption, not approved for use with pellet binders, may be fatal if accidentally fed to horses or adult turkeys		
<b>narasin</b> (approval for broiler chickens only) *1●USA (54–72) *1●EC (60–70) *1●Australia (60–80) <b>narasin/nicarbazin</b> (1:1) (total active ingredient) *2●USA (54–90) *2●EC, Australia (80–100) (in the USA: roxarsone or antibiotics combined with narasin or narasin/nicarbazin)	1*Monteban (Elanco AH; Eli Lilly, USA, Australia, EC) Type A Medicated Article, others (medicated feed), WT: USA, Australia 0d; EC 5d  2*Maxiban (Elanco AH; Eli Lilly, USA, Australia, EC) Type A Medicated Article, others WT: USA, EC 5d, Australia 0d	fermentation product of <i>Streptomyces aureofaciens</i> (introduced 1983) and closely related in its structure to salinomycin but not as active as this; to enhance activity, narasin has been combined with synergistic acting nicarbazin (2*Maxiban, introduced 1988); the combination may be used in starter phase of shuttle programs followed by a different ionophore in grower- finisher phase; 1*/2* <b>approved indications</b> : for prevention of coccidiosis in chickens (broilers only) caused by <i>E. necatrix</i> , <i>E. tenella</i> , <i>E. acervulina</i> , <i>E. brunetti</i> , <i>E. mitis</i> , ( <i>E. mivati</i> ), and <i>E. maxima</i> ; approved indication as <i>growth promoter</i> (Australia, elsewhere): for improved feed conversion efficiency in lot-fed <i>cattle</i> (approved: 5–13ppm); 1*/2* <b>limitations</b> : feed continuously as the sole ration, do not feed to laying hens, do not use in laying hens, turkeys, or game birds, nor in horses or other equines (may be fatal), poultry consuming narasin should not be treated with <i>tiamulin</i> (severe growth depression or death may occur)
<b>maduramicin</b> ammonium (MAD) ● EC (5 chicken broilers, turkeys growing up to 16 weeks) ● USA (4.54–5.45 chicken, broilers only) ● Australia (5 chicken broilers only)	*Cygro (Alpharma USA, Australia, EC) Type A Medicated Article, others (medicated feed), WT: USA, EC 5d, Australia 0d; <b>limitations</b> : feed continuously as sole ration, do not use in birds which are producing or may in the future produce eggs or egg products for human consumption	fermentation product of <i>Actinomadura yumaense</i> (introduced 1984), having a sugar moiety as side chain (monoglycoside polyether); it has affinity to both monovalent and divalent cations and shows at very low dose levels a good activity against all pathogenic <i>Eimeria</i> spp. of chickens; cross-resistance with other polyether antibiotics has been reported soon after its introduction in the poultry industry and *Gromax (MAD/nicarbazin, introduced 1992) increased anticoccidial activity; <b>limitation</b> : for the prevention of coccidiosis in broiler chicken; medicated feed containing *Gromax should be fed continuously to broiler chickens as the only ration; MAD is not as toxic as other ionophores for birds and mammals (not approved species like turkeys, guinea fowl, pheasants, geese, ducks, cattle, sheep, horses, pigs, or rabbits tolerate it at recommended dose level); it is well tolerated when fed with tiamulin; <b>approved indications</b> for *Cygro ( <i>Eimeria</i> spp. of chickens and turkeys cf. lasalocid)
<b>MAD/nicarbazin</b> (3.75/40 chicken broilers) <b>limitation</b> : do not use in birds, which are producing or may in future produce eggs or egg products for human consumption	*Gromax (Alpharma Inc. Australia) oral powder, Premix, WT 1d	
<b>semduramicin</b> Na (sodium) (SEM) approval for broiler chickens only ● EC (20–25) ● Australia (25) ● USA (25) <b>SEM/roxarsone</b> (22.7/45.4) *Nitro/Aviax WT: 5d use as sole source of organic arsenic	*Aviax (Phibro AH; USA, Australia, EC), Type A Medicated Article, others (medicated feed), WT: USA, Australia 0d, EC 5d; other drug products (in USA: roxarsone or antibiotics combined with SEM, all WT 5d); do not feed to laying hens	fermentation product of a mutant of <i>Actinomadura roseorufa</i> (introduced 1991, latest ionophore on the market) developed as feed additive for the prevention of coccidiosis in broiler chickens; it is a monovalent monoglycoside polyether ionophore (parent strain produced a diglycoside form of SEM; this can be semi- synthetically modified to obtain the monoglycoside; both forms have identical anticoccidial activity); it is active against all pathogenic <i>Eimeria</i> spp. of chickens with pronounced efficacy against <i>E. maxima</i> ; cross-resistance with other polyether antibiotics has been reported in Europe, South America, and the USA soon after its introduction in the poultry industry; concurrent use of tiamulin and SEM is well tolerated; approved indications (USA): for prevention of coccidiosis caused by <i>E. tenella</i> , <i>E. acervulina</i> , <i>E. maxima</i> , <i>E. brunetti</i> , <i>E. necatrix</i> , and <i>E. mivati/E. mitis</i> ;

**Coccidiocidal Drugs. Table 1** Anticoccidial drugs used in the poultry industry (Continued)

CHEMICAL GROUP nonproprietary name (oral dose: g/ton feed or ppm: part per million), other information	*BRAND NAMES (manufacturer, companies, distributors), WT, other information	COMMENTS
*Nitro/Aviax: including some field strains of <i>E. tenella</i> that are more susceptible to SEM combined with <i>roxarsone</i> than SEM alone; <i>general limitations</i> : feed continuously as sole ration, do not use in birds which are producing or may in the future produce eggs or egg products for human consumption		
ASYMMETRIC (1,2,4) TRIAZINES in the early 1980s there have been several 1,2,4-triazine derivatives under development, e.g., <i>clazuril</i> and <i>diclazuril</i> (US patent application to Janssen 1984) and HOE 092 V (DE patent application to Hoechst AG, 1985, drug development as a feed additive was discontinued during preclinical studies; there were adverse effects on endocrine system in rodents and feathering in chickens); HOE 092 V proved to be highly active against all pathogenic <i>Eimeria</i> spp. of chickens, turkeys, and rabbits; it had also an excellent effect against various pathogen protozoa and crustacean parasites of fish including a variety of gill- and skin-parasitizing monogeneans; thus a single medical bath (10 µg HOE 092 V/ml for 4 hours) was sufficient to kill trophozoites of <i>Ichthyophthirius multifiliis</i> ; at higher dose levels also <i>toltrazuril</i> is active against various fish parasites; it belongs to the symmetric (1,3,5) triazines (cf. <i>toltrazuril</i> (below) and may be used as a therapeutic drug against coccidiosis of birds and mammals, e.g., swine)		
<b>diclazuril</b> (DZU) • USA (0.91/1ppm chicken, broilers not laying eggs for human consumption), (0.91 in combination with bacitracin methylene disalicylate 4-50g/ton of feed: turkey, growing, not laying eggs for human consumption) • EC (1 chicken broilers, replacements up to 16 weeks of age, turkeys, growing up to 12 weeks of age)	*Clinacox (Schering-Plough AH, USA, Janssen AH EC) (not commercially available in Australia), Type A medicated article (medicated feed), WT: USA 0d, EC 5d  *Vecoxan (Janssen-Cilag, Germany, elsewhere) for calves (5 months of age), lambs, oral suspension (2.5 mg/ml), WT: 0d (single dose: 1mgDZU/kg b.w.) for prevention of coccidiosis	synthetic agent (introduced 1988), chemically a benzeneacetonitrile derivative with high anticoccidial activity when fed at low levels in feed; it has a strong anticoccidial activity against developing first- and second-generation schizonts, and gamonts of <i>E. tenella</i> and other pathogenic <i>Eimeria</i> spp. of chickens but developmental stages most affected by DZU varies with the <i>Eimeria</i> spp.; it is highly effective against <i>E. tenella</i> (all stages) but not so against <i>E. maxima</i> (gamonts only); because it is effective against this species later in its life cycle, subclinical intestinal lesions may be present for a short time after infection; nevertheless, DZU was shown in studies to reduce lesion scores and improve performance and health of birds challenged with <i>E. maxima</i> ; when used for longer periods in
straight programs, coccidia of chickens may develop resistance to the drug; for that reason it may be frequently used in shuttle programs; complete cross-resistance with <i>toltrazuril</i> may be evident in the field; DZU may be useful in the treatment of hepatic and intestinal coccidiosis of the domestic rabbit (currently not approved indication); <b>approved indications</b> (EC, USA, elsewhere): for prevention of coccidiosis caused by <i>E. tenella</i> , <i>E. necatrix</i> , <i>E. acervulina</i> , <i>E. brunetti</i> , <i>E. mitis</i> ( <i>mivati</i> ), and <i>E. maxima</i> in chicken, and <i>E. adenoides</i> , <i>E. gallopavonis</i> , and <i>E. meleagridis</i> , for increased rate of weight gain and improved feed efficiency in turkeys; it appears to be compatible with other feed additives and is a very safe drug in various animals (chicken broiler, breeder, turkey, guinea fowl, quail, duck, mouse, rat, rabbit, dog, piglet, horse, cattle, sheep, and goat); <b>limitations</b> : chicken feed continuously, not for use in hens producing eggs for human food; turkeys feed continuously as the sole ration, do not feed to breeding turkeys, not for use in hens producing eggs for human consumption		
<b>clazuril</b> (5 mg/kg b.w., minimum, carrier pigeons only) not for use in pigeons producing eggs for human consumption	*Appertex (Janssen-Cilag, Germany, elsewhere), oral tablets (2.5 mg clazuril/tablet)	highly active against coccidiosis in pigeons ( <i>Eimeria labbeana</i> , <i>E. columbarum</i> ); law may restrict this drug to be used by or on the order of a licensed veterinarian; standard dose is usually 1 tablet per pigeon (young, adult); treat all birds of a pigeon house; drug is well tolerated (overdose of 80, 320, and 640 mg/kg b.w. may produce emesis and diarrhea only); <b>limitations</b> : do not treat pigeons intended for human consumption
SYMMETRIC (1,3,5) TRIAZINES <b>toltrazuril</b> (TZU, *Baycox Bayer, Australia, Germany, elsewhere, introduced 1987) differs from diclazuril (an asymmetric 1,2,4 triazine above) principally in its pharmacokinetic properties (different biotransformation and excretion processes result in a long elimination half-life of TZU and consequently in long withdrawal periods before slaughter); thus TZU is not suitable to be fed continuously as a sole ration in poultry, other birds, and mammals; it is active against both developing first- and second-generation schizonts and gamonts of pathogenic <i>Eimeria</i> spp. of birds (e.g., chicken, geese, ducks and others) and mammals (e.g., cattle, sheep, goats, pigs, rabbits, and others); TZU inhibits nuclear division of schizonts and		



**Coccidiocidal Drugs. Table 1** Anticoccidial drugs used in the poultry industry (Continued)

CHEMICAL GROUP nonproprietary name (oral dose: g/ton feed or ppm: part per million), other information	*BRAND NAMES (manufacturer, companies, distributors), WT, other information	COMMENTS on efficacy, mode of action, toxicity, limitations as withdrawal time before slaughter (WT in days = d), target species, indication(s), contraindications and other information
<p>microgamonts and the wall-forming bodies of macrogamonts; because of similar mode of action of symmetric and asymmetric triazines there is cross-resistance between toltrazuril and diclazuril; intermittent administration of TZU via drinking water may help to establish efficient metaphylactic programs against coccidiosis in chickens and turkeys thereby allowing development of protective immunity; TZU may be used for the control of coccidiosis in neonatal <b>piglets</b> caused by <i>Isospora suis</i> (*Baycox Piglet Coccidiocide, Australia, oral liquid: 50 gTZU/L: 1mL/3–6 day-old piglet once, WT: 70d); *Baycox Bovis (50 mg/ml suspension, Bayer Vital Germany) can be used (15 mg/kg b.w. × 1, per os) to prevent coccidiosis in <b>calves</b> up to 5 months of age (WT 63d); moreover it has a broad-spectrum antiprotozoal activity against <i>Sarcocystis</i> spp., <i>Toxoplasma gondii</i>, <i>Cystoisospora</i> spp., and <i>Hepatozoon</i> spp. of mammals; its activity is also directed against <b>fish parasites</b> such as microsporidia, myxozoa, and monogeneans, or <i>Nosema apis</i> of bees; TZU is very well tolerated in birds, mammals, and fish; <b>approved dosage regimens</b> in <b>chickens</b> (Australia, elsewhere) (*Baycox Coccidiocide Solution, 25 gTZU/L oral liquid, dose rate: 3L/1000L, WT: 14d chickens) is intended for use in treatment programs (e.g., in case of a clinical outbreak of coccidiosis in chickens) and is given via drinking water in an 8-hour treatment period each day for 2 days, if required, treatment may be repeated after 5 days; it can be also used in preventive coccidiosis programs on days 9 and 10, 16 and 17, and 23, and 24 of life; an additional administration may be necessary after 35 days but not within the 14 days withdrawal period of slaughter; approved dosage regimens (Germany, elsewhere): treatment of coccidiosis in chickens and turkeys via drinking water on 2 successive days continuously for 24 hours/day (*Baycox 2.5%, oral liquid, WT: chicken 21d, turkeys 18d; dose rate 1mL/L drinking water = 25 ppm TZU), or as alternate: continuously for 8 hours/day (*Baycox 2.5%, oral liquid, dose rate 3mL/L drinking water = 75 ppm TZU), minimum dose should be 7 mg/kg b.w./day; <b>general limitations</b>: eggs do not use TZU within 6 weeks prior to laying of eggs to be used for human consumption or processing, do not use in replacements over 15 weeks of age; law may restricts this drug use by or on the order of a licensed veterinarian; drug products containing TZU are not commercially available in the USA</p>		
<p><b>AUTHORIZATION OF FEED ADDITIVES AS COCCIDIOSTATS</b> Only feed additives that were granted an authorization following a scientific evaluation for example by the US Food and Drug Administration (*FDA) Center for Veterinary Medicine (*CVM), the Australian Pesticides and Veterinary Medicines Authority (APVMA's), the European Food Safety Authority (EFSA), or other National Authorities will be put on the market. These authorities regulate the manufacture and distribution of approved feed additives (*and drugs) that will be given to animals. Concerning this table, approved feed additive products for target species (animals) listed as of year 2006/2007 (and possibly following years), are available on the market in all Member States of Europe, the USA, Australia, and elsewhere.</p>		
<p>Currently, European Parliament and Council Regulation 1831/2003 (replacing Directive 70/524/EEC) regulate the use of additives in animal nutrition. It sets out rules for the authorization, marketing, and labelling of feed additives, including the category &lt;coccidiostats and histomonostats&gt; previously authorized under Regulation 70/524/EEC. Regulation 1831/2003 also completes the <i>ban on antibiotic growth promoters</i> (January 1, 2006) in feed by prohibiting the use of 4 antibiotic substances (monensin sodium, salinomycin sodium, avilamycin, and flavophospholipol). The EU has already banned antibiotics used in human medicine from being added to animal feed. The Commission's overall strategy is to tackle the emergence of bacteria and other microbes resistant to antibiotics, due to their overexploitation or misuse. Antibiotics will now only be allowed to be added to animal feed for veterinary purposes.</p>		
<p>Commission Regulation (EC) No. 600/2005 (Annex I 'coccidiostats and other medicinal substances') laid down conditions for submission and application for a new authorization for 10 years of coccidiostats as additives in feeding stuffs. Most in-feed substances (at least one target species as broiler chicken, doses) listed in Table 1 are already authorized for 10 years (2014/15), such as decoquinat (756), monensin natrium (E 757), robenidine hydrochloride (758), lasalocid-A-natrium (E 763), narasin (E 765), salinomycin natrium (E 766), or less than 10 years such as diclazuril (E 771: 2009-2013), halofuginone hydrobromide (E 764: pullets, 2009), narasin 80 g/kg-nicarbazin 80 g/kg (Maxiban G160) (E 772: 2009), maduramin-ammonium alpha 1g/100 g (E 770: 2009/11: broiler chicken/growing turkeys), and semduramicin natrium (29/: June 2006, withdrawn ?). Withdrawn authorization (Directive 70/524/EEC) of feed additives as coccidiostats entered into effect on 1999 for aprinocid and dinitolmid (EC regulation 45/1999), and on 2001 for amprolium, amprolium/ethopabate, meticlorpindol, meticlorpindol/methylbenzoate, and nicarbazin (EC regulation 2205/2001).</p>		

Data of drug products (approved labels) listed in this table refer to information from literature, manufacturer, supplier, and websites such as the European Medicines Agency (EMA), Committee for Veterinary Medicinal Products (CVMP), the US Food and Drug Administration (FDA), Center for Veterinary Medicine (CVM), the Australian Pesticides and Veterinary Medicines Authority (APVMA) and associated Infopest (search for products), VETIDATA, Leipzig, Germany, and Clini Pharm, Clini Tox (CPT), Zurich, Switzerland. Data given in this table have no claim to full information

(chiefly young ones) may die very soon after the first clinical signs are seen. Since coccidia have a self-limiting life cycle, the acute phase of infection may have already passed before therapeutic treatment can be started. Thus, **treatment** is usually too late to prevent economic loss. All classes of domestic animals can be affected by coccidia, and losses due to coccidiosis in mammals (particularly in bovines: cattle, sheep, goats, swine, and rabbits) are difficult to determine. The expenses of management practices and the cost of preventive or therapeutic drugs are the main points of consideration. Using suitable control measures can minimize symptoms of the disease. There should be **strict sanitation** to prevent feed and water being contaminated by feces, and feedlots, pens, cages, or hutches should be kept dry and well drained and be cleaned out regularly (preferably every day in rabbitries). When outbreaks occur in pasture, water holes and ditches should be fenced off. Crowding of young animals should be avoided.

Negative effects of intensive animal production are numerous. Thus manure/mineral (phosphate/nitrate) accumulation (used as fertilizer), →ammonia emission, (one of main causes for acid rain), dead animal disposal, flies nuisance in densely populated areas, and availability of sufficient water of feed quality may increasingly lead to legislative restrictions and costs involved in preserving protection.

### Development of Acquired Immunity

Anticoccidials (Table 1) used in poultry may affect stages of the parasite inducing immunity. Pullets intended as commercial layers must develop immunity to coccidiosis when they receive preventive drugs. However, **anticoccidials**, which are effective against second-generation schizonts, can seriously delay the development of immunity if they are given at the dose levels recommended for broilers. Therefore, they should be fed at the lowest possible dose level and for the shortest practical period that give sufficient anticoccidial protection and allow progressive development of immunity in replacement pullets. One of the effects of immunity is to reduce the biotic potential of the coccidia; each →oocyst of the common chicken coccidium *E. tenella* is theoretically able to produce about 2.5 million second-generation merozoites although this maximum number may only occur in the case of initial infection. In partially immune animals, however, only some of the parasites complete their life cycle and produce variable oocyst numbers. In completely immune animals a few or no oocysts are produced for prolonged periods of time; some of the parasites may persist in an asexual stage within the host and thus fail to get further than the initial stage of trophozoite or first-generation meront. As a result, immunity to a challenge inoculum usually leads to a reduction in the clinical signs and in parasite

multiplication. The specificity of immunity to →*Eimeria* spp. is well known, although there may be considerable strain variations in immunity in some species of coccidia in commercial poultry houses as has been shown with *E. acervulina* and the very immunogenic *E. maxima*. The duration of protective immunity is uncertain and depends on several factors like mode of immunization, inoculum dose, age of the host, as well as on *Eimeria* spp. and strain variation. It is not yet clear whether immunity is of the sterile or pre-munition type. It seems likely that immunological control of poultry coccidiosis is achievable. In the not too distant future it will replace →chemoprophylaxis coming increasingly under public pressure because of drug residues in edible tissues and occasionally in eggs (→Chemotherapy/Withdrawal Time of Drugs in Target Animals). →Vaccination with attenuated or precocious strains of *Eimeria* spp. will be therefore an attractive alternative for parasite control since it lacks residual problems. In general, anticoccidials do not adversely affect build up of immunity after vaccination programs against bacterial and viral infections.

### Coccidiosis in the Domestic Fowl

The disease is responsible for considerable losses in the poultry industry. Rearing of thousands of birds on litter-covered floors in enormous houses may result in a tremendous and dangerous buildup of the oocyst population (→*Eimeria*). A change from litter-covered floors to wire-floored pens greatly reduces the exposure to coccidia. Thus, outbreaks of coccidiosis in laying hens maintained in cages rarely occur. In general, the prophylactic use of anticoccidial drugs is not required if the cages are kept clean and the feces do not contaminate watering and feeding systems. However, discouraging results have been obtained from experiments to convert broiler and breeder flocks entirely to cage operations (the most obvious problems being high equipment and maintenance costs, breast blisters, leg problems, removal of droppings and dead birds, and housefly control). Today most poultrymen rely on **floor rearing methods** for broiler production or breeder flocks and use continuous medication programs. Poultry producers also attempt to control coccidiosis by employing good sanitary programs. Litters should be kept dry so that oocysts cannot sporulate – many outbreaks occur after leaks in roofs or waterers. Wet litter must be cleaned out and replaced with dry litter. When broiler houses are emptied for a new batch of chickens the litter should be piled up for about 24 hours so that the heat generated can destroy the majority of oocysts. **Disinfection** is usually impractical since oocysts are resistant to disinfectants used against bacteria, viruses, or fungi. In parasitology laboratories where disinfection is needed, heat (30 minutes at 60°C) or “effective” fumigants such as ammonia and methyl bromide may be used.

Despite the use of continuous medication programs (see [Drugs Acting on Coccidiosis of Domestic Fowl, Table 1](#)), coccidiosis is still the most important parasitic disease in chickens. As a rule young birds are prone to mixed infections and older birds are carriers. In many outbreaks, however, clinical signs can be ascribed to one species or a combination of 2 or rarely 3; signs of coccidiosis become apparent about 3 days after infection; chickens cease feeding and huddle together for warmth; on the fourth day of infection blood may appear in the feces.

The *Eimeria* spp. of the domestic fowl show marked differences in their **pathogenicity**. *E. tenella* is the most pathogenic and important species occurring in the epithelial cells and submucosa of the ceca; it may produce severe hemorrhagic enteritis, which leads to high mortality in young birds. *E. necatrix* is also a common and highly pathogenic species, which occurs in the small intestine (first- and second-generation schizonts) and in the ceca (third-generation → [schizont](#) and gamonts). It tends to cause predominantly chronic enteritis in older birds but in acute cases severe submucosal hemorrhaging and even death may occur. *E. acervulina* (probably the most common species seen) occurs in the small intestine. The pathogenicity of *E. acervulina* strains may vary, and the clinical signs consist of weight loss and watery, whitish diarrhea. *E. maxima* is also common; it occurs in the small intestine and is moderately pathogenic causing numerous petechial hemorrhages and a marked production of mucus. *E. brunetti* is markedly pathogenic but relatively uncommon. In heavy infections, characteristic necrotic (hemorrhagic) enteritis is evident in the lower small intestine, colon, and tubular part of the ceca. *E. mitis* is common worldwide and occurs throughout the small intestine, even in the tubular part of the ceca. This species is slightly or moderately pathogenic; in severe infections numerous petechial hemorrhages may be present. *E. mivati* is fairly common in the USA and Canada (presumably worldwide) and seems to be more pathogenic than *E. acervulina*. It primarily occurs in the upper small intestine and has been included by several authors as a variant of *E. acervulina*. The pathogenicity of *Eimeria* spp. in particular that of *E. acervulina* and *E. tenella* seems to be reduced by intestinal digesta viscosity reducing enzymes as xylanases, glucanases, and pectinases. These enzymes may improve the nutritional value of wheat- or maize-based diets but mechanisms involved in reducing growth depression in coccidial infections are not yet known and need to be elucidated.

Economic losses (see [Economic Importance](#)) due to **subclinical infection** of avian coccidia are enormous and much more common than coccidiosis, and coccidiosis should be regarded as ubiquitous in commercially reared poultry. Because some species of coccidia are highly pathogenic while others are only slightly or moderately pathogenic the species present must be identified. Scrapings from the mucosal surface of the

intestine of affected birds should be examined microscopically for oocysts and endogenous stages of the parasite, and the location and type of lesions determined to establish a definite diagnosis.

### Coccidiosis of Turkeys

The disease may cause heavy economic loss in the turkey industry; it is primarily a disease of young turkey poults (aged 3–10 weeks); older birds are carriers. **Clinical signs** are enteritis, watery or mucoid diarrhea, and → [anorexia](#). The most pathogenic and important coccidia are *E. meleagridis* (located in the jejunum) and *E. adenoides* (located in the lower ileum, ceca, and rectum); several species (in particular *E. innocua*, *E. subrotunda*, and *E. meleagridis*) are nearly nonpathogenic. Therefore, oocysts of the latter species must be differentiated from the pathogenic ones as well as those of *E. gallopavonis* (lower small intestine, ceca, and rectum) and *E. dispersa* (duodenum, jejunum, ileum), which are not so common, and only slightly or moderately pathogenic. The presence of oocysts (even large numbers) in the feces can only be a tentative diagnosis for coccidiosis; satisfactory diagnosis can only be made at postmortem.

### Coccidiosis of Geese and Ducks

The disease seems to be of relatively little importance although several homoxenous coccidia are known. Some of these may be associated with severe disease and even death. *E. truncata* is highly pathogenic to goslings, and occasionally causes up to 100% mortality within a few days; older birds are carriers. This species occurs in the kidney tubules; its endogenous stages destroy the epithelial cells, causing enlarged and light-colored kidneys. Other species (goose: *E. anseris*, *E. nocens*, *E. truncata*, *E. kotlani*, duck: *E. kotlani*, *E. danailovi*, *Tyzzeria pernicioso*) appear to be important in areas where crowding and poor sanitation are present. Thus, large numbers of sporulated oocysts in a muddy environment often lead to sporadic outbreaks of intestinal coccidiosis.

### Action of Drugs on Developmental Stages of *Eimeria* spp.

The terms coccidiostatics and coccidiocidal (coccidiocides) for drugs, which characterize actions on coccidia, are often used confusingly. Drugs with a **coccidiostatic action**, such as clopidol or decoquinate, dinitolmide ([Table 1](#)), arrest the development of certain parasite stages in a reversible way; thus withdrawal of the drugs leads to completion of the life cycle and possibly the appearance of clinical signs several days after medication is discontinued. Drugs with **coccidiocidal action**, such as arprinocid, halofuginone, polyether antibiotics, toltrazuril, diclazuril and clazuril

(Table 1), kill or irreversibly damage most of certain parasite stages, and there is no evidence of clinical relapse after drug withdrawal. Some drugs (e.g., nicarbazin, amprolium) may have both coccidiostatic and coccidiocidal activity depending on how long the drugs and in which concentration they have been given in the feed or water. Continuous medication of these drugs for more than 48 hours usually results in the majority of parasitic stages being damaged. Polyether antibiotics mainly affect asexual *Eimeria* stages as sporozoites, schizonts of the first and second generation. Flow cytometric analysis has been shown to be a reliable and sensitive technique for characterizing coccidiocidal effects on sporozoites exposed to various ionophores *in vitro*. Diclazuril acts against most stages of *Eimeria* spp. but this may vary between species (e.g., in *E. maxima* gamonts only); this is also true for clazuril. Prophylactic drugs may preferably act on early and/or late asexual stages in the life cycle, like polyether antibiotics, decoquinatate, clopidol, robenidin, nicarbazin, halofuginone, diclazuril, or amprolium + ethopabate. A few **therapeutic drugs** used for treating outbreaks of coccidiosis may affect stages of second- and third-generation schizogony and to a certain degree →gamonts (sexual stages) as well; drugs reducing clinical signs of coccidiosis are amprolium, sulfonamides, clazuril, toltrazuril, and combinations of sulfonamides+dehydrofolate reductase inhibitors (Table 1). Toltrazuril administered in drinking water has brought substantial progress in treatment of coccidiosis in various animals. It has a broad spectrum of activity against various parasitic protozoa, and unlike other anticoccidials, it acts against schizonts and gamonts of various →*Eimeria* and →*Isospora* spp.

### Drugs Acting on Coccidiosis of Domestic Fowl

Today, chemoprophylaxis in continuous medication programs appears to be the only effective tool for controlling coccidiosis in floor-reared poultry although drug resistance in *Eimeria* spp. populations is a widespread problem in the broiler industry today. Strategic use of anticoccidials may thwart the development of resistance processes (see [Measures Against Drug Tolerance in the Broiler Industry](#)). However, neither improved sanitation nor vaccination of birds with pathogen species of live precocious oocysts (e.g., Paracox, Livacox, see →[Coccidiosis, Animals/Table 1](#)) via drinking water or feed can sufficiently substitute continuous medication programs today. The prophylactic use of anticoccidials is based on the application of additives in-feed, i.e., drugs are added directly to bird feed in small quantities, usually in concentrations of a few ppm (part per million). Such anticoccidials are approved by governmental agencies for use in growing birds (e.g., chickens, turkey, others). Thus, prescribed concentration rations of these drugs can

be fed to licensed table birds *ad libitum* from the beginning of their life (fattening/growing period) to a prescribed preslaughter withdrawal time, or age at first egg, or start of cage or battery keeping of pullets. Additives in-feed used worldwide for the prevention of poultry coccidiosis and therapeutic anticoccidials are listed in Table 1. There are (1) synthetic compounds (e.g., amprolium, clopidol, decoquinatate, diclazuril, halofuginone, nicarbazin, or robenidine), (2) polyether antibiotics or ionophores (lasalocid, maduramicin, monensin, narasin, salinomycin, semduramicin), and (3) drug combinations (e.g., amprolium+ethopabate, narasin+nicarbazin, maduramicin+nicarbazin). Most **continuous medication** programs may last 35–40 days, i.e., from the beginning of the fattening period to a fixed time prior to slaughter of birds. **Withdrawal times** (→[Chemotherapy/Withdrawal Time of Drugs in Target Animals](#)) for most prophylactically used anticoccidials may last 0–5 days and longer (e.g., toltrazuril, 14 days), or may exceed 5 days for other reasons, e.g., to minimize costs, or to promote “compensatory growth.” A withdrawal time longer than 5 days may lead to enhanced risk of coccidiosis at the end of fattening period, particularly if environmental →[hygiene](#) is poor. The prophylactic use of anticoccidials in-feed in **egg-laying birds** is not permitted, although the occurrence of residues of anticoccidials in eggs has been widely proven; carryover of medicated feed in the feedmill or elsewhere must be the cause. Sensitive and specific analytical assays, as spectrophotofluorometry, liquid chromatography, high performance liquid chromatography (HPLC), the qualitative vanillin test and others, are available to detect the parent compound (metabolites) or their residues in feed, edible tissues, and eggs of target animals or nontarget animals. In case of outbreaks of coccidiosis **therapeutic drugs** (e.g., amprolium, sulfonamides, dehydrofolate reductase inhibitors plus sulfonamides, toltrazuril) are preferably administered via drinking water for a 3- or 5-day treatment course, and withdrawal periods may exceed 14 days. In practice, this means that medication towards the end of the growing life of birds is not economically possible, and this is also true for drugs used outside their product license; such drugs may also require withdrawal periods that exceed 14 days. So often the medicines regulations how they relate to the withdrawal periods stipulated for therapeutic drugs and given to food animals withhold birds (meat chickens, ducks, turkeys) from the possibility of treatment for a significant part of their life.

### Drugs Acting on Coccidiosis of Turkeys, Geese, Ducks, and Gamebirds

Approved additives in feed, and maxima concentrations (EC directives, for new regulation 1831/2003: use of additives in animal nutrition cf. last page of Table 1) for prevention of coccidiosis in turkeys are

shown in Table 1. Drugs may be e.g., amprolium + ethopabate, diclazuril, halofuginone, lasalocid, monensin, and robenidine. The turkey industry (mainly found in the USA) has till now been rather small compared to that of chicken broilers. The most suitable drug program in turkeys is continuous medication but anticoccidial treatment covers only a part of the growing period of birds (till 12–16 weeks of age or 8–10 weeks of age if birds are moved to outside pastures or larger facilities). At this time →acquired immunity may be established in most of the birds; however, some birds may still be susceptible to damaging infections 12 weeks after the growout start. Intermittent medication is used relatively often since continuous anticoccidial programs are not universally practiced with turkeys up to 8 weeks of age because of the high resulting costs. Concentrations in the feed are generally in the same range as those administered in chicken broiler rations. There is evidence from field experience that drug resistance in coccidia of turkeys may exist. Generally it seems not to be a major problem although monensin resistance has been demonstrated in *E. meleagridis* field isolates. Under experimental conditions a drug sensitive laboratory strain became resistant to the drug after 10 generations of selection.

### Drugs Acting on Coccidiosis (Eimeriosis) of Ruminants and Horses

**Bovine** →eimeriosis (the most pathogenic species are *E. zuernii* and *E. bovis*) is primarily a disease in calves between the ages of 3 weeks and 6 months; older calves and adult animals are usually symptomless carriers. Crowding and lack of sanitation greatly increase outbreaks of disease. Coccidiosis in sheep and goats is often a disease of feedlot lambs, and often occurs in breeding flocks. Mixed infections build up to a peak that may last 1–4 weeks and then decline. *E. ovina* (sheep), *E. ashata* (sheep), *E. ovinoidalis* (sheep), *E. arloingi* (goat), and *E. christenseni* (goat) are of clinical importance. Batch rearing of lambs or calves in groups of similar ages may limit the buildup and spread of oocysts to younger animals thereby targeting potential treatment measures. Little information is available on the eimeriosis of equines, mainly caused by *E. leuckarti* in the small intestine or *Klossiella equi* in the kidneys of foals. Coccidiosis in horses (including asses and mules) seems to be very rare. Beware of polyether antibiotics in-feed in environment of horse facilities; they are highly toxic to equines.

Most drugs used in **cattle** are approved for the prevention of coccidiosis in poultry. The demand for grainfed beef has led to cattle rearing techniques (large feedlot complexes) that may encourage damaging infection pressure. Only a few drugs have been approved for treatment in cattle by some governments. **Decoquin**ate (Table 1) is approved in several countries for the treatment and prophylaxis of bovine coccidiosis. The

tissues of treated calves that had been on continuous medication with decoquinatate were free of schizonts, gamonts and oocysts. The drug apparently kills *E. bovis* sporozoites or arrests their further development if administered at 1.5 mg/kg b. w. in-feed.

Coccidiosis in bovines is often wrongly considered to be a sporadic disease with the result that drugs have rarely been used for prophylaxis. Outbreaks of the disease are still handled by spot treatment using therapeutic drugs as sulfonamides, e.g., sulfaguanidine, sulfamethazine, and sulfadimidine or sulfaquinoxaline. Combinations of sulfonamides with trimethoprim are used in manifest coccidiosis in cattle, sheep, and goats. Decoquinatate or amprolium (Table 1) are also effective against bovine coccidia. Amprolium and lasalocid are used in the USA for treatment of clinically ill calves and lambs. **Toltrazuril** (15 mg/kg × 1 orally) is very effective against bovine coccidiosis of cattle, sheep and goats (Table 1). **Preventive drugs** such as ionophorous antibiotics (monensin, or salinomycin) only approved for prevention of coccidiosis in poultry also exhibit distinct activity against coccidiosis in ruminants. The doses of monensin, and salinomycin used for improving feed efficiency in feedlot and pasture cattle correspond to the doses reported to prevent coccidiosis; it is assumed that the anticoccidial “side effect” of these “growth promoters” may considerably reduce coccidiosis problems in feedlot cattle. Calves artificially infected with *E. bovis* (88%) and *E. zuernii* were given lasalocid in-feed at 0.50, 0.75, or 1.0 mg/kg b.w., daily for 45 days. There were no dose-dependent effects but equal reduction rates in oocyst output and preventing clinical coccidiosis. Calves given lasalocid, decoquinatate, or monensin in-feed at 33 ppm for 46 days had significantly fewer oocysts in feces and fewer clinical signs of coccidiosis than those given nonmedicated rations. Mixing lasalocid in milk replacer or fresh milk (1mg/kg b.w./day) is an effective method of protecting young calves against early infection with coccidia. **Decoquin**ate can be also used as a feed additive approved for the prevention of coccidiosis in sheep and goats (Table 1). Ionophores in-feed such as monensin, lasalocid, or salinomycin prove effective also in preventing coccidiosis in sheep, and goats; against caprine coccidia they are, however, only moderately active. Treatment of coccidiosis in lambs and kids is done with drugs used in cattle. Often animals are clinically ill when the disease is diagnosed. At this time the intestinal mucosa is already extensively damaged, and consequently treatment cannot lead to a radical cure. As a rule, all lambs and kids in a flock should be treated, as even those showing no symptoms are likely to be infected. Fluid therapy using either oral rehydration solutions or parenteral solutions, and appropriate anthelmintic treatment are indicated in severely affected animals.

### Drugs Acting on Coccidiosis (Eimeriosis) of Rabbits

Coccidiosis in rabbits is essentially restricted to the young (adults are carriers) and occurs particularly in breeding and rearing establishments (rabbitries) although outbreaks of coccidiosis in warrens or similar types of habitat are not uncommon. The most important species seems to be *E. stiedai*, which is common, worldwide and occurs in the walls of the bile ducts in the liver causing hepatic coccidiosis. Other important and pathogenic species, which may occur in the intestine, are *E. irresidua*, *E. magna*, *E. intestinalis*, *E. media*, and *E. perforans*; mixed infections are the rule. The presence of parasites in a case of enteritis does not necessarily indicate the cause. Coccidia may be present in large numbers without any serious clinical signs. Therefore, the most satisfactory diagnosis is made at postmortem; only the presence of characteristic lesions are evident in the liver/or the intestine.

There are only a few additives in-feed approved for the prevention of rabbit coccidiosis in Europe or elsewhere. These are robenidine (50–66 ppm), and salinomycin (20–25 ppm). Preventive administration of salinomycin in pelleted feed at 25 ppm may not only reduce markedly the oocyst production but lead to almost total inhibition of hepatic and intestinal lesions as well. Several **sulfonamides** can be used for the **therapy** of coccidiosis. They may be given in various routes and dosage forms (in-feed, in-water, and as injection). Their preslaughter withdrawal times may range between 8 and 15 days. **Sulfaquinoxaline** (relatively cheap and water soluble) seems to be the most widely used sulfonamide for treating rabbit coccidiosis, and it has been found to be just as helpful in preventing coccidiosis when given in continuous medication programs in feed or water. The drug of choice for treatment of intestinal and hepatic coccidiosis appears to be toltrazuril. However, a proper management and good hygiene in rabbitries can markedly reduce long-term medication and treatment with anticoccidials.

### Drug Acting on Coccidiosis of Swine, Dogs, and Cats

Coccidiosis in **swine** is mainly restricted to young pigs; older pigs are carriers. *E. deblickei* and *E. scabra* are probably the most pathogenic species. *Isospora suis* has also been found to cause severe enteritis; however, intestinal disorders are so common in baby and young pigs and are caused by so many different pathogens that a diagnosis based only on fecal examination is not definite. Only a very large number of oocysts can indicate that coccidiosis is present. *Isospora suis* is an important causative agent of porcine neonatal diarrhea worldwide; it may occur on any farm with any type of management system and at any time of the year

although feces samples of sows always proved negative. Most canine and feline coccidia are usually nonpathogenic or only moderately pathogenic; however, coccidiosis in **dogs** and **cats** may be an important cause of the diarrheic syndrome often associated with secondary infections in puppies and kittens. Affected animals are frequently seen in breeding kennels and runways where sanitation is poor. Diagnosis is not definite if it is only based on clinical signs (e.g., diarrhea with blood in the feces), or on the presence of large numbers of *Isospora* spp. oocysts in the feces; postmortem examination is the most adequate diagnosis method. Coccidial infections in dogs and cats may also be caused by heterogeneous genera (→ *Sarcocystis* spp. in dogs, and *Sarcocystis* spp. and → *Toxoplasma gondii* in cats, see respective entries).

The most commonly used compounds for treatment of coccidiosis in dogs, cats (and piglets: Table 1) are **sulfonamides**, and **toltrazuril** affecting mainly later asexual stages of the schizogony cycle and to a certain degree sexual stages (gamonts). There are only a few controlled studies with experimental infections and no reliable evidence of practical problems associated with *Eimeria* spp. in swine. In contrast, *I. suis* infections appear to have become an economically important diarrheal disease in young piglets during the last 2 decades, and modern production systems seem to encourage the disease. Mortality due to *I. suis* infections may reach 10–20% in nursing pigs, and a similar percentage may be severely stunted. *I. suis* infections causing severe enteritis or even death in piglets have been treated successfully with amprolium (not approved indication); medication of sows with amprolium for 1–2 weeks before and after farrowing and of neonatal piglets may be helpful in reducing morbidity and mortality. Administration of toltrazuril in piglets (a single dose: 20 mg/kg, orally between 3 and 6 days of age) has been shown to reduce the morbidity in piggeries. There was a significant reduction in the number of antibacterial treatments given to piglets, fewer piglets developing diarrhea, and a significant improvement in growth rate of piglets. *I. suis* was detected in 38–50% of fecal samples from several piggeries and in 93% of those from the experimental piggery. Supportive treatment with antibiotics (e.g., chlortetracycline or oxytetracyclines) may reduce secondary bacterial infections in the intestine of piglets with severe enteritis. **Good sanitation** can effectively reduce diarrhea caused by *I. suis* infection in neonatal piglets in large farrowing facilities.

### Drug Tolerance Problems in the Broiler Industry

A new successful drug should have competitive advantages over other available drugs, e.g., high potency and broad-spectrum activity. Furthermore, at the recommended doses the coccidia must not be allowed to develop resistance or to survive for a longer

period. The reduction in coccidial sensitivity to any drug (partial drug resistance) encourages the development of subclinical or subacute coccidiosis. Low levels of infection usually cause a moderate drop in feed conversion and thus lead to considerable economic losses in the poultry industry.

The development of drug resistance may be evident if a change in the parasite can be demonstrated by comparing sensitivity before and after exposure to the anticoccidial. Possible causes for **drug failure** in the field may result from selection of resistant organisms, which rapidly become the dominant phenotype in broiler houses. Resistance is commonly believed to arise initially in the presence of “subtherapeutic” or lower than recommended drug concentrations. Contrary to that suggestion, it has been argued that resistance may occur more rapidly in the presence of higher drug concentrations as a result of a more rapid change in gene frequency caused by increasing the intensity of selection. Studies on the incidence of drug resistance in the field and in experimental investigations have shown that resistance among strains of coccidia to **synthetic drugs** such as 4-hydroxyquinolines (e.g., decoquinate, methylbenzoquate), arprinocid, meticlorpindol, and halofuginone is relatively high. The resistance may result from the selection of preexisting mutants in the parent population. Thus drug resistance appears to be a genetic trait and tends to remain in a coccidia population for some years. Recent investigations on intraspecific polymorphisms of *Eimeria* spp. due to drug resistance indicate that differences in drug sensitivity correlate with genetic differences and polymorphisms detected by random amplified polymorphic DNA (RAPD) might facilitate the selection of molecular markers for resistance genotyping.

**In vitro studies** on uptake of [ $^{14}\text{C}$ ] monensin by *E. tenella* sporozoites in primary chicken kidney cell cultures infected with ionophore-sensitive (IS) or ionophore-resistant (IR) isolates showed significant differences in [ $^{14}\text{C}$ ] monensin accumulation between IS and IR isolates. The latter isolates had decreased uptake of monensin and the amount of the drug required to inhibit development of *E. tenella* by 50% was 20–40 times higher for IR isolates of *E. tenella*, which might reflect differences in membrane chemistry. Studies on an *E. tenella* field isolate that was resistant to monensin, salinomycin, and lasalocid at double-use level and resistant to narasin and maduramicin at normal-use level showed good agreement between *in vitro* and *in vivo* results. Flowcytometric analysis of fluorescence after simultaneous exposure to fluorescein diacetate (FDA) and propidium iodide is a suitable indicator of cellular viability and proved to be a valuable technique in the study of  $\rightarrow$ sporozoite response to anticoccidials. Thus, various improved *in vitro* techniques in research programs have become increasingly important in recent

years. They may be a supplement to and, occasionally, a substitute for *in vivo* experiments in certain fields of the basic research, as in the field of biotechnology of poultry and farm animals. A first practical approach to countering **drug resistance** in the field may be an increase in the drug concentration. Increasing the drug concentration to compensate drug tolerance of coccidia is not only uneconomical but can also lead to toxic problems since several anticoccidials (e.g., nicarbazine, halofuginone, and various ionophorous antibiotics) are used at doses which are close to toxicity levels in birds. With the exception of some ionophorous antibiotics, such as monensin, salinomycin, and lasalocid, none of the synthetic drugs introduced have enjoyed prolonged marketability without developing tolerance problems in the broiler industry. The continuing success of the ionophorous antibiotics (monensin was introduced in the USA in 1971) is a result of their broad-spectrum activity, and possibly because resistance in coccidia may not be able to develop by the mechanisms known to occur for synthetic drugs. There have also been early reports that monensin “resistant” *E. maxima* strains may be present in the field. Later selected *Eimeria* spp. from broiler farms in the USA and Europe revealed that control of some isolates to *ionophorous drugs* was poor although none of the isolates judged in sensitivity tests was found to be completely resistant to the ionophores tested. Thus, prolonged use of ionophores in poultry units for nearly 10 years led to a decrease in their anticoccidial activity. Salinomycin provided the best overall control, followed by lasalocid and monensin. The latter findings are in agreement with results obtained from field studies on the comparative efficacy of salinomycin and monensin in 17 controlled field trials. They included more than 2 million broilers and were carried out in several European countries, and salinomycin at 60 ppm showed performance advantages over monensin at 100 ppm. Maduramicin proved to be more effective against ionophore-tolerant field isolates of broilers than monensin and narasin, but showed similar activity to salinomycin in reducing lesions and mortality and in protecting performance. Although **side-resistance** (colateral resistance) among related ionophores such as monensin, salinomycin, and narasin may occur “cross-resistance” between maduramicin and unrelated ionophores has also been reported; it is believed by some investigators that maduramicin is effective against strains resistant to the other ionophores. Results from drug-sensitivity tests with isolates of coccidia from broiler chickens in the USA, Brazil, Argentina, and Europe suggested in many cases incomplete side resistance of coccidia to polyether ionophorous drugs. Some field isolates revealed even complete multiple **cross-resistance** to synthetic and polyether antibiotics including maduramicin, and semduramicin (latest ionophore introduced into the market). An *E. acervulina*

laboratory strain, which was resistant to monensin by passaging the strain 14 times in the presence of the drug (100 ppm), was shown to be sensitive to lasalocid but not to maduramicin, narasin, and salinomycin. Cross-resistance between the latter ionophores may suggest a similar mode of action in coccidia. Thus, monensin, maduramicin, narasin, and salinomycin, preferentially form complexes with monovalent (e.g.,  $\text{Rb}^+$ ,  $\text{Na}^+$ ,  $\text{K}^+$ ,  $\text{Cs}^+$ ) rather than divalent alkali metals (e.g.,  $\text{Ca}^{++}$  in case of lasalocid), which may mediate electrically neutral exchange diffusion cation transport across membranes. Contrarily, a monensin-resistant *E. meleagridis* strain exhibited cross-resistance to narasin and lasalocid and a field isolate of *E. tenella* showed cross-resistance between lasalocid and several ionophores preferentially forming complexes with monovalent cations. To slow down development of drug resistance in coccidia alternate use of anticoccidials is widely practiced in the poultry industry.

### Measures Against Drug Tolerance in the Broiler Industry

As shown by epizootiological investigations, coccidial drug resistance poses a serious economic problem to intensive poultry farming both in the USA, in Europe, and elsewhere. Today, there is therefore an increasing use of **shuttle** or **dual programs** (rapid rotations), i.e., the switching of anticoccidials during broiler growout. The drug(s) to be switched should belong to different chemical classes (e.g., ionophore/synthetic drug or vice versa during starter/final phase of production) and should be effective at different stages of the parasites' life cycles. Any resistant coccidia, which appear during the use of the first drug, should be affected by the second. In **straight** or **slow rotation** programs a single and often the same drug may be used for several broiler growouts (e.g., about 6 months; each fattening period may last 35–40 days or longer); it is then replaced by an alternative drug. Shuttle programs are still being discussed with regard to their value in delaying drug resistance. Although alternation of the drugs between crops may delay the appearance of resistance, it is likely that the outcome will be the acquisition of multiple resistance. There may also be the risk of underdosing or insufficient activity of drug mixtures resulting from switching the drugs. This might allow resistance to be developed faster. However, by switching the drug, underdosing can be excluded if new and exactly medicated feed is poured onto remaining feed; then the 2 drug fractions at the base of the silo funnel must add up to 100% of any resulting mixture. Mixtures of ionophorous antibiotics were as effective in controlling drug-sensitive *E. tenella* and *E. acervulina* infections as a single antibiotic mixed in the feed at recommended prophylactic concentrations. However, such mixtures (e.g., monensin + narasin or salinomycin) may have

limited additive action if there is already a partial resistance to one of the partners. In these experiments it was also shown that combinations of ionophorous antibiotics and synthetic drugs are complementary, even against field isolates with unknown drug response.

**Drug combinations** (Table 1) have commonly been used for synergism in order to minimize the occurrence of drug resistance (e.g., Lerbek roxarsone + clodidol), or to extend the species spectrum to all 6 pathogenic *Eimeria* spp. in chickens. Amprolium, which shows activity against *E. tenella* and *E. necatrix* have been combined with ethopabate and organic arsenicals respectively, in order to expand their spectrum to include the upper intestinal species *E. maxima*, *E. acervulina*, and *E. mitis*. The only experimental evidence of retardation of drug resistance by synergistic effects of drugs was seen with methylbenzoate + clodidol (discontinued); complete resistance occurred to methylbenzoate 10 ppm and meticlorpindol 125 ppm, respectively, after 3 passages of *E. maxima*, but not with a 8.35 and 100 ppm combination of the 2 drugs.

To keep up their competitive position with other anticoccidials, narasin (and maduramicin) have been combined with nicarbazin, an old-timer among anticoccidials; these products, however, reveal no performance advantages over related monodrugs.

### Drugs Acting on Cryptosporidiosis in Birds

Species of the genus *Cryptosporidium* are coccidian parasites that infect epithelial cells (extracytoplasmic) of the intestinal and respiratory tract of vertebrates (see Opportunistic Infections). Although immunocompetent hosts show no, or only mild, clinical signs after *Cryptosporidium* infections, particularly young birds under stress may suffer from life-threatening watery diarrhea, or severe respiratory symptoms. Cryptosporidiosis in chickens, turkeys, quail, and pheasants is usually manifest as respiratory disease caused predominantly by *C. baileyi* or as enteric disease (small intestine) caused by *C. baileyi* and *C. meleagridis*. The severity of infection depends on the immunocompetence of the host. Infections are due to aerosol transmission of infective oocysts coughed up by carrier (seeder) birds, or may be transmitted by feed or water supplies containing sporulated oocysts derived from feces of infected birds. Clinical signs in birds are coughing, mucoid discharge, dyspnoe, diarrhea, **→dehydration**, weakness, and weight loss.

Causal therapy and chemoprophylaxis of chicken cryptosporidiosis with ionophorous antibiotics is problematic. Many approaches to anticryptosporidial efficacy of commercial drugs have failed to improve symptoms in birds suffering from *Cryptosporidium* infections. Several other anticoccidials as sulfonamides, lasalocid sodium, halofuginone, and decoquinate, or other antibiotics (e.g., paromomycin) have



proved to be insufficiently effective in controlling or even eradicating *Cryptosporidium* infection in birds. The drugs may exhibit positive short-term effects such as improvement of watery diarrhea and reduction of oocyst output in feces due to their “static” rather than “cidal” action on cryptosporidia.

### Coccidia of Humans

Coccidia that may cause clinical signs in humans are rare. →*Isospora belli*, a single host species in the small intestine, may be responsible for mild intestinal symptoms in some cases. Infections due to heterogeneous species like →*Sarcocystis* spp. (→*Sarcocystosis*) or →*Toxoplasma gondii*, and related protozoans with a 2-host life cycle are seen more often, especially in areas where raw meat is eaten and human beings have contact with cats or other felines. Moreover, *Isospora belli*, *Cryptosporidium parvum*, *Toxoplasma gondii*, and *Cyclospora* spp. belong to the opportunistic protozoa associated with immunosuppression caused by HIV →(AIDS), or other pathogens and pathogenic processes. →*Coccidiasis, Man*.

## Coccidiosis, Animals

### General Information

The →*coccidia* are members of the suborder Eimeriina. They are typically highly host-, organ-, and tissue-specific. Under natural conditions, most mammals pass small numbers of coccidial oocysts in their faeces, without apparent clinical effect. Coccidiosis becomes important as a disease when animals are reared under conditions that permit the build-up of high numbers of infective oocysts in the environment. This is because the degree of damage caused by coccidia depends upon the numbers of parasites able to replicate in any given site, which depends firstly upon the numbers of infective stages (oocysts) ingested. This is different from other →*protozoa* which may reproduce indefinitely by →*binary fission*, until halted by host immunity or death. →*Eimeria* infections are self-limiting because the parasites only pass through a limited number of asexual multiplications. Coccidiosis involves (extensive) destruction of the intestinal epithelia. The effects of intestinal coccidiosis in mammals vary with the host–parasite system. They are mainly related to →*malabsorption* induced by villous atrophy and reduction of brush border enzymes, or to →*anaemia*, hypoproteinaemia, and →*dehydration* due to exudative enteritis and colitis caused by epithelial erosion and ulceration. High mortality may occur in ruminants infected by the most pathogenic species (see also →*Alimentary System Diseases, Ruminants*).

### Pathology

#### Cattle

About 15 species of *Eimeria* parasitize cattle; of these *E. zuernii* and *E. bovis* are potentially highly pathogenic. Other species, such as *E. auburnensis* may at times contribute to the general clinical picture. In general, the infection occurs in calves or weaned feeder cattle under one year of age, but clinical disease occasionally occurs in adults, especially if massive infections are acquired during stressful situations. The diseases caused by *E. zuernii* and *E. bovis* are very similar; they are characterized by a haemorrhagic →*diarrhoea* which may become so severe that pure blood is passed instead of faeces. Tenesmus is marked, and there is anaemia, weakness, →*anorexia*, and emaciation. In severe infections death may occur. The first clinical signs appear just before the peak in oocysts output (day 18–19), when there is maximal loss of epithelium in the large intestine due to destruction of cells by second-generation →*schizogony* and →*gamogony*. This causes the exposure of the lamina propria and the formation of diphtheritic membranes. The destruction of the epithelium leads to reduction in the reabsorption of water, Na<sup>+</sup> and Cl<sup>-</sup> from the intestinal contents. The abrupt loss of weight and the reduction of the plasma concentration of these 2 ions support this contention. Exposed capillaries of the large intestinal lamina propria may rupture, leading to loss of erythrocytes and plasma.

#### Sheep and Goats

Coccidial infection is virtually universal in sheep and goats, and large numbers of oocysts may be found in the faeces of clinically normal animals. Coccidiosis in small ruminants is chiefly restricted to young animals up to 4–10 weeks of age. Close morphological similarity between the oocysts of *Eimeria* spp. from sheep and goats has caused some confusion in the literature. Relatively little is known about the pathogenicity of the different species, but it has been established that *E. ovinoidalis* in sheep and its analogue in goats, *E. ninakohlyakimovae* can be very pathogenic. Other species such as *E. bakuensis* (*E. ovina*) and *E. crandallii* in sheep, and *E. arloingi* and *E. christensenii* in goats may exacerbate the symptoms of the former 2 species. Outbreaks of coccidiosis are usually acute and characterized by moderate →*morbidity* and low mortality. There is a green or yellow watery diarrhoea with a fetid odour, occasionally with blood. →*Abdominal pain*, some anaemia (macrocytic, hypochromic), loss of appetite, dehydration, tenesmus, weakness, and loss of weight occur. Depression, inactivity, and recumbency are prominent. Pathological changes include thickening of the caecum and colon mucosa, →*oedema*, haemorrhage, and hyperaemia. Myiasis, bacterial diarrhoea, and bacterial septicaemia often accompany coccidiosis outbreaks.

## Horses

The only species occurring in horses, *E. leuckarti*, is not known to cause disease.

## Swine

At least 12 species of *Eimeria* are thought to occur in swine, and a single species of *Isospora*. *Eimeria* spp. are not considered a major cause of disease in pigs and many animals are asymptomatic carriers. *I. suis* is the only important species. It causes porcine neonatal coccidiosis, a disease of piglets from about 5–6 days to about 2–3 weeks of age. It is characterized by a yellow, foul-smelling diarrhoea, dehydration, occasional *→vomiting*, loss of condition, and death, or at the least a temporary check in growth. Morbidity is usually high, mortality low or moderate. Necropsy reveals villous atrophy and a marked, sometimes necrotizing, enteritis of the small intestine. Simultaneous infection of *I. suis* with viruses and *E. coli* results in more severe lesions and clinical disease than with coccidia alone.

## Carnivores

There are at least 14 species of coccidia in canine faeces: *Isospora canis*, *Isospora (Cystoisospora) ohioensis*, *I. burrowsi*, *I. neorivolta*, *→Hammondia heydomi*, *→Neospora caninum*, and 8 species of *→Sarcocystis*. A total of at least 15 species exist in cats: *Isospora felis*, *I. rivolta*, 5 species of *→Besnoitia*, *Hammondia hammondi*, *→Toxoplasma gondii*, and 6 species of *Sarcocystis*. In relation to pathogenicity, it is usually the intermediate hosts rather than the dog or cat that are adversely affected. Clinical coccidiosis in dogs or cats is apparently caused by certain species of *Isospora* and by *T. gondii*. For example *I. ohioensis* can cause clinical disease in newborn pups. Diarrhoea is caused by inflammation of the intestinal crypts, with *→necrosis* and massive desquamation of the tips of villi, especially in the lower part of the small intestine.

## Immunity and Vaccination

Reports from the literature suggest that immunity to coccidia is short-lived in young animals. In contrast, repeated coccidian infections induce a more long-lasting immunity than a single (primary) infection. An increasing infection pressure may cause a deterioration of immunity that is evident by an enhanced number of intracellular developmental stages and so, output

of oocysts, and possibly the development of clinical signs. The effect of immunity can range from complete (or close on zero) inhibition of oocysts production (premunition) to the passage of smaller numbers of oocysts in the faeces (partial immunity). It is assumed that **premunition** (immunity of the non-sterile type) to coccidia depends upon the persistence of some (occult, extraintestinal) development stages in the immune host from initial infection and/or reinfection. Thus, the acquired (often) species- or even life cycle stage-**specific immunity** of the host to coccidia plays an important role in the control of parasites and may depend on various host factors such as individual immune status, age of the host and its genetic background (breed type: *→innate immunity*). It seems that development of natural immunity to coccidiosis through digestion of sporulated oocysts is rather slow and may take several weeks or even longer. Therefore, using **vaccines** to prevent coccidiosis in the short lifespan of fattening young animals appears problematic because protective immunity resulting from vaccination may be insufficient. This is true particularly in case of broilers' life span which lasted about 35–40 days only. On the other hand, breeder replacement chicks and commercial layers are able to profit from the immunity protection against coccidiosis. They may be exposed to a controlled number of sporulated coccidia oocysts, i.e., to **live virulent vaccines**. Today, various types of live vaccine for the control of poultry coccidiosis are available (see [Table 1](#)). Coccivac or Immucox (sporulated oocysts of wild-type) has been used mainly for replacement birds, which represent a relatively small market in comparison with that of the broiler industry. In using such vaccines it appears economically acceptable to have some loss of performance as a result of immunization. However, live virulent *Eimeria* vaccines for control of coccidiosis in broiler chicken have rarely been used because of loss of body weight, and its effect on feed conversion is not acceptable. **Attenuated parasites** for water delivery (spray) or gel delivery are “sub-lines” of sporulated oocysts from chicken derived from the progeny of single oocysts. They may be attenuated after long-term passages through the chorioallantoic membranes of embryonating eggs (Livacox), or they may be recovered after only a few passages with selection for early

**Coccidiosis, Animals. Table 1** Live vaccines on the market

Trade name	Pathogenicity	Administration	Producer
Immucox for chicken I; II and for turkeys	virulent	water or gel delivery	Vetech Labs. Inc., Canada
Coccivac-B; D; T	virulent	water delivery (spray)	Schering–Plough
Paracox-S	attenuated	water delivery (spray)	Schering–Plough
Livacox-Q, T	attenuated	water delivery	Meril Brasil, Biopharm Czech Republic

development by passages through chickens (Paracox, Livacox) or rabbits. **Precocious lines** of coccidia species are drug sensitive and thus any use of anticoccidial drugs should be avoided during the month following vaccination. Precocious lines are characterized by a shorter life cycle, i.e., decrease in prepatent period, number, and size of endogenous stages (e.g., deletion of the terminal generation of schizonts of the wild-type parents). They can induce protective immunity against coccidiosis in spite of distinct attenuation of their virulence. Such parasites (oocysts) are no longer able to cause infections with severe clinical signs in chickens or rabbits (the production of precocious lines in cattle obviously failed). Problems arising from vaccination in the poultry industry or elsewhere may be the delivery and application practice of such live vaccines. Thus the application management of vaccines seems to be more sophisticated than that of feed-in products in widely used →chemoprophylaxis. Another problem may arise through genetic instability in precocious sublines. In addition, cost of production of live “cocktail” vaccines containing all (Paracox) or only certain *Eimeria* spp. (Livacox) may be considerable and above that of in-feed delivered anticoccidial drugs.

The chances for developing protective →recombinant vaccines against coccidiosis in chickens appear promising though *E. maxima* shows antigenic diversity, and live-*Eimeria* vaccines may show differences in their virulence and immunogenicity in the individual recipient and different breeds of poultry. The development of effective recombinant vaccines (genetically engineered *Eimeria* antigens) against poultry and farm livestock coccidiosis has become a major goal in modern parasitology. Since coccidiosis involves the intestinal immune system, understanding of the **complex gut-associated immune system** is most important in the development of immunological control strategies to coccidian parasites. **Different types of antigens** (surface-, internal-, secretory antigens of sporozoites, merozoites, gamonts) that induce parasite-specific immunity have been identified by means of monoclonal antibodies against various *Coccidia* species. Recombinant proteins derived from these antigens have been shown to induce either humoral or cellular response or both, whereas protection against live challenge (sporulated oocysts) proved to be insufficient to weak or partial only. For instance, responses of different poultry breeds vary considerably to such recombinant antigens (epitopes). Sub-unit vaccines developed so far lack epitopes that induce strong protection and this seems to be also true for optimal delivery systems that release these epitopes at the site of infection. Suitable live recombinant vectors derived from bacteria or viruses will be necessary to induce a persistent stimulation of the local immune system by presentation of “perfect”

recombinant target antigens to adequate immune effectors. Such approaches are only possible by using biotechnology that requires great skills of molecular biology as well as a profound knowledge of host immune responses to coccidian infection. Until now, there are large gaps in our existing knowledge concerning precise definition of target antigens and immune effectors. Consequently, the development of protective recombinant coccidiosis vaccines will be in any case a long-term and high-risk research project. Furthermore, such a vaccine must not only confer resistance but also be cheap and fit in with current management practice in the poultry industry and farm livestock. An exiting new approach to vaccine development may be highly attenuated bacterial vectors that have the ability to enter epithelial cells and direct plasmid DNA to the →cytoplasm of the host cell for protein synthesis and processing for →antigen presentation. **Delivery of DNA-encoded antigens** should permit mucosal immunization against the parasite simultaneously with multiple antigens that can stimulate T helper cells and antibody production, especially the proper folding and conformational epitopes for the immunoglobulins A (IgA) and G (IgG). Aside from the practical oral application of bacterial DNA delivery, this type of vaccines does not need DNA purification and can be produced for the →fermentation, lyophilization, and packaging.

## Therapy

→Cocciocidal Drugs, →Vaccination.

---

## Cochliomyia

→Callitroga.

---

## Cochliomyia hominis

In this genus there exist 4 species, 2 of them are active in humans →myiasis/*C. hominivorax* (Figs. 1, 2) – (the New World screwworm fly), and *C. macellaria* (secondary screwworm fly).

*C. hominis* attacks besides man cattle, horses, sheep, goats, pigs, dogs, and many species of wild life. The adults (Fig. 1) are common in slaughter houses (Southern USA, South America). The females lay up to 1,000 eggs in batches of 40–250. The larvae hatch in about 4 hours and develop to adults in 6–20 days.

## Cochlosoma anatis

Flagellated trophozoite with a ventral attachment disc and 6 flagella, measures 6–12 mm × 4–7 mm, and is found in the cloaca, caecum, and colon of ducks and turkeys (experimentally transmittable to chicken). This organism is apparently able to introduce enteritis.

## Cocoon

There are several meanings:

- Cover of →*puparium*, inside which the adults of holometabolous insects (e.g., →*fleas*) are developed.
- Chitinous ootheca of cockroaches containing 16–40 eggs (depending on the species).
- Egg-sack in annelids formed by →*clitellum* to surround the fertilized eggs (e.g., *Hirudo*).
- Eggs of →*trematodes* and other →*Platyhelminthes*, if they are composed of a →*zygote* plus a number of vitelline gland cells.

## Codworm Disease

Disease due to infection with anisakid worms (→*Anisakiasis*), e.g., from cods.

## Coelom

Secondary body cavity (e.g., in annelids, vertebrates).

## Coelomyarian Muscle Type

→*Nematodes*.

## Coelotropha

### Classification

Genus of →*Protococcidia* (*Apicomplexa*).

## Life Cycle

*C. dorchoni* lives in the body cavity of the polychaete *Nereis diversicolor*, it has not schizogonic reproduction, see →*Grellia* (syn. *Eucoccidium*) *dinophili*. See also →*Chromosomes*.

## Coenurosis, Animals

Coenurosis is a nervous system disease caused by the presence in the cranial cavity of *Coenurus cerebralis*, the larva of →*Taenia multiceps* (→*Nervous System Diseases, Carnivores*). The infection occurs in sheep and less commonly in other ruminants. It is rare in horses and man. In lambs, an acute →*meningoencephalitis* may develop if a large number of immature stages migrate in the brain. More commonly, the infection follows a chronic course and is associated with the presence of 1 or 2 coenuri in the brain, 4–6 months after infection. The →*coenurus* acts as a space-occupying lesion anywhere in the central nervous system. It occurs most often in the cranial cavity, sometimes between the hemispheres and cerebellum, and sometimes underneath, in the region of the mid-brain. Pressure signs develop slowly and are usually preceded by dullness, cessation of feeding, loss of weight, and the habitual resting of the head against any support. The ultimate signs depend upon the site of the cyst, and include →*blindness* and incoordination, as well as the turning movement which is said to be characteristic of the infection. Other locomotor signs include reacting, stumbling, abnormally high or low carriage of the head, and lunging forwards. These signs occur in attacks of some minutes duration followed by a remission of one or more hours, but the background of dullness and abnormal head carriage is continuous. Eventually the animal becomes recumbent, and death soon follows. A case of coenurosis has been described in a bullock, which resulted in the development of hydroencephalus.

## Therapy

→*Cestodocidal Drugs*.

## Coenurosis, Man

Coenurosis, is an infection with larval forms of the genus →*Multiceps* of canids, which gives rise to small cysts in the brain typically with prominent multiple scolices, but without daughter cysts. These are surrounded by a layer of fibrous tissue. Degenerating cysts

give rise to intense →[inflammatory reaction](#) with symptoms depending on location. Fibrosis and calcification follow.

### Therapy

→[Cestocidal Drugs](#).

---

## Coenurus

Larval stage of the →[tapeworms](#) *Taenia seralis* and *Multiceps multiceps*. →[Eucestoda](#).

---

## Coevolution

Coevolution is an evolutionary change in 2 or more species resulting from reciprocal selective pressures.

In parasite-host systems, the demonstrations of

- genetic variability in parasites for transmission to hosts and survival in hosts on the one hand,
- genetic variability in hosts for avoidance of parasites and resistance mechanisms on the other hand

constitute what Hochberg and Crompton call “a cornerstone prediction of active coevolution.”

When reciprocal selective pressures occur, parasites and hosts are engaged in arms races. Coevolution between parasites and hosts might thus be a universal phenomenon, although it has been rarely demonstrated.

Optimal pathogenicity is at the cross-roads of 2 arms races: In a first arms race (the encounter arms race), the parasite selects genes to improve the probability of contact with the host whilst the host selects genes to avoid meeting infective stages of the parasites. In a second arms race (the compatibility arms race), the host selects genes to kill the parasite whereas the parasite selects genes to survive. The first arms race implies reciprocal behaviours whereas the second implies defence and →[evasion mechanisms](#). A selective process in 1 of the 2 arms races can be compensated by a counter-selective process in the other; for instance, selection of adaptive behaviour in the parasite’s genome can be counter-balanced by selection of immune defence in the host’s genome. “Attack and defense invariably favor diversification .... The biochemical mechanisms that mediate attack and defense determine the limits of diversification” (Frank).

Coevolution must not be confounded with parallel evolution. When a phylogeny of hosts and their parasites is established (for instance by comparison

of DNA sequences or any other method), it can happen that host and parasite phylogenies are “parallel” (topologically identical) because parasites have regularly cospeciated with their hosts; in other cases, there is no congruence between the phylogenetic trees of parasites and hosts because a number of lateral transfers of parasites occurred between different host lineages. It is sometimes tempting to assume that parallel evolution and coevolution are linked to each other, or even synonymous. This is not true because coevolution implies that each partner has actually exerted selective pressures on the other and reciprocally. →[Cospeciation](#) can result from external factors (for instance geographical isolation) which caused parasite and host to speciate synchronously, and not as a result of reciprocal pressures.

### Examples

Parallel evolution of host and parasite, e.g., humans and their highly specialized lice species (*Pediculus*, *Phthirus*), live together since long, and the lice use exclusively humans as hosts.

### Related Entries

→[Virulence](#), →[Red Queen Hypothesis](#).

---

## Coleorhynchus

→[Gregarines](#).

---

## Collagen

→[Energy Metabolism](#).

---

## Collyriclum

→[Digenea](#).

---

## Colonisation

From Latin: *colonia* = settling; other term for infections due to the entering of a parasite.

## Colorado Tick Fever

### Synonym

CTF.

Colorado tick fever is caused by the CTF virus (ungrouped → [arbovirus](#)) and is chiefly transmitted by the tick *D. andersoni*. After an → [incubation period](#) of 3–6 days there may be → [encephalitis](#) and bleeding in children. Fatalities are rare.

## Combs

→ [Fleas](#).

## Commensalism

### Name

Latin: *commensalis* = guest at table = co-eater.

This term describes the activity of an organism to feed at the costs of a host without introducing a disease.

## Communities

In ecology, the word community designates a set of populations of different species which occupy, at least partially, the same environment and are susceptible to interact. In parasitology, the meaning is the same, with the particularity that it is always difficult to decide what are the limits of a community.

In general, a parasite community is considered as consisting of parasites of different species susceptible to interact in the same organ of the same individual host. It is more correct to call this community an → [infracommunity](#), since it is composed of several intrapopulations (→ [Populations](#)). For instance, the parasites which inhabit the digestive tract of a host constitute a infracommunity. It is clear that the definition of the infracommunity can be restricted (for instance to the duodenum) or enlarged (e.g., to the entire host, because, even in the absence of physical contacts, parasites in a same individual host can interact in a number of ways).

The difficulties increase if one considers the community at a scale greater than that of the individual host.

Holmes and Price, among others, accepted the following definitions:

In general ecology, a component community is an assemblage of species associated with a particular “microenvironment” (e.g., species living in tree holes); in parasitology, all the infracommunities in a population of hosts make up a component community.

In general ecology, a compound community is a mixture of component communities that interact to various degrees (e.g., species living in a forest); in parasitology, all parasites in an ecosystem, whatever their stage of development, constitute a compound community.

Combes suggested to simplify and homogenise the terms: a community of parasites comprises all the parasites of an ecosystem, a → [xenocommunity](#) comprises all the parasites of a particular host species of that community, an infracommunity comprises all the parasites of a particular individual host ([Fig. 1](#)).

## Competition, Interspecific

The level at which different species of parasites can interact (and thus in which interspecific competition can occur) is that of the → [infracommunity](#) (→ [Communities](#)).

Infracommunities are thought to range from isolationist to interactive, but there have been 2 main tendencies concerning the degree of interaction.

Price and Rhode think that infracommunities are principally isolationist because the host is rarely saturated. When different parasite species occupy different “niches” in a host (e.g., distributed along the digestive tract of a bird or at particular places of the gills of a fish), this is not the result of a competitive displacement, but rather of habitat preferences. In the case of monogeneans, which are ectoparasites on the gills, Rohde suggested that the gathering of different parasite species in particular areas has been selected to facilitate genetic exchanges between individuals when densities are low and do not reflect interspecific competition.

Holmes is more in favour of interactive communities, especially in the intestines of birds. Bush and Holmes, for instance, have demonstrated that the intestinal → [helminth](#) species of lesser scaup ducks are arranged in a strictly predictable pattern and that high densities of certain species provoke displacements of less competitive species. The occupation of different organs or parts of organs by the different species of an infracommunity is seen as the result of selective pressures. When a niche appears to be empty, this can be a “ghost of competition past.” Bush and Holmes have applied the notion of core and satellite species to

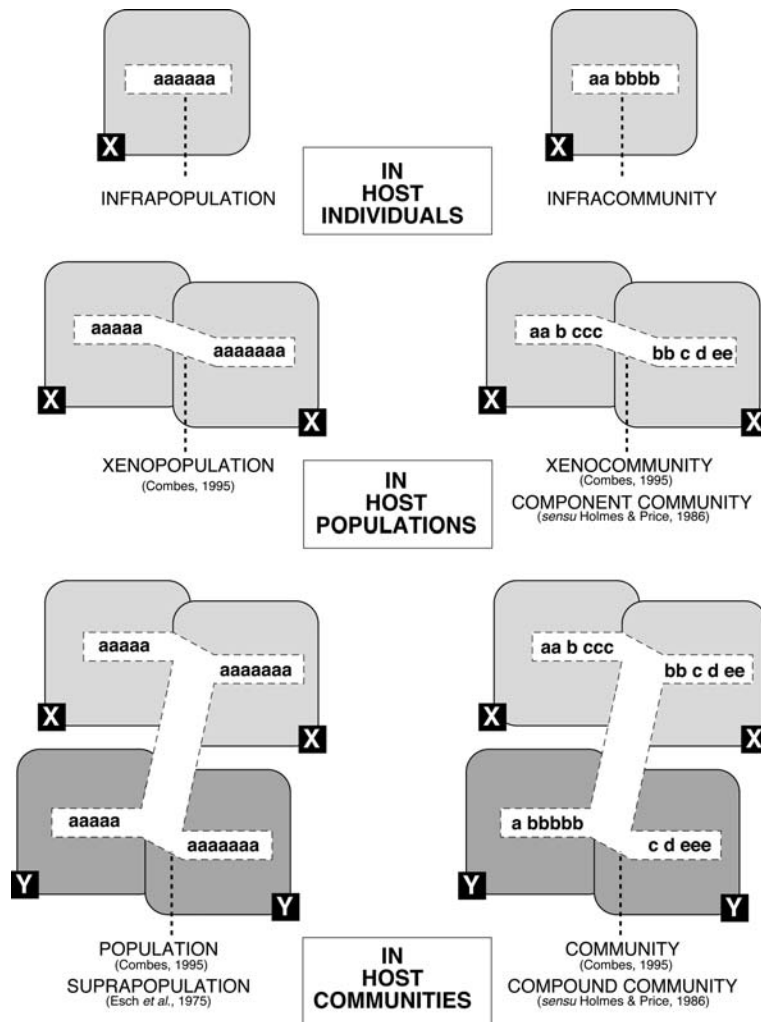

**Communities. Figure 1** Populations and communities as defined by various authors [original]. Grey boxes represent individual hosts of species X, Y, ... Letters represent individual parasites of species a, b, c, d, e, ...

parasite communities with success: core species constitute the predictable component of the community, are often specific to the host and compete for space and resources; satellite species are unpredictable, generalist, and do not intervene in the structure of the community. Satellite parasites in a given host species can be core species in another host.

## Competition, Intraspecific

Intraspecific competition is the rule on earth, and is one of the important mechanisms underlying regulation of populations. Individuals of a same species compete for space, for resources, for mates. Competition can be by exploitation (what is taken by certain individuals is no

longer available for others) or by interference (individuals show direct or indirect aggressiveness to each other). The consequence of intraspecific competition is a reduction of →fecundity and/or survival (which affects part or all of the populations), which contributes to regulate the populations. The effect is density-dependent: when density increases, competition increases, so that fecundity and/or survival decrease in proportion.

Intraspecific competition is one the major components of regulatory processes in parasite populations. Surveys as well as experiments have often demonstrated that the density of parasites in a host cannot exceed a certain level. It is, however, always difficult to separate the effects of competition from the effects of immune defence, which are also density-dependent. One of the most convincing demonstrations of intraspecific competition is the “enlargement of the niche”: in

the gut of a vertebrate, for instance, it is possible to determine what location is preferred when the individuals of a parasite species are in low densities; this is the “preferendum” of the species. When the size of the →infrapopulation increases, a part of the individuals are constrained to occupy less favorable places, sometimes far from the preferendum. It is then easy to show that these individuals have a →reduced fecundity and/or size. However, not all infrapopulations show signs of intraspecific competition: hosts are sometimes far from being saturated (→Competition, Interspecific).

## Complement Fixation Test (CFT)

Classic indirect diagnostic test, →serology.

## Compound Eye

The eyes of insects are composed of several single ommatidia, which are evert eyes containing 8 nerve cells, and a cuticular lense plus lateral covering cells.

## Concinnum procyonis

### Synonym

*Eurytrema procyonis*.

1.7–2.5 mm long, common fluke (family Dicrocoeliidae), in racoons (*Procyon lotor*) and occasionally in cats in the USA.

## Concomitant Immunity

→Premunition.

## Concrement Vacuole

Inclusion with sensory activity inside ciliates of the family Bütschliidae inside the alimentary channel of mammals (e.g., *Blepharoprosthium*).

## Congo Floor Maggot Myiasis

Disease of humans in Africa due to the activity of nightly sucking larvae of the fly species *Auchmeromyia luteola* (syn. *Senegalensis*). The larvae are thought to be mechanical vectors of trypanosomes.

## Conjugants

→Gametes.

## Conjugation

Sexual process during which 2 stages of →Ciliophora (= →conjugants) fuse for a short while with each other and exchange a so-called wandering →micronucleus, thus executing DNA exchange. After this process the cytoplasmic bridge is broken off, each individuum lives on its own, and finally starts reproduction by →binary fission. (See also →*Balantidium coli*, →*Ichthyophthirius multifiliis*).

## Conjunctivitis

→Eye Parasites.

## Connatal Infection

### Name

Latin: *connatus* = during birth.

Infection of the newborn during birth (e.g., →malaria and →AIDS may then become transmitted).

## Connatal Toxoplasmosis

Disease due to infection with →*Toxoplasma gondii* being already present during birth (prenatal infection; Latin: *natus* = birth) via the intrauterine way (= congenitally). This infection may only occur in pregnant women who were infected for the first time during pregnancy. →Prenatal Toxoplasmosis.



## Connexivum

Lateral fortified portion of the abdomen of some bugs (e.g., Triatomae), not covered by the wings.

## Conoid

The conoid ([→Kinete/Fig. 2](#), [→Pellicle/Fig. 5B](#)) is a hollow truncated cone composed of spiralling [→microtubules](#) 25 nm in diameter (Fig. 1). Two accessory structures, the conoidal or preconoidal rings, form an integral part of the conoid and they are connected with each other by a canopy-like membrane. During cell penetration the conoid protrudes through the anterior [→polar ring](#) system. The conoid is apparently involved in penetration of host cells. Conoids are found in the motile stages of some [→Coccidia](#), such as [→Eimeria](#), [→Sarcocystis](#), and [Toxoplasma](#) ([→Kinete/Fig. 2](#), [→Pellicle/Fig. 5](#)), but are always absent from the corresponding stages of haemosporidians (e.g., [→Plasmodium](#)) and [→piroplasms](#) ([→Babesia](#), [→Theileria](#)).

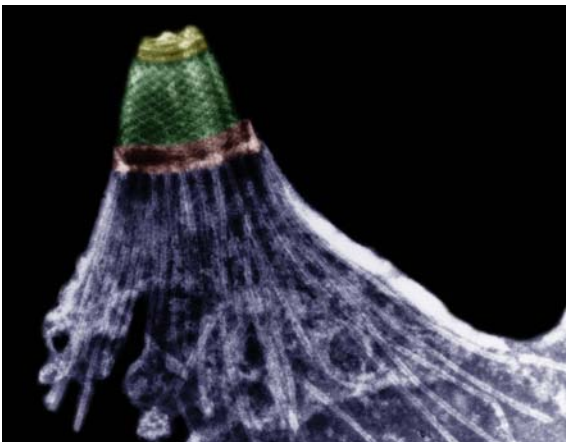

**Conoid.** **Figure 1** TEM of the anterior pole of a coccidian cyst-merozoite (= bradyzoite) showing the conoid being protruded anteriorly to the polar ring system, at which the subpellicular microtubules are attached.

## Conscutum

Dorsal plate of male ixodid ticks covering the whole backside.

## Constipation

Clinical symptom in animals due to parasitic infections ([→Alimentary System Diseases](#), [→Clinical Pathology, Animals](#)).

## Continua

Constantly high fever being a leading symptom in [→malaria](#) due to *P. falciparum*, [→amoebic liver abscess](#), flea transmitted plague, louse-transmitted typhus exanthematicus, and typhoid fever.

## Contracecum

Genus of ascarid [→nematodes](#) of marine mammals, larvae are found in marine fish ([→Anisakis](#)).

## Contractile Vacuole

[→Amoebae](#), [→Ichthyophthirius multifiliis](#), [→excretion](#).

## Control

[→Disease Control, Epidemiological Analysis](#), [→Disease Control, Methods](#), [→Disease Control, Planning](#), [→Disease Control, Strategies](#), [→Disease Control, Targets](#), [→Drugs](#), [→Chemotherapy](#).

## Control of Malaria

Factors see →[Disease Control, Epidemiological Analysis/ Table 2](#).

## Cooperia

Genus of the nematode family →[Trichostrongylidae](#). Species of *Cooperia*, live (as those of the genera *Trichostrongylus* and *Nematodirus*) in the small intestine of ruminants. The adult worms (male 5–8 mm, female 8–11 mm) are rather small, appear reddish, and are often spiral-shaped. Species are, e.g., *C. oncophora* (cattle), *C. curticei* (sheep/goat).

**Disease:** →[Cooperiosis](#), →[Alimentary System Diseases, Ruminants](#).

### Therapy

Nematocidal Drugs.

## Cooperiosis

Trichostrongylid →[trematodes](#) of the genus *Cooperia* (→[Trichostrongylidae](#)) live in the upper part of the small intestine of ruminants. The important species include *C. curticei*, which mainly infect sheep and goats, and *C. pectinata*, *C. punctata*, and *C. oncophora*, which mainly infect cattle. *C. oncophora* is less pathogenic for cattle than either *C. pectinata* or *C. punctata*. *C. curticei* is of little pathological significance in sheep. *C. oncophora* only produces pathological lesions in animals experimentally infected with very large numbers of infective larvae (250,000 or more). The lack of pathogenicity is probably explained by the rapid acquisition of resistance by the host, and the superficial character of the intestinal lesions induced. They rather brace or coil themselves among villi to maintain their place. *C. punctata* worms have been reported as penetrating into the mucosa or submucosa. Villous atrophy with reduction in the brush-border enzymes only occurs after heavy infections. Signs of the infection include soft faeces, intermittent or continued →[diarrhoea](#), progressive emaciation, reduced feed consumption, →[weight loss](#), and listlessness. There is no →[anaemia](#). The lack of any significant effect on serum calcium or phosphorus concentrations, or on the

skeleton suggest little interference with intestinal absorption. The slight →[hypoalbuminaemia](#) may, however, indicate macro-molecular leakage into the gastrointestinal tract. Mixed infections with →[Ostertagia ostertagi](#) produce severe adverse alterations of the metabolism in calves, which exceed those produced by infection with either of the species alone. The presence of *C. oncophora* in the small intestine seems to limit the extent of the compensatory digestive responses to *O. ostertagi* infection of the abomasum (→[Alimentary System Diseases, Ruminants](#)).

### Therapy

→[Nematocidal Drugs, Animals](#).

## Copepoda

### Morphology

Fig. 1. →[Crustacea](#), →[Lepeophtheirus salmonis](#).

## Copepodit

Invasive larvae of →[Copepoda](#) (→[Lepeophtheirus salmonis](#)).

## Copro's Itch

→[Mites](#).



**Copepoda. Figure 1** Antarctic ice fish (*Macrourus* sp.) with a female copepod, the anterior end of which has penetrated the body wall. Note the long paired egg bags.

## Coproantigen

From Greek: *kopros* = faeces; DNA – material of parasites that is excreted within the host's faeces.

## Coproscopy

Microscopical analysis (Greek: *skopein* = look at) of the faeces of hosts to diagnose parasitic stages.

## Coracidium

Swimming larva of pseudophyllidean →tapeworms provided with →cilia and centrally bearing a hooked →oncosphaera larva.

## Cordylobia

Genus of the fly family Calliphoridae. *C. anthropophaga* – the so-called →tumbu fly (Figs. 1, 2) causes the boil-like (furuncular) type of →myiasis like that produced by →*Dermatobia hominis*. These flies occur in Continental Africa, South of the Sahara. *C. rodhaini* is a related species (called Lund's fly), which infects humans much less frequently than *C. anthropophaga*.

1. *C. anthropophaga*, the Tumbu fly of continental Africa south of the Sahara. The eggs are laid in batches of 200–300 on dry, shaded ground.
2. *C. rodhaini* is found in the moister parts of tropical Africa in Central Africa.
3. *C. ruandae*, these flies attack humans as well as animals and lead to myiasis. Inside the skin of the host the development takes 8–15 days, before the larvae 3 emerge, fall to the ground, and pupate. Often up to 50 larvae may be found within one host.

## Corium

Thickened portion of the bug wing.

## Corpora Allata

→Insects, contain →Juvenile Hormones.

## Corpora Cardiaca

→Insects, contain →neurohormones, that induce the release of ecdyson (→Moulting Hormones) of the prothoracic glands of insects.

## Corridor Disease

→Piroplasms, →Theileriosis.

## Corynosoma semerme

→Acanthocephala.

## Co-speciation

→Phylogeny/Host-Parasite Co-speciation.

## Cost Effectiveness

→Disease Control, Planning.

## Costa

Elements of cell stabilization in →trichomonads (→Trichomonas).

## Costia necatrix

Syn. *Ichthyobodo necator*, a 10–20 µm by 6–10 µm – sized protozoan with 2 flagella – one measures 9 µm, the other is 18 µm long. It attaches to the skin and gills of sweet water fish and introduces severe slimy covers often leading to death due to the lack of oxygen.

## Cotugnia

Genus of tapeworms of the family Davaineidae.

## Cotylocidium

→ [Aspidogastrea](#).

## Cotylophoron

Genus of flukes related to → [Paramphistomum](#).

## Cotylurus

→ [Digenea](#).

## Coumaphos

Organophosphate compound acting as → [Arthropodical Drugs](#); it blocks the activity of cholinesterases.

## Courtship Behavior

→ [Behavior](#).

## Cowdria ruminantium

→ [Heartwater](#); *Rickettsia* transmitted to ruminants in Africa by the tick *Amblyomma hebraeum*.

## Coxa

Basal segment of the legs in insect and ticks, by means of which legs are attached to the ventral body side.

## Coxiella burneti

Rickettsial bacteria which are transmitted by *Derma-centor* and *Amblyomma* ticks introducing the so-called Q-fever of cattle, sheep, humans, and other hosts in Queensland (Australia).

## Crab Louse

→ [Lice](#) (*Phthirus pubis*).

## Craterostomum

Genus of small strongylid nematodes in horses.

## Creeping Eruption

Route of wandering larvae of → [Hookworms](#) (Fig. 1) in human skin (→ [Cutaneous Larva Migrans](#)).

## Crenosoma striatum

→ [Lungworms](#), → [Dictyocaulus](#).



**Creeping Eruption. Figure 1** Larvae of hookworms dig the inflamed channels after skin penetration.

## Crepidostomum

Genus of flukes, →[Digenea](#).

## Crepidostomum cooperi

→[Megalodiscus temperatus](#)/Fig. 1.

## Creutzfeldt-Jacob Disease

→[Prions](#); see also →[BSE](#).

## Crimean-Congo Hemorrhagic Fever

### Synonym

CCHF.

### General Information

Crimean-Congo hemorrhagic fever is caused by the CCHF virus (→[Bunyaviridae](#)). It is a disease which shows hemorrhagic symptoms, together with serious acute febrile conditions. The virus has been isolated mainly from *Hyalomma* →[ticks](#) (*H. marginatum marginatum*, *H. m. rufipes*, and other species) in South Europe and the Southwest of the former USSR, and several areas in Africa. These 2 foci are linked by migrating birds which can carry ticks. Ticks in other genera, including 1-, 2-, and 3-host ticks, have also been found to harbor the

virus. Recently, this disease has been associated with mortality in scientific and medical staff in South Africa after laboratory handling of ticks.

## Crista

There are several meanings:

- Crista sterni: Place of attachment of flight muscles at the breast of birds.
- Type of infolding of the inner membrane of →[mitochondria](#).
- Comb-like structures.

## Cristae

This is the number for infoldings (single: crista), the inner membrane of some mitochondria at the surface of which the →[TCA cycle](#) is anchored. For example, erythrocytic stages of avian malarial parasites (such as *Plasmodium lophurae*) are cristate, while those of rodent and most other mammalian *Plasmodium* spp. are acristate. Asexual stages of *P. falciparum* have a single acristate mitochondrion, which apparently gives rise during the formation of gamonts (gametocytes, →[Kinete](#)/Fig. 3) to several cristate ones. This fact suggests, that there is apparently a metabolic change. The mitochondria of the gamonts of the piroplasms remain, however, acristate (→[Gametes](#)) as are the trypanosomal mitochondrion in the region of the →[kinetoplast](#) (TAC). Energy metabolism, →[Kinete](#)/Fig. 3.

Other types of mitochondrial infoldings are tubuli (e.g., →[Gametes](#)/Figs. 1, 2A) or – if those are enlarged – they are named sacculi.

For further information see →[Energy Metabolism](#).

## Crithidia

→[Trypanosomatidae](#).

## Crithidia fasciculata

→[Amino Acids](#).

## Crowding Effect

Blocking of development of individual parasites due to overcrowding of a habitat.

## Crura

Apart from aspidobothreans (and a few other exceptions) the intestine of [→Platyhelminthes](#) divides after the esophagus into 2 lateral terminally closed branches = crura ([→Digenea/Fig. 6](#), [→Platyhelminthes/Intestine and Food Uptake](#)).

## Crust

Clinical and pathological symptoms of infections with skin parasites ([→Skin Diseases, Animals](#), [→Ectoparasites: New Approaches](#)).

## Crustacea

### Classification

Class of [→Arthropoda](#).

### General Information

The crustaceans were termed with respect to their often very strong chitinous [→cuticle](#), which is strengthened in comparison to that of insects by the inclusion of calcium salts; thus growth can only proceed after repeated molts. The heteronomously segmented [→dioecious](#) Crustacea appear in a great variety, although lower (former: Entomostraca) and higher (Malacostraca) groups can be clearly differentiated according to their larvae ([→nauplius](#) or zoea). Common to all crustaceans are the following features:

- They have 2 pairs of antennae (possibly of different size).
- The uptake of O<sub>2</sub> occurs by means of inner or outer gills.
- A pair of mandibles and 2 pairs of maxillae act as mouthparts. They are located ventrally at the head,

**Crustacea. Table 1** Some common parasitic crustaceans

Subclass, Order/Species	Length (mm)	Host/Habitat	Transmitted pathogens
<b>Branchiura</b>			
<i>A. coregoni</i>	10–15	Salmonids/Skin	Fungi, bacteria ( <i>Pseudomonas punctata</i> )
<i>Argulus foliaceus</i>	m 8–10 f 15	Many fish, amphibian species/Skin, gills	Fungi, bacteria ( <i>Pseudomonas punctata</i> )
<b>Cirripedia</b>			
<i>Sacculina carcini</i>	20–40	Crabs/Inner organs	–
<b>Copepoda</b>			
<i>Caligus elongatus</i>	7	Salmonids/Skin, gills	–
<i>Clavella adunca</i>	f 4	Marine fish/Skin	–
<i>Cyclops</i> spp.	up to 3	Free-living	Larvae of cestodes and nematodes
<i>E. gibbus</i>	1.0	Eals/Skin, gills	–
<i>Ergasilus sieboldi</i>	1.7	Freshwater fish/Gills	Fungi, bacteria
<i>Lepeophtheirus salmonis</i>	10	Salmonids/Skin	–
<i>Lernaeocera branchialis</i>	m 1.5 f up to 60	Marine fish/Gills	–
<i>Penella balaenoptera</i>	300	Whales/Skin	–
<i>Salmincola</i> spp.	1–1.5	Salmonids/Skin	–
<i>Sarcotaces arcticus</i>	m 2 f 25	Marine fish/Skin	–
<b>Isopoda</b>			
<i>Aega psora</i>	50	Marine fish/Skin	–
<i>Anilocra physodes</i>	20	Marine fish/Skin	–
<i>Cirolana borealis</i>	30	Marine fish/Skin	–

m = male; f = female

which is often closely connected to the thorax ([→Cephalothorax](#)) and covered dorsally by a carapax in some groups.

- Each of the heteronomous body segments is ventrally provided with a pair of extremities, which appear as maxillipodia, pereopodia, or pleopodia (depending on their location along the body).
- These extremities show a typical biramous organization and are composed of an inner endopodite and an outer exopodite.
- Eyes of the compound type are situated, if present, dorsally on stalks; eyes of the median type (e.g., nauplius eye) are composed of 3 or 4 small pigment-cup ocelli of the inverse form.
- The circulatory system is open, involving a dorsally located heart (in thorax or abdomen).
- Antennal or maxillary nephridial glands work as an excretory system supported by different cells (nephrocytes) opening at the body's surface.
- The development occurs in general as a [→metamorphosis](#) involving different larval stages (nauplius or zoea) and growth by repeated molts.

### System

The following taxa include some parasitic forms, although most members of the Crustacea are free-living:

- Class: Crustacea
  - Subclass: Ostracoda (some species are parasitic on gills of fish)
  - Subclass: [→Copepoda](#) (some are ectoparasites of fish, some are intermediate hosts for [→Cestodes](#) and [→Nematodes](#))
  - Subclass: [→Branchiura](#) (some species are blood suckers on fish, thus named fish lice, [→Argulus](#))
  - Subclass: [→Cirripedia](#) (some species are endoparasites in marine crabs)
  - Subclass: Malacostraca (higher Crustacea)
    - Order: Amphipoda (free-living, some are intermediate hosts for endoparasites)
    - Order: [→Isopoda](#) (some species are ectoparasites of fish)
    - Order: Decapoda (many species are intermediate hosts for endoparasites)

### Important Species

Table 1.

### Life Cycle

[→Lepeophtheirus salmonis](#).

### Integument

The cuticle of the crustaceans is constructed according to the same plan as in [→Ticks](#), [→Mites](#) and [→Insects](#).

However, in crustaceans minerals such as  $\text{CaCO}_3$  and  $\text{Ca}_3(\text{PO}_4)_2$  may occur additionally, thus leading to a further hardening of the cuticular exoskeleton (needed, e.g., to overwhelm high water pressures). The [→molt](#) ([→Ecdysis](#)) in crustaceans occurs due to activity of hormones such as in other arthropods. Here the so-called Y-organs are steered by [→neurohormones](#). [→Ecdysis](#) starts in Crustacea when the excretion of the molt-inhibiting hormone (MIH) is stopped and the Y-organs produce [→crustecdyson](#) ([→Ecdysteroids](#)).

### Nervous System

The nervous system shows trends towards concentrations at the anterior pole to form a large brain and in the thoracic region, where a large thoracic ganglion is formed by fusion of segmental ganglia during evolution. In the highly aberrant body shapes of the parasitic crustaceans many variations of the nervous system occur.

---

## Crustecdyson

Hormone that induces [→molt](#) in higher [→Crustacea](#) (Malacostraca) within the so-called Y-organ (= carapax gland).

---

## Cruzipain

[→Thiolproteinases](#).

---

## Cryptobia

Genus of Kinetoplastea (phylum Euglenozoa). The 2-flagellated members of the different species are either ectoparasites on the body surface or endoparasites in the digestive tract or in the blood of fish. *C. branchialis* is found on the gills of crabs and other cyprinids reaching a length of 10–20  $\mu\text{m}$ . *C. salmositica* occurs in salmonid fish in Western and Northern America in the blood and on the gills. An attenuated strain has been produced and is routinely used as an experimental live vaccine, which protects fish for up to 2 years. *Cryptobia* (syn. [→Trypanoplasma](#)) *iubilans* was described as an intracellular parasite in cichlid ornamental fish to destroy portions of the intestine liver and/or spleen.

## Cryptocaryon irritans

### Name

Greek: *cryptos* = hidden, *karyon* = nucleus, Latin: *irritare* = disturb.

The life cycle of this ciliate which parasitizes on/in the skin of marine fish is similar to that of →*Ichthyophthirius*, although it belongs to another group of ciliates. The trophozoites inside skin are only 0.5 mm in diameter. The macronucleus is only badly seen and appears as white dots in higher magnification (Fig. 1). The fish appears with white dots and may die due to heavy infections.

## Cryptocotyle

→Behavior, →Digenea.

## Cryptomitosis

→Nuclear Division occurring in most parasitic protozoans during which the nuclear membranes are retained.

## Crypto-Orthomitosis

→Nuclear Division.

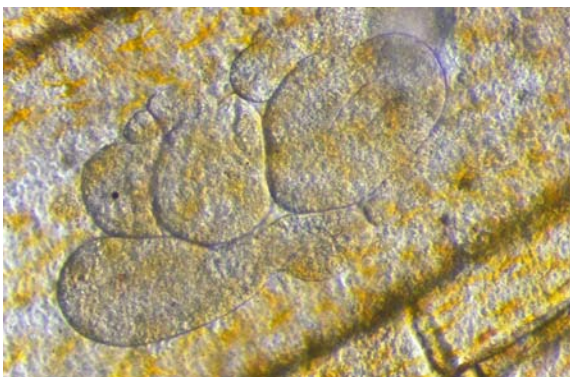

**Cryptocaryon irritans.** Figure 1 Trophozoite of *Cryptocaryon irritans* in the skin of a tropical fish.

## Crypto-Pleuromitosis

→Nuclear Division.

## Cryptosporidial Relations

The genus is more closely related to the →*gregarines* than to true →*Coccidia*. This was shown by phylogenetic analysis of apicomplexan parasites inferred using small-subunit ribosomal RNA gene sequence. These findings may explain why *Cryptosporidium* stages are not sensible to drugs which affect a broad spectrum of coccidians.

## Cryptosporidiosis, Animals

### Pathology

Cryptosporidiosis is an important infectious disease affecting mucosal surfaces commonly found in snakes, lizards, birds, and mammals. →*Cryptosporidium* spp. have been reported in all domestic animals including cats, dogs, and pigs. In horses, symptoms have been particularly observed in animals with inherited or acquired immunodeficiency. Cryptosporidiosis is economically most significant in calves and lambs. Symptoms are: enterocolitis in newborn animals manifested by →*diarrhoea* of variable severity; signs of depression, →*anorexia*, and →*weight loss* are also seen. The most prominent lesions occur in the ileum. They include blunting and some fusion of villi, and hypertrophy of the crypts of Lieberkühn. There are great individual variations in clinical reactions to *Cryptosporidium* infection and controversy exists as to whether the parasite occurs as a primary pathogen or whether it causes disease by interacting with other enteropathogens.

### Immune Responses

As the replication and development of the parasite is confined to mucosal surfaces, local immune functions of the mucosa-associated lymphoid tissue (→*MALT*) are of special importance. Interest in the nature of these host responses is heightened by a unique feature of the parasite's development. Merozoites reside intracellularly in epithelial cells and remain anchored at the luminal surface segregated from the host cell →*cytoplasm*. Since *C. parvum* infections of animals are generally found in neonates and refractoriness to infection develops 2–3 weeks after birth, most investigations



on the immune responses have been performed in suckling or immunocompromised mice. Some studies have been alternatively performed with *C. muris* which is able to infect adult immunocompetent mice.

### Innate Immunity

As with other coccidian, e.g., *T. gondii*, macrophage activation by IFN- $\gamma$  leads to partial control of microbial reproduction. In T cell deficient individuals such as  $\rightarrow$ AIDS patients or nude or SCID mice a  $\rightarrow$ chronic infection characterized by gradual expansion of inflammatory foci develops, which in the case of immunodeficient mice eventually results in  $\rightarrow$ morbidity and death. Several studies, however, have demonstrated the existence of partially protective innate immune mechanisms mediated by IFN- $\gamma$ . Treatment of SCID mice with anti-IFN- $\gamma$  or anti-IL-12 antibodies increased susceptibility to infection and reduced the time till death from  $>12$  to 5–6 weeks. Although cryptosporidium sporozoites or  $\rightarrow$ oocyst antigen preparations enhanced IFN- $\gamma$  production by splenic NK cells *in vitro*, treatment of mice with anti-ASGM1 antibodies to deplete NK cells had no effect on susceptibility to infection. In other experiments *C. parvum* infection of SCID mice was not influenced by IL-2 treatment which activates NK cells. Thus, the *in vivo* data on the role of NK cell activation conflict with the *in vitro* findings. Obviously, the cell type in the mucosa which produces IFN- $\gamma$  in the absence of T cells still has to be identified. Likewise, the accessory cells involved in the local inflammatory response have also to be identified, since the gut epithelium contains only few macrophages.

### B Cells and Antibodies

Different subclasses of parasite-specific Igs increase in serum and mucosal secretions during *C. parvum* infections of humans and animals and IgG titers especially may persist for up to several years post-infection. Coproantibody titers of IgA and IgM increase during infection and decrease after resolution of the disease. The antibodies produced recognize a number of immunodominant  $\rightarrow$ sporozoite antigens of approximately 11, 15, 20/23, 44, 100, 180, and  $>200$  kDa. Different antibodies induced by immunizations possess protective capacity as shown by (1) inhibiting the *C. parvum* development *in vitro* or in suckling mice by administering antibodies orally or by (2) effectively attenuating the clinical symptoms of human cryptosporidiosis by treating immunocompromised patients with hyperimmune bovine colostrum containing high concentrations of anti-cryptosporidia antibodies. Some of the antigens recognized by protective antibodies have been molecularly cloned, but the exact localization and characterization of the function of these proteins awaits further studies.

Although antibodies induced by immunization with antigens could inhibit parasite development, there is

considerable doubt about the protective role of antibodies during natural infection. AIDS patients with severe cryptosporidiosis have high titers of *C. parvum*-specific secretory IgA. Furthermore, depletion of B cells in neonatal mice by anti- $\mu$  chain treatment, did not alter the ability to control cryptosporidiosis. On the other hand, breast-fed babies are less likely to experience cryptosporidiosis while patients with congenital hypogammaglobulinemia sometimes develop chronic cryptosporidiosis.

### T Cells

*C. parvum* induces inflammatory infiltrates in the lamina propria of the gut containing lymphocytes, macrophages, and plasma cells. In the Peyer's patches of mice increased numbers of CD4<sup>+</sup> and CD8<sup>+</sup> cells were found and purified T cells from spleens of infected animals showed a proliferative response towards parasite antigens. A parasite-specific delayed type  $\rightarrow$ hypersensitivity (DTH) can be elicited in *C. parvum*-infected rats by oocyst antigen injection. The functional importance of a specific T cell immune response was demonstrated by the increased pathology villus atrophy, crypt  $\rightarrow$ hyperplasia, erosions of gut epithelium found in T cell-deficient hosts such as nude rats and mice, SCID mice, as well as, in normal mice depleted of T cells by administration of anti-T cell antibodies. In studies with *C. muris*,  $\rightarrow$ chronic infections in T cell-deficient mice developed similar pathology to those found in immunocompromised patients with cryptosporidiosis. In neonatal mice  $\gamma\delta$  as well as  $\alpha\beta$  TCR-expressing T cells are both involved in immunity against *C. parvum* while in adult animals the infection appears mainly to be controlled by  $\alpha\beta$  T cells. Clinical studies of human cryptosporidiosis in HIV patients and experiments with mice, both, indicated that CD4<sup>+</sup> T cells are the major players in host protection. Susceptibility to and severity of *C. parvum* infection increases with the decrease of CD4<sup>+</sup> cell counts in AIDS patients. In mice the continuous administration of anti-CD4 antibodies allowed chronic *C. parvum* infection to develop. The protective effect of lymphocyte transfer to SCID mice is abrogated by the depletion of CD4<sup>+</sup> cells. In contrast to the dominant role of CD4<sup>+</sup> T cells, CD8<sup>+</sup> cells play a negligible role as shown by cell depletion experiments *in vivo* or by using mice deficient for MHC class I expression. Only some investigators reported a small increase in oocyst production and/or a prolongation of patent infection as a result of treatment of mice with anti-CD8 antibodies. Using intraepithelial lymphocytes (IELs) from immune donor mice to adoptively transfer protection it was found that also in this cell population the CD4<sup>+</sup> subpopulation is the most effective.

One of the most important effector molecules produced by protective T cells is IFN- $\gamma$  as shown by

enhanced susceptibility of mice as a consequence of treatment with IFN- $\gamma$ -neutralizing antibodies. Production of this cytokine by IELs was found to be upregulated during the course of infection. However, IFN- $\gamma$ -independent mechanisms of immunity may also exist, since mice continuously treated with anti-IFN- $\gamma$  antibodies nevertheless eventually overcome the infection with *Cryptosporidia*. In line with this, mouse-strain-dependent differences in susceptibility to infection (BALB/b versus BALB/c mice) were not linked to differences in IFN- $\gamma$  production.

The mechanisms by which IFN- $\gamma$  mediates control of the parasite remain to be determined. Treatment of mice with inhibitors of  $\rightarrow$ nitric oxide production did not influence reproduction of *C. parvum*, unlike the effects found in other experimental infections with parasites such as  $\rightarrow$ Leishmania. Alternatively, documented IFN- $\gamma$  effects such as enhancement of the production of the secretory component of IgA or the enhancement of the respiratory burst may be operative in the IFN- $\gamma$ -mediated control of *Cryptosporidium* infection. IL-12 appears to be critically involved in the upregulation of IFN- $\gamma$  production as shown by treatment of newborn mice with anti-IL-12 antibodies resulting in enhanced disease susceptibility. Another cytokine involved in the protective immune mechanisms may be IL-2 since treatment of mice with anti-IL-2 increased oocyst production and in a human study IL-2 therapy resulted in less severe diarrhea and oocyst shedding in AIDS patients.

Recently, a protective role of Th2 cytokines in cryptosporidial infection has been reported. Although the amounts of IL-4 or IL-5 produced during the infection appear to be low, treatment of mice with anti-IL-4 or anti-IL-5 antibodies, especially when both were combined, increased oocyst shedding. In addition, adult IL-4-deficient mice excreted oocysts in feces approximately 23 days longer than control mice. Mast cells or eosinophils as effector cells stimulated by these cytokines are unlikely since these cells were not found in significant numbers by histopathological observation in the epithelial infiltrates and mast-cell-deficient mice were not significantly more susceptible to infection than control mice. Other studies, however, suggest that overproduction of IL-4 might correlate with increased susceptibility to infection. BALB/b mice produced significantly more IL-4 than the less susceptible BALB/c mice and onset of recovery in BALB/b mice coincided with a reduction of IL-4 production.

### Related Entry

$\rightarrow$ Alimentary System Diseases.

### Therapy

$\rightarrow$ Treatment of Opportunistic Agents.

## Cryptosporidiosis, Man

The coccidium  $\rightarrow$ *Cryptosporidium parvum*, the oocysts of which are 4–5  $\mu$ m in diameter, containing 4 sporozoites, parasitizes the microvillar border of the intestinal epithelial cells projecting into the lumen. With heavy infections the bile ducts, trachea, and possibly conjunctive may also be involved. In addition to the regular coccidian cycle, thin-walled oocysts are formed that sporulate in the intestine and are a source of  $\rightarrow$ superinfection; the thick-walled oocysts pass to the outside and develop 4 sporozoites. In healthy volunteers, acute infection can be produced by ingestion of 30–300 or more oocysts accompanied by  $\rightarrow$ abdominal pain, cramps, diarrhea, and fever lasting for 3–10 days.

*C. parvum* causes debilitating gastrointestinal illness in humans and other mammals and is a frequent opportunistic pathogen in  $\rightarrow$ AIDS patients.  $\rightarrow$ Chronic infection in immunosuppressed patients is associated with flattened villi resulting from loss of epithelial cells and lack of regeneration ( $\rightarrow$ Pathology/Fig. 6A). This is accompanied by often copious and frequent diarrhea,  $\rightarrow$ malabsorption, and  $\rightarrow$ weight loss. Both the light and evanescent infections in the immunocompetent and the heavy infections in the immunosuppressed show little  $\rightarrow$ inflammatory reaction. As studied in experimental animals, developing immunity is accompanied by the infiltration of lymphocytes into the lamina propria.

**Main clinical symptoms:** Abdominal pain, heavy  $\rightarrow$ diarrhoea (in immunocompromised persons).

**Incubation period:** 1–2 days.

**Prepatent period:** 2–4 days.

**Patent period:** 12–14 days.

**Diagnosis:** Microscopic determination of oocysts in fecal samples (Ziehl-Neelsenstain),  $\rightarrow$ *Cryptosporidium* Species/Fig. 1–3.

**Prophylaxis:** Avoid contact with human or animal feces.

**Therapy:** Treatment see  $\rightarrow$ Coccidiocidal Drugs and  $\rightarrow$ Treatment of Opportunistic Agents.

## Cryptosporidium Species

### Name

Greek: *kryptos* = hidden, *spora* = seed.

### Classification

Genus of  $\rightarrow$ Coccidea (of the Subphylum Apicomplexa).

**Cryptosporidium Species. Table 1** Valid species of the genus *Cryptosporidium*

Species	Size of oocysts (µm)	Main hosts	Prepatent period (days)	Pathogenicity
<i>Cryptosporidium parvum</i> –bovine genotype –porcine genotype	5 × 4.5 Ø	<b>Humans</b> (children and immunodeficient persons), Rhesus monkeys, Calves, lambs of goat and sheep, Young pigs, foals, Cats, dogs, rabbits, Guinea pigs, laboratory mice, Wild mice, nude mice, rats	2–3 Not given 2–3 Not given 4–6 2–3	+ +++
<i>C. hominis</i>	5 × 4.5 Ø	<b>Humans</b> , monkeys	2–3	+++
<i>C. baileyi</i>	4.6 × 6.3 Ø	Broiler chickens, birds	3–5	++
<i>C. muris</i>	7 × 5 Ø	Mice, rats, <b>humans</b>	4	++
<i>C. canis</i>	5 × 4.5 Ø	Dogs/ <b>humans</b>	Not given	+
<i>C. felis</i>	5 × 4.5 Ø	Cats/ <b>humans</b>	Not given	+
<i>C. wrairi</i>	5.2 × 4.5 Ø	Guinea pigs	Not given	+
<i>C. molnari</i>	4.7 × 4.4 Ø	Fish	Not given	+
<i>C. andersoni</i>	5.5 × 7 Ø	Bovines	Not given	++
<i>C. meleagridis</i>	5 × 4.6 Ø	Birds, <b>humans</b>	3–5	+
<i>C. crotali</i>	2 × 5 Ø	Reptiles	Not given	+
<i>C. serpentis</i>	5.8 × 6.8 Ø	Snakes, lizards	2–7	+
<i>C. nasorum</i>	2 × 5 Ø	Fish	Not given	+

**Cryptosporidium Species. Table 2** Sites of location of *Cryptosporidium* spp.

Location	Species
Small intestine	<i>C. canis</i> <i>C. felis</i> <i>C. hominis</i> <i>C. parvum</i> <i>C. suis</i> <i>C. wrairi</i>
Stomach	<i>C. andersoni</i> <i>C. muris</i> <i>C. molnari</i> <i>C. serpentis</i>
Trachea, cloaca Whole intestine, bile ducts, respiratory system	<i>C. baileyi</i> <i>C. hominis</i> , <i>C. parvum</i> in HIV-patients

### General Information

The species of this genus are very small (Table 1) and were known since more than 100 years within diarrheic feces of young animals. They obtained importance as important →**opportunistic agents** in AIDS-patients. In *C. parvum* there occur several genotypes: one is pathogenous for humans, one for calves, another for

pigs and man. Cryptosporidia are peculiar, since they are attached by a so-called feeder-organelle to the surface of their host cells (like some →**gregarines**), have only a few tubular →**mitochondria** and are not susceptible to any known antiparasitic drug. The wall of the →**oocyst** apparently develops into that of the →**sporocyst**. This may explain the observation of thin and thick-shelled oocysts. Recent molecular biological studies showed that *Cryptosporidium* spp. are closely related to gregarines. Although *Cryptosporidium* spp. possess the organelles of other coccidians, a typical mitochondrion is lacking. However a similar organelle, but without genome is present.

### Important Species

Tables 1, 2.

### Life Cycle

Figs. 1–4.

### Infection

Mostly due to contaminated water or fecal contact.

### Disease

→**Cryptosporidiosis, Animals**, →**Cryptosporidiosis, Man**.

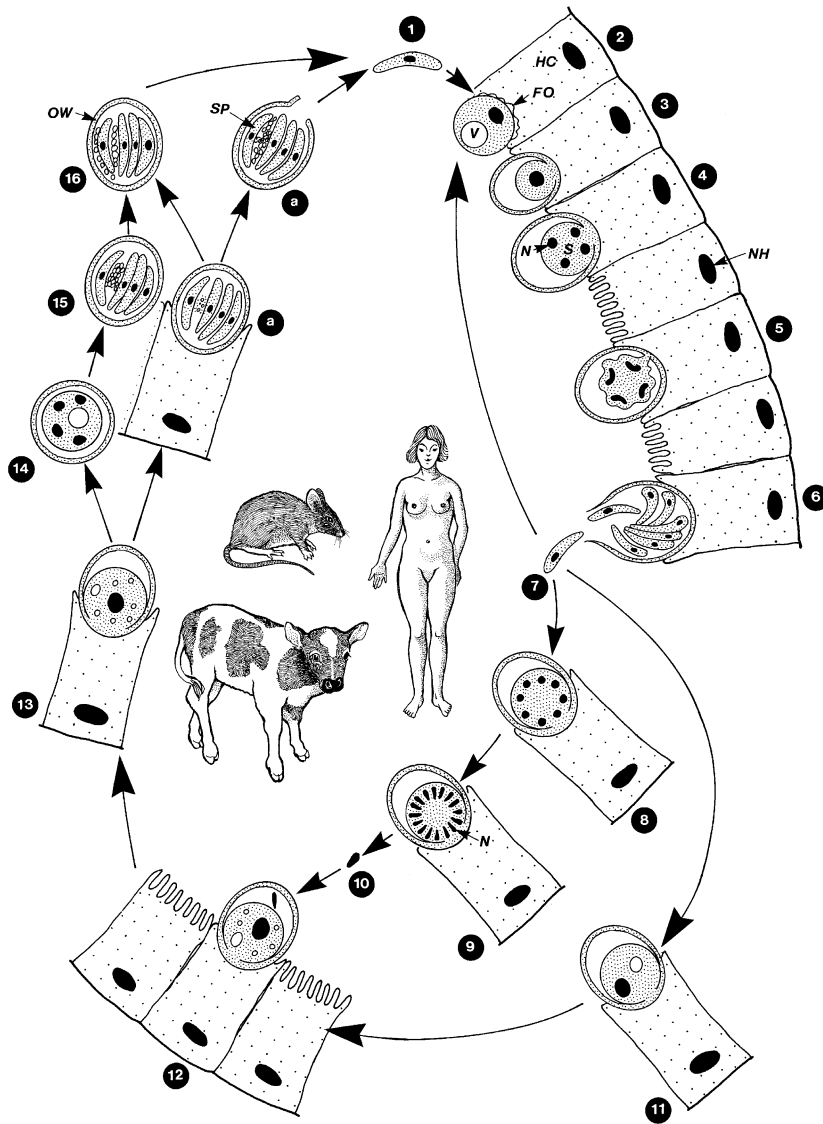

**Cryptosporidium Species. Figure 1** Life cycle of *Cryptosporidium parvum*. Species determination is still confusing as some authors believe in 2 species (*C. parvum*, *C. muris*), each parasitizing a wide range of mammals. Cross-transmission experiments by Göbel, however, indicate that there is only a single nonhost-specific species in mammals. Differences in pathogenicity depend on passages in different hosts. *Cryptosporidium parvum* is important, since infections in immunocompromised humans (e.g., →AIDS patients) are often fatal due to permanent endo-autoinfections (14), opportunistic agent 1 First infection of mammalian hosts occurs by ingestion of sporocysts (16) containing 4 sporozoites (1). The latter are set free in the small intestine when the sporocyst wall is ruptured along its suture. 2–7 From the interpretation of electron micrographs it appears that the →sporozoite becomes attached to the →microvilli of a gut cell and grows to form a →schizont with an inner vacuole (2; V). This vacuole is enlarged (3) and the nucleus divides twice (4). During the next →nuclear division (5) 8 merozoites (6) are produced and are set free (7). These merozoites may become attached to noninfected epithelial cells (2) and repeat the schizogonic process (2–7). 9–11 Formation of →gametes: some merozoites start formation of multinucleate →microgamonts and up to 16 nonflagellated →microgametes (10), which fertilize macrogametes (11) that had developed via macrogamonts from other merozoites (7). The →zygote (12, 13) may follow 2 different ways of development. 15a, 16a Endo-autoinfection: the oocyst sporulates on its host cell and releases the 4 sporozoites, leading to an increasing →autoinfection (important for immunosuppressed hosts including man). Such oocysts may also sporulate inside the intestine, but do not release their sporozoites (13–16). In this case they are excreted with the feces. During the →sporulation process a sporocyst wall is formed around the 4 sporozoites, replacing the apparently smooth and rupturing oocyst wall, so that the stages found in feces are sporocysts. This interpretation is supported by the occurrence of a peculiar suture of the wall, which is known from sporocyst walls of other →coccidia. Oocysts (13) may also be excreted unsporulated and then form their inner sporocyst wall and 4 sporozoites outside their host. The resulting sporocysts are as infectious to the range of host animals as the sporocysts excreted in sporulated form or the oocysts obtained by scraping the host's mucosa. FO, attachment zone, →feeder organelle; HC, host cell; N, nucleus; NH, nucleus of host cell; OW, oocyst wall; RB, residual body; S, schizont; SP, sporozoite; V, inner vacuole (for further species see Table 1).

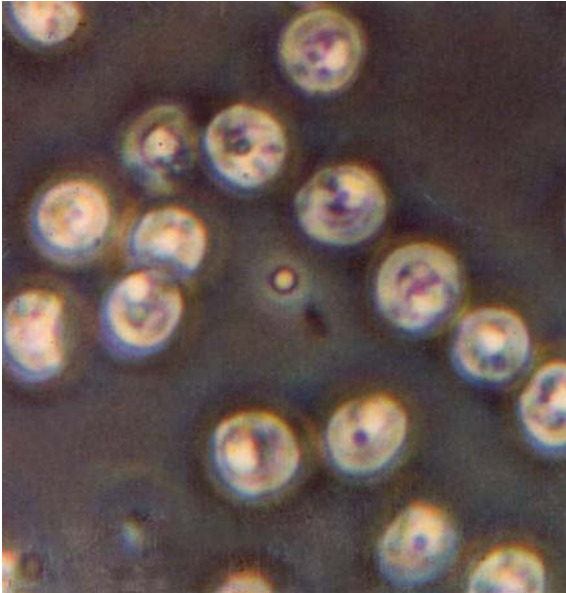

**Cryptosporidium Species.** Figure 2 LM of oocysts of *Cryptosporidium parvum*.

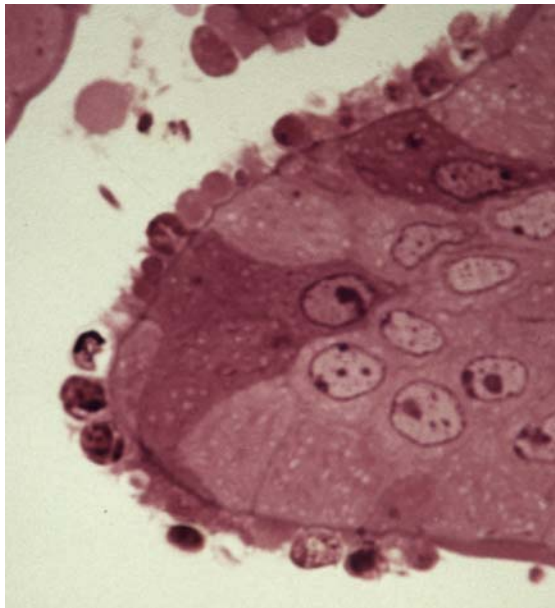

**Cryptosporidium Species.** Figure 3 LM of a carmin-red-coloured section of mouse intestine, the cells of which are closely covered by developmental stages of *Cryptosporidium parvum*.

---

## Cryptostigmata

→Acarina.

---

## Crystallospora cristalleroides

Coccidian species of freshwater fish (e.g., carps).

---

## CSF

Cerebrospinal fluid.

---

## CSL

Circumsporozoite-like antigen.

---

## CSP

Abbreviation for Circumsporozoite Protein, which covers as a thick layer together with →TRAP protein (and others) the surface of malarial sporozoites. These proteins are used in the development of vaccines.

→Apicomplexa/Surface Coat, →Vaccination.

---

## Ctenidium

→Fleas.

---

## Ctenocephalides

Genus of →Fleas.

---

## Ctenophthalmus agyrtes

Flea species of mice (*Apodemus flavicollis*, *A. sylvaticus*), Fig. 1 (page 307).

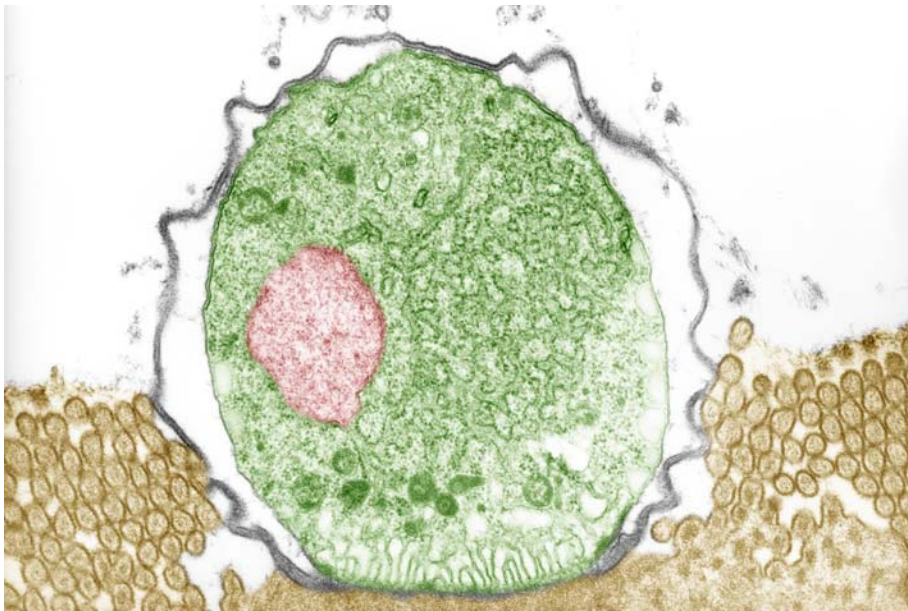

**Cryptosporidium Species. Figure 4** TEM section through a trophozoite of *Cryptosporidium parvum* being attached to the surface of a murine intestinal cell by a basal feeder organelle.



**Ctenophthalmus agyrtes. Figure 1** LM of the lateral view of a female.

## Culicidosis

Disease (e.g., →urticaria) due to bites of Culicid  
→mosquitoes.

## Culicoides

### Important Species

Tables 1, 2 (page 308).

→Diptera, →Filaridae, →Ceratopogonidae, →Biting  
Midges.

## Culex

→Diptera, →Filariidae, →Amblyospora, →mosquitoes.

## Culicidae

Family of →Diptera.

## Culiseta

Genus of rather large mosquitoes (formerly known as *Theobaldia*) containing about 35 species. Most species live in temperate countries (e.g., *C. silvestris*, *C. incidens*). Larval habitats are usually ground regions of water with submerged vegetation. The species *C. inornata*, *C. melanura* and *C. dyari* are vectors in North America for both Western and Eastern Equine Encephalomyelitis (virosis).

**Culicoides. Table 1** Important species of the genus *Culicoides* and their regional distribution

Species	Continent	Proven vectors
<i>C. insignis</i> <i>C. sonorensis</i>	North America	Viruses, <i>Franciscella</i> , protozoans
<i>C. insignis</i> <i>C. pusillus</i>	Central and South America	Viruses, <i>Franciscella</i> , protozoans, Oropouche virus
<i>C. bolitinos</i> <i>C. imicola</i>	Africa	Bluetongue virus, filariid worms
<i>C. dewulfi</i> <i>C. imicola</i> <i>C. impunctatus</i> <i>C. obsoletus</i> <i>C. pulicaris</i>	South Europe	Bluetongue virus, protozoans
<i>C. imicola</i>	Asia	Bluetongue virus, Akabane-virus, protozoans
<i>C. brevitarsis</i> <i>C. fulvus</i> <i>C. robertsi</i>	Australia	<i>Onchocerca</i> , viruses

**Culicoides. Table 2** Transmission of agents of disease by *Culicoides* species (examples)

Agents	Disease	Host	Region
<b>Virus</b> Rift valley Oropouche Equine encephalitis Bovine fever Bluetongue African horse sickness	Rift-valley fever Oropouche fever Encephalitis Bovine-ephemere fever Bluetongue Horse pest	Ruminants, <b>humans</b> <b>Humans</b> Horses, <b>humans</b> Cattle Ruminants Equids	Africa South-America New World Africa, Middle East, Australia Worldwide Africa
<b>Protozoa</b> <i>Trypanosoma</i> <i>Haemoproteus</i> <i>Hepatoctysis</i> <i>Leucocytozoon</i>	Trypanosomosis Blood disease Blood, liver disease White blood cell disease	Birds Birds Monkeys, rodents Birds	Worldwide Worldwide Africa, Asia Asia, Europe
<b>Worms</b> <i>Mansonella</i> <i>Onchocerca</i>	Filariasis Filariasis	<b>Humans</b> , monkeys, cattle, equids	Africa, South America Worldwide

## Cutaneous Larva Migrans

Cutaneous larva migrans is caused by →hookworms mainly of dogs and cats. The itching dermatitis often takes the form of tracks or “→creeping eruption” indicating the route of migration of the larvae in the epidermis of the skin. These papular and serpiginous lesions sometimes become vesicular and hemorrhagic, and are often secondarily infected with bacteria after scratching. These larvae never mature into adults, to

live in the intestine, but will die within 3 months at the latest.

### Therapy

Local application of a 15% tiabendazole-ointment.

## Cutaneous Leishmaniasis

→*Leishmania*, examples of symptoms: Figs. 1, 2.



**Cutaneous Leishmaniasis. Figure 1** Leishmanial lesion in a muco-cutaneous skin portion of a person from South America.

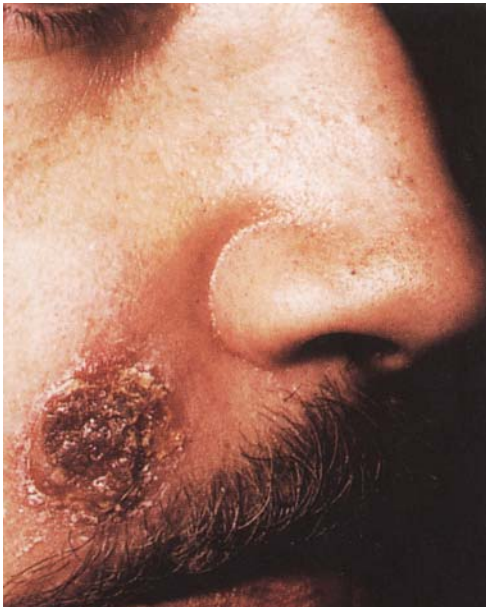

**Cutaneous Leishmaniasis. Figure 2** Leishmanial lesion in a dry region of the skin.

---

## Cuterebra

Genus of the fly family Cuterebridae, the species of which induce ophthalmomyiasis in humans in the Americas.

---

## Cuticle

The acellular filamentous type of [→body cover](#) excreted by an underlying cellularly organized hypodermis. Found, for example, in [→Nematodes](#), [→pentastomids](#), and in arthropods ([→Ticks](#), [→Mites](#),

[→Insects](#), [→Crustaceans](#)) with or without [→chitin](#) (depending on the group).

---

## Cuticulin

In the cortical layer of large ascarids there is a tanned structural protein which does not exhibit the striations characteristic for [→collagen](#), and which is not attacked by collagenase. [→Nematodes/Integument](#).

---

## Cyanobacteria-Like Bodies

The oocysts of [→Cyclospora species](#) were at first kept for bacteria when seen in the feces of [→AIDS](#) patients.

---

## Cyathocephalus

Genus of tapeworms in the intestine of freshwater fish.

---

## Cyathostoma

Synonymous to [→Syngamus](#).

---

## Cyathostomum

[→Nematodes](#).

---

## Cyclophyllida

From Greek: *kyklos* = cercle, *phyllon* = leaf. Order of tapeworms, e.g., [→Taenia](#) spp.

---

## Cyclops

[→Crustacea](#).



## Cyclorrhapha

→Diptera.

## Cyclospora Species

### Classification

Genus of →Coccidia.

### Important Species

Table 1.

### Life Cycle

In diarrhoeic stools of some immunocompetent, but mostly of immunodeficient people spherical, 8–10 µm-sized cysts were described as CLB = →cyanobacteria-like bodies, which turned to be typical coccidian oocysts belonging to the genus *Cyclospora*, which is known from millipeds, insectivores, rodents, and reptiles. The human species is now called *C. cayetanensis*. Outside the body within 5–13 days (at 25–32°C) 2 sporocysts are formed within each →oocyst. These sporocysts contained each 2 sporozoites with a size of 9 × 1.5 µm. Infection of humans apparently occurs via inoculation of such oocysts (Fig. 1). However, the further development is still unknown.

### Disease

→Cyclosporiasis, →Ciprofloxacin.

## Cyclosporiasis

In diarrhoeic stools of man especially in AIDS-patients the 8–10 µm-sized, unsporulated oocysts of →*Cyclospora cayetanensis* have been described. At first they were misdiagnosed as CLB (→Cyanobacteria-Like Bodies). They apparently induce watery intermittent →diarrhoea (3–4 times per day), which last for 2–9 weeks and may disappear without treatment. Infection apparently occurs by inoculation (with contaminated food) of sporulated oocysts containing 2 sporocysts with 2 sporozoites. The source of the oocysts is not yet clear, since *Cyclospora* exists in many animals without clinical symptoms. **Treatment** may be carried out with Cotrimoxazol (2 × 800 mg Sulfamethoxazol/160 mg →Trimethoprim).

**Cyclospora Species. Table 1** Important species of the genus *Cyclospora*

Species	Host	Infected tissues	Oocyst size	Prepatent period
<i>Cyclospora cayetanensis</i>	Humans (AIDS patients)	Intestinal cells	8–10 µm	?
<i>Cyclospora caryolytica</i>	Mole ( <i>Talpa</i> )	Intestinal cells	8–12 µm	?
<i>Cyclospora viperae</i>	Snakes	Intestinal cells	9–12 µm	?

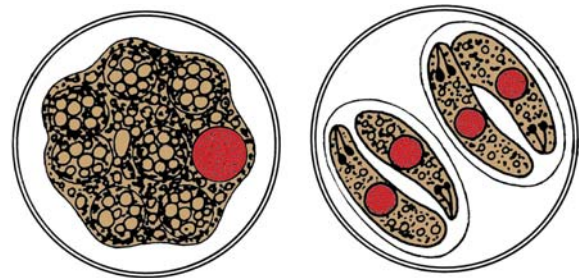

**Cyclospora Species. Figure 1** Diagrammatic representation of an unsporulated and a sporulated oocyst.

## Cyfluthrin

Ectoparasiticide (→Arthropodicidal Drugs) of the group of pyrethroid acting against flies on grazing cattle.

## Cyhalothrin

Pyrethroid, →Ectoparasiticides, →Arthropodicidal Drugs.

## Cylicocycclus nassatus

→Nematodes.

## Cylicodontophorus

Genus of the subfamily Cyathostominae = small strongylids.

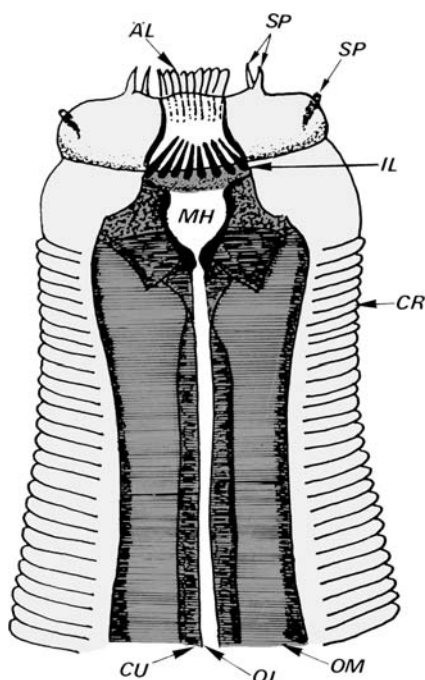

**Cylicostephanus.** Figure 1 DR of the anterior of a small strongylid nematode of horses: *Cylicostephanus* sp. AL, outer lamellae; CR, cuticular rings; CU, cuticle; IL, inner lamellae; MH, buccal cavity; OL, lumen of oesophagus; OM, muscles of oesophagus; SP, sense papillae.

## Cylicostephanus

Genus of small strongylid nematodes of horses (Fig. 1), subfamily Cyathostominae = small strongylids.

## Cymiazole

### Chemical Class

Amidine (formamidine).

### Mode of Action

Octopamine receptor agonist. →Ectoparasiticides – Modulators/Agonists of Aminergic Transmission.

## Cynomya mortuorum

*C. mortuorum* (fly family Calliphoridae 7–18 mm, metallic, blue-green) excretes its eggs on dead bodies

(especially on fish). This species is found in the holarctic region.

## Cypermethrin

### Chemical Class

Pyrethroid (type II,  $\alpha$ -CN-pyrethroids).

### Mode of Action

Open state voltage-gated sodium channel blocker. →Ectoparasiticides – Blockers/Modulators of Voltage-Gated Sodium Channels.

## Cyromazine

### Chemical Class

Aminotriazine.

### Mode of Action

Insect growth regulator (IGR, cuticle sclerotization effectors) →Ectoparasiticides – Inhibitors of Arthropod Development.

## Cyrtocyte

### Synonym

→Terminal Cell.

Portion of the excretion system of Platyhelminthes (→Platyhelminthes/Figs. 24, 25).

## Cyst Forming Coccidia

→Toxoplasma, →Sarcocystis, →Besnoitia.

## Cyst Wall

Many parasitic →Protozoa (e.g., →*Giardia*, →*Entamoeba histolytica*, →Coccidia) are capable of undergoing

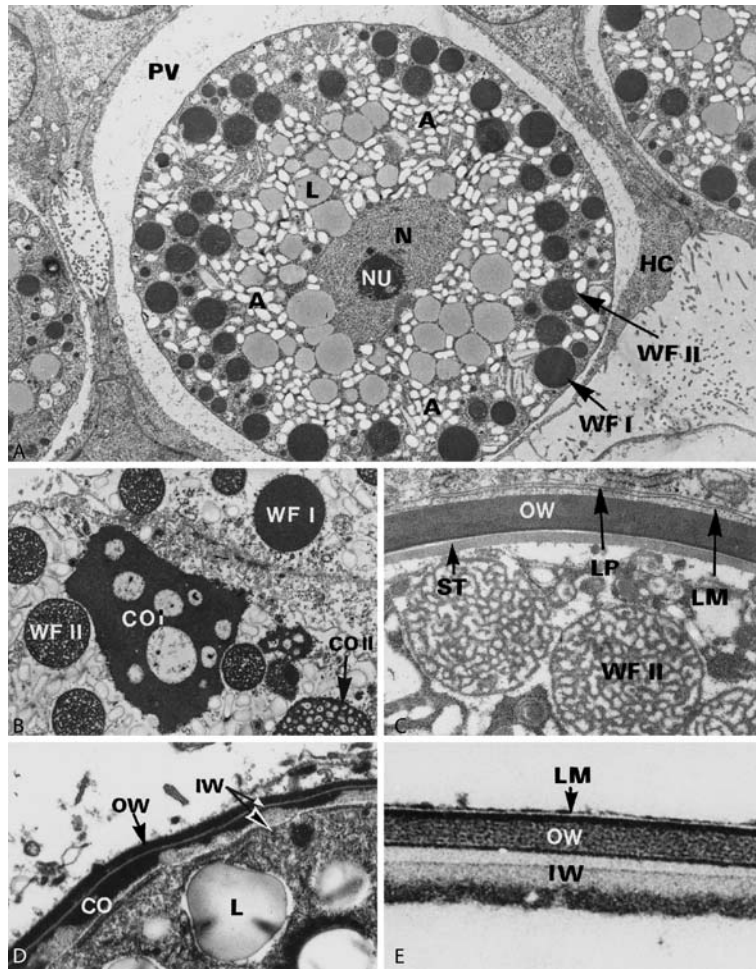

**Cyst Wall. Figure 1 A–E** Transmission electron micrographs of the formation of the oocyst wall in members of the Eimeriidea. **A–C** *Eimeria stiedai* in the bile ducts of rabbits; typical eimerian macrogamete with 2 types of wall-forming bodies, which combine to form the inner and outer layers of the oocyst wall (A  $\times 2,000$ , B  $\times 3,500$ , C  $\times 15,000$ ). **D** *Sarcocystis clethrionomyelaphis* from the intestine of the snake *Elaphe longissima* ( $\times 15,000$ ). **E** *Isospora* sp. from sparrows ( $\times 18,000$ ). A, amylopectin; CO I, II, confluent wall-forming bodies of types I and II; HC, host cell; IW, inner layer of oocyst wall; L, lipid; LM, limiting membrane of the parasite; LP, limiting membrane of the parasitophorous vacuole; N, nucleus; NU, nucleolus; PV, parasitophorous vacuole; ST, starting formation of IW; WF I, II, wall-forming bodies of type I, II.

→encystation, which involves formation of a cyst wall either outside or inside the →cell membrane. This cyst wall may be single- or multilayered. Walls formed outside the →plasmalemma are produced by →exocytosis of materials (→Wall-Forming Bodies). Cyst walls have 2 main tasks: (1) to protect the organism against unfavorable →environmental conditions when passing from one host to another, and (2) to create spaces for reorganization and →nuclear division. Cyst walls may also aid the parasite in its transmission from one host to another by facilitating attachment to host cell surfaces.

The cyst wall has one layer in cysts of →*Entamoeba histolytica*, *Giardia*, and some ciliates, such as the fish parasite →*Ichthyophthirius multifiliis* and the human

parasite →*Balantidium coli*. There are usually 2 types of cysts in the stages of →coccidia in feces: the oocysts and the sporocysts. The →oocyst wall is usually 2-layered but in a few species it may have 4 layers. It is formed by 2 types of cyst-→wall-forming bodies (→*Eimeria*) (Fig. 1).

The chemical composition of cyst walls varies according to the species, although proteins are usually the basic component. The cyst walls of *E. histolytica* and →*G. lamblia* contain proteins which are keratin-like or elastin-like albuminoids, composed of lysine, histidine, arginine, tyrosine, glutamic acid, and →glycine.

The 2-layered oocyst wall of the sporozoans is periodic acid-Schiff-positive (PAS-positive). The outer layer of these oocysts consists mainly of fatty alcohols

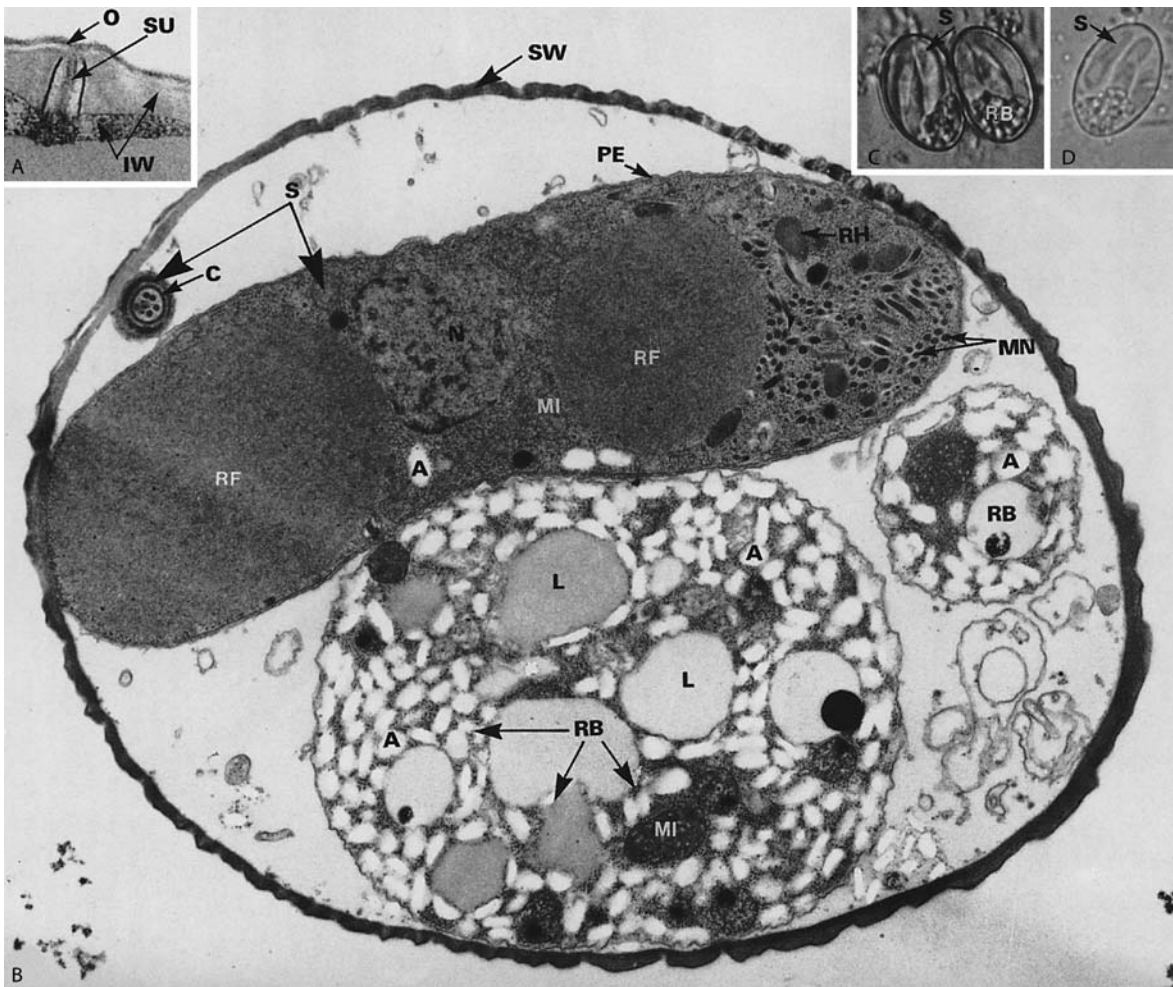

**Cyst Wall. Figure 2 A–D** Sporocysts under light (C, D) and transmission electron microscopy (A, B). **A** Suture of the sporocyst wall (characteristic of the genera *Sarcocystis*, *Toxoplasma*, *Isospora*); the wall ruptures here during the excystation of the sporozoites inside the intestinal tract of the host ( $\times 40,000$ ). **B** *Isospora* sp. from sparrows. Section through a sporocyst with 2 (of 4) sporozoites (S) in the section plane. Note the large, membrane-bound residual body ( $\times 12,000$ ). **C**, **D** *Sarcocystis* sp. oocysts (OC) contain 2 sporocysts with 4 sporozoites when excreted with feces; due to the smooth oocyst wall mostly sporocysts (D) are found in feces ( $\times 2,000$ ). A, amylopectin; IN, inner part of the sporocyst wall; L, lipid; MI, mitochondrion; MN, micronemes; N, nucleus; O, outer part of the sporocyst wall; PE, pellicle; RB, residual body; RE, retractile body; RH, rhoptries; S, sporozoite; SU, suture; SW, sporocyst wall.

(e.g., hexacosanol), some phospholipids, and fatty acids. It contains no carbohydrates or proteins. The inner layer is composed of glycoproteins and contains most of the carbohydrates found in the oocyst wall. These carbohydrates are composed of mannose, galactose, glucose, and hexosamine. The oocyst wall is highly resistant to the passage of potassium dichromate, sodium hypochloride, sulphuric acid, and sodium hydroxide and therefore these chemicals are used in the storage and cleaning of oocysts. It is permeable to  $O_2$ ,  $CO_2$ ,  $NH_3$ , methylbromide, carbon disulphide, and various organic solvents. The oocyst wall is highly susceptible to mechanical pressure and therefore may be easily ruptured by shearing forces.

Thus, the mechanical rupture of oocysts in the gizzard of the avian host is likely to be the normal method of excystation of avian coccidia. The  $\rightarrow$ micropyle (a preformed opening) is probably rarely used as a passage for the escape of sporocysts. The sporocysts in the oocyst are bound by a 2-layered wall, the inner layer of which is relatively smooth (Fig. 2). The sporocysts of eimerians have an opening which serves as an exit for the sporozoites. This is closed by the  $\rightarrow$ Stieda body, which can be dissolved by trypsin. The sporocysts of  $\rightarrow$ *Isospora* and the tissue-cyst-forming coccidia (e.g.,  $\rightarrow$ *Sarcocystis*, *Toxoplasma*) have sutures on which the excystation fluids act, causing collapse of the  $\rightarrow$ sporocyst wall (Fig. 2).

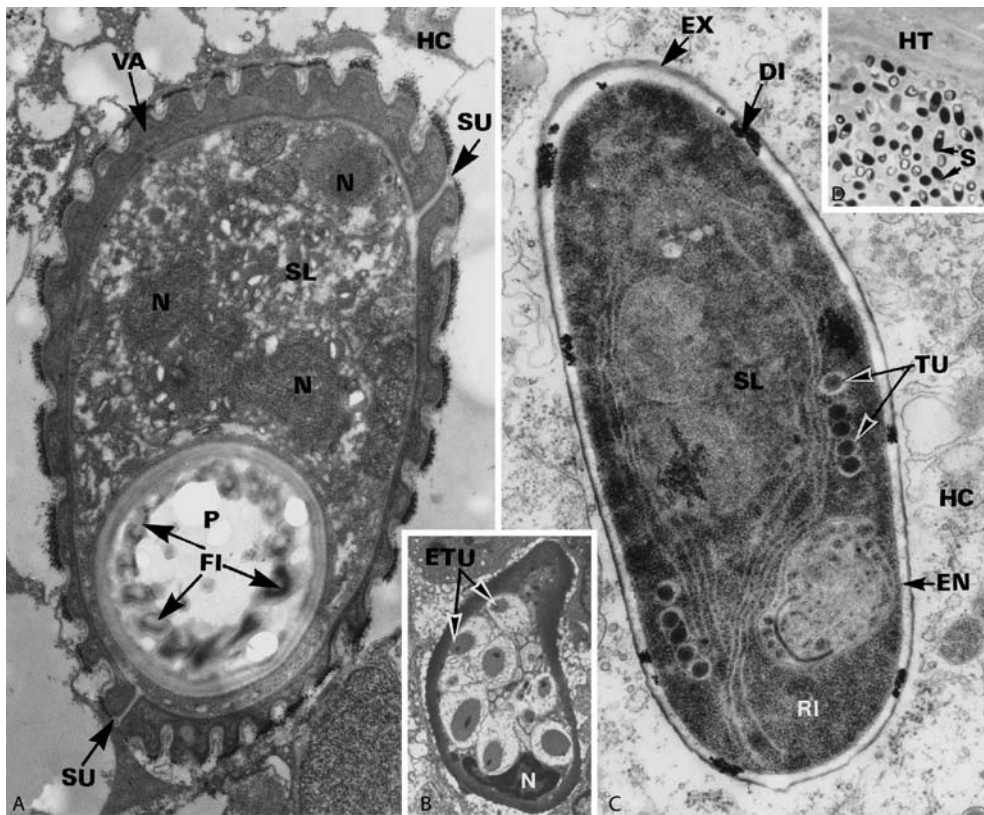

**Cyst Wall. Figure 3 A–D** Myxo- (A) and microsporidian cysts (B, D) in electron (A, C) and light micrographs (D). **A** *Myxosoma* sp. from fish skin, due to the oblique section only one polar capsule is seen ( $\times 10,000$ ). **B, D** *Glugea* sp. from intestinal wall of fish (B  $\times 3,500$ , D  $\times 2,000$ ). **C** *Nosema* sp. from tissues of *Pimpla* sp. ( $\times 12,000$ ). DL, densification in EN; EN, light endospore; ETU, enlarged TU; EX, dense exospore, HC, host cell; HT, host tissue; N, nucleus; RL, ribosomes; S, spores; SC, sporoplasm; SU, suture of valves; TU, polar tube (filament); VA, valve of shell.

The cyst walls of the members of the [→Myxozoa](#) and [→Microspora](#) are at least double-walled in most species (Fig. 3), but the layers can only be resolved by electron microscopy. In Myxozoa, the wall consists of 2 valves that open at pre-formed sites to release the infectious [→sporoplasm](#) (Fig. 3A). The Microspora have developed a hollow tube that protrudes from the surface of the wall (Figs. 3B, 4). It penetrates into a host cell and the infectious sporoplasm is passed through it. The [→exospore](#) layer in Microspora is proteinaceous and is 15–100 nm thick, depending on the species. The [→endospore](#) layer is chitinous and  $\sim 150$ –200 nm thick (Fig. 4). The [→Spores](#) are Gram-positive (i.e., stain reddish purple with the Gram stain), a fact that is of diagnostic value. They are also stained light blue by [→Giemsa](#). Besides these typical cysts, some genera such as *Toxoplasma* and *Sarcocystis*, form so-called [→tissue-cysts](#). They develop from a “normal [→parasitophorous vacuole](#),” the membrane of which becomes fortified to a so-called [→primary cyst wall](#),

which starts to form species-specific protrusions. Such tissue-cysts, while inside divisions go on, may become covered by host defense cells so that a [→secondary cyst wall](#) is produced (e.g., [→Sarcocystis ovifelis](#), [→Tissue Cyst](#)).

Encystation is also done by [→cercariae](#) of some digenean [→trematodes](#) ([→Digenea](#)) which excrete (via cystogenous glands) material to produce the wall of [→metacercariae](#), [→Fasciola](#). Further similar processes are seen in [→Acanthocephala](#)/[→Cystacanth](#).

## Cystacanth

An infective [→acanthella](#) is commonly called a cystacanth, referring to the cyst-shaped larvae of *Macracanthorhynchus hirudinaceus* ([→Acanthocephala](#)/Fig. 2) or [→Moniliformis moniliformis](#) ([→Acanthella](#)/Fig. 2C). Most

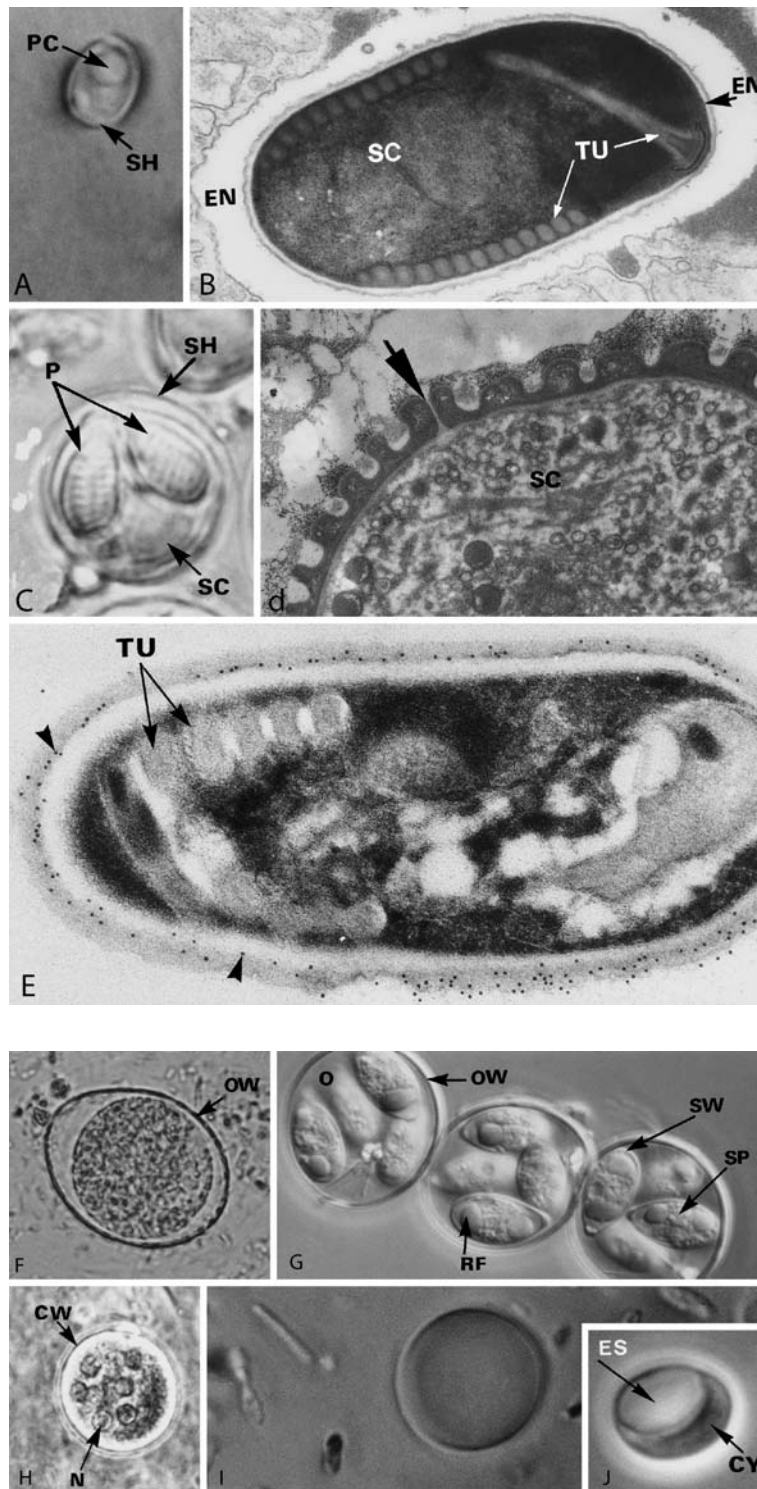

**Cyst Wall. Figure 4** Cyst stages (A, C, F–I light micrographs, B, D, E electron micrographs). **A, B** Microsporidian spore (*Nosema*). A  $\times 2,500$ , B  $\times 15,000$ . **C, D** Myxosporidian cyst (*Myxobolus*). C  $\times 1,000$ , D  $\times 30,000$ . **E** Immunogold reaction with a gold-labelled antibody against chitin (arrows).  $\times 20,000$ . **F, G** *Eimeria* oocysts (G = sporulated).  $\times 1,000$ . **H** *Entamoeba coli* cyst.  $\times 2,000$ . **I** *Blastocystis hominis* vacuolar and cystic stage (inset).  $\times 2,000$ . *CY*, cytoplasm; *CW*, cyst wall; *ES*, empty space in cyst interior; *N*, nucleus; *OW*, oocyst wall; *P*, polar capsule; *PC*, polaroplast; *RF*, refractile body; *SC*, cytoplasm; *SH*, shell valve; *SP*, sporocyst; *SW*, sporocyst wall; *TU*, tubular polar filament.

acanthocephalans, however, have elongated sausage-shaped infective larvae ([→Acanthella/Fig. 2C](#)), which resemble immature adults with an invaginated [→praesoma](#). Such larvae have well-developed sexual organs whereas the “cystacanth-like larvae,” with a large gap between them and the surrounding envelope, are usually retarded in the development of their sexual organs and may have a very solid body wall ([→Acanthella/Fig. 2C](#)). Therefore the general term infective larva appears more appropriate than the misleading term cystacanth. But usually names that have become established cannot be changed anymore. Cystacanth has almost-closed tegumental pores and compressed crypts in their outer membranes, corresponding to the dormant metabolism of this larva. The size of the [→surface coat](#) usually significantly exceeds that of the adult worms inside the gut of the final host.

---

## Cysticeroid

Tailed second larva, e.g., of [→tapeworms](#) of the families Anoplocephala, Davaneidae, Dipylidae, and Hymenolepidiae ([→Cestodes](#), [→Eucestodes](#)).

---

## Cysticercosis

### Pathology

Cysticercosis results from the development of larval [→tapeworms](#) in humans harboring adult [→Taenia solium](#) ([→Autoinfection](#)) or from ingesting soil containing eggs shed in the feces of humans, in areas where there are no latrines, or where they are so filthy that they are not used. Humans are accidental intermediate hosts and pigs are the normal intermediate hosts; their meat being “measly pork”. Oncospheres released from eggs penetrate the intestinal mucosa and develop into bladder-like, [→cysticercus](#) larvae of 1–2 cm which develop in many tissues, mostly in skeletal muscle and subcutaneous tissue. Clinically they are most serious when located in the central nervous system or in the eye where they persist for months to years. The intact cysticerci are surrounded by a fibrous capsule and rarely give rise to symptoms, unless they involve special areas of the brain such as the aqueduct or are present in large numbers. However, degenerating cysticerci give rise to fever with an intense eosinophilic [→inflammatory reaction](#) ([→Eosinophilic Reaction](#)) accompanied by tissue swelling, being especially serious in the brain. The dead parasites often calcify and become demonstrable by

radiography; the living cysticerci can be diagnosed by computerized axial tomography and magnetic resonance imaging and should correlate with positive serological findings.

**Main clinical symptoms:** Dysfunction of the organs, within which the cysticerci are located.

**Incubation period:** 8–10 weeks.

**Prepatent period:** 8 weeks.

**Patent period:** 2 years.

**Diagnosis:** Serodiagnostic methods, computer tomography, [→Serology](#).

**Prophylaxis:** Avoid contact with human feces.

**Therapy:** Treatment with praziquantel, see [→Cestodocidal Drugs](#).

### Immune Responses

The cysts have developed mechanisms to avoid the host inflammatory and immune response. The analysis of experimental infections of rodents with [→Taenia crassiceps](#) or [→T. taeniaeformis](#) has significantly contributed to our understanding of the host–parasite relationship.

### Complement and Macrophages Granulocytes

Destruction of oncospheres in sera of patients or immune animals is mediated by the classical complement pathway. However, also the primary resistance to *T. taeniaeformis* infection in naive mice is complement-dependent. C3b is deposited on the surface of oncospheres and proto-oncosphere larvae but only in resistant and not in susceptible murine hosts is C5a produced. In contrast, complement has little effect on viable metacestodes.

In experimental infections, the developing [→metacestode](#) is surrounded by neutrophils and eosinophils, which appear to have no detrimental effect on the parasite. The formation of infiltrates may be directly initiated by the parasite via the production of several chemotactic factors. *Taenia*-induced macrophages up-regulate molecules like death ligand 1 (PD-L1) and PD-L2. These molecules are responsible for the inhibition of parasite-specific response of lymphocytes, thus representing an immune-escape mechanism operative during *Taenia* infection.

### B Cells and Antibodies

Antibodies are thought to play a decisive role in the immune response to [→Taenia](#) oncospheres. Passive immunization studies have shown that protection can be transferred with antibody alone, while T cells are involved in the generation of protective immunity. In contrast, antibodies have little effect on

metacestodes. However, most viable parasites contain immunoglobulin on their surface, of which the majority is not specific for the parasite. It has been suggested that the parasites may have Fc receptors for host immunoglobulins, which could be taken up, digested, and thus serve as a primary protein source for the parasite.

### T Cells

Acute infections with taeniid oncospheres as well as viable cysts are associated with suppression of the host immune response. For example, spleen cells from acutely infected rats displayed decreased mitogenic responses, and in infected pigs a decreased number of CD4<sup>+</sup> T cells in the peripheral blood has been reported. The immune-suppressive effects seem to be mediated, at least in part, by modulation of the role of macrophages as antigen-presenting cells and appear to be dependent on the presence of viable parasites.

In mice infected with *Taenia crassiceps*, elevated levels of IgG1 and IgE suggested a dominant Th2 response. Increased production of IL-4, IL-6, and IL-10 has been detected, and active infection was also associated with a suppression of pro-inflammatory and Th1 cytokines.

The death of the parasite is associated not only with a granulomatous response but also with a switch to IgG2a production, a pattern associated with IFN- $\gamma$  production. In humans, parasite death is accompanied by elevations of neopterin within the spinal fluid, a marker for macrophage activation. In addition IL-12 and IFN- $\gamma$  expression has been detected in granulomas surrounding dying cyst, consistent with the idea, that death of the metacestodes results in a shift to a Th1 response.

### Evasion Mechanisms

Molecules able to detoxify reactive oxygen intermediates, such as superoxide dismutase and glutathion-S-transferase, were purified from *T. taeniaeformis*.  $\rightarrow$ Paramyosin, excreted by  $\rightarrow$ *T. solium*, is able to bind to C1 thereby inhibiting the classical complement activation. The protease inhibitor taeniaestatin, a glycoprotein secreted by *T. taeniaeformis* metacestodes, not only inhibited the classical and alternative pathway of complement activation but also suppressed mitogen- or IL-1-induced proliferation of rat spleen or mouse thymus cells, respectively. Furthermore, taeniaestatin interfered with neutrophil chemotaxis and aggregation *in vitro*. Prostaglandin E2 isolated from the excretory fluid of *Taenia* metacestodes may contribute to the inhibition of Th1 responses.

## Cysticercus

### Name

Greek: *kystis* = bladder, *kerkos* = tail.

Type of the second tapeworm larva ( $\rightarrow$ Eucestoda,  $\rightarrow$ *Taenia solium*),  $\rightarrow$ bladder worm,  $\rightarrow$ Cysticercosis, Figs. 1, 2.

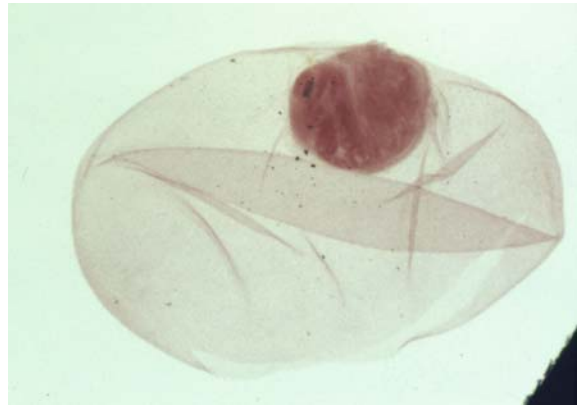

**Cysticercus. Figure 1** LM of a cysticercus of *Taenia solium* isolated from pig. The scolex region (dense part) is folded into a thin walled bladder, which thus is called *Cysticercus cellulosae*.



**Cysticercus. Figure 2** Evaginated *Cysticercus* in human eye.



## Cysticercus cellulosae

Larval stage of →*Taenia solium* in pigs, →Nervous System Diseases, Swine, →*Cysticercus*/Figs. 1, 2.

### Disease

→Coccidiosis, Animals.

## Cystidicola farionis

### Synonym

*Fissula*.

Nematode (male 10–20 mm, female 11–36 mm) in salmonids (trouts) in the wall/inside the swim bladder.

## Cystocaulus

Genus of the nematode family Protostrongylidae. *C. ocreatus* is found in the lungs of sheep and goats. Genus of 3–5 cm sized nematodes (lungworms) in cattle; larva 1 hatches already in the final host and thus are found in faeces.

## Cystoisospora

### Classification

Genus of →Coccidia.

### Important Species

Table 1.

### Life Cycle

→Coccidia/Fig. 2.

## Cystozoites

Developing stage inside of apicomplexan tissue-cysts (e.g., →*Toxoplasma gondii*, →*Sarcocystis* species); another name is →bradyzoite describing that it is developing at low speed in contrast to →tachyzoites = quickly reproducing stages of the same species found, e. g., in macrophages.

## Cysts

→Amoebae, →*Giardia*, →Coccidia.

## Cytauzoon

### Synonym

→Theileria.

## Cytauzoon felis

Piroplasmian parasite of cats (mainly in North America) that enters white and red blood cells leading to a →theileriasis-like disease with rapidly progressing clinical signs (fever, lethargy) and shortly followed by death. →Reservoir hosts are bobcats and vector is the ixodid tick *Dermacentor variabilis*. It was recently suggested that *C. felis* is a *Theileria* species as *C. taurotragi* (→*Theileria*).

**Cystoisospora. Table 1** Important species of the genus *Cystoisospora*<sup>1</sup>

Species	Host/Habitat	Size of oocysts (µm)	Prepatent period	Pathogenicity
<i>Cystoisospora burrowsi</i>	Canids/Small intestine, cecum, colon	21 × 18	6–9	+
<i>C. canis</i>	Dogs/Small intestine, cecum	36–44 × 29–36	8–11	–
<i>C. felis</i>	Cats/Small intestine, Ileum	30–53 × 23–32	6–17	–
<i>C. ohioensis</i>	Dogs/Small intestine, cecum, colon	19–27 × 18–23	6	–
<i>C. rivolta</i>	Cats/Small intestine, cecum, colon	22–36 × 21–27	5–7	–

<sup>1</sup> Some authors keep *Cystoisospora* synonym to *Levineia*, other retain the old name *Isoospora*

**Disease**

→[Cytosoonosis](#).

**Cytosoonosis**

Disease of domestic cats and bobcats (→[Reservoir](#)) in the USA due to infection with →[Cytosoon felis](#), a 2 µm-sized piroplasmic parasite of lymphocytes and erythrocytes being transmitted by →[ticks](#) (e.g., *Dermacentor variabilis*). Some authors believe that →[Cytosoon](#) is synonymous to →[Theileria](#). The disease shows rapidly progressing clinical signs such as high fever, icterus, lethargy, shortly followed by death.

**Therapy**

Unknown, try →[Theileriacidal Drugs](#).

**Cythioate****Chemical Class**

Organophosphorous compounds (monothiophosphate).

**Mode of Action**

Acetylcholine esterase inhibitor. →[Ectoparasiticides](#) – [Agonists and Antagonists of Cholinergic Transmission](#).

**Cytoadherence**

Binding of parasite-infected red blood cells to human endothelial cells, e.g., in →[Plasmodium falciparum](#), leading to thrombus.

**Cytochromes**

→[Energy Metabolism](#).

**Cytodites**

→[Mites](#).

**Cytokines****Name**

Greek: *kytos* = cell and *kinein* = move.

This term describes proteins produced and excreted by cells, which stimulate the activity of other cells (e.g., immune modulation).

**Cytomere**

→[Cell Multiplication/Multiple Divisions](#), →[Myxosoma cerebralis](#).

**Cytoplasm**

Eukaryotic cells consist of a membrane-bound cytoplasm containing one or more nuclei and various organelles that are also often membrane-bound, their compartments and membranes acting as sites, where reaction processes can occur. The cytoplasm in →[Protozoa](#) is generally divided into 2 zones: (1) the peripheral, electron-lucent →[ectoplasm](#) (→[Hyaloplasm](#)); and (2) the denser central →[endoplasm](#). The endoplasm contains the cell organelles and the nucleus. This differentiation is particularly prominent in the amebae and in the →[gregarines](#) (→[Pellicle/Fig. 1A](#), →[Pseudopodia/Fig. 1](#)), but is not apparent in all species. In some species, endoplasm and ectoplasm cannot even be distinguished by electron microscopy. Male →[microgametes](#) of most sporozoans, apart from those of the →[piroplasm](#)s, have a very reduced cytoplasm. They are comprised mainly of →[flagella](#), a mitochondrion, and a nucleus (→[Gametes](#)). The cytoplasm of most cells shows high viscosity and stability and has a prominent →[cytoskeleton](#).

**Cytoplasmic Inclusions**

The →[endoplasm](#) contains a variety of organelles and other structures within which metabolic processes occur, e.g., →[nucleus](#), →[mitochondria](#), →[Golgi apparatus](#), →[microbodies](#), →[rhoptries](#), →[micronemes](#), →[wall-forming bodies](#), →[vacuoles](#), endoplasmic reticulum, →[ribosomes](#), →[kinetoplast](#), →[apicoplast](#).

## Cytopyge

### Synonym

→Cell anus.

### Definition

Special place for →exocytosis developed by many →protozoa.

## Cytoskeleton

The network of protein filaments and →microtubules in the →cytoplasm is called cytoskeleton.

Contractile elements are responsible for the cytoplasmic flow and these include →actin filaments with a diameter of ~6 nm. These filaments are composed of a double chain of globular bodies. Cytoskeletons may also contain 10 nm filaments or intermediate filaments which, to date, have been found only in the cells of higher vertebrates. The various types of filaments are organized into the microtubules of the cytoskeleton. The tubules have an outer diameter of 25 nm and an inner diameter of 15 nm. They are composed of protofilaments that are visible in cross-sections. The protofilaments consist of  $\alpha$ - and  $\beta$ -tubulin elements in a helical arrangement. The microtubules are polymerized at particular points called microtubule organizing centers (→MTOCs). These centers exist at →centromeres, →centrioles and at certain places in membranes. They also occur as constituents of →flagella and →cilia (→Locomotory Systems, →Flagella/Fig. 1C).

The processes that bring about motility of the cytoplasm are well documented for metazoan cells, but for →Protozoa these processes are still poorly understood (→Apicomplexa/Motility). In all cases, it is probably the aggregation of →actin with →myosin and tropomyosin to form an actomyosin complex that leads to movement, as proposed in the sliding filament model of Huxley and Hanson. This ATP-dependent system may produce relatively rapid movements, as occur in amoeba (20  $\mu\text{m}$  per second), and in the sporozoites and merozoites of sporozoans. In addition to the cytoskeletal system, most parasitic protozoa have developed

unique skeletal elements composed of combinations of the usual cytoskeleton elements. These structures include the following:

- The →subpellicular microtubules of trypanosomes and the motile stages of the →Coccidia (→Pellicle/Figs. 2, 3, →Apicomplexa/Fig. 4).
- The kinetodesmal fibrils of ciliates.
- The bundles of cytoplasmic microtubules in gamonts of →piroplasms (→Gametes/Fig. 6B).
- The combined microtubules and filaments observed in the ventral disc of the diplomonads (→*Giardia lamblia*/Fig. 2).
- The crystalloid protein densifications that occur below the membrane of giardial →trophozoites, at the apex of eimerian →microgametes (→Gametes/Fig. 6A) and in the gamonts of piroplasms (→Gametes/Fig. 6B).
- The →axostyles and →pelta, occurring prominently in the →trichomonads and consisting of one or more parallel rows of microtubules (→Trichomonadida/Fig. 1).
- The →costa and parabasal filaments, the filamentous, sometimes striated elements (→Mitochondria/Fig. 1F, →Trichomonadida/Fig. 1) that line the →recurrent flagellum or the →Golgi apparatus in trichomonads.
- The →paraxial rods, which consist of a network of microfilaments that run along the axonemal microtubules of the →flagella of →Kinetoplastida (→Pellicle/Fig. 2A, →Trypanosoma/Fig. 5, →Flagella/Fig. 1D,E).
- The →conoids, which are found in the motile stages of some Coccidia, such as →*Eimeria*, →*Sarcocystis*, and *Toxoplasma* (→Pellicle/Fig. 5, →Kinete/Fig. 2), but which are always absent from the corresponding stages of haemosporidians (e.g., →*Plasmodium*, piroplasms).

## Cytostome

Cell mouth (→Micropore of →Apicomplexa). Special place for the uptake of food developed by many →Protozoa (→Endocytosis/Figs. 1, 2).

## Dactylogyrus vastator

→ Monogenea, → Platyhelminthes/ Fig. 17A.

## Dactylosoma

Genus of babesoid parasites in red blood cells of amphibian animals.

## Daily Biting Rate (DBR)

Number of bites of vectors of agents of diseases (e.g. → Malaria, → Onchocerciasis) at a given place. This number is used to evaluate the infection risk.

## Daily Visiting Frequency

Presence (man × hour) at places, where vectors may transmit agents of disease. This factor measures the population at risk for an infection.

## DALY

Disability aadjusted life years (due to parasites) represents a measure of disease burden. In the case of → malaria the number is around 40 million.

## Dapaong Tumour

Swelling as a result of adhesions around developing juvenile young stages of *Oesophagostoma* species in

the colon of humans. These swellings may be seen on the skin surface and can be painful or painless depending on the obstructions of the colon.

## Dasymetra conferta

Plagiorchiid trematode in mouth and gastrointestinal tract of snakes.

## Davaine, C. I. (1812–1882)

French physician and parasitologist, describer of tapeworms of the family Davaineidae.

## Davainea proglottina

Fig. 1 (page 322); → Eucestoda.

## DCL

Diffuse Cutaneous → Leishmaniasis.

## DDT (Dichloridiphenyltrichlorethane)

### Chemical Class

Organohalogenide (organochlorine compound).

### Mode of Action

Open state voltage-gated sodium channel blocker.  
→ Ectoparasiticides – Blockers/Modulators of Voltage-Gated Sodium Channels.

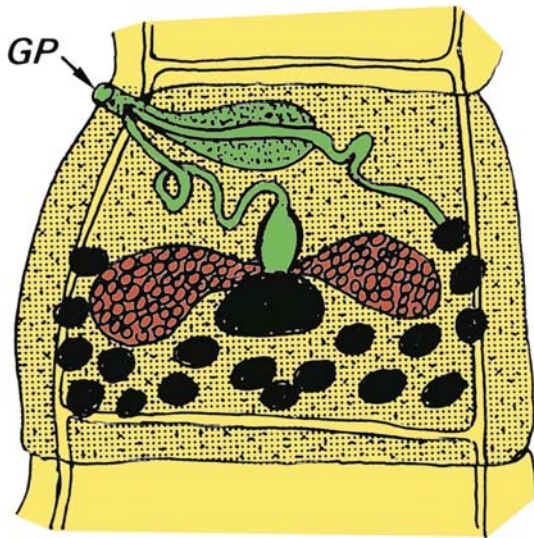

**Davainea proglottina.** Figure 1 Diagrammatic representation of a rather young proglottis of a *Davainea* tapeworm showing the ovoid testes (black) and the female systems, the discharging channels of which open both at the genital pore (GP).

## Deamination

→ [Amino Acids](#).

## Death

Some parasites have severe lethal effects on some of their hosts especially in combination with an existing immune deficiency (→ [Opportunistic Agents, Man](#)). Parasites with a high mortality rate in a given population (e.g., children) are among others → [Plasmodium falciparum](#), → [hookworms](#), schistosomes, etc.

## Debilitation

### Name

Latin: *debilitas* = weakening.

Decrease of immune reaction due to parasitic infections, e.g., during toxoplasmosis or helminthosis.

## Decacanth

In contrast to the larvae of the → [Eucestoda](#) which have only 6 hooks (→ [Hexacanth](#)) the → [Cestodaria](#) form 10 larval hooks (5 pairs) and are thus described as decacanth.

## Decontamination

Deletion of soiling.

## DEET

Diethyltoluamide, a repellent against mosquitoes.

## Defensines

Arthropods produce AMPs (antimicrobial peptides), which protect them against penetrating parasites. Some defensines got varying names since their composition is different, e.g., attacin, cecropin, dipterin, stomoxin, drosomycin, etc.

## Dehydration

Excessive loss of water from the body tissues caused by various factors (e.g., diarrhoea, repeated vomiting, excessive perspiration or urination).

Clinical symptom in animals due to parasitic infections, an excessive loss of water from the body tissues (→ [Alimentary System Diseases](#), → [Clinical Pathology, Animals](#)).

## Delamination

→ [Peritrophic Membranes](#).

## Deltamethrin

### Chemical Class

Pyrethroid (type II,  $\alpha$ -CN-pyrethroids).

### Mode of Action

Open state voltage-gated sodium channel blocker. → [Ectoparasiticides – Blockers/Modulators of Voltage-Gated Sodium Channels](#), → [Arthropodicidal Drugs](#).

## Demethylmenaquinone

→Quinones.

## Demodex folliculorum

### Name

Greek: *demas* = body, *dex* = stretched.

### Synonym

Follicle mites, sebaceum gland mites.

### Classification

Subclass – Acari, Order – Acariformes, Suborder – Prostigmata.

### Life Cycle

*D. folliculorum* mites are 0.4 mm long (Fig. 1) and live in the follicles of the hair. *D. brevis* lives in the sebaceous glands with a similar size. Adults have a lifespan of about 5 days, while the development of the whole generation needs about 15 days (→Mites).



**Demodex folliculorum.** Figure 1 *Demodex folliculorum*; SEM of an adult mite, from ventral; note the 8 short legs.

## Demodicidae

Family of →Acarina.

## Demodicosis, Animals

→Mange, Animals/Demodicosis, →Skin Diseases, Animals.

## Demodicosis, Man

Demodicosis occurs in the hair follicles and sebaceous glands usually of the face (→*Demodex folliculorum*/Fig. 1). The elongate, about 0.4 mm long →mites feed on the contents of the sebaceous glands and also penetrate the follicular epithelium with their mouthparts. A mild dermatitis may be produced with inflammation and fibrosis. Immunosuppression may accentuate the severity of infection as observed in certain breeds of dogs infected with another species of →*Demodex* (→Demodicosis, Animals).

**Main clinical symptoms:** Dermatitis, →alopecia, pyoderma.

**Incubation period:** 2 weeks.

**Prepatent period:** 2 weeks.

**Patent period:** Years.

**Diagnosis:** Microscopic inspection of hair bulbi and sebum from skin.

**Prophylaxis:** General →hygiene; avoid body contact with heavily infected people.

**Therapy:** Treatment see →Acarizides, →Arthropodicidal Drugs, →Ectoparasitocidal Drugs; use of ivermectin, neem.

## Dengue

Four types of virus exist to induce diseases (type of hemorrhagic fever) being transmitted by bite of →mosquitoes (→Arboviruses).

## Dense Bodies

The dense bodies occur in the motile stages such as sporozoites, merozoites (inclusive zoites, brady- and →tachyzoites and are found in front of the nucleus among the →micronemes and the bulbous ends of the club-shaped

→**rhoptries** (→**Merozoite**/Fig. 1). They appear spherical, are membrane-bound and have an electron dense interior. Their diameters are rather similar in most species, reaching about 0.2 μm at the maximum. Just after penetration of the parasitic stages into a host cell, the contents of the dense bodies, which consist of at least 6 different proteins (enzymes?, GRA 1-6), are excreted into the surrounding →**parasitophorous vacuole** and are found also on the outer surface of the parasite. It is thought that the contents of the dense bodies protect the parasite, which starts development, from the attack of the host cell's digestive enzymes.

## Dense Granule Protein (RESA)

→**Apicomplexa**.

## Deoxynucleotides

Deoxyribonucleotides, the building blocks of DNA, are derived in most parasitic protozoa and in helminths, as in mammalian cells, primarily from the corresponding ribonucleotides as catalyzed by ribonucleotide reductase. Some protozoa, including *Entamoeba*, *Giardia* and →*Trichomonas vaginalis*, lack ribonucleotide reductase and have to meet their deoxynucleotide requirements by salvage pathways. The synthesis of deoxythymidine nucleotides, which are required for →**DNA synthesis**, is initiated by the conversion of dUMP to dTMP (Fig. 1). In this process,

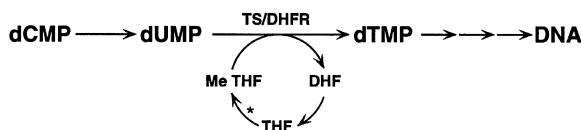

**Deoxynucleotides. Figure 1** The biosynthesis of deoxythymidylate (dTMP) in parasitic protozoa. TS/DHFR, thymidylate synthase/dihydrofolate reductase complex. MeTHF (N<sup>5</sup>, N<sup>10</sup>-methylene tetrahydrofolate) is produced from THF by the action of serine transhydroxymethylase (\*). DHF, dihydrofolate; THF, tetrahydrofolate. Protozoan TS and DHFR exists as a single bifunctional enzyme. Amitochondriate protozoa lack TS and are therefore unable to produce dTMP from dUMP.

the necessary methylation of the pyrimidine ring is catalyzed by the tetrahydrofolate-dependent enzyme thymidylate synthase (TS). In protozoa, TS is unusual in that it differs in its kinetic and structural properties from the corresponding mammalian enzyme and exists as a bifunctional protein associated with dihydrofolate reductase (DHFR) (Fig. 1). In →**helminth** and mammalian cells, both the synthase and reductase activities are attributed to separate enzymes. The greater susceptibility of the parasite DHFR domain of the bifunctional enzyme toward inhibition by antifolate drugs than the mammalian enzyme and the absolute dependence on the *de novo* synthesis for dTMP forms the basis for the selective toxicity of these compounds against apicomplexan parasites. The conversion of nucleoside mono- and diphosphates to the corresponding triphosphates is carried out in parasites primarily by nucleotide kinases as is common to most living organisms. Because of the lack of TS in *Entamoeba*, *Giardia*, and trichomonads, these organisms are unable to synthesize dTMP from dUMP and rely entirely on the host for this deoxynucleotide.

## Dermacentor

Genus of 3-host ixodid ticks, e.g., *D. reticulatus* parasitic in dogs (→**Dermacentor reticulatus**/Fig. 1).

## Dermacentor marginatus

Sheep →**tick** in Germany, that also sucks on cattle, man, and dogs, where it may transmit →*Babesia canis*.

## Dermacentor reticulatus

### Name

Greek: *derma* = skin, *centeo* = biting; Latin: *reticulum* = small net (English = ornate cow tick).

### Synonym

Formerly it was thought that *D. marginatus* (Sheep tick) is identical with *D. reticulatus*.

### Life Cycle

This 3-host tick (Fig. 1) is characteristic for southern Europe, but now enlarges its biotopes considerably northward; e.g., it is found in almost all German regions (perhaps a reaction to global warming). Larvae and nymphs feed on rodents, mice, rabbits, and birds, while adult stages attack larger animals (e.g., cattle, deer, horse, dogs) and humans. This species involves, obligatorily, 3 hosts in its life cycle, while other *Dermacentor* spp. (e.g., *D. albopictus*, *D. venustus* = *Anocentor* = *D. nitens*) may be 1-host ticks which molt on their hosts. The development of *D. reticulatus* in the egg takes 14–21 days, sucking as larva needs 2–6 days and molting takes 14 days on the ground to develop into the nymph. The nymphs feed for about 5 days on a new host and after dropping down to the ground they develop by molting within 12–14 days to adults, which can starve for up to 545 days before catching a new host. Thus there may be several genera within one season, if the larva, nymph, and adult are successful in catching a host. Since females lay up to 4,500 eggs and often 2 generations may occur per year, their spreading is rather quick. The unfed females are 4.5–5.5 mm long, the fed ones up to 1.5 cm.

**Transmission:** Besides of considerable blood loss, this species can harm its hosts by transmission of severe agents of disease (e.g., theileriosis of horses, babesiosis of dogs, spotted fever, borreliosis, arboviro-sis, tularaemia).

## Dermanyssidae

→Acarina.



**Dermacentor reticulatus.** Figure 1 LM of an adult female of *Dermacentor reticulatus* luring on grass.

## Dermanyssus gallinae

### Name

Greek: *derma* = skin, *nyssein* = bite.

Blood sucking mite, found on birds, humans etc. (Figs. 1, 2). →Mites.



**Dermanyssus gallinae.** Figure 1 LM of *Dermanyssus gallinae*. Surface view of an adult stage.



**Dermanyssus gallinae.** Figure 2 LM of *Dermanyssus gallinae*. Nymph with host blood in its intestinal tract.



## Dermatitis

Clinical skin symptom due to infections with skin-penetrating parasites (e.g., →*cercariae*, hookworm larvae) or blood-sucking arthropods (e.g., →*ticks*, →*fleas*, →*bugs*, →*lice*, →*Culicoides* sp.); →*Skin Diseases, Animals*.

## Dermatobia hominis

### Synonym

→*Human botfly*.

### Classification

Species of →*Diptera*.

### Life Cycle

Figs. 1, 2.

### Disease

→*Myiasis, Man*.

## Dermatomyiasis

From Latin: *derm* = skin, *myia* = fly →*Myiasis*.

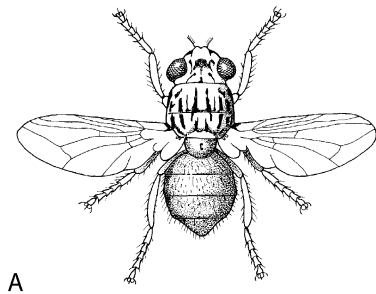

A

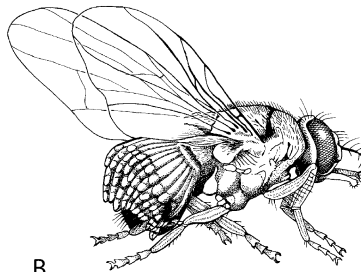

B

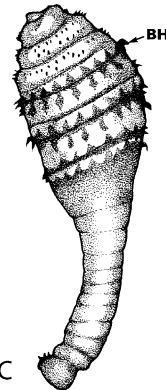

C

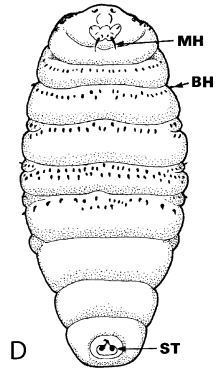

D

**Dermatobia hominis.** **Figure 1** Life-cycle stages of *Dermatobia hominis* (human botfly), which parasitizes man, cattle, dogs, and a number of wild and domestic mammals and birds (in Middle and South America). The females (A) deposit their eggs on day-flying →*Mosquitoes* (e.g., *Psorophora*), on other flies (→*Sarcophaga*, →*Musca*, →*Stomoxys*, B) or even on →*Amblyomma* →*ticks*. Eggs are laid directly on these arthropods or in their vicinity, so that they may become attached by help of their superficial cement. This peculiar way of transportation is known as →*phoresis*. The warmth of the vertebrate host induces the larva to hatch from the egg within 5 minutes and to penetrate the host's skin. At the site of the penetration the host tissue develops a →*nodule*, keeping open a breathing pore. Larvae (especially larvae 2 and 3 – C, D) have a characteristic shape with an attenuation of the posterior end. The larva feeds for 6–12 weeks in man's skin, then it drops to the ground, pupates, and develops inside the new adult stage. BH, body hooks; MH, mouth →*hooks*; ST, terminal stigmal plate.

## Dermatophagoides pteronyssinus

House dust mite (Figs. 1, 2), see →*Mites*.

## Dermatotropism

### Name

Latin: *derm* = skin, Greek *trope* = turning.

Activity of parasites that wander to the skin (from in-or outside of the body).

## Derrengadera

Disease of horses due to *T. brucei evansi*: transmitted by →*vampire bats* in Venezuela.

## Desmodus rotundus

→*Vampire Bats*.



**Dermatobia hominis.** Figure 2 Second stage larva of *Dermatobia hominis* (inset) and the cavity in the skin, where it had been located.



**Dermatophagoides pteronyssinus.** Figure 1 LM of adults of the house dust mite in food.



**Dermatophagoides pteronyssinus.** Figure 2 SEM of a house dust mite (dorsal side).

---

## Desmosomes

Structures attaching cells to cells or flagella to Protozoans. →[Flagella](#).

---

## Deutomerite

→[Gregarines](#).

---

## Deutonymph

The second of up to 3 →[nymphal stages](#) found in mites. In most cases the deutonymph molts to the adult stage. →[Mites/Ontogeny](#).

---

## Diaemus youngi

→[Vampire Bats](#).

---

## Diamanus montanus

New World flea of the family Ceratophyllidae (→[Ceratophyllus](#), →[Nosopsyllus](#)).

---

## Diapause

### Name

Greek: *diapausis* = interruption, rest.

This phase of inactivity during a development of arthropods may occur when the living conditions become bad, e.g., in winter. The individuum is then able to reduce considerably the processes of metabolism.

---

## Diaptomus

First intermediate hosts (crustaceans) of →[Diphyllobothrium](#) tapeworm.

## Diarrhoea

An intestinal disorder characterised by abnormal fluidity and frequency of fecal evacuations as a result of increased motility in the colon.

Clinical symptom in animals and humans due to parasitic infections (→[Alimentary System Diseases](#), →[Clinical Pathology, Animals](#)).

## Diarthrophallus quercus

Prostigmata mite species found on beetles.

## Diazinon (Dimpylate)

### Chemical Class

Organophosphorous compounds (monothiophosphate).

### Mode of Action

Acetylcholine esterase inhibitor. →[Ectoparasitocides – Agonists and Antagonists of Cholinergic Transmission](#), →[Arthropodicidal Drugs](#).

## Dichelyne minutus

Nematode species in the intestine of the round goby (*Neogobius melanostomus*) in the Baltic and Black Sea.

## Dichlorvos (DDVP)

### Chemical Class

Organophosphorous compounds (organophosphate).

### Mode of Action

Acetylcholine esterase inhibitor. →[Ectoparasitocides – Agonists and Antagonists of Cholinergic Transmission](#), →[Arthropodicidal Drugs](#).

## Diclazuril

→[Coccidiocidal Drugs](#).

## Dicranotaenia

Genus of tapeworms of the family →[Hymenolepidae](#). *D. coronula* lives in the small intestine of ducks.

## Dicrocoeliasis, Man

Disease due to infections with the digenetic trematode →[Dicrocoelium dendriticum](#) by oral uptake of infected ants being attached, e.g., to salad.

**Main clinical symptoms:** →[Abdominal pain](#), liver enlargement.

**Incubation period:** 2–4 weeks.

**Prepatent period:** 7–8 weeks.

**Patent period:** Years.

**Diagnosis:** Microscopic determination of eggs in fecal samples (Fig. 1).

**Prophylaxis:** Clean thoroughly salad, plants, etc., from attached ants.

**Therapy:** Treatment see →[Trematodocidal Drugs](#).

## Dicrocoelium dendriticum

### Name

Greek: *dikroos* = bi-branched, *koilia* = body hollow.

### Classification

Species of digenetic →[trematodes](#).



**Dicrocoeliasis, Man. Figure 1** Egg of *Dicrocoelium dendriticum*.

**Morphology**

Fig. 2 (page 331). Size →[Digenea](#).

**Life Cycle**

Fig. 1 (page 330).

**Disease**

→[Dicrocoeliasis, Man](#), →[Alimentary System Diseases](#).

**Dicrotophos****Chemical Class**

Organophosphorous compounds (organophosphate).

**Mode of Action**

Acetylcholine esterase inhibitor. →[Ectoparasiticides – Agonists and Antagonists of Cholinergic Transmission](#).

**Dictyocaulus****Name**

Greek: *diktyon* = net, *kaulos* = stab, stick.

**General Information**

The adult worms of *D. viviparus*, which reach as females a length of 70 mm and 40 mm as males and live in the trachea and bronchial cavities of cattle. Similar species (*D. eckerti*/deers), *D. filaria*/sheep/goat, *D. arnfieldi*/horses/donkeys) are found in other hosts in identical habitats. The females lay thin-shelled eggs which contain already the L<sub>1</sub>. This stage is set free inside the host, so that the larvae are found in the faeces. Within 1 week the sheathed infectious L<sub>3</sub> develops in the faeces (if there is a temperature higher than 16° C). After oral uptake the L<sub>3</sub> enters the mesenterial lymph nodes, where the L<sub>4</sub> is formed. By lymph and blood transport the L<sub>4</sub> reaches the lung beginning at the end of the 7th p.i. Within 21–25 days maturity is reached and after this prepatent period eggs/larvae can be found. The larval excretion extends over a period of only 5–6 weeks.

**Diseases**

→[Respiratory System Diseases, Ruminants](#).

**Therapy**

→[Nematocidal Drugs](#).

**Dictyocaulus arnfieldi**

Species of →[nematodes](#). →[Respiratory System Diseases, Horses, Swine, Carnivores](#).

**Dictyocaulus viviparus**

→[Nematodes](#), →[Respiratory System Diseases, Ruminants](#).

**Dictyosomes**

→[Golgi Apparatus](#).

**Dicyclanil****Chemical Class**

Aminopyrimidine.

**Mode of Action**

Insect growth regulator (IGR, cuticle sclerotization effectors). →[Ectoparasiticides – Inhibitors of Arthropod Development](#).

**Dicyema**

Genus of mesozoan parasites in, e.g., cephalopod hosts.

**Dientamoeba fragilis**

The →[trophozoites](#) of this species (→[Amoebic Infections](#)) reach a size of 3–12 μm, possess mostly 2 nuclei, include many food →[vacuoles](#), and live in the colon of humans and monkeys (often in Zoological Gardens), Fig. 1 (page 331). They may cause as facultative parasites →[abdominal pain](#) and →[diarrhoea](#). The transmission occurs by oral uptake of cysts from faeces

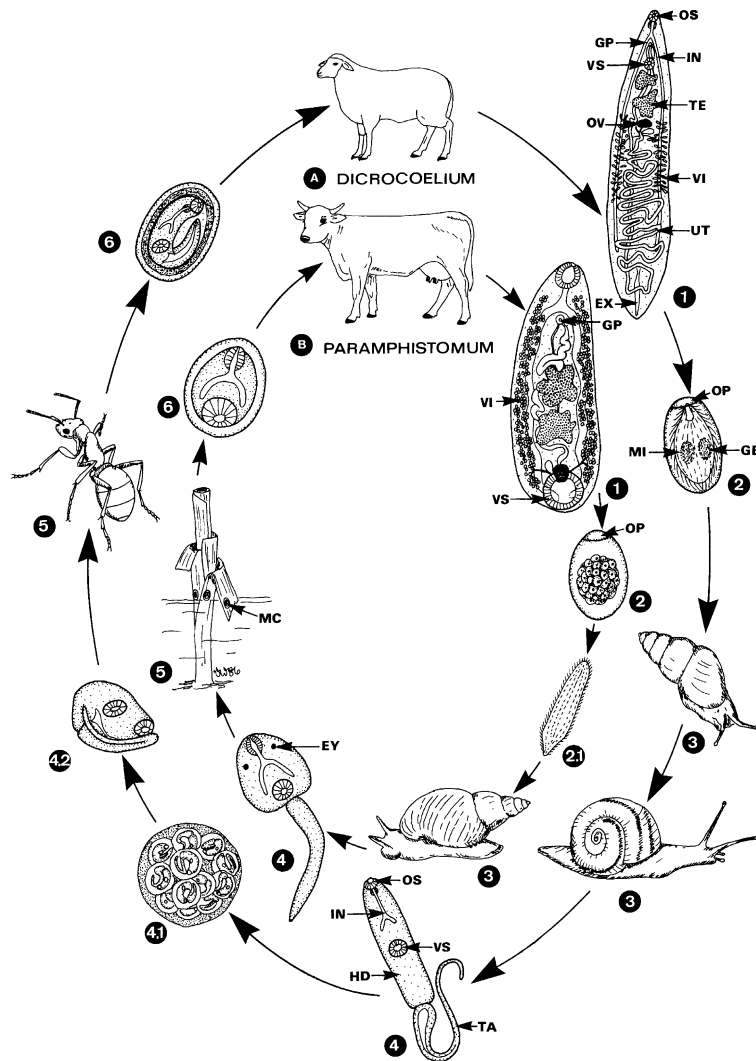

**Dicrocoelium dendriticum.** Figure 1 Life cycles of the →flukes *Dicrocoelium dendriticum* (A) and (→*Paramphistomum cervi*) (B) in sheep and cattle (final hosts: →Digenea/Table 1). 1 Adult worms in the bile ducts (a) or rumen (B). 2 Eggs are excreted in feces fully embryonated (A) or not (B). 2.1 In *P. cervi* the finally formed →miracidium hatches from the egg and enters a water snail, whereas in *D. dendriticum* land-living snails swallow the eggs containing the miracidium. 3–4 Intermediate hosts for *P. cervi* are water snails of the genera *Bulinus*, *Planorbis*, *Stagnicola*, and *Anisus*, whereas in *D. dendriticum* land snails of the genera *Zebrina* or *Helicella* are involved. Development in snails proceeds via 2 generations of sporocysts in *D. dendriticum*, whereas in *P. cervi* a →sporocyst and 2 →rediae occur. Finally, tailed →cercariae are produced, which leave the snail (3) or are excreted by the snails within slime-balls (4.1), but remain immotile (4.2). 5–6 In *D. dendriticum* ants become second intermediate hosts when eating slime-balls. Most of the cercariae encyst in the hemocoel (6) as →metacercariae and can then infect the final host. Where 1 or 2 cercariae enter the subesophageal ganglion, encyst there, and cause an alteration of the ant's behavior. When the temperature drops in the evening hours, the infected ants climb to the tips of grass (and other plants) and grasp them firmly with their mandibles, while uninfected ants return to their nests. The infected ants remain attached until the next morning, when they warm up, and resume normal behavior. These attached ants may be swallowed by plant-eating mammals. In *P. cervi* the free-swimming cercariae (with 2 eye spots) encyst on herbage and other objects (6), thus becoming metacercariae. Upon being swallowed along with forage, excystment of the metacercariae of both species occurs in the duodenum. From there they enter the bile duct (*D. dendriticum*) or return (via the intestinal wall) into the abomasum (*P. cervi*), and from there go to the rumen, where they attach among the villi. EY, →eye spot; EX, excretory bladder; GB, →germ balls; GP, genital pore; HD, head; IN, intestine; MC, metacercaria; MI, miracidium; OP, →operculum; OS, oral sucker; OV, ovary; TA, tail; TE, →testis; UT, uterus; VI, →vitellarium; VS, ventral sucker.



**Dicrocoelium dendriticum. Figure 2** Coloured preparation of the small liver fluke (*Dicrocoelium dendriticum*).



**Dictyocaulus viviparus. Figure 1** *Dictyocaulus viviparus* – worms in cattle lung system.

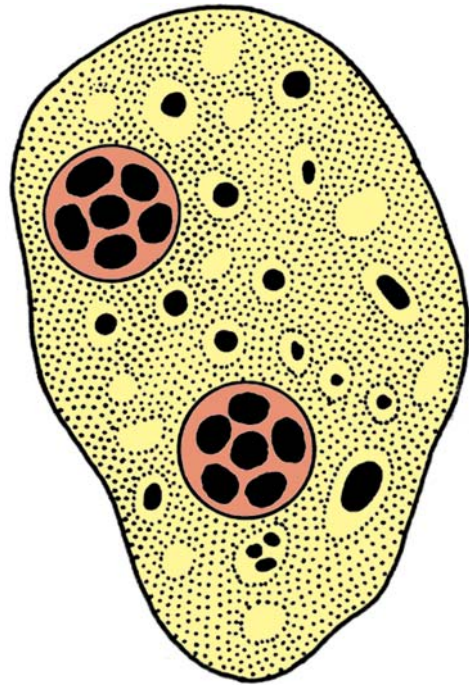

**Dientamoeba fragilis. Figure 1** Trophozoite in division (two-nucleated).

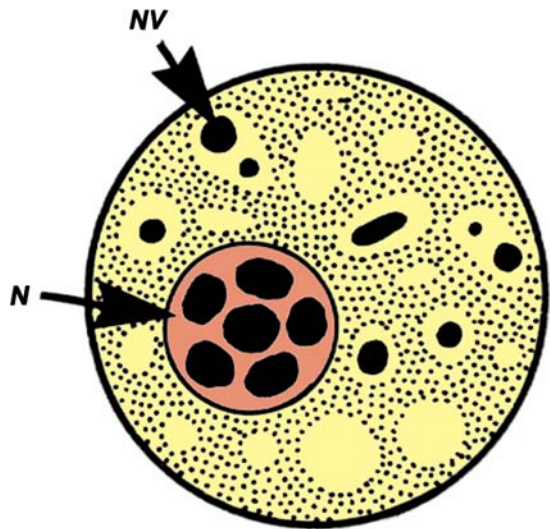

**Dientamoeba fragilis. Figure 2** Cyst. NV, food vacuole; N, nucleus.

(Fig. 2). It is discussed that trophozoites may become included in the eggs of the nematode (doubtful!).  
 → *Enterobius vermicularis*. → Diplomonadida, → Trichomonadida.

**Therapy**

→Antidiarrhoeal and Antitrichomoniasis Drugs.

**Diethyl Maleate****Chemical Class**

Synergist.

**Mode of Action**

Glutathion-S-transferase inhibitor.

**Diethylcarbamazine**

Drug to control the larvae, i.e., the microfilariae of →filariae. →Nematocidal Drugs.

**Diethyltoluamid (DEET)****Chemical Class**

Repellent.

One of the most often used insect repellents since 1945.

**Diflubenzuron****Chemical Class**

Benzoylphenyl urea.

**Mode of Action**

Insect growth regulator (IGR, chitin synthesis inhibitor).  
→Ectoparasiticides – Inhibitors of Arthropod Development.

**Digenea****Synonym**

→Flukes.

**Classification**

Class of →Platyhelminthes.

**General Information**

The 6,000 species of digenetic →trematodes are very common and widespread parasites of all classes of vertebrates and may inhabit (as adult or juvenile worms) nearly every organ of their hosts (Table 1). Externally they are characterized by a sucker around the mouth and an additional ventral sucker or →acetabulum that is involved both in the attachment to host surfaces and in locomotion. The shape and location of these suckers is species-specific. Digenean development occurs in at least 2 different hosts and involves several generations. The basic life cycle pattern employed by digeneans and examples of their larval stages are displayed diagrammatically in Figs. 1–5.

**System**

The proposed classification of the class Digenea according to the origin of the protonephridial excretory system (→Cyrtocyte, →Platyhelminthes/Fig. 24) is, in outline (excluding several families), as follows:

- Class: Digenea.
  - Superorder: →Anepitheliocystidia (in the adult worms the wall of the larval excretory bladder is retained).
  - Order: Strigeatida (→cercariae fork-tailed; miracidia with two pairs of protonephridia).
    - Families: Diplostomatidae, Schistosomatidae, Spirorchidae, Bucephalidae, Strigeidae, Cyclocoelidae.
  - Order: Echinostomatida (cercariae with simple tail, miracidia with a single pair of protonephridia).
    - Families: Echinostomatidae, Fasciolidae, Gastrodiscidae, Paramphistomatidae.
  - Superorder: →Epitheliocystidia (excretory bladder is newly formed by mesodermal cells; tail of cercariae unforked).
  - Order: Plagiorchiida (eggs operculated: →oral stylet usually present in oral sucker of cercariae; tail of cercariae often lacks excretory vessels).
    - Families: Dicrocoeliidae, Plagiorchiidae, Prosthogonimidae, Troglotrematidae.
  - Order: Opisthorchiida (eggs operculated; cercariae lack anoral stylet; tail of cercariae always contains excretory vessels).
    - Families: Opisthorchiidae, Heterophyidae.

**Important Species**

Table 1.

**Life Cycle**

Except for some groups (e.g., the →dioecious Schistosomatidae; Table 1), flukes are hermaphroditic, utilizing sexual reproduction (with cross-insemination) in

**Digenea. Table 1** Important families and species of digenean trematodes

Family/Species	Final host/Habitat	Size of adults (mm)	Size of eggs ( $\mu\text{m}$ )	First intermediate host <sup>a</sup>	Second intermediate host <sup>b</sup>	Prepatent period (weeks)
<b>Allocreadiidae</b>						
<i>Crepidostomum cooperi</i>	Fish/Pyloric ceca	1.5	45 × 60	Fingernail clams	Naiads of dragon-flies	3–4
<b>Clinostomatidae</b>						
<i>Clinostomum complanatum</i>	Herons/Mouth	3–8	70 × 120	<i>Helisoma</i> spp.	Fish	3 days
<b>Dicrocoeliidae</b>						
<i>Dicrocoelium dendriticum</i>	Ruminants, horses, pigs, rabbits, humans/Bile ducts	6–10	25 × 40	<i>Helicella</i> spp., <i>Zebrina</i> spp.	Ants	6–10
<b>Diplodiscidae</b>						
<i>Megalodiscus temperatus</i>	Frogs/Rectum	6		<i>Helisoma</i> spp.	–	4
<b>Diplostomatidae</b>						
<i>Alaria canis</i>	Dog, foxes/Small intestine	3–4	70 × 130	<i>Helisoma</i> spp.	Tadpoles <sup>c</sup>	5
<b>Echinostomatidae</b>						
<i>Echinoparyphium recurvatum</i>	Water birds/Small intestine	5	80 × 100	<i>Helisoma</i> spp.	Snails, tadpoles	2
<i>Echinostoma ilocanum</i> , <i>E. echinatum</i>	<b>Humans</b> , dogs/Small intestine	2.5–6.5	65 × 95	<i>Gyraulus</i> spp.	Snails, clams	3
<i>E. revolutum</i>	Birds/Rectum, cecum	10–22	65 × 110	<i>Helisoma</i> spp., <i>Physa</i> spp.	Tadpoles, snails	3
<i>Himasthla</i> sp.	<b>Humans</b> , gulls/Small intestine	11–17	70 × 130	<i>Nassa</i> spp.	Clams	2
<b>Fasciolidae</b>						
<i>Fasciola hepatica</i>	Sheep, cattle, horses, <b>humans</b> /Bile ducts	20–30	70 × 140	<i>Lymnaea</i> spp.	Water plants	8–13
<i>Fasciolopsis buski</i>	<b>Humans</b> , pigs/Small intestine	30–75	80 × 135	<i>Gyraulus</i> spp., <i>Planorbis</i> spp.	Water plants + fruits	9–13
<i>F. gigantica</i>	Cattle, horses/Bile ducts	25–75	90 × 140	<i>Lymnaea</i> spp.	Water plants	9–13
<b>Heterophyidae</b>						
<i>Heterophyes heterophyes</i>	<b>Humans</b> , fish-eating mammals/Small intestine	1–2	14 × 24	<i>Pirenella conica</i>	Marine fish	1–2
<i>Metagonimus yokogawai</i>	<b>Humans</b> , fish-eating mammals/Small intestine	1–2	16 × 28	<i>Semisulcospira</i> spp.	Freshwater fish	1–2
<b>Opistorchiidae</b>						
<i>Metorchis conjunctus</i>	Dogs, cats, <b>humans</b> /Gallbladder	1–6.5	15 × 25	<i>Amnicola</i> spp.	Fish ( <i>Catostomus</i> )	4–5
<i>Opisthorchis</i> (= <i>Clonorchis</i> ) <i>sinensis</i>	<b>Humans</b> , fish-eating mammals/Bile ducts	10–25	15 × 30	<i>Bulinus</i> spp. (= <i>Bithynia</i> spp.)	Fish (cyprinids/salmonids)	2–2.5
<i>O. felineus</i> (= <i>O. tenuicollis</i> )	<b>Humans</b> , fish-eating mammals/Bile ducts	7–12	11 × 30	<i>Bulinus</i> spp.	Fish (cyprinids/salmonids)	2–3
<b>Paramphistomatidae</b>						
<i>Gastrodiscoides hominis</i>	<b>Humans</b> /Cecum	5–10	65 × 150	Planorbids, <i>Heliocorbis</i> spp.	Water plants + fruits	9–14
<i>Paramphistomum cervi</i>	Ruminants/Rumen	5–12	85 × 140	<i>Anisus</i> spp., <i>Planorbis</i> spp.	Water plants	12–15
<i>P. microbothrium</i>	Ruminants/Rumen	3–12	70 × 160	<i>Bulinus</i> spp., <i>Stagnicola</i> spp.	Water plants	13–15
<i>Watsonius watsoni</i>	<b>Humans</b> /Small intestine	8–10	75 × 125	<i>Bulinus</i> spp., <i>Stagnicola</i> spp.	Water plants	?



**Digenea. Table 1** Important families and species of digenean trematodes (Continued)

Family/Species	Final host/Habitat	Size of adults (mm)	Size of eggs ( $\mu\text{m}$ )	First intermediate host <sup>a</sup>	Second intermediate host <sup>b</sup>	Prepatent period (weeks)
<b>Plagiorchiidae</b>						
<i>Haematoloechus medioplexus</i>	Frogs/Lungs	8	15 × 25	<i>Planorbula</i> spp.	Naiads of dragon-flies	5
<i>Plagiorchis muris</i>	Gulls, rats, dogs/Small intestine	3	19 × 38	<i>Lymnaea</i> spp.	Chironomid larvae	1
<b>Prosthogonimidae</b>						
<i>Prosthogonimus pellucidus</i>	Chickens, ducks, geese/Cloaca	9	15 × 25	<i>Bithynia</i> spp. (= <i>Bulinus</i> spp.)	Dragonflies, larvae + adults	1–3
<b>Sanguinicolidae</b>						
<i>Sanguinicola inermis</i>	Fish/Blood vessels	1–5	40 × 70	<i>Lymnaea</i> spp.	–	?
<b>Schistosomatidae</b>						
<i>Bilharziella polonica</i>	Ducks/Mesenteric veins	m 4 f 2	100 × 400	<i>Planorbis</i> spp.	–	2–3
<i>Schistosomatium douthitti</i>	Voies, muskrats/Intestinal mesenteric veins	m 2–6 f 1–5	60 × 150	<i>Lymnaeidae</i> , <i>Physa</i> spp., <i>Stagnicola</i> spp.	–	5
<i>Schistosoma mansoni</i>	<b>Humans</b> /Liver, intestinal mesenteric veins	m 6–10 f 7–14	50 × 150	<i>Planorbis</i> spp., <i>Biomphalaria</i> spp.	–	5–7
<i>S. bovis</i>	Ruminants/Intestinal mesenteric veins	m 9–14 f 12–28	60 × 80	<i>Bulinus</i> spp.	–	6
<i>S. haematobium</i>	<b>Humans</b> , monkeys/Veins of urinogenital system	m 10–15 f 20	50 × 150	<i>Bulinus</i> spp.	–	10–12
<i>S. intercalatum</i>	<b>Humans</b> , rodents, cattle/Intestinal mesenteric veins	m 11–15 f 13–24	36 × 140	<i>Physopdis</i> spp., <i>Bulinus</i> spp.	–	5–7
<i>S. japonicum</i>	<b>Humans</b> , dogs, cats, cattle/Intestinal mesenteric veins	m 12–20 f 20	55 × 90	<i>Oncomelania</i> spp.	–	3–10
<i>S. mattheei</i>	Ruminants/Intestinal mesenteric veins	m 9–14 f 17–25	72 × 170	<i>Bulinus</i> spp.	–	7
<i>Trichobilharzia cameroni</i> , <i>T. ocellata</i>	Ducks/Peri-intestinal blood vessels	m 3–6 f 4–5	65 × 180	<i>Physa</i> spp.	–	3–4
<b>Strigeidae</b>						
<i>Apatemon gracilis</i>	Ducks, chickens/Small intestine	0.2–0.9	65 × 100	<i>Helisoma</i> spp.	Leech, <i>Erpobdella</i> spp.	4 days
<i>Cotylurus flabelliformis</i>	Ducks, chickens/Small intestine	0.8	70 × 105	<i>Stagnicola</i> spp., <i>Lymnaea</i> spp.	<i>Stagnicola</i> spp., <i>Lymnaea</i> spp.	1
<b>Troglotrematidae</b>						
<i>Collyriclum faba</i>	Chickens, turkeys/Skin	5	10 × 20	Snails	Naiads of dragon-flies	?
<i>Nanophyetus salmincola</i>	Dogs, foxes/Small Intestine	1–2.5	45 × 80	<i>Oxytrema</i> spp.	Fish	1–15
<i>Paragonimus westermani</i>	<b>Humans</b> , carnivores/Lung	7–12	60 × 90	<i>Hua</i> spp., <i>Thiara</i> spp., <i>Melania</i> spp.	Crabs	8–12
<i>P. kellicotti</i>	<b>Humans</b> , carnivores/Lung	9–16	55 × 85	<i>Pomatiopsis</i> spp.,	Crabs	22–24

m = male f = female

<sup>a</sup> Several other species of gastropods may become first intermediate host<sup>b</sup> There is no reproduction either in the true second intermediate hosts or on water plants<sup>c</sup> Here so-called mesocercariae are found; third intermediate hosts are snakes or rats which contain metacercariae

the final host. The tanned eggs are produced after fertilization inside a complex system consisting of a central →ootype (→Oogenotop), an ovary, →vitelline glands, Mehlis's glands, and uterus (Figs. 6, 7). These eggs leave the host in feces, urine, or sputum, and the →zygote within the eggs develops (or has already developed by this stage) into a ciliated larva (→Miracidium; Fig. 2). In general this stage infects a gastropod mollusk or a lamellibranch (by penetration or via oral uptake = →Clonorchis) as first →intermediate host, inside which a polyembryonic, mitotic reproduction occurs involving different developmental stages (→Sporocysts, →Rediae) and leading finally to the production of numerous motile and infective →cercariae (Fig. 5). The latter leave the first intermediate host, often with a marked rhythm and, in some species, enter a second intermediate host (e.g., Clonorchis) or attach to the surface of plants, or in others directly penetrate the final host (Table 1, Fig. 2).

Inside the second intermediate host or on the surface of plants the cercariae encyst and develop into

→metacercariae; cyst walls are totally or partly produced by cystogenous glands in the cercarial apex.

The metacercariae grow and become mature adults when orally ingested by the final host. Inside the final host they feed on its fluids depending on their final habitat (Table 1). Nutrients are taken up and digested by means of their anus-less, branched intestine (Figs. 3, 4) and via the characteristic syncytial →tegument (→Platyhelminthes/Figs. 11–13).

## Reproduction

While the formation of the digenean eggs and of the first larva (miracidium) is rather well understood (reproductive organs), the ontogeny of other larvae remains a problem which is very complex and far from being solved. Electron microscopic studies have shown that the light microscopically visible →germ balls consist of mitotically dividing cells which give rise to embryos (→Polyembryony?) (Fig. 9; sporocysts, rediae, or cercariae) and to a line of new germ cells that

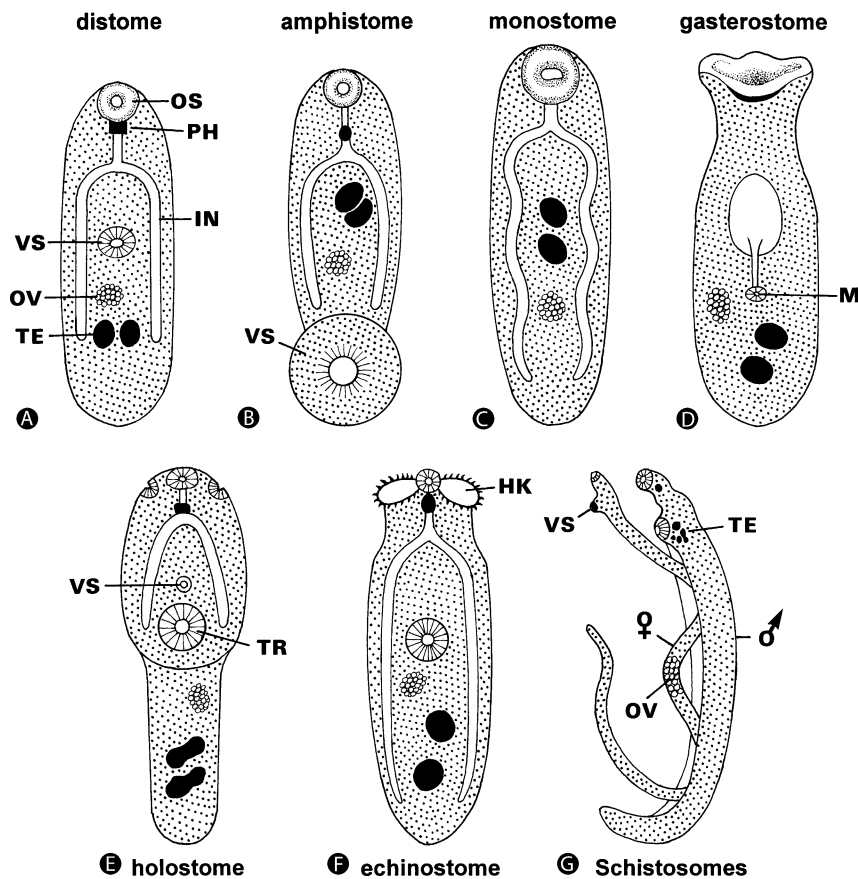

**Digenea. Figure 1** A–G Some common types of adult digenean worms, which are differential according to the appearance of their →holdfast organs (e.g., suckers). The location of sexual organs is only approximate. HK, hooks at collar; IN, intestine; M, mouth; OS, oral sucker; OV, ovary; PH, pharynx; TE, testes; TR, tribocytic organ; VS, ventral sucker.

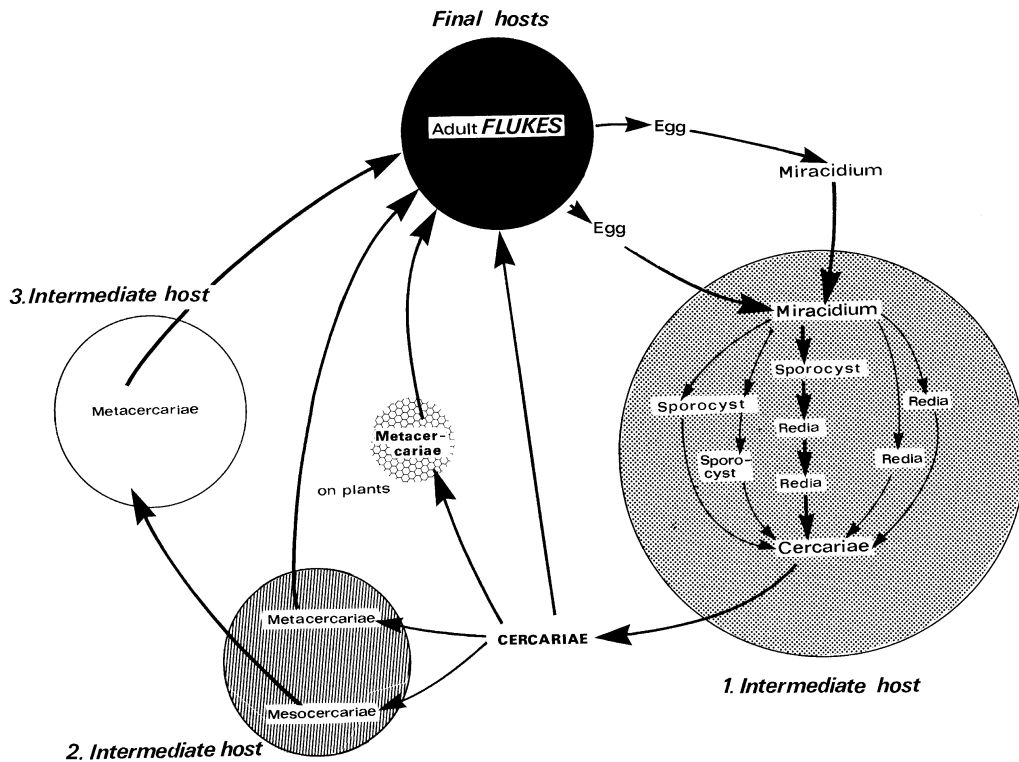

**Digenea. Figure 2** Some common pathways of digenean life cycles. (1) Egg-miracidium-redia-cercaria-metacercaria-adult worm (e.g., *Caecinola* sp.). (2) Egg-miracidium-redia I-redia II-cercaria-metacercaria-adult worm (e.g., *Stichorchis* sp.). (3) Egg-miracidium-sporocyst-redia-cercaria-metacercaria-adult worm (e.g., → *Metorchis* sp.). (4) Egg-miracidium-sporocyst I-redia I-redia II-cercaria-metacercaria-adult worm (e.g., → *Fasciola hepatica*, → *Clonorchis sinensis*). (5) Egg-miracidium-sporocyst-cercaria-metacercaria-adult worm (e.g., Bucephaloidea species). (6) Egg-miracidium-sporocyst I-sporocyst II-cercaria-metacercaria-adult worm (e.g., → *Dicrocoelium dendriticum*, *Prosthogonimus* sp.). (7) Egg-miracidium-sporocyst I-sporocyst II-cercaria-adult worm (e.g., → *Schistosoma* sp.). (8) Egg-miracidium-sporocyst I-sporocyst II-cercaria-mesocercaria-metacercaria-adult worm (e.g., *Alaria* sp.).

become included in these embryonic stages. Since the absence of meiotic processes is not proven, the exact definition remains doubtful. The same is true for embryonic development in the monogenean genus → *Gyrodactylus*. In any case, however, both processes are successful means of increasing the biotic potential and producing numerous daughter organisms.

Some digenean species belonging to the superfamilies Brachylaemoidea (e.g., *Postharinostomum* spp., *Leucochloridium* spp.) and Bucephaloidea (e.g., *Bucephalus* spp.) form branching sporocysts. By constrictions such branches may split off and finally grow to their former size. This occurs by mitotic divisions of undifferentiated cells which are found below the body wall (→ *Platyhelminthes*/Fig. 10).

### Integument

The shape and the development of the peculiar → *body cover* is described under → *Platyhelminthes*/Integument. In addition it is noteworthy that all larval stages seem to have a → *surface coat* containing proteoglycans

(acid mucopolysaccharides). In the miracidium even the → *cilia* are covered by a → *surface coat*. Mother sporocysts of *Fasciola hepatica* and *Schistosoma mansoni* show an amplification of the surface area by a mixture of branching folds and → *microvilli*. Both are covered by a fuzzy surface coat. Vesicles at the base of the microvilli suggest the occurrence of → *endocytosis*. Rediae also have a surface coat. Although there is evidence that they are able to take up nutrients through the mouth into the small digestive system, absorption of nutrients by endocytosis through the tegument has been observed for glucose, a polysaccharide, and amino acids.

### Host Finding Miracidia

Miracidia which actively reach their aquatic snail hosts are infectious for only a few hours, and their behavior seems to center entirely around finding and invading the host snail. Their behavior patterns have functions in at least four phases of host finding:

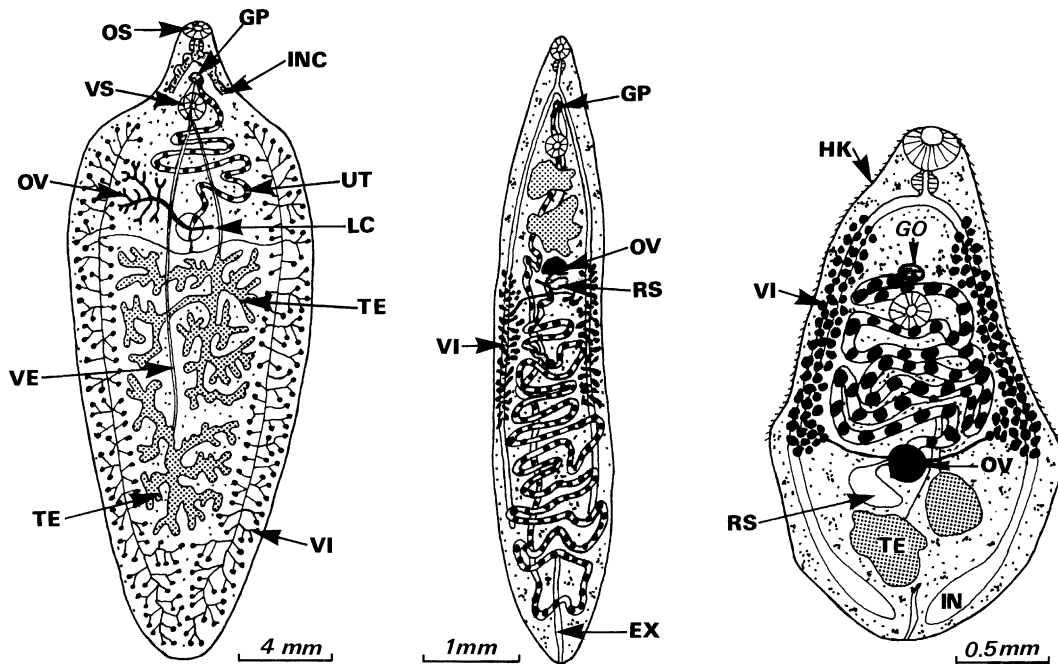

**A** *FASCIOLA HEPATICA*    **B** *DICROCOELIUM DENDRITICUM*    **C** *METORCHIS CONJUNCTUS*

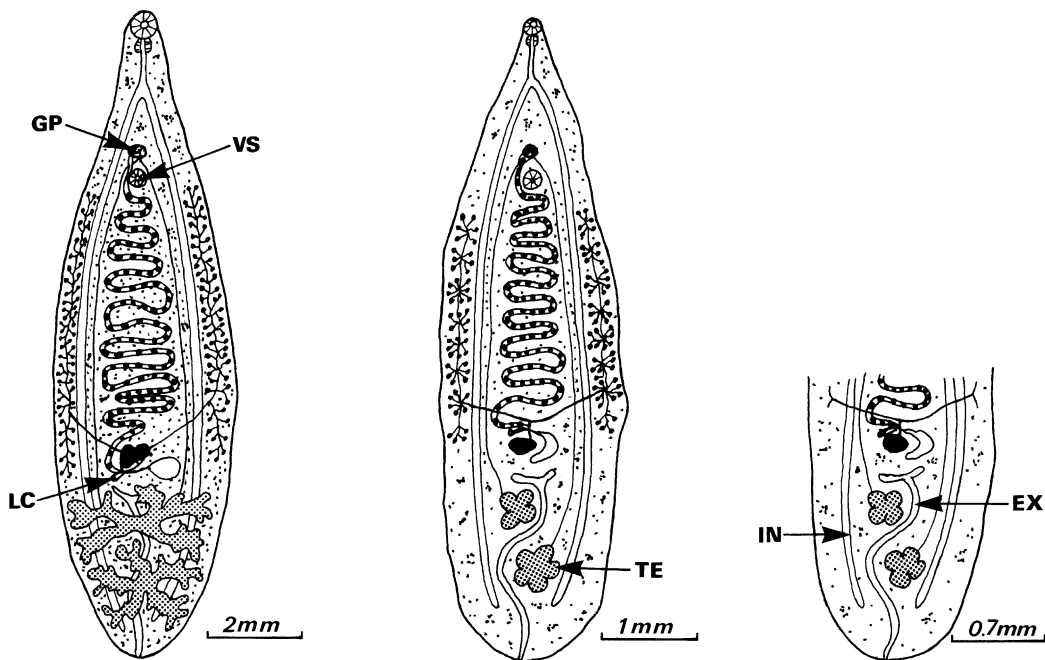

**D** *CLONORCHIS SINENSIS*    **E** *OPISTHORCHIS FELINEUS*    **F** *OPISTHORCHIS VIVERRINI*

**Digenea.** Figure 3 A–F Some common adult →liver flukes. EX, excretory bladder; GP, genital pore; GO, genital bulb; HK, hooks, spines of →tegument; IN, intestine; INC, intestine (cut off on drawing); LC, →Laurer's canal; OS, oral sucker; OV, ovary (→Germarium); RS, receptaculum Seminis; TE, →testis; UT, uterus with eggs; VE, vas efferens of TE; VI, vitellary glands (→Vitellarium); VS, ventral sucker (→Acetabulum).

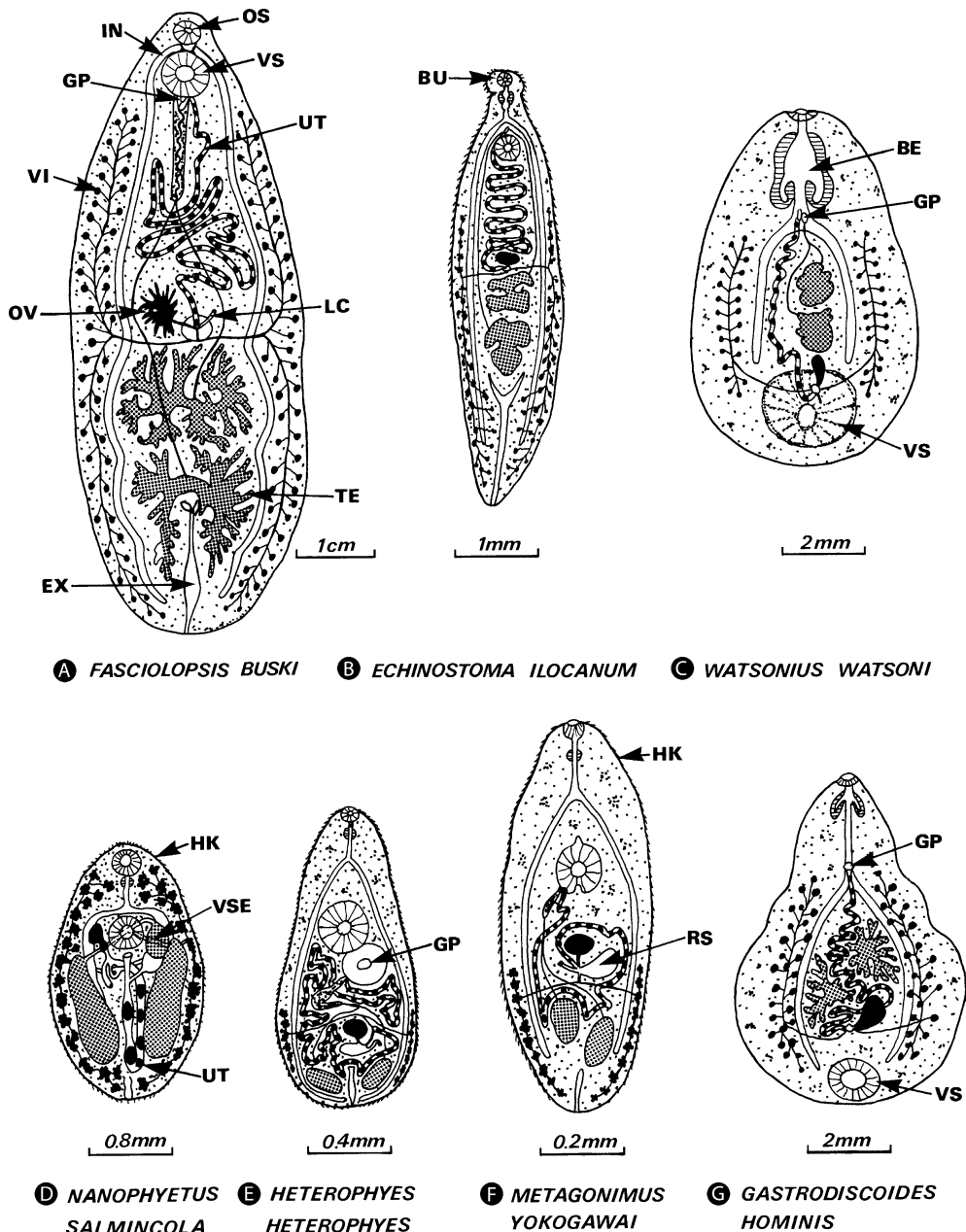

**Digenea.** Figure 4 A–G Some common adult intestinal flukes. *BE*, bulbus of esophagus; *BU*, bulbus (apical); *EX*, excretory bladder; *GP*, genital pore; *HK*, hooks, spines of tegument; *IN*, intestine; *LC*, →Laurer's canal; *OS*, oral sucker; *OV*, ovary (→*Germarium*); *RS*, receptaculum seminis; *UT*, uterus with eggs; *VI*, vitellary glands (→*Vitellarium*); *VS*, ventral sucker (→*Acetabulum*); *VSE*, vesicula seminalis (sperm →*reservoir*).

- Dispersal. After escaping from the egg, some miracidial species tend to disperse from the site of origin. They swim relatively fast and linearly, and even their →orientation to light and gravity seems to be conducive to dispersal. Species which later infect ground-dwelling hosts can exhibit photopositive and geonegative orientation for approximately the first hour after emergence. During this phase some miracidia are not as responsive and infective to their host snails as they are in later phases of the host-finding process.
- Microhabitat selection. Most miracidia tend to accumulate in the microhabitats which are preferred by their host snails. This is achieved by responding to environmental stimuli such as light, gravity, temperature, and the magnetic field. The type of orientation

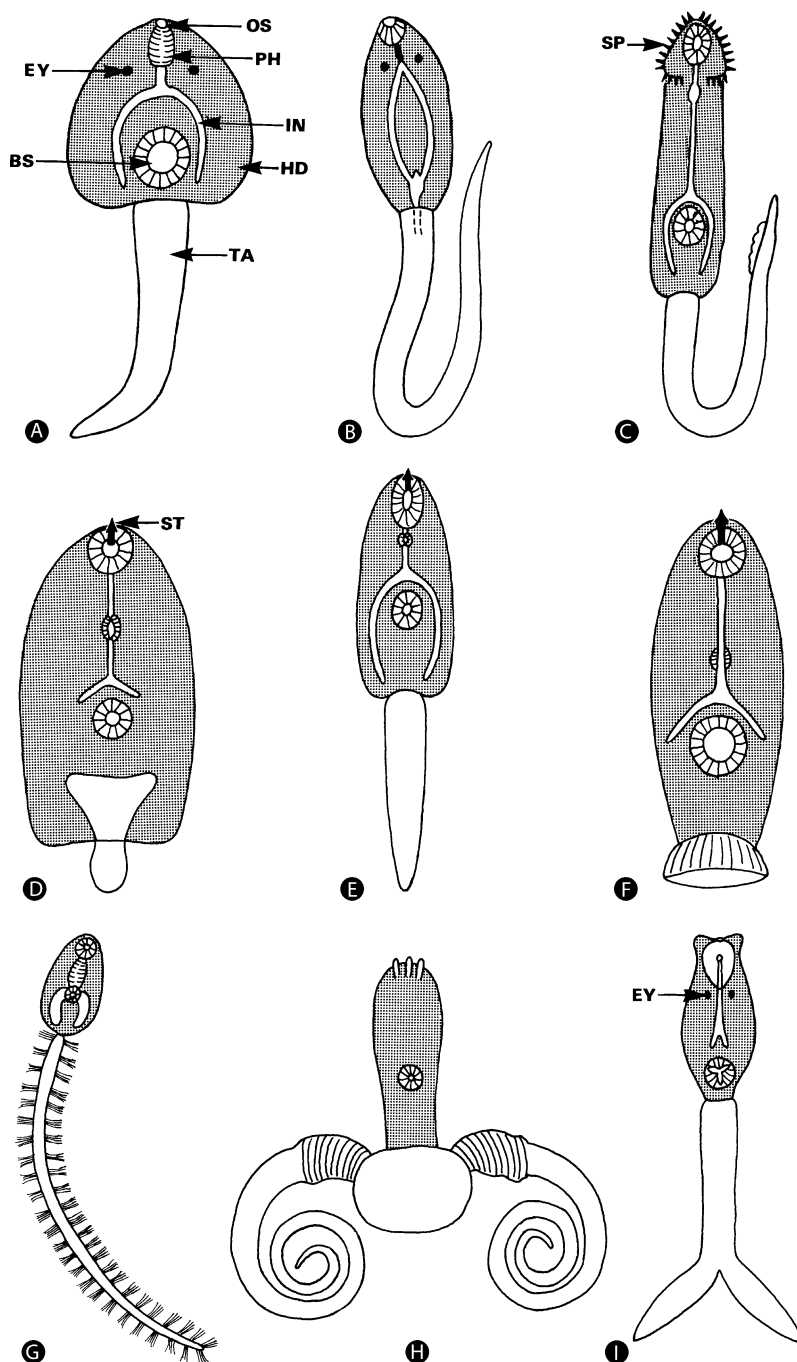

**Digenea. Figure 5 A–I** Some common types of cercariae. *A* Amphistome cercaria (Ophthalmocercaria). *B* Monostome cercaria. *C* Echinostome cercaria. *D–F* →Xiphidiocercariae *D* Microcercous cercaria *E* Xiphidiocercaria *F* Cotylocercous cercaria. *G* Trichocercous cercaria. *H, I* →Furcocercous cercariae *H* Gasterostome cercaria *I* Apharyngate cercaria. *EY*, eyespot; *HD*, head; *IN*, intestine; *OS*, oral sucker; *PH*, pharynx; *SP*, tegumental spines; *ST*, stylet inside the oral sucker; *TA*, tail; *VS*, ventral sucker.

may resemble very closely that of the host snail. For example, *Schistosoma mansoni* miracidia show a geonegative and photopositive orientation as do their host snails. The type of orientation may be modified

by certain →environmental conditions. For example, the negative photo-response of →*S. haematobium* miracidia reverses with decreasing temperature and they were found to infect their host snails in summer

preferentially at the bottom of the water and in winter near the water surface. Miracidia of *S. japonicum* reverse their photopositive orientation to a negative one with increasing temperature and/or light intensity, a behavior which also resembles that of the host snails.

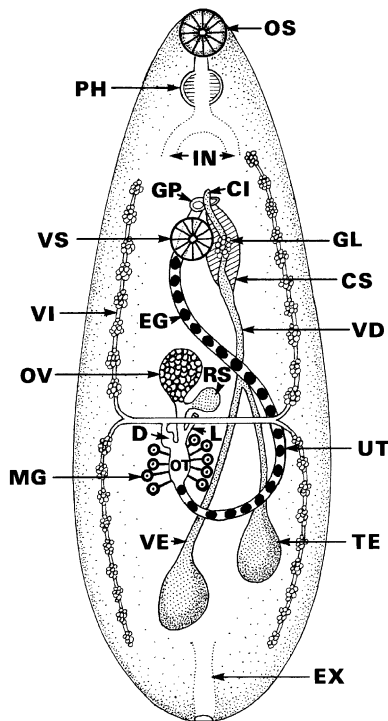

**Digenea.** Figure 6 Diagrammatic representation of the reproductive organs of a digenean trematode. *CI*, *→*cirrus; *CS*, cirrus sac; *D*, fused vitellocyst; *EG*, egg; *EX*, excretory bladder; *GL*, glands; *GP*, genital pore; *IN*, intestinal branches (interrupted); *L*, Laurer's canal; *MG*, *→*Mehlis' glands; *OS*, oral sucker; *OT*, *→*ootype; *OV*, ovary; *PH*, pharynx; *RS*, receptaculum seminis; *TE*, testis; *UT*, uterus; *VD*, vas deferens; *VE*, vas efferens; *VI*, vitellarium; *VS*, ventral sucker.

The photopositive orientation of at least *S. mansoni* miracidia is a phototaxis, as the miracidia are able to detect the relative intensities of two separate sources of light. The wavelengths to which the organisms respond have been determined for miracidia of *Fasciola hepatica*, *→Schistosomatium douthitti*, *S. mansoni*, and *Bunodera mediovitellata*. They all respond maximally to blue-green light between 500 and 550 nm, which penetrates deepest into clear water. *S. mansoni* and *B. mediovitellata* miracidia prefer in addition red-brown light of 650 nm, which is typical for muddy waters.

Several miracidial species are able to perform georientation independently of their photoresponses, but the mechanisms involved in this type of orientation are not well understood. A special mechanism occurs in miracidia of *Philophthalmus gralli*. Their strong geopositive orientation seems to be brought about by a sensitive north-seeking magnetotaxis in the northern hemisphere.

- Host-directed orientation. When miracidia enter the host snail's active space, they approach the host by responding to snail-emitted chemical signals. The type of orientation is a chemokinesis in most species studied so far, e.g., in *Schistosoma mansoni*, *S. haematobium*, *→Trichobilharzia ocellata*, *Fasciola hepatica*, *Echinostoma caproni*. The organisms increase their rate of change of direction (RCD) in increasing stimulus concentration gradients and they perform a sharp 180 degree turn when the concentration of the stimulus decreases (Fig. 10 A, B). For this type of orientation, the miracidia must only detect an increase or a decrease of the stimulus concentration. This is possible although the miracidia rotate along their long axis, which supports a straight path of movement. However, *S. japonicum* miracidia show a directed chemotaxis (Fig. 10C) and the rotating organisms seem to detect the direction of the concentration gradient in an unknown way.

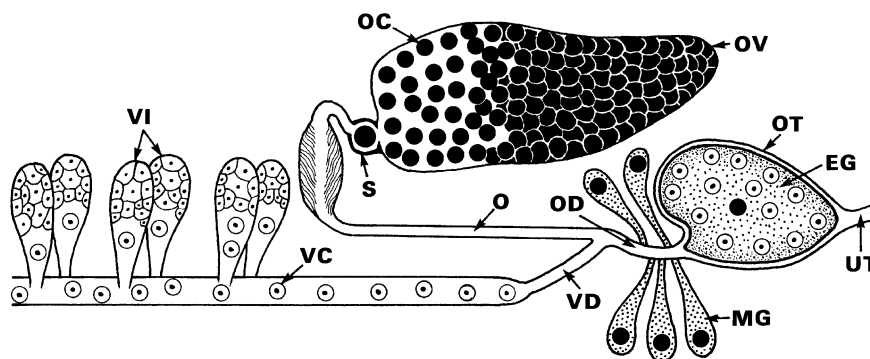

**Digenea.** Figure 7 Diagrammatic representation of the reproductive organs of a female of *→Schistosoma mansoni*. *EG*, egg (containing the zygote and vitellary cells); *MG*, Mehlis's glands; *O*, oviduct; *OC*, oocyte; *OD*, ovovitellary duct; *O*, ootype; *OV*, ovary; *RS*, receptaculum seminis; *S*, sphincter; *UT*, uterus; *VC*, vitellary cell; *VD*, vitellary duct; *VI*, vitellarium.

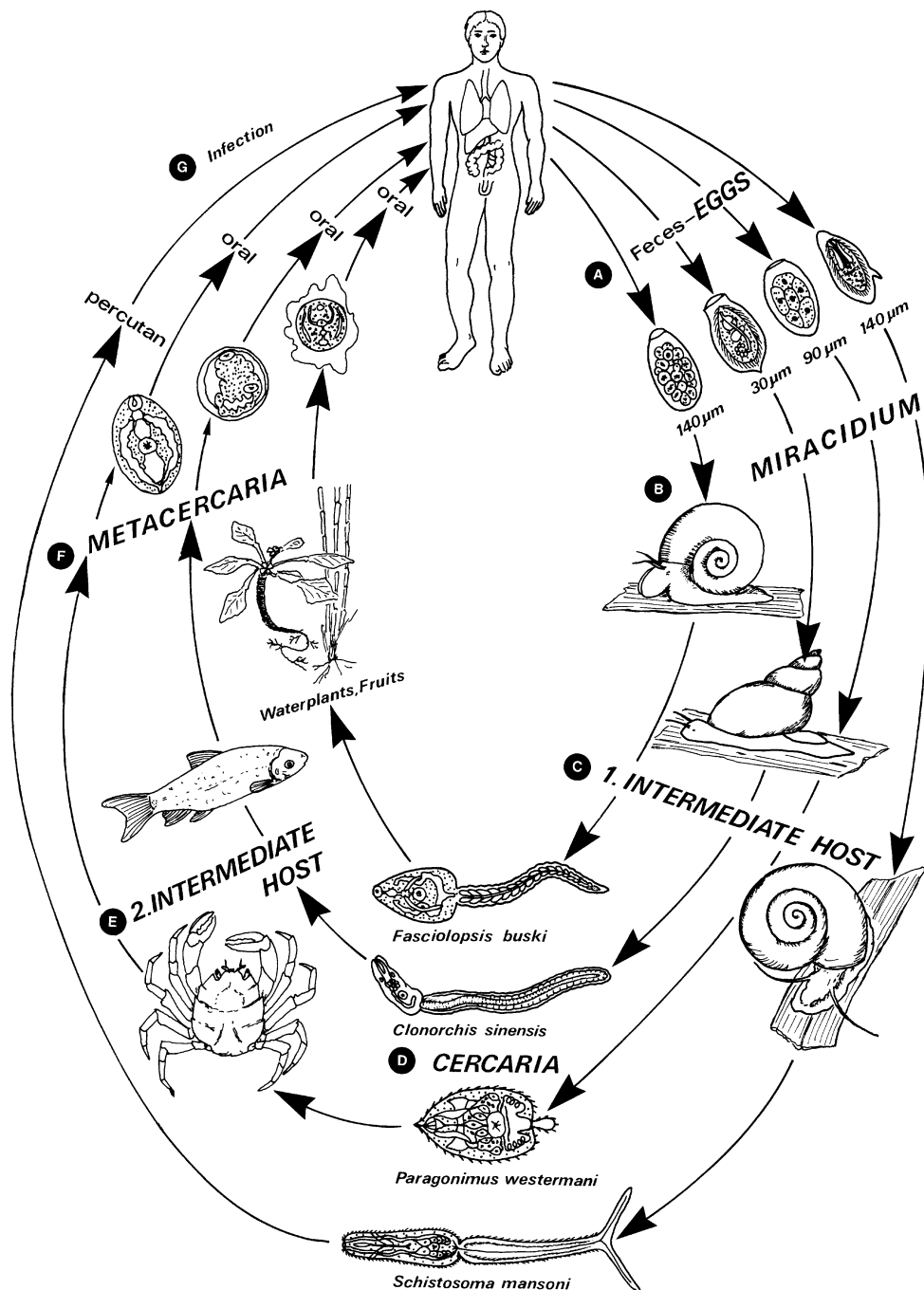

**Digenea. Figure 8** Life cycles of four species of digenetic trematodes parasitizing different human organs, thus representing different types of development and transmission (for similar species and details see Table 1). **A** Freshly excreted eggs may or may not contain a →miracidium (in the latter cases it develops after excretion). Egg size and shape vary with species (Table 1). **B** Except for *Clonorchis* (where the whole egg is swallowed) this miracidium hatches from the egg in water. **C** The miracidium (mother →sporocyst) penetrates the hepatopancreas of the first intermediate host (Table 1). **D** Inside the intermediate host cercariae are formed by sporocysts (*Schistosoma*) or by →rediae (other genera); these cercariae leave the host. **E** The cercariae follow species-specific pathways; they may encyst on waterplants (*Fasciolopsis*), penetrate and encyst in a second intermediate host forming metacercariae (*Clonorchis*) or immediately penetrate the final host (schistosomes). **F** Encysted metacercariae need some time for development (maturation) before they can infect the final hosts. **G** The final host is infected by oral uptake of metacercariae or by cutaneous penetration of metacercariae. The worms reach maturity in the intestine (*Fasciolopsis*), bile duct (*Clonorchis*), lung (→*Paragonimus*), or in blood vessels of the intestine (*Schistosoma*).



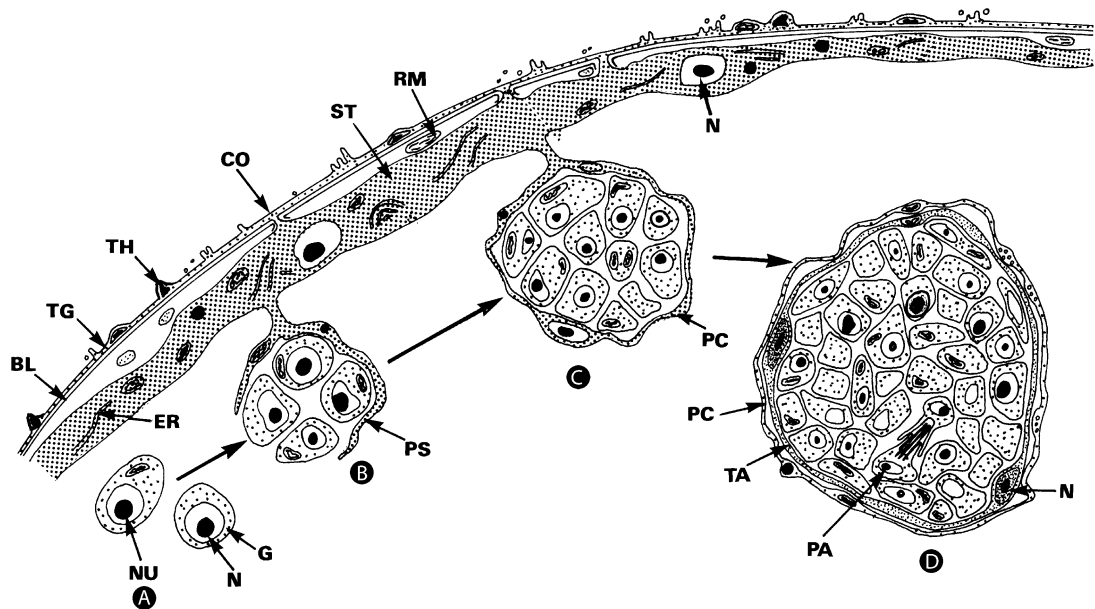

**Digenea. Figure 9 A–D** Diagrammatic representation of the formation of daughter individuals in digenean trematodes. **A** Germinal (undifferentiated) cells are found singly inside the lumen of the mother individual (mother sporocysts, daughter sporocysts, rediae). **B** Protruding parts of the syncytial subtegumental layer surround the dividing germinal cells. **C** Now the subtegumental layer has completely surrounded the dividing cells. **D** The growing daughter organism increases in size. It is covered by a smooth primary layer, under which a new syncytial tegument is formed by fusion of undifferentiated cells. Stages in C and D are also described as “germ balls”. *BL*, basal lamina; *CO*, connection between tegument and subtegumental layer; *ER*, endoplasmic reticulum; *G*, germinal cell; *N*, nucleus; *NU*, →nucleolus; *PA*, protonephridial anlage; *PC*, primary cover (formed by *ST*); *PS*, protruding part of subtegument; *RM*, remnant of muscle; *ST*, subtegumental layer; *TA*, tegument anlage; *TG*, tegument (differs in the different developmental stages); *TH*, thorn (hook).

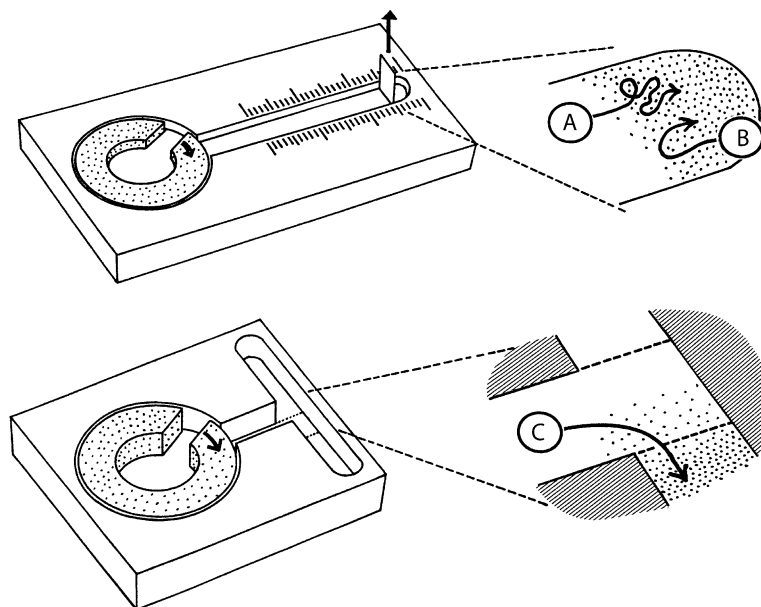

**Digenea. Figure 10** Mechanisms of chemoorientation of miracidia towards their snail hosts or snail conditioned water and its fractions can be studied in choice chambers. The →miracidia are released from the miracidia chambers by opening the closure ring (spotted) and their swimming paths in increasing and decreasing concentration gradients of attractants recorded. Most miracidia show an increase of their rate of change of direction (RCD) in increasing concentration gradients of the attractants (A) and a turnback swimming in decreasing gradients (B). Only *S. japonicum* miracidia were found to be capable of a directed chemotaxis in increasing concentration gradients (C). (Modified after Haas et al. 1995, Haas and Haberl 1997).

Much research was performed using various methods to identify the attractive components of snail tissues, mucus, and snail conditioned water (SCW). Most work dealt with miracidia of *S. mansoni*, but the results were very controversial. Small molecular compounds with low host-specificity were described, such as amino acids, magnesium ions, decreasing calcium ion concentration, peptides, short-chain fatty acids, N-acetylneuraminic acid, →ammonia, hydrogen ions, →glutathione, glucose. However, recent studies identified macromolecular glycoconjugates as the exclusively attracting molecules of SCW in miracidia of *S. mansoni*, *S. haematobium*, *T. ocellata*, *F. hepatica*, and *E. caproni*, and there is some

evidence that other species are also attracted by macromolecules. The molecules which attract *S. mansoni*, *T. ocellata*, and *F. hepatica* have very similar chemical characteristics, their saccharide chains are linked to a core protein via an *O*-glycosidic linkage probably between threonine or serine and *N*-acetylgalactosamine, and their identification signal is encoded in the →carbohydrate moiety. At least the miracidia of *F. hepatica*, *T. ocellata* and an Egyptian strain of *S. mansoni* identify their respective host-snail species with a very high specificity and sensitivity (Fig. 11). The signaling macromolecules are effective at concentrations as low as 1 mg in 10,000 liters of water, and the signaling carbohydrate structures not

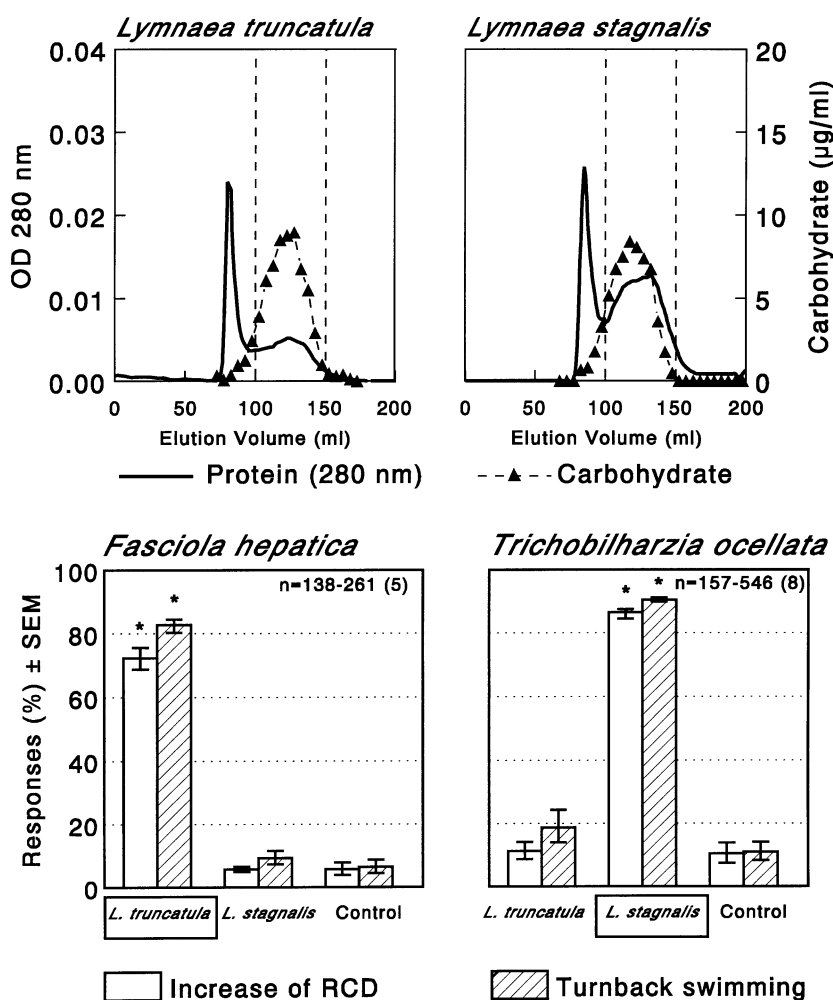

**Digenea. Figure 11** Specificity of miracidial host finding: The miracidia of *Fasciola hepatica* and *Trichobilharzia ocellata* orientate exclusively toward the isolated signal fraction of their respective host-snail species (framed) with the responses increase of RCD (spotted bars) and turnback swimming (hatched bars) (Fig.10). The signal fraction (elution volume 100–150 ml) was isolated from snail conditioned water (SCW) by molecular filtration, followed by ion-exchange chromatography and 2 succeeding size exclusion chromatographies; lines indicate the protein content, triangles the carbohydrate content of the fractions. (Modified after Kalbe et al. 2000).

analyzed so far may be recognized at an even considerably lower concentration.

- Host contact and invasion. After contact with solid surfaces miracidia show at least 12 different behavior patterns (MacInnis), the typical behavior at the suitable host snail's surface is "repeated investigation". This response is stimulated by the same host-specific glycoconjugates which stimulate the preceding chemo-orientation, at least in *S. mansoni*, *S. haematobium*, *T. ocellata*, and *F. hepatica*. The releasing cues for the subsequent attachment and penetration behavior patterns are poorly studied. At least in *S. mansoni* attachment and penetration is stimulated by the same glycoconjugates which release the preceding host-finding behaviors. This suggests that miracidia, in contrast to other parasites, use only this single complex signal for all of their host-finding phases.

A typical characteristic of digenean-snail interactions is a stringent degree of specificity. Each species of digenean is capable of developing only in very few of the available snails, often only a single species or geographic strain. The highly specific →host-finding behavior of miracidia is obviously fully adapted to this situation. The degree of miracidial specificity in host finding may vary even within a species: An Egyptian strain of *S. mansoni* responded highly specifically only to its host snail species, but a Brazilian strain could not differentiate between snail species. This could mean that the Brazilian parasites may have lost their original specificity as an adaptation to new intermediate host snails after they were introduced by slave transports from West Africa. The high specificity, which normally underlies miracidial host finding, may be easily overlooked in laboratory experiments, where the miracidia are exposed to the snails in a few milliliters of water. However, in the field the specific host-finding behavior might be a determining factor of the parasite-snail compatibility. First semi-field studies demonstrated that a high host-specificity of the host-finding behavior in miracidia greatly supports their transmission success. The fact that the host snails signal their species-specificity with such precision despite 400 million years of →coevolution with their digenean parasites suggests that the snails might need the signal molecules for other purposes. They might serve as →pheromones for intraspecific communication of the snails, and the digeneans possibly just misuse them for safe host identification. Whether the attractants can be used for specific control methods still has to be investigated.

### Cercariae

Cercariae of many digeneans find and recognize their hosts with complex behavior patterns and via very

different, highly sensitive and specific receptors. They have evolved an enormous diversity of host-finding strategies and can achieve very high host-specificities. This indicates that cercarial host finding plays a central role in the transmission of digeneans and that it is an important determinant in the evolution of their life cycles.

Cercariae of many digenean species invade their hosts directly within aquatic habitats. They are provided with limited accumulated energy reserves and must invade the hosts within their short life span of only 1–3 days. Most species support the transmission success by producing high numbers of cercariae (up to 500,000 cercariae per host snail daily). In addition to this, most cercariae show complex behavior patterns which seem entirely dedicated to finding hosts. The various cercarial behavior patterns have functions in the following host-finding processes:

- Departure from the snail host and dispersal. Immediately after leaving the snail hosts some species (such as →*Diplostomum spathaceum* and *Schistosoma haematobium*) show a particularly high swimming activity which carries them away from the snails towards their preferred position within the habitats. Some cercarial species that infest snails as second intermediate hosts avoid superinfections of the first intermediate host snails that emit them with characteristic behavior. They show phases of converted orientation towards light and gravity in their immediate postshedding period, and they search their second intermediate hosts later. For example, cercariae of *Hypoderaeum conoideum* start chemotactic orientation towards snail hosts at the earliest 1 h after they have left their first intermediate host snails.
- Habitat selection. Most cercariae tend to disperse in the habitats normally frequented by their potential hosts. For example, cercariae of human schistosomes accumulate in the uppermost water layers, whereas parasites of ground-dwelling invertebrates orientate towards the bottom of waters, and some of them select microhabitats there with a defined light intensity. This habitat selection is achieved with different types of spontaneous swimming behavior and by responses to environmental stimuli, such as gravity, light and shadow, water currents, temperature, and physical boundaries. The different species show an enormous diversity of mechanisms in responding to environmental cues. For example, some species achieve georientation exclusively by gravity-determined swimming movements, other species respond only to the direction of light radiation, and still others adjust their position in the water column by responding only to light intensity, independent of the direction of the light source.

- Localization in host time. Even the time of day the cercariae occupy the microhabitats is correlated with the habits of the subsequent hosts. This is in part achieved by the pattern of cercarial emergence from the host snail. For example, the human schistosomes leave their host snails in the middle of the day, *Schistosomatium douthitti* at night when their rodent hosts are active, and *S. margrebowiei* shows two emission peaks, one at dawn and one at dusk, i.e., when their antelope hosts water. Even an intraspecific →polymorphism in the shedding patterns was found: *S. mansoni* cercariae left their snails in foci with humans as hosts mainly at 11–12 h, but in nearby foci with rats as hosts at 16–17 h. The emergence behavior is hereditary and it is synchronized in schistosomes mainly by the photoperiod, but the thermoperiod and other factors also have an effect.
- Host-directed orientation. In many cercariae a first contact with the host seems to occur by chance. However, some species respond to stimuli emanating from their hosts in such a way, that the chances of encountering the host increase. Three types of stimulating host cues have been studied in more detail: chemical cues, water turbulence and touch, and dark stimuli (Table 2).

Chemical cues: Chemoorientation towards the host has been found in echinostome cercariae, which invade slowly moving aquatic snails (Table 2). Three species show chemokinetic orientation, they simply turn back when the concentrations of snail-emitted amino acids, →urea, and ammonia decrease. However, one species can swim by being directed chemotactically along increasing concentration gradients of snail-emitted peptides. A prerequisite for this chemotaxis is that the cercariae can detect the direction of the concentration gradient. Most other cercariae, which invade faster moving hosts, do not seem to use long-distance chemoorientation. Only *S. mansoni* responds to skin compounds (fatty acids and arginine-residues) by a reversal of the swimming direction, and this may guide them from hairs to the skin surface.

Water turbulence and touch: The schistosome cercariae respond only poorly or not at all to water currents. This may help to avoid energy-consuming responses to the frequent encounters with water-inhabiting nonhost organisms. The cercariae of the duck parasite *T. ocellata* react to water currents with forward swimming and a readiness to respond to host cues with attachment. This response is inhibited when the parasites save energy by clinging to the water surface (Fig. 12). All fish-invading cercariae of Table 2 respond to water currents by starting to swim, which may increase the chance of a contact with the moving hosts. At least in *D. spathaceum* and →*Opisthorchis viverrini* water turbulence not only triggers long swimming movements but also evokes

attachments, when the current-excited cercariae swim against solid substrates.

Dark stimuli: All fish parasites of Table 2 respond to shadow stimuli with the start of swimming movements. Whether this behavior may support an encounter with the fish hosts is not clear, as the shadow stimulus simultaneously inhibits the triggered swimming bursts and as it does not stimulate attachments. Among the *Schistosoma* species of Table 2 only *S. haematobium* responds significantly to shadows. The cercariae shift to a high swimming activity, which leads them upward in the water column, and this may increase the chance for an encounter with their human hosts. In the duck parasite *T. ocellata* a shadow response plays a dominant role in host finding (Fig. 12). These cercariae prefer an energy-saving position clinging to the water surface, where they do not respond to the frequent water current stimuli. But when a shadow falls on them they swim away from its source, usually downward. This may increase the chances of encountering the feet of their duck hosts. The shadow simultaneously triggers a readiness to respond to thermal and chemical duck foot cues with attachment behavior. Wavelengths to which cercariae respond maximally are 500 nm in *T. ocellata*, 490 nm in *S. mansoni*, and 550 nm in *Bunodera mediovitellata*.

- Host contact and invasion. After contact with the host's surface, the cercariae recognize and invade the host with a series of behavior patterns which can be carried out spontaneously, or in response to host signals of quite different host-specificity: (1) Attachment to the host; (2) enduring contact with (remaining on) the host; (3) creeping to suitable entry sites; (4) penetration into the skin with elements such as penetration movements, shedding of the tail, secretion of acetabular gland contents, and tegument transformation for →immune evasion. Each of these behavior patterns may be stimulated independently by separate host signals. Some species achieve a very narrow host-specificity employing strategies including: (1) A chronological succession of responses to different stimuli, which themselves may be of low specificity; (2) responses to a combination of different stimuli; (3) sensitive responses to individual stimuli with a high host-specificity. A typical characteristic of cercarial host finding is a high diversity of strategies. Each species studied so far recognizes its host with responses to host signals that differ considerably from those of other species, even when these invade the same host genera. This may reflect adaptations to maximal transmission successes within differing ecological conditions. The stimulating cues for cercarial behavior after host contact have been analyzed for species invading mammals, birds, and fish (Table 3).

**Digenea. Table 2** Host cues supposed to facilitate approach of swimming cercariae toward the host; -, no effect; [], weak effect

	Chemicals	Water turbulence or touch	Dark stimuli
<b>Schistosomatids invading mammals and birds</b>			
<i>Schistosoma haematobium</i>	- (?)	-	Start of long swimming movements - During swimming
<i>Schistosoma japonicum</i>	- (?)	- Passive adherence to hydrophilic substrates	-
<i>Schistosoma mansoni</i>	Fatty acids, arginine, peptides with arginine: reversals of swimming direction, leading to accumulation	[Tendency to attach when swimming]	[Start of swimming] - During swimming
<i>Schistosoma spindale</i>	- (?)	- During passive sinking Inhibition of active swimming	- During passive sinking Inhibition of active swimming
<i>Trichobilharzia ocellata</i>	- (?)	- In resting position Activation during sinking and swimming; start of forward swimming, readiness to attach	Activation in resting position, sinking and swimming; start of forward swimming, readiness to attach
<b>Species invading fish</b>			
<i>Acanthostomum brauni</i>	- (?)	Start of swimming, no readiness to attach	Start of swimming, [weak readiness to attach]
<i>Cryptocotyle lingua</i>	Fish extracts and amines; prolonged swimming, shorter sinking periods	Start of swimming, (attachment?)	Start of swimming, (not attachment?)
<i>Diplostomum spathaceum</i>	- Fish skin mucus; no effect on swimming, sinking, and readiness to attach	Start of long swimming with readiness to attach	Start of swimming, but inhibition of swimming and no readiness to attach
<i>Opisthorchis viverrini</i>	- (?)	Start of long swimming with readiness to attach	Start of swimming, but inhibition of swimming and no readiness to attach
<i>Posthodiplostomum cuticola</i>	?	Start of swimming, (attachment?)	Start of swimming, (not attachment?)
<b>Echinostomatids invading snails</b>			
<i>Hypoderaeum conoideum</i>	Small peptides; chemotactic swimming toward increasing concentration	-	-
<i>Pseudechinoparyphium echinatum</i> , <i>Echinostoma revolutum</i> , <i>Echinostoma caproni</i>	Amino acids, urea, and ammonia; turnback swimming in decreasing concentration gradients	-	-

Adapted from Haas (1994) and Haas and Haberl (1997)

Schistosomes invading mammalian hosts (Table 3) find their host in a characteristic manner, either by responses to different host signals or by an individual sensitivity of the responses. For example, *S. mansoni* cercariae respond in each of the host-finding phases with a particular sensitivity to chemical host cues. It was speculated that this might represent an adaptation to clear water habitats or to an infection near the water surface, where the detection of chemical cues

is not disturbed by mud components. In contrast to that, *S. haematobium* cercariae respond most sensitively to thermal stimuli. They attach maximally to substrates when their temperature exceeds ambient temperature by only 1° C (*S. mansoni* 11–13° C), and they migrate along temperature gradients as low as 0.03° C/mm (*S. mansoni* 0.15° C/mm). This specialization on thermal host cues was interpreted as adaptation to invading the hosts in cooler habitats, where warm

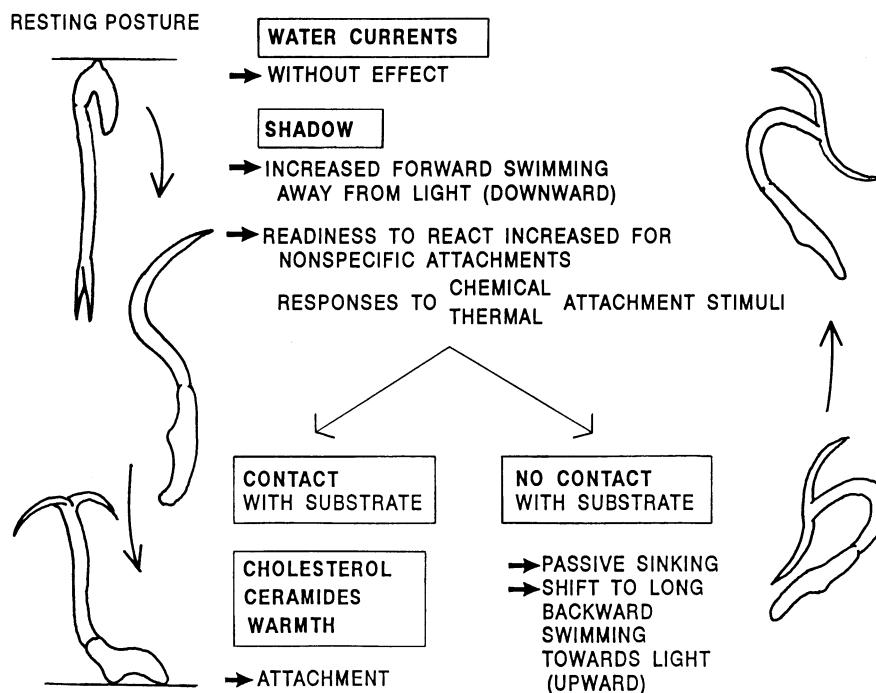

**Digenea. Figure 12** Host finding of the duck parasite *Trichobilharzia ocellata*: Function of the cercarial responses to external stimuli (boxes). (From Haas, 1992).

host surfaces are especially contrasting. A very low specificity occurs in the host finding of *S. japonicum* cercariae. They attach to and remain on the host purely by chance and their penetration behavior and tegument transformation can be stimulated by warmth alone. This bears the risk of cercarial losses by penetration attempts into warm nonhost substrates. However, this behavior enables the *S. japonicum* cercariae to invade a broad spectrum of mammals including species with a low content of free fatty acids in their skin surface. Their poor response to chemical host cues was interpreted as an adaptation to the muddy habitats in which they actually invade their hosts, i.e., habitats where chemical components of mud could interfere with chemoreception.

A common characteristic of all schistosomes studied so far is that they respond very sensitively to certain free fatty acids of mammalian skin surface with penetration behavior and transformation of their tegument for immune evasion. There is evidence that the fatty acids act via chemoreceptors and neural mechanisms. However, they may also have other functions in the invasion processes. *S. mansoni* and *T. ocellata* cercariae synthesize various eicosanoids when they are incubated in essential fatty acids, and it was suggested that these might directly act in the tegument transformation and immune evasion processes.

Host recognition of bird-invading schistosomatids has been studied only in 3 species in detail (Table 3). The host cues to which they respond are also characteristic for mammalian skin and this suggests, that they are not adapted to avoiding unsuccessful penetrations into mammals. In fact, several bird-invading schistosomatids are known to cause →cercarial dermatitis in humans. Each of the species studied so far responds to ceramides or cholesterol as host cues. These lipids also occur in mammalian skin surface, but they are lacking in the birds' uropygial gland secretions which are distributed on the feathers. Therefore, the response to these lipids may help to avoid useless attachments or penetration attempts to bird feathers.

Detailed data are available only for 3 fish-invading species (Table 3). The attachment response of *D. spathaceum* is stimulated by host-derived carbon dioxide, and the cercariae attach to nearly all animals. The disadvantage of the low specificity may be overcome by a high sensitivity to carbon dioxide, which allows a very fast attachment. The fish specificity is then achieved during the enduring contact and penetration phases, where the *D. spathaceum* cercariae respond to glycoconjugates. Each of the 3 fish-invading species achieves its fish-specificity by responses to 1–2 types of macromolecules. How the specificity is

**Digenea. Table 3** Host signals as stimuli for cercarial host-recognition and invasion phases

	Attachment	Enduring contact	Directed creeping	Penetration
<b>Species invading mammals</b>				
<i>Schistosoma haematobium</i>	[L-arginine] Warmth	No stimuli?	L-arginine Temperature gradients	Fatty acids (Not warmth)
<i>Schistosoma japonicum</i>	No stimuli	No stimuli (Favored by solid hydrophobic surfaces)	Temperature gradients (Not chemical gradients)	Fatty acids Warmth
<i>Schistosoma mansoni</i>	[Water turbulence] L-arginine Warmth	Ceramides  Warmth	L-arginine Temperature gradients	Fatty acids (Not warmth)
<i>Schistosoma spindale</i>	Warmth (Not chemical stimuli)	Warmth (Not chemical stimuli)	Temperature gradients (Not chemical gradients)	Fatty acids (Not warmth)
<b>Species invading birds</b>				
<i>Austroilharzia terrigalensis</i>	Touch	?	?	Free sterols
<i>Austroilharzia variglandis</i>	?	?	?	Cholesterol, fatty acids, triacylglycerols
<i>Trichobilharzia ocellata</i>	Dark stimuli Ceramides, cholesterol Warmth	Ceramides, cholesterol	? (Not warmth)	Fatty acids
<b>Species invading fish and amphibians</b>				
<i>Acanthostomum brauni</i>	[Dark stimuli] Glycoproteins with sialic acids	?	?	Combination of fatty acids and proteins
<i>Diplostomum spathaceum</i>	Water turbulence CO <sub>2</sub> + H <sub>2</sub> CO <sub>3</sub>	Carbohydrates	?	Fatty acids, glycoproteins with sialic acids
<i>Opisthorchis viverrini</i>	Water turbulence Glycosaminoglycans	?	?	Proteins

Modified after Haas, 2003

encoded in the signaling proteins and glycoconjugates is poorly understood. There is some evidence that terminally positioned sialic acids in the mucus are used to distinguish a host fish from mucus-covered aquatic invertebrates.

## Dilepis

Genus of cestode family Dilepididae, the species of which live in birds. Related genera are →*Dipylidium* in

mammals, *Liga* in birds, *Paradilepis* in birds, *Ophiovalipora* in snakes.

## Dimethoate

### Chemical Class

Organophosphorous compounds (dithiophosphate).

### Mode of Action

Acetylcholine esterase inhibitor. →[Ectoparasiticides – Agonists and Antagonists of Cholinergic Transmission](#).

## Dimetridazol

Drug to control infections with *Giardia*, *Trichomonas*, *Entamoeba*. → [Antidiarrhoeal and Antitrichomoniasis Drugs](#).

## Diminazen

Drug that acts against → [Babesia](#) and → [Trypanosoma](#) by interference with the DNA – synthesis. → [Babesiacidal Drugs](#).

## Dinobdella ferox

Leeches of this species enter the nasal cavities of domestic animals in Southern Asia to suck blood (→ [Leeches](#)).

→ [Respiratory System Diseases, Horses, Swine, Carnivores](#), → [Respiratory System Diseases, Ruminants](#).

## Dinotefuran

### Chemical Class

Neonicotinoide

### Mode of Action

Nicotinic acetylcholine receptor agonist. → [Ectoparasiticides – Agonists and Antagonists of Cholinergic Transmission](#).

## Dioctophyme renale

### Classification

Species of → [Nematodes](#).

### Life Cycle

Fig. 1 (page 350).

### Disease

→ [Urinary System Diseases, Animals](#).

## Dioecious

Males and females being different individuals.

## Dioecocestus

Genus of → [tapeworms](#), the specimens of which are not → [hermaphrodites](#) but form male and female adults.

## Diorchis stefanskii

Tapeworm in the intestine of ducks.

## Dipetalogaster

### Classification

Genus of triatomid → [bugs](#). → [Kissing Bugs](#).

## Dipetalonema

→ [Filariidae](#), → [Nematodes](#), → [Dirofilaria immitis](#).

## Dipetalonemiasis, Man

Zoonotic dipetalonemiasis is usually an infection of porcupines, beavers, or other mammals which is transmitted accidentally to man by → [mosquitoes](#). The adults live subcutaneously or in body cavities of the natural host, and are found subcutaneously or in the eyes of humans. Very rarely microfilariae are found, but their specific affinities usually remain undetermined. Living worms give rise to little inflammation, but dead worms cause → [hypersensitivity](#), → [necrosis](#) with eosinophils, followed by granulomatous reaction and fibrosis (compare → [Onchocerciasis, Man](#)).

### Therapy

→ [Nematocidal Drugs, Man](#).



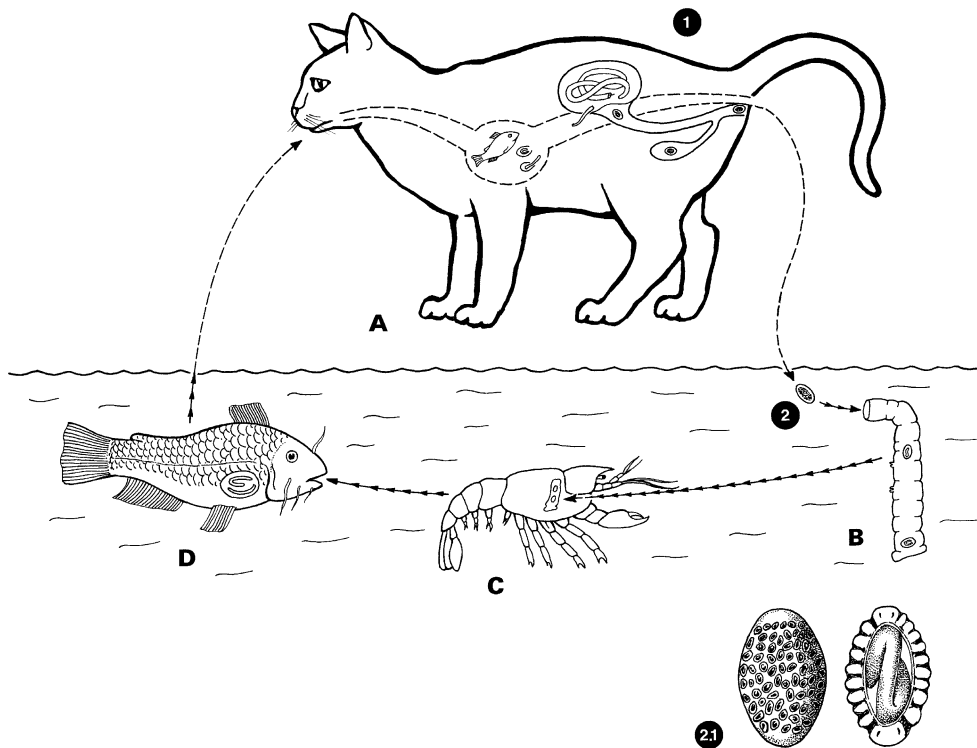

**Diocotophyme renale.** **Figure 1** Life cycle of the →kidney worm *Diocotophyme renale*. 1 Adult worm (females up to 1m long, males 30 cm long) live in the kidney of fish-eating mammals (A, cat, dogs, rarely man). 2 Eggs with a thick shell are laid uncleaved and need about 6 months to develop the larva 1 (2.1). Intermediate hosts (B, C, D, i.e., worms, crustaceans, fish) orally take up larva-containing eggs. In fish (D) the larva finally accumulate and develop until larva 4. When such contaminated fish are eaten by the final hosts, the larvae leave the intestine and migrate via the blood to the bowl of the kidneys. There they reach maturity after another 3–6 months and produce fertilized eggs for about 1–3 years if both sexes have reached the kidneys.

## Diphyllobothrium latum

→Vampire Bats.

## Diphyllobothriidae

Family of cestodes with 2 genera: *Echinobothrium* and *Ditrachybothrium*, all parasitizing in fish (elasmobranchs).

## Diphyllobothriasis, Man

Disease due to infection with the tapeworm →*Diphyllobothrium latum* (→*Pseudophyllidae*) by oral uptake of larvae (plerocercoids) in undercooked fish.

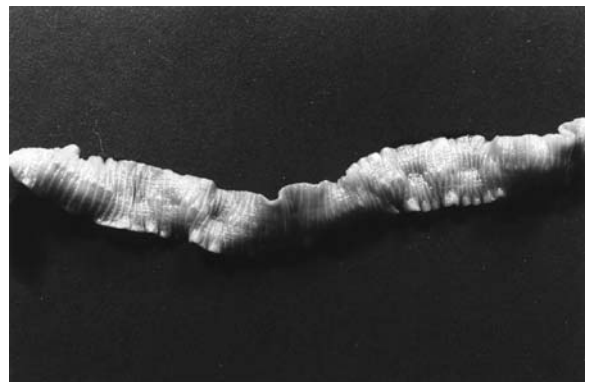

**Diphyllobothriasis, Man.** **Figure 1** Proglottids of *Diphyllobothrium latum*, which are broader than long.

**Main clinical symptoms:** →Abdominal pain, →anaemia due to deprivation of vitamin B12.

**Incubation period:** 3 weeks, if symptoms occur.

**Prepatent period:** 21–24 days.

**Patent period:** 10 years.

**Diagnosis:** Microscopic observation of proglottids and eggs in faecal samples (Figs. 1, 2).

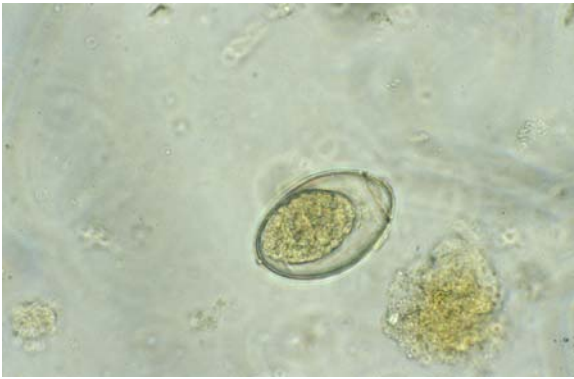

**Diphyllobothriasis, Man. Figure 2** Operculated egg of *Diphyllobothrium latum* containing the coracidium larva.

**Prophylaxis:** Avoid eating raw fish.

**Therapy:** Treatment with praziquantel, see →[Cestodocidal Drugs](#).

## Diphyllobothrium

### Classification

Genus of →[Pseudophyllidea](#), →[Eucestoda](#).

### Life Cycle

→[Pseudophyllidea/Life Cycle/Fig. 1](#).

### Morphology

→[Nervous System of Platyhelminthes/Fig. 8](#), →[Eucestoda/Fig. 2A](#).

### Disease

→[Diphyllobothriasis, Man](#).

## Diplectanum aequans

Monogenean worm on the gills of *Dicentrarchus labrax* (European sea bass), which is the second most important cultured marine fish species in Italy. The adults measure about 8 mm in length.

## Diplocaryon

Late stage of spore formation (with two nuclei), e.g., in species of the genus →[Amblyospora](#).

## Diplodiscus

→[Megalodiscus](#), →[Digenea](#).

## Diplomonadida

### Classification

Order of →[Mastigophora](#).

### General Information

The diplomonads are characterized by the occurrence of a symmetrically arranged double set of each group of organelles (→[Giardia lamblia/Fig. 1](#)). This unique appearance may be explained by the omission of cellular division after reduplication of organelles. The species of diplomonads ([Table 1](#)) inhabit the intestines of their hosts, where they are attached to the →[microvilli](#) (→[Giardia lamblia/Figs. 2, 3](#)) by means of their ventral sucker-like surface and feed by →[pinocytosis](#) on the intestinal fluid (→[Endocytosis/Fig. 1](#)). Reproduction proceeds as longitudinal →[binary fission](#) of the intestinal →[trophozoites](#), whereas transmission from one host to the other occurs via oral uptake of cysts, which are formed by →[Encystation](#) of trophozoites when feces enter the colon and begin to dehydrate. In some cases heavy infections may lead to severe diseases characterized by intensive diarrhea (→[Giardiasis, Animals](#), →[Giardiasis, Man](#)).

### Important Species

[Table 1](#).

### Life Cycle

→[Giardia lamblia/Fig. 1](#), →[Endocytosis/Fig. 1](#), →[Flagella/Fig. 3](#).

## Diplopylidium

Genus of the tapeworm family Dipylidiidae. *D. noelleri* and *D. acanthotetra* are found in cats and dogs. The egg package (cocoon) contains only a single egg.

**Diplomonadida. Table 1** Important species of the Enteromonadina and Diplomonadina

Genera/species	Size (µm)	Hosts	Pathogenicity
<b>Enteromonadina</b>			
<i>Chilomastix mesnili</i>	10–20	<b>Humans</b>	–
<i>Dientamoeba fragilis</i> <sup>a</sup>	7–12	<b>Humans</b>	+
<i>Enteromonas hominis</i>	4–10	<b>Humans</b>	–
<i>Retortamonas intestinalis</i>	8	<b>Humans</b>	–
<b>Diplomonadina</b>			
<i>Hexamita</i> (= <i>Octomitus</i> ) spp.	6–12	Fish	+
<i>Octomitus intestinalis</i>	9–12	Mice	–
<i>Spiroucleus</i> (= <i>Hexamita</i> ) spp.	6–14	Chickens, birds	+
<i>S. muris</i>	10	Mice	–
<i>Trepomonas</i> sp.	12	Fish	+
<i>Giardia lamblia</i> <sup>b</sup> (syn. <i>Lamblia intestinalis</i> , <i>G. duodenalis</i> )	10–20	<b>Humans, dogs, cats</b>	+
<i>G. agilis</i>	8–14	Anurans	+/-
<i>G. bovis</i>	11–19	Cattle	+
<i>G. caprae</i>	12–17	Sheep, goats	+
<i>G. canis</i>	11–17	Dogs	+
<i>G. duodenalis</i>	13–19	Rabbits	+

<sup>a</sup> Systematic position remains doubtful

<sup>b</sup> Systematics are far from being clear. Recently 3 genotypes were found: **A:** In man and many animals. **B:** in man, dogs, and cats. **C:** only in dogs

## Diplostomulæ

→ *Alaria canis*.

## Diplostomum

Genus of the → *Digenea*.

## Diplostomum spathaceum

→ *Behavior*, → *Digenea*.

## Diplozoon paradoxum

### Classification

Species of → *Monogenea*.

### Life Cycle

Figs. 1, 2 (page 353).

## Diporpa

Larva of the Monogenean species, → *Diplozoon paradoxum*.

## Diptera

### Name

Greek: *di* = two, *pteron* = wing.

### Classification

Order of → *Insecta*.

### General Information

The usually ectoparasitic and only seldom endoparasitic dipteran species show the following common features, although their basic body organization is modified according to their different ways of living:

- The pair of forewings is always present; the hindwings have been reduced to so-called halteres (→ *Peritrophic Membranes*/Fig. 1).
- Eyes are in general large compound ones composed of numerous ommatidia (→ *Insecta*/Figs. 8, 9).
- Mouthparts are of the licking-sucking type (in true flies) or of the biting type (in blood-sucking species).

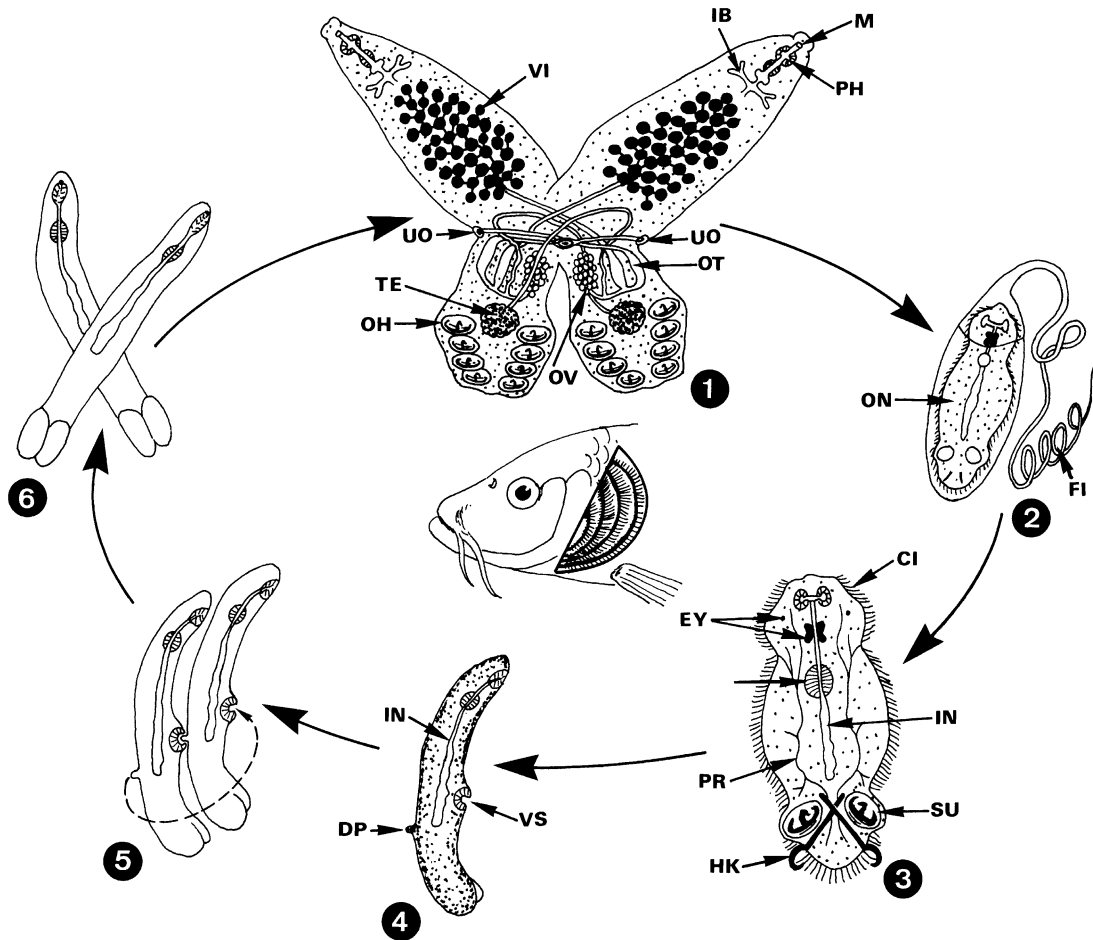

**Diplozoon paradoxum.** Figure 1 Life cycle of *Diplozoon paradoxum* on the gills of cyprinid fish. 1 Adults on the gills of fish. 2 Egg with an →oncomiracidium larva. 3 Free oncomiracidium. 4 After attachment to the gills of a host the oncomiracidium is transformed into the diporpa larva. 5, 6 Fusion of 2 diporpas on the host; each →diporpa attaches its sucker (*VS*) to the dorsal papilla (*DP*) of the other. This process stimulates their maturation and cross-fertilization. The blood-sucking adults can live for years in this form of complete copulation. *CI*, →cilia; *DP*, dorsal papilla; *EY*, eyes; *FI*, filament; *HK*, hook; *IB*, intestinal branch; *IN*, intestine; *M*, mouth; *OH*, →opisthaptor with suckers; *ON*, oncomiracidium; *OT*, ootyp; *OV*, ovary; *PH*, pharynx; *PR*, →protonephridium; *SU*, sucker (clamps); *TE*, →testis; *UO*, uterus opening; *VI*, →vitellarium (vitelline gland); *VS*, ventral sucker.



**Diplozoon paradoxum.** Figure 2 Coloured stage showing both partners being united for ever.

- The life cycle runs as →holometabolous development including apod (feetless) larvae, a non-feeding or even immotile →pupa, and →dioecious adults (Fig. 1).
- Larvae and adults may live as parasites, larvae in general as endoparasites, and adults as ectoparasites. With the exception of a few species (→Hippoboscidae), the adult dipterans feed periodically on their hosts (Table 1).

### Important Species

Table 1.

### Life Cycle

Fig. 1.

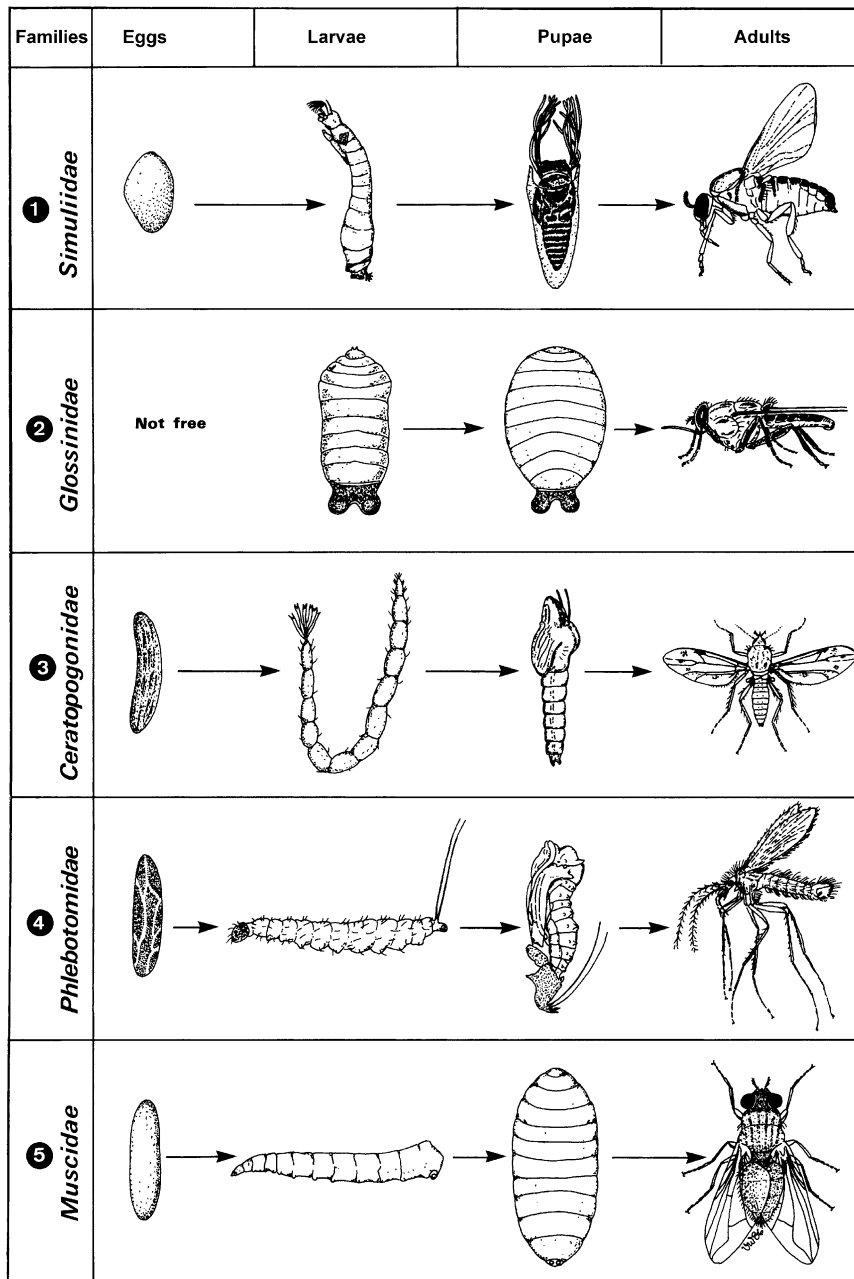

**Diptera. Figure 1** Developmental stages in the holometabolic life cycle of important groups of Diptera (cf. Table 1). Note that several larval stages may occur; temperature and other outer conditions regulate the developmental speed. **1** Family → *Simuliidae* (→ *Blackflies*). The 2–5 mm long females of → *Simulium* spp. usually feed diurnally on blood of their hosts (→ *Pool Feeders*), but males do not suck blood. The filtering larvae and the non-feeding pupae are enclosed in cocoons (not drawn) that are attached to the surface of objects submerged in swiftly running waters. **2** Fam. → *Glossinidae* (→ *Tsetse Flies*). Both sexes of the 6–14 mm long → *Glossina* spp. feed on blood of their hosts (pool feeders). Females pass at once a single fully grown third-instar larva which has developed inside the uterus with the aid of → *symbionts* and uterine glands. The pupation occurs in protected areas of the soil. **3** Fam. → *Ceratopogonidae* (biting → *midges*). The members of the (drawn) genus → *Culicoides* are very small (1–4 mm long). Females suck blood of their hosts. Larval development proceeds in wet, semisolid media or even in holes in trees. **4** Fam. → *Phlebotomidae* (→ *Sand Flies*). The members of the (drawn) mammal-biting genus → *Phlebotomus* are about 2.5 mm long and are characterized by numerous body hairs. Females suck their hosts's blood during the night. Larval development (four instars) proceeds in wet soil. **5** Fam. → *Muscidae* (houseflies). *Musca domestica* lays its eggs on urine- and dung-contaminated stable refuse, where larval development (three instars) proceeds. → *Musca* is saprophagous, whereas both sexes of → *Stomoxys calcitrans* feed on blood.

**Diptera. Table 1** Important dipterans and some transmitted pathogens

Family/Genus	Diseases of humans (pathogens)	Diseases of domesticated animals (pathogens)
<b>Suborder Nematocera</b>		
<b>Culicidae</b>		
<i>Aedes</i>	Yellow fever (V), Dengue fever (V), Filariasis (P)	Rabbit myxomatosis (V)
<i>Culex</i>	St. Louis encephalitis (V), West Nile disease (V), Filariasis (P)	Horse encephalitis (V), Chicken malaria (P), Dog filariasis (N)
<i>Anopheles</i>	Malaria (P), Filariasis, elephantiasis (N)	Filariasis (N)
<i>Mansonia</i>	Filariasis (N)	Filariasis (N)
<b>Simuliidae</b>		
<i>Simulium</i>	Onchocerciasis (N)	<i>Leucozytozoon</i> malaria of birds (P)
<b>Phlebotomidae</b>		
<i>Phlebotomus</i> , <i>Lutzomyia</i>	Bartonellosis (R/B), Papataci fever (V), Leishmaniasis (P)	Dog leishmaniasis (P)
<b>Ceratopogonidae</b>		
<i>Culicoides</i>	Japanese B encephalitis (V)	Blue tongue (V)
<b>Suborder Brachycera</b>		
<b>Tabanidae</b>		
<i>Chrysops</i>	Tularemia (B), Loiasis (N)	Surra (P)
<i>Tabanus</i>	Loiasis? (N)	Anaplasmosis (R)
<i>Haematopota</i>		Filariasis (N)
<b>Muscidae</b>		
<i>Musca</i>	Poliomyelitis (V), Shigellosis (B), Salmonellosis (B), Cholera (B), Trachom (V), Amoebiasis (P), Myiasis by larvae	Horse habronemiasis (N), Thelaziasis (N)
<i>Stomoxys</i>	Poliomyelitis (V), Bacteriosis (B)	Sleeping sickness (P), Chicken spirochaetosis (S), Habronemiasis (N)
<b>Suborder Cyclorrhapha</b>		
<b>Glossinidae</b>		
<i>Glossina</i>	Sleeping sickness (P)	Nagana (P), Surra (P)
<b>Sarcophagidae</b>		
<i>Sarcophaga</i>	Myiasis by larvae	Myiasis by larvae
<i>Wohlfartia</i>	Myiasis by larvae	Myiasis by larvae
<b>Calliphoridae</b>		
<i>Callitroga</i>	Myiasis by larvae	Myiasis by larvae
<b>Gasterophilidae</b>		
<i>Gasterophilus</i>	Myiasis by larvae	Myiasis by larvae
<b>Oestridae</b>		
<i>Oestrus</i>	Myiasis by larvae	Myiasis by larvae
<i>Hypoderma</i>	Myiasis by larvae	Myiasis by larvae
<i>Dermatobia</i>	Myiasis by larvae	Myiasis by larvae
<b>Hippoboscidae</b>		
<i>Melophagus</i>	Skin irritations	Loss of weight
<i>Lipoptena</i>	Skin irritations	Loss of weight

V, Virus; R, Rickettsiae; B, Bacteria; S, Spirochaeta; P, Protozoa; N, Nematodes

## Dipteraviridae

Viruses transmitted by dipteran insects (e.g., flies and →mosquitoes).

## Dipylidiasis, Man

Disease due to the infection with the tapeworm →*Dipylidium caninum* which is common in cats and dogs. Infection occurs via oral uptake of tapeworm larvae in crushed →fleas.

**Main clinical symptoms:** →Diarrhoea, →urticaria, loss of weight, and anal →pruritus.

**Incubation period:** 10–25 days.

**Prepatent period:** 19–25 days.

**Patent period:** 1 year.

**Diagnosis:** Occurrence of typical →proglottids in the faeces (Figs. 1, 2).

**Prophylaxis:** Deworming of dogs, cats, and treatment against fleas.

**Therapy:** Treatment with praziquantel, see →Cestodocidal Drugs.



**Dipylidiasis, Man. Figure 1** Typical proglottids of *Dipylidium caninum*.



**Dipylidiasis, Man. Figure 2** A typical egg-cocoon of *Dipylidium caninum*.

## Dipylidium caninum

### Classification

Species of →Eucestoda.

### Life Cycle

Figs. 1–3 (page 358, 359).

### Disease

→Dipylidiasis, Man, →Alimentary System Diseases.

## Dirofilaria immitis

### Synonym

→Heartworm.

### Classification

Species of →Nematodes.

### Life Cycle

Figs. 1–3 (page 359).

### Other Species

*D. repens* is found in canids and cats in South Europe, Asia, and Africa. The adults live in the subcutis, the 205–300 µm long microfilariae are found in blood vessels of skin. The vectors are Culicidae (mosquitoes).

*Acanthocheilonema reconditum* is endemic in Europe, Asia, America, and Australia and is transmitted to dogs by fleas. It lives in the subcutis and body cavities.

*Dipetalonema dracunculoides* is transmitted by ixodid ticks (*Rhipicephalus sanguineus*). The adults live in the body cavity of dogs in Europe, Asia, and Africa.

## Diseases

→[Dirofilariasis, Man](#), →[Heartworm Disease](#), →[Cardiovascular System Diseases, Animals](#), →[Nervous System Diseases, Carnivores](#).

---

## Dirofilariasis, Man

### Synonym

Zoonotic filariasis.

### Pathology

Dirofilariasis is an infection of dogs, raccoons, bears, etc., caused by →[Dirofilaria immitis](#). It is occasionally transmitted by →[mosquitoes](#) to humans. The young adult worms wander to the right heart and are usually propelled into a pulmonary artery branch, which they thrombus (→[Pathology/Fig. 28B](#)) giving rise to a localized pulmonary infarct. The worm is usually dead in the thrombus. The release of worm antigens provokes an intense hypersensitive reaction, with central →[necrosis](#) accompanied by eosinophils and a granulomatous or fibrotic reaction peripherally. Some of the older lesions calcify and become visible on radiological examination of the chest.

**Main clinical symptoms:** Undifferentiated heart pain, hypertrophy of heart, ascites.

**Incubation period:** 3–9 months.

**Prepatent period:** 7–9 months.

**Patent period:** 6–7 years (at least in dogs).

**Diagnosis:** Difficult, since no microfilariae are formed in humans; serological tests.

**Prophylaxis:** Avoid bites of mosquito vectors.

**Therapy:** Treatment see →[Nematocidal Drugs, Man](#).

---

## Disease Control, Epidemiological Analysis

Parasitic diseases originate from an interplay between parasite, vector or carrier, and principal host in an environment that is suitable for the parasite's maintenance or propagation. It is customary to differentiate

broadly between food-borne, water-borne, arthropode-borne, and directly invasive parasitoses. However, this rather coarse classification will be of little use in identifying targets of control intervention.

Some of the principal →[modes of infection](#) are given in [Table 1](#), but this grouping does not provide more than a summary →[orientation](#). With the individual parasitoses it will be indispensable to analyze, in detail, all stages of the parasite's life cycle and the biological and environmental factors governing its transmission, i.e., to consider the epidemiology of the disease. As an example, the main epidemiological components of the →[malaria](#) situation are summarized in [Table 2](#). The resulting picture will be specific for a given area and important inter-area differences are commonly seen. Since the epidemiological situation may change over time, resulting from modifications of environment, host – vector relationships and other factors, the analysis requires regular updating. The approach to analyzing the factors governing the transmission of other parasitic diseases is similar, and should yield the elements required for the identification of targets of intervention.

Mathematical models can be quite useful in epidemiological analysis inasmuch as they facilitate a quantitative appreciation of particular features in the parasite's life cycle and permit projections of the expected efficacy of specific interventions. Such models exist for malaria and some other diseases of major public health importance. The quality of results obtained from such models depends primarily on reliability and exhaustiveness of the data input (→[Mathematical Models of Vector-Borne Diseases](#)).

---

## Disease Control, Evaluation

The control of parasitic diseases has the purpose of reducing the burden caused by such diseases in the human population or in livestock, or both. The control programmes are usually supported by public funds. The planning of such programmes should be sound and based on a realistic strategy and target projections, and a reasonable expectation of success. The performance and efficacy of control measures should therefore be subject to monitoring as the basis of regular and continuous evaluation.

Parasitic diseases span a wide spectrum of severity and impact on human or animal health. On the other hand, the target levels of control may vary, dependent on technical and financial feasibility. Realistic planning should take these limitations into account. Whenever a plan of operation is drawn up, monitoring and evaluation should be integral components of it.



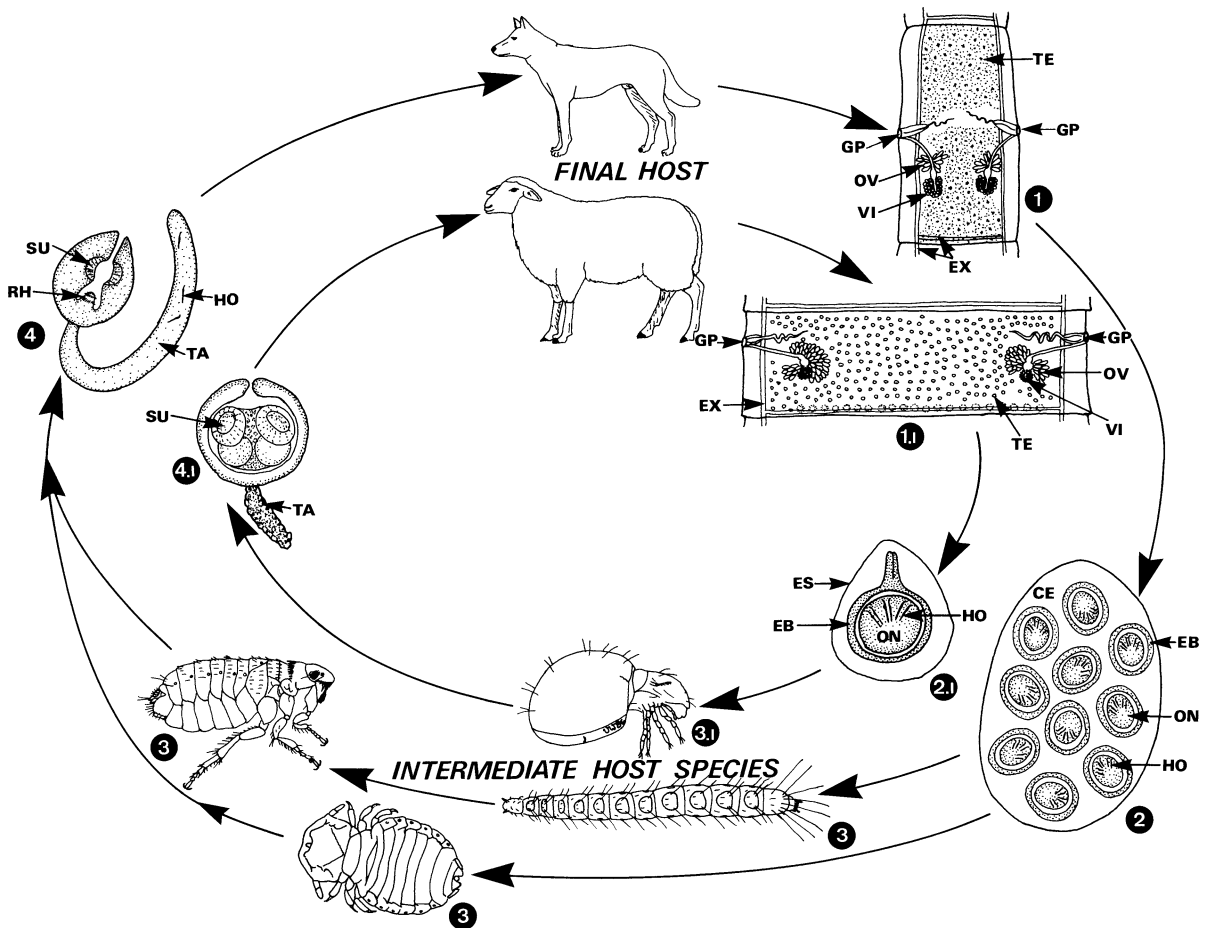

**Dipylidium caninum.** Figure 1 Life cycles of tapeworm with two sets of sexual organs per proglottid: *Dipylidium caninum* (1–4) of carnivores and man reaching a length of about 50 cm and *Moniezia expansa* (1.1–4.1) of ruminants with a maximum length of 6 cm. 1, 1.1 Premature proglottids of adult worms parasitizing the intestines of their final hosts. 2, 2.1 The uteri of fecally excreted cucumber-like proglottids are filled with typical eggs, which in the case of *D. caninum* are always enclosed in capsules (2). 3, 3.1 *D. caninum* uses larval and adult fleas (*Ctenocephalides* spp.) or chewing lice (*Trichodectes canis*) as intermediate hosts, whereas *M. expansa* develops in oribatid mites (3.1). When the eggs are eaten by such intermediate hosts, the oncosphaera hatches and migrates to the hemocoel. 4 Inside the hemocoel transformation to the second larval type (cysticeroid) occurs. The growth rate is dependent upon the ambient temperature. Infection of the final host is accomplished when infected intermediate hosts are swallowed. The cysticercoids evaginate in the intestine and develop directly into adult tapeworms; this takes 2–3 weeks for *D. caninum* and 4–8 weeks for *M. expansa*. CE, capsule containing eggs; EB, →embryophore; ES, egg shell; EX, excretory vessels; GP, genital pore; HO, hooks of oncosphaera, ON, oncosphaera; OV, ovary; RH, rostellar hooks; SU, sucker; TA, tail of cysticeroid; TE, testis; VI, vitelline gland.

The selection of monitoring tools is determined by the methods of intervention which might be relatively simple or complex, depending on the disease and the envisaged targets of intervention. In the following, examples of the choice of monitoring tools are given for some major tropical parasitic diseases.

In the control of African trypanosomiasis caused by *Trypanosoma brucei rhodensiense*, for instance, the early detection and treatment of human trypanosomiasis will be the objective of control as long as the effective

control of the vector population (*Glossina morsitans* group) and the sanitation of wildlife reservoir are not feasible. In this case morbidity and mortality from the human infection will be the primary parameters for monitoring, supported by quality control monitoring related to diagnosis and treatment of the disease.

The control of American trypanosomiasis, Chagas disease, is mainly based on the control of the vectors (reduviid bugs). While the diagnosis of infections with *T. cruzi* has become easy due to the development of



**Dipylidium caninum.** Figure 2 LM of the scolex with the extruded rostellum.



**Dipylidium caninum.** Figure 3 SEM of the scolex.

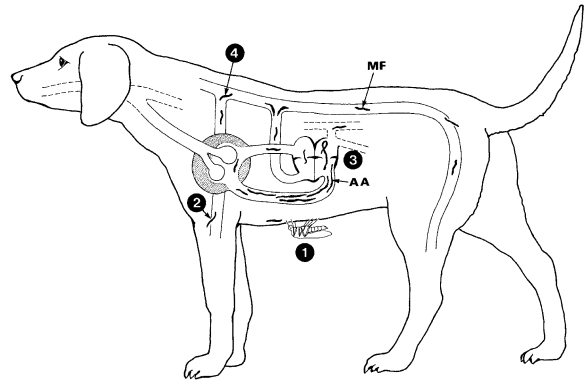

**Dirofilaria immitis.** Figure 1 Life cycle of the heartworm *Dirofilaria immitis*. 1–3 During blood meal of female → Mosquitoes larvae 3 are transmitted, which wander via lung to the heart and reach maturity within 6 months. While growing to a maximal length of 20 cm they may block the pulmonary arteries. 4 After copulation the females produce unsheathed microfilariae (MF) of about 200–3002 8 μm in size. AA, adult worms in artery; MF, microfilariae.



**Dirofilaria immitis.** Figure 2 Open heart of a dog showing the slender worms that may block the blood vessels.



**Dirofilaria immitis.** Figure 3 *Dirofilaria* worms from dog's heart.

**Disease Control, Epidemiological Analysis. Table 1** Principal modes of infection in parasitic diseases of man and other animals (according to Wernsdorfer)

Mode of infection (principal host)	Examples of parasite species
<b>No alternation of host species</b>	
Ingestion of infective stage, followed by self-replication within principal host	<i>Hymenolepis nana</i>
Ingestion of infective stage, often followed by self-contamination (immediate infectiousness)	<i>Enterobius vermicularis</i>
Ingestion of infective stage the development of which requires a period of non-parasitic existence in a suitable environment	<i>Ascaris lumbricoides</i>
Active invasion of infective stage the development of which requires a period of non-parasitic existence in a suitable environment	<i>Ancylostoma duodenale</i>
<b>One or several alternations of host species</b>	
Ingestion of free infectious stage (often on carrier material)	<i>Fasciola hepatica</i>
Ingestion of infectious stage within alternate host	<i>Gnathostoma spinigerum</i>
Active invasion of free infective stage	<i>Schistosoma</i> spp.
Active invasion, through bite wound inflicted by alternate host	<i>Wuchereria bancrofti</i>
Introduction of infective stage with insect bite at blood meal	<i>Plasmodium</i> spp.
Deposition of infective stage with faeces of vector at time of blood meal	<i>Trypanosoma cruzi</i>

reliable immunodiagnostic tests, the treatment continues to pose problems due to poor tolerability and relatively low efficacy of available medicaments, particularly in the management of chronic disease. The major operational approach relies currently on the prevention of future infections by environmental sanitation, i.e., reduviid-proofing of human habitations and animal shelters, which are simple and technically feasible measures applicable at low cost. In this case, the criteria for monitoring and evaluation of control measures will be the number of structures targeted for improvement and those actually improved as well as the adequacy of improvement work, in addition to a thorough search for structures missed, but deserving improvement. In addition, regular monitoring of the specific seropositivity rate for *T. cruzi* in the areas subject to housing improvement, and particularly the absence of new infections, will reflect the impact of the control measures.

The control of lymphatic filariasis caused by *Wuchereria bancrofti* relies mainly on the annual mass single-dose administration of ivermectin and albendazole that is also the principal tool adopted for eradicating the disease in scheduled areas. In urban areas endemic for lymphatic filariasis, this measure is usually complemented by vector control (*Culex* spp.). Effective monitoring of mass drug administration requires geographical reconnaissance and detailed population census in the entire operational area; information that needs regular updating. Monitoring criteria are the coverage of mass drug administration in

the scheduled population, the prevalence of infections with *W. bancrofti*, measured by microscopic diagnosis or antigen-detection tests, the incidence of new infections, and the prevalence and new occurrence of advanced clinical forms of lymphatic filariasis such as lymphoedema and elephantiasis. In addition, monitoring requires quality control of the diagnostic procedures. The complementary vector control operations need to be evaluated for the degree of coverage achieved in the detection and the sanitation potential confirmed breeding places, if possible supported by regular checking of vector density.

In malaria control the type of intervention will be largely determined by the envisaged and feasible target level. There are, basically, three target levels:

1. The elimination of mortality and the reduction of suffering from malaria
2. The elimination of mortality from malaria and the reduction of malaria prevalence, expressed in a significant decrease of morbidity
3. The elimination of malaria from a particular area or country

While the first objective can be reached by early diagnosis and treatment of all malaria cases, the achievement of the second objective usually requires also vector control measures and disease surveillance. The realization of the third objective necessitates rigorous precision in the performance of focus recognition and elimination as well as perfect coverage by disease surveillance in space and time.

**Disease Control, Epidemiological Analysis. Table 2** Major factors related to the transmission and control of malaria (according to Wernsdorfer)

Parasite	Human host	Anopheline vector	Environment
Species	Susceptibility to infection	Species	Topography (plains, hills, valleys)
Pathogenicity	Relative immunity (age)	Susceptibility to infection	Surface water (types, extension, depth, seasonality)
EE and E schizogony	Gametocytaemia	Feeding habits (hosts)	Vegetation
Hypnozoite infection	Exposure to vector contact	Feeding frequency (gonotrophic cycle)	Agricultural utilization
Recrudescence pattern	Occupation	Resting habits	Meteorology
Relapse pattern	Age	Flight span	Rainfall
Duration of infection	Migration	Life span in relation to relative humidity	Periodicity
Gametocytogony	Economic status and literacy	Breeding habitat	Abundance
Infectivity to anophelines	Housing conditions	Type of water collection	Temperature (seasons)
Temperature dependence of sporogony	Settlement pattern, population density	Stagnant, slow, or fast flowing	Wind
Sporozoite yield	General morbidity and mortality	Shade/sun	Relative humidity
Sporozoite infectivity (Drug sensitivity)	Rural and periurban economy	Vegetation	Man-made
	Malariogenic habits	Temperature/time correlation of breeding cycle (insecticide susceptibility)	malariogenic environments
	Awareness of malaria (Drug tolerance and compliance)		Water impoundments
			Irrigation systems Borrow and construction pits
			Intra- and peridomestic artificial breeding places
			Predators of anophelines

The elimination of mortality from malaria is usually the objective in areas where the currently available tools for malaria control are insufficient for achieving the reduction of prevalence of and morbidity from malaria. The goal can only be achieved by the competent operation of adequate diagnostic and curative facilities. Countries having adopted this primary objective, mainly in Africa, are still far from having established such adequate facilities. More than 80% of all "clinical" malaria cases are treated for falciparum malaria without laboratory-based diagnosis, thus unnecessarily increasing non-target drug pressure and promoting drug resistance. Here the structural and functional improvement of the health service infrastructure is the prerequisite for achieving the full coverage of the population in space and time which can ensure early recognition and treatment of true malaria cases. Such a system of evidence-based treatment requires continuous quality control at all levels and back-up by competent tertiary treatment facilities for the referral and management of patients with severe or complicated malaria. The key parameter for measuring success will be the mortality from malaria, but continuous monitoring of the efficacy of routine treatment will also be required in order to recognize therapeutic failure and to prevent avoidable mortality.

In areas aiming at the reduction of malaria prevalence, the type of appropriate interventions will depend on the baseline degree of prevalence and

morbidity. Usually it will require the application of vector control measures for the rapid reduction of malaria transmission and the building up of surveillance and focal sanitation activities to replace blanket vector control when the annual inoculation rate has dropped below 0.1%. Usually, such operations will be carried out in the framework of the general health infrastructure under the guidance of a specialized technical service. Given the complexity of operations, the criteria for monitoring encompass a relatively wide range and need to be adapted according to the progress of the control programme. The monitoring activities related to the vector control aspects depend on the selected operational methods, e.g., larval control by environmental sanitation, larviciding or deployment of larvivorous fish, or control of adult anopheline vectors by intradomestic application of residual insecticides. Here the validity and updating of geographical reconnaissance, the degree and regularity of operational coverage as well as the quality of material and logistics will be criteria for evaluation, complemented by the regular assessment of important entomological indices in well-chosen sentinel areas. These indices may, inter alia, include anopheline density, parous rate, human blood index, stability index and calculation of the inoculation rate. With regard to the disease-based parameters it will initially suffice to monitor the prevalence and the monthly and annual incidence of malaria, the area- and age-specific slide

positivity rates and the quality of diagnostic and therapeutic activities. With the implementation of surveillance the time has come for ensuring and monitoring quality and coverage of case detection, diagnostic and therapeutic activities in space and time, and the epidemiological classification of all malaria cases detected in the course of surveillance. These activities include the post-therapeutic follow-up of malaria cases and, if so indicated, revision of the treatment policies as well as the application of remedial focal vector control operations.

The achievement of the third and highest target level, i.e., the elimination of malaria from a larger geographical area or country may be attempted if preceding malaria control operations have shown consistent success and the likelihood of feasibility, based on an adequate and functionally competent service infrastructure. The indices for evaluation are essentially the same as those in the advanced phases of malaria control. Quality control of all aspects of passive case detection, diagnostic and therapeutic procedures, rapid implementation of epidemiological investigation and remedial focal measures need to be brought to near perfection. Once autochthonous malaria transmission has ended, the vigilance activities should be devoted to the rapid detection of imported malaria cases and preventing the establishment of new foci of transmission.

## Disease Control, Methods

### General Information

The approaches to the control of parasitic diseases are crucial components of the control strategy. The realization of the various approaches is dependent upon the use of individual measures the selection of which will be determined inter alia by expected efficacy, convenience, economy and acceptability. In most cases a variety of measures will be required simultaneously. This applies particularly to →anthropozoonoses and →zooanthropozoonoses with highly adaptable →biological systems. Such diseases are the most difficult to control, especially if non-domestic animals are involved as →reservoirs of infection. Another general aspect is man's awareness of parasitic diseases affecting humans and livestock, and the motivation for taking remedial action. If such broad motivation is lacking among the afflicted population, it is likely that imposed control programmes will have only limited and ephemeral success. →Health education

in the widest sense, encompassing both the health of humans and of domestic animals, should therefore prepare the ground for a systematic effort against the diseases affecting the community.

The simplest measures for achieving a set purpose are usually the best, but in their planning and execution due attention should be paid to acceptability, compatibility with cultural and religious background, and technical feasibility. For instance, it would be expecting too much if the dietary patterns of large populations were to be changed abruptly. Here the practical solution will consist of rendering the incriminated food safe rather than banning it. The adoption of particular individual protective measures will depend on the person's economic status. Wearing shoes will generally protect against →*ancylostomiasis*, and the use of impregnated bed nets supports protection against →*malaria*. However, shoes and bed nets have their price and not everybody may be able to afford them or even be willing to use them. Selection of the most appropriate measures for disease control requires therefore a sound appreciation of advantages, limitations and disadvantages of the methods.

Parasitic diseases encompass a wide range of biological systems. Hence, the control of these diseases has many facets, implying a host of different measures the most important of which are detailed in the following sections.

### Water Supplies

Water is one of the most important vehicles of parasitic diseases. It harbours a number of pathogens which can reach the human or animal host through transdermal penetration (e.g., →*Schistosomiasis*, *Man*) or through ingestion (e.g., →*Dracunculiasis*). It is also the medium through which the larvae of many parasitic species reach molluscan hosts, ultimately to be transmitted to man or livestock as a food-borne pathogen. Safe water is therefore an important means of controlling numerous parasitic diseases, especially →*helminth* infections (in addition to controlling the transmission of non-parasitic water-borne pathogens). Safe water should be available for consumption, bathing, washing and leisure activities. Ideally, piped, treated water should be available for household use. However, this will not be feasible as yet in most of the vast rural areas in the tropics and the subtropics. Well-maintained deep wells with elevated rims made out of masonry or concrete for the prevention of contamination will be an acceptable and feasible alternative in many places. The use of traditional step wells or ponds should be discouraged, but, if there is no other source, boiling or sieving water through a fine mesh may render it

largely innocuous. The installation of a supply of piped, treated water may permit the abolition of unhealthy water collections. There may be public objection to this if the water collections are used for producing food (e.g., fish, crabs) or for the irrigation of crops. However, larger pools can be constructed on a community basis and maintained in such a way that they do not permit the transmission of pathogens while fulfilling the purpose of pisciculture and serving as a source of water for agricultural and household needs.

### Excreta Disposal

Most helminth eggs or larvae have to reach water or humid ground for further development. They achieve this as a result of urination or defecation into water or onto wet soil. This may be part of a deliberate pattern, e.g., for the fertilization of family fish ponds in some parts of eastern Asia. In other instances it is due to an ingrained behavioral pattern or due to the lack of appropriate facilities for the safe disposal of excreta, or a lack of incentive for using available facilities. →Health education is probably the most important remedial factor in such situations. It is not advisable to embark on a major programme of building latrines before the population is willing to use them. This applies especially to rural areas in which the population has easy access to various types of surface water. The acceptability of latrines or of even better facilities for excreta disposal is usually higher in urban areas where the installation of sewage treatment will also often prove to be feasible and cost-effective. If the right type of sewage treatment plant is chosen, the resulting sludge will be biologically safe and usable as fertilizer.

### Agricultural Hygiene

The agricultural, pastoral and piscicultural environment is often intimately associated with the transmission of parasitic diseases. Agricultural labourers may serve as a source of infective material, especially if they do not dispose of their excreta in a safe way whilst in the fields. They are also exposed to a variety of pathogens, particularly in irrigated areas. In addition to these occupational aspects, the use of unsafe biological fertilizers (fecal matter) on vegetables will promote the spread of some parasitoses, e.g., →amoebiasis and ascariasis. Another important feature is the grazing of livestock in wetland areas. Again, health education and community efforts towards the development of safe grazing areas, e.g., through drainage, will be required to remedy the situation. Particular precautions should be taken when using wastewater and excreta in agriculture and aquaculture. Improperly managed water

resource development entails the risk of the propagation of parasitic diseases. This should be avoided through appropriate water management.

### Personal Hygiene

Apart from the obvious impact of unsafe excreta disposal, the lack of personal →hygiene is a leading cause of infection with a variety of parasitic pathogens such as →*Giardia lamblia*, →*Entamoeba histolytica* and →*Enterobius vermicularis*. Washing hands after defecation and before eating would largely reduce the transmission of these pathogens. The use of water and soap would also impede the transition from reversible lymphoedema to irreversible elephantiasis in →lymphatic filariasis. However, personal hygiene must go further than water and soap. It should include the seeking of treatment if there are symptoms of disease, and the avoidance of dangerous foodstuffs and of situations conducive to the contraction of infections. Health education will be an important vehicle for imparting the necessary knowledge, awareness and habits. This process should start at as early an age as possible and schools will have to play a major role in this endeavour.

### Housing

Siting and type of human habitations are closely related to the risk of contracting certain parasitic diseases. Houses with cracked masonry, mud walls and/or earth floors were found to be a particularly suitable environment for reduviid →bugs responsible for the transmission of Chagas disease. Simple housing improvement was found to reduce or even remove the risk of infection. Siting of settlements away from mosquito breeding grounds was an empirical yet highly effective means of protection against malaria. The siting of settlements at a long distance from irrigation canals (accompanied by the provision of safe household water) is an effective preventive measure against schistosomiasis since it will reduce the frequentation of the canals for washing, bathing and swimming.

Type and standard of housing play a major role in allowing the entrance and exit of disease-carrying mosquitos. It also determines the feasibility of mosquito and fly proofing, and the efficacy of ancillary →vector control measures such as mosquito coils and knock-down sprays.

### Environmental Management

Some measures of →environmental management as a means of disease control have been known since ancient

times. Environmental management was the mainstay of malaria control before the advent of residual →insecticides and synthetic antimalarials. It is making a comeback due to the limitations of other methods. The applicability of such measures in the control of parasitic diseases is very wide. The most important methods belong to environmental sanitation and water management. Water collections of various types are known to be breeding grounds for arthropod vectors of disease and the homestead of intermediate hosts of many helminthic organisms. Unless local economic (piscicultural and agricultural) and ecological reasons militate against them, filling, levelling and draining operations (drains, canals and use of trees) will be appropriate measures. The same applies to the sanitation of wetlands to be converted into safe land for agriculture and livestock.

Environmental sanitation, including peridomestic areas and the safe disposal of waste, is a field in which individual and community initiative can be used to great advantage, the more so when the necessary equipment is easily available and cheap (e.g., pickaxes and shovels) or obtainable on loan from various government departments (e.g., earth-moving machinery).

Water management applied to water-storage reservoirs (level management) and irrigation systems (watering and drying cycles) will facilitate disease control by rendering the areas unsuitable as a habitat of intermediate hosts or vectors of parasitic diseases. Water management should be an integral part of design and operation of water impoundments and irrigation schemes.

### Control of Vectors and Intermediate Hosts

The control of vectors and intermediate hosts of parasitic diseases may, to a large extent, be achieved through environmental sanitation. However, in some situations the applicability of such measures will be severely limited, as in the control of →*Simulium* spp., the vectors of onchocerciasis. Similarly, widespread temporary breeding places occurring during the rainy seasons in the tropics may pose insurmountable obstacles to environmental management. Alternative control approaches are therefore necessary.

At the beginning of the 20th century mosquito control was improved by the use of light oils and chemicals such as Paris Green. In spite of their efficacy the application of these measures has remained quite limited due to the need for repetitive use and high cost. The introduction of chemical insecticides has not fundamentally changed the situation. Moreover, ecological considerations and non-target effects against aquatic fauna and flora restrict the widespread repetitive use of insecticides. Chemical →larvicides, rapidly biodegradable insecticides with low non-target toxicity, are still useful in the rapid control of epidemics of

some vector-borne diseases. The same applies to the control of →*Cyclops* spp., the intermediate hosts of →*Dracunculus medinensis* and various other helminths.

→Biological methods for larval control have a long tradition inasmuch as larvivorous fish, e.g., *Gambusia affinis*, have been used since the beginning of the 20th century. Although appealing as a natural solution to a natural problem, larvivorous fish have a limited usefulness since seasonal and shallow breeding places are not suitable for their maintenance. It may also be difficult to find a local species of larvivorous fish. The introduction of non-local species may have a disastrous impact on the local aquatic fauna and interfere seriously with the production of food fish species.

Bacterial toxins from →*Bacillus thuringiensis* and →*B. sphaericus* are selectively directed against mosquito larvae and being used in the control of →*Culex* spp. and →*Aedes* spp. As the microorganisms sink to the ground they are not suitable for controlling →*Anopheles* spp. (surface feeders). *B. thuringiensis* does not reproduce in the breeding places, but *B. sphaericus* does to some extent though not sufficiently to relinquish the need for regular retreatment of the breeding places.

The intradomiciliary application of residual insecticides such as chlorinated hydrocarbons (DDT), organophosphorus compounds (malathion), carbamides (propoxur), fenitrothion and synthetic pyrethroids is suitable and often quite cost-effective for the control of adult endophilic →mosquitoes. However, the occurrence of specific resistance, aided and abetted by the agricultural use of insecticides of the same chemical groups, the presence of exophilic mosquitoes, increasing cost of insecticides and labour, and rising ecopolitical constraints have reduced their usefulness or applicability. Their use is still important, though, in the control of threatening or manifest epidemics where they are generally applied on a focal basis. These are situations where the ultra-low-volume (ULV) dispersal of suitable insecticides, may also show rapid effect. On the whole, the use of integrated vector control opens better prospects for an environmentally acceptable control of arthropod-borne parasitic diseases.

Pyrethroid-impregnated bed nets (deltamethrin or permethrin) or impregnated curtains and screens bar or reduce the contact between man and vector. They gained a firm place in malaria control, especially in areas with moderate or intensive transmission. Their efficacy is due to a repellent effect rather than specific insecticidal action, promoting also epidemiologically desirable vector deviation to animals.

The control of aquatic snails continues to present a serious problem. Environmental management is the only effective and widely acceptable procedure for snail control. The available molluscicides are either not

sufficiently effective (e.g., copper sulfate) or they are too toxic for the non-target fauna, including fish.

## Diagnosis

The ability to diagnose the presence of infections is an important factor in guiding the treatment of individuals, and forms the basis of epidemiological assessment which should enable the health authorities to determine the dimensions of the specific human and/or animal health problem. It is also an essential tool for monitoring the impact of disease control activities. Macroscopic and/or microscopic diagnosis of parasitic diseases may be relatively simple and reliable with some parasite species, especially intestinal helminths, but exceedingly difficult with others, mostly tissue-dwelling parasites, e.g., certain types of →nematodes. Serological methods based on the detection of specific antibodies usually reflect past or present host–parasite contact and therefore do not provide proof of current infection. Similarly, relatively fresh infections may not have given rise to detectable antibodies as yet and show seronegativity in spite of the living pathogen's presence. Demonstration of circulating antigens is a more reliable and specific basis for diagnosing current infections. Rather simple and reliable antigen detection tests have been developed for several human parasitoses, e.g., infections with *P. falciparum* or *W. bancrofti*. They are based on the detection of highly specific parasite antigens. However, relatively high costs continue to restrict their use in the framework of control programmes. The same still applies to tests for the detection of lactate dehydrogenase from malaria parasites.

Identification of infections by polymerase chain reaction (PCR) has been developed for numerous parasite species. However, the routine use of PCR is currently limited to research institutions and to diagnostic laboratories in prosperous countries. Its cost and operational requirements are too high to be affordable by most of the tropical countries.

In order to be widely practicable, diagnostic techniques for the most important human and animal parasitoses must be simple, cheap and undemanding in terms of sophisticated equipment, electricity supply and operator skill. Human and veterinary health services in many parts of the world still lack the infrastructure required for establishing reliable data on prevalence and incidence of major parasitic diseases and associated mortality. This accounts for serious deficiencies in national and international disease statistics.

## Treatment

Effective agents for the treatment of numerous parasitic diseases are available (see chapters on disease control). Some are reasonably cheap, such as those for the

treatment of intestinal nematode infections of humans and domestic animals. Other medicaments are expensive, such as third-line drugs for the treatment of →falciparum malaria. High costs may limit their use or encourage sub-optimal medication, and consequently allow a parasite →reservoir to be maintained that will be an obstacle to the effective control of the disease concerned. There are, however, a large number of parasitoses for which the therapeutic armamentarium is grossly deficient, e.g., Chagas disease, kala-azar and liver fluke infections.

With regard to malaria the situation was relatively satisfactory after the wider introduction of the 4-aminoquinolines in the late 1940s. However, the advent of chloroquine resistance in *P. falciparum* has compromised the efficacy of this group of drugs in wide parts of tropical Asia and South America. In the hyper- and holoendemic areas of tropical Africa juveniles and adults continue to derive therapeutic benefit from chloroquine, but young children whose immunity is not yet sufficiently developed generally require treatment with alternative drugs. →Resistance to the first-line alternative drugs, i.e., combinations of sulfonamides with pyrimethamine, already affects large areas in south-eastern Asia and South America, and is rising in parts of tropical Africa, necessitating the use of second-line alternative drugs which are considerably more expensive. Resistance to mefloquine and structurally related quinine occurs in Cambodia, parts of southern Vietnam and eastern Myanmar and in some parts of Thailand bordering on Myanmar and Cambodia. Here, combined treatment with artesunate or artemether with mefloquine still yields satisfactory results.

On the whole the veterinary health sector has had greater success in the development of anti-parasitic drugs than the human health sector. This is largely due to a better financial endowment of agricultural and livestock development and to the more stringent toxicological requirements governing the registration of medicaments for use in man. The situation is compounded by the fact that the development of medicaments against human parasitoses holds little attraction for the pharmaceutical industry since the main market for such drugs is in poor tropical countries.

## Immunization

In many parasitic diseases there is evidence of the natural development of immunity to the specific pathogen. Such immunity rarely induces total refractoriness to reinfection, but it will restrict parasite reproduction or acceptance and induce tolerance to the pathogen. The development of immunity is quite slow. Considerable efforts have been made in the field of immunization against parasitic diseases, especially against those caused



by →[protozoa](#). In bovine babesiosis, attenuated live *Babesia bigemina* is being used for inoculation of livestock. The resulting immunity is satisfactory, but there is still significant mortality associated with vaccination which is, on balance, economically acceptable. Such approaches are not feasible in human parasitic diseases except for agents with low virulence, e.g., *Leishmania major*.

Although immunization holds substantial promise in the control of many parasitic diseases and the progress in gene technology and polypeptide synthesis is likely to pave the way to economically acceptable products, there is still a long and arduous way to go before well-tolerated and reliable vaccination with more than palliative activity will become a reality in the control of parasitic diseases.

### Clinical Relevance

Diagnostic and therapeutic measures have direct clinical relevance. Other disease control measures have indirect clinical relevance inasmuch as they are geared to the reduction of the community's disease burden, and thus a lessening of the pressure on the health services.

---

## Disease Control, Planning

An almost universal shortage of resources, particularly marked in tropical developing countries, renders the simultaneous control of all major parasitic diseases difficult in most areas of the world. The available resources must therefore be used to address important issues with a reasonable prospect of success. Parasitic infections may be important and if the disease causes severe symptoms and kills humans or livestock people will be aware of it. Other parasitoses, however, though less spectacular, may cause even more damage on account of their wide distribution, but public awareness may be low due to the disease's unobtrusive manifestations.

The shortage of resources and competition for those available make it necessary to set priorities on the basis of human suffering and death, or on economic loss caused by particular diseases of man or domestic animals. Many such diseases are important obstacles to development but their impact needs to be quantified in terms of disease-associated loss in order to provide a solid basis for priority ranking by governments or other interested groups. Public awareness of the disease in question may influence priority selection via political pressure and may promote community participation, but there is a risk that priorities so selected may not represent the most appropriate choice.

Once the control of a particular disease or group of diseases has been tentatively allocated high priority, the time has come to review the existing approaches that seem to be feasible in the local situation. Knowledge of the local epidemiological features and earlier experience in control within or near the area will be an asset. The feasible approaches and the specific measures required to implement them need to be projected, on a provisional basis, in terms of requirements for resources, skills, infrastructure and expected results. At this stage, or earlier, it may be necessary to strengthen epidemiological information.

After the feasibility of possible approaches has been scrutinized the preliminary objectives should be determined. These may range from elementary forms of control for the prevention of death from parasitic disease(s) to the complete elimination of the parasitosis from a particular area, country or geographical region. The setting of the objectives should be realistic and take into account the available resources. A staged procedure may be envisaged that permits the future upgrading of objectives in keeping with the growth of resources and general development.

Provisional objectives should then be put to the test in realistic →[feasibility studies](#) to be undertaken under qualified technical guidance through the service structure that is expected to be ultimately responsible for the implementation of the control activities. There is little room for so-called pilot projects since they usually operate with relatively greater resources, more qualified and more motivated personnel, and much higher staffing levels than those ultimately available to the large-scale control programme. Results from pilot projects should therefore not be used for the extrapolation of the probable impact of more extensive routine operations. Feasibility studies of single or combined approaches will permit the →[validation of approaches](#) as well as technical adjustments to improve their efficacy. Such studies will also clarify requirements in terms of financial and manpower resources, training, equipment and supplies, logistics, mechanisms of evaluation and remedial action, and will provide the elements for determining →[cost-effectiveness](#).

In the light of feasibility studies, which need to be done in each major epidemiological and operational stratum, it will be possible to conclude whether the provisionally set objective can be reached with the available resources, whether the objective should be upgraded or downgraded or, in the worst of cases, whether attempts at any form of control would be futile under the present circumstances. Some thought should also be given to the capability of sustaining the control effort in the future when prevalence and/or incidence of the disease have been reduced since potentially infective →[reservoirs](#) will in most situations still be present and cause serious repercussions with any slackening of the

control effort. For this reason it may be more appropriate to use an existing general service structure (with technical backup and guidance from a specialized group) rather than a vertical, disease-specific service structure which is subject to political and budgetary vagaries and often lacks popular support. Control of parasitic diseases of man can be incorporated in the development and delivery of general health care, while livestock health can become part of community development activities. This approach would promote community understanding and involvement which are recognized as essential prerequisites for sustained effort and success.

Preliminary and intermediate feasibility assessment and the scrutiny of the inventory of requirements are followed by the preparation of a master plan for the control of a specific disease or group of diseases. Its successful implementation will largely depend on continuous and well-qualified technical guidance and evaluation, timely recognition of technical and administrative problems, and rapid remedial action.

Current strategies for the control of widespread and economically important human diseases such as →malaria, →schistosomiasis and →filariasis are described under the respective headwords.

Remote sensing by meteorological satellite technology is currently being developed as a tool for forecasting epidemics of mosquito-borne diseases. The application holds particularly high promise for areas where epidemics are known to occur as a result of cyclical changes of rainfall (e.g., the Sahel zone of Africa).

Although providing promising leads, efforts directed to the development of vaccines against →malaria and schistosomiasis have so far not been successful enough to make projections for the availability of operationally deployable products in the immediate future.

---

## Disease Control, Strategies

### General Information

Parasitoses are widespread in the animal kingdom and in plants, causing a wide spectrum of pathologic effects ranging from little more than commensalism to severe, even fatal disease. Many parasitic diseases cause considerable suffering and have an important impact on human health, and on livestock and crop production. Some parasitic diseases have a relatively low incidence but show high severity and a potential for producing epidemic outbreaks. Others are widespread, rarely causing gross pathology, but sapping the strength and health of those affected. The mode of transmission also

shows considerable variety, ranging from direct contact to obligatory passage through several host species. The distribution of such hosts and environmental factors may therefore limit the occurrence of specific parasitoses. Thus some parasitic diseases are cosmopolitan while others may be restricted to very small ecological niches, with many nuances between these extremes. Some parasites have a rather wide choice of vertebrate hosts, others are highly stenoxenic. In addition, naturally →acquired immunity may modify the manifestations of many parasitoses and lead to age-specific patterns of disease.

The detrimental impact of many parasitic diseases makes their control desirable if not indispensable in the interests of health and economy. The great variety of parasitic diseases and of the factors involved in their transmission requires widely different control approaches and strategies tailored to the specific epidemiological conditions and the goals of intervention.

In planning control strategies, it is helpful to classify the various parasitic diseases of man and other animals, irrespective of the causative species' taxonomic standing, into those affecting only humans (→Anthroponoses), those affecting only other animals (→Zoonoses), and those affecting both man and other animals (→Anthropozoonoses or →Zooanthroponoses). (Major representatives of the three groups are listed under the respective headwords in order to facilitate an appreciation of the wide range of causative agents and the modes of transmission involved.) In the majority of parasitic diseases, the causative organism's life cycle provides the essential elements for developing a control strategy. Such strategies invariably aim at the interruption or reduction of transmission at vital points.

Approaches to the control of parasitic diseases are based, essentially, on an analysis of the biological system characteristic of the given parasite species, the determination of targets of intervention, the critical consideration of measures suitable for such intervention, and an inventory of available experience in the control of parasitoses.

Some measures directed against parasitic diseases may exert a non-target environmental impact that needs to be considered in the planning of control activities. This may require environmental compatibility studies before clearing specific methods for wider application.

In all human parasitoses with gross pathology, e.g., →malaria, →visceral leishmaniasis, (→Kala Azar), African and →American trypanosomiasis, onchocerciasis and →lymphatic filariasis, clinical relevance is the motor for developing and enacting disease control strategies. These aim at improving human health and reducing disease incidence or prevalence. Similar considerations apply to diseases affecting livestock, where also economic aspects play a substantial role.

## Disease Control, Targets for Intervention

Knowledge of the parasite's life cycle is a prerequisite for determining feasible targets of control intervention. However, before such knowledge became available it was not rare for communities afflicted or threatened by certain parasitic diseases to take, empirically or intuitively, appropriate measures such as the prohibition of pork as a means of avoiding →[trichinosis](#), the siting of habitations to evade →[malaria](#) or the use of *Cinchona* bark as a febrifuge.

A rational approach to the control of parasitic diseases requires a full knowledge of potential targets. Measures directed against such targets may be practical, i.e., feasible and effective with currently available means and technology. Other targets may be too elusive for basing a strategy on their successful control. These are, nevertheless, worthy of exploration since a multifaceted approach to disease control usually offers better prospects for success than the deployment of a single measure.

Disease control is, by definition, clinically relevant. Community participation in disease control programmes depends largely on the visibility of results. Effective treatment is usually the best advertisement for a control programme and promotes the understanding for, and acceptance of, other programme activities. Programmes without a therapeutic component are generally unpopular. In order to be viable, programmes for the control of acutely life-threatening diseases, e.g., malaria in areas with *P. falciparum*, require an efficient mechanism for the rapid and competent management of severe and complicated cases.

### Related Entries

Detailed information on known →[targets for intervention](#) against specific diseases is given under the respective headwords.

## Diseases, Animals

- [Alimentary System Diseases, Animals](#)
- [Alimentary System Diseases, Carnivores](#)
- [Alimentary System Diseases, Horses](#)
- [Alimentary System Diseases, Ruminants](#)
- [Alimentary System Diseases, Swine](#)
- [Blood Diseases, Animals](#)

- [Cardiovascular System Diseases, Animals](#)
  - [Clinical Pathology, Animals](#)
  - [Genital System Diseases, Animals](#)
  - [Nervous System Diseases, Animals](#)
  - [Nervous System Diseases, Carnivores](#)
  - [Nervous System Diseases, Horses](#)
  - [Nervous System Diseases, Ruminants](#)
  - [Nervous System Diseases, Swine](#)
  - [Respiratory System Diseases, Animals](#)
  - [Respiratory System Diseases, Horses, Swine, Carnivores](#)
  - [Respiratory System Diseases, Ruminants](#)
  - [Skin Diseases, Animals](#)
  - [Urinary System Diseases, Animals](#)
- See at the different genera, species.

## Diseases, Man

See the different species and →[Endoparasites of Humans](#).

## Diseases of the Eye

→[Eye Parasites](#).

## Dispharynx

Genus of the nematode family Acuariidae, which parasitize at the walls of the stomach of birds.

## Dixenous Development

Many parasites have 2 (dixenous development) or more (→[Heteroxenous Development](#)) different hosts during their life cycle: a →[final host](#) (where the sexual phase proceeds), and an →[intermediate host](#) (with continuing asexual reproduction) or a →[paratenic host](#), inside which no development occurs but only an accumulation of infectious stages. This alternation of hosts may be facultative or obligatory.

**Related Entries**

→Paratenic Host, →Monoxenous Development, →Coc-cidia.

**DNA Synthesis**

→Deoxynucleotides.

**DNA-Synthesis-Affecting Drugs I: Alkylation Reactions****Structures**

Fig. 1.

**Nitroimidazoles****Important Compounds**

Metronidazole, Nimorazole, Ornidazole, Tinidazole.

**Synonyms**

Metronidazole: SC-32642, Artesan, Flagyl I.V., Clont, Arilin, Cont, Danizol, Deflamon, Fossyol, Gineflavir, Klion, Orvagil, Sanatrichom, Trichazol, Trichocide, Tricho Cordes, Torgyl Forte, Tricho-Gynaedron, Tricocet, Trivazol, Vagilen, Vagimid.

Nimorazole: N-2-morpholinoethyl-5-nitroimidazole, Nitrimidazine, K 1900, Acterol, Esclama, Naxofen, Naxogin, Nulogyl, Sirledi, Radanil, Rochagan.

Ornidazole: Tiberol.

Tinidazole: CP 12574, Fasigin, Fasigyn, Pletil, Simplotan, Sorquetan, Tricolam.

**Clinical Relevance**

The 5-nitroimidazoles (Fig. 1) exert a wide variety of activities against different pathogens. Their antibacterial activity is useful in different indications. Thus, they are useful against obligatory anaerobic intestinal bacteria, intra-abdominal gynaecological infections, aspiration pneumonia, superinfected bronchial carcinomas, brain abscesses, *Bacteroides fragilis* infections, gut wall necrosis as well as polymicrobial pelveoperitonitis. The antibacterial activity of metronidazole is also useful in the treatment of →*Dracunculus medinensis* infections. Moreover, 5-nitroimidazoles are applied in chronic non-bacterial diseases of the intestine like Morbus Crohn. In addition, metronidazole or tinidazole are effective in the treatment of peptic ulcera in

combination with omeprazole (lansoprazole or pantoprazole) and clarithromycin (with or without amoxicillin).

5-nitroimidazoles are in addition useful in protozoal infections caused by →*Giardia lamblia*, →*Trichomonas vaginalis*, →*Entamoeba histolytica* (Table 1), in urogenital infections caused by →*T. foetus* in cattle, as well as in intestinal trichomoniasis, giardiasis and →amoebiasis in dogs, cats and monkeys. The drug has additional activities against →*Blastocystis hominis* *in vitro* and *in vivo* and →*Balantidium coli* infections of pigs.

The antiprotozoal action of 5-nitroimidazoles is directed against *G. lamblia* →trophozoites and cysts in the duodenum, against *T. vaginalis* trophozoites in vagina, cervix, urethra, epididymis, prostate and in *E. histolytica* infections against trophozoites (minuta forms) in the phase of →binary fission and cysts in the intestinal mucosa and trophozoites (magna forms) in liver and other extraintestinal organs. The activity against *B. coli* is directed against the intestinal trophozoites which divide by binary fission and cysts in the faeces.

**Molecular Interactions**

The antibacterial action of metronidazole relies on its activation in anaerobic bacteria (*Bacteroides*, *Clostridium*) mediated by pyruvate-ferredoxin-oxidoreductase (PFOR). Metronidazole is generally not toxic to mammalian cells, because they lack electron transport proteins like PFOR with sufficiently negative redox potential for drug activation. The biochemical target of 5-nitroimidazoles is also the enzyme PFOR in *Giardia*, →*Trichomonas* and *Entamoeba* (Fig. 2). In *T. vaginalis* PFOR is located in the →hydrogenosomes. Comparison of the genes from *E. histolytica*, *T. vaginalis* and →*G. lamblia* encoding PFOR show 35–45% sequence identity. The PFOR from these parasites are dimeric or tetrameric proteins of 240 kDa subunits. 5-nitroimidazoles exert their activity only after the reduction of the nitro group by PFOR which occurs in single electron steps (in total 4 electrons) and results in the formation of a hydroxylamine derivative. The formation and disappearance of the nitro-free anion radical could be detected in →trichomonads (Fig. 2). Until now there is only indirect evidence for cytotoxicity of the intermediate nitroso-free radicals and hydroxylamines. It is presumed that the interaction of toxic intermediates with various cellular macromolecules (DNA, proteins, membranes) leads to an irreversible cellular damage by DNA-alkylation. Indeed, there is a correlation between the reduction of the nitro group of metronidazole and DNA damage *in-vitro* and *in-vivo*.

**Resistance**

PFOR is in the centre of the resistance mechanism in *G. duodenalis* resulting in reduced production of

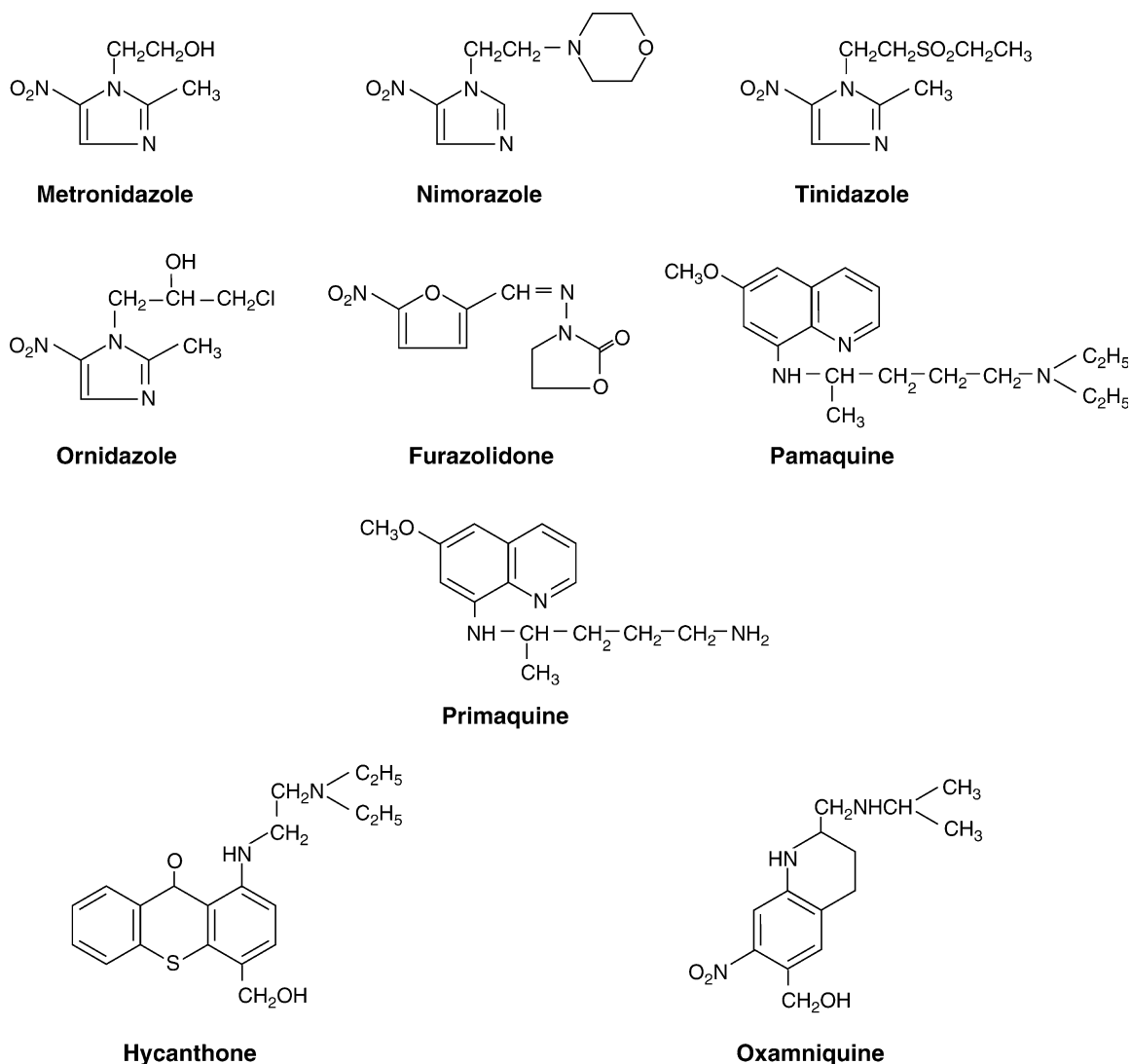

**DNA-Synthesis-Affecting Drugs I: Alkylation Reactions.** Figure 1 Structures of drugs affecting DNA-synthesis by alkylation reactions.

toxic radicals by decreased PFOR activities. Indeed, in *T. vaginalis* there is a correlation between increased metronidazole-resistance and decreased activity of the PFOR and hydrogenase. Besides PFOR in *T. vaginalis* ferredoxin (Fd) also seems to play an important role in the resistance mechanism. Thus, in metronidazole-resistant *T. vaginalis* a decrease of intracellular Fd levels by 50%, a decrease of Fd mRNA levels by 50–65% and a reduced transcription of Fd gene can be observed. Moreover, there is a correlation between resistance and the appearance of point mutations in the 5' flanking sequences of the gene. Two mutations could be identified with a reduced binding affinity of a 30 kDa protein to a 28 bp region within the mutated region upstream of

the Fd gene. Thus, metronidazole resistance strongly correlates with an altered regulation of the Fd gene transcription. The limitation of the ability of the cell to activate metronidazole by reduced gene transcription finally results in decreased intracellular levels of Fd, so that metronidazole is less efficiently reduced to its cytotoxic form.

There is an alternative hypothesis of the resistance mechanism in *T. vaginalis* in which a half-type P-glycoprotein should be overexpressed by a mechanism other than gene amplification. However, there is no clear correlation between levels of expression of the gene for this putative transporter protein and levels of resistance. Thus, the role of this gene in resistance remains doubtful.

**DNA-Synthesis-Affecting Drugs I: Alkylation Reactions. Table 1** Degree of giardicidal, trichomonacidal and amoebacidal drugs

Year on the market	Drug	Mastigophora				Sarcodina	Ciliata
		<i>Leishmania</i>	<i>Trypanosoma cruzi</i>	<i>Giardia lamblia</i>	<i>Trichomonas vaginalis</i>	<i>Entamoeba histolytica</i>	<i>Balantidium coli</i>
Energy-Metabolism-Disturbing Drugs							
	Iodoquinol					xx	
1999	Nitazoxanide (a)			xx		xx	
DNA-Synthesis-Affecting Drugs I: Alkylation Reactions							
1962	Metronidazole (b)	xxx	xE	xxx	xxx	xxx	xx
	Furazolidone (c)*			xx			
DNA-Synthesis-Affecting Drugs II: Interference with Purine-Salvage							
1956	Diloxanid (d)					xxx	
Protein-Synthesis-Disturbing Drugs							
1912	Emetine (Dehydroemetine) (d)	x	xE			xxx	
	Erythromycin, Paromomycin (e)*			xx			
	Tetracyclin			xx			
Hem(oglobin) Interaction							
(1937)	Chloroquine (d)					xx	
Microtubule-Function-Disturbing Drugs							
1979	Albendazole, Mebendazole (f)*			xxx			

xxx = high efficacy at least against some developmental stages and diverse species; xx = partially effective (regarding developmental stages and diversity of species); x = slightly effective; E = active experimentally (Haberkm 1993); (a) the only drug available against *Cryptosporidium parvum*; (b) other 5-nitro-imidazoles: Ornidazole, Tinidazole (1985), Nimorazole; (c) nitrofurantoin, as active as metronidazole, not as widely used, unavailable in Australia; (d) alone or in combination with metronidazole; (e) recommended during pregnancy; (f) benzimidazole, suitable alternatives to 5-nitroimidazoles

## Furazolidone

### Synonyms

3-(5-nitrofurfurylideneamino)-2-oxazolidinone, NF180, Furovag, Furoxane, Furoxone, Giarlam, Giardil, Medaron, Neftin, Nicolen, Nifulidone, Ortazol, Roptazol, Tikofuran, Topazone.

### Clinical Relevance

This drug is active against *Giardia lamblia* (Table 1). The action is directed against *G. lamblia* trophozoites in the small intestine which divide by binary fission.

### Molecular Interactions

The enzyme PFOR seems to be of great importance in the furazolidone action. The reduction of this nitro compound *in vivo* to cytotoxic products is assumed to be similar to that of 5-nitroimidazoles (Fig. 2). The reduction potential of furazolidone is regarded as being even greater than that of metronidazole. An additional

reduction mechanism of furazolidone via an NADPH/NADH oxidase to its nitroanion radical is also in discussion.

### Resistance

The molecular mechanism of furazolidone resistance is unclear to date. An involvement of thiol detoxification pathways is discussed. But any correlation between a decrease in furazolidone sensitivity and an increase in thiol cycling in *G. lamblia* is very doubtful since these parasites lack the enzymes of →glutathione metabolism.

## Primaquine/Pamaquine

### Synonyms

Primaquine: 8-(4-amino-1-methylbutylamino)-6-methoxyquinoline, SN 13272.

Pamaquine: Aminoquin, Beprochine, Gamefar, Plasmochin, Plasmoquine, Praequine, Quipenyl.

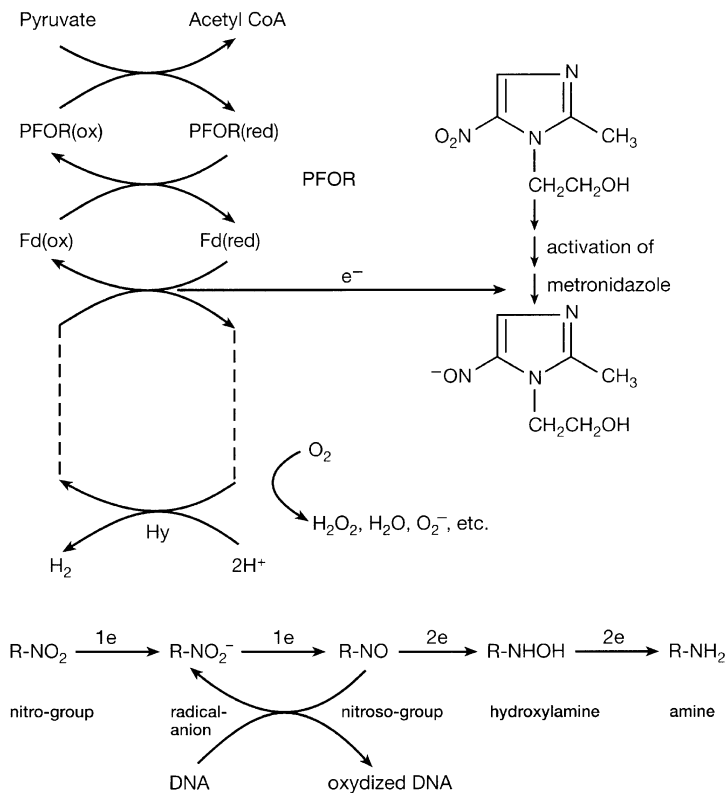

**DNA-Synthesis-Affecting Drugs I: Alkylation Reactions. Figure 2** Model of the mechanism of action of Metronidazole and other 5-nitroimidazoles.

### Clinical Relevance

Both drugs belong to the chemical class of 8-aminoquinolines. Pamaquine was discovered in 1924, primaquine was introduced in 1950. Primaquine is a very effective prophylactic antimalarial agent and very effective in preventing relapses of  $\rightarrow$ malaria so that it can be used for a radical cure ( $\rightarrow$ Haem(oglobin) Interaction/Table 1). Exoerythrocytic stages of  $\rightarrow$ malarial parasites in the liver (sporozoites,  $\rightarrow$ hypnozoites, schizonts) and the erythrocytic gamonts get severely damaged ( $\rightarrow$ Haem(oglobin) Interaction/Fig. 2). Primaquine has an additional influence on the  $\rightarrow$ sporogony in the mosquito vector, however, it has no effect on erythrocytic schizonts (parasitic stages responsible for fever). Besides the antimalarial activity primaquine shows an additional activity against *Theileria sergenti* infections.

### Molecular Interactions

Primaquine is presumably metabolised *in vivo* to products including 5,6-quinoline diquinone which structurally resembles hydroxynaphthoquinones. It is therefore assumed that the respiratory chain of the parasites is disrupted and the pyrimidine nucleotide synthesis

is inhibited. In an alternative theory the generation of free radicals during the primaquine interaction with the respiratory chain is believed to be of great importance.

### Oxamniquine

#### Synonyms

Mansil, Vansil, Vancil.

#### Clinical Relevance

Oxamniquine was introduced in 1973. The antitrema-todal activity is directed only against  $\rightarrow$ *Schistosoma mansoni*. Oxamniquine has no activity against  $\rightarrow$ *S. haematobium* or  $\rightarrow$ *S. japonicum* ( $\rightarrow$ Membrane-Function-Disturbing Drugs/Table 2).

#### Molecular Interactions

The *in vitro* activity of oxamniquine is very similar to that of the structurally related hycanthon. Oxamniquine leads to a delayed death of schistosomes until day 14. Thereby, an *in vitro* exposure of only 1h is sufficient for the delayed death of the worms. Because the worm motility is increased at oxamniquine concentrations comparable to hycanthon, an anticholinergic action of

oxamniquine was formerly proposed. However, this hypothesis is disproved in the meantime. Indeed, it could be shown that nucleic acid synthesis becomes irreversibly inhibited in drug-sensitive worms, in drug-resistant worms, in *S. japonicum* and in immature worms. The inhibition is more pronounced in male than in female schistosomes. The  $\rightarrow$ mode of action of hycanthon and oxamniquine is summarised in Fig. 3 according to the model of Cioli et al. 1995. At first hycanthon (and also oxamniquine) is converted to an ester (sulphate, phosphate or acetate) by a specific schistosomal enzyme. Thereafter, the ester spontaneously dissociates resulting in the formation of an electrophilic reactant which is capable of alkylating schistosomal DNA. Thus, the initial drug esterification is the only enzymatic step in the whole pathway (Fig. 3). The validity of this model is supported by experiments using the N-methylcarbamate esters of hycanthon. These hycanthon esters have been shown to be equally

active against sensitive and resistant worms, since the first enzymatic esterification step can be surmounted by these hycanthon esters. As a result covalent binding of hycanthon and oxamniquine to macromolecules including DNA occurs *in vitro*. In female and in immature schistosomes binding of hycanthon and oxamniquine to DNA is diminished compared to males. Adducts of hycanthon with guanosine residues of schistosomal DNA are formed.

ATP,  $Mg^{++}$  and another unknown small molecule are cofactors during the esterification step by the schistosomal enzyme. The activity of this enzyme can be restored by sulfate ions. Thus, this enzyme may function as a sulfotransferase with a molecular weight ranging from 30 to 35 kDa. The real function of this sulfotransferase is still unknown. A possible detoxifying function is discussed as well as an involvement in modifying male and female steroid hormones. Such a sulfotransferase is presumably also present

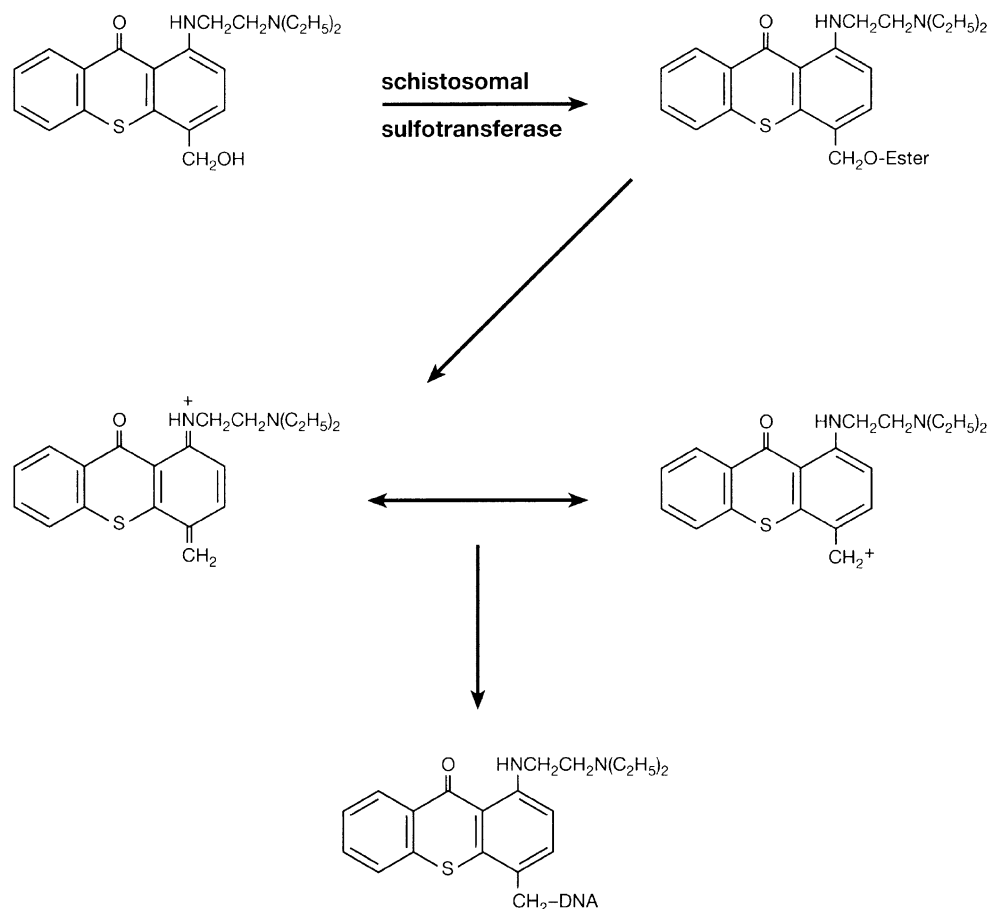

**DNA-Synthesis-Affecting Drugs I: Alkylation Reactions.** Figure 3 Proposed mechanism of action of hycanthon and oxamniquine.



in *S. haematobium* and *S. japonicum*. However, structural differences of the sulfotransferases between the different →*Schistosoma* spp. may be responsible for different binding of hycanthon and oxamniquine to this enzyme. While there is a strong binding of both drugs to *S. mansoni* sulfotransferase, only hycanthon can be bound by *S. haematobium* sulfotransferase. The sulfotransferase of *S. japonicum* is even unable to bind hycanthon or oxamniquine.

### Additional Features

There are also differences in the mutagenicity between hycanthon and oxamniquine. Oxamniquine has very low mutagenic activity compared to hycanthon. The mutagenicity of hycanthon is due to production of frameshift mutations as a consequence of its ability to intercalate between DNA base pairs resulting in an unwinding and distortion of the double helix. Therefore, hycanthon has been withdrawn as an antischistosomal drug. Oxamniquine also has some minor intercalative properties which are not enough for strong mutagenic effects.

### Resistance

Resistance against hycanthon and oxamniquine is controlled by a single, autosomal, recessive gene. Resistant schistosomes lack the activity essential for antischistosomal effects of oxamniquine in sensitive worms, because the enzymatic esterification step is missing in resistant parasites similar to the susceptible *S. japonicum*.

## DNA-Synthesis-Affecting Drugs II: Interference with Purine Salvage

### Structures

Fig. 1.

#### Diloxanide

##### Synonyms

2,2-dichloro-4'-hydroxy-N-methylacetanilide, Furamide, Entamide, Ame-Boots.

##### Clinical Relevance

Diloxanide is exclusively used as fluorate ester. The antiprotozoal activity is directed against →*trophozoites* and lumen cysts of →*Entamoeba histolytica* (→*DNA-Synthesis-Affecting Drugs I/*Table 1). Diloxanide has only minor activity in acute ulcerative intestinal →*amoebiasis*. Combinations of diloxanide with

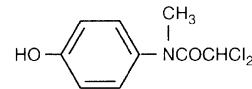

Diloxanide

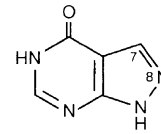

Allopurinol

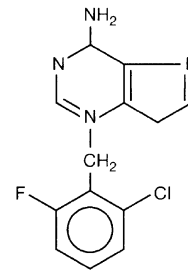

Arprinocid

**DNA-Synthesis-Affecting Drugs II: Interference with Purine Salvage.** Figure 1 Structure of drugs affecting DNA-synthesis by interfering with →*purine salvage*.

5-nitroimidazoles, emetine or chloroquine for the treatment of amoebic dysentery and liver abscesses can be very useful.

### Molecular Interactions

It is suggested that diloxanide interferes with the purine salvage system by impairing adenine incorporation during the RNA-synthesis in *E. histolytica*.

#### Allopurinol

##### Synonyms

Allopurinol, Zyloric.

##### Clinical Relevance

Allopurinol is in medical use against →*Leishmania* spp. In addition, it has experimental activity against →*Trypanosoma* spp. (Table 1). Furthermore, allopurinol is clinically used in the treatment of gout as urikostatic drug.

### Molecular Interactions

The antiprotozoal →*mode of action* against *Trypanosoma cruzi* and *Leishmania* spp. relies on the metabolism of allopurinol to adenosine nucleotide analogues. These are then incorporated into RNA with

**DNA-Synthesis-Affecting Drugs II: Interference with Purine Salvage. Table 1** Degree of efficacy of important drugs against kinetoplastid protozoa

Year on the market	Drug	Mastigophora		
		<i>Trypanosoma brucei</i> group	<i>Leishmania</i>	<i>Trypanosoma cruzi</i>
<i>I. Drugs against Trypanosoma brucei</i>				
Energy-Metabolism-Disturbing Drugs				
1920	Suramin	xxx (1)		x
DNA-Synthesis-Affecting Drugs III: Interference with Polyamine Metabolism and/or Trypanothione Reductase				
1949	Melarsoprol	xxx (2)		
about 1958	Diminazene aceturate	xxx	xE	
	Quinapyramine	xxx (1)		
1982	Eflornithine	xxx	xx	
<i>II. Drugs against visceral and cutaneous leishmaniasis</i>				
Energy-Metabolism-Disturbing Drugs				
	Glucantime (Meglumin-antimonate)		xxx	
	Sodium-Stibogluconate		xxx	
DNA-Synthesis-Affecting Drugs II: Interference with Purine Salvage				
	Allopurinol	xE	xx	
DNA-Synthesis-Affecting Drugs III: Interference with Polyamine Metabolism and/or Trypanothione Reductase				
about 1938/1942	Pentamidine/(Hydroxy)stilbamidine	xxx (1)	xx	
Protein-Synthesis-Disturbing Drugs				
2006	Paromomycin (4)		xx	
Membrane-Function-Disturbing Drugs				
	Amphotericin B		xxx	
1997/2005	Miltefosine (3)		xxx	
<i>III. Drugs against Trypanosoma cruzi</i>				
DNA-Synthesis-Affecting Drugs III: Interference with Polyamine Metabolism and/or Trypanothione Reductase				
1972	Nifurtimox	xxx		xxx
1978	Benznidazole			xxx

xxx = high efficacy at least against some developmental stages, and diverse species; xx = partially effective (regarding developmental stages and diversity of species); x = slightly effective; E = experimentally effective; (1) in blood (acute phase); (2) in liquor (late phase); (3) 1997 for visceral leishmaniasis, 2005 for cutaneous leishmaniasis; (4) for visceral leishmaniasis, potentially affordable alone or in combination; possible replacement for antimony

the result that the growth rate of sensitive parasites is significantly reduced.

The mode of action in gout is quite different from the antiprotozoal action presumably by the inhibition of xanthine oxidase.

## Arprinocide

### Synonyms

9-(2-chloro-6-fluorobenzyl)adenine, MK-302, Aprocox.

### Clinical Relevance

Arprinocide exhibits good anticoccidial and antioocidiostatic activity (→DNA-Synthesis-Affecting Drugs IV/Table 1). Its activity against *Eimeria tenella* is weaker compared to that against other →*Eimeria* spp.

## Molecular Interactions

Arprinocide is simultaneously a purine and pyrimidine analogue. The activity is directed against sporozoites, merozoites and first generation schizonts. The main mechanism of action remains unclear. Many pyrimidine nucleotide-requiring enzymes are inhibited. Also, the uptake of hypoxanthine and guanine in infected eukaryotic cells is inhibited. The anticoccidial activity of arprinocide is mediated by the N-1 oxide metabolite. Interestingly, the N-1 oxide metabolite itself is not a potent inhibitor of the biochemical pathways in spite of the very potent *in vitro* and *in vivo* activity. Electronmicroscopically, a vacuolization and degeneration of intracellular membrane systems of →coccidia can be observed.

## DNA-Synthesis-Affecting Drugs III: Interference with Polyamine Metabolism and/or Trypanothione Reductase

### Mode of Action

Fig. 1.

### Structures

Fig. 2.

### Melarsoprol

#### Synonyms

Melarsen oxide, Mel B, Arsobal.

### Clinical Relevance

Melarsoprol was explored in 1949 and was the drug of choice for late phase of infections with *T. b. gambiense* and *T. b. rhodesiense* until 1990 (Table 1). An intravenous application is necessary with 3.6 mg/kg b.w. in 3–4 series of 4 injections separated by at least one week. Melarsoprol possesses serious toxic side effects such as reactive encephalopathy in 5–10% of the cases with a mortality rate of 1–5%. In veterinary medicine melarsoprol is exceptionally used against *T. equinum* in horse. It has only low efficacy against *T. simiae* in pigs.

### Molecular Interactions

Melarsoprol is a trivalent organic arsenical. The activity is directed against →*trypomastigotes* in the liquor. An inhibition of trypanosomal pyruvate kinase (PK) as the →*mode of action* was proposed very early. There is a loss of motility of drug-treated trypanosomes, and cell lysis occurs within minutes. However, there is no correlation between melarsoprol-induced lytic effects and inhibition of pyruvate kinase. In the meantime trypanosomal phosphofructokinase (PFK) ( $K_i < 1 \mu\text{M}$ ) and fructose-2,6-biphosphatase ( $K_i = 2 \mu\text{M}$ ) are found to be better melarsoprol targets than PK ( $K_i = 100 \mu\text{M}$ ), resulting in a complete inhibition of the formation of fructose-2,6-bisphosphate.

As an alternative hypothesis the inhibition of trypanothione reductase (TR) by complexation of trypanothione with melarsoprol or melarsen oxide is discussed (Fig. 1). This complexation would lead to a complete disturbance of the redox balance within the trypanosomal cell. An inhibition of TR would have lethal effects on trypanosomes. The melarsen-trypanothione adduct Mel T has a stability constant of  $1.05 \times 10^7 \text{ M}^{-1}$ . The inhibition of →*glutathione* reductase and the *T. b. brucei* TR is characterised by  $K_i$  values of 9.6 and 17.2  $\mu\text{M}$ , respectively.

The main argument against TR as target for melarsoprol is the 18-fold-higher  $K_i$  value for the inhibition of TR compared to PFK. Furthermore an association of trypanothione with trivalent arsenicals is much weaker than that of 2,3-dimercaptopropanol or lipoic acid. Thus, the selective advantage of the presence of trypanothione in kinetoplastids has remained speculative until now. Melarsoprol is very efficient in forming adducts with a variety of dithiols (coenzyme dihydrolipoate, some proteins with cysteine residues). A nonspecific inhibition of many different enzymes may explain many severe toxic side effects of melarsoprol.

### Resistance

Resistance against melarsoprol is a general serious problem in the treatment of →*sleeping sickness*. Resistant trypanosomes are not lysed by melarsoprol or by the chemically related melarsen oxide at concentrations even higher than 100  $\mu\text{M}$ . A significant decrease in free trypanothione levels could not be detected in resistant strains, whereas a rapid decrease in trypanothione levels was described in sensitive strains just before lysis. Isolated TR from resistant or sensitive strains was shown to be equally inhibited by the melarsoprol-trypanothione adduct Mel T, indicating that TR may not be a validated target for melarsoprol.

A new hypothesis for the resistance mechanism of melarsoprol relies on alterations of melarsoprol transport in resistant trypanosomes with a possible participation of drug efflux mechanisms similar to multidrug-resistant cancer cells. Indeed, there is no lysis of melarsoprol resistant strains in the presence of melarsoprol plus  $\text{Ca}^{++}$  channel-blockers (verapamil, diltiazem or nifedipine). The mechanism of this so-called melarsen-based drug resistance in trypanosomes is due to their absolute purine requirement. Two non-identical purine transporters P1 and P2 have been identified in trypanosomes. The transporter P2 is responsible for the uptake of melarsen or melarsoprol, adenine and adenosine. The melarsen oxide-induced trypanosomal lysis can be inhibited by adenine, adenosine and dipyridamol, an inhibitor of nucleoside transport in mammalian cells. Adenine and melarsoprol thus compete for the transporter P2 in *T. b. brucei*. There is a reduction of the rate of adenosine transport by 80% in melarsen oxide resistant *T. b. brucei* compared to sensitive strains indicating a possible lack of transporter P2 in melarsen oxide-resistant *T. b. brucei*.

There is high cross-resistance between melarsoprol and the diamidine berenil in strains of *T. b. rhodesiense* clinical isolates, *T. b. brucei* veterinary isolates, in laboratory strains of *T. evansi* and others, but low cross-resistance between melarsoprol and pentamidine. Cross-resistance between melarsoprol and pentamidine

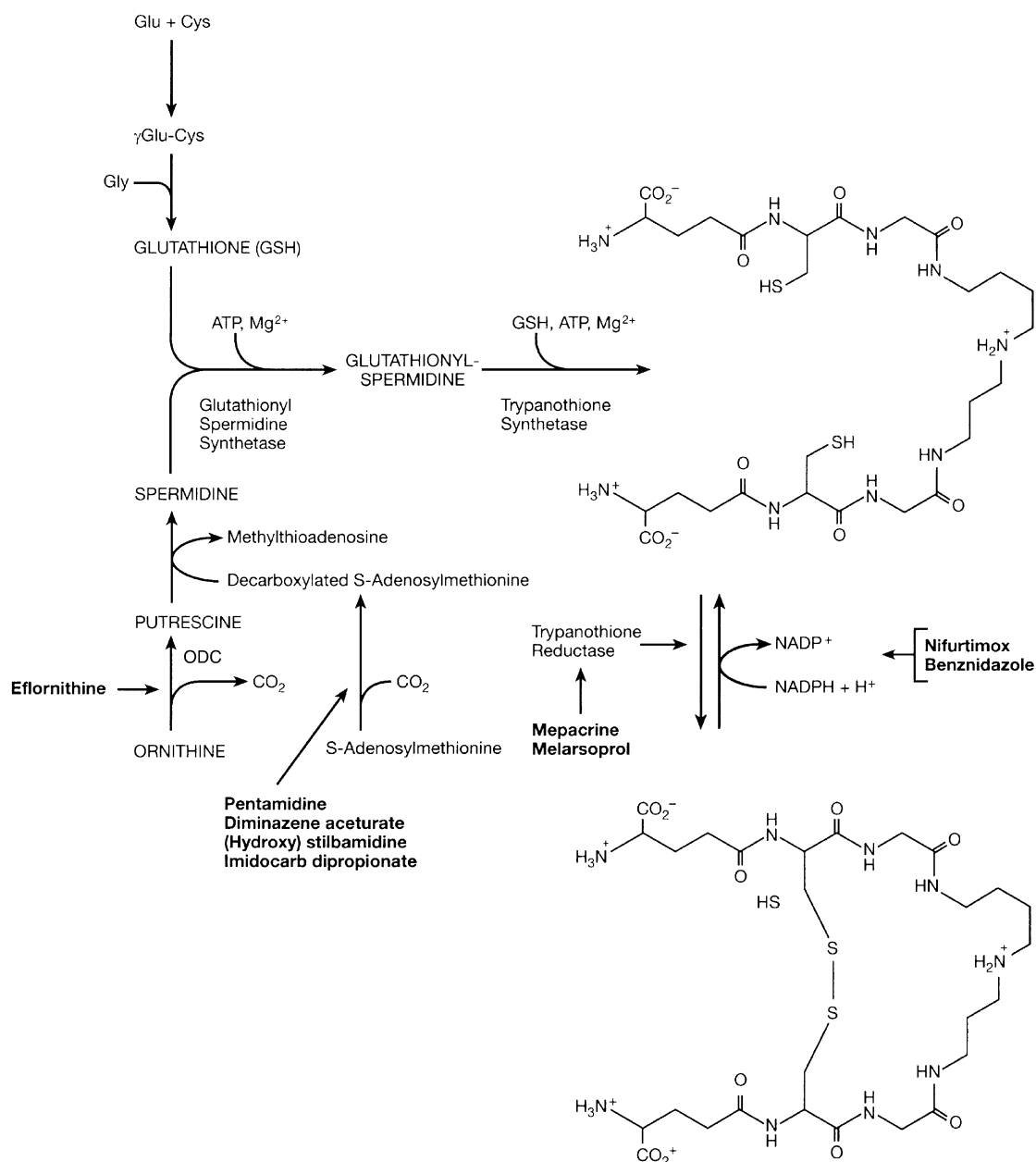

**DNA-Synthesis-Affecting Drugs III: Interference with Polyamine Metabolism and/or Trypanothione Reductase.**  
**Figure 1** Trypanothione metabolism and inhibition by drugs in kinetoplastid  $\rightarrow$  protozoa.

can be correlated with differences in their uptake rates in *T. b. brucei*.

Resistance against the so-called phenyl-based trypanosamide has been known since the 1930s. Interestingly, melarsen-resistant strains are sensitive to phenylarsenoxide and there is no cross-resistance between melarsoprol and phenylarsenoxide. This fact may be explained by the existence of another transporter (P1) for adenosine and inosine, which, however, does not transport melarsen oxide. Thus,

phenylarsenoxide-induced lysis of trypanosomes cannot be inhibited by adenine or adenosine in sensitive trypanosomes which supports the idea of different uptake mechanisms of melarsoprol and phenylarsenoxide into trypanosomes.

### Eflornithine

#### Synonyms

DFMO, DL- $\alpha$ -difluoromethylornithine.



### Clinical Relevance

Eflornithine was introduced in 1982 for the treatment of West African sleeping sickness (*T. b. gambiense*). It is active against early and late stages of *T. b. gambiense* (→DNA-Synthesis-Affecting Drugs II/Table 1). Eflornithine is characterised by a remarkably great safety index but possesses a relatively weak overall efficacy and a short duration of activity. An intravenous application is necessary with a dosage of 400 mg/kg b.w. per day in 4 equal doses every 6 hours for 14 days. Eflornithine also has activity against *T. b. brucei* and *T. congolense* and against multiresistant strains of *T. b. gambiense* (bloodstream forms and liquor forms). For the activity of eflornithine an intact immune system is necessary. A disadvantage of eflornithine is its ineffectivity against *T. b. rhodesiense* infections.

In addition eflornithine exerts some activity against leishmania and different opportunistic parasites such as →*Pneumocystis carinii*, *Cryptosporidium* in →AIDS patients as well as *in vitro* or *in vivo* activity against exoerythrocytic schizonts of *Plasmodium berghei*. Moreover, there is a report about some antitumor activity.

### Molecular Interactions

Eflornithine is a fluorinated amino acid derivative with zwitterionic properties. Under physiological conditions, it is poorly absorbed and rapidly excreted in the urine. The mechanism of action is well established and the *T. brucei* →ornithine decarboxylase (ODC) is a fully validated therapeutic target. In trypanosomes, which are fully dependent on their own polyamine biosynthetic machinery, DFMO acts as an irreversible “specific suicide” inhibitor of ornithine decarboxylase ODC (Fig. 1) by formation of a covalent adduct between the decarboxylated and defluorinated DFMO and the residue 360 in ODC. As a result the trypanothione biosynthesis is inhibited (Fig. 1) and also the biosynthesis of the →polyamines putrescine, spermidine and spermine. Thus, an *in vitro* and *in vivo* depletion of the putrescine and spermidine from dividing (→Binary Fission) *T. brucei* trypomastigotes in the blood and liquor occurs. As a result of the inhibition of polyamine metabolism many different cell functions are impaired, e.g., the differentiation of trypanosomes into non-dividing short stump-like forms. In addition, DFMO-treated *T. brucei* are kept in the dormant G1 phase by loss of ODC activity. Moreover, the synthesis of →variant surface glycoprotein is inhibited. The selective toxicity of eflornithine must be seen in direct connection with the slow turnover of ODC of *T. brucei* compared to the mammalian enzyme. Mouse ODC possesses an extra 36 amino acid peptide at the C-terminus (PEST sequence) triggering *in vivo* degradation of mammalian ODC. This is responsible for the short half-life of ODC of about 20 min in mammalian cells. By contrast the *in vivo* half-life of *T. brucei* ODC is longer than a day because

of the lack of the PEST sequence. A further consequence of the DFMO-induced increased levels of adenosyl-methionine may be an inappropriate methylation of proteins, nucleic acids or lipids. The lack of polyamines which are essential for the trypanothione synthesis may itself be sufficient for the explanation of the death of trypanosomes caused by DFMO.

### Resistance

Until now there are no reports about DFMO resistance because of the short time of its clinical use. Experimental resistance was examined *in vitro* using either procyclic forms of trypanosomes or naturally resistant strains. However, the mechanism of resistance on the molecular level remains unclear. In some resistant strains a reduced DFMO-uptake could be observed accompanied by an increase of intracellular concentrations of ornithine, whereas in other resistant strains no such reduced DFMO-uptake was detectable. There is no increased ODC activity in *T. brucei rhodesiense* field strains. However it could be shown that the ODC in DFMO-resistant *T. gambiense* possesses a rather short half-life compared to ODC in DFMO-susceptible trypanosomes which have an extraordinarily long half-life. As a result of the rapid *in vivo* turnover rates and synthesis of new active ODC molecules in resistant strains DFMO-inhibited ODC molecules are rapidly replaced. Thus, cells with a rapid ODC turnover are much less affected by the inhibition of ODC. A further difference between DFMO resistant and -susceptible trypanosomes seems to be the different increase in the adenosine methionine content by DFMO. Thus, in resistant strains an only 7-fold increase is observable compared to the up to 100-fold increase in sensitive strains. There also seems to be a correlation between DFMO resistance and decrease in adenosine methionine synthetase.

### Pentamidine/(Hydroxy)stilbamidine

#### Synonyms

Pentamidine isethionate, 4,4'-diamidinodiphenoxypentane, M&B800, RP2512, Lomidine, Pentacarinat.

### Clinical Relevance

The diamidines are in clinical use since 1937. Pentamidine is a therapeutic and prophylactic drug against bloodstream forms in sleeping sickness (Table 1). It is, however, active only against early stages of *T. b. gambiense* infections, but not against the liquor forms. 7 to 10 intramuscular injections are necessary with 4 mg/kg b.w. daily or on alternative days. Pentamidine also exhibits activity against *Leishmania donovani* and *L. chagasi* in spleen, liver and skin, but has only minor activity against the American mucocutaneous leishmaniasis (*L. brasiliensis*). Furthermore pentamidine possesses

antibabesial activity and is becoming increasingly important in replacing chloroquine against infections with  $\rightarrow$ *Babesia* spp. Pentamidine has no effect against *Trypanosoma cruzi*. (Hydroxy)-stilbamidine has a similar antiprotozoal spectrum and is useful in antimonial-resistant Kala-Azar (*L. donovani*).

The main indication for pentamidine is its activity against opportunistic parasites. It is the drug of choice for the *Pneumocystis carinii*  $\rightarrow$ pneumonia in AIDS patients. Moreover, pentamidine has some antifungal activity against North American blastomycosis (*Blas-tomyces dermatididis*).

### Molecular Interactions

The mechanism of action of pentamidine is directed against trypomastigotes in the blood which divide by binary fission. Following the uptake into the blood-stream forms of *T. b. brucei* via a carrier-mediated process the binding of pentamidine to nucleic acids is believed to be of great importance. Recently a pentamidine-dodecanucleotide-complex could be identified by cocrystallisation. Drug binding occurs in the 5'-AATT minor groove region of the duplex, preferentially to the minor grooves of the  $\rightarrow$ kinetoplast DNA in *T. brucei*. Thereby, the amidinium groups of pentamidine become H-bonded to adenine N<sub>3</sub> atoms. As a result the kinetoplast DNA is disrupted so that dyskinetoplastic cells are generated with intact mitochondrial membranes but lacking detectable kinetoplast DNA. Pentamidine has no effects on the trypanosomal nuclear DNA.

Furthermore, a 13-fold increase in lysine and 2.5-fold increase in arginine content is induced in the trypanosomes at the therapeutic dose. Electronmicroscopically, an intercalation of diamidines into the kinetoplast DNA (kDNA) could be detected resulting in lampbrush  $\rightarrow$ chromosomes. This observation supports the proposed inhibition of  $\rightarrow$ DNA synthesis by diamidines. Additional nuclear aggregation in diamidine-treated trypanosomes may also explain the inhibition of ribosomal RNA synthesis. The disintegration of kDNA begins at the periphery of the  $\rightarrow$ kinetoplast, where DNA replication starts. Moreover, pentamidine interferes with the trypanothione metabolism by inhibiting the decarboxylation of S-Adenosylmethionine (Fig. 1). Because of their close structural similarity to pentamidine, (hydroxy)stilbamidine presumably has the same mechanism of action (Fig. 1).

### Resistance

Resistance to diamidines is well established under field conditions. Resistant strains are characterised by a diminished ability to import pentamidine into the cells. However, it is unclear to date whether an impaired pentamidine uptake, drug efflux or drug metabolism is responsible for the mechanism of pentamidine resistance.

## Diminazene

### Synonyms

Berenil, Diminazene aceturate, Diminazene diacetate, Azidin, Ganasag, Trypan, Veriben.

### Clinical Relevance

Berenil was originally introduced in 1955 as a trypanocide and babesiacide. It is active against *Trypanosoma b. gambiense* and *T. b. rhodesiense* (Table 1). Of especial interest is the activity against liquor forms of *T. b. rhodesiense*. Berenil is often used in chronic human infections, although it is a veterinary product. The treatment of human trypanosomiasis with berenil is recommended in cases of arsen resistance or before starting treatment with melarsoprol. In veterinary medicine berenil is used against *T. brucei*, *T. congolense*, *T. vivax* and *Babesia* spp. in cattle, sheep and goats in Africa. Higher dosages are usually necessary for curative effects against *T. equiperdum* in horses. Berenil has only minor activities against *T. simiae* in pigs, *T. evansi* in camels and cattle and *T. equinum* in horses. It should be mentioned that berenil also has experimental effectivity against  $\rightarrow$ *Leishmania* spp. (Table 1).

Furthermore, berenil has activity against  $\rightarrow$ piroplasms of domestic animals (*Babesia* spp. with large erythrocytic parasitic stages). It has good efficacy against *Babesia bigemina*/cattle, *B. ovis* and *B. motasi*/sheep, *B. caballi*/horse, *B. canis*/dog, *B. hepailuri*/cat. However, the drug has far less activity against *Babesia* spp. with small erythrocytic stages (*B. bovis* and *B. divergens*/cattle,  $\rightarrow$ *Theileria* (formerly *Babesia*) *equi*/horse, *B. gibsoni*/dog) and apparently no effect against *B. felis*/cat.

### Molecular Interactions

Berenil as an analogue of pentamidine exerts a similar mode of action. The activity of berenil is directed against trypomastigotes in the blood and liquor. In berenil-treated *Leishmania tarentolae* the kDNA content is greatly reduced. It is reported that berenil binds to the minor groove of DNA with a higher affinity to 5'-AATT-3' than to 5'-TTAA-3'. The attachment to specific sites in DNA occurs via electrostatic and H-bond forces. In addition, it is discussed that berenil may inhibit the kinetoplast topoisomerase II in trypanosomes, resulting in the cleavage of 2% of the  $\rightarrow$ minicircle DNAs in the presence of 1  $\mu$ M drug. Also a possible interference of berenil with the trypanothione metabolism by inhibiting the decarboxylation of S-Adenosylmethionine is worth mentioning (Fig. 1).

### Resistance

Interestingly, there is no widespread development of berenil resistance in the field in spite of long-term use. There are reports on cross-resistance between quina-pyramine, melarsomine and berenil in laboratory and

field strains. The mechanism of resistance to berenil is possibly due to a diminished drug uptake by resistant trypanosomes.

### Imidocarb Dipropionate

#### Synonyms

Carbesia, Imixol, Imizol, Imizocarb, 4A65.

#### Clinical Relevance

The antiprotozoal activity of this drug is directed against *Theileria* (formerly *Babesia*) *equi* and *Babesia caballi* in donkeys and mules. In addition, babesiosis of cattle may be controlled relatively easily by imidocarb.

#### Molecular Interactions

Imidocarb is a diamidine derivative. Thus, its action may be similar to that of berenil ([→DNA-Synthesis-Affecting Drugs III/ Fig. 1](#)).

### Quinapyramine, Homidium, Isometamidium

#### Synonyms

Quinapyramine: M7555, Antrycide, Triguin, Trypacide.

Homidium chloride: RD1572, Novidium, Babidium.

Homidium bromide: Ethidium, Dromilac.

Isometamidium: Metamidium, M&B4180, Samorin, Trypamidium.

#### Clinical Relevance

Quinapyramine ([Table 1](#)) has activity against *Trypanosoma equiperdum* in horses and donkeys. Homidium and Isometamidium are used in [→chemoprophylaxis](#) against *T. brucei evansi* in cattle, sheep and goats in Africa, and they have also activity against *T. vivax* and *T. congolense*.

#### Molecular Interactions

Quinapyramine probably acts indirectly by inhibition of protein synthesis by displacement of magnesium ions and polyamines from the ribosomes. Homidium bromide belongs to the phenanthridinium derivatives. Its antitrypanosomal activity has been known for about 50 years. It is routinely used for staining nucleic acids in research laboratories because it intercalates into nucleic acids. It possesses mutagenic properties. The mechanism of antitrypanosomal action of homidium is unclear. There are reports on an interference with glycosomal functions, interference with the function of an unusual AMP binding protein, on impaired trypanothione metabolism and impaired replication of kinetoplast minicircle (2% of total minicircle become linearised by 1  $\mu$ M homidium) in trypanosomes.

As isometamidium is structurally related to both – homidium and berenil, the properties and activities may

be similar. Isometamidium has a great acute toxicity to mammals which is not observed with homidium or berenil. The acute toxic effects of isometamidium in mice can be reversed with atropine indicating probable inhibitory effects on acetylcholinesterase. However, the mechanism of antitrypanosomal action of isometamidium is not yet fully understood. A linearisation of 6% of the total minicircle DNA from *T. equiperdum* at 1  $\mu$ M may also contribute to the drug's action. *In vitro* an intercalation between the base pairs of the DNA can be observed which may explain the interruption of DNA functioning observed *in vivo*.

#### Resistance

The extensive use of homidium in the 1960s and 1970s has greatly reduced its usefulness by widespread trypanosomal resistance. The mechanism of resistance is so far unknown. The mechanism of resistance against isometamidium is presumably associated with reduced accumulation of the drug in trypanosomes. There are reports on cross-resistance between isometamidium and homidium, which supports the idea of a similar mode of action of both drugs.

### Nifurtimox

#### Synonyms

Lampit, Bay2502.

#### Clinical Relevance

Nifurtimox was introduced in 1972 as a causal therapeutic drug for [→American trypanosomiasis](#) (=Chagas disease) caused by *T. cruzi* ([Table 1](#)). It has curative effects in acute, subchronic and chronic disease. Infection-induced damages of organs, however, are not improved by this drug.

#### Molecular Interactions

Nifurtimox is a nitrofurfuralidene derivative. It induces a destruction of non-dividing trypomastigote bloodstream forms and intracellular amastigote tissue forms in the muscles of heart, skeleton, oesophagus and intestine, in the lymph nodes and in the nervous system. One possible action may be the inhibition of trypanothione reductase ([Fig. 1](#)). As *T. cruzi* has only low detoxification capacity, it is completely dependent on the trypanothione metabolism. As another action the generation of reactive oxygen derivatives (superoxide, H<sub>2</sub>O<sub>2</sub> and hydroxyl radicals) is discussed, which cause peroxidation of lipids and damage of the nucleic acids.

#### Resistance

At present there are no great problems concerning clinical resistance against nifurtimox.



**Benznidazole****Synonyms**

Ro7-1051, Radanil, Rochagan.

**Clinical Relevance**

Benznidazole was introduced in 1978. It damages trypomastigote bloodstream forms and amastigote tissue forms of *T. cruzi* (Table 1). There are reports on a low efficacy against the Brazilian →cutaneous leishmaniasis.

**Molecular Interactions**

The activity is directed against the same stages as by nifurtimox. Probably the trypanothione metabolism becomes disturbed (Fig. 1) and an involvement of generation of free radicals similar to nifurtimox is discussed. There are additional reports on an inhibition of protein- and RNA-synthesis and a damage of DNA.

## DNA-Synthesis-Affecting Drugs IV: Interference with Cofactor Synthesis

Tables 1, 2, Fig. 1.

**Structures**

Fig. 2.

**Sulfonamides****Important Compounds**

Sulfachloropyrazine, Sulfadiazine, Sulfadimethoxine, Sulfadimidine, Sulfadoxine, Sulfaguanidine, Sulfalene, Sulfamethazine, →Sulfamethoxazole, Sulfametoxypridazine, Sulfantran, Sulfaquinoxaline/Pyrimethamine, Sulfaisoxazole, Sulfathiazole.

**DNA-Synthesis-Affecting Drugs IV: Interference with Cofactor Synthesis. Table 1** Degree of efficacy of important anticoccidial drugs on various protozoan parasites

Year on the market	Drug	Apicomplexa				
		<i>Eimeria</i> (chicken)	<i>Toxoplasma</i> <i>gondii</i>	<i>Babesia</i>	<i>Theileria</i>	<i>Plasmodium</i>
Energy-Metabolism-Disturbing Drugs						
1960	Amprolium	xx	x			
1968	Clopidol	xxx				
1972	Robenidine	xxx				
1984	Clopidol/Methylbenzoate	xxx				
DNA-Synthesis-Affecting Drugs IV: Interference with Cofactor Synthesis						
1945	Sulfonamides	xx	x			xx
	Sulfaquinoxalin/Diaveridin	xxx				
	Sulfonamide/ Pyrimethamine	xx	xxx		xx	xxx
1956	Nicarbazine	xxx				
about 1963	Amprolium/Sulfonamide/ Ethopabate	xxx				
1980	Arprinocide	xxx				
DNA-Synthesis Affecting-Drugs V: Interference with Dihydroorotate-Dehydrogenase						
1968	Quinolones	xxxR	x (a)			xE
1987	Toltrazuril	xxx	xxx		x	
2001	Ponazuril	xxx	xxx			
Membrane-Function-Disturbing Drugs						
1971	Polyethers (b)	xxx	x (a)			
1986	Narasin, Nicarbazine	xxx				
Drugs with Unknown Antiparasitic Mechanism of Action						
1960	Zoalene	xx				
	Dinitolmide (DOT)	xxx				
1976	Halofuginon (e)	xxx			xxx	xx
1993	Diclazuril/Clazuril	xxx				

**DNA-Synthesis-Affecting Drugs IV: Interference with Cofactor Synthesis. Table 2** Drugs used against *Toxoplasma gondii*, *Neospora caninum*, *Sarcocystis* spp. and *Cryptosporidium* spp.

	Toxoplasmosis		Neosporosis	Sarcocystosis		Cryptosporidiosis	
	human medicine	veterinary medicine		human medicine	veterinary medicine	human medicine	veterinary medicine
DNA-Synthesis-Affecting Drugs IV: Interference with Cofactor Synthesis							
Pyrimethamine/ sulfonamide	xxx	xxx					
Sulfonamides				xx			
Epiroprim	xxE						
Epiroprim/Dapsone	xxxE						
Trimethoprim/ Sulfamethoxazole/ Clindamycin	xxx						
Clarithromycin/ Sulfonamide	xx (a)	xxx					xE
Clindamycin/ Sulfonamide			xxx				
Pyrimethamine/ Trimethoprim			xx				
Pirithrexim, Clindamycin, Diclazuril, Robenidine, Pyrimethamine			xE				
DNA-Synthesis Affecting-Drugs V: Interference with Dihydroorotate-Dehydrogenase							
Decoquinat		xxx					
Toltrazuril		xxx			xxx		
Letrazuril						xx	
Ponazuril		xxxE	xxxE		xxxE		
Protein-Synthesis-Disturbing Drugs							
Spiramycin	xxx						
Paromomycin						xx	xxx
Membrane-Function-Disturbing Drugs							
Monensin		xxx					

xxx = highly effective, xx = good effective, x = low activity; E = active experimentally; (a) low tolerability

### Synonyms

Sulfachloropyrazine: Cosulfa, Cosulid, Nefrosul, Prinzone, Sorilyn, Vetsulid.

Sulfadiazine: Adiazine, Debenal, Diazyl, Eskaiazine, Flamazine, Flammazine, Pyrimal, Silvadene, Sterazine, Sulfolex.

Sulfadimethoxine: Agribon, Albon, Ancosul, Bactrover, Diasulfa, Diasulfol, Dimetazina, Dinosol, Madribon, Maxulvet, Memcozine, Metoxidon, Neostreptal, Radonina, Retardon-N drops, Roscosulf, SDM.

Sulfadimidine: Sulfadimidine 33% Forte, Sulfadimidine powder, Unidim.

Sulfadoxine: Fansil, Fanzil, in combination with pyrimethamine: Fansidar.

Sulfaguanidine: Abiguanil, Aterian, Diacta, Ganidan, Guamide, Guanicil, Resulfon, Ruocid, Shigatox, Suganyl, Sulfaguine, Sulfoguenil, Enterosediv.

Sulfalene: Farmitalia, Dalysep, Kelfizina, Longum, Polycidal.

Sulfamethazine: Azolmetazin, Diazil, Dimezathine, Dimidin-R, Mefenal, Neazina, Pirmazin, S-Dimidine, S-Mez, Sulfa 25% powder, Sulfadine, Vesadin, Vertolan. Sulfamethoxazole: Abacin, Apo-Sulfatrim, Bactramin, Bactrim, Bactromin, Baktar, Drylin, Eltranyl, Eusaprim, Fectrim, Gantanol, Gantaprim, Gantrim, Kepinol, Linaris, Micotrim, Momentol, Nopil, Omsar, Sepra, Seprim, Sigaprim, Sinomin, Sulfotrim, Sulfotrimin, Sulprim, Sumetrolim, Suprim, Tacumil, Teleprim, TMS480, Trigonyl, Trimesulf, Trimforte, Uro-Septra.

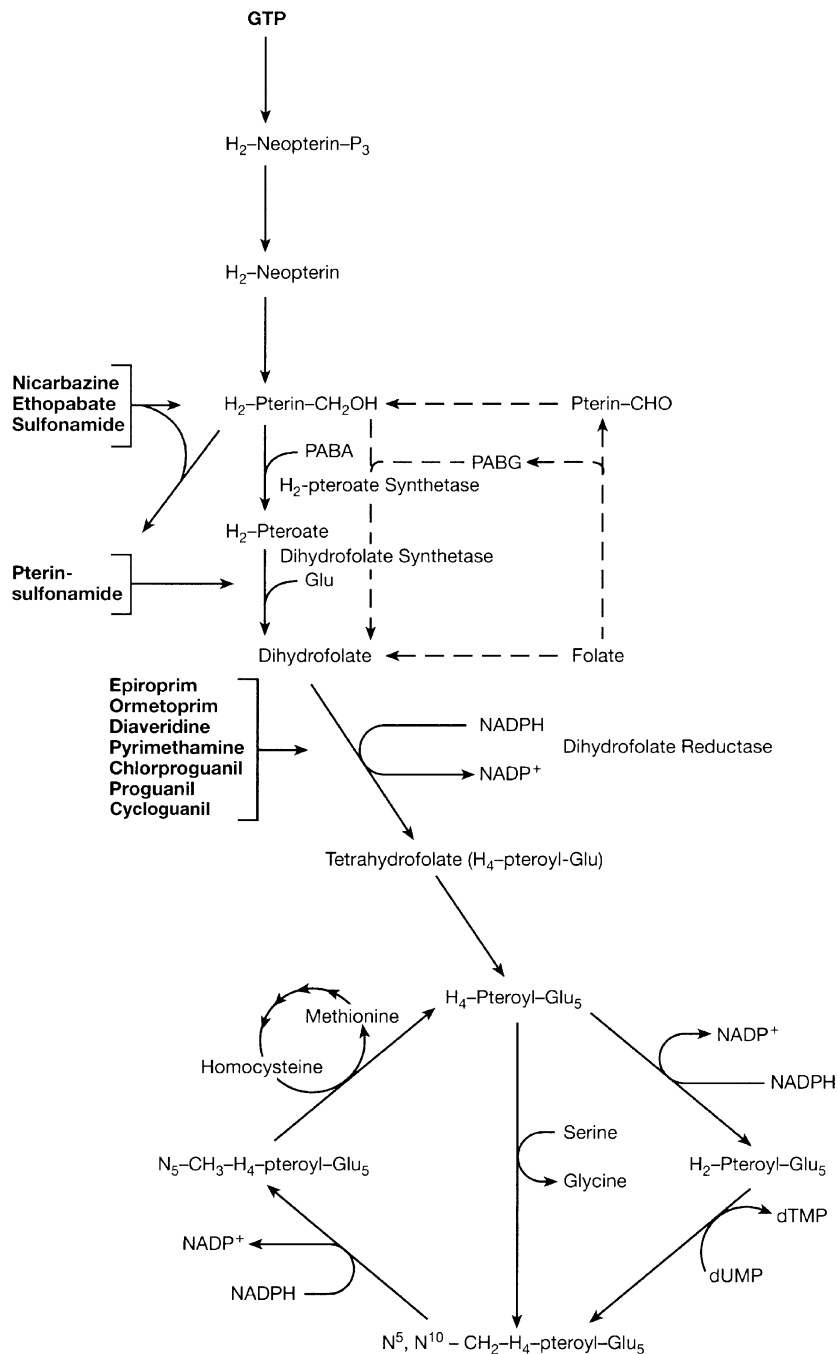

**DNA-Synthesis-Affecting Drugs IV: Interference with Cofactor Synthesis. Figure 1** Model of the *de novo* synthesis of →pyrimidines and folate in →apicomplexa.

Sulfamethoxypyridazine: Davosin, Depovernil, Durox, Kynex, Lederkyn, Lentac, Midicel, Midikel, Myasul, Mylo-Sulfurazin, Sultirene, Vinces.

Sulfanitran: Novostat, Polystat, Unistat.

Sulfaquinoxaline/Pyrimethamine: Sulka TAD, Coc-cex solution, single drug: Aviochina, Embazin, Dr. Hess SQX, Quinatrol, Quinel, Solquin, Sol-Quinel, S.Q.,

Sulfa-Nox, Sulfa-Q, Sul-Q-Nox, Sulfaquinoxaline 100% powder, Vineland Liquid Sulfaquinoxaline.

Sulfaisoxazole: Entusil, Entusul, Gantrisin, Gantrosan, Neazolin, Renosulfan, Sosol, Soxisol, Soxo, Soxomide, Suladrin, Sulfalar, Sulfazin, Sulfium, Sulfoxol, Sulsoxin, V-Sul.

Sulfathiazole: Eleudron solution.

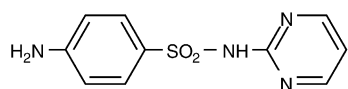
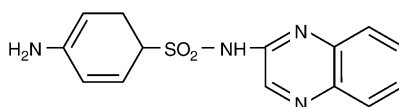
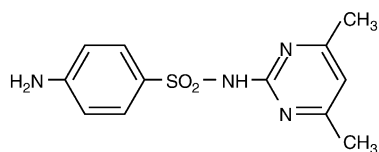
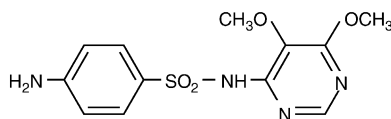
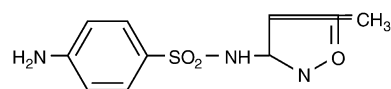
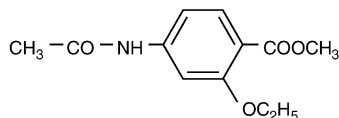
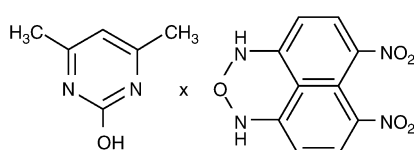
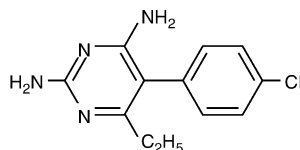
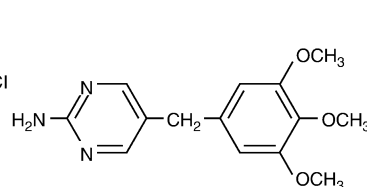
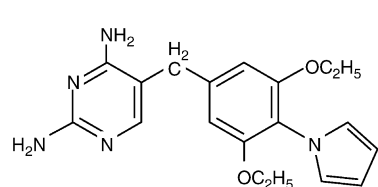
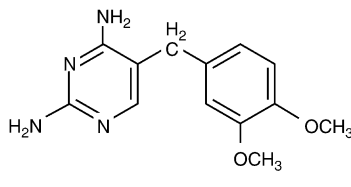
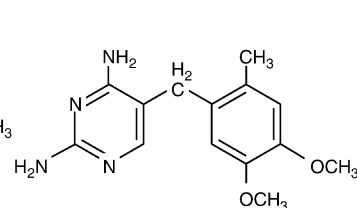
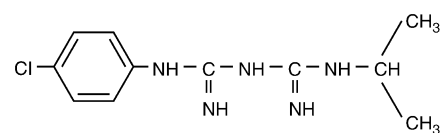
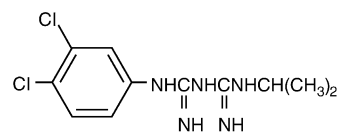
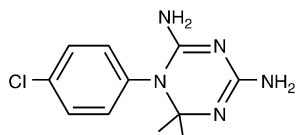
**Sulfadiazine****Sulfaquinolaxine****Sulfadimidine****Sulfadoxin****Sulfamethoxazole****Ethopabate****Nicarbazine****Pyrimethamine****Trimethoprim****Epiroprim****Diaveridine****Ormethoprim****Proguanil****Chlorproguanil****Cycloguanil**

**DNA-Synthesis-Affecting Drugs IV: Interference with Cofactor Synthesis. Figure 2** Structures of drugs affecting DNA-Synthesis by interfering with Cofactor Synthesis.

### Clinical Relevance

Sulfonamides exert activities against a variety of pathogens. They possess a broad-spectrum activity against gram positive and gram negative bacteria such as *Nocardia* spp., *Chlamydia* spp., *Yersinia* spp. and atypical mycobacteria (*Mycobacterium scrofulaceum*).

The first anticoccidial sulfonamides were introduced in 1946. Sulfonamides currently used in veterinary medicine are sulfaquinoxaline, sulfadimidine, sulfadiazine, sulfadimethoxazole, sulfadoxin and others. They are characterised by a narrow anticoccidial spectrum against  $\rightarrow$ *Eimeria* spp. residing in the small intestine (*E. acervulina*), and they have only minor activity against *E. necatrix* and *E. tenella*. Sulfaquinoxaline is used in combination with amprolium or 2,4-diaminopyrimidines or in a multidrug combination together with ethopabate and pyrimethamine (Table 1). There are also other combinations of veterinary importance (Table 2). Sulfonamides have been very useful against  $\rightarrow$ *Plasmodium falciparum* as single drug or in combination with pyrimethamine (sulfadoxin/pyrimethamine), because of their schizonticidal effects against both exoerythrocytic and erythrocytic stages ( $\rightarrow$ Hem(oglobin) Interaction/Table 1, Fig. 2). In general, they have greater efficacy against *P. falciparum* compared to *P. malariae*, *P. ovale* or *P. vivax*. Other indications in which sulfonamides are used are infections with  $\rightarrow$ *Toxoplasma gondii*,  $\rightarrow$ *Pneumocystis carinii*,  $\rightarrow$ *Sarcocystis* spp., *Cystispora* spp.,  $\rightarrow$ *Isospora* spp. and others. A sulfadiazine/clindamycin-combination is active against  $\rightarrow$ *Neospora caninum* in young dogs, if started very early in the disease (Table 2).

### Molecular Interactions

The antiparasitic activity of sulfonamides is primarily directed against second  $\rightarrow$ schizont generations. There is also activity against first schizont generation and sexual stages ( $\rightarrow$ Hem(oglobin) Interaction/Fig. 2). The activity of antimalarial sulfonamides such as sulfadoxin is directed against exoerythrocytic liver schizonts, erythrocytic schizonts and also oocysts in the gut of  $\rightarrow$ mosquitoes ( $\rightarrow$ Hem(oglobin) Interaction/Fig. 2). Sulfadoxin belongs to the long-acting sulfonamides. The first hint about the  $\rightarrow$ mode of action of sulfonamides came from the observation that the anticoccidial activities of sulfonamides can be reversed by para-aminobenzoic acid (PABA), an intermediate in folate biosynthesis. Now it has been known for a long time that the action of sulfonamides and of sulfones like dapsona relies on the inhibition of dihydropteroate synthase in intracellular  $\rightarrow$ sporozoa *Eimeria*, *Toxoplasma* and  $\rightarrow$ *Plasmodium*. Thus, the coccidial  $\rightarrow$ folate biosynthesis is inhibited by sulfonamides which is lethal to the  $\rightarrow$ coccidia because they do not utilise

exogenous folate but synthesise folate as cofactor of  $\rightarrow$ DNA synthesis de novo (Fig. 1).

### Resistance

Dihydropteroate synthetase (DHPS) is a validated target enzyme of sulfadoxin. This could be shown for sulfadoxin-resistant *P. falciparum* isolates. DHPS from resistant and sensitive strains differ in their amino acid sequences. Indeed, there is a correlation between point mutations in the bifunctional DHPS and sulfadoxin resistance. Interestingly, DHPS of *P. falciparum* is a bifunctional enzyme which includes the dihydro-6-hydroxymethylpterin pyrophosphokinase at the amino terminus.

### Ethopabate

#### Synonyms

Methyl 4-acetamido-2-ethoxybenzoate, Ethyl pabate, in combination with amprolium: Amprol Plus.

### Clinical Relevance

Ethopabate is only a narrow anticoccidial spectrum drug against *Eimeria acervulina*. It has no or only slight activity against *E. maxima*, *E. necatrix*, *E. tenella* or *E. brunetti*. Today, ethopabate is applied only in combination with amprolium and sulfonamide (Table 1).

### Molecular Interactions

Ethopabate is a 2-substituted PABA derivative (= 4-acetamido-2-ethoxybenzoic acid methylester) and functions as a prodrug. Its activity becomes potentiated by pyrimethamine and antagonised by the simultaneous administration of PABA. Thus, the mode of action of ethopabate is similar to that of sulfonamides or sulfones (Fig. 1).

### Nicarbazine

#### Synonyms

4,4'-dinitrocarbanilide, Altek, Elancocin, Nicarb, Nicoxin, Nicrazin.

### Clinical Relevance

Nicarbazine is used against coccidiosis in poultry. It has a coccidiostatic action by impairing the  $\rightarrow$ oocyst formation of the late life cycle stages. The numbers of oocysts are only reduced so that a latent infection up to the last life cycle stages is always detectable. Thus, nicarbazine-treated animals can develop immunity against coccidia.

## Molecular Interactions

The activity is directed against schizonts of the second generation of *Eimeria* spp. An inhibition of folate biosynthesis is proposed (Fig. 1).

## 2,4-Diaminopyrimidines

### Important Compounds

Pyrimethamine, →**Trimethoprim**, Diaveridine, Ormetoprim, Epiroprim, Pirithrexim.

### Synonyms

Pyrimethamine: Daraprim, RP4753, Chloridin, Darapram, Malocide, Tindurin; in: Fansidar, Suldox, Malocide, Maloprim, Metakelfin.

Trimethoprim: 2,4-diamino-5-(3,4,5-trimethoxybenzyl) pyrimidine, Monotrim, Proloprim, Syraprim, Tiempe, Trimanyl, Trimopan, Trimplex, Wellcoprim; in: Borgal, Cosumix, Leotrox, Protoc, Tribissen, Trafigal, Vetoprim, Bactrim, Eusaprim, Septrin, Sultrim.

Diaveridine in: Darvisul, Rofenon.

Ormetoprim in: Rofenaïd-40, Ektecin.

Epiroprim: none.

Pirithrexim: none.

### Clinical Relevance

2,4-diaminopyrimidines (pyrimethamine, trimethoprim) are active against a wide variety of human and veterinary pathogens. Thus, they possess a broad antibacterial spectrum. Antiprotozoal active 2,4-diaminopyrimidines used in human medicine are pyrimethamine and trimethoprim. They are used for →**prophylaxis** in →**malaria**, but the onset of antimalarial activity is very slow. They have no general effect on gamonts and no effect on →**hypnozoites** of *P. vivax* (→**Hem(oglobin) Interaction/**Fig. 2). Because of the frequently occurring resistance against pyrimethamine they are applied in combinations with sulfonamides (sulfadoxin) (Fansidar). In general, combinations of pyrimethamine and trimethoprim with sulfa drugs are of great medical importance for treatment of toxoplasmosis (Table 2), →**Isospora belli** infections and *Cyclospora cayetanensis* infections in →**AIDS** patients. Thus, combinations of pyrimethamine with sulfonamides such as sulfadiazine, sulfadimidine or sulfadoxin belong to the standard treatment for human toxoplasmosis. However, these combinations are restricted for the treatment of →**prenatal toxoplasmosis** in the time after the 20th week. In addition, a pyrimethamine-sulfonamide combination is the drug of choice for postnatal infections with *Toxoplasma gondii* in children and in AIDS patients. For tolerability reasons and especially for prophylactic treatment, a combination of trimethoprim and sulfamethoxazole sometimes in a combination with clindamycin is recommended.

There are only anecdotal reports of treatment of →**microsporidiosis** in AIDS with trimethoprim/sulfamethoxazole.

2,4-diaminopyrimidines used in veterinary medicine are pyrimethamine, ormetoprim, epiroprim, pirithrexim and diaveridine. They are routinely used against coccidiosis in combinations such as ormetoprim/sulfadimethoxine or sulfaquinolaxine/amprolium/ ethopabate/pyrimethamine (=Supracox). A combination of clarithromycin and pyrimethamine has been shown to be effective against toxoplasmosis in animals, but is not well tolerated. In addition, a pyrimethamine/sulfamethazine-combination is reported to be effective against *T. gondii* in sheep and goats (Table 2). Trimethoprim or pyrimethamine as single drugs or together in combination show curative effects in *Neospora caninum* infections, when motor nerve disturbances have already occurred (Table 2). Epiroprim is a relatively new 2,4-diaminopyrimidine for the treatment of toxoplasmosis. It possesses an *in vitro* activity against *T. gondii*. There are promising results in animal experiments with a dapsone/epiroprim-combination. Pirithrexim, another 2,4-diaminopyrimidine, and pyrimethamine have been shown to be active against *N. caninum* →**tachyzoites** in cell cultures.

Besides the antibacterial and the antiprotozoal activities 2,4-diaminopyrimidines are useful as anti-cancer drugs and in therapy of rheumatic diseases.

### Molecular Interactions

Pyrimethamin is a selective inhibitor of the dihydrofolate dehydrogenase (DHFR) of exoerythrocytic schizonts (in the liver) and erythrocytic schizonts of →**malarial parasites** (→**Hem(oglobin) Interaction/**Fig. 2) and other sporozoa such as *Toxoplasma* and *Eimeria*. Schizonts become damaged by pyrimethamine only during →**nuclear division**. There is no effect on the parasitic ring forms of *P. falciparum*. Pyrimethamine has an additional activity against oocysts in mosquito gut. Besides pyrimethamine the parasitic DHFR is also inhibited by the other 2,4-diaminopyrimidines trimethoprim, epiroprim, diaveridine and ormetoprim (Fig. 1). It has been well established for a long time that there are synergistic effects between the 2,4-diaminopyrimidines as DHFR-inhibitors and sulfonamides as inhibitors of dihydropteroate synthetase, when given in combination (Fig. 1).

### Resistance

Most knowledge about the resistance mechanism against pyrimethamine at the molecular level comes from experiments with plasmodia. A modification of the target receptor DHFR in the folic acid pathway in resistant strains very likely results in a decrease of DHFR sensitivity to inhibition. There are several reports that the molecular basis of pyrimethamine

resistance in naturally resistant isolates of *P. falciparum* are single point mutations (e.g., Ser-108  $\Rightarrow$ ) in the DHFR active site (Fig. 3). There is a good correlation between mutations with natural pyrimethamine resistance in a variety of geographically distant isolates. In addition, the two ancillary mutations Asn-51  $\Rightarrow$  Ile-51 and Cys-59  $\Rightarrow$  Arg-59 are associated with increased pyrimethamine resistance in the presence of Asn-108.

Another mechanism of pyrimethamine resistance in *P. falciparum* has been proposed. Thereby, an overproduction of DHFR achieved either by gene duplication or by other mechanisms resulting in increased expression is discussed as being responsible for resistance on the molecular level.

### Chlorproguanil

#### Synonyms

Chlorguanil, 1-(3,4-dichlorophenyl)-5-isopropylbiguanide, M5943, hydrochloride: Lapudrine.

#### Clinical Relevance

Chlorproguanil serves as a causal prophylactic, but not as a therapeutic drug for malaria. Its effectivity is not different from proguanil.

#### Molecular Interactions

The target of chlorproguanil is the dihydrofolate reductase of the parasitic stages. It has an influence on sporozoites and the exoerythrocytic stages of all four *Plasmodium* spp. ( $\rightarrow$ Haem(oglobin) Interaction/Fig. 2).

The onset of the effect on erythrocytic stages is very slow. The activity is directed against exoerythrocytic schizonts, erythrocytic schizonts and oocysts in mosquito gut ( $\rightarrow$ Hem(oglobin) Interaction/Fig. 2).

#### Resistance

There is cross-resistance between chlorproguanil and pyrimethamine indicating the same mode of action by inhibition of the DHFR (Figs. 1, 3).

### Proguanil

#### Synonyms

Chlorguanide, 1-(p-chlorophenyl)-5-isopropylbiguanide, Chloroguanide, M4888, RP3359, SN12837, Diguanyl, Drinupal, Guanatol, Paludrine, Palusil, Tirian; Combination: Proguanil, Atovaquone (Malarone<sup>®</sup>).

#### Clinical Relevance

Proguanil was explored in 1945. It was developed for prophylaxis against malaria, but the prophylactic activity is not complete. It leads to a damage of exoerythrocytic schizonts. It has no effect on the hypnozoites in the liver. The fixed combination of proguanil and atovaquone (Malarone<sup>®</sup>) is used for prophylaxis and therapy (including emergency self-medication) of uncomplicated *P. falciparum* infections for adult patients as well as for children. The combination shows good efficacy and tolerability ( $\rightarrow$ Hem(oglobin) Interaction/Table 1). For atovaquone see DNA-Affecting Drugs V.

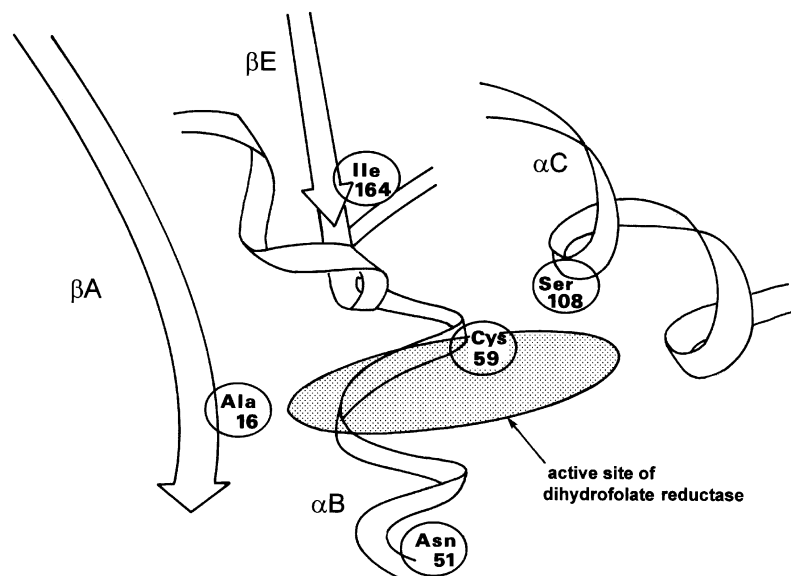

**DNA-Synthesis-Affecting Drugs IV: Interference with Cofactor Synthesis.** Figure 3 Schematic model of the point mutations in the active site of dihydrofolate reductase of *Plasmodium falciparum* (Gutteridge (1993) In: Cox FEG (ed) Modern Parasitology, 2nd edition, Blackwell Science, pp. 219–242).

### Molecular Interactions

Proguanil belongs chemically to the biguanids. It is a prodrug, which is converted to cycloguanil, a cyclic triazine with antimalarial activity. The activity is directed against exoerythrocytic schizonts in the liver, erythrocytic schizonts and oocysts in mosquito gut ([→Hemoglobin Interaction/Fig. 2](#)). The mode of action is the selective inhibition of the DHFR of malarial parasites ([Figs. 1, 3](#)).

### Resistance

There are specific DHFR point mutations responsible for resistance to cycloguanil which could be shown in a variety of independent *P. falciparum* clones and isolates. From examination of the point mutations of DHFR it becomes clear that there is a different molecular basis for resistance to cycloguanil and pyrimethamine, depending on the positions of the mutations and on the residues involved. Point mutations result in an inhibition of pyrimethamine binding at the active site of the reductase ([Fig. 3](#)). But there are presumably different effects of the DHFR point mutations on pyrimethamine and cycloguanil, since proguanil is sometimes effective against pyrimethamine-resistant *P. falciparum*, indicating that there may be different binding sites for both drugs. In other cases there is cross-resistance between proguanil and pyrimethamine observable.

## DNA-Synthesis-Affecting Drugs V: Interference with Dihydroorotate-Dehydrogenase

### Structures

[Fig. 1.](#)

### Hydroxyquinolines

#### Important Compounds

Amquinatate, Buquinolate, Decoquinatate, Methylbenzoquate.

#### Synonyms

Amquinatate: none.

Buquinolate: 4-Hydroxy-6,7-diisobutoxy-3-quinoline-carboxylic acid ethyl ester, Ethyl 6,7-diisobutoxy-4-hydroxyquinoline-3-carboxylate, Bonaid.

Decoquinatate: Ethyl 6-(n-decyloxy)-7-ethoxy-4-hydroxyquinoline-3-carboxylate, M&B15497, Deccox.

#### Clinical Relevance

4-hydroxyquinolines have antiparasitic activities against *Toxoplasma* spp., [→Pneumocystis carinii](#), and

*Cryptosporidium parvum*, and they furthermore possess anticoccidial, antimalarial, and antitheilerial activity. Decoquinatate is active against *T. gondii* in cats ([→DNA-Synthesis-Affecting Drugs IV/Table 2](#)) and is still used in shuttle programs against coccidiosis. For such shuttle programs it is of great advantage when the single components exert synergistic activity. This is the case for methylbenzoquate and meticlorpindol (clopidol) ([→Energy-Metabolism-Disturbing Drugs](#)), which are used in combination in such shuttle (rotation) programs. However, as single compounds they have only limited success as anticoccidials.

### Hydroxynaphthoquinones

#### Important Compounds

Parvaquone, Buparvaquone, Atovaquone, Menoetone; Combination: Atovaquone/Proguanil (Malarone®).

#### Synonyms

Buparvaquone: Butalex; Menoetone: Menoeton; Parvaquone: Clexon.

#### Clinical Relevance

The potential of this class of 2-hydroxynaphthoquinones was realized over 50 years ago. Parvaquone and buparvaquone have antibabesial and antitheilerial activity (*Theileria parva* in cattle). Against [→theileriosis](#) parvaquone acts against the schizonts in lymphoid cells, thereby, selectively destroying infected lymphocyte cells thus setting free the schizonts which are not protected against the host defense system in contrast to merozoites with their surface-coated [→pellicle](#). Menoetone (= 2-hydroxy-3-(8-cyclohexyl-octyl)-1,4-naphthoquinone) is active *in vitro* in infected bovine lymphoid cell cultures and against theileriosis in cattle *in vivo*.

Atovaquone exerts antimalarial and anticoccidial activity. It is used for treatment of [→malaria](#) in combination with proguanil and shows activity in opportunistic infections in [→AIDS](#) ([→T. gondii](#) cysts in the brain of mice). It has high efficacy in humans suffering from malaria after oral applications. Very recently a new drug combination atovaquone/proguanil (Malarone) was introduced for treatment of acute uncomplicated [→Malaria tropica](#). It is also effective for [→prophylaxis](#). There are no more clinical trials of atovaquone against cryptosporidiosis.

#### Molecular Interactions

The action of **atovaquone** against multidrug-resistant strains of [→Plasmodium falciparum](#) may be explained by its new [→mode of action](#) being different from that of the other antimalarial drugs. It is assumed that the antimalarial actions of 2-hydroxynaphthoquinones and 4-hydroxyquinolines are identical. Their activity is directed against schizonts in lymphocytes or against



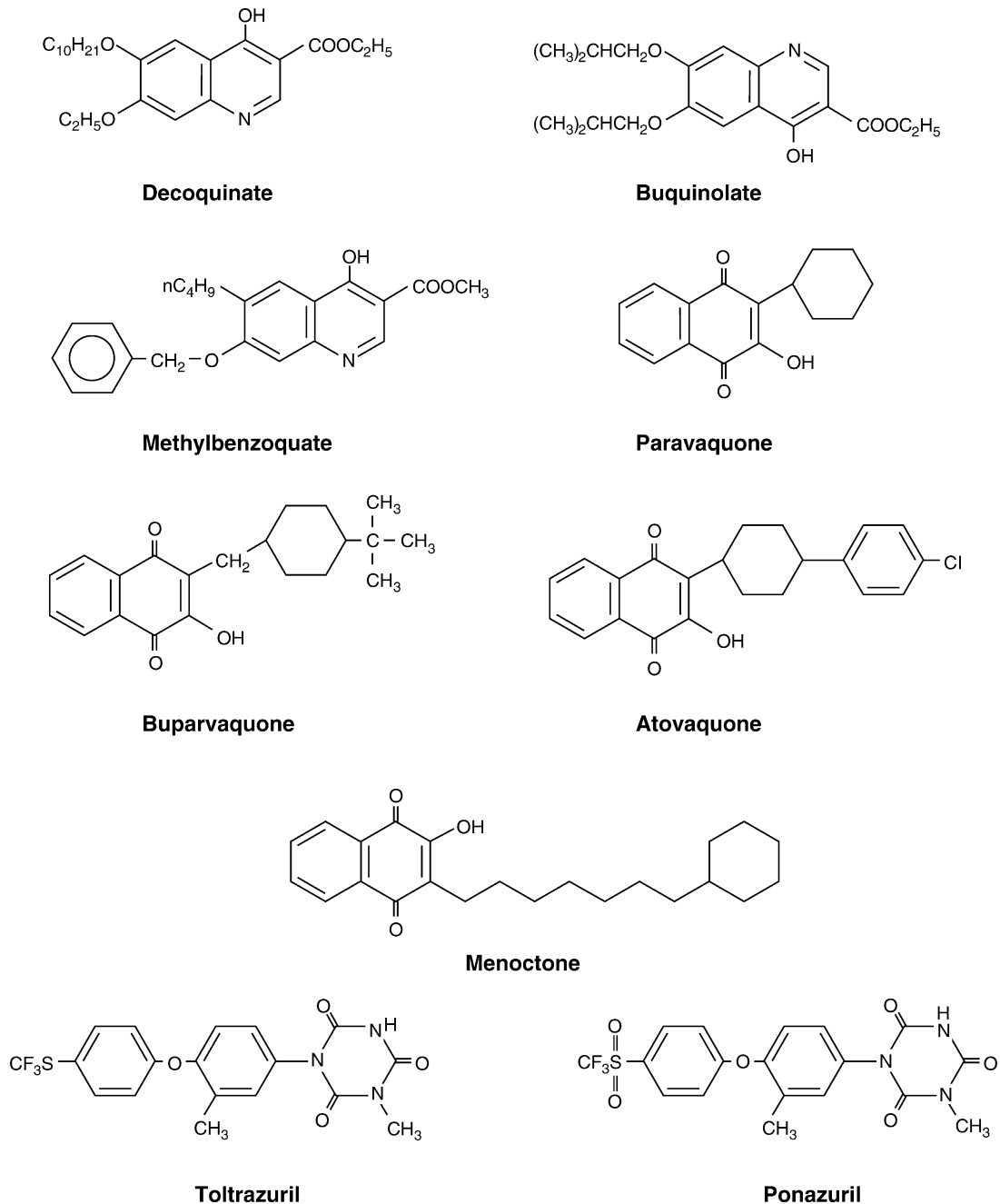

**DNA-Synthesis-Affecting Drugs V: Interference with Dihydroorotate-Dehydrogenase.** Figure 1 Structures of antiparasitic drugs affecting DNA-Synthesis by interference with Dihydroorotate Dehydrogenase.

erythrocytic schizonts ( $\rightarrow$ Hemoglobin Interaction/Fig. 2). There is additional activity against liver and mosquito stages of *P. berghei*. Besides, the formation of ookinets from mature gametocytes of *P. falciparum* is inhibited. As analogues of ubiquinones these compounds have structural similarity to reduced coenzyme Q, and they act through an inhibition of the electron transfer at complex III of the  $\rightarrow$ mitochondrial respiratory chain of parasites. Moreover, there are several reports of an

inhibition of cellular respiration by 4-hydroxyquinolines and an inhibition of mitochondrial succinate dehydrogenase and NADH-dehydrogenase activities from different sources. In isolated  $\rightarrow$ mitochondria from *P. falciparum* atovaquone is bound strongly and selectively to the ubiquinol-cytochrome c reductase site of the respiratory chain (= complex III). The point of block is located between the  $\rightarrow$ ubiquinone and cytochrome b. The inhibition can be reversed by addition of

coenzyme Q. The high therapeutic index and thus the high selectivity of 4-hydroxyquinolines correlates with the lack of inhibition of cell respiration in the chicken host. The reason for this is presumably the great difference of the electron transport chains between  $\rightarrow$ coccidia and their vertebrate hosts. Indeed, atovaquone is 2000-fold more active against the plasmodial respiratory chain compared to the corresponding rat liver mitochondria.

There is another hypothesis for the action of hydroxyquinolines, which relies on the inhibition of pyrimidine nucleotide synthesis at the level of dihydroorotate dehydrogenase (Fig. 2). This then would result in an inhibition of  $\rightarrow$ sporozoite and trophozoite development in the intestinal epithelium. Indeed, a strong inhibition of pyrimidine nucleotide synthesis

could be shown for amquinat, buquinolate, decoquinat, and meticlorpindol probably due to an inhibition of dihydroorotate dehydrogenase (DHOD) (Fig. 2). In  $\rightarrow$ Plasmodium, where ubiquinone plays an important role as an electron acceptor for dihydroorotate dehydrogenase (DHOD), atovaquone is believed to inhibit the pyrimidine synthesis at this level.

### Resistance

There are high frequencies of serious drug resistance in the field against 4-hydroxyquinolines of veterinary medicine. Thus, resistance against buquinolate already appeared within 6 months. There is cross-resistance between different quinines as indication for a similar mode of action. Mitochondria from 4-hydroxyquinoline-resistant *Eimeria tenella* are insensitive to drug

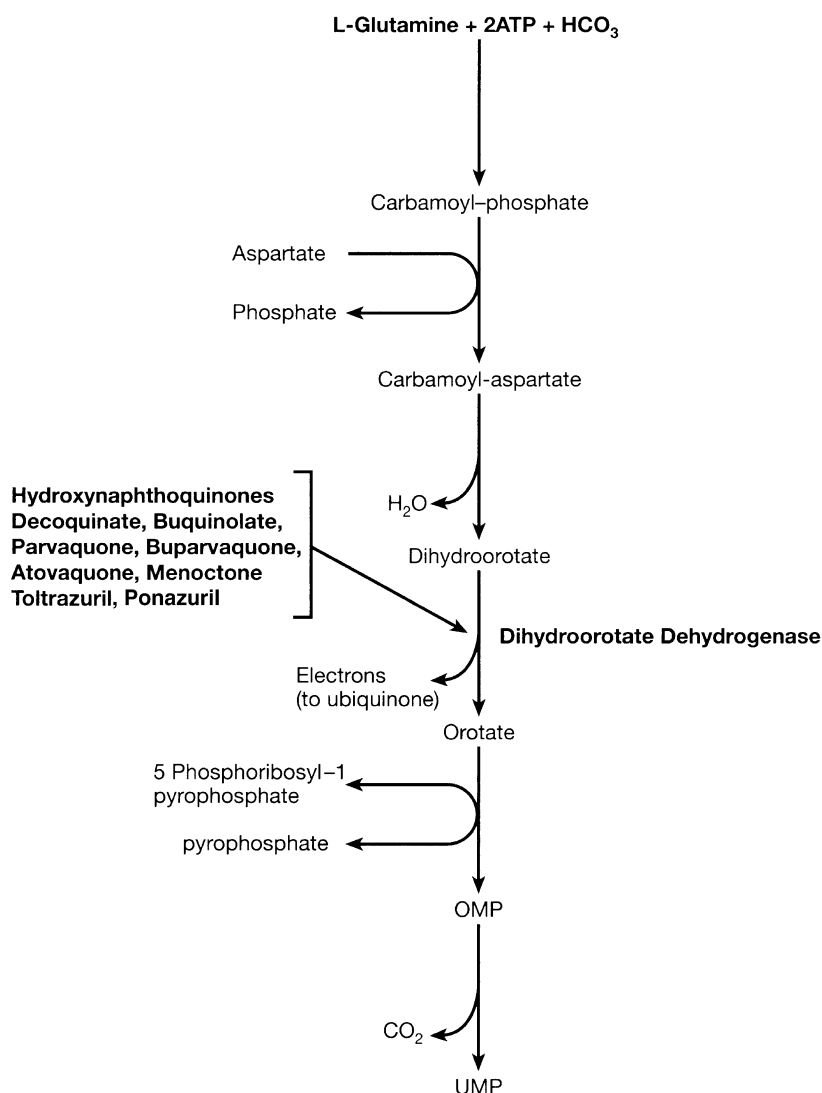

**DNA-Synthesis-Affecting Drugs V: Interference with Dihydroorotate-Dehydrogenase.** Figure 2 Model of dihydroorotate dehydrogenase as target for anticoccidial drugs.

inhibition. The mitochondrial respiration of amquinolate resistant cells is nearly 100-fold less sensitive to 4-hydroxyquinolines, but the real mechanism of resistance on the molecular level is still unknown. Until now resistance of malaria parasites against the 2-hydroxy-naphthoquinone atovaquone does not play any role.

## Toltrazuril

### Synonyms

Baycox.

### Clinical Relevance

Toltrazuril exerts high efficacies in the treatment of poultry coccidiosis. Moreover, the drug is very useful in the treatment of *Cystoisospora ohioensis* and *Isospora canis* in dogs under experimental and field conditions, *I. suis* in piglets, *Eimeria bovis* and *E. zuernii* in calves. Unlike other anticoccidials toltrazuril acts on all intracellular developmental stages of all known *Eimeria* and *Isospora* spp. In addition, toltrazuril exerts an activity against the schizogonous and gametogonic stages of *Toxoplasma gondii* in the cat (→DNA-Synthesis-Affecting Drugs IV/Table 1). For extraintestinal infections of *T. gondii* in cats longer treatment periods with toltrazuril are necessary. Toltrazuril has additional activity against sarcocystosis (→DNA-Synthesis-Affecting Drugs IV/Table 2).

### Molecular Interactions

Toltrazuril is a symmetrical triazinetrione. Its action is directed against first and second generation schizonts, →microgamonts, and macrogamonts. It has no activity against free sporozoites and merozoites. Toltrazuril probably acts by inhibiting the mitochondrial respiration and nuclear pyrimidine synthesis in the parasite. A destruction of the →wall-forming bodies II can be observed in the macrogamonts. Histochemical and biochemical studies reveal that dihydroorotate dehydrogenase may act as a further target of toltrazuril (Fig. 2). There is ultrastructural evidence that plastid-like organelles are present in *T. gondii*, *Sarcocystis muris*, *Babesia ovis*, and *P. falciparum* containing protochlorophyllidae as well as traces of chlorophyll bound to the photosynthetic reaction centers PS I and PS II. These plastid-like structures have been described as membranous cytoplasmic structures containing a →circular DNA molecule of 35-kb length having a →plastid ancestry. It is assumed that the sensitivity of apicomplexans to toltrazuril depends on the interaction of this drug with the D1 protein, a vital constituent of the photosynthetic reaction center II.

Until now there are only reports of isolated cases of resistance against toltrazuril. Under laboratory conditions resistance is relatively difficult to achieve.

## Ponazuril

### Synonyms

→Toltrazuril-sulfone; Marquis.

### Clinical Relevance

Ponazuril treatment is approved for equine neurological disease, called equine protozoal myeloencephalitis, which is caused by *Sarcocystis neurona*. Moreover, the drug is effective experimentally against *Neospora caninum* (syn. *Hammondia heydorni*) in mice and calves, *Toxoplasma gondii* tachyzoites in cell culture and mice, and *Eimeria vermiformis* infected mice.

### Molecular Interactions

Ponazuril (toltrazuril-sulfone) is the antiprotozoally active metabolite of toltrazuril. Therefore it presumably exhibits the same molecular interactions as the mother compound toltrazuril (Fig. 2).

---

## Dollo's Law

This reflects the long-held assumption, that in evolution an organism, which had changed from a complex to a simple state will never return to the complex one, e.g., a free-living stage, when having lost structures and living as a parasite, will never return to the free-living state. Recent findings, however, indicate that there may be reversal.

---

## Donovan, Charles (1863–1951)

English physician, known as discoverer of the intestinal →visceral Leishmaniasis, →Leishmania donovani.

---

## Doramectin

### Chemical Class

Macrocyclic lactone (16-membered macrocyclic lactone, avermectins).

### Mode of Action

Glutamate-gated chloride channel modulator. →Nematocidal Drugs, →Ectoparasiticides – Antagonists and Modulators of Chloride Channels.

## Dormozoite

→Hypnozoites, →Plasmodium.

## Dourine

Chronic venereal disease of horses caused by →*Trypanosoma equiperdum* (→Genital System Diseases, Animals, →Nervous System Diseases, Horses).

## Doxycyclin

Tetracycline, that is used to treat →*Balantidium*-infections and →*Borrelia*-derived Lyme-disease.

## Dracontiasis

### Synonym

→Dracunculiasis, →*Dracunculus medinensis*.

## Dracunculiasis

### Synonym

→Guinea worm infection, →Dracontiasis, Medina worm disease, Fil d'Avicenne.

### General Information

Dracunculiasis is acquired by the swallowing of copepods infected with larvae of →*Dracunculus medinensis* with drinking water. The larva molts and may leave the copepod to be ingested by another one. Or, the ingested L3 larva matures in the deep tissues of humans, and as mature female migrates to a subcutaneous site (usually arm or leg). Larvae are deposited into the tissue and because of →hypersensitivity a cutaneous vesicle is formed which may ulcerate. Upon immersion of the extremity into water, the adult projects into the →ulcer or vesicle and releases the

larvae which wait to be ingested again by copepods. Two types of lesions are produced in man, vesicles which ulcerate and subcutaneous or deep abscesses around dead adult worms. →Inflammatory reaction in the microabscess includes epithelial and giant cells, lymphocytes, and plasma cells; neutrophils and eosinophils are also present close to degenerating worms. These lesions eventually calcify.

### Targets for Intervention

The infective larvae of *Dracunculus medinensis* are ingested by the human host with water while they are still contained within their copepod host (→*Cyclops* spp.). Figure 1 illustrates that dracunculiasis is a disease that lends itself to simple and highly effective control. The major targets of intervention are the cycle of infection and the environment of the copepod host. The approaches to control include detection of infected persons, extraction of the adult worm, prevention of contamination of water used for human consumption, and control of *Cyclops* spp. in such water collections, as well as the use of safe drinking water.

**Main clinical symptoms:** Allergic skin reactions, skin →necrosis.

**Incubation period:** 3–4 months.

**Prepatent period:** 10–14 months until emergence of the female (→*Dracunculus*/Fig. 3).

**Patent period:** Female die usually within 2–6 weeks after emerging from the skin.

**Diagnosis:** Macroscopic inspection of appearing females.

**Prophylaxis:** Avoid drinking uncooked water in endemic regions.

**Therapy:** Surgical withdrawal of adult females, treatment see →Nematocidal Drugs.

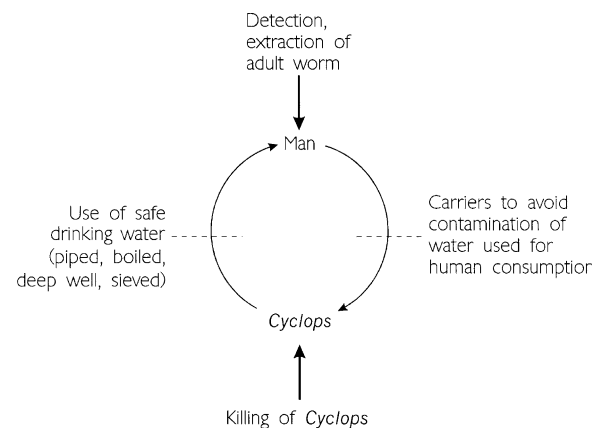

**Dracunculiasis. Figure 1** Targets and approaches for the control of dracunculiasis.

## Dracunculus medinensis

### Classification

Species of → *Nematodes*.

### Life Cycle

Figs. 1, 3.

### Distribution

Fig. 2.

### Disease

→ *Dracunculiasis*, → *Dracontiasis*.

## Drain of Energy

→ *Behavior*.

## Draschia

Genus of nematodes of the family Habronematidae (found in the intestinal tract of equines – being transmitted by flies).

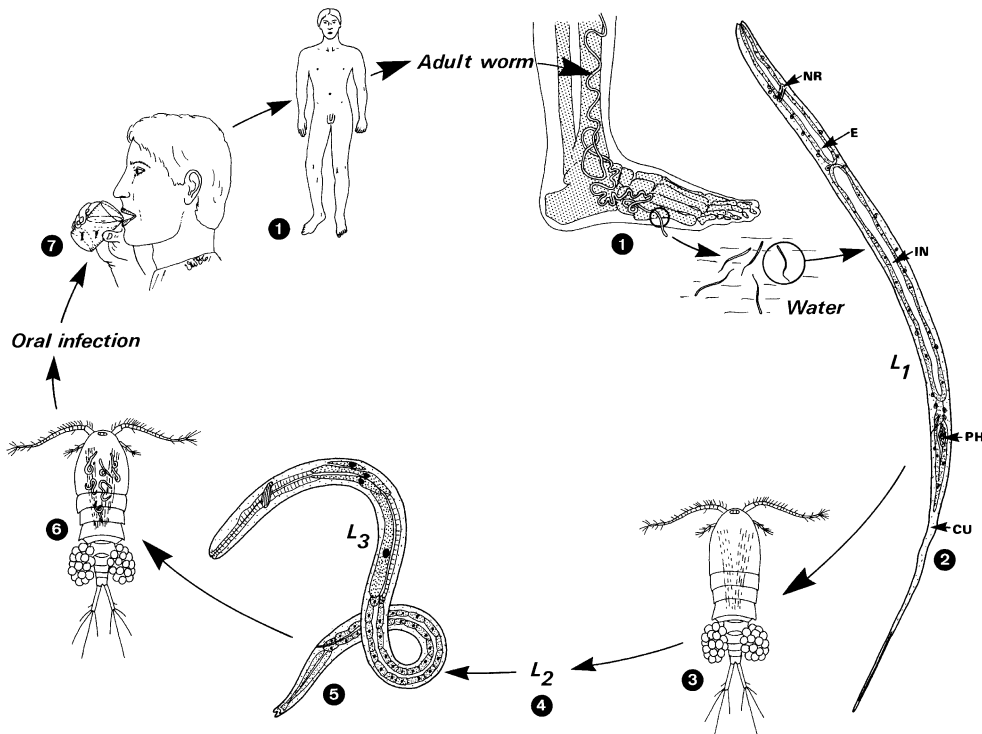

**Dracunculus medinensis.** **Figure 1** Life cycle of *Dracunculus medinensis* (i.e., Medina worm, fil d'Avicenne). 1 Adults (male 4 cm, female 80 cm × 2 mm) live in the subcutaneous tissues of the final host, man, where a gravid female induces the formation of an ulcer-like sore, through which it can protrude its anterior end (with water contact). Its body wall is ruptured by pressure, allowing the gravid uterus to prolapse and release a mass of first-stage larva ( $L_1$ ) - up to half a million per day. 2, 3  $L_1$  remain active in the water up to 1 week until being ingested by a suitable → *intermediate host* (copepodid crustaceans). 4–6 Inside the hemocoel of the intermediate host the transformation to infectious third-stage larvae (300–600 × 15 μm) occurs (via two molts) within 12–14 days (at 25°C). In general, a single larva is found inside a copepod. 7 Infection of man is effected when swallowing infected copepods in contaminated drinking water. Between 10 and 14 months are needed until a new blister in the skin appears (prepatent period). CU, → *cuticle* of first stage larva; E, esophagus; IN, intestine; NR, nerve ring; PH, → *phasmid cell anlage*.

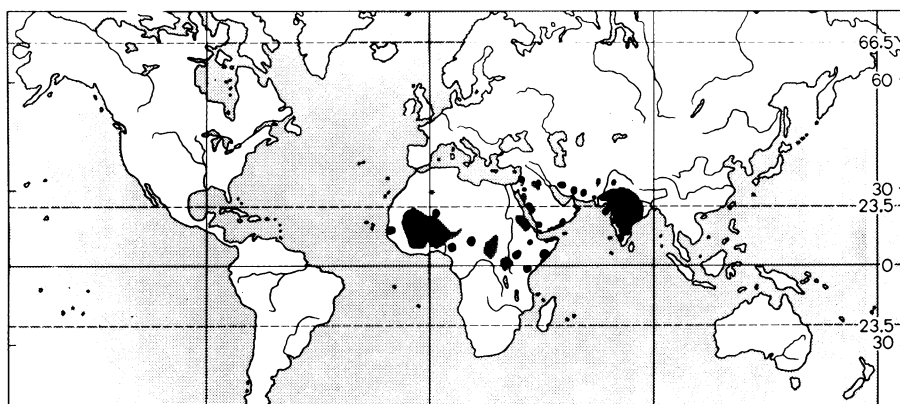

**Dracunculus medinensis.** Figure 2 Distribution map of *Dracunculus medinensis*, which now occurs focally in the dark and grey zones.



**Dracunculus medinensis.** Figure 3 Patients with female worms leaving the skin.

## Drepanidotaenia

Syn. *Hymenolepis lanceolata*, a worldwide occurring tapeworm of goose, ducks, and waterbirds, reaches a length of up to 25 cm, uses intermediate hosts (small crustaceans, e.g., *Cyclops*) and various transport hosts (water snails, e.g., Fam. Lymnaeidae).

## Drepanidotaenia lanceolata

Tapeworm in the intestine of ducks.

## Drug Discovery

The drug discovery and drug development process to screen and evaluate new chemical entities (NCE) with antiparasitic activity is similar to the well-known classical way in pharma industry. These are because of a high number of excellent, recent reviews in this field and distinct problems in the area of antiparasitic drug discovery should be discussed.

The use of antiparasitic drugs is a broad field ranging from ectoparasites, like lice, up to endoparasites like malaria or African sleeping disease, indicating that each parasite needs specific and well-targeted drugs for treatment. Because of the high diverse group of parasites in this review, we focus mainly on endoparasites that

belong to the group of protozoa like *Plasmodium*, *Leishmania*, *Trypanosoma*, and *Cryptosporidium*. Most of these protozoa cause diseases which affect, so-called low-income, countries in the Third World, and only a small market exists in industrialised countries affected by people travelling and contracting mostly malaria. Most of the diseases were neglected, because of low economic interest; in recent years non-profit organisations, like DnDi, MMV, Wellcome Trust, and Institute for OneWorld have taken action to bring these diseases to public awareness and to push academia and industry in private–public partnerships. This positive development has been supported by philanthropic institutions like Rockefeller and Gates Foundation allowing projects with million-dollar budgets. In recent years, product development partnerships have become the principal means, internationally, for the successful development of new medicines, and vaccines and diagnostics for diseases that predominantly affect people in the developing world.

### Drug Development Process

Development of new antiparasitic drugs is expensive, time consuming, and a complex and risky process that takes up to 10–12 years, costs in average €300–700 million Euros and requires a strict drug approval procedure. These aspects affect the willingness for the development of new drugs for neglected diseases. Figure 1 displays the major steps in drug development over 10–15 years.

The most important aspect is health impact of the final product for the target developing country patients. A literature survey of the parasitic disease literature related to the drug development process, a series of 21 independent metrics for safety, efficacy, affordability, and suitability of neglected disease drugs are published. An ideal antiparasitic drug would receive a maximum score on all criteria, what can be considered as not realistic, while a drug with low scores on all criteria would represent a very poor product and would be selected out of the drug development process. On the basis of the scores, drug development experts discriminate valuable antiparasitic drug candidates and products are then classified as below average (less than or equal to half the maximum score for an ideal drug) or above average (more than half the maximum score) on each metric. The major 4 criteria in drug development will be discussed here.

### Efficacy

Resistance is most crucial point and seriously affects efficacy when treating parasitic diseases. This was and is still obvious for chloroquine in malaria treatment; therefore efficacy must be measured for both the short term (cure rates) and the long term (likelihood of rapid development of resistance). Efficacy metrics are also tailored to each disease. For example, schistosomiasis treatments are assessed for whether they are active against all common strains and species, and lymphatic filariasis treatments are assessed for activity against both larval and adult worms.

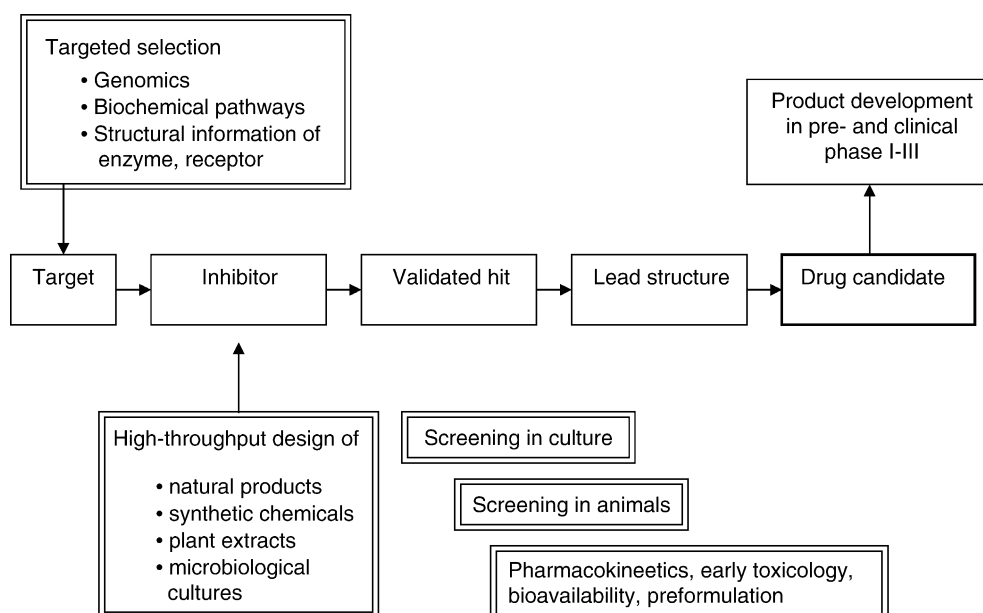

**Drug Discovery. Figure 1** Drug discovery process (modified according to Nwaka and Ridley, 2003).

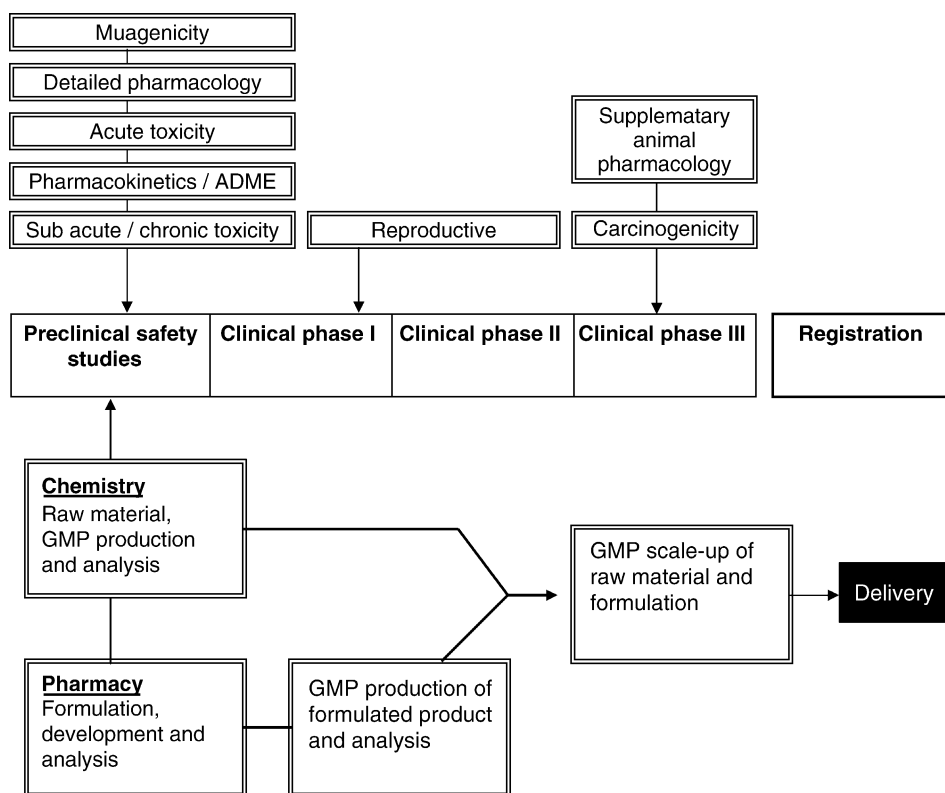

**Drug Discovery. Figure 2** Drug development process to market authorisation (modified according to Nwaka and Ridley, 2003).

### Safety

In principal, the safety concern should be on the same high level in Western or Third World countries. However, for antiparasitic drugs we have to consider a different safety profile, because of the low number of available drugs and cost-benefit analysis, the non-use of a medicine could be more harmful than the potential side effects. It must be under serious consideration to apply Western settings and safety assessment must take into account the incidence and severity of adverse effects (as usually experienced and reported). In that particular case a pharmacovigilance network should be installed to report about adverse events after administration to patients by trained physicians, but also given as over-the-counter drug. The lack of modern public health infrastructure explains high non-prescription use, but also buying drugs illegally from the black market.

### Market Costs and Suitability for Developing Country Use

No medicine can be as good as it is not available on the market. Therefore the price for antiparasitic can meet the realistic price for development and production in

industrialised countries, but would be rather inaccessible for the majority of patients in Africa and Asia. The average budget in a so-called low income country allows public health care by US\$4 per person and year. As an example artemisinin-based chemotherapy costs US\$2–2.5 per dosage, and artemisinin covers US\$1–1.5 from these costs. Annually each patients has to follow 10–12 treatment courses summing up the total price to US\$25–30 per year.

Logistically suitability has to be installed and is depending on several indices, including:

- (1) ease-of-use for patients and health care workers, e.g., dosing intervals, length of treatment required, availability of oral formulations
- (2) appropriateness to developing country health systems, e.g., requirement for cold chain, or for hospital-based administration
- (3) percentage of the affected patient group covered by the therapy, e.g., adults and
- (4) children, or only adults; all patients, or only second-stage or severely ill patients.

This index was also tailored to each disease, but special diseases like tuberculosis, what is not a parasitic disease, needs a long term treatment covering other



additionally indices, while antimalarials were additionally assessed for usefulness in pregnant women and paediatric patients, who make up the majority of malaria mortality figures.

For latest literature information please contact the author Professor Dr. Kayser.

---

## Drug Resistance

→Resistance Against Drugs.

---

## Drugs

### Synonyms

Compound, substance, agent, medicament, product.

### Definition

Drug can be broadly defined as any chemical compound that affects living processes and is used in the diagnosis, prevention, treatment (cure) of disease(s), or for controlling or improving any physiological or pathological disorder, or for relief of pain in animals and humans.

### General Information

→Chemotherapy/Drugs.

### Related Entries

→Acanthocephalacidal Drugs, →Antidiarrhoeal and Antitrichomoniasis Drugs, →Arthropodicidal Drugs (→Ectoparasitocides – Antagonists and Modulators of Chloride Channels, →Ectoparasitocides – Agonists and Antagonists of Cholinergic Transmission, →Ectoparasitocides – Modulators/Agonists of Aminergic Transmission, →Energy-Metabolism-Disturbing Drugs, →Repellents), →Babesiocidal Drugs, →Cestodocidal Drugs, →Chemotherapy, →Coccidiocidal Drugs, →Control, →DNA-Synthesis-Affecting Drugs I, →DNA-Synthesis-Affecting Drugs II, →DNA-Synthesis-Affecting Drugs III, →DNA-Synthesis-Affecting Drugs IV, →DNA-Synthesis-Affecting Drugs V, →Ectoparasitocidal Drugs (→Arthropodicidal Drugs, →Ectoparasitocides – Modulators/Agonists of Aminergic Transmission, →Ectoparasitocides – Antagonists and Modulators of Chloride Channels, →Ectoparasitocides – Agonists and Antagonists of Cholinergic Transmission, →Ectoparasitocides – Blockers/Modulators of Voltage-Gated Sodium Channels, →Ectoparasitocides – Inhibitors of Arthropod Development,

→Energy-Metabolism-Disturbing Drugs, →Repellents), →Energy-Metabolism-Disturbing Drugs, →Hem(oglobin) Interaction.

→Insecticides see →Ectoparasitocidal Drugs.

→Leishmaniacidal Drugs, →Malariacidal Drugs, →Membrane-Function-Disturbing Drugs, →Microsporidiosis, →Microtubule-Function-Affecting Drugs, →Myxosporidiacidal Drugs, →Mode of Action, →Nematocidal Drugs, Animals, →Nematocidal Drugs, Man, →Protein-Synthesis-Disturbing Drugs, →Repellents, →Sarcocystosis, →Theileriacidal Drugs, →Treatment of Opportunistic Agents, →Trematodocidal Drugs, →Trypanocidal Drugs, Animals, →Trypanocidal Drugs, Man.

## Mode of Action and Resistance of Drugs

→Ectoparasitocides – Agonists and Antagonists of Cholinergic Transmission, →DNA-Synthesis-Affecting Drugs I, →DNA-Synthesis-Affecting Drugs II, →DNA-Synthesis-Affecting Drugs III, →DNA-Synthesis-Affecting Drugs IV, →DNA-Synthesis-Affecting Drugs V, →Energy-Metabolism-Disturbing Drugs, →Hem(oglobin) Interaction, →Membrane-Function-Disturbing Drugs, →Microtubule-Function-Affecting Drugs, →Protein-Synthesis-Disturbing Drugs.

---

## Drugs Against Microsporidiosis

### General Information

→Microsporidians are eukaryotes of ancient origin (lack of →mitochondria) and obligate intracellular parasites entering host cells via a →polar tube within a spore. The organisms are ubiquitous and may occur in humans and a wide range of animals (wild, fish, and arthropods) but also dogs and other domestic animals commonly associated with humans. Today, there are no efficient control measures for prevention of →microsporidiosis in humans and →animal reservoirs. →Spores seem to be resistant to various physical effects such as sonification, freezing or thawing, ultraviolet or gamma radiation.

### Humans

Serious microsporidiosis may develop in immunocompromised individuals (e.g., →AIDS patients, travellers going to tropical areas). Ocular infection is manifest by conjunctival, corneal, and/or stromal invasion, predominantly by *Encephalitozoon hellem*, and *Vittaforma cornea* (syn. *Nosema corneum*). Intestinal infections are due to →*Enterocytozoon bienersi*, *Encephalitozoon*

*intestinalis*, and →*E. cuniculi*. Clinical signs may be severe diarrhea, →malabsorption, and wasting. Disseminated infections may be produced by *E. hellem*, *E. cuniculi*, and →*Pleistophora* spp. and are often accompanied by concurrent HIV infection (→Treatment of Opportunistic Agents/Drugs Acting on Cryptosporidiosis of Mammals and →Antidiarrhoeal and Antitrichomoniasis Drugs/Drugs Acting on Giardiasis, respectively).

### Pathology

Immunosuppressed humans have been sentinels of microsporidial infection, with enteric, neurologic, ocular, and pulmonary manifestation being recognized. Their symptomatology, pathology, and differential diagnosis, based on ultrastructure and the polymerase chain reaction, has been widely established. Microsporidiosis appears to be a common asymptomatic infection, that is not clinically recognized; about 10% of animal handlers were reported to have antibody to →*Encephalitozoon* sp. The organism grows intracellularly, destroying the infected cells. There is little inflammation. The →Brown-Brenn stain (Gram-stain for tissues), basic fuchsin, toluidin blue, Azur II-eosin, the →Warthin-Starry silver impregnation, and polarization facilitate recognition of →microsporidia in tissue sections. Tissue imprints (smears), dried, fixed, and stained as for blood smears, are useful for diagnosis of corneal and conjunctival lesions. Stool and sputum smears can be stained with a modified →trichrome stain employing chromotrope 2R or with a fluorochrome →chitin stain, such as Calcofluor.

A fatal disseminated infection of a 4-month-old thymic alymphoplastic baby with *Nosema connori* involved the smooth musculature, skeletal muscles, the myocardium, parenchyma! cells of the liver, lung, and adrenals. *Encephalitozoon* sp. was isolated from the cerebrospinal fluid of a 9-year-old Japanese boy with →meningoencephalitis who recovered (Matsubayashi). Intestinal microsporidiosis has been described in several patients with AIDS due to *Enterocytozoon bieneusi* also with cholangitis and due to *Encephalitozoon (Septata) intestinalis*. The patients had →diarrhoea, with →weight loss from malabsorption. Inflammation was minimal and the diagnosis was made ultrastructurally. Disseminated *Encephalitozoon cuniculi* infection was noted and *E. hellem* had been isolated from AIDS patients with nephritis and prostatitis and from others with keratoconjunctivitis, bronchitis, and sinusitis. Microsporidial myositis due to *Pleistophora* and *Trachypleistophora hominis* was reported in patients with AIDS. Intraocular microsporidiosis was diagnosed from the cornea next to Descemet's membrane with a subacute to granulomatous →inflammatory reaction; other HIV-negative cases

with corneal stromal infection were linked to *Nosema ocularum* (possibly *Vittaforma corneum*).

### Treatment

Treatment is problematic since the gram-positive staining spores (most familiar stage of microsporidia) are resistant to most drugs (→Treatment of Opportunistic Agents/Table 1). Several topical antimicrobial and anti-inflammatory drugs have been used for treating ocular disease such as keratoconjunctivitis. **Topical drugs** such as propamide isethionate or the water-soluble fumagillin derivative Fumidil-B (eyedrops) may resolve ocular symptoms caused by *E. hellem*, which reoccur, however, when treatment is stopped indicating a static rather than a cidal action of drugs. For lesions due to →*V. corneae*, topical therapy is generally not effective and keratoplasty may be required. Oral administration of **albendazole** may improve ocular, nasal, and enteric symptoms; the drug has a marked static effect on intestinal microsporidians like *Ent. bieneusi* and *E. intestinalis*. The latter species proves more susceptible to treatment with albendazole. The drug seems to inhibit polymerization of →microtubules within intranuclear spindles in dividing nuclei only, and for that reason growth of parasites will continue in the absence of →nuclear division. In the current situation almost nothing is known about epidemiology of human microsporidiosis; an open question is whether microsporidians in man are solely human infections or are some episodes of zoonotic origin.

### Fish

With respect to chemotherapy of microsporidiosis in fish, it was shown that the antibiotic **fumagillin** acts against *Glugea plecoglossi* in the Japanese ayu (*Plecoglossus altivelis*), but in some cases the mortality of treated fish was higher than that of untreated fish. The →mode of action of fumagillin is thought to inhibit DNA or RNA synthesis. More recent investigations have shown that a symmetric triazine **toltrazuril** and an asymmetric triazine (HOE 092V) kill the merogonic and the sporogonic stages of the microsporidian *G. anomala*. The drugs are also highly active against other fish and crayfish parasites. As revealed by ultrastructural investigations, the effects of the triazine derivatives on *G. anomala* comprised a decrease in the number of ribosomes, enlargement of the smooth ER, depletion of the nuclear membrane, and destruction of the nuclear structures. In a further study it was demonstrated that different **benzimidazole** derivatives (albendazole, mebendazole, and fenbendazole) disturbed the intracellular development of the microsporidian *G. anomala* by damaging its merogonic, sporogonic, and prespore stages as well as the mature spores.

## Drugs Against Sarcocystosis

→*Sarcocystis* spp. are obligate, heterogeneous coccidian parasites. Definitive host may be carnivores, felidae, humans, and primates. Their asexual reproduction may occur in herbivores (horse, cattle, sheep, goat, camel), omnivores (pigs, humans), and also birds (chicken, ducks). Consumption of feed contaminated with sporocysts (oocysts) from the feces of the definitive host leads to infection of herbivores.

### Pathology and Treatment

Experimental →*sarcocystosis* in cattle (*S. bovicanis*) or that of horses (*S. equicanis*) has been associated with acute and chronic myositis caused by intramuscular sarcocysts. Long-term treatment with orally administered pyrimethamine, and →trimethoprim + →sulfamethoxazole is necessary to achieve remission of clinical signs. This can be applied also to cases of naturally occurring equine protozoal myeloencephalitic (→EPM) caused by *S. neurona*. The treatment lasted between 45 and 211 days; adverse effects in horses were mild to severe, including →abortion. **Halofuginone** (→Coccidiocidal Drugs/ Table 1) appears to be effective against acute sarcosporidiosis in goats and sheep at 0.67 mg/kg on 2 successive days. In humans, who may serve as accidental →intermediate host for several unidentified *Sarcocystis* spp. sarcocysts have been found in striated muscles. Their clinical significance is unknown in naturally occurring life cycles. For **control** of sarcocystosis, carnivores should be excluded from animal houses, and from feed, water, and rearing facilities for livestock or dead livestock. Cooking or heating (60° C for at least 20 minutes) of contaminated material will kill sarcocysts.

### Vaccination

There is no protective vaccine against sarcocystosis in animals or humans.

## Drugs with Unknown Antiparasitic Mechanism of Action

### Structures

Fig. 1.

### DL-Propranolol

#### Clinical Relevance

The antiparasitic activity of propranolol is directed against →*Giardia lamblia*.

### Nitrobenzamides

#### Important Compounds

Dinitolamide, Zoalene, Nitromide.

#### Clinical Relevance

Dinitolamide, zoalene have activity mainly against first and second generation schizonts of *Eimeria tenella* and *E. necatrix*. They have only limited effects against *E. acervulina*. They do not interfere with the immunity of chicken hosts. Nitrobenzamides are assumed to act as a nicotinamide antagonist.

### Diclazuril/Clazuril

#### Clinical Relevance

Diclazuril and clazuril belong to 1,2,4-triazine-derivatives. They have broad-spectrum activity in →*Eimeria* infections. They exert additional activity against →*Neospora caninum* →tachyzoites in cell cultures. The →mode of action is unknown. The activity of diclazuril is directed only against specific endogen stages of *Eimeria* species. Thus, diclazuril is active against second generation schizonts of *E. acervulina*, *E. mitis*, and *E. necatrix*, against gamonts, late schizonts of *E. brunetti*, zygotes of *E. maxima* and first and second generation schizonts, and sexual stages of *E. tenella*. The →sporulation becomes delayed by diclazuril.

### Febrifugine

#### Clinical Relevance

Febrifugine is an antimalarial drug from traditional Chinese medicine.

### Pyronaridine

#### Clinical Relevance

Pyronaridine has high efficacy in clinical studies in China against chloroquine-resistant →*Plasmodium falciparum*. There is cross-resistance to 4-aminoquinolines and quinolinemethanol antimalarials. Morphological effects on →mitochondria, endoplasmic reticulum, and ribosomes can be observed. Food →vacuoles are probably a primary target of pyronaridine.

### Halofuginone

#### Clinical Relevance

Halofuginone is a quinazolinone derivative. It is an alkaloid originally isolated from the plant *Dichroa febrifuga*. It is effective against the six pathogenic *Eimeria* spp. of chicken. Halofuginone has an influence on sexual first-generation →schizogony. It specifically suppresses the skin →collagen synthesis in mammalian cells *in vivo* resulting in an increase in skin fragility. *In vitro* the incorporation of radiolabelled →proline into collagen by avian skin fibroblasts is impaired. Thereby,

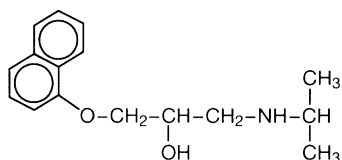
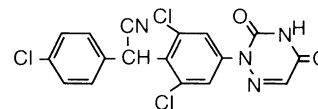
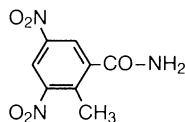
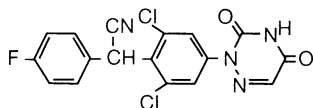
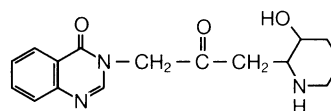
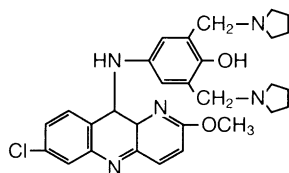
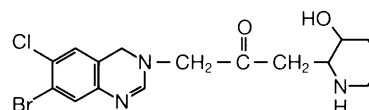
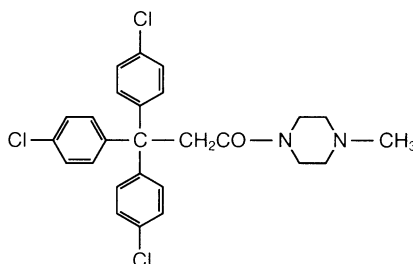
**Propranolol****Diclazuril****Zoalen****Letrazuril****Febrifugine****Pyronaridine****Halofuginone****Hetolin**

**Drugs with Unknown Antiparasitic Mechanism of Action.** Figure 1 Structures of antiparasitic drugs with unknown mechanism of action.

the expression of *α1* gene of collagen type I is specifically depressed but not that of collagen type II in skin fibroblasts and growth-plate chondrocytes. This results in a decrease in synthesis of collagen. The mechanism of action against *Eimeria* spp. is unknown at present. Furthermore, halofuginone has been used in *Theileria parva* and *T. annulata* infections in cattle. The activity is directed against schizonts in lymphocytes. Thereby, infected lymphocytic cells are destroyed setting free the schizonts, which in contrast to merozoites with

their surface-coated →pellicle are not protected against the defense system of the host. Halofuginone has additional activity against *Cryptosporidium parvum* in calves.

### Halogenated Hydrocarbons

#### Clinical Relevance

The halogenated hydrocarbons carbon tetrachloride, hexachloroethane, tetrachloroethylene and hexyloesorcinol were used until very recently in veterinary medicine.

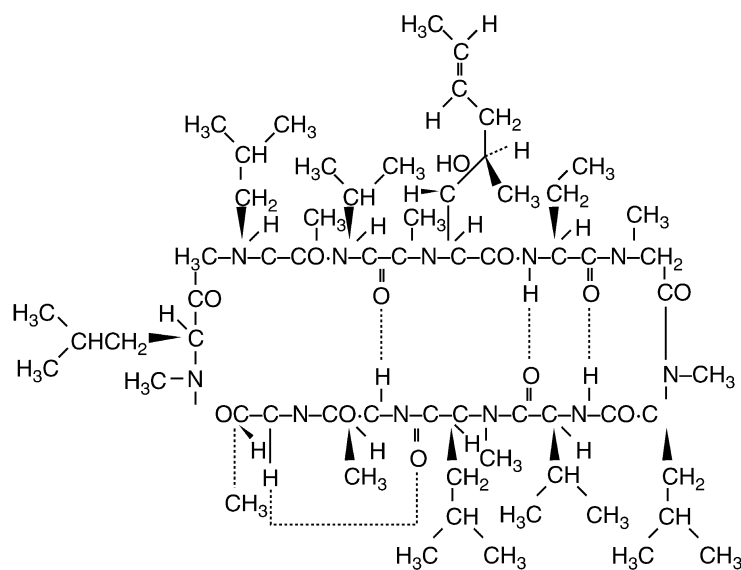

Cyclosporin A



Quinuronium Sulfate

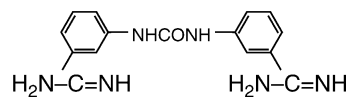

Amicarbalide

**Drugs with Unknown Antiparasitic Mechanism of Action. Figure 1** Structures of antiparasitic drugs with unknown mechanism of action. (Continued)

Now they are no longer used because of mutagenic properties. Hetol (= hexachloroparaxylene) was used to a limited extent in veterinary medicine against *Fasciola hepatica* infections and for human *Clonorchis sinensis* infections (*→Energy-Metabolism-Disturbing Drugs/*Table 2). However, it is characterized by serious side effects.

### Hetolin

#### Clinical Relevance

Hetolin is a specific compound against *Dicrocoelium dendriticum* (*→Energy-Metabolism-Disturbing Drugs/*Table 1) with erratic efficacies.

### Cyclosporin A

#### Clinical Relevance

The antiparasitic activity of cyclosporin A was discovered in 1981. The antiprotozoal activity is directed against *Leishmania* spp., *Toxoplasma* and *Plasmodium*. In addition, cyclosporin A has anticestodal and antischistosomal activity. The latter is directed against schistosomes. Here the compound has a long-lasting prophylactic effect up to 100 days before infection.

After treatment the number of worms is reduced. Immature worms and female worms are more affected than male worms. The use of cyclosporin A would mean important qualitative progress in the control of schistosomiasis since there would be protection by a single dose over a good part of the transmission season. A correlation between the antiparasitic and the immunosuppressive effects of cyclosporin A seems unlikely, since cyclosporin analogs with antischistosomal activity show only minor immunosuppressive activity. Cyclosporin A has lethal effects *in vitro* against schistosomes. Cell-mediated immunity does not play a role in the antischistosomal action of cyclosporin A. Furthermore, the compound has antifilarial activity and is used in human medicine as an immunosuppressing drug.

### Quinuronium sulfate (= Acaprine), Amicarbalide

#### Clinical Relevance

Babesiosis of cattle may be controlled easily by these two drugs. A single parenteral treatment results in the disappearance of clinical symptoms and premunity against, e.g., *Babesia divergens*. In general, however, improvement of parasitaemia is obtained only after several treatments with higher dosages.

## Duffy Blood Group

→ Natural Resistance.

## Dum-Dum Fever

→ *Leishmania*, → Visceral Leishmaniasis.

## Duncker's Muscle Fluke

Mesocercariae of → *Alaria allata* in pig muscles.

## Duplicidentata

Order Lagomorpha (hares, rabbits) → *Simplicidentata* (rodents = rats, mice, hamster).

## Dutton, John Everett (1874–1905)

English scientist, who discovered the tick-borne relapsing fever (due to transmission by → *Ornithodoros moubata*). His friend, the Canadian scientist J.L. Todd, honoured Dutton by naming the agent of this disease *Spirochaeta* (now *Borrelia*) *duttoni*. Dutton died at only 31 years of age from this disease on the February 5, 1905, while his colleague survived. The louse-borne relapsing fever was detected by → *Obermeier*.

## Duttonella

Subgenus of → *Trypanosoma*.

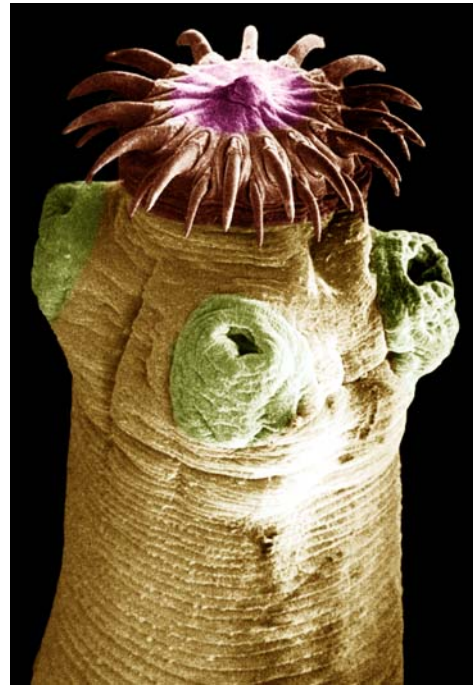

**Dwarf Tapeworm. Figure 1** SEM of the head of *Hymenolepis nana*.

## Dwarf Tapeworm

*Hymenolepis* (syn. → *Rodentolepis*, → *Vampirolepis*, Fig. 1) *nana* (→ *Hymenolepidae*, → *Eucestoda*), Fig. 1.

## Dye Test (DT)

Serologic test, e.g., to diagnose acute toxoplasmosis during pregnancy, → *serology*.

## Dyskinetoplastic Stage

The → *kinetoplast* of some trypanosomatids loses its DNA content in some developmental stages these stages may survive in mammals, but not in the vector.



## EANMAT

East African Network for Monitoring Antimalarial Treatment.

## Earcanker

Trivial name of the mite *Psoroptes cuniculi* entering the ear of goats and causing otitis. → [Acariosis, Animals](#).

## East Coast Fever (ECF)

→ [Theileria](#), → [Theileriosis](#).

## Eastern Equine Encephalitis (EEE)

→ [Arboviruses](#).

## EBA

### Synonym

Erythrocyte-binding Antigens. → [Apicomplexa](#).

## Ecdysis

### Name

Greek: *ecdysis* = hatch.

During growth arthropods have to discharge several times their cuticle. → [Ecdysteroids](#), used during → [molt](#) of → [nematodes](#) and arthropods.

## Ecdysteroid Receptor

### Synonym

→ [EcR](#).

### General Information

Genomic ecdysteroid effects in insects and crustaceans are mediated via an intracellular ecdysteroid receptor (EcR). This receptor belongs to the superfamily of nuclear receptors and is related to all vertebrate steroid hormone receptors. In its functional form the EcR is usually a heterodimer of EcR and another transcription factor, belonging to the same superfamily, which is called ultraspiracle (USP) and which is a homologue to the vertebrate retinoid X receptor (RXR). EcR and USP are phosphoproteins and can occur in different splice variants. They possess a ligand (= → [Hormone](#)) binding domain (LBD), a DNA binding domain (DBD), and a transactivation domain as well as interfaces for dimerization, interaction with → [heat shock proteins](#) and comodulators, and for nuclear transport.

Highest ligand affinity has been shown for ponasterone A and muristerone A, followed by 20-hydroxyecdysone (→ [Ecdysteroids](#)). Depending on the insect taxon high affinity for non-steroidal molting hormone agonists was shown. The EcR expression is under control of its own ligand.

→ [Nematodes](#) are claimed to be closely related to arthropods according to molecular criteria and → [ecdysteroids](#) have been demonstrated in this → [helminth](#) group unequivocally (→ [Ecdysteroids](#)). Therefore, one could assume the same → [mode of action](#) of ecdysteroids and thus the presence of ecdysteroid receptors also in nematodes, but so far all attempts to demonstrate ecdysteroid-binding proteins by ligand binding were unsuccessful. Using consensus sequences of the nuclear receptor superfamily for screening in → [Caenorhabditis elegans](#) libraries, cDNA clones were found with high sequence identity to steroid hormone receptors. Since orphan receptors and other transcription factors are also members of this superfamily, this is no proof for the existence of an ecdysteroid receptor in *C. elegans*. Expression of these cDNA clones and subsequent



binding studies must be performed before an unequivocal proof for the presence of an ecdysteroid receptor in *C. elegans* is valid.

### Gene Regulation

The concept of gene expression by steroid hormones was originally derived from studies on puff induction in giant [→chromosomes](#) by ecdysteroids and subsequently improved. Functional ecdysteroid receptors are essential for gene regulation by ecdysteroids and induce a set of gene products. As early responses transcription factors are induced which are members of the nuclear receptor superfamily themselves.

### Implications

Non-steroidal molting hormone agonists which bind to the functional ecdysteroid receptor are used for insect pest control by evoking precocious and incomplete molting. Successful applications of ecdysteroid agonists and antagonists to nematodes were not described so far. The ecdysteroid receptor in combination with RXR is used as an ecdysteroid-inducible expression system in mammalian cells.

---

## Ecdysteroids

### Synonym

[→Molting hormones](#).

### General Information

The name ecdysteroids refers to a class of steroid hormones whose main function the regulation of [→ecdysis](#) in arthropods. Ecdysteroid is a generic name for a total of more than 120 different polyhydroxylated steroids present either in plants (phytoecdysteroids), invertebrates (zooecdysteroids), or both. The ecdysteroids are present in all invertebrate phyla and thus represent the most widespread steroid hormones. The molecular weight is between 464 (e.g., ecdysone, ponasterone A) and 480 (20-hydroxyecdysone).

### Structure

In contrast to vertebrates, the invertebrates studied so far are unable to synthesize sterols *de novo* and are therefore dependent on the presence of cholesterol or related sterols. Another difference is the presence of a full side chain as in cholesterol. Zooecdysteroids are therefore mainly C27 steroids, in contrast to the vertebrate steroid hormones (C18, C19, and C21) ([Fig. 1](#)). All ecdysteroids bear a *cis*-fused A/B ring junction which is again different from the situation in vertebrates (*trans*-fused A/B ring junction). A further

difference to vertebrate steroid hormones is the good water solubility of ecdysteroids, caused by the high number of hydroxyl groups. Ecdysteroids can occur either in free form or as conjugates. The position of [→conjugation](#) as well as the main groups which are conjugated with ecdysteroids are shown in [Fig. 1](#).

Like in vertebrate steroid hormone research, non-steroidal molting hormone agonists (bisacylhydrazines) are useful tools for the study of hormonal action and for interference with molting processes. Recently molting hormone antagonists (cucurbitacins; triterpenoids of plant origin) have also been described.

### Physiological Function

In contrast to insects and crustaceans, much less information is available on the physiological roles of ecdysteroids in other phyla. Among parasites there are some data on presence, titer, and putative functions available for [→cestodes](#) and [→trematodes](#) but most information has accumulated for [→nematodes](#). Analogous to arthropods, there are mainly 2 processes, which are probably regulated by ecdysteroids in nematodes, i.e., development and reproduction. At least in some nematodes there is a clear correlation between titer of ecdysteroids and the molting cycle and there is also an effect of ecdysone on reinitiation of meiosis, on differentiation during early [→embryogenesis](#), cell rearrangement during gastrulation, and on [→fecundity](#).

### Implications

Non-steroidal moulting hormone agonists induce precocious and incomplete molt and are used for insect pest control. High concentrations of ecdysteroids are deleterious to insects (hyperecdysonism) and also kill nematodes both *in vivo* and *in vitro*. Certain amines and amides inhibit phytosterol dealkylation in insects and free-living nematodes and steps in the ecdysteroid biosynthetic pathway in insects and are powerful schistosomicidal agents.

---

## Echenebothrium dubium

Tetraphyllid tapeworm in Chondroichthyes (rays).

---

## Echidnophaga gallinacea

The name of this 2.5 mm-sized so-called crest-flea of birds comes from the old name of the ant-hedgehock (*Echidna hystrix*), at which the first specimen of this flea was detected. *Echidna* is a Greek mysterious monster

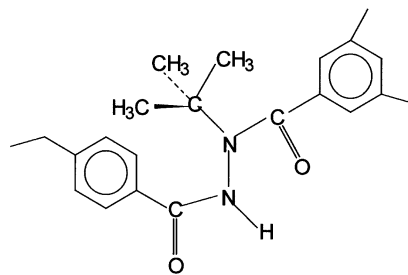
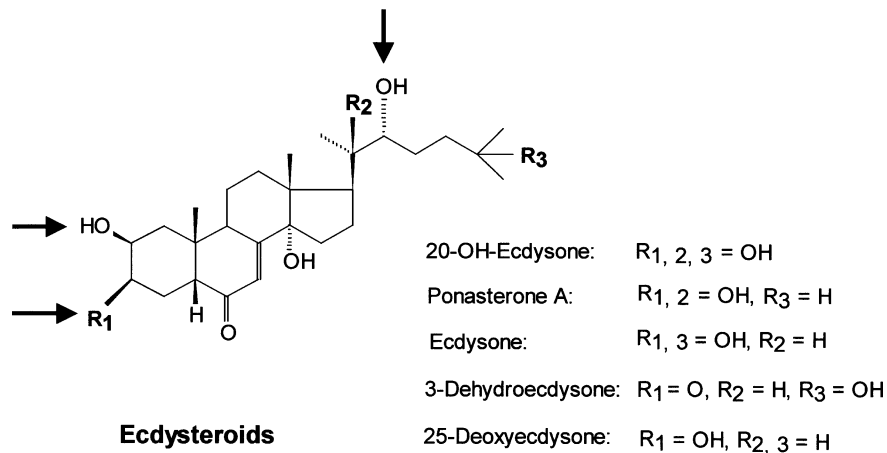

RH 5992

**Non-steroidal moulting hormone agonist**

**Ecdysteroids. Figure 1** Ecdysteroids. (A) Structure of ecdysteroids (20-OH-ecdysone, ponasterone A) and primary synthesis products. Arrows indicate preferential sites of conjugation with phosphate, fatty acids, acetate, glucosides, glucuronides and sulfates. (B) Representative of the group of nonsteroidal molting hormone agonists.

and Greek: *phagein* = feeding. Besides birds, *E. gallinacea* parasitizes worldwide at many host species including man. Since the females attach for a long time for feeding at the skin of their host, they were often erroneously kept for sand fleas ( $\rightarrow$  *Tunga penetrans*). The smaller males mate with the skin-fixed females for 15 minutes. The mouthparts of females are used as anchor and -form a deep hollow, from which the English common name “tight-stick-flea” derives.

Soon after the artistically copulation (the male hangs back down in the air; Fig. 7 in ( $\rightarrow$  *Fleas*)) the female starts to lay eggs (about 11–14 per day), which fall onto the soil for further development. Besides *E. gallinacea* 20 other species are described (e.g., *E. larina*, *E. aethiops* also occurring in Africa).  $\rightarrow$  *Fleas*.

**Echinochasmus perfoliatus**

Species of the trematode order Echinostomatida.

**Echinocirrus melis**

1 cm long echinostomatid flukes in the intestinal system of hedgehocks.

**Echinochasmus**

Genus of  $\rightarrow$  *Trematodes*.

**Echinococciasis**

$\rightarrow$  *Echinococcus*; syn.  $\rightarrow$  *Echinococcosis*.

## Echinococcosis

### Pathology

→*Echinococcus granulosus* is the causative agent of cystic →*hydatid disease* or cystic echinococcosis whereas infection with *E. multilocularis* in man leads to the more aggressive form of alveolar echinococcosis (Figs. 1, 2). In both cases, the primary site of contact with the parasite is the mucosal surface of the host's gastrointestinal tract. Echinococcosis is contracted by the inadvertent ingestion of eggs from the feces of dogs or other carnivores. Thus humans serve as intermediate hosts instead of normally, sheep, mice, or other herbivores. Larval cysts or →*hydatids* can be found in many tissues, most often in the liver, lung, mediastinum, and peritoneum, giving rise only to pericystic fibrosis when intact. Hydatid cysts attain a large size because of asexual reproduction and proliferation of the innermost cyst layer, the germinal epithelium. In *E. granulosus* small protoscolices develop in the hydatid cysts with suckers, hooklets, and calcareous bodies. Detached →*brood capsules* and sometimes daughter cysts develop, again with internal multiplication; the gross appearance may be one of a bunch of grapes of various sizes. In *E. multilocularis*, the external laminated membrane of the cyst is incomplete and the inner germinal epithelium proliferates diffusely in an alveolar pattern, spreading like a neoplasm through the human liver, which is destroyed (→*Pathology/Fig. 16, 29E,F*). Folded laminated membranes are usually present. Protoscolices are rarely found in humans, although they are common in natural hosts. The cysts of *E. vogeli* usually contain primitive scolices. Production of lesions by all species depends on the location, number, and state of the cysts. Slow seepage of cyst fluid may lead to seeding of new areas, and cystic

metastases to brain and lung can occur. Sudden hydatid cyst rupture can produce →*anaphylactic shock*. →*Eosinophilia* accompanies the infection. Molecular immunopathology is reviewed in detail by Gottstein and Hemphill.

### Immune Responses

The cellular and humoral →*immune response* in humans in response to migrating oncospheres and established metacestodes varies enormously as evidenced, for example, by different antigens recognized by individual patients with different courses of disease. Hydatid growth despite the presence of humoral and cellular anti-metacestode immune responses may result from the variation or downregulation of the parasite's antigens or from active immunomodulation by these →*cestodes*.

### B Cells and Antibodies

Most serological studies in humans were performed to monitor patients after long-term chemotherapy or postoperatively. In cystic echinococcosis strain variations of the parasite as well as genetic differences between host populations may significantly affect the antibody response. For example, conventional serological tests were often negative in patients from Kenya or in patients with lung localizations of the cysts. However, rapid seroconversion was observed in most of these patients early after treatment arguing in favor of immunosuppressive mechanisms which are reverted after surgical removal of the cyst. Much emphasis was given to the determination of parasite-specific antibody isotypes. However, only in the case of IgE has a significant (negative) correlation with the response to chemotherapy been reported. IgE bound to basophils may be involved in anaphylactic reactions upon preoperative or intraoperative cyst rupture.

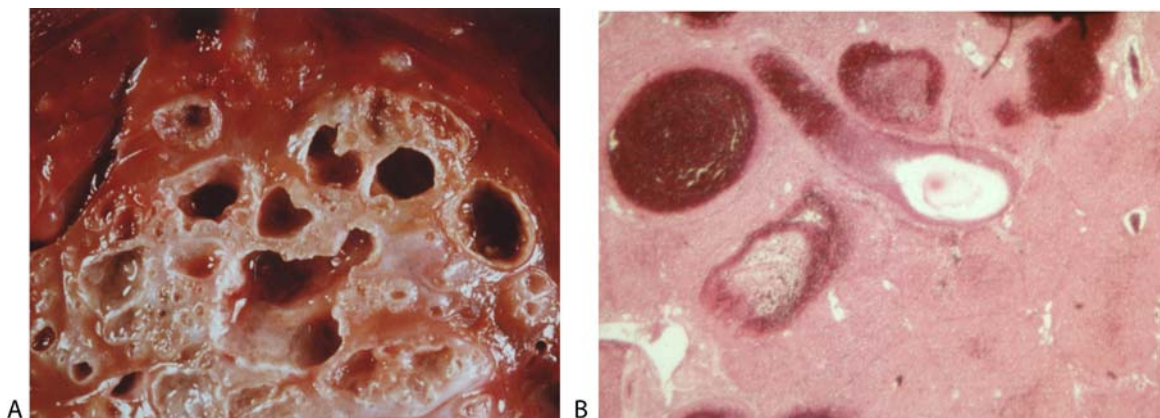

**Echinococcosis. Figure 1** Section through a human liver with the alveoles of *E. multilocularis*. **A** Total view, **B** Section through small strands of *E. multilocularis* in the liver.



**Echinococcosis. Figure 2** Liver of a sheep with numerous hydatids of *E. granulosus*.

In most patients with alveolar echinococcosis parasite-specific immunoglobulins of all isotypes can be measured at diagnosis and an association with hyperglobulinemia has been reported. Although protoscolexes and oncospheres of *E. multilocularis* can be lysed by antibody-mediated complement interaction *in vitro*, antibodies appear unable to control parasite proliferation *in vivo*. This inability may be due in part to complement-neutralizing factors released by the →metacestode or to the inactivation of C3 as it enters the metacestode tissue. Antibodies are produced against many different proteins of the parasite, and some of these antigens were postulated to critically participate at the host–parasite interplay. For example, antibodies against the protein Em2, localized in the laminated layer of the metacestode, were found to be associated with disease susceptibility in experimental murine alveolar echinococcosis. While in resistant C57BL/10 mice anti-Em2 antibodies of the IgG3 and IgG1 isotype were synthesized, only low levels of anti-Em2 IgG2a were detected in susceptible AKR and C57BL/6 mice.

### T Cells

In cystic echinococcosis patients there was no correlation between the detection of specific antibodies and the lymphoproliferative response to *E. granulosus* antigens. The fact that seronegative patients showed a positive proliferation assay and vice versa was taken as an argument for the existence of different pathways initiating humoral or cell-mediated responses. In murine cystic echinococcosis a marked reduction of the mean T cell percentage combined with an increase in suppressor activity was reported. An impairment of the →host response by the formation of anti-MHC antibodies or by parasite-derived immune-suppressive or -modulatory substances may account for the

enhanced susceptibility to mycobacterial infections close to the parasite lesions. In long-term infected BALB/c mice a higher percentage of CD4<sup>+</sup> T cells in peripheral blood and a relative increase of CD8<sup>+</sup> T cells in the spleen was observed. These cells appeared to be activated, because they showed a high level of interleukin-2 receptor expression. The finding that PBMCs from patients responding well to chemotherapy produced significantly more IFN- $\gamma$  and less IL-4 and IL-10 than cells from partial and low responders, indicated an implementation of Th1 cells in protective immunity.

In patients with alveolar echinococcosis the lymphoproliferative response to *E. multilocularis* antigens was highest in cured patients who had undergone radical surgery and significantly lower in patients with partial or no resections. A protective role of T cells has been found in murine models of alveolar echinococcosis. Depletion of T cells or the infection of nude or SCID mice resulted in enhanced metastatic formation and development of *E. multilocularis* accompanied by a drastically reduced host-tissue reaction. *E. multilocularis* infection of permissive mouse strains resulted in the depletion of T-dependent zones of lymphoid organs and thymic involution during rapid growth of the metacestode. Although the responsible mechanism has not yet been defined, activated macrophages adhering to the metacestodes *in vivo* and/or immunomodulatory products of the parasite may account for it. Immunosuppression in murine alveolar echinococcosis appears to be a more general phenomena since there was an enhanced frequency of malignant sarcomas in A/J mice infected with *E. multilocularis* when compared to noninfected controls.

Analysis of cytokine mRNA expression revealed the enhanced production of Th2-type factors such as IL-3, IL-4, IL-10, and predominantly IL-5 in stimulated cells of patients with alveolar echinococcosis. In murine alveolar echinococcosis there was an enhanced production of IFN- $\gamma$ , IL-2, IL-5, and IL-10 by stimulated spleen cells *in vitro* over the first weeks of infection which was almost completely suppressed at 21 weeks of infection. Analysis of the local intrahepatic periparasitic cytokine expression in tissues of patients showed an enhanced expression of IL-1, IL-6, and TNF by activated macrophages. These findings together with the observation that treatment of SCID mice with TNF promoted the formation of granulomatous changes around larval cysts argue for an involvement of the locally secreted proinflammatory cytokines in the development of periparasitic granulomas and fibrogenesis. In resistant hosts activated macrophages appear to kill protoscolexes by arginine-dependent generation of reactive nitrogen intermediates and other, ill-defined destructive effects on the parasite-protective laminated layer surrounding the oncospheres and vesicular cysts.

The genetic basis for either host resistance (no immunosuppression?) or susceptibility (→Immune Suppression?) is still unclear. Preliminary investigations showed that the frequency of certain HLA alleles (HLA-DR13) was increased in patients with a regressive course of disease after therapy compared to controls or patients with progressive alveolar echinococcosis. However, since inbred mice of the same H-2 haplotype differ significantly in their susceptibility to *E. multilocularis* there are obviously other, non-MHC-linked genes contributing to the disease susceptibility.

**Main clinical symptoms in humans:** Liver dysfunction, lung problems, ascites, →abdominal pain.

**Incubation period:** Years.

**Prepatent period:** Years.

**Patent period:** Years.

**Diagnosis:** Serologic tests, computer tomographic analysis of liver and other organs, →Serology.

**Prophylaxis:** Avoid contact with infected final hosts (dog, fox, cat).

**Therapy:** In *E. granulosus* infections hydatids may be removed by surgery, while it is **not** recommended in alveolar cysts of *E. multilocularis* since the eventual setting free of undifferentiated cells initiates metastasis-like formation of new cysts (thus biopsies are strongly forbidden). Chemotherapy see →Cestocidal Drugs, →Nematocidal Drugs, Animals and →Nematocidal Drugs, Man (Albendazole, Mebendazole).

## Echinococcus

### Name

Greek: *echinos* = spine, *kokkos* = grain.

### Synonym

→Alveococcus, *E. cysticus*, *E. unilocularis*, *E. hydatidosus*.

### Classification

Genus of →Eucestoda →Platyhelminthes/Fig. 19A.

**Echinococcus. Table 1** Most important species of the genus *Echinococcus*

Order/Species	Length of adult worm (m)	Egg size (µm)	Final host	Prepatent period	Intermediate host (i.h.)/Habitat	Stage inside intermediate host (i.h.)
<i>Echinococcus granulosus</i>	2.5–6 mm	35	Dogs, foxes	6–9	Ruminants, <b>Humans</b> /Liver, etc.	Hydatid; <i>Echinococcus hydatidosus</i> (= <i>cysticus</i> )
<i>E. multilocularis</i>	1.4–3.4 mm	35	Foxes, cats, dogs	4–6	Mice, <b>Humans</b> /Liver, etc.	Multilocular cyst: <i>Echinococcus alveolaris</i>

### Important Species

Table 1, Figs. 1, 2, 7, 8 (pages 411, 412, 416).

### Life Cycle

Fig. 1.

### Distribution

Fig. 2.

### Reproduction

Figs. 3–6 (pages 412–415).

### Diseases

→Echinococcosis, →Echinococciasis, →Hydatidosis, →Alveococcosis.

## Echinococcus oligarthrus

New species from the *E. multilocularis* complex, which may also infect humans. Intermediate hosts are rodents, final hosts are felids in Central and South America.

## Echinococcus ortleppi

Cattle strain (G 5) of *E. granulosus*, being infective to humans, occurs in Europe, South Africa, India, Sri Lanka, Russia, South America. Final host is dog.

## Echinococcus vogeli

New species from the *E. multilocularis* complex, occurs in Central and South America. Rodents are intermediate hosts; humans may be infected. Final hosts are bush dogs.

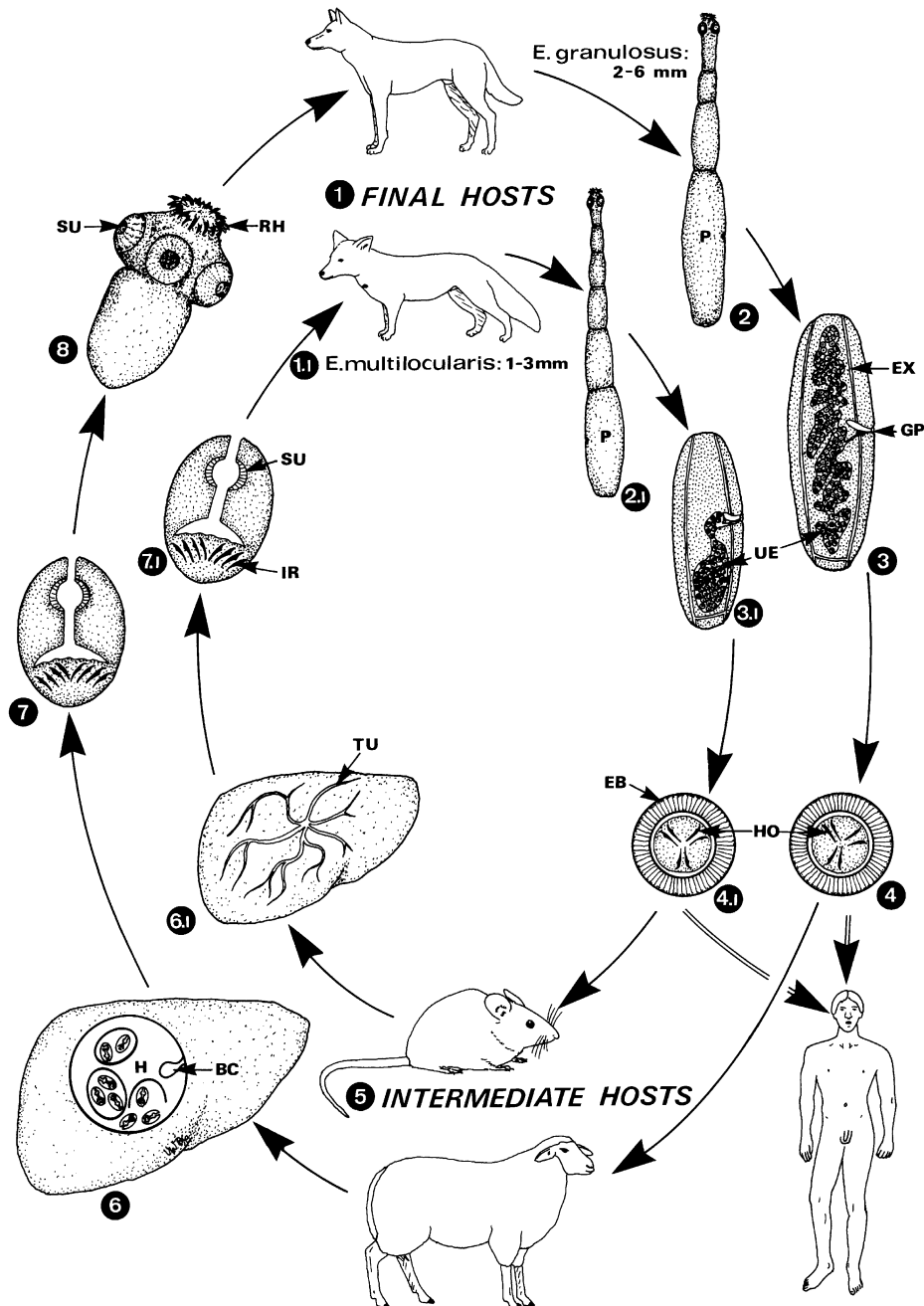

**Echinococcus. Figure 1** Life cycles of *Echinococcus granulosus* (1–8) and *E. multilocularis* (1.1–7.1). 1, 1.1 Final hosts may be dog, cat, or fox with clear, species-specific preference. 2–3.1 Adult worms, which live in the small intestine of the final host, may be differentiated according to the size of the terminal →proglottids (P), shape of uterus (UE) and size of rostellar hooks. 4, 4.1 Eggs containing an infectious →oncosphaera larva are released from the detached drying proglottid in the feces of the host; eggs are indistinguishable from those of →*Taenia* spp. 5, 5.1 Eggs are orally ingested by intermediate hosts or man with contaminated food. 6, 6.1 Inside the intestine of the intermediate hosts (including man) the oncosphaera hatches, enters the wall and may migrate (via blood) to many organs. Cysts are formed mostly in the liver and lung; in *E. granulosus* large unilocular →hydatids occur, which are filled with fluid (containing thousands of protoscolices), whereas in *E. multilocularis* a tubular system infiltrates the whole organ (giving rise to alveolar aspects in sections). 7–8.1 In →brood capsules of both cyst types, →protoscolices are formed, which may become evaginated (8) even inside their cysts. Evaginated or not, protoscolices are fully capable of infecting final hosts when they feed on infected organs of intermediate hosts. BC, →brood capsule; EB, →embryophore of the egg; EX, excretory vessels; GP, genital pore; H, hydatid; HO, hooks of oncosphaera; IR, invaginated rostellar hooks; P, →proglottid; RH, rostellar hooks; SU, sucker; TU, tubular system; UE, uterus containing eggs.

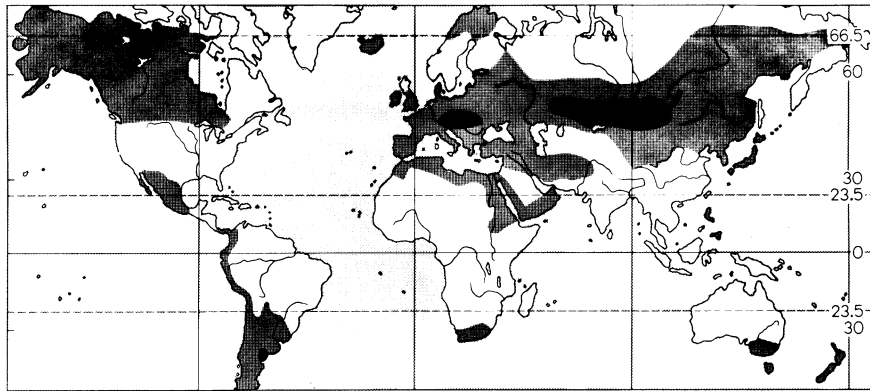

**Echinococcus.** **Figure 2** Distribution map of *Echinococcus granulosus* (grey) and *E. multilocularis* (black), which is now found in Hokkaido (Japan), Alaska, and also in the whole of Germany. *E. oligarthrus* and *E. vogeli* are found in Middle and South America in forest dogs, respectively, wild cats as final hosts, and a series of sylvatic animals.

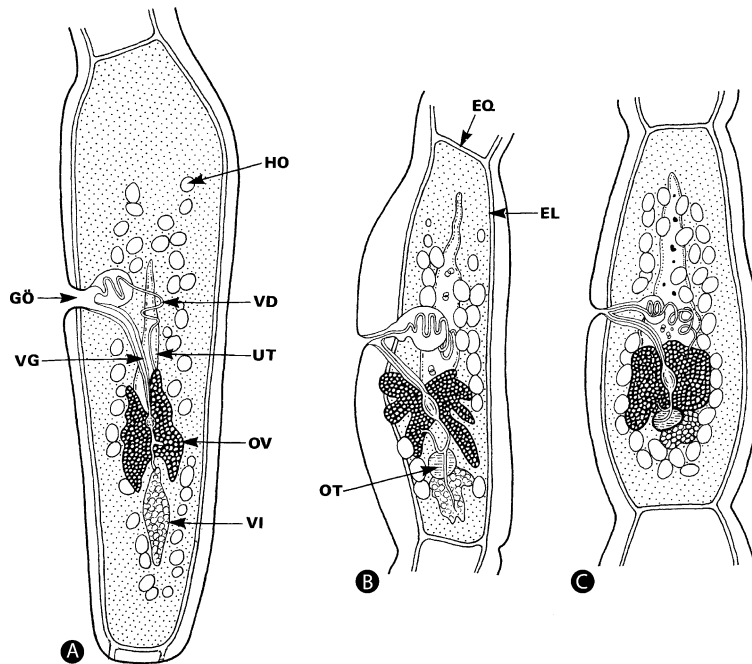

**Echinococcus.** **Figure 3** Diagrammatic representation of the last proglottids in different strains of *Echinococcus granulosus* in dogs. **A** Infections deriving from camels, **B** from cattle, **C** from pigs (according to Eckert). *EL*, longitudinal excretory channel; *EQ*, cross running excretory channel; *GÖ*, genital opening; *HO*, →testis; *OT*, ootyp; *OV*, ovary; *UT*, uterus; *VD*, vas deferens; *VG*, vagina; *VI*, →vitellarium.

**Echinolaelaps**

Genus of rat →mites.

**Echinolepis carioca**

→Hymenolepidae.

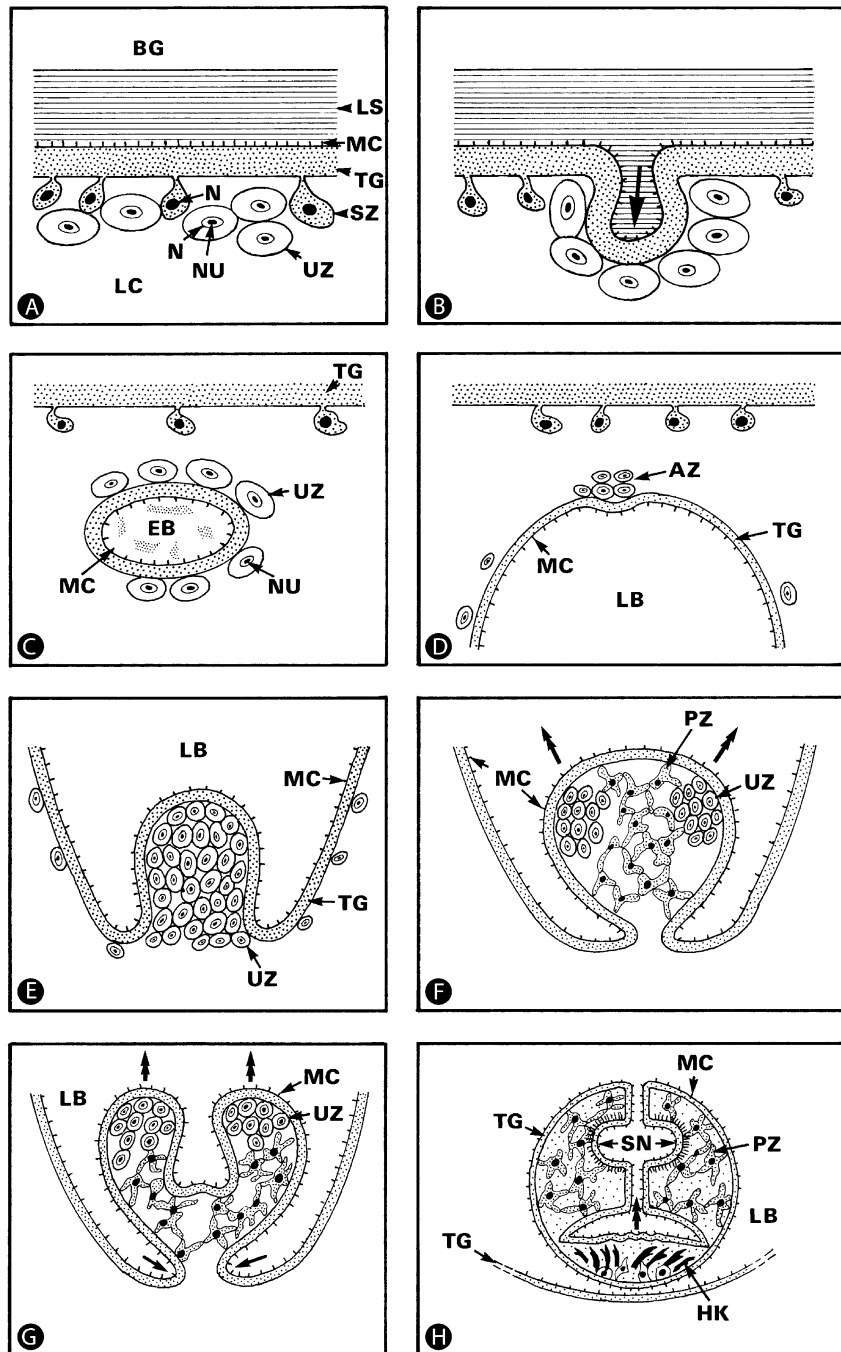

**Echinococcus.** Figure 4 A–H Diagrammatic representation of the asexual development of brood capsules and protoscolices in tissue-cysts formed by *Echinococcus* spp. **A** Cyst wall at the beginning of the development (muscle cells are omitted). **B** Invagination of the laminary layer and of parts of the →tegument (arrow). **C** Detachment of the invaginated parts. Inside this newly formed brood capsule the laminary material is dissolved, leading to a lumen (DL). **D** Growth of the brood capsule and divisions of the undifferentiated cells at 2 or 3 sites (only 1 is drawn). **E** Undifferentiated cells protrude into the interior of the brood capsules. **F** The protrusion starts a lateral growth (arrows). **G** Growth occurs in the direction of arrows with simultaneous occlusion at the posterior pole. **H** Detached →protoscolix may start evaginating growth (arrow) even within the degenerating brood capsule. This process again brings the tegument again onto the outer side of the worm as is required in adult worms (follow the position of the →microtriches). AU, accumulation of undifferentiated cells; C, connective tissue layer; DL, developing lumen of the brood capsules; HK, rostellar hooks; LL, laminary layer; LU, lumen of the brood capsule; MT, microtriches; N, nucleus; NU, →nucleolus; PA, parenchymal cell; PS, protoscolix; ST, subtegumental cell; SU, sucker; TG, tegument; TGI, tegument interrupted in drawing; UN, →undifferentiated cell.



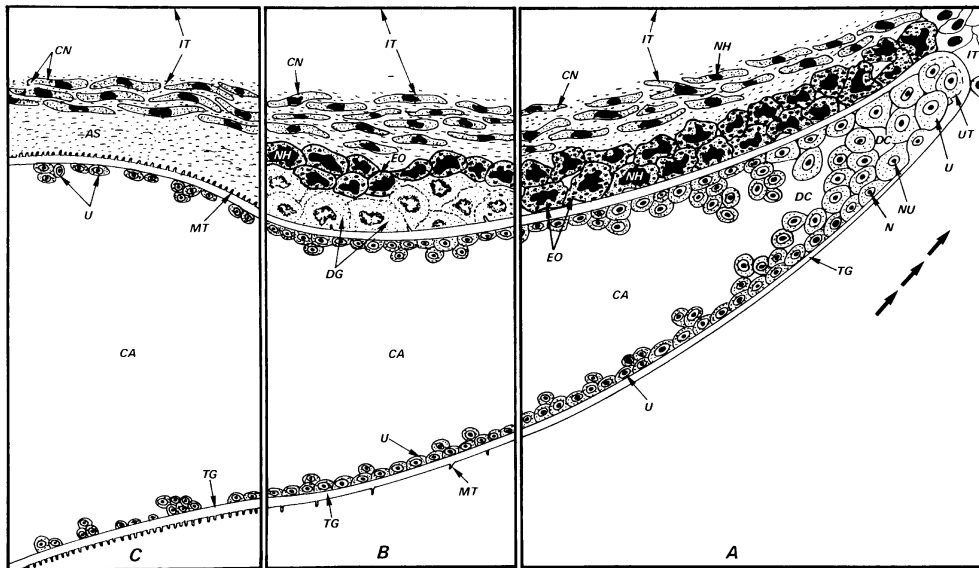

**Echinococcus. Figure 5** Diagrammatic representation of the development of the tube-like protrusions of the →alveolar cyst of *Echinococcus multilocularis* in tissues of the intermediate hosts in 3 phases (A–C). **A** At the end of solid strands undifferentiated cells (UT) fuse with the tegument and thus protrude the strand. At some distance from the tip, hollows (CA) occur inside the strand which becomes lined outside by eosinophilic granulocytes (EO) from the host defense system. Arrows indicate direction of growth. **B, C** The hollows (CA) in the strand become larger at the periphery undifferentiated cells (UT) initiate formation of brood capsules. *AS*, amorphous substance = laminated layer; *CA*, cavity; *CN*, connective tissue; *CO*, →collagen; *DC*, developing cavity; *DG*, degenerating defense cells; *DI*, division of undifferentiated cells; *EG*, eosinophilic granules; *EO*, eosinophilic granulocytes; *GR*, granules; *IF*, infiltration zone of hosts' defense system; *IT*, intact tissue; *M*, membranes of fusing UT; *MI*, mitochondrion; *MT*, microtriches of the tegument; *N*, nucleus; *NH*, nucleus of the host cell; *NU*, nucleolus; *PT*, protrusion of tegumental surface; *TG*, tegument; *U*, undifferentiated cells; *UT*, undifferentiated cells when fused with the tegument; *V*, vacuole.

## Echinoparyphium recurvatum

→Digenea.

### Disease

→Echinostomiasis, Man.

## Echinorhynchus truttae

→Acanthocephala.

## Echinostoma revolutum

→*Parorchis acanthus*/Fig. 1.

## Echinostoma ilocanum

### Name

Greek: *echinos* = spine, *stoma* = mouth.

### Morphology

Fig. 1 (page 416); →Digenea.

## Echinostomiasis, Man

Disease due to infections of →*Echinostoma* species via oral uptake of infected, uncooked snails and clams.

**Main clinical symptoms:** →Diarrhoea, →abdominal pain, →anaemia, →eosinophilia.

**Incubation period:** 1–3 weeks.

**Prepatent period:** 2–3 weeks.

**Patent period:** 6–12 months.

**Diagnosis:** Microscopic determination of eggs in faecal samples.

**Prophylaxis:** Avoid eating raw snails and clams.

**Therapy:** Treatment see Trematodocical Drugs.

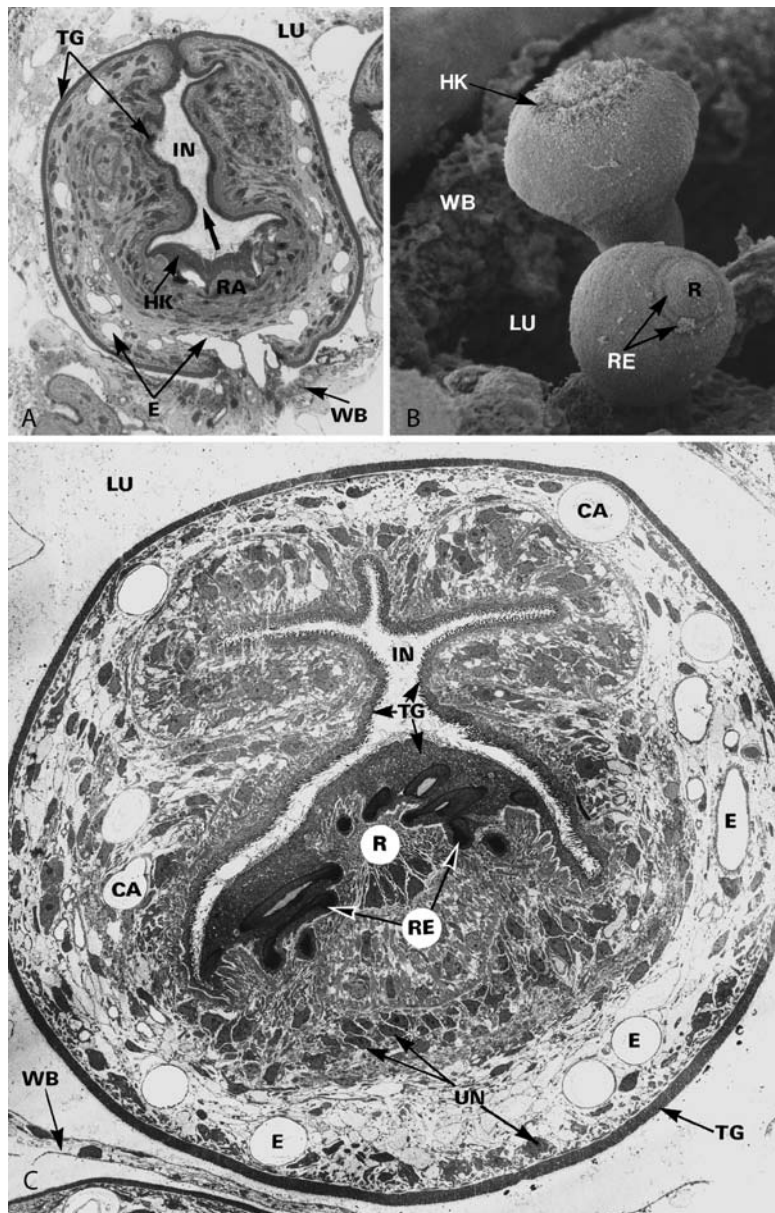

**Echinococcus.** Figure 6 A–C *Echinococcus* protoscolices within brood capsules of →tissue-cyst (hydatid, tubular system). **A** Light micrograph of a semithin longitudinal section through an inverted protoscolex of *E. granulosis*. During growth, which may start to occur inside the brood capsule, the rostellar anlage (RA) protrudes (arrow).  $\times 1,000$ . **B** Scanning electron micrograph of already protruded protoscolices of *E. multilocularis* found inside a brood capsule.  $\times 500$ . **C** Transmission electron micrograph of an obliquely sectioned inverted protoscolex of *E. granulosis*. Note the typical tegument lining the surface and the invagination through which the →rostellum finally protrudes.  $\times 3,000$ . CA, →calcareous corpuscles; E, excretory channel; HK, hooks of →scolex; IN, invagination; LU, lumen of brood capsules; R, rostellum; RA, rostellar anlage; RE, retracted hooks; TG, tegument; UN, undifferentiated cells; WB, wall of brood capsule.

## Echinuria uncinata

Stomach worms of ducks and geese (male = 10 mm, female = 19 mm).

## Eclosion

Shedding of pupal exuviae in insects (e.g., in *Nasonia* spp. among Ichneumonoidea).



**Echinococcus. Figure 7** SEM of adults of *Echinococcus* species, left: *E. granulosus*, right: *E. multilocularis*.



**Echinococcus. Figure 8** SEM of the scolex of *Echinococcus multilocularis*.

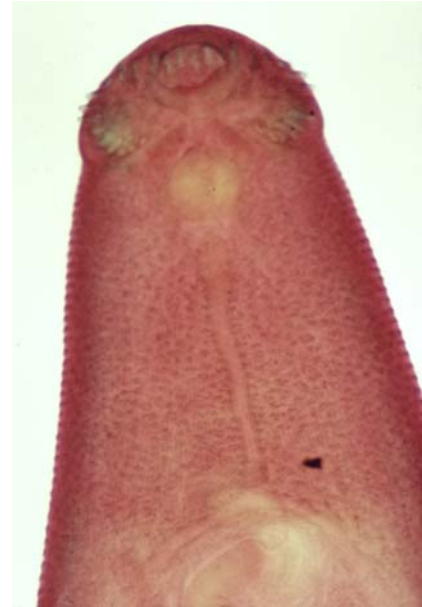

**Echinostoma ilocanum. Figure 1** LM of the anterior end of a carmin-red coloured echinostomal worm showing the characteristic apical spines.

---

## Ecoparasitological Aspects

Such factors have been taken into account when explaining fluctuations of population densities in the field. For example, some trematode developmental stages limit the number of their hosts in a given ecosystem.

---

## Ecosystems and Parasitism

The role of parasites can be extremely important in the equilibrium of ecosystems because a change in the impact of parasites, due, for instance, to an alteration of climatic or other conditions, may have unexpected and profound consequences.

Although the relationship between parasites and ecosystems is still little documented, the following examples illustrate the mechanisms by which apparently little parasitological causes can have dramatic effects.

Lindström et al. have shown that an epizooty of [→sarcoptic mange](#), which decimated the populations of red foxes in Scandinavia, has favoured the demographic growth of several small mammals which were the prey of the foxes; some of these mammals rapidly tended to pullulate, destroying certain plants, and finally modifying the landscape.

Holmes has drawn attention to the importance of ecosystem shrinking, due for instance to agriculture, deforestation, construction of highways, etc. In the new landscapes created by such fragmentation, there is an intrication of different faunas which lead some parasites to attack unusual host species, which have often limited innate defenses against them. Holmes mention the case of a Californian bird parasite, the brown-headed cowbird, *Molothrus ater*, which, in shrinking ecosystems, tend to lay its eggs in the nests of passerine it had never parasitized before. These new bird hosts are incapable of rejecting the eggs of the parasite, whereas the “usual hosts” identify and reject “alien” eggs to a certain extent. Some passerine species seem to have been threatened so much with extinction that scientific meetings have been organized to try to stop the process.

Parasites intervene also in the structure of biodiversity (composition of faunas) by interfering with competition processes (→[Host Demography](#)) and significantly alter the structure and functioning of ecosystems, as recently demonstrated by Lafferty, Dobson, and Kuris.

---

## EcR

### Synonym

→[Ecdysteroid Receptor](#).

---

## Ectoinsecticides

Drugs acting against ectoparasites such as →[ticks](#), →[fleas](#) (→[Insecticides](#), →[Ectoparasiticides](#), →[Arthropodicidal Drugs](#), →[Ectoparasites: New Approaches](#)).

---

## Ectoparasite

Organism living parasitically (e.g., sucking blood) on the outside of another organism.

---

## Ectoparasites: New Approaches

### Biological Control

The control of parasitic flies by →[biological methods](#) has become a viable method in some specific cases.

The release of large numbers of genetically manipulated (either by irradiation of genetic transformation)

sterile or “less fit” flies into the environment has led to the elimination of the screwworm fly (*Chrysomya*) in the USA. This control method has also been applied to blowflies (*Lucilia cuprina*) and is part of a long-term strategy to control sheep blowfly. In Australia the use of natural pesticides as another “environmentally friendly” biological pesticide is an area where innovative applications are expected to investigate these opportunities for future products. First biopesticides such as →[Bacillus thuringiensis](#) and *Metarhizium anisopliae*-based products reached the crop protection market in the late 1980s. But both approaches are still in their infancy in the animal health sector, since due to their high specificity they were suitable for combating only few fly species and never reached broad regional application.

### Vaccination

The growing problems of resistance and persistence of residues in meat and milk have created a renewed interest in antiparasitic vaccines.

It has been known for a long time that certain arthropods stimulate an immune response in infested animals. Apart from 2 x-irradiated worm vaccines there were no significant parasite immunologicals available until the late 1980s. The discovery and improvement of recombinant DNA technology has created hope that the capability of expressing specific, protective antigens not only against endoparasites, but also parasitic arthropods will lead to new innovative vaccines.

This field is potentially very interesting, but both the life cycle of the arthropods targeted and the limited range of cross-reactivity between related strains as well as the technology involved is highly complex.

[Table 1](#) shows where certain activities have been focused, but considering market success as final proof, none of these vaccines achieved a significant share either in treatment numbers or in sales, when compared even to “weak” chemicals.

One fundamental problem with vaccine research is the identification of the protective antigens. For complex organisms, such as arthropods, this makes the isolation of useful antigens very difficult, but in the future due to improvements in DNA technology, this technique may start to have a significant impact on treatment against arthropods.

---

## Ectoparasiticides – Agonists and Antagonists of Cholinergic Transmission

### Mode of Action

Fig. 1.

**Ectoparasites: New Approaches. Table 1** Vaccine approaches against ectoparasites

Target parasite	Approach/Status
Warble fly/Cattle grub ( <i>Hypoderma bovis</i> , <i>Hypoderma lineatum</i> )	The most advanced immunization trials against myiasis have been performed against <i>Hypoderma</i> . Some protection against later infections was observed in the field. More detailed investigation revealed, that particularly first-instar larvae were sensitive. Studies on the protein composition of <i>H. lineatum</i> larvae which might induce protection showed that so-called hypodermins were potentially useful antigens. Hypodermins (type A,B,C) are serine proteinases which are of importance for larval tissue migration. Vaccination with hypodermin antigens resulted in up to 90% protection (hypodermin A) and some degree of cross-protection between <i>H. lineatum</i> and <i>H. bovis</i> . So far, as with almost all insect ectoparasite vaccination approaches no field vaccine is currently available.
One-host ticks ( <i>Boophilus microplus</i> )	Tickgard is a vaccine based on a recombinant hidden antigen, membrane-bound glycoprotein Bm86. The vaccine has achieved some success in Australia against <i>B. microplus</i> , particularly in dairy herds. Vaccination results in some mortality in engorging ticks and to significant tick mortality between full engorgement and egg laying. The discovery of these specific tick antigens has opened the possibility of identifying similar proteins in other <i>B. microplus</i> strains and probably in other tick species as well. Other interesting antigens (Bm91, Qu13) have been identified, but so far none appear to be as effective as Bm86. Since the current vaccine is particularly effective in reducing the reproductive capacity in engorging female ticks, the continual introduction of ticks or tick-infested animals into a vaccinated herd significantly interferes with a successful strategic vaccination. Highest performance of the vaccination was observed when vaccinated animals were isolated from continual reinfection.
Blowfly strike ( <i>Lucilia cuprina</i> )	For the time being it is believed that binding of antibodies to the respective antigens leads to a layer covering the peritrophic membrane (PM) which results in restricted permeability of <i>L. cuprina</i> larvae fed on vaccinated sheep. Peritrophins of different molecular weight have been identified, which led to starvation through the binding of antibodies to these PM-associated antigens. Despite substantial progress in comparison to the past a useful vaccine is not available so far.
Fleas ( <i>Ctenocephalides felis</i> )	Hyperimmunized rabbit antisera against concealed antigens of flea midgut, the major digestive organ, revealed when fed in an artificial feeding system, significant decrease of survival rate and egg production of <i>C. felis</i> fleas. These preliminary studies demonstrated the feasibility of vaccination against cat fleas. Similar results were obtained following the vaccination of dogs with subsequent challenge. In these preliminary studies statistically significant reduction of about 25% regarding flea numbers remaining on the animal in comparison to control animals was observed. Despite the fact that at least partially protective antigens have been identified, so far no recombinant vaccine displaying substantial field success is available.
Salmon louse ( <i>Lepeophtheirus salmonis</i> )	Vaccination might be a valuable method to control copepod infestation which are major parasites of farmed salmonids. Antibodies were raised against various <i>L. salmonis</i> antigens. When assessed with immunohistochemical methods gut and ovarian hidden antigens were recognized by respective Mabs*. Then MAbs were used to screen <i>L. salmonis</i> DNA libraries in order to identify DNA fragment coding, for proteins which might be useful as a basis for recombinant vaccines.

\* Monoclonal antibodies

## Structures

Organohalogenides (Fig. 2).

## Important Compounds

Bromopropylate.

## General Information

Bromopropylate (phenisobromolate) [isopropyl 4,4'-dibromobenzilate] acts similar to organophosphorous or carbamate compounds and is a weak inhibitor of the insect acetylcholine esterase. Additionally, the compound has a measurable effect on voltage sensitive

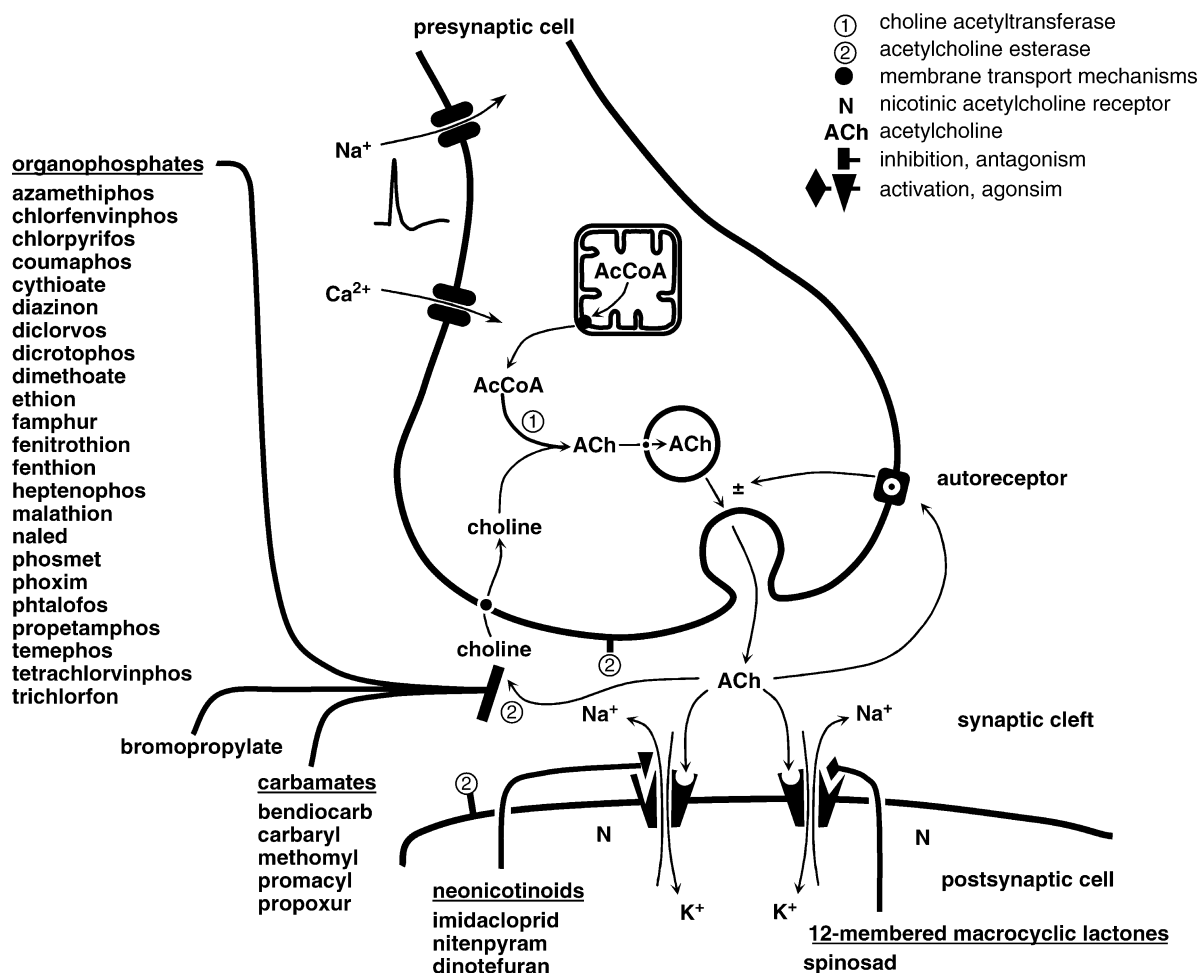

**Ectoparasiticides – Agonists and Antagonists of Cholinergic Transmission.** Figure 1 Model of the action of drugs interfering with acetylcholine mediated neurotransmission.

sodium channels of insect neurones. Despite its structural similarity with DDT or methoxychlor this effect is not comparable to that of DDT.

**Bromopropylate** is a non-systemic acaricide with contact action and long residual activity. The compound is used against ectoparasites for diagnosis and control of mite infestations in bees. LD<sub>50</sub> acute oral toxicity for rats is >5,000 mg/kg (acute percutaneous LD<sub>50</sub> > 4,000 mg/kg). The compound is toxic to fish. In mammals bromopropylate is rapidly and efficiently eliminated. Metabolism occurs mainly by cleavage of the isopropyl ester and to a minor extent by oxidation. Metabolites of the oxidation products are 3-hydroxybenzilate and conjugates.

## Resistance

Resistance of ectoparasites against Bromopropylate is based on sequestration by enhanced hydrolytic activities (carboxylesterases) as well as on oxidation by

mono-oxygenases. Bromopropylate-resistant varroa →mites have not yet been reported.

## Organophosphorous compounds Important Compounds

Organophosphates, Organophosphonates, Monothio-phosphates, Dithiophosphates.

### General Information

Insecticidal organophosphorous compounds were synthesised for the first time by G. Schrader nearly 60 years ago. Organophosphates are inhibitors of hydrolases, e.g., carboxyl esterases (ali-esterase), acetylcholine esterases. Several different isoforms of acetylcholine esterases have been identified in the insect central nervous systems which are differentially inhibited by organophosphates. The reaction mechanism of organophosphates with acetylcholine esterase resembles that of the endogenous substrate acetylcholine. The hydroxyl group of a specific

serin residue of the acetylcholine esterase is acetylated by acetylcholine, phosphorylated by organophosphates and carbamylated by carbamates. This indicates a competitive →mode of action. Since the inhibition constant of organophosphate compounds is small the compounds occupy the active site thus reducing hydrolysis of acetylcholine in the synaptic cleft. Neuronal transmission

is influenced by stimulation of cholinergic →synapses followed by depression and paralysis.

### Resistance

Tolerance or resistance occurs against all of the organophosphates currently on the market. However, resistance is still restricted to limited areas and specific

#### Monothiophosphates

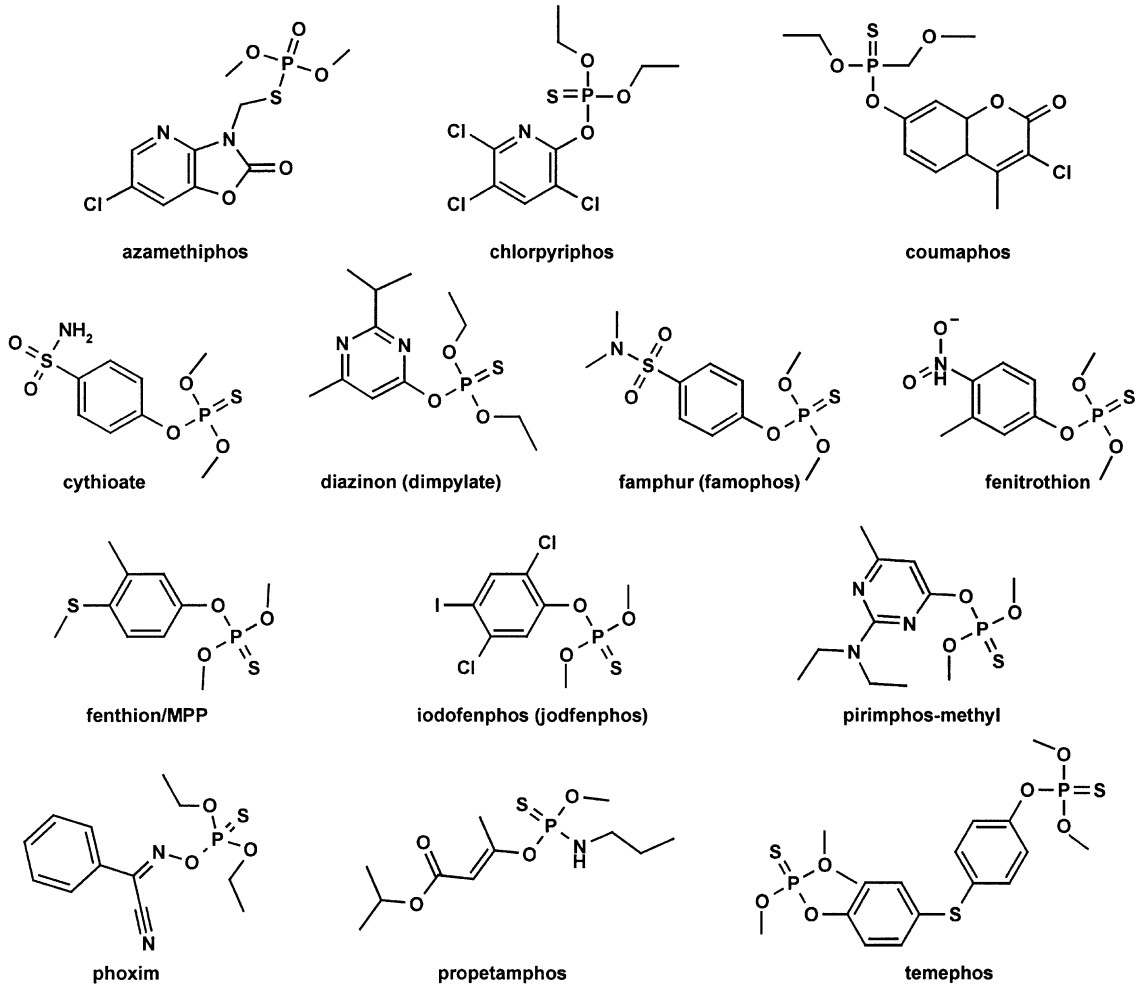

#### Dithiophosphates

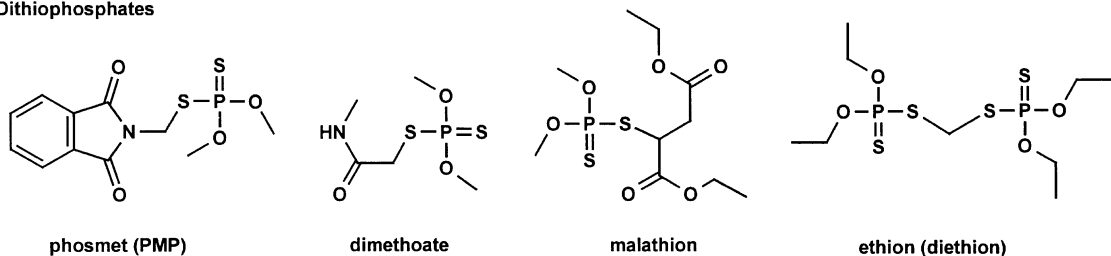

**Ectoparasiticides – Agonists and Antagonists of Cholinergic Transmission. Figure 2** Structures of drugs affecting cholinergic neurotransmission.

## Organophosph(on)ates

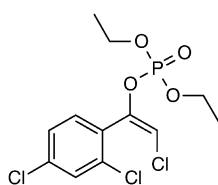

chlorfenvinphos

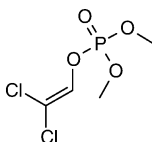

dichlorvos (DDVP)

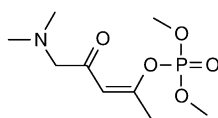

dicrotophos

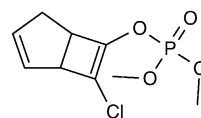

heptenophos

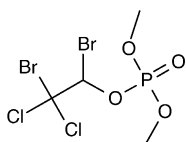

naled

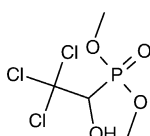

trichlorfon (metrifonate)

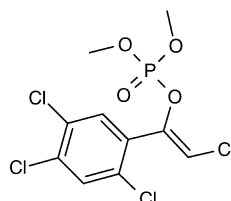

tetrachlorvinphos (CVMP)

## Carbamates

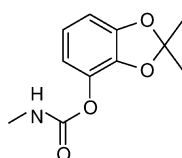

bendiocarb

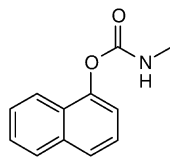

carbaryl

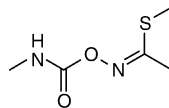

methomyl

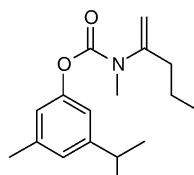

promacyl

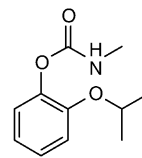

propoxur

## Organohalogenides

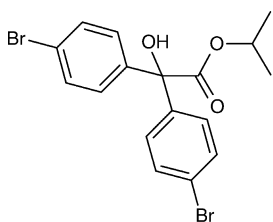

bromopropylate

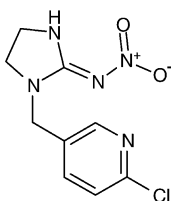

imidacloprid

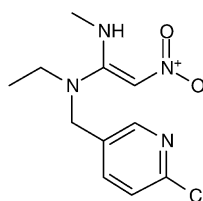

nitenpyram

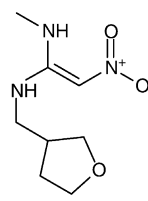

dinotefuran

## Neonicotinoids

## 12-membered macrocyclic lactones

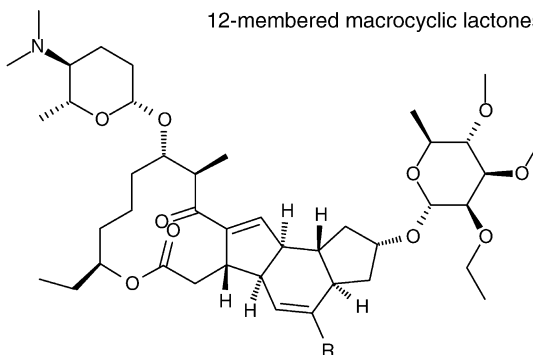

R = H: Spinosyn A

R = CH<sub>3</sub>: Spinosyn D

**Ectoparasiticides – Agonists and Antagonists of Cholinergic Transmission. Figure 2** Structures of drugs affecting cholinergic neurotransmission. (Continued)



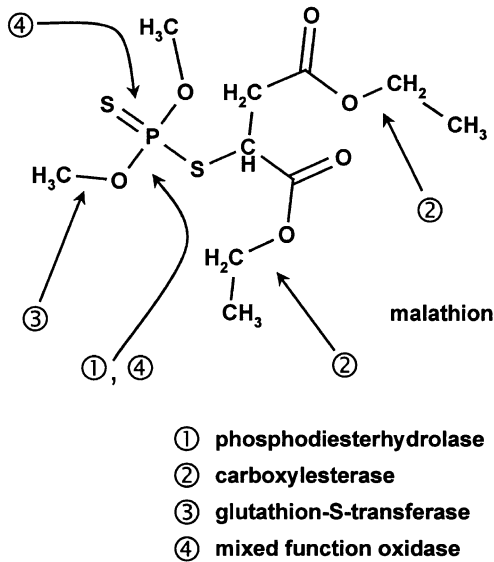

**Ectoparasiticides – Agonists and Antagonists of Cholinergic Transmission. Figure 3** Enzymes involved in detoxification of malathion.

ectoparasites. Reported resistance factors for ectoparasites like cattle tick or cat flea are in the range of 1.5-fold (which in fact should be called biological variability or at the most tolerance) to >100-fold. Organophosphate-resistant tick strains of the southern cattle tick *Boophilus microplus* have been identified in Australia, South Africa, Argentina, Brazil, Colombia, Ecuador, Costa Rica and Uruguay. Laboratory tests demonstrated different degrees of resistance from tolerance (1– to 4-fold reduced susceptibility) via slightly resistant (5– to 20-fold) to resistant strains (>20-fold). Field testing revealed that organophosphate resistance was widespread among Australian strains of *B. microplus*. Several organophosphate and carbamate →insecticides have been tested against a resistant flea strain (*Ctenocephalides felis*) from Florida and compared to a susceptible strain. Malathion (Dithiophosphates) and carbaryl (Carbamates) have been used in flea control at the Florida strain origin for about 30 years. The results indicated a <10-fold tolerance for organophosphates other than malathion which had a 25-fold higher  $LC_{50}$  than with susceptible control →fleas. Under laboratory conditions a 12-fold resistance against malathion has been observed upon continuous selection of adult fleas for 8 generations. In a organophosphate-resistant field strain of the cat flea *C. felis* two possible resistance mechanisms have been identified: detoxification by glutathion-S-transferases and target site insensitivity of acetylcholine esterase. Hence, it is speculated that rotation with carbamate insecticides would not control this flea strain.

Resistant strains of the housefly showed reduced →cuticle adsorption of organophosphates, reduced formation of biologically highly active oxon derivatives, accelerated formation of phosphates from thiophosphate derivatives, and reduced sensitivity of choline esterases.

For decades, organophosphates have been the only products for sheep treatment against blowfly strike and →lice in Australia. Resistance against, e.g., diazinon was detectable in 1965 in 20% of the adult blowflies at a low level. In 1970 about 95% of the flies were diazinon resistant. In 1995 this value had stabilised at about 97%. In case of blowfly control the occurrence of resistance did not mean a total control failure. For diazinon the protection period was reduced from about 12 weeks to 4–6 weeks. The actual resistance factors for more than hundred field populations of blowfly are in the range between 2-fold (tolerance) and 42-fold in laboratory trials predominantly concentrating at the higher range.

For diazinon (Monothiophosphates) and fenthion a delayed cuticular adsorption was observed with resistant housefly strains. For most ectoparasites resistant or tolerant against organophosphates one or more of the following resistance mechanisms have been identified: hydrolysis by carboxylesterases (ali-esterases), thus quenching the inhibitor, oxidation by microsomal enzymes (e.g., cytochrome P450 mono-oxygenases), dealkylation by glutathion-S-transferases and target enzyme insensitivity towards organophosphates. By molecular biology techniques additional resistance mechanisms have been demonstrated, e.g., multiple alleles of choline esterases with altered specificity, enhanced enzyme expression levels.

Organophosphorous compounds play an ongoing important role in the treatment of ectoparasitic diseases. Resistance has been encountered with synergistic additives inhibiting metabolic enzyme activities, e.g., piperonyl butoxide (PBO) as mixed function oxidase inhibitor, S,S,S-tributyl phosphorotrithioate (TBPT) and triphenyl phosphate (TPP) asinhibitors of detoxifying esterases, and diethyl maleate (DEM) as an inhibitor of glutathione-S-transferase mediated detoxification.

### Organophosphates and Organophosphonates Important Compounds

Chlorfenvinphos, dichlorvos (DDVP), dicrotophos, heptenophos, naled, tetrachlorvinphos (CVMP), trichlorfon/metrifonate.

### General Information

**Chlorfenvinphos** is a broad spectrum insecticide and acaricide with contact and stomach action. It has a long residual activity and requires withdrawal periods of 3–21 days (depending on the respective formulation) for meat producing animals treated with the compound.

It is used against blowfly strike and also for control of →ticks, lice, →keds and screw worm. Chlorfenvinphos shows fish toxicity and only slight bee toxicity. Among the organophosphorous compounds it shows a relatively high acute oral toxicity against rats (9.6–39 mg/kg LD<sub>50</sub>). On the other hand the compound is metabolised quickly in mammals by de-esterification to give 2-chloro-1-(2,4-dichlorophenylvinyl ethyl hydrogen phosphate). Excretion products are glucuronic acid conjugate and monohydrolysed metabolites. **Dichlorvos (DDVP)** is a rapid knockdown insecticide and acaricide with respiratory, contact and stomach action which rapidly decomposes in soil. Besides applications on pets and cattle dichlorvos has been used also against ectoparasites on salmon and trout. Because of its ability to act systemically dichlorvos is also used in animal treatment against →nematodes, →trematodes or →cestodes. It is metabolised in mammals by hydrolysis and O-methylation. Acute oral toxicity for rats is IC<sub>50</sub> mg/kg (LD<sub>50</sub>, acute percutaneous 90 mg/kg). High toxicity to birds and bees has been observed. The metabolism of DDVP in mammals occurs rapidly with a half-life of 25 minutes by hydrolysis and O-methylation in the liver. It is non-persistent in the environment. **Dicrotophos** is a systemic insecticide and acaricide with contact and stomach action and moderate persistence. Acute oral toxicity for rats is 17–22 mg/kg (LD<sub>50</sub>, acute percutaneous 110–180 mg/kg). Very toxic to honey bees but due to rapid decline of compound on surfaces with little effect in practice. Dicrotophos is completely metabolised and eliminated in rats and dogs a few days after oral administration. **Heptenophos** represents a systemic insecticide with contact, stomach and respiratory action with fast initial activity and short residual effect. Acute oral toxicity for rats is 96–121 mg/kg (LD<sub>50</sub>). In mammals the compound is excreted to 96% within 6 days in metabolised form in urine and faeces. **Naled** is a fast-acting non-systemic insecticide and acaricide with contact and stomach and some respiratory action. The biological activity may be due to *in vivo* debromination forming dichlorvos (q.v.). The compound is used against →hygiene pests and in animal houses and against ticks and fleas on pets. Acute oral toxicity for rats is 430 mg/kg (LD<sub>50</sub>). The compound causes skin irritation and eye burns on rabbits at an acute percutaneous LD<sub>50</sub> of 1100 mg/kg. **Tetrachlorvinphos (CVMP)** is a non-systemic insecticide and acaricide with contact and stomach action. The compound is active against, flies, fleas ticks and lice on pets and cattle, swine and poultry and in animal houses. LD<sub>50</sub> acute oral toxicity for rats is 4,000–5,000 mg/kg. Low toxicity for birds and high toxicity for bees have been observed. In mammals tetrachlorvinphos is metabolised and eliminated quickly. Major metabolites found in urine of rats and dogs were glucuronic acid derivatives, mainly 2,4,5-trichlorophenylethandiol glucuronide, 2,3,5-trichloromandelic

acid, and 2-chloro-1-(2,4,5-trichlorophenyl)-vinylmethyl hydrogen phosphate. **Trichlorfon** is an insecticide with contact and stomach action. It is used to control fleas flies, keds, lice, warble flies and →mange mites on farm animals. It is also active against a variety of fish ectoparasites. Acute oral toxicity for rats is 560–630 mg/kg (LD<sub>50</sub>; acute percutaneous >2,000 mg/kg). Toxicity to fish and bees is moderate. In mammals the compound is rapidly degraded in the blood. Trichlorfon excretion in the urine is complete within 6 hours. Major metabolites are dimethylphosphoric acid, monomethylphosphoric acid and dichloroacetic acid. As metrifonate the compound is used as an anthelmintic against nematodes, trematodes or cestodes.

## Monothiophosphates

### Important Compounds

Azamethiphos, chlorpyrifos, coumaphos, cythioate, diazinon (dimpylate), famphur (famphos), fenitrothion, fenthion (MPP), iodofenphos, phoxim, propetamphos, temephos.

### General Information

**Azamethiphos** is an insecticide and acaricide with predominantly contact action that shows quick knock-down and good residual activity. The acute oral toxicity for rats is low (LD<sub>50</sub> 1,180 mg/kg; percutaneous >2,150 mg/kg) but bee toxicity has been observed and it was classified as highly toxic to fish (rainbow trout). However, the compound has been tested against fish lice on salmon with positive results (efficacy at 0.01 ppm) and good tolerance by salmon. Major metabolite in mammals is the glucuronic acid conjugate of 1-amino-3hydroxy-5-chloro-pyridine. Azamethiphos is mainly used for control of public hygiene pests and insect pests in animal houses. **Chlorpyrifos** is a non-systemic compound with contact, stomach and respiratory action and efficacy against fleas, ticks and sarcoptic mite. Acute oral toxicity for rats is 135–163 mg/kg (LD<sub>50</sub>; acute percutaneous >2,000 mg/kg) but it shows bee toxicity and high fish toxicity (0.003 mg/l LC<sub>50</sub> for rainbow trout). Its slow degradation in soil to 3,5,6-trichloro-pyridin-2-ol with a half-life of 80–100 days is responsible for the long persistence in environment. Metabolism in mammals following oral administration is rapid and leads to the same major metabolite which is excreted via urine. **Coumaphos** is a broad spectrum insecticide and acaricide with predominantly contact action. Coumaphos (as 25% WP) has been approved APHIS-USDA-permitted pesticide for treatment of screw-worms, →scabies and ticks in federal eradication programmes. Systemic action in the host animal is directed against warble flies. Withdrawal periods for meat are 15 days to 3 weeks depending on formulation. LD<sub>50</sub> acute oral toxicity in rats is 16–41mg/kg

(LD<sub>50</sub> percutaneous 860 mg/kg) Because of its relatively low toxicity for bees it is also used as a miticide against *Varroa* mites in bee hives. Because of its ability to break existing resistance interest in the →*varroa* treatment with coumaphos has recently grown especially in the southern part of the United States. Coumaphos is also used in animal treatment against nematodes, trematodes or cestodes. **Cythioate** is rapidly absorbed from the gastro-intestinal tract after oral dosing with maximum drug effect for up to eight hours after administration. Fleas and other ectoparasites like ticks and mange mites are killed when they ingest the body fluids of the host. LD<sub>50</sub> acute oral toxicity for rats is 107–246 mg/kg. The compound is rapidly eliminated from the body. **Diazinon (dimpylate)** is a broad spectrum insecticide and acaricide with contact, stomach and respiratory action. Withdrawal times for meat range from 3 to 14 days depending on formulation and host species. Acute oral toxicity for rats has LD<sub>50</sub> from 240–480 mg/kg body weight. The compound shows a pronounced bee toxicity. The bird toxicity is impaired with bird repelling properties. Major metabolites in mammals are diethyl thiophosphate and diethyl phosphate. **Famphur** is used as ectoparasiticide against horn flies, grubs and lice in cattle and reindeer. LD<sub>50</sub> acute oral toxicity for rats is 27–62 mg/kg for rats. **Fenitrothion** is a non-systemic insecticide with contact and stomach action and ectoparasitidal activity against fleas. It is used as a public health insecticide and for control of flies in animal houses. LD<sub>50</sub> acute oral toxicity for rats is between 250 and 800 mg/kg (acute percutaneous LD<sub>50</sub> 890 mg/kg). Fenitrothion is rapidly excreted in the urine and faeces (90% after three days in rats). Major metabolites are dimethylfenitrooxon and 3-methyl-4-nitrophenol. **Fenthion** is a systemic broad spectrum insecticide with contact, stomach and respiratory action against a variety of ectoparasitic insects and hygiene pests. Acute oral toxicity for rats is 250 mg/kg (LD<sub>50</sub>; acute percutaneous 700 mg/kg). After oral administration the compound is eliminated in mammals mainly in the form of hydrolysis products in the urine. The major metabolites are fenthion sulfoxide, fenthion sulfone and their oxygen analogues. These metabolites are further hydrolysed to the corresponding phenols. **Iodofenphos** is a non-systemic insecticide and acaricide with contact and stomach action used as a premise ectoparasiticide in poultry houses. It shows low toxicity to mammals and is non-toxic for birds. **Phoxim** is a broad-spectrum insecticide and acaricide with contact and stomach action and a short-term activity. It controls mange mites, lice, keds, flies, fleas and fly larvae. Acute oral toxicity for rats is 1,976–2,170 mg/kg (LD<sub>50</sub>; acute percutaneous > 1,000 mg/kg). The compound is toxic for fish and bees (contact and respiratory action). In mammals it is rapidly metabolised to diethylphosphoric acid and desethylphoxim. The nitrile is metabolised to phoxim carboxylic acid and metabolism of the oxon is also unusually fast.

As much as 97% is secreted within 24 hours in the urine and faeces. **Propetamphos** is an insecticide and acaricide with contact and stomach action and long residual activity. Acute oral toxicity for rats is 60–119 mg/kg (LD<sub>50</sub>; acute percutaneous 2,825 mg/kg for male rats). In mammals, propetamphos is completely metabolised and rapidly excreted mainly via urine and exhaled air. It is detoxified through hydrolytic reactions involving the phosphorus and carboxylic ester bonds followed by →*Conjugation* and through oxidation processes leading ultimately to CO<sub>2</sub>. **Temephos**, a non-systemic insecticide is used in mosquito larvae control and for treatment of pets against fleas and treatment of humans against lice. The compound shows a low toxicity against mammals (LD<sub>50</sub> acute oral toxicity for rats 4,204–>10,000 mg/kg; LD<sub>50</sub> acute percutaneous toxicity for rats >4,000 mg/kg), birds and fish but is highly toxic to bees. In mammals, temephos is mainly eliminated unchanged in the urine and faeces.

### Dithiophosphates Important Compounds

Dimethoate, ethion (diethion), malathion, phosmet (PMP, phtalofos).

### General Information

**Dimethoate** is a fast acting insecticide and acaricide which quickly penetrates the insect cuticle. High initial penetration rate and slow detoxification rate have been observed with the housefly →*Musca domestica*. The oxon compound shows highest insecticidal activity but is more toxic to mammals. Acute oral LD<sub>50</sub> of dimethoate for rats is 250 mg/kg, acute oral LD<sub>50</sub> of the dimethoxon is 30 mg/kg. Dimethoate is toxic to bees, fish and arthropod aquatic organisms. **Ethion** is a non-systemic acaricide with predominantly contact action. Only combinations with pyrethroids (deltamethrin, permethrin) or other organophosphorous compounds (dichlorvos) are marketed. Acute oral toxicity for rats is 208 mg/kg (LD<sub>50</sub>). The compound is toxic to fish and bees. **Malathion** is a non-systemic pro-insecticide and acaricide with contact stomach and respiratory action. The compound is activated by metabolic desulfuration to the corresponding oxon. It is extensively used for →*vector control* in public health and against ectoparasites of cattle, poultry, dogs and cats. Malathion is also active against human head and body lice. The lice and their eggs are killed quickly upon treatment with 0.003% and 0.06% malathion in acetone. Acute oral toxicity for rats is 1,375–2,800 mg/kg. Malathion shows low toxicity to birds and is toxic for fish and bees. In mammals the major part of the dose is excreted in the urine and faeces 24 hours after oral administration. Microsomal liver enzymes start detoxification by formation of malaoxon that is subsequently

hydrolysed by carboxylesterases. **Phosmet** is a non-systemic insecticide and acaricide with predominantly contact action. Phosmet controls lice, horn flies, mange mites and ticks. The compound has also been formulated to act systemically against →warble fly larvae and mange mites. Acute oral toxicity for rats is 113–160 mg/kg (LD<sub>50</sub>). It is toxic to fish and bees. In mammals it is metabolised rapidly to phthalamic acid and phthalic acid (and derivatives) which are excreted in the urine.

### Resistance

Malathion: Organophosphorous compounds.

## Carbamates

### Important Compounds

Bendiocarb; carbaryl; methomyl; promacyl, propoxur.

### General Information

Insecticidal **carbamate** compounds are inhibitors of acetylcholine esterases and have been synthesised in 1954 at the first time. The kinetic of acetylcholine esterase inhibition with carbamates compound has a half-life of about 20 minutes for the carbamylated enzyme complex which is more reversible than with organophosphates. The more potent carbamates are structurally closely related to acetylcholine. Their weaker reactivity at the active site is compensated by more pronounced enzyme-binding abilities. The signs of intoxication are similar to those of organophosphates. Stimulation of cholinergic synapses is followed finally by paralysis of the →ectoparasite.

**Bendiocarb** is an insecticide with contact and stomach action that gives rapid knockdown and has good residual activity. LD<sub>50</sub> of acute oral toxicity in rats is 40–156 mg/kg (LD<sub>50</sub> acute percutaneous toxicity 566–800 mg/kg). The compound is toxic to bees and fish. In mammals bendiocarb is rapidly absorbed after oral administration or inhalation. It is rapidly detoxified and eliminated almost completely after 24 hours as sulphate or glucuronide conjugate of 2,2-dimethyl-1,3-benzodioxol-4-ol its major metabolite. **Carbaryl** is a widely used insecticide with slightly systemic properties and contact and stomach action. The compound was introduced onto the market in 1956. Due to its relatively low toxicity to mammals it is used against ectoparasites. It shows weak inhibition of cholinesterase. Acute oral toxicity for rats (LD<sub>50</sub> 500–850 mg/kg; acute percutaneous LD<sub>50</sub> >4,000 mg/kg). The compound is toxic to adult bees but carbaryl is not transferred to the breed. The compound shows moderate toxicity to fish if applied as aqueous solution. Carbaryl has very low toxicity for birds (>2,000 mg/kg for young pheasants) and has been developed for treatment of ectoparasitic diseases on poultry and other cage birds. Carbaryl does not accumulate in mammals body tissues and is

rapidly metabolised to non-toxic substances, particularly 1-naphthol. This metabolite and its glucuronic acid conjugate is eliminated in the urine and faeces. **Methomyl** is a mixture of (Z) and (E) isomers, the former predominating. It is a systemic insecticide and acaricide with contact and stomach action. It is used for control of flies in animal houses. Today, direct application is being replaced more and more by bait formulations, reducing the risk of mammalian intoxication. The acute oral toxicity for rats is 17–24 mg/kg (LD<sub>50</sub>; acute percutaneous toxicity for rabbits >5,000 mg/kg). **Promacyl** was used until recently as a special tickicide with contact and stomach action against a variety of tick species on cattle in Australia. Since 1997 the compound has not been produced any more. It has favourable withdrawal periods of 24 hours (meat) and no withdrawal period for milk. Acute oral toxicity for rats is 1,220 mg/kg (LD<sub>50</sub>; acute percutaneous toxicity >4,000 mg/kg). **Propoxur** is a non-systemic insecticide with contact and stomach action. It gives rapid knockdown and long residual activity. The compound is active against fleas ticks, lice and biting lice in dogs and cats. LD<sub>50</sub> acute oral toxicity for rats is 95–104 mg/kg (acute percutaneous LD<sub>50</sub> for male rats is 800–1,000 mg/kg). The compound is highly toxic to adult bees but shows low toxicity for birds. In rats main metabolites are 2-hydroxyphenyl-N-methylcarbamate and 2-isopropoxyphenol that are rapidly excreted in the urine. The carbamic acid residue is decomposed and carbon dioxide is exhaled.

### Resistance

Several different resistance mechanisms have been demonstrated in resistant hygiene pests and ectoparasites. Besides observations of reduced cuticle permeability of carbamates in resistant housefly strains detoxification through metabolising enzymes is the dominating mechanism of resistance against carbamates. Other than for organophosphates carbamate resistance depends more on oxidative metabolism. O-dealkylation, N-dealkylation, and N-methylhydroxylation and to a lesser extent hydroxylation are responsible for detoxification of carbamates like propoxur or carbaryl. In addition, turnover of these reactions is elevated by factors 2–3 in resistant strains compared to susceptible populations. Furthermore, for carbamate resistant strains of cattle tick (*Boophilus microplus*), sheep blowfly (*Lucilia cuprina*), and housefly (*Musca domestica*) choline esterases insensitive to carbamates have been identified. Carbamate insecticides have been extensively used in flea treatments in Florida. Several flea strains have been isolated that showed tolerance or resistance to carbamates and to organophosphates. Resistance factors for propoxur, carbaryl, and bendiocarb are 4-, 20- and 28-fold, respectively. Other authors reported strains of *Boophilus microplus* being resistant against carbamate ectoparasiticides.

## Neonicotinoids

### Important Compounds

Imidacloprid, nitenpyram.

### General Information

**Nicotine** is not registered anymore for use against ectoparasites in countries with high registration standards for reasons of its intrinsic high mammalian toxicity. However, the natural product nicotine guided the discovery of a new class of insecticides. About 2,000 derivatives have been synthesised on the way to a group of 10 candidates with highest insecticidal activity finally leading to the synthesis of **imidacloprid**. In comparison to nicotine, the compound impairs a 9-fold lower acute mammalian toxicity and an average >900-fold higher insecticidal activity.

Available data on the mode of action of neonicotinoids predominantly have been generated with imidacloprid. In general, other neonicotinoids behave similarly. From several studies it can be concluded that potent insecticidal neonicotinoids are (partial) agonists of the postsynaptic acetylcholine receptors of motoneurons in insects. Imidacloprid induces slow depolarisation in cell bodies of motor-neurone from cockroach nerve cord preparations which is sensitive to nicotinic antagonists like dihydro- $\beta$ -erythroidine. Imidacloprid is a more potent agonist than nicotine, however maximum depolarisation is slightly lower than with nicotine. Electrophysiological studies with mammalian nicotinic acetylcholine receptors from rat muscle expressed in *Xenopus*  $\rightarrow$  oocytes revealed that imidacloprid acts as a 1,000-fold less potent agonist to mammalian nicotinic receptors compared to the naturally occurring agonist acetylcholine. Additionally, the open state phases are significantly reduced compared to acetylcholine. Binding studies with insect and mammalian brain tissue incubated with tritiated imidacloprid revealed high affinity binding sites in insect neuronal tissues but not in the mammalian brain. Hence, the favourable toxicity profile of neonicotinoids is also based on target specificity for the different subtypes of nicotinic acetylcholine receptors present in mammals and insects. Additional insecticidal benefit results from the reduced positive charge under physiological conditions at the receptor-binding nitrogen of neonicotinoid compared to nicotine alkaloids. The positively charged nicotine alkaloids are barely able to cross the lipophilic cuticle of insects, leading to poor contact activity of nicotine. Neonicotinoids show good and long-term systemic action in plants. They are also quickly distributed in mammals upon oral ingestion. However, this efficacy is a short term response due to rapid elimination with dramatic loss of efficacy after less than 4 days. Residual activity on animals for at least 4 weeks is achieved only through topical application (e.g., imidacloprid). **Dinotefuran** is the most

recent addition to the neonicotinoid family. Instead of a chlorpyridyl or a chlorthiazolyl moiety a furanyl-residue has been introduced. Pharmacology at the nicotinic acetylcholine receptor and biological efficacy are comparable to the other members of the class of neonicotinoids. The compound is being developed for use against fleas on pets. Acute toxicity in rats gave an LD<sub>50</sub> of 2,804 mg/kg and 2,000 mg/kg body weight for male and female, respectively. Acute dermal toxicity is >5,000 mg/kg in rats. The compound shows moderate eye irritation and no skin irritation in rabbits. Dinotefuran is not a skin sensitizer. It is non-toxic to birds and fish, NOAEC for *Daphnia magna* is 95 ppm. Dinotefuran is highly toxic to bees.

**Imidacloprid** is an insecticide with contact and stomach action introduced in 1992 as a new chemical entity insecticide in crop protection. Four years later imidacloprid was introduced as the active ingredient of a new and highly effective ectoparasiticide against adult fleas. In topical formulations imidacloprid has a long residual activity. Recently, a combination of imidacloprid was developed with an endectocide that is used against intestinal parasites including heartworm, diseases caused by mite infections as well as against lice and fleas ( $\rightarrow$  Moxidectin). Acute oral LD<sub>50</sub> for rats is 450 mg/kg (acute percutaneous LD<sub>50</sub> >5,000 mg/kg). Very low toxicity for birds and fish was measured. In rats imidacloprid is quickly absorbed from the gastrointestinal tract and eliminated to 96% within 48 hours mainly via the urine. 15% was eliminated unchanged. The most important metabolic steps were hydroxylation at the imidazoline ring, hydrolysis to 6-chloronicotinic acid, loss of the nitro group with formation of the guanidine and conjugation of 6-chloronicotinic acid with  $\rightarrow$  glycine. **Nitenpyram** is an insecticide with contact and stomach action similar to imidacloprid. It has been very recently introduced in selected markets as an oral formulation for acute treatment of fleas on pets. Upon oral administration ectoparasiticide activity lasts not more than 3 days due to the quick elimination and excretion of the compound via urine. Nitenpyram is marketed only in combination with longer acting compounds. Acute oral LD<sub>50</sub> for rats is 1,600 mg/kg (acute percutaneous LD<sub>50</sub> > 2,000 mg/kg).

### Resistance

More than 10 years after introduction of imidacloprid as a pet flea product, field resistance of ectoparasites against imidacloprid has not been reported. Laboratory trials with the multi-resistant (organophosphates, carbamates, pyrethroids, benzoylphenylureas, cyclodienes) field strain "cottontail" from Florida revealed no cross-resistance for imidacloprid to other flea insecticides. It can be speculated from data obtained with insects relevant to crop protection (aphids, whiteflies) that mechanisms of detoxification of neonicotinoids in fleas

will be based on similar mechanisms. For whitefly and aphids the dominant route of detoxification relies predominantly on oxidative processes, however some of the first step oxidation products retain insecticidal activity. To date, no target insensitivity was observed in insect ectoparasites collected from the field. Susceptibility to imidacloprid was not significantly different in housefly strains resistant against organophosphates or pyrethroids, respectively, compared to fully susceptible flies. Generally, the housefly is less susceptible to neonicotinoids. This could be due to fast detoxification by mixed function oxidases as can be concluded from experiments enhancing the efficacy of neonicotinoids against houseflies through →**synergists** like piperonyl butoxide. Additionally, slow penetration through the cuticle of the housefly is also discussed. Besides the metabolic detoxification a point mutation has been identified very recently in  $\alpha 1$  and  $\alpha 3$  subunits of nicotinic acetylcholine receptors from field strains of plant hoppers after further selection in the laboratory. After more than 15 years of use as crop insecticides in the field this is the first target site mutation. It turned out recently that this Y151S point mutation causes reduced agonist potency to the whole range of known neonicotinoids. Dinotefuran as the weakest agonist turned out to be the compound that is least affected by the mutation. However, this point mutation has yet to be identified in field populations of ectoparasites.

### 12-membered Macrocyclic Lactones

Important compounds: Spinosad.

Spinosad is the first product introducing a new class of 12-membered macrocyclic lactones, a mixture of spinosyn A and spinosyn D, isolated from extracts of *Saccharopolyspora spinosa*. The mode of action is similar to that of neonicotinoids though a different subtype of nicotinic acetylcholine receptors is agonistically targeted by these molecules. The compound is marketed as a wound dressing and insecticide against blowfly on sheep and against flies and lice on cattle. Efficacy against fleas is on the same level as with neonicotinoids. The acute oral toxicity LD<sub>50</sub> for male and female rats is 3,738 mg/kg and >5,000 mg/kg bodyweight, respectively. Acute dermal toxicity is >2,000 mg/kg in rabbits. Acute inhalation LC<sub>50</sub> rat is >5.18 mg/l. Spinosad technical (90%) is slightly irritant to rabbits but it is not a skin sensitizer.

At >2,000 mg/kg bodyweight no acute neurotoxicity has been observed. The compound has a half-life of approximately one day in aqueous solution under sunlight. No bioaccumulation has been found in fish. In rat spinosad is rapidly absorbed and extensively metabolised. The compound is slightly respectively moderately toxic to birds, fish and aquatic life and highly toxic to bees.

### Resistance

No resistance of ectoparasites against spinosad has been described since the compound is relatively new to the market.

## Ectoparasiticides – Antagonists and Modulators of Chloride Channels

### Mode of Action

Fig. 1.

### Structures

Fig. 2.

### Organohalogenides

#### Important Compounds

Chlordane, Bromocyclene, Endosulfan, Lindane, Heptachlor, Toxaphene.

### General Information

**Lindane** was isolated from the mixture of isomers in 1912. In 1943 lindane was identified as the insecticidal principle of hexachlorhexane. Insecticidal properties of chlordane, a cyclodiene, were at first identified in the 1940s. The action of lindane and cyclodienes to stimulate synaptic transmission was demonstrated 40 years ago. However, it was not until the early 1980s that the GABA-gated chloride channel complex was suggested to be their target site. In nerve and muscle preparations lindane and cyclodiene →**insecticides** antagonised GABA-stimulated <sup>36</sup>Cl uptake and competed with the TBPS (*t*-butyl-bicyclophosphorothioate) binding site at the GABA-gated chloride channel. Recent studies with cockroach neurones revealed that lindane and cyclodienes decrease the frequency of the GABA-gated chloride channel opening without changing the mean opening time. Dieldrin suppressed the GABA-induced current in a non-competitive manner. Since picrotoxin attenuates the inhibitory effect of dieldrin, it is speculated that cyclodienes bind to the picrotoxin/TBPS binding site. It follows that lindane and cyclodienes are antagonists at GABA-gated chloride channels directly responsible for excitatory symptoms in poisoning of mammals and insects.

**Chlordane** (cyclodiene compound) is a non-systemic insecticide with contact, stomach and respiratory action and long residual activity. It controls household insects as well as pests of domestic animals and man. The compound has impurities of different stereo-isomers and heptachlor. Acute oral LD<sub>50</sub> for rats is 133–649 mg/kg (acute percutaneous LD<sub>50</sub> 217 mg/kg). The compound accumulates in body fat and lipid-containing organs.

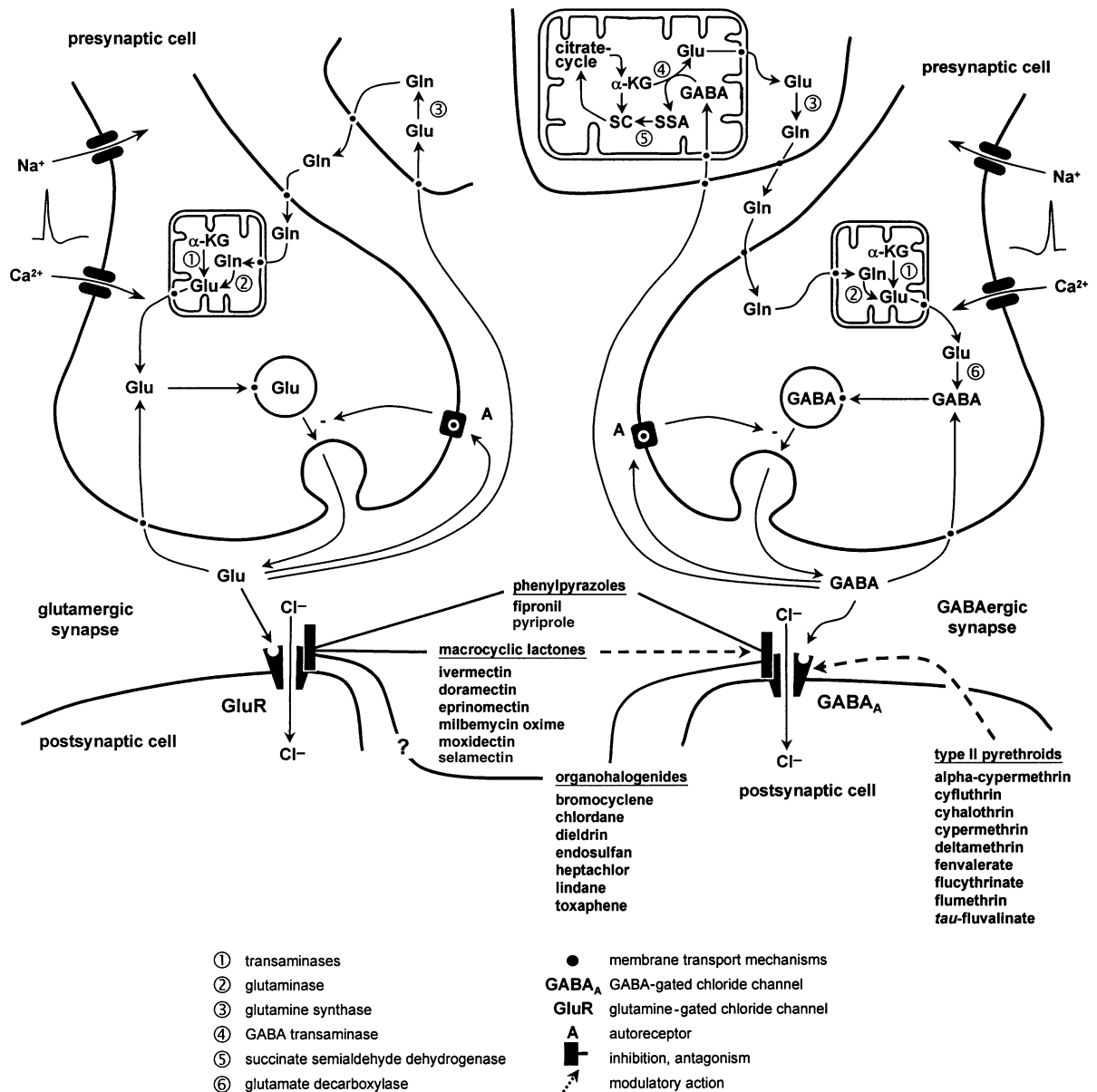

**Ectoparasiticides – Antagonists and Modulators of Chloride Channels. Figure 1** Model of drugs affecting neuromuscular transmission by inhibitory →neurotransmitters.

It shows serious chronic and cumulative toxicity. The compound is toxic to fish and bees. In mammals chlordane is metabolised mainly to hydroxylated products. **Bromocyclene** is a non-systemic insecticide with contact and stomach action. It is used against ectoparasites in sheep and against →fleas on pets. **Endosulfan** (cyclodiene compound) is a non-systemic insecticide with contact and stomach action. In animal and public health applications it is used for the control of →tsetse flies. Acute oral LD<sub>50</sub> for rats is 70–240 mg/kg depending on isomer and formulation (acute percutaneous LD<sub>50</sub> > 4,000 mg/kg). Endosulfan is toxic to fish *in vitro* but

no toxicity has been observed under field conditions. The compound shows no significant toxicity to bees. In mammals endosulfan is eliminated via the faeces within 48 hours. Residues accumulate in the kidney rather than in fat but are eliminated with a half-life of 7 days. The compound is rapidly metabolised to less-toxic metabolites and to polar conjugates. **Lindane (γ-HCH)** is one (>99%) isomer of the technically synthesised mixture of hexachlorhexane isomers. It is an insecticide with contact, stomach, and respiratory action and controls a broad spectrum of insects in public health and animal ectoparasites, e.g., →mites, sucking and biting →lice

## Organohalogenides (cyclodiene insecticides)

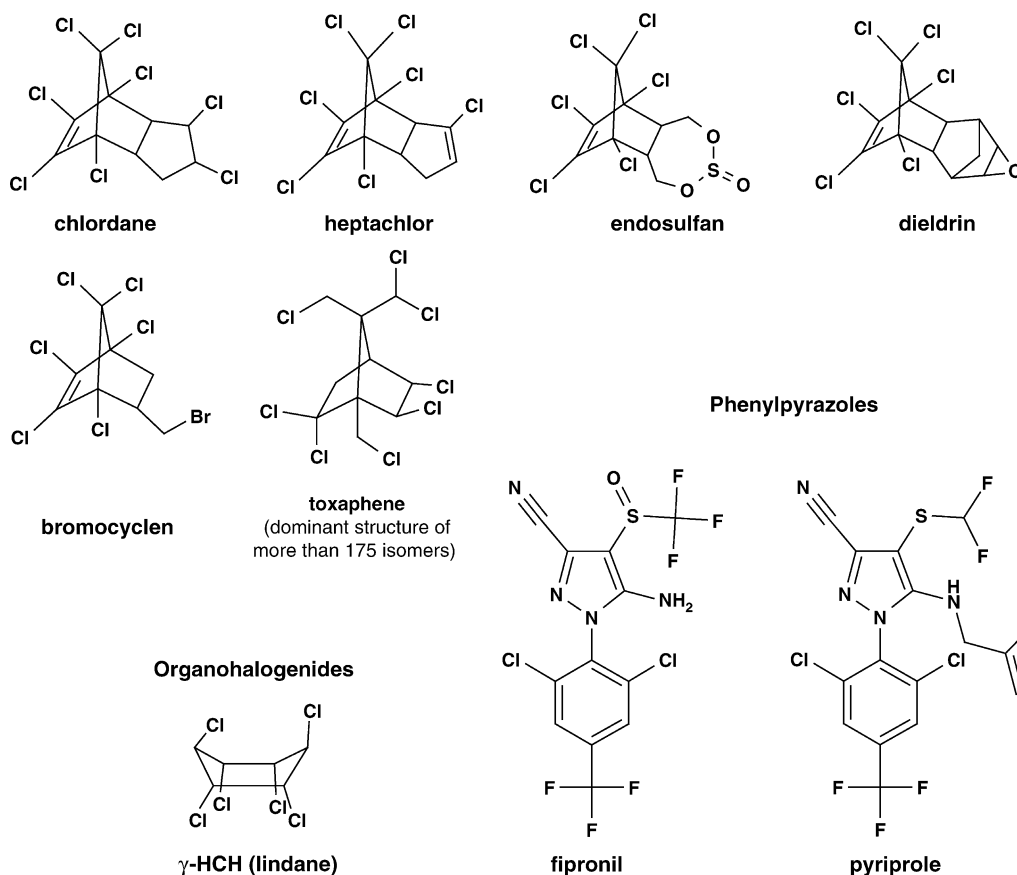

**Ectoparasiticides – Antagonists and Modulators of Chloride Channels. Figure 2** Structures of antiparasitic drugs affecting GABA- or glutamate-gated chloride channels (for structures of avermectins see [→Nematocidal Drugs, Animals](#), [→Nematocidal Drugs, Man](#)).

and [→ticks](#). Acute oral LD<sub>50</sub> for rats is 88–270 mg/kg depending on the carrier (acute percutaneous LD<sub>50</sub> 900–1,000 mg/kg). The compound shows toxicity to fish and to bees. In mammals lindane is found in the milk, body fat, and kidney after oral administration but rapid elimination occurs. Metabolites formed are less chlorinated compounds which are excreted as glucuronic acid conjugates.

### Resistance

Most of the organohalogenide compounds have been withdrawn from the market for toxicological and environmental reasons. From 1948 to 1954 chlorinated hydrocarbons like DDT ([→Ectoparasiticides - Blockers/Modulators of Voltage-Gated Sodium Channels/Organohalogenides](#)) and dieldrin were extensively used for flystrike control. 1954 field monitoring detected no resistant blowfly populations whereas in 1958, the year of the withdrawal of aldrin/dieldrin insecticides for sheep

treatment, 70% of the fly strains tested were resistant to dieldrin. The fast development of resistance against dieldrin was speculated to be pre-selected by the previous use of lindane, increasing the frequency of the *rdl*-gene (encoding for a dieldrin insensitive insect GABA receptor, see below). Resistance against this class of compounds is still present in the [→ectoparasite](#) populations. For dieldrin resistance, e.g., in blowfly populations 2–3% of the individuals still show the resistant phenotype. Therefore, application of selection pressure with new insecticides cross-resistant with this phenotype will favour the resistant individuals leading again to resistant populations in a few generations. Resistance against lindane was reported for Australian strains of the cattle tick *Boophilus microplus*.

Molecular biology techniques enabled the identification of the cyclodiene resistance mediating gene (*rdl*) that was identified as a member of the ligand-gated chloride channel gene family sensitive to GABA.



**Ectoparasiticides – Antagonists and Modulators of Chloride Channels. Table 1** Ectoparasitic control by ivermectin, doramectin and moxidectin in cattle at 200 µg kg<sup>-1</sup>

Ivermectin	Doramectin	Moxidectin
<b>Grubs/Myiasis</b>		
<i>Dermatobia hominis</i> larvae	<i>Dermatobia hominis</i> larvae	-
<i>Cochliomyia hominivorax</i> <sup>+</sup>	<i>Cochliomyia hominivorax</i>	-
<i>Hypoderma bovis</i>	na	na
<i>Hypoderma lineatum</i>	na	na
<b>Lice</b>		
<i>Linognathus vituli</i>	<i>Linognathus vituli</i>	<i>Linognathus vituli</i>
<i>Haematopinus eurysternus</i>	<i>Haematopinus eurysternus</i>	na
<i>Solenopotes capillatus</i>	<i>Solenopotes capillatus</i>	<i>Solenopotes capillatus</i>
<i>Damalina bovis</i> <sup>++</sup>	<i>Damalina bovis</i> <sup>++</sup>	na
<b>Mites<sup>++</sup></b>		
<i>Psoroptes ovis</i>	<i>Psoroptes ovis</i>	<i>Psoroptes ovis</i>
<i>Sarcoptes scabiei</i> var. <i>bovis</i>	na	na
<i>Chorioptes bovis</i>	na	na
<b>Ticks<sup>++</sup></b>		
<i>Boophilus microplus</i>	<i>Boophilus microplus</i>	<i>Boophilus microplus</i>
<i>Boophilus decoloratus</i>	na	na
<i>Ornithodoros savignyi</i>	na	na
<b>Flies</b>		
-	<i>Haematobia irritans</i>	-

na, not available; -, not effective at 200 µg kg<sup>-1</sup>; +, prophylactic (injection) or curative (topical) treatment; ++, parasitic control

## Macrocytic Lactones

16-membered Macrocytic Lactones.

### Important Compounds

Doramectin, Eprinomectin, Ivermectin, Latidectin, Milbemycin Oxime, Moxidectin, Selamectin.

### General Information

The class of 16-membered macrocytic lactones comprises two families: the avermectins and the milbemycins. The avermectins have been discovered by Omura at the Kitasato Institute in Japan. The compounds are active against ecto- and endoparasites and thus defined as endectocides. The biochemical [mode of action](#) is multifunctional. Recent reports established that the major target of the avermectins is the [glutamate-gated chloride channel](#). The compounds also exert modulatory agonistic activity at the GABA-gated chloride channel, thus causing paralysis. Detailed discussion of the mode of action of avermectins and target site identification has been described in [Nematocidal Drugs, Animals](#) and [Nematocidal Drugs, Man](#). The following compilation concentrates on the ectoparasiticidal activities of the macrocytic lactones.

**Doramectin** is a broad-spectrum insecticide and acaricide with contact and stomach action. The 25-cyclohexyl-ivermectin B<sub>1</sub> compound was the fourth avermectin derivative introduced into the animal health

market. It is a [fermentation](#) product of a mutant *Streptomyces avermitilis* strain. The lipophilic cyclohexyl moiety seems to be responsible for the greater tissue half-life of doramectin. It is used as a systemic endectocide with ectoparasiticidal activity against [warble fly](#), screw worm, lice, mite and ticks including multi-resistant strains. **Eprinomectin** is an ivermectin derivative with an amino-modification of the bisoleandrosyl moiety resulting in enhanced insecticidal efficacy and favourable pharmacokinetics with no withdrawal periods for meat and milk. The compound retains the insecticidal and acaricidal properties of ivermectin. Eprinomectin was introduced into the market as an endectocide in 1997. **Ivermectin** is a potent insecticide and acaricide with stomach and contact action. The product is a semi-synthetic derivative of avermectin analogue of *Streptomyces avermitilis* and consists of 22,23-dihydroivermectin B<sub>1a</sub> and 22, 23-dihydroivermectin B<sub>1b</sub> (4:1 mixture). The compound is used in different formulations (injectable, pour-on, bolus) against ticks, sucking and biting lice, cattle grubs, mites, horn flies and bot flies. Withdrawal period for meat is 28 days. Ivermectin is not allowed for use with cattle producing milk for human consumption. Withdrawal period for dairy cows is 28 days prior to calving. Acute oral LD<sub>50</sub> for rats is 10–50 mg/kg. The compound is toxic to fish and other aquatic organisms and toxic to honey bees. Excreted with faeces ivermectin is toxic to coprophagous insects.

**Latidectin** is a new semi-synthetic milbemycin derivative recently developed for treatment of intestinal nematodes and heartworm in pets. **Milbemycin-Oxime** is an insecticide, acaricide and nematocide with contact and stomach action. The compound is a mixture of milbemycin A3 and milbemycin A4 (3:7) produced by *Streptomyces hygroscopicus*. Subsequent derivatisation of the hydroxyl group at position 5 to a ketoxime resulted in a less potent compound with a favourable toxicological profile. The compound is predominantly active against →nematodes and shows only weak ectoparasitidal activities at the concentrations used in animal treatment. In combination with an insecticide the compound is used against endoparasites and fleas in pets (→Lufenuron). **Moxidectin**, the third macrocyclic lactone introduced into the market of endectocides is produced by a combination of fermentation and chemical synthesis by 23-methoxime derivatisation of nemadectin, a milbemycin produced by *Streptomyces cyanogriseus noncyanogenus*. The efficacy against endo- and ectoparasite is comparable to that of ivermectin. Withdrawal periods are 28–49 days for meat depending on product. The compound is less toxic to coprophagous insects when compared to ivermectin. In combination with an insecticide the compound is used against endoparasites and ectoparasites like fleas and mites in pets (→Imidacloprid). **Selamectin** is a semi-synthetic doramectin analogue which has been introduced into the market of pet endectocides in 1999. The compound is active against fleas, some ticks, intestinal →hookworms, ascarids, and immature heartworms. The favourable toxicology profile was achieved through introduction of a 5-ketoxime group and cleavage of one sugar moiety.

### Resistance

Broad resistance of parasitic arthropods against avermectins or milbemycins has not yet been reported. No cross-resistance has been found to other compounds. Reports of a milbemycin derivative breaking avermectin resistance of nematodes are under discussion. It is speculated that moxidectin has higher efficacy against specific nematodes compared to ivermectin leading to the control of ivermectin-resistant strains of these nematodes. A laboratory selection of sheep blowfly larvae with ivermectin was recently published. A pooled field strain was subjected to ivermectin treatment at a concentration producing more than 70% mortality. The larvae were selected over 60 generations, giving a 2-fold increase in the  $LC_{50}$  after the first selection and finally resulting in an 8-fold resistant strain. After relaxation of the selection pressure the selected strain reverted towards susceptibility fairly rapidly. Within 8 generations the  $LC_{50}$  values dropped from sevenfold to twofold compared to the parental strain.

## Phenylpyrazoles Important Compounds

Fipronil, Pyriprole.

### General Information

Phenylpyrazole intoxication of blowfly causes hyperexcitability and elevates nerve discharge. Inhibitory effects of GABA on *D. melanogaster* motor neurone discharge are reverted in a manner similar to that of picrotoxin and cyclodienes. Phenylpyrazoles are antagonists of the GABA-gated chloride channel and there is evidence that these compounds share a common binding site with cyclodienes, TBPS, and picrotoxin on the GABA receptor.

**Fipronil** is a broad-spectrum non-systemic insecticide and acaricide with contact and stomach action and good residual activity. It is used for the control of ectoparasites of pets and livestock as well as an insecticide in public health. Acute oral  $LD_{50}$  for rats is 97 mg/kg (acute percutaneous  $LD_{50} > 2,000$  mg/kg). Fipronil is harmful to some species of birds and fish and highly toxic to bees (direct contact and ingestion). In mammals fipronil is rapidly distributed and metabolised upon adsorption. Fipronil and its sulfone are eliminated mainly via the faeces. Urinary metabolites have been identified as conjugates of ring-opened pyrazole products. **Pyriprole** is a new broad-spectrum ectoparasiticide which has been developed very recently for use against ticks and fleas on dogs. The compound is less toxic than fipronil and is thought to be a pro-drug of the active compound with the free amine group. Acute oral  $LD_{50}$  for rats is  $>300$  mg/kg. Pyriprole is a moderate eye irritant and shows no dermal irritation potential.

### Resistance

Analysis of the *rdl* (resistant to dieldrin) gene isolated from cyclodiene-resistant →mosquitoes and flies showed a specific point mutation (A302S) responsible for the altered insecticide-susceptibility of the target. Cyclodiene-resistant fruit fly strains showed a more than 25-fold resistance against phenylpyrazoles. Phenylpyrazoletopical treatment of cyclodiene-resistant and glodiene-susceptible *Blattella germanica* resulted in  $LD_{50}$  values of 40 µg/insect and 0.07 µg/insect, respectively, indicating a 570-fold cross-resistance. A cyclodiene-resistant housefly strain showing nearly 2,900-fold resistance to dieldrin had an  $LC_{50}$  value of 36 ppm for fipronil whereas  $LC_{50}$  of a susceptible reference strain was 0.4 ppm revealing a 90-fold cross-resistance. Perhaps more interestingly, despite the fact that the A302S mutation greatly reduces the rate of GABA receptor desensitisation, the fitness of resistant flies does not seem to be decreased. Recently molecular biology analyses of *rdl*-genes in several flea strains from different areas throughout the world revealed a

high prevalence of the point mutation conferring resistance to dieldrin. However, the practical relevance of this observation of potential phenylpyrazole cross-resistance on a molecular level has yet to be proven in *in vivo* trials on animal.

**Structures**

Organohalogenides, Fig. 2.

**Important Compounds**

DDT, Methoxychlor.

**General Information**

DDT is a broad-spectrum insecticide introduced onto the market in 1943. Nowadays, the compound has been replaced by less persistent →insecticides in nearly all countries. DDT is a persistent non-systemic insecticide with contact and stomach action. DDT acts on the voltage-gated sodium channel causing slow open and closing characteristics of the ion channel. This results in an increased negative afterpotential, prolonged action potentials repetitive firing after single stimulus,

**Ectoparasiticides – Blockers/Modulators of Voltage-Gated Sodium Channels**

**Mode of Action**

Fig. 1.

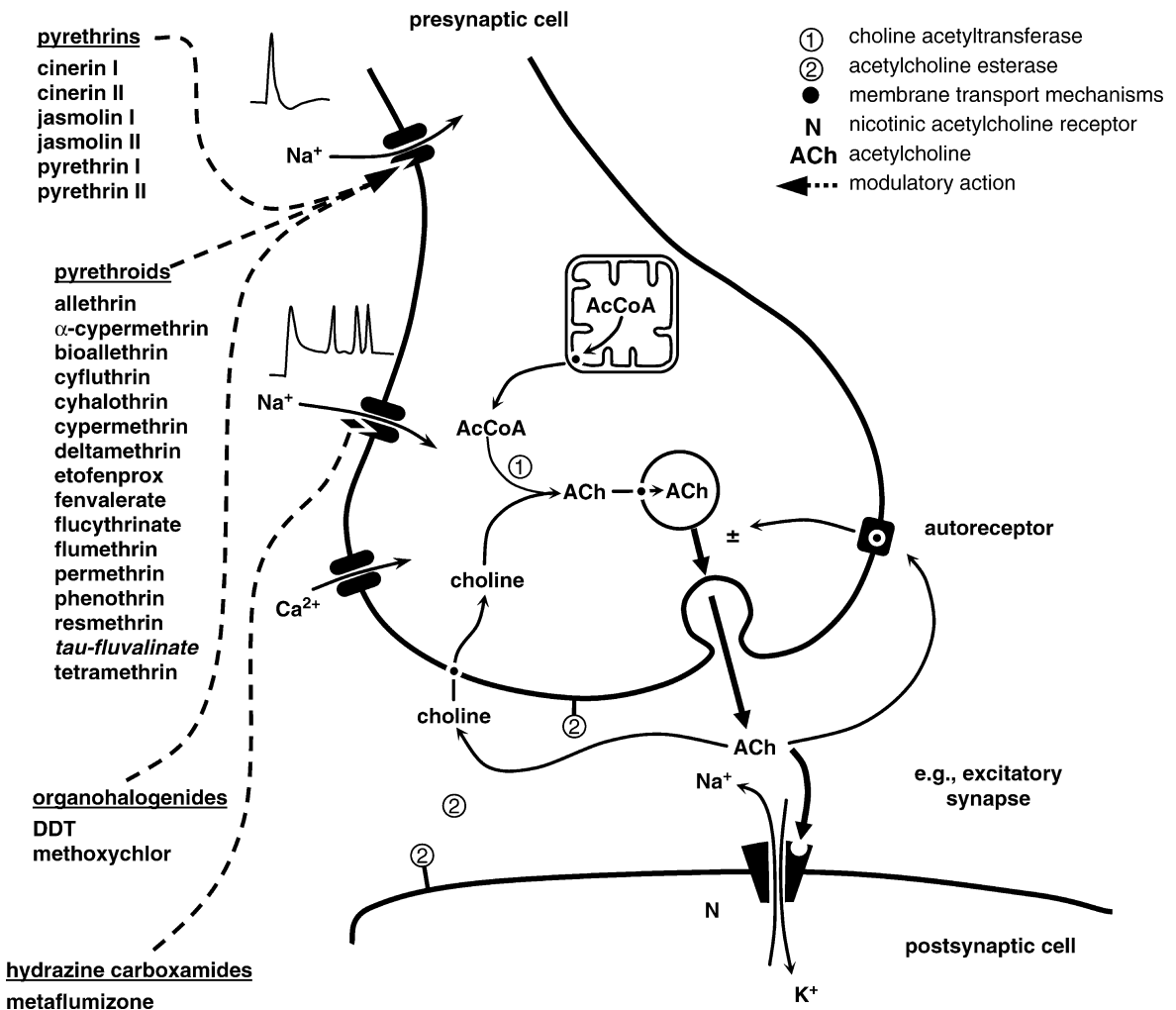

Ectoparasiticides – Blockers/Modulators of Voltage-Gated Sodium Channels. Figure 1 Model of drugs affecting neural transmission at voltage sensitive sodium channels.

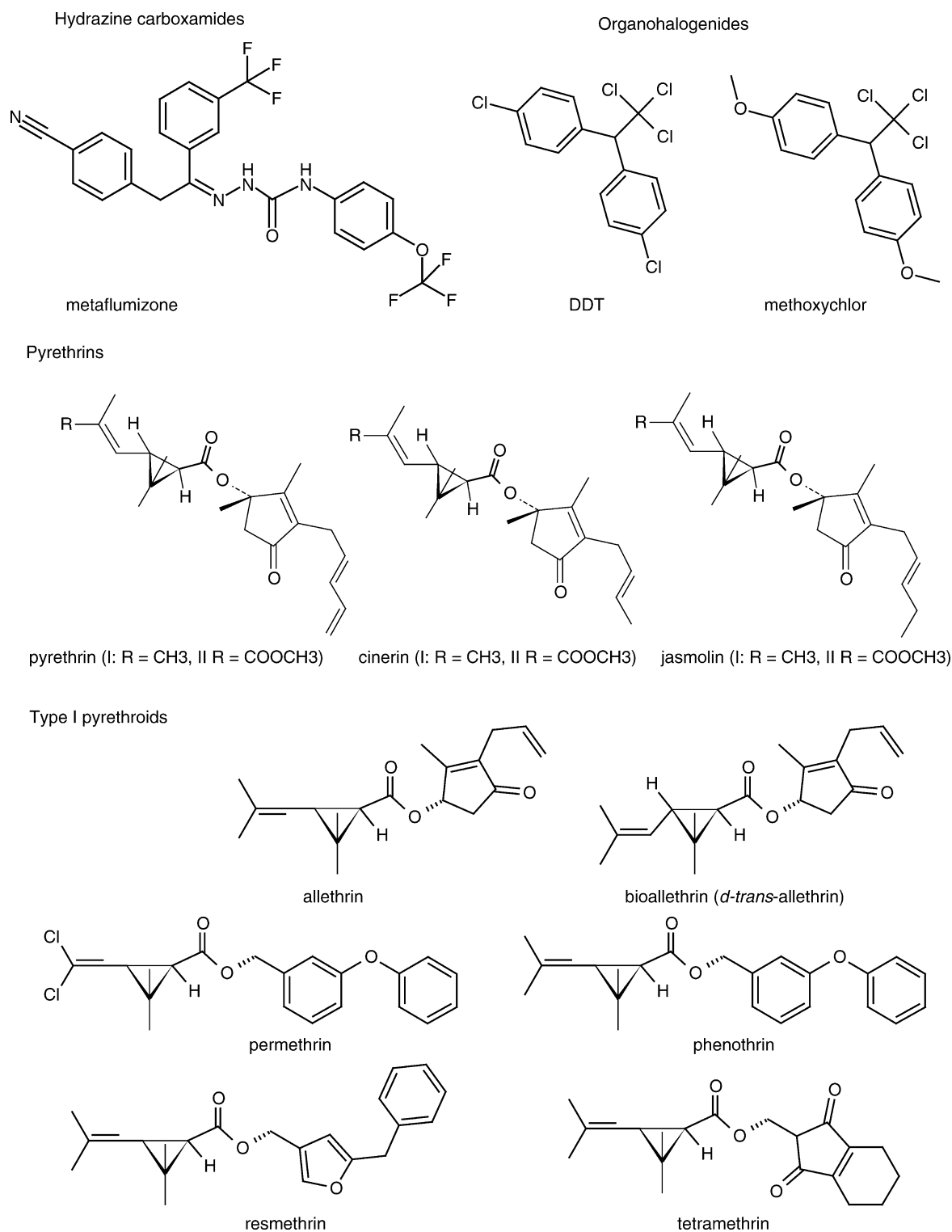

**Ectoparasiticides – Blockers/Modulators of Voltage-Gated Sodium Channels. Figure 2** Structures of antiparasitic drugs affecting voltage sensitive sodium channels.

## Type II pyrethroids

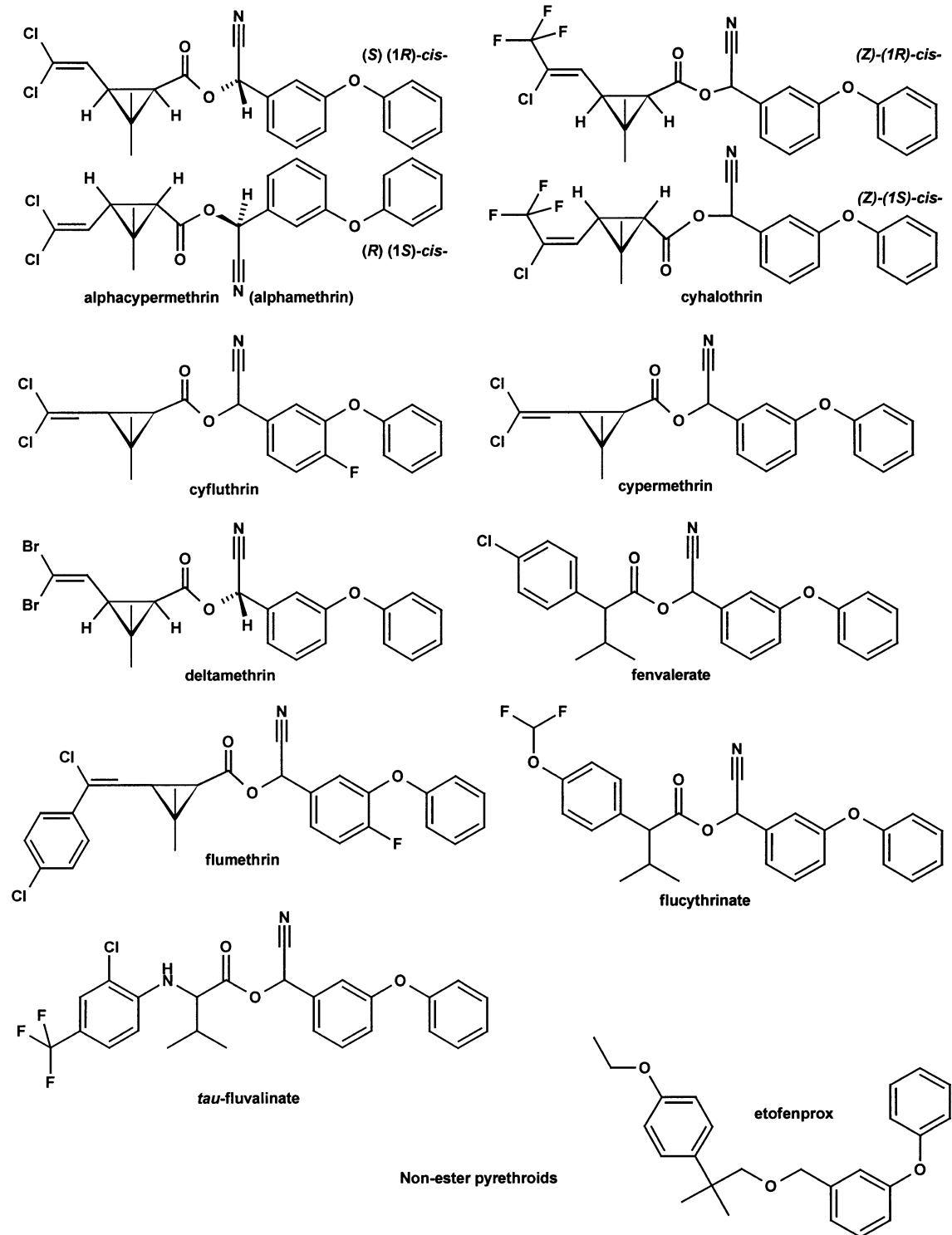

Ectoparasiticides – Blockers/Modulators of Voltage-Gated Sodium Channels. Figure 2 Structures of antiparasitic drugs affecting voltage sensitive sodium channels. (Continued)

and spontaneous trains of action potentials. Temperature has a profound effect on the insecticidal activity of DDT. Its potency to induce repetitive discharges from cockroach sensory neurones increases with lowering of the temperature with a  $Q_{10}$  of 0.2. While in most countries the use of DDT is prohibited by law, in some countries DDT is still used in mosquito eradication programs. Acute oral  $LD_{50}$  for rats is 113–118 mg/kg (acute percutaneous  $LD_{50}$  2,510 mg/kg). DDT is toxic to fish and aquatic life. A side effect of DDT is the inhibition of a Ca-ATPase that is necessary for the calcification of egg shells. The compound accumulates in fatty tissues of mammals and is excreted in milk. The high potential for bioaccumulation and its long persistence has been discussed to be a major hazard to the environment. **Methoxychlor** is an insecticide closely related to DDT with contact and stomach action. It is used for the control of insect pests in animal houses, dairies and household. Acute oral  $LD_{50}$  for rats is >6,000 mg/kg. The compound is toxic to aquatic life and fish. In mammals the compound is degraded by O-dealkylation to the corresponding phenol and diphenol, and by dehydrochlorination to 4,4'-dihydroxybenzophenone.

### Resistance

Resistance of ectoparasites against DDT and methoxychlor is mainly of metabolic origin. Primarily, elevated levels of dehydrochlorinase activity together with mixed function oxidases are involved in detoxifying DDT. Reduced penetration of DDT through the cuticular layers is another resistance mechanism, e.g., in DDT-resistant flies. Furthermore, DDT susceptibility is reduced in target site mutant *kdr* and super-*kdr* housefly strains. Housefly strains resistant to DDT show reduced susceptibility for methoxychlor. However, methoxychlor-resistant flies are fully susceptible to DDT indicating a different mechanism for methoxychlor detoxification. A possible pathway could be demethylation and subsequent →[Conjugation](#).

## Pyrethrins

### Important Compounds

Pyrethrin I, Pyrethrin II, Cinerin I, Cinerin II, Jasmolin I, Jasmolin II.

### General Information

Pyrethrum comprises a mixture of naturally occurring pyrethrins (pyrethrin I, pyrethrin II, jasmolin I, jasmolin II, cinerin I, cinerin II) CNA; (Z)-(S)-2-methyl-4-oxo-3-(penta-2,4-dienyl)cyclopent-2-enyl (+)-trans-chrysantemate (cinerin I); (Z)-(S)-2-methyl-4-oxo-3-(penta-2,4-dienyl)cyclopent-2-enyl (+)-trans-chrysantemate (pyrethrin I); (Z)-(S)-3-(but-2-enyl)-2-methyl-4-oxo-cyclopent-2-enyl (+)-trans-chrysantemate (cinerin I);

(Z)-(S)-2-methyl-4-oxo-3-(pent-2-enyl)cyclopent-2-enyl (+)-trans-chrysantemate (jasmolin I); (Z)-(S)-2-methyl-4-oxo-3-(penta-2,4-dienyl)cyclopent-2-enyl pyrethrate (pyrethrin II); (Z)-(S)-3-(but-2-enyl)-2-methyl-4-oxo-cyclopent-2-enyl pyrethrate (cinerin II); (Z)-(S)-2-methyl-4-oxo-3-(pent-2-enyl)cyclopent-2-enyl pyrethrate (jasmolin II) isolated from *Tanacetum* (= *Chrysanthemum* = *Pyrethrum*) *cinerariaefolium*. Pyrethrum is an ancient insecticide which was identified in China and spread to Dalmatia, France, USA, Japan in the 19th century (dried powdered flower heads were called Persian insect powder). Pyrethrum is a non-systemic insecticide with some acaricidal activity. It causes immediate paralysis with death occurring later and shows quick knock-down and short acting activities. The primary molecular target of pyrethrins is the neuronal presynaptic voltage-sensitive sodium channel. Pyrethrum is used in treatment of ectoparasites on companion and farm animals. The biological efficacy of pyrethrins and pyrethroids seems to be less pronounced in the larval stage of most insect species which might be due to the higher activity of the adult stages compared to larvae. Generally, it is combined with →[synergists](#) like piperonyl butoxide to encounter quick detoxification and to enhance potency. In mammals pyrethrins are rapidly degraded in the stomach by hydrolysis of the ester bond to non-toxic metabolites. The  $LD_{50}$  for acute oral toxicity in rats is 584–900 mg/kg ( $LD_{50}$  acute percutaneous toxicity >1,500 mg/kg in rats). Synergists seem not to enhance the toxicity of pyrethrins to mammals. Pyrethrins are highly toxic to fish and toxic to bees but show a repelling effect.

## Pyrethroids

### General Information

Pyrethrins served as a lead structure for the synthesis of the pyrethroids. The chemical class of pyrethroids is divided into structurally related subclasses. The type I pyrethroids are ester bond pyrethroids without  $\alpha$ -cyano-residue, the type II pyrethroids include all ester bond pyrethroids containing a cyano-group at the  $\alpha$ -carbon atom. An example for the class of non-ester bond pyrethroids is also given. A variety of structures were introduced onto the market during the 1970s and 1980s.

The insecticidal symptoms of type I pyrethroids are characterised by hyperexcitation, ataxia, convulsions and paralysis. Type II pyrethroids cause →[hypersensitivity](#), tremors and paralysis. The primary target of pyrethrins and all pyrethroids is the voltage-sensitive sodium channel on the presynaptic side of insect neuronal →[synapses](#).

The pyrethroids slow kinetics of both opening and closing of individual sodium channels resulting in delayed and prolonged openings. Pyrethroids also cause a shift of the activation voltage in the direction of hyperpolarisation. There then follows a membrane

depolarisation and an increase in depolarising after-potential. The latter reaches the threshold for excitation causing repetitive after-discharges. The membrane potential of sensory neurones increases discharge frequency, and that of nerve terminals increases the release of neurotransmitter and the frequency of spontaneous miniature postsynaptic potentials. The corresponding symptoms of mammalian or arthropod intoxication are hyperexcitation, hypersensitivity, convulsions and tremors. As described for DDT, pyrethroids also show a negative temperature coefficient for their activity on voltage-sensitive sodium channels revealing a  $Q_{10}$  value of 0.18 for tetramethrin between 25°C and 35°C. Type II pyrethroids also show some modulatory activity at a secondary target site identified as GABA-gated chloride channel.

### Type I Pyrethroids

Important type I pyrethroids are allethrin, bioallethrin, permethrin, phenothrin, resmethrin, and tetramethrin.

**Allethrin** [(1R)-isomers] is a non-systemic insecticide with contact, stomach and respiratory action. It gives rapid knock-down and paralysis before killing. It is used for insect control in animal houses and as an animal ectoparasiticide.  $LD_{50}$  of acute oral toxicity for rats is 900–2,150 mg/kg. In mammals the compound is detoxified after oral administration in the liver by oxidation of one terminal methyl group of the chrysanthemic acid moiety to a carboxyl group via an alcohol group. The compound is eliminated via urine and faeces within 2–3 days after treatment. **Bioallethrin**; d-trans-allethrin [ $\geq 93\%$  (1R)-,  $\geq 90\%$  trans,  $\leq 3\%$  cis-isomer] is a potent contact non-systemic, non-residual insecticide producing rapid knock-down. It is used mainly in household and public health and in some countries is marketed for [→ectoparasite](#) treatment of companion animals. Mammalian toxicity is slightly higher than with allethrin. Detoxification and elimination occurs as described for allethrin. Cis/trans isomerisation has not been observed in soil. **Permethrin** is a non-systemic insecticide with contact and stomach action and slight repellent effect. It is used for repellence and control of biting flies and is also active against biting and sucking [→lice](#) on cattle. Recently the repellence and acaricidal efficacy of permethrin have been used in a combination product against ticks and fleas, flies and mosquitoes on dogs ([→Imidacloprid](#)). Acute oral  $LD_{50}$  for rats is 4,000 and 6,000 mg/kg for a cis:trans isomer mixture of 40:60 and 20:80 respectively (acute percutaneous  $LD_{50} > 4,000$  mg/kg). Permethrin is toxic to fish and bees. In mammals hydrolysis of the ester bond occurs and the compound is eliminated as the glycoside conjugate. **Phenothrin** [(1R)-isomers] is a non-systemic insecticide with contact and stomach action that gives rapid knock-down. It is used in public health against a variety of injurious and nuisance insects and as a

combination product with allethrin or tetramethrin for control of [→fleas](#) and [→ticks](#) on dogs and cats. Acute oral  $LD_{50}$  for rats is  $>10,000$  mg/kg (acute percutaneous  $LD_{50} >10,000$  mg/kg). The compound is toxic to fish and bees. **Resmethrin** is a non-systemic insecticide with contact action, acting in a similar manner to the natural pyrethrins but is not synergised by pyrethrum synergists. It is often used in combination with more persistent insecticides. Acute oral  $LD_{50}$  for rats is  $>2,500$  mg/kg (acute percutaneous  $LD_{50} > 3,000$  mg/kg). The compound is toxic to fish and to bees. Metabolism in hens was principally by ester hydrolysis and oxidation, followed by conjugation. **Tetramethrin** is a non-systemic insecticide with contact action that gives rapid knock-down. It is used as flea insecticide for pets. Tetramethrin is often combined with synergists or other pyrethroid insecticides. Acute oral  $LD_{50}$  for rats is  $>4,640$  mg/kg (acute percutaneous  $LD_{50} > 5,000$  mg/kg). The compound is toxic to fish and to bees. Tetramethrin seems to be metabolised in a similar way to the natural pyrethrins. In mammals, following oral administration, about 95% of the metabolised tetramethrin is eliminated in the urine and faeces within 5 days. The principal metabolite is 3-hydroxycyclohexane-1,2-dicarboximide.

### Type II Pyrethroids

Important type II pyrethroids are alpha-cypermethrin, cyfluthrin, cyhalothrin, cypermethrin, deltamethrin, fenvalerate, flucythrinate, flumethrin and *tau*-fluvalinate.

**Alpha-cypermethrin** (formerly also known as alphamethrin) is a non-systemic  $\alpha$ -cyano-pyrethroid with contact and stomach action. It is used mainly to control body lice and blowfly strike on sheep with no withdrawal period required. Acute oral  $LD_{50}$  for rats is 474 mg/kg (acute percutaneous  $LD_{50} > 2,000$  mg/kg; tech. grade). The compound is toxic to fish and bees under experimental conditions but no toxic effects could be observed under field conditions. **Cyhalothrin** is a non-systemic insecticide and acaricide with contact and stomach action and repellent properties. It is mainly used for control of animal ectoparasites on sheep and cattle. Acute oral  $LD_{50}$  for rats is 114–166 mg/kg (acute percutaneous  $LD_{50}$  200–2,500 mg/kg). The compound is toxic to fish and other aquatic organisms. In mammals the orally administered compound is hydrolysed at its ester bond and polar conjugates are formed from both moieties. Cyhalothrin is rapidly eliminated via urine and faeces. **Cyfluthrin** is a non-systemic insecticide with contact and stomach action with rapid knock-down efficacy and long residual activity. The compound is used in public health, against stored product pests and against flies in animal health. Acute oral  $LD_{50}$  for rats is 590 mg/kg (acute percutaneous  $LD_{50} > 5,000$  mg/kg). Toxicity to bees and fish has been observed. Cyfluthrin was largely

and quickly eliminated in mammals. 98% of the administered amount was eliminated within 48 hours via urine and the faeces. **Cypermethrin** is a non-systemic insecticide and acaricide with contact and stomach action. It also deters ovipositioning blowflies on treated sheep. It has a broad activity against ectoparasites on farm animals. Withdrawal periods are 7 days for meat and at least 6 hours for milk. Acute oral LD<sub>50</sub> for rats is 200–800 mg/kg (acute percutaneous LD<sub>50</sub> > 1,600 mg/kg). The compound is toxic to fish and bees. **Deltamethrin** is a non-systemic fast acting insecticide and acaricide with contact and stomach action. It is used against a variety of ectoparasitic species on livestock. Acute oral LD<sub>50</sub> for rats is 128–139 mg/kg (acute percutaneous LD<sub>50</sub> > 5,000 mg/kg in aqueous solution). The compound is toxic to fish and bees under experimental conditions, but exhibits a repellent effect. **Fenvalerate** is a non-systemic insecticide and acaricide with contact and stomach action. It controls a broad-spectrum of parasitic arthropods and exhibits repellent activity. Acute oral LD<sub>50</sub> for rats is 451 mg/kg (acute percutaneous LD<sub>50</sub> > 2,500 mg/kg). The compound is toxic to fish and bees. In mammals fenvalerate is rapidly metabolised. Up to 96% of the compound administered orally is excreted in the faeces within 6–14 days. **Flucythrinate** is a non-systemic insecticide with contact and stomach action. It is registered for the control, of flies, fleas and other insects. Acute oral LD<sub>50</sub> for rats is 67–81 mg/kg. The compound is moderately toxic to fish and toxic to bees but shows a repellent effect. In mammals flucythrinate is eliminated within 24 hours (60–70%) to 8 days (>95%) in the faeces and urine. Major metabolic pathways are hydrolysis followed by hydroxylation of the hydrolysis products. **Flumethrin** is a non-systemic insecticide and acaricide with contact and stomach action. It is used for the control of ticks, biting and sucking lice, →mites and for diagnosis and control of →varroosis in beehives. At sub-lethal doses a sterilising effect of the pour-on formulation has been demonstrated for →*Hyalomma* ticks. Specific formulations have been granted nil withdrawal periods for meat and milk. Acute oral LD<sub>50</sub> for rats is mg/kg (acute percutaneous LD<sub>50</sub> mg/kg). The compound is moderately toxic to fish and shows low toxicity to bees which enables selective treatment against *Varroa* mites. **tau-fluvalinate** is a non-systemic broad range insecticide and acaricide. In animal health applications it is marketed as for the control of the *Varroa* mite in beehives. Acute oral LD<sub>50</sub> for rats is >3,000 mg/kg (acute percutaneous LD<sub>50</sub> > 20,000 mg/kg). tau-Fluvalinate is toxic to fish and other aquatic organisms.

### Non-ester Pyrethroids

**Etofenprox** is a non-ester pyrethroid insecticide with contact and stomach action. The compound is mainly

used in crop protection but is also used to control public health pests and on livestock against insects. Recently the compound has also been registered for use against ectoparasites on cats. Acute oral LD<sub>50</sub> for rats is >42,880 mg/kg (acute percutaneous LD<sub>50</sub> > 2,140 mg/kg). The compound is slightly toxic to fish.

### Resistance

Pyrethroid resistant strains of the cattle tick *Boophilus microplus* have been isolated in countries in Central and Southern America, Southern Africa and Australia. Resistance of Australian strains of *B. microplus* against pyrethroids has been reviewed by J. Nolan. Monitoring of →horn fly control measures with pyrethroid dips, sprays or pour-ons revealed significantly reduced susceptibility. The period of spray efficacy fell from 30 to 20 and even to 5 days in some areas of Argentina. Dips regularly able to control horn flies for 15 days protected animals ranging from 0 to 6 days. Pour-ons of deltamethrin, cypermethrin, cyhalothrin or cyfluthrin experienced a decline in efficacy from 45–60 days down to less than four weeks during the study. Knock-down resistant (*kdr*) and *super kdr*(*skdr*) phenotypes have been described in several housefly strains of different origin. Recently, point mutations responsible for pyrethroid and DDT resistance have been identified in the coding region of the *para* sodium channel gene (the insect analogue of the vertebrate voltage sensitive sodium channel) from *kdr* and *skdr* strains of the housefly as well as *kdr* strains of the German cockroach.

Since 1981 pyrethroids have been used as ectoparasiticides against sheep lice as pour-on or wet-dip formulations. By mid 1985 reports of failures of the pour-on pyrethroids were becoming more frequent. About 7 years later a lice strain was isolated in New South Wales (Australia) that was found to be 642× resistant to cypermethrin and able to survive pour-on and full immersion dips. Addition of piperonyl butoxide to the formulation resulted in 81% reduction of lice number again.

### Hydrazine carboxamide

#### Important Compounds

Metaflumizone.

Metaflumizone is the first compound used for animal health applications from a new class of chemicals acting as blocker of voltage sensitive Na<sup>+</sup>-channels in insects. The binding site and channel subtype is distinct from DDT or pyrethroid binding sites. The oxadiazine compound indoxacarb was the first member of a closely related chemical class with the same mode of action but is currently used only in crop applications. These type of carboxamides are insecticides mainly with stomach and contact action. While indoxacarb



requires esterolytic activation, metaflumizone already presents the active secondary amine group. Metaflumizone has been developed recently for use against fleas on cats as a single active application and against ticks and fleas on dogs in combination with an acaricide ( $\rightarrow$ Amitraz). The acute oral and dermal LD<sub>50</sub> in rat is  $>5,000$  mg/kg bodyweight. Inhalation toxicity LC<sub>50</sub> in rats is  $>5.2$  mg/L. Metaflumizone is non-irritant to eyes or skin of rabbits. The compound is also not a sensitiser.

### Resistance

Resistance to metaflumizone has not been reported yet since it will probably enter the first animal health markets in 2007. For indoxacarb that has the same mode of action esterolytic activities conferred high levels of resistance in leaf rollers. In houseflies mixed function oxidases (MFO) were found to be responsible for a 118-fold laboratory selected indoxacarb resistance in houseflies. A cross-resistance against kdr or skdr pyrethroid resistance is not to be expected. Several authors found negative cross-resistance between pyrethroid resistance and elevated indoxacarb efficacy in lepidopteran species.

---

## Ectoparasiticides – Inhibitors of Arthropod Development

### Mode of Action

Chitin synthesis inhibitors (Fig. 1).

### Structures

Fig. 2.

### Important Compounds

Diflubenzuron, Fluazuron, Lufenuron, Triflumuron.

### General Information

The chemical class of benzoylphenylurea (BPU) compounds is widely used as an insecticide also in animal health applications. The BPU compounds are inhibitors of chitin synthesis thus interfering with the formation of the insect  $\rightarrow$ cuticle. There is no inhibition of other poly-sugar synthesis pathways (e.g., hyaluronic acid synthesis) by BPU compounds indicating high specificity. The biochemical target within the chitin biosynthesis pathway has not yet been clearly identified. Recent findings showed interference of BPUs with GTP-mediated Ca-transport in intracellular vesicles in chitin depositing  $\rightarrow$ integument cells from American

cockroaches. Chitin synthase itself is not inhibited by BPU compounds. Inhibition of chitin synthesis by BPU compounds depends on intact cells.

**Diflubenzuron** is a non-systemic insect growth regulator with contact and stomach action. It shows activity against moulting larvae or hatching eggs. The acute oral LD<sub>50</sub> for rats is  $>4,640$  mg/kg (acute percutaneous LD<sub>50</sub>  $>10,000$  mg/kg). The compound shows very low toxicity for fish and is not toxic to bees and predatory insects. In mammals diflubenzuron is partly eliminated as the parent compound with the faeces following oral administration. The other part is excreted mainly as hydroxylated metabolites. **Fluazuron** is a non-systemic ixodid growth regulator with contact and stomach action. The compound was recently launched for strategic tick control in Australia. It shows activity against all developmental stages of the cattle tick *Boophilus microplus* including all resistant strains. The acute oral LD<sub>50</sub> for rats is  $>5,000$  mg/kg (acute percutaneous LD<sub>50</sub>  $>2,000$  mg/kg). Acatak has a withdrawal period of 42 days and treatment of dairy cows and sucking cattle is not allowed. The compound is harmful for fish but not toxic to bees. In mammals the compound is virtually not metabolised following oral administration. **Lufenuron** is an insect growth regulator that mostly acts by ingestion. The compound has been introduced in the pet market as a systemic flea growth regulator. Adult  $\rightarrow$ fleas feeding from blood of systemically treated animals lay non-fertile eggs. Larvae feeding from faeces produced by treated adult fleas will be unable to moult and also cease feeding. The compound is also used in combination with macrocyclic lactones against endoparasites and fleas in pets ( $\rightarrow$ Milbemycine Oxime). The acute oral LD<sub>50</sub> for rats is  $>2,000$  mg/kg (acute percutaneous LD<sub>50</sub>  $>2,000$  mg/kg). The compound shows very low toxicity for fish and is only slightly toxic to adult bees. In mammals lufenuron is mainly eliminated as the parent compound with the faeces following oral administration. **Triflumuron** is a non-systemic insect growth regulator with stomach action. It shows activity against moulting larvae and causes infertility of eggs. The compound is used against blowfly, fly larvae in animal houses, cockroaches and flea larvae. The acute oral LD<sub>50</sub> for rats is  $>5,000$  mg/kg (acute percutaneous LD<sub>50</sub>  $>5,000$  mg/kg). Triflumuron shows very low toxicity for fish and is not toxic to predatory insects. In mammals the compound is metabolised by hydrolytic cleavage-forming conjugated or partly hydroxylated metabolites containing the 2-chlorophenyl ring and correspondingly the 4-trifluoromethyl-methoxyphenyl ring.

### Resistance

In animal health, resistance of ectoparasites against BPU is still rare. This might change with the growing market

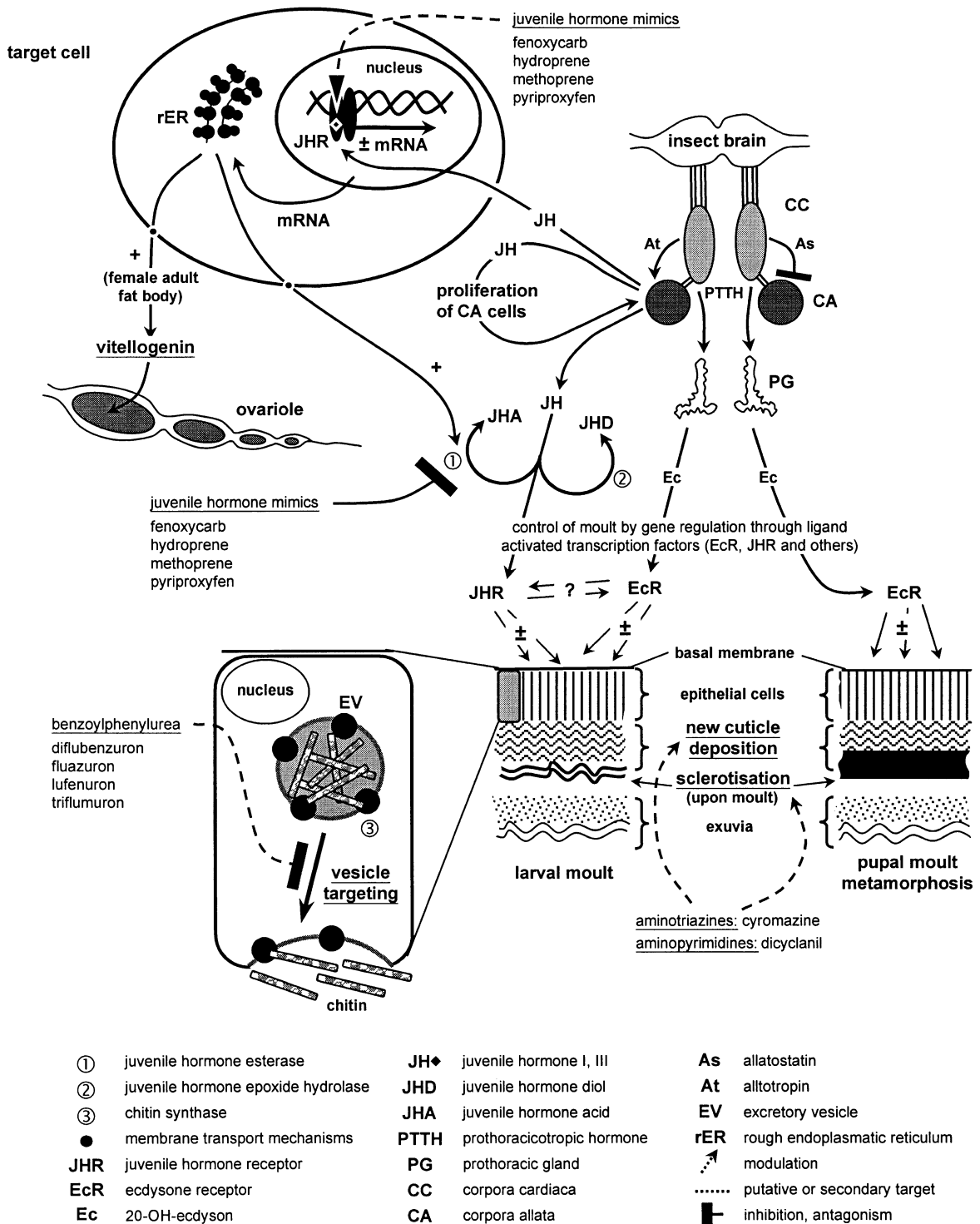

**Ectoparasiticides – Inhibitors of Arthropod Development. Figure 1** Model of drug interaction with arthropod development.

share of BPU as a sheep ectoparasiticide. In diflubenzuron-resistant strains of the housefly *Musca domestica* oxidation seems to be the predominant route of detoxification. Another mechanism of detoxification of BPUs

are hydrolases as could be demonstrated by the synergising effect of esterase inhibitors. Metabolic resistance against BPU has been demonstrated for a multi-resistant housefly population. Glutathion-S-transferase and mixed

## Benzoylphenylurea (BPU)

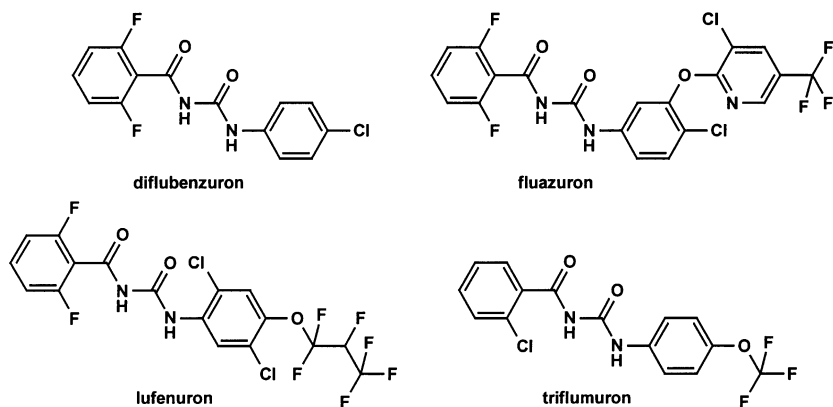

## Juvenile hormones mimics

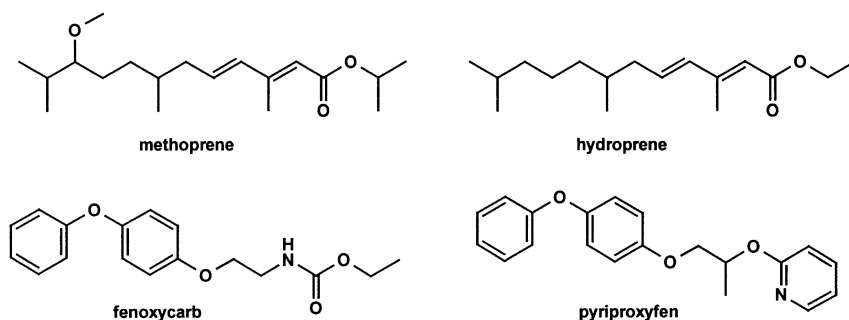

## Aminotriazine, aminopyrimidine

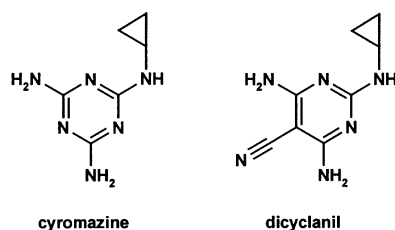

**Ectoparasiticides – Inhibitors of Arthropod Development.** Figure 2 Structures of ectoparasiticidal drugs interfering with arthropod development.

function oxidase enzyme activities were determined and showed elevated levels. A multi-resistant flea strain collected from Florida showed resistance to some BPU compounds in laboratory *in vivo* trials.

### Juvenile Hormone Mimics Important Compounds

Methoprene, Hydroxyphenoxymethoprene, Fenoxycarb, Pyriproxyfen.

### General Information

The class of [insecticides](#) comprises different chemical classes causing similar phenotypic damage to treated

insects. They are mimics of the endogenous juvenile hormone of insects, preventing [metamorphosis](#) to viable adults when applied to larval stages. Juvenile hormone mimics also exert ovicidal effects when applied to adults. Up to now, two primary targets of juvenoids have been identified. The compounds fulfil a dual function by inhibiting the juvenile hormone esterase from degrading endogenous juvenile hormone as well as by their weak agonistic effect on juvenile hormone receptors. This adds to the endogenous juvenile hormone effects thus compensating for the naturally occurring degradation of the juvenile hormone producing [corpora allata](#) glands. In adult

insects →juvenile hormones are involved in regulation of vitellogenesis of the eggs. Altering homeostasis in this developmental stage could cause infertile eggs. The complete cascade of effects remains to be established. Several candidates for the endogenous juvenile hormone receptor - in all probability a member of the ligand-activated nuclear transcription factor family - are currently under discussion in *Drosophila*, e.g., the gene products of *ultraspiracle* and *methoprene tolerant*. Juvenile hormones and juvenile hormone mimics act as suppressers and stimulators of gene expression depending on the developmental stage and type of regulated protein. Several genes under the control of juvenoids have been identified. This explains the variety of effects observed with juvenoid treated insects.

**Fenoxycarb** is an insect growth regulator with contact and stomach action. The compound exhibits a strong juvenile hormone activity, inhibiting metamorphosis to the adults stage and interfering with the moulting of early instar larvae. The acute oral LD<sub>50</sub> for rats is >10,000 mg/kg (acute percutaneous LD<sub>50</sub> > 2,000 mg/kg). The compound shows low toxicity for fish and is non-toxic to adult bees. In mammals, the major metabolic path for fenoxycarb is ring hydroxylation to form ethyl-[2-[p-(p-hydroxyphenoxy)phenoxy]ethyl]-carbamate. **Hydroprene** is an insect growth regulator closely related to methoprene, predominantly used against →hygiene pests. **Methoprene** is an insect growth regulator (juvenile hormone mimic) preventing metamorphosis to viable adults when applied to larval stages. The compound is also used for the control of public health pests as well as in combination products against fleas on pets (→Fipronil). The acute oral LD<sub>50</sub> for rats is > 34,600 mg/kg. The compound shows very low toxicity for fish and is non-toxic to adult bees. In mammals, methoprene is metabolised to simple acetates and also cholesterol has been identified as a secondary metabolite. The metabolites were present in milk and blood but have not been detected in tissues. Upon oral administration methoprene is not metabolised and excreted via the faeces and the urine. **Pyriproxyfen** is an insect growth regulator acting as a suppresser of →embryogenesis and adult formation (juvenile hormone mimic). The compound has been introduced in the pet market as a potent flea growth regulator and is used for the control of public health insect pests. The compound is also used for the control of flea development in combination with adulticides against fleas on pets (→Imidacloprid). The acute oral LD<sub>50</sub> for rats is >5,000 mg/kg (acute percutaneous LD<sub>50</sub> > 2,000 mg/kg).

### Resistance Against Juvenile Hormone Mimics

No resistance has occurred against juvenile-hormone-related ectoparasite treatments. In *Drosophila* the methoprene-tolerant (Met) mutation results in a high

(100-fold) level of resistance to the synthetic juvenile hormone analogue methoprene. The expressed Met-gene product has a high binding affinity to juvenile hormone in the nM range. Though JH regulation is disrupted and associated with fitness cost in Met-mutant flies, the Met-alleles have been shown to persist in wild type populations. Methoprene resistance that could not be reversed by different synergists has also been found in mosquito strains from different locations in the USA.

## Aminotriazines/Aminopyrimidines

### Important Compounds

Cyromazine, Dicyclanil.

### General Information

Currently, two structurally closely related drugs are marketed as insect growth regulators against larvae causing myiasis in animals and developing fly larvae in manure. The first of them, **cyromazine**, entered the market in 1979. The biochemical →mode of action remains unclear. Cyromazine has been tested in dihydrofolate reductase and tyrosinase assays but showed no inhibition of these enzymes while another study demonstrated an inhibition of dihydrofolate reductase. The compound is definitely not involved in inhibition of chitin synthase. There are strong hints on involvement of cyromazine in **sclerotization** of the cuticle. Cyromazine has its highest efficacy against first instar larvae and leads to changes in the elasticity of the cuticle which might cause physical instability and lesions in the cuticle, finally preventing further development. Cyromazine treated *Lucilia cuprina* larvae do not show signs of cuticle →apolysis. There was evidence of an abnormal continuous deposition of cuticle material by the epidermal cells. This also holds true for cuticle deposition in the foregut. The sum of observations is indicative of a fundamental interference with insect moulting at the hormonal level. However, recent results from positional cloning of a cyromazine resistance gene (achieved by chemical mutagenesis) and RNAi gene product disruption in *Drosophila melanogaster* supports the hypothesis that cyromazine interfere with nucleic acid metabolism.

**Cyromazine** is an insect growth regulator with contact action interfering with moult and pupation. The topically applied compound has a pronounced residual effect and protects sheep against blowfly strike for 8 weeks. There is a withdrawal period of 7 days for meat. Acute oral LD<sub>50</sub> for rats is 3,387 mg/kg (acute percutaneous LD<sub>50</sub> > 3,100 mg/kg). Cyromazine is non-toxic to fish and adult honey bees. The compound is efficiently excreted in mammals, mainly as the parent compound. **Dicyclanil** is an insect growth regulator

recently introduced into the market. The compound prevents development of larvae into pupae or adults when incorporated into the insect-breeding substrate. Dicyclanil shows a high specificity against developing flies and fleas. Its biological efficacy is higher compared to that of cyromazine.

### Resistance against Cyromazine

Although 20 years of cyromazine treatment has passed, no proven resistance has been reported from the Australian blowfly. From all field strains assayed only three strains had a few survivors at the discriminating dose, but these flies were unable to reproduce successfully. Cyromazine was able to control even a high level multi-resistant housefly strain with a slightly higher  $LC_{50}$  (tolerance factor 1.7). There seems to be no cross-resistance to other insecticides. The cyromazine-resistant *Drosophila* obtained by chemical mutagenesis also is cross-resistant to Dicyclanil. While laboratory-selected *Musca domestica* strains showed cyromazine resistance levels of more than 100-fold, current field populations of the housefly found in Denmark, Brazil, and the USA show only low resistance levels and can be called less susceptible at best.

## Ectoparasiticides – Modulators/Agonists of Aminergic Transmission

### Structures

Amidines.

### Important Compounds

Amitraz, Cymiazole.

### General Information

Formamidines are agonists of the octopamine receptors in the arthropod nervous system, causing an increase in nervous activity, reduction of feeding and disruption of reproductive behaviour. Octopamine can act as a

neurotransmitter, neuromodulator or even as a circulating neurohormone in insects. Octopamine is involved in energy mobilisation and stress responses. It has a function as a modulator of muscle contraction and controls the release of adipokinetic hormone. Formamidines have been shown to exert ovicidal effects in insects and acari. Additionally, formamidines of the chlordimeform type have been shown to efficiently inhibit monoamine oxidase from rat liver. Chlordimeform was withdrawn from the market in the late 1980s. General side effects of formamidines in mammals are possible alterations in the animals ability to maintain homeostasis for at least 24 hours after treatment. A symptom often observed with formamidine treated mammals is a reversible sedative effect.

**Amitraz** is a non-systemic acaricide and insecticide with contact and respiratory action. It has been shown that amitraz is rapidly metabolised in arthropods and that one metabolite (BTS-27271) shows a biological activity superior to that of amitraz itself. Therefore, it is thought that amitraz acts as a pro-insecticide and pro-acaricide. The tickicidal effect comes with an expelling action causing →ticks to withdraw mouthparts rapidly and fall off the host animal. The compound is used as an animal ectoparasiticide for the control of ticks, →mites and →lice on cattle, dogs, goats, pigs and sheep. Recently, the compound has also been developed for use in dogs against fleas and ticks in combination with a sodium channel modulator (→Metaflumizone). The acute oral  $LD_{50}$  for rats is 650 mg/kg (acute percutaneous  $LD_{50} > 1,600$  mg/kg). The compound is toxic to fish and other aquatic organisms but rapid hydrolysis makes it unlikely that toxicity will be observed in natural aquatic systems. Amitraz shows low toxicity to bees and predatory insects. Withdrawal period for the compound in meat is 24 hours (7 days for sheep). In mammals rapid breakdown occurs and 4-amino-3-methylbenzoic acid and to a lesser extent N-(2,4-dimethylphenyl)-N'-methylformamidine are excreted as conjugates. **Cymiazole** (CGA 50439) is a non-systemic ectoparasiticide with contact and respiratory action. It shows a good killing-effect as well as inhibition of viable egg production and has a pronounced detaching effect on ticks. Cymiazole is also used as a

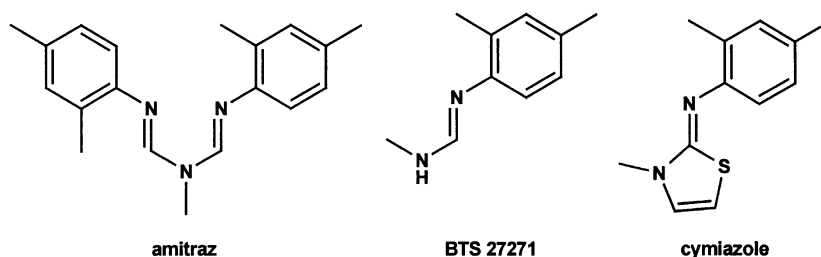

Ectoparasiticides – Modulators/Agonists of Aminergic Transmission. Figure 1 Structures of amidines.

systemic compound against varroa mites feeding on bees carrying the compound in their body fluid. The compound has a three-day withdrawal period for meat and can be used in milk producing cattle without restrictions. Cymiazole has an acute oral LD<sub>50</sub> for rats of 725 mg/kg (acute percutaneous LD<sub>50</sub> > 3,100 mg/kg). The compound shows only weak toxicity to fish and shows no significant toxicity to bees.

### Resistance

Resistance against amitraz has been observed in several strains of the southern cattle tick in Australia. No resistance against amidine acaricides was found in multi-host ticks so far with the exception of one case of moderate resistance against amitraz in a multi-resistant *Rhipicephalus sanguineus* strain recently isolated from a large quarantine kennel.

## Ectoparasitocidal Drugs

→ [Arthropodicidal Drugs](#), → [Ectoparasiticides](#).

## Ectopic Infections

Infections of other than the usual organs, e.g., → [Paragonimus](#) may occur not only in the lung but also in the brain, omentum, skin, and liver of their hosts.

## Ectoplasm

The peripheral, electron-lucent part of the → [cytoplasm](#) of many protozoans (→ [Entamoeba histolytica](#)).

## Ectospermatophore

→ [Ticks/Spermatogenesis and Fertilization](#).

## Edema

Symptom of parasitized tissues, the accumulation of watery substances leads to swellings, e.g., → [chagom](#), → [trypanosomiasis](#).

## Edhazardia Species

Microsporidian species of insects proceeding meiosis and change of ploidy.

## Eflornithine

Difluormethylornithine (DFMO), agent against → [trypanosomiasis](#). → [Trypanocidal Drugs](#).

## EGF

Epidermal growth factor.

## Egg-Reappearance Period (ERP)

Time from oral infection with helminthic eggs until excretion of new ones by fertilised females. → [Prepatency](#).

## Eggshell

→ [Acanthor](#), → [Cestodes](#), → [Nematodes](#).

## Egg-Sorting Apparatus

→ [Acanthocephala](#).

## Ehrlich, Paul (1854–1915)

German physician, creator of chemotherapy, inventor of the first drug against syphilis (Salvarsan) and developer (together with Behring) of the vaccine against diphtheria. Winner of the Nobel prize in 1908.

## Ehrlichia

### Name

Honoring Paul Ehrlich (→[Ehrlich, Paul](#)), a German Nobel Prize winner and co-worker of Robert Koch (→[Koch, Robert](#)).

### General Information

*Ehrlichia* is a genus of bacteria being transmitted by ticks. *E. phagocytophila* (transmitted by *Ixodes* ticks) introduces the granulomatous Ehrlichiosis in humans, horses, mice, and ruminants (Fig. 1); *E. canis* is the agent of the monocytic Ehrlichiosis in dogs (transmitted by *Rhipicephalus sanguineus*), while *E. chaffeensis* introduces this disease in humans being transmitted by *Amblyomma*-ticks in USA. *E. phagocytophilus* is synonym to *Anaplasma phagocytophilum*.

## Ehrlichiosis

Anaemian disease in sheep, cattle, cats, and dogs due to the rickettsian agents (e.g., *Ehrlichia canis*, *Haemobartonella felis*, and *Anaplasma* spp.) transmitted by →ticks (→[Tick Bites: Effects in Animals](#)). These rickettsial stages are spherical (genera *Anaplasma*, *Haemobartonella*) and are found on the surface of erythrocytes (*Haemobartonella*) or appear ovoid (genus *Ehrlichia*) and are situated inside monocytes. In particular the intraerythrocytic stages of *Anaplasma marginale* of cattle may become misdiagnosed as →[piroplasms](#).

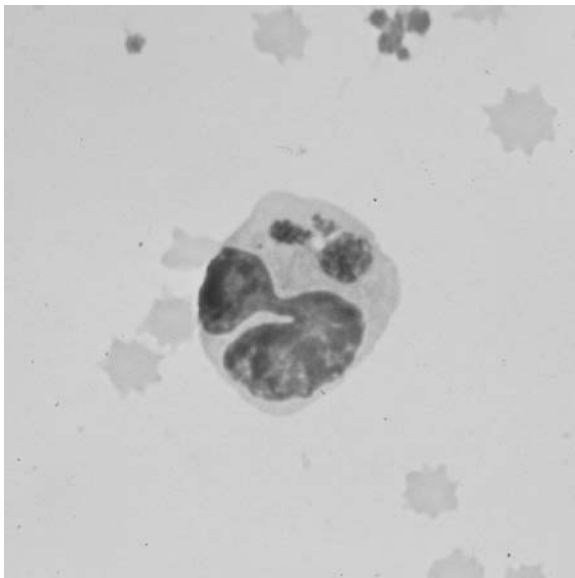

**Ehrlichia.** Figure 1 Giemsa-stained blood smear showing the morula-like stage of *E. phagocytophila* besides the curved nucleus of a white blood cell.

### Therapy

*Haemobartonella*: Tetracyclines; *Anaplasma*, *Ehrlichia*: Imidocarb (Imizol\*). In humans *Ehrlichia sennetsu* (Japan, South-East Africa) and *E. chaffeensis* (USA) may occur and are apparently also tick transmitted. They cause fever, →[vomiting](#), nausea, which may, however, be self-limiting.

## EIA

Enzyme immunoassay.

## Eichler's Hypothesis

Hosts belonging to a large taxonomic group will harbour a greater diversity of parasites than hosts belonging to a smaller systematic group.

## Eimer, Theodor G. H. (1843–1897)

Swiss zoologist and physician, professor at Tübingen, discoverer of many protists, honored by →[Eimeria](#).

## Eimeria

### Classification

Genus of →[Coccidia](#).

### Important Species

Table 1, Figs. 2–4.

### Life Cycle

Fig. 1.

### Diseases

→[Eimeriosis](#), →[Coccidiosis, Animals](#).

## Eimeriosis

Intestinal infection of many plant eaters due to oocysts of the genus →[Eimeria](#) (Fig. 1); the disease is also named coccidiosis (→[Coccidiosis, Animals](#)).

**Eimeria.** Table 1 Most important species of the genus *Eimeria*

Species	Host/Habitat	Oocyst size ( $\mu\text{m}$ )	Prepatent period (days)	Pathogenicity
	<b>Cattle</b>			
<i>E. bovis</i>	Posterior small intestine	23–34 $\times$ 17–23	15–21	+
<i>E. auburnensis</i>	Small intestine	36–42 $\times$ 19–26	17–20	+
<i>E. zuernii</i>	Small intestine	16–20 $\times$ 15–18	15–19	+
<i>E. ellipsoidalis</i>	Small intestine	18–26 $\times$ 13–18	8–13	+
	<b>Sheep</b>			
<i>E. faurei</i>	Small intestine	22–33 $\times$ 19–24	12–15	+
<i>E. intricata</i>	Small intestine, cecum	40–56 $\times$ 30–41	20–27	+
<i>E. ovina</i>	Small intestine	23–36 $\times$ 16–24	19	+
<i>E. ovinoidalis</i>	Colon	17–25 $\times$ 13–20	10–15	+
	<b>Goats</b>			
<i>E. arloingi</i>	Intestinal crypts	25–33 $\times$ 16–21	14–20	+
<i>E. ninakohlyakimovae</i>	Intestinal crypts	16–28 $\times$ 14–23	11–17	+
<i>E. christensei</i>	Small intestine	34–41 $\times$ 23–38	14–23	+
	<b>Pigs</b>			
<i>E. scabra</i>	Small intestine	25–45 $\times$ 17–28	7–10	+
<i>E. suis</i>	Small intestine	13–20 $\times$ 11–15	10	+
	<b>Horses</b>			
<i>E. leuckarti</i>	Small intestine	70–90 $\times$ 50–69	31–37	–
	<b>Rabbits</b>			
<i>E. intestinalis</i>	Cecum, colon	23–32 $\times$ 15–20	10	+
<i>E. perforans</i>	Small intestine	16–28 $\times$ 12–16	4–6	+
<i>E. magna</i>	Small intestine	28–40 $\times$ 18–30	7–9	+
<i>E. stiedai</i>	Bile ducts	26–40 $\times$ 16–25	12–16	+
	<b>Rats</b>			
<i>E. contorta</i>	Whole intestine	18–27 $\times$ 15–21	6	–
<i>E. nieschulzi</i>	Small intestine	16–26 $\times$ 13–21	7–8	+
	<b>Mice</b>			
<i>E. falciparum</i>	Cecum, colon	16–21 $\times$ 11–17	4–5	+
<i>E. ferrisi</i>	Cecum	17–20 $\times$ 14–16	4–5	–
	<b>Chickens</b>			
<i>E. tenella</i>	Cecum	23 $\times$ 19 (mean)	6	+
<i>E. maxima</i>	Small intestine	30 $\times$ 20 (mean)	5	+
<i>E. necatrix</i>	Small intestine	22 $\times$ 17 (mean)	6	+
<i>E. praecox</i>	Small intestine	21 $\times$ 17 (mean)	4	–
	<b>Geese</b>			
<i>E. truncata</i>	Kidneys	15–22 $\times$ 11–16	5	+
<i>E. anseris</i>	Small intestine	16–23 $\times$ 13–18	7	+
<i>E. nocens</i>	Colon	25–33 $\times$ 17–24	9	+
	<b>Ducks</b>			
<i>E. danailovi</i>	Small intestine	19–22 $\times$ 11–14	7	+
	<b>Turkeys</b>			
<i>E. adenoides</i>	Colon, Cecum	25 $\times$ 17 (mean)	5	+
<i>E. meleagridis</i>	Small intestine	20 $\times$ 17 (mean)	5	+
	<b>Pigeons</b>			
<i>E. labbeana</i>	Small intestine	15–18 $\times$ 14–16	6	+
<i>E. columbarum</i>	Small intestine	19–21 $\times$ 17–20	6	–/+



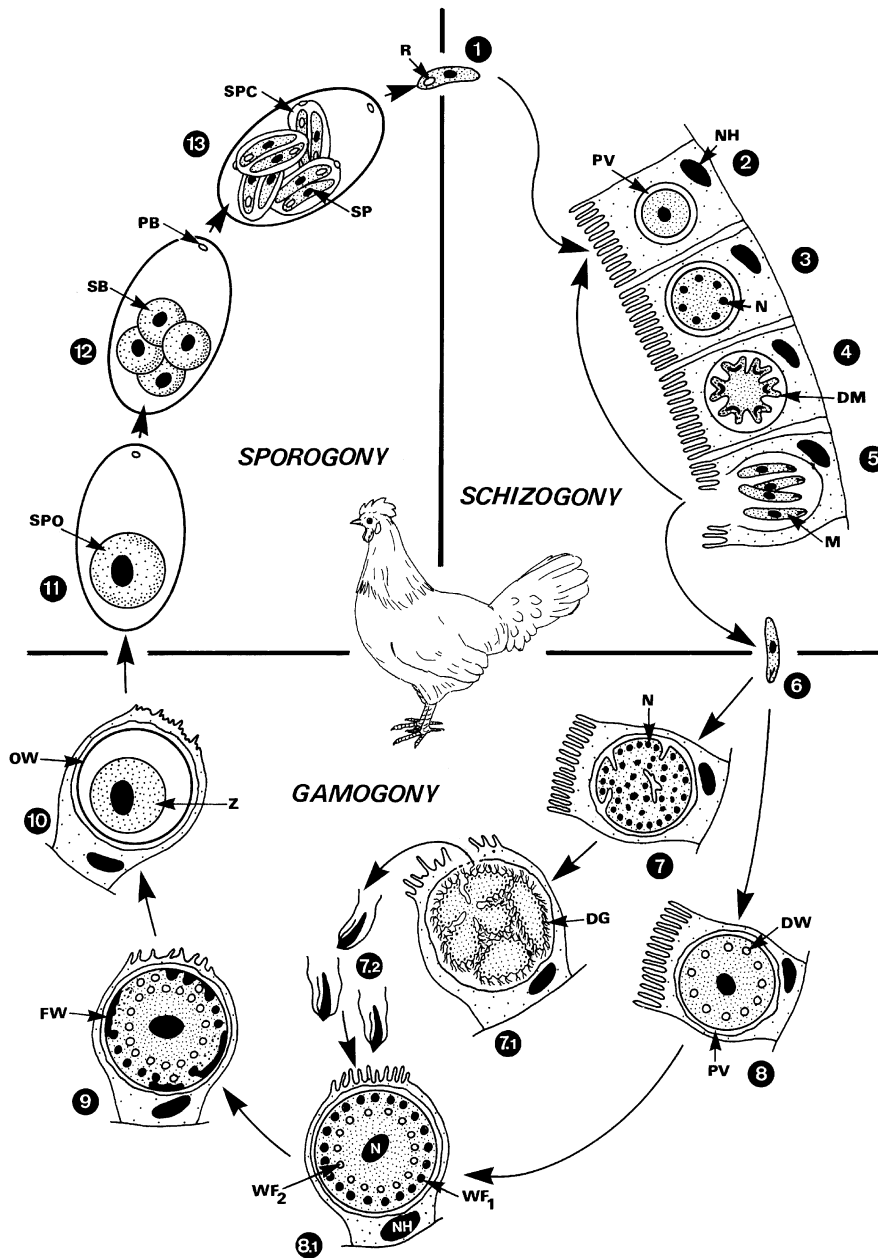

**Eimeria.** Figure 1 Life cycle of *Eimeria* spp. in chicken. For species and other hosts see Table 1. 1 After oral uptake of sporulated oocysts the sporozoites hatch in the small intestine from the sporocysts. 2–6 After penetration, multinucleate →schizonts are formed (3) inside a →parasitophorous vacuole (PV). The schizonts produce motile →merozoites (DM, M), which may initiate another generation of schizonts in other intestinal cells (2–5) or become gamonts of different sex (7, 8). 7 Formation of multinucleate →microgamonts, which develop many flagellated →microgametes (7.1–7.2). 8 Formation of uninucleate macrogamonts, which grow to be macrogametes (8.1) that are characterized by the occurrence of 2 types of →wall-forming bodies ( $WF_1$ ,  $WF_2$ ). 9 After fertilization the young →zygote forms the →oocyst wall by consecutive fusion of both types of wall-forming bodies (FW). 10 Unsporulated oocysts are set free via feces (exceptions are reptile- and fish-parasitizing *Eimeria* spp.). 11–13 →Sporulation (outside the host) is temperature-dependent and leads to formation of 4 sporocysts, each containing 2 sporozoites (SP), which are released when the →oocyst is ingested by the next host. DG, developing →microgametes; DM, developing →merozoite; DW, developing wall-forming bodies; FW, fusion of  $WF_1$  to form the outer layer of OW; M, merozoite; N, nucleus; NH, nucleus of host cell; OW, oocyst wall; PB, polar body (granule); PV, →parasitophorous vacuole; R, refractile (= reserve) body; SB, →sporoblast; SP, →sporozoite; SPC, →sporocyst; SPO, sporont;  $WF_1$ , wall-forming bodies I;  $WF_2$ , wall-forming bodies II; Z, →cytoplasm of zygote (= young oocyst).

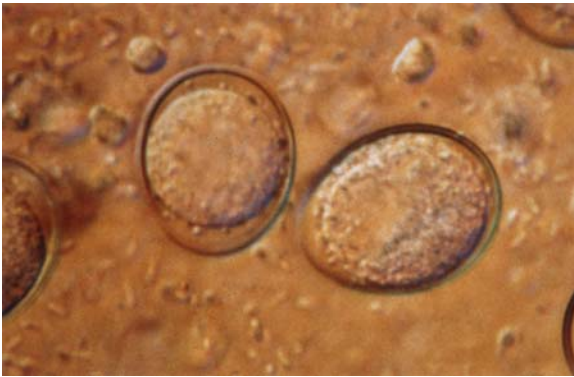

**Eimeria.** Figure 2 LM of unsporulated (= freshly excreted) *Eimeria* oocysts.

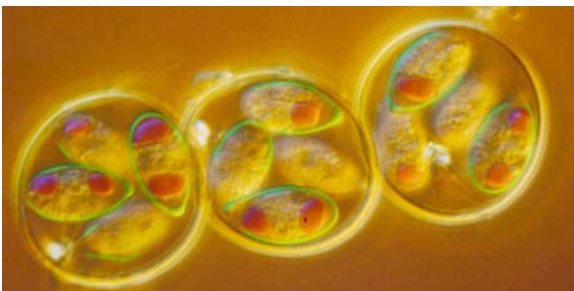

**Eimeria.** Figure 3 LM of 3 sporulated *Eimeria tenella* oocysts.

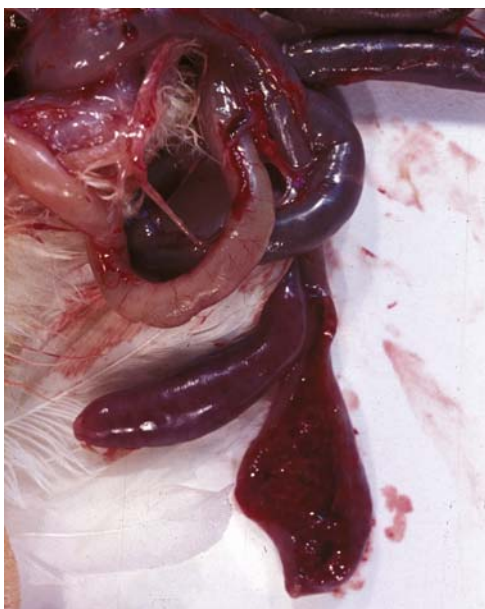

**Eimeria.** Figure 4 Bloody caeca of chicken infected with *Eimeria tenella*.

## EIP

→Extrinsic Incubation Period.

## Elaeophorosis, Elaeophorosis

*Elaeophora* (→*Filariidae*) infects deer, elk, and sheep. The adult parasites live in the common carotid and internal maxillary arteries and produce microfilariae which are found in the capillaries of the face and the head. In sheep the →microfilariae induce a granulomatous reaction in the capillaries of the skin, and a dermatitis. The lesions on the head, feet, and abdomen are characterized by intense →pruritus resulting in erythema, →alopecia, excoriations, ulcerations, crusts, and haemorrhage. Stomatitis, rhinitis, and keratitis also occur.

### Therapy

→Nematocidal Drugs, Animals.

## Elaphostrongylosis

### Name

Greek: *elaphos* = red deer; *strongylos* = cylindrical, and Latin: *cervus* = red deer.

Disease of deer or other ruminants due to infections with the 5–6 cm long (females) or the 3–4 cm long (males) of *E. cervi*. →Lungworms.

## Electron Transport Chain

→Energy Metabolism.

## Elephantiasis tropica

→*Filariidae*, →*Filariasis*, Lymphatic, Tropical; →Lymphatic Filariasis, →*Wuchereria*, →*Brugia*.

**Main clinical symptoms:** Lymphangitis, unfeelingness of skin portions; later: chylurie, elephantiasis, i.e., giant swelling of organs.

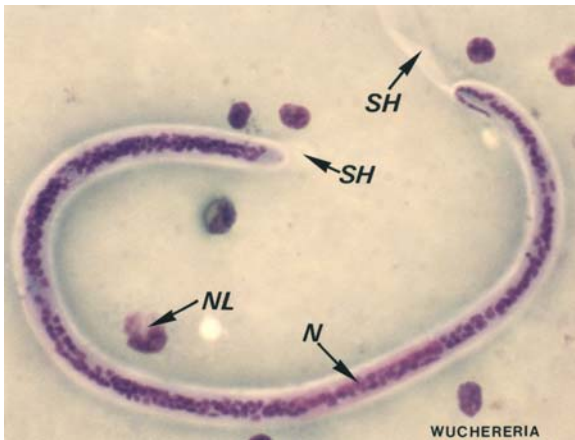

**Elephantiasis, tropica.** Figure 1 LM of the microfilaria of *Wuchereria bancrofti* (Giemsa stained).

**Incubation period:** 3–16 months.

**Prepatent period:** 7–24 months.

**Patent period:** 8–10 years (adults live for 18–20 years).

**Diagnosis:** Microscopic analysis of smear preparations or of membrane filtered material; microfilariae are found mainly at 10 p.m. in the peripheral blood (Fig. 1).

**Prophylaxis:** Avoid bites of vector → [mosquitoes](#) in endemic regions.

**Therapy:** Treatment see → [Nematocidal Drugs, Man](#).

## ELISA

### Synonym

Enzyme-linked Immunosorbent Assay.

Kind of indirect → [immunoassay](#) frequently used, e.g., in → [Serology](#). It needs only minor quantities of reagents and can equally be used for → [antigen](#) and → [antibody](#) detection.

## Elokomin

Agent of disease, → [Nanophyetus](#).

## Embden, Gustav Georg (1874–1933)

German physiologist, discoverer of the pathway of degradation of polysaccharids (together with Otto Fritz Meyerhof, 1884–1951).

## Embryogenesis

→ [Cestodes](#), → [Nematodes](#).

## Embryophore

Thick wall surrounding the larva (→ [Oncosphaera](#)) of → [cestodes](#) inside eggs. Since in several tapeworm eggs the outer eggshell is smooth and becomes ruptured, the embryophore is the only cover to protect the larva (e.g., → [Taenia](#), → [Echinococcus](#)).

## Emetine

Alkaloid out of *Cephalis ipecacuana* being used against amoebiasis or as vomitory means.

## Encephalitis

Inflammation of the brain. Often caused by the viral genus → [Flavivirus](#) (→ [Tick-Borne Encephalitis](#), → [Russian Spring-Summer Encephalitis](#), → [Powassan Encephalitis](#), → [Colorado Tick Fever](#)).

## Encephalitozoon

### Name

Greek: *en* = into, *kephale* = head, *zoon* = animal.

### Classification

Genus of → [Microspora](#).

### Important Species

Table 1.

### Life Cycle

Figs. 1, 2 (pages 450, 451).

### Disease

→ [Encephalitozoonosis](#).

**Encephalitozoon.** Table 1 Important species of the genus *Encephalitozoon*

Species	Host	Habitat	Size of spore (μm)	Geographic distribution
<i>Encephalitozoon lacertae</i>	Lizards ( <i>Podarcis</i> sp.)	Epithelium of intestine	3.5 × 1.5	France
<i>E. cuniculi</i>	Rabbits, rats, mice <i>Mastomys</i> spp., guinea pigs, hamsters, goats, sheep, dogs, foxes, felids, mustelidae, monkeys, <b>humans</b>	Intestine + many organs; tissue cultures	2.5 × 1.5	Worldwide
<i>E. helleri</i>	<b>Humans</b> (AIDS)	Many organs	2.4 × 1.5	Worldwide
<i>E. intestinalis</i>	<b>Humans</b> (AIDS)	Many organs	2.0 × 1.5	Worldwide

## Encephalitozoon cuniculi

→[Encephalitozoonosis](#), →[Nervous System Diseases, Carnivores](#), →[Opportunistic Agents](#).

## Encephalitozoonosis

### Synonym

→[Microsporidiosis](#), Encephalitozooniasis.

### General Information

Encephalitozoonosis is a nervous system disease caused by the obligate intracellular microsporidian →[Encephalitozoon cuniculi](#). The disease has been described in rodents, lagomorphs, primates, and several species of carnivores. Asymptomatic infection usually occurs in rodents and lagomorphs. In carnivores the neurological signs include repeated turning and circling movements, especially after disturbance, dysmetria, dysergia, →[blindness](#), and a terminal semi-comatose state. Lesions described are →[encephalitis](#) and segmental →[vasculitis](#). The course of the illness is usually 5–12 days. This parasite is also found in immunodeficient people as pathogen with a generalized spreading over many organs (→[Opportunistic Agents](#)).

### Therapy

→[Treatment of Opportunistic Agents](#), see also →[Drugs Against Microsporidiosis](#).

## Enchelys parasitica

→[Ciliophora](#).

## Encystation

Process found in many parasitic protozoans which involves formation of a →[cyst wall](#) either outside or inside the →[cell membrane](#). Worm stages may also become encysted to survive inside or outside hosts.

## Endectocides

→[Arthropodicidal Drugs](#); →[Ectoparasiticides](#).

## Endemic Zone

→[Geographic Zones of Occurrence of Diseases](#): infections are always present.

## Endemy

From *Greek*: endon = inside, demos = people. Persistent occurrence of parasites/agents of disease in a defined region.

## Endocytosis

In addition to the direct transport of molecules through the →[cell membrane](#) (→[Membrane Transport](#)), other mechanisms exist for internalization of materials by cells. For example, relatively large organic materials may be internalized by endocytosis, i.e., by the formation of endocytotic vesicles. This process is termed →[pinocytosis](#) for the uptake of liquids and

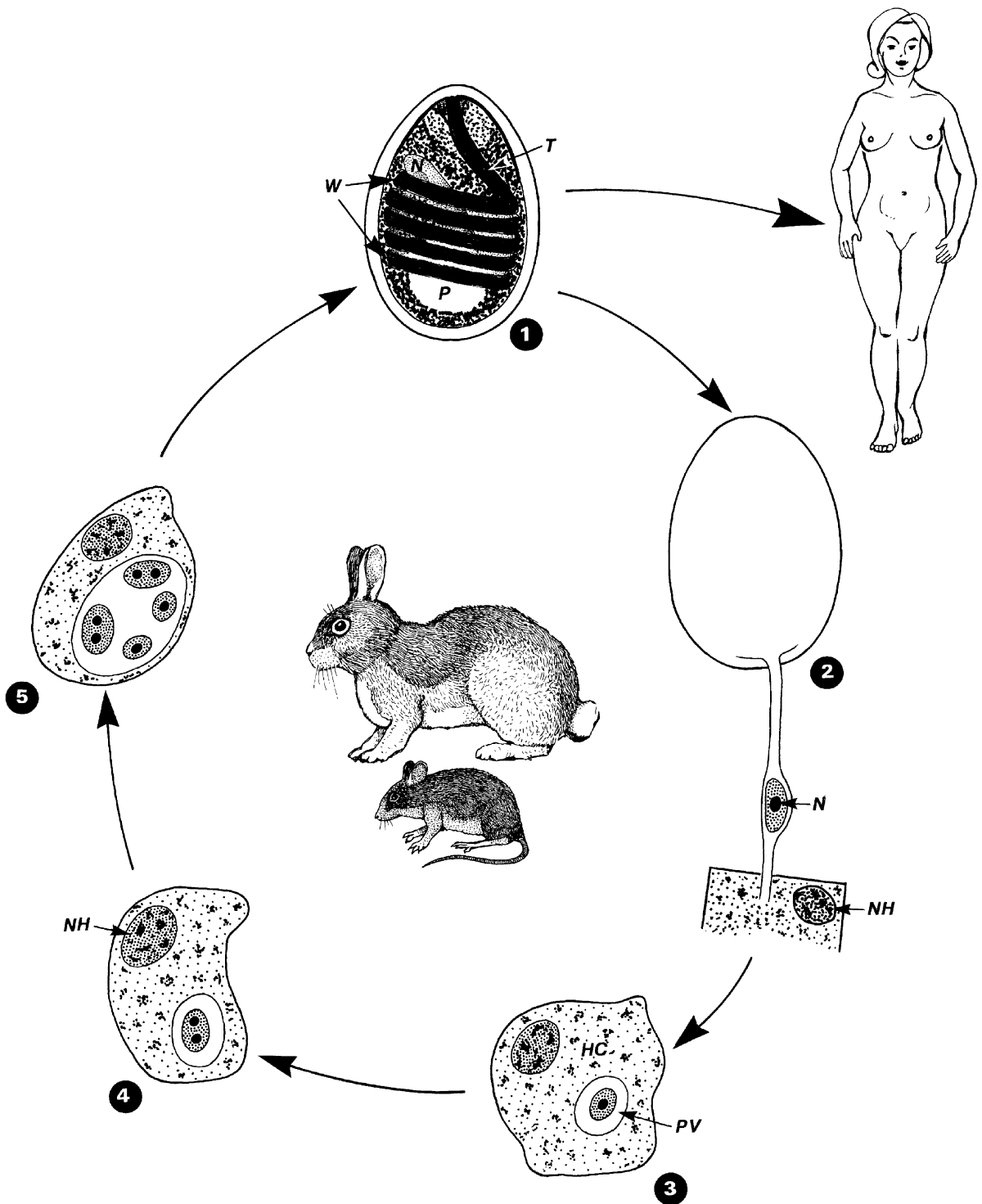

**Encephalitozoon. Figure 1** Life cycle of *Encephalitozoon cuniculi*, which may parasitize within a variety of hosts including immune depressive humans. 1 The infection of AIDS patients occurs via oral uptake of spores that derive from urine of animals (via contaminated food or via touching of furs). The mature uninuclear spore is characterized by 5 windings of the polar tube (1) and the occurrence of a posterior vacuole (P). 2, 3 In human intestine the spore extrudes the polar tube being injected into a host cell. The uninuclear sporoplasm creeps through the tube in the cytoplasm of the host cell, where it is included within a parasitophorous vacuole. 4, 5 Reproduction by repeated binary fissions. The last binary fission (5) leads to 2 uninuclear sporoblasts, which each grow up and differentiate into an infectious cyst. The latter are freed when the host cell is used up and bursts. Thus these spores may become distributed in the whole body or set free in human stool. HC, host cell; N, nucleus; NH, nucleus of host cell; P, posterior vacuole; W, windings of the polar tube; T, polar tube.

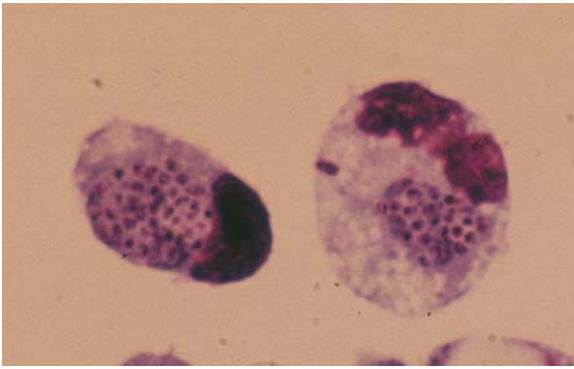

**Encephalitozoon.** Figure 2 Giemsa-stained blood smear showing enlarged human monocytes filled with large amounts of sporoblasts of *Encephalitozoon* sp. (courtesy Professor Dr. Heydorn, Berlin).

phagocytosis for the uptake of solid particles. Within the →vacuoles the material is degraded and then transported into the →cytoplasm by mechanisms similar to those used by the cell membrane. Alternatively, it may be released by dissolution of the membrane. Some →Protozoa have developed special places for the uptake of food, called cytostomes (Fig. 1). Endocytosis may occur at any point on the cell membrane (Fig. 1B) or is restricted to predisposed places. For example, in *Giardia* →trophozoites, endocytosis occurs only in the dorsal region, the region opposite the ventral sucker, which is the site of attachment (Fig. 1A); in trypanosomes, endocytosis occurs in the →flagellar pocket (→Pellicle/Fig. 2E); and in sporozoans it is found at small cytostomes called →micropores (Figs. 1C–F). While motile stages such

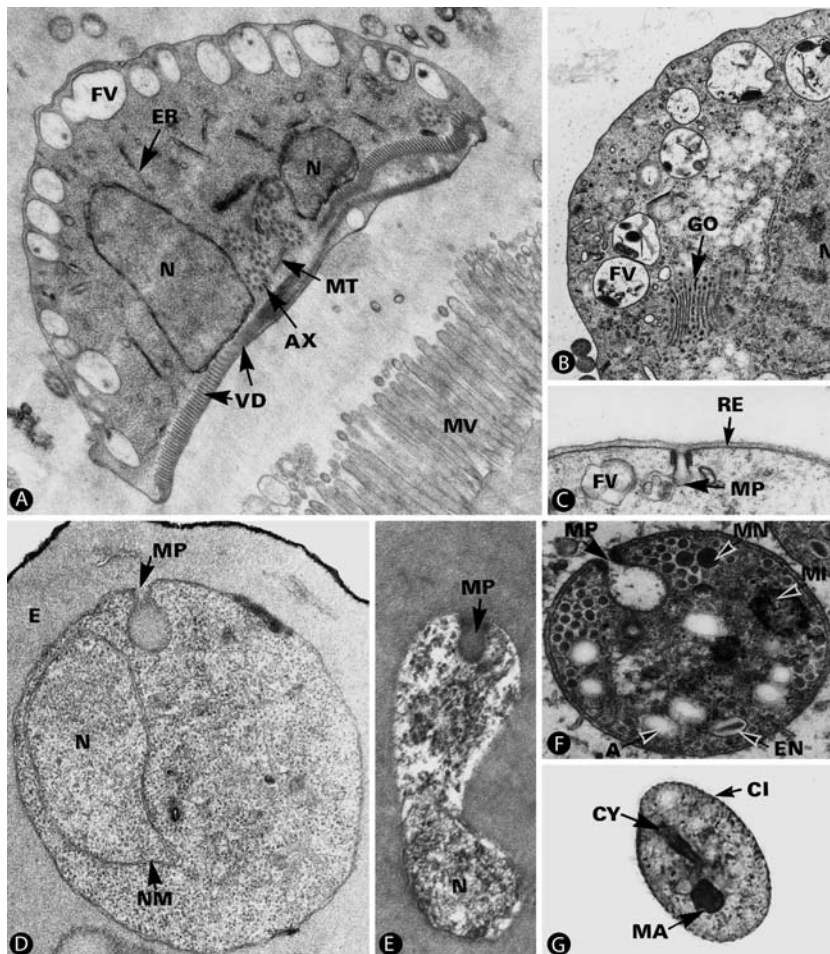

**Endocytosis.** Figure 1 A–G Transmission electron micrographs of feeding systems in protozoans. A Dorsal endocytosis in →*Giardia lamblia* ( $\times 10,000$ ). B General phagocytosis in →*Trichomonas vaginalis* ( $\times 8,000$ ). C–E Micropore in erythrocytic stages of →*Hepatozoon aegypti* (C  $\times 7,000$ ), →*Plasmodium falciparum* (D  $\times 22,000$ ), and →*Theileria annulata* (E  $\times 44,000$ ). F Micropore in a cross-sectioned cyst →merozoite of →*Besnoitia jellisoni* from mice. Acid phosphatase activity was shown in →mitochondria ( $\times 25,000$ ). G Cell mouth (→Cytostome) in a ciliate ( $\times 500$ ). A, →amylopectin; AX, →axoneme; CI, →cilia; CY, cytostome; EN, enigmatic body; ER, endoplasmic reticulum; FV, food vacuole; GO, →Golgi apparatus; MA, →macronucleus; MI, mitochondrion; MN, microneme; MP, micropore; MT, microtubule; MV, →microvilli of intestinal host cell; N, nucleus; NM, nuclear membrane; RE, remnants of erythrocyte; VD, →ventral disk.

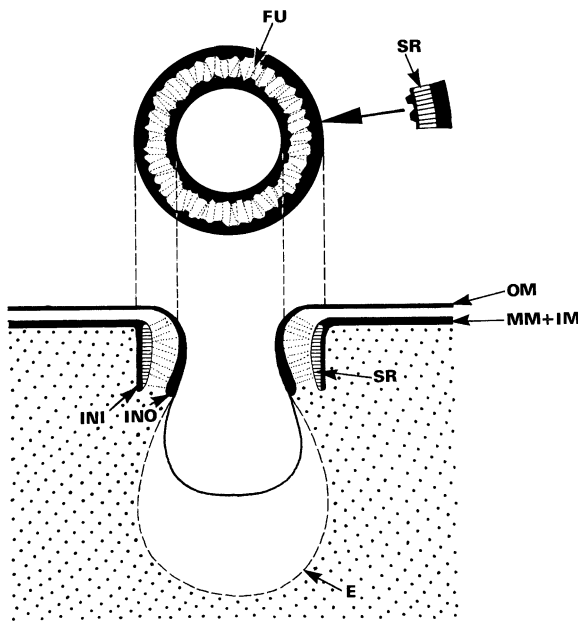

**Endocytosis.** **Figure 2** Diagrammatic representation of a sporozoan micropore in longitudinal and tangential sections. *E*, possible enlargement of the eystomal invagination; *FU*, filamentous elements; *IM*, inner membrane of the →pellicle; *INI*, interruption of *IM* (forms outer ring in tangential section); *INO*, densification along the inner ring (formed by the invaginated outer membrane); *MM*, middle membrane of the pellicle; *OM*, outer membrane of the pellicle; *SR*, solid densification between *IM* and *MM*.

as merozoites and sporozoites possess only one micropore, gamonts, schizonts, and/or growing stages develop several such →cytostomes due to their need of a quick uptake of nutrients. Large endocytotic elements (cytostomes or cell mouths) are characteristic of many ciliates, too (Fig. 1G). Cytostomes may be reinforced by various structures, for instance by bundles of →microtubules in trypanosomes and ciliates or by cylinder-like structures in coccidians (Figs. 1C, 2). After the →phagosomes have entered the cytoplasm, the contents are digested and resorption of the necessary molecules occurs. The residue may be voided to the outside (→Exocytosis) or stored as an inclusion.

Many cells contain clathrin-coated pits that are involved in the receptor-mediated endocytosis of macromolecules, but our knowledge of →coated pits in Protozoa remains limited.

## Endodyogeny

A peculiar longitudinal division of those →Coccidia (e.g., *Toxoplasma*, →*Sarcocystis*) that form →tissue-cysts (→Cell Multiplication).

## Endolimax nana

→Amoebae.

## Endoparasite

Organism living parasitically within another animal or man.

## Endoparasites of Humans

Some important human endoparasites are listed in Table 1 (pages 453–459).

## Endophagic

→Mosquitoes (e.g., *Anopheles gambiae*, the principal vector of →malaria in Africa) that bite predominantly indoors (rooms, buildings).

## Endoplasm

The dense central part of the →cytoplasm which contains the cell organelles and the nucleus.

## Endoplasmatic Reticulum

The endoplasmic reticulum (ER) is a large system of tubes and sacs that runs throughout the cell. It connects the perinuclear space with the cell interior and with the cell surface. There are 2 types of ER: rough ER (rER) and smooth ER (sER). The rER is characterized by the presence of →ribosomes (→Pellicle/Fig. 1B, →Trichomonadida/Fig. 1C) along its outer surface, whereas these are lacking in the sER. The rER and the sER may be interconnected.

Endoparasites of Humans. Table 1

Species	Human cases <sup>1</sup>	Stage used for diagnosis	Inter-human transmission <sup>2</sup>	Incubation period <sup>3</sup> (days)	Prepatency period <sup>4</sup> (weeks)	Patency (weeks) <sup>5</sup>	Prophylaxis <sup>6</sup>	Treatment <sup>7</sup>	Other/additional therapies <sup>8</sup>
<i>Acanthamoeba</i> spp.	Hundred thousands	Amoebae/liquor	+	2–14	<1	<3 or lethal	No bathing in contaminated rivers/lakes	Amphotericin B + Sulfadiazine (or Tetracycline)	Keratitits: Neomycine, Clotrimazole
<i>Acanthocheilonema</i> (= <i>Dipetalonema</i> ) <i>perstans</i>	50–60 million	Microfilariae	–	120	16–52	>52	Avoid bites of insects	Diethylcarbamazine	Antiallergical drugs
<i>Ancylostoma duodenale</i>	500 million	Eggs/feces	Free larvae +	14–28	5–7	~1000	Use of shoes	Albendazole, Mebendazole, Pyrantel pamoat	Antianaemic measurements
<i>A. braziliensis</i> , <i>A. caninum</i>	Many thousands	Migrating	Larvae	1–3	0	0	Use of shoes	Tiabendazole	?
<i>Angiostrongylus cantonensis</i>	Many thousands	Larvae/liquor	–	7–21	0 (no adults)	Larvae: months	No raw food	Tiabendazole	?
<i>Angiostrongylus costaricensis</i>	Many thousands	Eggs/biopsy of intestinal wall	–	1–4	3–4	>52	No raw snails	Tiabendazole, Ivermectin	?
<i>Anisakis</i> spp.	Thousands	Eggs/biopsy of intestinal wall	–	1 h - 7 d	0	Larvae: weeks	No raw fish	?	Surgical removal
<i>Armillifer armillatus</i>	Many thousands	Larvae/biopsy	–	?	0	0	Avoid feces of snakes	?	Surgical removal
<i>Ascaris</i> spp.	1.2 billions	Eggs/feces	+	4–7	6–11	>52	Avoid green salad, feces of pigs	Mebendazole, Abendazole	?
<i>Babesia</i> spp.	Some thousands	Merozoites/ blood smear	–	5–28	1	50	Avoid tick bites	Clindamycine, Chinine	Blood exchange
<i>Balantidium coli</i>	Many thousands	Veg. stages/ feces	+	4–14	<1	>20	Avoid pig feces	Metronidazole, Nitroimidazoles	Tetracyclines, Paronomycine
<i>Blastocystis hominis</i>	30–40 million	Cysts/veg. stages	+	1–3 ?	<1	2–3	Avoid feces	Metronidazole, Cotrimoxazole	Substitution of electrolytes
<i>Brugia malayi</i> , <i>B. timori</i>	100 million	Microfilariae/ blood	–	84–400	52	1000	Avoid bites of mosquitoes	Macro- + Microfilariae: Diethylcarbamazine	Antiallergical drugs
<i>Capillaria hepatica</i>	Few	Eggs/liver biopsy	–	?	?	Larvae: 50–100	Avoid green salad	Tiabendazole	?
<i>Capillaria philippinensis</i>	Thousands	Eggs/larvae/ feces	+	?	?	?	Avoid green salad	Mebendazole, Tiabendazole	?



Endoparasites of Humans. Table 1 (Continued)

Species	Human cases <sup>1</sup>	Stage used for diagnosis	Inter-human transmission <sup>2</sup>	Incubation period <sup>3</sup> (days)	Prepatency period <sup>4</sup> (weeks)	Patency (weeks) <sup>5</sup>	Prophylaxis <sup>6</sup>	Treatment <sup>7</sup>	Other/additional therapies <sup>8</sup>
<i>Cercarial dermatitis</i>	Hundred thousands	Cercariae/skin	-	Minutes	0	0	No bath in contaminated water	Antiallergical compounds	?
<i>Clonorchis sinensis</i>	30–30 million	Eggs/feces	-	14	2–3	~1000	Avoid raw fish	Praziquantel	?
<i>Creeping eruption</i>	Many thousands	Migrating larvae/biopsy	-	1–3	Larvae: weeks	Larvae: weeks	?	Tiabendazole	Icing, surgical removal
<i>Cryptosporidium</i> spp.	Hundred thousands	Oocysts/feces	+	1–12	2–4	1–2 up to 52	Avoid feces	?	Substitution of electrolytes
<i>Cyclospora</i> spp.	Thousands	Oocysts/feces	+	2–7	1	2–9	Avoid human feces	Cotrimoxazole	?
<i>Cysticercus cellulosae</i>	Hundred thousands	Cysticercus/serology/CT	Eggs of adult tapeworm	70–90	0	0	Avoid human feces	Praziquantel, Albendazole	Symptomatic; mechanical remove
<i>Demodex folliculorum</i>	Many millions	Skin probe	+	14	2	Years	Avoid contact to infected animals	Hexachlorocyclohexan; Crothamiton (10%), Neem	Symptomatic therapy
<i>Dicrocoelium dendriticum</i>	Thousands	Egg/feces	-	14–28	7–8	>250	Avoid unwashed green salad	Praziquantel	?
<i>Diocotophyme renale</i>	Few thousands	Egg/urine	-	30	12–24	150	Avoid raw fish	?	Mechanical removal
<i>Dipetalonema perstans</i>	50–60 million	Microfilariae/blood	-	120	>36	>52	Avoid bites of insects	Diethylcarbamazine	Antiallergical compounds
<i>Dipetalonema streptocerca</i>	4–10 million	Microfilariae/skin	-	120	>52	>52	Avoid bites of insects	Diethylcarbamazine	Antiallergical compounds
<i>Diphyllobothrium latum</i>	13–5 million	Proglottids/eggs/feces	-	>21	3	520	Avoid raw fish	Niclosamide, Praziquantel	Substitution of vitamins
<i>Dipylidium caninum</i>	Many thousands	Proglottids/feces	-	10–21	2–3	52	Avoid fleas	Niclosamide, Praziquantel	Protect pets against fleas
<i>Dirofilaria</i> spp.	Thousands	Larvae/biopsy	-	90–270	28	Larvae: years	Avoid bites of insects	Diethylcarbamazine	Surgical removal
<i>Dracunculus medinensis</i>	10 million	Adult worm/skin	-	90–200	40–56	♀ dies days after excretion of larvae	Avoid uncooked water	Mebendazole, Triabendazole	Remove worm from skin
<i>Echinococcus granulosus</i>	Hundred thousands	Cyst/CT/biopsy	-	>360	Years	Years	Avoid dog feces	Mebendazole, Albendazole	Surgical removal of cyst

<i>Echinococcus multilocularis</i>	Thousands	Cyst/CT	-	>360	Years	Years	Avoid fox, dog feces	Mebendazole, Albendazole	Do not touch the cyst
<i>Echinostoma ilocanum</i>	Thousands	Egg/feces	-	?	3	?	Avoid uncooked snails	Praziquantel	?
<i>Encephalitozoon cuniculi</i>	Hundred thousands	Spore/urine	+	7	?	?	Avoid human urine	Cloroquine, Oxytetracycline, Albendazole	?
<i>Entamoeba histolytica</i> (a) Intestinal stages	400–500 million	Cyst/feces	+	2–21	>1	Years	Avoid any uncooked food/human feces	Diloxanide furate, Nimorazol, Paromomycin, 8-Hydroxyquinoline	Antibiotica (Tetrazyklines, Erythromycine)
(b) Tissue stages		Amoebom/biopsy/CT/endoscopy/sonography	-	2–28, up to years	1–2	Years/recidives		Metronidazole, Tinidazole, Omidazole, Dehydroemetin	Remove fluid from the liver abscess
<i>Enterobius vermicularis</i>	1.2 billions	Eggs/anal grove	+	7–28	4–5	9–12	Clean anal region	Mebendazole, Albendazole, Pyrantelpamoat	Repeat treatment at least 2 times in 3 weeks intervals
<i>Enterocytozoon biteneusi</i>	Thousands	Spore/feces	+	7	1	20	Avoid human feces	Albendazole	?
<i>Enteromonas hominis</i>	200 million	Veg. stages/feces	+	?	?	?	Avoid feces	Not needed	?
<i>Fannia</i> -species (flies)	Thousands	Larvae/urine	-	-	0	0	Keep skin clean	Mechanical remove	Clean urine bladder
<i>Fasciola hepatica</i>	Thousands	Egg/feces	-	21–90	8–13	>250	Avoid eating plants from cow meadow	Dehydrometin, Praziquantel	?
<i>Fasciolopsis buski</i>	15–20 million	Egg/feces	-	21–90	9–14	>250	Avoid eating of chest nuts	Niclosamide, Praziquantel	?
Fly larvae	Hundred thousands	Larvae/biopsy	-	2–10	0	0	Keep skin clean	Mechanical removal	Use antibiotics
<i>Gastrodiscoides hominis</i>	Thousands	Egg/feces	-	21–90	9–14	>250	Avoid eating waterplants	Niclosamide, Praziquantel	?
<i>Giardia lamblia</i>	450 million	Cyst/feces	+	3–21	3–4	Years	Avoid human/dog feces	Tinidazole, Metronidazole, Omidazole, Nimorazole	Reduce uptake of carbohydrates
<i>Gnathostoma spinigerum</i>	Thousands	Larvae/biopsy	-	?	0	100	Avoid raw fish	Albendazole	Corticosteroids

Endoparasites of Humans. Table 1 (Continued)

Species	Human cases <sup>1</sup>	Stage used for diagnosis	Inter-human transmission <sup>2</sup>	Incubation period <sup>3</sup> (days)	Prepatency period <sup>4</sup> (weeks)	Patency (weeks) <sup>5</sup>	Prophylaxis <sup>6</sup>	Treatment <sup>7</sup>	Other/additional therapies <sup>8</sup>
<i>Haemonchus</i> spp.	Few	Egg/feces	+ via free larvae	28–35	12–24	>52	Avoid contaminated plants	Tiabendazole, Mebendazole, Albendazole	?
<i>Hartmannella</i> spp.	see <i>Acanthamoeba</i> (= synonym)								
<i>Heterophyes heterophyes</i>	10 million	Egg/feces	–	7–21	1–3	24–40	Avoid raw fish	Praziquantel	?
<i>Hymenolepis diminuta</i>	Thousands	Eggs/proglottids/feces	–	7–14	2	8–12	Avoid larvae in beetles	Niclosamide, Praziquantel	?
<i>Hymenolepis nana</i>	75 million	Eggs/proglottids/feces	+	7–28	4	2–50	Avoid self-infection	Niclosamide, Praziquantel	?
<i>Isospora belli</i>	Hundred thousands	Oocyst/feces	+	2–13	1	4–7	Avoid human feces	Sulfonamids	?
<i>Lambia</i> (= <i>Giardia</i> ) <i>intestinalis</i>	Old name for <i>Giardia lamblia</i>								
<i>Leishmania braziliensis</i>	10–15 million	Veg. stage/skin smear	–	14–21 up to 1 year	1	Years	Avoid bites of sand flies	Amphotericin B, Antimon-V-compounds, Metronidazole, Pentamidine	Antibiotics, Sulfonamids
<i>Leishmania donovani</i> , <i>L. chagasi</i> , <i>L. infantum</i>	20–40 million	Veg. stage/smile	–	10–120	1–3	>52	Avoid bites of sand flies	Pentamidine, Antimon-V-compounds, Diamidine	Support immune system
<i>Leishmania tropica</i> -group	60 million	Veg. stage/skin scrape	–	14–21	1–3	40	Avoid bites of sand flies	Natriumstibogluconate	Antibiotics, Sulfonamids
<i>Linguatula serrata</i>	Few	(a) Egg/saliva (b) Larvae/biopsy	+	a/b 5–10	(a) 3 at ♀ (b) 0 at larvae	(a) 50–100 at ♀ (b) 0 at larvae	Avoid raw meat	?	Mechanical removal
<i>Loa loa</i>	40 million	Microfilariae/blood	–	60–360	52–200	17 years	Avoid bites of tabanids	Diethylcarbamazine	Mechanical removal of adults.
<i>Macracanthorhynchus hirudinaceus</i>	Many hundred thousands	Larvae/intestinal biopsy	–	14–80	0	No adults	Do not eat raw insects	Loperamid	Surgical removal

<i>Malaria</i> -agents	see <i>Plasmodium</i> spp.									
<i>Mansonella</i> -species	see <i>Dipetalonema</i> spp.									
<i>Mansonella ozzardi</i>	12–15 million	Mikrofilariae/ blood	–	?	?	?	Avoid bites of insects	Diethylcarbamazine		
<i>Metagonimus yokogawai</i>	Hundred thousands	Egg/feces	–	?	?	?	Avoid raw fish	Praziquantel		
<i>Metorchis conjunctus</i>	Thousands	Egg/feces	–	?	4–5	250	Avoid raw fish	Praziquantel		
<i>Microsporidia</i>	see <i>Encephalitozoon</i> sp. and <i>Enterocytozoon bienersi</i>									
<i>Myiasis</i> -agents (fly larvae)	Hundred thousands	Larvae/biopsy	–	10–14	Larvae: 5–10	Larvae: 5–10	Use of repellents	Subcutaneously: symptomatic Eye: 1% Mintacol	Mechanical removal	
<i>Nanophyetus salmincola</i>	Few thousands	Egg/feces	–	6–10	1–2	>50	Avoid raw fish	Praziquantel	?	
<i>Naegleria</i> spp.	Thousands	Amoebae/ liquor	–	2–7	>1	>3, possibly lethal	Avoid bath in contaminated water	Amphotericin B + Sulfonamids + Tetracyclines	?	
<i>Necator americanus</i>	500 million	Egg/feces	– (free larvae)	14–28	4–17	~1000	Use shoes	Albendazole, Mebendazole, Parantelapamoat	Antianaemic treatment	
<i>Oesophago-stomum</i> spp.	Few	Egg/feces	+/- (free larvae)	5–7	5–8	>52	Avoid raw food	Tiabendazole	?	
<i>Oestrus ovis</i>	Thousands	Larvae/biopsy	–	–	0	0		Subcutaneously: symptomatic therapy Eye: Mintacol (1%)	Extraction	
<i>Onchocerca volvulus</i>	40–45 million	Microfilariae/ skin	–	90–120	36	~750	Avoid bites of simulids	Ivermectin, Diethylcarbamazine	Removal of nodules	
<i>Opisthorchis felineus</i>	1–2 million	Egg/feces	–	14	2–3	>250	Avoid raw fish	Praziquantel	?	
<i>Opisthorchis viverrini</i>	2–5 million	Egg/feces	–	14	2–3	>250	Avoid raw fish	Praziquantel	?	
<i>Paragonimus</i> spp.	30 million	Eggs/saliva	–	63–84	12	~1000	Avoid raw crabs	Praziquantel	?	
<i>Philophthalmus</i> spp.	Few thousands	Adult worms/ eye	–	?	?		?		Surgical removal	
<i>Plasmodium falciparum</i>	200–300 million	Gamonts/ rings/blood smear	– (blood transfer)	8–24	5 days	50	Chemoprophylaxis and use of repellents	Compounds according to countries	Symptomatic therapy	
<i>P. malariae</i>		Schizont/ blood smear	–	20–40	13–16 days	~1000				
<i>P. ovale</i>		Schizont/ blood smear	–	10–15	8 days	~200				
<i>P. vivax</i>		Schizont/ blood smear	–	9–16	8 days	250				

Endoparasites of Humans. Table 1 (Continued)

Species	Human cases <sup>1</sup>	Stage used for diagnosis	Inter-human transmission <sup>2</sup>	Incubation period <sup>3</sup> (days)	Prepatency period <sup>4</sup> (weeks)	Patency (weeks) <sup>5</sup>	Prophylaxis <sup>6</sup>	Treatment <sup>7</sup>	Other/additional therapies <sup>8</sup>
Plerocercoids (Spargana)	Thousands	Larvae/biopsy	-	?	0	0	Avoid raw fish and uncooked water	Praziquantel, Cotrimoxazole	Surgical removal
<i>Pneumocystis carinii</i>	Acute: hundred thousands latent: 400 million	Cysts/saliva	+	7	1	Years	Avoid feces	Pentamidin-Isothionate, Trimethonrim + Sulfonamids	Symptomatical therapy
<i>Sarcocystis</i> spp.	Hundred thousands	Sporocysts/feces	-	4-8 hours	5-10 days	6-18	Avoid raw meat	Sulfonamids	Substitution of electrolytes
● Intestine	Few	Tissue cysts	-	?	?	1 year	?	?	?
● Tissue	5-10 million	Mite in skin + scrape	+	7	2	>250	Avoid contact with hosts/unproper clothes/beds	Hexachlorocyclohexan, Crotramiton, Neem extracts	Symptomatical therapy
<i>Sarcoptes scabiei</i>									
<i>Schistosoma haematobium</i>	100 million	Egg/urine	-	28-600	10-12	>750	Do not bathe in contaminated rivers and lakes	Praziquantel	Use shoes in field work
<i>S. intercalatum</i>	Hundred thousands	Egg/feces	-	28-49	5-8	>250			
<i>S. japonicum</i>	30 million	Egg/feces		7-14	3-10	>250			
<i>S. mansoni</i>	100 million	Egg/feces	-	14-21	4-8	>750			
<i>Schistosoma granulomes</i>	200-300 million	Egg/biopsy	-	>42	7	Years	Do not bathe in contaminated rivers and lakes	Praziquantel	Use shoes in field work
Spargana (see Plerocercoid)	Thousands	Larvae/biopsy	-	?	0	0	Avoid raw fish and uncooked water	Praziquantel	Surgical removal
<i>Strongyloides stercoralis</i>	100 million	Larvae/feces	-/+ (free larvae)	1-17	3	>52	Use shoes, avoid human feces	Tiabendazole, Mebendazole, Albendazole	Therapy control
<i>Taenia saginata</i>	60-80 million	Progloftids/feces	-	56-70	10-12	>1000	Avoid raw beef	Niclosamide, Praziquantel	Check feces after treatment
<i>T. solium</i>	6-10 million	Progloftids/feces	+	56-70	8-12	>1000	Avoid raw porc	Niclosamide, Praziquantel	Antiemeticum, laxans
(a) Worm	Hundred thousands	Cysticercus	-	>20	0	Years	Avoid human feces	Praziquantel	Mechanical removal
(b) Cysticercus									
<i>Termitidens deminutus</i>	Thousands	Eggs/feces	-	?	?	?	Avoid feces	Tiabendazole	?
<i>Toxocara</i> spp.	Hundred thousands	Larvae/biopsy	-	14-21	0	Larvae: weeks	Avoid feces of carnivores	Tiabendazole, Diethylcarbamazine	?

<i>Toxoplasma gondii</i>	Acute: 40–50 million latent; 50% of world-population	Merozoite/smear	– (only man-eater)	1–21	1–2 days	Months →years	No raw meat; avoid cat feces	Pyrimethamin + Sulfonamids	Symptomatical treatment
<i>Trichinella spiralis</i>	40 million	Larvae/ biopsy	–	1–28	1	2; Larvae: years	Avoid raw meat	Tiabendazole, Mebendazole, Albendazole	Corticosteroids
<i>Trichomonas vaginalis</i>	60–80 million	Veg. stages/ smear	+	5–21	5–21	>52	Safer sex	Clotrimazole, Metronidazole	Symptomatical treatment
<i>Trichostrongylus</i> spp.	8–10 million	Egg/ feces	–	14–21	3–4	>52	Avoid animal feces	Tiabendazole, Pyrantelpamoat	?
<i>Trichuris trichiura</i>	550–600 million	Egg/feces	+	30–120	4–12	>52	Avoid human feces	Mebendazole, Albendazole	?
<i>Trypanosoma brucei gambiense</i>	Hundred thousands	Veg. stages/ blood smear	–	1–21	1	9 months (lethal)	Avoid bites of tsetse flies	1. blood: Suramine, Pentamidin	Nifurtimox kills <i>T. brucei</i>
<i>T. brucei rhodesiense</i>	Hundred thousands	Veg. stages/ blood smear	–	1–21	1	3–4 months (lethal)		2. liquor: Melaminyl-derivative, Melasoprol, Elflornithine	gambiense in liquor
<i>T. cruzi</i>	40 million	Veg. stages/ blood smear	–	5–20	1–8	Years	Avoid bites of reduviid bugs	Nifurtimox, Benznidazole	Symptomatical treatment
<i>Vampirolepis</i> spp.	see Hymenolepis = Rodentolepis								
<i>Watsonius watsoni</i>	Thousands	Egg/feces	–	?	?	?	Do not eat raw water plants	Praziquantel	
<i>Wohlfahrtia</i> larvae	Thousands	Larvae/biopsy	–	1–3	0	3	Keep skin clean	Antibiotics	Mechanical removal
<i>Wuchereria bancrofti</i>	300 million	Microfilariae/ blood	–	>90	36–100	>1000	Avoid bites of mosquitoes	Microfilariae + Macrofilariae, Diethylcarbamazine	Antiallergical compounds

1 Numbers according to estimations of WHO and other sources (clinical symptoms are not obligatory in all cases)

2 Possible = +

Not possible = –

3 Period until occurrence of clinical symptoms

4 Period until parasites reappear in humans or are excreted by humans after infections

5 Period within which parasites remain within humans after an initial infection

6 Raw includes undercooked in any way

7 WHO recommended drugs; details see in the keywords of the book dealing with drugs

8 In all cases improvement of the general fitness supports the action of any treatment

CT = Computer tomography

## Endopolygeny

→ [Cell Multiplication/Multiple Divisions](#).

## Endospermatophore

→ [Ticks/Spermatogenesis and Fertilization](#).

## Endospore

Inner layer of spore wall in microsporidians.

## Endosulfan

### Chemical Class

Organohalogenide (organochlorine compound, cyclo-diene).

### Mode of Action

GABA-gated chloride channel antagonist. → [Ecto-parasitocides – Antagonists and Modulators of Chloride Channels](#).

## Endotrypanum

*E. schaudinni* and *E. monterogei* are parasites of Neotropical tree sloths being transmitted by phlebotomids. These species are unique among → [Trypanosomatidae](#) in that they enter the erythrocytes of their vertebrate hosts.

## Endozoites

→ [Bradyzoites](#), → [Tachyzoites](#).

## Energetic Trade-Off

→ [Behavior](#).

## Energy Metabolism

### Synonym

Bioenergetics.

### General Information

The generation of chemical energy for the cell (usually in the form of ATP) can be accomplished by either aerobic or anaerobic strategies. Aerobic generation of energy is defined as the complete oxidation of substrates to carbon dioxide and water via the combined action of the tricarboxylic acid (TCA) cycle and a mitochondrial respiratory chain. In this pathway, in which oxygen acts as the final electron acceptor to reoxidize reduced coenzymes, the major portion of ATP is produced by a process known as oxidative phosphorylation. In parasitic protozoa and helminths, the occurrence of this conventional type of energy metabolism is rather limited. It is mainly the free-living and some larval stages of helminths that are supposed to possess a functional TCA cycle and an aerobic mitochondrial respiratory system. A special category of organisms are the trypanosomatids, such as the bloodstream form of *Trypanosoma brucei*, whose energy metabolism is dependent on a plantlike alternative terminal oxidase. These organisms use oxygen as terminal electron acceptor, but this oxidative process via the alternative oxidase is not coupled to phosphorylation. Most parasites use, in the stages inside their hosts some kind of fermentation process for the production of ATP. Fermentations are defined as energy generating processes that produce their own oxidants to balance the production and consumption of coenzymes (NADH) without the use of oxygen as final electron acceptor. In some cases, this strategy is linked to an electron transport chain and oxidative phosphorylation (anaerobic “respiration”). Suitable substrates for fermentations are carbohydrates, because both oxidation and reduction of these compounds can occur, which is not possible using fatty acids as substrate. During lactate or ethanol producing fermentations these redox reactions are accomplished in the linear process of glycolysis. An alternative strategy, which is widely found in helminths involves a branched pathway (malate dismutation), in which a portion of the substrate is oxidized while another portion is reduced. Fermentations are widespread in endoparasites and are the sole or major ATP-producing routes in many protozoan and adult helminth parasites.

In all living cells, nutrient molecules are broken down to provide the energy required for the generation of ATP. This ATP can be synthesized from ADP via 2 basically different processes: substrate-level phosphorylation and oxidative phosphorylation. Substrate-level phosphorylation is the formation of ATP by the

direct phosphorylation of ADP via the transfer of a phosphoryl group from a high-energy intermediate to ADP. Oxidative phosphorylation is the process in which ATP is formed when electrons are transferred from the reduced coenzymes NADH or FADH<sub>2</sub> to oxygen via a series of electron carriers that make up the mitochondrial electron transport chain (also called respiratory chain). NADH and FADH<sub>2</sub> (produced in glycolysis, fatty acid oxidation, and the TCA cycle, from NAD<sup>+</sup> and FAD, respectively) are energy-rich compounds. They contain high-energy electrons obtained from metabolic intermediates. Transfer of these electrons from the reduced coenzymes to oxygen releases a large amount of free-energy that can be used to produce ATP. The transport of electrons through the electron transport chain leads to the pumping of protons across the mitochondrial inner membrane by 3 electron-driven proton pumps: NADH-ubiquinone reductase (Complex I), cytochrome reductase (Complex III), and cytochrome oxidase (Complex IV). The resulting proton gradient across the inner mitochondrial membrane is then used for the generation of ATP when electrons flow back into the mitochondrial matrix via ATP synthase. Oxidative phosphorylation provides most of the energy in aerobically functioning parasites, but is also connected to malate dismutation, the anaerobic fermentation variant operative in most adult helminths, where instead of oxygen, fumarate acts as terminal electron acceptor of the electron transport chain.

Inhibitors of the electron transport chain are often used to study the energy metabolism of parasites. These compounds bind to a component of the chain and block the flow of electrons, which results in a decreased ATP production, as electron transport and energy production are tightly coupled. Examples of frequently used inhibitors are: rotenone and amytal (inhibitors of Complex I), antimycin A (an inhibitor of electron flow through Complex III), and cyanide, azide, or carbon monoxide (inhibitors of Complex IV). Oligomycin and other unrelated compounds block the proton channel of the ATP-synthase, thereby directly inhibiting ATP synthesis. As some components of the electron-transport chain in parasites are often structurally slightly different from those in their hosts, the electron transport chain is also a suitable target of antiparasitic drugs. The anti-malarial drug atovaquone, for instance, acts on complex III of the electron transport chain of *Plasmodium*; ascofuranone is a potent inhibitor of the alternative oxidase of trypanosomes, and nafuredin shows selective inhibition of complex I in helminth mitochondria.

In the energy metabolism of endoparasites, several biochemical reactions exist which have either no parallel in other eukaryotes or are a result of a modification of rather universal pathways. The energy metabolism of endoparasites is a fascinating and extensively studied

research area of parasite biochemistry. Its vital function and divergence from that of their hosts makes the energy metabolism of parasites an interesting target for anti-parasitic drug design.

Closely related to bioenergetics is the function of molecular oxygen in living organisms. Most of the oxygen consumed by animal cells is utilized by the cytochrome oxidase-linked mitochondrial respiration. In many parasitic protozoa and helminths this metabolic capability often does not exist or is considerably reduced. On the other hand, many endoparasites unequivocally have an aerobic requirement, if not for energy generation, then for specialized oxidative reactions such as eggshell tanning in helminths. These other functions of oxygen vary greatly between different species and their developmental stages, and have not yet been very well studied.

### Adaptations

The major functions of the metabolism of animals are (1) to catabolize organic substances and to couple these processes to the conservation of chemical energy; (2) to assemble distinct, low-molecular weight precursors that are derived either directly from external sources or via metabolic interconversion of absorbed nutrient molecules into species-specific polymeric components (nucleic acids, proteins, polysaccharides, and lipids); and (3) to form and degrade the biomolecules required in specialized functions. Endoparasites are no exception to this universal concept but obviously, as a consequence of their parasitic way of life, they have evolved a variety of specific modifications, extensions, or simplifications to the metabolic pattern observed in most other forms of life.

As in many habitats, the major nutritional requirements for parasites are supplied by the host. Many synthetic pathways in parasites were abandoned during their evolution. These reduced biosynthetic capabilities have resulted in the elaboration of efficient mechanisms for substrate absorption and in specific pathways for interconversion and modification of substrate molecules. Additional features relate to the sophisticated adaptive mechanisms which enable parasites to evade the host's immune response and other defense systems. In many cases, unique metabolic structures and processes are maintained by parasites to cope with the extreme physical and chemical conditions often prevailing within their host environments. Still other metabolic peculiarities may be related to the distinct morphological organization of parasites, such as the lack of a circulatory system in helminths or the absence of a digestive tract in cestodes. Next to the adaptations in metabolism related to their opportunistic way of living as a parasite, helminths show a second type of



adaptations, i.e., those connected to the environmental changes that occur in their life cycle. During their complex developmental cycles, these organisms live alternating periods as free-living and parasitic stages. Usually, the free-living stages cannot obtain substrates from the environment. They have to live on the endogenous reserves that they obtained in their previous host. In the environment of parasitic stages, on the other hand, substrates are plentiful, and their only concern is to produce offspring and avoid being destroyed by the host's immune system. These changes in the environmental conditions are accompanied by metabolic adaptations. Unusual adaptive processes are found particularly in the strategies of energy metabolism, in the various routes of purine and pyrimidine salvage, and in the synthesis of numerous other molecular structures serving specialized functions.

### Kinetoplastid Flagellates

The energy metabolism of kinetoplastid flagellates is better characterized than that of any other group of protozoan parasites. Most of the knowledge of the bioenergetics in these organisms has derived from studies on *Trypanosoma brucei*, *T. cruzi*, and a few *Leishmania* spp. This work has uncovered a variety of metabolic properties unique to the kinetoplastids, although large differences in metabolism also exist between the different species and stages of these organisms.

The long slender bloodstream trypomastigotes of *T. brucei* rely entirely on glycolysis for their energy production, with pyruvate being the sole end product (Fig. 1). In this pathway one molecule of glucose is converted to 2 molecules of pyruvate with a net synthesis of 2 molecules of ATP. Glucose is first degraded to 3-phosphoglycerate within membrane-bounded microbody-like organelles, called glycosomes, that are unique to the order Kinetoplastida. The 3-phosphoglycerate formed is then further degraded in the cytosol to pyruvate. Unlike in anaerobic lactate fermentation, in which the reducing equivalents generated by glyceraldehyde 3-phosphate oxidation are finally transferred to pyruvate (resulting in the formation of lactate), in *T. brucei* molecular oxygen serves as terminal electron acceptor, resulting in the formation of water as catalyzed by a plantlike alternative oxidase that is present in the inner membrane of the trypanosome's single mitochondrion (Fig. 1).

All of the glycolytic enzymes necessary to convert glucose into 3-phosphoglycerate are localized within the glycosomes (Fig. 1). These organelles, that are related to the peroxisomes in other eukaryotes, are unique to the trypanosomatid flagellates, such as *Trypanosoma*, *Leishmania*, *Phytomonas* and *Crithidia*. Glycosomes are bounded by a single membrane, extremely homogeneous in size, measure about 0.3  $\mu\text{m}$  in diameter and

represent more than 4% of the total cell volume. In *T. brucei*, more than 200 glycosomes are present per organism while in other genera these organelles are not as abundant.

The possible functional advantage of the extreme subcellular compartmentation and enzyme association within the trypanosome cell is still debated. About 90% of the glycosomal protein content consists of glycolytic enzymes which appear to be in close association. Originally it was suggested that compartmentalization of glycolysis in the glycosome enables the parasite to sustain its high rate of glycolysis because of the high concentration of substrates and enzymes which provided some kind of channeling in the pathway. There is, however, no experimental evidence for metabolite channeling in trypanosomes. Furthermore, calculations performed during modelling of glycolysis in bloodstream trypanosomes indicated that compartmentation of the enzymes in glycosomes is not necessary to obtain the observed glycolytic flux. Even if the glycolytic enzymes were not sequestered in a single compartment, diffusion should not be controlling the glycolytic flux in *T. brucei*. In addition, *T. brucei* indeed has a fairly high glycolytic flux when compared to mammalian tissues, but similar and even higher fluxes are also observed in other microorganisms, which do not possess glycosomes. Furthermore, all kinetoplastids possess glycosomes, including those that are not solely dependent on glycolysis for energy generation. Recent kinetic modelling suggested that concentrating the enzymes in glycosomes protects the trypanosome from phosphate depletion or osmotic shock caused by an unrestricted accumulation of sugar phosphates, and that it protects the cell from a failure to recover from glucose deprivation. Glycosomal metabolism is also involved in  $\text{CO}_2$  fixation and in the biosynthesis of purine and pyrimidine nucleotides and ether-lipids.

Under anaerobic conditions, bloodstream trypomastigotes convert glucose to equimolar amounts of pyruvate and glycerol (Fig. 1). Under these circumstances, high concentrations of glycerol 3-phosphate and ADP are expected to accumulate inside the glycosomes. This allows the glycerol kinase (which is present in extremely high specific activities in trypanosomes capable of producing glycerol under anaerobiosis) to proceed in the unusual direction of ATP formation. As shown in Fig. 1, anaerobic glycolysis yields 1 ATP per glucose, via pyruvate kinase, but this is apparently not sufficient for growth. Incubation of bloodstream form *T. brucei* under anaerobic conditions leads to cell death, while attempts to knock out the alternative oxidase were unsuccessful and a 95% depletion of the alternative oxidase by RNAi led to a serious growth defect.

Transformation of bloodstream form *T. brucei* into the procyclic insect stage is accompanied by striking

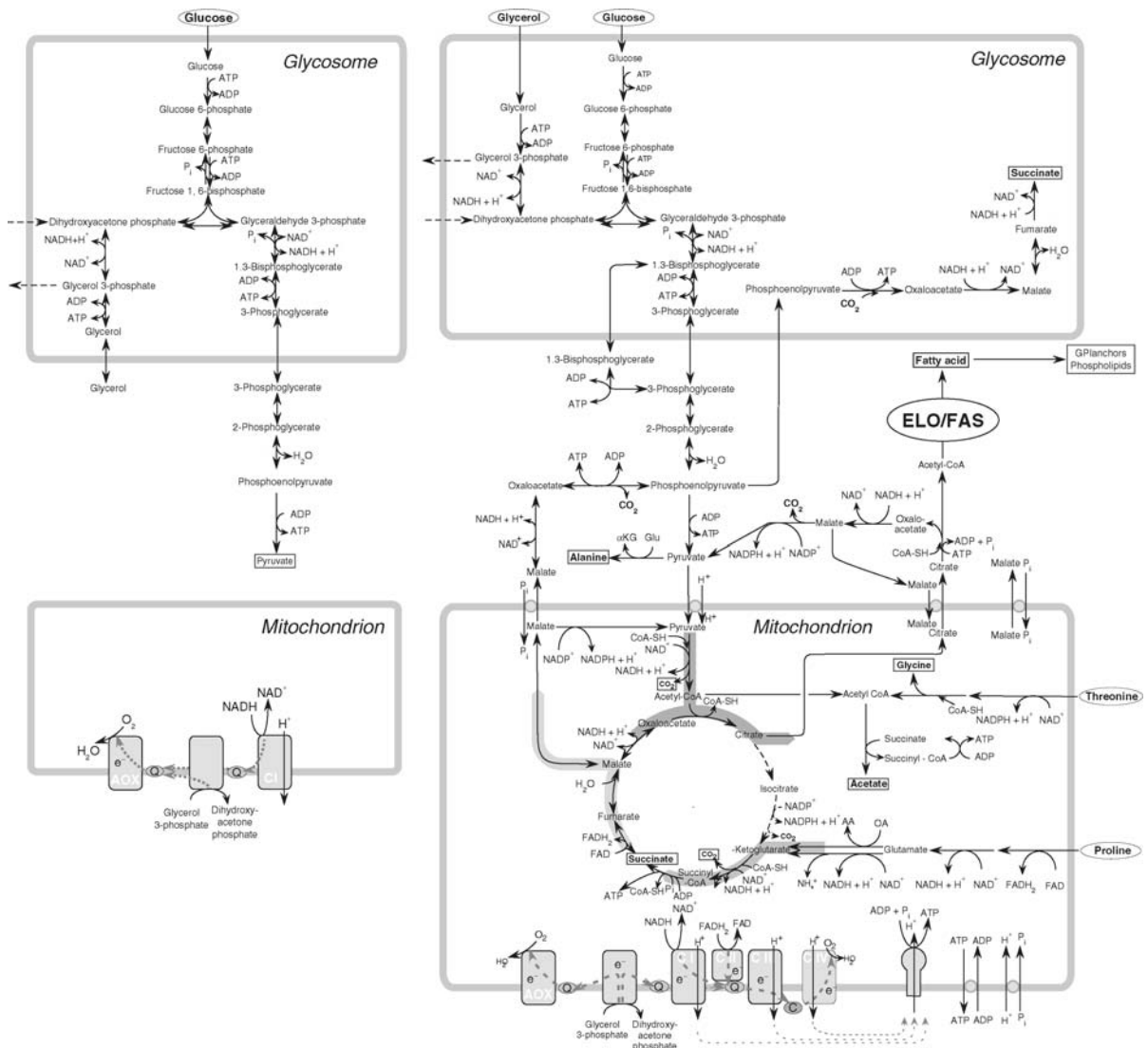

**Energy Metabolism. Figure 1** Schematic representation of pathways involved in carbohydrate and amino acid metabolism in bloodstream (left panel) and procyclic (right panel) form *Trypanosoma brucei*. Substrates are shown in ovals and end products in boxes. The shaded broad arrows in the background of the TCA-cycle represent functions of those parts of the cycle that are active in procyclic forms. The dark-shaded arrow indicates the flux from pyruvate and oxaloacetate to citrate in the transport of acetyl-CoA units from the mitochondrion to the cytosol, the intermediate shaded one represents that part of the cycle that is used for the degradation of proline and glutamate to succinate, whereas the lightly shaded one indicates the part of the cycle that is used during glyconeogenesis. Of the glycerol-3-phosphate shuttle only the components are shown and the travel of dihydroxyacetonephosphate and glycerol-3-phosphate between the glycosomes and the mitochondrion is not shown. AA, amino acid; AOX, plantlike alternative oxidase; CI, II, III, and IV, complex I, II, III, and IV of the respiratory chain; c, cytochrome c; FAS, fatty-acyl synthesis; Glu, glutamate;  $\alpha$ -KG,  $\alpha$ -ketoglutarate; OA, oxoacid; PPP, pentose phosphate pathway; Q, ubiquinone.

changes in energy metabolism (Fig. 1). Upon transformation into the procyclic insect stage, the glycosomal metabolism is extended, and part of the produced phosphoenolpyruvate is imported from the cytosol and subsequently converted into succinate via phosphoenolpyruvate carboxykinase, malate dehydrogenase,

fumarase, and a soluble glycosomal NADH:fumarate reductase. Furthermore, in this procyclic insect stage the end product of glycolysis, pyruvate, is not excreted but is further metabolized inside the mitochondrion, in which it is mainly degraded to acetate. Acetate production occurs by acetate:succinate CoA-transferase

and involves a succinate/succinyl-CoA cycle that generates extra ATP. Surprisingly, under all conditions studied so far, the TCA cycle does not function as a cycle in procyclic *T. brucei* for the complete oxidation of acetyl-CoA to carbon dioxide. It was shown that parts of the TCA-cycle machinery are used in other processes, such as partial degradation of amino acids, but also for biosynthetic purposes, such as fatty acid biosynthesis and gluconeogenesis (Fig. 1). In addition to carbohydrate degradation amino acids, mainly proline and threonine, are thus important substrates for the production of ATP in procyclic insect stage *T. brucei*. Utilization of amino acids correlates well with the change in the trypanosome's environment. Under resting conditions, proline is present in tsetse hemolymph in excessively high concentrations, and the midgut of the fly is deficient in carbohydrates but rich in amino acids and peptides.

The reducing equivalents (NADH), generated by substrate oxidation, are in all trypanosomatids delivered to a respiratory chain that uses oxygen as the final electron acceptor, but essential differences in respiratory chains exist among the various species and developmental stages. The long-slender bloodstream stage of *T. brucei* lacks cytochromes and a classical respiratory chain, but contains instead a plantlike alternative oxidase. Reducing equivalents produced in the glycosomes are transferred to the mitochondrion via the classical mammalian-type glycerol 3-phosphate/dihydroxyacetone phosphate shuttle (Fig. 1). The mitochondrial FAD-linked glycerol-3-phosphate dehydrogenase donates electrons to the ubiquinone/ubiquinol pool, and the reduced ubiquinol is then the electron donor for the alternative oxidase. This process of electron transfer via the alternative oxidase is not linked to ATP production, does not involve cytochromes, is insensitive to cyanide and antiycin A, but is susceptible to inhibition by aromatic hydroxamic acids like salicylhydroxamate (SHAM) and the antifungal agents ascofuranone and miconazole.

The procyclic insect stages of trypanosomes, in contrast, possess not only the alternative oxidase system, but also a classical, cyanide-sensitive cytochrome-containing respiratory chain, coupled to oxidative phosphorylation (Fig. 1). Apart from complex I, this part of the respiratory chain of trypanosomatids strongly resembles the mammalian type respiratory chain, as no dissimilarities have been found yet. It is unknown yet, what physiological advantage the multiple oxidase assembly may offer to trypanosomes. Under the conditions of the midgut of the tsetse fly where oxygen concentrations are low, expression of the alternative oxidase system would be downregulated, but the cytochrome *aa*<sub>3</sub>-linked respiratory chain would be induced and become functionally operative. As the

latter system is coupled to oxidative phosphorylation, the economic efficiency of the overall energy generating metabolism of procyclic trypanosome stages would by far exceed that of the bloodstream forms. This would well reflect the environmental transition from the vertebrate blood with its abundant supply of nutrients and oxygen to the insect midgut, where limited substrate and oxygen concentrations may have forced the parasite to develop a more efficiently functioning and versatile energy-generating system. Intermediate and short stumpy bloodstream forms of *T. brucei* have better-developed mitochondria than the long-slender forms and are not dependent only on glycolysis for energy generation. Apparently, the transition in energy metabolism between the glycolysis-dependent long-slender form and the mitochondrion-dependent procyclics occurs already in the bloodstream. The transitional bloodstream forms are thus pre-adapted to functioning in the insect vector if ingested with a blood meal. Substrate availability and/or energy metabolism seem to have a function in the induction of differentiation processes during the trypanosomal life cycle, but the underlying mechanisms are not yet fully understood.

The substrates and metabolic pathways utilized for energy generation by other kinetoplastids are similar to those observed in the procyclic culture forms of *T. brucei*. The differences in energy metabolism between the two main morphological forms of *Leishmania* spp. are less pronounced than those of *T. brucei*. The glycolytic enzymes are present in glycosomes, and the cristate mitochondria of *Leishmania* possess TCA-cycle enzymes and a cytochrome-oxidase-linked respiratory chain, just like *T. brucei*. The relative importance of carbohydrates and amino acids as an energy source is not completely clear, however, and may vary with the stages, species, and phase of growth.

*Leishmania* promastigotes have an energy metabolism in which a small part of the carbohydrate is completely oxidized to carbon dioxide via the TCA cycle, but in which large amounts of partly oxidized products, like acetate, pyruvate and succinate, are also produced as end-products of glucose metabolism. A small part of the pyruvate is transaminated to alanine, which is then excreted. In *Leishmania* promastigotes, the partly oxidized end products are the result of an aerobic metabolism involving an electron-transport chain, with oxygen as final electron acceptor, as in procyclic trypanosomes. *Leishmania* promastigotes, like the insect stage of *T. brucei*, have a classical respiratory chain but lack the alternative oxidase that is present in the other Trypanosomatidae. *Leishmania* promastigotes are strongly dependent on this classical respiratory chain for their energy generation, which is in agreement with the observation that *Leishmania* promastigotes possess an energy metabolism in which

most of the carbohydrate is degraded to partially oxidized end products, a process concomitantly producing NADH that is reoxidized by the respiratory chain.

*Leishmania* amastigotes most likely have an energy metabolism very similar to that of the promastigotes, both stages being dependent on TCA-cycle activity and a mammalian-type respiratory chain, although fatty acids probably are a more important substrate in the insect stage, at least in *L. mexicana*. This would correlate with the nutritional conditions of their intracellular habitat, the macrophage, in which a sufficient supply of lipids is likely to be available.

The energy metabolism of *T. cruzi* strongly resembles that of *Leishmania*, i.e., all stages of this parasite possess TCA-cycle activity and a mammalian-type respiratory chain linked to the generation of ATP. However, like *Leishmania*, *T. cruzi* catabolizes glucose only partially to carbon dioxide and produces, in addition, various organic compounds as metabolic end products, including acetate and succinate.

### Anaerobic Protozoa

Protozoan parasites which have been classified as anaerobes occur in the taxonomic groups of trichomonad flagellates, and *Entamoeba* and *Giardia* spp. These organisms differ from most other eukaryotes in that they lack morphologically recognizable mitochondria (amitochondriate) and such biochemical attributes as the tricarboxylic acid cycle, cytochromes, and oxidative phosphorylation. They do not require oxygen for their survival and multiplication, but can tolerate low oxygen concentrations. As a consequence of this metabolic organization, energy generation in these organisms functions anaerobically and is exclusively associated with substrate-level phosphorylations. An important source of energy for anaerobic protozoa are carbohydrates which are stored in large amounts in the form of glycogen and degraded via an extended glycolytic pathway to different organic end products and CO<sub>2</sub>. On the other hand, these organisms do consume O<sub>2</sub> when it is available, but the mechanism of this oxygen utilization process is unclear (see below).

Recently, mitochondrion-related organelles, called mitosomes, have been identified in a number of amitochondriate parasitic protozoa, including *Entamoeba histolytica*, *Giardia*, *Cryptosporidium parvum*, and microsporidians. Like mitochondria, mitosomes are double-membrane-bounded and contain some mitochondrial-type proteins, including chaperonin 60 (Cpn60), heat shock protein 70 (Hsp70), and the protein machinery responsible for iron-sulfur cluster assembly, but in contrast to mitochondria, mitosomes have not retained an organellar genome. The presence of mitosomes in parasitic protozoa lacking typical

mitochondria provides evidence that these organisms are not primary amitochondriate, but have diverged from other eukaryotes after the mitochondrial endosymbiosis event.

Trichomonad flagellates distinguish from *Entamoeba* and *Giardia* in their ability to eliminate substrate-derived reducing equivalents in the form of molecular hydrogen by a pathway resembling that observed in some anaerobic eubacteria. As illustrated in Fig. 2, catabolism of carbohydrate in these parasites proceeds by classical glycolysis up to the step of pyruvate which is further metabolized to acetate, CO<sub>2</sub>, and hydrogen. *Trichomonas vaginalis* and *Tritrichomonas foetus* show the same metabolic pattern, except that the former trichomonad produces lactate and the latter succinate as additional end products. The process of acetate formation in trichomonads is highly unusual for a eukaryote in that it is achieved by oxidative decarboxylation of pyruvate via a ferredoxin-linked step catalyzed by pyruvate:ferredoxin oxidoreductase. In a subsequent reaction, catalyzed by the iron-sulfur enzyme hydrogenase, the electrons are transferred from ferredoxin to protons to form molecular hydrogen. The ferredoxins involved in pyruvate oxidation of anaerobic protozoa are 12 kDa iron-sulfur proteins that differ in their structural properties among different species. The trichomonad ferredoxin possesses only a [2Fe-2S] cluster similar to mitochondrial iron-sulfur proteins, whereas the ferredoxins of *Entamoeba* and probably *Giardia* contain 2 clusters of 4 iron atoms bound to 4 acid-labile sulfur atoms (2[4Fe-4S]). The characteristic trichomonad ferredoxin-dependent metabolic properties account for the selective toxicity of 5-nitroimidazole antiprotozoal drugs.

Another feature unique to the trichomonads is that the enzymes involved in pyruvate oxidation are carried in a separate organelle, the hydrogenosome, which is bounded by 2 closely apposed unit membranes and thus represents a metabolic compartment separate from the cytosol. The exact evolutionary position of the hydrogenosome is still debated, but functional and morphological considerations leads to the suggestion that hydrogenosomes and mitochondria are related organelles. The presence of hydrogenosomes is not restricted to trichomonad flagellates since they have been discovered also in anaerobic rumen ciliates, in fungi and in free-living protozoans of anaerobic sediments. The establishment of these organelles appears to be one of the various evolutionary approaches to adapt to an anaerobic mode of life. The advantage achieved with this strategy over that evolved in other anaerobic systems is that substrate-derived reducing equivalents can be directly eliminated in the form of molecular hydrogen and that substrate oxidation beyond the pyruvate step increases the economic efficiency of the energy generating system over that observed in simple lactate or ethanol

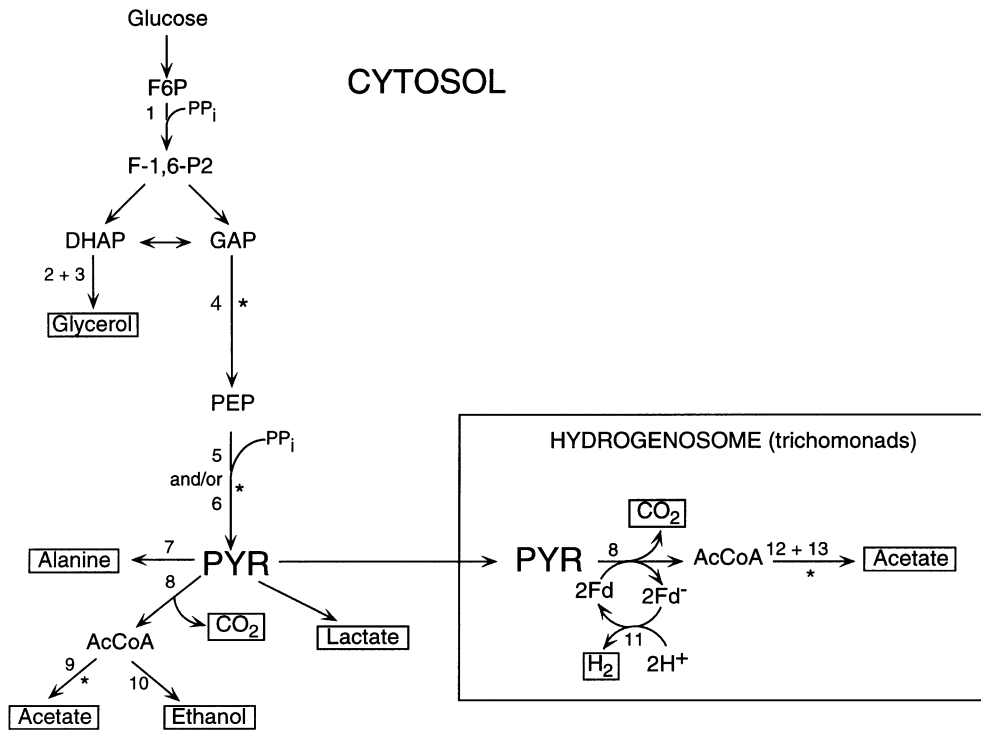

**Energy Metabolism. Figure 2** The pathways of energy metabolism in anaerobic protozoa. 1, PP<sub>i</sub>-dependent phosphofructokinase; 2, glycerol-3-phosphate dehydrogenase; 3, glycerol-3-phosphatase; 4, 4 glycolytic enzymes; 5, pyruvate phosphate dikinase (not present in trichomonads); 6, pyruvate kinase; 7, alanine aminotransferase; 8, pyruvate:ferredoxin oxidoreductase; 9, acetate thiokinase (not present in trichomonads); 10, acetyl CoA reductase/alcohol dehydrogenase; 11, hydrogenase; 12, acetate:succinyl CoA transferase; 13, succinyl CoA synthetase. Glycerol formation occurs only in trichomonads and lactate formation only in *T. vaginalis*. In *Giardia* and *Entamoeba*, acetate formation occurs in the cytosol and is not coupled to hydrogen production. Metabolic end products are boxed. Asterisks indicate sites of ATP formation. *AcCoA*, acetyl coenzyme A; *DHAP*, dihydroxyacetonephosphate; *Fd*, ferredoxin; *F6P*, fructose-6-phosphate; *F-1,6-P<sub>2</sub>*, fructose-1,6. bisphosphate; *GAP*, glyceraldehyde-3-phosphate; *MAL*, malate; *OAA*, oxalacetate; *PEP*, phosphoenolpyruvate; *PYR*, pyruvate.

fermentation. The conversion of acetyl CoA, the primary product of anaerobic pyruvate oxidation in trichomonads, to free acetate can be coupled to substrate-level ATP synthesis, a process catalyzed by the combined action of 2 enzymes involving a CoA transferase and succinyl CoA synthetase.

Like trichomonad flagellates, the energy metabolism of *Giardia* and *Entamoeba* is entirely fermentative (Fig. 2), irrespective of whether oxygen is present or not, which is in accordance with the lack of mitochondria and the functions associated with these organelles. The utilization of carbohydrate results in the formation of a mixture of acetate, ethanol, and CO<sub>2</sub>. Anaerobically, more ethanol and less acetate are produced, whereas in the presence of oxygen the catabolism switches to produce more acetate. In this pathway, the major fate of glycolytically formed pyruvate is its oxidative decarboxylation to acetyl CoA, catalyzed by an enzyme analogue to the ferredoxin-linked oxidoreductase of trichomonad flagellates. However, unlike trichomonads, *Giardia* and *Entamoeba*, because of the lack of a

ferredoxin-linked hydrogenase, are not able to form molecular hydrogen. As an alternative, in these anaerobes reduced ferredoxin is utilized in the formation of ethanol as catalyzed by the bifunctional enzyme, acetyl CoA reductase/alcohol dehydrogenase. Oxygen may also act as terminal acceptor for the reducing equivalents removed from pyruvate, which would explain the aerobic requirement for acetate formation, but the precise steps involved in this pathway of electron flow are still unclear. As in trichomonads, hydrolysis of the acetyl CoA in these parasites can also be linked to energy generation by substrate level phosphorylation, but this step is catalyzed by a single enzyme, a novel type of acetate thiokinase (Fig. 2), which is known to occur only in some prokaryotes.

A notable feature of glycolysis in anaerobic protozoa is its dependency on pyrophosphate (PP<sub>i</sub>) as a phosphate donor rather than on adenine nucleotides (Fig. 2). In a first step, a phosphofructokinase (PP<sub>i</sub>-PFK) utilizes PP<sub>i</sub> to phosphorylate the glycolytic intermediate fructose 6-phosphate to form the corresponding

1,6-bisphosphate. The second  $PP_i$ -dependent enzyme, pyruvate phosphate dikinase (PPDK), is located in lower glycolysis, where it replaces the pyruvate kinase (PK). In *T. vaginalis*, only the phosphofruktokinase is  $PP_i$ -specific, whereas in *Entamoeba* and in *Giardia* both  $PP_i$ -PFK and PPDK are present. Recently, the coexistence of PPDK with PK in *Giardia* and the occurrence of a glycosomal PPDK in addition to cytosolic PK have been reported for *Giardia* and *T. brucei*, respectively. Other parasitic protozoa, including some apicomplexans, were also found to contain  $PP_i$ -PFK instead of the corresponding ATP-dependent enzyme, though these species are not considered to be anaerobic. A third  $PP_i$ -linked enzyme, phosphoenolpyruvate (PEP) carboxyphosphotransferase, is a constituent of a three-enzyme system functioning in *Entamoeba* as an alternative route for PEP utilization (Fig. 2). In this step, the high-energy phosphate bond of PEP is transformed into a  $PP_i$  bond with simultaneous fixation of  $CO_2$ . *Entamoeba* appears to be the only eukaryotic cell in which this enzyme is present. The possible physiological roles of inorganic  $PP_i$  utilization may be to conserve the energy of the  $PP_i$  generated during anabolic processes and, as the  $PP_i$ -linked enzymatic reactions are reversible under physiological conditions, they may have functions not only in catabolic but also anabolic routes.

Anaerobic protozoa experience sometimes aerobic conditions within their natural environments and consume oxygen when provided, at rates comparable to those observed for aerobic protozoa and can tolerate surprisingly high concentrations of this gas *in vitro*. *T. vaginalis* has even been shown to grow optimally in the presence of small amounts of oxygen, and therefore these organisms may be classified as microaerophiles rather than anaerobes. Although the trichomonads, *Giardia* and *Entamoeba*, are devoid of any heme-containing proteins, reducing equivalents can be transferred from substrates to molecular oxygen. This reaction is catalyzed by NAD(P)H oxidoreductases which are located in the cytosol and apparently produce water as the reaction product. As an alternative, electrons to oxygen may be also donated through a succession of electron carriers containing flavins, non-heme iron, and other high potential carriers of an unknown nature. The precise architecture and physiological role of these presumptive respiratory systems of anaerobic protozoa, which are not associated with energy generation, remain to be elucidated. The fact that, with the exception of the large intestine, neither of the tissues colonized by these parasites are notably deficient in oxygen suggests that aerobic processes may be operative *in vivo*, and it was suggested that the respiratory systems may have a role in protecting the cell against oxygen damage.

## Apicomplexans

Detailed knowledge of the bioenergetics of apicomplexan protozoa is limited to the intraerythrocytic stages of *Plasmodium* and *Eimeria*, while this aspect in the case of other genera has received only little attention. Generally, carbohydrates serve as the main energy source throughout the life cycle of apicomplexans. The erythrocytic stages of the malarial parasite lack energy stores and, consequently, use blood glucose as the primary nutrient. *Eimeria* spp. and *Toxoplasma gondii* bradyzoites store carbohydrate in the form of amylopectin, a known reserve polysaccharide of plants and some free-living protozoa and rumen ciliates. Like most other endoparasites, apicomplexan protozoa have a limited capacity to oxidize substrates completely to  $CO_2$  and water but instead satisfy their energy requirements by fermentative mechanisms. The erythrocytic forms of mammalian malarial parasites convert glucose almost quantitatively to lactate, regardless of whether oxygen is present or not. Carbohydrate metabolism of the intraerythrocytic stages of *Babesia* seems to parallel that of human malarial parasites in that glucose is primarily or solely degraded to lactate. *Eimeria*, *Toxoplasma*, and *Cryptosporidium* also ferment carbohydrate to lactate with minor formation of acetate and glycerol. In common with anaerobic protozoa, glycolysis of various apicomplexans is unusual in that it contains  $PP_i$ -PFK instead of the conventional ATP-dependent enzyme. Another unique feature of these protozoans is that their lactate dehydrogenases, including those of *Plasmodium*, *Eimeria*, and *Toxoplasma*, contain a five-amino-acid insert around the active site, which may explain, at least in part, the unusual specificities of these enzymes in apicomplexans. A common feature of coccidian parasites is also the accumulation of mannitol, a carbohydrate previously known to be present only in fungi. The presence of mannitol in *Eimeria*, and probably also in *Toxoplasma* and *Cryptosporidium*, is associated with a cyclic pathway (mannitol cycle) that involves a synthetic and catabolic part and is linked to glycolysis via fructose 6-phosphate. The function of mannitol in coccidian parasites is still unclear, but suggested possibilities are its role as an energy reserve or osmoregulator, or it may act as a mechanism for dealing with oxygen radicals.

The lack of a full complement of the tricarboxylic acid cycle (TCA-cycle) enzymes in the apicomplexan parasites investigated has left a classical mitochondrial function involving complete substrate oxidation doubtful. Furthermore, in *Toxoplasma gondii* and *Plasmodium* spp. pyruvate dehydrogenase is only present inside the apicoplasts and not inside the mitochondria. This implies that acetyl-CoA, the substrate for the TCA-cycle, cannot be generated from pyruvate inside the mitochondria. On the other hand, several apicomplexans, notably

all life cycle stages of *Eimeria* and *Toxoplasma*, contain distinctive, cristate mitochondria. The presence of various cytochromes have been detected in these parasites and their respiration is sensitive to inhibition by cyanide and other mitochondrial electron transport inhibitors. For *Eimeria* it was suggested that during the processes of sporulation and excystation, which are associated with high respiratory activities, but also within those parasite stages preparing for an extracellular phase of life, a more aerobic type of metabolism may be established using the TCA cycle and cytochrome-linked substrate oxidation. As oxygen is required for optimal growth *in vitro* and inhibitors of respiration have significant effects on the survival of malarial and other apicomplexan parasites, a function of the mitochondrion in a capacity other than energy generation must be crucial. A possible functional significance of respiration in apicomplexans could be its coupling to the pyrimidine biosynthetic pathway as appears to be the case for blood stage *P. falciparum*. The observation that the anti-coccidial quinolones and pyridinols inhibit respiration in *Eimeria* sporozoites and oocysts rather selectively suggests major differences between the coccidial and mammalian type of mitochondrial electron transport systems. Avian malarial parasites seem to have rather different bioenergetic capacities. Their cristate mitochondria appear to possess a functional TCA cycle, and in accordance with these properties, free erythrocytic stages of these species are able to oxidize a significant portion of the carbohydrate utilized to CO<sub>2</sub>. *C. parvum* seems to lack mitochondria suggesting that oxygen is unimportant and glycolysis is the major strategy of energy generation in this apicomplexan.

## Helminths

### Adult Helminths

As substrate for energy conservation the adult stages of most helminths use primarily carbohydrate, of which glycogen is the main storage polysaccharide, consisting in many cases of as much as 10% of the worm's wet weight. The catabolism of amino acids does not seem to be of particular importance for energy generation with the exception of glutamine, whose co-utilization with carbohydrate was shown to be energetically advantageous for some helminth species. Generally, the bioenergetic pathways found in adult helminths function primarily anaerobically. Effective terminal oxidative processes, such as the TCA cycle and a conventional type of respiratory chain, are very often absent or of limited activity, which precludes the utilization of fatty acids as an energy source. For the same reason, the degradation of carbohydrates and amino acids beyond the acetyl-CoA stage is only hardly feasible. As a consequence, most adult helminths are not capable of oxidizing organic compounds to a significant extent to CO<sub>2</sub> and water. More

pronounced oxygen-dependent routes, however, appear to exist in small helminth species and in the outermost tissue layers of larger worms.

Although the pattern of end products varies greatly between different species of adult helminths, none of them degrades carbohydrates completely to carbon dioxide, as the free-living stages do. As helminths in general do not use oxygen as final electron acceptor, they must have a fermentative metabolism instead and excrete organic substances as metabolic end products. When oxygen cannot function as terminal electron acceptor, the degradation of substrates has to be in redox balance. Two approaches are pursued by helminths to fulfil this requirement. Some species, including adult schistosomes and filarial nematodes, use the classical adaptation to anaerobic metabolism by degrading carbohydrates to lactate or ethanol. This so-called anaerobic glycolysis yields 2 molecules of ATP per molecules of glucose degraded. Although most adult parasites use this strategy to some extent, the majority uses a different approach (malate dismutation), in which carbohydrates are degraded to phosphoenolpyruvate (PEP) via the conventional Emden-Meyerhof pathway. PEP is then carboxylated by phosphoenolpyruvate carboxykinase (PEPCK) to form oxaloacetate, which is subsequently reduced to malate (Fig. 3). The fate of PEP at the pyruvate kinase/PEPCK branch point will depend on the activity ratios and kinetics of the 2 enzymes involved, but is also determined by substrate concentrations, the rate of subsequent reactions and other factors. This part of the pathway occurs in the cytosol and is comparable to the formation of lactate or ethanol in being redox balanced and yielding 2 molecules of ATP per mol of glucose degraded. However, the malate produced in the cytosol is, unlike lactate, not excreted but transported into the mitochondria for further degradation. In a branched pathway, a portion of malate is oxidized to acetate and another portion of it is reduced to succinate. The oxidation occurs via 2 consecutive steps of oxidative decarboxylation, first to pyruvate via malic enzyme and subsequently to acetyl CoA via pyruvate dehydrogenase. The pyruvate dehydrogenase complex of *Ascaris suum* was shown to be specifically adapted to anaerobic functioning. The acetyl CoA formed is converted to acetate via a succinate/succinyl-CoA cycle. In the other part of the pathway, reduction of malate occurs in 2 reactions which reverse part of the TCA-cycle. Many helminths metabolize succinate further to propionate, which is then excreted. This so-called malate dismutation is in redox balance when twice as much propionate is produced as compared to acetate.

Apart from the electron-transport-associated ATP formation in the reduction of fumarate (see below), malate dismutation is also accompanied by substrate-level phosphorylations (Fig. 3). Formation of acetate from acetyl-CoA occurs via 2 consecutive enzymatic

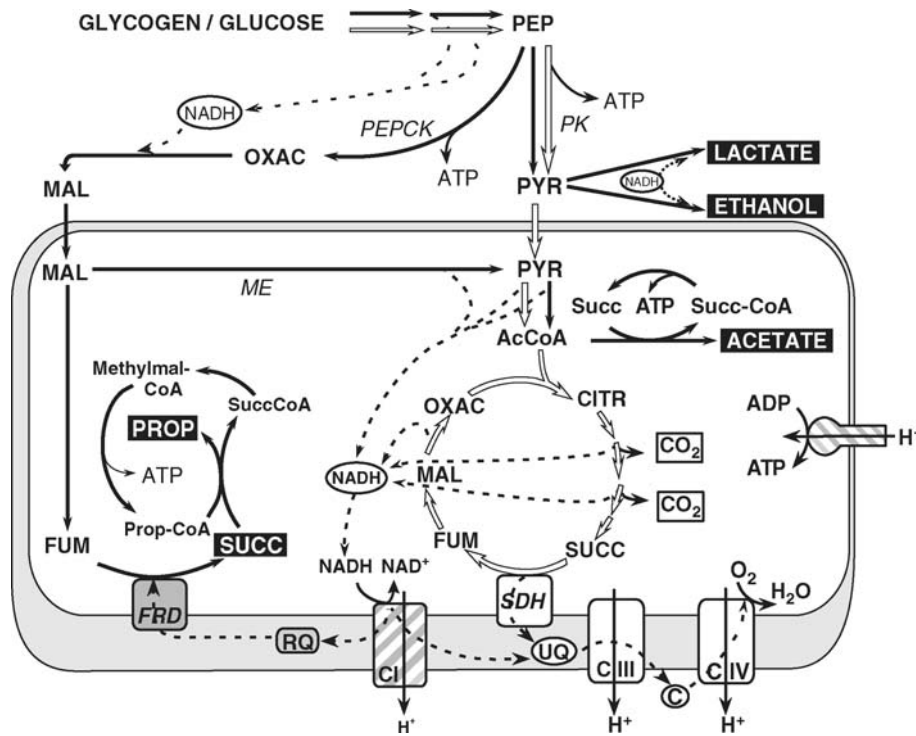

**Energy Metabolism. Figure 3** Generalized pathways of carbohydrate degradation by parasitic helminths. The aerobic metabolism of free-living and larval stages is shown in open arrows and the anaerobic fermentation pathways of adults in closed arrows. End products are in black boxes. *AcCoA*, Acetyl-CoA; *CI, III and IV*, complex I, III and IV of the respiratory chain; *CITR*, citrate; *FRD*, fumarate reductase; *FUM*, fumarate; *MAL*, malate; *Methylmal-CoA*, methylmalonyl-CoA; *ME*, malic enzyme; *OXAC*, oxaloacetate; *PEP*, phosphoenolpyruvate; *PEPCK*, phosphoenolpyruvate carboxykinase; *PK*, pyruvate kinase; *PROP*, propionate; *Prop-CoA*, propionyl-CoA; *PYR*, pyruvate; *RQ*, rholoquinone; *SDH*, succinate dehydrogenase; *SUCC*, succinate; *Succ-CoA*, succinyl-CoA; *UQ*, ubiquinone.

steps with the concomitant production of ATP. The presence of the first enzyme of this reaction, acetate:succinate CoA-transferase, has now been unequivocally demonstrated in *F. hepatica*. The formation of propionate from succinate occurs through a sequence of metabolic reactions required for propionate utilization in animal tissues but working in reverse (Fig. 3). This cyclic pathway involves a set of enzymatic reactions which require deoxyadenosylcobalamin and biotin and accomplish the loss of a carboxyl group as CO<sub>2</sub>. Each pass of the sequence promotes the synthesis of one molecule of ATP through coupling of ADP phosphorylation with the decarboxylation of methylmalonyl CoA. In total, the anaerobic production of propionate and acetate yields approximately 5 molecules of ATP per molecule of glucose degraded.

In the anaerobically functioning mitochondria of helminths capable of malate-dismutation, the electron-transport chain is different from the one present in mammals in that endogenously produced fumarate functions as the terminal electron acceptor instead of oxygen. In this case, electrons are transferred from NADH to fumarate via complex I and fumarate reductase (Fig. 4). Free-living stages of helminths, however,

possess an aerobic energy metabolism with a classical mammalian type respiratory chain (see below). This implies that during the development of free-living into the parasitic stages, a transition occurs from succinate oxidation via succinate dehydrogenase in the TCA cycle to the reverse reaction, reduction of fumarate to succinate. Bacteria contain 2 homologous but distinct enzyme complexes to catalyse these reactions, one to oxidize succinate (succinate dehydrogenase) and one to reduce fumarate (fumarate reductase). Different enzymes are needed for these 2 reactions because the electron flow through the 2 complexes is in opposite direction, which implies differences in the affinity for electrons (standard electron potential) of the electron-binding domains of these enzyme complexes. Distinct enzyme complexes have now also been described in the parasitic nematodes *Haemonchus contortus* and *A. suum*. These complexes were shown to be differentially expressed during the life cycle of the parasites and are suggested to function either as a succinate dehydrogenase or as a fumarate reductase. In addition to customary enzyme complexes for succinate oxidation and fumarate reduction, also distinct quinones are involved in these processes in helminths.



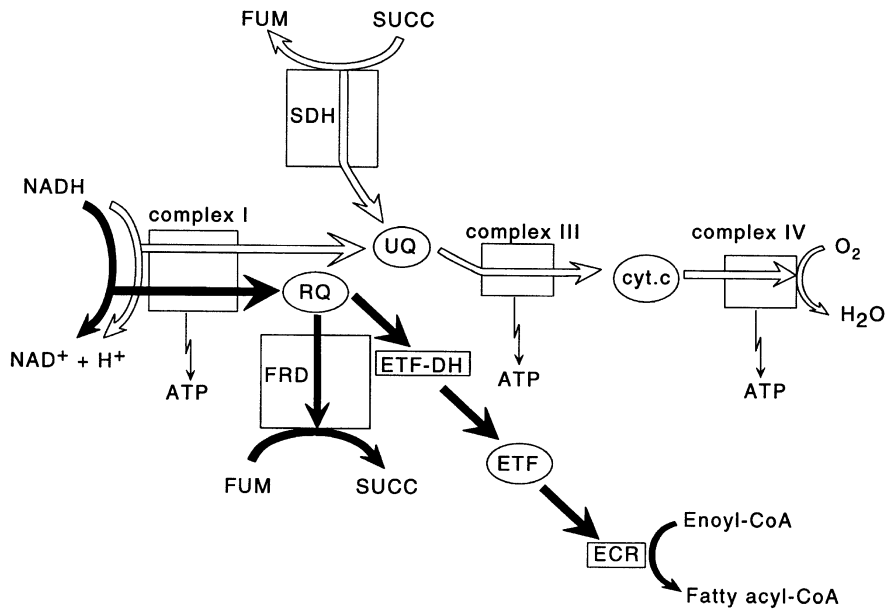

**Energy Metabolism. Figure 4** Schematic representation of the electron-transport chain in parasitic helminths. Electron flow to oxygen is shown in open arrows and the flow through fumarate reductase and to enoyl CoA reductase (*ECR*) in closed arrows. *Cyt. c*, cytochrome *c*; *ETF*, electron-transferring flavoprotein; *ETF-DH*, ETF-dehydrogenase (*ETF*:rhoquinone oxidoreductase); *FRD*, fumarate reductase; *FUM*, fumarate, *SDH*, succinate dehydrogenase, *RQ*, rhoquinone; *SUCC*, succinate, *UQ*, ubiquinone.

In many helminths, the primary products of anaerobic malate metabolism, acetate, succinate and propionate, accumulate as major excretory products. Some other helminths metabolize these compounds further to branched-chain fatty acids. In *A. suum*, the branched-chain fatty acids, 2-methylbutyrate and 2-methylvalerate, are the predominant end products of anaerobic carbohydrate metabolism. As demonstrated in Fig. 5, these acids arise from the condensation of acetyl CoA with propionyl CoA or of 2 propionyl CoA units, with subsequent conversion of the condensation products to the saturated fatty acids. This pathway is also located inside the anaerobically functioning mitochondrion and is similar to the reversal of  $\beta$ -oxidation of fatty acids, although some of the enzymes involved in branched-chain fatty acid production of helminths differ in their kinetics and regulatory properties from the corresponding mammalian  $\beta$ -oxidation enzymes. There is evidence to suggest that 2 sites of ATP generation may be operative in this reductive process (Fig. 4). One is associated with the penultimate step in which the dehydroacyl CoA compound is reduced to the saturated CoA ester and involves phosphorylation linked to electron transport, in a way similar to that occurring during fumarate reduction. NADH is reoxidized and the electrons are used for enoyl CoA reduction. A second site of energy generation is thermodynamically feasible in the final step of free branched-chain fatty acid formation which occurs with a large drop in free energy upon hydrolysis of the CoA

thioester bond. Probably ATP formation proceeds either by a thiokinase or by the combined action of 2 enzymes, analogous to acetate formation from acetyl CoA. The production of these branched-chain fatty acids does not generate more energy than the production of acetate and propionate but functions as an alternative electron sink. More rarely occurring pathways of glucose utilization, such as those leading to propanol in *H. contortus*, have not yet been elucidated and thus their relevance to energy conservation is unknown.

The anaerobic energy generation in helminths can apparently be associated with several sites of ATP formation. At the substrate level, these are coupled to glycolysis, PEP carboxylation, methylmalonyl-CoA decarboxylation (in the formation of propionate) and succinyl CoA synthetase (in the formation of acetate), while NADH-coupled reductions of fumarate and enoyl CoA compounds serve to produce ATP via electron-transport-associated phosphorylation. Energy generation in helminths mediated by mixed fermentations and anaerobic electron transport would thus display a clear advantage over simple lactate or ethanol fermentation. The latter pathways yield only 2 ATP per molecule of glucose catabolized, whereas for an organism like *F. hepatica*, which degrades glucose almost solely to acetate and propionate in a ratio of 1:2, approximately 5 molecule ATP is produced per mol of glucose catabolized. In spite of the obvious advantage of multiple anaerobic catabolic systems over simple

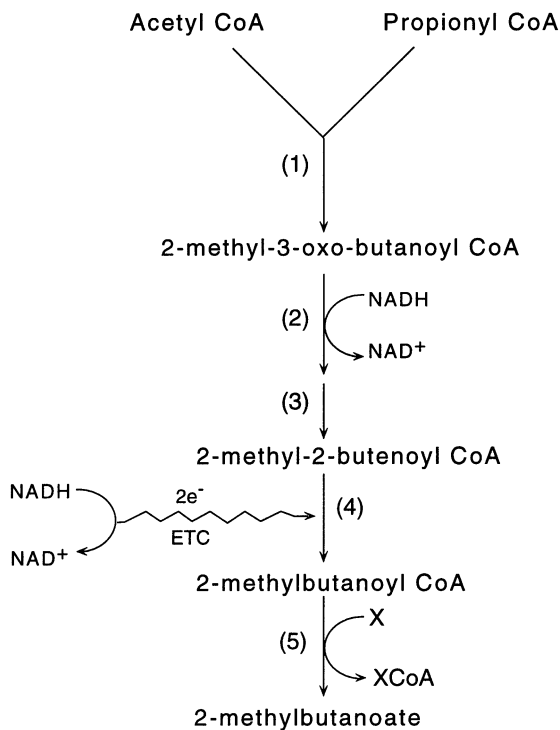

**Energy Metabolism. Figure 5** Formation of branched-chain fatty acids by *Ascaris suum*. (After Komuniecki and Harris (1995)) 1, propionyl condensing enzyme; 2, 2-methyl acetoacyl CoA reductase; 3, 2-methyl-3-oxo-acyl CoA hydratase; 4, 2-methyl branched-chain enoyl CoA reductase; 5, acyl CoA transferase; *ETC*, electron-transport chain (see Fig. 4). The synthesis of 2-methylpentanoate (2-methylvalerate) proceeds in a similar way, except that 2 propionyl CoA units are used in the condensing reaction then.

lactate fermentation, the economic efficiencies of these pathways are still very low compared to that obtained from complete substrate oxidation to CO<sub>2</sub> and water, which generates approximately 30 molecules of ATP per molecule glucose degraded.

### Free-Living and Larval Stages of Helminths

Most free-living stages of helminths are self-supporting, i.e., they do not obtain food or substrates other than oxygen from their environment. They are completely dependent on the endogenous food stores that they have obtained in their previous host. Glycogen is present in many free-living stages and is used to span the gap in food supply until the next host is entered. The free-living and parasitic developmental stages of helminths have, unlike the adult parasites, usually an aerobic energy metabolism. Many of them, such as the free-living infective eggs of *A. suum*, eggs and developing larvae of *Nippostrongylus brasiliensis* and *H. contortus*, juvenile liver flukes and young

schistosomula, and various free-living cercariae, have a high oxygen requirement, mainly for energy generation, with high TCA-cycle and mitochondrial respiratory chain activities. These organisms thus are capable of completely oxidizing substrate carbon to CO<sub>2</sub> and water. In addition, smaller amounts of oxygen are needed for synthetic purposes, such as the formation of collagen and fatty acid desaturation. Another feature of the developmental stages of helminths is that the diversity of energy sources that can be utilized is, in many cases, greater compared to that of the respective adult forms. For instance, the free-living stages of many parasitic nematodes and some cercariae rely heavily on lipids for their energy generation, implying that a functional  $\beta$ -oxidation sequence is present in these stages. Generally, there is, however, great variation in the oxygen requirements and the capabilities for substrate utilization in the developmental stages of helminths, and the situation in one species may not be necessarily relevant for another species.

If the metabolism of helminths differs between larval and adult stages, then the developmental cycle of these organisms must involve, at some stage, a transition from one metabolic strategy to another, triggered by appropriate environmental and physiological conditions. In the development of *A. suum*, the transition from aerobic to anaerobic energy metabolism is likely to occur during the third molt when larvae develop in the small intestine from the third to the fourth stage. In contrast to the adult, which lacks a functional TCA-cycle and cyanide-sensitive respiration, the earlier larval stages of this parasite rely on aerobic strategies for energy conservation resembling those functional in mammalian cells. A similar adaptation is exhibited in the life cycle of *F. hepatica* (Fig. 6). While the early liver-parenchymal stages of this parasite possess a predominantly aerobic metabolism and are capable of complete substrate oxidation, these oxidative capacities decline gradually during development. In flukes between 2 and 8 weeks old, TCA cycle activity is already largely suppressed, but aerobic reactions still remain functional as characterized by the oxygen-linked formation of acetate. In this pathway, most of the chemical energy may still be conserved by mitochondrial oxidative phosphorylation, but the reducing power necessary to drive respiration is not derived from the TCA-cycle but from the formation of acetate. Compared to complete substrate oxidation, the relative efficiency of this energy-generating pathway is much lower, resulting in approximately 14 molecules of ATP per molecule of glucose catabolized to acetate and CO<sub>2</sub>. After arrival of the flukes in their definitive environment, the bile ducts, a further drop in oxidative capacities and relative efficiency for energy generation occurs. From this stage on, anaerobic redox-processes, resulting in the formation of acetate and propionate,



↓ 1st Transition

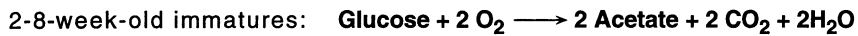

↓ 2nd Transition



**Energy Metabolism. Figure 6** Changes in the energy metabolism of *Fasciola hepatica* during its development in the final host. Contribution of the 3 pathways of glucose breakdown to ATP synthesis is shown. (After Tielens 1994).

remain functional throughout adult life. In the development of the liver fluke, therefore, 2 pronounced shifts in energy metabolism seem to occur: one being characterized by the transition from complete substrate oxidation to aerobic acetate formation, and the other by a change from aerobic to anaerobic metabolism as is observed during the development of the late immature worms into the adult stage.

Also in schistosomes such a switch occurs from an aerobic metabolism in the free-living stages to an anaerobic one in the parasitic stages. The free-living cercariae and miracidia of *Schistosoma mansoni* possess an aerobic energy metabolism in which their endogenous glycogen reserves are degraded, mainly to  $\text{CO}_2$ . Adult schistosomes, on the other hand, live in the bloodstream of their host and despite their small size and life in an aerobic environment, they have a fermentative metabolism and degrade glucose, mainly to lactate. When cercariae penetrate the skin of the final host and transform into schistosomula, they switch rapidly from TCA-cycle activity to lactate production via glycolysis. This metabolic switch was shown to be initiated by the sudden presence of external glucose when the free-living stages penetrate the new host, and is not linked to a decreased availability of oxygen, as in *F. hepatica*. The mere presence of external glucose results in an increased glycolytic flux, probably caused by the rapid uptake of glucose that occurs upon expression at the surface of a specific schistosomal glucose transporter protein, SGTP4. This increased glycolysis is maintained as a result of the specific kinetic properties of schistosomal hexokinase, the first enzyme in glucose catabolism. The observed rapid switch to lactate production occurs only in cercarial heads, the region of the larvae that develops into the mature parasite. The tail of the cercaria, which only propels the organism through the water, is fully dependent on the degradation of endogenous glycogen

reserves as it contains little or no SGTP4 and hexokinase, and it degenerates following the separation from the penetrating schistosomulum. In contrast to *Ascaris*, *F. hepatica* and several other helminth species, no significant changes in the energy metabolism occur during the further development of schistosomes. Lactate remains the main end product, although TCA-cycle activity and oxidative phosphorylation also contribute significantly to ATP production, even in adults.

The reason for the more pronounced oxidative capacities in developmental stages of helminths than in adults is not completely understood, but may be due to their smaller body size, which causes less oxygen diffusion problems than in adults, in conjunction with a sufficient availability of oxygen in the habitats of free-living and many parasitic larval stages. Both circumstances are likely to be essential for the establishment and function of the processes responsible for complete substrate degradation, i.e., the tricarboxylate cycle,  $\beta$ -oxidation route and a conventional type of phosphorylating respiratory chain. Upon increasing in body size which, for a migrating parasite, is often accompanied by a decreasing access to oxygen and changes in other environmental conditions, a marked drop in oxidative capacities often occurs in the adult, where anaerobic strategies are becoming the major ATP-generating sites. While in the latter stage these pathways cannot be reversibly replaced by aerobic processes, most developmental aerobic stages can survive anaerobically by utilizing anaerobic energy-conserving strategies which often coexist with aerobic routes. An example is *F. hepatica*, in which the ability of the adult to catabolize glucose anaerobically to acetate and propionate is present immediately after excystment and persists in all stages until the mature parasite. The interesting question of how the metabolic transitions occurring during the developmental cycle of helminths are regulated remains largely to be determined.

## Energy-Metabolism-Disturbing Drugs

Tables 1, 2.

### Structures

Fig. 1.

### Rotenoids

#### General Information

Rotenone is a natural product isolated from the roots of *Derris* spp. and *Lonchocarpus* spp. The derris root has long been used as a fish poison among the Malaysian natives. The insecticidal properties of derris extracts were known in China long before isolation of the active principle in 1895 by Geoffrey. Rotenone

**Energy-Metabolism-Disturbing Drugs. Table 1** Degree of efficacy of drugs against *Fasciola hepatica*, *Dicrocoelium dendriticum* and *Paramphistomum* spp.

Year on the market	Drug	<i>Fasciola hepatica</i>	<i>Dicrocoelium dendriticum</i>	<i>Paramphistomum</i>	Additional parasites
<b>Energy-Metabolism-Disturbing Drugs</b>					
<b>Halogenated Phenols and Bisphenols</b>					
	Disophenol	x			blood-ingesting nematodes
1968	Nitroxynil	x	x		
1957	Hexachlorophen	x	x	x (only matures)	cestodes
1933	Bithionol	x		x	cestodes, lung, and intestinal flukes
	Bithionol-sulfoxid	x		x (only matures)	cestodes
1959	Niclofolan	x		x (only immature)	Metagonimus
<b>Salicylanilides</b>					
1960	Niclosamide			x (only immatures)	cestodes, intestinal flukes
1963	Tribromsalan	x	x		
1968	Oxyclozanide	x	x	xx	cestodes, intestinal flukes
1966	Clixanide	x	x		
1969	Rafoxanide	xx		x (only immature)	cestodes, intestinal flukes, blood-ingesting nematodes
1970	Brotianide	x	x	x	
	Bromoxanide	x	x		
	Closantel	xx	x		blood-ingesting nematodes
1969	Resorantel			xxx	cestodes
<b>Benzene sulfonamides</b>					
	Clorsulon	x			
<b>Protein-Synthesis-Disturbing Drugs</b>					
1973	Diamphenethide	xxx	x		
<b>Microtubule-Function-Disturbing Drugs</b>					
	Cambendazole		x		nematodes
1961	Thiabendazole		x		nematodes
1971	Mebendazole	x	x		cestodes, nematodes
1971	Fenbendazole		x		nematodes
1978	Febantel		x		nematodes
1979	Albendazole	x	x		Giardia, cestodes, nematodes
1983	Triclabendazole	xxx			
<b>Membrane-Function-Disturbing Drugs</b>					
1975	Praziquantel		xx		<i>Giardia*</i> , <i>E. histolytica*</i> , trematodes, cestodes
<b>Drugs with Unknown Antiparasitic Mechanism of Action</b>					
1964	Hetolin		x		

xxx = high efficacy at least against some developmental stages and diverse species; xx = partially effective (regarding developmental stages and diversity of species); x = slightly effective

represents the most toxic and abundant member of about 13 rotenoids. Three other members also have been reported to show insecticidal activity but are less potent than rotenone: deguelin, tephrosine, toxicarol with 10%, 2.5%, and 0.25% of the rotenone activity, respectively (Fig. 2). In the last 40 years rotenone has been intensively used. The world production is in the range of 10–20t.

### Molecular Interactions

Rotenone acts as an inhibitor of the electron transport system (site one) of the →mitochondrial respiratory chain. It inhibits the oxidation of NADH to NAD via coenzyme Q (reducing quinone to hydroquinone), thus also blocking the oxidation by NAD of substrates such as →glutamate, α-ketoglutarate, and pyruvate.

Rotenone is a nonsystemic selective insecticide with secondary acaricidal activity with contact and stomach action. It is used for the control of →lice, →ticks, and warble flies and against fire ants in premises as well as mosquito larvae (ponds). Today, its primary use as an ectoparasiticide is against ear →mites and demodectic mange and in combination with other ectoparasiticides like organophosphates and pyrethroids against sheep ectoparasites. Inactivation by photo-oxidation limits the use of rotenone as a single product when long residual activity is required. The LD<sub>50</sub> of acute oral toxicity for rats is 132–1500 mg/kg. The estimated lethal dose for oral application of rotenone for humans is 300–500 mg/kg. Rotenone is highly toxic for mammals upon injection (LD<sub>50</sub> 0.1–4 mg/kg). Rotenone is highly toxic to pigs but shows no toxicity to bees. The compound is also used as fish toxicant in fish management. Rotenone is metabolized in the rat liver or insect by enzymatic opening and cleaving of the furan moiety or, alternatively, by oxidation of the methyl group of the isopropenyl residue.

### Resistance

Resistance of ectoparasites against rotenone has not yet been described.

### Iodoquinol

#### Synonyms

5,7-diiodo-8-hydroxyquinoline, SS578, Diodoquin, Di-Quinol, Disoquin, Floraquin, Dyodin, Dinoleine, Searlequin, Diodoxylin, Moebiquin, Rafembin, Ioquin, Direxioide, Stanquinat, Quinadome, Yodoxin, Zoquin, Enterosept, Embequin.

### Cells and Cellular Interactions

Iodoquinol is active against →*Entamoeba histolytica* and against facultative pathogenic *Entamoeba* spp. such

as *Dientamoeba fragilis*. The activity of iodoquinol is directed against →trophozoites (minuta forms) in the intestinal mucosa and cysts in the feces (→DNA-Synthesis-Affecting Drugs I/Table 1).

### Molecular Interactions

The mechanism of action is unknown. It is tempting to speculate from some structural similarities with hydroxyquinolines that iodoquinol may interfere with the energy metabolism (→oxidative phosphorylation, inhibition of ATPase) in amoebes.

### Nitazoxanide

#### Synonyms

2-acetoxloxy-N-(5-nitro-2-thiazolyl)benzamide.

### Clinical Relevance

The drug was first described in 1984 as a human cestocidal drug against *Taenia saginata* and *Hymenolepis nana*. In 1994 development of nitazoxanide was re-initiated as an antiprotozoal agent. It is active against anaerobic protozoa and bacteria (*Trichomonas vaginalis*, *Entamoeba histolytica* and *Clostridium perfringens*) (→DNA-Synthesis-Affecting Drugs I/Table 1). However, nitazoxanide possesses broad-spectrum antiparasitic activities against protozoa, cestodes, and nematodes with modest to high cure rates depending on the degree of infection (light, moderate, heavy). Thus, the drug is effective against *E. histolytica*, *Giardia intestinalis*, *Isospora belli*, *Balantidium coli*, *Blastocystis hominis*, *Hymenolepis nana*, *Ascaris lumbricoides*, *Ancylostoma duodenale*, *Trichuris trichiura* and *Strongyloides stercoralis*.

Moreover, nitazoxanide had resolved diarrhoea caused by *Cryptosporidium parvum* in more than 80% of patients 7 days after beginning therapy. 67% of patients treated with the drug did not produce *C. parvum* oocysts. There are also studies in AIDS patients conducted in Africa and Mexico with favorable results.

### Molecular Interactions

Experiments in the anaerobic protozoa *T. vaginalis* and *E. histolytica* as well as in the bacteria *C. perfringens* and *Helicobacter pylori* have shown that nitazoxanide inhibits pyruvate ferredoxin oxidoreductase (PFOR), the vital enzyme of the central intermediary metabolism. By contrast to the nitroimidazoles, nitazoxanide seems to interact directly with PFOR and the products of nitazoxanide activation do not induce mutations in DNA. This different mechanism of action is important in explaining the therapeutic efficacy of this drug

**Energy-Metabolism-Disturbing Drugs. Table 2** Activity of drugs against other trematodes of human importance

Drug	Intestinal flukes	Liver flukes	Lung flukes
Energy-Metabolism-Disturbing Drugs			
niclofolan	Metagonimus (x)		
bithionol			Paragonimus (xxx)
dichlorophene	Fasciolopsis (x)		
resorantel	Gastrodiscoides (xxx)		
niclosamide	Fasciolopsis, Metagonimus, Heterophyes, Echinostoma, Gastrodiscoides, Watsonius, Nanophyetes (xxx)		
Hem(oglobin) Interaction			
chloroquine		Clonorchis (x)	
Membrane-Function-Disturbing Drugs			
praziquantel	Fasciolopsis, Metagonimus, Heterophyes, Echinostoma, Gastrodiscoides, Watsonius, Nanophyetes (xxx)	Clonorchis, Opisthorchis, Metorchis	Paragonimus (xxx)
Microtubule-Function-Disturbing Drugs			
Triclabendazole		Fasciola hepatica (xxx)	Paragonimus (xxx)
Drugs with Unknown Antiparasitic Mechanism of Action			
hexachloroparaxylene		Clonorchis (x)	
hexachloroethane	Fasciolopsis (x)		
hexylresorcinol	Fasciolopsis (x)		
tetrachloroethylene	Fasciolopsis, Metagonimus, Heterophyes, Echinostoma, Gastrodiscoides, Watsonius, Nanophyetes (x)		

xxx = high efficacy at least against some developmental stages and diverse species; xx = partly effective (regarding developmental stages and diversity of species); x = slightly effective

against metronidazole-resistant protozoa. The molecular mechanism of nitazoxanide in helminths is unclear at present.

## Suramin

### Synonyms

Bayer 205, 309F, Antrypol, Germanin, Moranyl, Naganol, Naganin, Naphuride Sodium.

### General Information

Suramin was explored in 1916 and originally introduced in 1922 as a trypanosomicidal drug in cattle.

### Molecular Interactions

Suramin is chemically a sulfonic acid and structurally related to dyes such as trypanred, eboliblue, or trypanviolet. The six negative charges at physiological pH may be of great importance for the proposed [mode of action](#). The action of suramin is directed against [trypomastigotes](#) of *Trypanosoma brucei gambiense* and *T. b. rhodesiense* in the blood dividing by [binary fission](#). The drug is taken up by trypanosomes via receptor-mediated [endocytosis](#) in presence of serum proteins 18-fold higher compared to the normal fluid endocytosis alone. Intracellular suramin concentrations

(about 100  $\mu\text{M}$ ) are equivalent to exogenous drug concentrations. Suramin is bound to albumin and low density lipoprotein (LDL) resulting on the one hand in reduced host toxicity but on the other hand leading to an inhibition of intralysosomal proteolysis in the host cell. The complexation of suramin to albumin is also responsible for a reduced total amount of free drug in the [cytoplasm](#) of host cells.

The antitrypanosomal action of suramin on the molecular level is relatively unclear. There are reports on the inhibition of a variety of kinases and dehydrogenases from mammalian, bacterial, and fungal cells. In trypanosomes glycerol-3-phosphate oxidase and glycerol-3-phosphate dehydrogenase become inhibited, resulting in a disturbed redox balance within the trypanosomal cell and a decreased ATP-synthesis rate ([Fig. 3](#)). In addition, other enzymes of *T. brucei* such as DHFR, thymidine kinase, and a number of glycolytic enzymes (hexokinase, phosphoglucosomerase, phosphofructokinase, triosephosphate isomerase, aldolase, glyceraldehyde-3-phosphate dehydrogenase, phosphoglycerate kinase, glycerol-3-phosphate dehydrogenase, and [glycerol](#) kinase) become inhibited. The  $\text{IC}_{50}$  values of suramin on trypanosomal glycolytic enzymes (between 10 and 100  $\mu\text{M}$ ) are much lower compared to the corresponding enzymes from mammalian cells.

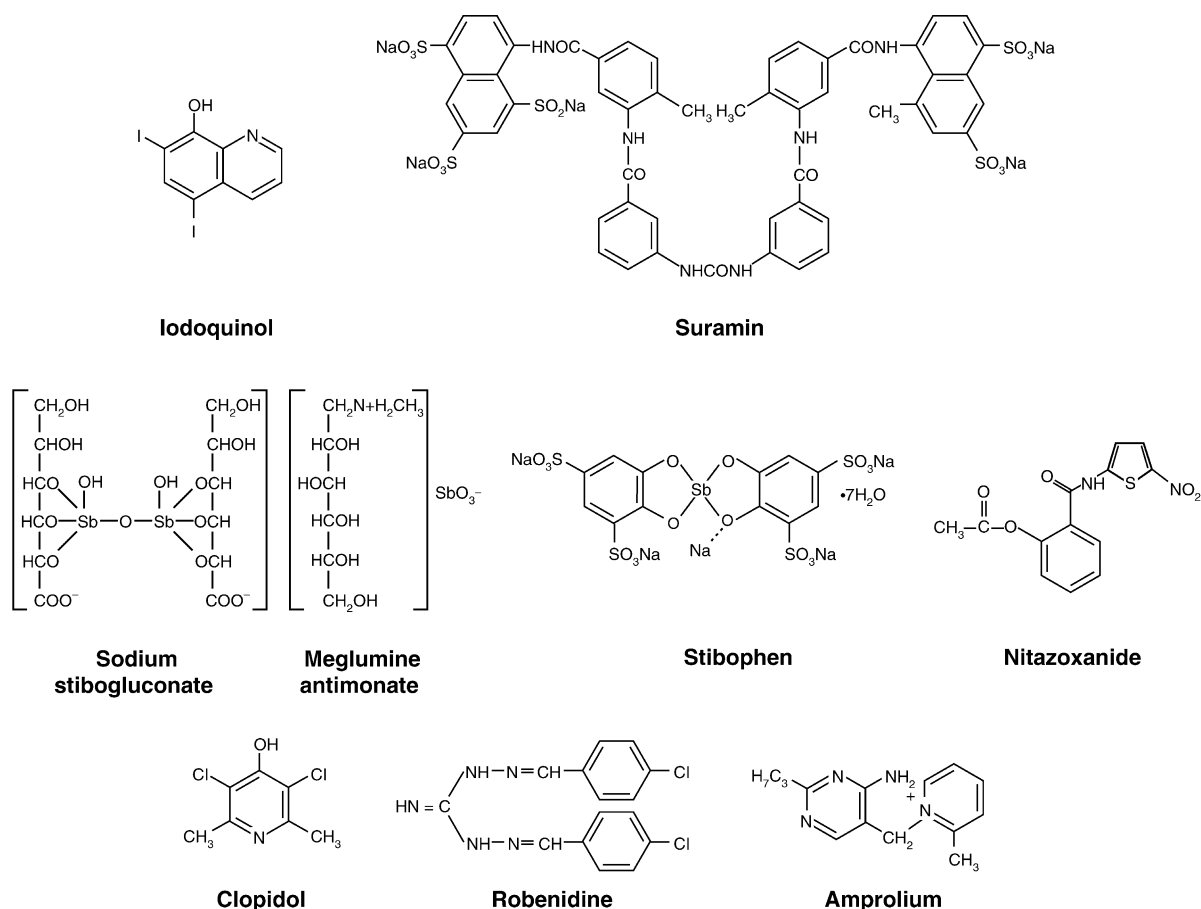

**Energy-Metabolism-Disturbing Drugs. Figure 1** Structures of drugs affecting →energy metabolism.

The reason for the selective toxicity may be explained by the unusually high isoelectric points (between 9 and 10) for most of the glycolytic enzymes from *T. brucei*. The basic properties of the trypanosomal glycolytic enzymes resulting in additional positive charges on their surfaces may facilitate the binding of the highly negatively charged suramin. Thus, there are likely to be potentiated inhibitory effects by electrostatic interactions between positively charged trypanosomal enzymes and negatively charged suramin, and there is no direct inhibition of trypanosomal glycolytic enzymes in →glycosomes.

A further hypothesis for the suramin action on the molecular level is as follows. The nine glycolytic enzymes are synthesized on free →polysomes in the parasite's cytoplasm. These enzymes are then imported into the glycosomes post-translationally without any proteolytic modification within 3–5 minutes and become thus protected from suramin by compartmentalization in the glycosomes. Suramin possibly binds to the glycolytic enzymes in the cytoplasm on their way to the glycosome and/or interferes with their import into the glycosomes

(Fig. 3). The inhibition of glycosomal protein import is followed by a gradual decrease of enzyme concentrations in the glycosomes. The average half-life of glycolytic enzymes is about 48 h inside the glycosomes. By this action suramin induces a slowing down of energy metabolism in suramin-treated trypanosomes. The inhibition of the import of glycosomal protein is either partially or totally with disruption of →glycolysis in the trypanosomes.

An additional hypothetical action of suramin is the indirect interaction with the DNA/RNA-replication resulting in retarded trypanocidal activity after 24–36 h corresponding to 4–7 divisions.

The antifilarial activity of suramin is directed against →macrofilariae and to a minor degree against microfilariae of →*Onchocerca volvulus* (→River Blindness). For a long time it was the only drug against adult *O. volvulus* in man, but today the use of suramin is limited. The antifilarial mechanism against *O. volvulus* is delayed (4–7 weeks after treatment). An inhibition of the cAMP-independent protein kinase I in *O. volvulus* is discussed. This protein is also the target

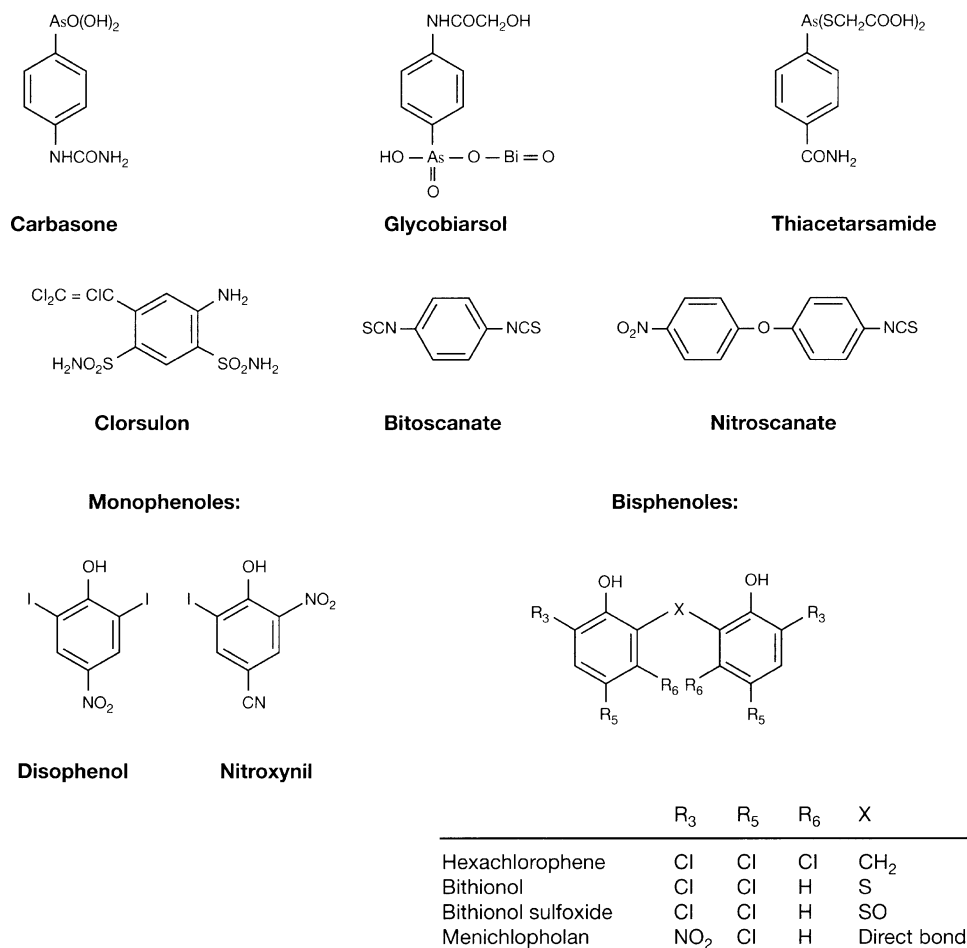

**Energy-Metabolism-Disturbing Drugs. Figure 1** Structures of drugs affecting  $\rightarrow$ energy metabolism. (Continued)

of suramin and stibophen against  $\rightarrow$ *Ascaridia galli* *in vitro*. Suramin further exerts curative effects against  $\rightarrow$ *Wuchereria bancrofti* filariasis and in addition shows effectivity against all stages of *Litomosoides carinii*. There is a requirement for intravenous injection which is accompanied by severe side effects. Suramin leads to a sterilization of adult filariae. *L. carinii* in *Mastomys coucha* are killed within 6 weeks. Despite great chemical-synthetic efforts there is no possibility for improvement of better tolerability without loss of filaricidal activity. In general there is no correlation between filaricidal effects of suramin derivatives and trypanosomicidal activity.

#### Additional Features

Suramin has additional activities against a wide variety of pathogens. Thus it is a potential anti-AIDS drug, due to a potent inhibitory effect on the reverse transcriptase from a variety of retroviruses. In addition, an inhibitory effect on DNA polymerase activity is discussed.

#### Clinical Relevance

The main indication of suramin relies on the activity against early stages (bloodstream forms) of human African trypanosomes (*T. b. gambiense* and *T. b. rhodesiense*) ( $\rightarrow$ DNA-Synthesis-Affecting Drugs III/Table 1). Suramin is usually given with five intravenous injections at a dosage of 20 mg/kg b.w. once every 5–7 days. In veterinary medicine the drug exerts efficacies against *T. b. brucei* ( $\rightarrow$ Nagana), *T. b. evansi* ( $\rightarrow$ Surra), and *T. equiperdum* ( $\rightarrow$ Dourine). In addition, suramin has experimental activity against *Entamoeba histolytica*,  $\rightarrow$ *Eimeria* spp., and avian  $\rightarrow$ malaria.

#### Resistance

The mechanism of resistance of suramin on the molecular level is unclear. Generally the resistance to suramin is rare even after 70 years of application in trypanosomiasis field clinics. This might be an indirect support for the hypothetical action on multiple targets in trypanosomes.



## Salicylanilides:

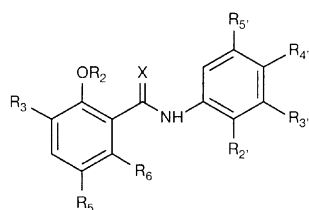

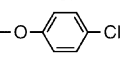
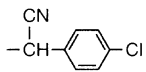
	R <sub>2</sub>	R <sub>3</sub>	R <sub>5</sub>	R <sub>6</sub>	X	R <sub>2'</sub>	R <sub>3'</sub>	R <sub>4'</sub>	R <sub>5'</sub>
Tribromsalan	H	Br	Br	H	O	H	H	Br	H
Oxyclozanide	H	Cl	Cl	Cl	O	OH	Cl	H	Cl
Clioanide	COCH <sub>3</sub>	I	I	H	O	H	H	Cl	H
Rafoxanide	H	I	I	H	O	H	Cl		H
Brotianide	COCH <sub>3</sub>	Br	Cl	H	S	H	H	Br	H
Bromoxanide	H	C(CH <sub>3</sub> ) <sub>3</sub>	NO <sub>2</sub>	CH <sub>3</sub>	O	CF <sub>3</sub>	H	Br	H
Closantel	H	I	I	H	O	CH <sub>3</sub>	H		Cl
Resorantel	H	H	H	OH	O	H	H	Br	H
Niclosamide	H	H	Cl	H	O	H	H	NO <sub>2</sub>	Cl

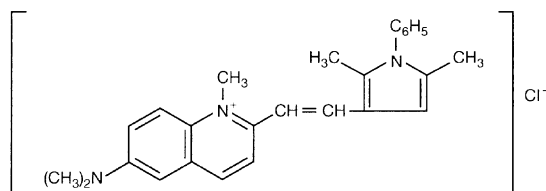

Pyrvinium chloride

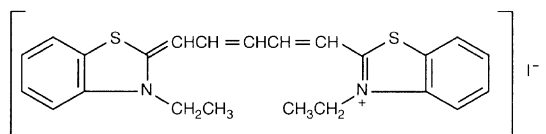

Dithiazanine iodide

Energy-Metabolism-Disturbing Drugs. Figure 1 Structures of drugs affecting →energy metabolism. (Continued)

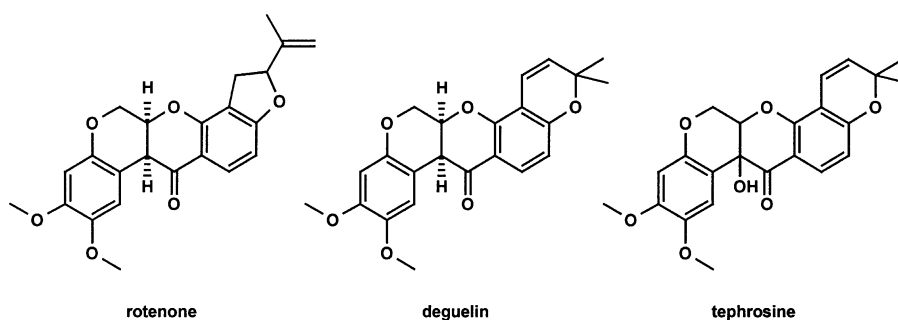

Energy-Metabolism-Disturbing Drugs. Figure 2 Structure of important rotenoids with insecticidal efficacy.

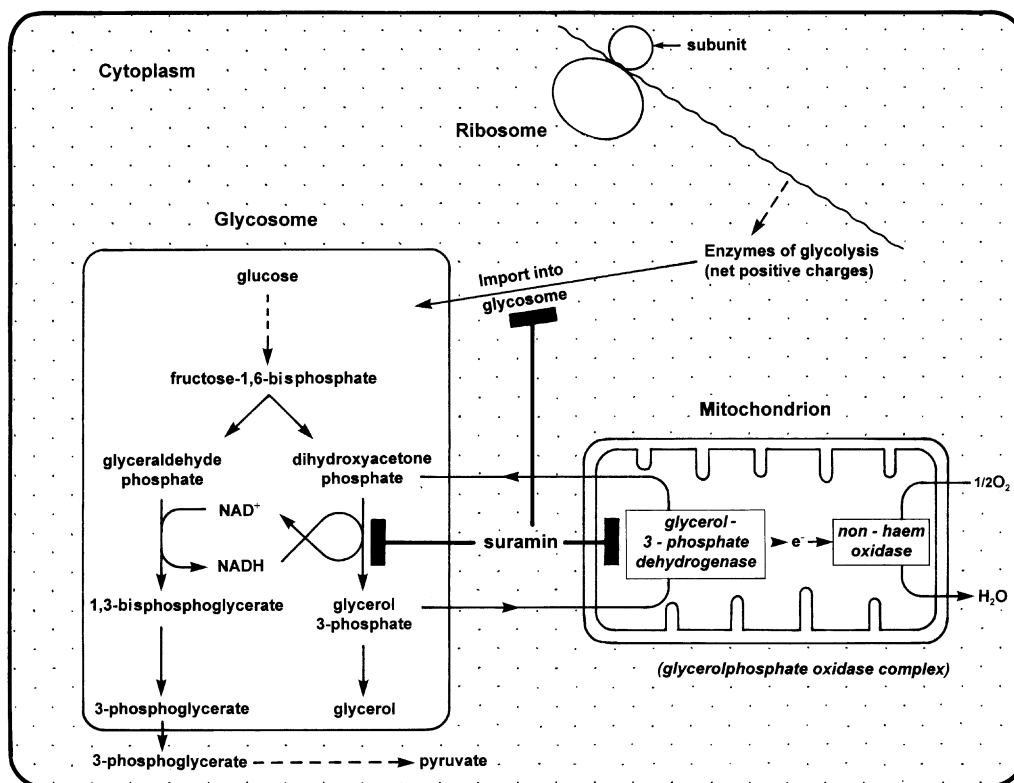

**Energy-Metabolism-Disturbing Drugs. Figure 3** Target enzymes of suramin; metabolic processes impaired by suramin are indicated by the symbol —|; highly schematic representation of trypanosomal cell organelles and their metabolic processes; relationships of the magnitudes of organelles are not correct.

## Antimonials

### Important Compounds

Sodium-stibogluconate, Meglumine-antimonate, Stibophen.

### Synonyms

Sodium-stibogluconate: Antimony sodium gluconate, Pentostam, Myostibin, Solustibosan, Solyusurmin, Stibanate, Stibanose, Stibatin, Stibinol.

Meglumine-antimonate: N-methylglucamine antimonate, glucantime.

Stibophen: Sodium antimony bis(pyrocatechol-2,4-disulfonate), Sdt 91, Fuadin, Fouadin, Pyrostib, Corystibin, Trimon, Fantorin, Repodral, Neoantimosan, Sodium Antimosan.

### Cells and Cellular Interactions

The antiprotozoal activity of the antimonials sodium-stibogluconate and meglumine-antimonate is directed against cutaneous, visceral, and mucocutaneous leishmaniasis (→DNA-Synthesis-Affecting Drugs II/Table 1). They have no activity against cultured leishmanial →promastigotes. Stibophen shows besides the activity

against *Leishmania tropica* and *L. mexicana* also activity against →*Schistosoma haematobium*.

### Molecular Interactions

The mechanisms of antiprotozoal action of the pentavalent antimonials sodium-stibogluconate and meglumine-antimonate rely on their reduction to the corresponding trivalent antimonials by host metabolism. The activity is directed against those stages dividing by repeated binary fissions such as *L. donovani* and *L. chagasi* in spleen, liver, and skin stages, intracellular →amastigotes of *L. tropica*, *L. major* in the skin and *L. brasiliensis* and *L. mexicana* in mucous tissues of nose and mouth. Thereby, presumably those enzymes with sulfhydryl groups become inactivated by trivalent antimonials. Thus, the inhibition of cytoplasmic pyruvate kinase and other kinases with reactive sulfhydryl groups at their active sites results in a decreased flow of glucose into the citrate cycle in *L. tropica* promastigotes in presence of trivalent antimonials, in addition, there is an accumulation of glycolytic metabolites and a disturbance of energy production within the parasites. As an alternative hypothesis a disruption of

trypanothione reductase (TR) by antimonials is discussed. The real mode of antileishmanial action of the antimonials is yet unknown.

The antitrepatodal action of stibophen may be explained by the inhibition of phosphofructokinase of →*Schistosoma mansoni*.

### Resistance

Resistance against pentavalent antimonials is an increasing problem varying between 5%–70% of patients in some endemic areas. Resistant →*Leishmania* isolates tolerate concentrations of antimonials, which are 100-fold higher than the maximal achievable serum levels of drugs in humans.

The real mechanism of resistance against antileishmanial antimonials is still unknown. Biochemical studies indicate that there is a decreased accumulation of sodium-stibogluconate in resistant cell lines. It remains, however, unclear whether there is a decreased uptake or an increased efflux of drug. The resistance of *Leishmania* spp. against pentavalent antimonials can be reversed *in vitro* and *in vivo* by verapamil indicating a P-glycoprotein-mediated resistance mechanism.

In addition, it was proposed that the resistance mechanism in *Leishmania* spp. against antimonials is based on gene amplifications. Such a mechanism is proposed for the resistance against different compounds such as methotrexate, arsenite, tunicamycin, DFMO, mycophenolic acid, and vinblastine.

### Clopidol

#### Synonyms

Meticlorpindol, Clopidol, Coyden; in combinations: Lerbek (= Meticlorpindol + Methylbenzoate).

#### Cells and Cellular Interactions

The antiprotozoal activity of clopidol is directed against *Eimeria* spp. in chicken (→DNA-Synthesis-Affecting Drugs IV/Table 1). Clopidol leads to an inhibition of the development of sporozoites and trophozoites.

#### Molecular Interactions

Clopidol is a pyridone-derivative structurally related to the →quinolones. Its real mode of action is unclear to date. There is no interference with mitochondrial respiration of *E. tenella*. Synergistic effects between clopidol and methylbenzoate indicate that the action of clopidol may be similar but not identical to that of quinolones. The differences are probably due to an alternative pathway of electron transport in coccidial →mitochondria with specific sensitivity to clopidol.

#### Resistance

There is cross-resistance between methylbenzoate and clopidol in strains of *E. maxima*. The resistance

against clopidol in a methylbenzoate-resistant strain appears after many passages in chicken.

The mechanism of resistance against clopidol is unclear.

### Robenidine

#### Synonyms

Robenzidene, Cycostat, Robenz.

#### Cells and Cellular Interactions

The antiprotozoal activity of robenidine is directed against all five economically important *Eimeria* spp. in poultry (*E. acervulina*, *E. maxima*, *E. necatrix*, *E. tenella*, and *E. brunetti*) (→DNA-Synthesis-Affecting Drugs IV/Table 1). Furthermore Robenidine exerts activity against →*Neospora caninum* →tachyzoites in cell cultures.

#### Molecular Interactions

Robenidine acts against developing first generation schizonts by possible interference with the oxidative phosphorylation and ATPase in mitochondria of *Eimeria* spp. and rat liver mitochondria. In chicken erythrocytes there is an induction of efflux of K<sup>+</sup>-ions observable.

### Amprolium

#### Synonyms

1-((4-amino-2-propyl-5-pyrimidinyl)methyl)-2-picolinium chloride, Corid, Amprol, Amprovine; in combinations: Amprol Plus, Amprol Hi-E, Amprolmix, Pancoxin, Supracox.

#### Cells and Cellular Interactions

Amprolium has been used for the therapy of coccidiosis in poultry, zoo birds, and mammals since 1960. It has activity against *Eimeria tenella*, *E. maxima*, and *E. necatrix* (→DNA-Synthesis-Affecting Drugs IV/Table 1). The action of amprolium is directed against →wall-forming bodies II of schizonts of the first and second generation.

#### Molecular Interactions

Amprolium is structurally related to thiamine, but lacks the hydroxymethyl group of this vitamin. Thus, the phosphorylation to the corresponding thiamine pyrophosphate analogue is abrogated. Thiamine is an essential cofactor for →pyruvate dehydrogenase activity, which is interestingly also the site of inhibition by antiprotozoal arsenicals. Amprolium competitively inhibits the transport of thiamine across the cell membranes of second generation schizonts. Amprolium possesses a high therapeutic index which may be explained by differences of thiamine transport rates between chicken epithelial cells and *Eimeria* spp.

#### Resistance

The mechanism of resistance against amprolium is explained by a modification of the target receptor

resulting in a decreased sensitivity to inhibition. The  $K_i$ -value for amprolium is increased nearly 15-fold to 115  $\mu$ M in the resistant *E. tenella* strain.

## Arsenicals

### Important Compounds

Carbasone, Glycobiarsol, Melarsoprol, Thiacetarsamide, Mel PH, R7/45.

### Synonyms

Carbasone: N-carbamoylarsanilic acid, Amebevan, Ameban, Amibiarsol, Arsambide, Carb-O-Sep, Histocarb, Fenarsone, Leucarsone, Aminarsone, Amebarsone.

Glycobiarsol: Bismuth glycolylarsanilate, Broxolin, Dysentulin, Milibis, Viasept, Wintodon.

Thiacetarsamide: Arsenamide, Thioarsenite, Caparsolate, Caparside, Arsphenamide, Filicide, Filaramide.

### Clinical Relevance

The great interest in arsenicals at the beginning of the 20th century relied on their antibacterial activities. Thus, 4-arsanilic acid sodium (**Atoxyl**) and Salvarsan were the first drugs to be active against syphilis.

**Carbasone** as one of the antiprotozoal arsenicals was introduced in 1931 against infections with  $\rightarrow$ *Trichomonas vaginalis* and *Entamoeba histolytica*. **Glycobiarsol** introduced in 1938 exerts activities against *T. vaginalis*, *E. histolytica*, and  $\rightarrow$ *Giardia lamblia*. **Melarsoprol** is still one of the drugs of choice for the treatment of late stage  $\rightarrow$ sleeping sickness caused by *Trypanosoma brucei gambiense* or *T. b. rhodesiense*. Arsanilic acid and roxarsone exhibit activity against *E. tenella* sporozoites. **Acetarson**e in combination with arecoline was used as an anticestodal drug in small animals. In addition, sodium arsanilic acid in combination with copper sulfate has antinematodal activities against  $\rightarrow$ nematodes in ruminants. The macrofilaricidal efficacy of arsenicals is also known for a long time. Interestingly, all arsenicals obtain almost exclusively adulticidal effects which is clinically proven in man. **Thiacetarsamide** potassium is a drug routinely used against  $\rightarrow$ *Dirofilaria immitis* in the dog ( $\rightarrow$ Inhibitory-Neurotransmission-Affecting Drugs/Table 1). Another arsenical is **melarsomine** used as adulticide against *D. immitis* in dogs. The main disadvantage of the arsenicals are their severe side effects, such as the arsenical encephalopathy. In the meantime new and less toxic organic arsenicals such as **Mel PH** and **R7/45** have been developed. In general, there are no marked reductions of microfilariaemia levels until day 7 p.i. and the adulticidal efficacy of drugs varies with the parasite species. Thus, thiacetarsamide is much more active against *Brugia* spp. than other arsenicals;  $\rightarrow$ *Acanthocheilonema viteae* is more resistant to Mel PH

and **R7/45** than *Litomosoides carinii* and *B. malayi*. Arsenicals exert better activity against female *L. carinii* and *B. malayi* than against males whereas both worm sexes of *A. viteae* are equally sensitive to arsenicals.

### Molecular Interactions

The mechanism of action of antiprotozoal arsenicals is presumably due to an inhibition of glycolytic enzymes and/or protein kinases with SH-groups. Also trypanothione reductase may be a target of some arsenical compounds such as melarsoprol ( $\rightarrow$ DNA-Synthesis-Affecting Drugs III/Fig. 1).

The antifilarial arsenicals lead to an *in vitro* and *in vivo* inhibition of  $\rightarrow$ glutathione reductase as shown in *L. carinii* adults. Thereby, the parasitic enzyme is more susceptible to inhibition than the corresponding mammalian enzyme.

## Clorsulon

### Synonyms

L-631,529, MK-401, Curatrem, in combinations: Ivomec Plus.

### Clinical Relevance

Clorsulon belongs to the fasciolicidal drugs (Table 1) with good activity against  $\rightarrow$ liver flukes ( $\rightarrow$ *Fasciola hepatica*) from the age of four weeks. It has low toxicity and is excreted rapidly. Clorsulon is suitable for the use in meat-producing animals. Now clorsulon is used in combination with ivermectin (Ivomec F).

### Molecular Interactions

It is the only one of the most commonly used fasciolicides whose action is directed against glycolysis on the level of 3-phosphoglycerate kinase and phosphoglyceromutase. There is no great disruption of glycolysis *in vivo* by clorsulon. At a concentration of 500  $\mu$ g/ml for 1 hour the glucose utilization is decreased by 60%, formation of acetate and propionate is inhibited by 54% and 85%, respectively, and ATP levels are reduced by 67%. The motility of the  $\rightarrow$ flukes is gradually suppressed ending in a flaccid paralysis which may be explained by the slow depletion of energy reserves and cessation of feeding. Until now there are no reports about clorsulon resistance.

## Isothiocyanates

### Important Compounds

Bitoscanate, Nitroscanate.

### Synonyms

Bitoscanate: Jonit, Bitovermol, Sicur.

Nitroscanate: Lopatol, Cantrodifene, Canverm.

**Clinical Relevance**

Nitroscanate was introduced in 1973. Its anticestodal activity is directed against → *Taenia* spp., → *Dipylidium caninum* and *Echinococcus granulosus* in dogs (→ **Membrane-Function-Disturbing Drugs/**Table 1). Furthermore, nitroscanate is used in dogs against → hookworms and → *Toxocara* spp. Bitoscanate exerts activities against → *Ancylostoma* and *Necator*.

**Molecular Interactions**

There are no data about the mode of action of nitroscanate in → cestodes. There is one report showing that the → **ATP synthesis** in the trematode *Fasciola hepatica* is inhibited (Fig. 4).

**Halogenated Monophenols****Synonyms**

Disophenol: Ancylool, DNP, Iodophene, Syngamix.  
Nitroxynil: Fasciolid, Dovenix, Trodax.

**Clinical Relevance**

Disophenol and nitroxynil are two members of monophenols with antitrematodal activity against *Fasciola hepatica* (Table 1). Moreover, disophenol exerts antinematodal activity against → *Haemonchus contortus*.

**Halogenated Bisphenols****Important Compounds**

Bithionol, bithionol sulfoxide, Meniclopholan.

**Synonyms**

Bithionol: Actamer, Bitin, Lorotheidol.  
Bithionol sulfoxide: Bitin-S, Disto-5.  
Meniclopholan: Niclofolan, Bayer 9015, Me 3625, Bilevon-M, Dertil, Distolon.

**Clinical Relevance**

Bithionol and bithionol sulfoxide (so-called thiobisphenols) were the first members of the class of halogenated bisphenols discovered in the 1930s. Dichlorophene was introduced in 1946 and hexachlorophene in the late 1950s. The anticestodal activity of these drugs is directed against *Taenia saginata*, → *T. solium*, *Diphyllobothrium latum*. They have some effects against *Hymenolepis nana*. These compounds are now replaced by more active drugs.

Hexachlorophene has some additional antitrematodal activity against mature *Fasciola hepatica*, → *Dicrocoelium dendriticum*, adult paramphistomes (Table 1). Dichlorophene shows activity against → *Fasciolopsis buski* (Table 2) and bithionol against → *Paragonimus* spp. (Table 2). Furthermore, bithionol is active against immature and adult paramphistomes (Table 1). However, it is toxic at the effective antitrematodal dose rate. Another member of the bisphenols, meniclopholan (= niclofolan) has fasciolocidal activity and high effectivity against immature paramphistomes in sheep (Table 1), but not against immature and adult flukes in cattle. Niclofolan exhibits additional activity against → *Metagonimus* spp. (Table 2).

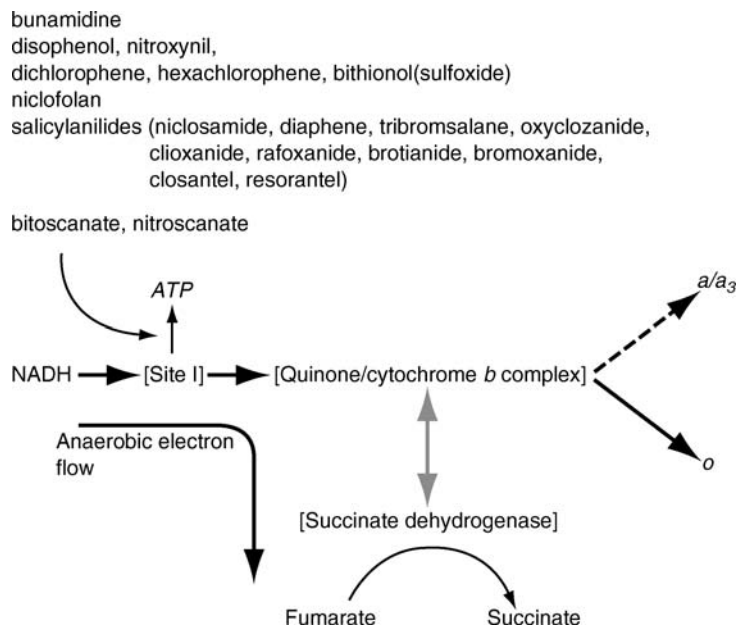

**Energy-Metabolism-Disturbing Drugs. Figure 4** Action of anthelmintics by uncoupling of oxidative phosphorylation.

## Characteristics

The structure-activity relationships for the fasciolocidal activity of bisphenols are similar to that for monophenols. The safety index of monophenols and bisphenols is generally rather low between 1 and 4. Disophenol and nitroxynil obtain as electron-withdrawing substituents halogen, nitro, or cyano groups, which are necessary in at least the ortho- and/or para-positions of the phenol for the fasciolocidal activity. Nitroxynil, niclofolan, bithionol, and hexachlorophene have structural similarity to 2,4-dinitrophenol, a known uncoupler of oxidative phosphorylation in mammalian systems (Fig. 4).

## Molecular Interactions

The mode of action studies with mono- and bisphenols have been carried out in isolated cestodal or mammalian mitochondria but not in liver flukes. Nevertheless, it is proposed that the action of monophenols and bisphenols relies on the decrease of ATP synthesis.

## Salicylanilides

### Important Compounds

Niclosamide, Oxyclozanide, Clioanide, Rafoxanide, Brotianide, Bromoxanide, Closantel, Resorantel.

### Synonyms

Niclosamide: Mansonil-P, Lintex-M, Mansonil-M, Yomesan, Bayluscid, Cestocid, Devermin, Fenasal, Radeverm, Sagimid, Tredemine, Vermitin.

Oxyclozanide: 3,3',5,5',6-Pentachloro-2'-hydroxysalicylanilide, Zanyl, Diplin, Metiljin.

Clioanide: 2-Acetoxy-4'-chloro-3,5-diiodobenzanilide, Tremerad.

Rafoxanide: 3'-Chloro-4'-(p-chlorophenoxy)-3,5-diiodosalicylanilide, MK-990, Bovanide, Duofas, Flukanide, Ranide, Ursovermid.

Brotianide: 3,4'-Dibromo-5-chlorothiosalicylanilide acetate, Bay 4059, Dirian.

Bromoxanide: none.

Closantel: Flukiver, Seponver.

Resorantel: Resorcytan, Terenol.

## Clinical Relevance

The first salicylanilide niclosamide was discovered in 1958 and introduced in the early 1960s as anticestodal drug. The fasciolocidal activity of diaphene was discovered in 1963.

Niclosamide exerts anticestodal activity (→[Membrane-Function-Disturbing Drugs/](#)Table 1). It was the drug of choice in cestodiasis before the discovery of praziquantel. It has high curative efficacy against *Taenia saginata*, *T. solium*, *Diphyllobothrium latum*, *Hymenolepis nana*, →[Mesocestoides](#) spp., and *Dipylidium*

spp., but only low activity against *Echinococcus granulosus*. Its absorption from the intestinal tract is poor (only 2%–25% absorption in the first four days), and it is not accumulated in any organ. More than 70% of the drug is excreted via feces and the excretion is completed within 1–2 days. Resorantel, another salicylanilide, exhibits anticestodal activity against →[Moniezia expansa](#) in ruminants.

In general, the antitrepatodal activities are the main actions of salicylanilides. Niclosamide exerts activity against immature paramphistomes. It is regarded as the most effective and safe compound for the control of an outbreak of paramphistomiasis (Table 1). However, it has no effectivity against adult paramphistomes in ruminants. In general, drugs with high efficacy against the adult flukes are not active enough for elimination of pasture contamination. Furthermore Niclosamide has activities against intestinal flukes (*Fasciolopsis*, *Metagonimus*, *Heterophyes*, *Echinostoma*, *Gastrodiscoides*, *Watsonius*, *Nanophyetes*) (Table 2), but it is not active against *Fasciola hepatica*.

Diaphene is a mixture of 3,4,5'-tribromosalicylanilide (**tribromsalane**), the main component and fasciolocidal compound, and 4',5-dibromosalicylanilide used as a germicide. Tribromsalane was a new lead structure in the 1960s for a variety of salicylanilides such as **oxyclozanide**, **clioanide**, **rafoxanide**, **brotianide**, **bromoxanide**, and **closantel**. Salicylanilides show an increased potency against adult and particularly also against immature flukes. They possess a greater therapeutic index between 4 and 6 compared to the halogenated phenols with a therapeutic index between 1 and 4. With salicylanilides mass treatment of sheep and cattle is possible for the first time, because they have good activity against 4–6 week old immature flukes.

Resorantel, a 4'-bromo-γ-resorcytanilide-derivative, is a specific and the most effective drug against immature and adult paramphistomes in sheep, goats, and cattle with slightly erratic, but good efficacy. In addition it has some activity against *Gastrodiscoides* (Table 2).

Oxyclozanide is probably the most suitable drug for the control of an outbreak of acute intestinal paramphistomes in calves, especially in concurrent *Fasciola*-infections.

Besides their anticestodal and antitrepatodal activity, salicylanilides are also active against some nematodes. Thus, rafoxanide and closantel are active against the blood-ingesting nematode *Haemonchus contortus* (Table 1).

## Molecular Interactions

The mechanism of the anticestodal action of niclosamide is the uncoupling of oxidative phosphorylation from electron transport in cestodes (Fig. 4). Thereby, protons are translocated through the inner

mitochondrial membrane. There is a measurable decrease of ATP synthesis in →*Ascaris* muscle mitochondria. The selective toxicity of niclosamide is explained by its poor absorption from the host intestine resulting in a protection of host cells against the uncoupling properties of this drug.

The fasciolicidal salicylanilides possess highly lipophilic groups like iodine, chlorophenoxy, tert-butyl-substituents which are responsible for prolonged plasma half-lives between 2–4 days. Rafoxanide and bromoxanide have even longer half-lives of 5–6 days. Moreover, there is slow excretion resulting in persistent drug residues. Therefore, several weeks of withdrawal periods before slaughter are necessary and most of the phenol-type fasciolicides are not used for treatment of milk-producing ruminants.

For rafoxanide, oxcyclozanide, and closantel there is more direct evidence for an uncoupling action within the fluke (Fig. 4). An increased end-product formation by 32% and decreased ATP-synthesis by 29% by rafoxanide can be detected. Furthermore, there is an increased glucose uptake, decreased →glycogen content, enhanced end-product formation (succinate), increased mitochondrial ATPase activity, reduced ATP levels by closantel. A probable correlation between death of the flukes and reduced ATP levels is discussed. A deformation of mitochondria in many fluke tissues is observable. The →Golgi apparatus in the tegumental and gastrodermal cells is reduced in size and contains vacuolated cisternae. The basal infolds of the →tegument are swollen and ion pumps associated with the tegumental membranes are inhibited. There is as a result a general induction of rapid spastic paralysis of the adult flukes by the action of the presumptive uncoupler-type fasciolicides such as rafoxanide, oxcyclozanide, nitroxylin.

### Resistance

A selection of resistant strains of *Fasciola hepatica* in Australia has occurred by prolonged use of rafoxanide and closantel. There is cross-resistance between salicylanilides and the halogenated phenol nitroxylin. The resistance is manifest against immature but rarely against adult flukes. There is no side resistance in rafoxanide- and closantel-resistant liver flukes to oxcyclozanide. It is assumed that selection for resistance in the case of rafoxanide and closantel is favored by possible differences in the mode of action and pharmacokinetic properties between oxcyclozanide on the one hand and rafoxanide/closantel on the other hand. Thus, quick peak concentrations in the blood and quick elimination are seen with oxcyclozanide in contrast to the strong binding to plasma proteins with rafoxanide and closantel resulting in long-lasting persistence in the blood at therapeutic concentrations for more than 90 days.

## Cyanine Dyes

### Important Compounds

Pyrvinium, Dithiazanine iodide.

### Synonyms

Pyrvinium pamoate: Pyrvinium embonate, Vipryinium embonate, Alnoxin, Molevac, Neo-Oxypaat, Pamovin, Poquil, Povan, Povanyl, Pyrcon, Altolat, Tolapin, Tru, Vanquil, Vanquin, Vermitiber.

Dithiazanine iodide: Abminthic, Anelmid, Anguifugan, Delvex, Dejo, Deselmine, Dilombrin, Dizan, Nectocyd, Partel, Telmicid, Telmid.

### Clinical Relevance

Pyrvinium exerts antinematodal activity against *Enterobius*, *Trichuris vulpis*, dithiazanine iodide against *T. vulpis*. In addition, dithiazanine iodide has experimentally antifilarial activity against *Litomosoides carinii*.

### Molecular Interactions

The antinematodal action against *T. vulpis*, a nematode residing in a more anaerobic environment, is probably the inhibition of glucose uptake by dithiazanine and also by pyrvinium. Responsible for the antifilarial action of dithiazanine is presumably the irreversible inhibition of oxygen uptake of adult *L. carinii*, an oxygen requiring nematode.

---

## Entamoeba coli

→Amoebae.

---

## Entamoeba histolytica

### Classification

Species of →Amoebae, Table 1.

### Life Cycle

Fig. 1.

### Distribution

Fig. 2.

### Morphology

→Pellicle; Fig. 1; →Amoebae.

### Disease

→Amoebiasis, →Entamoebiasis.

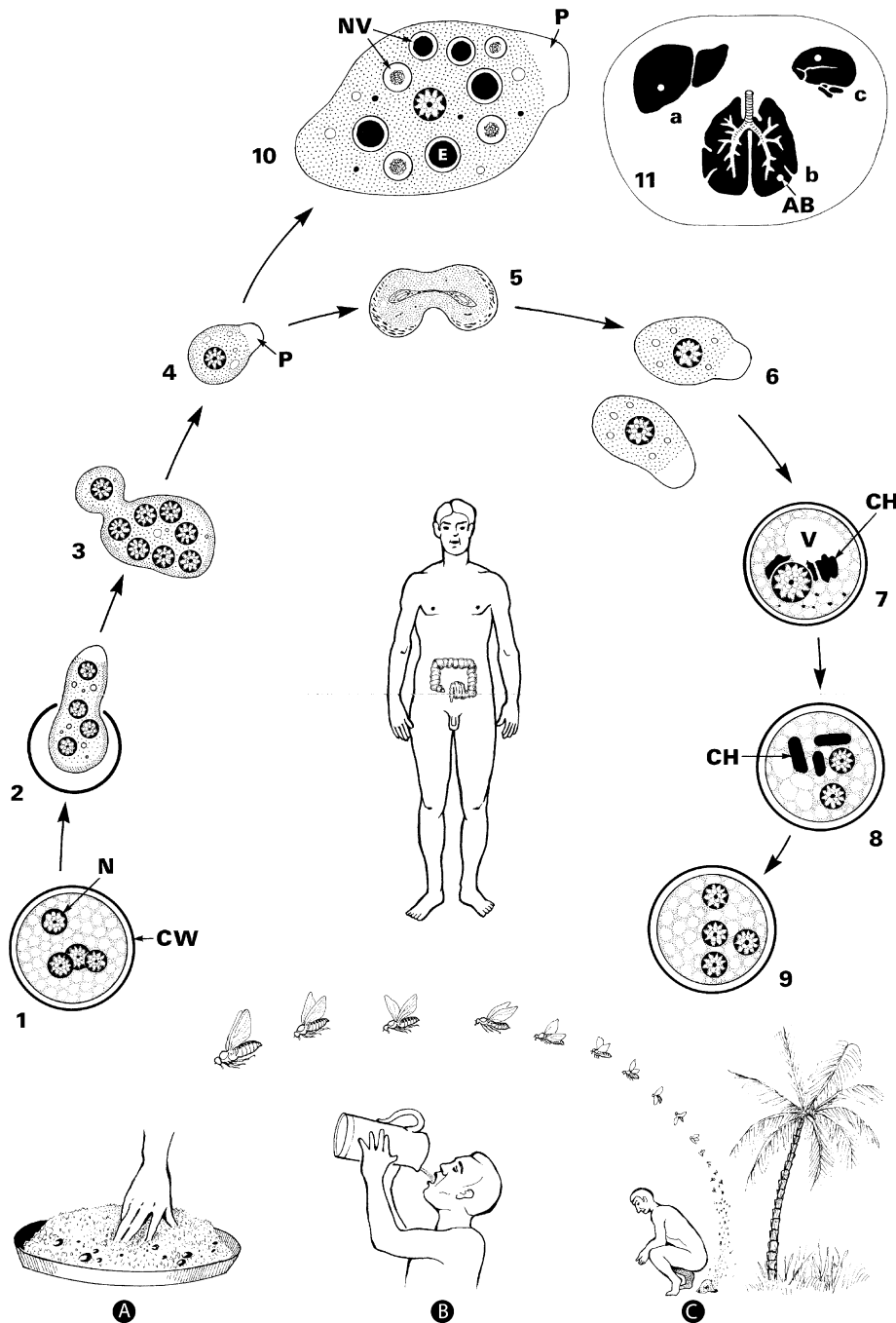

**Entamoeba histolytica.** Figure 1 Life cycle of *Entamoeba histolytica*. 1 Cysts with 4 nuclei (i.e., metacysts) are ingested orally with contaminated food or drinking water (A–C). 2–4 After excysting in the small intestine, both the cytoplasm and nuclei divide to form 8 small amoebulae (i.e., metacystic trophozoites). 5, 6 Mature trophozoites (i.e., minuta forms) reproduce by constant binary fission. 7 Uninucleate cyst (i.e., precyst) contains chromatoid bodies and (often) a large glycogen vacuole. 8 Cysts with 2 nuclei and chromatoid bodies. 9 Cysts with 4 nuclei (metacysts) are set free with the feces and become infectious when ingested by man. 10–11 Some of the minuta forms may grow to magna forms, which enter the intestinal wall and, via the bloodstream, other organs such as liver, lung, and brain (11 a–c), where they lead to abscesses (i.e., Amoebomae). Living amoebas are only found at the periphery of these amoebomae. AB, abscess; CH, chromatoid body; CW, cyst wall; E, erythrocyte; P, single, pale pseudopodium; N, nucleus with central nucleolus (karyosome); NV, food vacuole; V, glycogen vacuole of young cysts (for further species see Amoeba/Table 1).



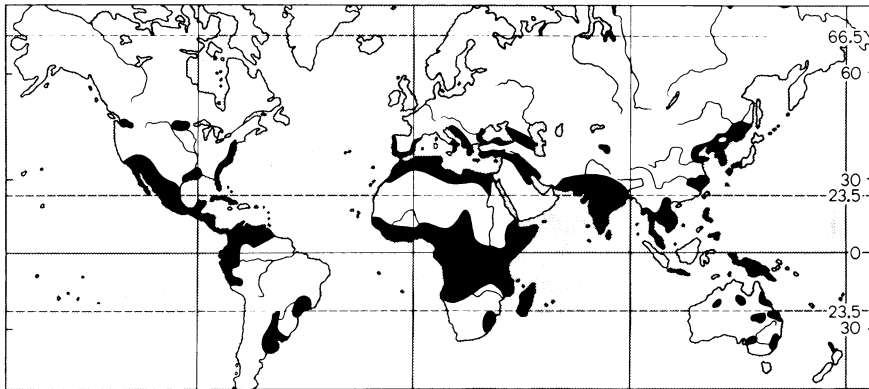

**Entamoeba histolytica.** Figure 2 Distribution map of amebic dysentery.

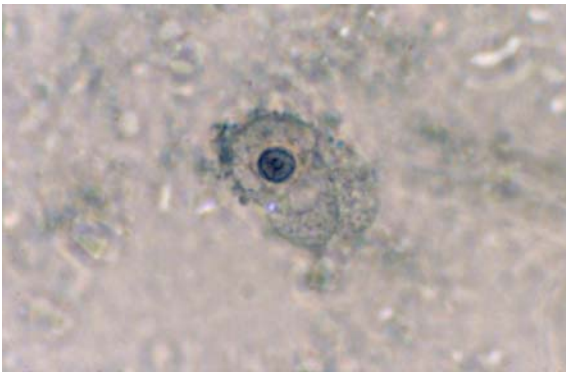

**Entamoeba histolytica.** Figure 3 Unstained minuta-stage of *Entamoeba histolytica*; note the nucleus with the centrally located nucleolus.

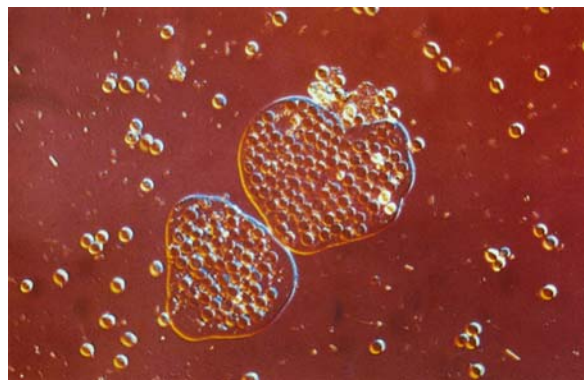

**Entamoeba histolytica.** Figure 4 LM of 2 magna-forms as seen with the Nomarski-technique.

## Entamoeba Species

From Greek: *entos* = inside; *amoibos* = changing.  
→Amoeba.

## Entamoebiasis

Disease due to the protozoan. →*Entamoeba histolytica*, →Alimentary System Diseases, Carnivores.

**Main clinical symptoms in humans:** →Abdominal pain, bloody-slimy →diarrhoea, liver dysfunction in case of liver →abscess.

**Incubation period:** 2–21 days.

**Prepatent period:** 2–7 days.

**Patent period:** Years.

**Diagnosis:** Microscopic determination of cysts in faecal samples.

**Prophylaxis:** Avoid uncooked food/water in endemic regions.

**Therapy:** Treatment see →Antidiarrhoeal and Antitrichomoniasis Drugs.

## Enterobiasis

### Pathology

Enterobiasis is a human infection with the ubiquitous →pinworm, →*Enterobius vermicularis*. This small nematode has a simple life cycle in the intestinal lumen (→Pathology/Fig. 22A). The adult female deposits eggs in the anal canal and on the perianal skin, causing irritation leading to itching. The adults are sometimes found in the lumen and even the mucosa of the vermiform appendix, but their role in causing appendicitis is in doubt. Ectopic worms may be found in the vagina, uterus, migrating up the fallopian tubes into the peritoneum, and occasionally elsewhere, where they tend to die and become

surrounded by small granulomas containing eosinophils (→Pathology/Fig. 27B-D). It has been speculated that eggs of *Enterobius* spp. transmit *Dientamoeba fragilis*, which may cause diarrhea, sometimes with blood and mucus.

### Targets for Intervention

Infections with the nematode →*E. vermicularis* tend to be transmitted directly from man to man (anus-hand-hand-mouth), and self-reinfection is frequent since the worm eggs are immediately infective. However, some infections are also indirectly transmitted through contaminated material. Figure 1 shows potential targets and approaches of intervention.

The main targets will be infective reservoir and transmission from man to man. The approaches to control consist of detection and treatment of infections, and improving personal →hygiene and food hygiene. Blanket presumptive treatment campaigns without prior diagnosis have been successfully conducted, especially in populations of children with high infection rates. The best results were obtained with repeated treatment at an interval of 2–4 weeks.

**Main clinical symptoms:** →Pruritus analis, →diarrhoea, disturbances of sleep.

**Incubation period:** 1–4 weeks.

**Prepatent period:** 4–6 weeks.

**Patent period:** Years due to repeated autoinfections.

**Diagnosis:** Microscopic determination of eggs attached to the skin of the outer anal region (Fig. 2).

**Prophylaxis:** Repeated cleaning of toilets and daily cleaning of perianal skin; treatment of the whole family.

**Therapy:** Treatment see →Nematocidal Drugs.

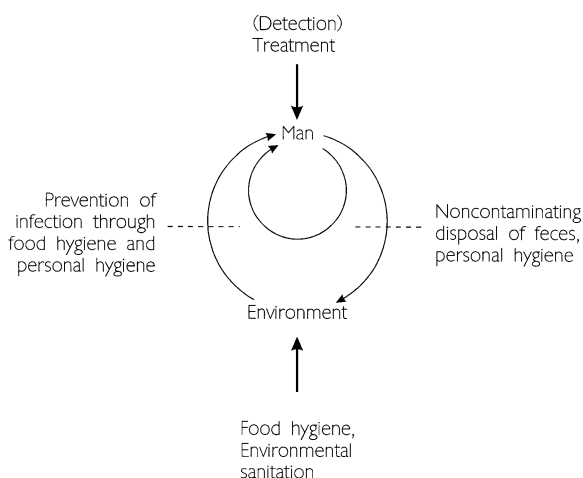

**Enterobiasis.** Figure 1 Targets and approaches for the control of enterobiasis.



**Enterobiasis.** Figure 2 Eggs of *Enterobius vermicularis*.

## Enterobius vermicularis

### Synonym

→Pinworm of man, →*Oxyuris*.

### Morphology

The adult female worms reach a length of 8–13 mm, are 0.3–0.6 mm in width, and have a long pointed tail (Fig. 2). The male is smaller (2.5 mm), its hind end is curved and contains a single copulatory spicule.

### Classification

Species of →Nematodes.

### Life Cycle

Figs. 1–3 (pages 488, 489).

### Disease

→Enterobiasis.

## Enterocytozoon

### Classification

Genus of →Microsporidia.

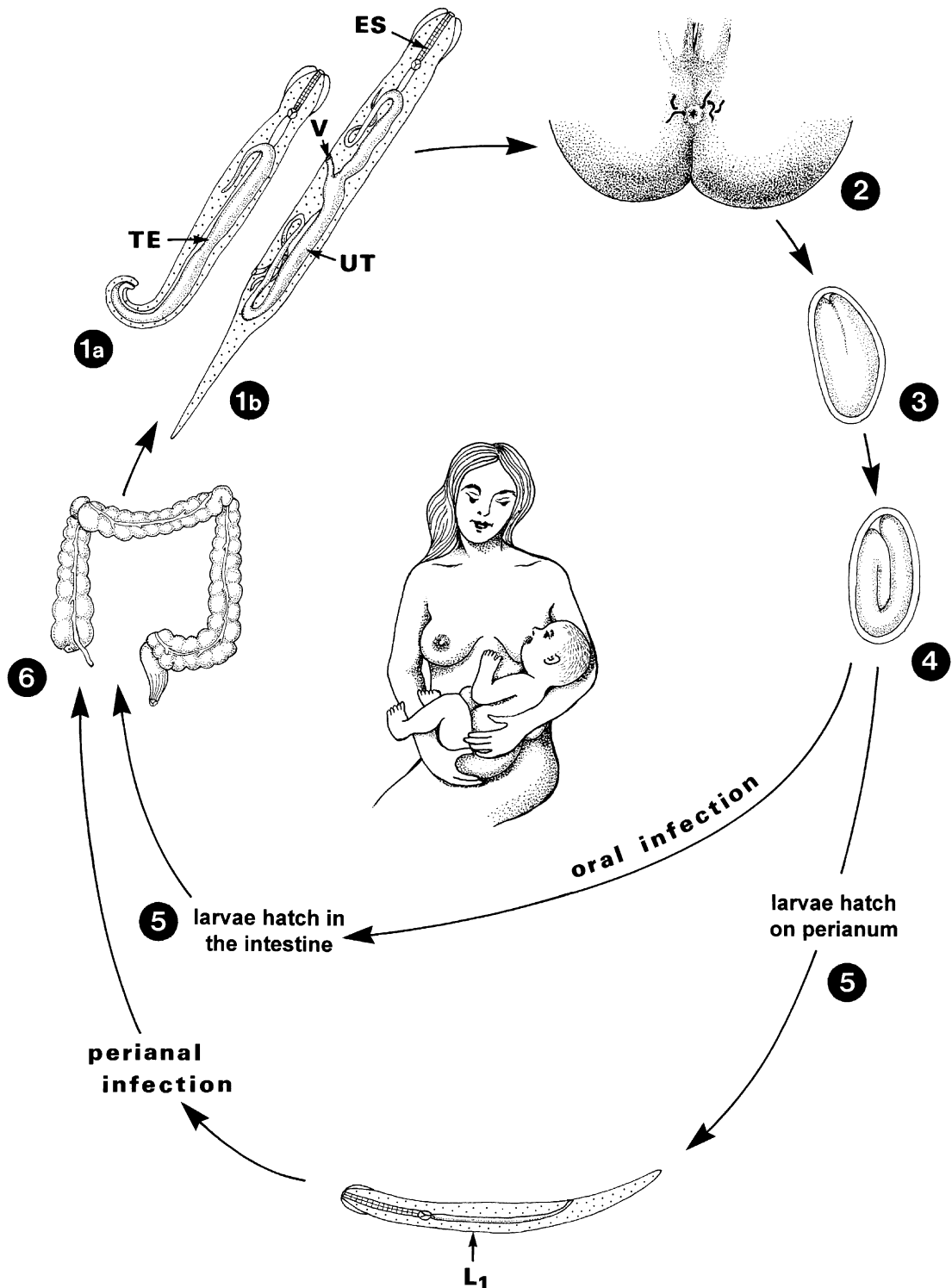

**Enterobius vermicularis. Figure 1** Life cycle of *Enterobius vermicularis*. 1a/b Whitish adult males (1a: 2–5 × 0.6 mm) and females (1b: 8–13 mm in length) live in the colon and rectum of man (especially children). 2/3 After copulation females migrate (at night) through the anus onto the perianal region, lay numerous (10,000) eggs and die. 4 Eggs embryonate within 6 h, forming the infectious first larval stage. 5 These eggs may be swallowed, or hatched larvae may enter the intestine directly via the anus, or erroneously via the vagina of women. 6 Inside the intestine the life cycle is completed within 4–6 weeks, leading to mature adults inside the colon. ES, esophagus; L, larva; TE, →testis; UT, uterus; V, vulva.



**Enterobius vermicularis.** Figure 2 LM of an adult female of *Enterobius vermicularis*.



**Enterobius vermicularis.** Figure 3 Higher magnification of the anterior pole of a female of *Enterobius vermicularis* with many excreted eggs; the anterior bulbus is characteristic.

## Enterocytozoon bieneusi

This most common microsporidian in →AIDS patients (leading to chronic diarrhea with wasting syndrome) has recently been found in pigs, macaccas, dogs, and rabbits, thus underlining its zoonotic properties. →Microsporidia, →Opportunistic Agents.

## Enteromonadina

Group of diplomonadid protozoans. →Diplomonadida/ Table 1.

## Enteromonas hominis

Flagellated human intestinal parasite (Fig. 1). →Diplomonadida/ Table 1.

## Enteromyiasis

From Greek: *endon* = inside; *myia* = fly. Due to fly larvae, that parasitize in the gut system (e.g., →*Gasterophilus*).

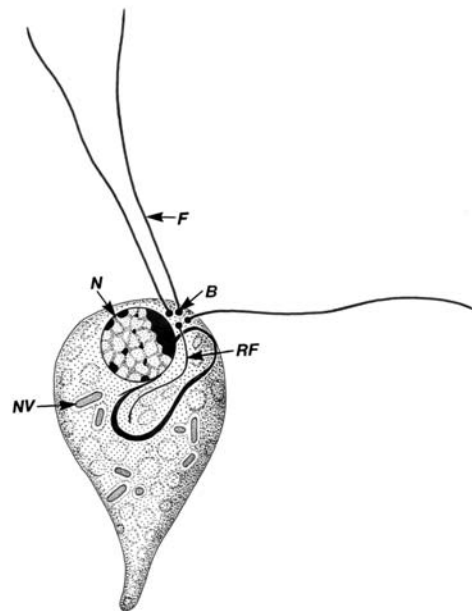

**Enteromonas hominis.** Figure 1 Drawings of a trophozoite (a) and of an encysting stage (b) of *Enteromonas hominis*.

## Entobdella

→[Monogenea](#).

## Entodiniomorphids

Group of ciliates that occur in the stomach of cattle, sheep, and goats (e.g., *Diplodinium dendatum* in cattle).

## Entopolypoides

Genus of blood parasites that is now considered to belong to the genus. →[Babesia](#). Two human cases had been described due to *E. macaci*.

## Envelope

Locke proposed the name envelope for all such extracellular structures which have dimensions similar to those of plasma membranes and which are formed at membrane surfaces. Such envelopes (e.g., 3 in →[Trichinella spiralis](#)) occur in a variety of organisms, from bacteria to vertebrates. More information is needed about their biochemical and functional properties, since they allow many different transport processes and are apparently resistant towards hosts' digestive enzymes as well as cellular attacks.

## Environmental Conditions

It is well known that parasites are more detrimental to their hosts when environmental conditions make the latter more vulnerable, principally because resources are limited and, as a consequence, immune defences weakened. In humans for instance, periods of famine are often aggravated by epidemics.

This happens also in the wild. De Lope et al. write: "It is inherent in the definition of parasitism that

parasites are costly to their hosts. Costs can be measured in absolute terms, but may vary in relative magnitude as a consequence of variation in access by hosts to essential resources. If parasites are costly to their hosts in terms of fitness, they should be so to a larger extent under stressful environmental conditions."

De Lope et al. have tested this prediction by comparing the impact of the →[ectoparasite](#) →[Oeciacus hirundinis](#) on its bird host, the house martin *Delichon urbica*. (The parasite feeds on the blood of nestlings and can cause their death.) All nests under study were fumigated in order to kill the parasites, then: (a) First third of nests were left without parasites, (b) 10 →[bugs](#) per nest were added in the second third, and (c) 100 bugs per nest were added to the last third. The authors then studied various parameters of bird reproduction, especially hatching success and fledging success (In the area -southern Spain- where the study was carried out, usually 2 broods are reared each year.) They showed that ([Fig. 1](#)):

- in the nests without (or nearly without) parasites, hatching and fledging successes are close to 100% in both clutches;
- in the nests with few bugs, there is little decrease in hatching and fledging successes in the first clutch, but in the second clutch the success goes down to ~50%;
- in the nests with a high parasite load, the first clutch is still little affected, but the second clutch experiences a dramatic decrease of reproductive success.

Fledging and fledging success of second broods thus decreased considerably with increasing parasite intensity. In other words, parasites were more costly to house martins in the second clutch. The explanation is that the second clutch is reared when food (*D. urbica* is a strictly insectivorous passerine) is less abundant: the negative effects of parasites on their hosts increase as external conditions become worse. One may conclude that, when food is readily available, the negative effects of parasites are compensated on the part of the hosts to such an extent that decrease of host fitness is virtually absent or at least difficult to detect. In contrast, the impact of parasites on host fitness increases dramatically when environmental conditions are poor.

## Environmental Management

→[Disease Control, Methods](#).

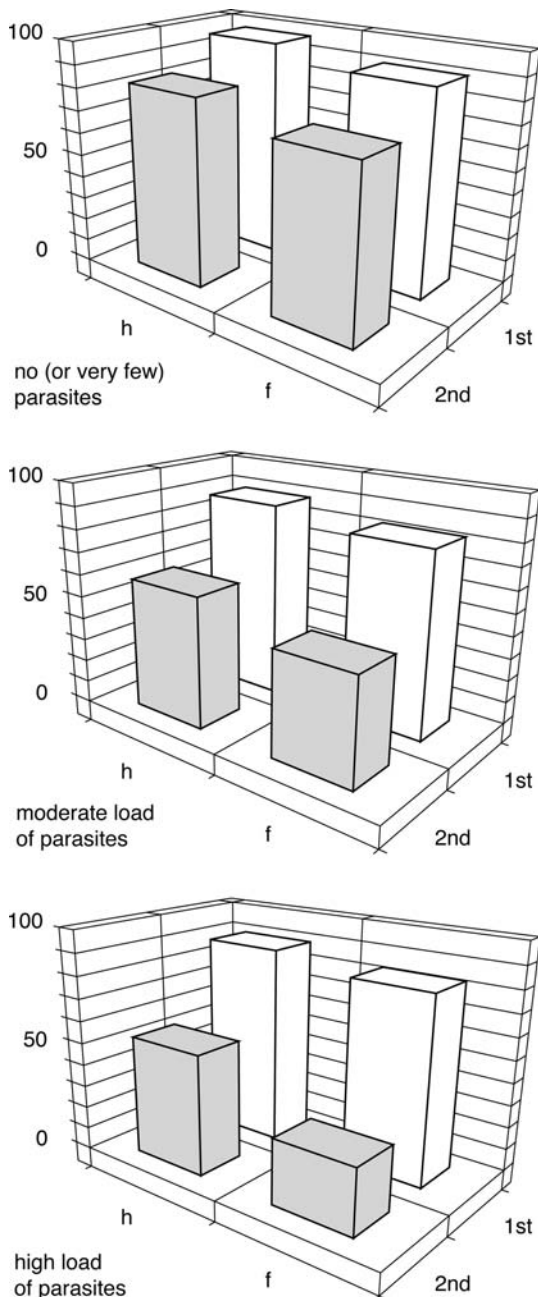

**Environmental Conditions.** Figure 1 Hatching (H) and fledging (F) successes of house martin in first (1st) and second (2nd) clutches (original, data from de Lope et al.).

## Environmental Parasitology

Parasites can be used as sentinels or biomarkers for the occurrence of pollution and/or presence of toxic substances, e.g., parasites were shown to accumulate

metal ions, etc. from the food of their hosts, thus allowing conclusions on the food and/or on the situation of the habitat of the host.

## Enzyme Linked Immunosorbent Assay (ELISA)

This is a type of sandwich-test for the diagnosis (e.g., of parasites) using antigen or antibodies that were marked with enzymes. In case of **antigen-ELISA** a specific antibody (directed against the antigen) becomes attached at a plate. Then the test substance (with the antigen) is filled onto the plate thus giving rise to antibody-antigen-complexes. As next step a second antigen specific antibody, which is marked with an enzyme, is added. If then the test substrate is added, the antigen can become qualitatively and quantitatively determined.

## Eoacanthocephala

→ [Acanthocephala](#).

## Eocollis arcanus

→ [Acanthocephala](#).

## Eomenacanthus

Genus of → [Acanthocephala](#).

## Eosinophilia

As effect of the occurrence of some parasites in peculiar organs (e.g., → [Ascaris](#) during lung passage, schistosomal eggs in liver etc.) the general number of eosinophilic cells may become considerably increased. This increase is often used as help in diagnosis.

## Eosinophilic Granulomas

→*Angiostrongylus cantonensis*, →*Schistosoma*, →Pathology.

## Eosinophilic Meningoencephalitis

Disease in humans, e.g., due to infections with →*Angiostrongylus cantonensis* (L3 enter the brain and die there). Such infections were reported from more than 30 countries in South East Asia, Africa, Australia and America.

## Eosinophilic Reaction

→Pathology.

## Eperythrozoon

Genus of rickettsiales (e.g., *E. suis* in pigs), transmitted mechanically by blood suckers.

## EPG

Eggs per gram of feces. Method to measure the intensity of an infection using the techniques of the McMaster chambers or of the Kato-Katz smears.

## Epicuticle

The outermost layer of the →cuticle in →nematodes. It is between 6 and 60 nm thick and consists mainly of 2 dark lamellae separated by a lighter interspace (→Nematodes/Fig. 7B, 8E, →Nematodes/Integument).

## Epidemia

From Greek: *epi* = over, above; *demos* = people. Occurrence of diseases in different groups of hosts.

## Epidemic Spotted Typhus

Disease of humans due to infection with the spherical, 0.3–0.5 μm-sized *Rickettsia prowazekii* stages transmitted by the feces of →lice (*Pediculus humanus corporis*) via inhalation or skin scratching. After an →incubation period of 10–14 days high fever occurs leading to death in 20% of (untreated) cases.

### Therapy

Tetracyclines.

## Epidemic Zone

→Geographic Zones of Occurrence of Diseases; infections occur at intervals.

## Epidemiology

Epidemiology (expression in medicine) or →epizootiology (expression in veterinary medicine) is a science dealing with occurrence, distribution, prevention, and control of disease, injury, and other health-related events (e.g., influence of climatic conditions) in a defined animal or human population.

## Epidermal Growth Factor (EGF)

Apical addition of this factor may block the activity of →*Giardia-trophozoites* to disrupt the tight junction-zone of their host cells.

## Epieimeria

→[Eimeria](#) species, →[Coccidia](#).

## Epimastigotes

Developmental stage of →[Trypanosomatidae](#) mostly found in the intestine of the vectors. The single flagellum is anchored in the mid of the cell body (beyond the nucleus), →[flagella](#).

## Epimerite

→[Gregarines](#).

## Epistylis

→[Ciliophora](#), →[Flagella](#).

## Epitheliocystidia

→[Digenea](#).

## Epizootiology

Epizootiology (expression in veterinary medicine) or epidemiology (expression in medicine) is a science dealing with occurrence, distribution, prevention, and control of disease, injury, and other health-related events (e.g., influence of climatic conditions) in a defined animal or human population.

## EPM

Equine protozoal myceloencephalitis described as result of infections with *Sarcocystis neurona* in horses (→[Sarcocystis](#)). The pathway of transmission remains unclear.

## Eprinomectin

### Chemical Class

Macrocyclic lactone (16-membered macrocyclic lactone, avermectins).

### Mode of Action

Glutamate-gated chloride channel modulator. →[Nematocidal Drugs](#), →[Ectoparasiticides – Antagonists and Modulators of Chloride Channels](#).

## Epsiprantel

→[Cestodocidal Drugs](#).

## Equine Protozoal Encephalomyelitis (EPM)

Disease of horses due to cerebral infection with the coccidian parasite *Neurospora*. Another often fatal viral disease is called equine encephalomyelitis (EEM).

## Equine Protozoal Myeloencephalitis

→[EPM](#).

## Ergasilus

Fig. 1 (page 494); →[Crustacea](#).

## Eradication

Trial to eliminate a vector of agents of diseases from a certain region.



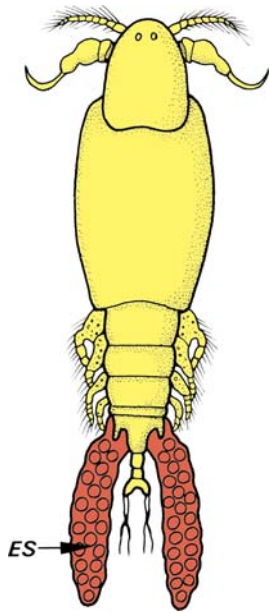

**Erpobdella octoculata.** Figure 1 DR of an adult female with two egg-bags (ES).

---

## Erpobdella octoculata

→Leeches.

---

## Erysipeloid

→Fleas.

---

## Erythema

Clinical and pathological symptoms of infections with skin parasites (→Skin Diseases, Animals, →Tick Bites: Effects in Animals, →Tick Bites: Effects in Man, →Ticks as Vectors, →Lyme Disease).

---

## Erythema chronicum migrans

→Lyme Disease.

---

## Erythrocyte-Binding Antigens (EBA)

→Apicomplexa.

---

## Escape Behavior

→Behavior.

---

## Espundia

→Cutaneous Leishmaniasis.

---

## Esthiopterum crassicorne

Species of Mallophaga of chicken.

---

## Ether-Lipids

→Energy Metabolism.

---

## Ethion (Diethion)

### Chemical Class

Organophosphorous compounds (dithiophosphate).

### Mode of Action

Acetylcholine esterase inhibitor. →Ectoparasiticides – Agonists and Antagonists of Cholinergic Transmission.

---

## Etofenprox

### Chemical Class

Pyrethroid (non-ester pyrethroid).

## Mode of Action

Open state voltage-gated sodium channel blocker.  
 →Ectoparasitocides – Blockers / Modulators of Voltage-Gated Sodium Channels.

## Eubothrium

→Eucestoda.

## Eucestoda

### Classification

Subclass of →Cestodes.

### General Information

The adult members of the Eucestoda are extremely dorso-ventrally flattened, appear mostly white-opaque, and inhabit the alimentary system of vertebrates (except for *Archigetes* spp., which may also reach sexual maturity in freshwater oligochaetes; Table 1). Most →tapeworms are polyzoic animals (Fig. 1, page 498) characterized by the repeated occurrence of sets of reproductive organs (exceptions are members of the orders Caryophyllidea (→*Caryophyllaeus laticeps*/Fig. 1) and Spathebothriidea). With the exception of the members of the order Dioecocestidae (parasites of the grebe and ibis), the tapeworms are protandric →hermaphrodites (monoecious animals) which cover a size range from 1 mm up to 25 m. Apart from the caryophyllideans, which are considered as sexually mature larvae (→Progenesis, →Neoteny) of pseudophyllideans, members of the Eucestoda show a characteristic body differentiation into →scolex, →neck, and →strobila consisting of a few to up to 4000 →proglottids (Figs. 1–3, pages 498–500).

The scolex is very small (mostly less than 1 mm) and endowed with specific holdfast systems such as →rostrum, acetabula, suckers, bothria, grooves, and hooks (Fig. 4, page 501; →Cestodes/Fig. 1). The small neck region is the continuously differentiating zone that produces immature proglottids; the cytological processes are only poorly understood. The strobila, representing the main bulk of the body, consists of a more or less long chain of proglottids. The latter contain, in a species-specific pattern, 1 or 2 sets of sexual organs which, however, do not mature at the same time. Just behind the neck proglottids are immature, then further posteriad there are proglottids with mature

male organs, then those with mature female organs, and finally those whose uterus contains fertilized eggs; the latter proglottids are thus described as gravid. Copulation occurs before egg formation; a given proglottid can copulate with itself, with others in the same strobila, or with those in other worms. When a gravid proglottid reaches the end of a strobila, it detaches (→Apolysis) and passes out intact with the feces (e.g., →*Taenia* spp.) or partly disintegrates before reaching the anus (→*Vampirolepis/Rodentolepis* = *Hymenolepis*). In cases where the uterus has an opening, the proglottids release the eggs and become detached when exhausted (→Pseudoapolytic, →Anapolytic; e.g., →*Diphyllobothrium*). Besides the sexual organs (repeated in each proglottid), some systems (such as excretory canals, nerve fibers, body wall with →tegument, longitudinal muscles) are common to the whole worm and run from the scolex to the posterior end (Fig. 1).

In general, ontogenesis of members of the Eucestoda proceeds as a →metamorphosis using different larval stages in alternating hosts (→Cestodes/Fig. 2, Table 1). The first and most common larva is the 6-hooked →oncosphaera, which is infectious to intermediate hosts and develops into other larval stages (→Cestodes/Fig. 2). In some species some of these later larval stages give rise to an asexually produced generation (e.g., →*Echinococcus*, →*Taenia multiceps*, →*Mesocestoides* sp.), thus initiating a →metagenesis, which is characterized by alternating sexually and asexually reproducing generations.

### Important Species

Table 1.

### Life Cycle

→*Archigetes* Species, →*Dipylidium caninum*/Fig. 1, →*Echinococcus*/Fig. 1, →*Hymenolepidae*/Fig. 1, →*Mesocestoides*/Fig. 1, →*Pseudophyllidea*/Fig. 1, →*Taenia*/Fig. 1.

## Eucoccidium

Genus of the →Protococcidia; →*Grellia*.

## Euceleus

### Synonym

→*Capillaria contorta*, the females reach a length of 2 cm, the males 12 mm; they live in the esophagus of goose, duck, chicken.

**Eucestoda. Table 1** Some common species of the Eucestoda

Order/Species	Length of adult worm (m)	Egg size ( $\mu\text{m}$ )	Final host	Prepatent period	Intermediate host (i.h./Habitat)	Stage inside intermediate host (i.h.)
<b>Caryophyllidea</b>						
<i>Caryophyllaeus laticeps</i>	0.03	40 × 55	Fish (many species)	6–8	<i>Tubifex</i> /Body cavity	Procercoid?
<i>Glaridacris catostomi</i>	0.03	40 × 50	Fish ( <i>Catostomus</i> )	?	<i>Tubifex</i> /Body cavity	Procercoid?
<i>Archigetes sieboldi</i>	2.7 mm	50	Fish and <i>Tubifex</i>	?	<i>Tubifex</i> /Body cavity	Procercoid?
<b>Pseudophyllidea</b>						
<i>Diphyllobothrium latum</i>	25	50 × 70	Humans, cats, dogs	3–6	1st i. h.: Copepods/Body cavity	1st i. h.: Procercoid
					2nd i. h.: Fish/Muscles	2nd i. h.: Plerocercoid (= Spaganum)
					(possibly) 3rd i. h.: Predator fish/Muscles	(possibly) 3rd i. h.: Plerocercoid (= Spaganum)
<i>Spirometra erinacea euopaei</i>	1	35 × 60	Cats, dogs, humans	2–4	1st i. h.: Copepods/Body cavity	1st i. h.: Procercoid
					2nd i. h.: Frogs, snakes/Muscles	2nd i. h.: Plerocercoid
<i>Ligula intestinalis</i>	0.3	35 × 60	Fish-eating birds	?	1st i. h.: Copepods/Body cavity	1st i. h.: Procercoid
					2nd i. h.: Freshwater fish/Body cavity	2nd i. h.: Plerocercoid
<i>Schistocephalus solidus</i>	0.05		Fish-eating birds, rodents		1st i. h.: Copepods	1st i. h.: Procercoid
				<i>i</i>	2nd i. h.: <i>Gasterosteus</i> sp./Body cavity	2nd i. h.: Plerocercoid
<i>Triaenophorus</i> sp.	0.15	30 × 50	Predator fish	2–10	1st i. h.: Copepods/Body cavity	1st i. h.: Procercoid
					2nd i. h.: Fish/Muscles	2nd i. h.: Plerocercoid
<i>Eubothrium</i> sp.	0.8	40 × 55	Salmonid fish	2–10	1st i. h.: Copepods/Body cavity	1st i. h.: Procercoid
					2nd i. h.: Fish/Muscles	2nd i. h.: Plerocercoid
<b>Tetraphyllidea</b>						
<i>Rhinobothrium</i> sp.	15 mm	40 × 50	Rays, sharks	2–10	1st i. h.: Copepods/Body cavity	1st i. h.: Procercoid
					2nd i. h.: Fish/Muscles	2nd i. h.: Plerocercoid
<i>Phyllobothrium</i> sp.	9 mm	40 × 50	Rays, sharks	2–10	1st i. h.: Copepods/Body cavity	1st i. h.: Procercoid
					2nd i. h.: Fish/Muscles	2nd i. h.: Plerocercoid
<b>Proteocephala</b>						
<i>Proteocephalus ambloplites</i>	0.1–1	20–40	Predator fish	2–10	1st i. h.: Copepods/Body cavity	1st i. h.: Procercoid
					2nd i. h.: Fish/Muscles	2nd i. h.: Plerocercoid
<b>Cyclophyllidea</b> <b>Fam. Taeniidae</b>						
<i>Taenia solium</i>	2–7	35–40	Humans	5–12	Pigs, humans/Many Tissues	Cysticercus; <i>C. cellulosae</i>
<i>T. saginata</i>	6–15	35–40	Humans	10–12	Cattle/Many organs	Cysticercus; <i>C. bovis</i> ( <i>C. intermis</i> )
<i>T. asiatica</i>	5–7	35–40	Humans	8–18	Pigs, cattle, goat	Cysticercus
<i>T. (= Hydatigera) taeniaeformis</i>	0.6	35	Cats	7	Rats, mice/Variou organs	Strobilocercus; <i>Cysticercus fasciolaris</i>

**Eucestoda. Table 1** Some common species of the Eucestoda (Continued)

Order/Species	Length of adult worm (m)	Egg size ( $\mu\text{m}$ )	Final host	Prepatent period	Intermediate host (i.h.)/ Habitat	Stage inside intermediate host (i.h.)
<i>T. hydatigena</i>	1	20	Dogs	11–12	Ruminants/ Omentum	Cysticercus; <i>C. tenuicollis</i>
<i>T. ovis</i>	1	30	Dogs, foxes	6–7	Sheep/Muscles	Cysticercus; <i>C. ovis</i>
<i>T. pisiformis</i>	0.5–2	35	Dogs, cats	6	Rodents/Omentum	Cysticercus; <i>C. pisiformis</i>
<i>T. (= Multiceps) multiceps</i>	0.4–1	33	Dogs, foxes	6	Sheep, <b>humans</b> /Brain	Coenurus; <i>C. cerebralis</i>
<i>T. serialis</i>	0.2–0.7	35	Dogs, foxes	1–2	Lagomorpha/ Connective tissues	Coenurus
<i>Echinococcus granulosus</i>	2.5–6 mm	35	Dogs, foxes	6–9	Ruminants, <b>humans</b> / Liver, etc.	Hydatid; <i>Echinococcus hydatidosus</i> (= <i>cysticus</i> )
<i>E. multilocularis</i>	1.4–3.4 mm	35	Foxes, cats, dogs	4–6	Mice, <b>humans</b> / Liver, etc.	Multilocular cyst: <i>Echinococcus alveolaris</i>
<b>Fam. Anoplocephalidae</b>						
<i>Moniezia expansa</i>	4–5	50	Ruminants	4–6	Mites (Oribatids)/Body cavity	Cysticercoid
<i>Avitellina</i> sp.	3	20 × 40	Ruminants	4–8	Mites (Oribatids)/Body cavity	Cysticercoid
<i>Thysaniezia</i> sp.	2	25	Ruminants	4–8	Mites (Oribatids)/Body cavity	Cysticercoid
<i>Stilesia</i> sp.	0.6	25	Ruminants	4–8	Mites (Oribatids)/Body cavity	Cysticercoid
<i>Anoplocephala magna</i>	0.8	60	Horses	4–6	Mites (Oribatids)/Body cavity	Cysticercoid
<i>A. perfoliata</i>	0.25	60	Horses	4–6	Mites (Oribatids)/Body cavity	Cysticercoid
<i>Cittotaenia</i> sp.	1	40	Lagomorpha	2	Mites (Oribatids)/Body cavity	Cysticercoid
<b>Fam. Davaineidae</b>						
<i>Davainea proglottina</i>	1–4 mm	30	Chickens	2	Snails/Tissues	Cysticercoid
<i>Railletina tetragona</i>	0.25	35	Chickens	6	Insects/Body cavity	Cysticercoid
<i>Amoebotaenia</i> sp.	4 mm	0	Chickens	3–4	Insects/Body cavity	Cysticercoid
<i>Choanataenia</i> sp.	0.25	30	Chickens, turkeys	3	Insects/Body cavity	Cysticercoid
<b>Fam. Mesocestoididae</b>						
<i>Mesocestoides leptothylacus</i>	0.4–0.8	40	Foxes, dogs, rarely <b>humans</b>	2–3	Amphibians, birds, mice/Body cavity	Tetrathyridium
<b>Fam. Dipylidiidae</b>						
<i>Dipylidium caninum</i>	0.2–0.8	40	Dogs, foxes, cats	2–2.5	Fleas/Body cavity	Cysticercoid
<b>Fam. Hymenolepididae</b>						
<i>Rodentolepis</i> (syn. <i>Vampiro-</i> , <i>Hymenolepis</i> ) <i>nana</i>	20–40 mm	40–50	<b>Humans</b> , mice	4	Insects/Body cavity; but also direct development	Cysticercoid
<i>H. diminuta</i>	0.8	60–80	Rats, mice, <b>humans</b>	2	Insects/Body cavity	Cysticercoid
<i>H. carioca</i>	30–80 mm	60–70	Chickens	2–3	Insects/Body cavity	Cysticercoid
<i>Fimbriaria</i> sp.	0.4	60	Chickens,	2–4	Copepods/Body cavity	Cysticercoid

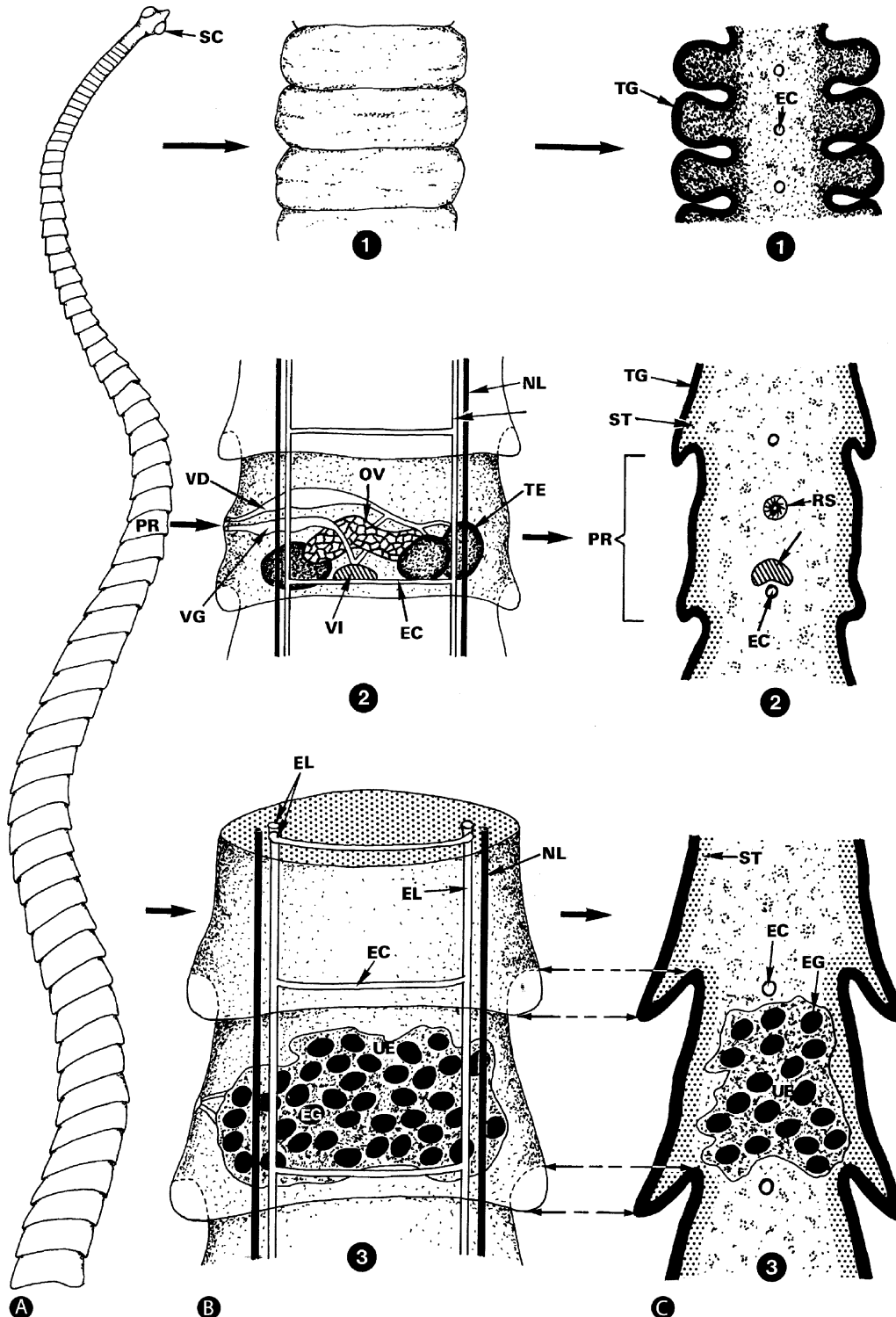

**Eucestoda. Figure 1 A–C** Diagrammatic representation of the organization of an eucestodean tapeworm (e.g., *Hymenolepis* sp.) showing the repeated reproductive organs and the common systems (nerves, excretory channels). Note the folded surface leading to the aspect of separate proglottids. Parenchymal muscles are left out. *EC*, cross-running excretory canal (connecting the ventral longitudinal vessels); *EG*, egg (containing the oncosphere); *EL*, longitudinally running excretory canals (2 on each side); *NL*, nerves running longitudinally; *PR*, proglottis; *OV*, ovary; *RS*, receptaculum seminis; *SC*, scolex; *ST*, subtegumental cells and muscle layer (circular, longitudinal); *TE*, testis; *TG*, tegument; *UE*, uterus filled with eggs; *VD*, vas deferens; *VG*, vagina; *VI*, vitellarium.

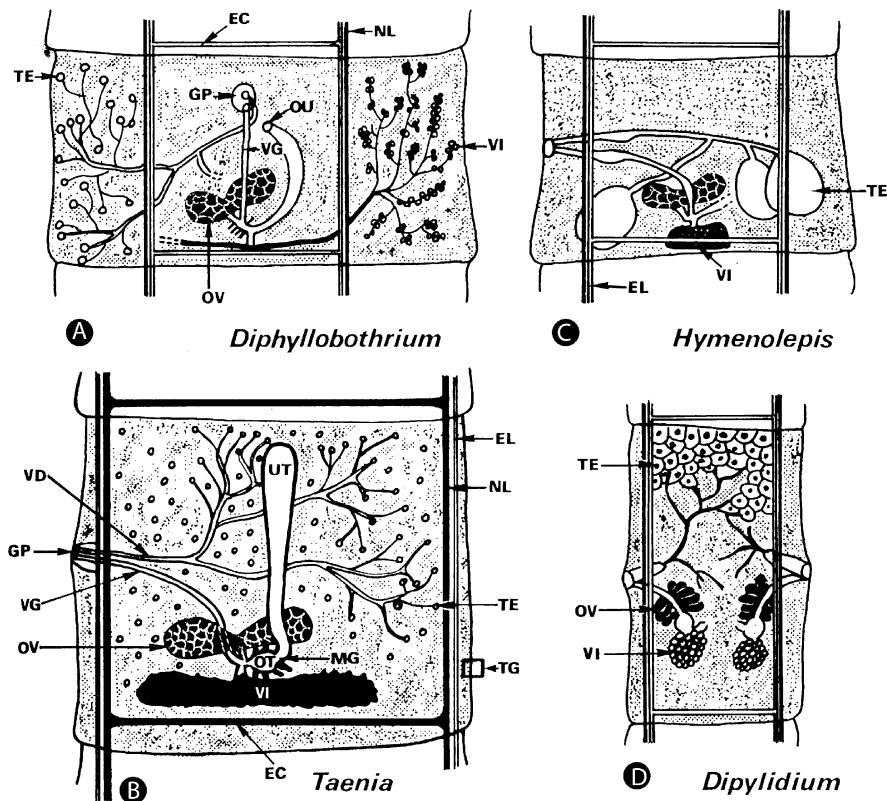

**Eucestoda. Figure 2 A–D** Diagrammatic representation of the reproductive organs within proglottids of different genera of tapeworms. Note the different size and number of testes, the occurrence of an uterus opening, and the position of the genital porus. In **A** (*Diphylobothrium* spp.) only 1 of the 2 vitellaria and half of the branched male system is drawn. *Dipylidium caninum* (**D**) has 2 sets of reproductive organs per proglottis. *EC*, cross-running excretory channel; *EL*, longitudinal excretory channel; *GP*, genital porus; *NL*, nerve running longitudinally; *OT*, ootype; *OU*, opening of the uterus; *OV*, ovary; *TE*, testis; *TG*, tegument (details not drawn); *UT*, uterus; *VD*, vas deferens; *VG*, vagina; *VI*, vitellarium.

## Euglenozoa

Phylum of protozoans (e.g., it contains the →[Kineto-plastida](#), with specimens of the genus →[Trypanosoma](#). →[Classification](#).

## Eukaryonts

Old name for →[Eukaryota](#). See also →[Nuclear Division](#).

## Eukaryota

Eukaryotes may consist of a single cell or they may be multicellular organisms – termed →[Metazoa](#) – made up of differentiated (specialized) cells. They may be unicellular in all their developmental stages (→[Protists](#)), or unicellularity may be limited to certain developmental stages, such as the sexual stages (→[Gametes](#)) of plants and animals. Even highly differentiated →[Metazoa](#) retain vestiges of their unicellular origin, as shown by their development from unicellular “eggs,” some of which may develop even if they are not fertilized. They also have the ability to reconstruct their whole bodies from a single cell, as do easily the sponges, but also the fertilized →[oocytes](#) of vertebrates. Eukaryotic

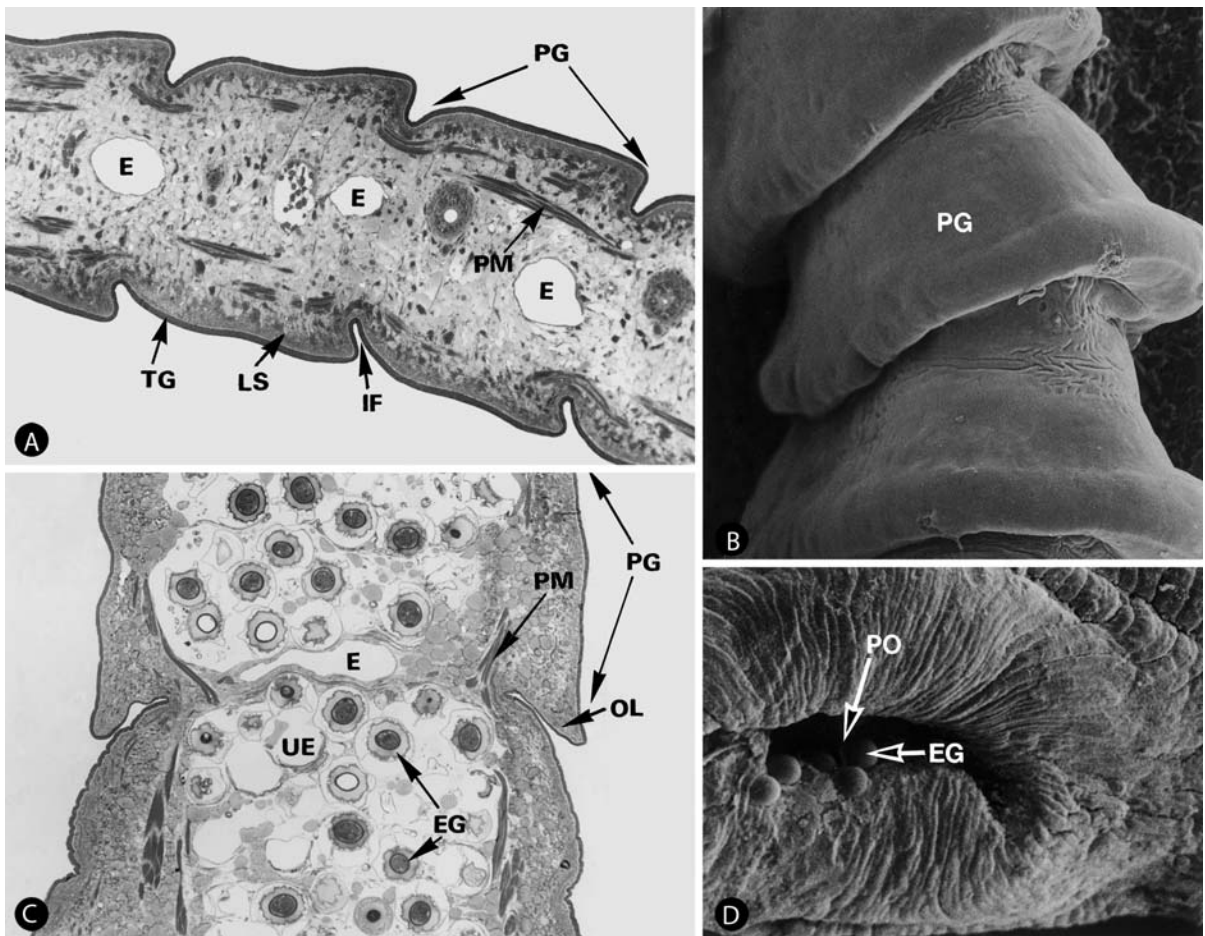

**Eucestoda. Figure 3 A–D** *Hymenolepis nana*: organization of the strobila. **A, C** Light micrographs of semithin sections, **B, D** scanning electron micrographs. **A** Longitudinal section of young proglottids (PG). Note the formation of infoldings at the distal end of proglottids ( $\times 250$ ). **B, C** Typical aspects of mature craspedote proglottids in longitudinal section (**C**) and surface view (**B**). Note the overlapping region (OL) and the absence of a definite border between the proglottids in **C**. (**B**  $\times 80$ , **C**  $\times 100$ ). **D** Pore at the end of the terminal proglottid, through which eggs (EG) may pass ( $\times 80$ ). **E**, Excretory channel (connecting the longitudinal vessels); **EG**, egg; **IF**, infolding of the tegument; **LS**, layer of subtegumental cells; **OL**, overlapping part of the preceding proglottid; **PG**, proglottid; **PM**, parenchymal muscles (here running longitudinally); **PO**, pore; **TG**, tegument; **UE**, uterus filled with eggs.

cells consist of a membrane-bound  $\rightarrow$ cytoplasm (containing 1 or more nuclei and various organelles that are also often membrane-bound, their compartments and membranes acting as sites) where reaction processes can occur. The most significant differences between the components of eukaryotic and prokaryotic cells are listed in [Table 1](#).

## Eumitosis

$\rightarrow$ Nuclear Division of the metazoans during which the nuclear membrane disappears.

## Euparyphium melis

Species of the trematode order Echinostomatida.

## Eurytrema

Genus of the trematode family Dicrocoeliidae. *E. pancreaticum* (8–16  $\times$  5–8 mm, Fig. 1, page 502) is found in the pancreas of ruminants, pigs, camels, and monkeys in Asia and South America. Related species of birds are found occasionally in humans.

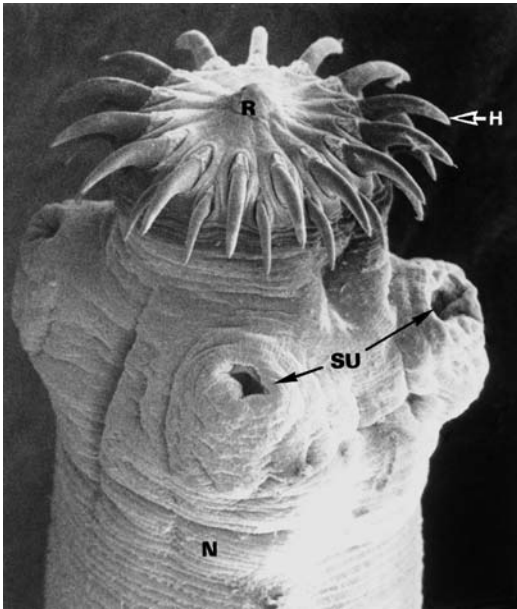

**Eucestoda. Figure 4** Scanning electron micrograph of typical platyhelminthic →holdfast organs: *Taenia* spp. scolex with rostellar hooks (H) and suckers (SU) ( $\times 150$ ). *N*, →neck region; *R*, →rostellum.

## Euschongastia indica

Species of the mite family Trombiculidae, the larvae of which live as parasites.

## Eutely

Absence or strict reduction of all divisions, e.g., →cell multiplication in →nematodes after last hatching is very restricted (if not entirely absent) -except within the reproductive system, midgut, epidermis, and somatic muscles.

## Evasion

From Latin: *evadere*. Active slip out of parasites (e.g., →*Oxyuris*). →Immune Responses.

## Euryenie

Greek: *euris* = wide/large; *xenos* = foreign; species with a large spectrum of possible hosts.

## Evasion Mechanisms

Mechanisms of parasites to avoid the attacks of the immune system. →Amoebiasis, →Cysticercosis, →Giardiasis, Man, →Sleeping Sickness; →immune Responses.

**Eukaryota. Table 1** Differences between prokaryotes and eukaryotes

Attributes	Prokaryotes	Eukaryotes
Cell nucleus	–	+
DNA-amount	Low (up to $1.4 \times 10^{-2}$ pg/cell)	High ( $1.6 \times 10^{-2}$ – 96 pg/cell) (in haploidy)
Organization	Circular	Linear (chromosomes) plus circular elements
Recombination	Conjugation	Meiosis and syngamy
Introns	–	+
Cell division	+	+
– Speed	Quick (20 minutes)	Slow (hours)
– Mode	By formation of septa	By mitosis and cytokinesis
Ribosome type (subunits)	70S (30S + 50S)	80S (40S + 60S)
Membrane bound organelles (mitochondria, plastids, Golgi etc.)	–	+
Mictotubules	–	+
Membrane bound flagella ( $9 \times 2 + 2$ pattern)	–	+
Use of actomyosin for movement	–	+
Endo- and exocytotic activity (i.e., movement)	–	+

+ Present, – Not present





**Eurytrema. Figure 1** Adult from pancreas duct of a pig.

---

## Exacerbation

From Latin: *acerbare*. Increase of the intensity of symptoms of disease.

---

## Excoriation

Clinical and pathological symptoms (loss of surface layers) of infections with skin (Latin: *corium*) parasites (→[Skin Diseases, Animals](#), →[Demodicosis, Man](#)).

---

## Excretion

The process of eliminating waste materials (→[Exocytosis](#)).

---

## Excretory Gland

Some →[Nematodes](#) possess paired glands to drain their body cavity, others have the so-called H-cell-system

running as channels inside the lateral chords. Crustaceans developed similar excretory systems at the bases of antennae and/or their coxae (= first segment of leg).

---

## Excyzoite

Stage that hatches from the 4-nucleated cyst of →[Giardia](#), as soon as the cyst has reached the small intestine a few hours after oral ingestion.

---

## Exflagellation

Formation of microgametes of →[Plasmodium](#) species in the gut of female anopheline mosquitoes.

---

## Exocytosis

The process of →[excretion](#) similar to →[endocytosis](#) but in reverse. It may occur anywhere on the surface or, as in ciliates, at a specialized place called the →[cell anus](#) or →[cytopyge](#).

---

## Exophagic

→[Mosquitoes](#) that bite mainly outdoors (e.g., *Anopheles albimanus* in Central America).

---

## Exospore

Outer layer of spore wall in microsporidians.

---

## Exposition

Period during which hosts are exposed to possible transmission of agents of disease or time that have blood suckers for engorging parasitic stages.

## Expression Associated Genes (ESAG)

At the plasma membrane of trypanosomes the transferring receptor is encoded by →VSG gene expression site associated genes (ESAG) no. 6 and 7 (with several alleles). However, only one form is expressed at a time.

## Expulsion

### Name

Latin: *expulsare* = eject.

Some drugs paralyse intestinal worms, which then are expelled and may start creeping in the feces: Living worms are also ejected during vomitory process.

## Extended Phenotype

The notion of extended phenotype is due to Richard Dawkins, who defined it as “all the effects of a gene upon the world.” In parasitology and more practically, it is the expression of a parasite’s genotype into the phenotype of its host.

Many species of parasites manipulate the morphology and/or the behaviour of their hosts with the aim of facilitating their transmission to the next host in the life cycle. This is specially true when parasites have a life cycle involving an →intermediate host. Dawkins writes: “Parasites that have a life-cycle involving an intermediate host, from which they have to move to a definitive host, often manipulate the behaviour of the intermediate host to make it more likely to be eaten by the definitive host.”

One of the first experimental demonstrations of an extended phenotype was achieved by Bethel and Holmes who showed that uninfected freshwater amphipods *Gammarus lacustris* tend to avoid light and remain close to the bottom of the lakes, whereas individuals infected by the acanthocephalan →*Polymorphus paradoxus* stay close to the surface and cling to surface debris. This behaviour makes them more vulnerable to surface-dabbling ducks, and thus facilitates parasite transmission. Dawkins regards the altered behaviour of the amphipods as an adaptation on the part of the parasite: “We may, therefore, talk of worm genes having phenotypic expression in shrimp bodies, in just the same sense as we are accustomed to talking of human genes having

phenotypic expression in human bodies.” Since the publication of a chapter by Bethel and Holmes in 1973, a great number of host phenotype manipulations by parasites have been reported. Poulin has drawn attention to the fact that energy spent on host manipulation is not available for other functions, which means that manipulation has a cost and must be optimized by selection as any adaptive trait. Maybe one of the most extraordinary examples of extended phenotype concerns immune avoidance by Strepsiptera, a group of insects which parasitize other insects. When penetrating a new host, the larva of the strepsipteran manipulates host epidermal tissue so that it may wrap within it; the larva is thus dissimulated to host immune defense; it is the manipulated host epidermis which constitutes a barrier to the host hemocytes.

The expression of parasite genes into the host phenotype might exist in humans. The best-documented case is that of *Toxoplasma gondii* which establishes persistent infections within the central nervous system of rodents but also in humans (20–80% of infection, depending on the country). In rats, *T. gondii* provokes an increase in activity, a decrease in neophobic behaviour, and an alteration of the perception of risk; as a result infected rats are easily preyed upon by cats, in which *T. gondii* completes its life cycle. While in humans, although the parasite is in a “dead end host,” it provokes various disorders, including changes in the personality; even the risk of car accidents seems significantly increased in infected people.

Although the question of host manipulation must be regarded with a “critical eye” and the fact that the demonstration of the adaptive value of the host morphological and/or behavioral changes has not always been achieved, it is now widely accepted that the “extended phenotype” is one of the major adaptations facilitating parasite transmission.

## Extrinsic Incubation Period (EIP)

This term (EIP) describes the period that is needed for a biting organism (e.g., insect, tick) to transmit an agent of disease after its uptake during a preceding blood meal. The **minimal EIP** is the time until the first female of a vector group transmit the agent of disease. The **middle EIP** is the period needed until 50% of the once infected blood suckers transmit. The EIP depends on the outer temperature, e.g., in the case of the transmission African horse sickness virus or bluetongue by →*Culicoides variipennis* respectively by *C. imicola* the virus replication starts only at an outer temperature of 9.9°C. At 15°C the EIP was 12.4 days, which was

shortened to 3.4 days, when the temperature arose to 30°C. The rise of temperature, however, shortens on the other hand the lifespan. Thus there must be found an optimum mixture of both in addition with other outer factors like rain, wind, etc., which influence the feeding activity of potential vectors.

## Extrusome

→ Flagella.

## Exuvius

From Latin: *exuviae* = detached clothes. This term describes the empty chitinous or horny cover, which is left by, e.g., arthropods or reptiles after molt.

## Eye Gnat

The chlorpid fly *Hippelates pusio*, which is only 2 mm long, bears yellow legs, eyes, and antennae, makes minute lesions in the conjunctival epithelium and may transmit the agents of contagious conjunctivitis, thus introducing the “sore- or pink-eye disease.”

## Eye Parasites

Parasites may enter each organ of the body. Several parasitic stages, however, have developed a special favor for this organ, which of course is especially sensible with respect to human welfare. Table 1 summarizes the parasites found in the different regions of the human eye. The life cycles, morphology, reproduction modes, and the pathological effects are described in the entries on the respective organisms). Figures 1–4 show some of the most common aspects of

**Eye Parasites. Table 1** Ophthalmologic manifestation of parasitic infections

Ocular regions and ophthalmologic signs	Genera of parasites
<b>Eyebrows and eyelids</b>	<i>Pediculus, Phthirus, Ixodes</i>
Eyelid edema	Ixodids, <i>Pulex</i> , fly larvae, <i>Giardia, Trypanosoma, Plasmodium, Schistosoma, Paragonimus, Taenia, spargana, Ancylostoma, Gnathostoma, Toxocara, Trichinella, filariae</i>
Chalazion and pseudochalazion	<i>Demodex</i> , fly larvae, <i>Trypanosoma, Schistosoma, Onchocerca, Leishmania</i>
Ptosis	<i>Taenia solium</i> (cysticercus)
Inflammations of the eyelid margin (blepharitis)	<i>Demodex, Pediculus, Phthirus, Plasmodium</i>
Ophthalmomyiasis	Fly larvae
<b>Lacrimal ducts and glands</b>	
Dacryocanaliculitis and dacryocystitis	Fly larvae, <i>Plasmodium, Ascaris, Mammomonogamus, Trypanosoma, Thelazia</i>
Dacryoadenitis	<i>Schistosoma, Plasmodium</i>
<b>Orbit</b>	
Exophthalmos	<i>Echinococcus, coenurus, Taenia, Schistosoma, spargana, Ascaris, Trichinella, Trypanosoma, Plasmodium, Entamoeba, Loa, Dracunculus, Dirofilaria, Gnathostoma</i>
<b>Ocular muscles</b>	
Diplopia	<i>Trichinella, Parastrongylus, Ancylostoma, spargana, Taenia, Plasmodium</i>
<b>Conjunctiva</b>	
Parasites in the cul-de-sac	Fly larvae, <i>Enterobius, Thelazia</i>
Subconjunctival parasites	Fly larvae, <i>Thelazia, Loa, Wuchereria, Brugia, Dracunculus, Porocephalus</i>
Subconjunctival cysts	<i>Schistosoma, Taenia, Dirofilaria, Dipetalonema, Habronema, Mansonella, spargana, Philophthalmus</i>
Chemosis	<i>Ascaris, Trichinella, Giardia, Onchocerca, Trypanosoma</i>
Hemorrhages	<i>Schistosoma, Trichinella</i>

**Eye Parasites. Table 1** Ophthalmologic manifestation of parasitic infections (Continued)

Ocular regions and ophthalmologic signs	Genera of parasites
Conjunctivitis	Fly larvae, <i>Loa</i> , <i>Schistosoma</i> , <i>Entamoeba</i> , <i>Leishmania</i>
<b>Cornea</b>	
Parasites in the cornea	<i>Onchocerca</i> , <i>Toxocara</i> , <i>Trypanosoma</i> , <i>Ascaris</i>
Keratitis, scleritis	<i>Onchocerca</i> , <i>Toxocara</i> , <i>Trypanosoma</i> , <i>Acanthamoeba</i> , <i>Entamoeba</i> , <i>Leishmania</i> , <i>Ancylostoma</i>
Sclerosing keratitis	<i>Onchocerca</i>
Corneal ulcers	<i>Trypanosoma</i> , <i>Acanthamoeba</i>
<b>Anterior chamber</b>	
Parasites in the anterior chamber	<i>Onchocerca</i> , <i>Loa</i> , <i>Wuchereria</i> , <i>Brugia</i> , <i>Entamoeba</i> , <i>Acanthamoeba</i> , <i>Trypanosoma</i> , <i>Schistosoma</i> , <i>Paragonimus</i> , <i>Taenia</i> , <i>spargana</i> , <i>Parastrongylus</i> , <i>Ascaris</i> , <i>Gnathostoma</i> , <i>Toxocara</i> , <i>Dirofilaria</i> , <i>Thelazia</i> , <i>Linguatula</i> , <i>Porocephalus</i> , <i>Dipetalonema</i> , fly larvae
Cysts in the anterior chamber	<i>Taenia</i>
Hypopyon	<i>Entamoeba</i> , <i>Acanthamoeba</i> , <i>Taenia</i> , <i>Gnathostoma</i> , <i>Toxocara</i>
<b>Secondary glaucoma</b>	<i>Entamoeba</i> , <i>Giardia</i> , <i>Leishmania</i> , <i>Toxoplasma</i> , <i>Trypanosoma</i> , <i>Plasmodium</i> , <i>Schistosoma</i> , <i>Paragonimus</i> , <i>Taenia</i> , <i>Echinococcus</i> , <i>Parastrongylus</i> , <i>Ascaris</i> , <i>Dirofilaria</i> , <i>Onchocerca</i> , <i>Brugia</i> , <i>Wuchereria</i> , <i>Gnathostoma</i> , <i>Toxocara</i> , <i>Porocephalus</i> , <i>Linguatula</i> , fly larvae
<b>Iris</b>	
Mydriasis	<i>Enterobius</i> , <i>Trichinella</i> , <i>Ascaris</i>
Miosis	<i>Enterobius</i> , <i>Ascaris</i>
Reflectory pupilloplegia (Argyll Robertson)	<i>Plasmodium</i>
Distortion of the pupil	<i>Onchocerca</i>
Hemorrhages	<i>Schistosoma</i> , <i>Paragonimus</i> , <i>Loa</i>
Iritis and iridocyclitis	<i>Entamoeba</i> , <i>Giardia</i> , <i>Leishmania</i> , <i>Toxoplasma</i> , <i>Trypanosoma</i> , <i>Plasmodium</i> , <i>Paragonimus</i> , <i>Schistosoma</i> , <i>Taenia</i> , <i>Parastrongylus</i> , <i>Ancylostoma</i> , <i>Ascaris</i> , <i>Trichinella</i> , <i>Toxocara</i> , <i>Onchocerca</i> , <i>Brugia</i> , <i>Wuchereria</i> , <i>Loa</i>
<b>Lens</b>	
Cataract	<i>Leishmania</i> , <i>cysticercus</i> , <i>Ancylostoma</i>
Subluxatio	<i>Linguatula</i> , fly larvae
<b>Vitreous body</b>	
Hemorrhages	<i>Ascaris</i> , <i>Schistosoma</i> , <i>Trichinella</i> , <i>cysticercus</i> , <i>Gnathostoma</i> , fly larvae
Cysts	<i>Cysticercus</i> , <i>Echinococcus</i> , <i>coenurus</i>
Parasites in the vitreous	<i>Parastrongylus</i> , <i>Ascaris</i> , <i>spargana</i> , <i>Dipetalonema</i> , <i>Dirofilaria</i> , <i>Linguatula</i> , <i>Onchocerca</i> , <i>Wuchereria</i> , fly larvae
Cyclitis	<i>Schistosoma</i> , <i>Cysticercus</i> , <i>Gnathostoma</i> , <i>Onchocerca</i> , <i>Toxocara</i> , <i>Trichinella</i>
<b>Optic nerve</b>	
Papilledema	<i>Entamoeba</i> , <i>Leishmania</i> , <i>Taenia</i> , <i>Parastrongylus</i> , <i>Ancylostoma</i> , <i>Ascaris</i> , <i>Trichinella</i>
Papillitis	<i>Entamoeba</i> , <i>Giardia</i> , <i>Trypanosoma</i> , <i>Plasmodium</i> , <i>Paragonimus</i> , <i>Taenia</i> , <i>Ancylostoma</i> , <i>Ascaris</i> , <i>Toxocara</i> , <i>Trichinella</i> , <i>Onchocerca</i>
Optic atrophy	<i>Entamoeba</i> , <i>Giardia</i> , <i>Leishmania</i> , <i>Toxoplasma</i> , <i>Trypanosoma</i> , <i>Plasmodium</i> , <i>Paragonimus</i> , <i>Parastrongylus</i> , <i>Taenia</i> , <i>Ancylostoma</i> , <i>Ascaris</i> , <i>Toxocara</i> , <i>Trichinella</i> , <i>Onchocerca</i>
<b>Retina and chorioidea</b>	
Hemorrhages	<i>Entamoeba</i> , <i>Giardia</i> , <i>Leishmania</i> , <i>Trypanosoma</i> , <i>Plasmodium</i> , <i>Schistosoma</i> , <i>Ancylostoma</i> , <i>Gnathostoma</i> , <i>Toxocara</i> , <i>Trichinella</i> , <i>Wuchereria</i> , <i>Loa</i> , fly larvae
Retinal detachment	<i>Taenia</i> , <i>Porocephalus</i> , fly larvae
Cysts	<i>Entamoeba</i> , <i>Echinococcus</i>
Retinitis and choroiditis	<i>Entamoeba</i> , <i>Giardia</i> , <i>Leishmania</i> , <i>Toxoplasma</i> , <i>Schistosoma</i> , <i>Taenia</i> , <i>Parastrongylus</i> , <i>Ascaris</i> , <i>Toxocara</i> , <i>Trichinella</i> , <i>Wuchereria</i> , <i>Loa</i> , <i>Onchocerca</i> , fly larvae

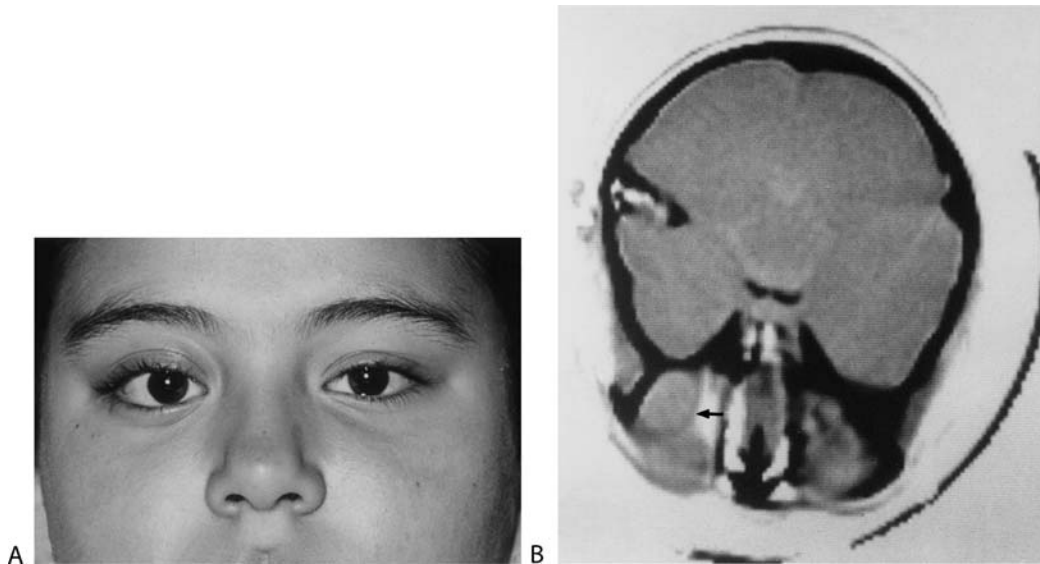

**Eye Parasites. Figure 1 A,B** Effects of →hydatids of *Echinococcus granulosus*. **A** Exophthalmos (right eye) in the orbit of a 10-year-old girl. **B** Computer tomogram (CT) of a hydatid cyst in the right orbit (by courtesy of Prof. J. Grüntzig, Düsseldorf).



**Eye Parasites. Figure 2 A,B** Adult worms and the eye. **A** Fibroma-like onchocercal →nodule (arrow) containing several adult female →*Onchocerca volvulus* worms in the right eyebrow of a Mexican child. **B** Adult →*Loa loa* worm being surgically removed from the subconjunctival space (by courtesy of Prof. J. Grüntzig, Düsseldorf).

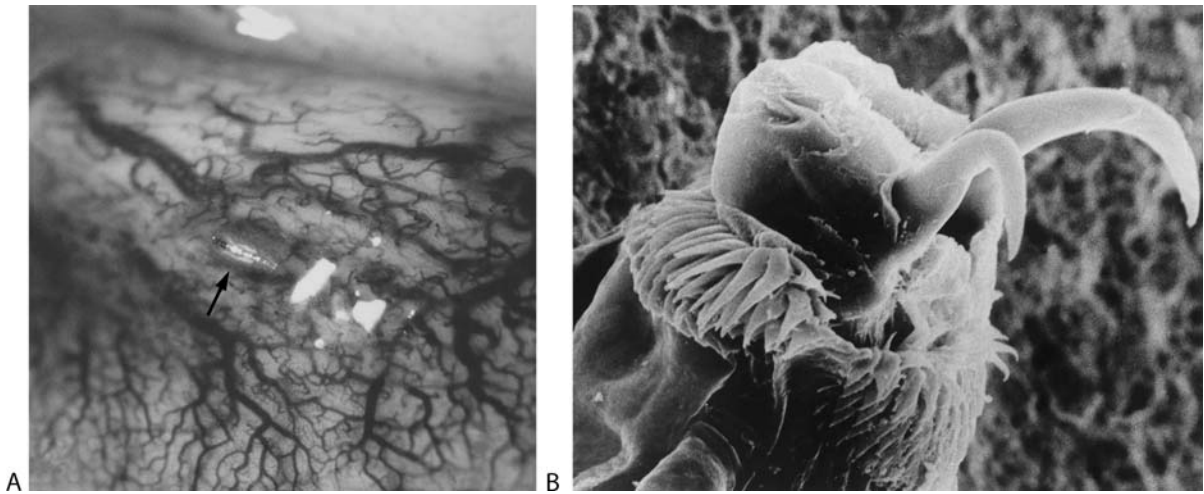

**Eye Parasites. Figure 3 A,B** Effect of fly larva in the eye (ophthalmomyiasis). **A** Acute →conjunctivitis caused by a fly larva (arrow). **B** SEM-micrograph of the anterior pole of a larva of the fly →*Oestrus ovis* showing its long mouth hooks (by courtesy of Prof. J. Grüntzig, Düsseldorf).

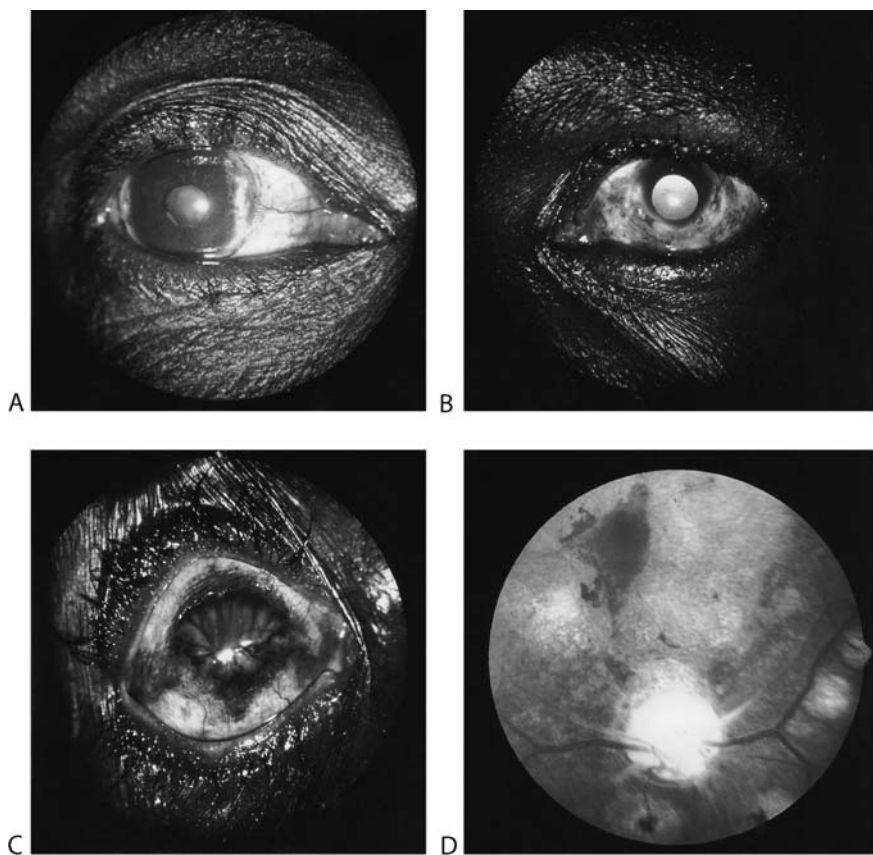

**Eye Parasites. Figure 4 A–D** Effects of →*onchocerciasis*. **A** Early sclerosing keratitis in the 2–4 and 8–10 o’clock positions. **B** Confluent opacification in sclerosing keratitis (keratitis semilunaris). **C** Advanced sclerosing keratitis. **D** Optic atrophy with extensive choroidoretinal lesions (by courtesy of Prof. J. Grüntzig, Düsseldorf).

parasites in eyes (pages 506, 507). For eye parasites of animals →[Nervous System Diseases, Animals](#).

---

## Eye Spot

Several →[trematodes](#) and especially their larvae possess an optical system to register light and dark in order to find suitable hosts. Since dense →[pigment](#) surrounds the optic cells, which are protrusions of ganglia of the anterior region or of the midbody and contain microtubuli →[aberrant cilia](#), the developmental

stages appear with dense spots. The number and arrangement of such spots are species-specific.

---

## Eye Worm

Nematodes of the genus →[Thelazia](#) parasitize in the lachrymal ducts of horses and cattle. Transmission occurs by means of flies of the genus *Musca* that take up larvae 1 from the conjunctiva and introduce finally larvae 3. The mass of larvae 1 block the excretion of the lachrymal fluid. See also →[Filaridae](#), →[Loa loa](#), →[Thelazia](#).

---

## Facultative Anaerobes

### Name

Greek: *aer* = air, *bios* = life.

These animals may survive also in absence of oxygen; e.g., *Toxocara* worms obtain most of their energy from glycogen degradation.

---

## Facultative Pathogens

→Opportunistic Agents.

---

## FAD

Flea allergy dermatitis: a reaction in sensitive dogs/cats or some other hosts on saliva of biting →fleas.

---

## Fahrenheit' Hypothesis

The common ancestors of modern parasites were themselves parasites of the common ancestors of their present hosts.

---

## Fahrenheit' Rule

Hypothesis that →Mallophaga and their bird hosts passed through the same →co-speciation and co-evolution, and that thus their phylogeny reflects this.

---

## Falcipain

→Thiolproteinases.

---

## Falciparum Malaria

→Malaria tropica, →*Plasmodium falciparum*, →Mathematical Models of Vector-Borne Diseases, →Insulin.

---

## Famphur (Famophos)

### Chemical Class

Organophosphorous compounds (monothiophosphate).

### Mode of Action

Acetylcholine esterase inhibitor. →Ectoparasiticides – Agonists and Antagonists of Cholinergic Transmission.

---

## Fannia

Genus of flies, e.g., *Fannia scalaris* and *F. canicularis* (= i.e., smaller houseflies) look very similar to *Musca domestica*. However, the larvae of *Fannia* spp. have characteristic lateral branches (Fig. 1, page 510). The adults fly without zigzag movements mostly horizontally close to the ceiling of rooms. Larvae of these flies may be found in the rectum, vagina, or bladder of humans (→Myiasis).





**Fannia.** Figure 1 Larvae of *Fannia scalaris* (left) flies and *F. canicularis* (so-called small houseflies) or toilette.

## Fasciola gigantica

This species which reaches a length of 75 mm is endemic in Africa (south of the Sahara), in subtropical and tropical Asia, and in countries along the East Coast of

the Mediterranean Sea. Like →*Fasciola hepatica* it is found in the bile ducts of cattle. Recently it was proven that →hybridization is possible with *F. hepatica*.

Reported prevalence rates reach from 3% in Southern Spain to 72% in some regions of China. Inside the large eggs the miracidium develops within 17 days after appearance, if the temperature is high (26°C) and the eggs are included in water. Inside the intermediate snails (*Lymnaea* spp.) the development of cercariae (via sporocysts and rediae) occurs within 4–7 weeks. Within minutes up to 2 hours after leaving the snails, these stages shed their tail and fix themselves at the leaves of water plants. Being covered by excretions of their cystogenous glands they become metacercariae, which are infectious to the final hosts.

As soon as they are swallowed by the final host, they hatch in the upper small intestine, penetrate the intestinal wall, and are found after 24 hours in the body cavity. From there they enter the liver within 4–6 days and migrate for 9–12 weeks, until they reach the biliary ducts and obtain maturity.

## Fasciola hepatica

### Name

Latin: *fasciola* = small band; Greek: *hepai* = liver.

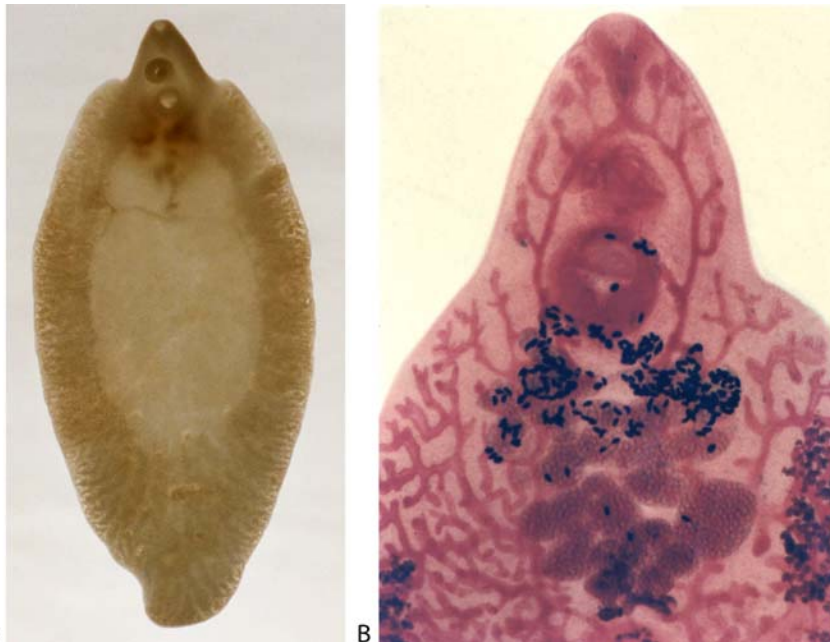

**Fasciola hepatica.** Figure 1 Light micrograph (LM) of an adult fluke and higher magnification of the anterior end.

## Classification

Genus of →[Digenea](#).

## Morphology

Adult worms are characterized by an apical protrusion and a tegument with many toothed hooks (Figs. 1, 2). The eggs are very large, have an operculum, and can be isolated by the sedimentation technique (Fig. 3).

## Life Cycle

Details see →[Digenea/Table 1](#), →[Digenea/Fig. 3](#).

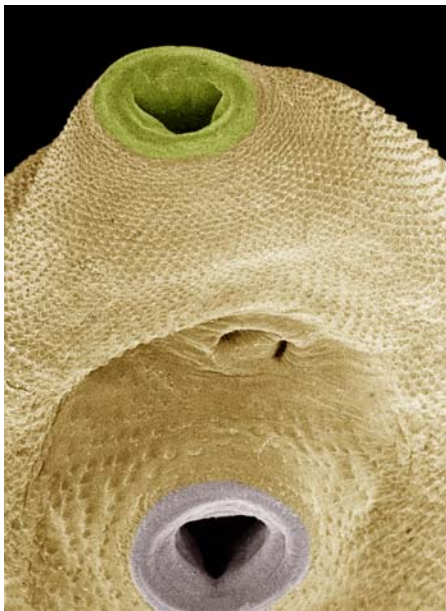

**Fasciola hepatica. Figure 2** Scanning electron micrograph (SEM) of the anterior portion of an adult fluke; note the numerous tegumental spines, 2 suckers and 2 genital openings.



**Fasciola hepatica. Figure 3** LM of an egg obtained from faeces by flotation technique, note the slightly opened operculum.

## Disease

→[Fascioliasis](#), →[Fasciolosis](#).

## Fascioliasis, Man

Fascioliasis describes an infection of the bile ducts with →[Fasciola hepatica](#), the liver fluke of sheep, cattle, and man. After the ingestion of the metacercaria encysted on water plants (water cress salad), the larvae wander through the wall of the gut, into the liver →[parenchyma](#), and into the bile ducts. The migration tracts are accompanied by an intense →[inflammatory reaction](#) with prominent eosinophils and Charcot-Leyden crystals, resolving ultimately by fibrosis (→[Pathology/Figs. 3A,B, 21A,C](#)). The liver may be enlarged and show abnormal function. Blood leukocytosis with →[eosinophilia](#) and fever are prominent. After long-standing infection with →[flukes](#), bile duct →[hyperplasia](#), pericholangitis, periportal fibrosis, and obstruction of the bile duct may develop. *F. hepatica* eggs are shed in the stools.

## Targets for Intervention

Among the food-borne zoonothropotic parasites, *F. hepatica* deserves attention as its control, seemingly simple, may pose major practical problems, foremost the relatively poor response to treatment and the high probability of reinfection. Upon reaching water the eggs release miracidia which infect aquatic snails. After completing development in the snail host, the infective →[metacercariae](#) leave the snail and attach themselves to plants and so reach their vertebrate hosts, especially sheep, cattle, and humans. [Figure 1](#) shows the targets of intervention which consist of the elimination of infection and the interruption of the infection cycle. The practical approaches to control include the detection and treatment of vertebrate carriers, the safe disposal of human feces, the avoidance of raw aquatic vegetables and of those grown in wetlands, and as far as livestock is concerned, the avoidance of grazing in wetlands. The control of aquatic snails is a hypothetical possibility rather than a practical proposition.

**Main clinical symptoms:** Liver infection, fever, dyspepsy, ascites, eosinophilia.

**Incubation period:** 3–12 weeks.

**Prepatent period:** 3–4 months.

**Patent period:** 1–20 years.

**Diagnosis:** Microscopic determination of eggs (→[Fasciola hepatica/Fig.3](#)) in fecal samples by sedimentation method. →[Serology](#).

**Prophylaxis:** Avoid eating raw freshwater plants.

**Therapy:** Treatment see →[Trematocidal Drugs](#).

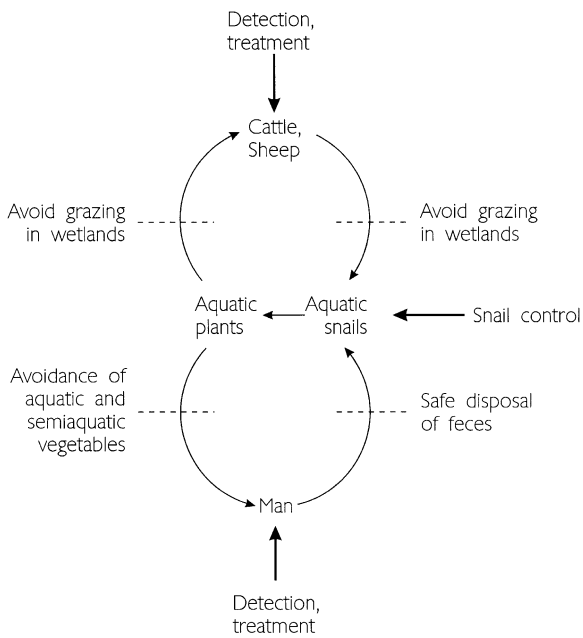

**Fascioliasis, Man. Figure 1** Targets and approaches for the control of fascioliasis.

## Fasciolopsiasis

Fasciolopsiasis is an infection of the duodenum and jejunum of humans with adults of *Fasciolopsis buski* (Figs. 1, 2). It is usually asymptomatic when small numbers of worms are present. However, the multiple attachment sites that become ulcerated, can lead to appreciable blood loss and abscess formation. Intestinal obstruction by large numbers of worms has been reported.

**Main clinical symptoms:** *Diarrhoea*, nausea, *vomiting*, *oedema*, *anaemia*, ascites.

**Incubation period:** 1–2 months.

**Prepatent period:** 2–3 months.

**Patent period:** 1 year.

**Diagnosis:** Microscopic determination of eggs (*Fasciolopsis buski*/Fig. 3) in faecal samples (by sedimentation technique).

**Prophylaxis:** Avoid eating uncooked tropical vegetables or fruit.

**Therapy:** Treatment with praziquantel, see *Trematocidal Drugs*.

## Fascioloides magna

8 cm long agent of Fasciolosis in North American sheep, cattle, and game animals.

### Disease

*Fasciolosis, Animals*.

## Fasciolopsis buski

### Classification

Species of *Digenea*.

### Distribution

Fig. 1.

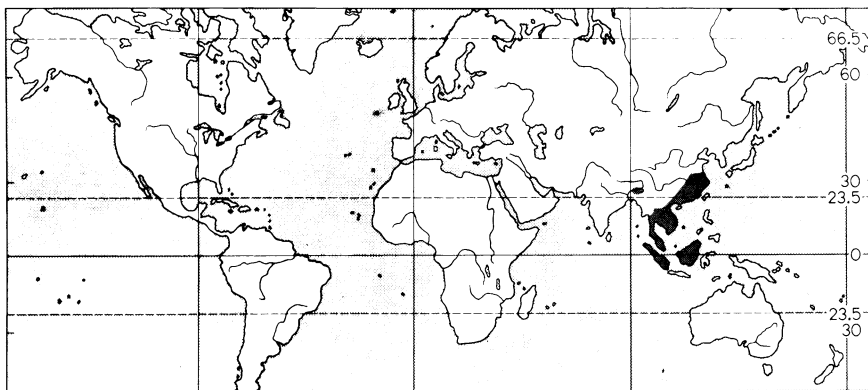

**Fasciolopsis buski. Figure 1** Distribution map of *Fasciolopsis buski* endemic in Asia.

## Morphology

The giant intestinal fluke is characterized by a very big ventral sucker and a smooth tegument without hooklets (Figs. 2, 3). The eggs are very large and possess an operculum (Fig. 4).

## Life Cycle

→ Digenea/ Fig. 8.



**Fasciolopsis buski.** Figure 2 Light micrograph of an adult fluke.

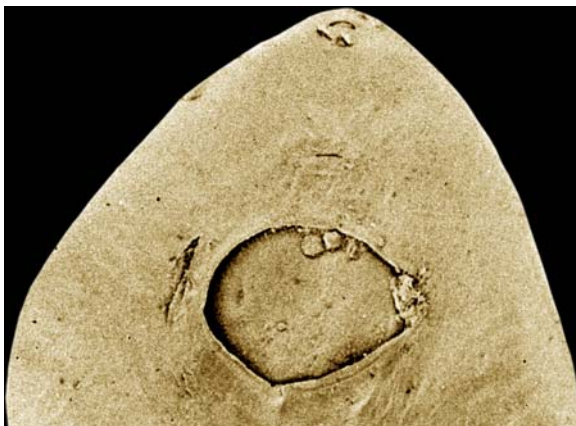

**Fasciolopsis buski.** Figure 3 SEM of the anterior part of a fluke, note the very large ventral sucker.



**Fasciolopsis buski.** Figure 4 LM of an egg obtained by faeces flotation method.

## Disease

→ Fasciolopsiasis.

## Fasciolosis, Animals

### General Information

Disease caused by the → liver fluke genus *Fasciola*. *F. gigantica* occurs in the tropics. → *F. hepatica*, the common liver fluke, is the most widespread and important of the group. It is found mainly in sheep and cattle but a patent infection can develop in horses, pigs, wild animals, and in humans (→ Fascioliasis, Man). The pathogenesis of fasciolosis is attributable in part to the invasive stages in the liver and in part to the blood-feeding by the adults in the bile ducts (Fig. 1). The process in all hosts shows close similarities, but considerable variation in severity occurs.



**Fasciolosis, Animals.** Figure 1 Sheep liver with adults of *Fasciola* in the calcified bile ducts (artificially opened).

## Pathology

### Ruminants

The pathological manifestations depend on the number of metacercaria ingested. The disease may follow acute or chronic courses. Acute fasciolosis is less common than the chronic entity and is almost invariably seen in sheep. It is essentially a traumatic hepatitis produced by the simultaneous migration of large numbers of adolescaria. It is towards the end of this development phase, about 6 weeks after infection, that the signs are apparent, with the major losses occurring 7–8 weeks after infection. Death may occur rapidly or after several days. Animals are disinclined to move, are anorexic, and show a distended abdomen which is painful to the touch. This is also the stage of parasitism in which “[→black disease](#)” occurs (*Clostridium novi* Type B).

Fasciolosis is most commonly a chronic disease, with no characteristic clinical signs. Loss of appetite and paleness of the mucous membranes appear to be constant features, and submandibular and udder [→oedema](#) are occasionally seen. Jaundice is hardly ever a sign in the living animal. Chronic debility with vague digestive disturbances are common. There is a substantial effect on milk production, and a reduction in food conversion efficiency with reduced weight gain. A reduction in wool production may occur in sheep, without symptoms of fasciolosis being apparent. Fasciolosis in sheep also has an adverse effect on conception and/or establishment of the fetus.

Changes in serum protein generally take the form of a depression in albumin compared with the globulins. They develop in 2 stages. The first stage coincides roughly with the period of fluke migration and is characterized by a progressive but usually mild [→hypoalbuminaemia](#), with a more pronounced hyperglobulinaemia of variable severity. The second stage, which is associated with the presence of adult parasites in the bile ducts, is attended by further deterioration of albumin as well as a progressive reduction in globulin concentrations. There is little disagreement on the cause of the hyperglobulinaemia, which is generally considered to reflect increase synthesis of immunoglobulins in response to parasitic antigens. On the contrary a more complex nature of the different processes and inter-relationships are involved in the pathogenesis of hypoalbuminaemia. During the migratory stage hypoalbuminaemia is brought on by a combination of reduced albumin synthesis and plasma volume expansion. During the biliary stage of the disease the severity of hypoalbuminaemia is related to the loss of albumin into the intestine and to the rate of albumin synthesis and the fractional and total rates of albumin catabolism. These, in turn, are related to the levels of nutrition, appetite, and fluke burden. The increased synthesis of albumin probably diverts available amino acids away

from other protein metabolism (muscle, milk, wool), thus accounting for the lowered levels of productivity seen in animals infected with *F. hepatica*.

The [→anaemia](#) is of the normocytic normochromic type, though some macrocytosis has been reported. The anaemia is well-recognized but its etiology is controversial.

Several factors may account for the anaemia:

- anaemia in the migratory phase is caused by accidental damage to hepatic vessels and haemorrhages.
- intrabiliary haemorrhage and consequent loss of red blood cells occur when adults arrive in the bile ducts. The ultimate degree of anaemia is not related to the severity of biliary haemorrhage, but rather to the animal’s erythropoietic capacity which is influenced by levels of dietary protein and iron.

Good correlation between the bromsulphthalein excretion test, serum [→glutamate](#) oxalo-acetate transaminase and gamma glutamyl transferase determinations for the assessment of liver damage are found in infected sheep (liver function test).

### Horses

*F. hepatica* is occasionally found in the equine and camel liver. Heavy infections are rare, and are usually only discovered during post-mortem examination.

### Swine

*F. hepatica* has been found in pigs, but infections are very rare.

### Targets for Intervention

[→Fascioliasis, Man/Targets for Intervention.](#)

### Therapy

[→Trematocidal Drugs.](#)

---

## Fatigue

Symptom of clinical babesiosis in humans.  
[→Babesiosis.](#)

---

## Favorisation

Favorisation was defined as an adaptation which gives the meeting of a host by a parasite a higher probability

than it would have only by chance (i.e., by causes unrelated with transmission). For instance, any process of chemical attraction which provokes the encounter between a larval stage of a parasite and its target host is a favorisation process.

Favorisation plays a variable role in parasite life cycles but is rarely absent. Although some parasite species invest principally in the production of a great number of infective stages which meet the host by chance, probably a majority of parasites have selected favorisation processes in the course of evolution.

The main aspects of favorisation are as follows:

- There is a free-living stage which disperses in the environment and exhibits some capacity to “find” the host. This is a simple process and the one most widely used by predators to “find” the prey. However, larval stages of parasites have, in general, limited capacities to localize a suitable host at distance. As exceptions, one must mention the numerous studies carried out on the larval stages of monogeneans and →trematodes. These researches demonstrate that aquatic larval stages may, to a certain extent, detect chemical gradients of substances emitted by the target hosts. It is surprising that the specificity of the attraction is wider than the specificity of development, with the result that a number of larval stages attach themselves to or penetrate into unsuitable hosts. The loss of infective stages known as “decoy effect” has been envisaged as a method of biological control (introduction of decoy organisms) but without any real success until now. The capacity of locating a host is much more developed when it is the adults, not the larvae or juveniles, which infect the host, as is the case of insect parasitoids. To a high degree, the parasitoids possess all the sensory organs common in →arthropoda. Some species detect their hosts, mainly lepidopterans, by odour (sometimes by the odour of the plant on which they feed), by vibrations (sometimes through several centimeters of wood), etc. The capacities of parasitoid insects to localize their hosts are sometimes surprising; possibly the most amazing of all is the wasp *Ichneumon eumerus*, which lays its eggs in a caterpillar (of the genus *Maculinea*) which lives itself in the depth of *Formica* nests. The wasps penetrate only into the nests which do harbour a caterpillar. It is supposed that the wasp listens at the entrance of the nest and is capable of detecting the noise made by the mandibles of the caterpillar. Let us add that the wasp emits a substance which makes the ants fight between themselves instead of attacking the wasp, whilst the latter makes its way to the caterpillar.
- There is a coincidence between the presence of the parasite and the presence of its host in space and/or

time. This has been particularly studied in aquatic →cercariae of trematodes and microfilariae of nematodes. The coincidence in space is achieved by a particular behaviour: in a same aquatic environment not all the species of cercariae swim at the same depth. Certain species swim rapidly towards the surface, others remain at the bottom, others scan the water column, etc. These different behaviours increase the probability of meeting the convenient target hosts. The coincidence in time is achieved through the emergence of cercariae from the snail →intermediate host. In most species, there is a very precise pattern of emergence (see Combes 2003) which is correlated with the activity rhythms of the host. Théron has shown that “→chronobiology” of cercariae can be selected rapidly with the result of increasing continuously the probability of meeting the host: in Guadeloupe for instance, →*Schistosoma mansoni* has 2 different hosts; humans and the black rat *Rattus rattus*: in transmission sites where humans are the main hosts, cercariae emerge from snails in the morning or around midday; in transmission sites where rats are the main (sometimes the unique) hosts, cercariae emerge later, at the end of the afternoon (Fig. 1). Microfilariae of →nematodes which live in the blood of vertebrates must be taken by →Mosquitoes or other biting arthropods to pursue their development. Most species aggregate in peripheric vessels at a period of the day corresponding to the time of biting activity of the vector. For instance, 80–100% of microfilariae of →*Wuchereria bancrofti* are found in the peripheric blood of humans during the night (i.e., when the principal vector →*Culex fatigans* is active) whereas they are virtually absent there during the day. A difference between microfilariae and cercariae is that microfilariae have a long lifespan (several weeks) and migrate to the peripheric vessels every day, whereas cercariae live only a few hours and have only “one chance” to find a host. The rhythm of microfilarial migrations is determined by the variation of physiological parameters of the human body; people working at night show the highest peripheral microfilaraemia during the day and constitute probably dead ends for transmission. The rhythm of peripheral microfilaraemia is not the same in areas where the vectors have different activity rhythms; in Polynesia, for instance, where the vector *Aedes pseudoscutellaris* bites during the day, the rhythm is reversed.

- The parasite manipulates the behaviour of its “upstream” host. At any transmission event in the life cycle, the “upstream” host is the host where the parasite comes from. The most astonishing example of a manipulation of the behaviour of the upstream host is that of the trematode *Gynaecotyla adunca*. The snail intermediate hosts live normally at a certain distance from the shore. The presence of larval stages

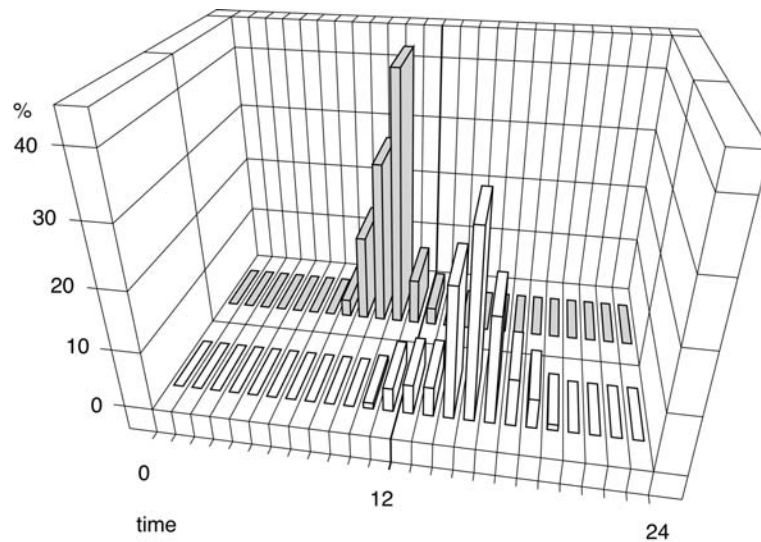

**Favourisation. Figure 1** Patterns of emergence of *Schistosoma mansoni* cercariae in foci where humans are the main hosts (grey bars, at the back) and in foci where rats are the main hosts (white bars, at the front). Confidence intervals are omitted. [Original, data from several papers by A. Théron].

of *G. adunca* provokes an alteration of the snail behaviour, which move towards the nearest beach where the second intermediate hosts (various crustaceans) live, and where the cercariae are emitted.

- The parasite manipulates the behaviour of its “downstream” host. The “downstream” host is the host to which the parasite moves during a transmission event. In contrast with the previous case, this process of manipulation is extremely frequent and intervenes when the parasite is transmitted from a prey to its predator. The parasite provokes various changes in the prey’s behaviour (the upstream host), which make it either debilitated, or more conspicuous, or both. However, it is the behaviour of the downstream host which is manipulated since it is attracted by a prey which is easier to catch, but carries the infective stage of the parasite. A striking and well-known example is that of various species of the trematode → *Diplostomum*. To become an adult, the parasite must be transmitted from a freshwater fish to a piscivorous bird: the larval stages (→ *Metacercariae*) of the parasites encyst in the eye of the fish, making it blind, and incapable of detecting the predator. In other life cycles, the presence of the parasite provokes an increase of the activity of the intermediate host, which makes it more conspicuous to the predator. Several studies show that the alteration of the behaviour appears only when the larval stage is actually infective. This is the case for the cestode → *Schistocephalus solidus*, which develops successively in a copepod, a fish (which ingests the copepod) and a piscivorous fish. Both the copepod

and the fish exhibit a particular behaviour which makes them more susceptible to predation, but this occurs only when the corresponding larval stages of the parasite are mature. Another example is that of shore crabs whose hiding behaviour at low tide is modified by an acanthocephalan; crabs exposed are at a greater risk of predation by definitive bird hosts. A study demonstrates a different strategy on the part of the parasite: the tapeworm → *Hymenolepis diminuta* which infects the rats when they ingest the beetle *Tenebrio molitor*, impairs the chemical defense of the insects, which make them more palatable to the rats.

### Related Entry

→ [Host Behavior](#), → [Extended Phenotype](#).

---

## Feasibility Studies

→ [Disease Control, Planning](#).

---

## Febantel

A pro-benzimidazole, → [Nematocidal Drugs](#).

## Fecampia

Genus of parasitic turbellarians (in marine crustaceans).

## Fecundity

Recent experiments have shown that parasites do not only influence the longevity of parasites, but also their fecundity. For example *Ornithonyssus* – →mites reduce fecundity in swallows, *Dermanyssus* in starlings, or *Thelodorsagia* worms in sheep.

## Feeder Organelle

Attachment zone of the developmental stages of →*Cryptosporidium* species to their host cell surface.

## Feeding Mobility

Range/circle, within which a host is sought by a blood-sucking arthropod.

## Felicola subrostratus

→Lice.

## Feltwork Layer

→Acanthocephala.

## Feminization

Some parasites (e.g., →*Microsporidia* such as *Nosema* species, →nematodes) and bacteria (e.g., *Wolbachia*

species) may lead to a female phenotypic appearance of their sexually male determined hosts →Phenotypic variability. →Behavior.

## Fenbendazole

Benzimidazole, →Nematocidal Drugs.

## Fenitrothion

### Chemical Class

Organophosphorous compounds (monothiophosphate).

### Mode of Action

Acetylcholine esterase inhibitor. →Ectoparasiticides – Agonists and Antagonists of Cholinergic Transmission.

## Fenoxycarb

### Chemical Class

Juvenile hormone agonist (phenoxyphenyl ether).

### Mode of Action

Insect growth regulator (IGR, juvenile hormone mimics). →Ectoparasiticides – Inhibitors of Arthropod Development.

## Fenthion (MPP)

### Chemical Class

Organophosphorous compounds (monothiophosphate).

### Mode of Action

Acetylcholine esterase inhibitor. →Ectoparasiticides – Agonists and Antagonists of Cholinergic Transmission.



## Fenvalerate

### Chemical Class

Pyrethroid (type II,  $\alpha$ -CN-pyrethroids).

### Mode of Action

Open state voltage-gated sodium channel blocker.  
 → [Ectoparasitocides – Blockers / Modulators of Voltage-Gated Sodium Channels](#).

## Ferida

Ferida brava, Ferida seca are common names for cutaneous and mucocutaneous leishmaniasis due to infections with *Leishmania braziliensis*. → [Espundia](#).

## Fermentation

→ [Energy Metabolism](#).

## Fertilisation Membrane

→ [Acanthor](#).

## Festoons

Small portions of the posterior ventral body of some ixodid ticks, marked by rectangular delicate grooves.

## Feulgen, Robert (1884–1955)

German physiologist and chemist, his stain shows the places of DNA occurrence.

## Fiboblastic Proliferation

→ [Pathology](#).

## Filaments

→ [Nucleus](#).

## Filariasis, Lymphatic Tropical

### Synonyms

Filariosis, Brugiiasis, Wuchereriasis, LF.

### General Information

→ [Lymphatic filariasis](#) is an infection with one of several mosquito-borne filarial worms of the species → [Wuchereria bancrofti](#), → [Brugia malayi](#) or *Brugia timori*, which live in the subcutaneous lymphatics or lymph nodes, with larvae circulating in the bloodstream. About one-fifth of the world's population live in areas where lymphatic filariasis is endemic. The disease is worldwide, 110 million people are estimated to harbour such infections. *W. bancrofti* is widely distributed throughout the tropics. *B. malayi* is restricted to parts of Southeast Asia and *B. timori* shows an even more restricted distribution in the Malay Archipelago. Adult *W. bancrofti* is restricted to man, while domestic and wild animals may serve as alternative hosts of *B. malayi* and *B. timori*. *W. bancrofti* is transmitted by → [Culex](#), → [Anopheles](#), and → [Aedes](#) spp., *B. malayi* and *B. timori* predominantly by → [Mansonia](#) spp.

Clinical manifestations of filariasis are almost exclusively due to the microfilariae shed by the adult female worms. The symptoms include initial filarial fever and lymphangitis which later gives rise to recurring lymphoedema. High adult wormload, and consequently high microfilarial density, favours the development of lymphangitis and elephantiasis.

### Pathology

The larvae are injected intradermally with a mosquito bite and find their way to the large lymphatics, where they mature and mate. Swelling of lymph nodes containing adults is a common feature. However, when

an adult worm dies severe →[lymphadenitis](#) with chronic inflammatory to granulomatous reaction results, including eosinophils which ultimately leads to fibrosis. In some multiply infected individuals this may lead gradually to chronic lymphatic obstruction, which in a small percentage of cases progresses to the lymphoedematous complication of elephantiasis, usually in an extremity. The newborn larvae circulate in the bloodstream within the internal organs, such as the spleen, and sometimes they migrate cyclically to the peripheral circulation, coincident with the biting/feeding habits of the prevalent transmitting mosquito. Tropical eosinophilic fever with pulmonary infiltration is often attributed to this infection.

### Immune Responses

Because of the very long periods of survival of the →[macrofilariae](#) (=adult worms) in their hosts (5–15 years), it is obvious, that these parasites must have developed complex mechanisms to evade killing by the host immune defenses. In addition, the host's immune response significantly contributes to the different pathological manifestations of the disease.

There is a broad range of immune reactivity with considerable individual variation. In lymphatic filariasis, microfilaremic individuals (MF) who are clinically asymptomatic have high parasite burdens and little or no parasite antigen-specific cell-mediated responses. In contrast, patients with chronic lymphatic disease, e.g., elephantiasis, typically are amicrofilaremic and vigorous T cell responses against the parasite can be detected.

As for most of the other parasitic diseases, models of filarial infection in inbred mice significantly contributed to the understanding of the disease-influencing immunoregulatory events. Since laboratory mice are not permissive for filarial species found in infected humans, immunity to different stages of these filariae (3rd-stage larvae, adults, and microfilariae) has been analyzed separately as a surrogate approach. On the other hand, in the mouse model of *Litomosoides sigmodontis* infection, the full developmental cycle can be established in inbred mice, allowing to study immunity during maturation of infective larvae into adult worms.

### Innate Immunity

Information on the role of components of →[innate immunity](#) in the early control of filariae is limited. Innate immune responses to *Brugia malayi* and *Onchocerca volvulus* are interestingly initiated by endosymbiotic *Wolbachia* bacteria and are dependent on TLR2, TLR6, and MyD88. In chronic infections however, the observed diminished expression and function of TLR is a likely consequence of chronic Ag stimulation and

could serve as a novel mechanism underlying the dysfunctional immune response in filariasis. In a study by Babu et al. an unexpected role of NK cells was described. Comparisons of *B. malayi* worm survival in strains of mice with different levels of NK cell activity showed, that host NK cells are required for the growth of this human filarial parasite. While NOD/LtSz-SCID mice with diminished or absent NK cell activity were non-permissive to worm growth, C.B17 SCID mice with normal NK cell activity were highly permissive. Furthermore, transfer of NK cells into NK-deficient mice rendered these animals permissive. Although the mechanisms by which NK cell allow the growth of filariae is enigmatic so far, these findings clearly point to an interesting role of the innate immune system in the establishment of this parasitic disease. The most compelling evidence for a role of eosinophils in immunopathology of filarial infections comes from analysis of onchocercal dermatitis and keratitis. There is a consistent presence of eosinophils and eosinophil granule proteins at the site of tissue damage, either after parasite death or direct injection of parasite antigens. However, the role of IL-5 and other chemoattractant mediators for the recruitment and activation of eosinophils has yet to be established.

### B Cells and Antibodies

High levels of parasite-specific IgE and IgG4 are produced in filariasis patients, generally accompanied by →[eosinophilia](#). A reciprocal expression of these 2 isotypes has been found in lymphatic filariasis patients, with asymptomatic patients having much higher ratios of IgG4:IgE than found in elephantiasis patients, suggesting either that IgE is an antifilarial antibody, and/or that high IgE is involved in the pathogenetic pathway of the disease. High quantities of IgG4 can be frequently found in sera of microfilaremic patients, where sometimes up to 95% of the filarial-specific antibodies are of this subclass. In contrast, in elephantiasis patients IgG1, 2 and 3, dominate the filaria-specific antibody response. It seems likely that these antibodies may contribute to the pathology through →[ADCC](#) or →[immune complex formation](#).

In mice infected with *B. malayi* the clearance of microfilariae was found to be clearly antibody-dependent. CBA/N mice which carry the Xid defect have a pronounced impairment of the B1 cell subset and are therefore unable to develop certain T-cell-independent IgM antibodies. The findings that microfilaremia can not be controlled in these animals after i.v. injection of *B. malayi* or implantation of *A. viteae* gravid females strongly suggest that T cell-independent IgM antibodies to the microfilariae's surface are involved in the clearance of microfilariae.

## T Cells

Immunity to most filarial infections is clearly T cell dependent. Nude mice and rats are susceptible to infection with a number of species (*A. viteae*, *B. pahangi*, *B. malayi*) to which their normal, immune competent littermates are resistant, and infection against *B. pahangi* can be established in normally resistant CBA mice when these are deprived of T cells. The resistance of mice to *B. malayi* can be probably mediated by either CD4<sup>+</sup> T cells or CD8<sup>+</sup> T cells: Resistance to the maturation of infective larvae (L3) was not abrogated in either  $\beta$ 2-microglobulin knockout mice, which lack MHC class I molecules and class-I-restricted CD8<sup>+</sup> T cells, or in anti-CD4-treated or CD4-deficient mice.

Important clues for the contribution of Th1 or Th2 cells to pathology or control of the parasite came from analysis of onchocerciasis patients. In individuals with generalized infections characterized by high microfilarial loads, low proliferative T cell responses to parasite antigens is accompanied by a production of Th2 cytokines. On the other hand, a minority of patients able to prevent maturation of L3 displays an immune response characterized by the predominance of IFN- $\gamma$  producing Th1 cells. Several experimental studies have been performed to analyze the relative contributions of Th1 and Th2 cells and their products (cytokines) to the control of filarial parasites in mice. Following infection with L3 or immunization with L3 there is a strong expansion of parasite-specific Th2 cells and of associated immune responses such as IgE production and eosinophilia. In infections with both  $\rightarrow$ *Brugia* and *O. volvulus* the Th2 responses appear to be protective, since antibodies against IL-4 or IL-5 resulted in longer survival of larvae. However, resistance to maturation of L3 into adults was not abrogated in IL-4 knockout mice, arguing for compensatory mechanisms in these gene-deficient mice. Infection of BALB/c mice with adult *B. malayi* worms, especially females, also induced strong IL-4 production by splenocytes.

The Th cell response to microfilariae has been most extensively investigated using *A. viteae*, *B. malayi*, *O. volvulus*, and *O. lienalis*. Interestingly, a dominant Th1 response has been observed during the first 2 weeks of infection, which is followed by an enhanced induction of IL-4 and IL-5 in addition to IFN- $\gamma$  during the subsequent weeks. Thus, the time of exposure to microfilarial antigens seems to drastically influence the type of Th cell response. Both Th cell subsets may significantly contribute to the control of microfilariae, since both IFN- $\gamma$ -stimulated macrophages as well as IL-5-dependent eosinophils are operative against microfilariae. Activated macrophages are able to damage microfilaria by releasing NO. In addition, microfilariae of some species (e.g., *O. lienalis*) but not of others (*B. malayi*) are sensitive to H<sub>2</sub>O<sub>2</sub> which may be produced by eosinophils.

Filaria nematode infection is associated with a profound downregulation of the host immune system. When mice are infected with *B. pahangi*, natural T<sub>reg</sub> expand and suppress excessive Th2 responses. In a model of murine filarial infection, the infection and subsequent immunosuppression is associated with accumulation of T<sub>reg</sub> in the thoracic cavity.

## Shaping of the Immune Response by the Parasite

Recent reports suggest that filarial parasites have the capacity to actively shape their immunological environments in their host. For example, secreted products of the  $\rightarrow$ nematodes have been found to differentially modulate the expression and activation of protein kinase C isoforms in B lymphocytes. Furthermore, the expression of CD23 on human splenic B and T cells and Th2 responses are enhanced by soluble products of the parasite. Pastrana et al. cloned homologues of the mammalian migration inhibitory factor (MIF) from *B. malayi*, *W. bancrofti*, and *O. volvulus*. The effects of recombinant forms of the parasite MIF and human of inflammatory and T cell responses by filarial MIF could provide the parasite with a survival advantage.

## Planning of Control

The approaches to the control of lymphatic filariasis were formerly based on the elimination of infection by treatment (diethylcarbamazine = DEC) and  $\rightarrow$ vector control for the prevention of infection. Both approaches were only marginally effective due to the poor macrofilaricidal activity of DEC and constraints of controlling *Culex* spp. in urban areas and *Anopheles* spp. in the rural environment. Moreover, the first dose of DEC may cause severe and even fatal adverse reactions in persons infected with  $\rightarrow$ *Loa loa*, a tissue-dwelling filaria occurring in tropical Africa.

The control of lymphatic filariasis has been revolutionized by the finding that a single dose of ivermectin or DEC or both will eliminate microfilaraemia for several months due to an action against microfilariae and embryonic stages. Although recurring, microfilaraemia will stay below 1% of the initial level for a year or more. With repeated dosing, once a year, microfilaraemia will not reach the level at which it could cause lymphoedema or elephantiasis. Essentially the same applies to onchocerciasis with regard to the prevention of irreversible ocular lesions. The reduction of microfilarial rates and densities will also lead to a rapid reduction of disease transmission, more effective than it could ever be expected from vector control.

Based on these findings, the WHO has embarked on the global elimination of lymphatic filariasis through the annual single dose administration of a combination of ivermectin and DEC to all persons (approximately 1,100 million) residing in areas where the disease is endemic. There is still the caveat of adverse reactions to

DEC in people infected with *Loa loa* (→Loiasis), but this only applies to tropical Africa and can be overcome by using ivermectin alone. The other, yet unknown, factor is the potential role of animal reservoir as an obstacle to the ultimate elimination of human brugian filariasis.

**Targets for Intervention**

The infective larvae of →*W. bancrofti* leave the arthropod vector at the time of a blood meal, slide along the outer surface of the →proboscis stem, and actively enter the bite wound. After reaching the lymphatic target organ, they will become adults and mate. The females will produce microfilariae which will periodically or sub-periodically enter the blood stream from where they can be taken up by the vector. Figure 1 shows that the detection and treatment of infected persons, suppression of microfilaraemia, vector control, and the interruption of contact between man and vector are potential approaches to the control of →bancroftian filariasis.

**Main clinical symptoms:** Lymphangitis, unfeelingness of skin portions; later: chylurie, elephantiasis, i.e., giant swelling of organs.

**Incubation period:** 3–16 months.

**Prepatent period:** 7–24 months.

**Patent period:** 8–10 years (adults live until 18–20 years).

**Diagnosis:** Microscopic analysis of smear preparations or of membrane filtered material (Figs. 2, 3); microfilariae are found at 10 p.m. in the peripheral blood, →Serology.

**Prophylaxis:** Avoid bites of vector →mosquitoes in endemic regions.

**Therapy:** Treatment see →Nematocidal Drugs, Animals, →Nematocidal Drugs, Man.

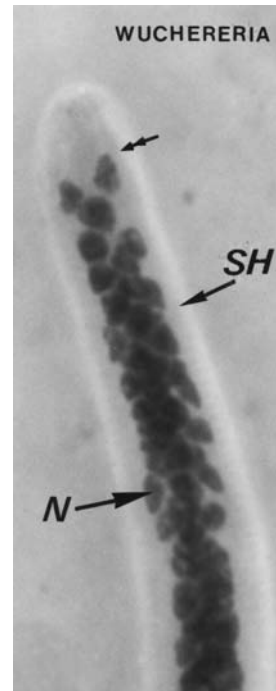

**Filariasis, Lymphatic Tropical. Figure 2** Giemsa-stained anterior end of a microfilaria of *Wuchereria bancrofti*.

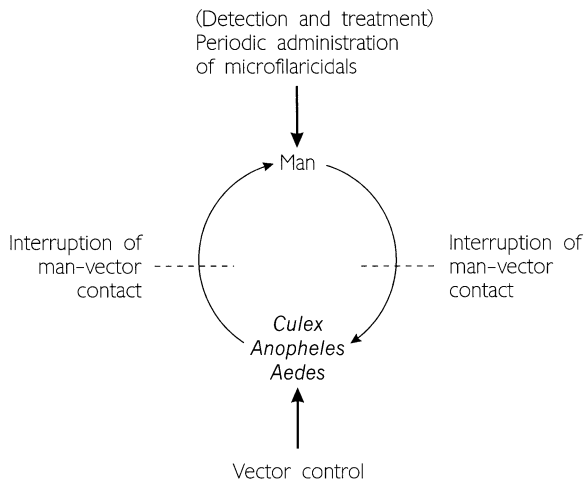

**Filariasis, Lymphatic Tropical. Figure 1** Targets and approaches for the control of bancroftian filariasis.

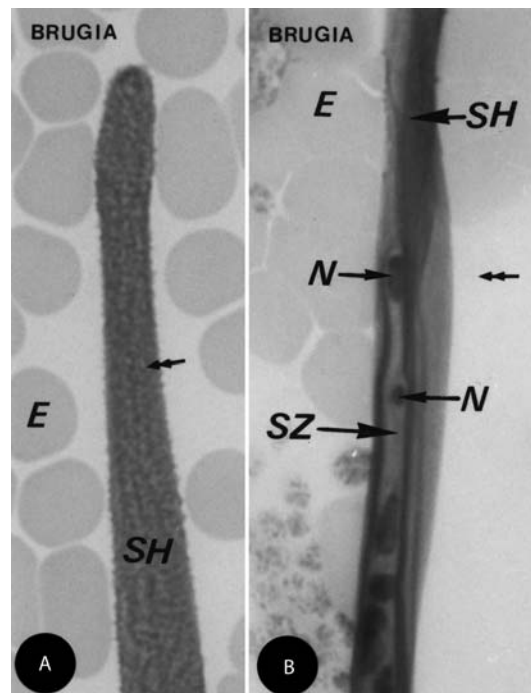

**Filariasis, Lymphatic Tropical. Figure 3** Giemsa-stained sheath of 2 microfilariae of *Brugia malayi*. E, erythrocyte, N, nucleus, SH, sheath, SZ, nucleus-free zone of microfilaria.

**Related Entry**→[Filaridae](#).**Filariform Larva**

→[Hookworms](#), →[Strongyloides](#), third larvae, the esophagus of which is rather long and fine.

**Filaridae****Name**

*Latin:* filum = filament.

**Classification**

Family of →[Nematodes](#).

**Important Species**

Tables 1, 2.

**Life Cycle**

Fig. 1 (page 524).

**Distribution**

Fig. 2 (page 525).

**Diseases**

→[Filariasis](#), [Lymphatical Tropical](#), →[River Blindness](#), →[Roble's Disease](#), →[Tropical Elephantiasis](#), →[Eye Worm](#). →[Kalabar Swelling](#), →[Loiasis](#).

**Filaroides (Oslerus) osleri**

Nematode, →[Respiratory System Diseases](#), [Horses](#), [Swine](#), [Carnivores](#), →[Oslerus osleri](#).

**Filaridae. Table 1** Important species of the Filaridae

Species	Length of adult worms (mm)		Size of eggs (or larvae) (µm)	Final host/Habitat	Intermediate host	Prepatent period in final host (weeks)
	f	m				
<i>Onchocerca volvulus</i>	350–700	20–40	Larvae in subcutaneous tissues, unsheathed, 300 × 7	<b>Humans/</b> Subcutaneous tissues	<i>Simulium</i> spp.	32–52
<i>O. gutturosa</i>	40–60	40	Larvae in blood, unsheathed, 260 × 7	Cattle/ Subcutaneous tissues	<i>Odagmia</i> spp.	28
<i>Wuchereria bancrofti</i>	100	40	Larvae in blood, sheathed, 275 × 8	<b>Humans/</b> Lymph nodes	<i>Aedes</i> spp., <i>Culex</i> spp.	52
<i>Brugia malayi</i>	80–90	30	Larvae in blood, sheathed, 250 × 8	<b>Humans/</b> Lymph nodes	<i>Mansonia</i> spp., <i>Anopheles</i> spp.	12
<i>Loa loa</i>	70	35	Larvae in blood, sheathed, 260 × 8	<b>Humans/</b> Subcutaneous tissues, eye	<i>Chrysops</i> spp.	52
<i>Litomosoides carinii</i>	60–120	20–25	Larvae in blood, sheathed, 90 × 7	Rats/Pleural cavity	Mites ( <i>Bdellonyssus</i> )	10–11
<i>Dirofilaria immitis</i>	250–300	120–180	Larvae in blood, unsheathed, 200–300 × 8	Dogs, cats, <b>humans/</b> Pulmonary artery	<i>Culex</i> spp., <i>Anopheles</i> spp.	25
<i>Dipetalonema perstans</i>	70–80	45	Larvae in blood, unsheathed, 150 × 8	<b>Humans, dogs/</b> Body cavity	<i>Culicoides</i> spp.	36
<i>D. viteae</i> ( <i>Acanthocheilonema</i> )	60–100	40	Larvae in blood, unsheathed, 230 × 7	<i>Meriones</i> sp./ Subcutaneous	<i>Ornithodoros moubata</i>	10–12

**Filariidae. Table 2** Filariae of dogs and humans (accidentally)

Species	Mf Length (µm)	Virulence	Vector in humans or dogs	Location in host(s)	Other hosts
<i>Dirofilaria immitis</i>	281–349	High	<i>Culex, Aedes, Mansonia</i>	Pulmonary artery, right ventricle	Felidae, horse, humans
<i>D. repens</i>	278–290	Low	<i>Aedes, Mansonia</i>	SC tissues	Felidae, humans
<i>Acanthocheilonema reconditum</i>	241–277 291–309	Nil	<i>Ctenocephalides felis, Rhipicephalus sanguineus</i>	Body cavity	Camel, humans
<i>Brugia malayi</i>	280	Nil	<i>Mansonia, Anopheles</i>	Lymphatics	Humans, Felidae, monkeys
<i>B. pahangi</i>	220	Nil	<i>Mansonia, Anopheles</i>	Lymphatics	Felidae, monkeys

## Filicollis anatis

→[Acanthocephala](#).

## Filopodia

Fine →[pseudopodia](#), e.g., in →[Acanthamoeba](#) species.

## Fimbriaria

→[Eucestoda](#).

## Final Host

Host, within which the sexual reproduction of a parasite occurs; this host type is also named definitive host or terminal host. →[Heteroxenous Development](#).

## Finlay, Carlos John (1833–1915)

Discoverer in Havana (Cuba) of the transmission of the yellow fever via the mosquito species *Aedes aegypti*.

## Fipronil

### Chemical Class

Arylpyrazole.

### Mode of Action

GABA-gated chloride channel antagonist.  
→[Ectoparasiticides – Antagonists and Modulators of Chloride Channels](#).

## Fixed Pore

A fixed pore is a protein structure that stretches through the →[cell membrane](#). The molecules to be transported pass through the space, or through a channel formed between the subunits of the pore (→[Membrane Transport](#)).

## Flagella

Many →[Protozoa](#) use flagella or →[cilia](#) as locomotory organs. These structures are constructed according to a common plan. Whilst flagella are longer and generally less numerous than cilia, their basic structures are similar (Figs. 1–3, pages 526, 527; see also →[Blastocrithidia Triatomae](#)/Fig. 2E, →[Gametes](#)/Fig. 6, →[Pellicle](#)/Fig. 1C, →[Trichomonadida](#)/Fig. 1A). Both types of organelle are c. 0.2–0.4 µm in diameter and both possess an →[axoneme](#) (an arrangement of 9 pairs of outer →[microtubules](#) and a

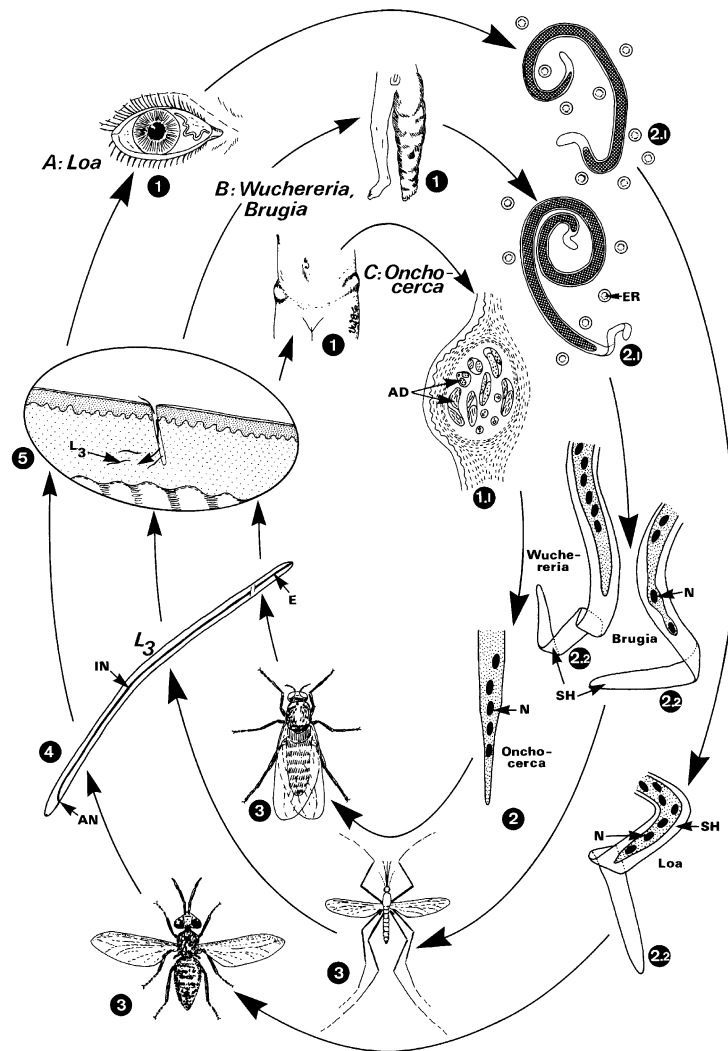

**Filariidae. Figure 1** Life cycles of human filarial worms. **A** → *Loa loa* adult worms (= → macrofilariae: male 3.5 cm, female 7 cm) wander subcutaneously and may pass the anterior chamber of the eye (1). **B** → *Wuchereria bancrofti* adults (male 4 cm, female 10 cm) and → *Brugia malayi* adults (male 3 cm, female 9 cm) live in lymph vessels and lead to a late-stage disease called → elephantiasis tropica (1). **C** → *Onchocerca volvulus* adults (male 2–4 cm, female 70 cm) are knotted together in groups in the subcutaneous tissues. Because of host reactions these groups are encapsulated, leading to palpable → nodules (1). In sections of these nodules coiled adults are seen (1.1). Microfilariae may induce → blindness. 1 Visible signs of diseases. 2 Microfilariae; the long-living females produce (after copulation) thousands of first-stage larvae daily, which measure about  $260 \times 8 \mu\text{m}$ . Their shape (2.1), structure (2, 2.2), and diurnal occurrence are species-specific: they may or may not be sheathed (2.2); their terminal nuclei have a species-typical appearance (2, 2.2); they can be found in blood vessels (*Loa*, → *Brugia*, → *Wuchereria*) or in lymphatic gaps (→ *Onchocerca*); their occurrence in the peripheral blood can be periodical (*Loa*, during the day; *Wuchereria*, during the night; some subperiodic strains also exist), or may not be (*Onchocerca*, always present, but in lymph vessels). 3 Intermediate hosts: Depending on the periodic appearance of microfilariae in the host's skin, insects with different biological behavior are involved as → vectors. Daytime feeding vectors (deerflies, → *Chrysops* spp., → blackflies, → *Simulium* spp.) transmit *Loa loa* or *Onchocerca volvulus*, whereas night-feeding → mosquitoes (→ *Aedes*, → *Culex* → *Anopheles*) may be vectors of the nocturnal strains of *Wuchereria* and *Brugia*. When microfilariae are ingested by the intermediate hosts during the blood meal, they penetrate the intestine, and enter the abdominal cavity and the thoracic muscles. After a → molt the L<sub>2</sub> is formed, which has a stumpy shape (sausage stage). Another molt finally leads to the filariform infectious L<sub>3</sub>. 4–5 L<sub>3</sub> reach a length of about 1.5 mm and migrate to the → proboscis, from which they escape when the vector is feeding. They enter the skin through the wound channel made by the biting insect (5, arrow). Inside the final host (man) the larvae mature until they reach their favorite site of location, where they mature (after another 2 molts) within 1 year (prepatent period; → Nematodes/Table 1). AD, adult worms (in section); AN, anus; E, esophagus; ER, erythrocyte; IN, intestine; L<sub>3</sub>, third-larval stage; N, nuclei (their arrangement at the poles of microfilariae is species specific); SH, sheath (→ Eggshell).

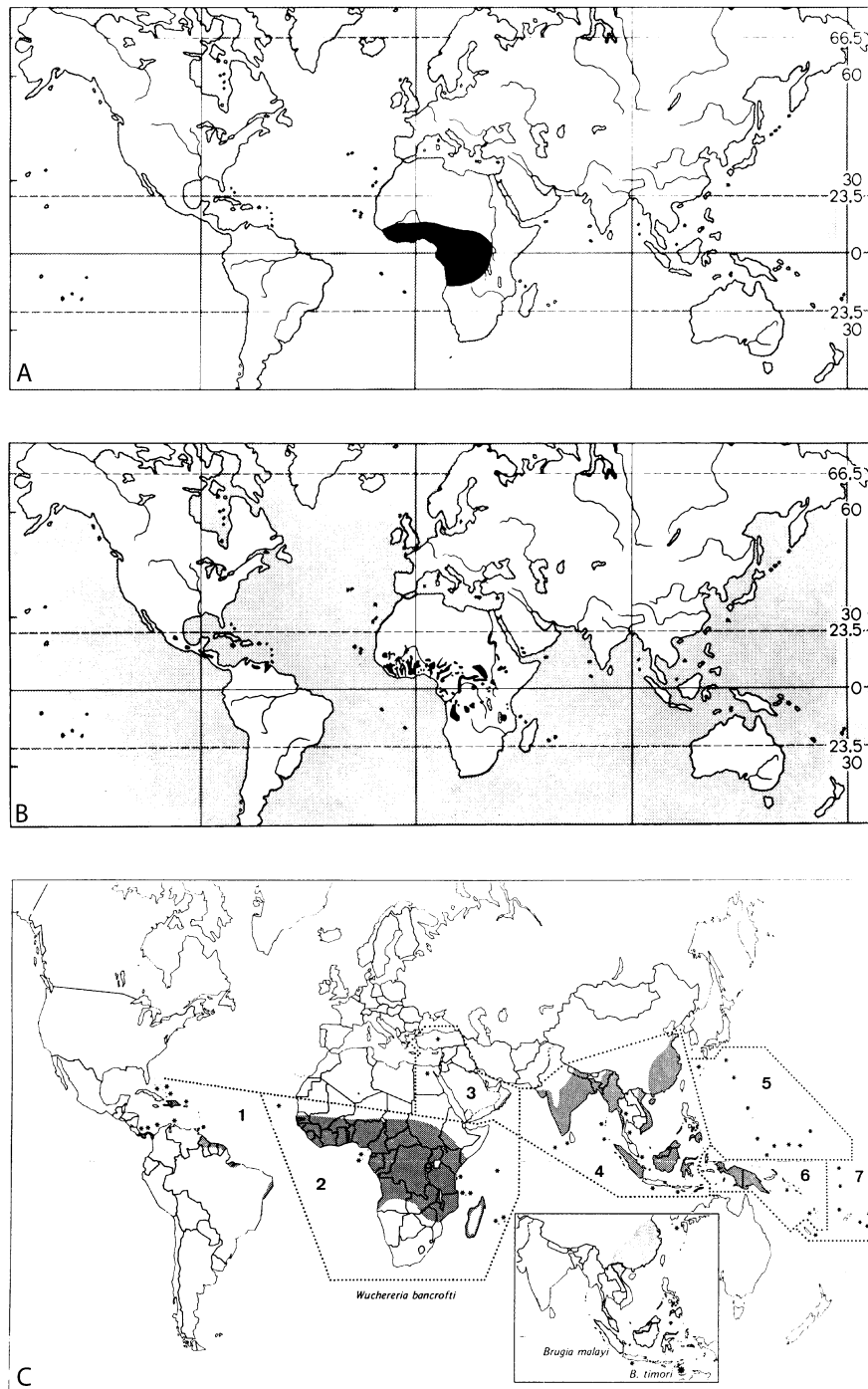

**Filariidae. Figure 2** Distribution maps of *Loa loa* **A**, *Onchocerca volvulus* **B**, and **→lymphatic filariasis** **C**: 1–6 Regions with *Wuchereria bancrofti* periodic form; 4, 7 Regions with *Wuchereria bancrofti* subperiodic form.

single pair of central microtubules) that is anchored to a basal body (→*Kinetosome*) that resides inside the cortical →*cyto-plasm* of the cell (Fig. 1C, →*Trypanosoma*/Fig. 5B). The →*basal bodies* are similar to centrioles in having 9 sets of 3 microtubules arranged in a ring-like pattern. The basal bodies may be connected to filamentous elements such as the kinetodesmal filaments of cilia.

Several species of Protozoa have a rod-like structure consisting of a network of protein filaments inside the flagellum (Fig. 1D, E). These rods lie beside the axoneme, probably adding to the thickness and stability of the flagellum. This enhancement may be particularly important for Protozoa living in viscous media such as blood or intestinal fluids. Although flagella and cilia are



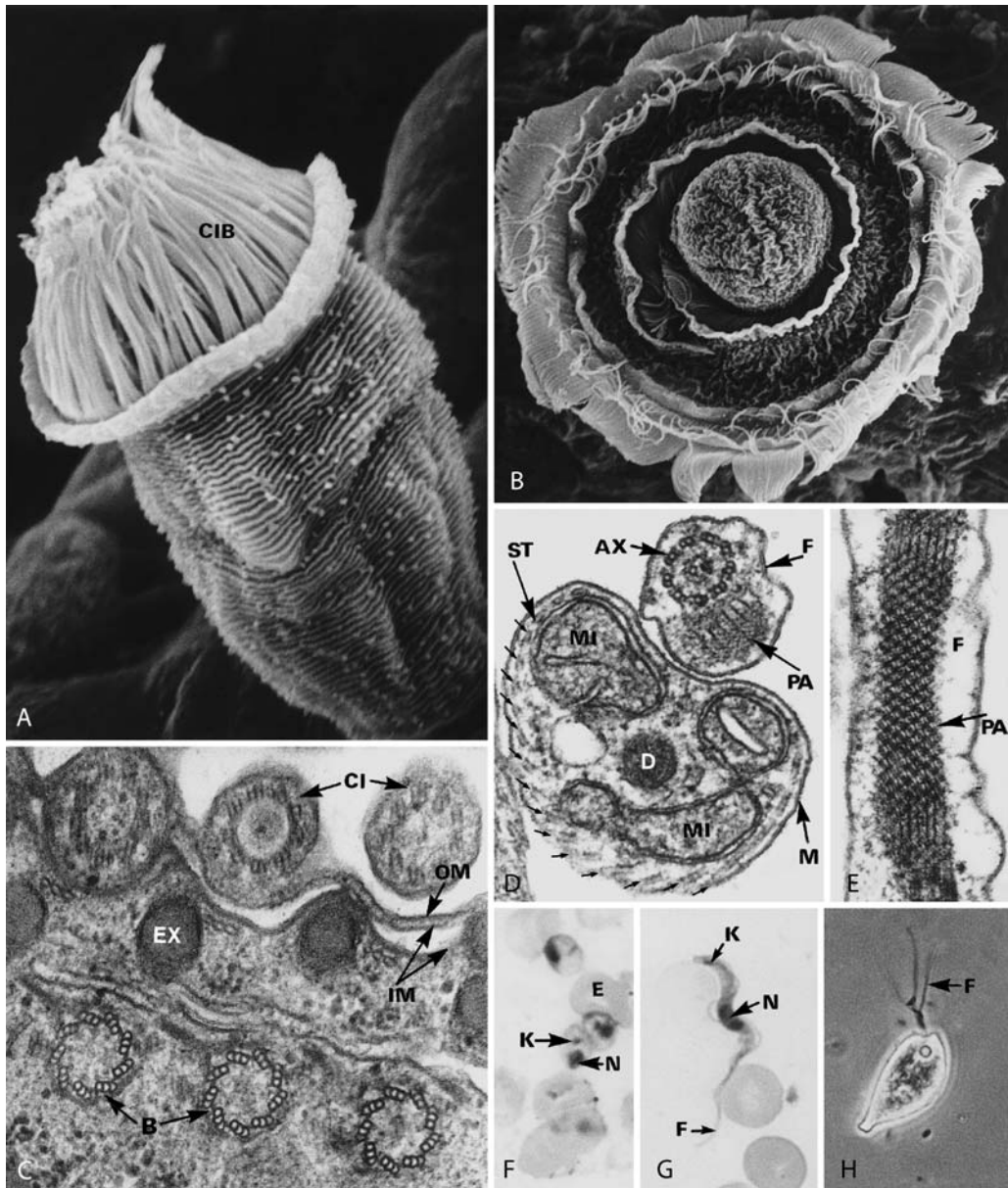

**Flagella.** Figure 1 A–H Flagella and cilia under SEM (A, B), TEM (C–E), and light microscopy (F–H). **A** *Apiosoma* sp.; this ciliate is attached to the skin of a fish; note the bundles of cilia (CIB) ( $\times 3,000$ ). **B** *Trichodina* sp., ventral view of this ciliate parasitic on fish, note the concentric rows of cilia ( $\times 2,000$ ). **C** *Ichthyophthirius multifiliis*; section through the periphery of a young trophont, which has just entered the skin of the fish host ( $\times 40,000$ ). **D, E** *Blastocrithidia triatomae*; note that the flagellum of trypanosomes contains a *paraxial rod* (PA) as well as the axoneme (AX) ( $\times 35,000$ ). **F** *Amastigotes* of *Leishmania donovani* do not show their short flagellum with light microscopy ( $\times 2,200$ ). **G** *Trypanosoma cruzi*; S-shaped trypomastigote form within mammalian blood ( $\times 2,000$ ). **H** *Naegleria gruberi*; nonfeeding mastigote stage from freshwater ( $\times 2,100$ ). AX, axoneme; B, basal body; CI, cilia; CIB, bundles of cilia; E, erythrocyte; EX, *extrusome*; F, flagellum; IM, inner 2 membranes of *pellicle*; M, membrane; MI, mitochondrion; N, nucleus; OM, outer membrane of *pellicle*; PA, *paraxial rod*.

constructed according to a general blueprint, in different Protozoa the paired outer microtubules in the flagella and cilia may differ in shape. The A-tubule, which is furnished with 2 dynein arms, typically possesses 13 protofilaments, whereas the B-tubule has only

9 protofilaments and shares 3 or 4 of the protofilaments of the A-tubule. The dynein arms act as enzymes for breaking down ATP and are assumed to represent the motor system in the gliding-filament theory. This theory postulates that the movement of flagella and cilia is

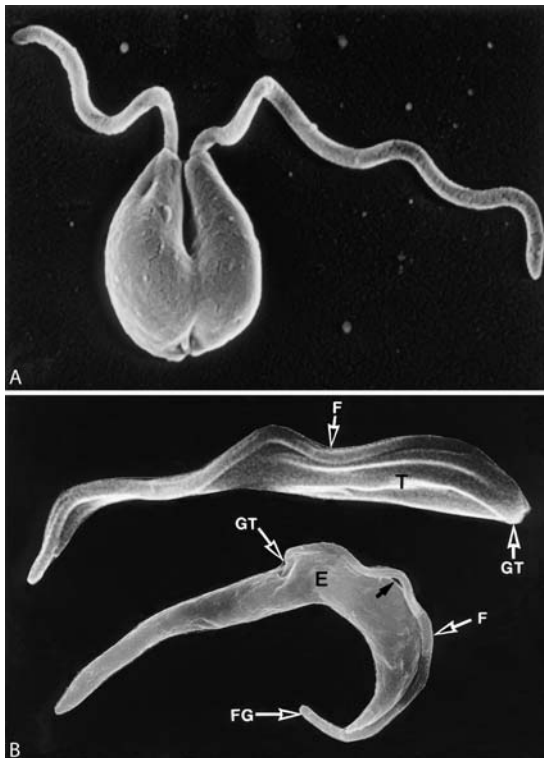

**Flagella.** Figure 2 SEM-micrographs of flagella of trypanosomatids. A *Leishmania major* promastigote in division.  $\times 10,000$ . B Trypomastigote and epimastigote stage of  $\rightarrow$  *Trypanosoma* sp. Note that the flagella run separately along the surface and no undulating membrane is formed.  $\times 13,000$ . F, flagellum; FG, free end of flagellum; GT,  $\rightarrow$  flagellar pocket.

initiated by the gliding of microtubules along each other using the dynein arms as linking elements. The central regions of flagella are stabilized by spike-like elements, in addition to the rod. In the  $\rightarrow$ trichomonads and in the trypomastigote stages of trypanosomes, a flagellum may be connected to the cell surface by  $\rightarrow$ desmosomes ( $\rightarrow$ Trypanosoma/Fig. 5B). The  $\rightarrow$ recurrent flagellum is attached in this manner and when it pulls the plasma membrane away from the body, the  $\rightarrow$ undulating membrane is created ( $\rightarrow$ Trichomonadida/Fig. 1C). The recurrent flagella never run inside the cytoplasm, but the  $\rightarrow$ axonemes of *Giardia*  $\rightarrow$ trophozoites run inside the cytoplasm for several micrometers (Fig. 3).

## Flagellar Pocket

$\rightarrow$ Flagella.



**Flagella.** Figure 3 SEM-micrograph of the ventral side of a trophozoite of  $\rightarrow$  *Giardia lamblia*.  $\times 10,000$ . D, disk; F, flagellum.

## Flagellata

### Synonym

$\rightarrow$ Mastigophora.

### Classification

Subphylum of  $\rightarrow$ Sarcomastigophora.

## Flame Cell

### Synonym

$\rightarrow$ Terminal Cell,  $\rightarrow$ Cyrtocyte,  $\rightarrow$ Platyhelminthes/Fig. 24.

## Flatworms

### Synonym

$\rightarrow$ Platyhelminthes.

## Flaviviridae

### Classification

Family of RNA viruses, transmitted by arthropods  
→ [Arboviruses](#).

### General Information

Positive-sense single-stranded → [RNA viruses](#) (spherical, with envelope); about 60 species.

### Important Species

→ [Flavivirus](#).

### General Information

Positive-sense single-stranded → [RNA viruses](#) (spherical, with envelope). Altogether about 60 virus species (some of them with several types/subtypes) described. Presently these species are assigned to 3 main divisions: Tick-borne viruses (with 2 groups), mosquito-borne viruses (with 7 groups), and viruses with no known arthropod vector (with 3 groups).

### Important Species

Table 1.

## Flavivirus

### Classification

Genus of Viruses including some → [arboviruses](#).

## Flea Allergy Dermatitis (FAD)

Allergic reaction due to injection of even smallest amounts of flea saliva. A sensitized animal in general may show two types of reactions:

**Flavivirus. Table 1** Arboviruses V. Positive sense, single-stranded RNA viruses: Family Flaviviridae, genus Flavivirus

Serogroup (no. of known members)	Species (selected)	Arthropod host	(Main) vertebrate hosts	Distribution	Disease in man	Disease in animals
Tick-borne group (14)	Tick-borne encephalitis, European, Siberian, Far Eastern subtype	Ixodidae ( <i>Ixodes ricinus</i> , <i>Ixodes persulcatus</i> and other species and genera)	Rodents	Northern and Central Europe, Northern Asia	Tick-borne encephalitis, Central European encephalitis, Russian Spring Summer encephalitis (fever, encephalitis)	Neurological disease
	Louping ill	Ixodidae ( <i>Ixodes ricinus</i> )	Rodents, sheep, grouse	Britain, Norway, Spain	Louping ill disease (encephalitis)	Neurological disease
	Kyasanur Forest	Ixodidae <i>Haemaphysalis spinigera</i> and other species)	Rodents, insectivores, bats	India	Kyasanur Forest disease (fever, hemorrhagic fever)	Hemorrhagic fever
	Omsk hemorrhagic fever	Ixodidae ( <i>Dermacentor</i> , <i>Ixodes</i> )	Rodents	Russia (Western Siberia)	Omsk hemorrhagic fever (fever, hemorrhagic fever)	Hemorrhagic fever
	Powassan	Ixodidae ( <i>Ixodes</i> , <i>Dermacentor</i> )	Rodents	North America, Asia	Powassan encephalitis	
	Negishi	Ixodidae (?)	?	Japan	Encephalitis	Neurological disease
	Alkhumra	Ixodidae (?)	Cattle, camels (?)	Arab Peninsula	Arabian hemorrhagic fever	
	Langat	Ixodidae ( <i>Ixodes</i> , <i>Haemaphysalis</i> )	Rodents (?)	Malaysia, Thailand, Russia	Encephalitis (experimentally)	

**Flavivirus. Table 1** Arboviruses V. Positive sense, single-stranded RNA viruses: Family Flaviviridae, genus Flavivirus (Continued)

Serogroup (no. of known members)	Species (selected)	Arthropod host	(Main) vertebrate hosts	Distribution	Disease in man	Disease in animals
	Tyuleniy	Ixodidae ( <i>Ixodes</i> )	Seabirds	Russia, Northern America	Fever (?)	Neurological disease in birds
	Meaban	Argasidae ( <i>Ornithodoros</i> )	Seabirds	France		
Aroa (4)	Bussuquara	Culicidae ( <i>Culex</i> , <i>Mansonia</i> )	Rodents	Panama, Brazil, Colombia	Fever	
Dengue (4)	Dengue 1	Culicidae ( <i>Aedes</i> )	<b>Man</b> , monkeys	South-Eastern Asia, Central America, Southern America, Africa	Dengue fever, Dengue hemorrhagic fever, Dengue Shock syndrome	
	Dengue 2	Culicidae ( <i>Aedes</i> )	<b>Man</b> , monkeys	South-Eastern Asia, Central America, Southern America, Africa	Dengue fever, Dengue hemorrhagic fever, Dengue Shock syndrome	
	Dengue 3	Culicidae ( <i>Aedes</i> )	<b>Man</b> , monkeys	South-Eastern Asia, Central America, Southern America, Africa	Dengue fever, Dengue hemorrhagic fever, Dengue Shock syndrome	
	Dengue 4	Culicidae ( <i>Aedes</i> )	<b>Man</b> , monkeys	South-Eastern Asia, Central America, Southern America, Africa	Dengue fever, Dengue hemorrhagic fever, Dengue Shock syndrome	
Japanese encephalitis (10)	Japanese encephalitis	Culicidae ( <i>Culex tritaeniorhynchus</i> and other species)	Birds, pigs	South-Eastern Asia, Eastern Asia	Japanese encephalitis	
	Murray Valley encephalitis	Culicidae ( <i>Culex</i> )	Water birds	Australia	Australian X Disease, Murray Valley encephalitis	
	Kunjing	Culicidae ( <i>Culex annulirostris</i> )	Birds	Australia	Encephalitis	
	St. Louis encephalitis	Culicidae ( <i>Culex</i> )	Passeriform and columbiform birds	Northern America, Central America, Southern	St. Louis encephalitis	

**Flavivirus. Table 1** Arboviruses V. Positive sense, single-stranded RNA viruses: Family Flaviviridae, genus Flavivirus (Continued)

Serogroup (no. of known members)	Species (selected)	Arthropod host	(Main) vertebrate hosts	Distribution	Disease in man	Disease in animals
				America		
	West Nile	Culicidae ( <i>Culex</i> and other genera), Ixodidae (?)	Birds	Worldwide (except Australia)	West Nile fever, West Nile encephalitis	
	Usutu	Culicidae ( <i>Culex perfuscus</i> and other species)	Birds	Africa, Asia, Europe (Austria)	Fever	
	Koutango	Ixodidae ( <i>Rhipicephalus</i> , <i>Hyalomma</i> )	Rodents	Senegal, Central African Republic	Fever	
Kokobera (2)	Kokobera	Culicidae ( <i>Aedes</i> , <i>Culex</i> )	Wallabies, kangaroos	Australia		
Ntaya (6)	Ilheus	Culicidae ( <i>Psorophora</i> , <i>Aedes</i> , <i>Culex</i> , <i>Sabethes</i> , <i>Haemagogus</i> , <i>Coquillettidia</i> , <i>Wyeomyia</i> )	Birds	South America	Fever, encephalitis	
	Rocio	Culicidae ( <i>Psorophora</i> , <i>Aedes</i> )	Birds (?)	Brazil, Peru	Rocio encephalitis	
	Israel Turkey encephalomyelitis	Culicidae ( <i>Culex</i> ) Ceratopogonidae ( <i>Culicoides</i> ) (?)	Birds (?)	Israel, South Africa		Neurological disease in birds
Spondweni (2)	Spondweni	Culicidae ( <i>Aedes</i> , <i>Mansonia</i> , <i>Eretmapodites</i> , <i>Culex</i> )	?	Africa	Fever	
	Zika	Culicidae ( <i>Aedes</i> )	Monkeys, <b>man</b>	Africa	Fever	
Yellow fever (10)	Yellow fever	Culicidae ( <i>Aedes</i> , <i>Sabethes</i> , <i>Haemagogus</i> )	Primates	Sub-Saharan Africa, South America	Yellow fever (fever, hemorrhagic fever, hepatitis)	Hemorrhagic fever in new world primates
	Wesselsbron	Culicidae ( <i>Aedes</i> )	Cattle, sheep, goat	Africa	Fever, hepatitis, neurological disorders	Amniitis and congenital malformation in sheep, goats; febrile illness in cattle
	Banzi	Culicidae ( <i>Culex</i> , <i>Mansonia</i> )	Rodents (?)	Africa	Fever	
	Sepik	Culicidae ( <i>Mansonia</i> , <i>Ficalbia</i> , <i>Armigeres</i> )	?	New Guinea	Fever	
Entebbe bat (16)	Rio Bravo	None	Bats	North America	Fever	
	Dakar bat	None	Bats	Africa	Fever	

1. A humoral reaction (= immediate hypersensitivity reaction of type I) occurs within a few minutes after the bite due to intensive histamine excretion.
2. A delayed cell-mediated reaction (= hypersensitivity of type IV), which causes heavy pruritus, loss of hair and (occurrence) various lesions.

## Flea Bites

Fleas can be easily disturbed during their blood meal. Thus they bite again in close neighbourhood to the first bite leading to “rows or chains” of bites (Figs. 1, 2). Scratching may inoculate bacterial superinfections (Fig. 2). In some persons/animals flea bites may introduce severe flea allergy dermatitis (→FAD).



**Flea Bites. Figure 1** Three flea bites in a row.



**Flea Bites. Figure 2** Flea bites with bacterial superinfections.

## Fleas

### Classification

Order of →Insects.

### Synonym

→Siphonaptera, Aphaniptera.

### Morphology

Figs. 1–7.

### General Information

Of the approximately 2,500 species of fleas, about 94% suck on mammals, the remaining on birds. If they are hungry, many species probe on any warm-blooded vertebrate. Whereas larvae feed on organic material in the nest or lair of the host, adult males and females are obligate bloodsuckers and may live upto 12 months. Fleas can transmit various pathogens due to their repeated sucking activity on different hosts (Table 1), but are mainly known as vectors of →plague.

The life cycle proceeds as →holometabolous development (Fig. 2), including 3 detritus-feeding larval stages and a →pupa in a →cocoon, within which the finally formed adult fleas can rest for a long time (6 months), e.g., until a bird's nest is settled again or the material re-used. Adults are brown, wingless, laterally flattened, and about 1–6 mm long, jumping away if there is a risk of being caught. Since fleas react super-sensitively, several punctures are usually made by a single flea in the course of blood meal.

### Important Species

Table 1.

### Distribution

Fleas occur worldwide.

### Morphology

The relatively small, rounded head of fleas has often ventral, heavily sclerotized outgrowths, the ctenidia and in some nest fleas no eyes or lateral ocelli. The antennae are very short (3 main segments), recessed in deep grooves. The ventral mouthparts consist of 3 stylets, a pair of maxillary laciniae, and the unpaired epipharynx, held by the 5-segmented labial palps. The →cuticle is tough and difficult to rupture. The dorsal sclerites of the 3 thoracic segments overlap the respective following one, and there they often possess many spinelets, the first of which is often a comb of

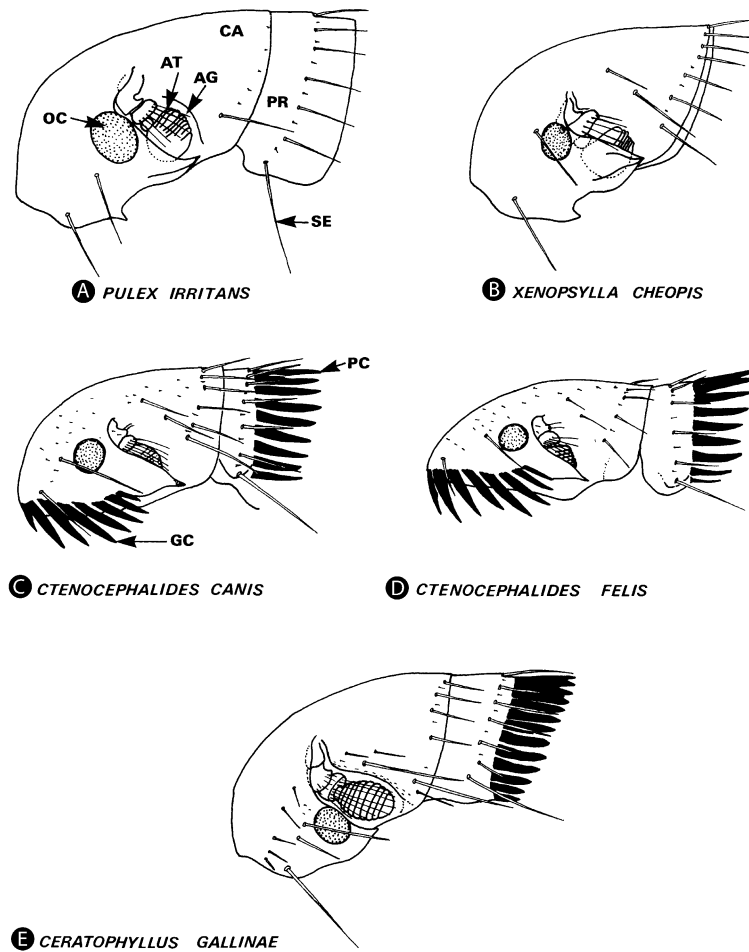

**Fleas. Figure 1** Diagrammatic representation of heads of some important fleas (Table 1). The occurrence of →combs (*PC*, *GC*), the arrangement of setae (*SE*) and the shape of the antenna (*AT*) are specific. *AG*, antennal groove; *AT*, antenna; *CA*, caput; *GC*, genal comb (with several spines); *OC*, ocellus; *PC*, pronotal comb (with several spines), *PR*, pronotum; *SE*, →seta.

ctenidia. The legs are long, well-developed for jumping, and bear strong claws. Each of the 8 abdominal segments also overlaps the following one, often possessing many spinelets there which help to anchor the flea in the fur. In addition to the ctenidia, species can be identified by the genital organs, visible through the cuticle of the last segment, especially in specimens that were cleared chemically and mounted on microscope slides. Males and females can be separated according to the shape of the abdomen, genital organs, and the copulatory apparatus of males. The larvae are elongated and worm-like, without eyes and with legs possessing long setae on the body. Mature larvae are 4–10 mm long. Pupae develop in a cocoon, which is spun by the larvae, and to which dust adheres (Figs. 2, 5).

The female sand flea (*Tunga penetrans*) penetrates into the skin (→Jigger).

## Genetics

Variations in the biology of different populations of *Pulex irritans* indicate that it is not a single species, but a species complex.

## Reproduction

Breeding in the laboratory is possible for many species, especially for fleas of cats and rodents, but labour-intensive. Usually the living host is necessary, except for a strain of the cat flea which has adapted to artificial feeding with cow blood.

Adults copulate immediately after emergence from the cocoon. Beginning 1 or 2 days later, females lay several hundred eggs (0.3–0.5 mm long), a cat flea 700–900 within 3 to 4 weeks. Most species need blood for the development of eggs (anautogenous). Fertility

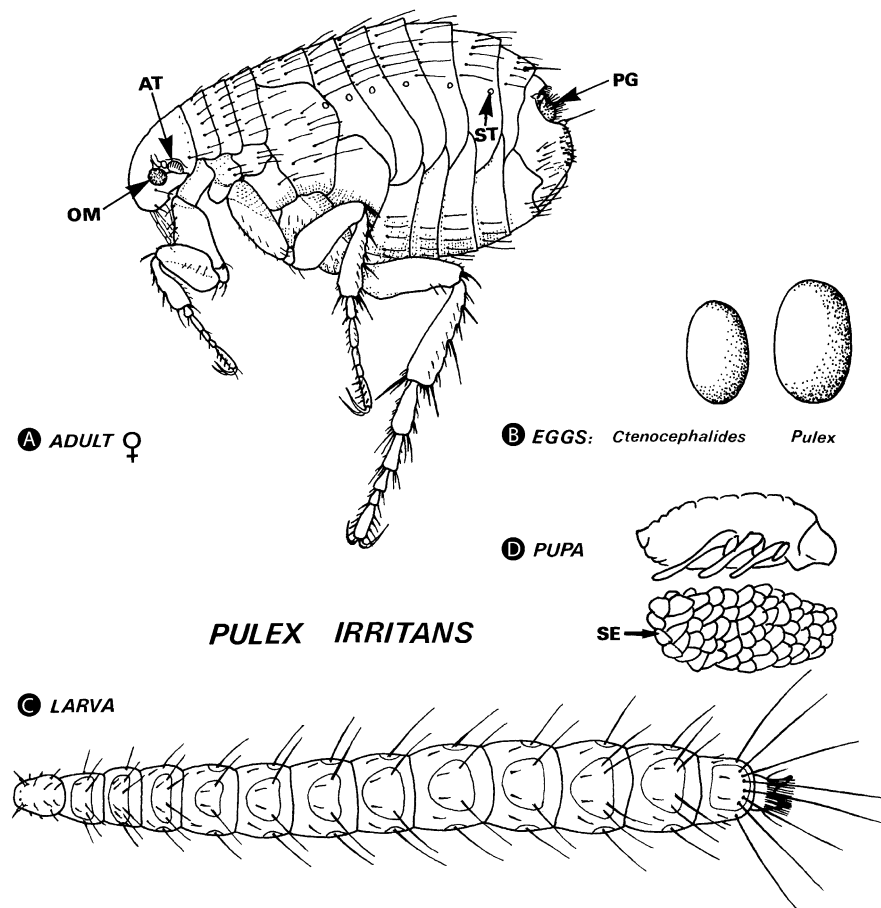

**Fleas. Figure 2 A–D** Life-cycle stages of fleas; the larva (C), which hatches from a 0.3–0.5 mm egg (B), has no eyes and reaches a length of 4–10 mm when fully grown. There are usually 3 larval instars, but only 2 in →*Tunga penetrans*. Larvae feed on organic debris and on undigested blood from the feces of adults. The differentiated third-stage larva constructs a loosely woven cocoon (3 × 1 mm) which may become encrusted by sand (D). Inside, the flea pupates (pupa shows anlagen of extremities (D), and remains quiescent until it emerges as an adult (females emerge 3–4 days before the males). Both males and females feed exclusively on blood and may live up to 12 months. AT, antenna; OM, →ommatidium (ocellus); PG, →pygidium (sensillum); SE, sand-encrusted cocoon; ST, stigma (spiracle).

is reduced if the typical host is not present and if females have fed on other hosts. In some species more than 1 mating is necessary to fertilize all eggs. In the rabbit flea reproduction is regulated by the hormones of the host, i.e., maturation of adults is induced by blood meals from pregnant rabbits or newborn progeny (→*Insects*/Fig. 2).

### Biochemical/Molecular Data

Biochemical investigations focus on the cat flea, e.g., components of the saliva. Other allergens are also considered in mRNA investigations. PCR is used to find pathogen-infected fleas and 18S rDNA sequencing for phylogenetic studies.

### Life Cycle

After a temperature-dependent, low-humidity-sensitive (>70% necessary) embryonic development of about 5 days, the 1st-→*instar* larvae (1 mm long) hatch. The larvae live in the nest or lair of the host – in houses preferably in carpets – feeding organic material, but mainly remnants of digested blood and drops of undigested blood, both deposited by the adults during feeding. After 2 moults within 2–3 weeks, mature larvae spin cocoons from silk produced by the salivary glands. Dust adheres to the freshly spun silk in which the larva moults to the pupa within 2–3 days, the latter usually completing its development within 1 or 2 weeks. They die if humidity is <45%. The adult flea



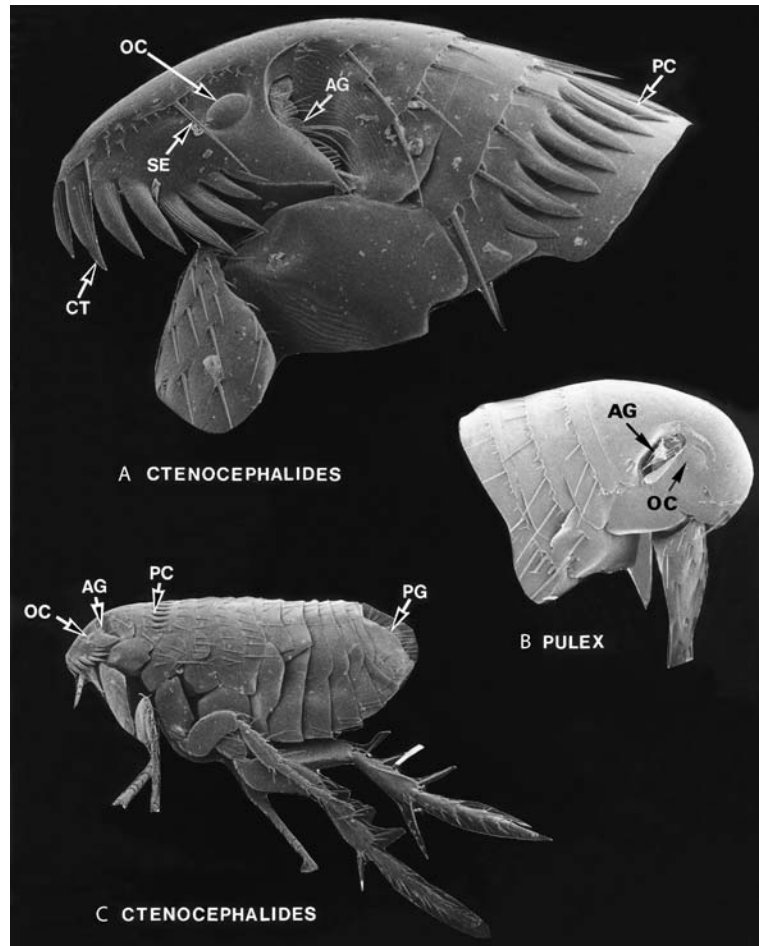

**Fleas. Figure 3 A–C** Scanning electron micrographs of fleas of dogs, cats and man **A, C** *C. felis*, **B** *Pulex irritans* (**A**  $\times 150$ , **B**  $\times 50$ , **C**  $\times 20$ ). *AG*, antennal groove; *CT*, ctenidium (genal comb); *OC*, ocellus; *PC*, pronotal comb; *PG*, pygidium; *SE*, setae.

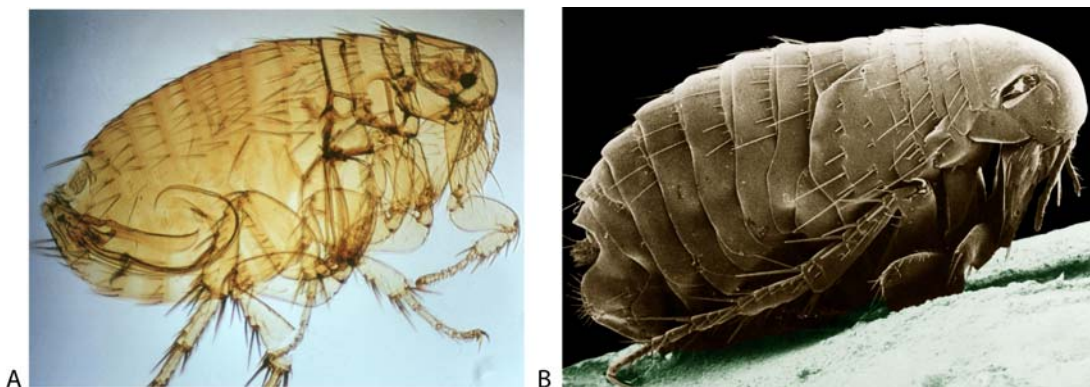

**Fleas. Figure 4 A** LM of *Pulex irritans*. **B** SEM of *Pulex irritans*.

remains in the cocoon and can wait long periods of time (6–12 months) until vibrations indicate the presence of a host. (Therefore, after holidays the dog or cat should be the first entering a room.) Adult fleas live several

months, sometimes more than a year and can survive long periods of starvation. Under optimal conditions, the whole developmental cycle (egg to egg) lasts about 4 weeks. The majority of species are univoltine.



**Fleas.** Figure 5 LM of larvae of fleas containing blood excreted by adult fleas (black inclusion).



**Fleas.** Figure 6 SEM of a male sand flea (*Tunga penetrans*).

Whereas the majority of fleas irregularly sucks blood and rests near the host or in its fur, the adults of the sand fleas penetrate the skin and develop there, growing to the size of a small pea.

### Transmission

Fleas jump from one host to a neighbouring one, the rat and the human flea covering 31 cm in a single jump. Nest-dwelling species do not jump as far. The energy for the jumps cannot be supplied by direct muscle action, but fleas possess a pad of resilin, a protein that can store and release energy like rubber.

### Clinical Relevance

Main fleas of medical importance are especially the tropical rat flea →*Xenopsylla cheopis*, the →sand flea →*Tunga penetrans*, the cosmopolitan human flea *Pulex irritans* – all possessing no combs – and the cat flea *Ctenocephalides felis*. During the last years especially

cat fleas have occurred more often, also on dogs. However, the incidence of the major transmitted disease, plague, has decreased markedly during the last 80 years. Since the rodent hosts cannot be eradicated, outbreaks of plague will regularly occur in many parts of the world, e.g., India and Russia. Fleas may introduce dermatitis in man and animals, too. Recently it was proven that fleas may transmit a wide range of viruses and bacteria by regurgitation of freshly fed blood and via excretion of faeces.

### Feeding Behavior and Transmission of Disease

Fleas are attracted to the host by vibrations, warmth, carbon dioxide and shadowing. The natural main host is recognized by specific odours. Fleas are capillary feeders, some species →pool feeders, needing 2–10 minutes for a blood meal. Pumps transport the blood directly to the midgut in which it is stored and digested. The rupture of erythrocytes is achieved by many series of spines in the →proventriculus. The saliva of fleas causes itching and the resulting scratches secondary bacterial infections. The itching reaction is stronger if the fleas feed on an occasional, not the natural host.

Different flea species of rodents, especially the rat flea *Xenopsylla cheopis*, can transmit classic plague. Usually this occurs if many rats have died of the disease and the infected fleas attack other available hosts, e.g., human. Fleas also transmit →tapeworms to cats and filaria to dogs (→*Dirofilaria*, →*Acanthocheilonema*) and →murine typhus to man, the latter showing similarities in development and transmission to classic epidemic typhus transmitted by →lice (→*Pediculus*). Recent experiments have clearly shown, that fleas may also transmit viruses not only during engorging blood but also via faeces. This was proven for the Calici viruses of cats and Feline leucemia virus of cats. Thus it can be expected that many viruses of a similar stability may be transmitted to animal and human hosts.

### Interaction of Vector and Parasite

If the fleas suck blood of a plague-infected host, the causative agent →*Yersinia pestis* is transmitted and multiplies in the lumen of the gut, especially in the foregut, initially resulting in a plug of bacteria which later is partly reduced. The blockage is stronger in the more virulent strains of bacteria which adhere stronger to each other. From the foregut or contaminated mouthparts the bacterium is transmitted to the vertebrate host.

*Y. pestis* is pathogenic to fleas due to the blockage of the proventriculus by a plug. Since only reduced volumes of blood can be ingested, infected fleas attack hosts more often. If the plug is reduced, more blood can be ingested. The infection not only disturbs blood ingestion, but especially the total blockage reduces longevity.

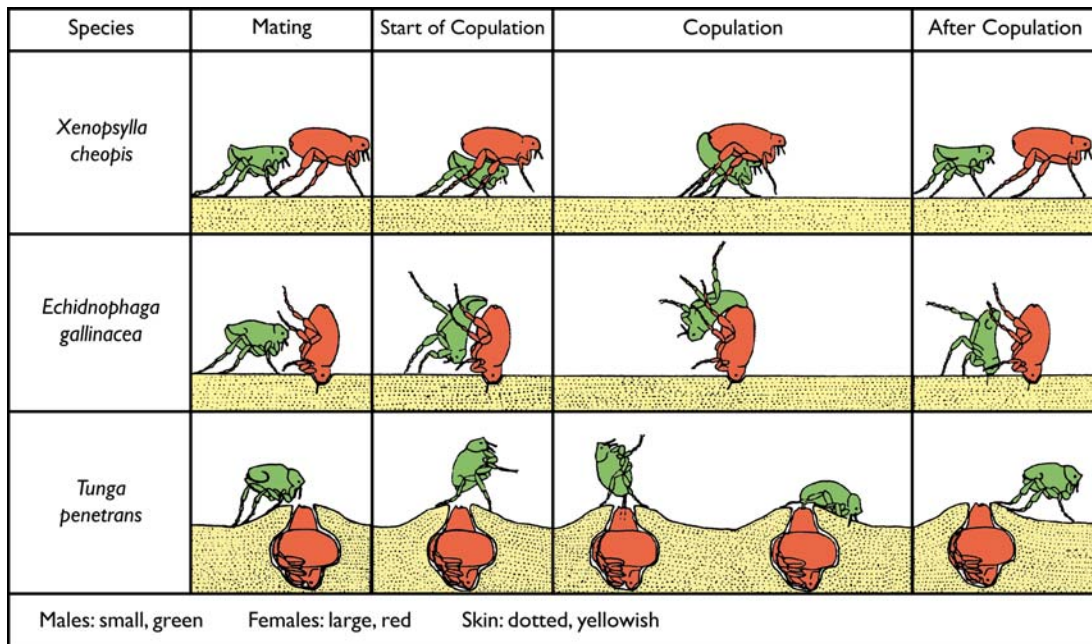

**Fleas. Figure 7** Diagrammatic representation of the mating behavior of 3 flea types, which occur free or partly, respectively, fully attached on the skin of their hosts.

**Fleas. Table 1** Some common fleas

Species	Length (mm)	Hosts	Main transmitted pathogens
<i>Ceratophyllus gallinae</i>	m 3.0 f 3.5	Chickens, turkeys, <b>humans</b>	Mechanically many pathogens
<i>Ctenocephalides canis</i>	m 2.5 f 3.5	Dogs, <b>humans</b>	Larvae of cestodes ( <i>Dipylidium</i> , <i>Hymenolepis</i> )
<i>C. felis</i>	m 2.5 f 3.0	Cats, <b>humans</b>	Larvae of cestodes ( <i>Dipylidium</i> , <i>Hymenolepis</i> )
<i>Echidnophaga gallinacea</i>	m 2.0 f 2.5	Chickens, dogs, <b>humans</b> (tropics)	Bacteria
<i>Leptopsylla segnis</i>	m 1.6 f 1.8	Mice	Mechanically many pathogens
<i>Nosophyllus segnis</i>	m 1.8 f 2.0	Rats, <b>humans</b>	<i>Yersinia pestis</i> , other bacteria, erysipeloid
<i>Pulex irritans</i>	m 2–2.5 f 4	<b>Humans</b> , domestic animals	<i>Yersinia pestis</i> , larvae of cestodes
<i>Spilopsyllus cuniculi</i>	m 1.6 f 2.0	Rabbits, <b>humans</b>	Myxomatosis virus, <i>Francisella tularensis</i>
<i>Tunga penetrans</i>	m 0.7 f 5–6.0	<b>Humans</b> , many animals	Penetrates skin
<i>Xenopsylla cheopis</i>	m 1.5 w 2.5	Rats, rodents, <b>humans</b> (tropics)	<i>Yersinia</i> (= <i>Pasteurella</i> ) <i>pestis</i> , Rickettsiae, cestode larvae

m = male, f = female

### Diagnosis of Bites

Since disturbed fleas interrupt blood ingestion, usually several neighbouring bites occur.

### Control

Information should emphasize the other feeding and infestation paths by larvae and thus the importance of

treatment of the house and not only the pet bedding. Pets should permanently wear an anti-flea collar. In regions with foci of sylvatic plague, the rats, ground squirrels, prairie dogs and marmots should be controlled or fed in bait boxes treated with →insecticides which then also act in the lair.

Infestations of pets with adult fleas can be reduced with insecticide collars. In infestations of homes, insect growth regulators, which are nearly non-toxic to vertebrates, can be used against larvae, e.g., methoprene, and insecticides against adults (→Ectoinsecticides, →Arthropodicidal Drugs).

## Flight Speed

To attack their hosts parasitic mosquitoes and flies reach a considerable speed: e.g., mosquitoes (3.2 km/h), *Musca* spp. (0.4 km/h), *Calliphora* spp. (11.0 km/h), tabanids (22.4 km/h), Oestridae (*Cephenemyia stimulator* of deer, 40.0 km/h).

## Floating Ovaries

→Acanthocephala.

## Flotation

Method to obtain small-sized cystic parasites from faeces probes (Fig. 1).

## FLP

FMRF amide-like peptides (FLPs) play a central role in nematode motor and sensory capabilities. Since they are widely preserved in their sequence in many species of nematodes, they might be candidates for new parasiticides.

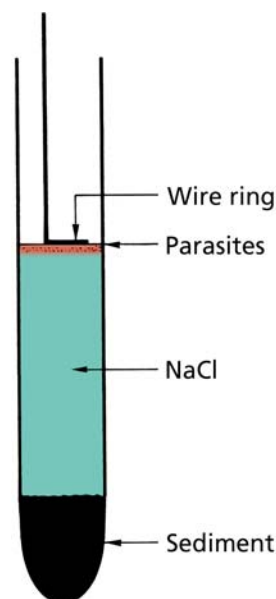

**Flotation.** Figure 1 Zonation in the tube after centrifugation.

## Fluazuron

### Chemical Class

Benzoylphenyl urea.

### Mode of Action

Insect growth regulator (IGR, chitin synthesis inhibitor).  
→Ectoparasiticides – Inhibitors of Arthropod Development.

## Flucythrinate

### Chemical Class

Pyrethroid (type II,  $\alpha$ -CN-pyrethroids).

### Mode of Action

Open state voltage-gated sodium channel blocker.  
→Ectoparasiticides – Blockers / Modulators of Voltage-Gated Sodium Channels.

## Flukes

### Synonym

→Digenea.

## Flumethrin

### Chemical Class

Pyrethroid (type II,  $\alpha$ -CN-pyrethroids).

### Mode of Action

Open state voltage-gated sodium channel blocker.  
 →Ectoparasitocides – Blockers / Modulators of Voltage-Gated Sodium Channels, →Arthropodicidal Drugs, →Ectoparasitocidal Drugs.

## FMRF-Amide-Like Peptides (FLP)

These peptides of parasites are targets of new designed antiparasitic drugs (due to their motor and sensory capabilities in signalling).

## Focus

Due to the complexity of the synecological systems in which →arboviruses circulate, preconditions for the maintenance of the virus cycle are usually fulfilled in limited areas only. These areas are called foci to which the viruses are endemic. →Arboviruses/Distribution.

## Folic Acid

Folate derivatives are important cellular cofactors in the synthesis of nucleotides and a variety of amino acids. Like higher eukaryotes other than plants, most parasites lack the biosynthetic folate pathway. An exception are the apicomplexan parasites, including →*Eimeria*, *Toxoplasma*, and →*Plasmodium* sp., that are capable of and dependent on the *de novo* synthesis of folate cofactors from GTP, p-aminobenzoate (PABA) and →glutamate. This route initially involves the conversion of GTP to dihydroneopterin triphosphate by GTP cyclohydrolase, an enzyme that is considerably different in plasmodia compared to the mammalian homologue. Dihydroneopterin triphosphate can then be utilized by apicomplexans in a biosynthetic pathway

leading to dihydrofolate. Conversion of this product to tetrahydrofolate and other folate derivatives occurs in both parasites and their vertebrate hosts, but the homologous enzymes involved in these reactions can differ remarkably in their properties. These unique metabolic features of plasmodia and related protozoans explains the selective toxicity of →sulfonamides and folate antagonists against malaria and other apicomplexan-derived diseases and may continue to provide a source for the development of new drugs and novel therapeutic strategies.

## Food Uptake

→Acanthocephala.

## Foraging Behavior

→Behavior.

## Forest Yaws

Common name of the disease due to infections with *Leishmania guyanensis* (= cutaneous leishmaniasis), also called pian-bois and bosch-yaws.

## Formol-Ether-Fecal Concentration

Method of preparation of feces to diagnose parasitic stages (cysts, oocysts, worm eggs).

## Fortification

Formation of a primary →cyst wall inside a host cell or more general the strengthening.

---

## Fosmidomycin

→New Drugs.

---

## Francisella tularensis

Agent of →tularemia being transmitted by contaminated mouthparts of various ectoparasites (e.g., →fleas, ceratopogonids = →Culicoides).

### Therapy

Streptomycine, Gentamycine.

---

## Frenkelia

Genus of tissue-cyst-forming →Coccidia, named in honor of Prof. Jack Frenkel, Kansas City, USA.

---

## Fülleborn, Friedrich Georg Hans (1866–1933)

German physician (Fig. 1) and 1930–1933 director of the Hamburg Tropical Institute, important reports on →filaridae, leader of Filaria expedition (1908/1909).

---

## Fumagillin

Insecticide to be used against →Varroa mites.



**Fülleborn, Friedrich Georg Hans (1866–1933).** Figure 1 Professor Dr. Friedrich Fülleborn just prior to his death.

---

## Fungi

→Microsporidia, →Pneumocystis.

---

## Furazolidone

Drug used for treatment of giardiasis and *Blastocystis* infections. →Antidiarrhoeal and Antitrichomoniasis Drugs.

---

## Furcocercous Cercariae

→Alaria canis.



---

## GAE

Granulomatous amoebic → encephalitis of man due to infection with → oppportunistic agents, amoeba of the genera → Acanthamoeba and → Balamuthia, which also may penetrate and thus destroy the cornea of the eyes.

---

## Galactogenic Transmission

Transmission to next host generation via milk. → Arboviruses, → Toxocara, → Toxoplasma gondii, → Filariidae.

---

## Galenus, Claudius (129–199)

Greek-Roman physician, besides Hippocrates the most famous physician of the Antiquity.

---

## Galleria mellonella

Species of the butterfly group, a moth, that parasitizes inside stocks of bees.

---

## GALT

Gut Associated Lymphoid Tissue, → Immune System.

---

## Galton-Watson Process

→ Mathematical Models of Vector-Borne Diseases.

---

## Gambusia

Genus of fish to be placed into ponds to control → mosquitoes by eating their larvae.

---

## Gametes – Insects

The male gametes (sperms) of insects are in most cases flagellated with a species-specific size ranging from 20 µm until often 10 mm. The sperms include a nucleus, mitochondria, and an axoneme, which contains microtubules either in a 9 × 2 pattern or in a 9 + 9 + 2 pattern, terminates in single microtubules at the posterior end. At the top of the sperm a pointed fortified acrosome is formed (with a species-specific structure). The female gametes (oocytes) are spherical or ovoid and often rather large in comparison to the female insect.

---

## Gametes – Protozoa

Formation of sexual stages in → Protozoa is known for sporozoans including the → piroplasms, Ciliata, → Opalinata, → Hpermastigida (Fig. 8), and recently for trypanosomes (Fig. 7), but definite gametes are not always present (cf. → Plathyhelminthes/Gametogenesis, → Nematodes/Gametogenesis). In the other groups the formation and fusion of gametes may be hidden. This may occur especially in those cases where the number



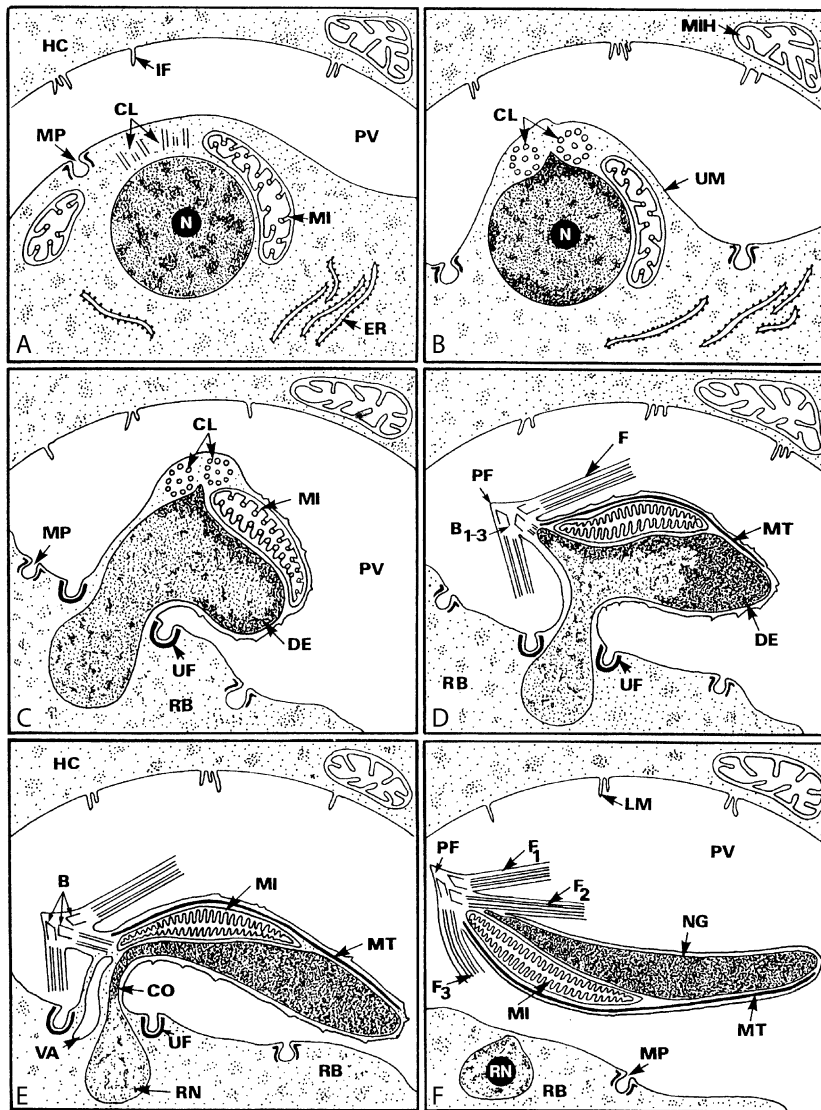

**Gametes – Protozoa. Figure 1 A–F** Diagrammatic representation of the formation of male (micro-) gametes of eimerian Coccidia (*E. maxima*) along the surface of →microgamonts. Other species have only 2 free →flagella. *B*, basal body; *CL*, →centriole-like structures (9 + 1 →microtubules); *CO*, connection; *DE*, densification; *ER*, endoplasmic reticulum; *F*, flagellum; *HC*, host cell; *IF*, intravacuolar folds; *LM*, limiting membrane of PV; *MI*, mitochondrion; *MIH*, mitochondrion of HC; *MP*, micropore; *MT*, microtubules; *N*, nucleus; *NG*, nucleus of the microgamete; *PF*, perforatorium; *PV*, →parasitophorous vacuole; *RB*, residual body; *RN*, residual nucleus; *UF*, underlying →fortification; *UM*, unit membrane; *VA*, vacuolization.

of gametes is low and where no clear differences between the fusing gametic partners are recognizable. Such →isogametes that look similar light microscopically, are found in the Opalinata, some →gregarines, piroplasms, and apparently in trypanosomes, where a true fusion of →epimastigotes is postulated to occur just before entering the salivary glands. In some gregarines, →anisogametes are described where both types of gamonts undergo divisions. In classic →Coccidia (e.g., →*Eimeria* spp., →*Isospora* spp.), tissue-cyst-forming coccidians (→*Sarcocystis* spp., →*Toxoplasma gondii*, etc.),

classic →Haemosporidia (→*Plasmodium* spp., *Leucocytozoon* spp., etc.), and adeleideans (e.g., *Klossia*), micro- and macrogametes are formed (Figs. 1, 2). The whole process is called →oogamy, since here only the microgamont is divided, whereas the macrogamont develops into a large single →macrogamete (looking like an ovum). In no case, however, is the question of the chronological order of meiotic reduction definitively solved; so the distribution of haploidy and diploidy is not yet quite clear (→Chromosomes). In piroplasms (e.g., →*Babesia* spp. and →*Theileria* spp.), gamete formation

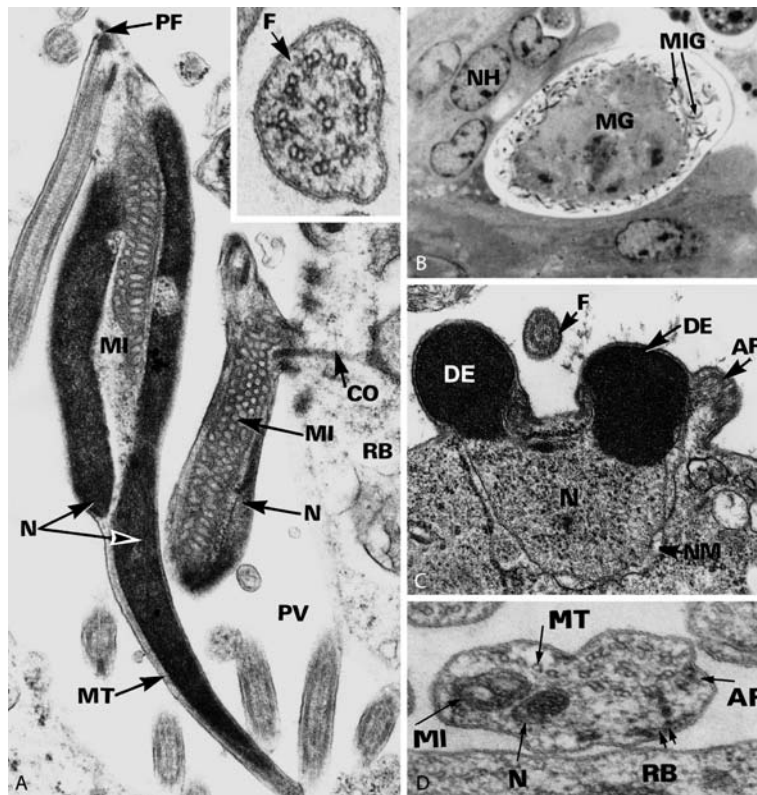

**Gametes – Protozoa. Figure 2** TEM (A, C, D) and light (B) micrographs of developmental stages of microgamonts and microgametes. **A** →*Sarcocystis sui*hominis: longitudinal section of microgametes connected to the residual body of the →gamont (RB) by a short bridge (CO). The microgametes consist of the nucleus (N) forming a groove, within which the mitochondrion (MI) is situated, 2 free flagella (F) with a typical cross-section (inset) and some microtubuli (MT) running below the →cell membrane. At the gamete's tip, a stiff perforatorium (PF) is formed that helps to enter into the macrogamete. PV, →parasitophorous vacuole. × 20,000. **B** Microgamont of →*Eimeria stiedai* during formation of microgametes (MIG). NH, nucleus of the host cell. × 1,000. **C** →*Isospora* sp. from sparrow's intestine; formation of 2 microgametes from a single nucleus (N) in a microgamont. AF, →attached flagellum; DE, densification = later nucleus a microgamonts; F, flagellum; N, nucleus (remnant); NM, nuclear membrane. **D** Cross-section through the anterior tip of a microgamete of *Eimeria maxima*. Note the presence of the nuclear tip (N), the mitochondrion (MI), the attached flagellum (AF) and two rows of microtubules (MT, arrows). × 40,000. RB, residual microgamont.

and fusion differ from those in other sporozoans and need still more investigation (Figs. 3–5, pages 544, 555).

In all specimens of parasitic protozoans with typical gametes, a complete →syngamy can be observed, i.e., the differently determined gametes fuse completely, whether they include large (iso- or anisogametes) or only small (→Microgametes) amounts of cytoplasmic material. Syngamy always starts with the fusion of the limiting membranes (Figs. 4–6, pages 544–546), thus leading to a unicellular diplokaryon. Although karyogamy may be more or less delayed depending on the species, no further fertilization can occur along the surface of such zygotes, whether a fertilization membrane (as in some eimerian species) is formed or not.

In ciliates (e.g., *Balantidium*) no typical gametes are produced, but 2 similar looking individuals

(→Conjugants) join temporarily for an exchange of a “wandering” nucleus during →conjugation. Similar processes may occur in other groups where sexual interchange has not yet been found or is reduced to a fusion of sister nuclei (→Myxozoa), which is called autogamy. Other hidden sexual processes are known from →Microsporidia, where so-called →meiospores may occur (e.g., →Amblyospora). More sophisticated methods, however, will surely contribute to the knowledge of this neglected, but extremely important phase of the parasite's life cycle.

In some groups of protozoans apparently, exchanges of DNA occur without a definite proof of fusion processes, which, however, may exist in low numbers and are thus not registered. Exchange experiments between different clones showed that in →*Trypanosoma*

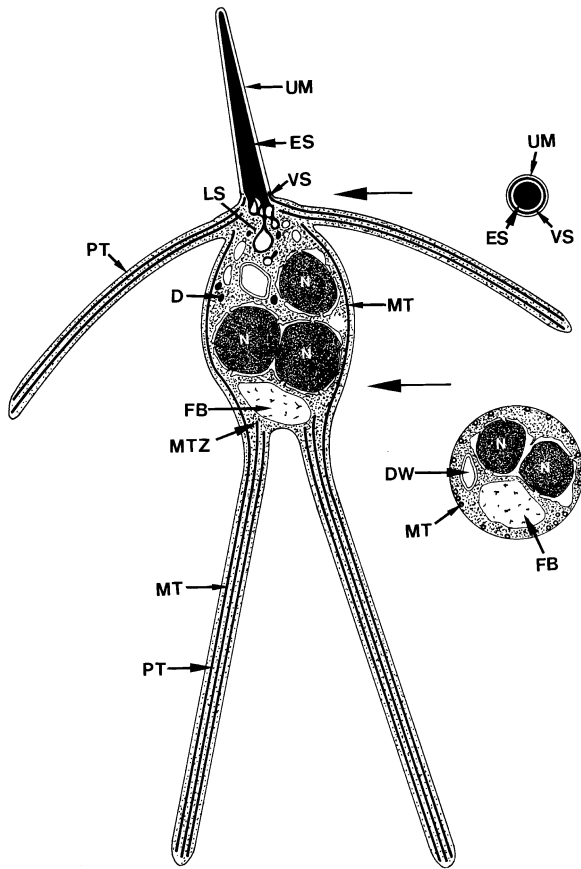

**Gametes – Protozoa. Figure 3** *Theileria* spp.; diagrammatic representation of a microgamont (= ray body) in cross- and longitudinal sections. *D*, dense granules; *DW*, double-walled organelle (mitochondrion); *ES*, spine; *FB*, fibrillar body; *LS*, labyrinthine structure; *MT*, microtubules; *MTZ*, microtubules are interrupted in drawing; *N*, nucleus; *PT*, protrusion (ray); *UM*, unit membrane.

haploid, diploid, and hybrid stages occur in the life cycle, a fact which underlines the suggested fusions (Fig. 7, pages 547). In *Entamoeba histolytica* DNA measurements proved that the tissue-invasive magnaforms possess at least twice as much DNA as the intestinal minuta forms – is this fact an indication for a preceding fusion process?

## Gametes – Ticks

The male ticks develop 500 µm long prospermia which mature via a complicated process (called capacitation = differentiation) within 24 hours (after transfer to the female system) into a fertile stage (spermiophore). However, when having got contact to the female gamete (oocyte), only the nucleus of the male gamete enters, while the remainder of the sperm disintegrates. The prospermia of argasid ticks may measure up to 1 mm in length, those of ixodid ticks are shorter. Below the outer border of the prospermia many microtubule are arranged to guarantee shape and motility.

## Gametes – Worms

### Trematodes

The sperms of schistosomes are different from those of other trematodes. They possess a head-like thickening, which contains the electron dense nucleus. At the basis of the nucleus, a mitochondrion occurs and a basal body

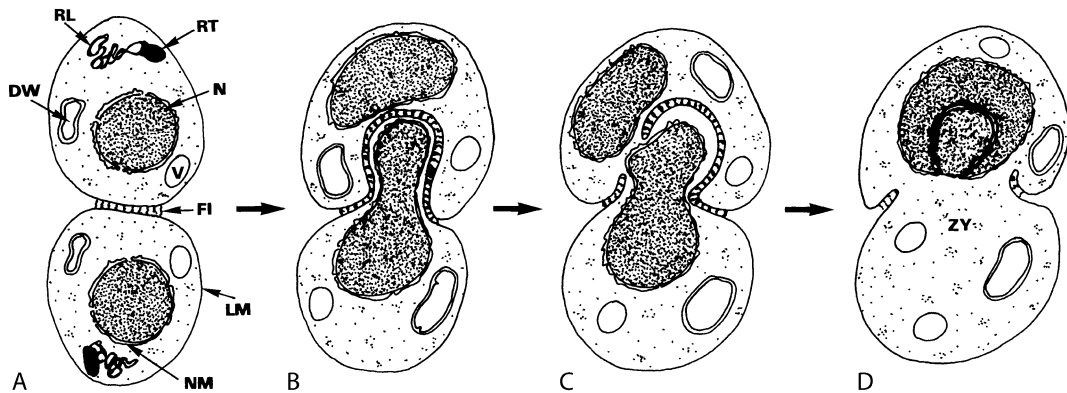

**Gametes – Protozoa. Figure 4 A–D** Fusion of gametes in *Theileria* spp. in 4 steps as seen *in vitro* and *in vivo*. *DW*, double-walled organelle; *FI*, filamentous elements; *LM*, limiting membrane (single); *N*, nucleus; *NM*, nuclear membrane; *RL*, remnants of labyrinthine structure; *RT*, remnants of the thorn; *V*, vacuole; *ZY*, *→*zygote.

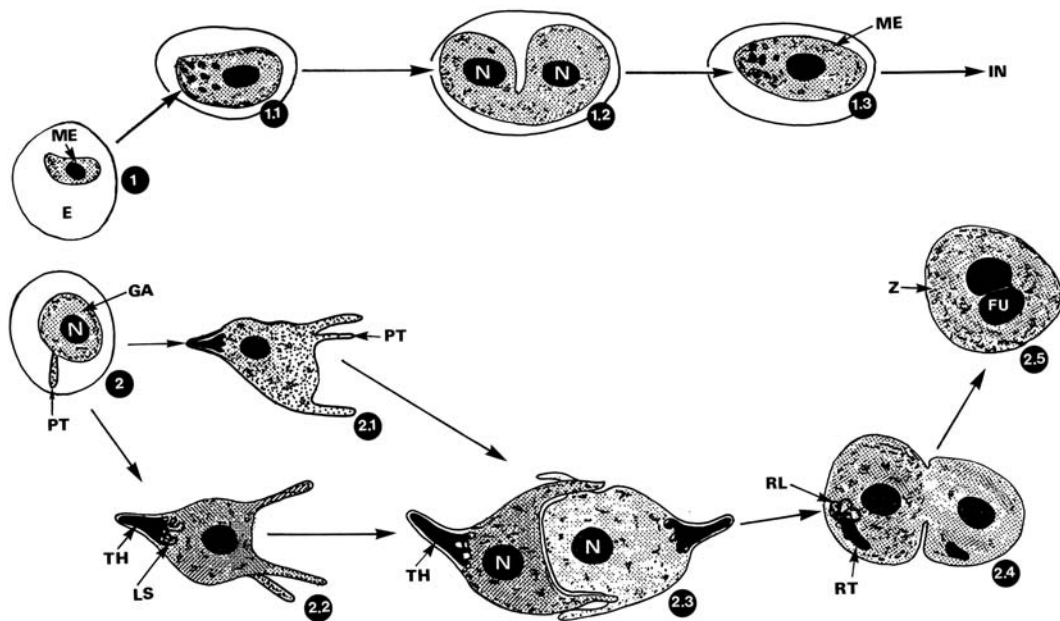

**Gametes – Protozoa. Figure 5** → *Babesia* spp.; formation and fusion of gametes. 1–1.3 Formation of merozoites by →binary fission (depending on the presence of fresh red blood cells in culture); this process does not occur in the tick's gut, where merozoites are dissolved. 2–2.5 Sexual processes. 2 Ovoid-spherical stages become gamonts and form protrusions (even in the vertebrate host blood). 2.1–2.2 Two types of ray bodies occur (one is more electron lucent than the other) after probable divisions. This process starts after disruption of the erythrocyte. 2.3 Syngamy of gametes. 2.4 Opening along the attached membranes. 2.5 Fusion of the nuclei. *E*, erythrocyte; *FU*, fusing nuclei; *GA*, gamont; *IN*, in culture indefinite repeated division occur; *LS*, labyrinthine structure; *ME*, →merozoite; *N*, nucleus; *PT*, protrusion; *RL*, remnants of the labyrinthine structure; *RT*, remnant thorn; *TH*, thorn; *Z*, zygote.

gives rise to a single axoneme which enters a long filament-like tail. The center of the axoneme only contains none, 1, or 2 microtubules (Figs. 1–3, pages 548, 549). Beneath the single cell membrane 25–115 microtubules are lining the inner surface of the gamete. In other digenetic trematodes (e.g., in *Clonorchis*) 2 axonemes are formed instead of 1 in schistosomes (Figs. 4, 5, page 549). In *Paragonimus*-sperms 2 mitochondria occur. The female gametes of most trematodes are ovoid or spherical.

### Cestodes

The male gametes of the cestodes are filament-like reaching a length of often 0.2 mm. They are limited by a single cell membrane, which is lined inside by 25–40 microtubules (Fig. 6, page 550). The nucleus is situated in the central portion and is accompanied by the single axoneme, which has only a single central element. Mitochondria were not seen, acrosomal structures are lacking, too. The female gametes are in general spherical.

### Nematodes

The gametes of nematodes are described and pictured in the keyword →nematodes.

## Gametocyte

Other word for →gamont, i.e., stage preceding →gametes.

## Gamma-Amino Butyric Acid

→Nervous System of Platyhelminthes.

## Gamogony

Sexual phase in the life cycle of →Coccidia which proceeds in general as →oogamy with macrogametes and →microgametes (→Gametes, →Eimeria, →Mitochondria/Fig. 1E).

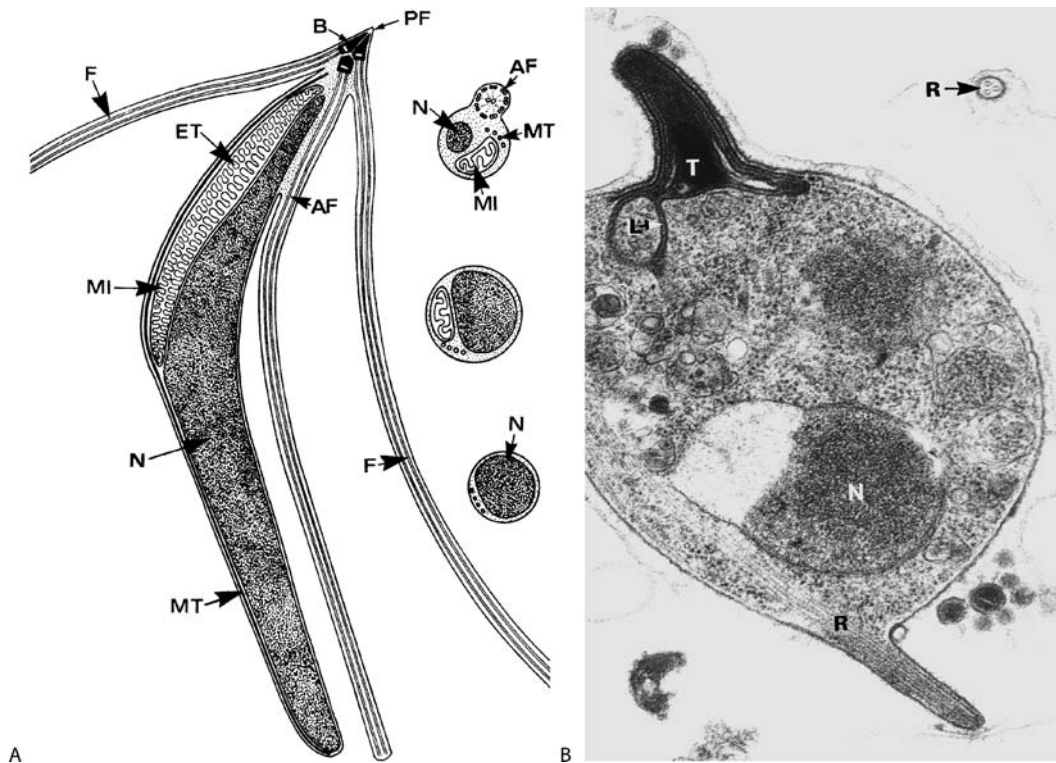

**Gametes – Protozoa. Figure 6** A Diagrammatic representation of a microgamete of *Eimeria maxima* in longitudinal and cross-section. AF, attached flagellum; B, basal body; ET, enlarged tubule (sacculus); F, free flagellum; MI, mitochondrion; MT, microtubule; N, nucleus; PF, perforatorium. B *Babesia canis*, longitudinal section through a microgamont inside a vector tick. Note the thorn-like dense apex (A), the microtubule-containing rays (R) and the labyrinthine structure (L) at the base of the thorn (T). N, nucleus  $\times 25,000$ .

## Gamont

Stage preceding the →gametes (in Protozoa).

## Gamontogamy

→Gregarines.

## Gasterophilosis

Disease due to infestation with →*Gasterophilus* species, see Table 1 (page 550).

## Gasterophilus

### Name

Greek: *gaster* = stomach, *phil* = loving it.

### Important Species

- *G. intestinalis* (eggs are deposited all over the host's (equids) body), about 900 in 3 hours
- *G. haemorrhoidalis*, *G. nasalis* (eggs are found at lips)
- *G. inermis* (eggs on the hair of cheeks)
- *G. pecorum* (eggs are deposited on host's food), up to 2,000 per female

Adults do not feed, larvae hatch in the case of *G. intestinalis* within 7–14 days.

Human infections may occur after contact with infested horses with *G. nasalis*, *G. intestinalis* and

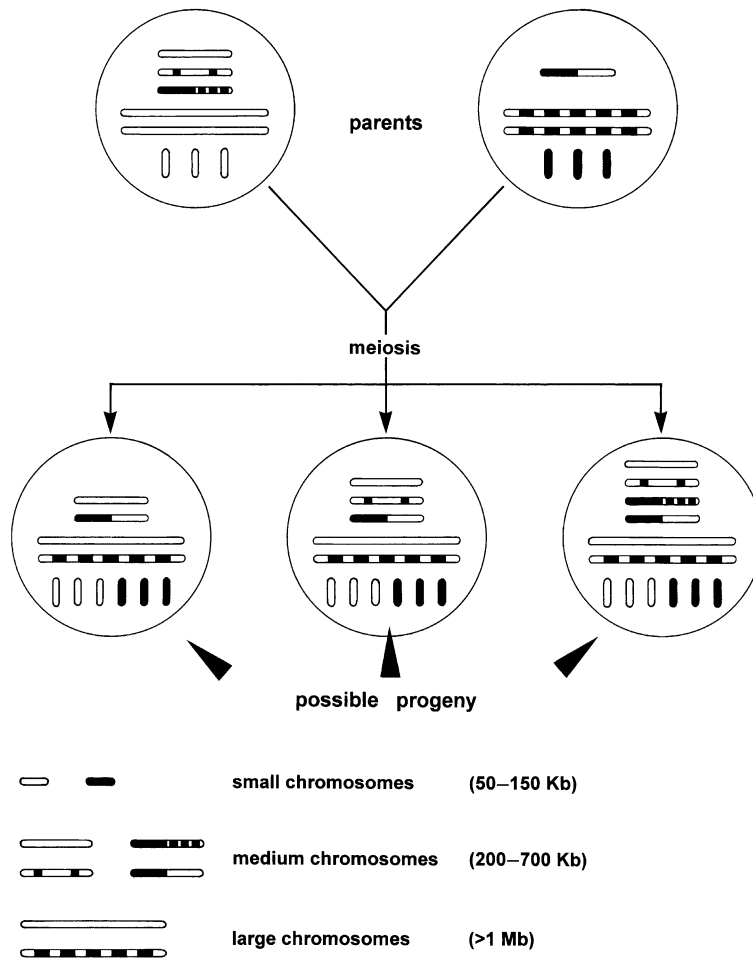

**Gametes – Protozoa.** Figure 7 Diagrammatic representation of the genealogy of the different chromosomes of trypanosomatids during meiotic processes (after Tait and Turner, 1990).

*G. haemorrhoidalis*. The larvae penetrate human skin and migrate in a serpentine causing a line. Thus this myiasis is called *myiasis linearis*. Adults of *G. intestinalis* (syn. *G. equi*) reach a length of 1.8 cm (Figs. 1, 2; page 551) and appear reddish-yellow, brown-black. As adults they do not feed anymore. After mating the females, which possess a pointed terminal end being bended below the abdomen, clue up to 5,000, 0.2 mm long eggs at the hair of horses. After 5–10 days the larvae hatch from the egg and enter the mouth actively or are transported there during the licking of the horse. In the stomach the larvae molt twice and grow up to 2 cm as larva III; this stage appears red and is excreted 8–10 months after infection with the faeces. Pupation occurs immediately on/in the soil. After 3–8 weeks the adult flies hatch from the puparium (during June). Their time of activity is July and August in Europe. → [Diptera](#).

## Gastritis chronica hyperplastica

→ [Trichostrongylosis, Animals](#).

## Gastrodiscoides hominis

→ [Digenea](#).

## Gastrodiscus aegyptiacus

→ [Alimentary System Diseases, Horses](#).

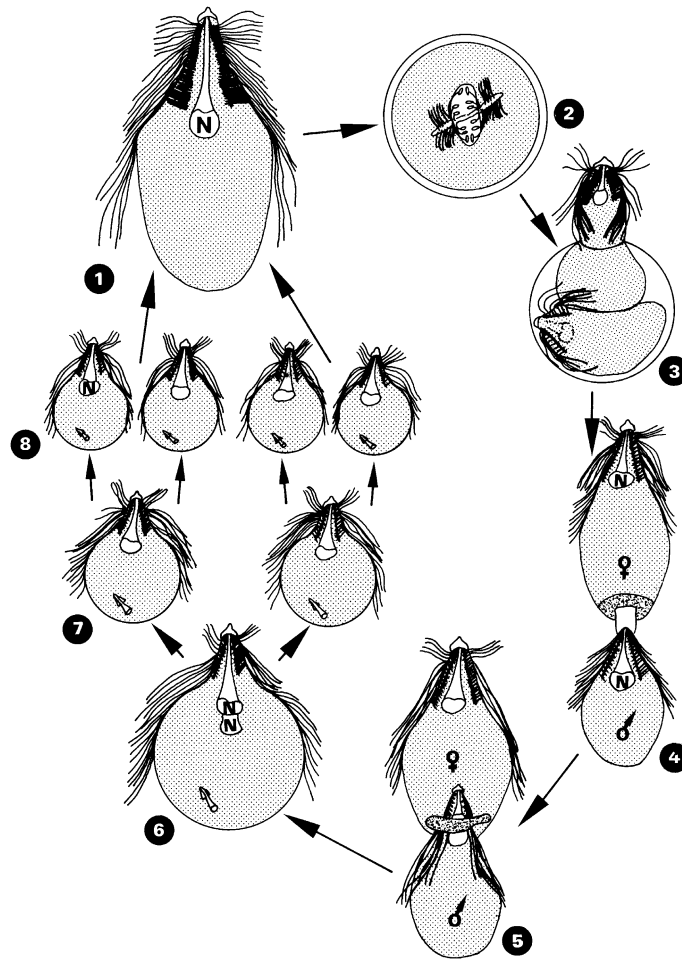

**Gametes – Protozoa. Figure 8** Diagrammatic representation of the modes of reproduction of the hypermastigine → *Barbulanympha* sp. from the intestine of the cockroach *Cryptocercus punctulatus*. 1 Trophozoite; 2, 3 division in a cyst; 4–6 fusion of gametes to form a zygote (6); 7, 8 formation of → trophozoites by repeated → binary fissions. *N*, nucleus.

## Gastrointestinal Hormones

### General Information

Gastrointestinal hormones like gastrin, cholecystokinin (CCK) and vasoactive intestinal peptide (VIP) are small peptides of 4–58 amino acids. Most of these hormones are sulfated.

### Physiological Function

Gastrointestinal hormones are not part of a hierarchical system like the hypophyseal-gonad or -thyroid, or -adrenal gland axis. They are released by → neurotransmitters, other hormones of the gastrointestinal tract and by components of the food. Interestingly,

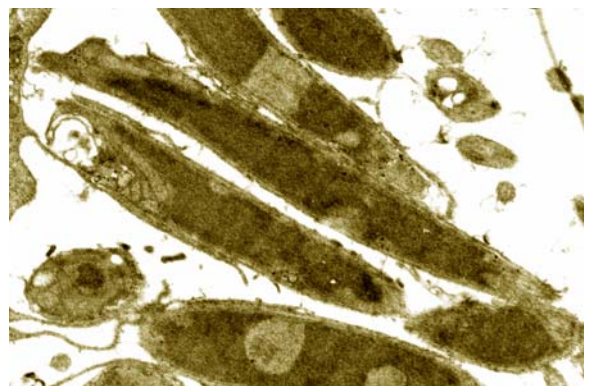

**Gametes – Worms. Figure 1** Longitudinal section through the anterior end (head) of schistosomal sperms.

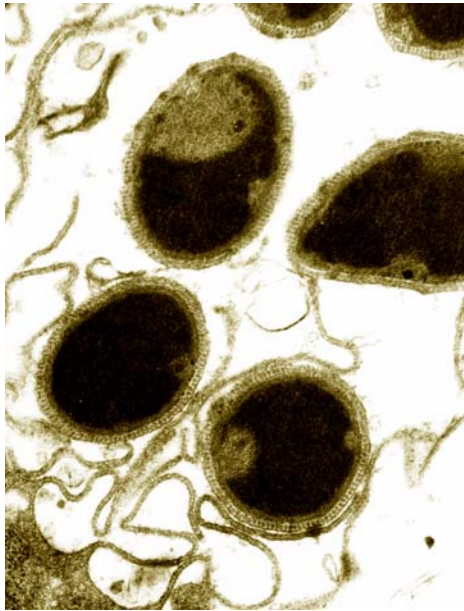

**Gametes – Worms. Figure 2** Cross-section through the head of schistosomal sperms showing the nuclei and the peripheral microtubuli.

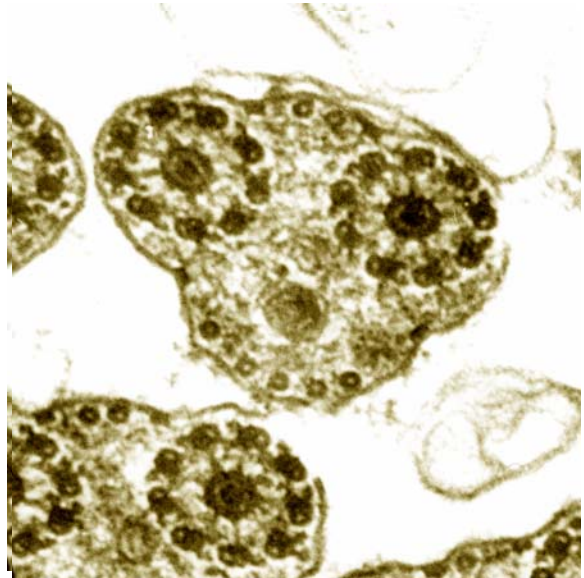

**Gametes – Worms. Figure 4** Cross-section through sperms of *Clonorchis* in a non-nuclear region.

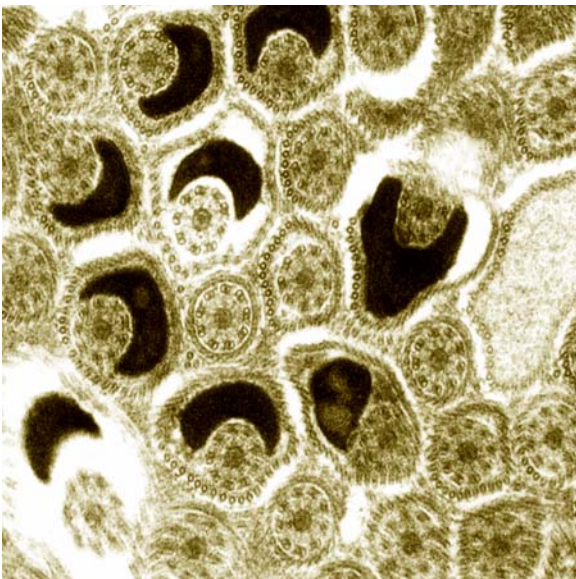

**Gametes – Worms. Figure 3** Cross-section through sperms of schistosomes at different levels of the axoneme. Note the terminal portion of the nucleus (black).

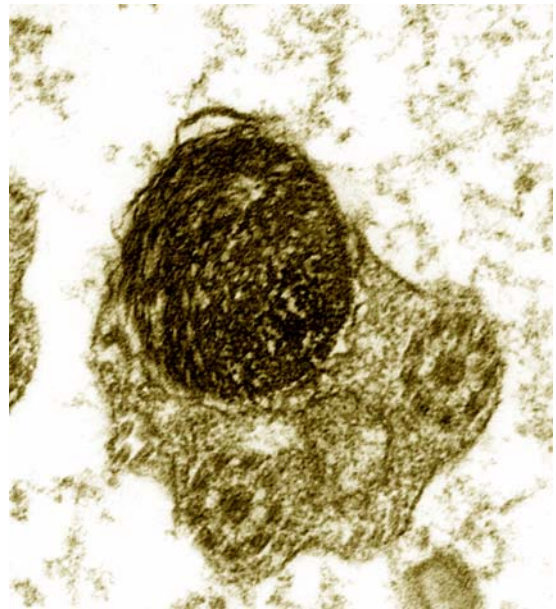

**Gametes – Worms. Figure 5** Cross-section of sperms of *Clonorchis* in a nuclear region.

these hormones are also produced in the central nervous system and their functions are different, depending on the localisation. For example, CCK increases the release of hormones and enzymes from the pancreas and also contracts the gall bladder, but in the brain it is an important sensor for satiety.

### Clinical Relevance

Infection with gastrointestinal [nematodes](#) is an important cause of impaired productivity in all domestic ruminants ([Alimentary System Diseases, Ruminants](#)). Changes in feed intake and gastrointestinal functions are essential mechanisms for these losses. Gastrin levels increase after infection, as well as the pH in the abomasum. Quite often, but not regularly, there is also an increase in serum pepsinogen. These different



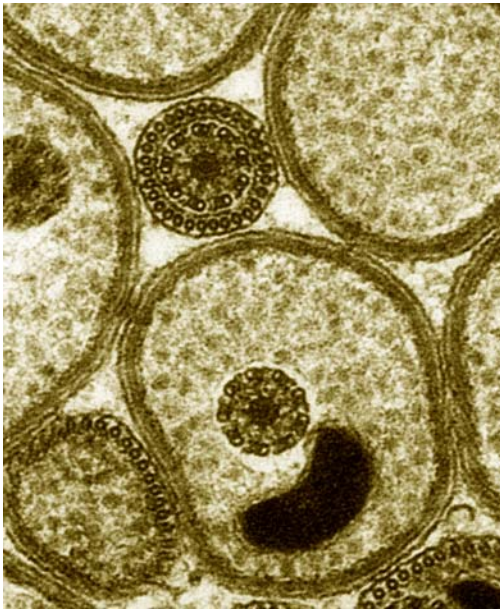

**Gametes – Worms. Figure 6** Cross-section through the sperms of *Hymenolepis nana* (Cestoda) at different levels.

effects finally lead to →hyperplasia and hypergastrinemia. In some gastrointestinal helminths, gastrointestinal hormones have been demonstrated by immunocytochemistry but the function of these parasitic hormones is unknown so far, with the exception of a

vasoactive intestinal peptide (VIP) from the nematode →*Nippostrongylus brasiliensis*. This hormone is part of the excretory/secretory material and it inhibits the amplitude of contractions of the intestinal tract as efficiently (in the pM range) as the corresponding vertebrate hormone. Since VIP is known to inhibit food intake and to stimulate ACTH and growth-hormone release in the brain, the nematode VIP might therefore have additional advantages for the parasite.

### Pathology

Infection of ruminants with adult worms (→*Haemonchus contortus*, resp. →*Ostertagia circumcincta*) leads to rapid responses (increase in serum pepsinogen and gastrin as well as abomasal pH) within less than a day, whereas with larval stages there is a lag phase of four to five days, though finally there is the same degree of response and also of hypergastrinemia. It is speculated that excretory/secretory products of adult worms lead to this cascade of events. Removal of the adult worms by treatment with antihelminthic agents rapidly normalises gastrin, pepsinogen and abomasal pH. The role of CCK for sensing satiety was demonstrated by the application of CCK which depressed short-term feed intake only in infected animals and also by a CCK antagonist which, after central infusion, increased short-term feed intake. The effect was more pronounced in infected animals than in controls.

**Gasterophilosis. Table 1** *Gasterophilus* species and Control Measurements

Parasite	Host	Symptoms	Country	Therapy		
				Products	Application	Compounds
<i>Gasterophilus haemorrhoidalis</i> (Nose or lip bot)	Horse		Worldwide	Eqvalan™ Paste 1.87% (Merial)	Oral	Ivermectin
<i>Gasterophilus inermis</i>	Horse		Europe, Africa, Asia			
<i>Gasterophilus intestinalis</i> (Common bot)	Horse	Most of the time asymptomatic; stomatitis, eating and chewing problems, erosions, ulcers, and dilatation of the stomach, chronic duodenitis, proctitis	Worldwide	Eqvalan™ Paste 1.87% (Merial) Quest Gel (Fort Dodge)	Oral	Ivermectin
<i>Gasterophilus nasalis</i> (Throat bot)	Horse		Worldwide	Eqvalan™ Paste 1.87% (Merial) Quest Gel (Fort Dodge)	Oral	Ivermectin
<i>Gasterophilus nigricornis</i>	Horse		Europe, Africa, Asia		Oral	Moxidectin
<i>Gasterophilus pecorum</i>	Horse		Europe, Africa, Asia			



**Gasterophilus.** Figure 1 Diagrammatic representation of the dorsal side of an adult female of *Gasterophilus intestinalis*. The pointed posterior end is bended below the abdomen.

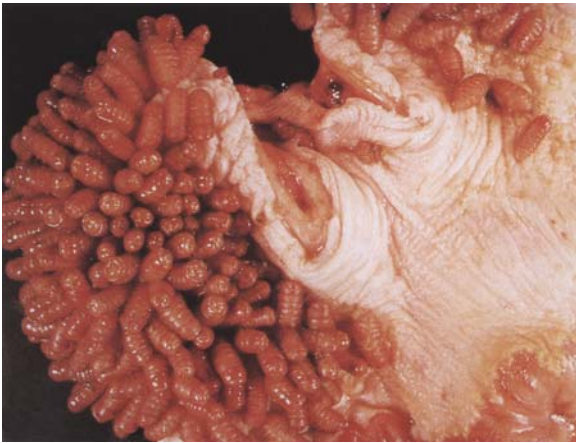

**Gasterophilus.** Figure 2 Larvae of *Gasterophilus intestinalis*, that are attached to the stomach wall of a horse.

## Gastrotaenia

Genus of the tapeworm family Hymenolepididae. *Gastrotaenia* sp. reaches a length of 13 mm and is found in the muscular stomach of ducks and swans. Intermediate hosts are copepods.

## GBD

Global burden of disease. Life time lost due to disease. All →DALY added results in the GBD-value of a distinct region.

## Gedoelestia Species

Flies of the family Oestridae, the larvae 1 of which penetrate occasionally into the conjunctival sac of cattle leading to a →conjunctivitis. In addition the larvae 2 and 3 are found in the sinus frontalis, in brain and in heart muscles (→Nervous System Diseases, Ruminants, →Uitpeuloog).

## Gehyrolina paragonopora

Species of →Cestodaria.

## Géné's Organ

Géné's organ is common to all female →ticks. It is found just above the position at which the capitulum is joined to the idiosome, in the camerostomal fold of ixodid ticks, the camerostomal depression of argasid ticks, or anterodorsally ventrad of the pseudoscutum in nuttalliellids. During →oviposition, Géné's organ emerges through an aperture to give each egg a waxy surface, as a final waterproofing. The →porose areas of female ixodid ticks (→Ticks/Fig. 6), whose function was not known for a long time, appear to act in conjunction with Géné's organ by producing inhibitors of the autoxidation of the unsaturated egg wax lipids (→Ticks/Reproduction). Terminal portion of the ixodid tick ovipositor system. Here the eggs were covered by a clueing layer, which protects the egg from drying when deponed onto the floor. This layer enables the rather undisturbed development of the larvae inside.

## Genital System Diseases, Animals

Parasitic infections of the genital tract are of major economic importance (Table 1), particularly those caused by the widely distributed protozoan parasites →*Toxoplasma gondii*, →*Neospora caninum* (syn. →*Hammondia heydomi*?) and →*Tritrichomonas foetus* which are major causes of reproductive failure in ruminants.

**Genital System Diseases, Animals. Table 1** Parasites affecting the Genital System of Domestic Animals (according to Vercruyse and De Bont)

Parasite	Host	Location	Clinical presentation	Principal lesions
<b>Protozoa</b>				
<i>Besnoitia besnoiti</i>	Cattle	Testicles	Infertility	Orchitis
<i>Neospora caninum</i>	Cattle, sheep, goat, horse, dog, cat	Neural tissues	Abortion, neuromuscular signs in congenitally infected calves	Encephalitis in transplacentaly-infected fetuses
<i>Sarcocystis</i> spp.	Cattle, sheep, goat, pig	Vascular endothelium of placenta, fetus	Abortion	Placentitis
<i>Toxoplasma gondii</i>	Sheep, goat	Placental cotyledons, fetus	Abortion	Necrosis in villous part of cotyledons, leukoencephalomalacia in congenitally-infected lambs or kids
<i>Tritrichomonas foetus</i>	Cattle	Vagina, cervix, uterus, oviduct, preputium	Early abortion, sterility	Vaginitis, endometritis, balanoposthitis
<i>Trypanosoma equiperdum</i>	Horses	Genitalia, skin, nerves	Genital phase: mucoid, vaginal or urethral discharge, nymphomania, micturition, rarely abortion	Oedema and inflammation of genitalia with ulcers, pigmentation of vulva or penis

*T. gondii* infections are ubiquitous throughout the world and are an important cause of →abortion in small ruminants. In fact, the parasite may invade many different organs in nearly all warm-blooded animals, and the clinical picture in a particular host species depends on the particular involvement of any one or more of these organs. However, in the vast majority of cases, infections remain asymptomatic. During initial exposure of pregnant ewes and does, the parasite primarily invades the placenta and may, at any gestational age, lead to fetal infection, with or without fetal death. Therefore, exposure of susceptible animals may lead to a wide range of clinical manifestations, including early embryonic death, mummification, abortion, stillbirth, neonatal death or birth of weak offspring. Abortion is generally caused by →necrosis of the cotyledons of the placenta. Congenital infection mainly affects the brain of the fetus, and lambs or kids born alive may show signs of →encephalitis. In pigs and dogs, cases of congenital toxoplasmosis have been reported, and clinically affected animals often show respiratory signs. *T. gondii* is apparently not a significant fetal pathogen in cattle and horses.

→*Sarcocystis* spp. are common, ubiquitous, sporozoan parasites of herbivores, but they rarely cause clinical signs or abortions in infected animals. Acute forms of →sarcocystosis are associated with the massive development of schizonts in endothelial cells of blood vessels. The clinical signs include high fever,

→anorexia, anemia, ataxia and loss of weight, sometimes with high mortality rates. *Sarcocystis* spp. have occasionally been reported as causing abortion in cattle, sheep, goats and pigs. In some cases, the absence of schizonts from the fetus suggest that the abortion is caused by maternal failure. In other cases, where the aborting mother may be otherwise normal, the extensive development of schizonts in the endothelial cells throughout the fetal tissues and within the placenta suggest that abortion is directly caused by the parasitic infection. It is uncertain whether some reported cases of *Sarcocystis* abortion in cattle, in fact, are *Sarcocystis* or possibly, *Neospora* infections.

*N. caninum*, which has long been misidentified as *T. gondii*, is now known to occur in a wide range of host species, including dogs, cats, horses, cattle, sheep and goats. Dogs have been identified as definitive hosts. Clinical manifestations of →neosporosis have mainly been observed in cattle and dogs. Transmission occurs orally, and via the transplacental route. *N. caninum* has a predilection for the central nervous system and skeletal muscles, generally leading to encephalomyelitis and polymyositis. In cattle, neosporosis is regarded as a major cause of abortion, particularly among dairy cattle. Although fetal death probably occurs throughout the gestation period, cows only abort from 3 months of gestation to term. It is likely that 1- to 2-month-old fetuses are killed *in utero*, resorbed, and the cow returns to heat again. Fetuses which die *in utero* may be

resorbed, mummified, aborted or stillborn. *N. caninum* is most often demonstrable in the brain and heart of the fetus, and rarely in other organs, including the placenta. Some congenitally infected calves may be born with signs of neuromuscular dysfunctions, while others may be born clinically normal but chronically infected. In aborted fetuses, the major lesion is a multifocal, necrotising, non-suppurative encephalomyelitis. *Besnoitia besnoiti* occurs in cattle in Southern Europe, Africa and Southeast Asia. Lesions, if any, are mainly confined to the skin and mucosa of the upper respiratory system, however, orchitis and subsequent infertility has been reported in bulls.

Trichomonosis is an important venereal disease of cattle caused by the flagellated protozoan *T. foetus*. In bulls infections usually go unrecognised. However, they remain chronically infected and transmission of the parasite to heifers or cows occurs at coitus. In the female, a primary infection invariably causes a vaginitis of varying intensity, with swelling of the vulva and vaginal discharge. Thereafter the parasites migrate upward through the cervix and invade the uterus. The inflammatory changes in the endometrium and cervix are relatively mild and non-specific, although the exudate, mucopurulent in character, may be rather copious. *T. foetus* does not prevent conception as such, but endometritis and uterine catarrh prevent proper fertilization, and result in aberrant →oestrus cycles and repeat breeding. Trichomonal abortion may occur at any time, but usually takes place early in gestation. Embryonal or fetal death may be followed by retention and sometimes pyometra, which occasionally result in permanent infertility. Unlike bulls, infections are self-limiting in females, with clearance of parasites after approximately 95 days.

→Dourine is a chronic venereal disease of horses caused by *Trypanosoma equiperdum*. The infection occurs in all species and breeds of Equidae, but not with the same intensity. Donkeys and mules are more tolerant to the infection than horses, while among the latter thoroughbreds and imported horses tend to be more susceptible to the disease than native horses. Unlike other species of trypanosomes, *T. equiperdum* is transmitted by coitus. It may take several months before clinical signs appear, by which time the infection may have spread significantly over the horse population. *T. equiperdum* is a tissue parasite and infects primarily the mucosa of the genital organs, the skin and nervous tissues. The disease which is insidious in nature, affects both stallions and mares. It usually progresses through three distinct phases. A first phase marked by swelling of the external genitalia is followed by an urticarial phase visible on the skin. These two phases may last several months to several years, during which time the animal gradually becomes cachectic.

A third, invariably fatal nervous phase characterised by incoordination and paralysis occurs in some horses. The genital phase is initiated by a mucoid vaginal or urethral discharge, →nymphomania and a mild fever with →oedema of the genitalia. Abortion in cattle associated with *T. brucei* or *T. congolense* infection (Nagana, African trypanosomosis) has been reported and this disease may also reduce fertility by altering testicular steroid production and sperm quality in bulls and causing atrophy of the ovaries in cows.

In horses, larvae of the →nematodes →*Strongylus vulgaris* and *S. edentatus* have occasionally been found migrating into the testes, leaving such lesions as inflamed, haemorrhagic migratory tracts. In warm climates, larvae of *Draschia megastoma*, *Habronema muscae*, and *H. majus* deposited near the prepuce by the →intermediate host flies (housefly *Musca domestica* and the →stable fly *Stomoxys calcitrans*) burrow into the dermis and cause extensive granulomatous inflammation. The infestation known as 'summer sores' is more common in geldings (accumulation of smegma) than in stallions.

### Therapy

See treatment of the various species, →Chemotherapy, →Drugs.

---

## Genome Sizes

→Nucleic Acids, →Chromosomes. The genome of parasites is much larger/bigger than that of bacteria. While *Escherichia coli* has 4.2 Mb, reach protozoans 9.4 (*Babesia bovis*), 12 Mb (*Giardia*), 20 Mb (*Trypanosoma brucei brucei*), or even 80 Mb (*Toxoplasma gondii*). Worm genomes become even much bigger, i.e., 150 Mb are reached in the case of *Onchocerca*, 270 Mb in schistosomes. The same size range is found in mosquitoes (280 Mb), while small mammalia (like mice) have 2,700 Mb.

---

## Geographic Distribution

Like all living species, parasites have adapted to particular →environmental conditions. No parasite species exists everywhere on earth. For a parasite to exist at any one place, there needs to be a suitable host and a suitable environment for transmission.

The expression “suitable host” implies several constraints: not only must the host be “qualitatively” present (i.e., a susceptible population), but also quantitatively (i.e., a density of hosts allowing sufficient production of larval stages and transmission); in heteroxenous life cycles, the constraints are multiplied by the number of different host species necessary for the completion of the cycle.

The expression “suitable environment for transmission” implies other constraints, because (with very few exceptions like *Trichinella*), parasites spend a part of their life outside the hosts and have, like all organisms, particular requirements such as range of temperature, presence of water, etc.

The geographic range of a particular parasite is usually constrained by a limiting factor, which is not always easy to identify (cf. maps added to several life cycles). When several host species are required for the development of a parasite species, this species can exist

only where all these host species coexist. This explains why parasites with simple life cycles adapt themselves to new environments better than parasites with complex life cycles. In the latter case, it is rare that all the conditions are met. For instance, when schistosomes were transported into America with the slave trade (Fig. 1), only one species of African schistosome found a convenient mollusc vector and became established (→ Specificity).

### Geographic Zones of Occurrence of Diseases

Agents of disease are found in different numbers in 4 different zones:

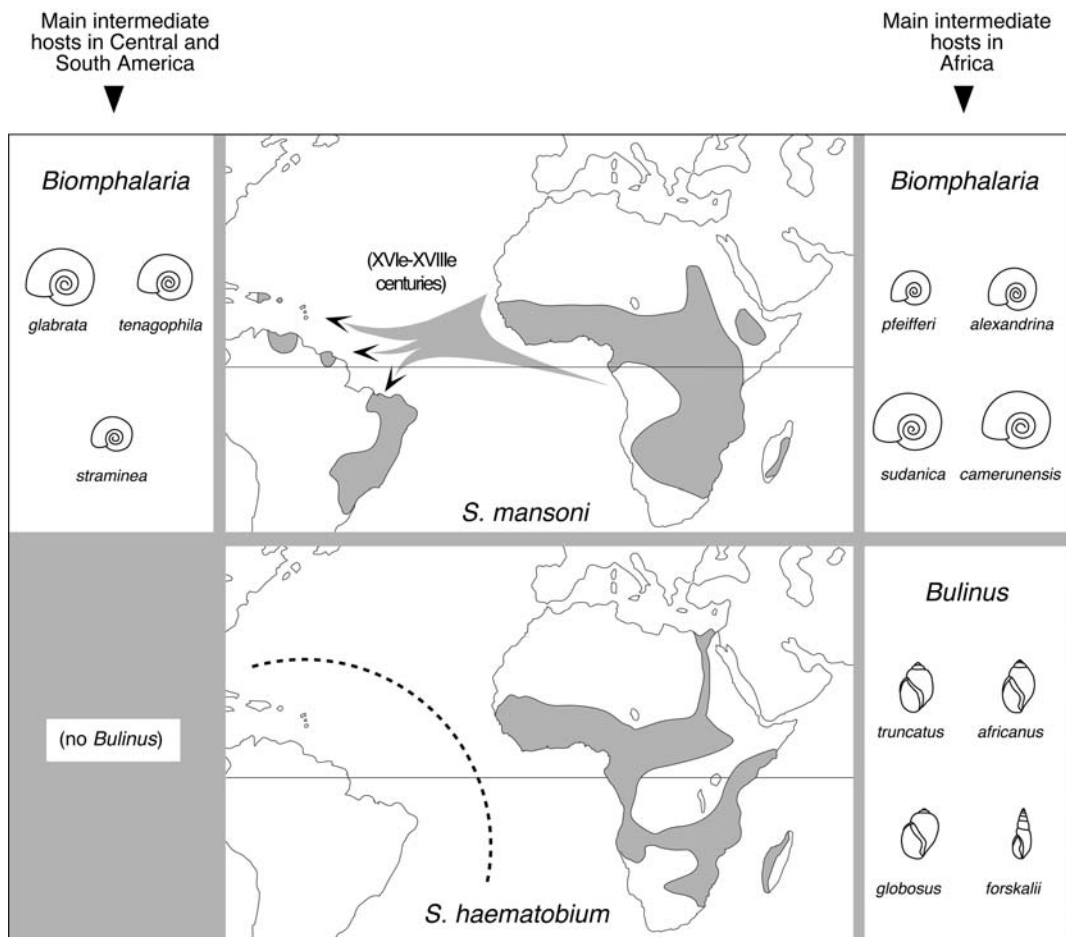

**Geographic Distribution. Figure 1** Current distribution of → *Schistosoma mansoni* and → *S. haematobium*, as explained by their vector distribution: *S. mansoni* and *S. haematobium* were both introduced into the New World during the 16th and 17th centuries but only the first one was compatible with local snails and became established (from Combes, 1995, modified).

- a) **Endemic zone:** infections are found the whole year.
- b) **Epidemic zone:** outbreaks occur at different intervals.
- c) **Incursive zone:** disease and its agents are only found occasionally.
- d) **Exterior zone:** here the agents of disease were not yet found.

## Germ Balls

→Digenea/Reproduction.

## Germ Theory of Disease

→Mathematical Models of Vector-Borne Diseases.

## Germarium

Ovary of →Platyhelminthes →Digenea.

## Giant Cells

A granulomatous reaction is introduced by multinucleated giant cells in human brain infected with *Acanthamoeba* or *Balamuthia amoebae* (→GAE). This reaction may not be present in cases of immunosuppressed patients. A similar reaction occurs in the liver of patients with schistosomiasis. There the remnants of the eggs of the schistosomes are finally engorged by such giant cells, which occur at the end of a strong granulocytic reaction in the liver. →granulomes/pathology.

## Giardi, Alfred (1846–1908)

French zoologist and describer of many protists.

## Giardia lamblia

### Synonym

*Lamblia intestinalis*, *Giardia duodenalis*.

### Classification

Species of →Diplomonadida.

### Life Cycle

Fig. 1.

*Giardia lamblia* (named after the scientists Giardi and Lambl) was already seen by van Leeuwenhoek in 1681 but not described till 1859 by Lambl. However, in recent years many new molecular biological results showed that the species situation is rather complicated, since many hosts are involved in human and animal →giardiasis (Table 1). The trophozoites of *G. lamblia* are pear-shaped, about 10–20 µm long with a width of about 5–15 µm, and possess 2 nuclei and 8 flagella (Figs. 2A, 4). Since the trophozoites are attached with their ventral disc (Figs. 2, 4) to the surface of epithelial cells (Fig. 5), they disturb the normal way of food uptake. The reproduction occurs by →binary fission. Finally, ovoid cysts of about 10–15 × 7–10 µm are formed. When excreted via feces they contain 4 nuclei (Fig. 3A). The fine structure of trophozoites and cysts is shown in Figs. 2–4.

### Morphology

Figs. 2, 3, see also →Flagella/Fig. 3.

### Species Relations

*Giardia lamblia*, that was described in papers until 2004 is apparently a mixture of several species and so-called genotype assemblages, which now were combined to *G. duodenalis* with several subtypes and different zoonotic properties (Table 1). Thus species names such as *G. cati*, *T. canis*, *T. bovis* are now invalid, and only a few other species of none or reduced anthroozoonotic importance are recorded (Table 1). The finding that *G. duodenalis* (Assemblage A) may infect a wide spectrum of mammals besides man is of high epidemiologic importance. In humans also mixed populations of different genotype assemblages may occur.

### Disease

→Giardiasis, Animals, →Giardiasis, Man.

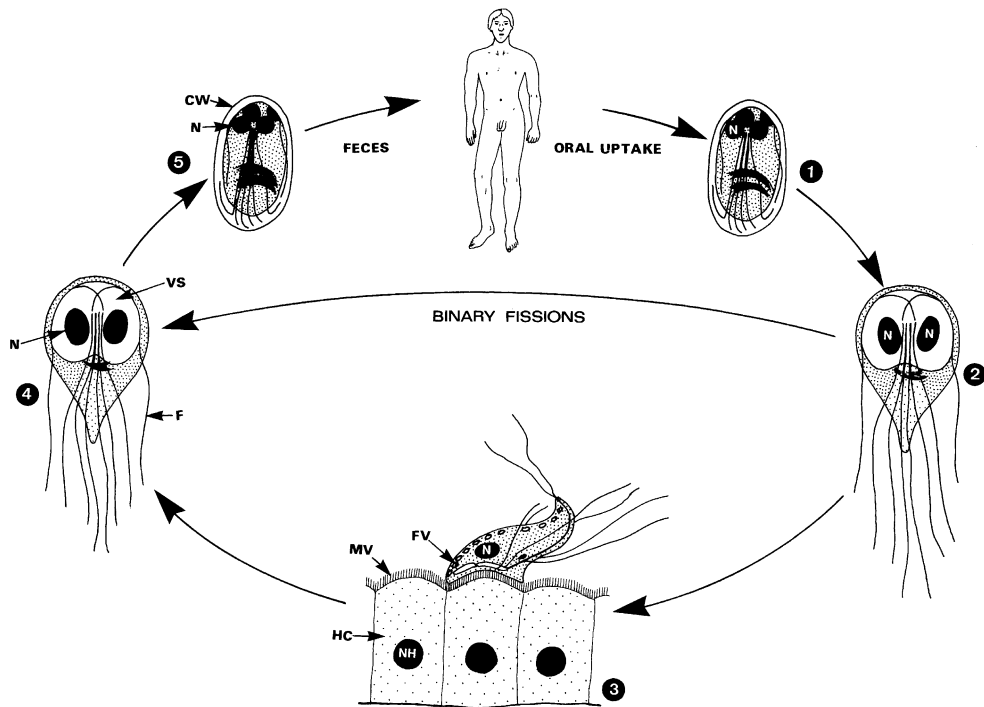

**Giardia lamblia. Figure 1** Life cycle of *Giardia lamblia* (for other species → *Diplomonadida*/Table 1). 1 Oral uptake of cysts after fecal contamination of food. 2 → trophozoites excyst in small intestine and may divide by → binary fission. 3 Trophozoites are attached to the surface of intestinal villi; → pinocytosis occurs at their dorsal side (FV). 4, 5 Free trophozoites encyst in the intestine and are passed in feces. CW, cyst wall; F, flagellum (4 pairs); FV, food → vacuoles; HC, host cell; MV, → microvilli of host cell; N, nucleus; NH, nucleus of host cell; VS ventral → sucker.

**Giardia lamblia. Table 1** Recent *Giardia* species names

Species name	Major hosts	Anthropo-Zoonotic	Former name
<i>G. duodenalis</i> Assemblage A	<b>Humans</b> , many mammals (livestock) dogs, cats, etc.	+	<i>G. lamblia</i>
<i>G. duodenalis</i> Assemblage B	Mainly <b>humans</b>	+	<i>G. lamblia</i>
<i>G. duodenalis</i> Assemblage C/D	Dogs	–	<i>G. canis</i>
<i>G. duodenalis</i> Assemblage E	Cattle	–	<i>G. bovis</i>
<i>G. duodenalis</i> Assemblage F	Cats	–	<i>G. cati</i>
<i>G. duodenalis</i> Assemblage G	Rats	–	<i>G. simondi</i>
<i>G. muris</i>	Mice	–	–
<i>G. microti</i>	Voies	–	–
<i>G. psittaci</i>	Birds	–	–
<i>G. agilis</i>	Frogs	–	–

## Giardiasis, Animals

### Pathology

*Giardia* species occur in dogs and cats, and giardiasis may represent an important problem in these hosts. It causes → *anorexia*, depression, and a mild recurring → *diarrhoea* consisting of soft, light-coloured stools with a characteristic “oatmeal” texture, frequently containing mucus. Growth retardation and cachexia may occur.

The mechanism by which giardial → *malabsorption* and diarrhoea occurs is unclear. Epithelial damage, increased turnover of epithelial cells, villous shortening, and disaccharidase deficiency have all been reported as manifestations of giardiasis.

*Giardia* spp. are usually non-pathogenic inhabitants of the intestine of horses, cattle, sheep, and goats. However, they may cause diseases under certain circumstances, such as in animals which are immunocompromised, malnourished, or very young.



**Giardia lamblia.** Figure 2 A–D Light (A) and transmission electron micrographs (B–D) of *Giardia lamblia* →trophozoite. A Fresh trophozoite preparation (× 2,000). B Tangential section of the ventral side (× 18,000). C, D Cross-sections through the →ventral disk (VD), which is formed by rows of →microtubules (MT) fortified by fibrils (FI) (C × 22,000, D × 45,000). AX, →axoneme; FI, fibril; GO, →Golgi apparatus; MT, →microtubules of VD; MTR, microtubular row along →axonemes; N, nucleus; VD, →ventral disk.

### Immune Responses

→Giardiasis, Man/Immune Responses.

### Related Entries

→Alimentary System Diseases, →Giardiasis, Man.

### Therapy

→Antidiarrhoeal and Antitrichomoniasis Drugs.

## Giardiasis, Man

### Pathology

→*Giardia lamblia* is a binuclear, pear-shaped flagellate which lives in the duodenum and upper small intestine,

where it is closely applied or attached to the epithelium by means of a suction disk. Ultrastructural examination of a biopsy of the small intestine often shows the epithelial →microvilli to be destroyed at the attachment sites of the flagellates. Acute infections are usually of short duration with →diarrhoea and epigastric distress which subsides with the development of immunity. →Chronic infections occur in patients with low or absent IgA, IgG, or IgM. In these patients the intestinal villi are often blunted from loss of epithelium which regenerates inadequately. The lamina propria is heavily infiltrated with lymphocytes and granulocytes. Diarrhoea, →weight loss, and intestinal →malabsorption with flatulence accompany chronic infections. The →trophozoites can be found in diarrhoeic stools, by duodenal aspiration or biopsy. The 4-nucleate →cysts (→*Giardia lamblia*/Fig. 3) are found in stools.



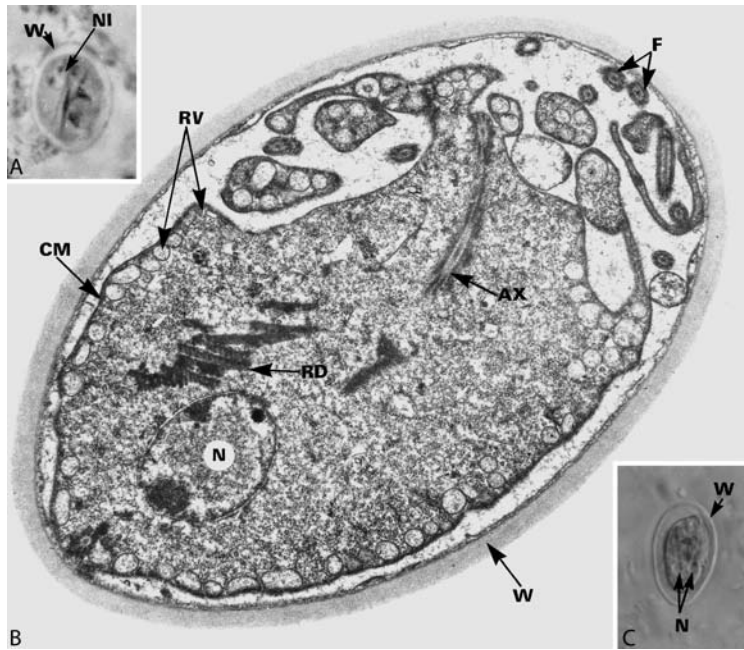

**Giardia lamblia.** Figure 3 A–C Cyst of *Giardia lamblia* under light (A, C) and transmission electron microscopy (B). (A, C  $\times 1,500$ ), (B  $\times 14,000$ ) AX, axoneme; CM, cell membrane; F, free flagellum (in cyst interior); N, nucleus; NI, nucleus in division; RD, remnants of the ventral disk; W, cyst wall.

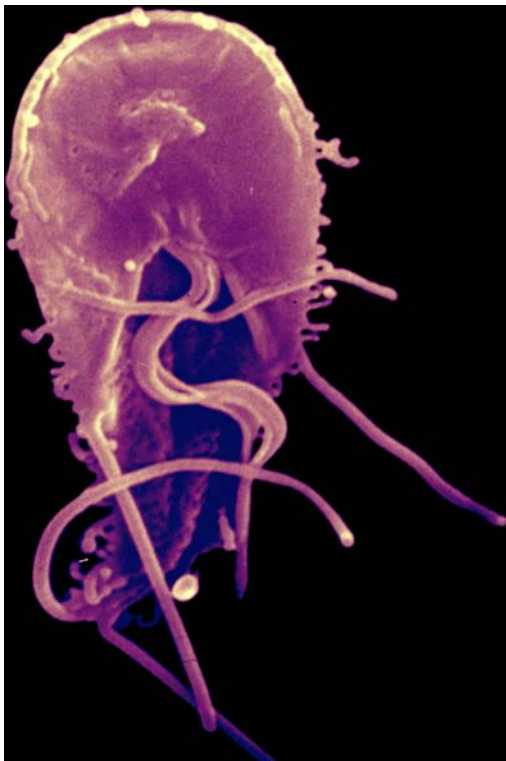

**Giardia lamblia.** Figure 4 Scanning electron micrograph (SEM) of a trophozoite showing its ventral side.

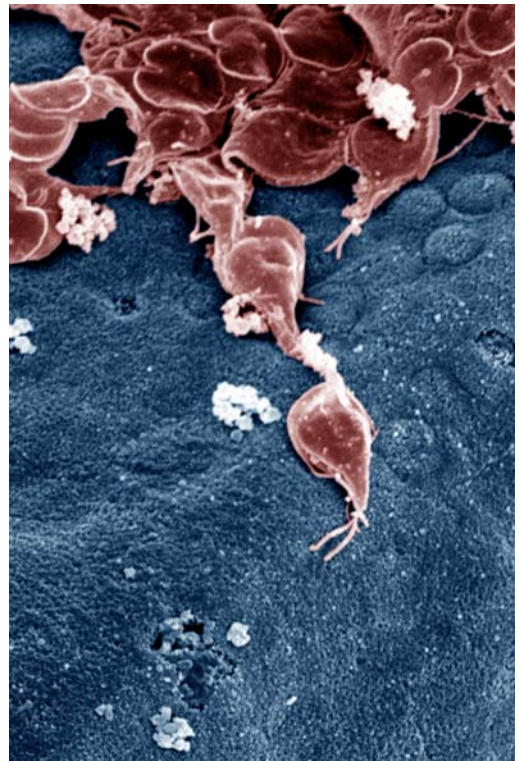

**Giardia lamblia.** Figure 5 SEM of places in the host's intestine, where trophozoites had been attached.

## Immune Responses

The establishment of animal models and the production of the whole life cycle of the parasite *in vitro* have greatly facilitated the characterization of stage-specific antigens as well as of analyzing the contribution of humoral and cell-mediated immune responses in the control of the infection. Most of the current knowledge comes from 4 different sources: (1) *in vitro* studies with axenically grown *G. lamblia* trophozoites and immune cells from different hosts; (2) studies with *G. lamblia*-infected mice or gerbils; (3) experiments with *G. muris*-infected mice; and (4) the analysis of immune responses in *Giardia*-infected humans.

## Innate Immunity

Since neutrophils are circulating blood cells, they are generally considered to play only a minimal role in intestinal infections. However, these cells are able to migrate like *amoebae* through small cracks in vessel linings to the exterior, where they eventually infiltrate tissues such as epithelial layers of the intestinal tract. It has been shown that certain products of neutrophils, cryptidins, and cationic neutrophil peptides, possess anti-giardial activity. The content of granules together with antibodies reduces parasite infectivity and antibody-dependent cytotoxicity (*ADCC*) was demonstrated with human peripheral blood neutrophils *in vitro*. Since all these anti-giardial effects of neutrophils have been analyzed only *in vitro* so far, the functional role of these cells *in vivo* remains to be elucidated. Although in mice infected with *G. muris* there was only a small rise in mucosal mast cell numbers, inhibition of mast cell products by cyproheptadine enhanced the infection.

## B cells and Antibodies

An important function of antibodies in the control of giardiasis is suggested by more severe infections in patients with hypogammaglobulinaemia. In B-cell-deficient mice, unable to mount an anti-*Giardia* Ig response, the infection with *G. lamblia* could not be resolved and antigenic diversification within the parasite population occurred in an unusually slow manner. Several studies have additionally demonstrated antibody-mediated killing of *Giardia* trophozoites *in vitro*, which is not in all cases complement dependent. The most important Ig for the control of giardiasis is IgA. The appearance of secretory IgA in the intestine correlates with the elimination of the parasite from the small intestine, but the effect of Ig subclass is complement-independent since IgA lacks C1q-binding sites in its Fc region required for the activation of the classical complement pathway. IgA may thus mediate its function

in a complement-independent manner, e.g., by binding to trophozoite surface proteins thereby causing detachment and aggregation of the parasite. However, a functional role of complement should not be ruled out since (1) proteins of the complement cascade are synthesized by epithelial cells of the intestine and (2) the alternative pathway of complement activation may be operative. Certain surface molecules, e.g., in the sucking disc of the parasite as well as metabolites released by trophozoites are able to activate the alternative pathway.

## T cells

There are few studies on the role of specific T cells in the defense against *Giardia*. The latent and acute phases of *G. lamblia* infection are accompanied by an increase of CD8<sup>+</sup> cells among IELs while in the elimination phase this population decreases and CD4<sup>+</sup> cells increase significantly. Since trophozoites are killed by oxidative-burst mechanisms stimulated in macrophages via IFN- $\gamma$ , it was tempting to speculate that T cells producing this cytokine might be involved in the control of parasite replication.

In addition, IFN- $\gamma$  leads to enhanced phagocytosis of *Giardia* trophozoites by macrophages. Comparing the antibody and cytokine response in relatively resistant B10 mice and more susceptible BALB/c mice it was found that B10 mice produced IgG2a while BALB/c mice produced IgG1 after *G. muris* infection, suggesting differential involvement of Th1 and Th2 cells. When lymphocytes from mesenteric lymph nodes were stimulated *in vitro*, only those of B10 mice produced measurable amounts of IFN- $\gamma$ . The application of neutralizing antibodies against IFN- $\gamma$  to B10 mice resulted in an enhanced intensity of infection, arguing for a protective role of Th1 cells in this parasitic infection.

## Immunopathology

The killing of the parasite can lead to injury as shown, for example, in co-culture experiments with enterocytes and activated macrophages from the gut of mice infected with *G. lamblia*. It is not clear, however, if villus atrophy and crypt *hyperplasia* observed in response to infection with *Giardia* as well as the phenomena of maldigestion and *malabsorption* are direct consequences of the parasite load or caused by the host's immune response. Antigenic extracts of *G. lamblia* containing proteins of 32–200 kDa transiently suppressed the activity of disaccharidases when gerbils were challenged with this fraction. It has been speculated that this short-lived effect could be mediated by lymphokines and/or mediators released by mast cell, neutrophils, or macrophages.

### Evasion Mechanisms

Only recently has the possible involvement of antigen-variation in establishing a *Giardia* infection been noticed. The antigens involved belong to a family of variant-specific surface proteins (VSGs), which are unique, cysteine-rich zinc-finger proteins. After inoculation of a single *G. lamblia* clone expressing one →VSG into mice or humans, the original VSP is gradually replaced by many others beginning 2 weeks post-infection. Selection by immune mechanisms is suggested because (1) switching occurs at the same time that antibodies are first detected and (2) the antigenic switching does not occur in SCID mice.

The →antigenic variation of *Giardia* parasites may increase the chance of successful initial infection or reinfection.

**Main clinical symptoms:** →Abdominal pain, Slimy non-bloody, diarrhoea, malabsorption.

**Incubation period:** 3–21 days.

**Prepatent period:** 3–4 weeks.

**Patent period:** Years.

**Diagnosis:** Microscopic determination of trophozoites and cysts in faecal samples.

**Prophylaxis:** Avoid contact with human or animal faeces.

**Therapy:** Treatment see →Antidiarrhoeal and Antitrichomoniasis Drugs.

## Giemsa, Berthold Gustav Carl (1867–1948)

German chemist and chemotherapeut at the Hamburg Tropical Institute, inventor of the famous blood-smear stain, which made it possible to diagnose →malarial stages, →Trypanosoma, →Filaridae, etc. Inventor of apparatuses to disinfect whole ships.

### Giemsa Stain

Peculiar staining to demonstrate blood parasites (e.g., →Plasmodium, →Trypanosoma) or stages in tissue cultures; nuclei appear blue, the plasma reddish.

### Gigantism

When parasitized, several snail species grow up considerably in order to compensate losses due to

parasites (e.g., in the mud snails *Hydrobia ulvae* and *H. ventrosa* when parasitized by trematode stages).

### Gigantobilharzia

In contrast to its name this genus includes very thin (filament-like) schistosomes of gulls. They are about 1.2 cm long, look similar as males and females, and have reduced mouth and ventral suckers. Their cercariae may initiate dermatitis in humans.

### Gigantocotyle

Genus of the digenetic trematode family Paramphistomatidae (→Paramphistomum cervi).

*G. explanatum* reaches a size of 8–13 mm × 3–4 mm and lives as adult in the bile ducts of cattle and buffaloes in Southeast Asia.

### Gigantolina magna

Species of →Cestodaria.

### GI-Nematodes

Abbreviation for gastrointestinal →nematodes, e.g., trichostrongylids.

### Gland Cell Secretion

→Platyhelminthes.

### Glaridacris catostomi

→Eucestoda.

## Glia-Like Cells

→Nervous System of Platyhelminthes.

## Gliding Motility

→Apicomplexa.

## Globidium

Genus of →Coccidia, forming large schizonts that look like →tissue-cysts, →Cell Multiplication.

Probably some of the stages belong to →Eimeria species.

## Globocephalus

→Hookworms, →Nematodes.

## Glomerulonephritis

→Pathology.

## Glossatella

→Ciliophora.

## Glossina

### Classification

Genus of →Diptera.

### Important Species

*G. morsitans*-complex, *G. austeni* complex, *G. palpalis*-complex, *G. fuscipes* (Figs. 1–3, page 562).

### Morphology

→Insects/Fig. 5A. The different species may contain symbiotic bacteria in the gut (*Wigglesworthia glossinida*, *Sodalis glossinidius*) or in the ovary *Wolbachia pipientis*.

### Life Cycle

Fig. 1 (page 562).

### Vector

→Trypanosoma species in Africa.

## Glossinidae

### Name

Greek: *glossa* = tongue, *tsetse* = local African name imitating the flight sound of this biting fly.

### Synonym

→Tsetse Flies.

Family of →Diptera, →Insects/Fig. 8A.

## GLP

Good laboratory praxis: defined operations in laboratory.

## Glucantime

The compound N-methylglucaminantimonat blocks the metabolism of *Leishmania* stages. →Leishmaniocidal Drugs.

## Glucocorticoids

### General Information

Glucocorticoids are lipophilic steroid hormones which are synthesized de novo in the cortex of the adrenal organ. They exert a variety of different effects on the host itself, e.g., on the water balance and regulation of

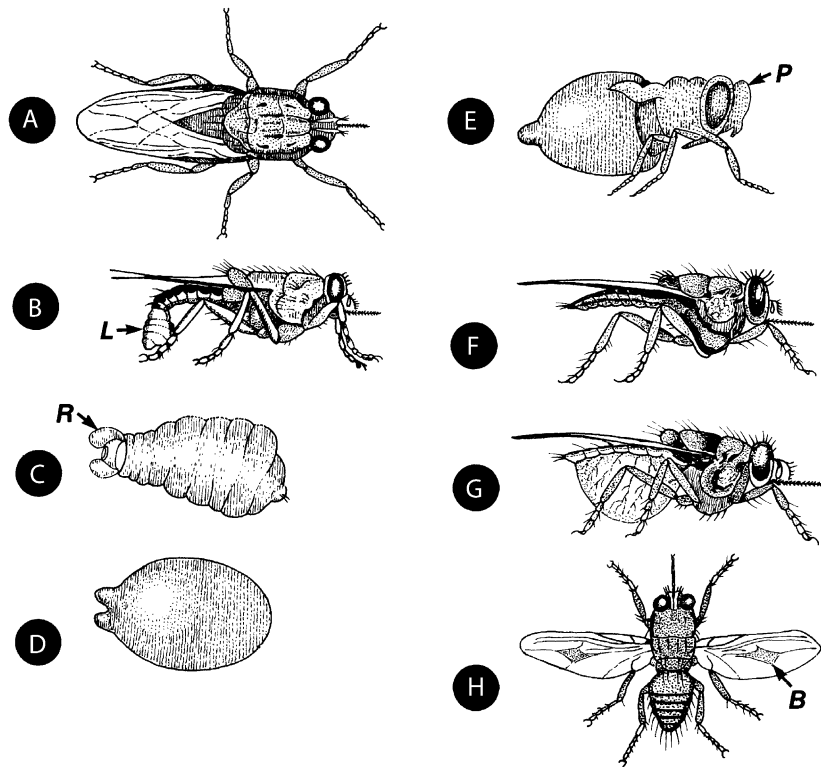

**Glossina. Figure 1** Life-cycle stages of *Glossina* species, the females of which give birth to a single larva (L), which soon becomes pupated and forms 2 respiratory bulbs (R). Hatching from the →puparium occurs by help of a toothlike structure called →ptilinum (P), and blood sucking starts soon. The genus *Glossina* has a typically shaped wing field (B).



**Glossina. Figure 2** LM of a tsetse fly on human skin.

ion content, growth and differentiation processes, and on the immune system. It is therefore difficult to define the mechanism of action of glucocorticoids on parasites and to clarify whether these are direct or indirect effects.

### Pathology

It is impossible as yet to give a coherent picture of the influence of glucocorticoids on parasites and vice versa.



**Glossina. Figure 3** SEM of the anterior portion of a tsetse fly.

In some instances there are even contradictory results: for example, corticosteroid hormones can increase or decrease the infection rate within the same systematic group. One possible explanation is the finding that the

→fecundity of adult parasitic →nematodes increases at lower glucocorticoid levels but decreases at higher concentrations of hormone.

### Clinical Relevance

Due to their immunosuppressive action glucocorticoids usually have a deleterious effect on the host and may lead to higher degrees or to prolonged parasitemia. Glucocorticoid therapy may therefore be risky, especially, e.g., if a patient suffers from →cerebral malaria.

## Glucose Transporter

→Energy Metabolism.

## Glugea anomala

→Microsporidia.

## GLURP

→Glutamate Rich Antigen (→Malaria/Vaccination).

## Glutamate

→Nervous System of Platyhelminthes.

## Glutamine

→Energy Metabolism, →Amino Acids.

## Glutamine Metabolism

→Amino Acids.

## Glutathione

### Synonym

→GSH, L-γ-glutamyl-L-cysteinylglycine.

### General Information

Low molecular weight →thiol compound responsible for the protection of cells against oxidative stress and the maintenance of an optimal intracellular redox state.

## Glycerol

→Energy Metabolism.

## Glycine

→Amino Acids.

## Glyciphagidae

→Acarina.

## Glycocalyx

### Synonym

→Surface Coat.

## Glycogen

→Energy Metabolism, →Reserve Granules.

## Glycolysis

Metabolic process to use glucose, →energy metabolism.

## Glycophorin A

→Apicomplexa.

## Glycosomes

These →microbodies are specific organelles of kinetoplastic →Trypanosomatidae. They are ovoid and membrane-bound, appear electron-dense and reach about 0.25 μm in diameter (→Trypanosoma/Fig. 5). They are rather numerous and contain 7 glycolytic enzymes, which in other cells normally occur in the →cytoplasm. In trypanosomes, however, this energy-delivering process of degrading sugar proceeds exclusively in these organelles, which thus play an important role in metabolic compartmentation. The bloodstream forms (i.e., trypomastigote stages) degrade glucose into pyruvate, which is finally excreted. During this process they need 50–100% of their dry-weight per hour. Since they are not able to store any polysaccharide internally, they have to take up glucose constantly. If this is not possible (e.g., in cultures), they will die. Therefore these glycosomes are extremely important for the

survival of trypanosomes in the bloodstream of their hosts, and thus they have become targets for drug development. *T. cruzi* is an exception and may survive several days without the presence of glucose. This may be due to the activation of the proteins within so-called →reservosomes and/or due to the initiation of the respiratory chain-elements, which are present in the blood stages of *T. cruzi*. Several authors found hints that the glycosomes are evolutionarily related to →peroxisomes, which are absent in trypanosomes (→Energy Metabolism).

## Glycosylphosphatidylinositols

Glycosylphosphatidylinositols (GPIs) are a family of glycolipids that are widespread in nature implying an important biological role. The major function of these molecules is to anchor proteins to →cell membrane surfaces. The occurrence of GPI anchors is particularly abundant in protozoan parasites, where they serve as the predominant mechanism for integrating glycoproteins and phosphosaccharides into membrane lipid bilayers. Examples are the variant surface glycoproteins (VSGs) of African trypanosomes, which have played a major role in the discovery of →GPI membrane anchors, the →promastigote surface protease of →*Leishmania* spp., the →merozoite surface proteins of →*Plasmodium falciparum* and the surface antigens of *Toxoplasma gondii* tachyzoites. In higher eukaryotes, GPI-anchored proteins constitute only a minor proportion of cell surface proteins. GPI anchors are composed of a common core structure of →phosphatidylinositol

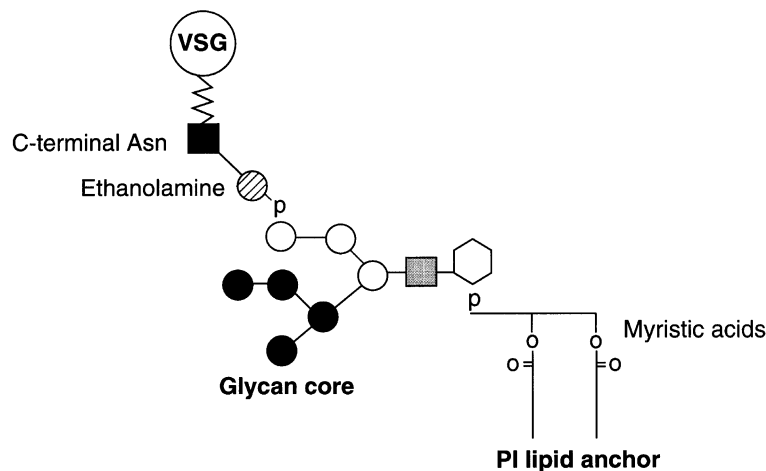

**Glycosylphosphatidylinositols.** Figure 1 Protein GPI anchor structure of the *Trypanosoma brucei* variant surface glycoprotein. ●, Galactose; ○, mannose; ▨, glucosamine; hexagonal ring structure, inositol; P, phosphate.

(PI), a mannose-containing glycan chain and ethanolamine phosphate, which is linked to the C-terminal end of the protein (Fig. 1). The alkyl or acyl chains of the phospholipid provide the attachment of the protein to the membrane from which they can be released by PI-specific phospholipases. The core structure of the GPI is conserved, but marked differences are found in the side chains attached to the core glycolipid. Heterogeneity also exists in the lipid composition. In *Trypanosoma brucei*, the VSG anchor of bloodstream forms contains exclusively dimyristoyl-PI, while the anchor of the  $\rightarrow$ procyclic acidic repetitive protein (PARP) of the insect stage contains 1-stearyl-PI and is palmitoylated on the inositol. The lipid moiety of *trans*-sialidase of metacyclic *T. cruzi* is a  $\rightarrow$ ceramide. The  $\rightarrow$ GPI anchor is synthesized in the endoplasmic reticulum by the sequential glycosylation of the PI followed by the addition of ethanolamine phosphate. GPI anchoring proceeds via a transamidation reaction, in which the GPI moiety is attached to the protein via an amide linkage between the GPI ethanolamine and the protein's C-terminal amino acid. GPIs and GPI-related glycolipids of protozoan parasites contribute to a protective  $\rightarrow$ glycocalyx formed over the plasma membrane, such as glycosylinositolphospholipids (GIPLs)

of mammalian and insect stage *Leishmania* and the PARP of *T. brucei*. The GPI-anchor of the latter protein is heavily substituted with galactose, *N*-acetylglucosamine and sialic acid. GPIs may also serve specific roles in intracellular trafficking, protein targeting, membrane signalling and, in  $\rightarrow$ malaria, as toxins by upregulating host endothelial cell surface molecules.

GPIs are also found in  $\rightarrow$ protozoa as mature surface glycolipids which are not linked to protein, such as the  $\rightarrow$ lipophosphoglycan (LPG) and GIPLs of leishmanial parasites. These structures have no analogs in higher organisms and appear to represent recent evolutionary adaptations to a parasitic mode of life. GIPLs are structurally closely related to the phosphosaccharide core PI region of LPG (Fig. 2) and form a dense surface  $\rightarrow$ glycocalyx above the plasma membrane of about 10 million copies in both  $\rightarrow$ amastigotes and promastigotes of *Leishmania* spp. They consist of small mannose- and other hexoses-containing glycans that are glycosidically linked to alkylated or alkylated-and-acetylated PI. The detailed structure of the GIPLs varies among different leishmanial species and developmental stages of the same species. GIPLs have been suggested to play critical roles in *Leishmania* amastigote survival and virulence.

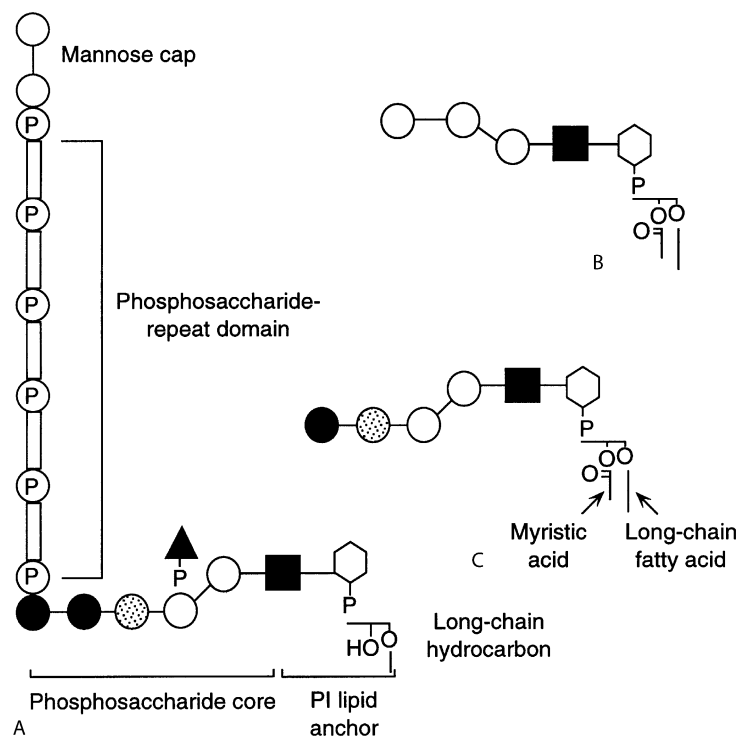

**Glycosylphosphatidylinositols.** Figure 2 Structures of  $\rightarrow$ lipophosphoglycan (LPG) and glycosylphosphatidylinositols (GIPLs) of *Leishmania* spp. **A** LPG of *L. major* promastigote; **B** GIPL of *L. donovani* amastigote; **C** GIPL of *L. major* promastigote. P, phosphate; O, mannose; ■, glucosamine; ●, galactose; ⊙, galactofuranose; hexagonal ring structure, inositol; ▲, glucose.



## Glycyphagus

→Mites.

## Glyoxisomes

→Microbodies that process lipids for energy production, mainly in plants. However, they have also been described in protozoans such as *Euglena gracilis* and *Tetrahymena pyriformis*, indicating a wider range of adaptations.

## Glyoxylate Cycle

→Lipids.

## GMP

Good medical praxis: defined activities in treatment.

## Gnathobdellida

→Leeches.

## Gnathostoma spinigerum

### Classification

Species of →Nematodes.

### Morphology

Adult male worms have a length of 10–30 mm, while females reach up to 50 mm; both are characterized by an anterior bulbous and defined rows of spines (Figs. 2, 3, page 568).

Further species with different numbers of hooklets at the anterior bulbous are:

1. *G. hispidum* (in pigs in Europe and Asia; occasionally in humans). The adults reach a length of 25 mm.
2. *G. doloresi*, which is found in pigs in the Philippines, India, and Asia. The females obtain a

length of up to 35 mm. →Creeping eruption in humans was seen after eating raw fish.

3. *G. nipponicum*; this species lives in groups or single in a hard tumor of the esophageal wall of the weasel in Japan. Adult males are 20–23 long, females 29–34 mm.

→Creeping eruption in humans occurred after eating loaches or various fresh water fish containing larvae.

### Life Cycle

Fig. 1 (page 567).

### Disease

→Gnathostomiasis.

## Gnathostomiasis

Gnathostomiasis is an aberrant infection of man with larvae of →*Gnathostoma spinigerum* of felines and dogs. It is acquired from contact with meat of infected intermediate hosts (fish, amphibians, reptiles, birds). The larvae from the intermediate hosts enter human tissue and may migrate slowly through many tissues, giving rise to the intermittent subcutaneous swellings and (very often) to intestinal nodules. The worm is surrounded by an →inflammatory reaction with many eosinophils. The larvae are especially destructive when they die in the brain or eye.

**Main clinical symptoms:** Eosinophilic encephalomyelitis due to wandering larvae in brain, leucocytosis, blood →eosinophilia, intestinal nodules.

**Incubation period:** 3–7 days.

**Prepatent period:** There is no reproduction in man.

**Patent period:** Months.

**Diagnosis:** Serodiagnostic methods.

**Prophylaxis:** Avoid eating raw meat or undercooked fish and crabs.

**Therapy:** Treatment see →Nematocidal Drugs.

## Golgi Apparatus

→Dictyosomes are composed of flat sacs with swollen peripheral regions (→Endocytosis/Fig. 1B, →Merozoite/ Fig. 1, →Trypanosoma/ Fig. 5), from which vesicles are formed. Several dictyosomes together form the Golgi apparatus of a cell. However, many protozoans (e.g., merozoites of coccidians) have only 1 dictyosome which then represents the Golgi apparatus, while other

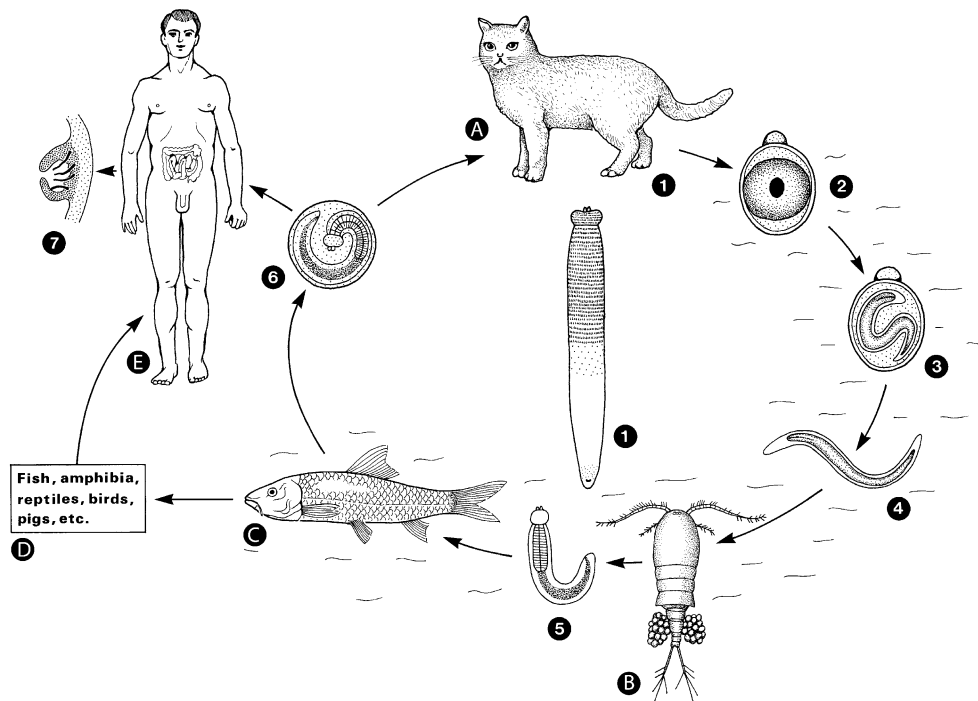

**Gnathostoma spinigerum.** **Figure 1** Life cycle of *Gnathostoma spinigerum* using different types of hosts (A–E). 1 Adults (male 10–30 mm; female up to 50 mm), which are characterized by a spiny anterior bulbus and many body rows of spines, live in the stomach wall of the final hosts (cats) leading to tumorlike growths. 2–4 The eggs (65–70 × 40 μm) are unembryonated when passed by feces (2). After 1 week of embryonation the first-stage larva (4) hatches in water and swims actively. It remains covered by a thin sheath representing the inner egg shell. 5 The first →intermediate host (B) is a cyclopoid copepod, where the L<sub>1</sub> penetrates the hemocoel and develops further into a second-stage larva (L<sub>2</sub>) within 7–10 days. The L<sub>2</sub> already has a swollen head bulbus covered with 4 transverse rows of spines. 6 Fish act as second intermediate hosts when they eat infected copepods. The L<sub>2</sub> penetrates the intestine of its new host and migrates to muscles or connective tissues, where it molts to form the L<sub>3</sub> which becomes encapsulated. The L<sub>3</sub>, measuring about 4 mm, is infective to the final host, where it reaches maturity. However, the encapsulated L<sub>3</sub> is also infective to other hosts (D) including humans (E). 7 If L<sub>3</sub> are eaten by other than the final hosts (including man), they wander in that host's tissues without further development; in humans and animals this leads to symptoms of *gnathostomiasis externa* or *interna*, depending on the infected tissues. If humans eat such uncooked paratenic hosts (D), they may become infected but no further development occurs, although the ingested L<sub>3</sub> remain infective for final hosts within such paratenic hosts (arrow not drawn to A). In the intestine of humans, worm stages lead to →nodule formation (7).

parasites (e.g., →*Trichomonas*) include several dictyosomes per cell. These organelles are always situated close to the rER and the 2 organelles act together as functional units in the production and transport of membrane and in the formation and transport of all types of macromolecular proteins and lipids. The dictyosomes are never covered by ribosomes. The principal function of the Golgi apparatus is the transport of secretions and excretions formed on the rER. These reach the dictyosomes at its cis-side and are transported within →vacuoles that are cut off at its periphery (the trans-region). Endocytotic vesicles such as food vacuoles also come into contact with the Golgi apparatus and the rER system at points where they fuse with enzyme-containing vacuoles produced by the Golgi apparatus; this is how digestive enzymes and other products enter the endocytotic vacuoles.

## Golgi, Camillo (1844–1926)

Italian anatomist, discoverer of the Golgi apparatus. Winner (1906) of the Nobel Prize (together with Ramon y Cajal).

## Golgi-Less-Secretory-System

In →*Giardia* encystation occurs via a unique secretory apparatus, which is not a typical Golgi-apparatus, but very probably a primordial Golgi or new secretory system composed of “encystation-specific vesicles”

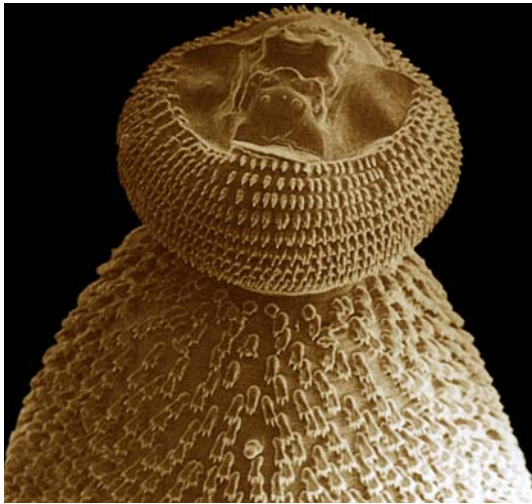

**Gnathostoma spinigerum.** Figure 2 SEM of the anterior end of *Gnathostoma spinigerum* showing the spiny cuticle.

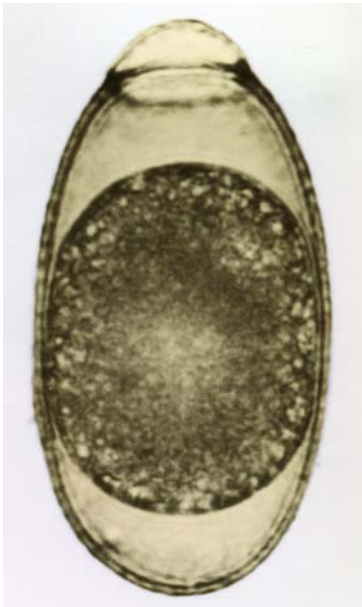

**Gnathostoma spinigerum.** Figure 3 LM of the typical egg of *Gnathostoma spinigerum* being characterized by a single terminal plug.

(ESV), the surface of which is covered with clathrin and dynamin. These ESV's become fragmented and form the cyst wall outside of the cell membrane.

---

## Gomori's Silver Impregnation

→Pneumocystis.

---

## Gongylonematidae

Nematode family of the suborder Spirurina, which is characterized by the fact that the males enrol their posterior end.

From Greek: *spira* = winding, *ura* = tail. *Gongylo-mema* spp. are found in mammals and birds parasitizing the wall of the esophagus. Their life cycle includes intermediate hosts such as beetles and cockroaches. Related groups are worms of the genus →*Camallanus*.

---

## Gonospora

→Gregarines.

---

## Gonotyl

→*Heterophyes heterophyes*, →Digenea.

---

## Good Gens Benefits Mating

→Behavior.

---

## Goussia

→Coccidia.

---

## GPELF

Global program to eliminate filariasis.

---

## GPI

### Synonym

→Glycosylphosphatidylinositol, →Apicomplexa.

## GPI Anchor

→Apicomplexa, →Glycosylphosphatidylinositols.

## Granulomatous Amebic Encephalitis (GAE)

### Brain

Human brain disease due to infection with free-living amoeba (→*Acanthamoeba castellanii*, →*Balamuthia mandrillaris*). While *Acanthamoeba*-GAE is mainly found only in immunocompromized persons, GAE due to *Balamuthia* occurs in both immunocompetent and immunocompromized ones. *Balamuthia*-trophozoites reach a size of 12–60 (mean 30) μm. *Acanthamoeba* is smaller (25–40 μm).

## Granulomes

### Name

Latin: *granulum* = grain, granule.

This term describes parasitic stages that are surrounded by defense cells of the host. →Schistosoma, →Pathology.

## Graphidium

Genus of trichostrongylid stomach worm of rodents and rabbits, e.g., *G. strigosum* (hare); *G. neoplasticum* (rat), up to 2 cm in length.

## Grassi, Giovanni Battista (1854–1925)

Italian physician and biologist, describer of the life cycle of →*Ascaris* and many details of →*Plasmodium*.

## Gregarina

Genus of →Gregarines, →Chromosomes.

## Gregarines

### Classification

Subclass of →Sporozoa.

### General Information

The gregarines exclusively parasitize invertebrates (Table 1). Because they are in general large cells, reaching up to 10 mm in some species, they are useful models for teaching. General features are:

- Sexual reproduction begins with the mating of gamonts (→Syzygy, →Gamontogamy).
- Gamonts of both sexes carry out →multiple fissions.
- Fusion of iso- or →anisogametes occurs inside the common gamontocyst.
- →Sporogony consists of 1 →nuclear division sequence (no →oocyst occurs, but only sporocysts which produce the infectious sporozoites).

### System

Among the gregarines there are extra- and intracellular parasites which belong to the following systematic orders (Figs. 1–3, pages 571, 572):

- Order: Archigregarinida
  - Extracellularly attached to host cells
    - Genus: *Selenidium*
- Order: Eugregarinida
  - Extracellular development prevailing, no →schizogony (Fig. 1B, C)
  - Family: Aseptinata
    - Body consists of a single unit (acephaline forms)
    - Genera: *Monocystis* (Fig. 2), *Lecudina*, →*Lankesteria*, *Rhynchocystis*, →*Gonospora*
  - Family: Septatina
    - Body is divided by a septum (formed by ectocytoplasm) into an anterior →protomerite (possibly bearing an anterior anchoring apparatus, the →epimerite) and a posterior →deutomerite containing the single large nucleus (Fig. 1)
    - Genera: →*Gregarina* (Fig. 3), →*Leidyana*, →*Neoschneideria*, *Stylocephalus*, →*Actinoc-ephalus*
- Order: Neogregarinida

**Gregarines. Table 1** Some common gregarines

Species	Size of trophozoites (µm)	Host/Habitat
<b>Order Eugregarinida</b>		
<b>Family Aseptatina</b>		
<i>Monocystis agilis</i>	200 × 65	Earthworm/Seminal vesicle
<i>Nematocystis vermicularis</i>	1000 × 100	Earthworm/Seminal vesicle
<i>Lankesteria ascidia</i>	240 × 60	Ascidia ( <i>Ciona intestinalis</i> )/Gut
<i>L. culicis</i>	200 × 40	Mosquitoes ( <i>Aedes aegypti</i> )/Gut
<i>L. planariae</i>	100 × 30	<i>Planaria</i> spp./Gut, ceca
<i>Ascogregarina taiwanensis</i> <sup>b</sup>	500 × 30	<i>Aedes albopictus</i> Malpigh. Tubules
<i>Gonospora beloneides</i>	800 × 80	Polychaetes/Body cavity
<b>Family Septatina</b>		
<i>Gregarina polymorpha</i>	350 × 100	Larvae of flourbeetle ( <i>Tenebrio molitor</i> )/Gut
<i>G. blattarum</i>	1100 × 400	Cockroaches/Gut
<i>G. queni</i>	65 × 25	Bees/Gut
<i>Neoschneideria douxi</i>	70 × 45	Bees/Gut
<i>Leidyana</i> sp.	125 × 40	Bees/Gut
<i>Stylocephalus longicollis</i>	100 × 20	Beetles ( <i>Blaps mortisaga</i> )/Gut
<i>Actinocephalus parvus</i>	80 × 20	Larvae of fleas/Gut
<i>Coleorhynchus heros</i>	3000 × 300	<i>Nepa cinerea</i> /Gut
<b>Order Neogregarinida</b>		
<i>Schizocystis gregarinoides</i>	400 × 15	Larvae of ceratopogonid gnats/Gut
<i>Lipocystis polyspora</i> <sup>a</sup>	Sporozoites 9 × 2	Mecoptera ( <i>Panorpa</i> sp.)/Fat body
<i>Ophryocystis mesnili</i> <sup>a</sup>	Sporozoites 9 × 2	Larvae of flour beetle ( <i>Tenebrio</i> sp.)/Malpighian tubules
<i>Mattesia dispersa</i> <sup>a</sup>	Sporozoites 9 × 2	Mealmoths ( <i>Ephestia kuehniella</i> )/Fat body

<sup>a</sup> Live as intracellular parasites in all developmental stages

<sup>b</sup> Syn. *Lankesteria*

- Development primarily intracellular with schizogony (Fig. 1A)
  - Genera: → *Mattesia*, → *Schizocystis*, *Lipocystis*, → *Ophryocystis*

### Important Species

Table 1, Figs. 2, 3.

### Life Cycle

Fig. 1.

## Grellia (syn. Eucoccidium) dinophili

Protococcidian within the body cavity of the Archiannelid *Dinophilus gyrocoliatius*. There is no →schizogony, only trophonts grow up to gamonts that form male and female →gametes. After →syngamy, the →oocyst gives rise to sporoblasts (sporocysts) containing the sporozoites.

## Grocer's Itch

Allergic reaction due to contact with dust or harvest →mites.

## Grocott's Modification

→*Pneumocystis*.

## Grooming Behavior

→Behavior.

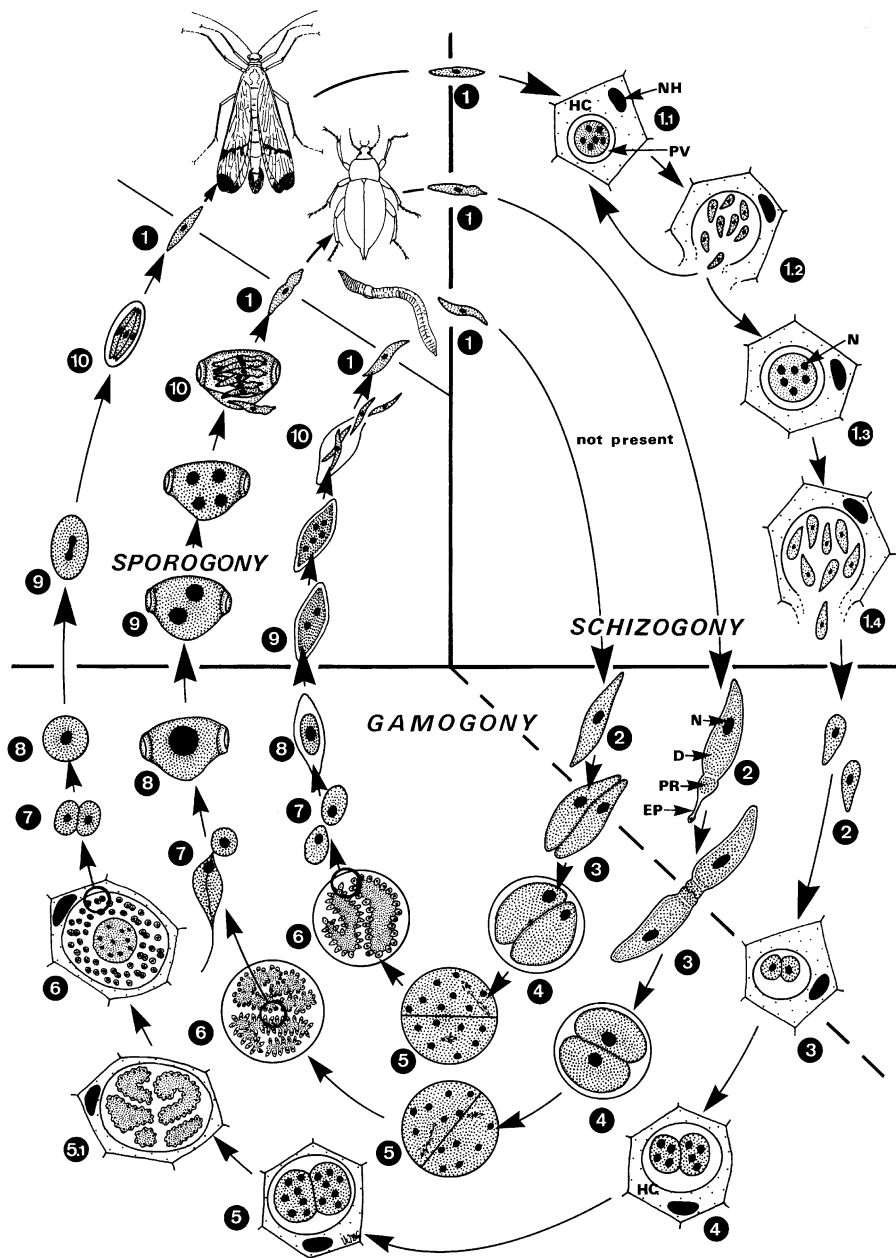

**Gregarines. Figure 1** Life cycle of different types of gregarines. **A** → *Lipocystis polyspora*; the whole development (1–10) takes place within the fat body cells of the scorpion fly *Panorpa communis* (type of schizogregarines). **B** → *Stylocephalus longicollis*; development takes place partly in the gut lumen of the beetle *Blaps mortisaga* (1–4), partly outside the host in its feces (type of eugregarines, Polycystidae, i.e., the gamonts are subdivided, and a septum is present). **C** → *Monocystis agilis*; main development (1–8) takes place within the lumen of the seminal vesicle of earthworms (*Lumbricus terrestris*, etc.), sporogony outside the host (type of eugregarines, Monocystidae, i.e., gamonts have no inner septum). **1** Sporozoites are orally ingested within sporocysts and set free in the lumen of the gut. **A 1.1–1.4** In *L. polyspora* repeated production of differently shaped merozoites occurs by schizogony in the cells of the fat body. **2** Sporozoites (B, C) or merozoites (A) become → **trophozoites** which grow to be gamonts. **3, 4** Pairs of gamonts (B, C) excrete a cyst wall (i.e., form a gamontocyst). In *L. polyspora* the paired gamonts are situated in a → **parasitophorous vacuole** of their host cell. **5–7** After repeated nuclear multiplications many iso- (A, C) or anisogametes are formed, which start fusing and thus lead to numerous zygotes. **8–10** The zygotes are surrounded by a wall and thus obtain their characteristic shapes; they may then be considered as sporocysts, within which 8 sporozoites are finally formed (in all 3 species). New infections of hosts start after swallowing the infectious sporocysts with contaminated food. **D**, deutomerite; **EP**, epimerite; **HC**, host cell; **N**, nucleus; **NH**, nucleus of the host cell; **PR**, protomerite; **PV**, parasitophorous vacuole (for further species see [Table 1](#)).

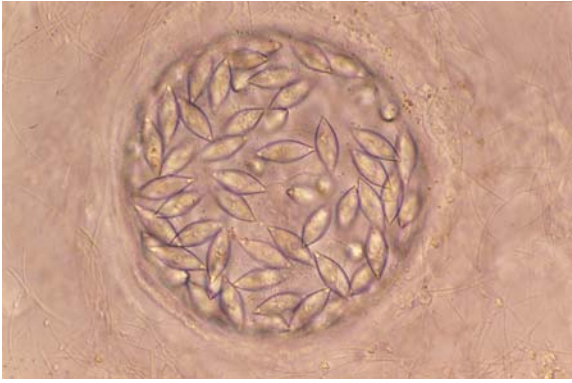

**Gregarines.** Figure 2 Gamontocyst of *Monocystis agilis* (with numerous sporocysts) inside the seminal vesicles of *Lumbricus* annelids (earthworm).



**Gregarines.** Figure 3 Motile gamont of a septate gregarine (*Gregarina polymorpha*) from gut of the flour beetle (*Tenebrio*).

---

## Growth Factors

### General Information

Epidermal growth factor (EGF) and insulin-like growth factor I (IGF-I) stimulate cell proliferation; IGF-I is also involved in metabolic functions. Their corresponding receptors are tyrosine kinases phosphorylating intracellular proteins.

Certainly all parasites living in vertebrate hosts come into contact with growth hormone, growth factors, and cytokines from the host, either circulating in the blood or being locally expressed like e.g., insulin-like growth factor I (IGF-I) in the skin. Cytokines of the host are primarily involved in immune responses whereas growth hormone and growth factors are signalling substances regulating, e.g., differentiation and proliferation in parasites.

### Pathology

Infection with parasites usually changes titres and cytokine profiles in the host, independently of whether →Protozoa or helminths are involved. Interestingly, the infective-stage larva of →*Brugia malayi* produces a cytokine which resembles the host macrophage migration inhibitory factor (MIF) and which is able to modulate the host immune response and to promote parasite survival. Another example of a substance produced by the parasite and mimicking a host hormone is the →plerocercoid growth hormone-like factor from spirometrid →tapeworms. This factor circulates in the blood, binds to the host growth hormone receptor and mimics many of the biological actions of growth hormone.

IGF-I of the host is recognized by *Leishmania mexicana* →vacuoles and →amastigotes and this external host signal is converted into a parasite signal. First, IGF-I binds to both promastigotes and amastigotes, it stimulates growth in both cell types and leads to a rapid tyrosine phosphorylation of parasite proteins. The pattern of phosphorylated proteins is dependent on the developmental stage. In another protozoan parasite, *Trypanosoma brucei*, EGF of the host is able to stimulate growth and to activate the signal transduction cascade in the parasite, leading finally to GTP-hydrolysis via small G-proteins. EGF is active at physiological concentrations. In the same species, bombesin, a peptide hormone from the brain and the gastrointestinal tract, also hydrolyses GTP.

---

## Growth Retardation

The presence of specimens of several species of worms hinders the normal growing of their human or animal hosts: *Ascaris*, *Strongyloides*, *Ancylostoma*, *Necator*, etc.

---

## GSH

### Synonym

→Glutathione.

---

## Gubernaculum

Portion of male copulatory apparatus in →nematodes.

## Guide RNA

Guide RNAs (gRNAs) are small RNA molecules that are encoded in the →mitochondrial DNA of kinetoplastid flagellates. These gRNAs have a template-like function during the →RNA editing process and specify the site and number of uridylyate residue (U) additions to and occasional deletions from precursor mRNA. gRNA sequences have been identified in more than 10 different kinetoplastid species, several hundred kinetoplastid gRNAs have been sequenced, and for some of them secondary structures and 3-dimensional working models have been proposed. The total number of gRNAs varies greatly between species and even between different strains of the same species. The greatest number is found in the trypanosomatids. The →minicircle kDNA contains the majority of the gRNA genes that are localized at specific sites within the variable region. In *Trypanosoma brucei*, each minicircle can encode 3–5 gRNAs, whereas *Leishmania tarantolae* contains only a single gRNA per minicircle, reflecting less extensive editing as compared to the former species. The →maxicircle kDNA also contains a small number of gRNA genes in addition to protein-coding genes, rRNA genes and cryptogenes. *T. brucei* possesses the greatest kDNA complexity with over 200 minicircle classes that can encode more than 1000 different gRNAs.

## Guinea Worm

→*Dracunculus medinensis*.

## Gula

Morphological structure of the Heteroptera (bugs). The head capsule is closed ventrally by a bridge behind the rostrum, so that the rostrum arises not at the hind margin of the head but some distance in front of it. Often the rostrum is brought further forward by a considerable elongation of the head.

## Gyalocephalus capitis

Small strongylid nematodes of equids (male 7–10 mm, female 8–13 mm).

## Gymnophallidae

Trematode family, the members of which mostly occur in birds. Only one genus (*Gymnophalloides*) includes a very small parasite of humans, which may occur in large numbers in the intestine or in the biliary system. This worm is characterized by the peculiarities, that the ventral sucker occurs in the posterior quarter of the body and that many tegumental hooks are formed. Intermediate hosts are marine oyster and clam.

## Gymnophalloides

### Species

*G. tokiensis*, *G. seoi*.

### Morphology

0.5 × 0.3 mm sized trematodes, which are found in the small intestine of birds (oyster catchers) and humans in Korea/Asia. The adults possess a large oral and a small ventral sucker. In addition, there occurs an unique ventral pit, which is situated (as the ventral sucker) in the posterior third of the spiny tegument (with many scales). The first intermediate host is unknown, but oysters are the second one containing the infectious metacercariae. In Korean villages infection rates of up to 46 % were found when diagnosing the thin eggs 25 µm × 15 µm in the faeces.

### Symptoms of Disease

Gastrointestinal troubles, fatigue, weight loss, diarrhoea.

### Therapy

→Trematocidal Drugs.

## Gynandry

From *Greek*: gynandros = bisexual. →Hermaphroditism.

## Gyrocotyle

### Classification

Genus of monozoic →Cestodes.



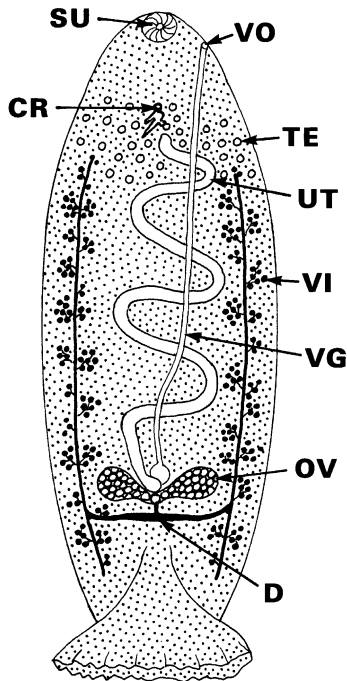

**Gyrocotyle.** Figure 1 DR of the adult monozoic tapeworm *Gyrocotyle* spp. (3 cm) from the stomach and intestine of chimaeroid fish; the characteristics of gyrocotylids are the (not drawn) ruffled body margins and the terminal posterior →rosette; intermediate hosts are unknown. AH, adhesion zone; CR, →cirrus; D, duct of vitelline glands; DB, →dense bodies in the vitelline system; GA, genital atrium (joint pore of UT and VE); OV, ovary; PB, →proboscis; SU, sucker; TE, testes; UO, opening of the uterus; UT, uterus; VD, vas deferens; VG, vagina; VI, →vitelline glands; VO, opening of vagina; Z, interruption (animals are longer).

**Life Cycle**

See also →Gyrocotylidea, →Cestodes/Life Cycle. Fig. 1.

**Gyrocotyle fimbriata**

Cestodarian parasite of chimaeroid fish.

**Gyrocotyle urna**

Species of →Cestodaria (→*Amphilina foliacea*).

**Gyrocotylidea**

→Cestodaria.

**Gyrodactylus**

**Classification**

Genus of →Monogenea.

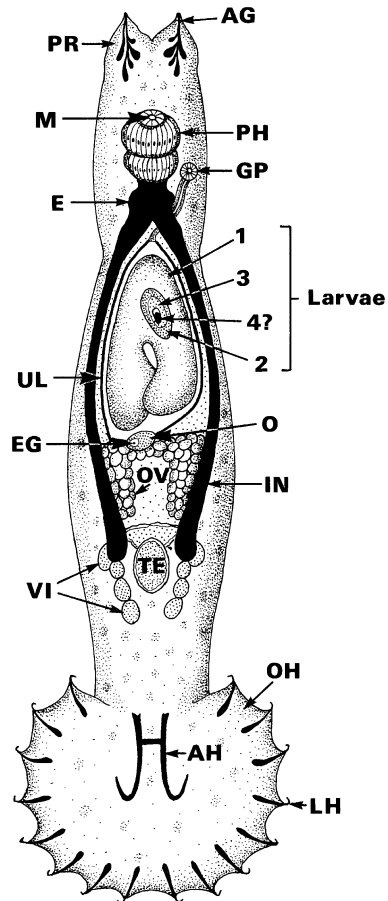

**Gyrodactylus.** Figure 1 Gyrodactylus: Organization of an adult monogenean: *Gyrodactylus* spp. containing several generations which were produced by →polyembryony (i.e., mitotic division of germ cells at a very early stage). AG, adhesion gland; AJ, anchoring central hooks; E, esophagus; EG, egg; GP, genital pore; IN, intestinal branch; LH, lateral hooklets; M, mouth; O, oviduct; OH, →opisthaptor; OV, ovary; PR, →prohaptor; TE, →testis; UL, uterus containing larvae 1–4; VI, vitellary gland (→Vitellarium).



**Gyrodactylus.** Figure 2 SEM of the dorsal side of an attached monogenean fluke (*Gyrodactylus aculeati*).

### Morphology

Fig. 1.

### Reproduction

After copulation a larva develops inside the uterus which is retained until grown up into a functional preadult already containing larvae of the second, third, and eventually fourth generation. This polyembryony (Figs. 1–3) is only poorly understood, but enables the parasite to establish quickly many offsprings on a new host (fish), →Platyhelminthes/Fig. 14.

---

## Gyrodactylus aculeati

→Platyhelminthes/Fig. 14, 17B.



**Gyrodactylus.** Figure 3 LM of an adult *Gyrodactylus* fluke on the skin of a fish. Note that this animal already contains the next 2 generations in its brood chamber.

---

## Gyrodactylus elegans

→Monogenea.

---

## Gyrostigma

Genus of the fly family Gasterophiliidae inducing myiasis in the stomach of rhinos in Tropical Africa.



---

## Habitat

### Name

Latin: *habitare* = dwelling.

This term – often used as a synonym of biotope – is the place/region, where a species lives, e.g., where ecological factors allow survival.

---

## Habitat Selection

### Name

Latin: *habitatio* = dwelling.

Habitat comprises all ecologic factors of the surroundings of an animal (often used as synonym to biotope).

Parasites which actively find and invade their hosts accumulate in favourable habitats, responding to very different environmental stimuli. Short-living stages such as trematode miracidia and →*cercariae* prefer mainly habitats frequented by their potential hosts, whereas many long-living stages such as some nematode infective larvae and →*ticks* primarily select habitats which support their survival. Such stages shift to habitats where an encounter with their hosts is increased when the conditions for their survival are favourable. For mechanisms of habitat selection see →*host finding*, miracidia of →*trematodes*, cercariae of trematodes (→*Digenea*), →*nematodes*, ticks.

---

## Habronema

From Greek: *habros* = fine, *nema* = filament. Genus of →*Nematodes*, →*Stomach worms*.

---

## Habronemiasis, Habronemosis

The larvae of →*Habronema* spp. and *Draschia* (→*Filariidae*) cannot penetrate normal skin. However,

cutaneous invasion and lesions occur when larvae are deposited near open wounds by their vectors. Areas frequently involved include the withers, the lower limbs, the medial canthus of the eye, and the urethral process and prepuce of the male. The gross lesions rapidly become progressive and proliferative in nature, comprising ulcerated tumorous masses of red-brown granulation tissue. The sore is already painful before the development of →*granuloma*. This causes an intense →*pruritus*, and infected animals exacerbate the condition by biting and rubbing the lesion.

### Therapy

→*Nematocidal Drugs, Animals*.

---

## Haemabartonella

Genus of rickettsiales, transmitted by blood suckers.

---

## Haemadipsa

→*Leeches*.

---

## Haemagogus

Genus of mosquitoes, which may transmit the virus of Yellow fever.

---

## Haemaphysalis

### Name

Greek: *haima* = blood, *physis* = bladder; English: Red sheep tick.

## General Information

Genus of hard →ticks comprising worldwide about 150 species (mostly in Africa, South Asia). In West and Middle Europe 3 species occur: *H. punctata*, *H. concinna*, and *H. inermis*. *H. punctata* is a small (female 3–3.5 mm, male 2.8 mm) 3-hosts tick, the adults of which attack sheep, cattle, goats, and horses, cervids, hare, hedgehog, mice. One generation needs about 3 years. This species transmits *Babesia*- and *Theileria* spp. The 2 other European *Haemaphysalis* ticks: *H. concinna* (Relict tick) and *H. inermis* (Winter tick) are of lower importance. On the other hand the tropical species *H. leachi*, which is able to develop all stages within 123 days, is an important vector of diseases in Africa especially of carnivores and ruminants. In America only a few species occur (e.g., *H. leporis* on rabbits).

## Haematobia

Genus of the fly family Muscidae, synonym to *Liperosia* (*L. irritans*) and *Siphona irritans*. *H. irritans* (small meadow biting fly, 3–5 mm long) occurs worldwide, sucks blood up to 20 times per day, and develops 4–5 generations per year. *H. stimulans* (synonym: *Stomoxys stimulans* and *Haematobosca stimulans*) is the so-called large meadow bite fly with a length of up to 7 mm. Its activity is mainly in late summer and autumn. While *H. irritans* practically lives on the host, *H. stimulans* leaves the host for the night. →Ectoparasiticides.

## Haematobia irritans

Small biting fly (3–5 mm), which occurs worldwide and appears grey, green-brown, or black with brown legs. It feeds up to 20 times per day at cattle sitting head down. The larvae develop in faeces of cattle – in Europe up to 5 generations occur (→Tabanids/Fig.1). Related species are *Haematobia (Stomoxys) stimulans* = large biting fly (5–7 mm), *Hydrotaea irritans* (head and udder fly (5.5–7 mm), and →*Stomoxys calcitrans*.

## Haematoloechus

### Life Cycle

→*Prosthogonimus macrorchis*/Fig. 1.

## Haematoloechus medioplexus

→Digenea, →*Prosthogonimus macrorchis*/Fig. 1.

## Haematophagous Animals

### Name

Greek: *haima* = blood, *phagein* = feeding.

Arthropods (→Insect), →Leeches, →Vampire Bats, →Vampire Fish that feed blood at the surface of their host.

## Haematopinus suis

### Name

Greek: *haimo* = blood, *pinein* = drinking.

This is the louse of pigs. The females measure 4–6 mm in length, the males are only 3.5–4.7 mm in size (Fig. 1). Their body appears brown and the neck is rather long. The eggs (1 mm) become glued at the hair. The whole development takes 20–26 days. The females lay about 60 eggs. Besides pigs also man is attacked. Related species are *Haematopinus eurysternus* (cattle), *Haematopinus asini* (horses, donkeys). →Lice.

### Therapy

→Ectoparasitocidal Drugs.



**Haematopinus suis.** Figure 1 Two swine lice (*Haematopinus suis*) – note the rather long and slender neck.

## Haematopota

→Diptera (Tabanids).

## Haementeria

Giant leech, which may grow up to 30 cm. →Leeches.

## Haemodipsus

Genus of lice of rabbits and hare (female 1.5 mm, male 1.2 mm). *H. ventricosus* (Fig. 1) and *H. lyriocephalus* may transmit of agents of tularaemia.

## Haemodipsus ventricosus

→Lice.

## Haemoglobinopathies

Defects of haemoglobin formation such as HbS, HbE, HbF, HbC, G 6 PD-deficiencies or  $\lambda$ -thalassaemia reduce or hinder the growth of →*Plasmodium falciparum* and thus provide some resistance to malaria.

## Haemoglobinuria

Urine appears bloody, symptom in infections with babesial and malarial diseases.

## Haemogregarina

→Apicomplexa, →Coccidia.

## Haemolysis

Lysis of red blood cells, symptom of infection with →*Babesia* species.

## Haemonchosis

Haemonchosis is a common and severe disease of the ruminant abomasum in many parts of the world. →*Haemonchus contortus* infects mainly sheep and goats, while *Haemonchus placei* occurs mainly in cattle. The pathogenesis of *Haemonchus* infection is the result of →anaemia and hypoproteinaemia caused by the bloodsucking activity of the parasite. Large

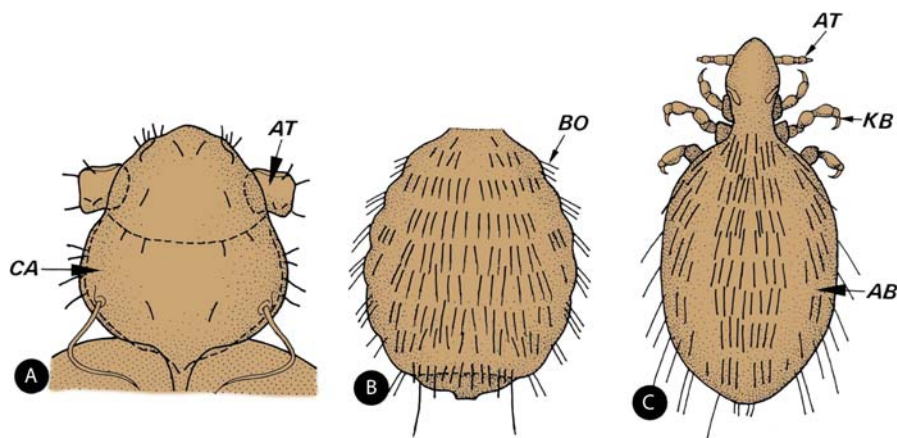

**Haemodipsus.** Figure 1 DR of the characteristics of the rabbit louse *H. ventricosus* (A, B) and the hare louse (*H. lyriocephalus*, C). A head of ♂; B abdomen of ♀; C female; AB, abdomen; AT, antenna; BO, spines; CA, caput, head; KB, leg with claws.

numbers of *Haemonchus* administered to sheep cause changes resembling those occurring in →*ostertagiosis*, including rises in abomasal pH and increased plasma pepsinogen. However, the latter 2 effects do not contribute to the spontaneous disease. The following description is mostly based on studies on ovine haemonchosis. The hyperacute form occurs in animals exposed over a short period of time to thousands of parasites, and is rare. The animal bleeds to death within a week, losing 200–600 ml of blood/day. In many cases there are no preliminary signs and death is sudden. In others there is an extreme anaemia and black faeces. Death occurs before compensatory erythropoiesis can take place, within 7 days. In the acute disease animals of all ages show anaemia, bottle jaw, and dark faeces. There are conflicting reports as to whether →*anorexia* occurs and it has even been reported that sheep eat more than they normally do. Animals lose weight, are weak and lethargic, and lose wool. Ewes suffer agalactia, so that their lambs may become emaciated and die from malnutrition. The anaemia of acute haemonchosis develops in 3 phases. The first phase which occurs during the pre-patent period is characterized by a fairly dramatic fall in packed cell volume, although serum iron at this stage is normal. This is considered to be the result of blood loss caused by immature worms, at a time when the haemopoietic system of the host is not fully mobilised to compensate it. In the second stage (from about 1–2 months) the packed cell volume does not decrease any further, because of the mobilisation of the haemopoietic system and the high serum iron concentrations. However, since the capacity of the sheep infected with *H. contortus* to reabsorb haemoglobin iron is limited, the iron reserves rapidly become depleted, which progressively leads to the third stage of the anaemia i.e., a low serum iron accompanied by a marked drop in packed cell volume. This indicates a dyshaemopoiesis due to iron deficiency and possibly to reduction in the availability of amino acids. →*Hypoalbuminaemia* occurs. Chronic haemonchosis may last for 2–6 months. Only a few adult worms (100–1,000) can cause a seepage of blood into the abomasum accounting at most for 50 ml/day. Anaemia is not present as compensatory erythropoiesis takes place, which depletes serum iron. The animal looks malnourished, with progressive loss of weight and wool-peeling in adult animals, and stunting of growth in lambs. The condition is aggravated by poor quality grazing as occurs in Africa and other tropical regions. A marked anaemia develops in terminal cases when iron and protein for erythropoiesis are depleted.

### Therapy

→*Nematocidal Drugs, Animals*.

## Haemonchus contortus

Trichostrongylid nematode of ruminants (Figs. 1, 2) of 20–30 mm in length (female). →*Nematodes*, →*Trichostrongylidae*/Fig. 1.

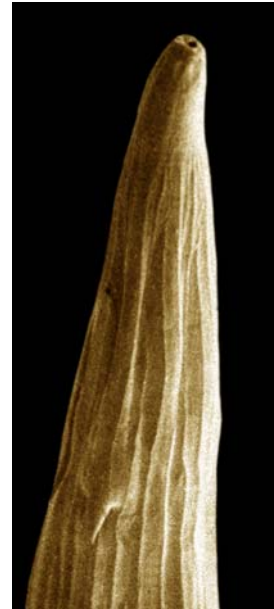

**Haemonchus contortus.** Figure 1 SEM of anterior end of *Haemonchus contortus*. Note the presence of a lateral hooklet at the cuticle.

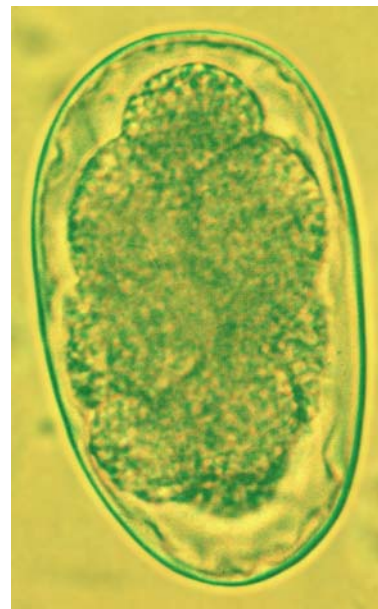

**Haemonchus contortus.** Figure 2 LM of an egg of *Haemonchus contortus* after M.I.F. concentration.

**Disease**

→ [Haemonchosis](#).

**Haemopsis sanguisuga**

→ [Leeches](#).

**Haemoproteus**

Genus of coccidian blood parasites of reptiles and birds (e.g., *Haemoproteus columbae*). Vectors are louse flies (→ [Hippoboscidae](#)) or midges (→ [Culicoides](#)). The schizogony occurs inside endothelial cells of the blood vessels, while the gamonts are found in red blood cells. In general there are low or no clinical symptoms of disease.

**Haemoproteus columbae**

Parasite of red blood cells of doves ([Figs. 1, 2](#)), *H. nettionis* is found in ducks, geese, *H. meleagridis* in

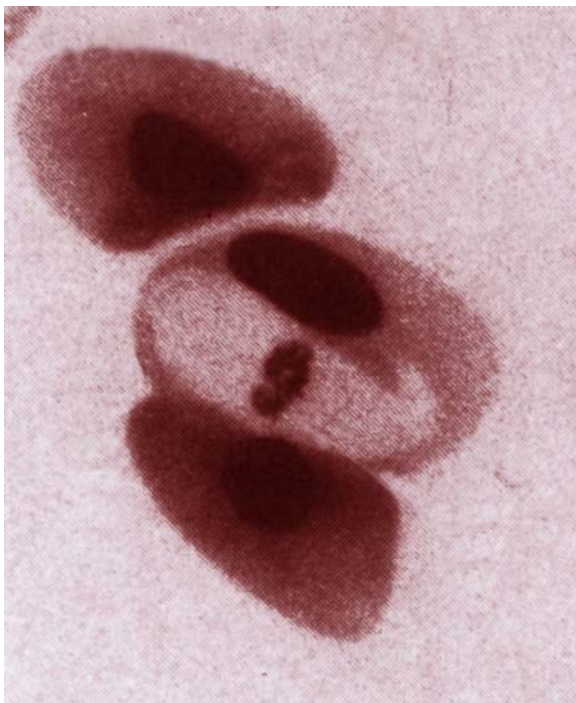

**Haemoproteus columbae.** **Figure 1** Blood smear of a gamont inside a red blood cell.

turkeys. Vectors are louseflies, → [Pseudolynchia canariensis](#) (= syn. *Lynchia maura*). Symptoms of disease are described as pseudomalaria.

**Prepatent period:** 4–5 weeks, → [Malariaicidal Drugs](#).

**Haemoptysis**

Sputum contains blood due to lung lesion in → [Paragonimus](#) infections and/or tuberculosis.

**Haemorrhagic Effects**

From Greek: *rhegnymie* = disrupt. Symptom of many parasitosis, when blood vessels become destroyed; e.g., → [sarcosporidiosis](#).

**Haemosporidia**

→ [Apicomplexa](#).

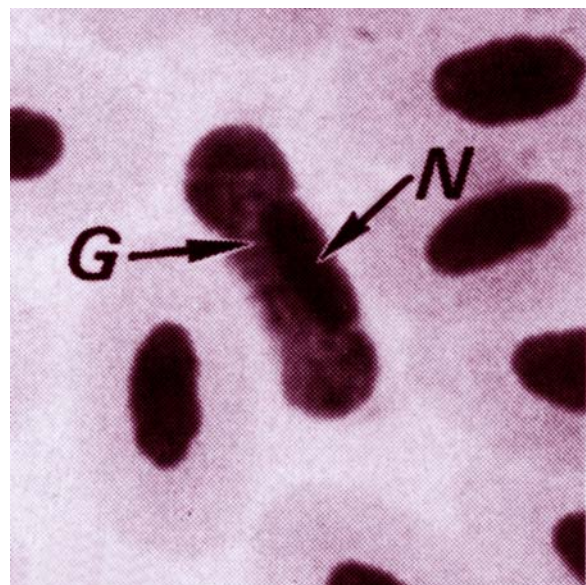

**Haemoproteus columbae.** **Figure 2** LM of a smear preparation of a gamont of *H. columbae* in the nucleated erythrocytes of a dove. G, gamont; N, nucleus of the parasite.



## Haemozoin – Protein Complex

→ *Plasmodium* degrade haemoglobin into such a complex appearing brown-black as pigment.

## Halicephalobus

### Name

Greek: *hyalinus* = transparent, clear, *kephalon* = head, *lobos* = lobe.

### Synonym

*Micronema*.

### General Information

Genus of free-living → *nematodes* of the family *Cephalobidae*, which are related to the members of → *Rhabditidae*. Some species such as *H. delectrix* (Latin: *delectio* = destruction), however, are able to penetrate the skin of vertebrates or enter them via food (as larvae or adults). The described, fully proven cases include horses, cattle, rabbits, and (even more rare) humans. In horses, brain, lung, ocular, and renal infections, granulomatous posthitis are described, while mastitis was found in addition, in cattle. Another species of horses is *H. gingivalis*. Up to now only females were found reaching a length of only 0.5 mm, while the larvae on the soil reach 120–220 μm, when hatching from the 40 × 12 μm sized eggs. All stages possess a rhabdoid oesophagus.

### Therapy

Ivermectin, → *Nematocidal Drugs*.

## Haller's Organ

Housing some of the tick's olfactory chemoreceptors, it is part of the sensory structures on the dorsal surface of the tarsi on leg one of → *ticks* (Fig. 1, → *Ticks/Host Recognition*).

This organ (Figs. 1, 2) consists of several units:

1. **posterior capsule:** except for *Ixodes ricinus* and a few others it is covered and exposed only via a small slit.

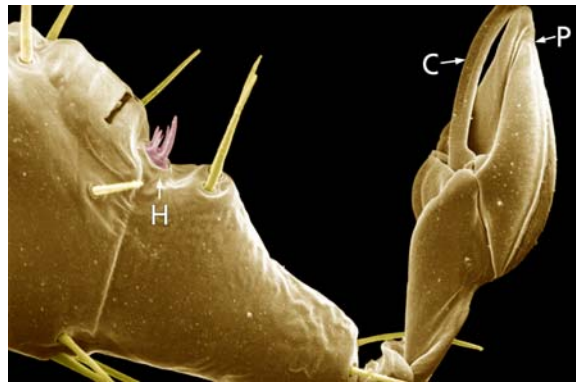

**Haller's Organ.** Figure 1 SEM of the first right leg of *Ixodes ricinus* showing the external structures of the Haller's organ (H) and one claw (C) and the pulvillus (P).

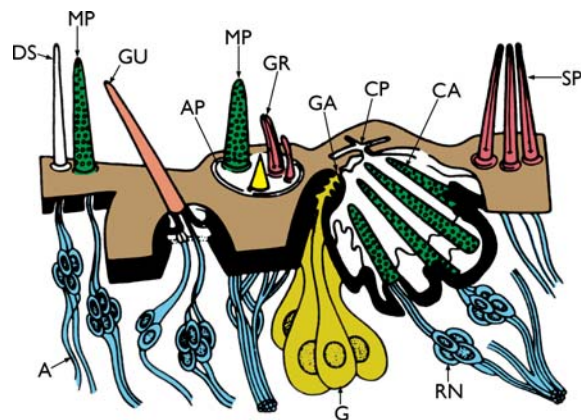

**Haller's Organ.** Figure 2 Diagrammatic representation of the arrangement of the sensilla in the Haller's organ of an ixodid (redrawn and modified after Sonenshein 1991). *A*, axons; *AP*, anterior dorsal pit; *CA*, capsular sensillum; *CP*, capsular aperture; *DS*, distal precapsular sensillum; *G*, gland; *GA*, gland's aperture; *GR*, grooved sensillum; *GU*, gustatory hair; *MP*, multiporose sensillum; *RN*, receptor neurons; *SP*, sensilla of posterior capsule.

2. **anterior pit,** which represents a depression located distal to the posterior capsule, surrounded by a cuticular fold and containing a small number of sensilla.

Small groups of olfactory sensilla (slightly posterior to the capsule and distal to the anterior capsule) apparently also function in the same way as the sensilla of the Haller's organ (Figs. 1, 2).

The composition and number of the sensilla involved are genus- and species-specific, thus explaining that different ticks react differently onto host attractants and repellents.

## Halofantrine

→ Malariacidal Drugs.

## Halofuginone

→ Theileriacidal Drugs.

## Halzoun Syndrome

Disease in humans due to infection with the dog pentastomid worm → *Linguatula serrata*, which block the nasal pathways and may thus introduce → oedema and unfeelingness of head regions.

**Main clinical symptoms:** Oedema, disturbances of organs.

**Incubation period:** 7 days to months.

**Prepatent period:** 6–7 months.

**Patent period:** 15 months.

**Diagnosis:** Microscopic determination of worm eggs in nasal mucus (Fig. 1).



**Halzoun Syndrome. Figure 1** LM of a pentastomid worm (*Linguatula*).

**Prophylaxis:** Avoid contact with dogs in tropical regions.

**Therapy:** Provocation of sneezing, mechanical withdrawal of the worms.

## Hamilton and Zuk Hypothesis

In 1982, Hamilton and Zuk published a paper whose consequences in the world of parasitologists and ecologists were considerable. It is well known that, in certain animal species, there is a marked dimorphism in size, ornamentation, and colours between males and females. This is the case especially in birds (although not only in them), where males are often brightly coloured and compete for females through complicated parades. Darwin explained → **sexual dimorphism** by natural selection: if there is a genetic diversity in, for instance, the length of feathers in males, and if females mate preferentially (sexual selection) with the males which have the longest feathers, then the genes responsible for long feathers increase their frequency in the population. If the genetic diversity of feather length is continually renewed, there is a runaway process which leads to extravagant ornamentation like that of pheasants and paradise birds.

This explains the possible mechanism of sexual selection, but it does not say why sexual selection exists. There are at least two difficulties: one is that these processes do not exist in all species (for instance, male and female magpies and many other birds look the same); another is that a price has to be paid for extravagant ornamentation (there is a metabolic price for constructing them and the bright colours make birds more prone to predation).

The Hamilton and Zuk hypothesis states that the brightness of colours and the quality of parades provide females with an indication of the “quality” of males, especially of their ability to resist parasites. The idea is that, if the male of a given species is brightly coloured, it may develop these colours fully only if it possesses resistance genes to parasites. The “interest” of the female to mate with such a resistant male is to associate her own genes with “good genes,” thus giving her offspring the best chance of survival. If the hypothesis is correct, there must be a positive correlation between the mean parasite load of a species and the degree of sexual dimorphism. Since Hamilton and Zuk published their article, a number of studies (comparative analyses and experiments) have tried to confirm or to contradict the hypothesis. Logically, the more a species harbours parasites, the more the cost of extravagant colours and ornamentation is compensated by the benefits of sexual selection. In other words, being bright and colourful is meaningful only if selection of resistance genes is necessary.

The hypothesis has been the subject of many controversies, some authors being very negative. More than 20 years after the publication of Hamilton and Zuk's article, it seems that a majority of surveys and comparative analyses demonstrate that the hypothesis is at least partly correct.

---

## Hammond, Datus (1911–1974)

American protozoologist, Logan, Utah.

---

### Hammondia hammondi

→*Coccidia*; final hosts are cats (like in →*Toxoplasma gondii*), however, the life cycle includes obligatorily intermediate hosts (such as mice, rats, pigs, goats, hamsters, dogs). *Toxoplasma*-like tissue-cysts (Figs. 1, 2) occur.

#### Therapy

Not needed since apathogenous to most hosts.

---

### Hammondia heydorni

Tissue-cyst-forming species of the →*Coccidia*. Final hosts are dog, fox, or coyote, intermediate hosts may be cattle, sheep, goat, rodents, etc, which shed small ovoid oocysts (Fig. 1). This nonpathogenic species is probably identical with →*Neospora caninum* (being a pathogenic strain).

---

### Hammondiosis

Disease due to →*Hammondia*, mostly symptomless. →*Neosporosis*.

#### Chemotherapy

→*Coccidiocidal Drugs*.

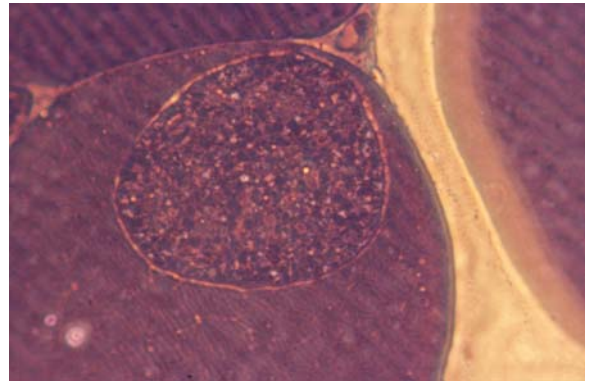

**Hammondia hammondi.** Figure 1 LM of a section through a muscle fiber of a mouse containing a cyst of *Hammondia hammondi*.

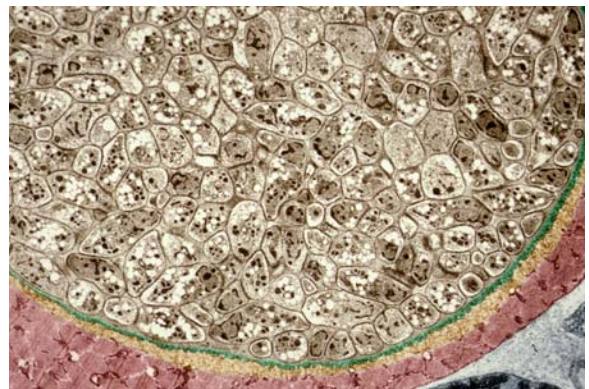

**Hammondia hammondi.** Figure 2 TEM of a section through the cyst depicted in Fig. 1.



**Hammondia heydorni.** Figure 1 Sporulated oocyst of *Hammondia heydorni* with 2 sporocysts.

## Hanging Groin

Symptom due to infection with → *Onchocerca* worms. Chronically enlarged lymph nodes may introduce a “mild local elephantiasis” due to superficial water influx.

## Hannemannia

Genus of mites of amphibia.

## Haplobothriidae

Family of cestodes in freshwater fish (e.g., genus *Haplobothrium globuliforme* of bowfin = *Amia calva*). These species are unique because they appear as intermediate forms between → *Pseudophyllidea* and → *Trypanorhyncha*, since their bothria are located at the tips of 4 tentacle-like projections known as proboscides.

## Haplometra cylindracea

This is a rather common plagiorchiid digenetic trematode in the lungs of frogs already known since 1800 (cf. → *Paragonimus* species of humans).

## Haplorchis

Genus of trematode flukes of the family Heterophyidae, which rarely may also occur in the intestine of humans. → *Heterophyes*.

## Haplosporidia

Group of parasites probably belonging to a known phylum of Protozoa, mostly parasitizing clams (e.g., *Haplosporidium armoricum* = *Minchinia armoricana* is found in clams such as *Ostrea edulis*). Recently they were included into protozoan phylum → *Alveolata*.

## Haplosporidium nelsoni

Microsporidian of the American oyster, formerly named → *MSX-body*.

## Happening

→ *Mathematical Models of Vector-Borne Diseases*.

## Hapyrhynchus

*H. nidulans* (syn. *Sarcopterinus nidulans* is a small mite that lives inside the feather shaft of doves and other birds (Fig. 1). → *Syringophilus*.

## Hardy-Weinberg Equilibrium

→ *Population Genetics*.

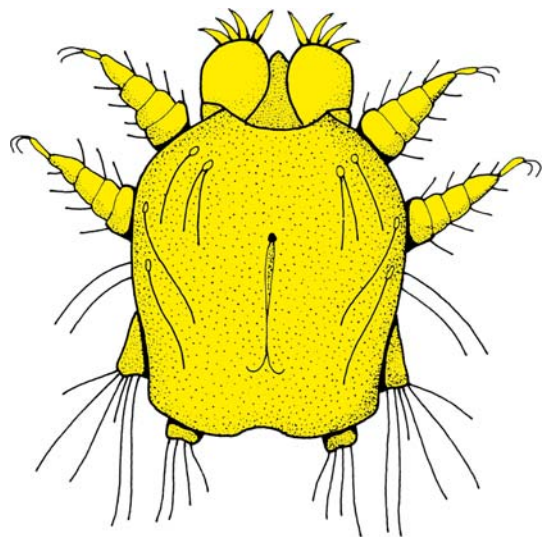

**Hapyrhynchus.** Figure 1 Adult male of *H. nidulans* (syn. *Sarcopterinus*).

## Hartmanella

Genus of opportunistic →[amoebae](#). *Hartmannella vermiformis* caused several human cases of fatal central nerve system disease.

## Harvest Mite

→[Neotrombicula autumnalis](#).

## Haustellum

From Latin: *haurire* = take away; feeding apparatus of dipteran and hemipteran bloodsuckers.

## H-Cell

→[Nematodes/Excretory System](#).

## Health Education

→[Disease Control, Methods](#).

## Heart-Lung-Trachea Passage

→[Ancylostoma](#), →[Ascaris/Life Cycle](#).

## Heartwater

The significance of some rickettsial diseases is difficult to assess. This applies particularly to heartwater, a disease of domestic ruminants caused by →[Cowdria](#) (syn. *Ehrlichia*) [ruminantium](#), which is transmitted by all

African species of →[Amblyomma](#) found on susceptible hosts. Experimentally, it is also transmitted by the American *A. maculatum*, too, and the disease's recently discovered presence on Guadeloupe and other Caribbean islands (where *A. variegatum* has been introduced from Africa) poses a severe threat to the cattle and sheep industries in tropical and subtropical mainland America. Heartwater is an acute disease in susceptible animals such as introduced *Bos taurus* cattle but is less apparent in endemic situations which exist in most of sub-Saharan Africa. After an →[incubation period](#) of 1–5 weeks following the bite of an infected tick, the first clinical signs are a rise in temperature to over 40°C; in many cases, few other signs appear until shortly before death. →[Hypersensitivity](#) and other nervous symptoms appear during the latter stages of the disease, culminating in central nervous effects. Many animals recover without showing any symptoms beyond fever. Definitive diagnosis is usually only possible at post mortem by demonstrating the causative organism in Giemsa-stained smears of brain tissues. Gross lesions commonly seen are pulmonary oedema, hydropericardium (from which the disease has its name), hydrothorax, and ascites. The mode of transmission may be through regurgitation of the midgut contents by the tick, but this has not been demonstrated. A crude and fairly inefficient form of immunization is available.

### Therapy

Treatment is possible through tetracyclines, but frequently not practically possible because of inadequate diagnostic resources.

## Heartworm

### Synonym

→[Dirofilaria immitis](#).

### Disease

→[Cardiovascular System Diseases, Animals](#).

## Heartworm Disease

→[Dirofilaria immitis](#), →[Cardiovascular System Diseases, Animals](#).

## Heat Shock Proteins

A family of ubiquitous polypeptic proteins also produced by parasites. Here they protect against stresses interacting with the host's immune system. The 70-kDa heat shock protein of *Toxoplasma gondii* (HSP 70) is able to allow tachyzoite production and cyst formation in rather virulent strains, while the specimens of apathogenic strains (without formation of HSP 70) will be killed by macrophages. In *Plasmodium falciparum* HSP genes are found on →chromosomes 7 and 8 (→Toxoplasmosis, Animals, →Toxoplasmosis, Man).

## Hectospylla

Genus of fleas (e.g., *H. psittaci* of birds), from Greek: *hektos* = attach, *psylla* = flea.

## Heleidae

Other name →Ceratopogonidae.

## Heligmosomoides polygyrus

Fig. 1, →Behavior, →Nematodes.

## Heligsomum

Genus of nematodes with about 17 species parasitic in rodents.

## Helminth

### Synonym

Worm, from Greek: *helminthos*.

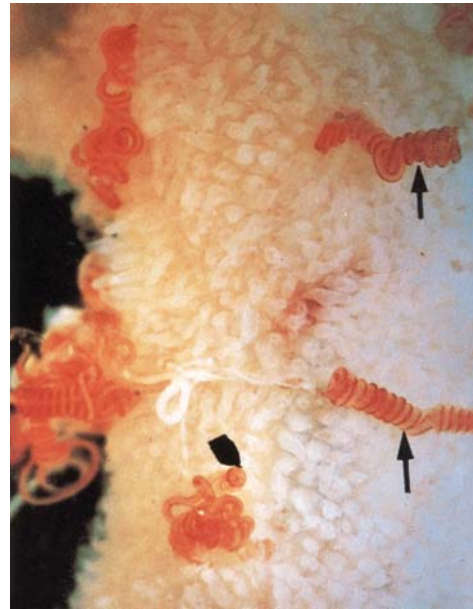

**Heligmosomoides polygyrus.** Figure 1 Photo of several adult worms being anchored in the intestinal wall of a mouse. The arrows point to the twisted posterior ends.

→Annelida, →Acanthocephala, →Platyhelminthes, →Cestodes, →Trematodes, →Nematodes, →Pentastomida, →Leeches.

## Helminthic Infections, Pathologic Reactions

Lesions and inflammatory reactions accompanying →helminth infections are particularly complex and variable. Immunity against these large organisms is generally less effective than against protozoans and part of a worm's life cycle may be spent in an immunologically privileged state, as with the adult schistosomes, or in a privileged site, as with the helminths living in the lumen of the intestine. Because of the more prolonged infections with schistosomes, and the release of eggs over a long period of time, the histologic reaction to a recently arrived egg can often be seen side by side with reactions to eggs that have been present for a long time as shown by granulomas destroyed eggs and fibrosing (→Pathology/Fig. 1A-D). One of the hallmarks of the defense against helminths is the eosinophilic granulocyte which is toxic to many worms. This is accompanied by an acidic lysophospholipase of a molecular weight of 13,000 with a free sulfhydryl group which may crystallize as Charcot-Leyden crystals (→Pathology/Fig. 3B). These crystals have been obtained not only

from eosinophils but also from basophils. The role of the latter cells has been studied less frequently than that of the eosinophils. Because basophils and tissue mast cells require special staining for their demonstration, such as Alcian blue at pH 0.5, and are not shown on routine histologic sections, little is known of the role of basophils in the inflammatory and possibly defensive reaction against helminths. More information is available about their participation in the [→inflammatory reaction](#) evoked by [→ticks](#).

## Helper-Cells

T = cells (Th1, Th2) belong to the group of T-lymphocytes. Their response informs the B-lymphocytes and thus initiates the formation of antibodies or via other signals the activation of interleukines.

## Hematuria

### Name

Greek: *haima* = blood, *uron* = urin.

Symptom of infection with [→Schistosoma haematobium](#), [→pathology](#).

## Heme Polymerase

[→Hemozoin](#).

## Hemelytron

Forewing of Heteroptera (bugs) consisting of a hard and membranous (hind) region.

## Hemiclepsis marginata

Leech that reaches a length of up to 3 cm, sucks at the surface of fishes. Its mouth sucker is heart-shaped (upside down).

## Hemidesmosome

Asymmetric (half-side) arrangement of desmosomes to be used for attachment of cells at different surfaces (e.g., [→undulating membrane](#) of trypanosomes).

## Hemimetabolous Development

In some orders of parasitic insects (e.g., [→lice](#), [→bugs](#)) the larvae hatching from eggs are very similar to the adults ([→Imago](#)) except for the absence of functional gonads and wings, if these are present at all in adults ([→Bugs/Fig. 1](#), [→Lice/Fig. 2](#)). Furthermore these types of larval instars, which are generally called nymphs, feed mostly in the same way as the adults. During growth several molts ([→Ecdysis](#)) occur, the number of which varies between species. The last [→ecdysis](#) during this gradual development leads to mature and fertile adults, which soon start reproduction.

## Hemiptera

### Synonyms

[→Bugs](#), [→Rhynchota](#).

## Hem(oglobin) Interaction

### Mode of Action

[Figs. 1, 2](#).

### Structures

[Fig. 3](#).

### Artemisinin and -derivatives

#### Important Compounds

Dihydroartemisinin, Artemether, Arteether, Artesunate, Bicyclic trioxanes, Tetraoxanes, Tricyclic trioxanes, 11-alkyl,12-deoxy artemisinins, Arteflene.

### Synonyms

Artemisinin: Qinghaosu.

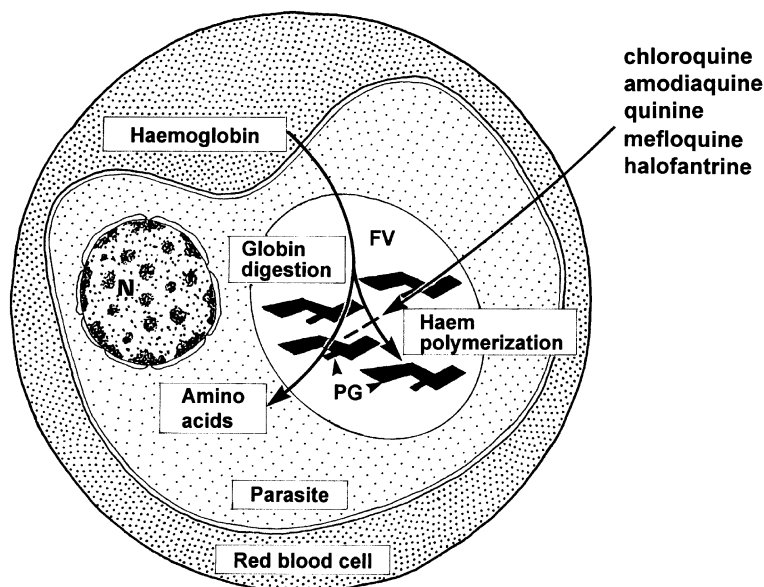

**Hem(oglobin) Interaction. Figure 1** Model of the formation of the noncovalent heme-chloroquine complex (Gutteridge (1993) In: Cox FEG (ed) *Modern Parasitology*, 2nd edition, Blackwell Science, pp. 219–242).

Combination: Artemether/Lumefantrine (Riamet<sup>®</sup>, Coartem<sup>®</sup>).

### Clinical Relevance

Artemisinin has been used so far for the treatment of malaria in at least 3 million people. The advantage of this drug is its rapid action against [→cerebral malaria](#) ([→Malaria](#)).

Artemisinin is isolated from the plant *Artemisia annua* and was originally developed in China. It is chemically related to 1,2,4-trioxanes. Among artemisinin and the so-called first generation compounds are esters or ethers obtained from the lactol, dihydroartemisinin.

The rediscovery of quinghaosu (artemisinin) in China in 1972 and the subsequent synthesis of artemether and artesunate have provided highly effective alternatives to quinine. The artemisinin derivatives are today the most rapidly acting and potent of all the antimalarial drugs. They can be given once daily and are safer and easier to administer than quinine. Artesunate or artemether given orally are an essential component of the combination treatment of uncomplicated falciparum malaria, which is now accepted as the treatment of choice. In the treatment of severe malaria, intravenous artesunate is more rapidly acting in terms of parasite clearance and simpler to administer compared to quinine. Mortality on artesunate recipients was 15% compared to 22% in quinine recipients with severe malaria. In addition, artesunate treatment was well tolerated, while quinine treatment was accompanied with hypoglycaemia. The combination artemether/lumefantrine (Riamet<sup>®</sup>, Coartem<sup>®</sup>) is not suitable for prophylaxis but

is recommended for stand-by self-medication. The dosage is 80 mg/ 480 mg (= 4 tablets) initially, followed by further 4 tablets after 8 hours, and 4 tablets two-times daily on days 2 and 3 (in total 24 tablets).

The antischistosomal effect of artemether and other artemisinin derivatives has been described in the 1980s. During 1994 and 1996 seven large-scale clinical trials had been conducted in China showing 85% protection against *Schistosoma japonicum* infections, if the drug is taken every two weeks starting before the first contact with water containing infected snails. Thus, artemether can be used for prophylaxis against schistosome infections ([→Membrane-Function-Disturbing Drugs/Table 2](#)). Effects against *S. mansoni* and *S. hematobium* infections have been shown in laboratory experiments. Successful clinical trials against these two species have been conducted in Africa in the late 1990s. The combination of praziquantel and artemether would be effective against all stages of schistosomes. Praziquantel acts primarily against adult worms and artemether against juvenile stages. This approach is in clinical trial in China, Egypt, and the Philippines.

### Molecular Interactions

Artemisinin is characterized by its new structure and new [→mode of action](#) unrelated to any other known antimalarial drug. Indeed, there is no cross-resistance against any of the known antimalarials. The activity of artemisinin and its derivatives is directed only against erythrocytic schizonts (Fig. 2). High drug concentrations are detectable in the region of membranes of



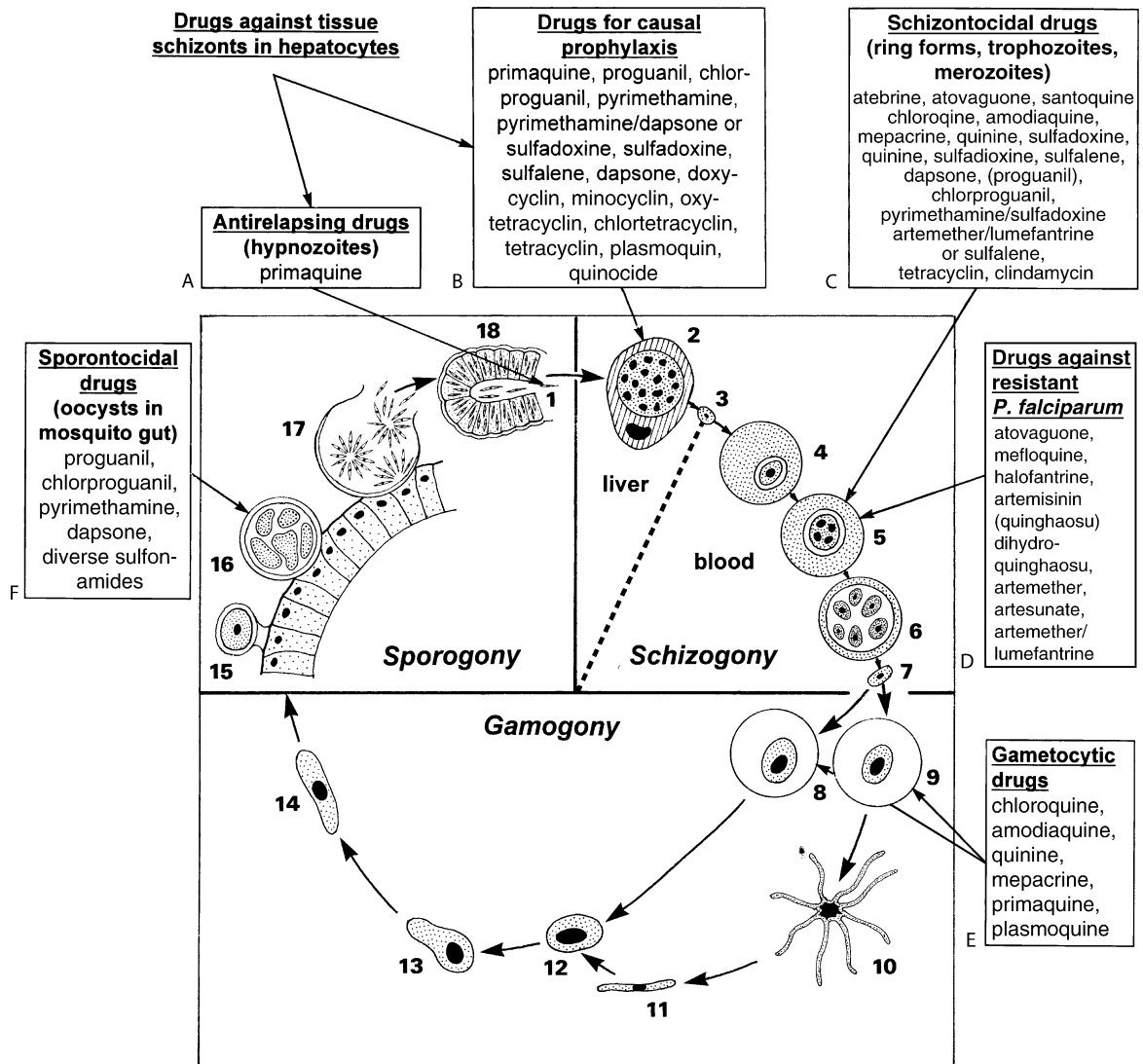

**Hem(oglobin) Interaction. Figure 2** Action of antimalarial drugs on life cycle stages. For life cycle details see the legend → [Plasmodium/fig. 2.](#)

intraerythrocytic → **trophozoites**. There are also other measurable artemisinin-induced metabolic alterations: an interference with the energy production, a reduction of → **DNA synthesis**, an inhibition of mRNA polymerase activity, and an inhibition of purine synthesis in *Plasmodium berghei* at the level of inosine monophosphate dehydrogenase.

The mode of action proceeds in two different steps. In the first step the endoperoxide bridge is cleaved (Fig. 4). This reaction is catalyzed by intraparasitic iron and heme, and leads to the generation of unstable free radical intermediates. The selective toxicity of artemisinin against malaria parasites is presumably due to this iron catalyzed generation of free radicals, and this is favored by the fact that just these intraerythrocytic parasitic stages are rich in iron and heme. In the second

step of the reaction, specific malaria proteins with molecular masses of 25, 32, 42, 50, 65, and >200 kDa become alkylated. These alkylation reactions take place in parasitic ring forms and trophozoites. Proteins of uninfected red blood cells or of infected red blood cells pretreated with the inactive derivative desoxyartether are not alkylated. Structure activity relationships of various tricyclic trioxanes reveal that certain rings in artemisinin are redundant. Thus, the high artemisinin-like activity is due to the structurally minimal bicyclic trioxane. A rapid rearrangement of active bicyclic trioxanes and spirocylane ring is induced by ferrous chloride.

It was recently reported that artemisinin may be involved in specific inhibition of plasmodial cysteine protease activity responsible for about 30% of hemoglobin degradation by *Plasmodium yoelii*.

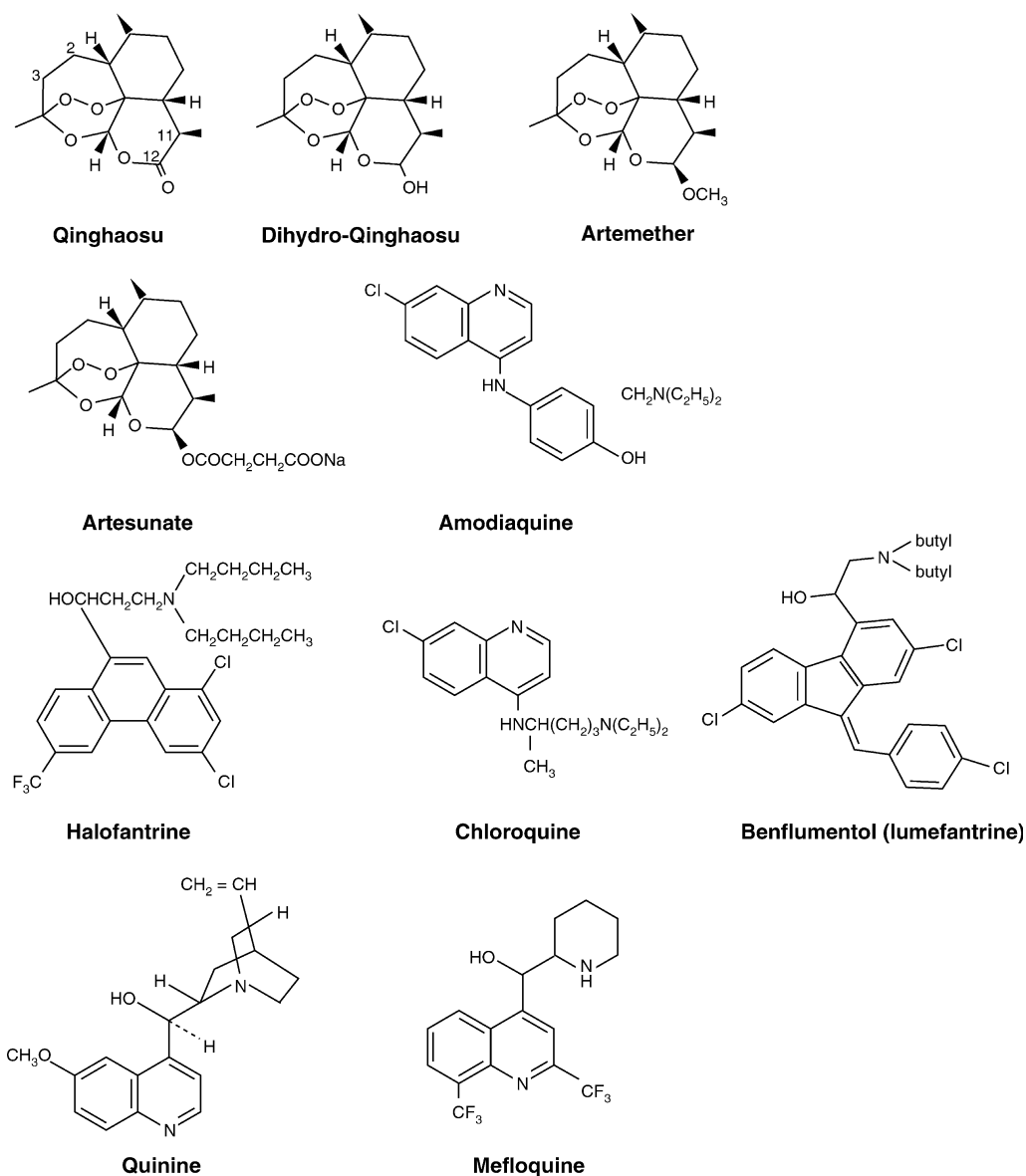

**Hem(oglobin) Interaction. Figure 3** Structures of antiparasitic drugs affecting hem degradation.

### Resistance

So far there are no reports about resistance against artemisinin or its derivatives. However, the clinical trials of artemether and artemether-benflumetol have led to the observation that artemisinin is able to induce drug metabolizing enzyme and, thus, may contribute to its own clearance.

### Amodiaquine

#### Synonyms

4-((7-chloro-4-quinolinyl)amino)-a-(diethylamino)-o-cresol, SN10751.

### Clinical Relevance

Amodiaquine was invented between 1941 and 1945 as an antimalarial drug and was introduced in 1975. Its antimalarial activity is comparable to that of chloroquine.

### Molecular Interactions

Amodiaquine is a member of the 4-aminoquinolines with an activity which is directed against erythrocytic schizonts and gametocytes of plasmodia (Fig. 2). Amodiaquine serves as a prodrug, which is converted to desethylamodiaquine responsible for the antimalarial activity. The mechanism of action is presumably identical to that of chloroquine (Fig. 1).

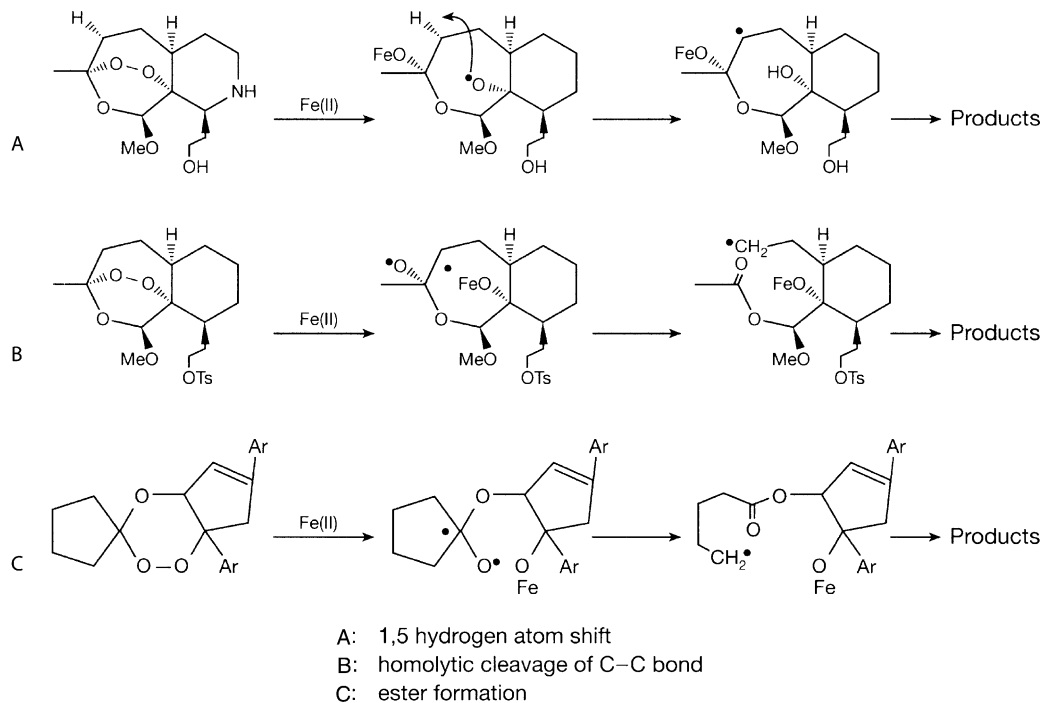

**Hem(oglobin) Interaction. Figure 4** Cleavage of the Endoperoxide Bridge of Artemisinin by Hem-Iron (Meshnick SR, Jefford CW, Posner GH, Avery MA, Peters W (1996) *Parasitol Today* 12: 79–82).

## Resistance

The mechanism of resistance against amodiaquine is also presumably identical to that against chloroquine which is assumed to be due to an impaired uptake mechanism. This is supported by the appearance of a general cross-resistance between amodiaquine and chloroquine. There are also a few hints of amodiaquine activity against chloroquine-resistant *Plasmodium* strains but in general resistance with this drug is no problem.

## Halofantrine

### Clinical Relevance

Halofantrine was developed within the Walter Reed Army Institute for Research (WRAIR) antimalarial drug development program in 1984. It had been introduced in 1988. However, because of severe cardiovascular side effects, halofantrine is no longer used. The antimalarial activity against *Plasmodium falciparum* and *P. vivax* is much better documented than that against *P. malariae* and *P. ovale*.

### Molecular Interactions

Halofantrine is a phenanthrene methanol, and its activity is directed against erythrocytic schizonts (Fig. 2). The action of halofantrine on the molecular level is unknown. It is presumably different from that of quinine and mefloquine, but it may be otherwise similar to that of mefloquine (Fig. 1).

## Resistance

First reports on resistance appeared in 1992. In Thailand there are mefloquine-resistant strains of *P. falciparum* which show simultaneously reduced sensitivity to halofantrine, thus indicating cross-resistance between mefloquine and halofantrine. On the molecular level, the resistance mechanism against halofantrine is suggested to be of the MDR phenotype similar to that against mefloquine and quinine, while it may be different from that against chloroquine.

## Chloroquine

### Synonyms

7-chloro-4-(4-diethylamino-1-methylbutylamino)quinoline, SN7618, RP3377, Aralen, Nivaquine B, Sanoquin, Artrichin, Bipiquin, Reumachlor, Bemaphate, Resoquin, Resochin, Chlorochin.

### Clinical Relevance

Chloroquine has been used in the treatment of malaria for some 60 years since its discovery in the 1930s. It exerts a wide variety of activities against different parasites.

The activity of chloroquine against *Entamoeba histolytica* is directed only against liver abscesses. It has no effect against intestinal stages. Chloroquine especially is used in combination with emetine to improve the curative effects of the latter. Other combinations

**Hem(oglobin) Interaction. Table 1** Degree of efficacy of antimalarial drugs on various protozoan parasites

Year on the market	Drug	<i>Mastigophora</i>				<i>Sarcodina</i>		<i>Apicomplexa</i>				
		<i>Leishmania cruzi</i>	<i>Trypanosoma brucei</i>	<i>Trypanosoma vaginalis</i>	<i>Entamoeba histolytica</i>	<i>Eimeria</i> in chicken	<i>Toxoplasma gondii</i>	<i>Babesia</i>	<i>Theileria</i>	<i>P. fal-ciparum</i>	<i>P. vivax</i>	
1. Single drugs												
DNA-Synthesis-Affecting Drugs I : Alkylation Reactions												
1951 (1924)	Primaquine	xx (5)						x		x (4)	x (4)	x (4)
	Pamaquine									x (4)		xx (4)
DNA-Synthesis-Affecting Drugs IV : Interference with Cofactor Synthesis												
1945 (1945)	Sulfonamides						xx	x			x	xx
	Biguanide/ Cycloguanide						x E				xx (R4)	xxx (R4)
1951	Pyrimethamine						x	x			x (R4)	x (R4)
DNA-Synthesis-Affecting Drugs V : Interference with Dihydroorotate-Dehydrogenase												
1996	Atovaquone										xxx	xxx
Hem(oglobin) Interaction												
1700 (1937)	Quinine		x								xxx	xxx
	Chloroquine (c)			xx	xxx		xx		xx		xxx	xxx
1970's	Artemisinins										xxx	xxx
	Sesquiterpene										xxx	xxx
about 1988	Mefloquine			x E							xxx	xxx
1989	Halofantrine										xxx	xxx
Protein-Synthesis Disturbing Drugs												
	Spiramycin								xxx			
	Clindamycin				x				xxx		x (4)	
	Doxycyclin										xxx	
Membrane-Function Disturbing Drugs												
1930	Mepacrine	x (3)					xx E				xxx	xxx
1931	Acaprine		x							xxx	x	x

**Hem(oglobin) Interaction. Table 1** Degree of efficacy of antimalarial drugs on various protozoan parasites (Continued)

Year on the market	Drug	<i>Mastigophora</i>			<i>Sarcodina</i>			<i>Apicomplexa</i>				
		<i>Leishmania cruzi</i>	<i>Trypanosoma brucei</i>	<i>Trypanosoma gambiense</i>	<i>Trichomonas vaginalis</i>	<i>Entamoeba histolytica</i>	<i>Eimeria</i> in chicken	<i>Toxoplasma gondii</i>	<i>Babesia</i>	<i>Theileria</i>	<i>P. falciparum</i>	<i>P. vivax</i>
-2700	Halofoinone						xxx		xxx	xx	xx	
	Febrifugine									xxx	xxx	xxx
	Pyronaridine									xxx	xxx	
Drugs with Unknown Antiparasitic Mechanism of Action												
2. Drug combinations												
1967	Sulfadoxine/Pyrimethamine (I)									xxx	xxx	xxx
	Chloroquine/Proguanil (II)									xxx	xxx	xxx
1998	Atovaquone/Proguanil (III)									xxx	xxx	xxx
1999	Artemether/Lumefantrine (IV)									xxx	xxx	xxx
?	Dihydroartemisinin/Piperaquine									xxx	xxx	xxx
?	Pyronaridine/Artesunate									xxx	xxx	xxx
2003	Chlorproguanil/Dapsone (V)									xxx	xxx	xxx
?	Chlorproguanil/Dapsone/Artesunate									xxx	xxx	xxx

1) Fansidar®; II) Paludrine®; III) Malarone®; IV) Riamet®, Coartem®, V) Lapdap®, ? = in different phases of clinical development  
xxx = high efficacy at least against some developmental stages, and diverse species; xx = partially effective (regarding developmental stages and diversity of species); x = slightly effective; E = active experimentally (Haberkorn 1993); R = resistance arose quickly; (4) = predominantly extrarethrocytic stages and gamonts; (c) = also Amodiaquine

with significant amoebicidal activity are chloroquine/dehydroemetine or chloroquine/diloxanide furamide.

As antimalarial drug chloroquine is mostly used as a diphosphate salt. It is effective against all four human malaria parasites. Thus, it has high activity against blood schizonts (asexual intraerythrocytic stages of *Plasmodium vivax* and *P. falciparum*) and against gamonts of *P. vivax* (Fig. 2). It has no significant effects against extraerythrocytic stages in the liver. Therefore, chloroquine cannot be used as a causal-prophylactic drug.

### Molecular Interactions

The amoebicidal action of chloroquine is directed against trophozoites (magna forms) in the liver and other extraintestinal organs. The precise mechanism of action in →amoebiasis is unknown. Presumably it is different from the antimalarial action by intercalation into DNA or by inhibition of protein-synthesis.

There are different hypotheses for the mode of action of chloroquine. The uptake of host-derived hemoglobin and its digestion in the food vacuole by developing parasites plays a vital role in survival of these parasites, and this is therefore the Achilles' heel, which makes the plasmodia vulnerable to →quinoline compounds. During the degradation of globin ferrous heme is released and oxidized to a ferric form, which is toxic for the parasites by damaging parasitic membranes and inhibiting various parasitic enzymes including proteases. To circumvent these toxic effects of ferrous heme plasmodia have evolved specific detoxification mechanisms. These rely on the conversion of the ferric hem into an insoluble, unreactive crystalline material called →hemozoin (= malaria →pigment). Hemozoin is a polymer of the iron porphyrin ferriprotoporphyrin IX (hemin) residues linked by iron-carboxylate bonding β-haematin. It is at present controversial, whether the formation of this polymer is catalyzed by a →heme polymerase or proceeds spontaneously without protein. Despite these differences there is no doubt that just this important polymerization step is susceptible to inhibition by quinoline-containing antimalarial drugs (chloroquine, quinine, amodiaquine), Fig. 1. This is supported by a strong correlation among a series of quinoline compounds between inhibition of parasite growth and inhibition of the heme polymerization. In addition, the subcellular localization of the inhibition of heme polymerization correlates with the site of drug accumulation. Thereby, the heme substrate is probably converted into a noncovalent complex with the quinoline. This hemin-chloroquine-complex is assumed to be toxic to the parasite by lysing membranes or by inhibiting further aspartic protease-mediated hemoglobin degradation.

In the alternative model of chloroquine action by Warhurst 1995, in which the presence of a heme polymerase is not necessary for β-haematin formation, the

formation of β-haematin can be inhibited by chloroquine, amodiaquine, and quinine just as they are reported to inhibit heme polymerase. The action of blood schizontocides is thus, according to this model, simply by binding to hemin monomers and preventing their polymerization and detoxification by sequestration with apohemozoin.

For all the known models of the chloroquine action it is proposed that the drug is taken up by the parasites by passive diffusion. However, recently a chloroquine-transporter in the plasma membrane of *P. falciparum* could be characterized. This transport protein is responsible for the accumulation of drug inside the parasite. The uptake mechanism is temperature-dependent, saturable, can be inhibited and follows the Michaelis-Menten kinetics in contrast to the chloroquine uptake into noninfected erythrocytes, which is by simple diffusion. It is proposed that the chloroquine-transporter works as a Na<sup>+</sup>/H<sup>+</sup>-exchange protein and is able to regulate the cytoplasmic pH. In contrast to other →eukaryotes *P. falciparum* appears not to possess other pH-regulatory systems beside this exchange protein. This is obviously an adaptation to the intracellular parasitism and may explain why this system is an Achilles' heel by which the plasmodia become vulnerable to the action of →quinolones. Corresponding exchange proteins from human cells do not bind or transport chloroquine. The energy for this process is gained via the Na<sup>+</sup>-gradient which is built by the Na<sup>+</sup>/K<sup>+</sup>-ATPase. Chloroquine is able to stimulate the exchange protein, thus leading to an enhanced exchange of protons and Na<sup>+</sup>-ions. As a result, pH and Na<sup>+</sup>-ions are enhanced intracellularly and chloroquine is taken up and accumulated during the initial activation phase. The chloroquine uptake proceeds as long as there is a Na<sup>+</sup>-gradient across the plasma membrane. The molecular mechanism of the activatory effect of chloroquine is unclear at present.

Besides the amoebicidal and antimalarial activity, chloroquine has also antibabesial and anticestodal activities. The mechanism of action of chloroquine in these indications is not yet known. In other nonparasitic indications chloroquine is used in rheumatoid arthritis, chronic polyarthritis and Lupus erythematoses. Here the membrane-stabilizing-effects of chloroquine may contribute to the anti-inflammatory effects. Thereby, the actions of lysosomal proteases become inhibited by this drug.

### Resistance

Chloroquine resistance in *P. falciparum* was first observed in 1957. The greatest hindrance for the elucidation of the resistance mechanism was lack of knowledge of the mode of action of the quinoline-based antimalarials on *Plasmodium* spp., which is still discussed controversially. In chloroquine-resistant *P. falciparum* the release of chloroquine is 40–50 times more rapid compared to



compounds mefloquine, halofantrine, and quinine. The neuroleptic agent and calcium-channel-blocker penfluridol increases the susceptibility of mefloquine-resistant strains to mefloquine, and interestingly, there is no increase of mefloquine-activity in mefloquine-resistant strains by verapamil. By contrast penfluridol cannot increase the susceptibility against chloroquine in chloroquine-resistant strains of *P. falciparum*. Mefloquine resistance exhibits patterns more indicative of the MDR phenotype and is often associated with halofantrine and quinine resistance. The EC<sub>50</sub> values for mefloquine, halofantrine, and artemisinin are decreased by penfluridol, but not by agents modulating chloroquine resistance. There are several reports on an association between mefloquine resistance and amplification of *pfmdr1*. Thus, a mefloquine-resistant clone selected by drug pressure exhibited a two- to four-fold increase in the copy number of *pfmdr1* and a significantly higher level of corresponding mRNA compared to the sensitive clone. In 10 mefloquine-resistant strains with concurrently reduced susceptibility to halofantrine, *pfmdr1* is present in multiple copies, whereas this amplification is not found in the only sensitive strain. A selection for mefloquine resistance in 2 clones generated amplification and overexpression of *pfmdr1* and overexpression of its product, Pgh1. The overexpression of Pgh1 correlates with increased resistance to halofantrine and quinine and decreased resistance to chloroquine. Thus, there seems to be an inverse correlation concerning Pgh1 expression in chloroquine resistance and a MDR phenotype involving mefloquine, halofantrine, and quinine.

### Lumefantrine

#### Synonym

benflumetol; Combination: artemether/lumefantrine (Riamet<sup>®</sup>, Coartem<sup>®</sup>).

#### Clinical Relevance

Lumefantrine is used in the drug combination with artemether and recommended for standby medication in uncomplicated malaria tropica.

#### Molecular Interactions

It is shown that lumefantrine interacts with synthetic phospholipid bilayers of dipalmitoyl- or dioleoylphosphatidylcholine, egg lecithin or mouse erythrocyte membranes, thereby provoking a condensing effect. Artemether and lumefantrine are shown to act synergistically against *P. falciparum* *in vitro*.

#### Resistance

The drug combination is active against multiresistant *Plasmodium* strains under field conditions.

## Hemozoin

Hemozoin (→malaria pigment, beta-hematin) is the chemically inert crystalline substance produced in the digestive food vacuole of blood-stage malaria parasites. The pigment is visible microscopically in stages that are actively degrading hemoglobin, such as →trophozoites and schizonts. During proteolysis of host erythrocyte hemoglobin, monomeric, toxic heme (hematin, ferriprotoporphyrin IX) is released. In order to protect itself, the malaria parasite has evolved a distinct mechanism for detoxification of free heme through its conversion to hemozoin, originally described as a polymer of heme but more recently characterized as heme dimers that form chains linked by hydrogen bonds in the crystalline hemozoin. The mechanism of hemozoin formation is still not well understood. →*Plasmodium* histidine-rich protein-2 and a polymerase enzyme have been proposed to mediate heme aggregation into hemozoin. But this process may also occur spontaneously in the acidic environment of the food vacuole. The heme detoxification process is unique to *Plasmodium*, and there is now considerable evidence that interference with hemozoin formation is the mechanism of antimalarial action of →chloroquine and other 4-aminoquinolines.

## Henneguya

Genus of →Myxozoa in fish.

## Hepatic Stellate Cells

These cells are activated and multiplied in the wall of liver blood vessels in case of chronic diseases, which may be induced by parasitic infections (e.g., due to schistosomes, *Clonorchis*, *Echinococcus*, etc.).

## Hepatitis interstitialis parasitaria multiplex

Syndrome due to infection with *Ascaris suum* in pigs. →Ascaris, →Milk Spots.



## Hepatocystis

Genus of coccidian blood parasites, the species of which are transmitted by midges (→*Ceratopogonidae*, →*Culicoides*) mainly to monkeys (*H. kochi*, *H. simiae*) in Africa and to other hosts (including hippos). Inside liver cells giant schizonts = meronts of 4 mm are formed, while in red blood cells only gamonts occur.

## Hepatomegaly

### Name

Greek: *hepar* = liver, *megale* = large.

Enlarged liver due to infections with →schistosomes, →*Echinococcus*, →*Entamoeba*, opisthorchiasis, →visceral leishmaniasis (→Kala Azar), →Chagas' disease (hepatosplenomegaly).

## Hepatoxylon

Genus of trypanorhynchid tapeworms in fish (→*Trypanorhyncha*).

## Hepatozoon

### Name

Greek: *hepar* = liver, *zoon* = animal.

### Classification

Genus of →*Coccidia*.

### Important Species

**Table 1.** In 2003 it was shown that within dogs two tick-transmitted *Hepatozoon*-species exist (perhaps another is transmitted by fleas):

1. *H. canis*, which is well adapted to its host (dogs) with low graded symptoms of disease.
2. *H. americanum*, which produces severe and frequently fatal myositis, is highly virulent. It has apparently recently crossed the species barrier from a wild host to pet dogs.

### Life Cycle

**Figs. 1–3** (pages 599, 600).

### Disease

Infections with *H. canis* are (often) symptomless, but may be potentially fatal due to lethargy, cachexia, and anaemia. Often 1–5% of the neutrophils are infected and more than 50,000 gamonts may be found per  $\mu$ l blood of dogs. The infections emerging today due to *H. americanum*, however, lead to a debilitating and often fatal disease, starting with fever, muscle atrophy, fatal myositis (due to heart infections). The vector of *H. americanum* is *Amblyomma maculatum* (so-called Gulf Coast tick). Natural hepatozoonosis similar or identical to *H. canis* was reported also in coyotes (*Canis latrans*) as well as that due to *H. americanum*.

## Heptachlor

### Chemical Class

organohalogenide (organochlorine compound, cyclo-diene).

**Hepatozoon. Table 1** Important species of the genus *Hepatozoon*

Species	Host	Hosts/Habitat	Vector/Habitat	Mode of infection/transmission
<i>Hepatozoon muris</i> (syn. <i>perniciosum</i> )	2	Rats, mice/Liver cells, leukocytes	Rat mites ( <i>Echinolaelaps</i> sp.)/ Hemocoel	Blood meal of vector
<i>H. erhardovae</i>	2	Bank voles ( <i>Clethrionomys</i> sp.)/ Lung, leukocytes	Rat fleas/Hemocoel	Blood meal of vector
<i>H. canis</i>	2	Dogs/Liver cells, Spleen leukocytes	Ticks ( <i>Rhipicephalus sanguineus</i> , <i>Ixodes</i> spp.)	Blood meal of vector
<i>H. aegypti</i>	2	Snakes ( <i>Spalerosophis diadema</i> )/ Lung, erythrocytes	Mosquitoes ( <i>Culex pipiens</i> )/ Body cavity	Blood meal of vector

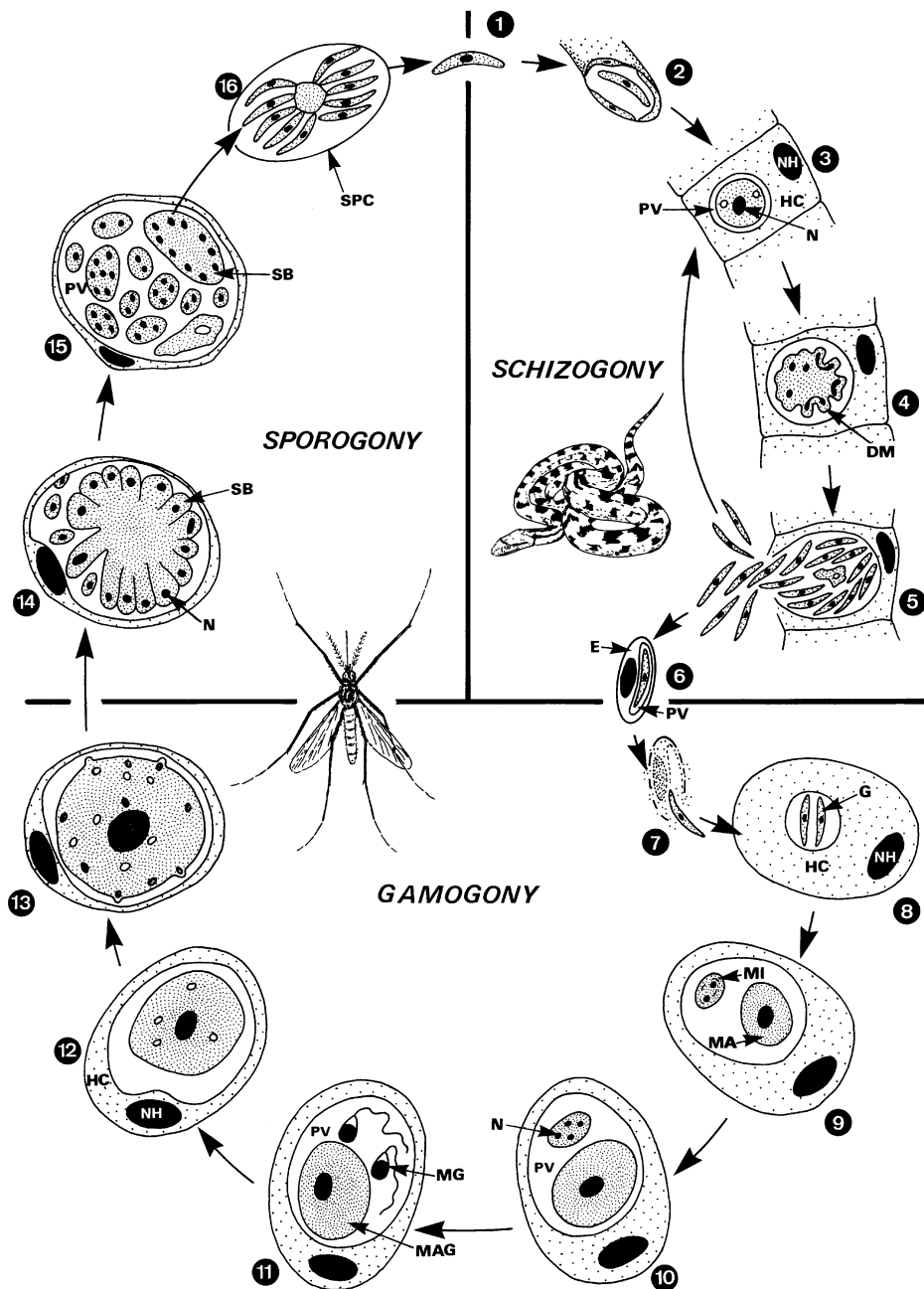

**Hepatozoon.** Figure 1 Life cycle of *Hepatozoon aegypti* inside snakes (*Spalerosophis diadema*; Colubridae) and →mosquitoes (*Culex pipiens*). 1, 2 Sporozoites are injected during bite of the female mosquito and enter the lung capillaries of the snake. 3–5 After penetration into endothelial cells (3) they grow to be schizonts (4) which form merozoites (5). 6 The free merozoites may enter other endothelial cells, where they repeat →schizont formation (3) or penetrate into erythrocytes and become gamonts of different sex. 7, 8 After sucking by a mosquito, the gamonts are set free (7), migrate into the hemocoel, and penetrate into host cells, where they associate in pairs within a →parasitophorous vacuole (8). 9 On day 2 after infection, differentiation to micro- and macrogamonts occurs. 10 Nucleus of →microgamonts divides. 11 Formation of the nonflagellated →microgametes on day 3 after infection. 12, 13 Fertilization on day 4 and growth of the young →oocyst during the following days. 14 Formation of sporoblasts on days 8–10. 15 Formation of 15–75 sporoblasts, the nuclei of which divide several times. Then the →sporoblast forms a smooth wall and thus becomes a →sporocyst. 16 These sporocysts become disrupted, leading to distribution of sporozoites inside the vector. The main method of infection is the bite, but in experiments oral infection of snakes was also possible. DM, developing →merozoite; E, erythrocyte; G, gamonts (of different sex); HC, host cell; MA, macrogamont; MI, microgamont; MG, microgamete; N, nucleus; NH, nucleus of the host cell; PV, parasitophorous vacuole; SB, sporoblast; SPC, sporocyst.

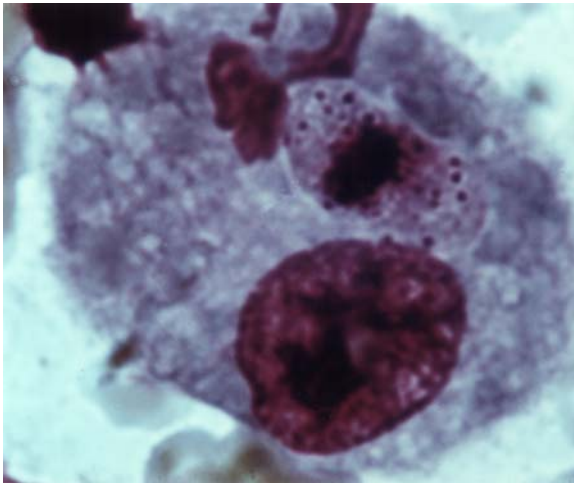

**Hepatozoon. Figure 2** LM of a stage in a white blood cell of a Giemsa-stained smear.

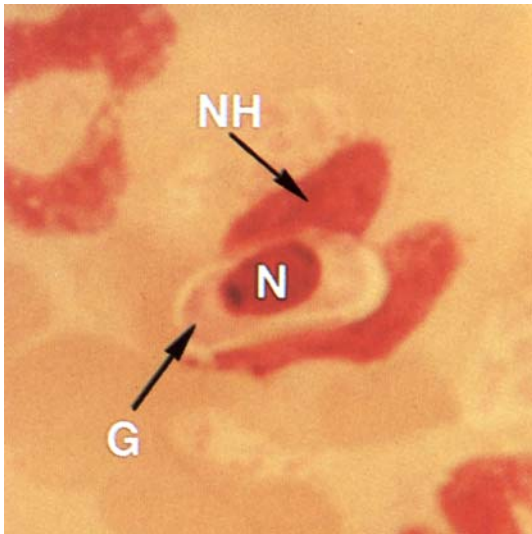

**Hepatozoon. Figure 3** LM of a Giemsa-stained blood smear of *H. muris* in a mouse lymphocyte. *G*, gamont; *N*, nucleus; *NH*, nucleus of the host cell.

### Mode of Action

GABA-gated chloride channel antagonist. → [Ectoparasitocides – Antagonists and Modulators of Chloride Channels](#).

---

## Heptenophos

### Chemical Class

Organophosphorous compounds (organophosphate).

### Mode of Action

Acetylcholine esterase inhibitor. → [Ectoparasitocides – Agonists and Antagonists of Cholinergic Transmission](#).

---

## Hermaphrodites

→ [Cestodes](#), → [Trematodes](#), → [Leeches](#), → [Nematodes](#) (*Rhabdias*).

---

## Hermaphroditism

### Name

Greek: *hermaphroditos* = son of the god Hermes and the goddess Aphrodite (= a bisexual stage).

The parasitic stages may be monoecious (hermaphroditic) having male and female gonads in a single individual. Male and female gonads usually mature at different times, but are visibly present in the same individual. Most common is → [protandry](#) (→ [Androgyny](#)), with maturation of the male gonads first; the inverse, → [protogyny](#) (→ [Gynandry](#)), is relatively uncommon (e.g., in a few → [tapeworms](#)). In addition, a peculiar type of protandry is found in some → [nematodes](#) and arthropods, where individuals develop female gonads only after the complete disappearance of the male ones, thus leading to a misleading → [dioecious](#) appearance. Hermaphroditism (with cross-fertilization) is the rule in some groups (platyhelminths, with exceptions such as schistosomes), whereas nematodes, acanthocephalans, pentastomids, and arthropods are dioecious (again, with some exceptions or modifications).

---

## Hermetia illucens

This co-called Black soldier fly (family Stratiomyidae) is often found in masses around poultry and swine houses. The adults are 2 cm long, with black legs and white-yellow tarsi. The antennae are long, project directly forward from the head, and the last segment (3rd) is tapered with no arista. The larvae reach a size of 2 cm, grow in manure of livestock and poultry. They induce the manure to become more liquified and thus suitable for the housefly larvae.

## Herpetomonas

→Trypanosomatidae.

## Herpobdella

Genus of leeches that may transmit trematodes of fish.

## Heterakis

→Nematodes.

## Heterobilharzia americana

*Schistosoma* spp. in dogs, which induces bloody diarrhoea, anorexia, loss of weight, and hypoalbuminaemia.

## Heterogony

### Name

Greek: *heteros* = different, *gone* = offspring.

Follow-up of generations that reproduce by →parthenogenesis or bisexual intercourse, e.g., →*Strongyloides stercoralis*.

## Heterophyes heterophyes

### Classification

Species of →Digenea.

### Morphology

These worms are very small (only 1.7–2 mm long) and live attached at the wall of the intestine. Their body is covered with many spiny scales (Figs. 2, 3, page 603). Their ventral sucker lies laterally away from the median line.

### Life Cycle

Fig. 1 (page 602).

## Heterophyiasis, Animals

→*Heterophyes heterophyes*, →Alimentary System Diseases.

## Heterophyiasis, Man

Disease due to infections with →*Heterophyes* species via oral uptake of uncooked infected fish.

**Main clinical symptoms:** →Diarrhoea, →abdominal pain.

**Incubation period:** 1–3 weeks.

**Prepatent period:** 1–2 weeks.

**Patent period:** 2–6 months.

**Diagnosis:** Microscopic determination of eggs in faecal samples (Fig. 1, 603).

**Prophylaxis:** Avoid eating raw fish.

**Therapy:** Treatment with praziquantel, see →Trematocidal Drugs.

## Heteroptera

From Greek: *heteros* = different, *pteron* = wing. →Bugs.

## Heteroxenous Development

### Name

Greek: *heteros* = the other, *xenos* = foreigner, guest.

This term describes cycles with involvement of different hosts (e.g., →Schistosomes). →Dixenous Development.

## Hexacanth

The larvae of the →Eucestoda have 6 hooks (3 pairs) and are thus described as hexacanth whereas the larvae of →Cestodaria form 10 larval hooks (→Decacanth).

## Hexachlorcyclohexan

Lindan is the  $\chi$ -isomer of this compound.

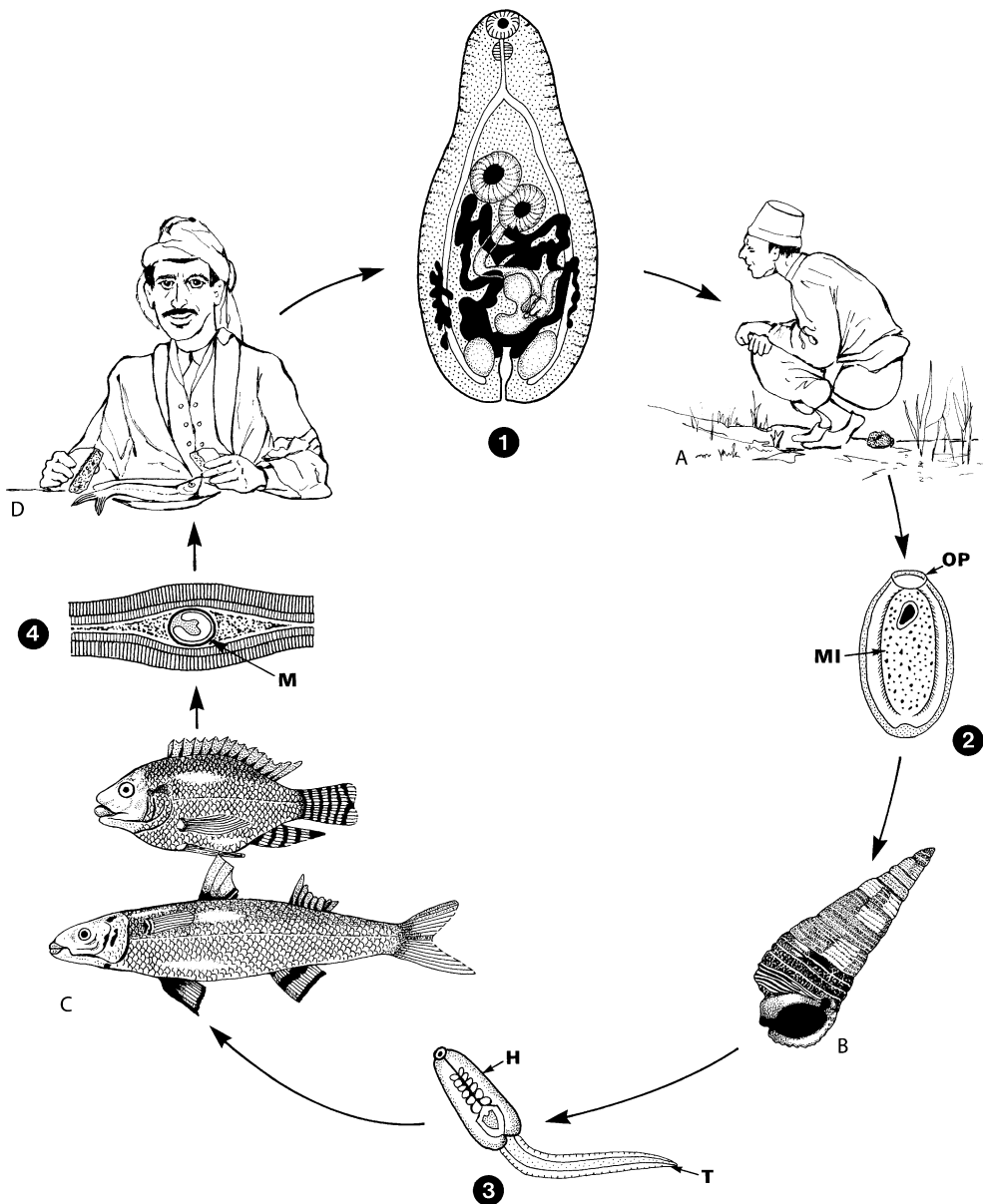

**Heterophyes heterophyes.** Figure 1 Life cycle of *Heterophyes heterophyes*. This fluke, which reaches a size of about 2–0.4 mm and is characterized by a large muscular bulbous (close to the ventral sucker) around the genital openings, lives in the small intestine and caecum of fish-eating mammals including man (A, D). It has snails (B, e.g., *Pirenella conica*) as first and various brackish species or freshwater fish (C, e.g., *Oreochromis* spp., *Tilapia* spp., *Mugil* spp.) as second intermediate hosts. 1 Adult worm, ventral side. 2 The small-sized ( $24\ \mu\text{m} \times 14\ \mu\text{m}$ ) eggs, which are operculated and contain a →miracidium larva, are set free within feces of the final host (A). They become ingested by snails (B) which are found in the Eastern Mediterranean Sea, Red Sea, Gulf, and may reach a length of up to 3 cm. 3 After several reproduction phases (like in →*Clonorchis*) including one →sporocyst generation and often 2 →rediae stages, tailed →cercariae are released from the snail and penetrate into the skin of fish (C). The cercariae reach a total size of  $185 \times 90\ \mu\text{m}$ . 4 Only the head of the cercaria penetrates and becomes encysted as so-called metacercaria (size: 0.8 mm in diameter) under the scales or in the flesh of fish. Humans (D) become infected by eating raw, pickled, or insufficiently cooked contaminated fish. The →metacercariae excyst in the intestinal tract, become attached to its wall and reach maturity within 1–2 weeks. G, →gonotyl, sexual sucker; H, head of cercaria; M, metacercaria; MI, miracidium; OP, →operculum; T, tail of cercaria.



**Heterophyes heterophyes. Figure 2** LM of an adult worm of *Heterophyes heterophyes* (ventral side, colored).

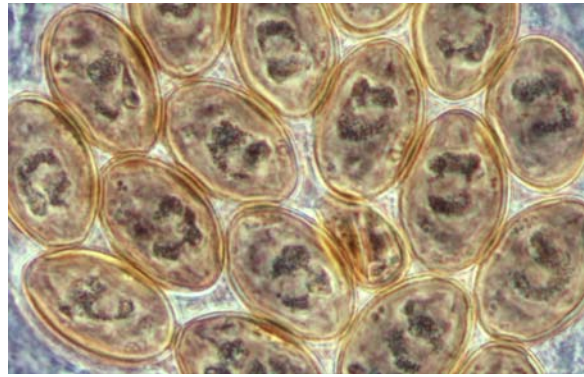

**Heterophyiasis, Man. Figure 1** LM of *Heterophyes heterophyes* eggs from feces.



**Heterophyes heterophyes. Figure 3** SEM of the ventral side of an adult *Heterophyes heterophyes*, note the scaly surface.

## Hexaflumuron

Growth regulator in insect larvae (= acts as insecticide and hinders the molt of larvae → [Diflubenzuron](#) = Dimilin), → [Methoprene](#).

## Hexamita

### Name

Greek: *hex* = six, *mitos* = filament.



**Hexamita. Figure 1** LM of *Hexamita* – stages from fish intestine.

### Morphology

The specimens of *Hexamita salmonis* and *S. symphysononis* parasitize in the fish intestine reach a size of about 8–12  $\mu\text{m}$  in length, possess 2 nuclei and in total 6 flagella, of which 4 become free at the anterior pole, 2 at the posterior (Figs. 1–3). Reproduction occurs by binary fission and transmission by cysts that are excreted with the feces (Figs. 2, 3, page 604).

### Symptoms of Disease

Apathy, loss of weight, white feces, death (also hollow – sickness in discus – fish).

### Therapy

Flagello1™ (5-nitroimidazoles). → [Diplomonadida](#).

## Hexapoda

Animals with 6 feet (→*Insecta*), from Greek: *hexa* = six, *podos* = feet.

## Hibernation

Overwintering, survival of developmental stages. In →*ticks*, e.g., all stages are capable to survive; in the

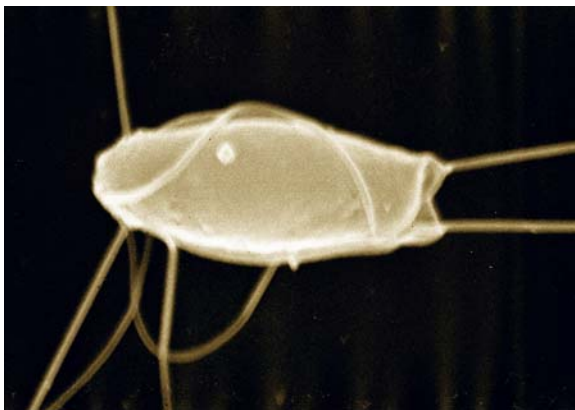

**Hexamita.** Figure 2 SEM a *Hexamita*-stage.

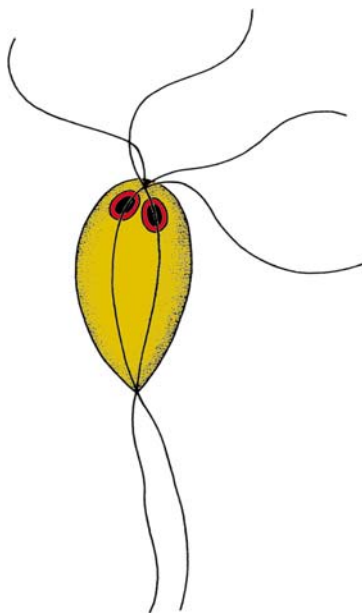

**Hexamita.** Figure 3 Diagrammatic representation of a *Hexamita*-stage.

→*Culicidae* *Anopheles maculipennis* and *Culex pipiens* fertilized females overwinter, while in many →*Aedes* species the eggs serve as anchor for the next generation.

## Himasthla

→*Digenea*.

## Hippobosca equina

### Name

Greek: *hippos* = horse, *boskein* = feeding on the meadow.

### General Information

This “horse louse fly” reaches a length of 8 mm (Fig. 1), has yellow-red legs and reddish wings, while the thorax is black with yellow stripes. The female places 7–10 larvae onto the soil, where they pupate within 4–6 hours. Mostly after 4 weeks (range 3–20) the adults hatch.

### Symptoms

The horses are restless due to the rapid movements of the adult flies within the hair and due to their painful bites. Humans are also attacked; the pain is intensive like that of bee bites.



**Hippobosca equina.** Figure 1 DR of an adult stage.

## Hippoboscidae

### Name

From Greek: *hippos* = horse, *boskein* = feeding at meadow. Horse louse flies.

### Classification

Family of →[Diptera](#).

### Morphology

Figs. 1–4.

## Hippoboscidosis

Disease due to infestation with hippoboscids, see [Table 1](#) (page 607).

## Hirnwurm

German term for →[metacercariae](#) of *Dicrocoelium* inside the brain of the second →[intermediate host](#) (ant).  
→[Behavior](#).

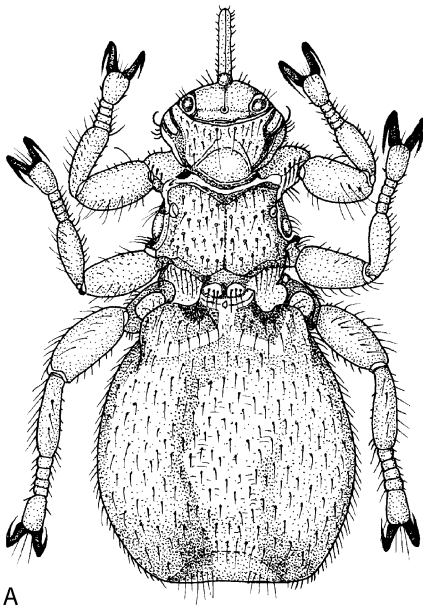

A

## Hirudo medicinalis

### Synonym

Medical leech, from Latin: *hirudo* = leech.

### Classification

Species of leeches (→[Annelida](#)).

### General Information

For further information see →[leeches](#).

### Morphology

Figs. 1–4 (pages 607–609).

## Histamine

→[Amino Acids](#), →[Nervous System of Platyhelminthes](#).

## Histiocytic Reactions

→[Pathology](#).

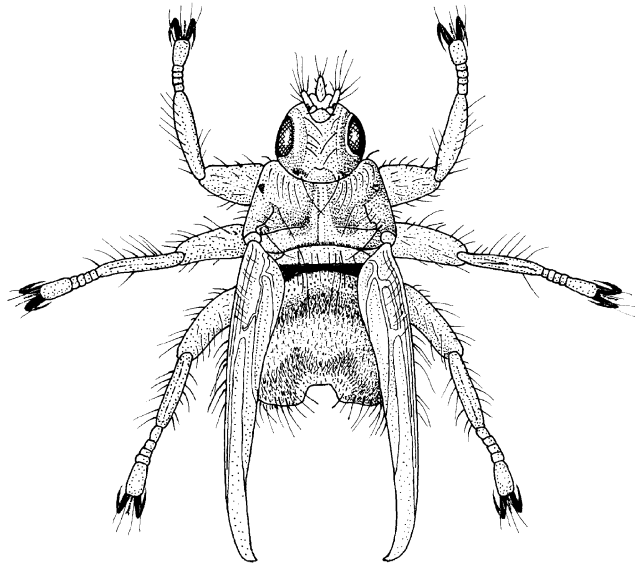

B

**Hippoboscidae.** **Figure 1** Species of the Family Hippoboscidae. **A** →[Melophagus ovinus](#), sheep ked, without wings. **B** *Stenoperyx hirundinis* from swallows, with wings.



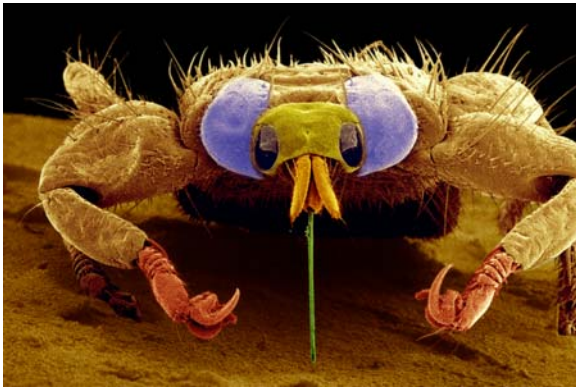

**Hippoboscidae. Figure 2** SEM of *Lipoptena cervi*.



**Hippoboscidae. Figure 3** LM of an adult *Melophagus ovinus* stage from dorsal.



**Hippoboscidae. Figure 4** LM of a puparium of *Melophagus ovinus* from hair of sheep.

---

## Histologic Reactions

→Pathology.

---

## Histomonas meleagridis

→Black Head Disease.

---

## Historical Landmarks

Parasites do not accept borderlines. Thus parasitology has been an international and interdisciplinary science from its beginnings in early human cultures. Philosophers, theologians, natural scientists, pharmacists, physicians, and veterinarians gave birth to deep insights into the world of parasites. Some of the highlights, the selection of which is, of course, an expression of personal taste, are listed below (Table 1, pages 610–613).

More recent findings are not listed, since several have to be confirmed and/or enlarged in their basic elements. Of course, many other discoveries – especially in the last decades – are surely worth citing. Their importance for the ongoing struggle against parasites will, however, become clearer in the future.

---

## HIV

Human immunodeficiency virus.

---

## HIV-Interactions

Many parasites grow much better in hosts that are HIV-infected (→Opportunistic Agents). Some like →*Leishmania* spp. induce the activation of HIV in latently infected monocyte and T cells.

**Hippoboscoidosis. Table 1** Hippoboscids and Control Measurements

Parasite	Host	Vector for	Symptoms	Country	Therapy		
					Products	Application	Compounds
<i>Hippobosca equina</i> (Horse louse-fly)	Horse, Cattle		Anal-/pubic area, irritation through movement and bloodsucking, itching, wool loss or alopecia through rubbing	Europe			
<i>Hippobosca variegata</i>	Cattle		Tail, irritation through movement and bloodsucking, itching, wool loss or alopecia through rubbing	Europe	Ivomec 1% injection for cattle (Merial)	Injection	Ivermectin
<i>Lipoptena capreoli</i>	Goat						
<i>Lipoptena cervi</i>	Deer, Cattle, Goat		Ear, irritation through movement and bloodsucking, itching, wool loss or alopecia through rubbing	Europe			
<i>Melophagus ovinus</i> (Sheep ked, sheep "tick")	Sheep	<i>Trypanosoma melophagium</i> (nonpathogenic)	Blood loss, itching, wool loss	World-wide	Butox (Intervet)	Pour on	Delta-methrin

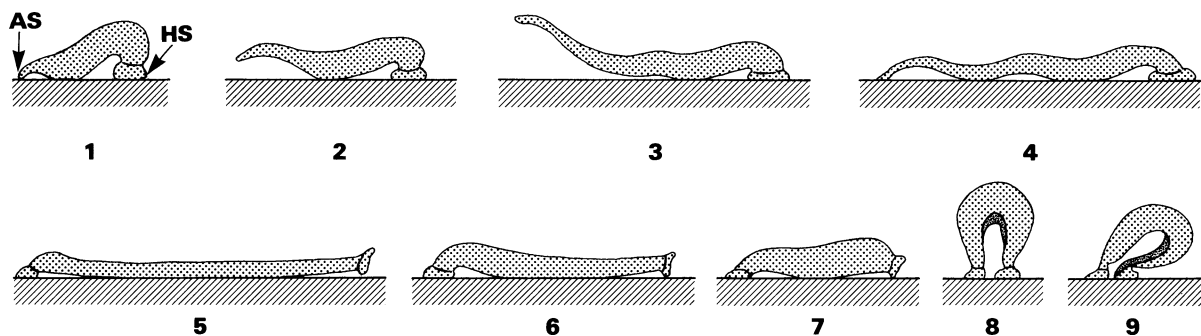
**Hirudo medicinalis. Figure 1** Movements of *Hirudo medicinalis* along the skin of a host. AS, anterior sucker; HS, posterior sucker.

## HIV-Protease-Inhibitors

The highly active antiretroviral therapy (HAART) in HIV-patients has shown a significant parallel regression of diseases due to infections with opportunistic parasites. This is not only explainable by support of the immune system (e.g., Indovir may reduce *Cryptosporidium*-infections up to 100%, *Toxoplasma*-infections up to 63%).

## Hoferellus

Genus of →Myxozoa of fish.

## Hoferellus cyprini

Species of →Myxospora in carps.

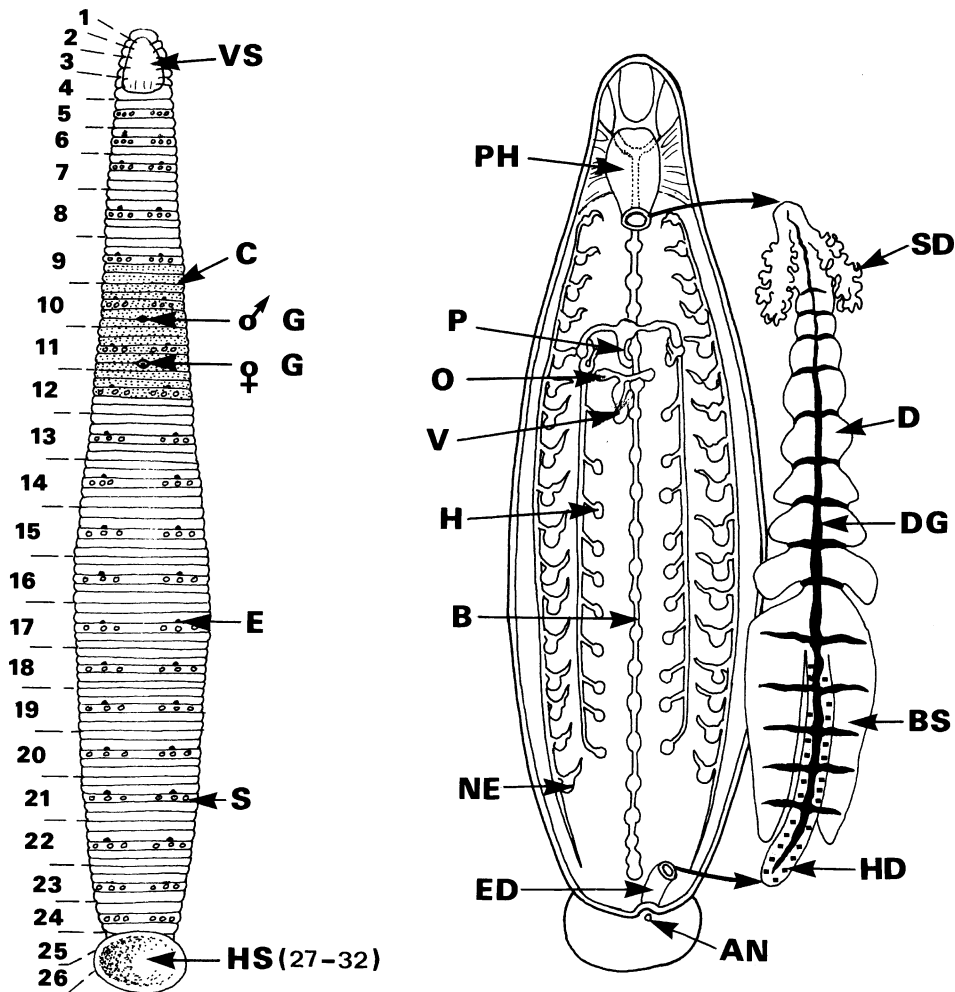

**Hirudo medicinalis.** Figure 2 *Hirudo medicinalis*, the medical leech. **A**, ventral aspect; the outer annulation does not confer to the inner segments (1–32). **B**, inner structure. After copulation and transfer of so-called double spermatophores, fertilized eggs are packed together into slime (→Cocoon) deriving from the →clitellum and are deposited on plants. After a period depending on the temperature of the water, the young worms hatch from the eggs and reach maturity within 5–6 months. *A*, anus; *B*, ventral nerve cord; BS, last intestinal caecum; *C*, →clitellum; *D*, intestinal caeca; *DG*, dorsal blood vessel; *E*, →nephropores = openings of the 17 pairs of →metanephridia; *ED*, rectum; *G*, genital porus; *H*, →testis; *HD*, hind gut; *HS*, posterior →sucker; *NE*, nephridium; *O*, ovary; *P*, penis; *PH*, pharynx; *S*, sensory papillae; *SD*, salivary glands; *V*, vagina; *VS*, apical sucker.

## Hohorstiella lata

Mallophagan species of doves.

## Holarctis

### Name

Greek: *holos* = total, *arctos* = north.

Zoogeographical region with typical animals and plants accommodated at moderate and cold climate around the northern pole.

## Holarktikos crassiceps

Mallophagan species of goats.



**Hirudo medicinalis.** Figure 3 LM of an adult *Hirudo medicinalis* from dorsal.

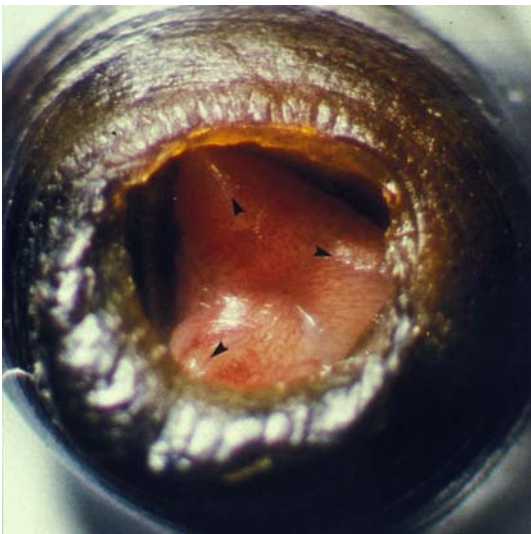

**Hirudo medicinalis.** Figure 4 LM of the oral sucker of *Hirudo medicinalis*. Note the 3 cutters.

## Holdfast Organs

→Acanthocephala, →Aspidogastrea, →Leeches, →Cestodes, →Argulus, →Ticks, →Lice, →Pentastomida.

## Hologamy

From Greek: *holos* = total, *gamein* = mating. Total fusion of 2 individuals (e.g., in protozoans).

## Hologonic Ovaries

In hologonic ovaries which are found in trichurid →nematodes the oogonia cover the entire wall of the ovarian tube. The germ cells develop via the various stages of oogenesis while moving from the wall towards the lumen of the ovary (→Nematodes/Reproductive Organs).

## Hologonic Testes

The hologonic type of →testis where the spermatogonia line the wall of the testis is found in trichurid →nematodes; moreover, →spermatogenesis occurs during migration towards the lumen of the testis (→Nematodes/Reproductive Organs).

## Holometabolous Development

This type of development, which is the most common in insects, is also found in large groups of ectoparasites (e.g., →Diptera, →Fleas, →Diptera/Fig. 1, →Fleas/Fig. 2, →Mosquitoes/Fig. 1). In general different types of developmental stages occur during a holometabolous life cycle: larva, →pupa, and adult →(imago). Larvae, which hatch from the egg and which may undergo a species-specific number of molts, are completely different from the adults. They feed on other substrates, in general lack the body appendages of adults (e.g., antennae, wings, mouthparts, legs), and often have only rudimentary eyes. The pupae are nonfeeding, very often remain quiescent (an exception are the motile pupae of →Mosquitoes, see →Mosquitoes/Fig. 1), and are in general in a thickened →cocoon or →puparium. Inside the puparial cover a complete reorganization of the insect's body occurs, leading to the final production of the adult male or female, which leave the pupa by typical opening mechanisms.

In general, the adults (imago) of ectoparasites feed on their hosts. In flies, tabanids, and fleas both sexes feed on the host's blood or body fluids, whereas in mosquitoes only the females take up blood (besides nectar) in order to produce viable eggs. The mouthparts (→Insects/Figs. 7–9) are species-specific as are the mating processes, which start soon after hatching from the puparial enclosure.

**Historical Landmarks. Table 1** Historical landmarks (not complete)

1500 BC	The Egyptian papyrus Ebers reported on human worms and schistosomiasis.
500 BC	The Greek poet <b>Herodot</b> reported that the Egyptians use fine nets against mosquitoes.
430 BC	<b>Hippocrates</b> (460–399 BC) described <i>Ascaris</i> , <i>Oxyuris</i> , adult <i>Taenia</i> , and Malaria.
342 BC	The great Greek natural scientist <b>Aristoteles</b> (384–322 BC) established a first classification system for animals ( <i>Historia animalium</i> ).
62 AD	In his <i>Historia naturalis</i> , the Roman <b>Lucius Columella</b> (40–88 AD) reported on parasitic animal diseases. <b>Plinius Secundus</b> (23–79 AD) also wrote on this subject.
158 AD	The Roman physician <b>Claudius Galen</b> (129–199 AD) propagated the knowledge of Hippocrates.
480 AD	The Roman <b>Vegetius Renatus</b> (450–510 AD) published his <i>Ars veterinaria</i> with detailed descriptions of intestinal worms.
1000	<b>Avicenna</b> (Abu Ali El-Hosein Abdallah Ibn Sina, 980–1037). This Persian theologian and physician reported in his book <i>Liber canonis medicinae</i> on malaria and on many worms, especially on <i>Dracunculus</i> , which today in French is still called <i>fil d'Avicenne</i> .
1150	<b>Hildegard of Bingen</b> (1098–1179). This German nun published methods of treating worms in her <i>De causis et curis morborum</i> .
1220	<b>Albertus Magnus</b> (1193–1280). This German theologian and physician reported in his 26-volume opus <i>De animalibus</i> on Aristoteles' insights.
1498	<b>Savanorola</b> (1452–1498). In his <i>Tractatus de vermibus</i> , this Italian scientist described the occurrence and treatment (by mercury) of worm-infected humans.
1520	The German physician P.A.T. <b>Bombastus</b> von Hohenheim, called <b>Paracelsus</b> (1496–1541) introduced inorganic salts (e.g., zinc salts) as anthelmintica.
1552	The Belgian physician <b>Cornelius Gemma</b> (1534–1579) published the first picture of a human tape-worm.
1583	Discovery of quinine for malaria treatment by an unknown Peruvian (Indian) and the Augustinian monk <b>Antonio de la Calancha</b> .
1674–1681	The Dutch optician and autodidact <b>Antonie van Leeuwenhoek</b> (1632–1723) described oocysts of the later established genus <i>Eimeria</i> and several <i>Giardia</i> stages taken from its own feces.
1684–1698	The Italian physician and philosopher <b>Francesco Redi</b> (1626–1697) described in his book <i>Osservazioni interno agli animali viventi</i> about 108 different worms and published (in 1698) a detailed study on <i>Fasciola hepatica</i> . Due to his leadership he is considered the <b>Father of Parasitology</b> – the name rediae for special trematode developmental stages honors this.
1699	The Dutchman <b>Nicolaas Hartsoeker</b> (1656–1725) and the Frenchman <b>J. Andry</b> (1658–1742) proposed that helminth infections derive from oral intake of excreted worm eggs.
1717	The Italian <b>Lancisco</b> postulated that malaria is caused by bites from mosquitoes.
1739–1778	The Swedish physician <b>Carl von Linné</b> (1707–1778) created within the different editions of his book <i>Systema naturae</i> a comprehensive system of classification of animals and plants.
1756	The English physician <b>Alexander Russel</b> (1715–1768) discovered in Aleppo the skin leishmaniosis.
1766	The German physician and natural scientist <b>Peter Simon Pallas</b> (1741–1811) was the first to begin the experimental transmission of parasites to animals.
1782	The German theologian <b>J.A.E. Goeze</b> (1731–1793) initiated the taxonomy of helminths.
1790	The Danish pharmacist and veterinarian <b>P.C. Abildgaard</b> (1740–1801) experimentally transmitted <i>Diphyllobothrium</i> -larvae to chicken.
1801	The German physician and natural scientist <b>Carl Asmund Rudolphi</b> (1771–1832) published his <i>Entozoorum historia naturalis</i> with a taxonomy of all available parasites.
1801	The French natural scientist <b>Jean Baptiste Lamarck</b> (1744–1829) presented the first general theory of the evolution within his <i>Philosophie Zoologique</i> .
1820	The French scientists <b>Pierre Joseph Pelletier</b> and <b>Joseph Lavendou</b> isolated quinine from plants.
1835	The English medical student <b>J. Paget</b> (1814–1899) and his teacher <b>R. Owen</b> described trichines in human muscles. Since the name originally given, <i>Trichina</i> , was prefixed for an insect, the worm name was changed in <i>Trichinella</i> by Railliet (1895).
1838	The German scientists <b>N. Schleiden</b> and <b>Theodor Schwann</b> (1810–1882) formulated the <b>cell theory</b> , which became the dead end for the former <i>de-novo</i> -creation-theory.
1841	The Swiss scientist <b>G.G. Valentin</b> described the first trypanosomes in the blood of a salmonid fish.
1848	The American <b>Josiah Nott</b> postulated again that mosquitoes were vectors of malaria and yellow fever.
1849	The Swiss <b>G. Gross</b> discovered <i>Entamoeba gingivalis</i> as the first parasitic amoeba.
1853	The German <b>C.T.E. von Siebold</b> (1804–1885) showed the life cycle of <i>Echinococcus granulosus</i> .

**Historical Landmarks. Table 1** Historical landmarks (not complete) (Continued)

1859	The Germans <b>Rudolph Virchow</b> (1821–1902) and <b>Rudolph Leuckart</b> (1822–1898) independently found the life cycle of <i>Trichinella spiralis</i> .
1859	The English philosopher, theologian and natural scientist <b>Charles Darwin</b> (1809–1882) published his <i>The Origin of Species</i> – another landmark of the evolution theory.
1865	The Bohemian monk <b>Gregor Mendel</b> (1822–1884) formulated the basic laws of genetics.
1869	The German physician <b>Otto Wucherer</b> (1820–1873) discovered in Brazil microfilariae and schistosome eggs in human urine.
1875	The German physician <b>F.A. Lösch</b> described at the Court in St. Petersburg (Russia) for the first time stages of <i>Entamoeba histolytica</i> .
1878	The Scottish scientist <b>Sir Patrick Manson</b> (1844–1922) working in China showed that <i>Wuchereria bancrofti</i> is transmitted by mosquitoes ( <i>Culex</i> sp.).
1880	The French man <b>Charles L.A. Laveran</b> (1845–1922) showed malaria stages within erythrocytes.
1882	The Russian scientist <b>Ilya Metchnikoff</b> (1845–1916), working in Italy, was the first to describe the phenomenon of phagocytosis and to develop the concept of cellular immunity (Nobel Prize 1908).
1885	<b>A.L.J. Railliet</b> (1852–1930); this French zoologist described a large range of protozoans and helminthes.
1888	The French physiologist <b>Charles Richet</b> (1855–1935) formulated the basic concept of humoral immunity (Nobel Prize 1919).
1890	The German veterinarian <b>Robert von Ostertag</b> (1864–1940) described a large variety of parasitic nematodes in animals.
1893	The Americans <b>Theobald Smith</b> and <b>F.L. Kilbourne</b> identified the transmission of <i>Babesia bigemina</i> by ticks ( <i>Boophilus annulatus</i> ).
1895	The English military physician <b>David Bruce</b> (1855–1932) showed that the tsetse fly is the vector of animal trypanosomes.
1897	In India the English Army doctor <b>Sir Ronald Ross</b> (1857–1932) proved that avian malaria was transmitted by <i>Anopheles</i> mosquitoes (Nobel Prize in 1902). In the same year the Italians Bignami, Bastianelli and Grassi did the same for human malaria.
1898	The German physician and discoverer of the agent of tuberculosis ( <i>Mycobacterium tuberculosis</i> ) <b>Robert Koch</b> (1843–1910) described <i>Theileria parva</i> , the agent of East Coast fever (Nobel Prize 1905).
1898	The French man <b>P.L. Simond</b> succeeded in demonstrating the transmission of plague by rat fleas.
1900	In Cuba an American group working with <b>Walter Reed</b> demonstrated the transmission of yellow fever by <i>Aedes aegypti</i> .
1903	The English scientists <b>W. B. Leishman</b> and <b>C. Donovan</b> independently described <i>Leishmania donovani</i> , the agent of Kala-azar disease.
1904	In Cairo the German helminthologist <b>Arthur Loos</b> (1861–1923) discovered the transmission of the hookworm.
1906	The American physician <b>Howard T. Ricketts</b> (1878–1910) recorded the tick <i>Dermacentor andersoni</i> as being a vector of the agents of the Rocky Mountain spotted fever.
1906	The German zoologist and discoverer of the agent of syphilis <b>Fritz Schaudium</b> (1871–1906) described <i>Entamoeba histolytica</i> as a human parasite.
1907	The American <b>E.E. Tyzzer</b> described stages of the genus <i>Cryptosporidium</i> .
1907	The German chemist <b>Paul Ehrlich</b> (1854–1925) – the father of chemotherapy – proposed the drug trypan red against trypanosomiasis (Nobel Prize 1908).
1908	In North Africa the French military doctors <b>Charles Nicolle</b> (1866–1936) and <b>L.H. Manceaux</b> described <i>Toxoplasma gondii</i> in a rodent.
1909	The Brazilian <b>Carlos Chagas</b> (1879–1934) discovered the life cycle of <i>Trypanosoma cruzi</i> and described <i>Pneumocystis carinii</i> .
1909	Teams working with the Frenchman <b>Charles Nicolle</b> (1866–1936) (Tunis) and the American <b>H.T. Ricketts</b> (Mexico) proved that the louse <i>Pediculus humanus corporis</i> is a vector of the typhus-causing rickettsia.
1910	The Italian <b>Carini</b> discovers <i>Pneumocystis carinii</i> in rats.
1914	The Japanese scientists <b>M. Miyairi</b> and <b>M. Suzuki</b> worked out the life cycle of <i>Schistosoma japonicum</i> .
1916–1920	Development of Suramin (B205) against trypanosomiasis (Bayer Co., Germany).
1917	The Austrian psychiatrist <b>Julius Wagner Ritter von Jauregg</b> (1857–1940) tested a live vaccination using <i>Plasmodium vivax</i> -stages (Nobel Prize 1927).
1925	The English natural scientist <b>D. Keilin</b> elucidated the electron cascade (cytochrome) system while using parasitic insects and worms as models.

**Historical Landmarks. Table 1** Historical landmarks (not complete) (Continued)

1934	Discovery of chloroquine as a malariacidal drug at Bayer Co. (Wuppertal, Germany).
1938	The German scientists <b>Helmut</b> and <b>Ernst Ruska</b> developed the transmission electron microscope at Siemens Co. (Berlin) (Nobel Prize 1985).
1939	Sulfonamides were introduced as anticoccidial drugs and the Nobel Prize was awarded to their discoverer <b>Gerhard Domagk</b> (1895–1964) (Bayer Co., Leverkusen, Germany).
1944	<b>Erich Reichenow</b> and <b>N. Mudrow</b> (Leverkusen, Germany) demonstrated the liver stages of avian malaria.
1950	In the USA <b>C. Bueding</b> demonstrated the carbohydrate metabolism in <i>Schistosoma mansoni</i> .
1953	The Americans <b>J.D. Watson</b> and <b>F.H.C. Crick</b> described the structure of DNA.
1955	DDT, which had been developed in 1939 by the Swiss <b>Paul Müller</b> , was introduced as an insecticide.
1956	The English scientists <b>P.C.C. Garnham</b> and <b>S. Short</b> demonstrated the liver stages of <i>Plasmodium</i> within humans.
1959	The English natural scientist <b>J.D. Smyth</b> and <b>J.A. Clegg</b> elucidated the egg shell formation in flatworms.
1960	<b>Erich Scholtzseck</b> (Bonn, Germany) and <b>Datus Hammond</b> (Logan, Utah) started systematical electron microscopic studies on Coccidia.
1961	The American <b>L.S. Diamond</b> cultured <i>Entamoeba histolytica</i> axenically.
1961	First reports on chloroquine resistance in Asia and Africa.
1963	The Americans <b>F.M. Fischer</b> and <b>R.M. Sanborn</b> demonstrated that the microsporidian <i>Nosema</i> produces juvenile hormones for its insect host.
1963	The Americans <b>C.P. Read</b> , <b>A.H. Rothman</b> , and <b>J.E. Simmons</b> demonstrated the basics of the membrane transport in cestodes.
1964	The American <b>R. Damian</b> proved molecular mimicry in schistosomes.
1965	The Australian <b>W.P. Rogers</b> discovered the role of enzymes in the moulting of nematodes.
1966	Introduction of benzimidazoles as broad spectrum anthelmintics.
1969	The American <b>Jack Frenkel</b> (Kansas) and the Indian <b>J.P. Dubey</b> together described the cat as final host of <i>Toxoplasma gondii</i> . <b>Work</b> and <b>Hutchinson</b> (Scotland) and <b>Overdulve</b> (Holland) independently achieved the same result.
1972–1977	German research teams led by <b>Micheal Rommel</b> , <b>Alfred Otto Heydorn</b> , and <b>Heinz Mehlhorn</b> discovered and described the life cycles of several <i>Sarcocystis</i> species and related cyst forming species.
1975	<b>Georg Köhler</b> and <b>J. Milstein</b> developed the hybridoma technique for the production of monoclonal antibodies (Nobel Prize 1986).
1975	The English biologist <b>C. Cross</b> characterized the glycoprotein surface coat of trypanosomes.
1975–1978	German research teams led by <b>Eberhard Schein</b> , <b>Karl Friedhoff</b> , and <b>Heinz Mehlhorn</b> discovered the complete life cycles of 10 <i>Theileria</i> and <i>Babesia</i> species.
1976	The Americans <b>Trager</b> and <b>Jensen</b> succeeded in establishing continuous <i>in vitro</i> cultures of <i>Plasmodium falciparum</i> .
1976	The American <b>C.H. Zierdt</b> and the Chinese <b>J. Tan</b> introduced <i>Blastocystis</i> as a parasite.
1978	The Scottish scientists <b>Keith Vickerman</b> and <b>G.A.M. Cross</b> demonstrated antigenic variation in the surface coat of trypanosomes.
1981	Introduction of ivermectin.
1981	The Swiss <b>Burgdorfer</b> recognized <i>Ixodes</i> ticks as vectors of <i>Borrelia</i> bacteria, the agent of Lyme disease.
1982	American scientists defined the first malaria antigen-circumsporozoite antigen.
1984	The threat of AIDS was growing and the importance of <b>opportunistic parasites</b> became recognized.
1985	Application of PFGE to parasitological problems.
1986	Recognition of the importance of zymodemes for the identification of strains of <i>Trypanosoma cruzi</i> .
1987	Use of DNA probes in the field.
1988	Application of DNA-amplification techniques in parasitology.
1988	The Colombian microbiologist <b>M.E. Patarroyo</b> presented a synthetic vaccine against <i>Plasmodium falciparum</i> .
1989	RNA editing in parasites.
1989	RNA-editing was found to occur in trypanosomes.
1990	Possible role of transgenic mosquitoes in control measures.
1990	The reasons for sequestration in <i>Plasmodium falciparum</i> were detected.
1991	Cross-regulation of Th1 and Th2 subsets in parasitic infections.
1991	The function of nitric oxide in human malaria and other parasitic infections was detected.

**Historical Landmarks. Table 1** Historical landmarks (not complete) (Continued)

1992	Potential of understanding genomes of parasites and vectors.
1993	Avermectins and management of arthropods of medical and veterinary importance.
1993	<b>M.E. Pattarroyo</b> reported on first successful malaria vaccine trials in South America (failures occurred later).
1994	HIV-AIDS and leishmaniasis.
1995	Trials of the SPf66 malaria vaccine in humans.
1996	Combination therapy for malaria.
1997	Global mapping of filariasis.
1998	Climate change and vector-borne diseases.
1999	Roll Back Malaria initiative.
2000	<i>Wolbachia</i> in filarial worms as a target for chemotherapy.
2000	<i>Plasmodium falciparum</i> genome completed.
2001	Apoptosis of intracellular protozoa.
2002	Genetic analysis of arthropod blood meals.
2003	Transgenic mosquitoes and malaria control.
2003	Human genome completed.
2004	DNA microarray analysis of protozoan gene expression. Application of DNA fingerprinting to forensic science. Beginning of the Human Genome Project.

## Homidium

Salt → [Trypanocidal Drugs](#).

## Hooks

→ [Holdfast organs](#) of → [Acanthocephala](#), some digenetic Trematodes, → [Cestodes](#), → [Monogenea](#), → [Pentastomida](#).

## Homology

Common ancestry of 2 genes (characters, genes, positions, etc.)

## Hookworm Disease

### Pathology

Hookworm disease is produced by → [Ancylostoma duodenale](#), → [Necator americanus](#), and several other species (→ [Hookworms](#)). The larvae live in moist soil and enter the skin, giving rise to allergic dermatitis with a papular and sometimes vesicular focal rash that is intensely pruritic and is sometimes referred to as “ground → [itch](#)”. The larvae enter the blood stream, get to the lungs where they may give rise to focal hemorrhages and to allergic → [pneumonia](#). The larvae migrate up the bronchial tree to the pharynx and are swallowed. They reach adulthood in the upper small intestine where they attach to the mucosa with their powerful buccal capsule enclosing a tag of mucosa from which they draw blood. This may be accompanied by → [abdominal pain](#) after 35–40 days. From time to time the worm moves to another site, sometimes leaving the microscopic → [ulcer](#) to bleed until the vessels thrombose and the site heals. With heavy infection anemia develops.

## Homoplasy

→ [Phylogeny](#).

## Homoxeny

From Greek: *homos* = identical, *xenos* = foreign. Uniform development, development in 1 host-type.



Because the worms take in more blood than they assimilate; black stools, or melena, are common, but some of the iron lost is resorbed in the intestine.

### Immune Responses

Data indicate that a Th2-dominated immune response acts to reduce the weight and →fecundity of →hookworms like *Ancylostoma duodenale* and *Necator americanus* in the human gut. Parasite specific IgE and →eosinophilia may be involved in host protection. In elder patients there is significant negative correlation between antilarval IgG antibodies and parasite burden. The fact that human hookworms nevertheless survive in an immunological hostile host for many years may be best explained by efficient escape mechanisms preventing the immune system from exerting its full effects. Several molecules secreted by hookworms have a potential to inhibit or antagonize the immune system of the host. In →*Ancylostoma* species, the neutrophil inhibitory factor (NIF), a glycoprotein of 41 kDa potently inhibits CD11b/CD18 dependent neutrophil activation and adherence to vascular endothelium. Since *Necator americanus* lacks NIF it may rely on acetylcholinesterase, glutathion-S-transferase, and superoxide dismutase to suppress inflammation. Acetylcholinesterase not only inhibits gut peristalsis but may also suppress the release of inflammatory cytokines by lymphocytes stimulated via their muscarinic receptors. Secreted glutathion-S-transferase, and superoxide dismutase may represent protective mechanisms of the hookworms against reactive oxygen intermediates produced by activated leukocytes in the gut. An IgA protease present in *Necator americanus* has the potential to produce IgA Fab fragments capable of blocking complement or phagocytic attack mediated by intact IgG or IgM. Since secretory IgA provides a potent signal for eosinophil degranulation, the secretion of an IgA protease would be beneficial to the parasite also on this level.

### Targets for Intervention

Both *Ancylostoma duodenale* and *Necator americanus* require specific →environmental conditions for their larvae to hatch and become ensheathed, rhabditiform, infective organisms that will actively enter a new host through the skin, usually that of the feet or lower part of the legs. Most of the infections are contracted in the peridomestic environment. Figure 1 indicates the infected host, the contaminated environment, and the infection cycle as targets of intervention. Suitable approaches to control include the detection and treatment of infected persons, the safe disposal of feces, rigorous environmental sanitation, and wearing shoes as a means of avoiding skin contact with contaminated soil.

**Main clinical symptoms:** →Pruritus, bronchitis, eosinophilia, red-diarrhea, fever, →anemia, cachexia, breakdown of circulation

**Incubation period:** Dermatitis: 4 hours, intestinal symptoms: 2 weeks.

**Prepatent period:** 5–6 weeks.

**Patent period:** 20 years.

**Diagnosis:** Microscopic determination of eggs in fecal samples (Fig. 2).

**Prophylaxis:** Use solid shoes in endemic regions and avoid human feces.

**Therapy:** Treatment see Nematocidal Drugs.

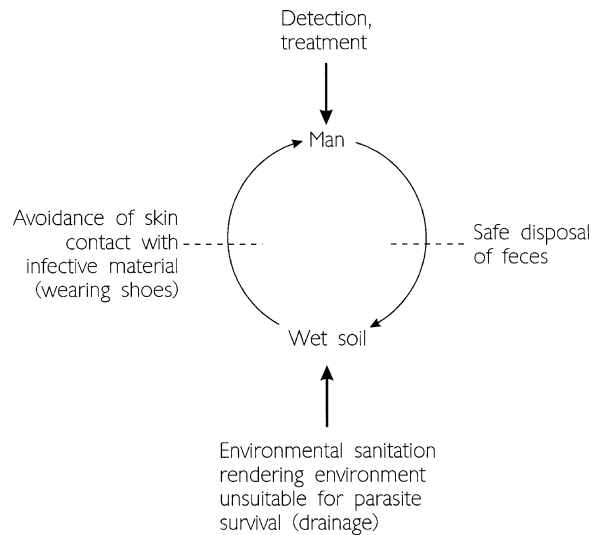

**Hookworm Disease. Figure 1** Targets and approaches for the control of hookworm disease.

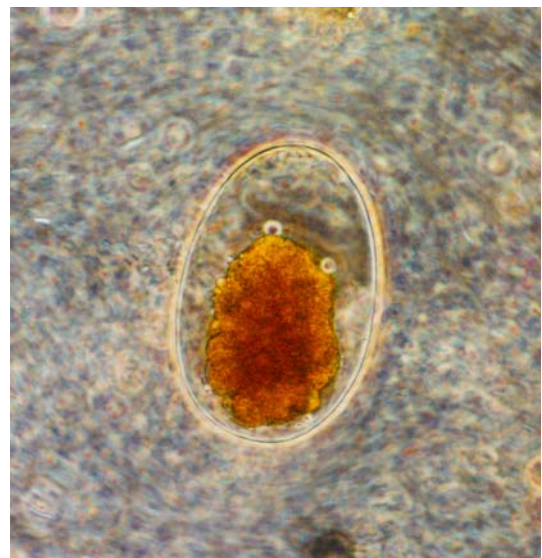

**Hookworm Disease. Figure 2** Egg of *Ancylostoma duodenale* obtained by M.I.F. concentration method.

## Hookworms

Trivial name for Ancylostomatidae, since the worms appear hook-like when attached at the host's intestinal wall to suck blood.

### Synonym

Ancylostomatidae.

### Classification

Class → *Secernentea* of → *Nematodes*.

### Life Cycle

Figs. 1, 3 (pages 616, 617).

### Distribution

Fig. 2 (page 617).

### Disease

→ *Ancylostomiasis*, → *Necatoriasis*, → *Hookworm Disease*, → *Creeping Eruption*.

## Hoplopsyllus anomalis

Flea; plaque vector of California ground squirrel and of rats.

## Hormones

For detailed information on the following subjects please refer to the respective headwords: → *Ecdysteroids*, → *Ecdysteroid Receptor*, → *Gastrointestinal Hormones*, → *Glucocorticoids*, → *Growth Factors*, → *Host Endocrine System*, → *Insulin*, → *Juvenile Hormones*, → *Opioids*, → *Sex Steroid Hormones*.

## Horn Fly

→ *Haematobia irritans* (→ *Diptera*), → *Tabanids*.

## Horse Bot Flies

→ *Gasterophilus*.

## Horse Flies

→ *Tabanus*, → *Tabanids*.

## Horse Leech

→ *Limnatis nilotica*.

## Horse Tick

*Dermacentor albipictus*.

## Host Behavior

### General Information

Host behavior can be modified in various ways by parasites, for instance just because of debilitation. However, the most interesting alterations are related to the → *extended phenotype*.

In the last 20 years, an increasing number of “manipulations” of host behavior by parasites have been reported. These manipulations increase the chances of the life cycle being completed.

The case of the “brainworm” which manipulates ant behaviour was one of the first cases to be described in detail. → *Dicrocoelium dendriticum* is a trematode which develops in 3 successive hosts: a terrestrial gastropod, an ant, and a mammal (usually a sheep). → *Cercariae* are produced in the snail and emitted in small mucus balls which attract ants and are eaten by them. For the life cycle to be completed, the ant must be then ingested by a sheep. One of the ingested cercariae makes its way towards the brain of the ant and provokes a drastic change in the behavior of its host: “whereas an uninfected ant would normally retreat into its nest when it became cold, infected ants climb to the top of

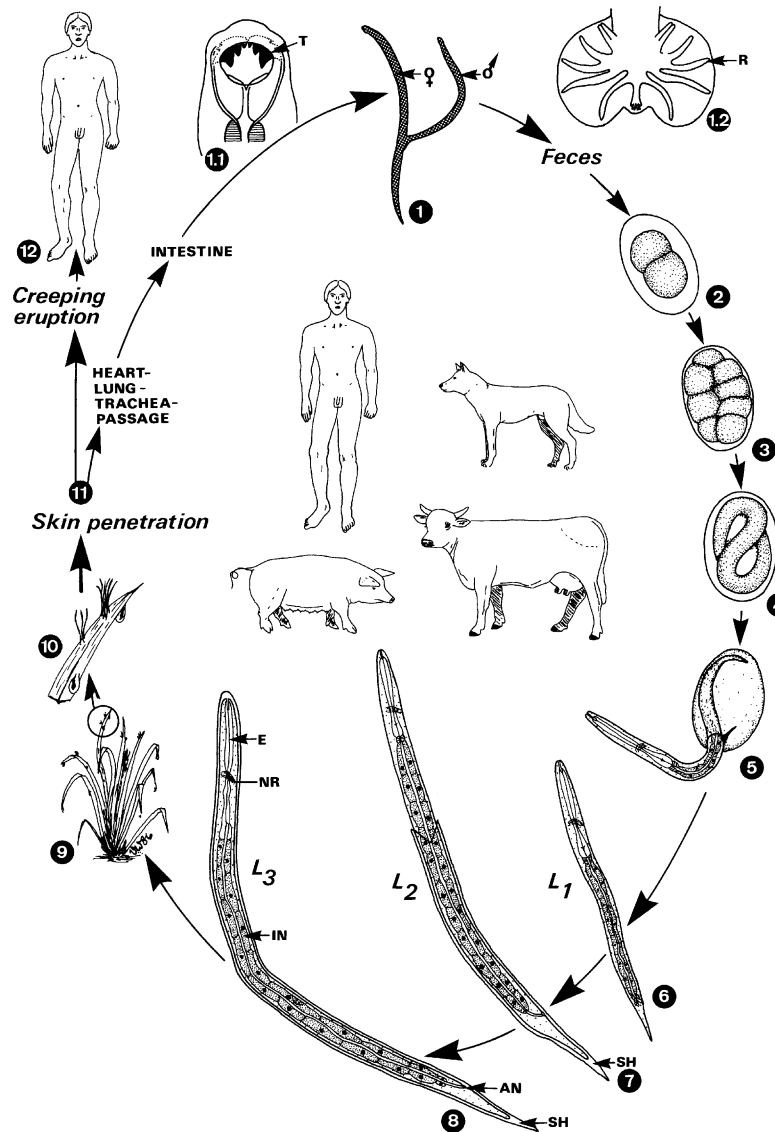

**Hookworms.** Figure 1 Life cycle of hookworms (e.g., *Ancylostoma duodenale*, *A. caninum*, *A. braziliense*, *Necator americanus*, *Globocephalus* sp., *Bunostomum* sp.). 1 As shown here for *A. caninum*, the adults inhabit (in copula; 1) the small intestine of their hosts, attaching by means of their buccal cavity to the mucous layer and sucking blood using their species-specific teeth (1.1). By help of their copulatory bursa (fortified with specific rays; 1.2) the males are attached to the female vulva (location varies according to species) thus giving rise to the typical Y-shaped copulatory aspects. 2–4 Eggs are excreted unembryonated and develop the L<sub>1</sub> in the soil. 5–8 The L<sub>1</sub>, which is called a rhabditiform larva (due to its esophagus), escapes from the eggshell and feeds on organic material; it then undergoes the first molt, completely shedding its cuticle. After a time spent feeding, the L<sub>2</sub> (still rhabditiform) molts to the infectious filariform L<sub>3</sub>. The second-stage cuticle may be retained (8) as a loose-fitting sheath or it may be lost earlier (7). 9–10 L<sub>3</sub> live in the upper few millimeters of soil, migrate to the surface, and are often found in groups of thousands on the soil or on plants (moving synchronously). 11 Infection of final hosts occurs when L<sub>3</sub> contacts the skin and burrows into it. After a heart-lung-trachea passage the L<sub>3</sub> reach the intestine, molt twice, and become sexually mature. (In some species transplacental transmission of L<sub>3</sub> or transmission in mother's milk is possible.) 12 If a human becomes invaded by L<sub>3</sub> of a species or strain that normally matures in animals (e.g., *A. caninum*, *A. braziliense*) the larvae migrate for months through the cutaneous layers, leading to a disease called creeping eruption. AN, anus; E, esophagus; IN, intestine; NR, nerve ring; R, rays of bursa copulatrix; SH, sheath (originating from the molted cuticle of the preceding larval stage); T, tooth (here each with 3 peaks).

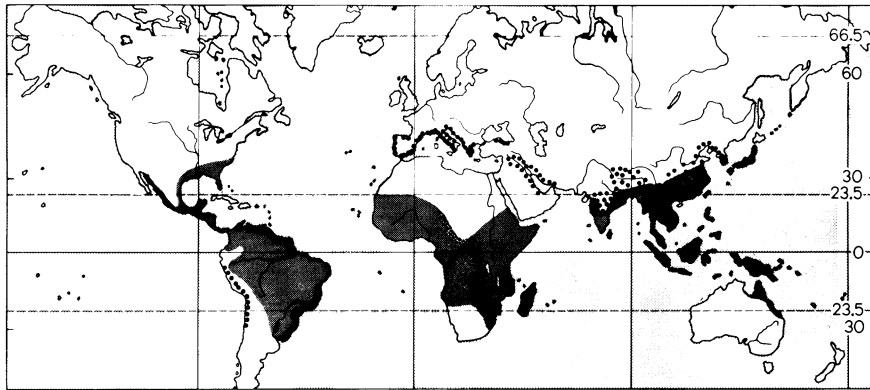

**Hookworms. Figure 2** Distribution map of *Ancylostoma duodenale* (grey) and *Necator americanus* (black).

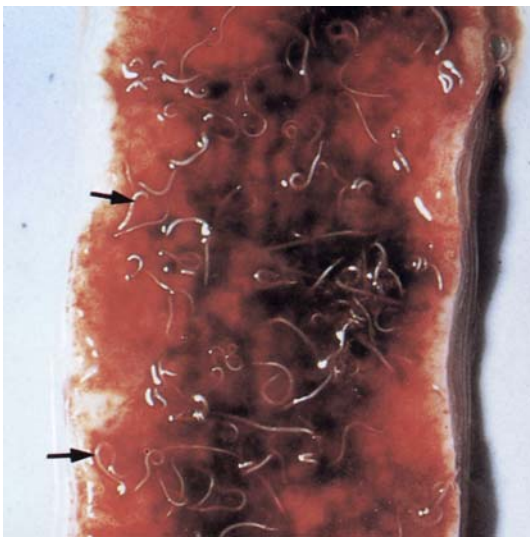

**Hookworms. Figure 3** Dog intestine filled with numerous blood sucking *Ancylostoma* worms leading to an enormous bleeding.

grass stems, clamp their →jaws in the plant and remain immobile as if asleep.” This “abnormal” behavior increases considerably the probability of the infected ants being eaten by sheep. It is also remarkable that the infected ant, if not eaten, goes down to its nest during the hot period of the day (which prevents it from desiccation) and returns at night to its position at the top of stems.

Such adaptive processes, which increase the probability of a parasite completing its life-cycle by modifying host behavior, are part of a more general aspect of parasite adaptations, called →favourisation.

### Related Entry

→Extended Phenotype.

## Host Cell Invasion

### General Information

When a parasite comes into contact with a potential host cell, 2 series of events may occur which lead to intracellular parasitism. First comes a recognition step which enables a suitable close association between both partners, then comes the internalization of the organism within the host cell. The mechanisms of recognition are far from being entirely elucidated, as well as the ones by which entry occurs. Data have been obtained however, which show that the different parasite groups have evolved different strategies toward these goals.

A major question when dealing with host cell invasion by a pathogen is to decide whether this one actively enters a cell or whether it is engulfed by the process called phagocytosis. The matter is rather clear with those parasites which force their way through the plasma membrane of the host cell or fuse their membrane with it; it is more confusing when internalization occurs within a →parasitophorous vacuole, the membrane of which is continuous with the host cell →plasmalemma during the whole invasion process, as is the case with most protozoan parasites. Moreover, when a parasite uses phagocytosis to gain access into a cell, another important issue is its behavior facing the fate of a phagosome, i.e., fusion with a lysosome and exposure to a cocktail of lytic enzymes which are supposed to digest the phagosomal contents. Parasites seem to have also evolved various ways of escaping this fatal outcome, as will be described below. Different invasion processes which occur among intracellular eukaryotic pathogens are depicted in Fig. 1.

Because of their medical interest, host cell invasion by Apicomplexan zoites (e.g., →*Plasmodium*, *Toxoplasma*, →*Eimeria*, →*Sarcocystis*, or →*Piroplasms*) has

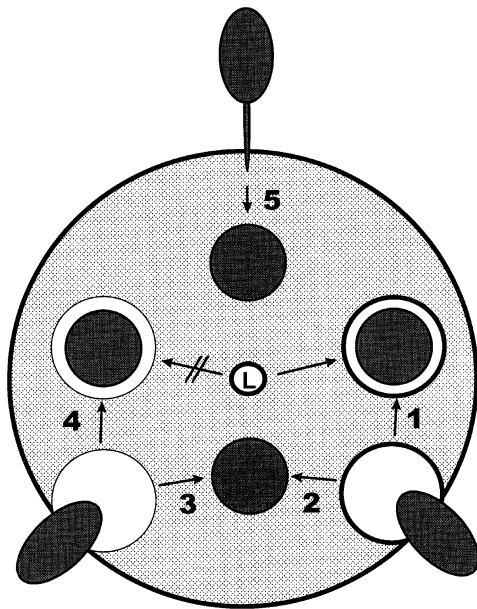

**Host Cell Invasion.** Figure 1 Invasion processes observed among different intracellular pathogens. 1 Invasion by phagocytosis, parasite development in →phagolysosomes (e.g., →*Leishmania* spp.). 2 Invasion by “phagocytosis,” escape of the parasite into the host cell cytoplasm (e.g., *Trypanosoma cruzi*). 3, 4 Active invasion of →Apicomplexa, characterized by a →moving junction and the development of the parasitophorous vacuole. An originality of piroplasms (e.g., →*Babesia*) is the disintegration of the parasitophorous vacuole membrane soon after invasion, the parasite then lying directly within the erythrocytic stroma (3). Other Apicomplexa complete their →schizogony within a parasitophorous vacuole after inhibition of fusion with →lysosomes (4). 5 Invasion through the host cell plasmalemma (Microsporidia).

been studied to a great extent (→Apicomplexa/Host Cell Invasion).

In contrast, little morphological data are available on the invasion of host cells by kinetoplastids. More studies deal with the ways these organisms escape the phagosome lysosome fusion (→*Trypanosoma*/Host Cell Invasion, →*Leishmania*/Host Cell Invasion). Although rather poorly known, the mechanism of cell invasion by →Microsporidia has very peculiar characteristics. →Microsporidia self-inject into their host cell by devaginating a membranous organelle (→Polar Tube) which forces its way through the host cell plasmalemma and through which the parasite →cytoplasm moves into the recipient cell (Fig. 1). Invasion is thus intrusive: this is the only case known among intracellular parasitic →protozoa where parasite development may occur either in the cytoplasm of the cell or within a parasitophorous vacuole; but whether this →vacuole forms at invasion or later is not known.

## Host Demography

The impact of parasites on host demography was underestimated by ecologists for a long time but, during the last 20 years, several studies have demonstrated that parasites play a prominent role in the regulation and sometimes even breakdowns of their host populations.

Among the studies on the relationship between the parasitic load and the demography of the hosts, the following are especially demonstrative.

In Scotland, important variations in the population densities of the grouse *Lagopus lagopus scoticus* depend at least in part on the abundance of the nematode *Trichostrongylus tenuis*, which lives by thousands in the caeca of the bird. The years when climatic conditions favour the survival of the larvae of the nematode in the open air, the grouse experience increased predation and loss of →fecundity.

Similarly, another nematode, *Obeliscoides cuniculi*, makes the snowshoe hare *Lepus americanus* vulnerable to its predators. Individuals which are treated by an anti-helminthic (ivermectin) are 2–3 times less often captured by predators than controls.

However, parasites are not always detrimental to their hosts. This happens when parasites interfere with competition between hosts. A parasite is capable of modifying the status of competition between free-living species, as soon as the species in competition are differently affected by this parasite. For instance, the fruit flies *Drosophila melanogaster* and *D. simulans*, species morphologically similar but genetically isolated, are attacked, at the larval stage, by the parasitoid wasp *Leptopilina boulardi*. Experiments by Boulétreau et al. have demonstrated that, when *D. melanogaster* and *D. simulans* are grown together in equal numbers at 25°C, *D. melanogaster* eliminates *D. simulans* in a few weeks. However, when the parasitic wasp is added to the system, an equilibrium becomes established, and the species of *Drosophila* coexist. Boulétreau et al. explained this result by a different receptivity of the 2 *Drosophila* to the parasitoid, which parasitizes *D. melanogaster* more frequently than *D. simulans*. Field studies in African oases have demonstrated that, the more abundant the wasp is, the more an equilibrium between the species of fruit flies is realised: the conclusion is that a parasite may be detrimental to individuals, but beneficial to the population (in this example, any individual of *D. simulans* which is infested by *Leptopilina boulardi* is finally killed by the parasite, but *D. simulans* can compete successfully with *D. melanogaster* only where the parasite is present).

Freeland thinks that a species may invade an ecosystem only if its susceptibility to the local parasites is lower than that of the related autochthonous species. This case is probably rather rare because the immigrant, being in contact with the parasite for the first time, may have limited defences. This means that certain parasites can contribute to maintaining the composition of faunas (biodiversity), by protecting them from invasions. A classical example is that of the nematode *Parelaphostrongylus tenuis*, a parasite of the North American white-tailed deer *Odocoileus virginianus*, which reduces the competition of its host with other ungulates. For instance, the moose *Alces alces* is more susceptible to the parasite than the white-tail deer and experiences important mortality rates when it invades the territories of the white-tailed deer.

The same kind of “protection by parasites” can play a role within a given species, between populations of this species. It is probable that →malaria protected Africans from colonisation until the discovery of quinine and that, nowadays, trypanosomes protect native African ungulates from the introduction of alien species.

Because the impact of parasites on the competition between hosts is often unpredictable, the consequences of introduction of allochthonous species with their parasites can be dramatic: the Caspian sturgeon *Acipenser stellatus* was introduced 40 years ago in the Aral Sea with its monogenean parasite *Nitzschia sturionis* which passed onto the local sturgeon *A. nudiiventris*. There this new parasite provoked disastrous mortality rates in the autochthonous species. It is not impossible that the extinction of some vertebrates in the course of geologic times were due partly to parasites.

Finally, the history of the conquest of Latin America is perhaps the best example of the impact of “new” parasites on host populations. Black estimates that more than 50 million native Americans died from pathogens introduced by the invaders. This recalls the sentence of Haldane: “a non-specific parasite to which partial immunity has been acquired, is a powerful competitive weapon.”

## Host Endocrine System

### General Information

A possible strategy for a successful adaptation of a parasite to its host is the induction of conditions favourable for its own development and metabolism by manipulating the endocrine system of the host. This same goal can also be reached by producing hormones

which are similar to host hormones and which mimic their actions (→Gastrointestinal Hormones, →Growth Factors). Modification of the endocrine system of the host by a parasite leading to favourable conditions has indeed been found in a variety of host–parasite interactions in both invertebrates and vertebrates and practically every hormone system in a host might be involved. Changes in hormone titres of the host may not only be seen under the aspect of favourable for the parasite but may also represent adaptations of the host to a disadvantageous condition. For example, the reduced level of thyroxine in severe →falciparum malaria patients is interpreted as an adaptation of men to accelerated catabolism. One also has to keep in mind, that one hormone might act in various ways, may be dependent on the parasite species. In the case of nematode-infected mammals thyroxine exerts its influence presumably via the immune system of the host.

### Manipulation Mechanisms

Manipulation of the host’s endocrine system in order to improve the living conditions for the parasite involves several mechanisms:

- Maintenance of an adequate food and energy supply (→Ecdysteroids, →Gastrointestinal Hormones, →Growth Factors, →Insulin, →Juvenile Hormones).
- Induction of immunosuppression, not only by interfering with immunomodulatory steroid hormones (→Sex Steroid Hormones, →Glucocorticoids), but also by the induction of specific defence molecules. A newly described Ig-superfamily member from the snail *Lymnaea stagnalis* is downregulated during the course of parasitosis with the trematode →*Trichobilharzia ocellata*.
- Induction of analgesia in the host (→Opioids).
- Control of the speed of development, an adequate body size and reproduction of the host. These diverse effects might be brought about by one and the same hormone. For example, higher juvenile hormone concentrations in larval stages of insects increase body size, prolong larval life and prevent reproduction, whereas in females →juvenile hormones induce vitellogenin synthesis in the fat body and facilitate vitellogenin uptake into →oocytes. Both processes are inhibited in females if they are infected by metacestodes. In the *Lymnaea-Trichobilharzia* system mentioned above, not only is immunosuppression induced by the →cercariae but also the synthesis and/or release of a peptide, called schistosomin, which has cytokin-like functions without being a cytokine and which leads to →castration and giant growth in the snail host (→Ecdysteroids, →Growth Factors, →Juvenile Hormones).

All these processes are under hormonal control and may be the result of a rapid and direct change in gene expression in the host, evoked by the parasite. Of course these processes can also be regulated by other factors and they may not be realised simultaneously. It is also not clear in all instances whether the changes in the host's hormonal system are specific or general stress reactions.

## Host Finding

Many parasite stages reach and infect their hosts, and an increasing amount of research is concerned with the question of how the parasites find and recognize their hosts. In most cases where host-finding behavior has been analyzed in some detail, it has been found to consist of a series of different behavioral phases. In each of these phases the parasites may respond to different environmental or host signals, a fact which often complicates the experimental analysis of host-finding behavior. Most information on the complex nature of host finding is available in →[helminth](#) parasites for digenean miracidia and →[cercariae](#) (→[Digenea](#)), and →[nematode](#) larvae, and in bloodsucking arthropods for →[mosquitoes](#), →[tsetse flies](#) and →[ticks](#) (for details see *host finding* in the entry of the respective group).

The mechanisms of host finding and host recognition in these better-studied parasite groups support the following views. Most parasites which actively reach and infect their hosts have evolved very complex behavior patterns for finding their hosts and most of them achieve a narrow range of host-specificity. This is

also true for stages which are produced in very large numbers (e.g., trematode cercariae). Another typical characteristic of host finding is a high diversity of host recognition strategies. Normally, each species finds and identifies its host with mechanisms and in response to host signals that differ from those of other species, even when these attack the same host genera. The high complexity, specificity, and diversity of host recognition strategies suggest that host finding and host recognition are important determinants in the evolution of parasitism.

## Host Hormone Effects on Parasites

Some parasites are considerably affected in their development by host hormones ([Table 1](#)).

## Host Response

→[Pathology](#).

## Host-Parasite Interface, Protozoa

The protozoan parasites developed a great variety of contacts to their hosts. The origin of parasitism started surely from free-living stages, that entered the

**Host Hormone Effects on Parasites. Table 1** Examples of host hormone effects

Parasite	Hormone	Parasite stage	Effects
<i>Entamoeba histolytica</i>	Cortisol	Trophozoites	↑ Reproduction, ↑ metabolic activity
<i>Leishmania mexicana</i>	GM-CSF	Promastigotes	↑ Growth
<i>Trypanosoma cruzi</i>	EGF	Amastigotes	↑ Growth, ↑ reproduction, ↑ metabolic activity
<i>Plasmodium falciparum</i>	Cortisol	Merozoites	↑ Growth, ↑ reproduction
<i>Schistosoma mansoni</i>	Cortisol	Adult worms	↓ Reproduction, ↓ oviposition
<i>Taenia crassiceps</i>	Estradiol	Cysticerci	↑ Growth, ↑ reproduction
<i>Onchocerca volvulus</i>	Hydroxyecdysone	Microfilariae	↑ Metabolic activity
<i>Brugia malayi</i>	EGF	Microfilariae	↑ Growth, ↑ differentiation

EGF: Epidermal growth factor

hollows of the host's body. Then more or less fixed attachments to inner surfaces occurred and finally penetration into cells took place. Once inside, the parasites became situated directly in the →cytoplasm or were included into parasitophorous →vacuoles (→Host Cell Invasion, →Coccidia). From the latter several genera (e.g., *Toxoplasma*, →*Sarcocystis*, →*Frenkelia*, →*Besnoitia*, →*Cystoisospora*, *Hammondia*, *Neospora*, *Caryospora*) formed so-called tissue-cysts by →fortification (= formation of a →primary cyst wall) and development of species-specific protrusions of the original membrane of the parasitophorous membrane (→Tissue-Cyst). The main features are summarized in Table 1.

## HRP-1 Protein

→Knobs, →*Plasmodium falciparum*.

## HSC

→Hepatic Stellate Cells.

## House Fly

*Musca domestica* (→Diptera).

## Human Botfly

→*Dermatobia hominis*.

**Host-Parasite Interface, Protozoa. Table 1** Position of unicellular parasites in vertebrate hosts

Genus/Species	Extracellular	Attached to cells	Intracellular: directly in the cytoplasm	Intracellular: in parasitophorous vacuoles
<i>Giardia</i>	+	+		
<i>Trichomonas</i>	+	+		
<i>Leishmania</i>			+	+
<i>Trypanosoma brucei</i> -group	+			
<i>Trypanosoma cruzi</i>	+		+	
<i>Entamoeba histolytica</i>	+			
<i>Naegleria</i>	+			
<i>Acanthamoeba</i>	+			
<i>Monocystis</i>	+			
<i>Gregarina</i>	+			
<i>Eimeria</i> , <i>Isospora</i>				+
<i>Toxoplasma</i>				+
<i>Sarcocystis</i>				+
<i>Cryptosporidium</i>		+		
<i>Plasmodium</i>				+
<i>Babesia</i> , <i>Theileria</i>			+	
<i>Hepatozoon</i>	+			
<i>Haemogregarina</i>				+
<i>Microsporidia</i>			+	+ (some species)
<i>Myxozoa</i>	+			
<i>Trichodina</i>		+		
<i>Balantidium coli</i>	+			
<i>Ichthyophthirius</i>	+			
<i>Blastocystis hominis</i>	+			
<i>Pneumocystis carinii</i>	+	+		



## Human Parasitic Diseases: Origins

Like other host species, humans harbour 2 kinds of parasites, from an evolutionary point of view. Some of them have been parasitic in the hominid lineage for a long time and have coevolved with our primate ancestors. Others are the result of lateral transfers (or “host-switchings”).

The classical example of parasites which are probably inherited from our primate ancestors is the nematode → *Enterobius vermicularis*, simply because all other primates harbour species closely related to “our” parasite. This does not mean that lateral transfers of oxyurids did not occur between some species of primates but these transfers occurred inside the phylum.

The classical example of human parasites which are certainly the result of “true” lateral transfers is provided by schistosomes. There is no evidence that schistosomes evolved in primate hosts. On the contrary, a phylogeny based on DNA sequences showed that they have evolved in host phyla, rodents and ungulates. These studies led to the conclusion that the human parasite → *Schistosoma mansoni*, the agent of intestinal schistosomiasis, is close to a rodent parasite, whereas the human parasite → *S. haematobium*, the agent of urinary schistosomiasis, is related to ungulate parasites. It is probable that the schistosomes were acquired by hominids when they increased their contact with water sources in the African savannahs. The period of the host switching was tentatively suggested to be about 2 million years ago, on the basis of molecular comparisons. The origin of the genus *Schistosoma*, as deduced from molecular phylogeny, is in Asia.

Similarly, on the basis of molecular studies, it has been proposed that → *Plasmodium falciparum* could be the result of a transfer from birds to humans, and also because the shape of the parasite (“*falciparum*”) seems better adapted to the shape of an avian red cell (oval) than to that of a primate red cell (circular).

Anderson and Jaenike have considered → *Ascaris* from humans and pigs, which are morphologically closely related. Taking into account that domestication of pigs occurred between 7,000 and 20,000 years before the present time, the authors ask the question: did humans acquire the parasite from pigs or the contrary? Their study of the introns of several nuclear genes, of ribosomal DNA spacers, and of a part of → mitochondrial DNA, suggests that the pigs are the ancestral hosts and that all the *Ascaris* of present-day humans originate from a unique event of lateral transfer from pigs, which could have occurred in Asia.

Many other parasites of mankind are probably the result of lateral transfers due to the invasion of new ecosystems and the acquisition of new behaviours by

humans, which put them in contact with infective stages of parasites which had evolved in other phyla. The transfer is of course sometimes impossible. For instance, swimmers are frequently infested in lakes by → cercariae of various bird schistosomes, but the disease is limited to a dermatitis (→ “Swimmer’s Itch”) because the schistosomes cannot mature into adult worms.

A lateral transfer is not necessarily followed by a → speciation process. Humans may simply become a new species in the host-spectrum of the parasite. This has consequences on pathogenicity: when parasites have a wide host-spectrum, the optimal pathogenicity (→ Virulence) cannot be selected in every host species. The pathology may remain either sub-optimal or over-optimal. This causes a permanent maladaptation of the parasite to certain of its hosts, sometimes to humans.

## Humoral Immune Response (HIR)

HIR is concerned with B-lymphocyte cell products (i.e., formation of immunoglobulin (Ig) antibodies. The IgA, IgG, IgM, and IgE occur in different situations and are effective against parasites in different ways (e.g., neutralization of invading stages, agglutination, complement activation, facilitated opsonization, etc.).

## Hunterella

Genus of ichneumonid wasps, which parasitize as larvae in ticks. In some regions of West Africa *H. hookeri* kills about 90% of the nymphs of *Rhipicephalus sanguineus*.

## Hyalomma

### Name

Greek: *hyalos* = glass, *omma* = eye.

### General Information

Genus of hard → tick species with two hyaline eyes (name); about 30 species are found in arid or semi-arid species in Africa, Asia, and southern Europe. Important as vector of → *Theileria* stages is *H. anatolicum anatolicum* on ruminants and horses, while *H. marginatum* occurs on birds and *H. aegypticum* on turtles. The life

cycle may be completed in less than 4 months, thus the infection risk is increased by this short period as well as by the fact that *Hyalomma* spp. may depon more than 10,000 eggs.

## Hyaloplasm

### Synonym

→Ectoplasm.

## Hybridization

Formation of progeny between 2 different species (e.g., →*Schistosoma mansoni* and →*S. japonicum* or →*Fasciola hepatica* and *F. gigantea*).

## Hydatid Disease

### Synonyms

→Hydatidosis, cystic →echinococcosis.

## Hydatidosis

→Echinococcus, →Echinococcosis.

## Hydatids

Large (up to 20 cm in diameter), fluid-filled cysts formed by →*Echinococcus granulosus* inside intermediate hosts (e.g., sheep, humans). The aqueous fluid contains thousands of →brood capsules and protoscolices that are infectious to the final hosts (e.g., dogs, foxes).

## Hydatigera taeniaeformis

Synonym of →*Taenia taeniaeformis*, →cestodes; tapeworm of cats and other felids reaching a length of up to

60 cm; intermediate hosts are rodents harbouring so-called →strobilocercus larvae.

## Hydrocephalus

→Toxoplasmosis, Man/Pathology.

## Hydrogen

→Energy Metabolism.

## Hydrogenosomes

The →trichomonads, which are anaerobic, have →microbodies called hydrogenosomes. They are limited by mostly 2 closely attached membranes surrounding a granular matrix (→Trichomonadida/Fig. 1C, E). The enzyme system of these bodies differs from that of →mitochondria, as they metabolize pyruvate from →glycolysis into acetate, CO<sub>2</sub> and H<sub>2</sub>. In ciliates, similar hydrogenosomes with double membranes are present, in addition to regular →mitochondria (→Energy Metabolism).

## Hydropene

### Chemical Class

Juvenile hormone agonist (juvenile hormone analogue).

### Mode of Action

Insect growth regulator (IGR, juvenile hormone mimics). →Ectoparasiticides – Inhibitors of Arthropod Development.

## Hydrotaea

Genus of the fly family Muscidae; important species are *H. irritans* (5.5–7 mm long) of cattle being called head and udder fly. The larvae live in the feces, highest

activity is in July and August. This fly is involved in the disease described as summer mastitis. On horses *H. albipuncta* occurs in addition to *H. irritans*.  
→[Ectoparasiticides](#).

## Hydroxychloroquine

→[Malariacidal Drugs](#).

## Hydroxyquinoline Derivatives

→[Malariacidal Drugs](#).

## Hygiene

Science of health and its preservation. →[Disease Control, Methods](#).

## Hygienic Behavior

→[Behavior](#).

## Hymenolepiasis

### General Information

The cestode *Hymenolepis nana* (syn. →[Rodentolepis nana](#)) is primarily a parasite of rodents, but is also frequently found in man where it is autoreproductive, but in general not very pathogenic. [Figure 1](#) shows the presence of man-man, rodent-rodent, man-rodent, and rodent-man cycles.

### Targets for Intervention

Possible targets are the rodent reservoir, the human cases, transmission both from and to man, and the environment where infective material may be encountered ([Fig. 1](#)). It is evident that one approach on its own will probably do very little to improve the situation.

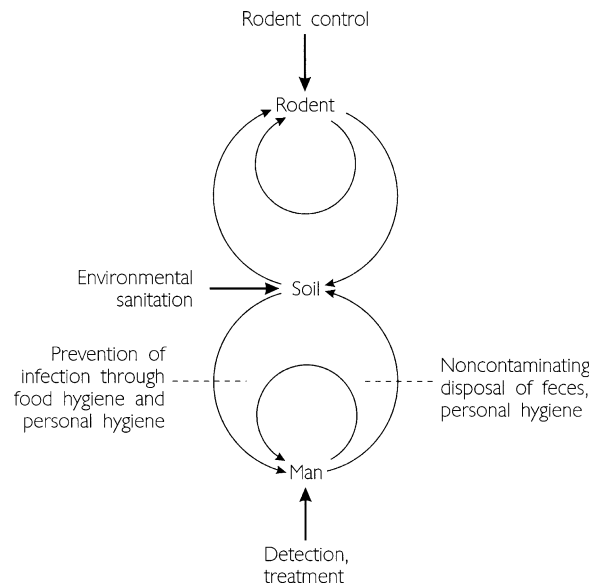

**Hymenolepiasis.** [Figure 1](#) Targets and approaches for the control of hymenolepiasis.



**Hymenolepiasis.** [Figure 2](#) LM of an egg of *Hymenolepis nana*.

**Main clinical symptoms:** Malnutrition, →[diarrhoea](#), →[abdominal pain](#).

**Incubation period:** 1–4 weeks.

**Prepatent period:** 2 months.

**Patent period:** 2–4 weeks.

**Diagnosis:** Microscopic diagnosis of eggs in fecal samples ([Figs. 2, 3](#)).

**Prophylaxis:** Avoid contact with rodent and human feces.

**Therapy:** Treatment with praziquantel, →[Cestodocidal Drugs](#).



**Hymenolepiasis.** Figure 3 LM of an egg of *Hymenolepis diminuta*.

## Hymenolepidae

### Name

Greek: *hymen* = fine membrane, *lepis* = scale.

### Classification

Family of →Eucestoda.

### Life Cycle

Figs. 1–6 (pages 626, 627).

### Disease

→Hymenolepiasis.

## Hymenolepis diminuta

From Greek: *hymen* = thin membrane, *lepis* = cover.  
→Cestodes, →Hymenolepidae.

## Hymenolepis microstoma

→Cestodes, →Hymenolepiasis.

## Hyostrongylus

### Name

Greek: *hyo* = belonging to, *strongylos* = rounded.

### Classification

Genus of the nematode family Trichostrongylidae.

### General Information

This so-called red-stomach-worm of pigs reaches as female about 1.2 cm in length, the males are only 0.7 mm long. The worms suck blood in the stomach and after copulation the 70–85 mm × 40 mm sized eggs appear in the faeces. After some days the larva 1 hatches from the egg and develops into larva 2, which survives often for 1 year in the food. After oral uptake the larva 3 develops within 3 weeks (including 2 moults) into the adult stage.

### Disease

→Alimentary System Diseases, Swine.

## Hyostrongylus rubidus

→Nematodes.

## Hypergammaglobulinemia

Symptom of disease in cystic →*echinococcosis* and in →*malaria* being characterized by an enormous amount of gamma-globulines in the blood.

## Hyperinfections

### Name

Greek: *hyper* = over, Latin: *inficere* = infect.

Infections with enormous amounts of parasites, which then disseminate also in other than the normal organs, e.g., in →*Strongyloides stercoralis*, →*Capillaria philippensis*. This often is the case, when →*autoinfection* is possible.

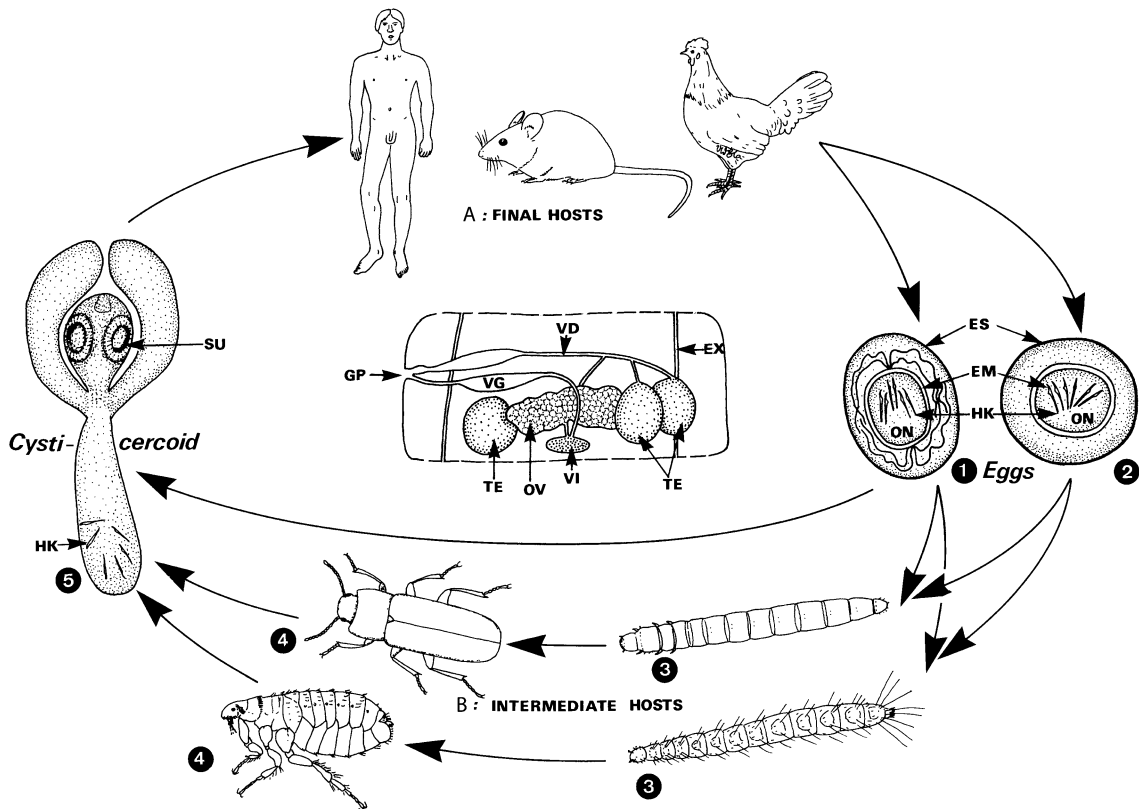

**Hymenolepididae. Figure 1** Life cycle of tapeworms of the family Hymenolepididae. **A** Species and final hosts (others see →Eucestoda/Table 1): →*Rodentolepis* (*Vampirolepis*, *Hymenolepis*) *nana* (*fraterna*) of mice and humans, 4–6 cm long and 1 mm broad, scolex with 24–27 rostellar hooks; →*Hymenolepis diminuta* of rats, mice, dog, and humans, up to 6 cm long and 3.5 mm broad, no rostellar hooks; *Echinolepis* (*Hymenolepis*) *carioca* of chickens and birds. →*Strobila* up to 8 cm long and 3–5 mm broad, scolex has no rostellar hooks. The sexually mature →proglottids are characterized by 3 spherical testes (TE); there is no distinct border wall between the proglottids (dotted lines). **B** Intermediate hosts (→Eucestoda/Table 1). 1–4 Eggs containing the →oncosphaera larva (1 *H. nana*, 40–60 × 30–50 μm; 2 *H. diminuta*, 60–80 × 70 μm) are infectious to various insects (larvae, adults) as intermediate hosts (3, 4). 5 Inside the body cavity of these hosts a second larva (→Cysticeroid) is formed, which grows to be a mature tapeworm when the →intermediate host is swallowed by the final host. In *H. nana* the intermediate host is optional; when eaten by a man or a rodent, the egg (1) hatches in the duodenum, releasing the →oncosphaera, which penetrates the mucosa. Here it develops directly into a cysticeroid (5). In about 6 days the →cysticeroid emerges into the lumen of the small intestine, where it attaches and grows to be a mature worm. EM, →embryophore (layer surrounding the oncosphaera); EX, excretion system (longitudinal); ES, →eggshell; GP, genital pores; HK, hooks of oncosphaera; ON, oncosphaera; OV, ovary (→Germarium); SU, sucker; TE, →testis; VD, vas deferens; VG, vagina with enlarged seminal vesicle; VI, →vitellarium.

## Hyperkeratosis

Symptom of diseases due to →*Onchocerca volvulus*. The microfilariae in the skin introduce an immune reaction described also as “paper skin.”

## Hypermastigida

### Classification

Order of →Mastigophora.



**Hymenolepididae. Figure 2** SEM of an adult of *Hymenolepis nana*.

### General Information

Members of the Hypermastigida (Fig. 1, page 628), like the →Oxymonadida, inhabit the intestine of wood-feeding insects and are involved in the digestion of cellulose; however, the question of whether they



**Hymenolepidae. Figure 3** SEM of the scolex of *Hymenolepis nana*.

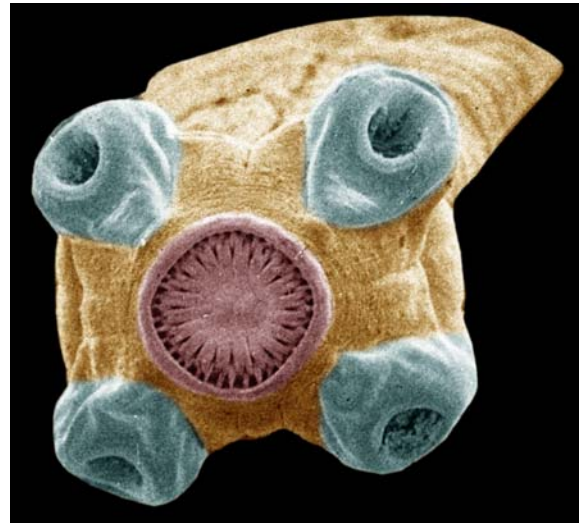

**Hymenolepidae. Figure 5** SEM of the scolex of *Hymenolepis microstoma*.

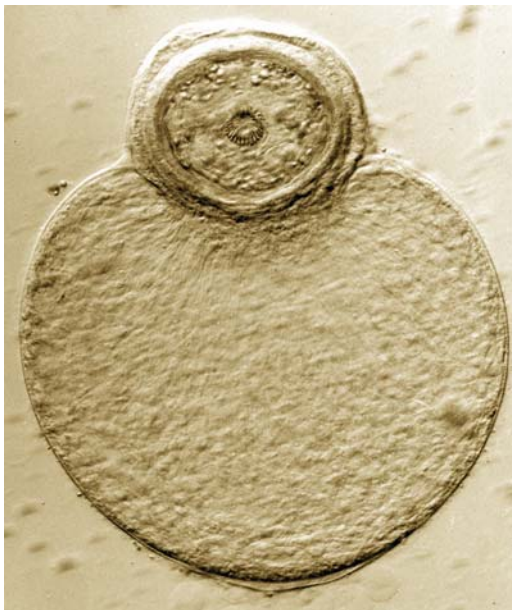

**Hymenolepidae. Figure 4** TEM of the cysticercoid of *Hymenolepis nana*.

produce the necessary enzymes themselves or whether they are obtained from endosymbiotic bacteria, has not yet been answered. Others are found in the intestine of cockroaches (e.g., →*Barbulanympha*, see →*Gametes*). This group is characterized by the occurrence of many repeated sets of 4 apical →*flagella*, which are arranged



**Hymenolepidae. Figure 6** LM of *Hymenolepis diminuta* (this species has no hooks at the scolex).

in a trichomonadid-like basal pattern, thus giving them the appearance of a wild tuft. Reproduction occurs by longitudinal division, while also sexual processes are unknown. During this process the flagella become resorbed except for a set of 4; their duplication initiates the →*cell division* and the final formation of other flagella sets. In some species transmission occurs by oral uptake of fecally passed cysts.



**Hypermastigida. Figure 1** LM of a specimen of the order Hypermastigida from the intestine of cockroaches.

## Hypermastigina

Order of flagellates with numerous apical →flagella, →Barbulanympa.

## Hyperparasitism

A second type of parasite is hidden inside a parasite and thus is also fed indirectly by the host.

## Hyperplasia

From Greek: *hyper* = over and above, *plasso* = formation. Some parasites introduce an enlargement of organs. →Pathology.

## Hypersensitivity

→Pathology.

## Hypertrophy

Enlargement of cells due to parasitism, e.g., →*Theileria* schizonts, →*Trichinella*.

## Hypnozoites

Stages (sporozoites, merozoites of →malarial parasites) that stay within host cells (e.g., liver cells) and start reproduction only after a longer phase of inactivity. They are also called dormozoites (→*Plasmodium*/Fig. 2).

## Hypoalbuminaemia

Clinical symptom in animals due to parasitic infections (→Alimentary System Diseases, →Clinical Pathology, Animals).

## Hypobiosis

Delayed ongoing of development (→*Trichostrongylidae*/Life Cycle, →Lungworms, →Nematodes).

## Hypodectes

Genus of mites in the nests of birds (e.g., *H. propus* of doves).

## Hypoderaeum

→Digenea.

## Hypoderma

From Greek: *hypo* = below, *derma* = skin. →Diptera.

## Hypoderma bovis

### Synonym

→Warble Fly.

### Classification

Species of →Diptera.

### Life Cycle

Figs. 1–4.

### Diseases

→Nervous System Diseases, Horses, →Skin Diseases, Animals.

## Hypoderma lineatus

→Diptera, →Nervous System Diseases, Horses, →Skin Diseases, Animals.

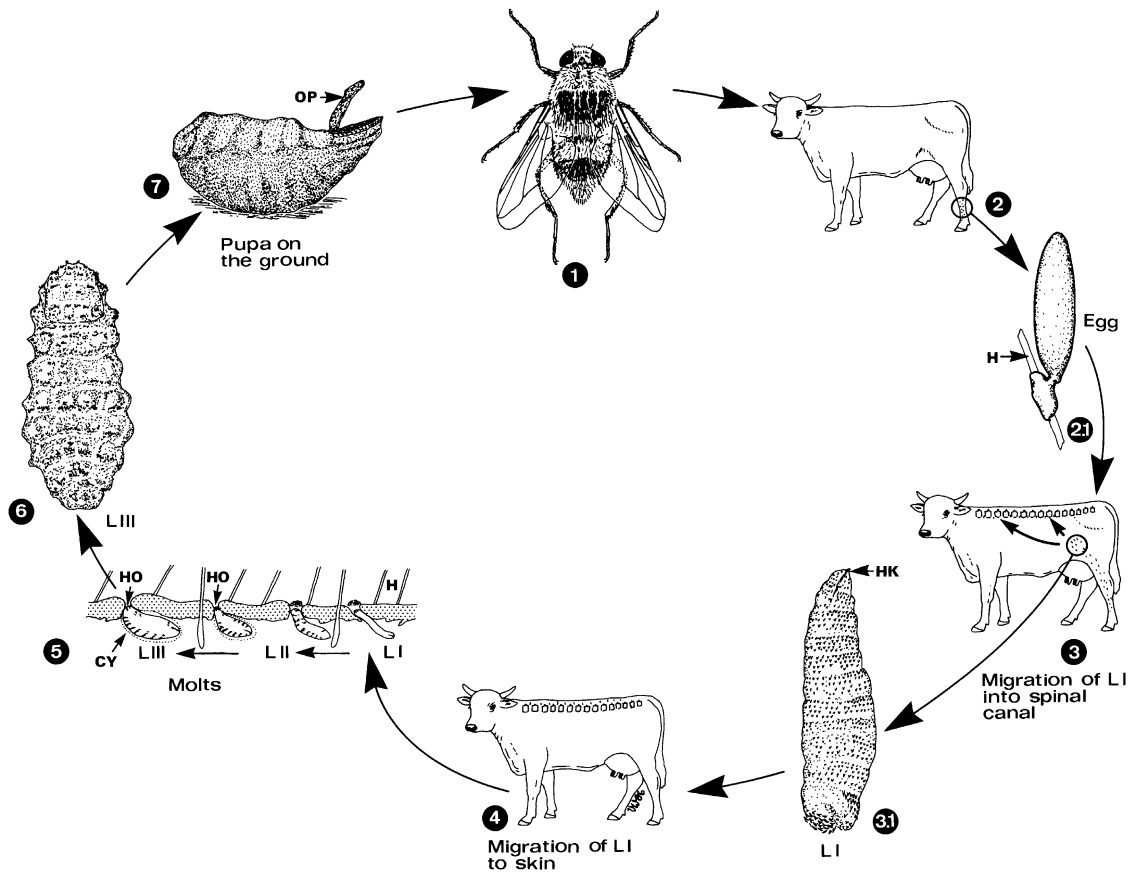

**Hypoderma bovis.** Figure 1 Life cycle of *Hypoderma bovis* (warble fly). 1, 2 Adult females lay several hundred eggs which are singly deposited and become attached to the host's hair (2.1) by an attachment organ. The first-stage larva hatches from the egg in about 4 days, crawls down the hair, and penetrates the skin. 3 The exact route taken by migrating larvae in the host is not known, but after several months they reach the final site, the epidural fat of the spinal canal (3.1). 4–6 At the beginning of the year the L<sub>1</sub> leave the spinal canal and move to their final site on the back; this is an area of 25 cm on either side of the midline from shoulder to tail and is where the cysts (=warbles) are formed from March to July. The L<sub>1</sub> (3.1) measures about 10 mm in length just after arrival; it molts into the second-stage larva soon after reaching the skin and cuts a hole (HO) in it through which it respire by means of paired terminal →spiracles. After →molt the third larval →instar appears and then develops into the 30-mm-long prepupa (6). After several weeks the yellowish-brown prepupa forces its way through the skin's opening, drops to the ground and moves actively seeking shelter. 7 The pupal stage needs 3–10 weeks depending upon external conditions (*H. lineatum* needs 4 weeks or less). Adults of *Hypoderma bovis* appear from June to mid-September, are unable to feed, and live for only 3–5 days; they emerge early in the day and mate within 1 h. CY, cyst, or warble; H, hair; HK, larval mouth hooks; HO, hole in the skin; OP, opening (for emergence) in the pupal →cocoon.





**Hypoderma bovis. Figure 2** Cow with several nodules containing larvae of *Hypoderma bovis*.



**Hypoderma bovis. Figure 3** Extraction of a larva 3 of *Hypoderma bovis*.

---

## Hypodermis

→Arthropoda, →Body Cover, →Nematodes.

---

## Hypodermosis

Disease due to infestation with grub flies (Table 1, page 631).



**Hypoderma bovis. Figure 4** LM of an extracted larva 3 of *Hypoderma bovis*.

---

## Hypoglycemia

A frequently encountered complication in *Plasmodium falciparum* →malaria, which is apparently based on increased use of glucose and impaired glucose production due to inhibition of gluconeogenesis.

---

## Hypopus

In members of the Acaridida the →deutonymph is completely different from the preceding and the following stage with respect to morphology and behavior. This so-called hypopus stage has no functional mouthparts and is a facultative developmental route which may be present in the life cycle of a mite generation. This special phenotype of a deutonymph can survive bad environmental influences much better than the normal form. The hypopodes are able to attach themselves to animals by ventral suckers or claspers and are thus transported to new environments or hosts (→Phoresis). In the genus →Glycyphagus inert hypopodes occur, which remain within the exuvia of the protonymphs; they are not provided with organs to fix themselves and thus can be moved by air currents. In certain members of the family Glycyphagidae (e.g., *Rodentopus sciuri*) the hypopus also lacks organs for attachment. The hypopus forms of these →mites are found in the subepidermal tissues of various animals. →Mites/Ontogeny.

**Hypodermosis. Table 1** Grub and warble flies and control measurements

Parasite	Host	Symptoms	Country	Therapy		
				Products	Application	Compounds
<i>Hypoderma bovis</i> (Northern cattle grub)	Cattle, (Horse)	Cattle have a panic fear of flying <i>Hypoderma</i> and try to escape; inflammation of skin with strong exsudation, then encapsulation, fistula; high economic loss through skin damages, loss of fattening performance (meat loss), milk loss	Europe, Former Soviet Union, North America, Africa, Asia	Neguvon (Bayer): No treatment during migration	Wash or Spray	Trichlorfon/ Metrifonate
				Warbex Famphur Pour-on for Cattle (Schering Plough)	Pour-on	Famphur
				Co-Ral 25% Wettable Powder (Bayer)	Dip or Spray	Coumaphos
				Ivomec 1% Injection for Cattle (Merial)	Injection	Ivermectin
				Dectomax (Pfizer)	Injection	Doramectin
				Cydectin (Bayer)	Injection	Moxidectin
<i>Hypoderma lineatum</i> (Common cattle grub)	Cattle, (Horse)	Creep on the cattle, no fear	In areas with an early spring, early drive to pasture	Co-Ral 25% Wettable Powder (Bayer)	Dip or Spray	Coumaphos
				Warbex Famphur Pour-on for Cattle (Schering Plough)	Pour-on	Famphur
				Ivomec 1% Injection for Cattle (Merial)	Injection	Ivermectin
				Dectomax (Pfizer)	Injection	Doramectin
				Cydectin (Bayer)	Injection	Moxidectin
<i>Przhevalskiana silenus</i> (syn. <i>Grivellia</i> )	Goat, rare Sheep	Inflammation of skin with strong exsudation, then encapsulation, fistula; high economic loss through skin damages, loss of fattening performance (meat loss), milk loss	Mediterranean area			
<i>Dermatobia hominis</i> (Tropical warble fly or torsalo)	Cattle, Dog, Humans, etc.	Inflamed skin pustules	Latin America	Co-Ral 25% Wettable Powder (Bayer)	Dip or Spray	Coumaphos
				Warbex Famphur Pour-on for Cattle (Schering Plough)	Pour on	Famphur
				Ivomec 1% Injection for Cattle (Merial)	Injection	Ivermectin
				Dectomax(Pfizer) Topline (Merial)	Injection Pour on	Doramectin Fipronil

## Hypostome

Ventral part of the gnathosoma of →ticks (→Ticks/  
Alimentary System).

## Hypoxia

From Greek: *hypo* = below, *oxys* = oxygen. Lack of oxygen. Endoparasites have to develop systems to survive this lack →Anaerobiosis.

---

## Hysterosoma

From Greek: *hystera* = uterus, *soma* = body. This term describes the 3rd and the 4th, legless abdominal region of →[Acari](#).

---

## Hysterothylacium aduncum

Nematode species in the mesenteries and intestine of flat fish of Baltic sea.

---

## Hystrichis tricolor

Species belonging to the family Dioctophymatoidea (→[Dioctophyme renale](#)). *Hystrichis tricolor* appears 3-colored, reaches a size of 40 mm in females, 25 mm in males, and lives in the digestive stomach of wild and domestic birds in Europe. Intermediate hosts are earthworms.

---

## Icaridin (Bayrepel)

### Chemical Class

Repellent.

### Mode of Action

Olfactory reception.

---

## Ichthyobodo necator

### Synonym

*Costia necatrix*.

### Classification

→ **Phylum** Euglenozoa, **Classis** Trypanosomatidea, **Order** Bodonida.

### Morphology

The spherical, free-swimming (10–20 µm × 6–10 µm) swarmer has 2 flagella (9 and 18 µm long) and a long typical mitochondrial kinetoplast (Fig. 1). The reproduction occurs by binary fission. The free-swimming stages become attached to the surface of a fish and then appear pear-shaped (Fig. 2, page 634) and develop a chitinous layer as outer cover.

### Life Cycle

After feeding the fixed trophozoites (Fig. 2) detach from the skin, sink to the ground, close the feeding opening, and thus become a cyst, within which 256 so-called dinospores (or swarmers) are formed, which must find a host within 24 hours.

### Therapy

Flagello1™ (Sera), (nitroimidazoles).

---

## Ichthyonema

### Name

Greek: *ichthys* = fish, *nema* = filament.

### Synonym

→ *Philometra* spp. of fish nematodes, which reach as females a length of 5 cm and a diameter of 1 mm (males 2–3 mm long). They parasitize inside blood vessels, body cavity, and in/on the gills. *Cyclops*-crustaceans are apparently the intermediate hosts.

---

## Ichthyophthiriasis

Disease of free freshwater and ornamental fish due to an infection with the holotrich ciliate → *Ichthyophthirius multifiliis*, which lives between the epidermis and the corium. Infection can be diagnosed by the occurrence of white dots on the skin (= other name for the disease: white-dots disease). Fish try to get rid of the apparently itching parasites by scrubbing at stones etc.; their fins are kept compressed. If gills are highly infected, fish show apathy, do not feed, are seen in a lateral upside-down position, do not show escape-reflexes and may die due to inflammation of the skin lesions within 4–5 days.

### Therapy

Protazo1™ (Sera/Alpha-Biocare).

---

## Ichthyophthirius multifiliis

### Name

Greek: *ichthys* = Fisch, *phtheiros* = louse; Latin: *multus* = much, *filia* = daughter.

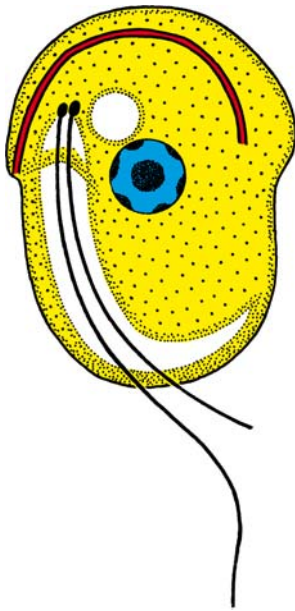

**Ichthyobodo necator.** Figure 1 Diagrammatic representation (DR) of the swarmer of *Ichthyobodo necator*.

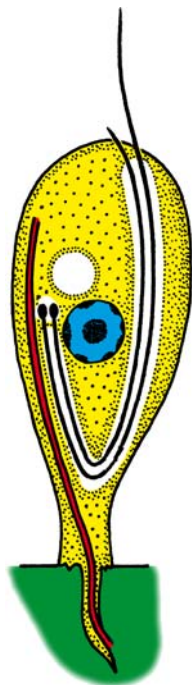

**Ichthyobodo necator.** Figure 2 DR of the skin-attached trophozoite of *Ichthyobodo necator*.

**Classification**

Species of →Ciliophora, phylum Alveolata.

**Life Cycle**

Figs. 1–3 (page 635).

**Disease**

→White Dot Disease; name: →Ichthyophthiriasis: fish appear with white spots (Fig. 2). Due to the feeding of the trophozoites in the skin (Fig. 3) superinfections with bacteria occur and the fish often die due to lack of oxygen.

**Therapy**

Protazol® as medical bath.

---

**Ichthyosporidium**

→Microsporidia.

---

**Icterus**

Symptom of infections with the yellow fever virus, A-hepatitis, or liver infections due to parasites.

---

**Idiosoma**

Main portion of the body of →Acarina, being subdivided into the podosoma (bearing the walking legs and the genital pore) and the opisthosoma. The latter is the region posterior to the leg coxae and the anal aperture.

---

**Idiosyncrasia**

Effect of high dosages of chinin lead in malaria to black urine excretion.

---

**IFA**

Indirect fluorescent antibody assay.

---

**IFAT**

Indirect fluorescent antibody test.

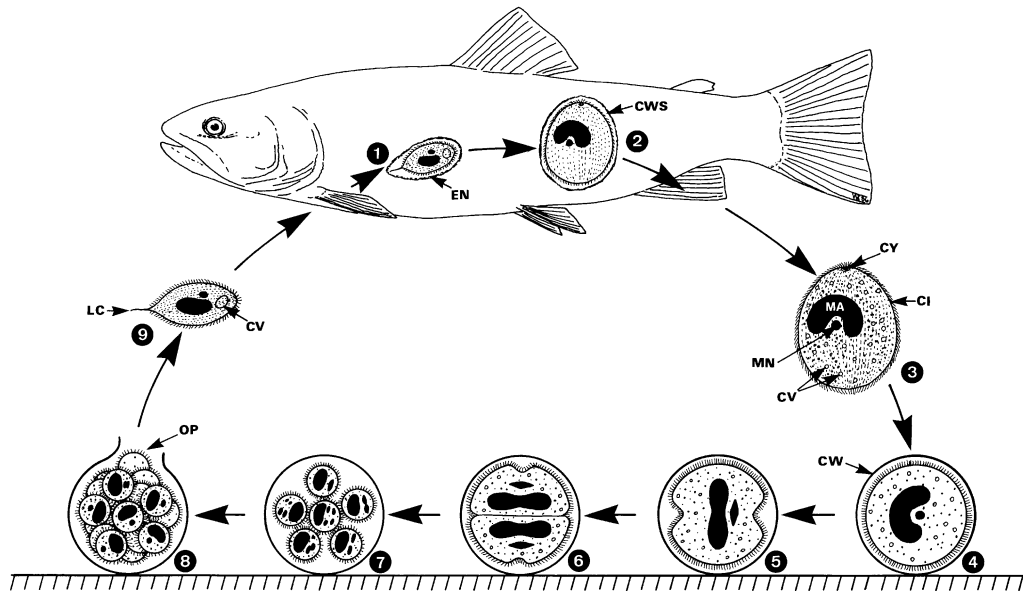

**Ichthyophthirius multifiliis.** Figure 1 Life cycle of *Ichthyophthirius multifiliis* parasitizing many species of freshwater fish. 1 → Swarmer penetrates the skin of a fish and becomes encysted (EN) by host tissues. 2 The encysted →swarmer grows to be a trophozoite, reaching a diameter of up to 1 mm; the skin then presents with a large grayish pustule at these places. 3 Upon rupture of the pustules the →trophozoites, which have numerous contractile →vacuoles, are liberated and swim about feebly. Upon coming to rest on the bottom of the pond the →trophozoite secretes a thick-walled gelatinous cyst wall about itself. 4–8 Within an hour of →Encystation the mother trophozoite starts reproduction by simple transverse division, this being repeated until up to 1,024, 30–50 µm long, pear-shaped swimmers (with a single →contractile vacuole) are formed. 9 After rupture of the cyst, the liberated swarmer attaches to the skin of fish within 1 day (unattached ones die during the second day). CI, →cilia; CV, contractile vacuole; CW, cyst wall of cysts on the bottom of the pond; CWS, cyst wall in skin; CY, →cytostome; EN, encysting swarmer; LC, long terminal cilium; MA, →macronucleus; MI, →micronucleus; OP, opening rupture of CW; SW, swarmer.



**Ichthyophthirius multifiliis.** Figure 2 Black molly fish with white dots of *Ichthyophthirius*.

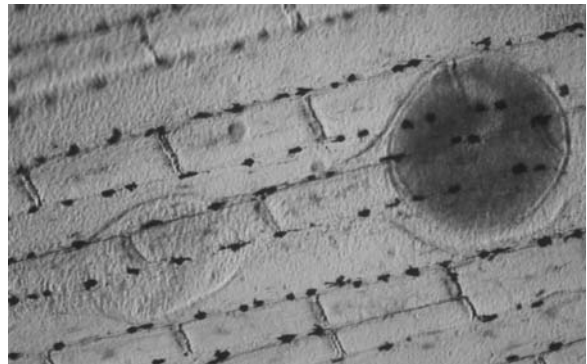

**Ichthyophthirius multifiliis.** Figure 3 LM of the skin of a fish with a trophozoite of *Ichthyophthirius multifiliis* in a feeding tunnel.

## IHA

Indirect hemagglutination assay.

## IHAT

Indirect hemagglutination test.

---

## Imago

An [→insect](#) in its final, adult, sexually mature, and often winged state.

---

## Imidacloprid

### Chemical Class

Neonicotinoide.

### Mode of Action

Nicotinic acetylcholine receptor agonist. [→Ectoparasitocides – Agonists and Antagonists of Cholinergic Transmission](#), [→Insecticides](#), [→Ectoparasitocidal Drugs](#).

---

## Imidathiazoles

[→Nematocidal Drugs](#).

---

## Imidocarb

[→Babesiocidal Drugs](#).

---

## Immune Complex

### Synonym

Antibody–Antigen Interaction.

### General Information

The formation of immune complexes with subsequent clearance is a physiological process during the acute phase of an immune reaction. When antibody-antigen aggregates develop in rising quantities they become detectable in the peripheral blood as so-called circulating immune complexes ([→CIC](#)). The formation of CIC is a common event during chronic parasitic infection like schistosomiasis, filariasis, leishmaniasis, trypanosomiasis, toxoplasmosis, and quartan [→malaria](#). Only the deposition of immune complexes may cause severe pathological changes in the host.

During parasitic infection various circulating antigens appear at different developmental stages. Due to a selective immune response only few of them are complexed by antibodies. The antibody–antigen interaction may lead to structural changes in the antigen. The clearance of immune complexes depends on the structure of the antigen and the quality (affinity) and quantity of the antibody.

Immune complexes are able to bind complement compounds and to activate the cellular immune response via Fc-receptors. Resulting pathological changes are either membrane proliferative [→glomerulonephritis](#) or, when the antigen is tissue bound, an [→Arthur's Phenomenon](#).

CICs are a common phenomenon in the sera of [→Wuchereria bancrofti](#)-infected patients. Renal abnormalities like chronic progressive glomerulonephritis are reported for patients with malaria (*Plasmodium malariae*) and [→Bancroftian filariasis](#). Also, a chronic *Leishmania infantum*-infection in dogs may cause glomerulonephritis.

---

## Immune Evasion

Mechanisms developed by parasites to survive the attack of the host immune system ([→Immune Responses](#)).

---

## Immune Responses

A general feature of many parasitic infections by [→protozoa](#) or helminths is their chronicity and several reasons contribute to this, e.g., weak [→innate immunity](#) and the capacity of parasites to withstand or to evade destruction by specific immune responses of the vertebrate host. General aspects of the various host immune responses are described in the following. Peculiarities of the immunological response to specific parasites are described in detail under the headwords of the respective diseases.

### Innate Immunity

The skin and the linings of the respiratory, gastrointestinal, and urogenital tract present formidable physical and chemical barriers to infective organisms and represent a first line of defense. These barriers provide a [→natural resistance](#), also called innate immunity, to infection, but they are not perfect. Protozoan and helminthic parasites, have evolved in such a way that

they either are able to penetrate the body's barriers directly or are transmitted by insect bites.

In the body the alternative pathway of complement activation provides a first line of defense against many parasites. The complement component C3 is cleaved spontaneously in plasma to produce C3b; once bound to the parasite surface and stabilized to form a C3 convertase, activation of the terminal complement components C5-C9 takes place, and the parasites are lysed by the major attack complex MAC. A second line of defense is provided by macrophages and neutrophilic leukocytes, which play a major role in all stages of host defense. These cells by means of their CR3-receptors are able to recognize microbial substances and thus ingest the parasites. In addition, Toll-like receptors (TLRs) have been defined as important transmembrane receptors that confer a certain degree of specificity to the cells of innate immune system. TLRs have been implicated in recognition of every known category of pathogen that causes infectious disease. TLRs can recognize minute concentrations of microbial components and orchestrate an early defense, largely dependent on the MyD88-dependent activation of NF- $\kappa$ B, which will trigger microbiostatic/microbicidal effector mechanisms and lead to the production of proinflammatory cytokines thereby also shaping the adaptive immune response. The importance of the TLR-mediated signaling pathways in the host resistance and pathogenesis during parasitic diseases has been demonstrated by experimental infections of MyD88-deficient mice with various protozoan parasites and helminths. The identification of a single TLR involved in the *in vivo* host responses to protozoan parasites has been a more difficult task, because protozoan parasites might be recognized by more than one TLR. Nevertheless, a number of distinct molecules derived from protozoan parasites have been shown to activate cells from the innate immune system via TLRs, e.g., glycosylphosphatidinositol anchors from parasite surface proteins are recognized by TLR2, nucleic acids by TLR3 and TLR9, and a profiling-like protein of *Toxoplasma gondii* by TLR11, respectively. As a result of the TLR-stimulation and the parasite uptake, the secretion of cytokines by phagocytes is initiated which include interleukin-1 (IL-1), IL-6, IL-8, IL-12, and tumor  $\rightarrow$ necrosis factor (TNF). These factors recruit more phagocytes to the site of the infection and an increase in circulating neutrophils. Phagocytes also release other proteins with significant local effects, such as oxygen radicals, peroxides,  $\rightarrow$ nitric oxide, prostaglandins, leukotriens, complement components, etc. Infection of cells with viruses, but also with parasites induced the production of interferon (IFN)- $\alpha$  and - $\beta$ . These interferons contribute to the inhibition of natural killer cells (NK-cells), cells which are known to function in the initial phase of infection with intracellular

pathogens, including parasites such as  $\rightarrow$ Leishmania. Activated NK-cells secrete large amounts of IFN- $\gamma$ . This IFN- $\gamma$  is critical for the control of some parasitic infection before T cells have been triggered to liberate this cytokine. A further effect of IFN- $\alpha$  and - $\beta$  is to augment the expression of MHC class I molecules, which favors the ability of host cells to present parasite antigenic peptides to CD8<sup>+</sup> cells (see below). Once parasites have survived the innate immune response, the  $\rightarrow$ acquired immunity comes into effect.

### Acquired Immunity

Acquired immunity is mediated by the humoral and cellular immune system, in which the B-lymphocytes are mediators of the humoral responses. Upon direct recognition of the parasites, i.e., antigen, they produce antibodies of different isotypes, that are specific for the antigen. A remarkable difference between bone marrow-derived B and thymus-derived T cells is the inability of T cells to recognize antigens directly as B cells do. T cells, on the other hand, need adequate presentation of antigens mostly by major histocompatibility complex (MHC) molecules expressed on antigen-presenting cells (APCs), such as dendritic cells, Langerhans cells, macrophages, B cells, and vascular endothelial cells. The  $\rightarrow$ T-cells are distinguished according to their T cell-receptor (TCR) and accessory molecules. The TCR is composed of an  $\alpha$  and  $\beta$  chain or an  $\gamma$  and  $\delta$  chain. Accessory molecules are the CD4 or the CD8 marker.

### Antigen Presentation

Before further discussing the functions of the T cells, interest will be focused on the MHC and  $\rightarrow$ antigen presentation. MHC genes are organized in a gene complex of about 3.5 mb on chromosome 6 in man. Several classes of molecules are encoded in this gene complex, of which the MHC class I and class II molecules are central to antigen presentation. MHC class I molecules are formed by a variable polypeptide chain and a constant  $\beta$ -2 microglobulin. The MHC class II molecules represent heterodimers composed of variable  $\alpha$  and  $\beta$  chains. Association of antigen with MHC molecules occurs inside the antigen-presenting cell and processing of foreign antigen to peptide fragments is an essential prerequisite for successful association and presentation. The complex of the MHC molecule and antigen peptide is transported to the cell surface and presented to T cells. MHC class I and II molecules can be subdivided into classical and nonclassical MHC molecules. Classical class I molecules are encoded in man by the HLA-A, -B, and -C genes. These highly polymorphic molecules present processed peptides to CD8<sup>+</sup> T cells. Nonclassical class I molecules are much less polymorphic and are encoded



by HLA-E, -F, and -G. Their function in man is still ill-defined. In the mouse, the related Qa-1 and Qua-2 molecules present a restricted set of peptide antigens, for instance a fragment of lysteriolysin, to CD8<sup>+</sup> T cells. Classical MHC class II molecules in man are encoded by HLA-DP, -DQ, and -DR. These molecules present processed peptides to CD4<sup>+</sup> T cells. Nonclassical class II molecules, such as DMA and DMB, appear to support classical class II molecules in antigen presentation.

CD1 molecules form a non-MHC-encoded family of molecules involved in antigen presentation. As class I molecules, they are composed of a polymorphic  $\alpha$  chain and  $\beta$ 2-microglobulin. So far, the isoforms CD1 a-e have been described in humans. Recently, it became apparent that CD1 molecules act as restriction elements in the presentation of several mycobacterial lipids, such as mycolic acid, and glycolipid antigens, such as lipoarabinomannan to T cells. Interestingly, CD1 molecules seem to present nonpeptide antigens not only to classical T cells but also to the recently described subsets of CD4<sup>+</sup> NKT 1. 1<sup>+</sup> and CD4<sup>-</sup> CD8<sup>-</sup> NK 1. 1<sup>+</sup> T cells, that are also designated as natural killer T cells or NKT-cells. These NKT-cells, because of their capacity to produce interleukin 4 and other cytokines, can potentially influence the phenotype of the immune response to class II-restricted antigens. Their role in parasite infection, however, is still unclear.

Whether an antigen will be processed and presented with class I or class II MHC molecules appears to be determined by the route that the antigen takes to enter a cell. Exogenous antigen is produced outside of the host cell and enters the antigen-presenting cells, which degrade the exogenous protein within the phagosome into peptides of 12-15 amino acids length. The peptides are loaded into the cleft within the MHC class II molecules. The MHC class II peptides complex is then exported to the cell surface, where it is recognized by T-cells displaying CD4. CD4<sup>+</sup> T cells recognize their antigen MHC class II restricted. Endogenous antigen is produced within the host cell itself. It is either of host cell or of parasite origin. In the cytosol, proteasomes degrade endogenously synthesized proteins to peptides, which are then transported by particular transport-associated proteins, so-called TAPs to the endoplasmic reticulum. Here the peptides bind to MHC class I molecules. Thereafter the complex is exported to the cell surface. T cells displaying CD8 recognize the complex and are thereby stimulated. Therefore, they are said to be MHC class I restricted.

The great  $\rightarrow$ polymorphism of genes coding for MHC molecules allows man to bind and present a vast diversity of different peptides produced by the many parasite pathogens, to a large T cell repertoire, resulting in highly specific immune response.

## T-Cell Mediated Responses

Next, the various T cells, to which antigen is presented will be discussed. In man, the T cell population in the periphery amounts to more than  $10^{12}$  cells, of which more than 90% carry the  $\alpha/\beta$  T-cell receptor (TCR) and less than 10% the  $g/d$  receptor. The TCR associates with the variable region of the MHC-molecule which carries the antigenic peptide and the CD4 or CD8 molecules bind to the constant regions of the MHC molecules. Binding of the antigen/MHC-complex to the TCR results in the engagement of the CD3-complex, with subsequent signal transduction and T cell activation. This signal transduction is modulated by costimulatory effects induced by the accessory receptor/ligand pairs CD40/CD40 ligand or B7/CD28. CD40-mediated signals seem to affect primarily CD4<sup>+</sup> T cells of the Th1 subtype, whereas the B7 costimulus trigger T cells of the Th2 subtype. The CD4<sup>+</sup> T-cells according to their cytokine secretion pattern have been first subdivided by Tim Mossmann into the Th1 and Th2 family, Th1 cells producing IL-2 and IFN- $\gamma$ , cytokines that serve as stimuli of T-cells or macrophages respectively, and Th2 cells producing IL-4, IL-5, and IL-10, that is T-cells that act as true helper cells for  $\rightarrow$ B-cells. The Th1 cells, via IFN- $\gamma$ , seem to act as classical cells of delayed type of  $\rightarrow$ hypersensitivity, i.e., of cell-mediated immunity for instance in the tuberculin reaction. Thus, they are of prime importance in the control of intracellular microorganisms such as toxoplasma, leishmania, mycobacteria, and others. By virtue of their IFN- $\gamma$  production Th1 cells also downregulate Th2 cells. The Th2 cells, on the other hand represent the classical T helper cells, which are involved in the allergic reaction and in humoral immune responses. IL-4 is central to IgE production and IL-5 to IgA production and IL-10 downregulates Th1 cells. The subdivision of CD4<sup>+</sup> T cells in Th1 and Th2 cells should however not be taken too strictly because during a developing immune response, T cells producing both Th1 and Th2 cytokines are found, and Th1 and Th2 cells might well coexist in the tissue.

Differentiation of Th0 cells into Th1 or Th2 is driven by cytokines produced by different cells of the immune system. IL-12 is the major player in the Th1 pathway and IL-4 driving the Th2 cells. Undoubtedly, the signals which in leishmaniasis are decisive for the initiation of a protective Th1 response versus a disease-promoting Th2 response, are by far not clear.

Besides CD4<sup>+</sup> T cells, CD8<sup>+</sup> cells are involved in  $\rightarrow$ immune reactions to most if not all intracellular parasites including plasmodia, toxoplasma, and leishmania. CD8<sup>+</sup> cells function by their capacity to act as cytolytic killer cells as well as producers of cytokines such as IFN- $\gamma$ , etc. CD8<sup>+</sup> T cells lyse infected target cells by cell-to-cell contact subsequent to the recognition of

the target peptide that is presented by class I molecules. Target cell lysis is mediated by 2 separate mechanisms. The first mechanism involves the secretion of perforins and granzymes by the killer cells, which both lead to osmotic lysis of the target cells. The second mechanism requires the cross-linking of the Fas-ligand and the cytolytic CD8<sup>+</sup> cells with the Fas-antigen on the target cells with subsequent chromatin condensation, DNA fragmentation, and cell rupture. This mechanism induces →apoptosis, also known as programmed cell death, in the target cells. Cytolytic activity is most prominent in CD8<sup>+</sup> T cells, however also some CD4<sup>+</sup> T-cells have been shown to act as killer cells as in the case of →*Toxoplasma gondii*-infected macrophages. CD8<sup>+</sup> cells may act in synergy with Th1 cells, when Th1 cells produce the cytokines IL-2 and IFN-γ and CD8<sup>+</sup> cells contribute their cytolytic activity to the pathogen-eliminating process. Another type of T cells involved in the regulation of antiparasitic immunity are regulatory T cells (T<sub>reg</sub>). Several types have been described based on their origin, generation, and mechanism of action, with 2 main subsets identified: “natural” Foxp3<sup>+</sup>CD4<sup>+</sup>CD25<sup>+</sup> T<sub>reg</sub>, which develop in the thymus and regulate self-reactive T cells in the periphery, and “inducible” T<sub>reg</sub> (e.g., Tr1 or Th3 cells), which can develop in the periphery from conventional CD4<sup>+</sup> T cells. Both types of T<sub>reg</sub>, by virtue of their capacity to control the intensity of effector responses, have been shown to play a major role in the control of various parasitic infections.

### Specific Aspects of Immune Responses to Helminths

Worms such as *nippostrongylus*, *filaria*, →*ascaris*, and schistosomes induce high levels of specific IgE antibodies and eosinophilia. This characteristic response pattern is caused by the particular ability of helminths to preferentially stimulate the Th2 subset of CD4<sup>+</sup> cells, which secrete the cytokines IL-4 and IL-5, IL-4 involved in the production of IgE antibodies and IL-5 acting as growth factor for eosinophils. *In vitro* studies suggest that helminths opsonized with specific IgE antibodies are lysed by eosinophils that carry Fc receptors specific for IgE, the toxic product contained in the major basic protein of the eosinophils granules. This effector mechanism however does not relate to cell helminths infections as immunity to →*schistosoma* induces Th1 cells and the production of IFN-γ, which results in activation of macrophages that directly delete the schistosome larvae by means of →*nitric oxide* (NO).

### Strategies of Evasion of Immune Mechanisms by Parasites

The capacity of parasites to survive and to persist in their hosts is a result of coevolutionary events that

enable the parasites to evade immune effector mechanisms. Most parasites have developed multiple →*evasion* strategies to circumvent both innate and acquired defense mechanisms of the host, which will be discussed separately for each parasite.

### Related Entries

→Amoebiasis, →Babesiosis, Animals, →Babesiosis, Man, →Chagas' Disease, Man, →Cryptosporidiosis, Animals, →Cryptosporidiosis, Man, →Cysticercosis, →Echinococcosis, →Filariasis, Lymphatic, Tropical, →Giardiasis, Animals, →Giardiasis, Man, →Hookworm Disease, →Leishmaniasis, Animals, →Leishmaniasis, Man, →Malaria, →Nematode Infections, Man, →Pneumocystis, →Schistosomiasis, Man, →Sleeping Sickness, →Theileriosis, →Toxoplasmosis, Animals, →Toxoplasmosis, Man, →Trichinelliasis, Man, →Visceral Larva Migrans, Man.

## Immune Suppression

→Opportunistic Agents, →Chagas' Disease, Man, →Echinococcosis, →Sleeping Sickness, →Toxoplasmosis, Animals, →Toxoplasmosis, Man.

## Immunization

See Vaccination Chapters.

## Immunoassay

### General Information

Immunological assays are available for measuring the humoral immune response after parasitic infections. For the detection and quantitation of antibodies or antigens an immunoassay has to fulfill 3 basic requirements: highly specific, highly sensitive, and reproducible. The field of application and the quality of antigen/antibody available are the main variables which determine the choice for 1 specific assay. A test system may be adequate for population screening or for individual diagnosis. Ideally, it is a single definitive test which can equally detect antibodies in low-responders, in people with recently contracted infection or with high titers and clinical signs, and be suitable for a posttreatment follow-up.

The stability of the antigen-antibody complex (avidity) determines the success of all immunological assays.

## IFA, EIA, WB

The indirect immunofluorescence (fluorescent antibody) assay (test) (IIFA, IFA, IIFAT, IFT) has long been the best choice in parasitology. By using cryosections from different developmental stages of helminths or free →protozoa as antigens the test provides a satisfactory discrimination between specific and non-specific reactions. The differential binding of antibodies to different structures of the parasite or cell is used to distinguish between specific and nonspecific reactivity. Its disadvantage is subjective reading and labour intensiveness. Screening of a large population is practically impossible. The indirect haemagglutination test (IHAT, IHA) is applied for fast screening at low costs of several parasitic infections. A broad application of the indirect enzyme-linked immunosorbent (enzyme immunosorbent) assay (→ELISA, EIA) has long been delayed by the use of nondefined, crude parasite extract antigens, resulting in a high degree of cross-reactivity. This disadvantage is now partly overcome by the availability of secretory/excretory (E/S) antigens, synthetic peptides and recombinant antigens. Still, the sensitivity and specificity of the ELISA vary considerably but it is an easy and fast alternative especially for population and herd screening and epidemiological studies. The western blot (WB, enzyme immunoblot, EIB), which provides a species or stage specific diagnosis is a confirmation test and applied as the final diagnostic step when screening results are positive.

## Other Test Systems

Today, only few laboratories still use immunodiffusion (ID), gel precipitation, complement fixation test (CFT), Sabin Feldman dye test (DT), counterimmunoelectrophoresis (CIE) or radioimmunoassay (RIA) in routine →serodiagnosis. These test systems consume much antigen in comparison to the ELISAs, are less sensitive or use radiolabelled conjugates. Other test systems like card agglutination test (CATT), direct agglutination test (DAT), latex agglutination test (LA), carbon immunoassay (CIA), dot blot, and dip stick antigen assay were developed for a rapid, low cost screening under field conditions.

The rapidly increasing knowledge on immunology and molecular biology may result in a large scale production of characterized parasitic antigens applicable in different test systems. However, the suitability of each product for diagnostic purposes depends on the dynamics of the hosts immune response to that particular antigen.

## Characteristics

IIFAT results depend not only on the kind of antigen used but also on its processing. Fixation is one of the most important steps (unfixed, formalin, acetone, methanol, heat, and others) to enhance or decrease

the sensitivity or specificity of the test. The reading of the IIFAT requires a specific microscope. Reading of the slides by inexperienced staff may lead to different end-point titers due to subjective impressions. A new generation of IHATs using selected red blood cells of the 0 Rh- type for antigen cross-linking reduces the non-specific agglutination of erythrocytes and improves the specificity of this fast test system. ELISA is a suitable test system for the detection of both antigen and antibody. It is very sensitive and economic for testing a large number of serum samples within a relatively short time. The test principle allows many variations in the performance of the assay and the use of detection systems. Direct and indirect, capture and dip stick and many other ELISA systems are described as efficient in different diagnostic fields. Reading of the test is normally by use of a photometer. In highly specific assays a discrimination between positive and negative results is also possible visually. Indirect ELISAs, which are predominately used in parasitology for →antibody detection, measure antibody binding and not antibody levels and therefore provide only a limited quantitative information. The WB analysis demonstrates serum reaction patterns with antigen fractions of either a complex mixture or predefined extracts of parasites. It is used to demonstrate either an individual stage specific antibody response in follow-up studies or species specific reaction for the discrimination of infection with closely related parasites. The CATT is an easily and fast to perform low-cost system which uses the surface antigen of different *Trypanosoma*-species for antibody detection. It is applied as a screening tool for the (West) African →sleeping sickness and animal trypanosomiasis caused by *T. brucei/congolense* and *T. evansi*.

## Standardisation

Standardisation of immunological assays is a crucial problem in parasitology. The evaluation of the specificity, sensitivity, and negative/positive predictive value of an assay requires either a “gold standard” or a population based evaluation of numerous defined serum samples. Only the DT is an accepted “gold standard” for toxoplasmosis →serology. For other parasitic infections either parasite detection, disease, or some other immunological assay with proven diagnostic value are used as “gold standard.” Many home made or commercial test systems still work with undefined antigens. Also, reference sera are not available for all parasitic infections. Hopefully, standardization will improve with the availability of defined antigens.

## Clinical Relevance

The clinical value of an immunoassay depends on its ability to allow the identification of an infected individual on the results of single test. Ideally, the

producer provides information on the positive and negative predictive value for his immunoassay. Due to a comparatively low demand for parasitological immunoassays in the low incidence “developed” countries test systems are often produced in parasitological laboratories. At present, only the serodiagnosis of toxoplasmosis is to a high degree commercialized and, in Germany, submitted to an official, external quality control. The choice of a suitable test system is therefore essential for a good diagnosis. For individual diagnosis a quantitative and specific measurement of the serum antibody concentration is required. The approximate antibody concentration is given either by end-point titers (IIFAT, IHAT), units, or absorbances (ELISA). The WB pattern can provide only semiquantitative, but highly specific results. In any case, an interlaboratory comparison of test results is only possible when identical assays are performed. The application of intra- and interassay quality controls by use of defined reference material is obligatory. For screening purposes a sensitive assay is preferred for primary diagnosis, followed by a more specific test for definitive diagnosis. Qualitative test results (positive/negative) will be sufficient for population screening or herd control. When interpreting test results it has to be considered that there is not only a population-based variability of the antibody responses to parasitic infections but also a great variability of the individual response depending on the parasite load and stage of infection. Finally, antibodies show variation among different techniques due to differences in multivalent binding.

The use of different test systems for seroepidemiological studies may result in different rates of seroprevalence achieved. These differences may reflect basic differences in the sensitivity or specificity between test systems. However, when direct parasite detection as “gold standard” for test evaluation is used, the resulting sensitivity depends not only on the experience of the investigator but also the frequency of sampling and the parasite load of the individuals tested. When disease is used as “gold standard” for test evaluation, a comparatively high seropositivity will result when the infective parasite exhibits a long →incubation period and/or low →morbidity rate. The clinical outcome of parasitic infections depends also on the genetic predisposition of the infected individual. A positive test result in 1 immunoassay may therefore provide evidence for a yet unknown immunological recognition of the parasite, which is undetectable in other assays. Discrepant rates in the prevalence of *Toxocara canis*-antibodies in human serum were reported when either CIEP and IIFAT or E/S-ELISA was applied. The interpretation of unresolved positive values is carried out by considering the incubation period and possible pathological effect of each parasite.

## Immunodiagnosis

→Serology.

## Immunofluorescence Antibody Test (IFAT)

Diagnostic method.

## Immunofluorescence Assay (IF)

Diagnostic method to detect parasitic cells.

## Immunoglobins

Antibodies (IgA, IgE, IgM, IgG) that were produced by the B-lymphocyte system.

## Immunoprophylaxis

→Vaccination.

## Immunosorbant Agglutination Assay (ISAGA)

Diagnostic method.

## Immunosuppression

Reduction of the activity of the immune system, e.g., due to HIV-infection, constant uptake of cortisone or co-infection with several parasites leads to the abnormal reproduction of some parasites. →Opportunistic Agents.

## Incidence

Number of new cases of disease with respect to a defined population.

## Incubation Period

Period up to the first appearance of clinical symptoms after an infection with →agents of disease. It is mostly not identical to →prepatency.

## Incursive Zone

→Geographic zones of occurrence of diseases: agents of disease are only found occasionally.

## Indoor Feeding

→Endophagy (e.g., mosquitoes, that take their blood meal inside of human dwellings).

## Indoxacarb

### Chemical Class

Carboxamide (oxadiazine carboxamide).

### Mode of Action

Voltage-gated sodium channel modulator. →Ectoparasitocides – Blockers / Modulators of Voltage-Gated Sodium Channels.

## Inermicapsifer madagascariensis

Small only 5 cm long tapeworm of humans in East Africa, Asia, Cuba, and South America.

## Infection

Moment of invasion/introduction/transmission of →agents of disease, which reproduce inside the host. With respect to man there are main routes (e.g., eating plants infected with *Fasciola* →metacercariae or pig meat with →cysticercus of →*Taenia solium* or uncommon, but also highly effective ones (e.g., eating infected raw liver in the case of *Fasciola* or imported sweet potatoes covered with eggs of *Taenia solium*, as was shown in a Jewish population).

## Infestation

Settlement of a parasite, in or on a host without local reproduction (e.g., sucking of a tick/flea).

## Inflammatory Reaction

→Pathology.

## Infracommunity

→Communities.

## Infrapopulation

This term includes all individuals of a single species parasitic in a single host.

## Inhibitors of the Electron Transport Chain

→Energy Metabolism.

## Inhibitory-Neurotransmission-Affecting Drugs

Overview see [Table 1](#).

### Structures

Fig. 1.

### Piperazine

#### Synonyms

75 different synonyms (Chemotherapy of parasitic diseases (Campbell WC, Rew RS (eds), Plenum Press, New York and London, p. 629).

#### Clinical Relevance

The antinematodal activity of piperazine is directed against → *Ascaris lumbricoides*, *Enterobius*, ascarids in dogs and cats, adult → *Oesophagostomum* in pigs, adult

**Inhibitory-Neurotransmission-Affecting Drugs. Table 1** Drugs active against micro- and macrofilariae

Year of introduction or discovery	Drug	Effects against filariae	Effect on other parasites
<b>Drugs with predominantly microfilaricidal effects</b>			
Acetylcholine-Neurotransmission-Affecting Drugs			
1955	Metrifonate	<i>Onchocerca volvulus microfilariae</i>	<i>Ascaris</i> , <i>S. haematobium</i> , insects
1965	Levamisole	<i>W. bancrofti</i> , <i>B. malayi</i>	Intestinal nematodes
Inhibitory-Neurotransmission-Affecting Drugs			
1980	Ivermectin	<i>Onchocerca volvulus</i> , <i>W. bancrofti</i> , <i>Loa loa</i> ; <i>Dirofilaria immitis</i>	Nematodes, arthropods
1980's	Milbemycin D	<i>Dirofilaria immitis</i> **	Nematodes, arthropods
1990	Milbemycin A4 oxime	<i>Dirofilaria immitis</i> ; microfilariae in rodent models*	Nematodes, arthropods
1990	Moxidectin	<i>Dirofilaria immitis</i> ; microfilariae in man and rodent models*	Nematodes, arthropods
1993	Doramectin	Microfilariae in man and rodent models*	Nematodes, arthropods
1999	Selamectin	<i>Dirofilaria immitis</i>	Nematodes, arthropods
2005	Latidectin	<i>Dirofilaria immitis</i>	Nematodes, arthropods
Membrane-Function-Disturbing Drugs			
1947/48	Diethylcarbamazine	<i>W. bancrofti</i> , <i>Brugia</i> spp., <i>Onchocerca volvulus</i> , <i>Loa loa</i>	
<b>Drugs with predominantly macrofilaricidal effects</b>			
Energy-Metabolism-Disturbing Drugs			
1916	Suramin	<i>Wuchereria</i> , <i>Brugia</i> (macrofilariae); adult <i>O. volvulus</i>	Trypanosomes
1984	Arsenamide (Thiacetarsamide)	<i>Dirofilaria immitis</i> (dog)	
Microtubule-Function-Affecting Drugs			
1971	Flubendazole, Mebendazole, Albendazole	<i>Wuchereria</i> , <i>Brugia</i> (macrofilariae), <i>O. volvulus</i> , also embryostatic effects	Nematodes, cestodes, trematodes, Giardia
<b>Drug combinations</b>			
	Ivermectin/DEC	Lymphatic filariasis	Mites/microsporidia
	Ivermectin/Albendazole		
<b>Drugs with macro- and microfilaricidal effects</b>			
1980	Benzothiazoles	<i>Onchocerca</i> , <i>Brugia</i> spp., <i>Dipetalonema</i> spp.	Cestodes

\* Schares G, Hofmann B and Zahner H (1994) Trop. Med. Parasitol. 45: 97–106

\*\* McKellar QA and Benchaoui HA (1996) J. Vet. Pharmacol. Therap. 19: 331–351

horse →nematodes, and *Ascaridia* in chicken. Piperazine is only effective against large intestinal nematodes.

### Molecular Interactions

Piperazine (Fig. 1) induces a reversible paralysis of *Ascaris suum* *in vitro* by exerting hyperpolarizing effects, thus acting as a selective GABA agonist (Fig. 2). The average duration of piperazine-induced channel openings is 14 msec, and is thus shorter than the GABA-produced openings with 32 msec.

Piperazine is about 100 times less potent than GABA in *A. suum*. The difference in potency correlates with the need for higher piperazine concentrations to achieve a similar opening rate to GABA. The →*Ascaris* GABA receptor is pharmacologically distinguished from the vertebrate GABA<sub>a</sub> receptors. The action becomes potentiated by the presence of a high pCO<sub>2</sub> probable by interaction of CO<sub>2</sub> with the heterocyclic ring of piperazine which partially substitutes for the carboxylgroup of GABA.

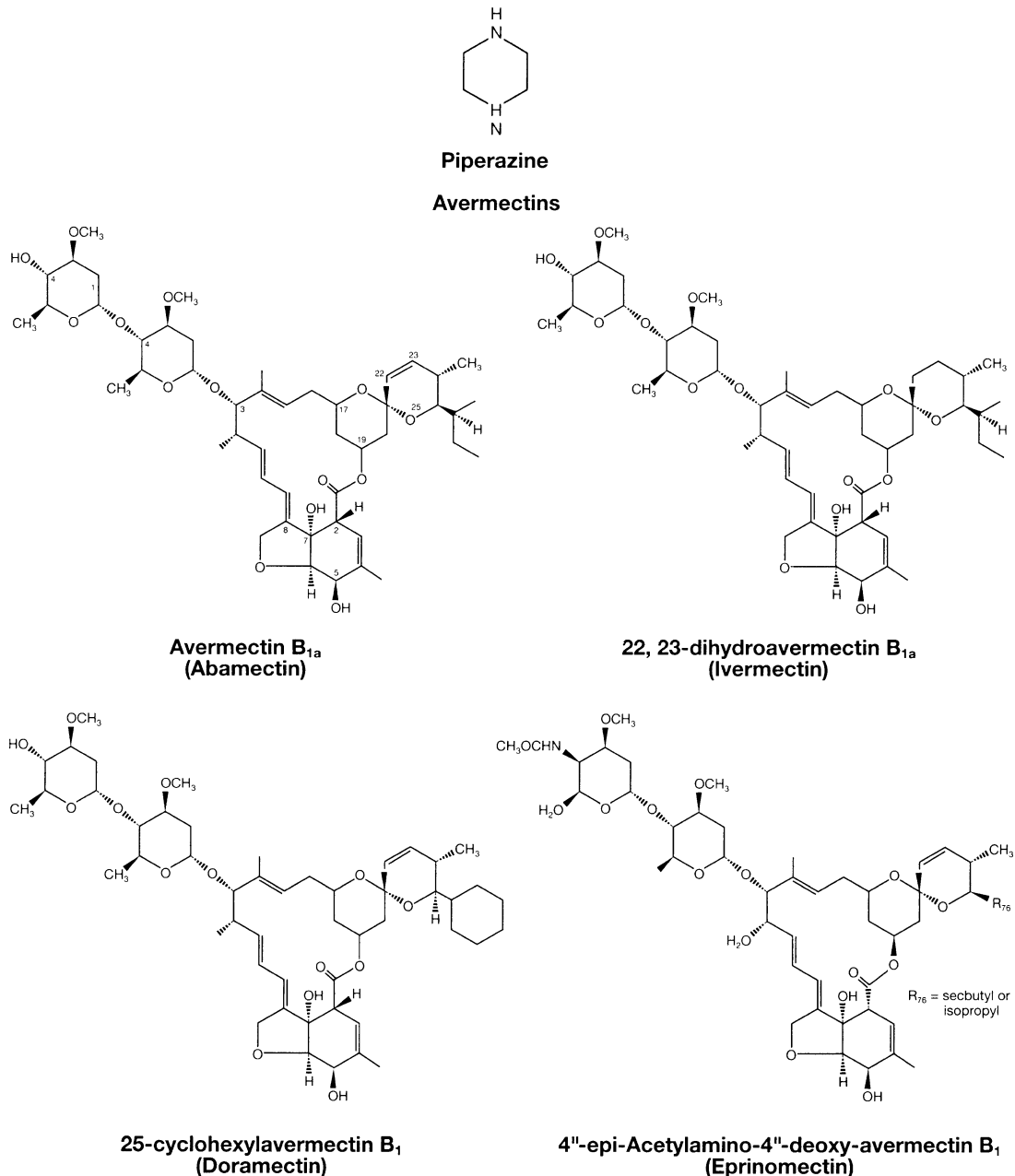

**Inhibitory-Neurotransmission-Affecting Drugs. Figure 1** Structures of antiparasitic drugs affecting GABA- or glutamate-gated chloride channels.

**Milbemycins**

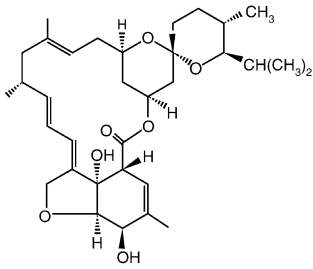

**Milbemycin D**

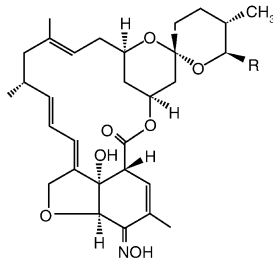

**Milbemycin 5-oxime**  
**A3 (R = CH<sub>3</sub>)**  
**A4 (R = C<sub>2</sub>H<sub>5</sub>)**

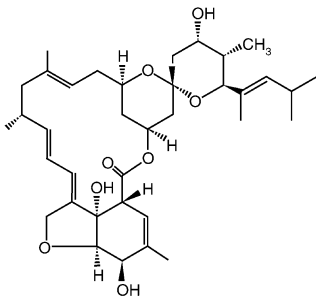

**Nemadectin**

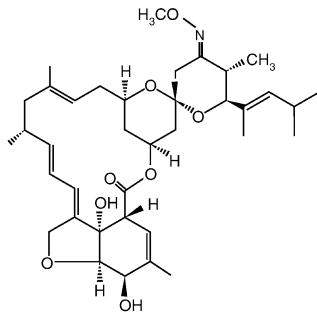

**Moxidectin**

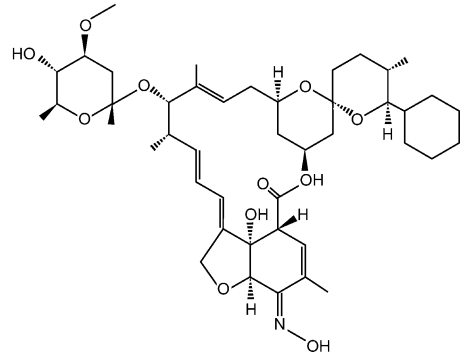

**Selamectin**

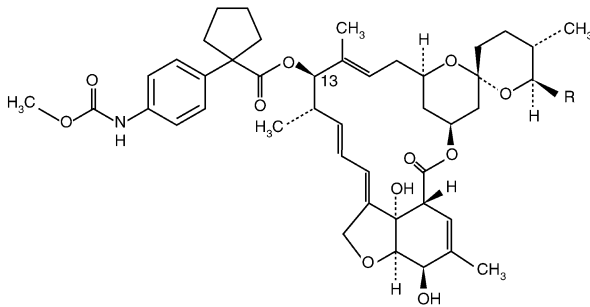

**Latidectin**

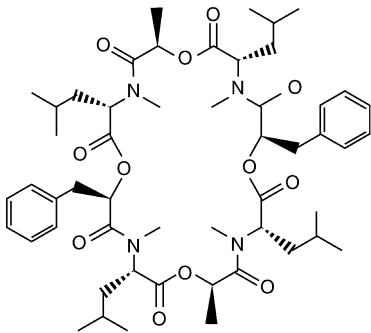

**PF 1022 A**

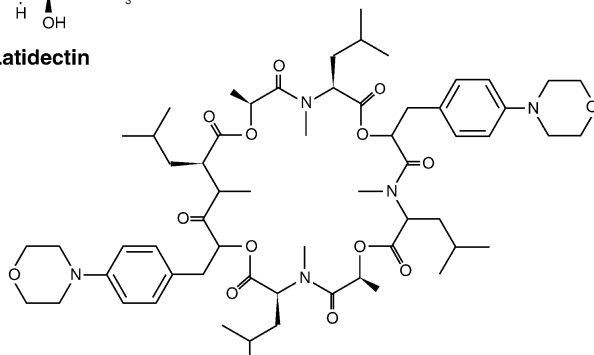

**Emodepside**

**Inhibitory-Neurotransmission-Affecting Drugs. Figure 1** Structures of antiparasitic drugs affecting GABA- or glutamate-gated chloride channels. (Continued)



## Macrocyclic Lactones

### Important Compounds

Ivermectin, Abamectin, Doramectin, Eprinomectin, Latidectin, Milbemycin oxime, Moxidectin, Selamectin.

### Synonyms

Ivermectin: Baymec, Ivomec, Ivomec-Premix Ivomec-S, Cardomec, Equell, Eqvalan, Furexel, Heartguard 30, Heartgard Chewable, Mectizan, Oramec, Rotectin, Strongid, Zymectrin; in: Ivomec-P, Heartgard Plus.

Abamectin: Avomec, Duotin, Enzec; in: Equimax.

Doramectin: Dectomax.

Eprinomectin: Eprinex.

Latidectin: Lifenal

Milbemycin oxime: Interceptor, Interceptor Flavor Tabs; in: Sentinel.

Moxidectin: Cydectin, Equest, Pro Heart, Quest.

Selamectin: Revolution, Stronghold.

### Clinical Relevance

The group of these macrocyclic lactones is subdivided into 2 groups, the **avermectins** and **milbemycins**. To the avermectin anthelmintics belong avermectin (explored 1975), ivermectin (marketed 1980), abamectin (1980), doramectin (1993), eprinomectin (1996), selamectin (1999) and latidectin (2005). To the milbemycin anthelmintics belong milbemycin (explored 1973), milbemycin oxime and moxidectin (1993). Avermectin is produced by *Streptomyces avermitilis*, an actinomycete strain. Avermectin was isolated in 1975 and its antiparasitic activity discovered in mice infected with *Nematospiroides dubius*. The components avermectin B<sub>1a</sub> and B<sub>1b</sub> exert the highest anthelmintic activities. The chemical reduction leads to dihydro-derivatives with low toxicity. The mixture of 80% dihydro avermectin B<sub>1a</sub> and 20% B<sub>1b</sub> is named **ivermectin**.

Macrocyclic lactones are applied as broad-spectrum anthelmintics and ectoparasiticides in dogs, horses, cattle, sheep, pigs (Tables 1, 2, →[Microtubule-Function-Affecting Drugs/](#)Table 1, 2). Ivermectin is the drug of choice against →[Strongyloides stercoralis](#) infections in immunosuppressed patients. In addition, this drug is used for →[heartworm](#) →[prophylaxis](#), in human onchocerciasis it is the drug of choice and it is of growing importance in →[lymphatic filariasis](#) (e.g., →[Wuchereria bancrofti](#) infections) as single drug or in combination with DEC or albendazole (Table 1). It has microfilaricidal effects and leads to a suppression of →[embryogenesis](#) in human onchocerciasis. It was introduced to Onchocerciasis Control Program of WHO in 1987 as Mectizan. In addition, ivermectin has some activity against male →[Onchocerca volvulus](#) in man as well as against microfilariae of *W. bancrofti*, →[Loa loa](#). Ivermectin activity can be observed against

*Litomosoides carinii* microfilariae in the circulating blood but not against microfilariae in the pleural cavity. Ivermectin has some *in vitro* activity against filarial parasites, e.g., →[Onchocerca](#) spp. There is generally a great discrepancy between the good *in vivo* efficacy and the minor *in vitro* effects. In general, treatment with ivermectin is not accompanied by severe side effects.

### Molecular Interactions

Macrocyclic lactones act at the junction of ventral cord interneurons and motoneurons resulting in the immobilization of nematodes and at the neuromuscular junction of arthropods causing paralysis. Macrocyclic lactones are taken up by many gastrointestinal and filarial nematodes via the cuticula and presumably with equal importance by oral ingestion (→[Acetylcholine-Neurotransmission-Affecting/](#)Fig. 3), while in blood-sucking parasites (→[Haemonchus contortus](#), arthropod ectoparasites) the oral absorption is by far more important. This view is supported by the observation that macrocyclic lactones exert greater activities against sucking →[lice](#) (*Haematopinus eurysternus*, *Linognathus vituli*) than biting lice (*Damalina bovis*). They also have high efficacy against →[mites](#) (*Sarcoptes scabiei* var *bovis*), which are known to be blood consumers.

The →[mode of action](#) of avermectins and milbemycins relies on the opening of the chloride ion channels in the neuronal membranes of nematodes and the muscle membranes of arthropods (Fig. 3). Thereby, cells become hyperpolarized and can no longer respond to incoming stimuli. All the physiological effects of avermectins and milbemycins can be reversed by picrotoxin, a specific blocker of the chloride ion channels. There is an ivermectin-induced increase of chloride permeability of nerve and muscles membranes of invertebrates observable. The structure and regulation of chloride ion channels of nematodes on the molecular level is unclear at present and also the identity of the target ion channel is controversial. Results from experiments with crayfish and *Ascaris suum* reveal that there is an interaction with receptors at chloride channels. The action is obviously not mediated by GABA-gated chloride channels. Expression experiments with *Xenopus*→[oocytes](#) lead to a proposed action of avermectins on a glutamate-gated chloride channel (GluCl). Genes encoding ivermectin-sensitive glutamate-gated chloride channel subunits could be isolated from →[Caenorhabditis elegans](#). Moreover, the avermectin-binding site could be purified from *C. elegans*. A 1.8–2.0 kbp mRNA of *C. elegans* encoding a chloride channel with sensitivity to both ivermectin and →[glutamate](#) could be identified. The channel is presumably a pentamer similar to

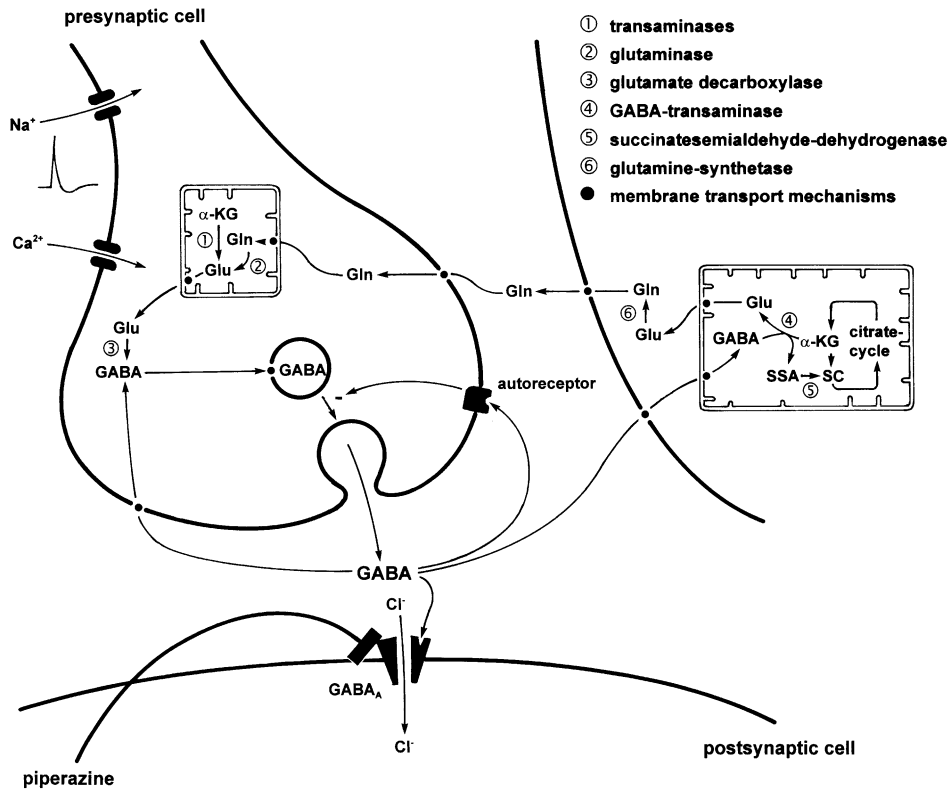

**Inhibitory-Neurotransmission-Affecting Drugs. Figure 2** Model of the action of piperazine on the GABAergic neurotransmission.

the nicotinic receptor and is selectively permeable for anions (chloride). The pentamer consists presumably of GluCl- $\alpha$  subunits with a glutamate-binding site and a GluCl- $\beta$  subunit which contains the ivermectin-binding site. Molecularbiological experiments reveal that the GluCl- $\beta$  subunit of the glutamate-gated channel is expressed in the pharyngeal muscle of *C. elegans*. There are considerable identities of  $\alpha$ - and  $\beta$ - subunits of the glutamate-gated ion channels with the  $\alpha$ - and  $\beta$ -subunits of mammalian GABA and  $\rightarrow$ glycine receptors.

According to a hypothesis the pharyngeal pumping of nematodes is inhibited by ivermectin. In the pharyngeal muscle of *A. suum* a potentiation of the action of glutamate on glutamate receptors that gate chloride channels by ivermectin analogues could be observed. The hyperpolarization of the nerve and muscle membranes leads to a flaccid paralysis of the parasites. The CNS side effects of ivermectin are explained by the strong action on the receptors in rat brain through potentiation of GABA- and benzodiazepine-binding to open the channel. Nevertheless the relatively safe use of avermectins is due to the inability to cross the blood-brain barriers into the CNS in mammals with the exception of *Collies*. Moreover, the selectivity of macrocyclic lactones is due to different neurotransmitter

functioning of glutamate in invertebrates (protostomes) where it acts as an inhibitory neurotransmitter in contrast to vertebrates where glutamate acts as an excitatory neurotransmitter.

Macrocyclic lactones like milbemycin oxime have only slight inhibitory and stimulatory concentration-dependent effects on the motility of filariae such as  $\rightarrow$ *Dirofilaria immitis*. It is assumed that definite host factors are required, which are independent of a specific immune status of the host. In  $\rightarrow$ *Acanthocheilonema viteae* an ivermectin-mediated cell adherence to the living microfilariae is observable and also cellular cytotoxicity by complement activation via the alternate pathway and/or antibodies. *L. carinii* microfilariae are killed without direct contact between cells and larvae. Here a very short-living mediator, which can be inhibited by the arginin-analogs such as N<sup>G</sup>-monomethyl-L-arginine and L-canavanine, seems to be involved in the drug's action. Leucocytes are also required for the *in vitro* efficacy of ivermectin against microfilariae of *Dirofilaria immitis*. The immobilization of the larvae is necessary for cell adherence or cellular toxicity similar to ivermectin-induced paralysis of *Acanthocheilonema suum*. In addition, the paralysis of microfilariae of *O. volvulus* presumably facilitates the phagocytic

**Inhibitory-Neurotransmission-Affecting Drugs. Table 2** Antiparasitic spectrum of ivermectin, doramectin, eprinomectin, and moxidectin in cattle (according to the technical manuals of the suppliers)

Ivermectin	Doramectin	Eprinomectin	Moxidectin
<b>1. Gastrointestinal nematodes (adults and L4 larvae)</b>			
<i>Ostertagia ostertagi</i> and arrested larvae	<i>Ostertagia ostertagi</i> and arrested larvae	<i>Ostertagia ostertagi</i> and arrested larvae	<i>Ostertagia ostertagi</i> and arrested larvae
<i>O. lyrata</i>			<i>O. lyrata</i>
<i>Haemonchus placei</i>	<i>Haemonchus</i> spp. <i>H. similis</i>	<i>Haemonchus placei</i>	<i>Haemonchus</i> spp. <i>H. similis</i> <i>H. contortus</i>
<i>Trichostrongylus colubriformis</i>	<i>Trichostrongylus colubriformis</i>	<i>Trichostrongylus colubriformis</i>	<i>Trichostrongylus colubriformis</i>
<i>Trichostrongylus axei</i>		<i>Trichostrongylus axei</i>	<i>Trichostrongylus axei</i>
<i>Cooperia oncophora</i>	<i>Cooperia</i> spp.	<i>Cooperia oncophora</i>	<i>Cooperia oncophora</i>
<i>C. punctata</i>	<i>C. punctata</i>	<i>C. punctata</i>	<i>C. punctata</i>
<i>C. pectinata</i>	<i>C. pectinata</i>		<i>C. pectinata</i>
			<i>C. spatulata</i>
		<i>C. surnabada</i>	
<i>Bunostomum phlebotomum</i>	<i>Bunostomum phlebotomum</i>	<i>Bunostomum phlebotomum</i>	<i>Bunostomum phlebotomum</i>
<i>Oesophagostomum radiatum</i>	<i>Oesophagostomum radiatum</i>	<i>Oesophagostomum radiatum</i>	<i>Oesophagostomum radiatum</i>
<i>Nematodirus helvetianus</i> *	<i>Nematodirus helvetianus</i> *	<i>Nematodirus helvetianus</i>	<i>Nematodirus helvetianus</i>
<i>N. spathiger</i> *	<i>N. spathiger</i> *		<i>N. spathiger</i>
<i>Strongyloides papillosus</i> *	<i>Strongyloides papillosus</i> *		
	<i>Trichuris</i> spp.	<i>Trichuris</i> spp.	<i>Trichuris discolor</i>
<b>2. Lungworms (Adults and L4 larvae)</b>			
<i>Dictyocaulus viviparus</i>	<i>Dictyocaulus viviparus</i>		
	<i>Dictyocaulus viviparus</i>	<i>Dictyocaulus viviparus</i>	
<b>3. Grubs/Myiasis</b>			
<i>Dermatobia hominis</i> larvae	<i>Dermatobia hominis</i> larvae		–
<i>Cochliomyia hominivorax</i> <sup>+</sup>	<i>Cochliomyia hominivorax</i>	<i>Hypoderma bovis</i>	–
<i>Hypoderma bovis</i>		<i>Hypoderma lineatum</i>	
<i>Hypoderma lineatum</i>			
<b>4. Lice</b>			
<i>Linognathus vituli</i>	<i>Linognathus vituli</i>	<i>Linognathus vituli</i>	<i>Linognathus vituli</i>
<i>Haematopinus eurysternus</i>	<i>Haematopinus eurysternus</i>	<i>Haematopinus eurysternus</i>	
<i>Solenopotes capillatus</i>	<i>Solenopotes capillatus</i>	<i>Solenopotes capillatus</i>	<i>Solenopotes capillatus</i>
<i>Damalinia bovis</i> <sup>++</sup>	<i>Damalinia bovis</i> <sup>++</sup>	<i>Damalinia bovis</i>	
<b>5. Mites</b>			
<i>Psoroptes ovis</i>	<i>Psoroptes ovis</i>		<i>Psoroptes ovis</i>
<i>Sarcoptes scabiei</i> var. <i>bovis</i>		<i>Sarcoptes scabiei</i>	
<i>Chorioptes bovis</i>		<i>Chorioptes bovis</i>	
<b>6. Ticks</b>			
<i>Boophilus microplus</i>	<i>Boophilus microplus</i>		<i>Boophilus microplus</i>
<i>Boophilus decoloratus</i>			
<i>Ornithodoros savignyi</i>			
<b>7. Flies</b>			
–	<i>Haematobia irritans</i>	<i>Haematobia irritans</i>	–

+ prophylactic (injection) or curative (topical) treatment; ++ parasitic control; \* only adult stages

cell-trapping. The effects of ivermectin on adult worms are not fully understood to date. Electron microscopic studies on *Acanthocheilonema viteae* reveal a vacuolization and an increased electron density in all organs

beginning 8 days after treatment. In *L. carinii* a degeneration of intrauterine stages and an extreme folding of the uterine wall can be observed accompanied by a generally increased electron density.

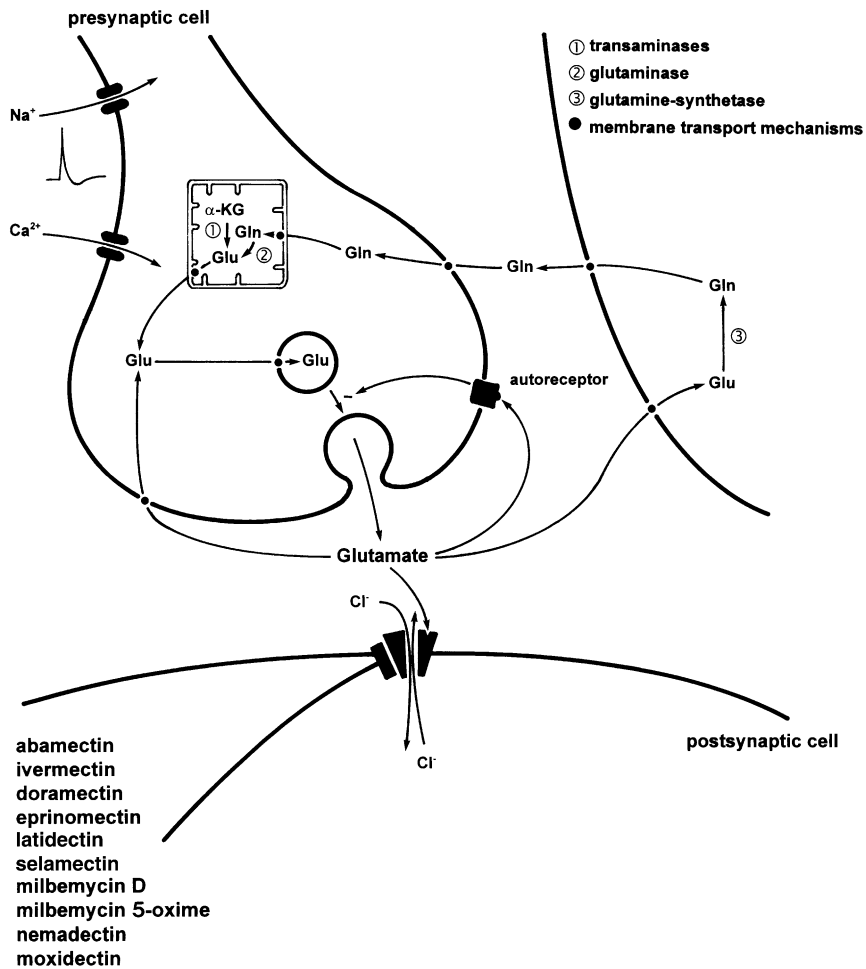

**Inhibitory-Neurotransmission-Affecting Drugs. Figure 3** Model of the drugs affecting neuromuscular transmission by inhibitory neurotransmitters in protostomes.

### Resistance

Resistance against macrocyclic lactones is probably inherited by a single dominant allele in *Haemonchus contortus*. The mechanism of ivermectin resistance on the molecular level is still unknown. Membranes of ivermectin-resistant and -susceptible larvae of *H. contortus* contain similar numbers of ivermectin-binding sites with the same affinity characteristics. It could recently be shown that ivermectin resistance may be caused by an altered P-glycoprotein homolog in *H. contortus*. Thereby the expression of P-glycoprotein mRNA is higher in the ivermectin-resistant *H. contortus* strain than in the susceptible strain. This multidrug-resistance mechanism can be reversed by verapamil and there is an increased efficacy of ivermectin and moxidectin against moxidectin-resistant *Haemonchus* in jirds (*Meriones unguiculatus*) in the presence of verapamil. The disruption of the *mdr1a* gene, which encodes P-glycoprotein in mice, results in

→hypersensitivity against ivermectin. In another report an involvement of P-glycoprotein in ivermectin resistance in *H. contortus* was excluded. Now there exists a *Caenorhabditis elegans* mutant with a high level of ivermectin resistance, which can serve as a tool for further investigations of alterations in the glutamate/ivermectin chloride channel receptor and mechanism of ivermectin resistance in future.

### Cyclic Octadepsipeptides

#### PF1022A

Synonyms.

#### Clinical Relevance

This compound has potent antinematodal properties against →*Toxocara canis*, *T. cati*, and →hookworms in dogs and cats and *Trichuris vulpis* in dogs. In addition, it has high efficacies against gastrointestinal →nematodes in horses, sheep, chicken, and rodents.

### Molecular Interactions

PF1022A is a 24-membered cyclic depsipeptide isolated from *Mycelia sterilia*, a fungus which belongs to the →microflora of the plant *Camellia japonica*. Recently the chemical synthesis of PF1022A and also the radiolabelled compound have been reported. The anthelmintic action on the molecular level remains obscure to date. It appears that it exerts its activity by interfering with the neuromuscular transmission of nematodes. At low concentrations, the motility of →*Angiostrongylus cantonensis* is depressed, and picrotoxin, bicucullin, and  $\text{Ca}^{++}$  can antagonize the action. Thus, the action is explained by an antagonism of acetylcholine receptors and/or gabaergic mechanisms. It could also be shown that PF1022A has a high affinity binding to the  $\text{GABA}_A$  receptor in *Ascaris suum*.

Recent experiments show that PF1022A and emodepside bind to a latrophilin-like receptor in the parasitic nematode *Haemonchus contortus* and the free-living nematode *Caenorhabditis elegans*.

### Emodepside

#### Synonyms

PF1022-221, Bay 44-4400, emodepside as part of the anthelmintic combination emodepside/praziquantel in Profender Spot-On® for cats.

#### Clinical relevance

Anthelmintic research of the class of cyclic octadepsipeptides to which emodepside belongs started at the beginning of the 1990s. PF1022A, the starting material

of emodepside, is a natural secondary metabolite of the fungus *Mycelia sterilia*, which belongs to the microflora of the leaves of *Camellia japonica*. PF1022A consists of four N-methyl-L-leucins, two D-lactic acids and two D-phenyllactic acids. These molecules build up a cyclic octadepsipeptide with an alternating L-D-L configuration. Emodepside is a semisynthetic derivative of PF1022A, which contains a morpholine attached in para-position at each of both D-phenyllactic acids.

Emodepside is effective against a wide variety of nematodes in cats, dogs, sheep, cattle, horse, poultry, mice, and rats. In cats after spot-on application of the all de-wormer Profender®, emodepside is highly efficacious against *Toxocara cati* and *Ancylostoma caninum* (→Microtubule-Function-Affecting Drugs/Table 2). In addition to its effects against gastrointestinal nematodes emodepside shows activities against lungworms in cattle, different larval stages of filariae in rodent models, and *Trichinella spiralis* larvae in mice.

### Molecular Interactions

Emodepside binds to a presynaptic latrophilin-like receptor in the parasitic nematodes *Haemonchus contortus*, *Ostertagia ostertagi*, *Cooperia oncophora*, *Ancylostoma caninum*, and the free-living nematode *Caenorhabditis elegans*. Binding of drug to the latrophilin-like receptor is followed by the activation of a presynaptic signal transduction cascade (Fig. 4). The activation of  $\text{Gq}\alpha$  protein and phospholipase- $\text{C}\beta$  leads to mobilization of diacylglycerol (DAG). DAG then activates UNC-13 and synaptobrevin, two proteins which play an important role in presynaptic vesicle

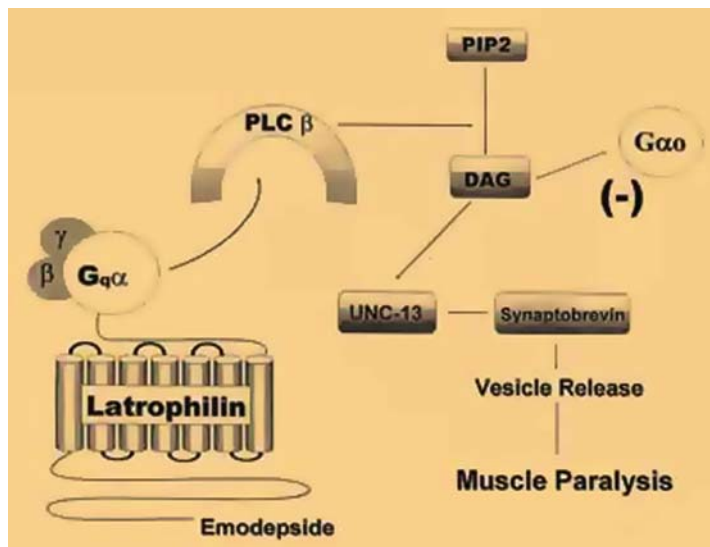

**Inhibitory-Neurotransmission-Affecting Drugs.** Figure 4 Proposed mechanism of action following activation of a presynaptic latrophilin receptor by emodepside. PLC, Phospholipase, PIP2, phosphatidylinositol- 4,5-bisphosphate, DAG, diacylglycerol.

functioning. This finally leads to the release of a currently unidentified neurotransmitter. The transmitter (or modulator) exerts its effects at the postsynaptic membrane and induces a flaccid paralysis of the pharynx and the somatic musculature in nematodes.

## Innate Immunity

See related entries: →Amoebiasis, →Chagas' Disease, Man, →Filariasis, Lymphatic, Tropical, →Giardiasis, Animals, →Giardiasis, Man, →Leishmaniasis, Man, →Malaria.

## Inoculation

From Latin: *oculus* = eye. Experimental infection of a host.

## Insecticides

→Ectoparasiticides, →Acarizides.

## Insects

### Classification

Class of →Arthropoda.

### General Information

The Insecta are the largest group of animals with respect to the number of species (~773,000) and to individuals. The classification is based on the original occurrence (→Pterygota) or absence (→Apterygota) of wings. The further developed subclass Pterygota includes all important parasitic species; some of them, however, have apparently lost their primary wings during adaptation to parasitism (e.g., →fleas). Insects may act as ectoparasites when sucking blood on the surface of their hosts (e.g., →mosquitoes), or may even become endoparasites when entering the skin, and the intestinal and/or respiratory tracts in a variety of hosts (e.g., flies leading to myiasis; →*Dermatobia hominis*).

In addition to this method of parasitism the insects may be directly or indirectly involved in the life cycles of a large number of parasites. These insects are encountered:

- as true intermediate or final hosts of important parasites of humans and animals (e.g., →Protozoans, →Platyhelminthes, →Nematodes)
- as true vectors of pathogens (including an inner production phase) such as bacteriae, rickettsiae, and viruses (e.g., fleas, body →lice)
- as mechanical vectors of some parasites (transporting parasitic stages via mouthparts) (e.g., *Entamoeba*-, *Giardia* cysts)

The body organization of parasitic insects is very often closely adapted for its peculiar way of life and the special needs of feeding. However, the following basic features are commonly recognized:

- The body shows a clear segmentation into the head (caput), breast (thorax), and trunk (abdomen), each part consisting of several specific segments (visible from outside or not).
- The chitinous exoskeleton is regularly molted during growth (Fig. 4).
- The caput, the segments of which form a strong capsule, is endowed with a pair of dorsal, segmented antennae (Fig. 9) and 3 pairs of ventral mouthparts (mandibles, maxillae 1 and 2), the latter being strongly adapted for their special way of feeding. In general, eyes are compound and located close to the basis of the antennae; the eyes are mostly composed of numerous single ommatidia, in rare cases (e.g., fleas) only one or a few ommatidia are present.
- The thorax always consists of 3 segments (pro-, meso- and metathorax), which each bear ventrally a pair of legs (e.g., the name hexapoda means six feet). These legs are segmented and composed of 5 distinct parts (coxa, trochanter, femur, tibia, and tarsus); the tarsus comprises several single segments and is equipped with species-specific holdfast systems, claws, etc.
- The meso- and/or metathorax may form typical membranous wings (formed by the →integument) which are moved by strong inner (mostly indirect) muscular systems. Wings, however, are reduced secondarily in some groups (e.g., fleas, bedbugs, lice).
- The abdominal segments form no ventral extremities except for some specific copulatory appendages. Inside the abdomen important systems of the insects are found (gonads, heart, excretory system, Malpighian tubules, etc.).
- Respiration of insects proceeds using a large, widely branched tracheal system reaching up to the surface of single cells.

- The inner side of the gut of many species is lined by a single or several chitinous →**peritrophic membranes** (Fig. 7), which are a considerable obstacle for some parasites on their way to the intestinal wall and to the body cavity.
- In general, the fertilized eggs of insects show a total, superficial cleavage, which in the Pterygota is followed by 2 different types of larval development. Hemimetabolic development proceeds as constant →**metamorphosis** via molting larvae (also named nymphs), which resemble the final adult stage and become sexually mature after the last →**molt**. Holometabolic development is characterized by an additional →**pupa**, which gives rise by molt to the sexually mature adult (→**Imago**). The pupa may be completely inactive (e.g., fleas, flies) or may be motile (as in →**mosquitoes**), but never feeds.

### System

Considering exclusively the parasitic groups, the following summarized classification is in general accepted:

- Class: Insecta
- Subclass: Apterygota (wingless forms)
- Subclass: Pterygota (primarily with wings which may become reduced in some groups)
- Order: →**Phthiraptera** (animal lice)
  - Suborder: →**Anoplura** (bloodsucking lice)
  - Suborder: →**Mallophaga** (chewing lice)
- Order: →**Rhynchota** (→**Hemiptera**, →**Bugs**)
  - Family: →**Reduviidae** (predacious bugs)
  - Family: →**Cimicidae** (bedbugs)
- Order: →**Diptera** (forewings fully developed, hindwings as halteres)
  - Suborder: Nematocera
    - Family: →**Phlebotomidae** (→**Sand Flies**)
    - Family: →**Culicidae** (→**Mosquitoes**)
    - Family: →**Ceratopogonidae** (→**Midges**)
    - Family: →**Simuliidae** (→**Blackflies**)
  - Suborder: →**Brachycera**
    - Family: Tabanidae (horseflies, deerflies, clegs)
  - Suborder: →**Cyclorrhapha**
    - Family: →**Muscidae** (houseflies, stable flies)
    - Family: Calliphoridae (bluebottles, blowflies)
    - Family: Sarcophagidae (meat flies)
    - Family: →**Glossinidae** (tsetse flies)
    - Family: Oestridae (nostril flies)
    - Family: Gasterophilidae (stomach botflies)
    - Family: Hypodermatidae (warble flies)
    - Family: →**Hippoboscidae** (keds, louse flies)
- Order: →**Siphonaptera** (→**Aphaniptera**, →**Fleas**)

### Reproduction

Most parasitic insects are →**oviparous**. In some genera (e.g., →**Oestrus**, →**Sarcophaga**) eggs are retained until larvae are ready for hatching (→**Ovoviviparous**). A few species (e.g., some →**Musca** spp., →**Glossina** spp.) are →**larviparous**, laying more or less highly developed larval →**instars**. Even →**puparity** can be found (e.g., →**Melophagus ovinus**) when immobile, fully developed larval instars pupate during deposition. The ontogeny of parasitic insects occurs either as →**hemimetabolous development** or →**holometabolous development**.

### Reproductive Organs

Insects are typically →**dioecious**, this being regulated by different →**sex chromosomes**. →**Sexual dimorphism** becomes evident with the development of the abdominal copulatory appendages. In general the female genital pore is situated ventrally at the posterior margin of the 8th segment (sternite), whereas the male pore is situated along the ventral midline of the 9th, which also forms the copulatory appendages.

The **male** system (e.g., fleas; Fig. 1) is situated dorsal to the intestine. It consists of 2 testes, each with

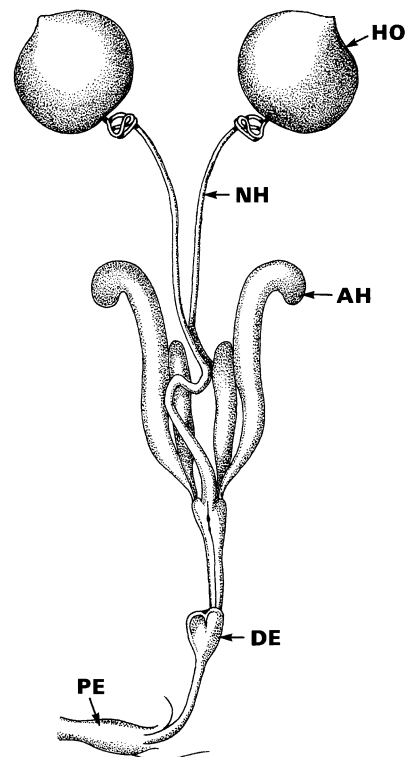

**Insects. Figure 1** Diagrammatic representation of the reproductive system of a male dog flea (→**Ctenocephalides canis**). AH, accessory glands; DE, ductus ejaculatorius; HO, →**testis**; NH, “epididymis” (vas efferens); PE, penis.

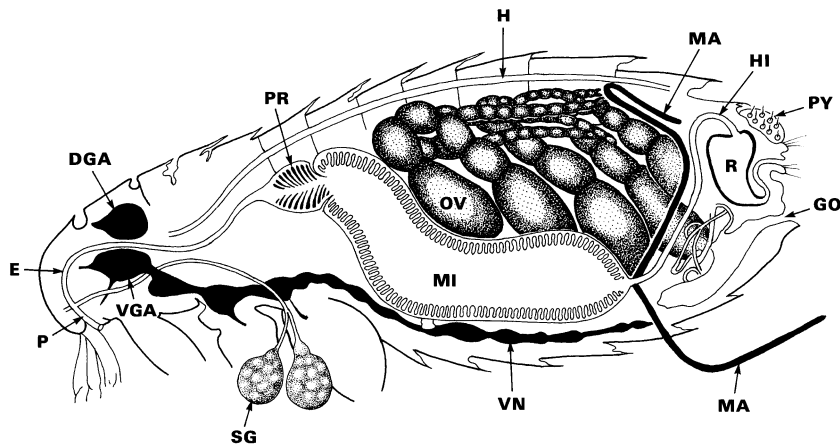

**Insects. Figure 2** Diagrammatic representation of a longitudinal section through a female flea (*Xenopsylla cheopis*). *DGA*, dorsal head ganglion (superesophageal); *E*, esophagus; *GO*, genital opening; *H*, heart; *HI*, hindgut; *MA*, Malpighian tubules; *MI*, midgut; *OV*, ovarioles; *P*, pharynx; *PR*, proventriculus; *PY*, pygidium; *R*, rectum; *SG*, salivary gland; *VGA*, ventral head ganglion (subesophageal); *VN*, ventral nerve chord.

1 to several sperm-producing follicles, 2 vasa deferentia (each with an enlargement, the seminal vesicle), 2 accessory glands which join the vasa deferentia, a single ejaculatory duct formed by fusion of the vasa deferentia, a penis which communicates with the exterior via the genital pore, and several species-specific external copulatory appendages.

The female system (Figs. 2, 3) has 2 ovaries. These are composed of a species-specific number of tube-like ovarioles, which differ with respect to the location of the vitelline cells, but which all include a string of oocytes, of which the one nearest the oviduct is the first to mature. In the posterior part the ovarioles unite to form the calyx, which opens into the lateral oviduct. The female system also has 2 lateral oviducts, a common central oviduct, a common vagina often leading into an exterior ovipositor, a single spermatheca (seminal receptacle, which opens into the vagina as does a spermathecal gland) and paired accessory glands that empty into the vagina.

### Gametogenesis and Fertilization

The testes of insects produce, via a meiosis, numerous filariform haploid spermatozoa, which are finally endowed with a head containing the nucleus and a midregion including the masses of mitochondria, and which end in a long motile flagellum extending from the base of the nucleus. During copulation these spermatozoa are transferred directly or via a spermatophore into the female system. The ovary

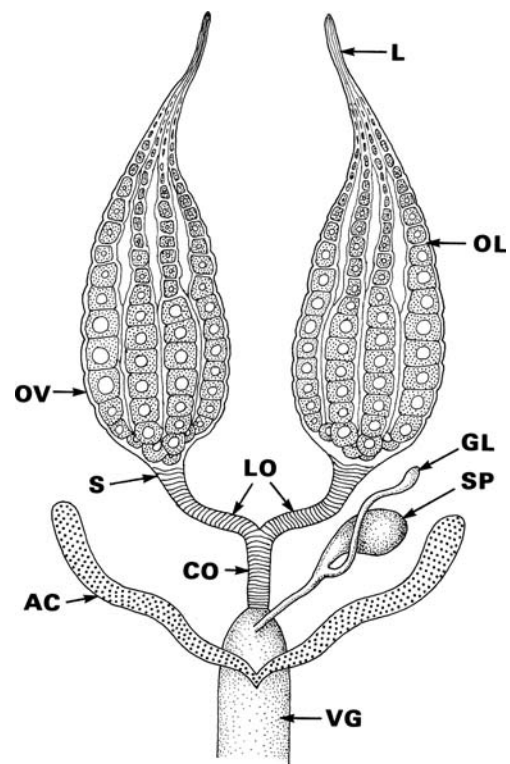

**Insects. Figure 3** Diagrammatic representation of the reproductive system of female insects. *AC*, accessory glands; *CO*, common oviduct; *GL*, spermathecal gland; *L*, ligament; *LO*, lateral oviduct; *OL*, ovariole; *OV*, ovary; *S*, sphincter; *SP*, spermatheca; *VG*, vagina.



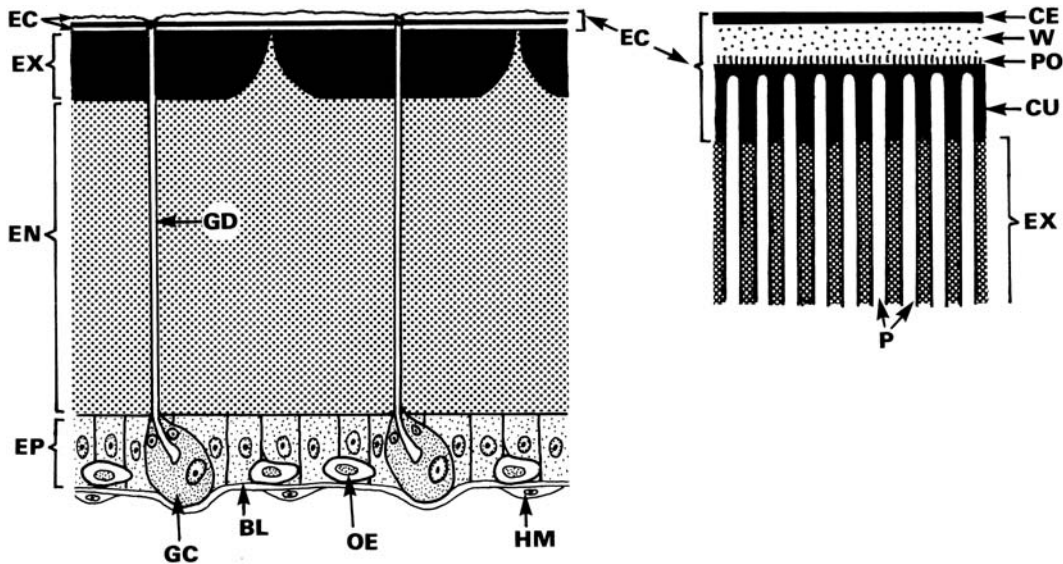

**Insects. Figure 4** Diagrammatic representation of a typical insect →cuticle. *BL*, basal lamina; *CE*, cement layer; *EC*, epicuticle; *EN*, endocuticle; *EP*, epidermis; *EX*, exocuticle; *GC*, gland cell; *GD*, gland ductus; *HM*, hemocyte; *OE*, oenocyte; *P*, pore channel; *PO*, polyphenol layer; *W*, wax layer.

(→*Germarium*) of the latter produces mature eggs which in Pterygota contain centrally located →yolk masses (i.e., centrolecithal eggs) and which are surrounded by an →eggshell provided with a thin place for fertilization (→*Micropyle*).

Single mating is the rule in insects, and it involves internal insemination and filling of the →*spermatheca*. When the mature ovum is shed, the empty ovarian sac contracts, but often remains as a remnant body, thus indicating the individual physiological age (this is helpful, e.g., in populations of *Glossina* spp., →*Simulium* spp., and →*Anopheles* spp.). When the ova pass the openings of the →*spermatheca*, fertilization occurs and the final egg shape is regulated by the excretions of the accessory glands. Several spermatozoa enter totally via the →*micropyle*. During the time needed by the spermatozoa to pass through the yolk, the female nucleus divides meiotically into 4 haploid nuclei. Of these 3 nuclei degenerate, whereas the fourth fuses with the nucleus of the spermatozoon that arrives first. This leads to the diploid set of →*chromosomes*, the number of which varies among species and even races, e.g., *Culex pipiens* has 6 chromosomes (= 2 *n*). This egg starts the embryonation, which in parasitic insects occurs superficially since the cells initially divide as a surface layer on the centrally situated yolk.

### Integument

The →cuticle covers the whole body of insects and the anterior and posterior parts of their intestine (Fig. 7).

The nonliving cuticular masses are excreted by an epidermis (→*Hypodermis*), which consists of a single layer of cells resting on a basal lamina (basement membrane; Fig. 4). This hypodermis includes a variety of different cells such as the typical epidermal cells, hair-forming cells (tomogen and trichogen cells), oenocytes, sensory cells, and various dermal gland cell types; the latter may form long tubular cytoplasmic protrusions, which extend close to the surface, thus giving rise to the “cuticular pores” seen in sections (Fig. 4). The “normal” hypodermal cells produce the nonliving cuticle, which is composed of 3 distinct layers, epi-, exo- and endocuticle. The innermost layer is the thick endocuticle which includes →*chitin* filaments and nontanned protein and thus remains flexible. The exocuticle is also relatively thick and represents the main component of the exoskeleton, since it is built up of chitin and tanned protein (sclerotin). On its outside the exocuticle is covered by the epicuticle, which in general is only 1–3 μm thick; the epicuticle is composed of an inner layer of lipoprotein (→*Cuticulin*), a polyphenol layer, a wax layer, and finally is covered by a cement layer, thus providing waterproofing and survival in atmospheres that are not water-saturated.

This typical construction of the cuticle, which is regularly molted (→*Diptera*/Fig. 1), is altered at places where flexibility is needed. Thus, the membranes between sclerites (segments) lack the rigid exocuticle, and the endo- and epicuticle remain smooth to allow body flexion. Molt (→*Ecdysis*) occurs due to activity of hormones such as ecdyson, neotenin, etc. (→*Hormones*).

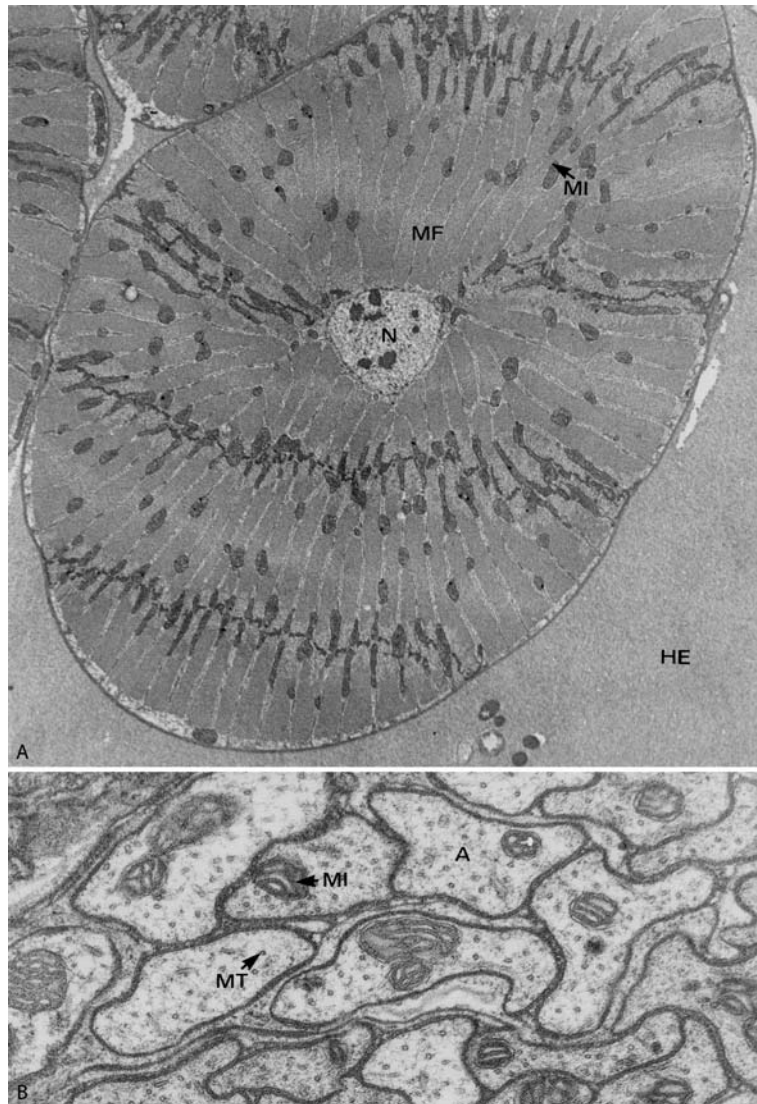

**Insects. Figure 5** Transmission electron micrographs of insect tissues. **A** Cross-section through a muscle cell stretching through the body cavity in the sheep-keed *Melophagus ovinus*. Note the central arrangement of the nucleus (N) and the lining up of the mitochondria (MI). HE, hemolymph; MF, muscle filament packages ( $\times 13,000$ ). **B** Cross-section through the subesophageal ganglion of a cat flea ( $\rightarrow$ *Ctenocephalides felis*) showing the axons (A) including mitochondria (MI) and microtubuli (MT) ( $\times 30,000$ ).

### Musculature

The quickly acting muscles of insects as well as arthropods are always of the cross-striated type (Fig. 5A), showing the characteristic arrangement. They are no longer parts of the  $\rightarrow$ body cover, but are segmentally arranged and insert at intersegmental  $\rightarrow$ tendons. The muscular bundles may run in all directions, but in many cases have antagonistic counterparts. Extremities such as the mouthparts, legs, and wings (if present at all) possess muscles that are independent of those of the body, thus allowing countermovements. In addition to these quickly acting striated muscles, the intestine, some other internal organs and external appendages are

lined by muscles of the smooth type containing relatively few filaments.

### Intestine and Food Uptake

The asymmetrical tube-like gut of adult insects is oriented through the midregion of the body and consists of 3 main portions (Figs. 6, 7): (1) stomodeum (foregut), (2)  $\rightarrow$ ventriculus (midgut), and (3) proctodeum (hindgut).

The stomodeum opens anteriorly through the mouth, which is located in the preoral cavity and connected with the excretory ducts of the paired salivary glands.

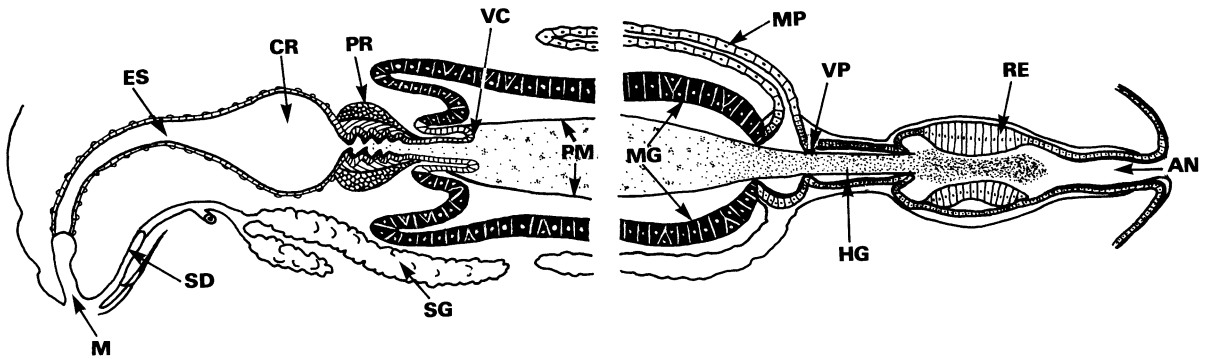

**Insects. Figure 6** Diagrammatic representation of the intestinal tract of insects (after Weber). AN, anus; CR, crop; ES, esophagus; HG, hindgut; M, mouth; MG, midgut; MP, Malpighian tubes; PM, →peritrophic membrane; PR, →proventriculus; RE, rectum; SD, salivary duct; SG, salivary gland; VC, valvula cardiaca; VP, valvula pylorica.

The mouth is armed by (originally) 3 pairs of ventral appendages of the head (caput) modified as mouthparts which are species-specific and adapted to the particular feeding habits. In parasitic insects the following types of mouthparts can be found:

- The chewing type (e.g., Mallophaga, biting lice) is considered the most basic one, since it is common in many free-living species (beetles, ants, etc.) and consists of large mandibles (to masticate the food), and a pair of separate maxillae I and of fused maxillae II (i.e., labium). Both types of maxillae serve to push the minced food particles into the mouth.
- The sponging or lapping type is found in most nonbiting dipterans (e.g., *Musca*, *Calliphora*; Fig. 9). The mandibles and maxillae are nonfunctional, whereas the remaining parts form a →proboscis with a superficially enlarged tip, the surface of which consists of halfmoon-shaped plates (labella) surrounding the mouth. Foods dissolved by excretion of saliva are ingested in liquid form via the superficial capillary channels, which lead to the mouth.
- The cutting-sponging (lapping) type is characteristic of tabanids (Fig. 9). Their mandibles are modified as sharp blades and the maxillae appear as long stylets; both may cut the host's skin. Bloodsucking (lapping) occurs via a sponge-like labium together with the hypo- and epipharynx (i.e., protrusions of the body wall).
- Piercing-sucking types are present in many blood-sucking ectoparasites such as mosquitoes (Fig. 8), →tsetse flies, other flies (Fig. 9), lice (→Lice/Figs. 1, 3), bedbugs (→Bugs/Fig. 2), or fleas (Fig. 7, →Fleas/Fig. 3). Modifications found in the different groups are so great that the homologies between mouthparts can only barely be recognized. In any case, however, 2 different channels are formed by the mouthparts, the larger one is used as a food canal, while the other

conveys saliva containing an anticoagulant and several other substances.

The size and shape of the skin-piercing mouthparts are related to the 2 different methods of blood feeding. The mouthparts of vessel or capillary feeders such as some →bugs (*Cimex* spp., *Rhodnius* spp.), fleas, and some mosquitoes (e.g., *Anopheles* spp.) are injected into the lumen of capillaries of suitable caliber, whereas →pool feeders such as most nematocerans (e.g., Simuliidae), some flies (e.g., →*Stomoxys* spp., Glossinidae), and tabanids destroy peripheral blood vessels with their armed mouthparts, wait until sufficient blood has collected inside the wound, and then ingest it rapidly, thus visibly distending their stomach.

In parasitic bugs, fleas, lice, tabanids, and some flies (e.g., muscids, tsetse flies), both sexes are hematophagous, whereas in nematocerans such as culicids, simuliids, phlebotomids, and ceratopogonids only the females possess piercing-sucking mouthparts and the males feed exclusively on moisture, etc. or even do not feed.

The mouth opens into the buccal cavity and leads to the pharynx, which eventually acts as a muscular pump and conveys the food down the narrow esophagus to a crop which acts as a storage system. The crop, which in dipterans is a blind-ending diverticulum from the esophagus, in general opens into the narrower valve-like proventriculus, which prevents regurgitation of food from the midgut (cf. Figs. 2, 6).

- The ventriculus (midgut, stomach in part) is the main digestive organ and in several parasitic insects is lined with an inner nonadherent tube of chitinous components (peritrophic membrane), which is of great importance in the transmission of pathogens (cf. Fig. 7, →Lice/Fig. 3). The midgut may be divided into different regions with concentrative, digestive,

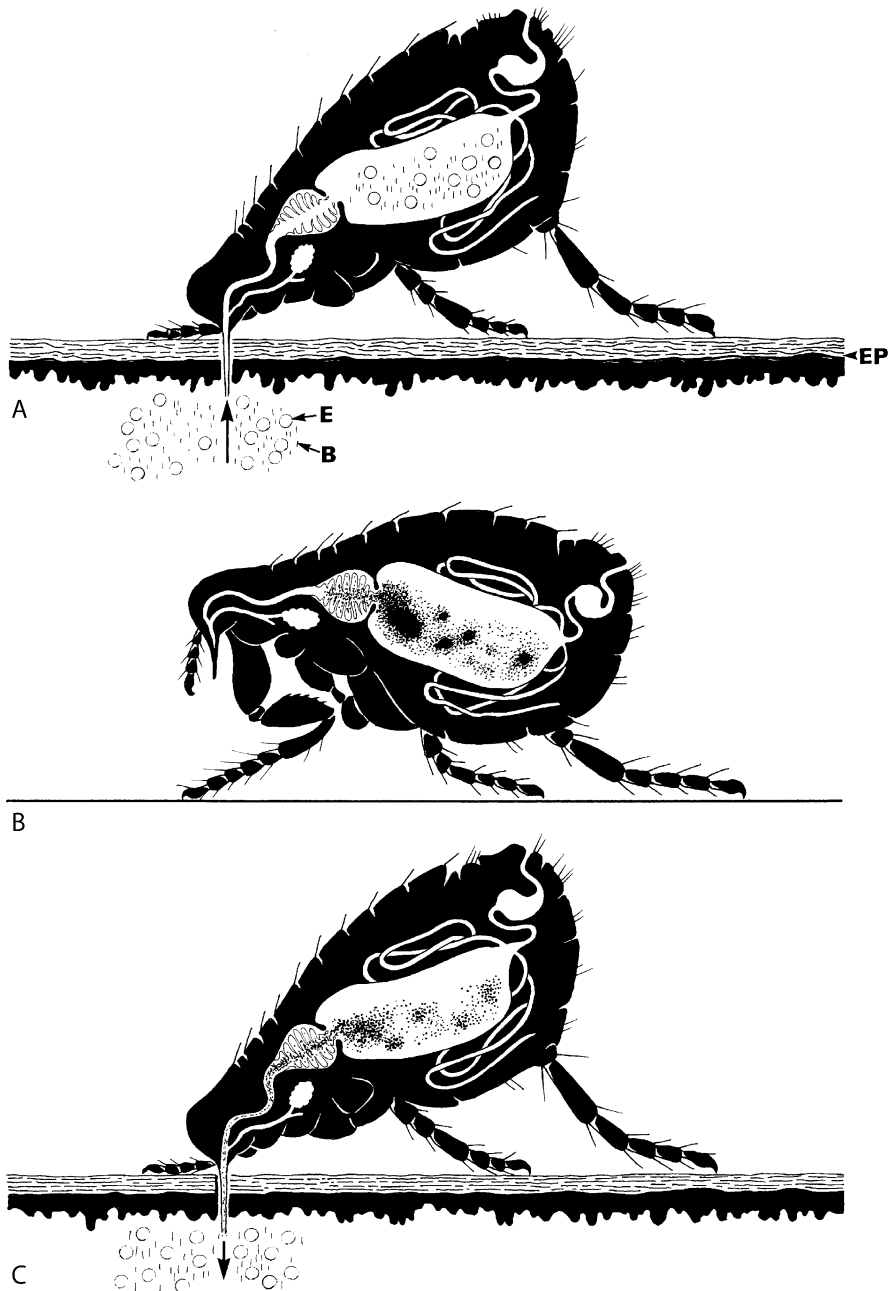

**Insects. Figure 7** Diagrammatic representation of the transmission of →plague bacteria during blood meals of a flea (e.g., →*Xenopsylla cheopis*). **A** The flea sucks bacteria (B) among red blood cells at an infected host. **B** Between 2 blood meals the bacteria reproduce inside the flea and block the opening of its stomach. **C** During the next blood meal the flea regurgitates intestinal contents (with bacteria) into the other host (according to Geigy).

and absorptive functions. In nematoceros larvae and some other insect groups additional gastric ceca may increase the surface area for absorption.

The proctodeum (hindgut) extends posteriorly from the midgut, from which it is separated by a pyloric sphincter. The main function of the hindgut is the

resorption of water from the feces and the urine. The components of the latter come from the Malpighian tubules, which open at the border between the mid- and hindgut. The hindgut usually has an intestinal part, followed by the colon and rectum, and finally opens into the ventrally located anus (Fig. 6).

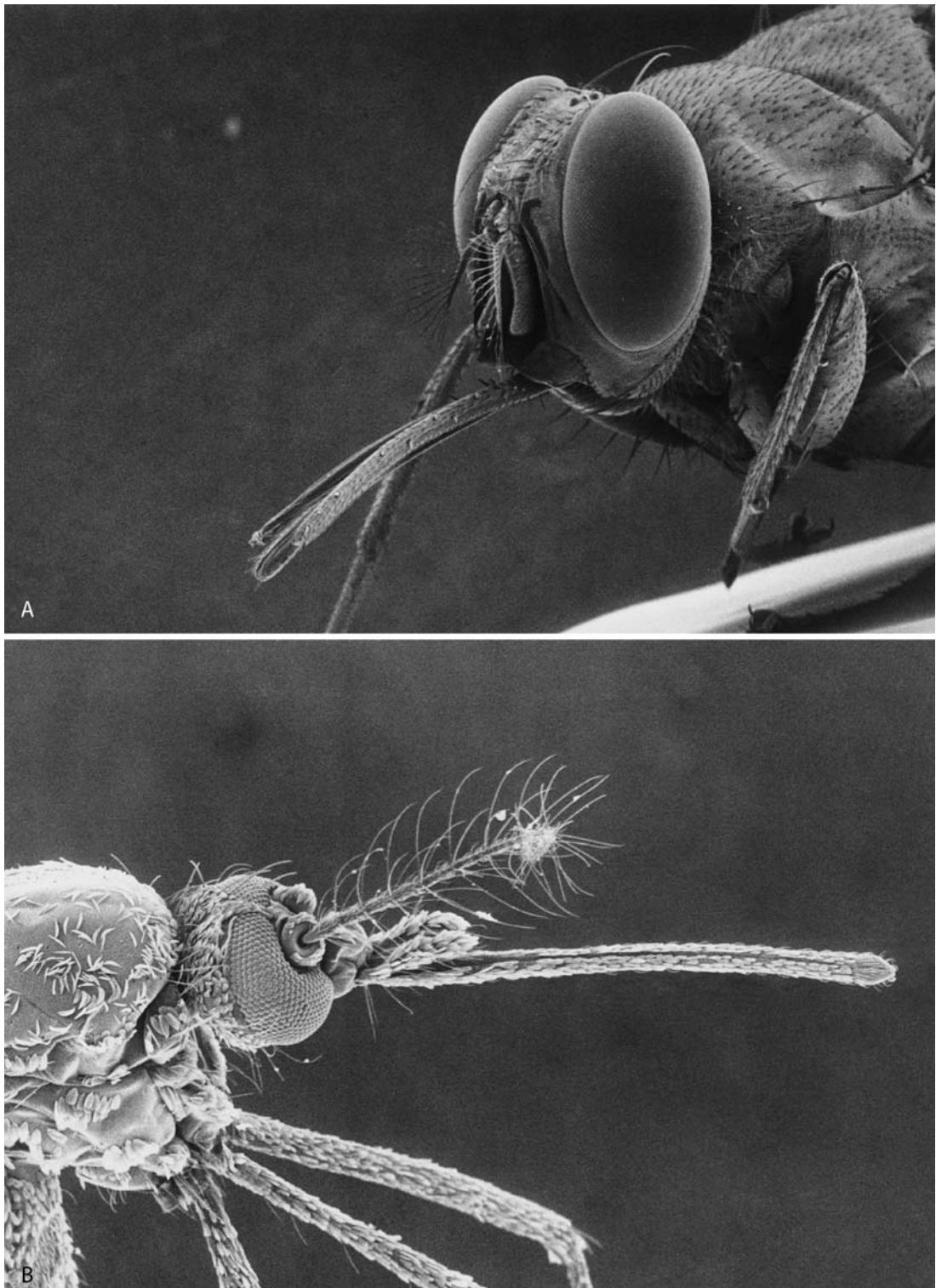

**Insects. Figure 8** SEM-micrographs of the mouthparts of dipteran bloodsuckers. Both hide their stylet-like injectors in a protrudible sheath. **A** The tsetse fly → *Glossina morsitans*. × 50. **B** The → Yellow fever transmitting mosquito *Aedes aegypti*. The antenna of the females (like in the present picture) possess only a few lateral hairs (× 30).

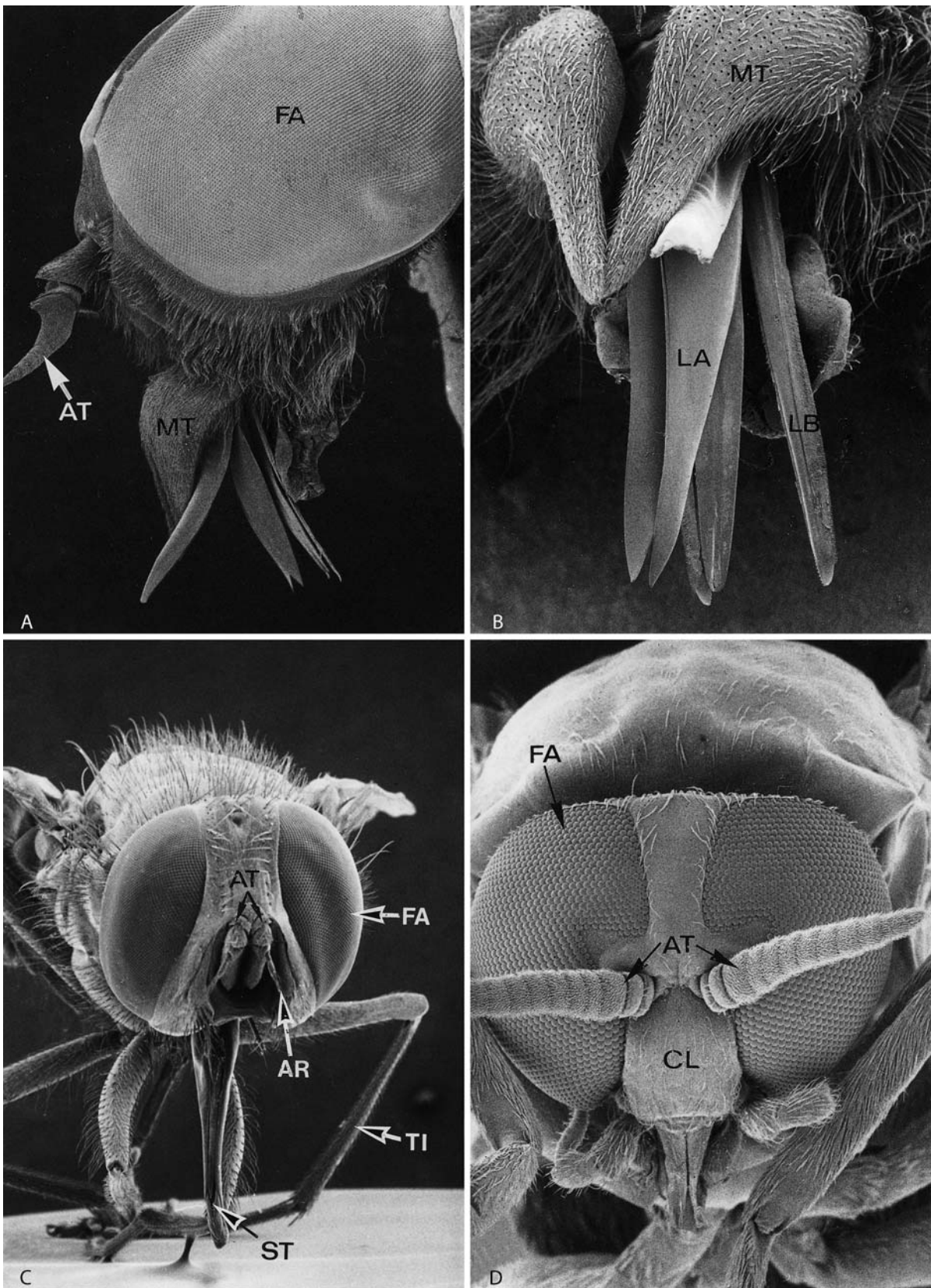

**Insects. Figure 9** SEM micrographs of heads of dipteran bloodsuckers. **A/B** → *Tabanus* sp.; lateral aspect and magnification of the cutting mouth parts (**B**) (**A** × 40, **B** × 60). **C** → *Stomoxys calcitrans* (× 40). **D** → *Simulium damnosum*, head of a female (× 80). **AR**, arista; **AT**, antenna; → **CL**, clypeus; **FA**, compound eye; **LA**, labrum; **LB**, labium; **MT**, maxillary palps; **ST**, piercing apparatus; **TI**, tibia.

## Excretory System

In insects the Malpighian tubules are of ectodermal origin and function as the main excretory system; they are blind-ending, tube-like appendages of the intestine and open at the border between the mid- and hindgut (Fig. 6). Apparently the waste-containing hemolymph circulates in the hemocoel near these structures, the number of which is species-specific. The main function is the absorption of uric acid (as sodium and potassium salts) and their discharge into the lumen of the intestine, from where the excretory products are passed with the feces. Strict water resorption usually occurs at the base of the Malpighian tubules and in the rectum, avoiding the waste of water.

## Nervous System

The nervous system of insects mainly consists of a rather thick rope ladder-like ventral chord with a pair of ganglia within each segment. In several insect groups this rope-ladder becomes, however, condensed to a rather thick chord. The “brain” (i.e., →cerebral ganglion) is comprised of the enlarged supra = epiesophageal ganglion (Fig. 2, 5B), which is connected by connectives with the subesophageal ganglion, which has been formed due to the fusion of the ganglia of the mouthparts. The epiesophageal ganglion is subdivided into 3 regions:

- The protocerebrum is rather large; it innervates the compound eyes with large lobi optici and functions as center of associations.
- The smaller deutocerebrum innervates the antennae, which are equipped with numerous sensillae.
- The tritocerebrum forms a commissure running below the intestine.

The rather large ganglia pairs of the pro-, meso-, and metasomal segments innervate the 3 pairs of legs and – if present – the muscles of the wings. In the abdomen 7 pairs of ganglia are present. Ring nerves to steer the different body organs initiate from these sites.

The additional visceral (i.e., vegetative) nerve system consists of 3 regions:

- The stomatogastric part, which innervates the mouth and anterior intestine comprising frontal, hypocerebral and ventricular ganglia, the →corpora cardiaca, and the →corpora allata.
- A singular ventral nerve chord which innervates the →stigmata.
- The caudal system which is responsible for the intestine and the gonads.

The whole nervous system of insects is 5,000 times more sensible to →insecticides of the recently used pyrethrum/pyrethroid family than that of vertebrates – a

fact which is used to control pests and bloodsucking insects (→Ectoparasiticides, →Arthropodicidal Drugs).

---

## Instar

A stage in the life of an arthropod between 2 successive molts, e.g., in →Ticks and →Insects.

---

## Insulin

### General Information

Insulin is a phylogenetically old peptide hormone, being present at least in molluscs, insects, and vertebrates. Its functions are related to regulation of →energy metabolism and growth.

### Pathology

Hypoglycaemia is a major complication of severe →malaria, especially in →cerebral malaria where it is associated with increased mortality. In uncomplicated →falciparum malaria, glucose production is increased by about 25%, due to an increase in gluconeogenesis and a simultaneous decrease in glycogenolysis, but hypoglycaemia is mainly caused by hyperinsulinaemia. If insulin secretion is blocked, hypoglycaemia can be reversed. Glycophosphatidyl inositol membrane anchors of malaria proteins are released as malaria toxic antigens and act synergistically to insulin. They induce production and release of tumour →necrosis factor from macrophages, they stimulate lipogenesis and inhibit lipolysis in adipocytes.

### Implications

Monoclonal antibodies against the glycophosphatidyl inositol of parasite origin can neutralize the toxic effects of parasite extracts.

---

## Integument

### Synonym

→Body Cover.

See neodermis/tegument of →[Acanthocephala](#), →[Platyhelminthes](#), →[Nematodes](#), →[Insects](#), →[Ticks](#), →[Mites](#), →[Crustacea](#).

## Intermediate Host

→[Dixenous Development](#), →[Digenea](#)/Fig. 2.

## Invasion

→[Apicomplexa](#).

## Iodamoeba bütschlii

This non-pathogenic →[amoeba](#) (5–25 µm) lives in the large intestine of humans and is characterized by a large vacuole in the cyst stage containing starch (Fig. 1).

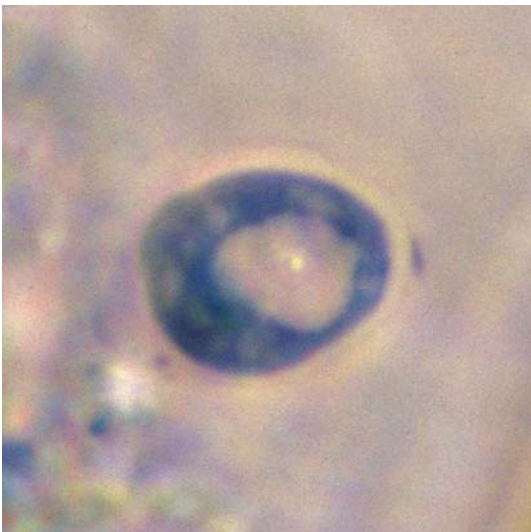

**Iodamoeba bütschlii.** Figure 1 LM of a *Iodamoeba bütschlii* cyst showing the large starch containing vacuole.

## Iodofenphos

### Chemical Class

Organophosphorous compounds (monothiophosphate).

### Mode of Action

Acetylcholine esterase inhibitor. →[Ectoparasiticides – Agonists and Antagonists of Cholinergic Transmission](#).

## Iodoquinol

Drug to cure infections with →[Dientamoeba](#) or [Blastocystis](#).

## Ipronidazole

→[Antidiarrhoeal and Antitrichomoniasis Drugs](#).

## IRAC

Insecticide resistance action committee; grouping = committee of different drug-producers to survey the occurrence against resistance in insecticides or acaricides.

## Iridocyclitis

Symptom of eye disease due to infections with →[Toxoplasma](#), →[Onchocerca](#), →[Entamoeba histolytica](#), etc.

## Irondeficiency Anemia

Symptom in cases of infection with →[Diphyllobothrium](#), →[hookworms](#), intestinal worms.



## ISAGA

Immunsorbent agglutination assay.

## Ischnocera

Suborder of [→mallophaga](#), which may crawl along the feathers of birds.

## ISG

Invariable surface glycoprotein.

## Isoenzymes

The isoenzymes were widely used to characterize strains of different species of parasites (e.g., amoebae, trypanosomes, leishmanial parasites, etc.).

## Isogametes

[→Gametes](#) that look similar in light microscope. They are, for example, found in the [→Opalinata](#), some [→gregarines](#), [→piroplasms](#), and apparently in

trypanosomes, where a true fusion of [→epimastigotes](#) is postulated to occur just before entering the salivary glands.

## Isopoda

### Name

Greek: *isos* = identical, *pos, podis* = foot.

Crustacean order, some members of which may suck blood at the surface of fish. [→Livoneca symmetrica](#).

## Isospora

### Classification

Genus of [→Coccidia](#), Phylum Alveolata.

### Important Species

Table 1.

### Life Cycle

[Figs. 1, 2](#), [→Coccidia/Fig. 2](#).

### Disease

[→Isosporosis](#), [Man](#), [→Coccidiosis](#), [Animals](#), [→Coccidiosis](#), [Man](#).

## Isospora belli

[→Coccidia](#), [→Isospora/Table 1](#).

**Isospora. Table 1** Important *Isospora* species<sup>1</sup>

Species	Host/Habitat	Size of oocysts (µm)	Prepatent period	Pathogenicity
<i>Isospora belli</i>	Humans/Small intestine	20–33 × 10–19	9–10	+
<i>I. canaria</i>	Canaries/Intestine	13 × 10	4–5	–/+
<i>I. erinacei</i>	Hedgehogs/Small intestine	28–34 × 23–27	7–14	+
<i>I. lacazei</i>	Sparrows/Intestine	22–35	7–8	–
<i>I. serini</i>	Canaries/Intestine and its wall, liver, lung	12 × 10	9–10	+
<i>I. suis</i>	Pigs/Small intestine	17–22 × 17–19	5–6	+

<sup>1</sup> [→Cystoisospora](#)

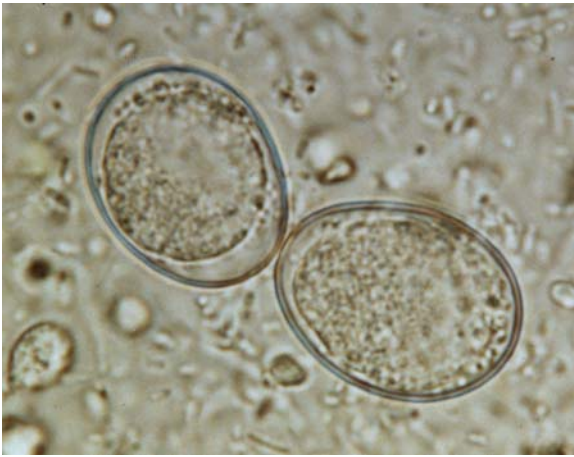

**Isospora. Figure 1** LM of 2 unsporulated oocysts of the genus *Isospora*.

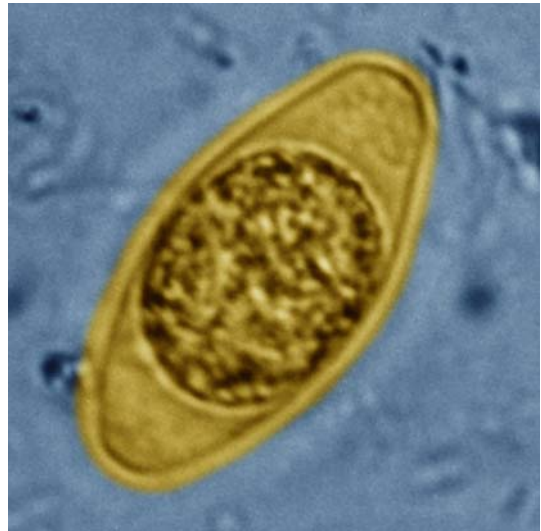

**Isosporosis, Man. Figure 1** LM of an unsporulated oocyst of *Isospora belli*.



**Isospora. Figure 2** LM of a sporulated oocyst of *Isospora*; note the presence of 2 sporocysts, each with 4 sporozoites.

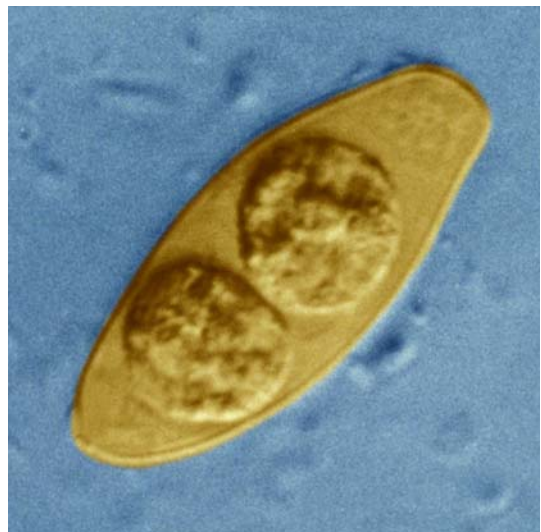

**Isosporosis, Man. Figure 2** LM of a sporulated oocyst of *Isospora belli*.

## Isosporiasis, Animals

→ [Isospora](#), → [Coccidiasis, Man](#), → [Coccidiosis, Animals](#),  
→ [Alimentary System Diseases, Animals](#).

## Isosporosis, Man

→ *Isospora belli* undergoes a classical coccidian cycle with → [schizogony](#) and gametogony mainly in the small intestinal epithelium. Unsporulated oocysts 20–32 μm in size and containing 2 sporoblasts are shed in the stools. In addition, individual encysted zoites are found

in the lamina propria and mesenteric lymph nodes (→ [Pathology/Fig. 5C](#)). These are similar to those that occur in cats and in rodents, which can serve as the intermediate hosts of feline → *Isospora*, which has been reclassified as *Cystoisospora felis* and *Cystoisospora rivolta*. The presence of unizocic → [cysts](#) suggests that the human *I. belli* may also be heteroxenous, and may better be classified as *C. belli*. There is an intense → [inflammatory reaction](#) in the lamina propria involving plasma cells, lymphocytes, neutrophils, and eosinophilic granulocytes. With → [chronic infection](#) there is villar atrophy. Intermittent diarrhea, → [malabsorption](#), and sometimes fever.

**Main clinical symptoms:** →Diarrhoea, →vomiting, loss of weight.

**Incubation period:** 2–13 days.

**Prepatent period:** 7–9 days.

**Patent period:** 2 weeks to 1–2 months (in case of →AIDS patients).

**Diagnosis:** Microscopic determination of oocysts in fecal samples (Figs. 1, 2).

**Prophylaxis:** Avoid contact with human feces.

**Therapy:** Treatment see →Cocciocidal Drugs.

## Itch

Reaction due to bites of blood suckers. →Mites, →Insects.

## ITS

Internal transcribed spacer.

## Ivermectin

### Chemical Class

Macrocyclic lactone (16-membered macrocyclic lactone, avermectins).

### Mode of Action

Glutamate-gated chloride channel modulator. →Nematocidal Drugs, →Ectoparasiticides – Antagonists and Modulators of Chloride Channels.

## Ixodes scapularis

North American ixodid tick, the genome of which was first sequenced. This black-legged tick is widespread in Southeastern USA and along the East Coast. It is a vector of tick-borreliosis, too. However, the prevalence rate of *B. burgdorferi* bacteria inside is lower than in *I. dammini* (~30% in USA), 2% in *I. pacificus* (West Coast of USA), or in *I. ricinus* (~30% in Central Europe).

## Ixodes Species

### Name

Greek: *ixos* = clue, *ixodes* = clueing; Latin: *ricinus* = oil of a plant.

### Synonym

Hard ticks.

**Ixodes Species. Table 1** Important *Ixodes* species found on humans

Species	Length (mm) of unfed adults <sup>a</sup>	Hosts during development	Main hosts <sup>b</sup>	Disease (pathogens) <sup>c</sup>	Type of bite-transmitted pathogens <sup>c</sup>
<i>Ixodes ricinus</i>	f 2.8–3.4 (7–8)	3	Dogs, cats, cattle,	Borreliosis, Ehrlichiosis,	B
	m 2.8–4		<b>Humans</b>	Spring-summer encephalitis,	V
				Redwater ( <i>Babesia divergens</i> , <i>B. microti</i> ) <sup>d</sup>	P
<i>I. dammini</i> <sup>d</sup>		3	Deer, cattle,	Borreliosis	B
<i>I. pacificus</i>		3	<b>Humans</b>	Encephalitis,	V
<i>I. scapularis</i>		3		Babesiosis	P

<sup>a</sup> Size of feed ticks in brackets. <sup>b</sup> Hosts were selected according to important diseases; other hosts are possible; <sup>c</sup> These pathogens do not occur in all hosts and may be transmitted by other tick species; <sup>d</sup> Some authors claim that *I. dammini* is *I. scapularis*. B, Bacteria; P, Protozoa; V, Virus; m = male, f = female

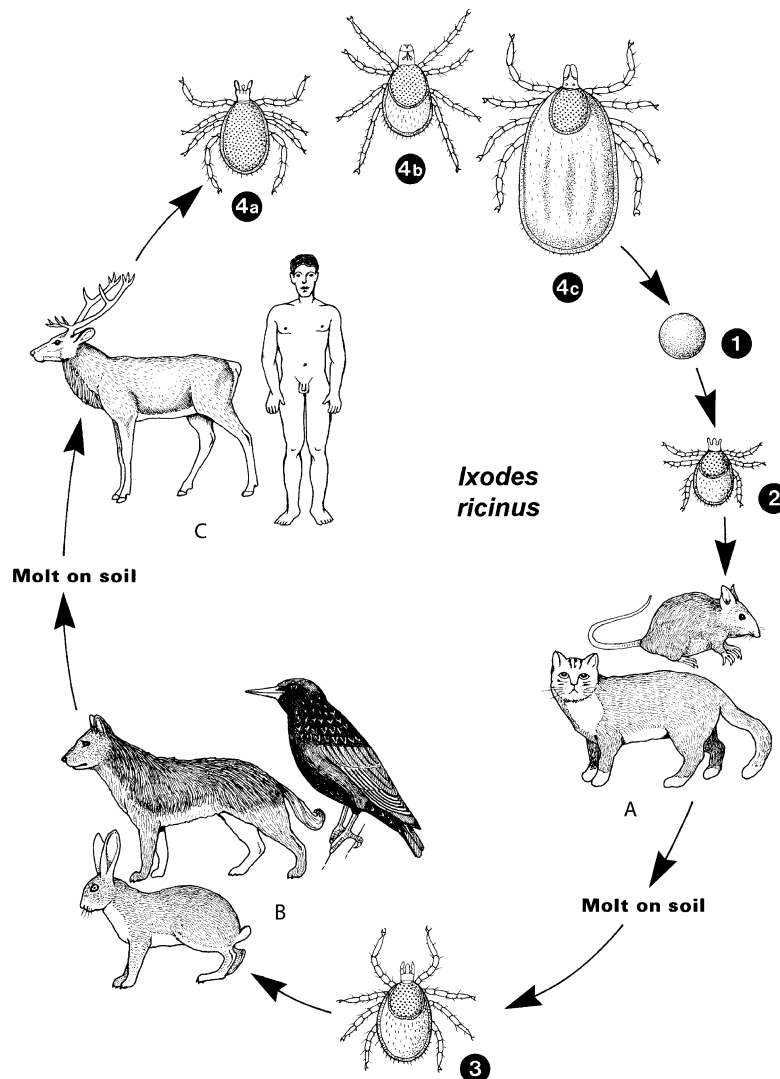

**Ixodes Species. Figure 1** Life cycle of *Ixodes ricinus* (as an example of a 3-host tick, A–C). 1 Engorged females (4c) reaching a length of up to 1.5 cm drop down to the soil and over a period of 1 month they lay about 2,000 spherical to ovoid eggs which become attached to each other and thus appear as clusters on the soil. 2 6-legged larvae hatch from the eggs after 3–36 weeks (depending on the temperature) and creep onto the tops of grass blades, from where they attach to passing hosts (mostly small mammals, but also birds and humans; A) 3 Fed larvae drop to the soil, and →molt within 5–7 weeks (sometimes up to 5 months) to become 8-legged nymphs which at this point have no genital opening. Nymphs attack larger mammals and many other hosts (B), suck blood for 4–7 days and drop to the soil, where they →molt within 2–8 months and become sexually mature adults (4 a = male, 4 b = unengorged female). Mostly in spring the adults attack larger mammals including humans (C), where especially females suck for 5–14 days. The whole development is temperature-dependent and requires about 2–3 years in Europe.

### Classification

Genus of →Ticks, →Acarina.

### Important Species

Table 1.

### Life Cycle

Figs. 1–7 (pages 665–667).

### Disease

→Ixodidiosis, →Paralysis.



**Ixodes Species. Figure 2** Unfed *Ixodes ricinus* female luring for hosts.



**Ixodes Species. Figure 4** LM of female and male *Ixodes ricinus* in copula.



**Ixodes Species. Figure 3** LM of a fully engorged female.

*I. canisuga* occurs on red foxes, *I. trianguliceps* on mice. *I. holocyclus* is found in Australia (named common bush tick). It is found on a very broad spectrum of hosts and is considered as the most potent agent of tick →paralysis found in house and wild animals. Considerable losses are reported among dogs, cats, horses, cattle, sheep, goats, pigs, and even chicken.

## Ixodes Species other than *I. ricinus*

In mid-Europe the following *Ixodes* species are relatively common: *I. hexagonus* is found on 90% of all hedgehogs, but also occurs on dogs and martens.

## Ixodidae

### Synonym

Hard →ticks.

### Classification

Family of →ticks. →Acarina.



**Ixodes Species. Figure 5** SEM of the anterior part of the capitulum of *Ixodes ricinus* showing the toothed sucking channel.



**Ixodes Species. Figure 6** SEM of a larva of *Ixodes ricinus* from dorsal.



**Ixodes Species. Figure 7** Two adult females of *Ixodes* laying eggs on plant leaves.

## Ixodidiosis

Disease due to infestation with ixodid →ticks, see Tables 1–3 (pages 668–674).

## Ixodiphagus

Genus of ichneumonid wasps, the larvae of which specialize in parasitizing and killing ticks.

**Ixodidiosis. Table 1** One Host Ticks and Control Measurements

Parasite	Host	Vector for	Symptoms	Country	Therapy		
					Products	Application	Compounds
<i>Boophilus microplus</i> (Cattle fever tick)	Cattle	<i>Babesia bigemina</i> (Red Water Disease), Anaplasmosis	Blood loss, local dermatitis	Africa, Australia, Asia, Central- and South America	Taktic E.C. (Intervet) Topline (Merial)	Spray or Dip Pour on	Amitraz Fipronil
<i>Boophilus decoloratus</i>	Cattle	<i>Babesia bigemina</i> (Red Water Disease), Anaplasmosis, Spirochaetosis			Bayticol (Bayer)	Pour on	Flumethrin
<i>Boophilus annulatus</i> (Southern cattle fever tick)	Cattle	<i>Babesia bigemina</i> (Red Water Disease), Anaplasmosis, Spirochaetosis			Taktic E.C. (Intervet)	Spray or Dip	Amitraz
<i>Boophilus calcearatus</i>	Cattle	<i>Babesia bigemina</i> (Red Water Disease), Theileriosis					

**Ixodidiosis. Table 2** Two Host Ticks and Control Measurements

Parasite	Host	Vector for	Symptoms	Country	Therapy		
					Products	Application	Compounds
<i>Hyalomma aegypticum</i>	Ruminants	<i>Theileria annulata</i> (tropic theileriosis), Rickettsiosis	Blood loss, local dermatitis	Africa, Asia, South Europe	Bayticol (Bayer)	Pour on	Flumethrin
<i>Hyalomma marginatum</i>	Ruminants	<i>Theileria annulata</i> (tropic theileriosis), Rickettsiosis			Taktic E.C.	Spray or Dip	Amitraz
<i>Hyalomma transiens</i>	Ruminants	Sweating sickness		Africa			
<i>Rhipicephalus evertsi</i>	Ruminants	<i>Babesia bigemina</i> (Red Water Disease), Anaplasmosis		Africa, Florida			

**Ixodidiosis. Table 3** Three host ticks and control measurements

Parasite	Host	Vector for	Symptoms	Country	Therapy		
					Products	Application	Compounds
<i>Ixodes ricinus</i>	Dog, cat, man	Tick borne encephalitis, Babesiosis, Lyme disease	Blood loss, local dermatitis	Central Europe, Northern Africa	Advantix (Bayer)	Spot on	Permethrin + Imidacloprid
					Dura Dip (Davis)	Spray, Sponge-on or Wash	Rotenone
					Performer Flea and Tick Collar (Performer)	Collar	Naled
					Adams Flea and Tick Dip (Pfizer)	Dip	Chlorpyrifos
					Duocide Flea and Tick Collar (Allerderm/Virbac)	Collar	Chlorpyrifos
					Bayticol (Bayer)	Spray	Flumethrin
					Mycodex Pet Shampoo, Carbaryl (Pfizer)	Shampoo	Carbaryl
					Kiltix (Bayer)	Collar	Flumethrin + Propoxur
					Zodiac Duo-Op (Exit)	Spray	Pyrethrin + Piperonylbutoxid + N-octyl bicycloheptene dicarboximide + S-



Ixodiosis. Table 3 Three host ticks and control measurements (Continued)

Parasite	Host	Vector for	Symptoms	Country	Therapy		
					Products	Application	Compounds
							Methoprene
					Defend Just-For-Dogs Insecticide (Schering Plough)	Spray	Pyrethrin + Permethrin + Piperonylbutoxid + N-octyl bicycloheptene dicarboximide
					Exspot (Schering Plough)	Spot on	Permethrin
					Prac-tic (Novartis)	Spot on	Pyriprole
					Promeris Duo (Fort Dodge)	Spot on	Amitraz + Metaflumizon
<i>Ixodes ricinus</i> (continuation)	Cattle, horse, pig	<i>Trypanosoma theileri</i> , <i>Babesia bovis</i> , <i>Babesia divergens</i> , <i>Babesia motasi</i> (Northern countries), Louping-ill-virus, tick-borne encephalitis, <i>Borrelia burgdorferi</i> , Tetnang-virus, Swiss rickettsia, <i>Dipetalonema</i> larvae, <i>Ehrlichia phagocytophila</i> (Rickettsiosis)	Blood loss, local dermatitis	Central Europe, Northern Africa	Bayticol (Bayer)	Pour on	Flumethrin
<i>Ixodes hexagonus</i>	Dog, (cat)		Blood loss, local	Central	see list <i>Ixodes ricinus</i>		
<i>Ixodes canisuga</i>	Fox, dog		Dermatitis	Europe			
<i>Ixodes pilosus</i>	Ruminants		Blood loss, local dermatitis, tick paralysis	South Africa			
<i>Ixodes rubicundus</i>	Ruminants			South Africa			
<i>Ixodes scapulari</i> (Black-legged tick)	Ruminants, dog, (cat), man	Anaplasmosis, Ehrlichiosis (human granulocytic ehrlichiosis), <i>Borrelia burgdorferi</i> , <i>Babesia microti</i>		North America	Taktic E.C. (Intervet)	Spray or Dip	Amitraz
<i>Ixodes</i>	Dog, cattle,		Tick paralysis	Australia			

<i>holocyclus</i>	man												
<i>Haemaphysalis concinna</i>	Dog, (cat)						Blood loss, local dermatitis		Central Europe				
<i>Haemaphysalis punctata</i>	Cattle, horse	<i>Babesia major</i> , <i>Babesia motasi</i> , Q-fever							Asia, Africa, Europe				
<i>Haemaphysalis cinnabarina</i>	Ruminants	Babesiosis, Anaplasmosis, Q-fever ( <i>Coxiella burnetii</i> )					Blood loss, local dermatitis		Asia, Africa, Europe				
<i>Haemaphysalis otophila</i>	Ruminants	<i>Babesia motasi</i>							Asia, Africa (not Egypt), Europe				
<i>Dermacentor marginatus</i>	Dog, cattle, horse, man	<i>Babesia canis</i> , <i>Babesia ovis</i> , <i>Babesia bovis</i> , <i>Babesia caballi</i> , <i>Babesia equi</i> , <i>Theileria ovis</i> , <i>Anaplasma ovis</i> , Q-fever ( <i>Coxiella burnetii</i> ), Tularemia ( <i>Francisella tularensis</i> )							Central Europe, China, Iran, Northern Afghanistan				
<i>Dermacentor reticulatus</i>	Cattle, dog, sheep, horse	<i>Babesia divergens</i>							Europe, China	Advantix (Bayer)	Spot on	Permethrin + Imidacloprid	
										Prac-tic (Novartis)	Spot on	Pyriprole	
										Promeris Duo (Fort Dodge)	Spot on	Amitraz + Metaflumizone	
<i>Dermacentor pictus</i>	Dog								Central Europe	Advantix (Bayer)	Spot on	Permethrin + Imidacloprid	
										Prac-tic (Novartis)	Spot on	Pyriprole	
										Promeris Duo (Fort Dodge)	Spot on	Amitraz + Metaflumizone	
<i>Dermacentor albipictus</i> (Winter or Moose tick)	Ruminants	Anaplasmosis, Phantom moose disease (Canada), Colorado tick fever virus							North America, Mexico	Taktic E.C. (Intervet)	Spray or Dip	Amitraz	
<i>Dermacentor andersoni</i> (Rocky)	Ruminants, <b>man</b>	Colorado tick fever virus, Powassan virus, <i>Anaplasma marginale</i> , <i>Anaplasma ovis</i> , Tularemia ( <i>Francisella tularensis</i> ), Q-fever ( <i>Coxiella</i> )					Blood loss, local dermatitis, tick paralysis		North- and Central America	Advantix (Bayer)	Spot on	Permethrin + Imidacloprid	
										Prac-tic	Spot on	Pyriprole	

Ixodidiosis. Table 3 Three host ticks and control measurements (Continued)

Parasite	Host	Vector for	Symptoms	Country	Therapy		
					Products	Application	Compounds
Mountain wood tick)		<i>burnetii</i> , Rocky Mountain spotted fever ( <i>Rickettsia rickettsii</i> )			(Novartis)	Spot on	Amitraz + Metaflumizone
<i>Dermacentor variabilis</i> (American dog tick)	Ruminants, dog, (cat), <b>man</b>	<i>Rickettsia rickettsii</i> (Rocky Mountain spotted fever), Sawgrass virus, <i>Anaplasma marginale</i>		North- and Central America	Taktic E.C. (Intervet)	Spray or Dip	Amitraz
<i>Hyalomma mauritanicum</i>	Ruminants, <b>man</b>	Theileriosis, Crimean-Congo haemorrhagic fever virus	Blood loss, local dermatitis	Africa	Advantix (Bayer)	Spot on	Permethrin + Imidacloprid
<i>Rhipicephalus sanguineus</i> (Brown dog tick or Kennel tick)	(Import-) Dog, cat	<i>Babesia canis</i> , <i>Ehrlichia canis</i> , <i>Rickettsia rhipicephali</i> , <i>Rickettsia conorii</i> , Crimean-Congo haemorrhagic fever virus, Thogotovirus	Blood loss, local dermatitis	Mediterranean (area) (Africa, South Europe), can be established in buildings worldwide	Dura Dip (Davis)	Spray, Sponge-on or Wash	Rotenone
					Performer Flea and Tick Collar (Performer)	Collar	Naled
					Adams Flea and Tick Dip (Pfizer)	Dip	Chlorpyrifos
					Duocide Flea and Tick Collar (Allerdern/Virbac)	Collar	Chlorpyrifos
					Escort (Schering-Plough)	Collar	Diazinon
					Mycodex Pet Shampoo, Carbaryl (Pfizer)	Shampoo	Carbaryl
					Frontline Top Spot (Merial)	Spot on	Fipronil

							Bayticol (Bayer)	Spray	Flumethrin
							Prac-tic (Novartis)	Spot on	Pyriprole
							Promeris Duo (Fort Dodge)	Spot on	Amitraz + Metaflumizone
							Kiltix (Bayer)	Collar	Flumethrin + Propoxur
							Zodiac Duo-Op (Exil)	Spray	Pyrethrin + Piperonylbutoxid + N-octyl bicycloheptene dicarboximide + S-Methoprene
							Defend Just-For-Dogs Insecticide (Schering Plough)	Spray	Pyrethrin + Permethrin + Piperonylbutoxid + N-octyl bicycloheptene dicarboximide
							Exspot (Schering Plough)	Spot on	Permethrin
							Taktic E.C. (Intervet)	Spray or Dip	Amitraz
<i>Rhipicephalus bursa</i>	Cattle, sheep, goat	<i>Babesia ovis</i> , <i>Babesia motasi</i> , <i>Theileria ovis</i> , Crimean-Congo haemorrhagic fever virus	Blood loss, local dermatitis, ovine paralysis	Africa, South Europe			Taktic E.C. (Intervet)	Spray or Dip	Amitraz
<i>Rhipicephalus appendiculatus</i> (Brown ear tick)	Ruminants	<i>Theileria parva parva</i> (East Coast Fever), <i>Theileria parva lawrencei</i> (Corridor disease), Nairobi sheep disease virus, <i>Theileria taurotragi</i> , <i>Ehrlichia bovis</i> , <i>Rickettsia conori</i> , Thogotovirus	Blood loss, local dermatitis, fatal toxæmia (in susceptible cattle, severe ear damage)	Africa, South Europe			Taktic E.C. (Intervet)	Spray or Dip	Amitraz
<i>Rhipicephalus capensis</i>	Ruminants		Blood loss, local dermatitis	Africa, South Europe			Taktic E.C. (Intervet)	Spray or Dip	Amitraz
<i>Rhipicephalus</i>	Ruminants	<i>Theileria parva lawrencei</i> (Corridor disease)		Africa			Taktic E.C. (Intervet)	Spray or Dip	Amitraz

**Ixodiosis. Table 3** Three host ticks and control measurements (Continued)

Parasite	Host	Vector for	Symptoms	Country	Therapy		
					Products	Application	Compounds
<i>zambeziensis</i> <i>Amblyomma</i> <i>americanum</i> (Lone star tick)	Ruminants, dog, <b>man</b>	<i>Ehrlichia chaffeensis</i> (Human monocytic ehrlichiosis), Tularemia ( <i>Francisella tularensis</i> ), Q-fever ( <i>Coxiella burnetii</i> ), <i>Rickettsia rickettsii</i> (Rocky Mountain spotted fever), Lyme disease ( <i>Borrelia burgdorferi</i> )	Blood loss, local dermatitis, tick paralysis	America	(Intervet) Commando Insecticide Cattle Ear Tag (Fermenta)	Dip Ear tag	Ethion
<i>Amblyomma</i> <i>variegatum</i> (Tropical African bont tick)	Ruminants	Q-fever ( <i>Coxiella burnetii</i> )	Blood loss, local dermatitis, tick paralysis	Africa	Taktic E.C. (Intervet)	Spray or Dip	Amitraz
<i>Amblyomma</i> <i>maculatum</i> (Gulf Coast tick)	Ruminants, dog, (cat)	Q-fever ( <i>Coxiella burnetii</i> )		America	Commando Insecticide Cattle Ear Tag (Fermenta)	Ear tag	Ethion
<i>Amblyomma</i> <i>hebraeum</i> (Southern)	Ruminants, <b>man</b>	<i>Rickettsia conorii</i> (tick typhus), <i>Cowdria ruminantium</i>		Africa			

## Japanese B Encephalitis

→ *Arbovirus* disease in humans being transmitted during the bite of ceratopogonid → *Diptera* (e.g., *Forcipomyia taiwana*).

## Jasmolin

### Chemical Class

Natural products (terpenoid).

### Mode of Action

Open state voltage gated sodium channel blocker.  
→ *Ectoparasitocides – Blockers/Modulators of Voltage-Gated Sodium Channels*.

## Jaundice

The skin and/or eyes of people infected with → *Babesia* spp. or with obstructive liver flukes appear yellow due to disintegration of blood cells.

## Jaws

Mouthparts that may occur in the anterior sucker of → *leeches* (→ *Hirudo medicinalis*) and are used to cut the skin of man and animals. They contain the excretion pores of the unicellular salivary glands.

## Jigger

### Synonym

→ *Tunga penetrans*, → *sand flea*, → *fleas*.

## Jodamoeba

→ *Iodamoeba*.

## Joyeuxiella

Genus of tapeworms belonging to the family Dipylidiidae (→ *Dipylidium caninum*). Species of the genera *Joyeuxiella* and *Diplopylidium* are described to have coprophagous beetles as first intermediate hosts. In addition, small mammals and/or lizards are active as transport hosts.

## Juvenile Hormones

### Synonym

→ *Methyl farnesoates (MF)*.

### General Information

A unique feature of insect and crustacean endocrinology is the presence of a class of hormones with a dihomosesquiterpenoid skeleton, the so-called juvenile hormones (JH), resp. methyl farnesoates (MF). These are lipophilic compounds that are degraded by specific (JH-epoxid-hydrolase, JH-esterase) and unspecific (esterases) enzymes. As in → *ecdysteroids*, there exist congeneric hormones, JH 0 to JH III (Fig. 1), but in contrast to → *ecdysteroids*, JH and MF are synthesised by the insects and crustaceans themselves. The synthesis, metabolism, titre regulation, transport, and physiological functions of this class of hormones is summarised in recent reviews. The distribution of juvenile hormones in other animal taxa has been investigated much less than that of ecdysteroids. There are reports on the presence of juvenile hormone activity in other invertebrates, but these reports are questionable for methodological reasons.

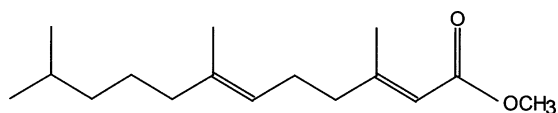
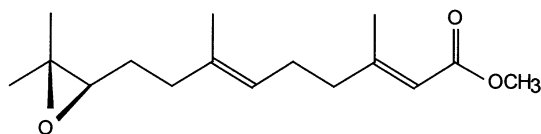
**Methyl farnesoate****(10R)-Juvenile hormone III**

**Juvenile Hormones. Figure 1** Juvenile hormone. Structure of 1 juvenile hormone from an insect and the corresponding crustacean representative methyl farnesoate. Molecular weights: 263 (JH I), 247 (MF).

### Physiological Function

Juvenile hormones not only exert juvenoid actions (that means that the larval character is maintained and further development to the adult inhibited) but they also function as gonadotropic hormones during adulthood.

### Implications

Because of the unique structure of juvenile hormones and their function during different developmental stages, these compounds as well as their antagonists are well suited as insect growth regulators and have been successfully applied in pest control. They also affect [nematodes](#) although the [mode of action](#) in this systematic group is completely unknown. There are neither unequivocal proofs for the existence nor for a putative function of juvenile hormones in this taxon.

## Kala Azar

### Synonym

→Visceral leishmaniasis (→Leishmaniasis, Man/Visceral Leishmaniasis).

## Kalabar Swelling

→Filariidae, clinical symptom due to infection with  
→*Loa loa*.

## Karakurte

Black widow spider (= *Latrodectus mactans*).

## Karyogamy

From Greek: *karyon* = nucleus, *gamein* = fuse. Process of fusion of the nuclei of mating gametes.

## Karyolysus lacertae

### Classification

Species of →*Coccidia*, phylum Alveolata.

### Life Cycle

Fig. 1 (page 678).

## Karyosome

Former name of →nucleolus. →*Entamoeba histolytica*.

## Katayama Syndrome

Clinical symptoms in humans due to rather fresh infections with →*Schistosoma japonicum*.

## Katipo

Black widow spider (= *Latrodectus mactans*).

## Kato-Katz-Smears

Method of a WHO recommended evaluation of the number of worm eggs per gram (epg) stool. This technique is used to measure the infection intensity of gastrointestinal nematodes and schistosomes.

## kDNA

Kinetoplast DNA.

## Keds

### Synonyms

→Hippoboscidae, →louse flies.

→*Melophagus ovinus*, →*Lipoptena cervi*.

## Keratitis of Eye

Symptoms of an infection with →*Acanthamoeba*.  
→Pathology.



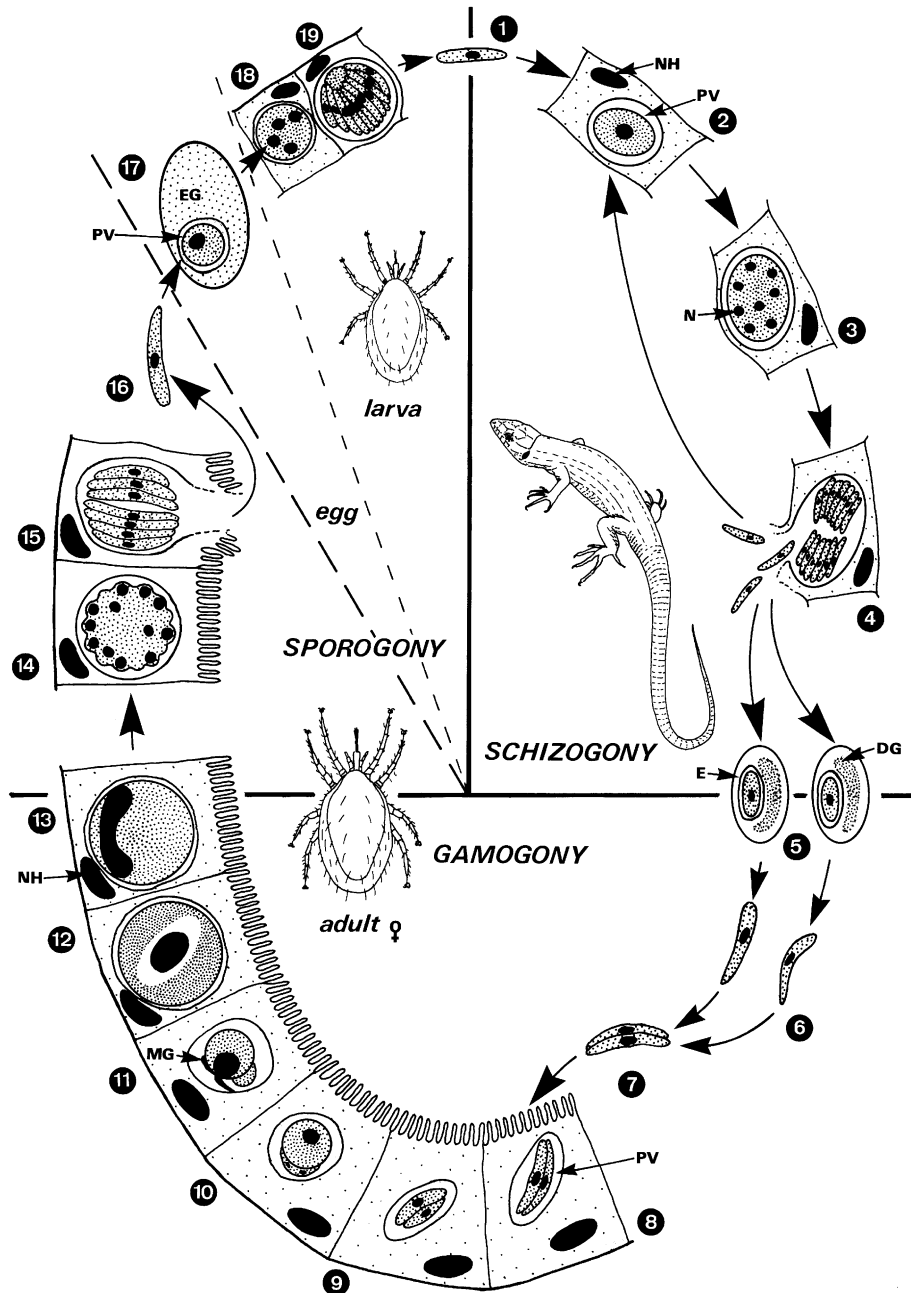

**Karyolysus lacertae.** Figure 1 Life cycle of *Karyolysus lacertae* inside its hosts, the lizard (*Lacerta muralis*) and the bloodsucking mite (*Liponyssus saurorum*). 1 Lizards become infected when they swallow *mites* containing sporozoites. 2–5 The sporozoites penetrate the gut epithelium and invade the endothelial cells of blood capillaries. After repeated formation of differently shaped schizonts and merozoites the last generation of merozoites enters erythrocytes, where they grow into gamonts (5). 6–8 The gamonts are ingested by the bloodsucking female mite and are released into the gut during digestion; they associate in pairs, forming an elongated, spindle-shaped “syzygy”. In this shape the pairs of gamonts are engulfed by the gut cells of the mite. 9–12 Once inside the host cell the macrogamont increases in size. The nucleus of the microgamont divides once and finally produces 2 flagellated *microgametes* (11; MG). One microgamete fertilizes the macrogamete, which grows considerably as a *zygote* (12). 13–16 After nuclear divisions (13, 14) motile *sporokinetes* (up to 50 μm long) are formed, which leave the gut epithelium for the body cavity (16) and may enter the ovary and finally the egg. 17–19 Inside the *yolk* cells of the mite’s egg and later in the cells of the larva and nymphs, each *sporoblast* gives rise to 20–30 infectious sporozoites by an asexual, intracellular reproduction. Typical oocysts or sporocysts do not occur. DG, degenerating host nucleus; E, erythrocyte; EG, egg of the mite; HC, host cell; MG, microgamete; N, nucleus; NH, nucleus of host cell; PV, *parasitophorous vacuole* (for further species see *Coccidia/*Table 6).

## Khawia

Genus of the basic cestode family Caryophyllidae. *K. sinensis* is found in cyprinid fish. It has only one set of sexual organs, reaches a length of about 5–10 cm, and lives in the upper intestine. The scolex is folded and thus often compared to a flower; the body does not show segmentation. Intermediate hosts are annelids (*Tubifex*), which feed the 75  $\mu\text{m}$  sized eggs. The development in the final host fish is temperature-dependent and takes 2 weeks up to 6 months.

## Therapy

Tremazol™ (Sera/Alpha-Biocare).

## Kidney Worm

### Synonym

→*Stephanurus dentatus*, →*Dioctophyme renale*.

## Killigrewia

### Synonym

Aporina.

### Classification

Genus of tapeworms.

*K. delafondi* reaches a length of 23 cm and a width of 4.5 mm in the small intestine of doves and other birds; oribatid mites are claimed as intermediate hosts.

## Kinete

In the protozoan genera →*Plasmodium* (e.g., agents of →malaria), →*Babesia* and →*Theileria*, the →zygote (→Gametes) develops into a motile stage (Figs. 1, 3), that is able to leave the intestine of the vectors (→mosquitoes or →ticks). In →*Plasmodium* the whole spherical

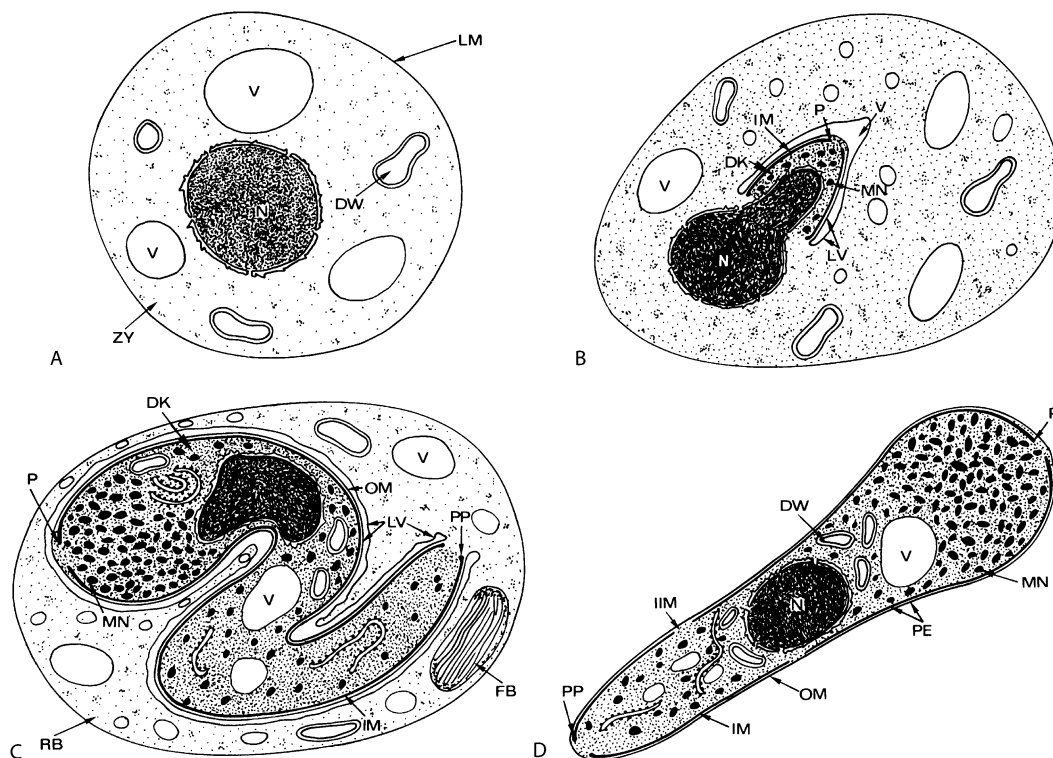

**Kinete.** Figure 1 A–D *Theileria parva*; formation of a motile kinete (D) from a zygote (A) inside the intestinal cells of a vector tick. DG, dense granule; DK, developing kinete; DW, double-walled vesicle (mitochondrion, →apicoplast); FB, fibrillar organelle; IIM, interruption of the inner membranes; IM, inner complex of the →pellicle; LM, limiting membrane; LV, limiting membrane of the inner vacuole; MN, →micronemes; MV, multilaminar body; N, nucleus; NM, nuclear membrane; OM, outer membrane of the pellicle; P, →polar ring; PE, pellicle; PP, posterior pole; RB, residual body; V, vacuole; ZY, zygote.

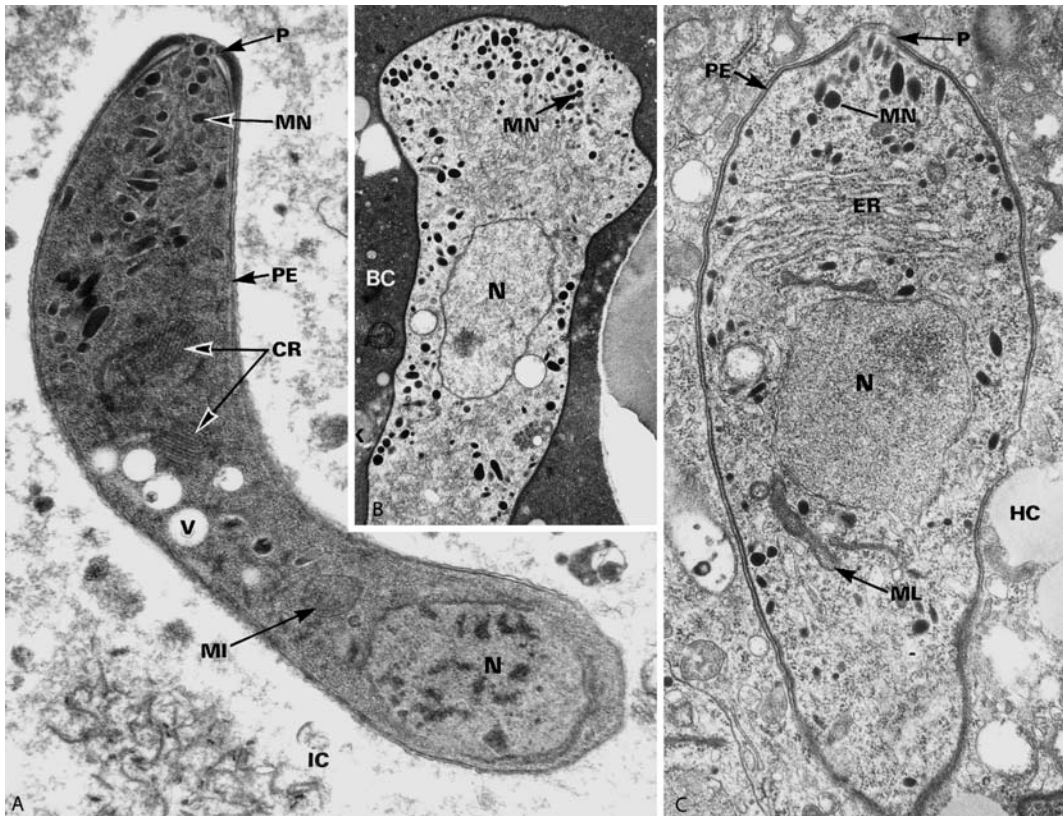

**Kinete.** **Figure 2 A–C** Transmission electron micrographs of longitudinal sections through ookinetes of *Plasmodium gallinaceum* (A), and kinetes of *Theileria mutans* (B) and *Babesia bigemina* (C) inside their vectors (compare life cycles). Note that these stages have a pellicle with an anterior polar ring system, but no →conoid (A  $\times 10,000$ , B  $\times 8,000$ , C  $\times 7,000$ ). BC, blood contents of intestinal cell; CR, crystalloid structures; ER, endoplasmic reticulum; HC, host cell →cytoplasm; IC, intestinal contents; MI, mitochondrion; ML, mitochondrion-like organelle; MN, micronemes, N, nucleus; P, anterior polar ring; PE, pellicle; V, vacuole.

zygote stretches and becomes a slender so-called →ookinete. In →piroplasmids the kinetes (Fig. 2) develop inside a vacuole of the zygote (Fig. 1). Both kinetes and ookinetes (more correct would be →zygotokinetes) are diploid and start early with meiotic nuclear divisions (Figs. 4–7, page 682, 683).

## Kinetochor

→Nuclear Division.

## Kinetoplast

The →Kinetoplastida (e.g., species of →*Trypanosoma* and →*Leishmania*) have a single, large →mitochondrion that contains some extra DNA. These organisms have

5% of their DNA in a single structure called the kinetoplast (→*Blastocrithidia triatomae*/Fig. 2A, →*Mitochondria*/Fig. 1A, →*Trypanosoma*/Fig. 5B) which is located close to the basal body of the flagellum. Kinetoplastid flagellates have no infoldings of the inner membrane in this region of the →mitochondria, providing space for the thousands of minicircles (0.3–0.8  $\mu\text{m}$  in length) and the few maxicircles (9–11  $\mu\text{m}$  in length) that make up their →mitochondrial DNA; this region stains with →Giemsa solution and is visible as a deep purple dot (formerly also called →blepharoplast). During →cell division the kinetoplast is always reproduced before →nuclear division occurs.

## Kinetoplast DNA

Kinetoplast DNA (kDNA), the first extranuclear DNA to be discovered in eukaryotes, is a distinguishing feature of all kinetoplastid species. Within the cell, the

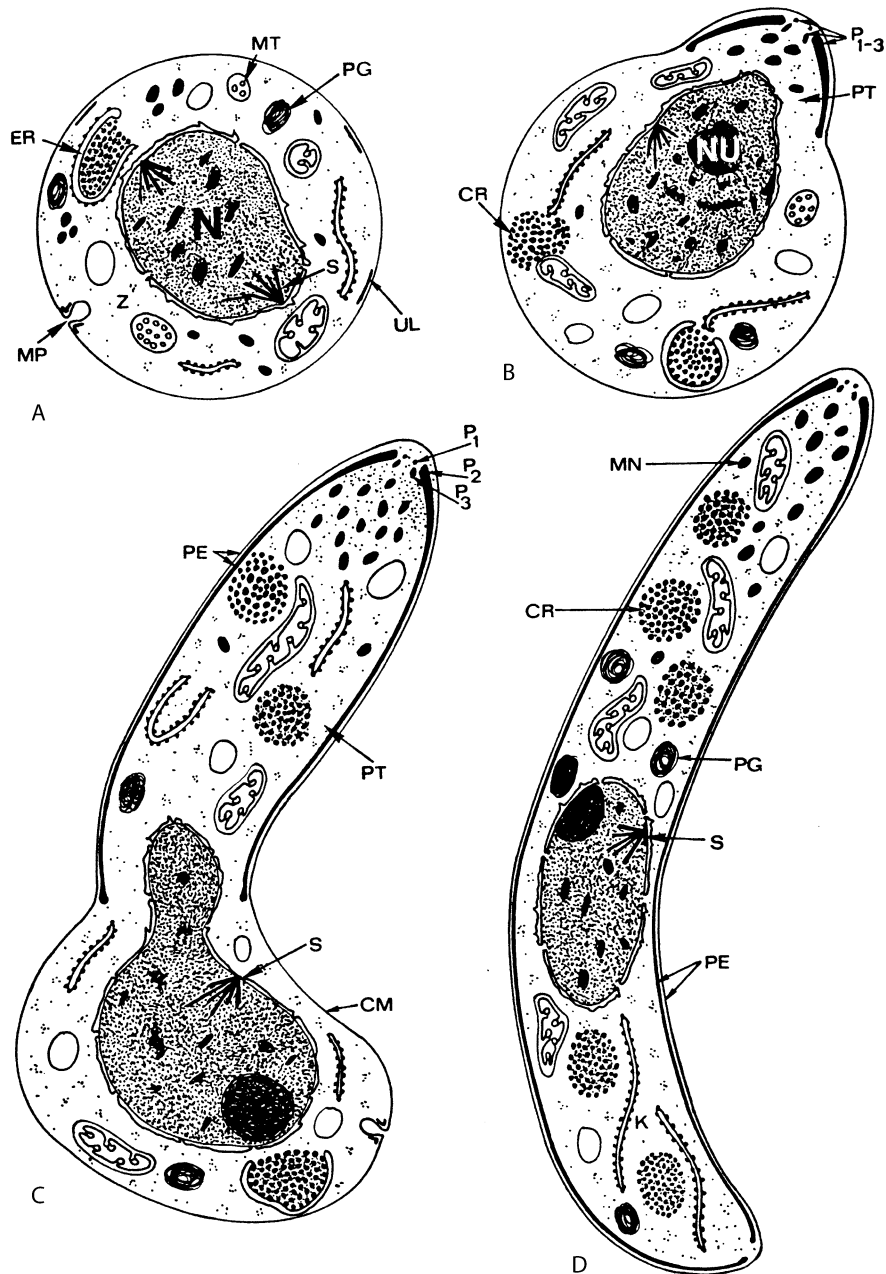

**Kinete.** **Figure 3** Diagrammatic representation of the development of an ookinete of *Plasmodium gallinaceum* (inside its vector). From a zygote (in **A**) a protrusion is formed (**B**), which increases considerably in size until the banana-shaped final stage (**D**) is reached. Note the occurrence of several half-spindles; apparently the internal divisions of the different chromosomal sets are initiated. CR, crystalline reserves; CM, membrane of the zygote; ER, endoplasmic reticulum; MN, micronemes; MP, micropore; MT,  $\rightarrow$ microtubules; N, nucleus; NU,  $\rightarrow$ nucleolus; P<sub>1-3</sub>, pellicular layers 1-3; PE, pellicle; PG, protein granules; PT, protrusions; S, spindle pole.

kDNA is composed of a giant network of catenated,  $\rightarrow$ circular DNA molecules condensed into a disc-shaped structure that is localized in the part of the single mitochondrion adjacent to the flagellar basal body. This DNA represents 5–25% of the total cell DNA

mass and consists of about 50 (23–36 kb, depending on the species)  $\rightarrow$ maxicircles and several thousand (5,000–10,000 copies per cell) of 0.5–2.5 kb minicircles. In addition, various proteins are associated with the kDNA that are suggested to be involved in the

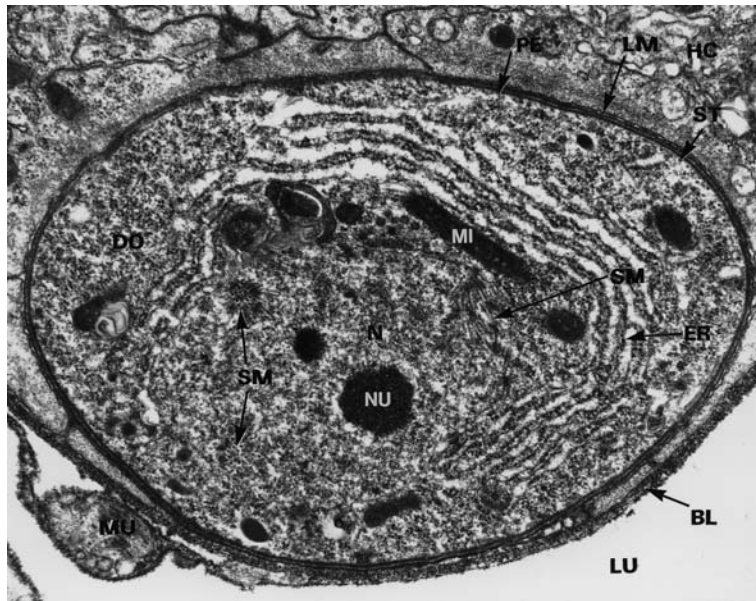

**Kinete. Figure 4** Transmission electron micrographs of peripheral intranuclear spindles in *Plasmodium gallinaceum*; young (still ookinete-shaped) →oocyst, which is situated extracellularly between the membrane of intestinal cells (LM) of the vector and the basal lamina (BL) of the gut. Note the occurrence of several spindles (SM) within the undivided nucleus ( $\times 18,000$ ). BL, basal lamina; DO, developing oocyst; ER, endoplasmic reticulum; ERH, endoplasmic reticulum of the host cell; HC, host cell; LM, limiting membrane of the gut cell; LU, lumen (body cavity); MI, mitochondrion; MU, muscle cell; N, nucleus; NM, nuclear membrane; NU, nucleolus; PE, pellicle of the ookinete; SM, spindle microtubules; ST, →subpellicular microtubules.



**Kinete. Figure 5** LM of an ookinete of *Plasmodium* species (in the intestine of a mosquito).



**Kinete. Figure 6** LM of kinetes of *Babesia* species (in the

organization and segregation of the network. →Maxicircle DNA is homogeneous in sequence and contains transcriptionally active genes that correspond to those of other →mitochondria. Maxicircle transcripts

are cryptic and require editing to form functional mRNAs. The 20 identified genes in maxicircle DNA of *Trypanosoma brucei* encode 2 ribosomal RNAs, 2 small RNAs, termed →guide RNAs (gRNAs), and



**Kinete. Figure 7** LM of a kinete of *Theileria parva* from the body fluid of its vector.

18 proteins with homology to NADH dehydrogenase, apocytochrome *b*, cytochrome *c* oxidase subunits I, II, and III, and a subunit of mitochondrial ATPase. →Minicircle DNA represents a unique form of →mitochondrial DNA not only because of its small size and large numbers but also because it is responsible for the kDNA complex network structure. They are usually heterogeneous in sequence but identical in size within a network. Minicircles encode gRNAs that control →RNA editing specificity within the kinetoplastid mitochondrion. In *T. brucei*, each minicircle encodes 3–5 gRNAs, whereas *Leishmania tarentolae* encodes only a single gRNA per minicircle. The replication of kDNA occurs during nuclear S phase and includes the duplication of free detached minicircles and catenated maxicircles followed by the generation of two daughter kDNA networks that segregate upon cell division.

## Kinetoplastida

### Classification

Order of →Flagellata.

### General Information

The Kinetoplastida were named for the presence of a Feulgen-positive →kinetoplast which is a distinct region of the single, long mitochondrion containing

coiled DNA filaments (→Cell Multiplication/Fig. 2). The →kinetoplast is always closely associated with the basal body of the flagellum. The species of the Kinetoplastida are heterotrophic and feed as saprozoic or parasitic organisms. In general, they have 1 (→Trypanosoma/Fig. 1) or 2 →Flagella (→Trypanoplasma/Fig. 1) which arise from a depression of their surface (→Flagellar Pocket) and include a →paraxial rod in addition to the →axoneme. Characteristic of some groups of the Kinetoplastida is their facultative or obligate assumption of different shapes (→Polymorphism), so that they may appear as →amastigotes (= →Micromastigotes), pro-, epi- or →trypomastigotes. Reproduction occurs by an asexual longitudinal →binary fission; recently, sexual processes were described in cloned strains, indicating that at least a fusion of nuclear material must occur (→Gametes). Transmission of the endoparasites belonging to this group mainly occurs via active vectors; cysts, if present at all, are rare (→Blastocrithidia triatomae/Fig. 1) and are usually an additional means of propagation.

### System

- Order: Kinetoplastida
  - Suborder: Bodonina (with 2 →flagella)
    - Family: Bodonidae
    - Family: Cryptobiidae (parasites of fish, snails)
      - Genus: →Trypanoplasma (→Trypanoplasma/Fig. 1)
      - Genus: *Cryptobia*
  - Suborder: Trypanosomatina (with a single flagellum)
    - Family: →Trypanosomatidae
      - Genus: →Leptomonas
      - Genus: →Leishmania (→Leishmania/Fig. 1)
      - Genus: →Phytomonas
      - Genus: →Crithidia
      - Genus: *Blastocrithidia* (→Blastocrithidia triatomae/Fig. 1)
      - Genus: →Herpetomonas
      - Genus: →Trypanosoma (→Trypanosoma/Figs. 1, 2)
        - Stercoraria (fecally transmitted by vectors),
        - Salivaria (transmitted by saliva and/or feeding organs of the vectors)

### Host Cell Recognition

In *Trypanosoma cruzi*, glycoproteins have been shown to be involved in the interaction, and lectins or sugars could interfere with the phenomenon. Fibronectin, a high molecular weight glycoprotein present in blood, connective tissue, and at cell surfaces, has also been suggested to mediate interaction between trypomastigotes and host cells *in vitro*, and a fibronectin receptor

of 85 kDa has been identified on the surface of trypomastigotes. The fibronectin molecule thus seems to act as a bridge between host and parasite preceding internalization.

Sialic acids which bind the surface transsialidase are needed for invasion, together with sulfated glycosaminoglycans that bind the parasite surface molecule named penetrin.

→*Leishmania* spp. →*promastigotes* have been shown to activate complement and to bind C1 and C3, which enhances their phagocytosis by macrophages via the C1 and C3 receptors of the cells, the surface glycoprotein GP63 being one of the parasite ligands involved in the binding.

---

## Kinetosome

→*Flagella*.

---

## Kissing Bugs

### Synonym

→*Triatominae*.

### Classification

Subfamily of →*Rhynchota*. →*Hemiptera*, →*Bugs*.

### General Information

The *Triatominae* belong to the order *Hemiptera*, of which fossil specimens are about 250 million years old. Of the about 80,000 recent species of *Hemiptera*, the majority does not suck blood, but sucks on plants, or they are predators of insects and other invertebrates. Only species of the 2 families →*Cimicidae* (bedbugs) and *Polyctenidae* are all bloodsuckers, and in the family →*Reduviidae* only those 119 species belonging to the subfamily *Triatominae* (kissing bugs). The name of the latter group reflects a behavior of these →*bugs*, often sucking blood in the face which is unprotected at night during sleep. The majority of *triatomines* lives sylvatically, some peridomestically around the house, and only some species mainly domestically; of these →*Triatoma infestans*, *Rhodnius prolixus*, →*Panstrongylus megistus*, and *Triatoma dimidiata* are the most important species. *Triatomines* are important vectors, transmitting *Trypanosoma cruzi*, the causative agent of →*Chagas' disease*, *Man*. This is the only important tropical disease in which the parasite was

first detected in the vector, then in a cat and a little girl, and then Carlos Chagas recognized symptoms of the disease. *Chagas disease* is mainly a disease of the poor people, because poor housing conditions, e.g., houses made of a wooden frame covered with mud and a roof of palm leaves, offer optimal hiding places in the cracks and crevices of the wall or in the roof for the nocturnal bugs.

*Triatomines* are hemimetabolous insects and all →*nymphal stages* and adults suck blood. The length of adults varies between 0.5 and 4.5 cm in the different species. *Triatomines* can easily be distinguished from other bloodsucking insects by a hemipteran characteristic: anteriorly the forewings are strongly sclerotized, whereas the posterior part is membranous. The membranous hindwings are folded beneath the forewings, which are closed flatly over the abdomen. In addition, *triatomines* possess sucking mouthparts which are reflexed under the head in rest, just barely reaching the first pair of legs. In contrast to the other hemipteran bloodsuckers, they possess a →*neck*, clearly separating head and thorax. Rooms infested by *triatomines* and also *Cimicidae* have a special smell.

### Distribution

Nearly all *triatomines* occur only on the American continent, from latitude 46° S to 42° N, the majority occurring in Latin America. Exceptions are some species on the Indian subcontinent and Southeast Asia, and one species, *Triatoma rubrofasciata*, which is associated with rats and thereby cosmopolitan, occurring in ports of the tropical and subtropical regions.

### Morphology

The slender head laterally has large compound eyes, in adults additionally a pair of ocelli just behind the eyes. The long, thin antennae (4 segments) bear the temperature and carbon dioxide sensory organs. The mouthparts consist of a 3-segmented, straight labium, termed →*proboscis* or →*rostrum*, which forms a hollow sheath, never penetrating the skin. It protects the fine, piercing stylets, the 2 pairs of hair-like maxillae and mandibles, the latter forming the food- and also the salivary channel. Only in the proximal region of the mouthparts a small labrum is visible. Head and thorax are clearly separated by a neck. The dorsal part of the thorax is covered by the strongly sclerotized pronotum and the triangular scutellum; in the ventral part they have a prosternal stridulatory groove which is used by the tip of the proboscis to produce sounds. Most species are black or brown, but in adults, the lateral sides of the tergites often show yellow, orange, or red bands or patches. Directly after emergence all stages are pink-colored until the →*cuticle* sclerotizes. The long legs indicate that these insects are good runners. Adults of

*Rhodnius* possess pads of setae at the legs enabling them to climb on smooth surfaces, e.g., in glass beakers. Adults of all species rarely fly. Only in one species, *Triatoma spinolai*, females are always wingless and males with or without wings. In this species the females and in *Dipetalogaster maxima* both sexes possess folded connectiva, allowing greater abdominal extensions during bloodsucking or before egg deposition. Both species inhabit extremely arid regions, the two South American fog deserts in Chile and Mexico. Males and females of triatomines can only be distinguished by the genital organs which are hidden under a round scale in males. Thereby, the tip of the male abdomen appears smoothly rounded, that of the female pointed. The habitus of the nymphs is similar to that of the adults, only wings are lacking, but in the course of the 5 nymphal instars the wing pads increase in size. Often nymphs “camouflage,” i.e., they throw fine dust particles onto their back which adhere there to the cuticle folds. Eggs possess an →operculum which is forced away when the first →instar →nymph emerges, leaving the white egg shell.

### Genetics

In colonies several species can produce interspecific hybrids, and also variously colored mutants develop, e.g., red eyes that are due to an autosomal recessive character. Hybrids between *Triatoma infestans* and *T. platensis* have been collected in the field.

### Reproduction

Breeding in the laboratory is easily possible for many species of triatomines if they can feed on living hosts. *In vitro* feeding through membranes is also possible, but colonies do not develop if fed for years in this way.

Adults are ready to copulate about 3 days after the final emergence. Sex →pheromones are known for some species. A single mating provides sufficient sperm for the eggs of a female, but they usually mate several times. Eggs develop after a blood meal, but some are also laid by starved females. Females lay 100–600 eggs. Most species lay the eggs loosely on the ground, but species which inhabit trees glue them to the substrate or to the feathers of the host.

### Life Cycle

The duration of the different stages is not only temperature-dependent, but after eclosion from the egg also strongly determined by the availability and quality of blood and also by the supply with symbiotic bacteria. There seems to be a specific symbiont belonging to the group of Actinomycetes in each of the so far investigated 4 triatomine species, but development of nymphs and a reduced reproduction

is also possible if the bugs do not take up the correct symbiont by coprophagy, but another Actinomycete. The →symbionts colonize mainly the anterior midgut (cardia and stomach). The embryonic development usually lasts about 10–30 days. (The first 4 instars are termed larvae and the fifth a nymph by mostly scientists in Central Europe, but all are termed nymphs by other scientists.) In each of the instars, the nymphs require one full engorgement (or several smaller ones), in the final instar sometimes more to enable the molt to the next instar/adult. If no host is available, nymphs can starve for long periods of time, several months in colonies and, as found when determining starvation resistance under high humidity conditions, for up to 1 year in the most resistant instar. However, it remains to be determined whether or not they develop normally after such prolonged starvation. Nymphal instars can be distinguished by size, especially of the head capsule and legs, not so much of the body. Final instars can easily be recognized by the great wing pads which are much smaller in the fourth instar and not previously recognizable. Under optimal conditions in the laboratory, adults of some species live about 1 year, but under natural conditions on average 3–6 months. The whole developmental cycle of most species lasts 5–12 months.

### Transmission

Triatomines usually remain in the surroundings where they have emerged from the egg. However, if the host has left, starved adults fly. High population densities can be achieved in a house: by demolition 8,000 bugs of all stages were collected. Inside the house, highest population densities are found in the bedrooms or near the rest places of pets.

### Feeding Behavior and Transmission of Disease

Triatomines are attracted to the host mainly by warmth, carbon dioxide, and odours of the host. In addition, bloodsucking bugs attract hungry bugs, e.g., by →ammonia present in feces and urine and perhaps pheromones. Triatomines are capillary feeders on a wide range of warm-blooded hosts. Piercing of the skin is painless. Depending on the instar and the size of the species, they need 3–30 minutes to engorge 6–12 times their own body weight. In nymphs this is made possible by the extensibility of the abdominal cuticle, a hormone-dependent plasticization. In the capacious stomach the blood is stored and remains nearly undigested except for lipid- and →carbohydrate uptake and lysis of erythrocytes. Clotting of blood is inhibited by anticoagulants either from the →salivary gland or the stomach. The hemoglobin is given in small portions into the small intestine in which digestion and absorption takes place. Before defecation, the dark remnants of blood digestion and the yellow urate



spheres are stored in the rectum, presumably modified by absorption processes via the rectal pads. Since the amount of blood affects movement, triatomines rapidly excrete those compounds of the blood without nutritional value, at first mixed with the rectal remnants of blood digestion, then clear urine. Species defecating during or soon after blood ingestion are more important vectors than others defecating much later, because thereby *Trypanosoma cruzi* is deposited on the skin or mucous membranes of the host. Since the saliva causes itching, especially after repeated exposure, the induced scratching produces slight skin lesions. This may cause an infection, because the infectious stage, the metacyclic →*trypomastigotes*, cannot penetrate intact skin, but needs skin lesions or mucous membranes.

### Interaction of Vector and Parasite

After ingestion of blood trypomastigotes of *Trypanosoma cruzi*, these transform in the stomach or the small intestine of the vector to a, sphero- and →*epimastigotes*. Only the 2 latter stages multiply. Nearly exclusively in the rectum the metacyclic trypomastigotes develop. Higher percentages of spheromastigotes develop during starvation periods of the vector, and for a relatively short period of 3–5 days after feeding of such long-starved bugs, many giant cells with many nuclei, kinetoplasts, and →*flagella* also develop. Within an hour after feeding, metacyclogenesis is induced by factors present in the urine of the vector.

*Trypanosoma cruzi* is subpathogenic to triatomines, i.e., under optimal rearing conditions the vector is not affected, but starvation resistance and the capacity to inhibit the development of airborne bacteria in the intestinal tract is reduced.

### Prophylaxis

Mosquito nets can protect against the usually night-active triatomines. However, they should not lay loose on the bed, but should be fixed below the mattress. Beds should be controlled before sleeping for nymphs hidden in them. A strong reduction of the number of triatomines was obtained by control campaigns.

### Control

Education is included in the control campaigns to achieve better housing conditions and to avoid hiding places of triatomines inside the house. Adults and nymphs of triatomines can be killed using →*insecticides*. To achieve permanent application, insecticides are incorporated in wall paints or in fumigant canisters. Whereas DDT was ineffective, BHC, dieldrine, propoxur and more recently pyrethroids are used (→*Insecticides*, →*Ectoparasiticides*). If control campaigns are interrupted or finished, the original vector or species of triatomines

from the peridomestic populations rapidly colonizes the house. In addition, such long-term treatment may also induce the development of insecticide resistances. Therefore, new strategies of attack should be investigated. Theoretically very promising seems to be the introduction of transformed symbionts which produce substances that kill the flagellate but do not affect the vector.

## Kitasato, Shibasaburo (1853–1931)

Famous Japanese microbiologist, who stayed in R. →*Koch's* laboratory (1885–1886). He achieved the culturing and antibody formation of the tetanus bacillus (1889–1890), discovered the dysentery bacillus, the plague bacillus (with Yersin), and created the Kitasato clinic (1914).



**Kitasato, Shibasaburo (1853–1931).** Figure 1 Professor Dr. Kitasato, photograph of a painting while on the top of his career as founder of the Tokyo Kitasato Clinic and Institute.

## Kleine, Friedrich-Karl (1869–1951)

German physician, coworker of Robert Koch, describer of the cycle of trypanosomes inside the glossines and of the *Theileria* stages inside the ticks. Developer of first blood cultures (1905), leader of the →*Germanin expedition*.

## Klossia helicina

→Coccidia.

## Klossiella Species

*Klossiella* spp. (Fig. 1, e.g., *K. equi* in horses, *K. muris* in laboratory and other mice, *K. cobayae* in guinea pigs or *K. boae* in boid snakes) develop in cells of the kidneys of their hosts, lead to the formation of thin-walled oocysts with up to 60 sporocysts, and often introduce a severe disease including nephritis and haematuria. Infection occurs due to the oral uptake of sporocysts (containing 10–15 sporozoites), which after ingestion leave the intestine, enter blood capillaries, and thus reach the kidneys. Treatment may be done by coccidiostatica.

## Knemidocoptes

Genus of →mites, which are mange mites of birds. The males grow up to 0.25 mm, the spherical females (Fig. 1, page 688) reach a diameter of 0.5 mm.

*K. mutans* is found in the skin of the feet of chicken and doves and develops via 1 larva and 2 nymphs within 20 days (male), respectively, 26 days (females). *K. pilae* is mainly found in the face of psittacine birds,

but also occurs in the cloaca. *K. laevis* parasitizes the skin of the back of chicken and doves.

## Disease

*K. mutans* introduces the so-called chalk-leg-mange in birds, *K. pilae* the bill-mange of birds and *K. laevis* leads to the body-mange with the typical loss of feathers.

## Therapy

→Acarizides, →Ectoparasiticial Drugs.

## Knobs

Protrusions at the surface of →*Plasmodium falciparum*-infected host cells (Figs. 1–3, page 688). This protein (HRP-1) binds, together with a so-called Mesa complex (mature parasite erythrocyte surface antigen), the spectrin-dimers of the →cytoskeleton of the host cell. At the tip of these knobs →adhesion proteins (e.g., →sequestrin) are formed which are responsible for the adhesion and rosetting of infected red blood cells, thus leading to thrombic blockade of blood vessels. →Malaria.

## Knock-Down Effect

Degree of killed bloodsuckers, when attaching/getting contact to an insecticide-treated animal or surface. It is measured in percentage of killed vectors in relation to the days after treatment.

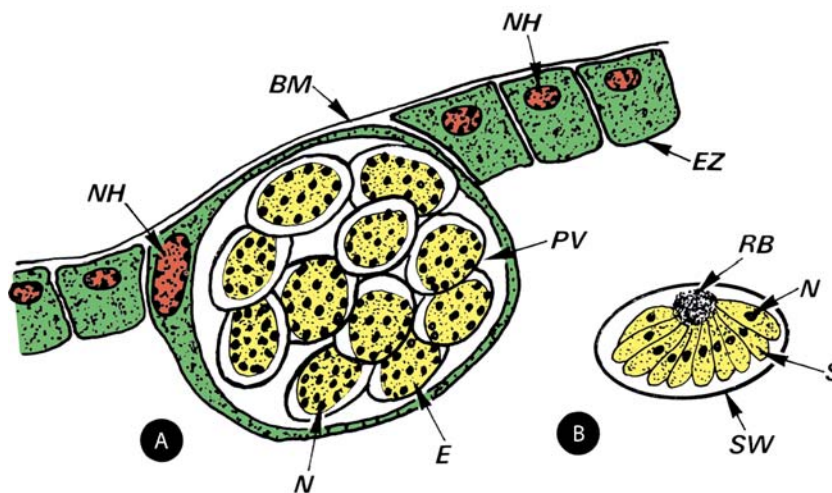

**Klossiella Species. Figure 1** Diagrammatic representation of an equine kidney endothelial cell containing an oocyst with many developing *K. equi* sporocysts (A). (B) Separated sporocysts with sporozoites. The oocysts measure 50–100  $\mu\text{m}$ , which produce about 40–60 sporocysts with a diameter of 10  $\mu\text{m}$ . BM, basal membrane; E, developing sporozoites; EZ, epithelial cell; N, nucleus; NH, nucleus of host cell; PV, parasitophorous vacuole; RB, residual body; S, sporozoite; SW, wall of sporocyst.

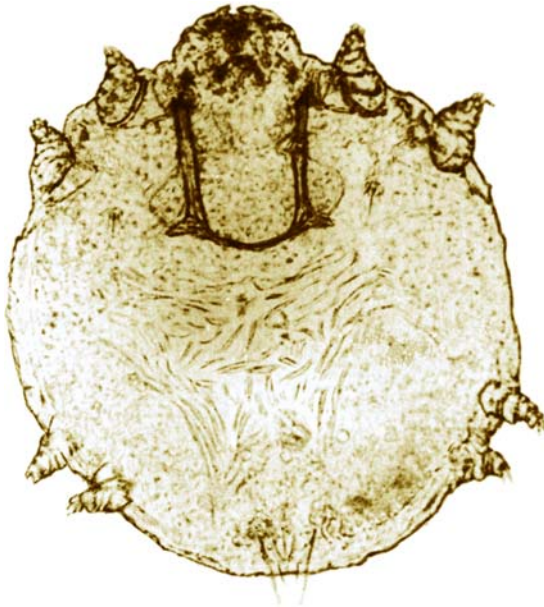

**Knemidocoptes.** Figure 1 LM of the ventral side of *Knemidocoptes pilae* (courtesy of Professor Dr. Ribbeck).

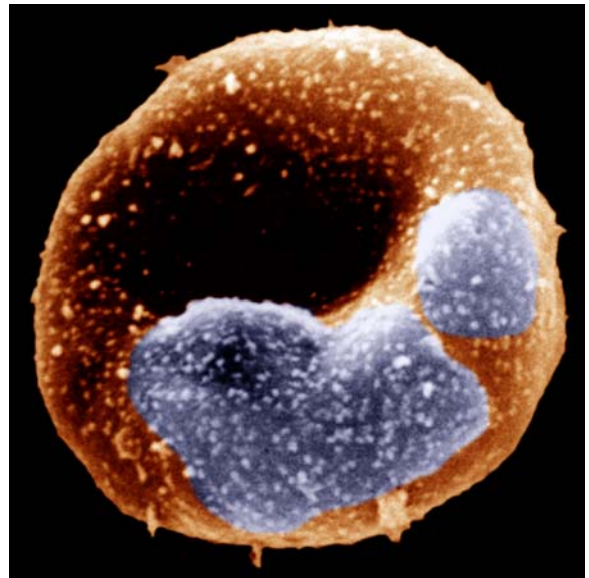

**Knobs.** Figure 1 SEM of a human red blood cell being infected with 2 schizonts (protruded) showing numerous dots = knobs at the surface.

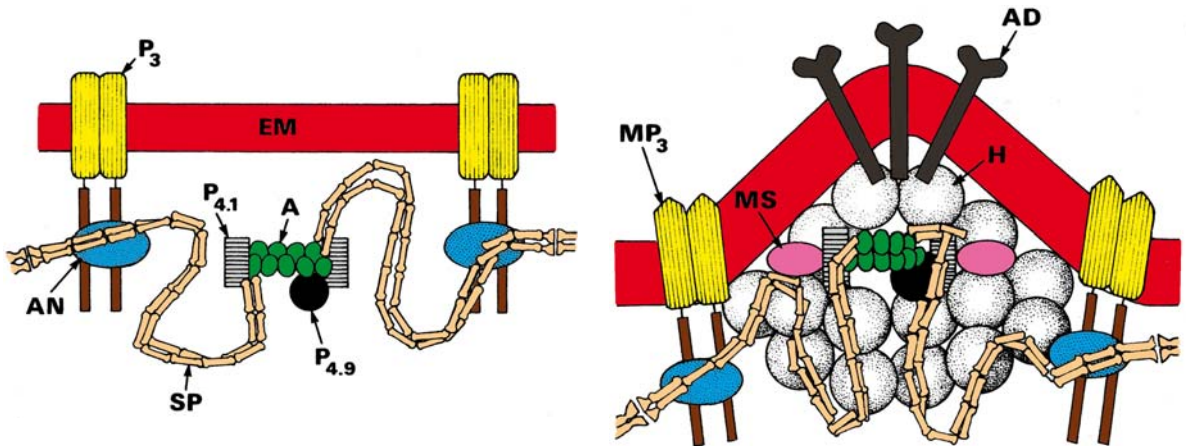

**Knobs.** Figure 2, 3 Formation of a knob-like structure (3) at the surface of a human red blood cell being infected with stages of *Plasmodium falciparum*. Figure 2 represents the normal membrane components (after Foley and Tilley). A, Actin; AD, adhesion proteins (e.g. sequestrin); AN, ankyrin; EM, membrane of erythrocyte; H, HRP - 1 Protein (= knob) protein; MP<sub>3</sub>, modified proteins 3; MS, mature parasite erythrocyte surface antigen (MESA); P, protein bands; SP, spectrin dimers.

## Knott's Blood Test

Method to detect microfilariae in blood of a patient. The blood is taken at species-specific hours (→ *Wuchereria*, → *Loa loa*). 1–10 ml blood is diluted with 10 times more of a 2% aqueous solution of formalin, centrifuged for 10 minutes at 1,500 g, and then the sediment is examined with the light microscope.

## Koch, Robert (1843–1910)

German physician (Fig. 1), who won the Nobel Prize in 1905 for the discovery of the agent of tuberculosis (1882); he described then the anthrax-bacterium (1876) and the Cholera-vibrio (1883). He also delivered important contributions in parasitology (→ *Trypanosomiasis*, → *Theileriasis*); he created a large



**Koch, Robert (1843–1910).** Figure 1 Painting of the 46-years-old scientist just after his major discoveries and at the time of his second marriage to Hedwig Freyberg.

school of famous national and international co-workers (→Ehrlich, →Prowazek, →Kleine, →Löffler, →Kitasato, etc.).

## Koch's Body

→Theileria →schizont inside the →cytoplasm of newly dividing lymphocyte, eventually forming merozoites.

## Krebs Cycle

→Amino Acids.

## Küchenmeister, Gottlob Friedrich Heinrich (1821–1890)

German physician, describer of the transmission pathway of tapeworms and the treatment of scabies by oils.

## Kudoa

Genus of the →Myxozoa. Most *Kudoa* spp. infect the somatic muscles of fish establishing cysts. However, human cases (apparently due to eating raw fish) might be common, too.

## Kupffer, Karl Wilhelm (1829–1902)

German anatomy professor, described the phagocytic “Kupffer-cells” in the liver, →malaria.

## Kupffer's Cells

These cells named honouring the German physician →Kupffer are found on the lumen side of endothelial cells of liver blood vessels; they become activated during infections, e.g., with malarial parasites and react by catching floating sporozoites. They also eliminate other material from blood and are named after the German anatomist Karl W. von Kupffer (1829–1902).

## Kussmaul Breathing

This form of deep breathing named after Adolf Kussmaul (1822–1902) occurs in children with malaria as a sign of the presence of acidosis. Metabolic Acidosis.

## Kwashiorkor Malaria

Symptom of malign malnutrition that leads to oedems, hepatomegaly diarrhoea, apathy. However, this disease reduces the severity of children's malaria.

## Kyasanur Forest Disease

→[Russian spring-summer encephalitis](#). It is caused by the KFD virus (→[Flavivirus](#), group B). The mortality rate is approximately 5%.

### Synonym

KFD.

### General Information

The Kyasanur forest disease in India is associated with the tick →[Haemaphysalis](#) spp. and is related to

---

## Labyrinthomorpha

Phylum of →[Protozoa](#) that form cysts and ameba-like stages on marine organisms.

---

## Laelaps agilis

About 2 mm long bloodsucking mite in the fur of mice ([Fig. 1](#)).

---

## Laelaptidae

Family of mites, that are found on insects (e.g., genus *Myrmonyssus*), while others parasitize mammals (genera *Echinolaelaps*, *Haemolaelaps*, *Laelaps*). The larvae and nymphs are mostly lymph feeders, while the



**Laelaps agilis.** **Figure 1** SEM of the ventral side of an adult; note the stiletto-like chelicerae.

adults are hematophagous. The life cycles (including egg, larva, protonymph, deutonymph, and adults) is completed within 8–28 days. During the blood meal the blood parasite →[Hepatozoon](#) may become transmitted.

---

## Lagochilascaris

Genus of ascarid →[nematodes](#), which occur in general in wild animals, but which may also enter (as larvae) humans leading to →[larva migrans interna](#).

---

## Lama branchialis

Microsporidian species of freshwater fish (→[Glugea](#)).

---

## Lamarck, Jean Baptiste de Monet (1744–1829)

French zoologist and evolutionist; he believed in the genetic transmission of acquired qualities.

---

## Lambl, W. D. (1824–1895)

Austrian physician, discoverer of the agents of the →[giardiasis](#).

---

## Lambli

Old genus name for *Giardia* spp. →[Diplomonadida](#), →[Giardia lamblia](#).

## Lambliasis

### Synonym

→ [Giardiasis](#), [Man](#).

## Landmarks

→ [Historical Landmarks](#).

## Landsteiner, Karl (1868–1943)

Austrian pathologist, discoverer of the human blood groups and the rhesus factor. Winner of the Nobel prize in 1930.

## Lankesteria

→ [Gregarines](#).

## Lapudrine-Dapsone (Lapdap)

→ [Malariaicidal Drugs](#).

## Larva

From Latin: *larva* = mask. Non-fertile developmental stage of helminths and arthropods (plural: larvae).

## Larva currens

Larva 3 of → [Strongyloides stercoralis](#) which after penetration wanders with a high speed (20 cm/hour) inside the skin of humans and leads to serpiginous pruritic eruptions.

## Larva migrans

Larvae of → [nematodes](#), which have animals as final hosts, wander through the body of humans in case they become infected.

- Larva migrans externa: For example, larva of → [hookworms](#) of dogs (→ [Ancylostoma caninum](#)) stay within the skin and lead to externally visible channels.
- Larva migrans interna: the larvae, for example, of ascarids of dogs or racoons (→ [Toxocara canis](#), → [Bayliascaris procyonis](#)) wander through internal organs if eggs are swallowed by humans.
- Spargana: larvae of → [tapeworms](#) of fish-predating birds wander as a so-called → [sparganum](#) inside the body of humans if they have eaten raw fish meat containing → [plerocercoid](#) larvae.

→ [Cestodes](#).

## Larvicides

→ [Disease Control, Methods](#).

## Larviparous

### Name

Latin: *larva* = mask, *parere* = giving birth.

Producing larvae instead of eggs (→ [Oviparous](#)) from within the body, e.g., in → [mites](#), → [Trichinella spiralis](#), and → [Filariidae](#).

## Lasalocid

→ [Coccidiocidal Drugs](#).

## Lasiohelea

Genus of → [Ceratopogonidae](#), → [Midges](#), → [Culicoides](#).

## Latency

Period between infection with an agent of disease and first signs of disease.

### Synonym

Incubation period.

## Latidectin

### Chemical Class

Macrocyclic lactone (16-membered macrocyclic lactone, milbemycins).

### Mode of Action

Glutamate-gated chloride channel modulator. → [Ecto-parasiticides – Antagonists and Modulators of Chloride Channels](#).

## Latrodectus mactans

Black widow spider, may harm humans.

## Laurer's Canal

Found in some digeneans, it probably represents a vestigial vagina that no longer functions but may be used as an excretory system for superfluous sperm, etc. (→ [Platyhelminthes/Reproductive Organs](#)).

## Laveran, Charles-Louis Alphonse (1845–1922)

French military physician ([Fig. 1](#)), who won the Nobel Prize in 1907 for the discovery of malaria due to → [Plasmodium malariae](#).

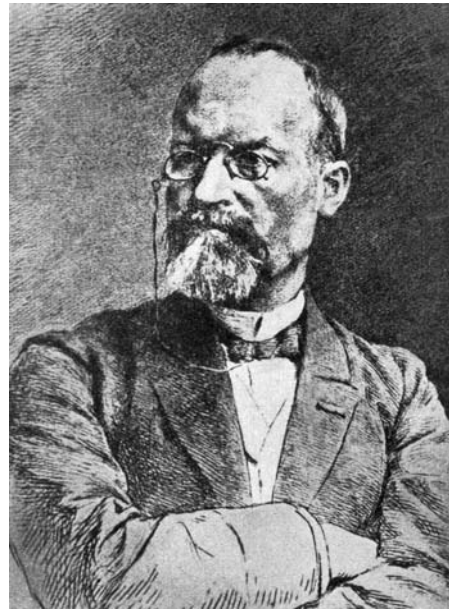

Laveran, Charles-Louis Alphonse (1845–1922).

**Figure 1** Painting of Prof. Alphonse Laveran, the great French malaria researcher at his zenith of fame.

## Lazear, Jesse William

American entomologist ([Fig. 1](#), page 694), discoverer (together with → [Reed](#)) of the transmission of yellow fever by *Aedes (Stegomyia)*-mosquitoes, died in 1900, during a self-experiment with yellow fever.

## Lecithodendriidae

Family of flukes with spined tegument parasitizing the gut of insectivorous vertebrates. However, *Phanerosolus* sp., *Prosthodendrium* sp., or *Paralecithodendrium* also live in humans. Intermediate hosts are aquatic insects.

## Leeches

### Synonym

Hirudinea, from Latin: *hirudo* = leech.





**Lazear, Jesse William.** Figure 1 Photo of Dr. Jesse W. Lazear just before his death in a self-infection experiment with yellow fever.

### Classification

Subclass of →Annelida.

### General Information

In general, members of the Hirudinea, which are endowed with a complete intestinal tract, look like plathelminths, and are dorsoventrally flattened monoecious animals (→Hermaphrodites). Mostly they develop 32 inner segments (except for 29 in →*Acanthobdella*), which each correspond to 2–14 outer annuli (some authors count 34 segments). Except for *Acanthobdella* the Hirudinea, parasitic or not, are characterized by an oral sucker and a posterior disklike →acetabulum, which act as strong →holdfast organs supporting movements on the surface of animal hosts or plants, etc. (Fig. 1, →*Hirudo medicinalis*/Figs. 1, 2). Blood-sucking leeches produce enzymes (e.g., hirudin) preventing coagulation of blood during feeding. Typically, closed circulatory vessels and a definitive respiratory system are lacking in most species and the coelom cavities are restricted to a few blood-transporting lacunae. The ontogenesis of the Hirudinea proceeds directly, without involving any larval stages (such as the →trochophora larva which is characteristic for other annelids). Thus, juvenile worms hatch immediately from eggs which are joined in packs of 1–200 into a →cocoon; the latter is secreted 2 days to months after copulation of 2 individuals by their →clitellum region (segments 9–11).

### System

The classification of the Hirudinea is still a matter of debate; however, the following groups are widely accepted:

- Subclass: Hirudinea (some parasitic species)
- Order: →*Acanthobdellida*  
Unlike other orders, they show only the posterior →acetabulum, are endowed with some surface bristles, and are composed of 29 inner segments (each with 4 outer annuli).
- Order: →*Rhynchobdellida*  
The anterior part of the intestine forms a large, protrusible, and retractile →proboscis without teeth; specimens suck blood and thus may transmit several endoparasites; they are eyeless, their blood colorless; host location occurs by body contact.
- Order: →*Gnathobdellida*  
Anterior part of intestine is noneversible, but is armed by 3 pairs of →jaws with varyingly strong cuticular teeth, the members of this group that are up to 25 cm long are characterized by 5 pairs of eyes, 5 annuli per segment, and red blood in a lacunar system; →host finding occurs by means of olfactory systems.
- Order: →*Pharyngobdellida*  
Specimens have no teeth and a nonprotrusible pharynx; they suck blood by means of their strong muscular pumping pharynx (armed with 1 or 2 stylets but no teeth), are provided with 3 or 4 pairs of eyes, and contain red blood in lacunae.

### Important Species

Table 1.

### Integument

As in other members of the phylum →Annelida, the leeches are covered by a unilayered, cellular epidermis which excretes to its surface a thin →cuticle consisting of a proteinaceous ground substance including →collagen fibers. →Chitin is only present in the rigid bristles (chaeta) which are, however, absent in most hirudineans except *Acanthobdella*. This →cuticle remains very elastic and is molted several times (not at definite intervals) in Hirudinea, but not in other annelids.

### Intestine and Food Uptake

The intestine of parasitic leeches consists of a frequently armed mouth, a pharynx, an esophagus, a stomach, an intestine with 6–7 large paired diverticles, a hindgut, and the rectum ending with the anus (→*Hirudo medicinalis*/Fig. 1). In the medicinal leech *H. medicinalis* the teeth of the 3 jaws are pored by the

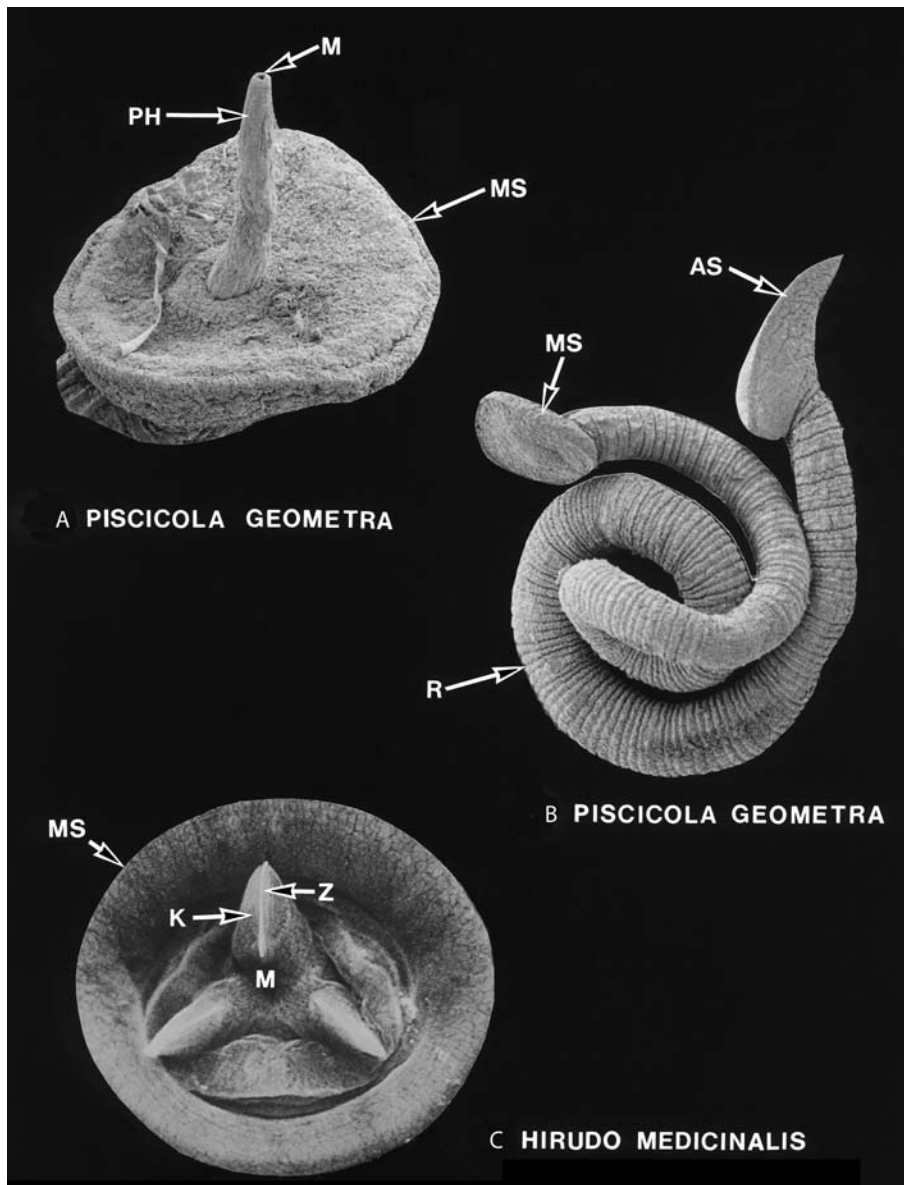

**Leeches. Figure 1** SEMs on leeches. **A** Anterior pole of the fish leech *Piscicola geometra* with the protruded pharynx ( $\times 80$ ). **B** Total lateral view of *P. geometra* ( $\times 8$ ). **C** Mouthpart of the medical leech  $\rightarrow$  *Hirudo medicinalis* ( $\times 15$ ). *AS*, anal sucker; *K*, jaw; *M*, mouth; *MS*, oral sucker; *PH*, pharynx; *Z*, row of teeth.

canaliculi of unicellular glands, which produce besides anesthetic and vasodilatory compounds, an anticoagulant (hirudin) which acts as an antithrombokinase. Due to this fact a large leech may ingest about 15 g blood (i.e., tenfold his own body weight) within a few minutes. This phenomenon was used for centuries in human medicine as a general remedy ( $\rightarrow$  Introduction). The blood cells are stored in the intestinal diverticles, while the fluid compounds are rather quickly excreted. This amount of blood allows the leeches to survive starving periods of up to 2 years. The blood cells inside the intestine are retained due to the activity of the hirudin in full shape for

a long time and become digested bit by bit due to the activity of a particular bacterium (*Pseudomonas [Aeromonas] hirudinis*) instead of its own digestive enzymes (which, however, are not completely absent). The bacteria are packed by the adult worm on its eggs and are thus transmitted to the next generation. Investigations of our group prove the long (half year) survival of many agents of diseases (viruses, bacteria, protozoan parasites) inside the stored blood. Furthermore, the antibodies of HIV and Hepatitis B viruses were found in African leeches, so that leeches pose a considerable danger for their hosts.

**Leeches. Table 1** Some common species of leeches (Hirudinea)

Family/Species	Length (mm)	Main hosts/Habitat
<b>Acanthobdellidae</b>		
<i>Acanthobdella peledina</i>	35	Salmonid fish/Skin
<b>Rhynchobdellidae</b>		
<i>Piscicola geometra</i>	70	Freshwater fish/Skin
<i>Theromyzon tessulatum</i>	50	Waterbirds/Nose, pharynx, trachea
<i>Haementeria ghilianii</i>	500	Many vertebrates/Skin
<i>Glossiphonia</i> spp.	20	Snails, oligochaetes/Skin
<b>Gnathobdellidae</b>		
<i>Hirudo medicinalis</i>	170	Mammals, <b>humans</b> /Skin
<i>Haemadipsa</i> spp.	70	<b>Humans</b> , mammals, birds/Skin
<i>Xerobdella</i> spp.	50	Amphibia/Skin
<i>Limnatis nilotica</i>	120	Horses, mammals/Nose, pharynx
<i>Haemopsis sanguisuga</i>	100	Feeds on oligochaetes
<b>Pharyngobdellidae</b>		
<i>Erpobdella octoculuta</i>	20	Predacious leeches, feed on insect larvae

### Excretory System

The excretory system of leeches consists of 10–17 pairs of →[metanephridia](#) (→[Hirudo medicinalis](#)/Fig. 1) which each open with a porus at the ventral body surface. They start with a ciliated funnel that opens into the body cavity or into a spherical nephridial capsule (depending on the species) and collect materials to become excreted.

### Nervous System

The nervous system of leeches (→[Hirudo medicinalis](#)/Fig. 1) corresponds in principle to that of other annelids, while being composed of a ventral chord system with a typical broad fused ganglion in each segment. From there 3–4 ringlike running pairs of nerves extend to the periphery. The ganglia of the segments of the posterior sucker are fused to form a large terminal ganglion. Anteriorly, a supraesophageal ganglion is developed innervating sensillae of various types. This epi- = supraesophageal ganglion is connected to the subesophageal ganglion which innervates the mouth and the anterior intestine.

## Leeuwenhoek, Antony van (1632–1723)

Developer and user of the first type of microscope, described, e.g., human sperms, →[Giardia](#), etc.

## Leidy, Joseph (1823–1891)

German-American anatomist, discoverer of the muscle stages of →[Trichinella](#) (1846) and recommending to eat only cooked meat. In 1886 Leidy described the hookworm of cats.

## Leidyana

→[Gregarines](#).

## Leishman, W. B., Sir (1865–1926)

English tropical physician, honored by genus →[Leishmania](#).

## Leishmania

### Classification

Genus of →[Trypanosomatidae](#), named after Sir William Leishman (1865–1926).

## Important Species

Table 1, Figs. 1–4.

## Life Cycle

Fig. 1.

## Surface Coat

Besides several GPI-anchored glycoproteins on the surface of *Leishmania* spp., the major component of the →surface coat in these parasites is represented by a →lipophosphoglycan which is also a →GPI-anchored family of molecules harboring a large glycanic moiety mostly made of repeats of a disaccharide phosphate motif that differs in size and terminal →capping sugars among developmental stages. →LPG stage-specific differences are responsible for the specific interaction of the developmental stages with their respective target cells or organs.

## Host Cell Invasion

In this group, 2 forms of the parasite are invasive: the promastigote (due to extracellular multiplication in the vector) and the amastigote (due to intracellular

development). The target of these parasites is essentially a phagocyte (Monocyte, macrophage). They have been described as entering the host cell via phagocytosis (→Host Cell Invasion/Fig. 1) although some participation of the parasite cannot be completely excluded. The *Leishmania* containing phagosome then acquires properties of late endosomes-lysosomes, and is therefore a particular compartment of the host cell, partly connected to the vesicular traffic of the cell. This compartment has a low pH (around 5), and its membrane contains the major lysosomal glycoproteins (LGPs) and the proton ATPase. The vacuole is readily accessible to the fluid phase →endocytosis pathway of the host cell, but accessibility to receptor endocytosis markers is not universal, showing that this vacuole is not simply a lysosome. Promastigote to amastigote transformation occurs in this compartment before parasite multiplication. An intriguing feature of *Leishmania* invasion is that the →vacuoles formed by the different species do not possess the same properties with regard to their size and their interaction with the endosomal compartment of the host cell and this may have consequences for the respective pathogenicity of these parasites.

Adaptation of *Leishmania* amastigotes to optimal survival at low pH under the adverse conditions of a

**Leishmania. Table 1** Important *Leishmania* spp. parasitizing humans

Species	Type of disease	Reservoir hosts	Geographic distribution	Vector
<b>Cutaneous Leishmaniasis<sup>a</sup></b>				
<i>L. tropica minor</i>	Dry cutaneous	Rodents, dogs	Southern Europe, Middle East	<i>Phlebotomus</i> spp.
<i>L. tropica major</i>	Wet cutaneous, oriental sore	Rodents, dogs	Southern Europe, Africa, Middle East	<i>Phlebotomus</i> spp.
<i>L. aethiopica</i>	Diffuse or dry cutaneous	<i>Hyrax</i> sp.	Ethiopia, Kenya	<i>Phlebotomus</i> spp.
<i>L. braziliensis braziliensis</i>	Espundia, mucocutaneous	Rodents	Mexico, Brazil	<i>Lutzomyia</i> spp., <i>Psychodopypus</i> spp.
<i>L. peruviana</i>	Uta, cutaneous	Dogs	Peru	<i>Lutzomyia</i> spp.
<i>L. mexicana mexicana</i>	Chiclero ulcer, cutaneous	Rodents	Central America	<i>Lutzomyia</i> spp.
<i>L. mexicana amazonensis</i>	Diffuse, cutaneous	Rodents	Amazonas region	<i>Lutzomyia</i> spp.
<i>L. mexicana pifanoi</i>	Cutaneous, mucocutaneous	Rodents	Venezuela	<i>Lutzomyia</i> spp.
<b>Visceral Leishmaniasis</b>				
<i>L. donovani donovani</i>	Kala-azar, dum-dum fever, visceral	Dogs, foxes	Africa, Asia, Middle East, southern Russia, South America	<i>Phlebotomus</i> spp.
<i>L. donovani infantum</i>	Visceral, infantile	Dogs	Mediterranean countries	<i>Phlebotomus</i> spp.
<i>L. donovani chagasi<sup>b</sup></i>	Visceral	Foxes, cats, dogs	South America	<i>Lutzomyia</i> spp.

<sup>a</sup> Some cutaneous species may also initiate visceral leishmaniasis

<sup>b</sup> Some authors keep this species synonymous to *L. infantum*

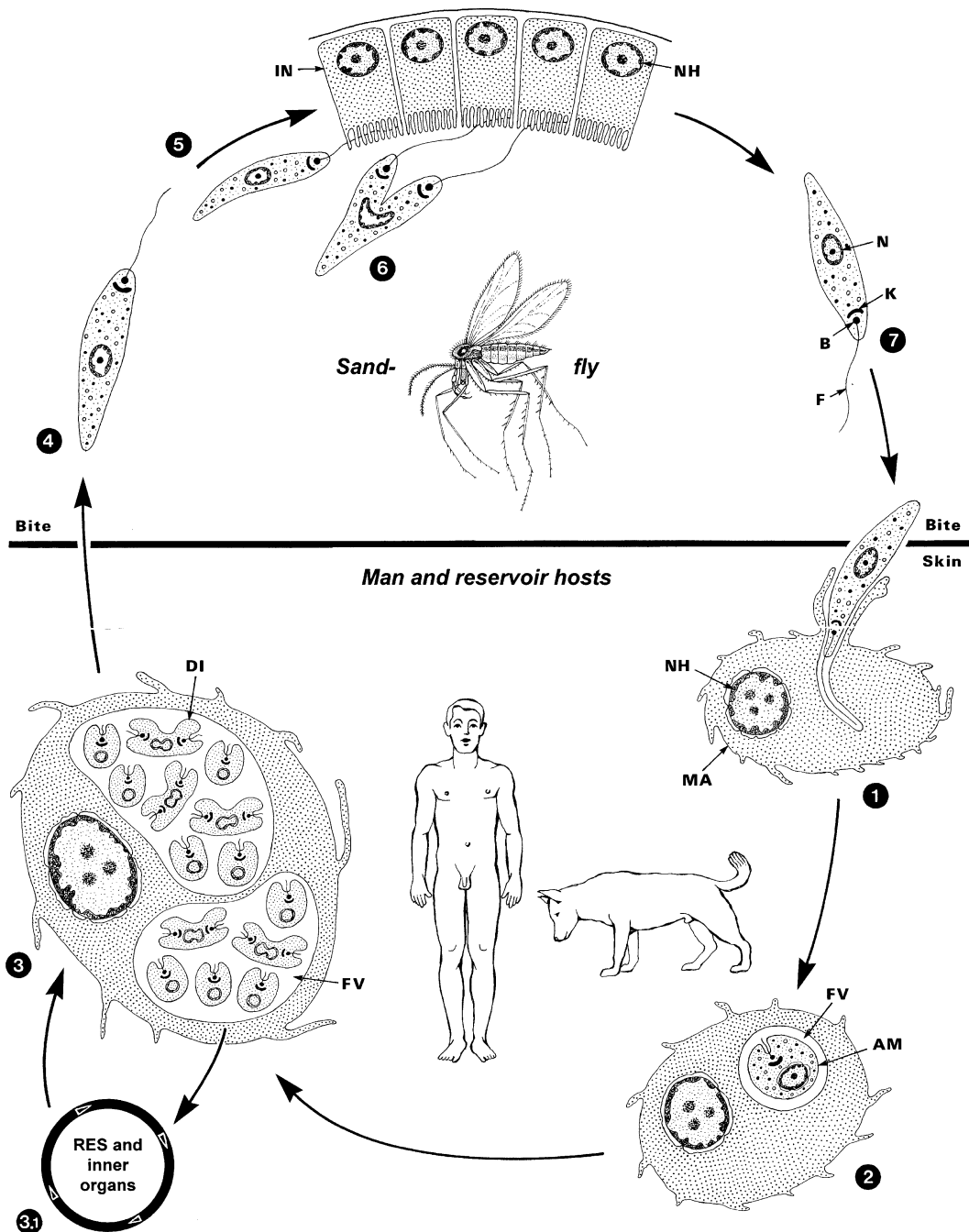

**Leishmania. Figure 1** Life cycle of *Leishmania* spp. (see Table 1). 1 After bite of the →vector the injected promastigote stage is engulfed by macrophages in the skin of the vertebrate host. 2 Transformation of →promastigotes into amastigote stages (2–4 μm in diameter) requires 1–4 hours; reproduction proceeds as →binary fission inside a →parasitophorous vacuole, which later breaks down. 3 When macrophages are closely filled with →amastigotes (after 48 hours), they finally burst and set free the parasites which may enter other macrophages in the skin, leading to a *cutaneous leishmaniasis* (→*Leishmaniasis*, Man/Fig. 2). 3.1 Amastigotes of the *L. donovani* group are carried to inner organs and may enter various host cells, where they are reproduced by repeated binary fissions and lead to a *visceral leishmaniasis* within 4–6 months (*kala-azar*, *dum-dum* fever; →*Leishmaniasis*, Man/Fig. 1). 4–7 When a sand fly (genera →*Phlebotomus*, →*Lutzomyia*) ingests amastigotes along with its blood meal, the latter are transformed into slender →promastigotes (10–20 μm in length) in the midgut, where they multiply by repeated →binary fission (6). Quickly they block up the gut of the vector and move to the pharynx and buccal cavity, where they are injected into a new host with the fly's next bite (7). All stages have a slight →surface coat. AM, →amastigote stage; B, basal body of flagellum; DI, dividing stage; F, free flagellum; FV, food vacuole; IN, intestinal cell; K, →kinetoplast; MA, macrophages; N, nucleus; NH, nucleus of host cell.

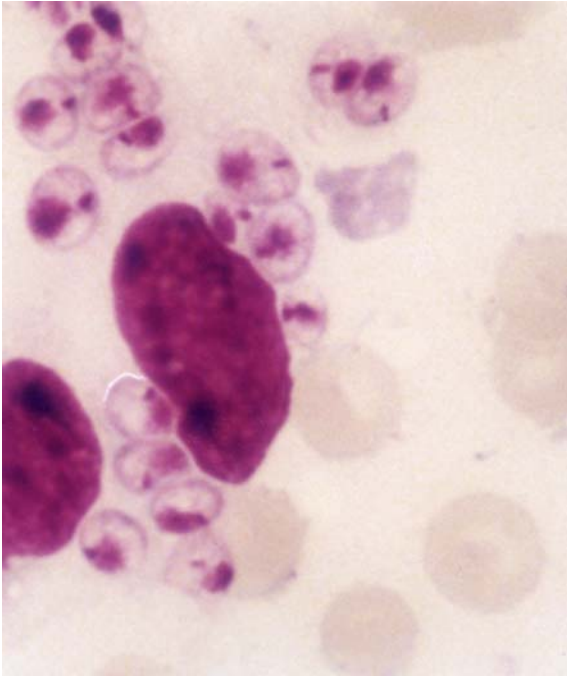

**Leishmania. Figure 2** LM of a Giemsa-stained blood smear. Several amastigotes of *Leishmania* spp. are situated closely to 2 red host cell nuclei, the cells of which were disrupted. Note inside the amastigote the small red colored kinetoplast and the larger nucleus.



**Leishmania. Figure 3** SEM of a dividing promastigote (= infectious stage).

lysosome is not fully explained; high levels of glycoinositol phospholipids and glycosphingolipids may be in part responsible for this unusual resistance.

### Transformation Inside Vector

If a female *Phlebotomus* has taken up amastigotes of *Leishmania*, they are transformed within 24–48 hours in the foregut into procyclic stages, which transfer



**Leishmania. Figure 4** SEM of an amastigote stage of *Leishmania* in a host cell.

inside the terminal midgut (enclosed within the →peritrophic membrane) to nectomonads (= swimming promastigotes) within 48–72 hours. Later (within 4–7 days) leptomonads (= slender promastigotes) and haptomonads (wall-attached forms) occur prior to the occurrence of the transmissible metacyclics, which are found around day 6–7 at the inner side of the stomodeal valve. During the next sucking activity of the *Phlebotomus* these stages are regurgitated into the wound.

### Diseases

→Leishmaniasis, Animals, →Leishmaniasis, Man.

## Leishmaniacidal Drugs

Table 1.

### General Information

→*Leishmania* spp. are intracellular parasites (amastigote stages) that affect mainly humans, dogs, and rodents. The parasites are transmitted to various hosts by bites of sand flies (→*Phlebotomus* spp. and →*Lutzomyia* spp., small in size). *Leishmania* invades resting macrophages and reaches cells of the reticuloendothelial system in various organs causing inflammatory processes and immune-mediated lesions. *Leishmania* can cause various disease patterns. Leishmaniasis comprises a variety of syndromes ranging from asymptomatic and self-healing infections (e.g., single cutaneous lesions caused by *L. major* or *L. tropica*) to those with a significant →morbidity and mortality. The lesions may be confined to skin or disseminated to various tissues as in the case of the potentially fatal →visceral leishmaniasis (VL). This zoonotic form (Kala-azar, Dum Dum Fever,

**Leishmaniacidal Drugs. Table 1** Drugs used against *Leishmania* sp. in humans

Parasite, disease, distribution	Stages affected (location)	CHEMICAL CLASS, nonproprietary name (*Trade name), dose regimens (adult = pediatric)	Miscellaneous comments on drug characteristics
<b>Old World and the New World Leishmaniasis:</b>			
are transmitted by sand flies and caused by various <i>Leishmania</i> occurring in the Old World and the New World; in humans and animals, <i>Leishmania</i> produce numerous clinical manifestations attributed to them; thus leishmaniasis comprises a variety of syndromes ranging from asymptomatic and self-healing infections (e.g., single cutaneous lesions caused by <i>L. major</i> or <i>L. tropica</i> ) to those with a significant morbidity and mortality. The lesions may be confined to skin or disseminated to various tissues as in the case of the potentially fatal visceral leishmaniasis (VL); post-kala-azar dermal leishmaniasis (PKDL) is a relatively common consequence of therapeutic cure from VL caused by <i>L. (L.) donovani</i> ; amastigote (intracellular) stages can be diagnosed clinical, parasitologic, serologic, and by isoenzyme electrophoresis, and DNA-based detection; however, it may be difficult to detect amastigotes in impression smears or in biopsy material (e.g., from bone marrow); these very small spherical to ovoid stages characterized by large nucleus and a prominent ovoid or rod-shaped kinetoplast may be differentiated from organisms such as <i>Histoplasma</i> or <i>Toxoplasma</i> ; <i>Leishmania</i> has recently been divided into two subgenera, <i>Leishmania (Leishmania)</i> (most species) and <i>Leishmania (Viannia)</i> , e.g., <i>L. (V.) braziliensis</i> and related species, taking into consideration many factors, including morphology, biochemical, and genetic characteristics of the organisms as well as their geographic distribution, clinical manifestations, and epidemiological factors; drugs used in humans may be also used in dogs			
DRUGS MAY BE USED FOR TREATMENT OF ALL LEISHMANIASIS IN HUMANS AND ANIMALS			
SPECIES OCCURRING IN THE OLD WORLD			
<b>Cutaneous leishmaniasis (=CL)</b> (oriental score) <i>L. (L.) tropica</i> , <i>L. (L.) major</i> , <i>L. (L.) aethiopia</i>	<b>amastigote</b> (parasites invade resting macrophages of the skin; infection is often confined to the dermis and subcutaneous tissue)	<b>CL: DRUGS OF CHOICE</b> <b>PENTAVALENT ANTIMONIALS</b> <b>sodium stibogluconate</b> (*Pentostam GSK) or <b>meglumine antimonate</b> (*Glucantime, Sanofi-Aventis): (20 mg Sb/kg/d i.v. or i.m. x20d, may be repeated or continued) <b>ALTERNATIVES</b> <b>DIAMIDINES</b> <b>pentamidine isethionate</b> (*various): ( <i>L. panamensis</i> , Columbia: 2–3 mg/kg i.v. or i.m. daily or every second day x4–7 doses) <b>AMINOGLYCOSIDE ANTIBIOTIC</b> <b>paromomycin</b> (*various): (topically 2x/d x10–20d may be repeated or continued) or *Leshcutan, a special formulation with methylbenzethonium HCl in soft white paraffin	<b>Sb compounds</b> are generally toxic: frequent fatigue, nausea, muscle and joint pain, increased transaminases, changes in ECG (T wave inversion), occasionally hepatic and renal dysfunction; shock sudden death (rare); <b>pentamidine</b> may cause frequent hypotension, hypoglycaemia often followed by diabetes mellitus, renal damage, pain at injection site, GI disturbance, vomiting; it proved effective in CL patients (Columbia) where likely organism was <i>L. panamensis</i> (its effect against other species is not well established)
<b>Visceral leishmaniasis (=VL)</b> (kala-azar) <i>L. (L.) donovani</i> <i>L. (L.) infantum</i> complex (certain strains may also cause CL; PKDL is not associated with this species)	<b>amastigote</b> (parasites initially invade resting macrophages of the skin and subsequently cells of RHS in liver, spleen, lymph nodes, and, bone marrow)		
SPECIES OCCURRING IN THE NEW WORLD			
<b>American visceral leishmaniasis (=AVL)</b> <i>L. (L.) chagasi</i> (on rare occasions it may cause CL)	<b>amastigote</b> (location in host see above) clinical features in children closely resemble those of 'infantile' VL due to <i>L. (L.) infantum</i> of Old World	<b>VL: DRUGS OF CHOICE</b> <b>sodium stibogluconate</b> (*Pentostam GSK) or <b>meglumine antimonate</b> (*Glucantime, Sanofi-Aventis): (20 mg Sb/kg/d i.v. or i.m. x28d, may be repeated or continued) or <b>POLYENE MACROLIDE ANTIBIOTICS</b> <b>amphotericin B</b> (*various) (0.5–1 mg/kg i.v. daily or every second day for up to 8 weeks) or <b>liposomal amphotericin B</b> (*AmBisome FDA approved): (3 mg/kg/d i.v.: d1–5, and 3 mg/kg/d i.v. d 14 and d21) <b>ALTERNATIVES</b> <b>pentamidine</b> (*various) (4 mg/kg/d i.v. or i.m. daily or every second day for 15–30 doses) <b>ALKYL PHOSPHOLIPID</b> <b>miltefosine</b> (*Miltex, *Impavido Zentaris, Frankfurt Germany) (2.5 mg/kg/d x28d per os: children suffering from kala-azar in India)	<b>paromomycin</b> should be used only in regions where CL species have low potential for mucosal spread; *Leshcutan proved effective against <i>L. major</i> in Israel and Guatemala ( <i>L. mexicana</i> , <i>L. braziliensis</i> ); for other effects of the drug cf. → <b>Antidiarrhoeal and Antitrichomoniasis Drugs</b> , or → <b>Cestodocidal Drugs</b> ); <b>amphotericin B</b> , an antibiotic with extreme toxicity: generalized pain, convulsions, anaphylaxis, flushing chills, fever, phlebitis, anemia, thrombocytopenia, nephrotoxicity; there are various lipid formulations of the drug: *AmBisome (see dosage regimen), or

**Livoneca symmetrica. Table 1** Drugs used against *Leishmania* sp. in humans (Continued)

Parasite, disease, distribution	Stages affected (location)	CHEMICAL CLASS, nonproprietary name (*Trade name), dose regimens (adult = pediatric)	Miscellaneous comments on drug characteristics
<b>Mucocutaneous leishmaniasis (=MCL)</b> <i>L. (V.) braziliensis</i> , <i>L. (V.) guyanensis</i> (and others) may also cause CL <i>L. (L.) amazonensis</i> (and others)	<b>amastigote</b> (parasites invade resting macrophages of the skin and then they may spread to mucocutaneous junctions to cells of RHS; extensive destruction of dermis and other tissues	<b>AVL/MCL: DRUGS OF CHOICE</b> <b>sodium stibogluconate</b> (*Pentostam GSK) or <b>meglumine antimonate</b> (*Glucantime, Sanofi-Aventis): (20 mg Sb/kg/d i.v. or i.m. x28d, may be repeated or continued) <b>amphotericin B</b> (*various) (0.5–1 mg/kg i.v. daily or every second day for up to 8weeks)	*Abelcet (lipid complex of amphotericin B) and *Amphotec (amphotericin B cholesteryl sulfate) investigational drug products with good results in patients infected with <i>L. infantum</i> ; <b>miltefosine</b> proved effective (97%) against kala-azar in adults in India (100 mg/d orally) after 6 months; GI disturbances are common, drug is contraindicated in pregnancy; the drug was also effective against CL caused by <i>L. panamensis</i> in patients (≥12 years old) in Colombia but not <i>L. braziliensis</i> in Guatemala (2.5 mg/kg/d per os for 28d: frequent adverse effects: ‘Motion sickness’, nausea, headache and increased creatinine)
<b>Cutaneous leishmaniasis (CL)</b> <i>L. (L.) mexicana</i> <i>L. (V.) lainsoni</i> <i>L. (V.) guyanensis</i> (and others)	<b>amastigote</b> (location in host see above; some species may spread to mucocutaneous junctions)		

Dosages listed in the table refer to information from manufacturer, literature, and The Medical Letter, “Drugs for parasitic infections”

More information on adverse effects, manufacturers of drugs and brand names are given in The Medical Letter and partially in → Trypanocidal Drugs, Animals

Data Given in this Table have no claim to full information.

or →**Black Sickness**) is produced by *L. donovani* in China, India, the Middle East, and Africa, by *L. infantum* in North Africa and the Mediterranean region, and by *L. chagasi* in Latin America. Various clinical signs referring to the Old World →**cutaneous leishmaniasis** (CL) are due to *L. major*, *L. tropica*, *L. aethiopica*, and certain zymodemes of the *L. infantum* complex. *L. mexicana* complex and *L. braziliensis* complex cause the New World cutaneous leishmaniasis and mucocutaneous leishmaniasis (MCL) (“Espundia”); they focally occur from Texas (USA) and Mexico, southwards throughout Central America and South America as far south as São Paulo state of Brazil. All species except *L. tropica* are essentially →**zoonoses** that occur in scattered foci primarily rural and suburban, but there is a trend towards urbanization. Annually, about 500,000 clinical cases of VL occur worldwide and more than 200 million people are exposed to infection.

Zoonotic VL in **dogs** is a progressive systemic disease characterized by chronic wasting. Initial clinical signs are vague and may be →**weight loss**, fever, →**anorexia**, and exercise intolerance. Clinical signs indicative of systemic involvement include nonpruritic skin lesions, peripheral lymphadenopathy, lameness,

and epistaxis. However, there may be different clinical features depending on individual variations, species of *Leishmania*, and phase of the disease. CL is a localized skin disease, which can show cutaneous, or mucocutaneous →**nodules** and ulcerations but does involve other organs. Canine leishmaniasis in the Old World is mainly due to *L. infantum* endemic in parts of Spain and throughout the Mediterranean basin where its incidence may be up to 40%. In the New World, *L. chagasi* (→**reservoir** crab eating “fox”, *Cerdocyon*, possibly others, dogs, serve as domestic reservoir) is the causal agent for American VL in dogs.

### Drugs Acting on Leishmaniasis of Humans and Animals

For 50 years, pentavalent antimony compounds (sodium stibogluconate, identical to sodium antimony gluconate and meglumine antimoniate) have been the first-line drugs for the treatment of leishmaniasis in humans. The precise chemical structure of these drugs is difficult to identify. Thus quality control relies on chemical analysis for **pentavalent antimony** (Sb<sup>5+</sup>) rather than



sugar component, and other physicochemical analyses. Drug tolerance to antimonials in human and canine leishmaniasis is known and there may be considerable rates of treatment failure and relapsing patients; drug tolerance may also be due in part to long-term treatment. Besides unresponsiveness, these drugs may show marked toxic effects such as arthralgia, nephrotoxicity, and cardiotoxicity leading in rare cases to sudden death. Antimonials are administered either by intralésional infiltration in simple single cutaneous lesions or by intramuscular injection in all cases with systemic involvement. The parenteral administration may be associated with unpleasant side effects. However these drugs seem to be safe if administered in the correct doses. Antimony is excreted quickly from the body so that daily treatment is necessary throughout each course for patients with VL (regimen see [Table 1](#)). The polyene antibiotic, **Amphotericin B**, is known to be effective in the treatment of VL, MCL (South America), and systemic mycoses but because of its toxicity it has so far been used only as a second-line drug (regimen see [Table 1](#)). There are now lipid formulations of amphotericin B with lower toxicity on the market and all have been on clinical trial for leishmaniasis. Thus the unilamellar liposome formulation, AmBisome, proved highly active against VL in Europe, Africa and India. *L. donovani* resistant to pentavalent antimony compounds may respond to lipid-encapsulated amphotericin B (NexStar is partner of TDR, WHO). In the search for nontoxic antileishmanials, attention has been directed toward currently used oral antifungal drugs such as the allylamine, terbinafine, N-substituted azoles, ketoconazole, and itraconazole. This is also true for the oral purine (hypoxanthine) analogue, **allopurinol** (see [Table 1](#), also →[Trypanocidal Drugs, Man/Drug Acting on American Trypanosomiasis \(Chagas' Disease\) of Humans](#)) or parenteral and topical formulations of the aminoglycoside **paromomycin** (= monomycin = aminosidine, [Table 1](#)). Most of these drugs and the 8-aminoquinoline WR6026, including synergistic combinations of antimonials either with paromomycin, allopurinol, or interferon- $\gamma$ , which are or were on clinical trial for VL and CL have proved variably effective so far and well-tolerated. VL/HIV coinfections present special problems. Indirect methods of diagnosis (→[Serology](#)) frequently fail in treated and relapsing patients and direct invasive methods and skilled microscopy are then required. DNA-based identification of parasites by means of PCR method appears to provide a solution to diagnosis of persistent infections. Standard treatment of VL with conventional drugs gives poor results with HIV patients (about 40% relapsed or showed persistent →[chronic infections](#)) demonstrating the importance of the immune response during chemotherapy.

Current treatment of **leishmaniasis in dogs** with pentavalent antimony derivatives and/or allopurinol does not always provide complete elimination of parasites and in most cases clinical remission. If treatment period is too short clinical relapses are common. Oral long-term treatment with **allopurinol** for 4 weeks or longer (up to several months) may lead to clinical remission after intermittent administration of the drug. Dose used is usually 10–20 mg/kg b.w. twice daily or higher (up to 30mg/kg b.w./day) and well-tolerated (sometimes vomitus). Simultaneous administration of **meglumine antimoniate** and allopurinol resulted in maintaining clinical remission in dogs. Dose regimen for Sb was 100 mg/kg b.w. s.c. for 20 days, followed by discontinuation of treatment for 15 days and repetition of the same regimen for 10 days, and that for allopurinol 30 mg/kg b.w. p.o. for 3 months, followed by 20 mg/kg b.w. for 7 days each month. Another intermittent regimen, which has successfully been used in treating canine leishmaniasis, is the intravenous (i.v.) administration of meglumine antimoniate, alone or in combination with, oral allopurinol. The intermittent regimen with meglumine antimoniate was 50 mg/kg b.w. (diluted with 0.9% NaCl solution) for 2 days, followed by 100 mg/kg b.w. for 8 days. After discontinuation of treatment for 14 days, the same dosage regimen was repeated. The overall maintaining clinical remission was satisfactory in most patients but bone marrow continued to be PCR positive in the majority (11 of 16) of treated dogs.

---

## Leishmaniasis, Animals

### Synonym

Leishmaniosis.

### Pathology

Leishmaniosis is caused by →[protozoa](#) of the genus →[Leishmania](#) that affect various mammalian hosts, but disease occurs most commonly in humans and dogs. The disease in dog is caused by *L. infantum*. The parasite is obligatory intracellular. It multiplies within macrophages and other cells of the mononuclear phagocytic system and causes chronic inflammatory processes. Clinically, the disease in dogs is characterized by a chronic loss of weight, nonregenerative →[anemia](#), intermittent pyrexia, and generalized or symmetrical lymphadenopathy. Cutaneous lesions are very common, and include dry exfoliative dermatitis, →[nodules](#), ulcers, onychogryphosis (clawlike curvature of the nails), and diffuse, symmetrical, or periorbital →[alopecia](#). Ocular

lesions such as keratoconjunctivitis, uveitis, and panophthalmitis may be present. Other signs include intermittent lameness, epistaxis, arthropaties, ascitis, and intercurrent →diarrhea. During postmortem examination, generalized lymphadenopathy, and hepato- and splenomegaly are also observed.

### Immune Responses

→Leishmaniasis, Man/Immune Responses.

### Therapy

→Leishmaniocidal Drugs.

## Leishmaniasis, Man

### Synonyms

*Skin Form*: Oriental Sore, Aleppo Boil, Delhi Boil, Chiclero's →Ulcer, French Bouton d'Orient; *Visceral Form*: →Kala azar; *Mucocutaneous Form*: Espundia.

### General Information

Leishmaniasis is a disease corresponding to a large spectrum of clinical symptoms, including visceral (→VL), cutaneous (CL), diffuse cutaneous (→DCL), and mucocutaneous (→MCL) forms. Recent estimations indicate that more than 400 million people are at risk of catching VL and →CL and the annual number of cases of VL or CL has turned into hundreds of thousands. The different species are responsible for various clinical manifestations and exhibit peculiarities of their natural cycle such as →animal reservoirs or species of vectors as well as epidemiological features. Therefore a universal control strategy is not possible. Species such as *L. major*, *L. tropica*, *L. braziliensis*, *L. mexicana*, and *L. aethiopica* cause mostly single, self-healing cutaneous →ulcers in humans while chronic diffuse cutaneous forms or progressively destructive mucocutaneous forms occur after infection with *L. mexicana* and *L. amazonensis* or *L. braziliensis*, respectively. The most severe, visceral form (kala-azar), which is fatal, if left untreated, and affects spleen, liver, and bone marrow, is caused by *L. donovani* and *L. infantum* (→Leishmania).

The infections usually start in the skin after the bite of a phlebotomid sand fly which inoculates →Promastigotes. In all clinical forms of leishmaniasis (see below) →amastigotes multiply in monocytes. Parenchymal cells appear rarely to be involved, suggesting that organisms are phagocytized. Although the organisms are capable of multiplying extracellularly,

such as in the gut of the sandfly or in culture, there appears either to be little or no extracellular multiplication in the mammalian host, where such organisms are destroyed by the processes of immunity. Traditionally *L. major*, *L. tropica*, *L. aethiopica*, *L. mexicanum*, *L. peruviana*, *L. braziliensis*, and *L. pifanoi* have been recognized, with several subspecies. The classification of the various leishmanial groups by zymodemes and serodemes and the correlation with clinical forms is in progress.

### Pathology

The primarily cutaneous forms of leishmaniasis may be limited to the skin and adjacent tissues, possibly because the temperature optimum of the causative organisms is 33–35°C, i.e., as in the skin; also the expression of cellular immunity is impaired at lower skin temperatures. A similar situation appears to account for the superficial localization of leprosy. In contrast to this, the organisms causing →visceral leishmaniasis infect the deep tissues even though they are inoculated by →Phlebotomus spp. bite into the skin.

### Cutaneous Leishmaniasis (CL)

→Cutaneous leishmaniasis occurs in both the Old and the New Worlds, produced by →Leishmania tropica, and *L. mexicana*. Lesions start as papules composed of proliferating histiocytes (macrophages) which contain numerous amastigotes (→Pathology/Fig. 1). The lesions are usually found on the exposed areas of the face or extremities, at the presumed inoculation site. Satellite lesions develop sometimes on skin surfaces with intact epidermis. Diagnosis is easily accomplished in histologic sections or impression smears; however organisms may be sparse. The lesions become infiltrated by varying numbers of lymphocytes and plasma cells and eventually become granulomatous, containing fewer amastigotes after several weeks or months. With the development of delayed →hypersensitivity the lesions ulcerate. They become secondarily infected with bacteria and the base of the ulcer contains neutrophils. The amastigotes remain in the epidermally covered areas peripheral to the ulcer and can best be isolated by aspiration from there for diagnosis in culture.

With developing immunity, the ulcers heal with granulation tissue and fibrosis, often leaving a slightly depressed scar. However, chiclero ulcers, typically on the earlobes, do not heal readily in Mexico and Central America, a fact believed to result from the lower body temperature which impairs the expression of cellular immunity.

**Main clinical symptoms:** Skin →nodules, papulae, ulceration, →necrosis.

**Incubation period:** 2–4 weeks up to 1 year.

**Prepatent period:** 1–3 weeks.

**Patent period:** Months.

**Diagnosis:** Microscopic determination of amastigotes in skin biopsies, serodiagnostic methods, →serology, →*Leishmania*/Fig. 2.

**Prophylaxis:** Avoid the bite of the vector.

**Therapy:** See →*Leishmaniocidal Drugs*.

### Mucocutaneous Leishmaniasis (MCL)

Mucocutaneous leishmaniasis, or espundia, caused by *Leishmania brasiliensis* complex is also transmitted by sand fly bite in South America. However, skin lesions often metastasize from the site of inoculation to other areas of skin and the mucous membranes, especially of the oro- and nasopharynx. Histologically the lesions are granulomatous with relatively few amastigotes and numerous lymphocytes and plasma cells. The lesions ulcerate, become bacterially infected, and often persist for months or years, at times destroying the cartilaginous nasal septum.

### Diffuse Cutaneous Leishmaniasis (DCL)

Diffuse cutaneous leishmaniasis may be produced by a distinct species of *Leishmania*, or it may be an individual reaction, as occurs in lepromatous leprosy. It occurs in the Caribbean, Brazil, and Ethiopia (Fig. 1). Huge numbers of macrophages filled with amastigotes accumulate and develop into nodular cutaneous lesions without necrosis, ulceration, or the formation of granulomas, and accompanied by only few lymphocytes and plasma cells (→Pathology/Fig. 14).

### Visceral Leishmaniasis (VL)

Visceral leishmaniasis, or kala-azar, occurs in South Europe, the Middle East, India, Africa, and focally in Central and South America (Figs. 2–5). It is produced by several forms of *Leishmania* which can be arranged into several groups according to results of isoenzyme analysis, antibody tests, and nucleic acid analysis; these groups may include species other than the classical species, *L. donovani*, *L. infantum*, in the Middle East, and *L. chagasi* in Latin America. The reticuloendothelial cells of the viscera are parasitized by amastigotes and multiply greatly, resulting in hepatomegaly and splenomegaly (up to 3,000 g) which is palpable through the abdominal wall. Splenomegaly leads to hypersplenism with erythrophagocytosis, anemia, and is accompanied by hyperglobulinemia and hypoalbuminemia. The lymph nodes and bone marrow are usually also involved. Impaired hematopoiesis, leucopenia and thrombocytopenia are commonly found. Histological examination shows that the Kupffer cells of the liver and the histiocytic cells of the spleen are filled with large numbers of amastigotes; the hepatic parenchymal cells often show steatosis and atrophy and the splenic follicles are also atrophic. Immunoglobulins (IgA, IgM, and IgG) are deposited in the glomerular mesangia and around the tubules in the kidney. A long febrile course with progressive cachexia and secondary infection often precedes death. An unknown number of patients recover spontaneously and many do after timely chemotherapy with a regression of the reticuloendothelial →hyperplasia. Some of these patients develop post-kala-azar dermal leishmaniasis with amastigote-laden histiocytes accumulating in the skin

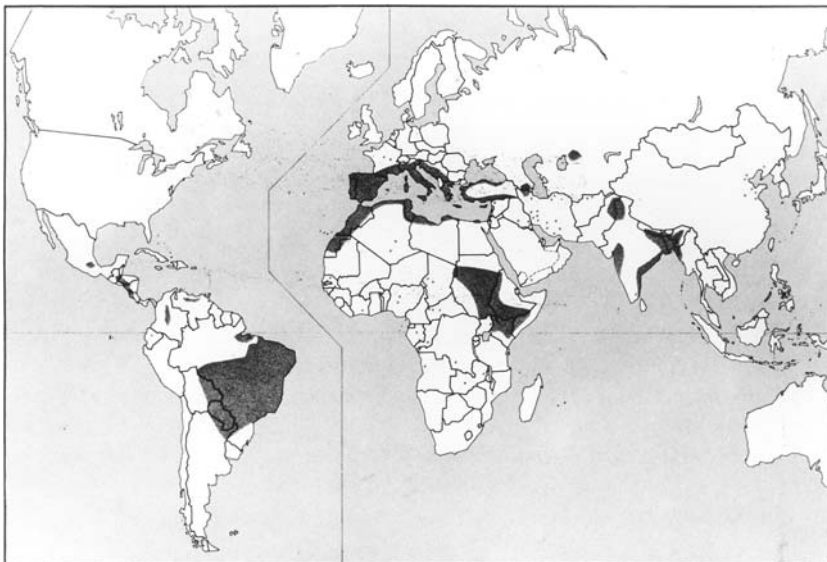

**Leishmaniasis, Man. Figure 1** Distribution map of skin leishmaniasis (according to WHO).

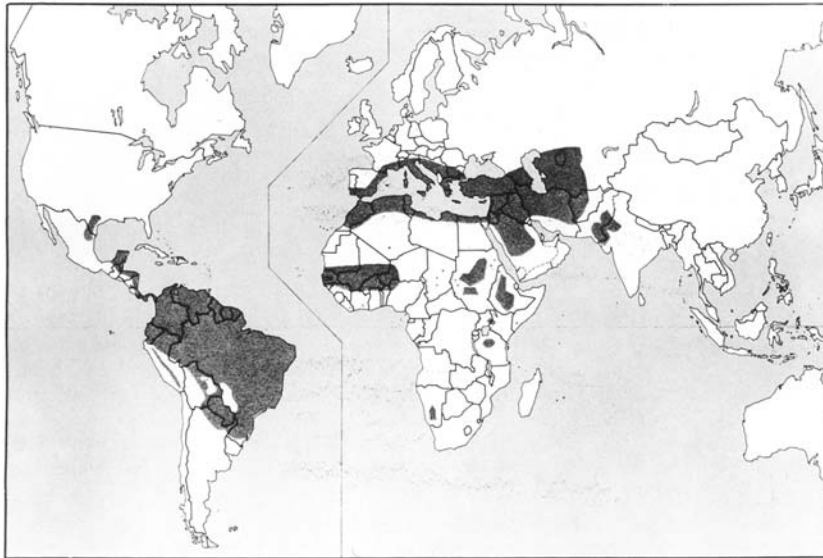

**Leishmaniasis, Man. Figure 2** Distribution map of visceral leishmaniasis (according to WHO).



**Leishmaniasis, Man. Figure 3** Non-healing leishmanial wound at the arm.

and producing nodules covered by thin epidermis similar to an anergic cutaneous leishmaniasis (→[Pathology/ Fig. 14](#)). Apparently, effector mechanisms of cellular immunity, which operate in the viscera, were not effective in the cooler skin.

**Main clinical symptoms:** Fever of 39–40°C, with two peaks in 24 h, →[anemia](#), leucopenia, pale skin, kachexia, bacterial superinfections.

**Incubation period:** 10 days to 1 year.

**Prepatent period:** 1–3 weeks.

**Patent period:** Months to years.

**Diagnosis:** Serologic tests and microscopic determination of smear preparations of bone marrow, →[Serology](#).

**Prophylaxis:** Avoid the bite of phlebotomids in endemic regions.

**Therapy:** Treatment see →[Trypanocidal Drugs, Man](#) and →[Leishmaniacidal Drugs](#).

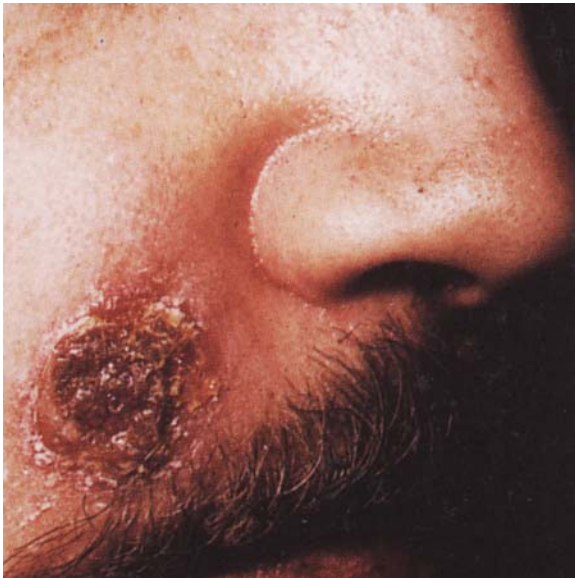

**Leishmaniasis, Man. Figure 4** *Leishmania*-sore in the face.



**Leishmaniasis, Man. Figure 5** *Leishmania*-sore at the border of the ear.

### Immune Responses

In their mammalian host, *Leishmania* typically reside within macrophages, dendritic cells, and fibroblasts which not only serve as potentially safe habitats for the parasite, but may also possess antigen-presenting and/or antimicrobial functions. Experimental infections of mice with either *L. major* or *L. donovani* have greatly attracted many immunologists over the last decades to study the role of innate or acquired immune mechanisms to control an intracellular microorganism. In particular,

the existence of inbred mice, which either cure or succumb to the infections has helped to define protective and nonprotective functions of the immune system.

### Innate Defense Mechanisms

An initial study has demonstrated the ability of *L. major* promastigotes to activate the IL-1 promoter in macrophages via a MyD88-dependent pathway. Consistently, three studies have shown that mice lacking functional MyD88 adapter protein are very susceptible to infection with *L. major*. Contrasting with the WT mice, in the MyD88 KO mice infected with *L. major*, the Th responses were characterized by the production of high levels of IL-4 and low levels of IFN- $\gamma$ . Importantly, upon treatment with exogenous IL-12 or anti-IL-4 antibodies, MyD88 KO mice develop Th1 responses and become resistant to infection. Additional studies have demonstrated that the lipophosphoglycan (LPG), a dominant molecule that covers the surface of the promastigote stage of *Leishmania*, is a TLR2 agonist. The lipid moiety was shown to be essential for TLR2 signaling by LPG, suggesting the involvement of the GPI anchor. Together, these results indicate that LPG is an agonist for TLR2 and that induction of IL-12 synthesis and protective immunity during infection with *L. major* in mice involves the TLR signaling pathway. While noninfective, procyclic *Leishmania* promastigotes are sensitive to complement-mediated lysis, the infective stages transmitted by [sand flies](#) (metacyclic promastigotes) are relatively resistant to direct serum killing. As shown recently by Dominguez and Torano, *Leishmania* promastigotes bind natural anti-*Leishmania* IgM antibodies within 30 sec, which then activate the classical complement pathway resulting in opsonization by the third component of complement. The opsonized promastigotes then bind quantitatively to erythrocyte CR1 receptors. Progression of infection implies promastigote transfer from erythrocytes to monocytes/macrophages where the parasite uptake is predominantly mediated by CR3. Since cross-linking of the CR3 does not elicit an oxidative burst in monocytes, complement components of the host are used by *Leishmania* for silent invasion of host macrophages. Macrophages harbor *Leishmania* and allow the parasite to replicate or when activated by appropriate stimuli such as IFN- $\gamma$ , kill and destroy the parasites. Toxic nitrogen products, predominantly [nitric oxide](#), which are synthesized by iNOS, are the main parasitocidal molecules produced by activated macrophages. Mice genetically deficient for iNOS or treated with iNOS inhibitors are unable to restrict parasite replication and reactivation of latent leishmaniasis occurred after treatment of long-term-infected C57BL/6 mice with the specific iNOS-inhibitor L-iminoethyl-lysine (L-NIL). In addition, iNOS appeared to have important immunoregulatory functions during the early phase of

a Leishmania infection. At day 1 of infection genetic deletion or functional inactivation of iNOS abolished the IFN- $\gamma$  and NK cell response, increased the expression of TGF- $\beta$ , and caused systemic parasite spreading. Since neutralization of IFN- $\alpha/\beta$  *in vivo* inhibited iNOS-expression and mimicked the phenotype of iNOS-deficient mice, type I interferons and iNOS are critical regulators of the innate immune response to *L. major*.

More than macrophages, dendritic cells are extraordinarily efficient in presenting antigen to naive T cells. Langerhans cells of the skin ingest Leishmania parasites, process native antigen, and express relevant epitopes in context with MHC molecules on their surface. The Langerhans cells move to the draining lymph nodes where they activate parasite-specific naive T cells. Evidence suggesting that this takes place not only in experimentally infected mice but also in humans comes from immunohistochemical investigations of biopsy material from patients with cutaneous leishmaniasis: Langerhans cells containing Leishmania antigens have been found in the epidermis and dermis at the site of an oriental sore.

Homogeneous populations of mouse mast cells released preformed mediators such as b-hexosamidase or TNF in response to living Leishmania promastigotes. By local cutaneous reconstitution of mast-cell-deficient mice, it was found, that the presence of mast cells augmented the lesion size caused by *L. major*. However, there was no influence of mast cells on the cytokine response in the draining lymph nodes or the ultimate outcome of the infection.

Studies with *L. major*-infected mice pointed at NK cells as an important source of IFN- $\gamma$  during the early course of infection. Genetically resistant mice had a higher NK-activity after infection than susceptible mice and the depletion of NK cells resulted in less IFN- $\gamma$  production and a transient increase in lesion size. On the contrary, activation of NK cells in susceptible mice by injection of poly I-C enhanced IFN- $\gamma$  synthesis and led to lower parasite burdens. However, the effects of NK cells appeared to be transient and did not influence the ultimate outcome of experimental *L. major* infections. C57BL/6 mice deficient in NK cell activity due to the beige mutation were less able to control *L. donovani* infection compared to normal control mice and reconstitution with NK cells restored this defect. While in lesions of patients with cutaneous leishmaniasis high numbers of NK cells have been detected, impaired NK activity has been found in the blood of patients with visceral leishmaniasis, which could be restored *in vitro* by incubation with IL-2.

### B Cells and Antibodies

*In vivo*, B cells respond to Leishmania infections by production of parasite-specific antibodies, which are generally considered not protective against the

intracellular Leishmania. The levels of Leishmania-specific antibodies may be very high and in most severe infections an unspecific polyclonal B cell activation leading to hypergammaglobulinemia occurs additionally.

Although B cells cannot be infected by Leishmania parasites, activated B cells are able to process and present leishmanial antigens to T cells. It has been proposed, that  $\rightarrow$ antigen presentation by B cells is involved in the generation of a Th-2 response. In fact, BALB/c mice treated neonatally with anti-IgM were resistant to *L. major*, and BALB/c X-linked immunodeficient (Xid) mice, which lacked the B1 subset of B cells, displayed enhanced resistance to *L. major*. In line with these findings, the cotransfer of B cells converted resistance into susceptibility in T cell-reconstituted, *L. major*-resistant scid mice. However, more recent experiments with mice harboring a targeted disruption of the IgM locus ( $\mu$ MT mice) and therefore lacking B cells showed no influence of B cells on the polarization of T helper cells:  $\mu$ MT mice on the BALB/c background were susceptible to *L. major* infection and developed a Th2 response.

### T Cells and Cytokines

A significant increase of  $\gamma/\delta$  T cells was found in skin lesions of patients with cutaneous leishmaniasis. Similarly, expansion of  $\gamma/\delta$  T cells has been observed in genetically resistant mice following *L. major* infection, indicating that  $\gamma/\delta$  T cells may be involved in host defense against this parasite. However, C57BL/6 knockout mice lacking  $\gamma/\delta$  T cells (TCR  $\delta$ -/-) effectively controlled the infection and produced similar levels of IFN- $\gamma$  when compared with control mice, strongly arguing against an essential protective role of this T cell subset in *Leishmania* infection. In contrast, mice depleted of or genetically deficient for conventional  $\alpha/\beta$  T cells were unable to control leishmania parasites. While ample evidence has demonstrated the central role of CD4<sup>+</sup> Th cells in the control of a *L. major* infection, the role of CD8<sup>+</sup> T cells in cutaneous leishmaniasis is less well defined. Although CD8<sup>+</sup> T cells appear to be important for resistance to a secondary challenge with *L. major*, there appears to be no essential function of CD8<sup>+</sup> T cells in primary infection. Both, mice genetically deficient for  $\beta$ 2-microglobulin and CD8 thus lacking CD8<sup>+</sup> T cells were able to mount an effective and long-lasting immune response against *L. major*.

Unlike the *L. major* model, resolution of primary *L. donovani* infection requires not only CD4<sup>+</sup> T cells but also CD8<sup>+</sup> T cells. Acquisition of resistance involves the secretion of IL-2, IFN- $\gamma$  and TNF. Similar to cutaneous leishmaniasis, resistance of *L. donovani*-immune mice to rechallenge was strongly dependent on CD8<sup>+</sup> T cells.

Mice from the majority of inbred strains (C3H/He, B10.D2, C57BL/6, Sv129/Ev, etc.) are resistant to infection with *L. major*, while only mice of a few strains such as BALB/c, develop progressive lesions and succumb to the infection. Healing of lesions induced by *L. major* requires the induction and expansion of specific CD4<sup>+</sup> Th1 cells that are restricted by MHC class II and produce IFN- $\gamma$ , while susceptibility was found to be associated with the development of a predominant Th2 cell immune response. However it has been shown that susceptibility is not an absolute trait but one conditional on parasite dose, since infection with low numbers of parasites (about 1000-fold lower than the number employed ( $10^5$ ) to define the susceptible phenotype of BALB/c mice) induced long-term protective Th1 immunity in BALB/c mice. Thus in addition to host factors the parasite dose determines the Th1/Th2 nature of the response to *L. major*, and this was found to occur independently of the infection route and parasite strain. A large number of studies has focused on the immunoregulatory mechanisms determining the Th1/Th2 decision and the role of these different Th cells in *L. major*-infected mice.

The role of IFN- $\gamma$  in the control of infection with *L. major* was firmly established by experiments showing that genetically resistant mice with disrupted genes for IFN- $\gamma$  or its receptor failed to resolve their lesions. More recently, the additional importance of the Fas-Fas-L pathway in the elimination of parasites has been demonstrated. In contrast to wild-type C57BL/6 mice *gld* or *lpr* mice lacking either a functional Fas or Fas-L were unable to resolve *L. major*-induced lesions although they mounted a normal Th1 response and their macrophages produced normal levels of NO in response to IFN- $\gamma$  *in vitro*. Since IFN- $\gamma$  upregulated the expression of Fas on *L. major*-infected macrophages, thereby rendering these cells susceptible to apoptotic death by Th1 cells, IFN- $\gamma$  might contribute by at least two mechanisms to the defense against intracellular Leishmania.

Th1 and Th2 cells develop from a common native precursor. Both accessory molecules and cytokines are known to influence the differentiation of CD4<sup>+</sup> T cell precursors *in vivo*. CD80 (B7-1) and CD86 (B7-2) as well as the CD40 molecule and its ligand have been shown to influence the Th cell differentiation and thus the clinical outcome after infection with *L. major*. Deficiency in either CD40 or its ligand resulted in the inability of mice to generate a Th1 response and to control *L. major* or *L. amazonensis* infections. While the blockade of CD86 by mAb treatment ameliorated the infection and inhibited Th2 development in BALB/c mice, BALB/c mice deficient for CD28, a ligand of CD80 and CD86, remained susceptible to infection. In contrast, the interaction of the CD4 molecule with MHC class II appeared to be of importance for the development of a

Th2 cell immune response. There is ample evidence that IL-4 is essential for the development of Th2 cells after infection with *L. major*. The neutralization of IL-4 by mAb or recombinant soluble forms of the IL-4 receptor resulted in Th1 development in BALB/c mice which thereby controlled primary *L. major* infection and became resistant against secondary challenge infections. Confirmatory evidence came from experiments with mice deficient for either IL-4 or STAT-6 (one of the major IL-4 signal-transducing molecules) which were more resistant against *L. major* or *L. mexicana*, respectively, when compared with their control littermates. Only in susceptible BALB/c mice there was a very early IL-4 production by activated CD4<sup>+</sup> T cells during the first day after infection with *L. major*. A highly restricted subpopulation of CD4<sup>+</sup> T cells expressing the TCR V $\beta$ 4 and V $\alpha$ 8 chains specific for a single immunodominant antigen called LACK (Leishmania-activated C kinase) was identified as source for the early IL-4. Interestingly, mice deficient in V $\beta$ -4 mounted a polarized Th1 response and were fully resistant to infection, suggesting that a single epitope of the LACK antigen drives the early IL-4 response and instructs subsequent Th2 differentiation and susceptibility to infection in BALB/c mice. In agreement with this concept, transgenic BALB/c mice expressing the LACK antigen in the thymus were tolerant to this antigen and resistant to infection with *L. major*. However, since LACK appears not to be the dominant antigen in MHC haplotypes other than H-2<sup>d</sup> (N. Glaichenhaus, personal communication) it remains to be determined, which antigen(s) or mechanism(s) are responsible for the susceptible phenotype of BALB congenic mice.

The essential role of IL-12 for the development of a protective Th1 cell response against *L. major* has been demonstrated by several experimental approaches. Neutralization with antibodies or disruption of the IL-12 gene in resistant mice resulted in susceptibility, while treatment of BALB/c mice with recombinant IL-12 during the first week of infection enabled these mice to develop a Th1 response and allowed the resolution of lesions. In line with this, mice deficient for the transcription factor IRF-1 (Interferon regulatory factor 1) were susceptible to *L. major*, most likely due to the impaired ability of their macrophages to produce IL-12. While in resistant C3H mice an enhanced expression of the IL-12 receptor subunits  $\beta$ 1 and  $\beta$ 2 was detected after *L. major* infection this was not the case in lymph nodes of BALB/c mice unless these mice were rendered resistant by neutralization of IL-4 or treatment with IL-12. Thus, the upregulation and maintenance of IL-12 receptor molecules or its counterregulation by IL-4 on CD4<sup>+</sup> T cells may be critically involved in the generation of a protective Th1 cell response. The nonhealing lesions caused *L. major* in mice were associated with enhanced IL-10 production and T<sub>reg</sub>

presence at the site of infection. Enhancement in the number of natural  $T_{reg}$  in mice chronically infected with *L. major* was sufficient to trigger disease reactivation and to inhibit the effector memory response. Thus, enhancement of  $T_{reg}$  regulatory function, either from the endogenous pool or induced by the infection, can clearly become detrimental to the host by allowing excessive parasite expansion. On the other hand in the nonhealing model of *L. major* infection, pathology is also held in check by natural  $T_{reg}$ . *Leishmania amazonensis* infection in mice is characterized by the accumulation of natural  $T_{reg}$  at sites of infection that transiently downregulate immunopathology.

Several other cytokines are additionally involved in the regulation of immunity against *Leishmania*. It has been shown that leishmanial infection induced the production of active TGF- $\beta$ , both *in vitro* and *in vivo*. Since application of recombinant TGF- $\beta$  markedly exacerbated the disease while treatment with anti TGF- $\beta$  resulted in protection of BALB/c mice after infection with *L. amazonensis*, induction of TGF- $\beta$  has been regarded as a parasite escape mechanism. TNF, which had no direct toxic effects on leishmania, was found to activate in combination with other cytokines such as IFN- $\gamma$  the leishmanicidal activity of macrophages *in vitro*. *In vivo*, there were no differences in the expression levels of TNF, lymphotoxin (LT) or the TNF receptors I and II (p55 and p75) when susceptible BALB/c and resistant CBA mice were compared. Using knockout mice deficient for either TNFRp55, TNFRp75 or both receptors it was reported that the TNFRp75 plays no essential role in *L. major* infection while the TNFRp55 might be required for optimal macrophage activation. TNFRp55 deficient mice developed larger lesions than control mice and failed to resolve these lesions. However, they were able to eliminate parasites within these lesions. Migration inhibitory factor (MIF), granulocyte-macrophage colony stimulating factor (GM-CSF) and IL-7 were found to enhance leishmania killing by macrophages *in vitro*. While MIF delivered via a *Salmonella*-based expression system *in vivo* enhanced resistance of mice, application of GM-CSF or IL-7 surprisingly caused aggravation of lesions in *L. major*-infected mice. Cytokines such as IL-10, TGF- $\beta$  (see also above) and IL-13 have been found to deactivate macrophages and to enhance intracellular survival of leishmania. With the exception of TGF- $\beta$ , the role of these proteins during an immune response against leishmania *in vivo* remains to be determined.

The expression of chemokines has been analyzed in lesions of patients with localized cutaneous leishmaniasis and diffuse cutaneous leishmaniasis. While high levels of macrophage chemoattractant protein 1 (MCP-1) and moderate levels of macrophage inflammatory protein 1  $\alpha$  (MIP-1a) were detected in the localized forms of leishmaniasis, the pattern was reversed in

diffuse cutaneous leishmaniasis, suggesting a functional role of these chemokines in the differential recruitment and activation of macrophages in the different forms of cutaneous leishmaniasis.

It is important to emphasize that susceptibility or resistance to *L. major* most likely involves several mechanisms since it appears to be controlled by several genes. Six loci located on the mouse  $\rightarrow$ chromosomes 6, 7, 10, 11, 15, and 16 were found to be associated with resistance to *L. major* in BALB/c  $\times$  B10.D2 backcross mice. Another study analyzing (BALB/c  $\times$  C57BL/6) F2 mice showed a linkage to the h2 region on chromosome 17 and to chromosome 9.

Although *L. donovani* and *L. chagasi* also readily parasitize and cause noncuring visceral infection in inbred mice, these leishmania species do not regularly provoke an active, functional Th2 response in experimental infection as they seem to induce in human disease. The one reported exception was in mutant C57BL/6 ep/ep (pale ear) mice in which noncuring *L. donovani* infection was related to multiple host defense defects including an active Th2 response. In most other cases noncuring *L. donovani* infection has been ascribed to the failure to properly express a Th1-associated cytokine response rather than to dominant activity of Th2 cells.

In mice the susceptibility to infection with intracellular parasites such as *Salmonella*, *Mycobacteria*, and *L. donovani* is controlled by the Nramp1 locus (also known as *Bcg*, *Ity*, or *Lsh*) on chromosome 1. The integral membrane protein Nramp1 is expressed exclusively on professional phagocytes in the late endocytic compartments. Since a single nonconservative amino acid exchange at position 169 of this protein resulted in enhanced susceptibility of mice to *L. donovani*, the Nramp1 protein may alter the intravacuolar environment of the parasite-containing phagosome.

### Evasion Mechanisms of *Leishmania*

The complement resistance of metacyclic leishmania promastigotes was explained by the spontaneous shedding of the lytic membrane attack complex from the parasite surface, which might be causally linked to the elongation of the phosphoglycan chain of the surface  $\rightarrow$ lipophosphoglycan (LPG). In addition, leishmanial protein kinases have been reported to phosphorylate components of the complement system, thereby inhibiting the classical and alternative complement pathway. The 63 kDa surface metalloprotease (gp63) accelerated the conversion of C3b to a C3bi-like molecule, which acts as an opsonin and facilitates the uptake of leishmania into macrophages. *Leishmania* parasites are able to invade not only macrophages but also host cells devoid of important defense mechanisms such as iNOS. Langerhans cells of the skin as well as cells negative for all classical macrophage and



dendritic cell markers, presumably reticular fibroblasts, might function as safe habitats for the parasite enabling its long-term persistence. *Leishmania* parasites are able to survive in the phagosome and phagolysosome. LPG is able to inhibit phagosome–endosome fusion and scavenge hydroxyl radicals and superoxide anions which are rapidly produced during phagocytosis. In addition, the protease activity of gp63 has been shown to protect the parasites from intraphagolysosomal degradation and is required for virulence of leishmania. *Leishmania* parasites are able to interfere with both main antimicrobial effector mechanisms, the release of superoxide, and the synthesis of NO. LPG, gp63 and GIPLs, a group of glycolipids related to LPG have been shown to mediate these suppressive effects, at least in part by inhibiting the translocation and activation of the protein kinase C (PKC) of the host cell.

A further, important mechanism by which leishmania influence the host immune response is the modulation of cytokine production. As discussed above, different leishmania species induce the production of TGF- $\beta$  which has been found to inhibit antileishmanial defense mechanisms of macrophages and to aggravate the disease *in vivo*. The selective suppression of IL-12 p40 synthesis by macrophages mediated by phosphoglycans of the parasite occurring on the transcriptional level appears to be an important mechanism by which leishmania avoid or delay the development of a host-protective Th1 response. Interestingly, this effect appears to be cell type-specific, since uptake of *L. major* amastigotes by skin-derived dendritic cells results in activation of these cells and IL-12 release.

The processing and presentation of antigen is also targeted by the parasite. It has been demonstrated that *L. donovani* amastigotes interfered with upregulation of MHC class II molecules on the transcriptional level. Downmodulation of MHC class II occurs additionally on the posttranslational level, most likely by an enhanced internalization and degradation of these molecules. In contrast to other intracellular microorganisms, *L. donovani* prevents the upregulation of costimulatory molecules like CD80 on macrophages. The recently reported finding that gp63 selectively cleaves CD4 molecules from T cells is intriguing, as CD4 via binding to MHC class II, stabilizes the interaction between antigen-presenting cells and T helper cells. A phenomenon called antigen sequestration not allowing the transport of sufficient numbers of MHC-peptide complexes to the cell surface may let infected macrophages go unnoticed by T helper cells. The molecular mechanism of this phenomenon is not yet defined, and prevention of intracellular protein degradation appears only partially responsible.

In addition to the numerous [→evasion mechanisms](#) of *Leishmania* species summarized above, the saliva of the parasite-transmitting sand fly exerts various

immunomodulatory functions. Saliva components, such as the peptide maxadilan, inhibited killing of *Leishmania* by suppressing the production of NO. Furthermore, sand fly [→salivary gland](#) lysates were found to downregulate a Th1, but to upregulate a Th2 response in mice infected with *L. major*. Interestingly, the salivary gland lysates directly upregulated expression of IL-4 mRNA also in the absence of infection with *L. major*.

## Vaccination

Although a treatment for leishmaniasis exists, it is costly and difficult to apply because it requires daily injections for weeks. Moreover, resistance against the classical antimonial treatment has been increasing and increased doses, prolonged hospitalization, and needs for second treatment can be necessary. Thus, an effective and affordable vaccine remains the only realistic hope of controlling such a parasitic disease. This has been the goal for many years of the tropical disease research program of the WHO, which plays a major role in *Leishmania* vaccine development and several formulations are currently under trial with encouraging results.

The use *L. major* mouse model of *Leishmania* infection has been helpful for the understanding of mechanisms involved in immunity to leishmania. It was first observed that genetically different mice presented a different degree of susceptibility to the *L. major* infection, with some strains such as C57BL/6 being resistant ([→spontaneous healing](#) of controlled cutaneous lesion) while others, such as Balb/c are susceptible and present progressive disease. It was further demonstrated that the difference in the susceptibility was linked to the expansion of CD4<sup>+</sup> T cells secreting different patterns of cytokines. Th1 cytokines such as IFN- $\gamma$ , in conjunction with the IL-12 and TNF- $\alpha$  secretion by macrophages/dendritic cells are essential for the induction of the inducible nitric oxide synthase (iNOS) leading to large amounts of NO which play a major role in the killing of intracellular *Leishmania*. In contrast, expansion of CD4<sup>+</sup> T cells secreting Th2 cytokines such as IL-4, IL-5, and IL-10 but no IFN- $\gamma$  in conjunction of macrophage-deactivating factors such as TGF $\beta$  and/or PGE2, is commonly associated to nonhealing infection.

Recent studies have shown that the activation/differentiation of one of the Th type inhibits the induction or expansion of the reciprocal subset, via reciprocal feedback inhibition by Type 1 or Type 2 cytokines. For instance, IFN- $\gamma$  inhibits the induction/expansion of TH2, and, IL4 and IL10 inhibit the induction TH1 cells. The mechanisms leading to the expansion of Th1 or Th2 depend on early events, IL-12 secretion in the first case and IL-4 secretion in the last case. IL-12 injection has been shown to induce protection against cutaneous leishmaniasis in susceptible

Balb/c mice leading to expansion of a Th1 cell response. From these experiments, the use of IL-12 has been proposed as an adjuvant eliciting a Type 1 response for the delivery of a *Leishmania*-vaccine in particular, but also in general for vaccine against other pathogens.

If these new concepts emerging from the mouse model have allowed important progress in the comprehension of the induction of anti-*Leishmania major* immune response in humans, there is still much to do in understanding the reasons why *L. major* induces generally cutaneous lesions whereas *L. donovani* leads to visceral leishmaniasis and *L. braziliensis* to mucocutaneous disease. Therefore vaccine development against leishmaniasis has proceeded, so far, entirely within empirical approach. The observation that *L. major* induce usually benign infections with spontaneous healing after 6 to 9 months protecting from pathogenic reinfections was the starting point of vaccine strategies known as [→leishmanization](#). It consists in injecting viable parasites to produce a controlled lesion in a nonvisible area of the skin. This induces a significant protection against reinfection. This immunity is essentially T-cell-mediated. Leishmanization was used for a long time and was until recently used in the former USSR, in Israel, and in Iran. However, the use of live organisms can induce persistence of parasites in the immune host able to cause serious diffuse or mucocutaneous lesions in cases of change of the immune status. This program has now been abandoned. With the development of *Leishmania* transfection techniques, the production of an avirulent strain lacking the dihydrofolate reductase/thymidilate synthetase gene infecting and persisting in the macrophage is an interesting alternative for attenuated vaccine. This vaccine does not induce side effects but, so far, very little is known about the long-term consequences of such vaccine in particular in HIV-infected individuals. Killed parasites have thus renewed interest. Several trials using whole killed parasites with BCG as adjuvant are under evaluation in South America (*L. braziliensis*, *L. guyanensis* and *L. amazonensis*) and in Iran (*L. tropica* and *L. major*) and are encouraging even if they are inferior to live vaccine.

Recently significant progress have been obtained using [→subunit vaccines](#). Molecules such as gp63, gp46, PSA-2, and LACK have given interesting results in mouse models using adjuvant not appropriate to humans. Other delivery systems using recombinant bacteria such as *Salmonella typhimurium* or BCG or recombinant vaccinia virus are under study. Beside proteins, the lipophosphoglycan (LPG) seems to be an interesting candidate. It can protect mice from infection with *L. major*. Despite the prevailing dogma that only peptide can induce T cell responses, LPG is presented by Langerhans cells to the T cells, not in the context of

classical MHC molecules but by the newly CD1 pathway. Because of possible genetic restriction as well as their partial protective effect, such vaccine candidates have to be mixed in a cocktail vaccine and tested as one vaccine. Subunit vaccine also has the disadvantage of inducing a usually short-lived immune response. One possible solution is to use the vaccine candidates not as proteins or peptides but as their encoding DNA. Indeed DNA vaccine is particularly attractive because it can induce a long-lived immune response. The antigen is constantly produced at low doses inducing an immune response similar to the situation of natural infection. gp63, PSA-2 and LACK delivered as plasmid DNA have already demonstrated efficient protection in mice.

The first generation of *Leishmania* vaccine against CL have already shown a relative efficacy (killed parasites), that needs to be improved by use of appropriate adjuvant. However, because the preparation of such a vaccine is difficult to standardize, research on a second generation against the different forms of leishmaniasis using defined molecules is more than ever necessary.

---

## Leishmanin-Test

This test of [→leishmaniasis](#) is also called Montenegro-skin-test and often used in epidemiological studies, but less important in clinical diagnosis.

---

## Leishmanization

The observation that *Leishmania major* induce a usually benign infection with [→spontaneous healing](#) after 6–9 months protecting from pathogenic reinfections was the starting point of vaccine strategies known as leishmanization. It consists of injecting viable parasites to produce a controlled lesion in a nonvisible area of the skin. This immunity is essentially T-cell-mediated. Leishmanization was used for a long time and was until recently used in the former USSR, in Israel, and in Iran ([→Leishmaniasis, Man/Vaccination](#)).

---

## Lemniscus

String-like organ at the apical pole of [→Acanthocephala](#).

## Leopard Skin

Type of depigmentation of skin in patients with →*onchocerciasis*.

## Lepeophtheirus salmonis

### Classification

Species of →*Crustacea*, Order of →*Copepoda*.

### Life Cycle

Fig. 1.

### Disease

Salmon disease; due to wounds in the skin superinfections with bacteria or viruses occur, which – together with the sucking activity of the parasite – weaken the fish, delay growing, and even may lead to death.

### Treatment

Monthly medical bath with →*insecticides*, Argulol™ (→*Emamectine*), Sera/Alpha-Biocare.

## Lepikentron ovis

→*Lice*.

## Leptocimex boueti

→*Bugs*.

## Leptoconops

Genus of →*Ceratopogonidae*, which attack warm-blooded animals, suck blood all 3–5 days and are

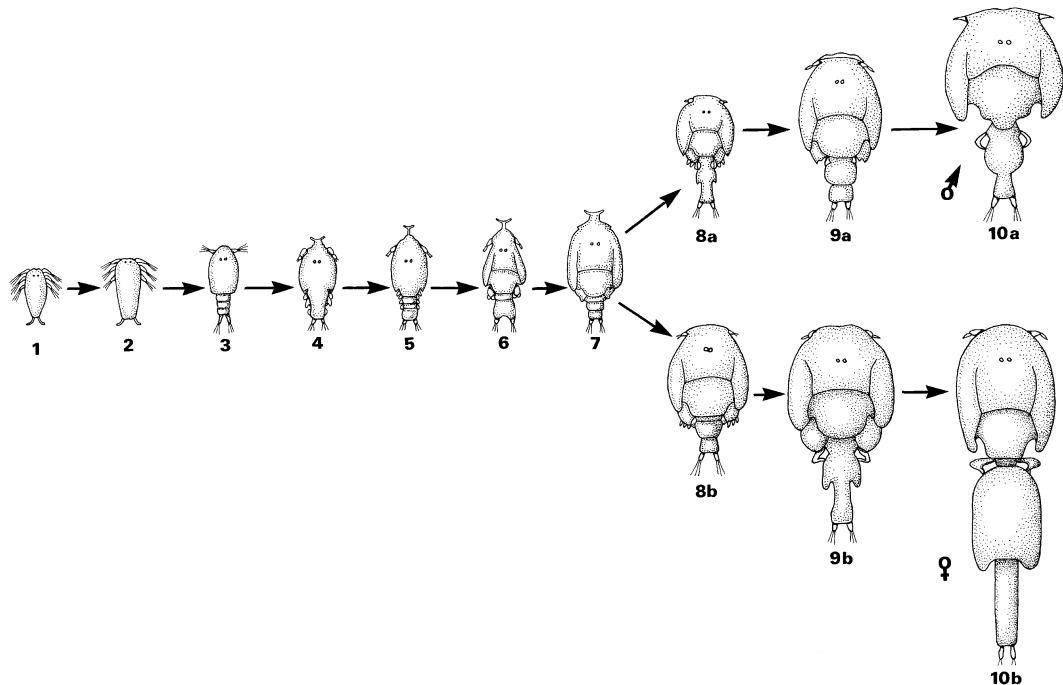

**Lepeophtheirus salmonis.** Figure 1 Life cycle of *Lepeophtheirus salmonis* (order Copepoda), the so-called louse of salmon. 1, 2 →*Nauplius* stages (0.54–0.85 mm), free-swimming. 3 →*Copepodit* stage (invasive stage, 0.7 mm). 4–7 →*Chalimus* stages I–IV (1.2–2.8 mm long), engorging stages. 8a, 9a Preadult males – motile on skin. 8b, 9b Preadult females – motile on skin. 10a, 10b Adults (male 5 mm, female 10 mm). One generation needs about 6 weeks at a water temperature of 10–12°C.

known vectors of agents of diseases (viruses, protozoans, worms).

## Leptomonas

→Trypanosomatidae.

## Leptopsylla segnis

→Fleas.

## Leptorhynchoides thecatus

→Acanthocephala.

## Leptotheca

Myxozoan species parasitizing in the urinary system of freshwater fish.

## Lernaocera branchialis

→Crustacea.

## Lethality

Number of dead individuals in relation to sick people.

## Leuckart, Friedrich Andreas Sigismund (1794–1843)

German physician and biologist, founder of the German Parasitological Society and worker on many worms (e.g., →*Diphyllobothrium*, →*Onchocerca*, →*Trichinella*).

## Leucochloridium macrostomum

Syn. *L. paradoxum*. →Digenea. The colourful sporocysts of this trematode of the →cloaca of birds enter the tentacles of their vector snail, form →cercariae and →metacercariae (Fig. 1), which pulsate, and thus attract the final host (→Behavior).



**Leucochloridium macrostomum.** Figure 1 The tentacles of this amber snail are filled each with a metacercaria of the trematode, which initiates active movements, thus attracting the final hosts (birds).

## Leucocytozoon simondi

### Synonym

*L. anseris*.

### Classification

Species of →Coccidia.

### Life Cycle

Fig. 1.

### Disease

→Leucocytozoonosis.

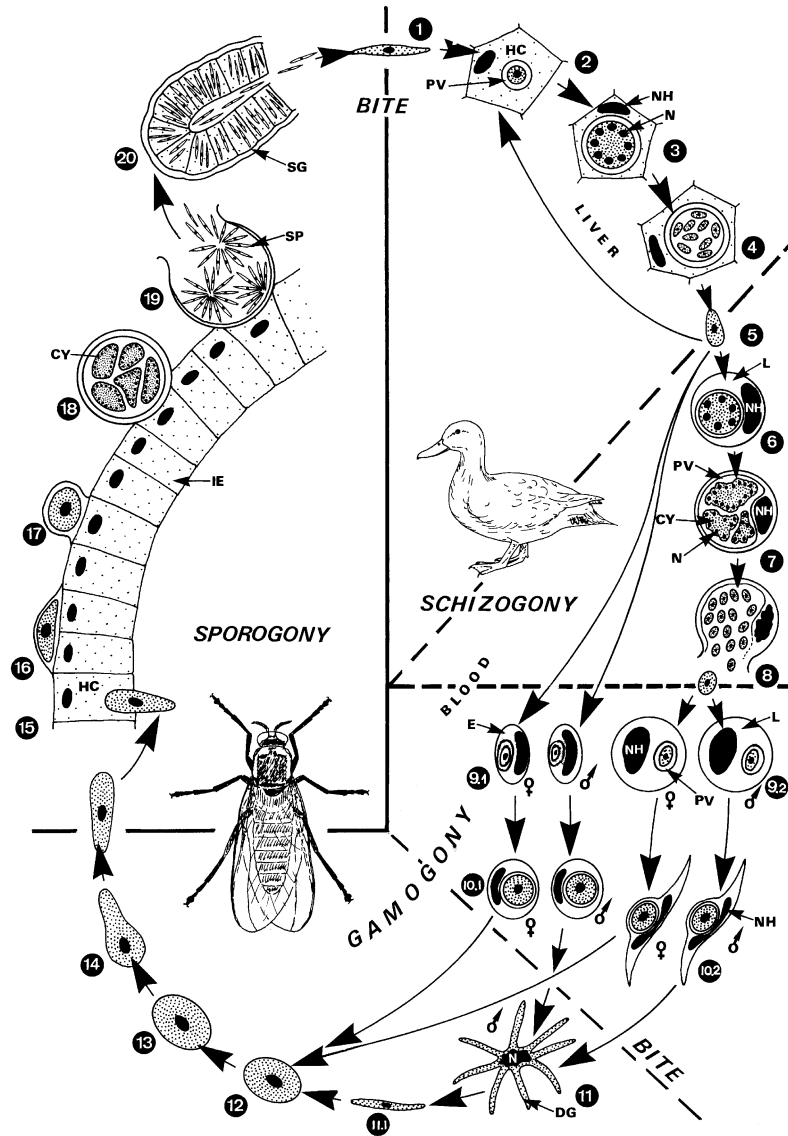

**Leucocytozoon simondi.** Figure 1 Life cycle of *Leucocytozoon simondi* in its vertebrate hosts (domestic and wild ducks and geese) and in its vector (*Simulium* spp., blackflies). 1–5 Sporozoites injected by the *Simulium* fly are carried by the bloodstream to the liver, where they enter Kupffer cells, and form the multinucleate first-generation schizonts. The latter give rise to small merozoites (5) which may re-infect other hepatic cells (2), or invade lymphoid cells (6–8) or erythrocytes (9.1). 6–8 After invasion of lymphoid cells or macrophages 4–6 days after infection, large schizonts (= megaloschizonts) of 60–150  $\mu\text{m}$  diameter are formed, which via cytomeres (7) produce numerous merozoites (8). 9–12 Having entered lymphoid cells, the majority of merozoites probably develops into gamonts (9.2), but it is thought that some may initiate further asexual reproduction. During the formation of the finally elongate or ovoid  $\rightarrow$ gamonts (20  $\times$  5  $\mu\text{m}$ ) the host cells become distorted and appear elongated-spindle-shaped (10.2). Occasionally, spherical gamonts appear (10.1) which are thought to originate from hepatic merozoites (5) that have penetrated erythrocytes instead of lymphoid cells. However, there is no evidence that these differ functionally from the elongate forms. When the vector has sucked blood, the formation of  $\rightarrow$ gametes (11, 12) is initiated inside the gut, leading, after fertilization, to an extracellular  $\rightarrow$ zygote (13). 13–17 The immobile zygote is transformed into a motile  $\rightarrow$ ookinete, which enters the intestinal wall (15), migrates through the  $\rightarrow$ cytoplasm of a gut cell, and begins its transformation into an  $\rightarrow$ oocyst, situated between basal membrane and epithelial cells of the gut (17). 18–20 Formation of multinucleate sporoblasts (18) which give rise to numerous sporozoites (19; SP). The latter are released into the body cavity and migrate to the salivary glands (20). These slender sporozoites are finally injected into the next host. CY,  $\rightarrow$ cytomere; DG, developing microgamete; E, erythrocyte; HC, host cell; IE, intestinal epithelium; L, lymphoid cell/macrophage; N, nucleus; NH, nucleus of host cell; PV,  $\rightarrow$ parasitophorous vacuole; SG,  $\rightarrow$ salivary gland; SP,  $\rightarrow$ sporozoite.

## Leucocytozoonosis

Disease due to →*Leucocytozoon simondi* in domestic and wild ducks and geese transmitted by bite of *Simulium* spp. (North America, Central Europe). *L. smithi* is found in turkeys in Europe. *L.* (syn. *Akiba*) *caulleryi* is transmitted by →*Culicoides* spp. and occurs also in red blood cells.

### Symptoms

The most important symptom is anaemia, which may lead to death. Initial symptoms are: loss of weight, uncontrolled turning of the head, problems when moving, reduction of egg production.

### Diagnosis

Microscopical analysis of Giemsa-coloured blood smears.

### Treatment

Pyrimethamine plus sulfonamides as prophylaxis; in clinical cases: Furazolidon or pyrimethamin.

## Levamisole

→[Nematocidal Drugs](#).

## Levineia

Genus of →*Coccidia*, synonymous to →*Cystoisospora*.

## LF

Short for →*Lymphatic filariasis*, disease due to infections with *Wuchereria bancrofti* or *Brugia malayi*. 120 million people are infected, 40 million with severe symptoms of disease; it is the world's leading cause of disability. →[Filariidae](#).

## Lice

### Synonym

→[Phthiraptera](#)

### Name

Greek: *phtheir* = louse, *a* = non, *pteron* = wing.

### Classification

Order of →[Insects](#).

### General Information

The order Phthiraptera is subdivided into 2 suborders, →[Anoplura](#) (bloodsucking lice) and →[Mallophaga](#) (feeding on skin, keratinous substances of feathers and hairs, and dermal secretion fluids). Both groups show the following common features:

- They have very short antennae (often in grooves).
- They are always wingless.
- Their eyes are reduced; they are eyeless or have 1 or 2 ommatidia.
- Their feeding (on keratin or blood) always requires the aid of endosymbionts in mycetomes (which are transmitted to progeny).
- Their life cycle constantly proceeds →[hemimetabolous development](#); the relatively large eggs are always attached to hairs, feathers, etc.
- All developmental stages stay on their hosts permanently; host-to-host transmission occurs by body contact.

Members of the →[Mallophaga](#) (Fig. 2) are furthermore characterized by a head which is broader than the thorax and by visible chewing mouthparts, whereas the bloodsucking mouthparts of members of the Anoplura are hidden inside their short and stumpy →[proboscis](#) (Fig. 3).

Of the about 500 known species of the suborder Anoplura, only 3 species are ectoparasites of humans: →*Pediculus humanus capitis* (head louse), living in head hair, *P. humanus corporis* (body or clothing louse), occupying the clothes and visiting the body only to feed, and →*Phthirus pubis* (→[Crab Louse](#)), developing mainly in the hairs of the genital region, but regularly also colonizing the other coarse hairs of the head and body, e.g., the eyelashes (Fig. 1). These lice are highly host-specific, obligate parasites, spending their entire life cycle on the host, and only infesting humans and monkeys. Animal lice only occasionally attack humans

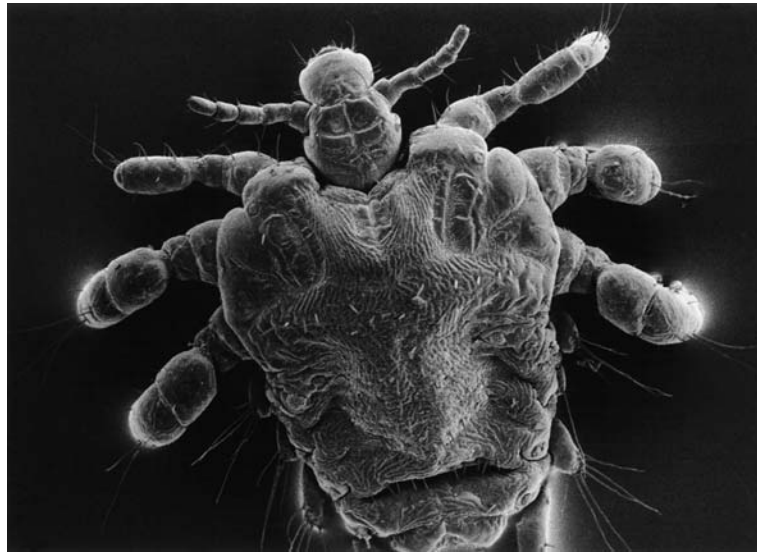

**Lice. Figure 1** SEM of *Phthirus pubis* ( $\times 30$ ).

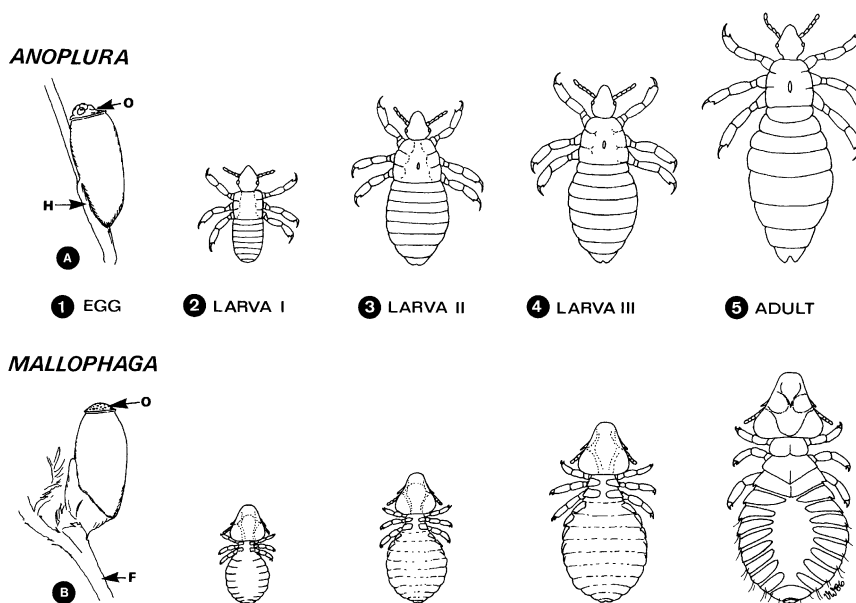

**Lice. Figure 2** Life cycles of bloodsucking Anoplura: **A**,  $\rightarrow$  *Pediculus* sp. from humans and chewing Mallophaga, **B**,  $\rightarrow$  *Stenocrotaphus* sp. from birds. 1 Eggs are glued to hairs or feathers of the host. 2–5 First-stage larvae (nymph) hatch from the egg and  $\rightarrow$  molt 3 times to become sexually mature adults (5; males, females). Development is temperature-dependent (2–4 weeks); the lifespan is about 1–3 months. All developmental stages of Anoplura suck blood, but all Mallophaga feed on fragments of feathers, hairs, and/or other epidermal products. Note the typical differences in the head–thorax breadth relationship. In both groups the eyes are often reduced or absent (animal lice). Compound eyes are never present. *F*, feather; *H*, hair; *O*,  $\rightarrow$  operculum of egg.

( $\rightarrow$  *Haematopinus suis*). Lice are even common in cold water when parasitizing, e.g., seals.  $\rightarrow$  *Antarctophthirus*. Only *P. h. corporis* transmits rickettsial or bacterial diseases.

### Life Cycle

For details of the life cycle of biting lice (Fig. 2B) see  $\rightarrow$  Mallophaga. In human lice (Fig. 2), after a temperature-dependent embryonic development of

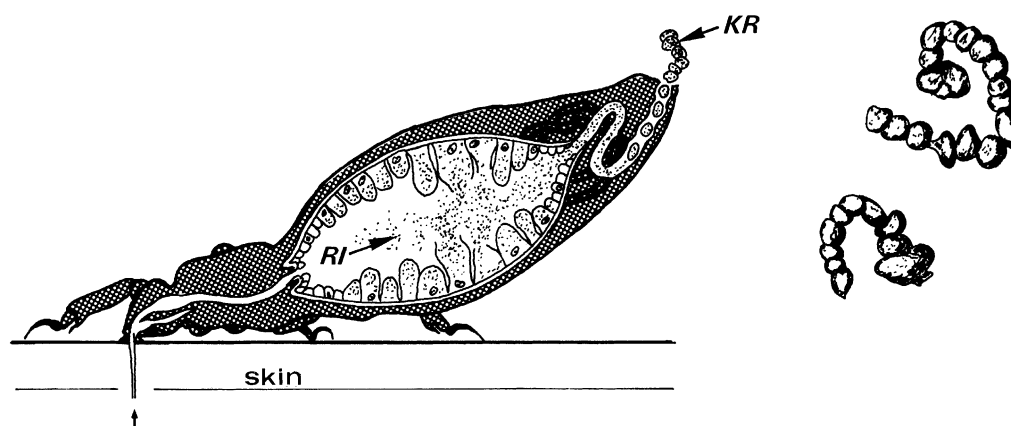

**Lice. Figure 3** Diagrammatic representation of a body louse (*Pediculus humanus corporis*), which is infected with *Rickettsia prowazekii* during blood meal and excretes the agents of the disease ( $\rightarrow$ Louseborne Spotted Fever) in its chain-like feces. KR, feces balls; RI, rickettsial stages.

about 8 days, the first  $\rightarrow$ instar nymphs (1 mm long) hatch and within 7–10 days after 2 additional  $\rightarrow$ nymphal stages, the adults. (The term larva is used by scientists in Central Europe, but the term  $\rightarrow$ nymph by other scientists.) The whole developmental cycle (egg to egg) lasts about 2–3 weeks. Bacterial and fungal  $\rightarrow$ symbionts, which are restricted to special organs ( $\rightarrow$ Mycetomes) near the gut or ovaries and transmitted transovarially to the eggs, are necessary for larval development and adult reproduction.

### Important Species

Table 1.

### Distribution

Human lice occur worldwide, clothing lice regularly in poor regions where people possess only one set of clothes. In the USA, white people are more frequently infested with head lice than Afro-Caribbean people, probably because of the better adaptation of the claws of the lice to hairs which are round or oval in cross section, respectively.

### Morphology

The relatively small, narrow head of lice has very short antennae (5 segments), and eyes are strongly reduced to 2 big ommatidia. The mouthparts are hidden inside the head. The labrum ensheathes the 4 long, thin stylets made from the 2 maxillae, the labium and the hypopharynx, the latter containing the salivary channel, whereas blood is ingested through the tube formed by the maxillae. The thoracic segments are fused, and the short legs bear strong claws, that are optimally adapted to the diameter of the hairs of the host and cling onto hairs or fibers. The  $\rightarrow$ cuticle is very tough. The

*Pediculus* spp. are slender insects of about 2–4 mm length, much longer than wide. Males and females can be distinguished by the body and claw sizes, patterns on the thorax, the shape of the abdomen, and the sclerotized penis-like genitalia of males. *P. pubis* is about twice as long as wide and about 1.5–2 mm long. The eggs (so called  $\rightarrow$ nits) are about 0.8–1 mm long and about 0.3 mm wide and glued onto hairs or cloth fibers. After eclosion of the nymphs, the eggs appear white and remain glued. Eggs of the genera *Pediculus* and *Phthirus* can be distinguished by the shape and the appearance of the pores on the  $\rightarrow$ operculum, those of *P. h. capitis* show similar pores as *P. h. corporis*, but are more intensively glued to hairs. The pores ( $\rightarrow$ Aeropyls) are needed for the oxygen supply of the embryo.

Crossbreeding of the 2 *Pediculus* spp. is possible (therefore regarded as subspecies by different authors), but both can be distinguished by their tibial lengths, habitat preference, i.e., cloth or hair, and temperature preference, 28–29°C for head lice and 31–33°C for clothing lice. The individual color is genetically determined, darker clothing lice occurring more often in association with inuits and other dark-skinned humans.

### Reproduction

Only *P. h. corporis* colonies breed in the laboratory after adaptation to feeding on rabbits. Other species are fed on volunteers.

Adults copulate shortly after emergence or at a later point in time. About 24 hours after mating,  $\rightarrow$ oviposition begins. Females of *P. h. corporis*, *P. h. capitis*, and *P. pubis* live about 5, 3, and 4 weeks and lay about 300, 90, or 30 eggs, respectively. *P. h. capitis* prefers to deposit eggs singly onto hairs in the neck and behind the ears, *P. h. corporis* in clusters on the fibers of



**Lice. Table 1** Some common species of the Phthiraptera (lice)

Species	Length (mm) of adults (females)	Host/Habitat	Transmitted pathogens
<b>Mallophaga</b>			
<i>Trichodectes caninum</i>	2	Dogs/Hairs	<i>Dipylidium caninum</i>
<i>Felicola subrostratus</i>	1.3	Cats/Hairs	<i>Dipylidium caninum</i>
<i>Werneckiella equi equi</i>	1.8	Horses/Hairs	Virus of anemia
<i>Bovicola bovis</i>	2	Cattle/Hairs	–
<i>Lepikentron ovis</i>	1.5	Sheep/Hairs	–
<i>Eomenacanthus stramineus</i>	3.2	Turkeys, chickens/Feathers	–
<i>Menopon gallinae</i>	1.8	Chickens/Feathers	–
<i>Lipeurus caponis</i>	2.3	Chickens/Feathers	–
<i>Columbicola columbae</i>	2.3	Pigeons/Feathers	–
<b>Anoplura</b>			
<i>Pediculus humanus capitis</i> <sup>a</sup>	3.4	Humans/Head	–
<i>P. h. corporis</i> <sup>b</sup>	4.5	Humans/Body, clothes	<i>Rickettsia prowazekii</i> , <i>Borrelia recurrentis</i> , <i>Rochalimaea quintana</i>
<i>Phthirus pubis</i>	1.7	Humans/Hair of genitalia, eye-lashes	
<i>Linognathus setosus</i>	2.5	Dogs, cats/Hairs	–
<i>Haematopinus suis</i>	6	Pigs/Skin, hairs	Rickettsiae: <i>Epyerythrozoon suis</i>
<i>H. asini</i>	3.5	Horses/Hairs	–
<i>H. eurysternus</i>	3	Cattle/Hairs	–
<i>Linognathus</i> sp.	2.5	Sheep, goats/Hairs	–
<i>Haemodipsus ventricosus</i>	1.5	Rabbits/Hairs	<i>Pasteurella</i> (= <i>Francisella tularensis</i> )

<sup>a</sup> Some authors name this species *P. capitis*

<sup>b</sup> Also named *P. humanus*

clothes, e.g., on the seams, and *P. pubis* lays several eggs on a single hair.

### Transmission

Lice are transmitted by interhost contact and/or by shared use of →combs, hats, clothes, etc. Usually less than 10 lice per person occur, but more than 20,000 *P. h. corporis* or several hundred *P. h. capitis* have been collected from one person.

### Feeding Behavior and Transmission of Disease

Lice are attracted to the host by warmth and odors. They are permanent ectoparasites, capillary feeders who suck blood about every 2–3 hours. The ingested blood is stored and digested by trypsin and chymotrypsin in a capacious anterior midgut, followed by digestion of peptides in the narrow posterior midgut, and formation of feces in the hindgut. The saliva causes itching and the resulting scratches secondary bacterial infections. However, louse feces usually induces the first irritations.

Only *P. h. corporis* can transmit classic epidemic typhus, →trench fever, and louseborne →relapsing fever, but experimental transmission of the pathogens is possible using *P. pubis*.

Classical epidemic typhus is caused by *Rickettsia prowazekii* and transmitted only among humans by pathogens present in the deposited feces (Fig. 3). These pathogens invade through skin lesions or are inhaled. The pathogens are infective in the feces for up to 3 months. The disease is prevalent in Europe, Africa, and South America, but incidence is declining.

Trench or 5-day fever, occurring in Europe, is caused by →*Rochalimaea quintana*, showing a mode of transmission similar to that of typhus.

Louseborne relapsing fever is caused by →*Borrelia recurrentis* and transmitted by crushing infected lice between the fingers or teeth. Thereby, bacteria present in the hemolymph or intestinal tract can invade skin lesions or the mucous epithelia. This disease occurs in Europe, Africa, South America, and Asia, but not in Australia.

## Interaction of Vector and Parasite

If the lice suck blood within the first 10 days of illness, *R. prowazekii* is transmitted and multiplies in the lumen of the gut, but also in the cells of the intestinal wall. *R. prowazekii* is pathogenic to lice due to the destruction of gut cells. In the other bacterial infections no pathogenic effects on the vectors are reported.

*B. recurrentis* invades the hemocoel of the insect about 4 days after ingestion, slowly multiplying there.

## Diagnosis

By regular macroscopic control of hairs for the white eggs, the head- and crab lice, and by use of a fine-toothed comb, the head lice can be detected. In cases of itching of the skin of head and genital regions, a careful control for nits or lice should be performed. In heavy infestations with *P. h. corporis*, skin is darkened and hardened (morbus errora), and in *P. pubis* infestations bluish spots (maculae caeruleae) develop, since these lice prefer to bite repeatedly in the same places. In the latter infestations, black spots of louse feces also occur in the underwear.

## Control

Information beginning with the parents of children in kindergarten and school can strongly reduce the infestations. However, it should be pointed out that usually more than one member of a household is infested.

All lice can be killed using →insecticides either as powder (clothing lice) or in lotions or shampoos (head- and crab lice). Malathion, carbaryl, and pyrethroids are used. Lotions left for some hours on the hair are more effective than shampoos. During the last years head lice have occurred more often, especially on young children, mainly due to the attitude of some parents who do not wish to use insecticide lotions or shampoos. All stages of clothing lice are killed within less than 30 minutes at 50°C, and within 1 minute at 90–100°C; using a tumble drier for 15 minutes and >60°C is also sufficient. Exposition to –20°C has not been investigated, but 24 hours should be sufficient for killing. Since lice show a relatively weak starvation capacity, *P. h. capitis* and *P. h. corporis* will die after 3 and 4 days at 23°C, respectively; for the latter a storage of clothes for 17 days in a polythene bag is recommended. No vaccination is available (→Insecticides, →Arthropodocidal Drugs). However, appropriate Neem extracts (WASH AWAY) clean the hair from lice.

## Resistance

In several countries lice are resistant to DDT, carbaryl, lindane, malathion, and in recent years to permethrin or similar pyrethroids.

## Lichenification

Clinical and pathological symptom (dry scrub, small papule exanthem) of infections with skin parasites (→Skin Diseases, Animals, →Lice).

## Ligula intestinalis

Tapeworm related to the family Diphyllbothriida (→Pseudophyllidea) living in the intestine of fish-eating birds and reaching a length of up to 28 cm. Its →plerocercoid is found in cyprinid fish, measures 2–60 cm in length, and often represents 25% of the fish's body weight (Fig. 1). →Eucestoda.



**Ligula intestinalis. Figure 1** LM of a larva (Ligula) of a bird tapeworm taken from the muscles of a carp.

## Limax

### Name

Latin: *limax* = slimy.

Genus of free-living → [amoebae](#) in not too cold, often polluted waters. The specimens possess a nucleus with a large karyosom and a pulsating vacuole. Some species may become facultative parasites (→ [Naegleria](#) spp.).

---

## Limnatis nilotica

Leech species of the family Gnathobdellidae, reaching as adults a length of 8–12 cm. This “large horse leech” parasitizes as adult stage on mammals (inclusive humans), but on insects and frogs as juvenile forms. *Limnatis nilotica* occurs in North Africa and Near East. If present in large numbers in nostrils, pharynx, or oesophagus, they may cause asphyxia and anaemia. The related species *L. africana* is found in Senegal, Congo, India, and Singapore.

---

## Lindane ( $\gamma$ -HCH, Gamma Benzene Hexachloride)

### Chemical Class

Organohalogenide.

### Mode of Action

GABA-gated chloride channel antagonist. → [Ectoparasiticides – Antagonists and Modulators of Chloride Channels](#), → [Ectoparasitocidal Drugs](#).

---

## Linguatula serrata

### Name

Latin: *lingua* = tongue, *serratus* = sawlike.

### Classification

Species of → [Pentastomida](#).

### Morphology

Females grow up to 13 cm, while males reach only 2 cm. Both live inside the nasal system of meat-eating mammals (including dogs, man). They keep attached at the wall of the respiratory system by means of their mouth hooks ([Fig. 2](#), page 722). Females excrete

thousands (up to 5,000,000) eggs per day. These stages are infectious for plant feeders (including humans), where the larva take them into different organs away from the intestine. If these larvae are eaten by the final hosts, the larvae invade the nasal system and reach maturity within 6–7 months and live for about 15 months (patency period).

### Disease

Halzoun Syndrome or Marrara syndrome are the human diseases described as infection of man, who can be final host (with worms in the nose) and intermediate host (with encapsulated larvae in inner organs). The symptoms are nasal infections, blocking of breathing, edema, but also deafness in case of infections with adult worms. In cases of encapsulated larvae these symptoms depend on the infected organ.

### Life Cycle

[Fig. 1](#) (page 721).

### Disease

→ [Respiratory System Diseases, Horses, Swine, Carnivores](#), → [Halzoun Syndrome](#).

---

## Linguatulidae

### Name

Latin: *lingula* = small tongue.

Family of the animal phylum → [pentastomida](#), which comprises important parasites of dogs and even humans.

---

## Linné, Carl von (1707–1778)

Swedish physician and botanist, introduced the binary nomenclature of species in his books (*Systema Naturae*: 1735–1764).

---

## Linognathus setosus

→ [Lice](#).

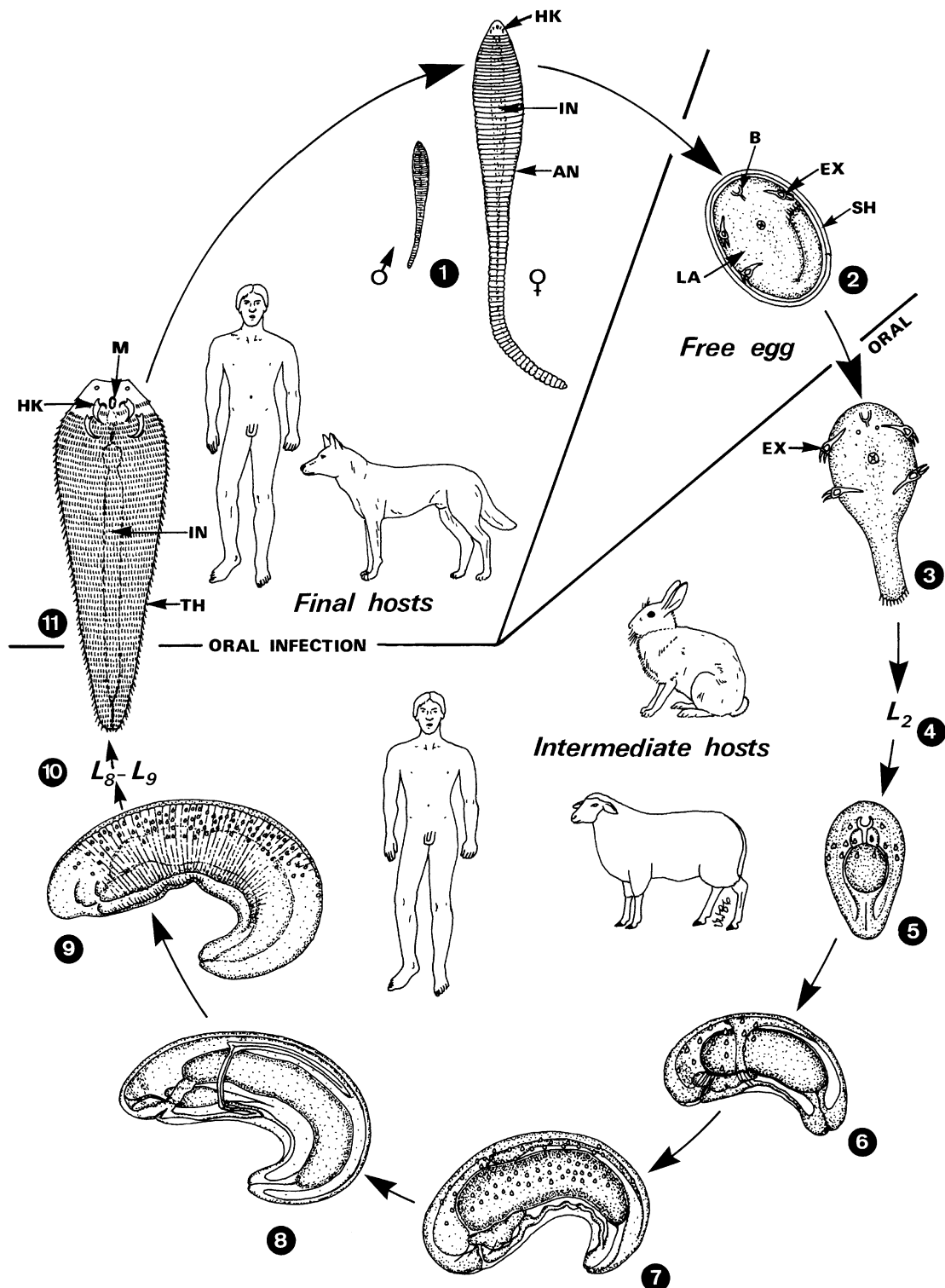

**Linguatula serrata.** Figure 1 Life cycle of *Linguatula serrata*. 1 Adults live in the nose of dogs (and rarely of man). 2 Embryonated eggs are set free via nasal mucus and/or feces. The thin outer →eggshell is left out in drawings, since it disappears soon. 3 If intermediate hosts swallow eggs, the four-legged primary larva hatches and migrates via blood vessels to the inner organs. Humans may also become accidental intermediate hosts. 4–11 Larval stages 2–11 are included in a capsule of host origin and grow after molts. When final hosts ingest raw (or uncooked) meat of intermediate hosts, the adult stages develop inside the nasal tract. Infected humans suffer from the →Halzoun syndrome. AN, annuli; B, →bore organ; EX, extremity with a claw; MK, mouth hooks; IN, intestine; LA, primary larva; M, mouth; SH, inner eggshell; TH, thorns.



**Linguatula serrata. Figure 2** Anterior end of an adult of *Linguatula serricata*.

## Linognathus vituli

This louse of cattle reaches a length of about 3 mm (Fig. 1), has, however, no eyes.

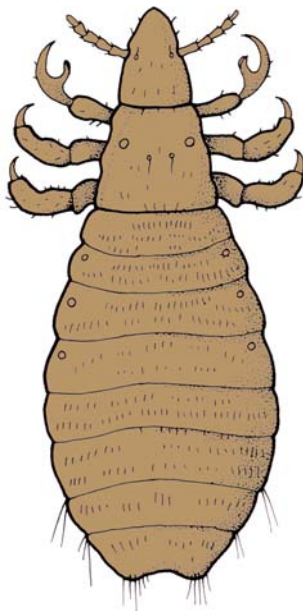

**Linognathus vituli. Figure 1** DR of a female from the dorsal.

## Lipeurus caponis

Species of so-called feather lice or wing lice of chicken birds (Fig. 1). These dorsoventrally flattened → Mallophaga reach a length of 2.3 mm, while their eggs measure about 0.7 mm.

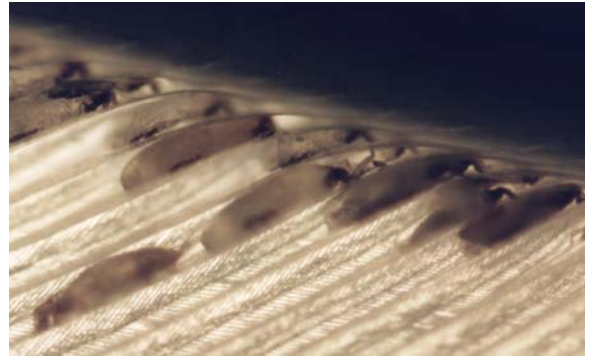

**Lipeurus caponis. Figure 1** Feather lice (*Lipeurus* sp.) in a chicken feather.

## Lipid Synthesis

→ Amino Acids.

## Lipids

All major classes of lipids found in free-living organisms are also essential biochemical constituents of parasitic protozoa and helminths. Lipid metabolism in parasites has several unique features and the content, distribution, and requirement of lipids and the synthetic capabilities for these substances show considerable variation between different parasite species. In addition, profound modifications in the lipid composition may occur during differentiation and maturation of a parasite and even in a specific stage, and rearrangements in lipid composition may be central to avoid host defence mechanisms. In addition to their common functions, lipids in endoparasites may be associated with adaptive mechanisms to parasitism. For example, in schistosomes the outer bilayer of the tegumental membrane complex contains lipids which have been suggested to play a major role, through inducible

modifications, in modulating the host's effector mechanisms of immunity and in parasite survival. Since lipid metabolism in endoparasites is characterized by substantial limitations of both synthetic and catabolic capabilities, these organisms seem to selectively absorb lipids from the host's diet with subsequent incorporation of these substances into their species- and stage-specific lipid pattern.

In most organisms the oxidation of fatty acids is an important source of ATP. This is, however, not the case in most parasites. In the majority of protozoa and in adult helminths, utilization of lipids as an energy source is either very limited or not feasible at all (Fig. 1). The reason for the absence of a functionally active  $\beta$ -oxidation in those parasites where all the enzymes involved in this process are present, is unclear. A possible explanation for this deficiency could be that sufficiently effective terminal oxidative processes are lacking in most parasite cells and tissues, in particular the tricarboxylic acid cycle and a cytochrome oxidase-linked respiratory chain, for oxidation of reduced coenzymes accumulating in large amounts during fatty acid degradation. Thus, the role of the  $\beta$ -oxidation enzymes of protozoa and helminths remains unclear, but their action may be associated with biosynthetic

processes, such as fatty acid elongation or the formation of volatile fatty acids from carbohydrates. However, some protozoa seem to possess the ability to catabolize lipids to carbon dioxide and water, but even if it occurs, this process is not a significant source of energy. Amongst the helminths, such marked oxidative capacities appear to be restricted to some larval parasitic and most free-living stages.

In accordance with their opportunistic way of living, parasites usually have very limited biosynthetic capacities. Whenever possible they obtain substrates for the synthesis of their structural elements from the host. Most parasites indeed acquire the vast majority of their lipids from the host. Protozoan parasites and helminths are generally unable to synthesize fatty acids *de novo*. However, in common with other organisms, many parasites have the ability to desaturate or to lengthen the chains of fatty acids absorbed from their habitat by the sequential addition of acetyl CoA as two-carbon unit (Fig. 1). Trypanosomatids and apicomplexan parasites can synthesize fatty acids *de novo* using the type II fatty acid synthase (FAS II) machinery found in prokaryotes and plants. This system is composed of multiple proteins rather than being a multifunctional enzyme complex as in higher animals, is membrane-associated rather than

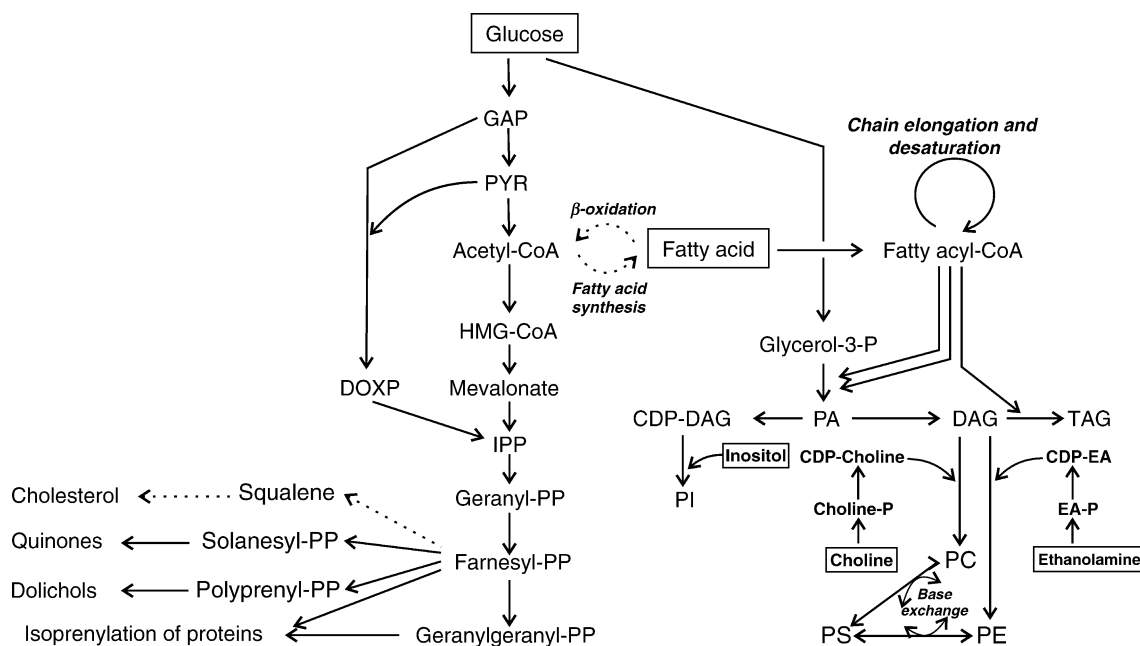

**Lipids. Figure 1** Generalized representation of the central pathways for *de novo* biosynthesis of lipids by parasites. Boxed substrates are obtained from the host. Pathways present in the mammalian host, but absent in most parasites, are represented by dotted arrows. For instance, few of the parasites studied appear capable of *de novo* biosynthesis of fatty acids. Abbreviations: DAG, diacylglycerol; CDP-DAG, cytidine diphosphodiacylglycerol; DOXP, 1-deoxy-D-xylulose-5-phosphate; Farnesyl PP, farnesylpyrophosphate; GAP, glyceraldehyde-3-phosphate; Geranyl PP, geranylpyrophosphate; Geranylgeranyl PP, geranylgeranylpyrophosphate; HMG-CoA, hydroxymethylglutaryl-CoA; IPP, isopentenylpyrophosphate; TAG, triacylglycerol; PA, phosphatidic acid; PC, phosphatidylcholine; PE, phosphatidylethanolamine; PI, phosphatidylinositol; PYR, pyruvate.

cytosolic and is sensitive to the naturally occurring antibiotic thiolactomycin. Surprisingly, *T. brucei* uses mainly, instead of the FAS II system, 3 microsomal elongases in a consecutive way for the stepwise synthesis of fatty acids, for instance in the bloodstream stage for the synthesis of myristate, which is required for the synthesis of GPI anchors in larger amounts than the host can provide.

In trypanosomes, acetyl CoA used in fatty acid elongation is preferentially derived from threonine via a pathway involving threonine dehydrogenase and glycine acetyltransferase. Trypanosomatids are also able to desaturate exogenously supplied fatty acids. Most deficient in lipid metabolism are the anaerobic protozoans, including *Giardia*, amoebae and trichomonads, which cannot synthesize fatty acids, cholesterol, and other sterols from acetate or mevalonic acid. They are also unable to employ fatty acids as energy source, nor are they able to elongate, shorten or desaturate fatty acids. However, they possess the capacity to remodel the fatty acid composition of their phospholipids.

Fatty acids, which are absorbed by parasites from exogenous sources, are rapidly incorporated into their triacylglycerols and phospholipids (Fig. 1), and the pathways responsible for these processes appear to be similar to those found in other animals. Most parasites appear able to manufacture phosphoglycerides and sphingolipids via *de novo* synthetic pathways, provided they have access to suitable precursors, such as fatty acids and sugars. Activation of fatty acids to acyl CoA thioesters is catalyzed by acyl CoA synthetase, which is widely found in parasites. The routes involved in the subsequent steps of synthesis and interconversion of complex lipids are, like the initial step, also similar to those present in higher animals (Fig. 1).

Although sterols, such as cholesterol, are not synthesized *de novo* by parasitic helminths, they do possess a mevalonate pathway (Fig. 1). In most helminths as well as parasitic protozoa, this mevalonate pathway is active and is used for the biosynthesis of dolichols for protein glycosylations, of quinones as electron transporters in the respiratory chain, and of farnesyl and geranylgeranyl pyrophosphates as substrates for the isoprenylation of proteins. Cestodes and trematodes also excrete isoprenoids that act as hormones in the development of insects, notably ecdysteroids. In contrast to helminths, trypanosomatids can synthesize sterols *de novo*. However, they do not synthesize cholesterol, but instead synthesize ergosterol-related sterols, by a biosynthetic pathway similar to that operating in pathogenic fungi, a finding that explains the sensitivity of these protozoans to particular antimycotic drugs, such as ketoconazole. The bloodstream stages of African trypanosomes cannot synthesize sterols and have to acquire host cholesterol to meet

their sterol requirements. A unique feature of apicomplexan parasites is the utilization of a mevalonate-independent route for the biosynthesis of isoprenoid precursors found in many prokaryotes and in the plastids of plants (Fig. 1). In *Plasmodium* and related parasites, this 1-deoxy-D-xylulose-5-phosphate (DOXP) pathway is located within the apicoplast, and because it is not present in the host it provides several attractive targets for chemotherapy.

Several unique lipid structures and pathways have been identified in parasites. A peculiar class of triacylglycerols, which contain esterified volatile fatty acids (2-methylbutyrate, 2-methylvalerate, *n*-valerate), occurs in *Ascaris suum* and a few related nematodes, where they are especially abundant in the eggs. The fatty acids are end products of carbohydrate metabolism in the nematode's muscle tissue and then transported to the ovaries where they are incorporated into triacylglycerols. During egg development, the volatile acids are enzymatically released from the fat storage and serve as an energy-rich fuel for the larval parasite. In nematode eggs, long-chain fatty acids, which also derive from triacylglycerols, are utilized for the resynthesis of carbohydrates through a functional, glyoxylate cycle. The presence of this pathway in developing eggs of some helminths is unusual, as it does not occur in most other animals. A characteristic feature of trypanosomatids is that the entire machinery for the synthesis of ether lipids from glycerol and fatty acids is associated with the glycosomal compartment of the cell. Another unusual feature of many helminths is the presence of the lipid rhodoquinone instead of ubiquinone as a functional constituent of anaerobically functioning mitochondrial respiratory chains in eukaryotes, and it is remarkable that they can synthesize this electron carrier *de novo* (Quinones). In general, parasites have retained only those biosynthetic pathways that are required to modify lipids obtained from the host. Lipids (such as fatty acids and cholesterol) are obtained from the host, but the lipids that are more difficult to acquire because of their low concentration in the host are synthesized by the parasite, usually by modification of more abundant lipid substrates. Other examples of these important unique lipid structures, such as the glycosylphosphatidylinositol anchors and the lipophosphoglycans, are discussed separately.

---

## Lipocystis polyspora

→ Gregarines.

## Liponyssidae

→ *Acarina*, → *Ornithonyssus*, → *Bdellonyssus*, → *Mites*.

## Lipophosphoglycan

Lipophosphoglycan (LPG) is the major glycoconjugate on the surface of → *Leishmania* promastigotes. In these protozoan stages, approximately 3–5 million copies of LPG together with glycoprotein molecules (mainly the promastigote surface proteinase) protrude above a dense cell surface → *glycocalyx* of about 10 million copies of glycosylinositolphospholipids (→ *Glycosylphosphatidylinositols*). The molecule consists of several domains, some of which are highly unusual for a eukaryotic glycoconjugate (→ *Glycosylphosphatidylinositols*/Fig. 2). This includes the means of membrane anchoring by phosphatidylinositol-linked C<sub>24</sub> or C<sub>26</sub> saturated hydrocarbons, the presence of a galactofuranose in the glycan core and the repeating phosphorylated saccharide backbone containing a unique 4-*O*-substituted mannose. While the lipid anchor of LPG is highly conserved, the glycan composition shows extensive variability among different *Leishmania* spp. and stages, the most striking of which is the increase in size of the phosphorylated saccharide domain as displayed by metacyclic stages. The distinctive structural features of LPG and its developmental modification suggest important functions for this molecule. In the sand fly, stage-specific alterations of LPG are responsible for the attachment and release of promastigotes from the midgut. In the mammalian host, the glycoconjugate may participate in resistance to complement-mediated lysis and in protection from toxic macrophage products.

## Liptoptena

Genus of louseflies (e.g., *L. cervi*, *L. capreoli* of small ruminants and wild deer), reaching a length of about 5 mm. → *Hippoboscidae*, → *Diptera*, → *Keds*.

## Lister, Joseph, Lord (1827–1912)

English scientist, discoverer of antiseptics.

## Listeria

Gram-positive bacteriae, which may be transmitted by bites of → *Ixodes* ticks besides the contamination of food (syn. *Listerella*).

## Lithoglyphus naticoides

→ *Apophallus muehlingi*.

## Litomosoides

### Classification

→ *Nematode*, → *Filariidae*.

### General Information

The adults of *L. carinii* (♀ up to 7 cm ♂ 2.8 cm in length) live in general in the pleural cavity of *Sigmodon* rats. However, occasionally they occur also in the eyes of their hosts (Fig. 1). The females produce sheathed microfilariae, which reach a length of 90–120 μm and occur all day in the blood. Blood-sucking mites (→ *Ornithonyssus*) take up such L<sub>1</sub>, which grow up to the infectious L<sub>3</sub> inside the mite. During blood sucking the transmission occurs and the worms reach maturity within 50–80 days.

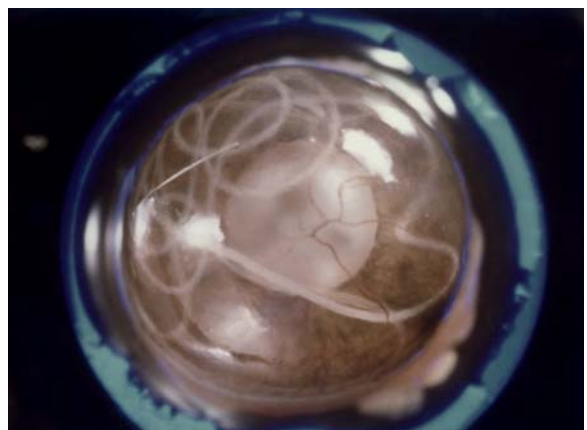

**Litomosoides.** Figure 1 Macrophoto of an eye of a cotton-rat containing an adult worm of *Litomosoides carinii*.



**Diagnosis**

Giemsa-stained blood smears.

**Therapy**

Ectoparasitocidal drugs, diethyl-carbamazine against microfilariae.

**Litomosoides carinii****Synonym**

*L. sigmodonti*.

This nematode species which is kept in laboratory animals (*Mastomys*, *Sigmodon*) that are imported from desert regions and reared in laboratories, lives in the pleural cavity of mice. The males reach a length of 2.8 cm, the females grow up to 7 cm and are mostly found in coiled crowds (like the other members of the family Onchocercidae). The females produce many sheathed larvae (microfilariae) with a length of 90–120 µm. They are found in the blood, from where they are taken up by bloodsucking mites (*Bdellonyssus*, *Ornithonyssus*). After two molts the larvae 3 are injected into the mammal during the next blood meal. The adult may also occur accidentally in the anterior chamber of the rodents (Fig. 1). **Prepatent period:** 70–80 days; **Patency** 1–3 years. This worm is used in laboratory as model to develop onchocercidal drugs.



**Litomosoides carinii.** Figure 1 Macrophoto of the eye of a jird (*Meriones* sp.), within which an adult female is accidentally seen.

**Liver Coccidiosis**

Infection of the biliary ducts of rabbits with the coccidian *Eimeria stiedae* (syn. *E. stiedai*).

**Liver Flukes**

A variety of digenean *trematodes* are very important parasites of the liver of animals and man. They belong to the families Fasciolidae (*Fasciola hepatica*, *F. gigantica*, and *Fascioloides magna*), Dicrocoeliidae (*Dicrocoelium dendriticum*, *D. hospes*), and Paramphistomatidae (*Gigantocotyle explanatum*) (*Digenea*/Table 1). *F. hepatica*, the common liver fluke, is the most widespread and important of the group (*Digenea*/Fig. 3). *F. gigantica* occurs in the tropics mainly in sheep and cattle, but a patent infection can develop in horses, pigs, wild animals, and in humans, too.

**Liver Penetration**

The young *flukes* of *Fasciola hepatica*, when leaving the metacercarial sheath inside the host's intestine, penetrate the intestinal wall, and enter the liver from outside on their way to the bile ducts, their final habitat. Penetration of liver also occurs in *Ascaris* and *Schistosoma* spp. as well as in many other parasites (*Pathology*).

**Livoneca**

Genus of parasitic isopods (Fig. 1, page 727) on the skin of freshwater fish (sucking blood).

**Livoneca symmetrica**

Species of isopod crustaceans parasitizing on freshwater fish (*Livoneca*/Fig. 1).

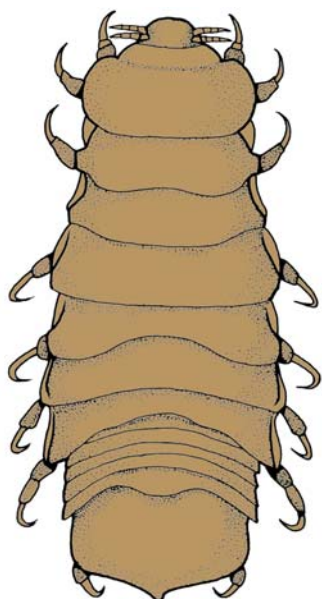

**Livoneca. Figure 1** DR of an adult stage from the dorsal.

## Llaga

Common name for the disease due to an infection with *Leishmania* (syn. *Viannia*) *peruviana*.

## LM

Light microscopy.

## Loa loa

### Synonym

Eye worm, Old Calabar-worm, name comes from local African (Gyot 1778).

### Classification

→Nematodes, →Filaridae.

### Life Cycle

Figs. 1–3 (pages 728, 729); →Filaridae.

### General Information

This worm is found in Africa between 10° North and 5° South. The female adults reach a length of up to 7 cm and a width of 0.5 mm, while the males are smaller (3.2 cm × 0.4 mm). It is characteristic that the adult worms wander throughout the subcutaneous tissues and may appear in the anterior chamber of the eye (Fig. 1). The microfilariae live in the blood and appear most often between 10 am and 1 pm–3 pm in the peripheral blood. The vectors are biting flies and tabanids) of the genus →*Chrysops*, within which the L<sub>3</sub> is developed.

### Diagnosis

Microscopy of Giemsa-stained blood smears showing the unsheathed microfilariae (Fig. 2). →Loiasis.

## Lobopodia

Thick lobe-like →pseudopodia in →amoebes.

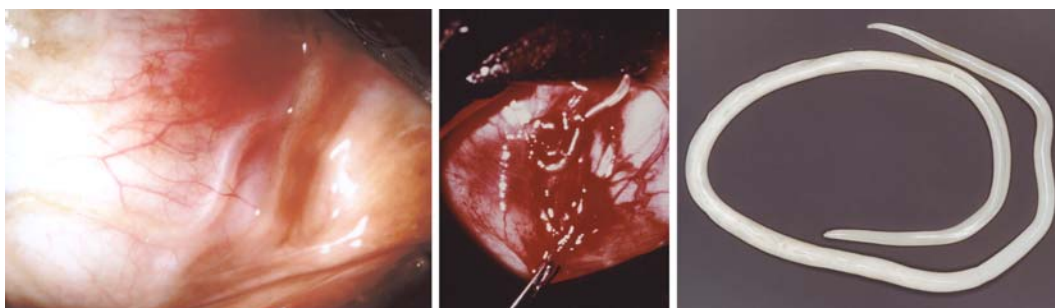

**Loa loa. Figure 1** Adult worm in eye (left), being surgically removed (middle) and taken out from anterior eye chamber (right), courtesy Prof. Grüntzig.



**Loa loa.** Figure 2 Giemsa-stained microfilaria of *Loa loa* with its colourless sheath.

## Local Adaptation

Aubry reports that in 1895, when French armies conquered Madagascar, 5,756 soldiers died during the campaign: 25 died from injuries, the 5,731 others died from local parasitic diseases, mainly →*malaria*. Such an event (many others could be reported) means that autochthonous human populations are usually better adapted to resist local parasitic diseases than are allochthonous invaders.

This example illustrates an old question, that of “local adaptation,” which has been recently the subject of active debates. The question is: which one (the host or the parasite) is locally better adapted to the other?

If the host is better adapted, this means that its defenses are more efficient against local populations of the parasite than against foreign populations (in this case, the reproductive success of the parasite is better in allochthonous than in autochthonous populations of the host). This case is illustrated by the French army in Madagascar.

If the parasite is better adapted, this means that its fitness (reproductive success) is better in local populations of its hosts than in foreign populations. This case is illustrated by many experimental studies. For instance, Xia et al. demonstrate, both by miracidial exposure and microsurgical transplantation of larval stages (sporocysts), that →*Schistosoma japonicum* develops significantly better in local populations of the intermediate snail host *Oncomelania hupensis* than in populations of the same species collected at another place 1,000 km away. In particular, histological observations show that rejection of grafts

is significantly more frequent in allopatric than in sympatric combinations.

Various genetical models predict that better local adaptation of the parasite should be the rule: parasites should stay closer to “optimal virulence” in sympatric populations of hosts than in allopatric ones. This prediction seems to contradict the example cited above of the susceptibility of human populations to allochthonous diseases. In fact, the contradiction is only apparent, because “better adapted” does not mean “more virulent”: the dramatic pathogenicity of →*Plasmodium falciparum* in European invaders certainly provided less opportunities for transmission than a more lasting disease, so that the parasite, although less virulent, was better adapted to local human populations.

## Related Entry

→*Virulence*.

## Locomotory Systems

All →*Protozoa* are motile in at least one stage of their life cycles. During their evolution, the different species have developed distinct locomotory systems such as →*pseudopodia* (e.g., →*Amoeba*), →*flagella* or →*cilia*. The invasive stages of sporozoans, i.e., the merozoites and sporozoites, have 3 types of movement: gliding, twisting, and bending (→*Coccidia*, motility). Only the first of these leads to active displacement of the organisms; the other 2 only change the direction of movement. The gliding form of movement is extremely rare in eukaryotic cells. It is temperature-dependent and cytochalasin B-sensitive, the latter property suggesting the participation of →*actin* in the process. The gliding movement may be related to the →*capping* phenomenon in sporozoans. In capping, the organisms aggregate materials on their surfaces and move them towards the posterior pole, from where they release them into the surroundings. A parasite floating in a liquid could move forward using this type of action. The most studied of the capping phenomena is the circumsporozoite reaction of *Plasmodium falciparum* sporozoites (→*Micronemes*).

## Löffler, Friedrich (1852–1915)

Co-worker of Robert →*Koch*. Discoverer (together with Schütz) of the agent of Malleus (*Pseudomonas mallei*) of horses and carnivores (1882), the agent of

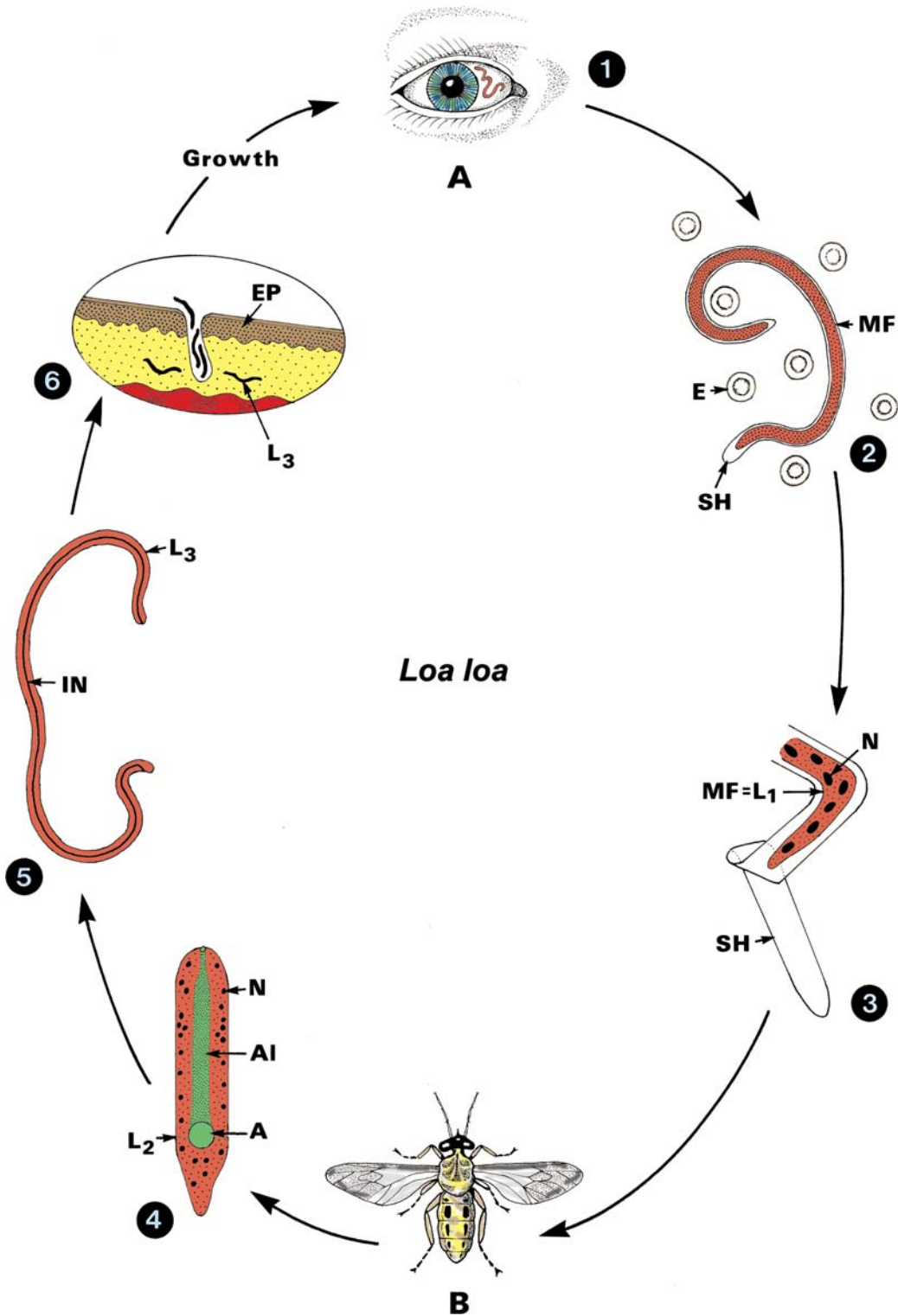

**Loa loa. Figure 3** A Stages in humans: 1, Adult in eye chamber; 2, Microfilaria in blood (= L<sub>1</sub>); 3, Tail of microfilaria. B Stages in vector (*Chrysops*): 4, Larva 2; 5, Larva 3; 6, Larva 3 penetrating into skin during bloodsucking of *Chrysops* specimens. After molt to larva 4, molt to adult occurs. A, anus; AI, anlage of intestine; E, erythrocyte; EP, epidermis; IN, intestine; MF, microfilaria; N, nucleus; SH, sheath.

diphtheria (1894), the agent of erysipelas suis (*Erysipelothrix rhusiopathiae*), and together with Frosch (1897) the virus of the foot-mouth disease (*Aphthae epizooticae*) plus a vaccination against this disease.

## Löffler Syndrome

Hemorrhages and inflammation foci within lungs of humans during the migration phase of larval ascarids (→[Ascariasis](#), [Man](#)) being accompanied by dyspnea, slight fever, blood →[eosinophilia](#) plus coughing.

## Löffler's Lung Infiltration

Clinical symptom due to infections with →[Ascaris](#), →[hookworms](#), →[Strongyloides](#), →[Paragonimus](#).

## Loiasis

### Synonym

→[Eye worm](#) disease.

Loiasis results from an infection of the subcutaneous and deep tissues with adult →[Loa loa](#), transmitted by a biting fly (→[Chrysops](#); →[Filariidae](#)). Larvae enter at the site of the fly bite and slowly develop into adults. Adult worms make their appearance after a year or more, when they give rise to symptoms during their subcutaneous or subconjunctival migration (→[Eye Parasites](#)). The living worm is not inflammatory, but dead worms give rise to microabscesses (→[Abscess](#)) with eosinophils. The released microfilariae circulate in the blood and when they die elicit small →[granulomas](#) with epithelioid and giant cells; these may give rise to symptoms referable to many organs, including the brain.

**Main clinical symptoms:** Swellings (so-called calabar-swellings) of the skin = →[oedema](#) of skin, passage of worms through the eye.

**Incubation period:** 2–12 months.

**Prepatent period:** 6 months–4 years.

**Patent period:** 4–17 years.

**Diagnosis:** Microscopic analysis of blood smear, →[microfilariae](#) are found at 1–5 clock p.m. in the peripheral blood, →[Serology](#), →[Loa loa/](#)[Fig. 1](#).

**Prophylaxis:** Avoidance of *Chrysops*-bites in West Africa.

**Therapy:** Treatment see →[Nematocidal Drugs](#), surgical removal of the worm, when passing the eye.

## Loma

→[Microsporidia](#).

## Longevity, Longivity

The lifespan reached by larval and adult parasites is species-specific (short: hours – miracidia; weeks – *Enterobius* or long: months – female mosquitos, →[fleas](#); years: tapeworms, schistosomes, hookworms).

## Looss, Arthur

German parasitologist ([Fig. 1](#)), died in 1923, discoverer (1900 in Cairo) of the transmission of the hookworm infections.



**Looss, Arthur. Figure 1** Photo just prior to his death in 1923. His great discovery was the transmission of the hookworms.

## Loperamid

Drug that stops diarrhoea; it is also active against acanthocephalans (e.g., →*Macracanthorhynchus hirudinaceus*).

## Lophotaspis vallei

→*Aspidogastrea*.

## Loss in Performance

The parasitic load often introduces considerable reduction of the fitness of hosts, i.e., they look tired, their skin is pale, their hairs appear dull, their movements are slow, and they grow slowly if at all. Thus several female birds clearly prefer bright, shining, and highly active male mating partners that indicate health.

## Louping ill

Louping ill is a sheep disease found in North Britain which is caused by the LI virus (→*Flavivirus*, group B). It is transmissible to human beings in close contact with sheep (laboratory workers, sheep farmers, veterinarians, and butchers), or those exposed to tick bites; at least one human death has been proven.

## Louse Flies

### Synonyms

→*Hippoboscidae*, →*Keds*.

## Louse-Borne Spotted Fever

Human disease due to infection with →*Rickettsia prowazekii* being transmitted by the feces of →lice.

## LPG

→Lipophosphoglycan.

## Lucilia sericata

### Name

Latin: *lux* = light, Greek: *serikos* = silk.

The larvae of this fly causing →*Myiasis*, *Man* may be used to clean skin abscesses from the bacterial coat, since they feed only from necrotic tissues and not from healthy ones.

The larvae excrete intestinal fluids, which are later engorged again. These fluids lead to a debridement of badly healing wounds. Extracts are used as medicament (Alpha-Biocare, Düsseldorf).

## Lufenuron

### Chemical Class

Benzoylphenyl urea.

### Mode of Action

Insect growth regulator (IGR, chitin synthesis inhibitor).  
→*Ectoparasitocides – Inhibitors of Arthropod Development*.

## Lung Worms

### Systematics

Members of several families of the class →*Secernentea* (→*Phasmidea*) of →*Nematodes*, →*Dictyocaulus* (Fig. 1).

### Life Cycle

Figs. 1–3.

### Disease

→*Respiratory System Diseases*, *Ruminants*.

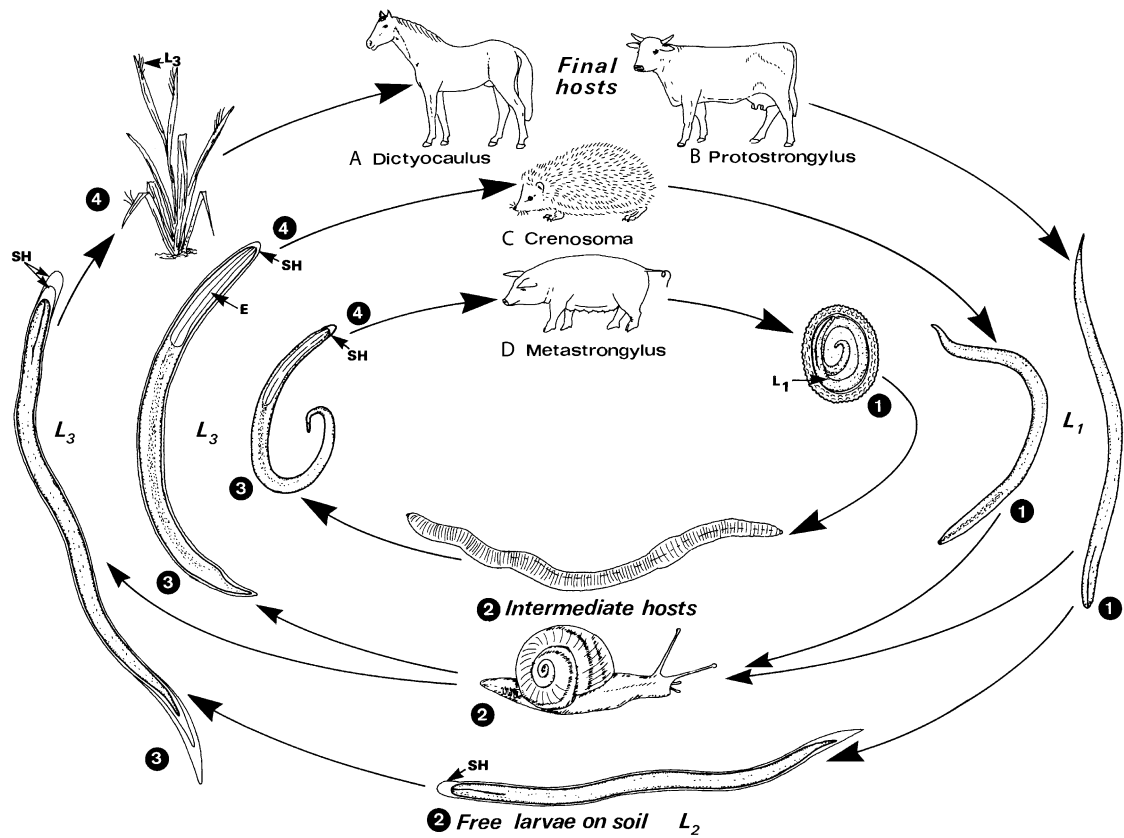

**Lung Worms. Figure 1 A–D** Life cycles of several lungworms of different hosts. **A** → *Dictyocaulus* spp. (large lungworms, see Table 4.1). **B** → *Protostrongylus* spp. (small lungworms; see → *Nematodes/*Table 1). **C** → *Crenosoma striatum* (male 5–7 mm, female 12–16 mm long). **D** → *Metastrongylus elongatus* (syn. *M. apri*: male 15–25 mm, female 20–55 mm long). 1 Fully embryonated eggs (D) or first-stage larvae are excreted with saliva and/or feces of final hosts. 2, 3 In → *Metastrongylus* spp. ( $L_1$  in eggs), in *Protostrongylus* spp. (as in → *Muellerius* spp., → *Neostrongylus* spp.), and in *Crenosoma* spp., the  $L_1$  is ingested by intermediate hosts (earthworms or various species of land-living snails), inside which the sheathed third larval stage ( $L_3$ ) is formed via 2 molts. *Dictyocaulus* spp. do not need an → *intermediate host*, but develop free-living  $L_2$  and  $L_3$ , which are ensheathed by the molted cuticles of the preceding larval stage. 4 The infection of the final hosts occurs by oral uptake of free larvae ( $L_3$ ) on tops of grass blades or by eating infected intermediate hosts with forage. Ingested larvae enter the intestinal wall at species-specific sites, penetrate lymph nodes, → *molt* there, and thus become larvae of the fourth type. The  $L_4$  enters the heart via the bloodstream, thus reaching the lung, and passing into the bronchial and tracheal cavities, where it becomes mature (after another molt). If  $L_3$  are taken up late in the year, their development proceeds until the preadult stage, then it stops, and they hibernate, reaching maturity in early spring (→ *Hypobiosis*). E, esophagus;  $L_{1-3}$ , larval stages; SH, → *sheath* (formed by larval → *cuticle*).

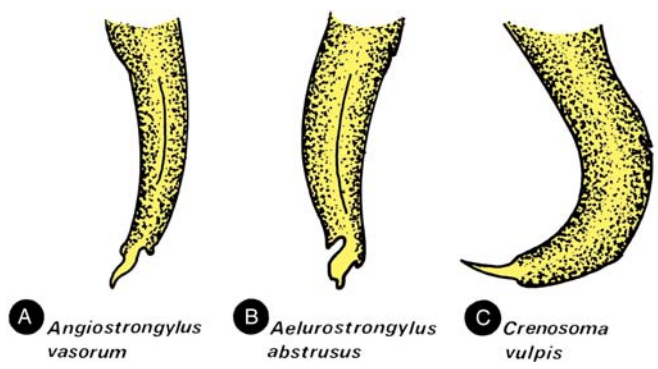

**Lung Worms. Figure 2** DR of the terminal ends of several larvae of lung worms of carnivores.

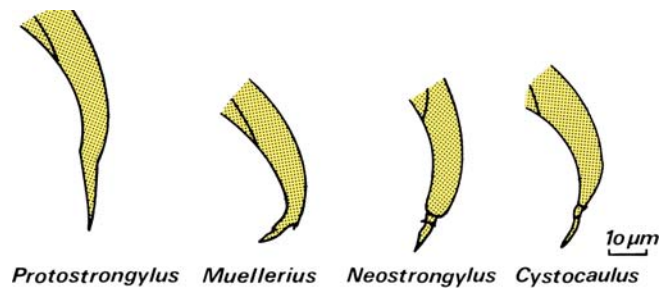

**Lung Worms.** Figure 3 DR of the terminal ends of lung worm larvae of ruminants.

## Lutzomyia

Genus of →sand flies (Fig. 1) with about 350 different species distributed throughout North, Central, and South America. Most human biters are confined to a few subgenera: *Lutzomyia*, *Helcocertomyia*, *Nyssomyia*, *Psychodopygus*, which may transmit →*Leishmania*-stages to man in those regions. →Diptera, →Sand Flies, →Phlebotomidae, →*Leishmania*.



**Lutzomyia.** Figure 1 Adult female of *Lutzomyia* sp., the vector of →*Leishmania*-species in South America.

## Lycophora

Ten-hooked larva of →Cestodaria (genus →*Amphilina*).

## Lycosa tarentula

Tarantula spider with long legs, hairy appearance. It was erroneously believed, that a bite introduces extensic dancing in humans.

## Lyme Disease

The name Lyme came from the little town in USA, where many cases were first noted and where the first →*Borrelia burgdorferi* bacteria were isolated.

Other names for this disease are tick-borreliosis (→ticks as vectors of human diseases).

After a bite of an infected *Ixodes* tick the 3 phases of disease with the following symptoms may occur:

1. **Within days up to 6 weeks:** Erythema migrans, myalgia, swelling of lymphnodes, apathy (Fig. 1).
2. **Within weeks to months:** Urticaria, diffuse erythema, meningitis neuritis, radiculitis, myopericarditis, arthritis myositis, myalgia, severe-sickness feeling, affection of the respiratory tractus, osteomyelitis, pain during any movement, pareses (Fig. 2).
3. **Months to years:** Acrodermitis atrophicans, chronical encephalomyelitis, spastic paresis, mental disturbances, chronical arthritis, arthropathy, severe apathy.

### Diagnosis

Anamnesis: tick bite, erythema migrans (the latter occurs only in 70% of the cases), serology.

### Therapy

First-stage treatment: oral application of Doxycyclin, Ampilicin or Cefuroxim, later: i.v. Ceftriaxon.

→Tick Bites, →Ticks as Vectors of Human Diseases, →*Borrelia*.





**Lyme Disease. Figure 1** Typical *Rosacea migrans* = primary sign of Lyme-borreliosis.



**Lyme Disease. Figure 2** Face of child with a paresis of the Nervous trigeminus (courtesy of Professor Ackermann, Cologne).

---

## Lymnaea

Snail species, vector of many trematodes, e.g.,  
→*Fasciola*.

---

## Lymphadenitis

→Pathology.

---

## Lymphatic Filariasis

→Filariasis, Lymphatic Tropical, →Serology, →Filariidae.

---

## Lymphocytic Meningoradiculitis Bannworth

Symptom of phase 2 of →Lyme disease.

---

## Lynchia maura

Lousefly (→Hippoboscidae) of birds (synonym of =  
*Pseudolynchia*), e.g., *P. canariensis*.

---

## Lysosomes

Lysosomes are vesicles measuring 0.2–0.5  $\mu\text{m}$  and bounded by a single membrane. They are derived from the sER and are formed and released from the secretion side of the →Golgi apparatus (the trans-side). They

contain enzymes such as phosphatases, →proteinases, lipases, nucleases, etc. and have an internal pH of 4–5. When first released they are called primary lysosomes. After fusion with the endocytotic vesicles their enzymes become active and the vesicle is then called a secondary lysosome. In these secondary lysosomes,

or →phagolysosomes, the ingested food is dispersed (→Endocytosis/Fig. 1B). Another type of secondary lysosome is the →autolysosome, which is involved in the disintegration of cellular waste material, thus providing the function of debris disposal. Defective lysosomes introduce diseases (e.g., mucopolysaccharidosis).



## MacDonald Model

→ [Mathematical Models of Vector-Borne Diseases.](#)

## Macracanthorhynchus

### Classification

Genus of → [Acanthocephala](#).

### Species

*M. hirudinaceus*.

### Name

Greek: *makros* = large, *acantha* = thorn, *rhynchos* = mouth; Latin: *hirudo* = leech.

### Life Cycle

→ [Acanthocephala/Life Cycle](#).

### Disease

This worm (female 60 cm, male 15 cm) is a parasite of pigs, where it reaches maturity ([Fig. 1](#)) and excretes the typical eggs ([Fig. 2](#)). In pigs the **prepatent period** is 8–12 weeks, the **incubation period** takes only 10 days; then the following **symptoms of disease** may be seen: enteritis, peritonitis, diarrhoea, malnutrition, abdominal pain. In humans, however, the worm does not reach maturity. It becomes attached with the hooked proboscis at the intestinal wall and may introduce even perforation (acute abdomen with peritonitis). The rather long worm leads to intestinal disturbances within 2–12 weeks (incubation period). The infection of humans and pigs occurs orally by uptake of infected beetles or parts of them.

### Diagnosis

In pigs: microscopical demonstration of eggs ([Fig. 2](#)); in humans: Röntgen–image analysis of the gut shows wall-attached worm larvae.

### Therapy

Loperamid was shown to be efficacious in pigs; see → [Acanthocephalacidal Drugs](#).

## Macrobilharzia

A genus of giant schistosomes (up to 8 cm long) of birds, the cercariae of which may lead to dermatitis in humans, too.



**Macracanthorhynchus.** **Figure 1** Adult *Macracanthorhynchus hirudinaceus* from pig.



**Macracanthorhynchus.** **Figure 2** Infectious eggs of *Macracanthorhynchus hirudinaceus* from feces of pigs.

## Macrocyclic Lactones

Group of different →nematocidal drugs.

## Macrofilariae

Adult male or female filariid worm. →Filaridae.

## Macrogamete

In →Coccidia →gamogony proceeds as →oogamy, i.e., the female →gamont grows without any division to become a macrogamete. After fertilization by a microgamete the →wall-forming bodies of the macrogamete fuse below the fecundation membrane (Fig. 1, page 739; →Cyst Wall/Fig. 1).

## Macrogametocytes

Stages (macrogamonts), that develop into →macrogametes (female gametes), e.g., in →Plasmodium spp. or in other →Coccidia.

## Macronucleus

In ciliates, 2 morphologically distinct nuclei occur: a generative →micronucleus and a somatic macronucleus (→Nucleus, →Balantidium coli), →Ichthyophthirius.

## Macrophages

Phagocytic cells of mammalian hosts, which engulf agents of diseases that have penetrated. When they have digested these agents, they present the MHC 1- or MHC 2- complex at their surface, so that the B-lymphocytes can become informed (via CD 4 cells)

to produce antibodies. However, some parasites (e.g., →Toxoplasma, →Leishmania) grow inside such cells and destroy them.

## Maduramycin

Ionophorous polyether, which acts on Eimeria-coccidians by influx of  $\text{Na}^+$ ,  $\text{K}^+$ , and  $\text{H}_2\text{O}$  into the parasitic cell (killing it finally).

## Magnetic Resonance Imaging

Syn. NMR-tomography, non-invasive, computer-directed method to diagnose cysts of →Echinococcus, →Taenia cysticerci, →Entamoeba abscesses or →Paragonimus or Schistosoma granulomas.

## Major Histocompatibility Complex (MHC)

There are 2 complexes which are presented by macrophages either to  $\text{T}_8$  – cells (from cells infected with viruses, MHC 1) or to  $\text{T}_4$  – cells (from cells infected with, e.g., parasites, MHC 2). The first cell type excretes perforine, the second informs by excreting interleukine 2 the B-cell system.

## Major Sperm Protein

Protein of nematode sperm, that facilitates the crawling motility of these sperms (without flagella). It is a 14.5 kDa polypeptide forming a dynamic cytoskeleton that anchors to the plasma membrane at the leading edge of the pseudopod and then treadmills rearward to the cell body. The MSP's of *Ascaris* and *Caenorhabditis* form symmetric homodimers in solution that polymerize into helical subfilaments that wind together in pairs to form larger coiled structures. In *Ascaris* the sperm cytoskeleton has about 20–30 branched filament networks or fiber complexes. →Nematodes.

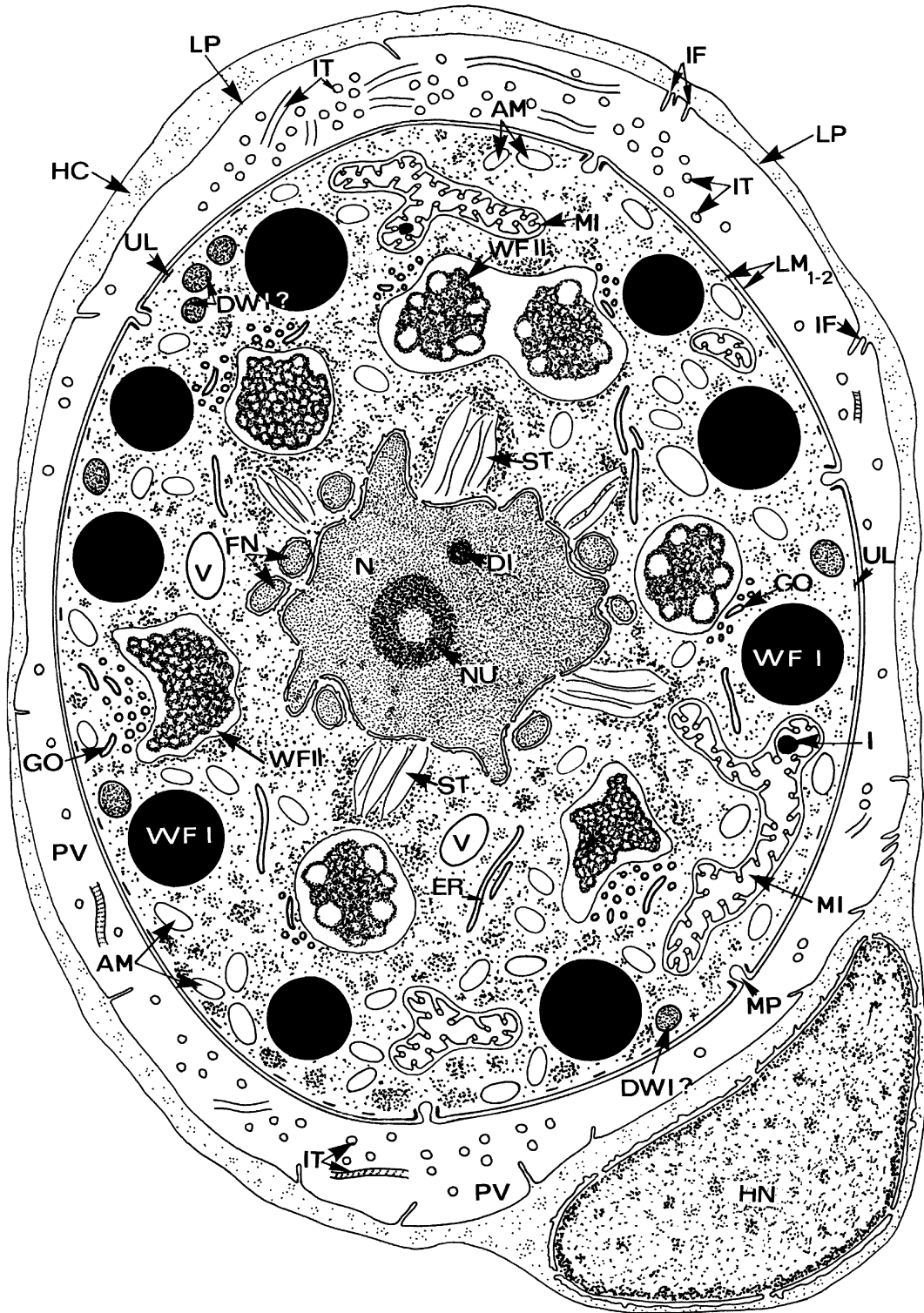

**Macrogamete. Figure 1** Diagrammatic representation of a mature eimerian macrogamete (limited by 2 membranes, other species have only 1). *AM*, → amylopectin; *DI*, dense inclusion; *DWI*, developing wall-forming body of type I; *ER*, endoplasmic reticulum; *FN*, finger-like protrusion of the active nucleus; *GO*, → Golgi apparatus; *HC*, host cell; *HN*, host cell nucleus; *I*, inclusion in → mitochondria; *IF*, intravacuolar folds; *IT*, intravacuolar tubules; *LM*, limiting membranes of the macrogamete; *LP*, limiting membrane of PV; *MI*, mitochondrion; *MP*, micropore; *N*, nucleus; *NU*, → nucleolus; *PV*, → parasitophorous vacuole; *ST*, structures surrounding the active nucleus; *UL*, underlying material; *V*, vacuole; *WF I, II*, wall-forming bodies of types I and II.

## Major Surface Glycoprotein

→MSP, →pneumocystis, →Surface Coat.

## Mal de Caderas

Disease (paresis) due to infection with *Trypanosoma equinum* that is transmitted to horses and cattle, mechanically by bites of →tabanids and →vampire bats in South and Central America.

## Malabsorption

→Hookworm Disease, →Alimentary System Diseases, Animals.

## Malachite Green

Product that acts against several fish parasites (e.g., →*Ichthyophthirius*).

## Malaria

### Name

Latin: *malus* = bad, *aria* = air.

### Pathology

→*Plasmodium* spp. parasitize the red blood cells, which are metabolized during the schizogonic cycle, leaving →pigment granules. Reticular and endothelial cells phagocytize red blood cell fragments and accumulate malarial pigment. *P. vivax* and *P. ovale* predominantly infect the relatively scarce young red blood cells, thus restricting the level of parasitemia. *P. falciparum* and *P. malariae* infect mature cells a few or many of which may be infected, often resulting in anemia. Red blood cells parasitized with *P. falciparum* are sequestered in capillaries of internal organs by →knobs on their surface reacting with receptors on the vascular endothelium, thereby causing →tissue anoxia. This is particularly serious in the brain (→Pathology/Fig. 15), where endothelial cells die and capillaries break, giving rise to multiple petechial hemorrhages. Brain anoxia leads

to edema and coma, which may be fatal in a few hours. Occasionally glial reactions are seen in response to microinfarcts.

Hepatic damage leads to deep jaundice. Phagocytosis of destroyed red cells imparts a brownish, and after fixation, a slate-gray color to the enlarged liver and spleen. However, malarial pigment must be differentiated from formalin pigment or acid hematin. Marked renal tubular →necrosis is sometimes seen with hemoglobinuric nephrosis in the presence of anoxia and acidosis, the so-called black water fever. Deposition of immunoglobulin in the glomeruli may lead to mesangial thickening. The preerythrocytic cycle of *P. falciparum* takes place in the liver and large schizonts are occasionally seen in hepatic parenchymal cells. With *P. falciparum*, →schizogony proceeds easily in the maternal sinuses of the placenta leading to fetal anoxia, placental and fetal edema, and →abortion after the third month of pregnancy.

### Immune Responses

One of the underlying difficulties still hindering the successful malaria vaccine design at the beginning of the 21st century is our incomplete knowledge of the precise type(s) of immune responses involved in the control of the different stages of the parasite on the one hand and malaria immunopathology on the other hand. Understanding the nature of the effector mechanisms to blood-borne plasmodia in humans so far have proven intractable since only blood samples on just one or a few time points have been analyzed and in most cases little is known on the detailed parasitological and immune status of the subject studied. The pliability of rodent systems for investigating immunoregulation has provided valuable insight into the balance between protection and pathology in human malaria. However, there are important differences in the antiparasitic responses between humans and rodents. First, immunity in mice to various malaria parasites can develop within weeks following infection, but rapid acquisition of immunity to malaria is not observed in humans. Children in endemic areas can take several years to develop effective immunity, while this occurs much faster in adults. A second obvious difference between the course of infection in both species is that parasitemias are typically much greater in mice than in humans, which might be explained by the fact that rodent plasmodia are not natural parasites for mice.

Nevertheless, various murine models have been developed with parasites isolated from African wild rodents. There are 4 rodent malaria species (*P. berghei*, *P. chabaudi*, *P. vinckei*, and *P. yoelii*) which allow investigation of diverse aspects of the host immune response to malaria. While *P. berghei*, and some *P. vinckei*, *P. chabaudi* and *P. yoelii* strains are lethal

to mice, other strains such as *P. chabaudi adami*, *P. chabaudi chabaudi*, *P. vinckei petteri* cause infections in mice which resolve after initial parasitemia and are either eliminated completely (*P. yoelii* strains) or have smaller patent recrudescences. Although no single model reflects infections exactly in humans, the different models together provide valuable information on the mechanisms of immunity and immunopathogenesis.

One of the most studied models is that of *P. chabaudi chabaudi*-infected mice most closely resembling *P. falciparum* infection of humans since (1) it usually infects normocytes (2) undergoes partial →sequestration (although in the liver and not in the brain), and (3) in resistant strains of mice there are recrudescences by parasites of variant antigenicity.

Protective immunity to the asexual blood stages of malaria parasites, the pathogenic stage of the life cycle, involves both cellular and antibody-mediated mechanisms.

### Innate Immunity

GPI anchors have been identified as a major proinflammatory agent in *P. falciparum*. GPI anchors, in the 0.1–10  $\mu$ M range, isolated from the erythrocytic stage of the *P. falciparum*-derived merozoite surface proteins, were shown to induce IL-1 and TNF- $\alpha$  secretion by murine macrophages. Removal of the fatty acids linked to the glycerol portion by phospholipases abolished most of the cytokine induction, indicating that the lipid moiety plays an essential role in the macrophage activation process. Studies performed in different mouse models suggest the importance of proinflammatory cytokines both in resistance to early infection as well as in pathogenesis. While MyD88-deficient mice displayed a decreased production of endogenous IL-12 and less severe pathology than the WT mice, no clear phenotype was observed when KO mice with a specific TLR deficiency were infected with a highly virulent strain of *P. berghei*.

### B Cells and Antibodies

In both humans and mice, passive transfer of antibodies from immune individuals to those suffering from acute malaria resulted in quick and marked reduction of parasitemia. Most recently, it has been reported that antiadhesion antibodies, which limit the accumulation of parasites in the placenta, appear in women from Africa and Asia who have been pregnant on previous occasions (multigravidas). These antibodies were found to be associated with greatly reduced prevalence and density of infection. In addition, infections with *P. berghei* and *P. yoelii* cannot be controlled in mice from which B cells are removed by neonatal anti- $\mu$  treatment and the elimination of parasites is also impaired in mice with a targeted deletion of the

JH-gene segment of the Ig gene locus. While IgG2a is essential in the mouse model, IgG1 and IgG3 appear to be most effective in humans. In addition several epidemiologic studies have shown a strong association of IgG1 and IgG3 antibodies with immunity to *P. falciparum*, and the same antibody subclasses might also account for the resistance of newborns delivered by malaria-immune mothers in malaria endemic areas.

IgG1 and IgG3 in humans and IgG2a in mice are cytophilic isotypes able to promote activation of monocytes and macrophages via Fc receptors. The antibody-dependent killing of parasites *in vitro* is either dependent on the presence of mouse neutrophils or human monocytes. One mechanism possibly involved in this antibody activity is the induction of TNF by monocytes leading to growth inhibition of intracellular parasites in neighboring cells. In fact, anti-TNF antibodies prevented asexual parasite growth inhibition and parasite inhibitory activity is present in cell-free supernatants. Selective agglutination of infected erythrocytes is consistently associated with reduced parasite density. There is growing evidence that both opsonizing and agglutinating antibodies recognize PfEMP1 (*P. falciparum*-infected erythrocyte membrane protein 1), a group of large (200–350 kDa) proteins inserted into the red →cell membrane by mature asexual blood stage parasite. PfEMP1 proteins play a critical role in the retention of infected erythrocytes in the blood vessels avoiding sequestration of the parasite in the spleen, since PfEMP1 interacts with a variety of endothelial receptors such as CD36, E-selectin, thrombospondin, vascular cell adhesion molecule 1, and intercellular adhesion molecule 1. Thus, an important function of antimalaria antibodies might be the inhibition of endothelial cell–blood cell interaction but facilitating the interaction of opsonized infected erythrocytes with phagocytes in the spleen. Indeed, it has been shown that the spleen is essentially involved in the IgG2a-dependent clearance of *P. berghei* and *P. yoelii* in mice.

### T Cells

Two stages of the malaria parasite are truly intracellular, that which infects the liver and the asexual stage which resides in red blood cells. Since intracellular parasitism is a strategy for evading antibody-dependent immune responses, T cells most likely are involved in the defense against malaria. Infections with plasmodia stimulate CD4<sup>+</sup>, as well as CD8<sup>+</sup>  $\alpha\beta$  T cell receptor expressing T cells, and  $\gamma\delta$  TCR<sup>+</sup> T cells. While mice genetically deficient for  $\alpha\beta$  TCR T cells were very susceptible to *P. chabaudi* infection and died rapidly after infection, there was no difference between  $\gamma\delta$  TCR-deficient mice and control mice. However, there is a differential expansion of  $\gamma\delta$  T cell subset in the peripheral blood and spleens of mice and humans and



it has been shown in the *P. chabaudi adami* mouse model that the  $\gamma\delta$  T cell blast response coincides with the remission of parasitemia. Since  $\gamma\delta$  T cells proliferate in response to malaria antigens, e.g.,  $\rightarrow$ heat shock proteins, *in vitro*, the systemic expansion of this T cell subset *in vivo* might reflect the systemic release of malaria exoantigens liberated from parasitized erythrocytes upon  $\rightarrow$ schizont rupture.

CD8<sup>+</sup> T cells mediate killing of the liver stage of plasmodia, possibly by producing cytokines (IFN- $\gamma$ , TNF) which induce the production of NO by infected hepatocytes.

The central role of CD4<sup>+</sup> T cells for the protective immunity against the asexual blood stages of experimental malaria have been shown by *in vivo* cell depletion analysis and by cell transfer studies. Since transfer of purified CD4<sup>+</sup> T cells or of CD4<sup>+</sup> T cell lines to SCID mice or lethally irradiated mice cleared the infection only in the presence of B cells, there is the need for T–B cell interaction in the establishment of a fully protective immune response to malaria parasites.

It has been demonstrated that the host-protective response in *P. chabaudi chabaudi*-infected mice involve both Th1-type and Th2-type CD4<sup>+</sup> T cells. The relative contribution of these subsets changes during the course of infection: While Th1 cells predominate during the acute phase, Th2 cells are primarily found during later phases of infection. However, among the nonlethal murine malarias *P. chabaudi chabaudi* can be seen in an intermediate position between 2 poles of protective immunity. Whereas a strong Th1 response is involved in the response against *P. chabaudi adami*, a dominant Th2 cell activation is found after infection with *P. yoelii* and *P. berghei*. The severeness and  $\rightarrow$ lethality of an infection appears to be linked to the early and strong induction of a Th2 response. This is best demonstrated by the fact that infection with a nonlethal strain of *P. yoelii* leads to both Th1 and Th2 activation while in the case of an infection with a lethal strain of *P. yoelii* only a Th2 response was detectable. It is unknown, however, why more severe infections fail to trigger an adequate Th1 response.

A protective function of both Th1 and Th2 cells has been indicated by cell transfer experiments to *P. chabaudi*-infected mice. The protective effect of transferred Th1 cells could be blocked by inhibitors of iNOS (L-NMMA), while in contrast resistance conferred by Th2 cells was not influenced. Even in the case of Th1 cells there are clearly NO-independent mechanisms of protection involved, since Th1-mediated protection against *P. yoelii* is not dependent on NO. Protective Th2 cells clones specific for *P. chabaudi chabaudi* drive a strong protective malaria-specific IgG1 response *in vivo* (see above) which is promoted by IL-4.

An interesting phenomenon observed is the temporal shift from Th1- to Th2-regulated immunity during *P. chabaudi chabaudi* infection of mice. It has been suggested that the type of antigen-presenting cell is critically involved in the Th cell differentiation process. While during the first days of infection professional antigen-presenting cells such as dendritic cells or macrophages might favor the development of Th1 cells, the subsequent activation of malaria-specific B cells appears to be responsible for the observed Th2 cell differentiation. The latter is strongly suggested by the fact that mice rendered B-cell-deficient by lifelong treatment with anti-IgM antibodies or by targeted disruption of the Ig- $\mu$ -chain gene are unable to generate a malaria-specific Th2 response, while the ability to develop Th1 cells is not altered.

In addition to the type of antigen-presenting cell or the cytokine milieu the antigen-concentration is also involved in the regulation of the different Th-subsets. Whereas high-dose challenge of resistant mice led to an enhanced Th1-mediated immune response, low-dose challenge causes more pronounced Th2 cell development.

Given the central protective role of CD4<sup>+</sup> T cells in murine models of malaria it is still puzzling that there is no major effect of the HIV pandemic on the incidence or severity of human malaria, as has been observed for tuberculosis, toxoplasmosis, or leishmaniasis. It has been speculated, that progression to  $\rightarrow$ AIDS involves a preferential depletion of Th1-type CD4<sup>+</sup> T cells and not Th2-type cells, and that the latter might be sufficient to allow a protective antibody-mediated immunity to malaria to be maintained.

The early burst of IFN- $\gamma$  production by CD4<sup>+</sup> T cells (Th1) as found in *P. tabai chabaudi*-infected mice appears to be important for the control of primary parasitemia, since neutralization of IFN- $\gamma$  or injection of rIFN- $\gamma$ , respectively, exacerbates or inhibits the infection. Part of the protective IFN- $\gamma$ -mediated effects might be due to the enhancement of TNF production by macrophages. It has been reported recently, that the Th1-associated increase in endogenous TNF in the spleen during early infection correlates with resistance to *P. chabaudi chabaudi*, whereas high TNF levels in the circulation and liver late after infection have a deleterious effect for the host. Because TNF and IFN- $\gamma$  are not directly toxic for plasmodia, the main effect of these 2 cytokines contributing to the  $\rightarrow$ control of malaria is most likely the enhancement of macrophage cytotoxic activity. Regulatory T cells may have detrimental functions in malaria. In a murine model of malaria depletion of natural T<sub>reg</sub> protected mice from death caused by the lethal strain of *P. yoelii* by restoring an efficient effector immune response, which eradicated the parasites. Similarly, in humans infected with

*P. falciparum* removal of T<sub>reg</sub> *in vitro* enhances peripheral blood mononuclear cell proliferative and IFN- $\gamma$  responses to malaria antigen.

### Control of Parasites by Activated Macrophages

TNF and IFN- $\gamma$  together with parasite exoantigens activate macrophages to secrete several products into the local environment amongst which are reactive oxygen and nitrogen derivatives. Although reactive oxygen derivatives are toxic for plasmodia *in vitro*, the *in vivo* studies yielded conflicting results. Injection of the ROI scavenger hydroxyanisole resulted in enhanced parasitemia in *P. chabaudi adami*-infected mice. In contrast, P/J mice with an intrinsic defect for the generation of ROI resolve acute *P. chabaudi chabaudi* infection.

It has been argued that NO might be an improbable defense mechanism against blood stage malaria since the hemoglobin in intimacy with intraerythrocytic parasite has a high affinity to NO and may thereby scavenge this molecule. Nevertheless, NO and related compounds are able to inhibit the growth of several *Plasmodium* spp. *in vitro* at concentrations in the range generated locally by activated macrophages (40–100  $\mu$ M). In the presence of hemoglobin, this activity of NO is dependent on the local O<sub>2</sub> tension. While at high O<sub>2</sub> tension the formation of S-nitroso-hemoglobin is favored, at low O<sub>2</sub> tension the S-nitroso-hemoglobin functions as NO donor.

A protective role of NO *in vivo* has been demonstrated by studies with iNOS inhibitors. Injection of L-NMMA during the ascending parasitemia caused elevated parasitemia of extended duration, and, as mentioned above, the protective effect of Th1 cell transfer was significantly reduced by L-NMMA-treatment. A correlative support for the involvement of NO in the defense against malaria comes from the observation that iNOS expression was inversely proportional to the disease severity in African children with *P. falciparum* infection.

In addition to direct antiparasitic effects of NO, other host-protective functions of this molecule have been proposed: NO is able to inhibit leukocyte adhesion to the endothelium and to increase vasodilation thereby possibly preventing hypoxic tissue damage.

### Immunopathology

Besides its protective function, the cellular immune response to malaria is also involved in the pathogenesis of the disease. Already more than 15 years ago it was reported that CD4<sup>+</sup> lymphocytes play a major role in the pathogenesis of murine *cerebral malaria*. The transfer of malaria-specific Th1 cells to SCID mice reduced parasitemia, but the animals died early at low parasitemia, indicating T cell-mediated immunopathology.

There is evidence that the systemic pathology is due to an exuberant inflammatory response to the parasite resulting in manifestations such as *diarrhoea*, nausea, fever, anemia, and cerebral malaria. TNF, produced either by activated macrophages or T cells, appears to be a central molecule in this scenario. In humans, high serum levels of TNF are associated with a poor outcome of cerebral malaria and homozygosity of the TNF2 allele, causing enhanced TNF transcription by a different TNF-promotor, predisposes children to cerebral malaria. This important role of TNF in the pathogenesis of malaria has focused most interest on malaria toxins as TNF-inductors. Several molecules, such as ring-infected erythrocyte surface antigen (RESA), the *merozoite surface proteins* MSP1 and MSP2, a soluble protein complex known as AG7 complex as well as lipid moieties have been shown to induce the production of TNF.

Overproduction of IFN- $\gamma$  is also of relevance to the development of cerebral malaria. In synergy with TNF, IFN- $\gamma$  stimulates the upregulation of adhesion molecules like ICAM-1 on endothelial cells in the brain, implicated in the pathogenesis of the disease. The critical balance between protective and immunopathologic effects of cytokines like IFN- $\gamma$  and TNF is tightly controlled by anti-inflammatory cytokines such as IL-10. In line with this, the susceptibility of IL-10-deficient mice to an otherwise nonlethal infection is not simply due to a dominant parasitemia, but is associated with an enhanced IFN- $\gamma$  production.

Most recently, it has been shown that mice depleted of  $\gamma\delta$  T cells by mAb treatment did not develop cerebral malaria after infection with *P. berghei*, suggesting an important function of this T cell subset in the pathogenesis of at least some manifestations of malaria.

### Evasion Mechanisms

Malaria parasites are obviously able to avoid a protective immune response, since people subject to repeated infections in malaria endemic areas rarely develop complete or sterile immunity to the parasite. Repeats in the structure of parasite surface proteins may help the parasite to evade host immunity by exhibiting sequence *polymorphism* and preventing the normal affinity and isotype-maturation of an immune response. Furthermore, some of these proteins may act as B cell superantigens and, when expressed in large quantities, capture protective antibodies. Sequence diversity and *antigenic variation* in nonrepetitive parasite molecules located on the surface of infected erythrocytes, e.g., the existence of 5 different *variable antigen types* (VAT) in the case of *P. chabaudi*, have also been described as potential mechanisms of *immune evasion*.

## Vaccination

Human malaria is, among animal and human parasite protozoan diseases, the one for which, the most intense effort of research has been accumulated in the last decades in view of the development of vaccines. Scientific literature on this topic accounts for thousands of references every year, particularly concerning *falciparum* malaria. This is comprehensible because of the importance of malaria as a leading cause of →morbidity and mortality in the tropical areas of the world, with an estimated 300–500 million cases each year and more than 1 million deaths, mainly among children below 5 years of age in Africa.

A naturally →acquired immunity against malaria is observed in endemic areas where people are exposed to frequent infections. This immunity develops slowly and is characterized, in a first step, by the acquisition of clinical resistance to symptoms, clinical immunity, and later by the ability to control parasitemia at a low level, antiparasite immunity, usually fully expressed only in adults. Classical experiments of British immunologists working in Africa showed in the 1960s that the natural immunity was antibody-dependent, directed against the asexual blood stages of the parasite. More recently, sero-epidemiological surveys in endemic areas have shown the existence of ant sporozoite-specific antibodies as well as antibodies and CTL cells directed against antigens of the hepatic stage. Finally, naturally and artificially raised antibodies against the gametocytes and latter forms of the sexual stage have been described as able to block the development of the parasite in the mosquito. These observations indicate that immunity in malaria is stage-specific and this was indeed proved in laboratory experiments with rodent and primate models. Thus, efforts in the construction of vaccines have been directed toward different target alternatives. The starting point was the impossibility of raising vaccines from parasite materials since no culture systems are available for preerythrocytic stages of the parasites while culture of blood stages (*P. falciparum*) require growth in human red cells. These constraints made malaria vaccines one of the first domains of medical sciences in which nascent genetic engineering technology was actively introduced with the aim of preparing subunit vaccines. In principle the ideal target would be the preerythrocyte stages antigens (sporozoites and hepatic forms) since an effective vaccine against these stages would block transmission. However, an inconvenience of such a vaccine is that it would need to induce sterile immunity, because a surviving →sporozoite or hepatic schizont would be sufficient to produce erythrocyte →invasion and multiplication of the parasite in the blood. Sterile immunity against blood stage, however, is not naturally observed in humans of endemic areas and is usually not

experimentally obtained in animal models. In contrast, nonsterilizing, partially active vaccines against asexual blood stages would be favorable to avoid the development of high parasitemia and presumably reduce severe malaria outcome responsible for mortality. However, it would poorly interfere at the level of sources of infection in an endemic area and, therefore, in the level of transmission. Anti-sexual stage vaccines or transmission blocking vaccines, would abolish or reduce transmission but would not protect the vaccinated individual from infection (altruistic vaccine). In conclusion, these considerations point to the interest in developing multigene, multistage vaccination approach like the CDC/NIIMALVAC-1, for which preliminary assays are now in course.

## Preerythrocyte Stages Vaccines (Sporozoite and Hepatic Stage Vaccines)

After the successful vaccination of human volunteers in the 1970s with irradiated sporozoites the search of the antigen(s) responsible for protection was started. With the development of the monoclonal antibody technology it was possible to identify the protein responsible for the circumsporozoite reaction named CS protein. As the (anti-CSP) Fab' monoclonal antibody was able to confer protection in rodent malaria infection by *P. berghei*, →CSP was identified as protective antigen. The corresponding antigen of the primate parasite *P. knowlesi* was the first parasite antigen successfully cloned and sequenced by the Nussenzweig, revealing the surprising presence of amino acid repeats in tandem in the central region of the molecule, which turned out to represent the immune dominant B epitope, target of the protective antibodies. Very quickly, the corresponding proteins of *P. falciparum* (containing repeats of NANP peptides) and *P. vivax* parasites were cloned and sequenced. Synthetic peptides and recombinant fusion proteins were built containing the repeat tandem units of the corresponding CSPs. Vaccine trials using these molecules were performed in human volunteers in 1986/87 which produced disappointing results with poor protection. However, efforts for improving the immunogenicity of the CSP protein have been recently developed. At the same time, new important knowledge about the structure and functional interaction of the protein with the mosquito and hepatocytes of the human host have been obtained. The region of the CSP molecule responsible for the interaction with hepatocytes (and consequent penetration of the →sporozoite) was identified and depends on the presence of an amino acid sequence containing RGD motif (arginine-glycine-aspartic) with heparan sulfate (a protein polysaccharid conjugate) present in the surface of the hepatocytes. The same sequence RGD is present in a second protein of the sporozoite more recently described

by the name of TRAP (→[Thrombospondine-Related Anonymous Protein](#)). The name TRAP was given by the presence of RGD sequence that is found in thrombospondine. These sequences (or associations of CSP and TRAP polypeptides) have now been included in new sporozoite vaccines' preparations under study. In other studies, genetic analysis using gene disruption techniques has been performed showing the functional role of CSP and TRAP in sporozoite movement, interaction with the salivary glands of →[mosquitoes](#) and with hepatocytes. Finally, new adjuvants have been used in association with CSP-derived antigens which considerably increased the immunogenicity of the protein. A series of trials (primate and human volunteers) are now in course of development, and sporozoite vaccines are still important hopes for the future of malaria vaccines, particularly in association with other antigens in multistage, multigenes vaccines.

In another line of research related to the role of CTL in the cellular immune response, it was shown in animal models that CSP epitopes were expressed in the infected hepatocyte and present in the cell membrane, representing possible target of specific cytotoxic T cells. In addition to CSP, other liver stage antigens of *P. falciparum* like LSA-1 and LSA-3 (liver stage antigen 1 and 3) and antigens expressed both in sporozoites and liver stages (SALSA sporozoite and liver stage antigen) have been used to vaccinate primates with induction of partial protection against sporozoite challenge.

### Asexual Blood Stage Vaccines

Asexual blood stage antigens account for the larger number of molecules, essentially polypeptides, described as potential vaccine candidates. Corresponding genes have been isolated and completely and/or partially sequenced. An abundant literature has been accumulated in the past decades about these antigens concerning molecular biology, immunological assays, experimental vaccination of primates, sero-epidemiological surveys, etc. This is comprehensible in view of the demonstration by the British immunologists in the 1960s, confirmed and developed by others, on the ability of antibodies from immune adults in Africa to control blood parasites and symptoms of acutely infected patients. In consequence the search for identification of protective antigens of the asexual blood stage followed 2 strategies: (1) Differential recognition by antibodies from sera of immune and acutely infected Africans using immunoprecipitation and western blot techniques; (2) Recognition by monoclonal or/and monospecific polyclonal antibodies able to inhibit the parasite in *in vitro* assays. In the present chapter, we will summarize recent progress

concerning the main antigens defined as those that have been used with success in experimental vaccination of primates promoting at least partial protection.

→[Merozoite surface protein 1](#) (MSP1) is the most studied malaria antigen for *falciparum* and *vivax* parasites. The original protein of 185–200 kDa undergoes a double processing at the →[merozoite](#) surface: in a first step 3 products of 83 kDa (N terminal), 36 kDa and C-terminal 41 kDa originate; in a second step the 41 kDa fragment is proteolytically cleaved in a 33 kDa, and a 19 kDa products. The C-terminal 19 kDa polypeptide is cysteine rich, contains 2 epidermal growth factor domains and is the only part of the MSP-1 molecule that penetrates the red blood cell with the merozoite. Numerous vaccination experiments have been performed in primates using the whole molecule or recombinant corresponding to the 83 kDa, 41 kDa, and 19 kDa fragments, or synthetic peptides corresponding to sequences of the N or C terminal regions. The better protection in monkey trials has been obtained with the whole natural molecule but positive results have also been regularly referred with the subunit molecules for *falciparum* and *vivax* malaria, as well as in rodent models using the equivalent molecules. Both antibodies (inhibiting red blood cell invasion) and cellular immune responses have been described in the protective mechanisms.

MSP-3 antigen and GLURP (→[glutamate](#) rich antigen) were described as involved in an antibody dependent cellular inhibition (ADCI) *in vitro* assay that correlates with natural immunity and has induced partial protection effect in primate vaccination experiments.

Other merozoite antigens that have shown protective effect in monkey trial areas are RAP1/2 (rhostry antigen), AMA-1 (apical membrane antigen), and EBA-175 (erythrocyte-binding protein of 175 kDa) which are discharged on the red blood cell by the merozoite during the invasive process. It might also be referred to as the →[SPf66](#) of Patarroyo et al., a polymerized chimera peptide containing sequences of the MSP-1 N terminal region, 2 unknown antigen, and the sporozoite NANP sequence. SPf66 has been extensively used in monkey and human trials but final evaluations indicate a disappointing poor or absent protective effect.

A second family of asexual blood antigens is represented by proteins secreted by the parasite in the plasma, i.e., →[PfHRP-2](#) (histidine rich protein 2), Ag2, and →[SERA](#) (serine rich protein). SERA antigen, also described as Pf140 and Pf126 codes for a protease of unknown function and is localized in chromosome 2 where no less than 8 copies of closely homologous sequences are present in tandem. Very good protection was obtained in monkey trials using recombinant proteins of the original SERA.

Finally, parasite antigens associated to the red cell membranes have been shown to represent targets of opsonizing antibodies that can mediate →ADCC or phagocytosis by macrophages. The Pf332 and →PfHRP-2, in this family, have been described as inducing partial protection in primate trials. The PfEMP-1 (erythrocyte membrane protein) has now been identified as the antigen derived from the polygenic family of the variant antigen *var* gene family with 50–100 copies showing extensive polymorphism. Some of the variant antigens could be associated to severe malaria by promoting sequestration of schizonts in capillary venules of brain and other tissues. Intensive search for common structures of *var* genes products, to be used as vaccine targets against cerebral malaria, is now in progress in many laboratories. This goal was recently complicated with the description of other families of variant antigens, under the names of →STEVOR and →RIF that seem exposed at the infected erythrocyte membrane.

In the slow development of immunity in high endemic areas of →*falciparum* malaria, the first step, already observed in children over 5–7 years is the reduction in disease severity which evolves to complete asymptomatic infections, eventually with high parasitemias. The similarity between the malaria attack and the toxemic shock produced by bacterial LPS induced the search of malaria toxins which became a preferential area of research. Such toxins would be released at the schizont rupture and be responsible for the secretion of TNF- $\alpha$  by immunocompetent cells. TNF- $\alpha$  is found at very high levels in the blood of severe malaria patients and has been shown to correlate with the severity of the illness. The contamination with *Mycoplasma* of *Plasmodium* lines maintained *in vitro* raised numerous questions about potential artefactual nature of some of the work describing the so-called malaria toxin published over the last 10 years. Among the many parasite – derived molecules proposed to fulfill the function of a toxin in terms of TNF- $\alpha$  production, the →GPI anchor of membrane proteins of the merozoite remains the only still accepted candidate. Other molecules such as phosphorylated nonpeptidic antigens (termed as phosphoantigens) are also molecules inducing TNF- $\alpha$  production by  $\gamma\delta$  T cells, which could contribute to physiopathology of the illness. None of these potential toxins have yet been prepared in conditions allowing use in vaccination trials.

### Sexual Stage Vaccines (Transmission Blocking Vaccines)

The description of parasite antigens specific of the latter stages of the sexual development of the parasite provide interesting candidates for an altruistic vaccine. Natural antibodies from infected humans and raised monoclonal antibodies have shown, indeed, their

ability to block parasite development in the mosquito. These antigens which are not seen by the immune system of infected humans have thus inspired the search for candidates for transmission blocking vaccines. The rationale of such altruistic vaccine is that immunized people would produce antibodies able to inhibit the parasite development in the mosquito and thus interfere with the natural life cycle of the parasite. Among the various candidate antigens, the most promising is the Pfs25 (and equivalent in *P. vivax*) for which a phase I and IIa trial have been completed.

### Planning of Control

Attempts to control malaria date back to ancient times, but a rational fight against the disease only became possible after the discovery of the parasite's life cycle, early in the 20th century. Control then consisted of measures against the anopheline vectors, mainly in their larval forms, and the use of quinine for treatment. Conditions improved with the introduction of potent residual →insecticides and highly effective drugs in the late 1940s. At that time three-quarters of the world's population were living in malarious areas. The new tools were considered effective enough for attempting malaria eradication in wide areas of the globe, with the exception of tropical Africa. Malaria eradication was achieved in more than 30 countries, freeing more than one-third of the formerly affected areas from the disease. In other countries the goal of eradication was not attained, but the disease's impact was greatly reduced. Since the late 1960s there has been a stagnation, and in some areas a deterioration, of the malaria situation and the problem of the disease's hard core in tropical Africa is still unresolved.

Today malaria is still endemic in 100 countries and approximately 40% of the world's population live in malarious areas. The annual number of clinically manifest cases is estimated at 300–500 million, and the annual number of deaths due to malaria at 1.5–2.7 million. There is a large reservoir of chronically infected persons, especially in Africa. Approximately 90% of malaria cases occur in tropical Africa, nearly 10% in Asia and western Oceania, and less than 1% in the Americas. *P. falciparum*, the most dangerous and most widely distributed species of malaria parasites, accounts for approximately 90% of all infections world-wide. It is the lead-species in tropical Africa, where it is often accompanied by *P. malariae*. In subtropical areas outside Africa *P. vivax* prevails over *P. falciparum*. The occurrence of *P. ovale* is practically restricted to tropical Africa.

In a policy statement on the implementation of the global malaria control strategy the World Health Organization stated that the goal of malaria control is to prevent mortality and reduce morbidity and social

and economic loss, through the progressive improvement and strengthening of local and national capabilities. The 4 basic technical elements of the global strategy are:

- to provide early diagnosis and prompt treatment;
- to plan and implement selective and sustainable preventive measures, including →vector control;
- to detect early, contain, or prevent epidemics;
- to strengthen local capacities in basic and applied research to permit and promote the regular assessment of a country's malaria situation, in particular the ecological, social, and economic determinants of the disease.

In view of the vastly different resources available for malaria control in various countries and of the substantial differences in the intensity of malaria transmission and the capability of conducting health program it will be useful to differentiate the following levels of achievement as objectives of antimalaria action:

1. Elimination of mortality and reduction of suffering from malaria
2. Reduction of the prevalence of malaria
3. Elimination of malaria

Level 1 can be achieved by the timely detection and effective treatment of malaria cases and the protection

of specific vulnerable groups. This requires the wide availability of health-care facilities throughout the malarious areas, and a well-developed, rapid, and efficient referral system that can cope with severe and complicated malaria. Primary health care, backed up by efficient secondary and tertiary health-care structure, is the vehicle through which this most elementary objective can be reached. Wherever they were established, malaria clinics proved to be a very useful component of the system. The reliance on drugs as the primary tool necessitates continuous monitoring of drug response and adherence to strict policies for rational drug use. A major constraint is the lack of sufficiently simple and cheap diagnostic techniques which do not require oil-immersion microscopy. In areas with intensive malaria transmission it has been shown that the detrimental impact of malaria (mortality and clinical incidence) can be substantially reduced by the use of pyrethroid-impregnated bed nets.

Level 2 requires measures directed against the transmission of malaria in addition to those needed for achieving level 1. This will be more demanding in terms of resources and skills. Based on sound epidemiological knowledge, proper operational stratification, and the results of →feasibility studies, the appropriate approaches are to be selected for each operational area in accordance with the degree of control that is to be achieved. Here the focal application

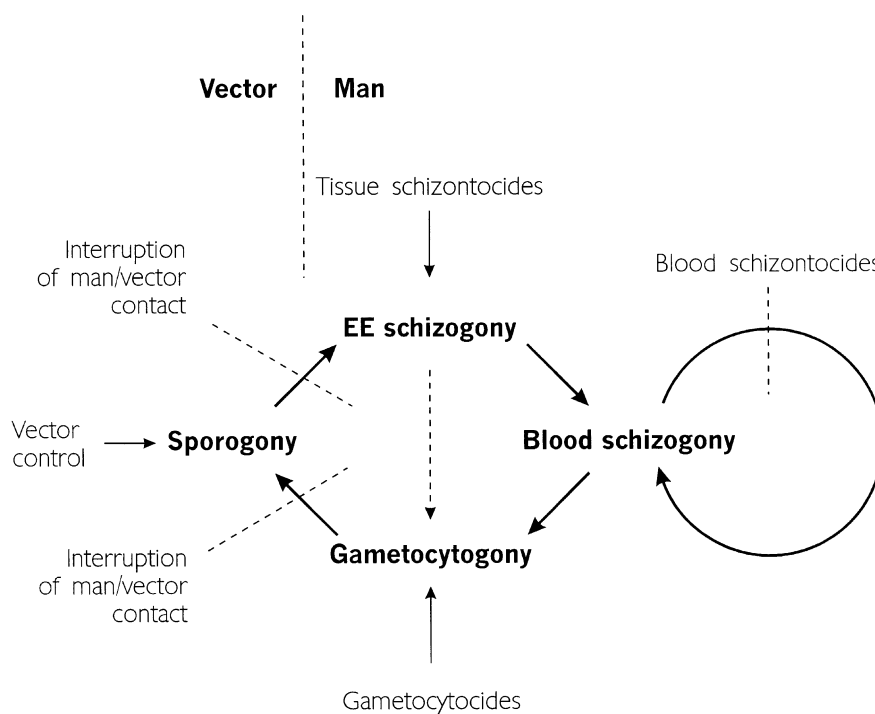

**Malaria. Figure 1** Targets and approaches for the control of *Plasmodium falciparum* malaria.

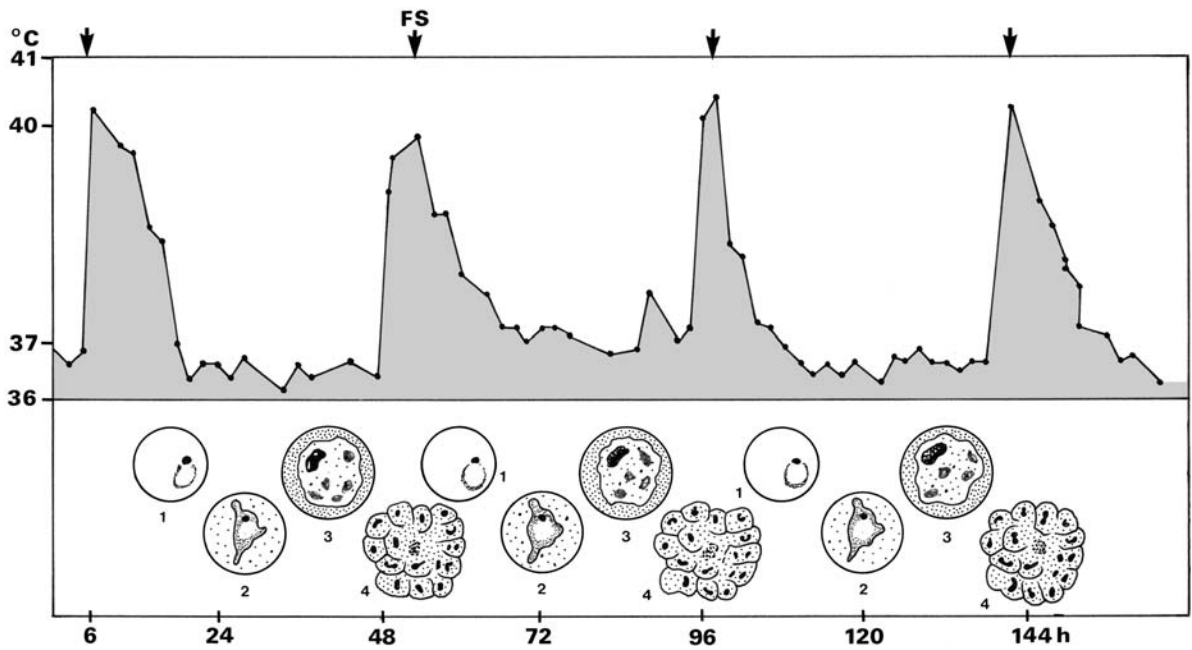

**Malaria. Figure 2** *Plasmodium vivax*. Diagrammatic representation of the relationships between development of parasites in blood and occurrence of fever in the case of Malaria tertiana (*P. ovale* is similar). 1 Signet ring-stage; 2 Polymorphous trophozoite; 3 Immature schizont; 4 Mature schizont before formation of merozoites.

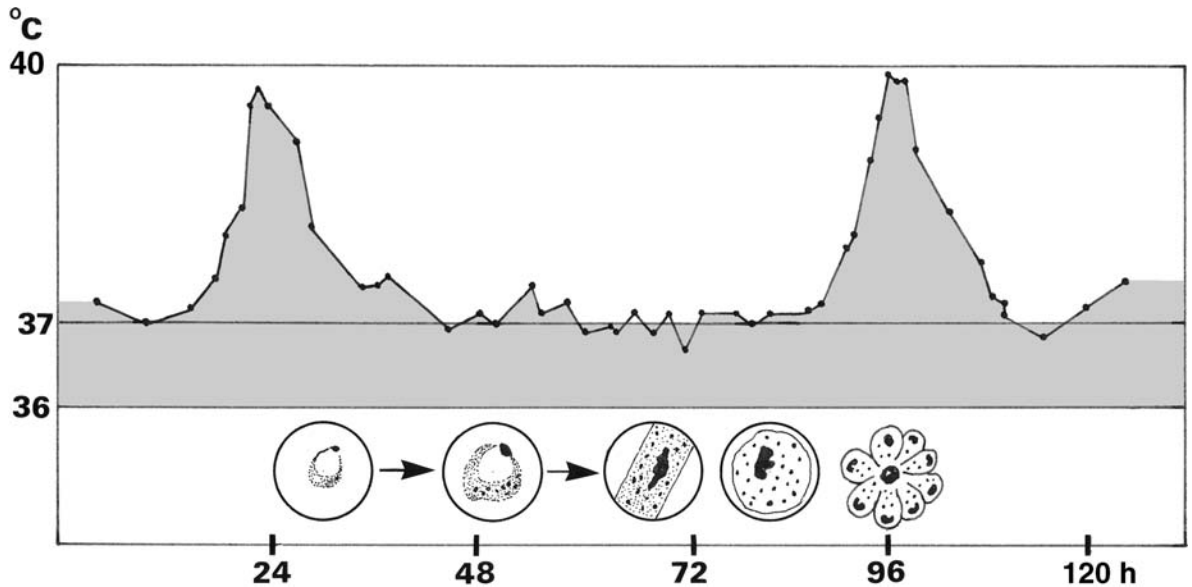

**Malaria. Figure 3** *Plasmodium malariae*. Diagrammatical representation of the relationships between fever and development of parasites in blood cells during the Malaria quartana.

of vector control measures may be required and therapeutic intervention based on the microscopic diagnosis of malaria. Level 2 is therefore more demanding in technical skills and guidance, and specialized manpower may also be required in the periphery. Continuous evaluation is indispensable in order to detect

changes in the response to certain measures and to adapt operational procedures accordingly.

Level 3 is still realistic for some countries and may come into the reach of others if and when more effective antimalaria tools become available. Under this objective malaria is regarded as a parasitosis rather than

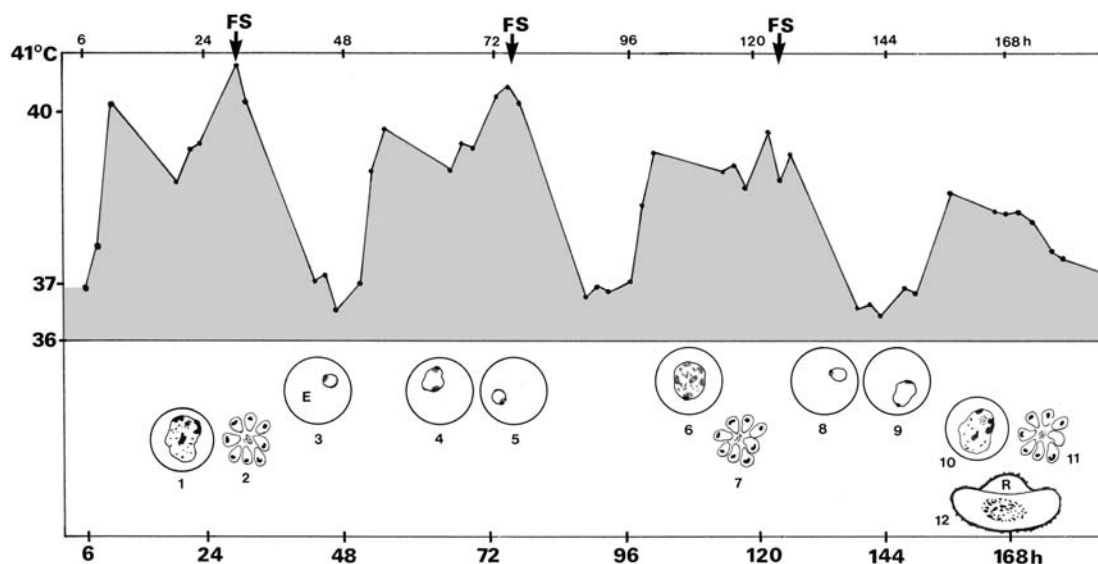

**Malaria. Figure 4** *Plasmodium falciparum*. Diagrammatical representation of the relationships between fever and development of parasites in blood cells during the Malaria tropica. **1, 6, 10** Immature schizont; **2, 7, 11** Mature schizont; **3, 8** Uninucleate signet ring-stage; **4, 5, 9** Binucleate signet ring-stage; **12** →Gamont; E, Erythrocyte; FS, Peaks of fever; R, Residuals of the erythrocyte.



**Malaria. Figure 5** LM and SEM of a *Plasmodium* sporozoite (N = nucleus).

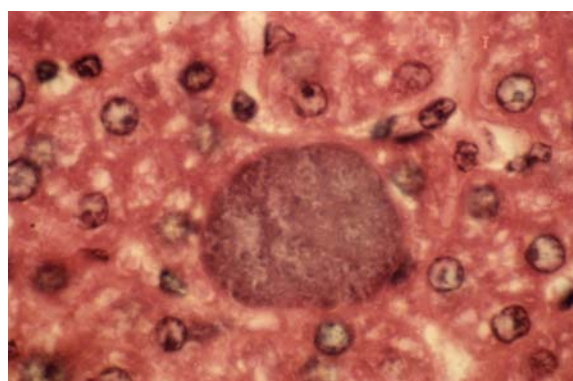

**Malaria. Figure 6** LM of a section through a schizont of *Plasmodium falciparum* in a human liver cell.

a disease. This implies that every malaria infection, whether symptomatic or not, is of importance and requires radical treatment in order to eliminate infective reservoir. The traditional malaria eradication campaigns relied on a very limited choice of attack measures and on a vertical service structure. This will not be appropriate in the future since the selection of operational approaches will require more flexibility and the fast flow and utilization of epidemiological information. Level 3 should be understood as a logical extension of level 2. See also →[Disease Control](#), [Epidemiological Analysis](#).

### Targets for Intervention

Targets of intervention ([Fig. 1](#)) are infected humans, the vector, and the infection cycle. Approaches are numerous and their selection depends on the given epidemiological situation, the available resources, and the envisaged level of control. Treatment of infected persons may be suppressive or radical and gametocytocidal. Vector control may be directed against the aquatic stages of →[Anopheles](#), the adult mosquitoes, or both. The interruption or reduction of man–vector contact is a valuable ancillary measure.



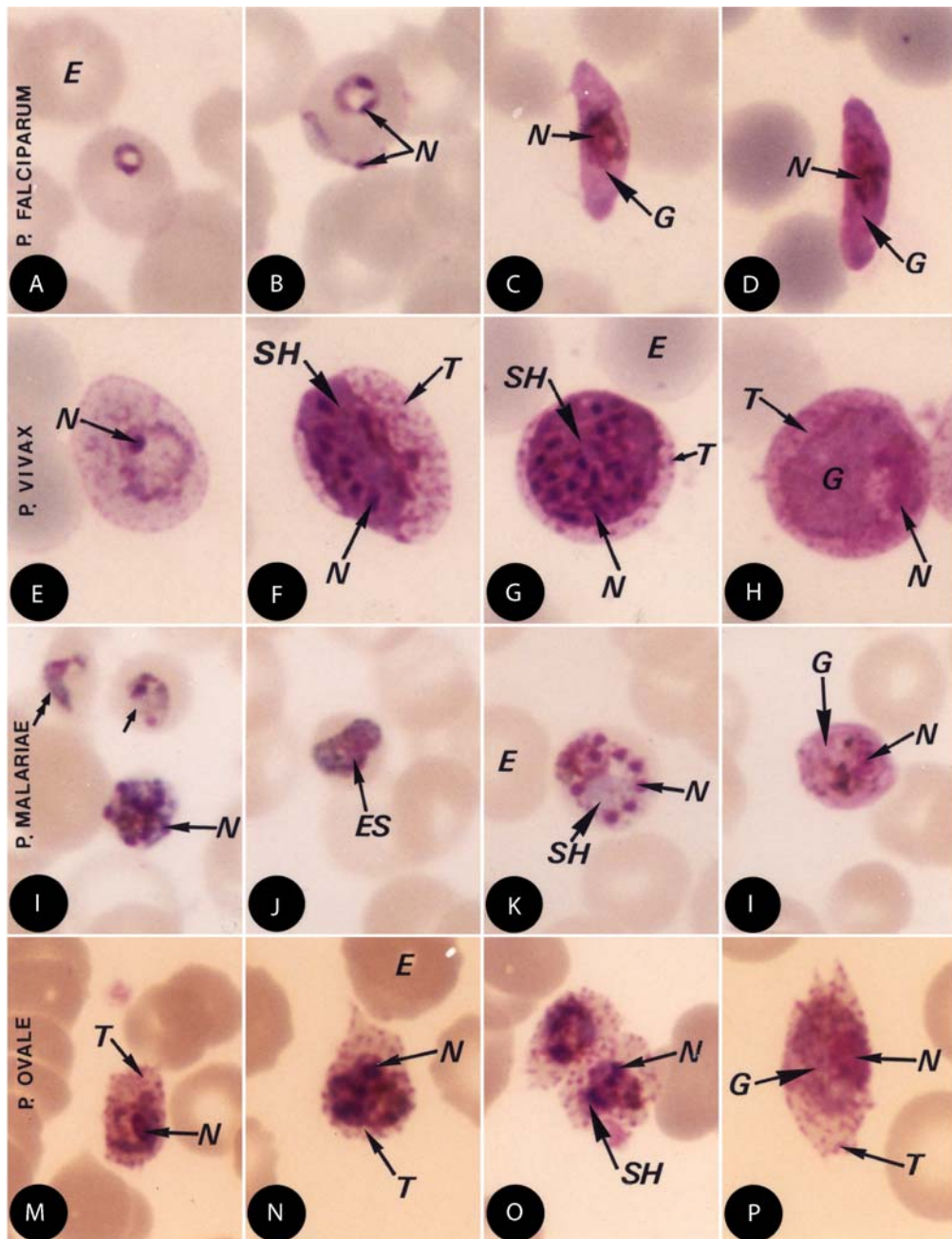

**Malaria.** Figure 7 LM of characteristic Giemsa-stained stages of the 4 human *Plasmodium* spp. E, erythrocyte; ES, developmental stage; G, gamont (= gametocyte); N, nucleus; SH, schizont; T, Schüffner's dots.

#### Main clinical symptoms:

- Plasmodium vivax* (Malaria tertiana): fever of 40–41°C for several hours, (after 1 hour of shivers) is repeated within 48 hours (Fig. 2)
- P. ovale* (M. tertiana): as in *P. vivax* infections (Fig. 2)
- P. malariae* (M. quartana): rhythmic fevers of 40–41°C (after shivers) reappear within 72 hours (Fig. 3)
- P. falciparum* (→Malaria tropica): Irregular high fevers of 39–41°C appear continuously after a phase of headache and general abdominal symptoms; fevers may be rhythmic (48 hours) or even absent (Fig. 4); eventually followed by coma and death.

#### Incubation period:

- P. vivax*: 12–18 days, occasionally longer
- P. ovale*: 10–17 days

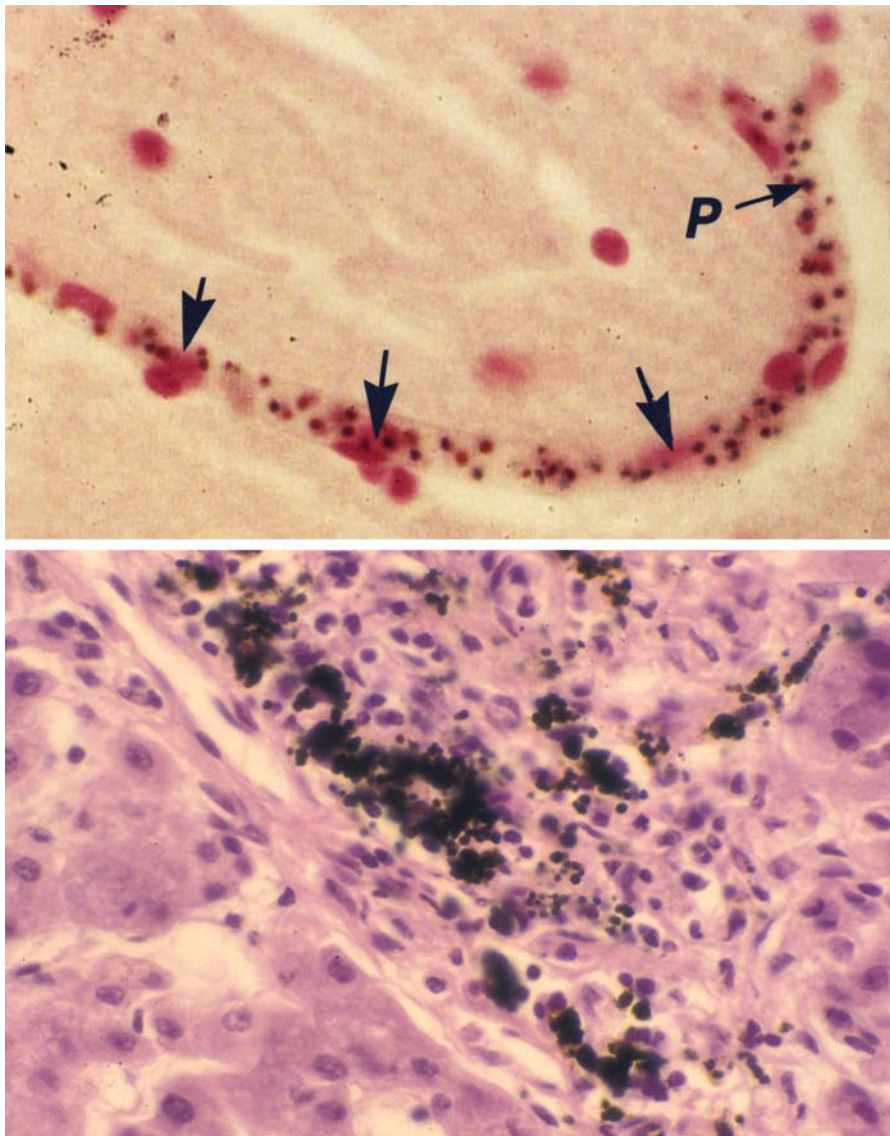

**Malaria. Figure 8** Blood vessels that are blocked by pigment (black) containing *Plasmodium*-infected red blood cells.

- c) *P. malariae*: 18–42 days
- d) *P. falciparum*: 8–24 days

**Prepatent period:**

- a) *P. vivax*: 8–17 days, occasionally longer
- b) *P. ovale*: 8–17 days
- c) *P. malariae*: 13–37 days
- d) *P. falciparum*: 5–12 days

**Patent period:**

- a) *P. vivax*: up to 5 years
- b) *P. ovale*: up to 7 years
- c) *P. malariae*: 30 years and more
- d) *P. falciparum*: under treatment 4–6 weeks, without treatment 18 months

**Diagnosis:** Microscopic determination of stages in blood smears and thick droplets (Figs. 5–9, page 752); malaria quick tests in *P. falciparum* commercially available.

**Prophylaxis:** Avoid the bite of *Anopheles* mosquitoes, see →Repellents, →Insecticides and use →Chemoprophylaxis in endemic regions.

**Therapy:** Treatment see →Malaricidal Drugs.

---

## Malaria Containment

Attempts to eliminate outbreaks.

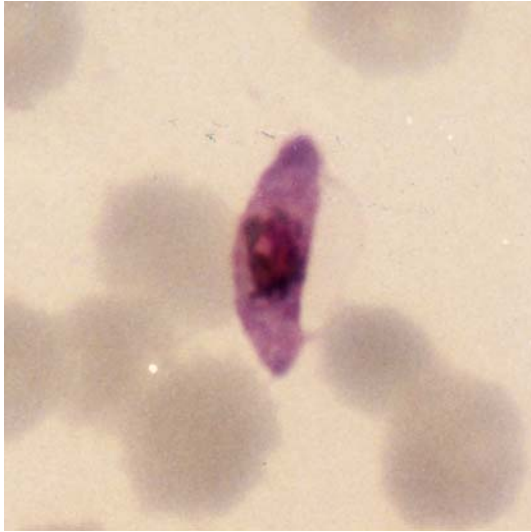

**Malaria.** Figure 9 LM of a Giemsa-stained gamont of *Plasmodium falciparum*, which are typically banana-shaped in human blood.

## Malaria Suppression

Attempts to lower prevalence.

## Malaria tropica

→*Plasmodium falciparum*.

## Malariacidal Drugs

### Animal Diseases

#### Hepatozoonosis of Dogs

The protozoan *Hepatozoon canis* (→*Hepatozoon*) has been diagnosed in dogs throughout the world and is transmitted by the brown dog tick, *Rhipicephalus sanguineus* (→*Ticks*). Clinical hepatozoonosis may be accompanied by concurrent **diseases** caused by other hematropic parasites such as →*ehrlichiosis* (*Ehrlichia canis* belonging to intracellular bacteria of fever-group rickettsiae), babesiosis (*Babesia canis*, *B. gibsoni*), leishmaniasis (*Leishmania infantum*, *L. chagasi*), canine distemper (a viral infection), or dirofilariasis (→*Dirofilaria immitis*). A distinct clinical syndrome involves fever, chronic myositis, debilitation, and

death. Treatment of hepatozoonosis is problematic; **toltrazuril** (→*Coccidiocidal Drugs*), at 5 mg/kg b.w., orally, every 12 hours for 5 days may reduce signs of pain, stiffness, and fever so that the initial response to the drug seems excellent. However, the drug failed to prevent relapses, i.e., intracellular schizonts, and cysts are still present during clinical remission. The action of **imidocarb** dipropionate (→*Babesiocidal Drugs*) seems to be inferior to toltrazuril; the drug exhibits moderate effect on *H. canis* and cholinergic side effects in dogs. A combined administration of **clindamycin** and the DHFR/TS inhibitors →**trimethoprim** sulfate (antifolates: dihydrofolate reductase/thymidylate synthase inhibitors), and **pyrimethamine** hydrochloride (**Table 1**), given orally for 14 days, may result in remission of clinical signs; relapses were evident within 3–4 months. The antimalarial drug **primaquine** (**Table 1**) also appears to be effective against *H. canis* infection. Palliative treatment with nonsteroidal, anti-inflammatory drugs will relieve fever and signs of pain in affected dogs.

#### Leucocytozoonosis of Poultry

→*Leucocytozoon* occurs in cells of various organs and the blood, e.g., erythrocytes and leukocytes; →*Simulium* flies and other arthropods transmit them. *L. smithi* in turkeys, *L. caulleryi* in chickens, or *L. simondi* in geese or ducks may cause death and thus economic loss in the poultry industry in Japan and other countries of Southeast Asia. Though antimalarial drugs (**Table 1**) have only a limited curative effect they can be used prophylactically (e.g., pyrimethamine plus sulfonamides). A few anticoccidial drugs as meticlorpindol or halofuginone in combination with furazolidone (→*Coccidiocidal Drugs*) may exhibit some activity against the parasites when used prophylactically.

#### Malaria of Birds, Rodents, and Monkeys

→*Plasmodium* of birds occurs in erythrocytes and cells of the reticulohistiocytary system (RHS). Culicine →*mosquitoes* transmit the parasites. Though avian plasmodia infect birds all over the world, clinical signs are infrequently seen. In Europe, *P. relictum* may occur in songbirds and water birds. →*Malaria* of birds caused by *P. gallinaceum* or *P. juxtannucleare* has only limited veterinary importance. The disease may occasionally produce anemia and high mortality in domestic fowl or turkeys and occur in subtropical and tropical areas, particularly in Southeast Asia or southern parts of the USA. Antimalarial drugs, which can be used against avian malaria parasites are listed in **Table 1**.

For many years avian malaria has played an important role in malaria research as the model of choice for screening of antimalarial drugs prior to the discovery of rodent *Plasmodium* spp. Because the biology of avian malaria differs considerably from that of mammals, various rodent models (e.g., *P. berghei*,

**Malariacidal Drugs. Table 1** Classification of antimalarial drugs according to the stages of *Plasmodium*-affected

DISEASE <i>Plasmodium</i> species (other information)	STAGE AFFECTED (location), other information	CHEMICAL CLASS (other information)	INN (preferable oral route) (*Tradename)	COMMENTS (toxic reactions and other comments)
MALIGNANT TERTIAN MALARIA	<i>Plasmodium falciparum</i> infection can be fatal during initial attack; repeated attacks are due to <b>recrudescence</b> (= renewed manifestation of infection due to the survival of erythrocyte forms); the infection seldom exceeds 1 year			
BENIGN TERTIAN MALARIA	<i>P. vivax</i> / <i>P. ovale</i> infection; repeated attacks are due to recrudescence (see above) or relapses, i.e., renewed manifestations of an infection originating from exoerythrocytic stages of the parasite; the infections die out within 3–4 years			
QUARTAN MALARIA	<i>P. malariae</i> infection; recrudescence originate from chronic undetectable erythrocytic infection; the latter tends to persist for many years			
there are no drugs acting directly against sporozoite of <i>P. falciparum</i> , <i>P. vivax</i> , <i>P. ovale</i> , <i>P. malariae</i> ; sporozoites inoculated by female mosquitoes during blood meal temporarily circulate in blood, and then enter liver cell to undergo schizogony				
<b>DRUGS ACTING ON PRIMARY TISSUE STAGES IN THE LIVER (TISSUE SCHIZONTOCIDES)</b>				
current use of these agents (with the exception of primaquine) is principally in conjunction with an appropriate blood schizontocidal drug for radical cure of chloroquine-resistant <i>P. falciparum</i> strains and other malaras; primaquine may be used for short-term prophylaxis of malaria, e.g., in G-6-PD normal, nonpregnant, visitors to malarious areas; there are new primaquine analogues of interest				
<i>P. falciparum</i> , <i>P. vivax</i> , <i>P. ovale</i> (effect against <i>P. malariae</i> unknown)  (failed when used against some chloroquine-resistant strains)	<b>primary tissue schizonts Hypnozoites</b> (liver parenchyma cells = hepatocytes)	<b>8-aminoquinolines</b>  causal prophylactic action prevents vivax and falciparum malaria (for more detail see Table 2: prevention of relapses)	<b>primaquine</b> (*Malirid, others) (chiefly used for radical cure of vivax and ovale malaria) (see antirelapse drugs below)  reductase deficiency), risk of intravascular haemolysis in G6PD-deficient patients (African or Caucasian type); for interaction with quinacrine see → <a href="#">Giardiasis/Man/Therapy</a>	much less active against erythrocytic stages than tissue stages; adverse effects may be methemoglobinemia (NADH methemoglobinemia
<i>P. cynomolgi</i> (rhesus monkey), <i>P. berghei</i> , and <i>P. yoelii</i> spp. (rodent malaria, mice)	<b>primary tissue schizonts hypnozoites</b> (liver parenchyma cells = hepatocytes)	<b>8-aminoquinoline</b> analogues causal prophylactic and radical curative drug	<b>tafenoquine</b> has been developed by Walter Reed Army Institute for Research, Washington DC	activity compared to primaquine: about >13 times as hypnozoitocidal drug ( <i>P. cynomolgi</i> ), >10 – 90 times as blood schizontocidal drug ( <i>P. berghei</i> ); it may have utility for the treatment of falciparum malaria
<i>P. vivax</i>	<b>primary tissue schizonts hypnozoites</b> (liver parenchyma cells = hepatocytes)	<b>8-aminoquinoline</b> analogues causal prophylactic and radical curative drug clinical investigations are under way	<b>bulaquine</b> = elubaquine has been developed by Central Drug Research Institute, Lucknow, India	may have utility for the treatment of vivax malaria; though not as potent as tafenoquine, it is claimed to be significantly less toxic than primaquine
<i>P. falciparum</i> ( <i>P. vivax</i> : fleeting inhibitory action on exoerythrocytic (EE) forms only)	<b>primary tissue schizonts</b> (hepatocytes)	<b>biguanides</b> (antifolate Type 2) has been used for causal prophylaxis; drug-resistant plas- modia limited its use	<b>proguanil</b> (*Paludrine) (= chloroguanide) <b>chlorproguanil</b> (*Lapudrine)	currently used only in combination with sulphas (see below) or other antimalarials (e.g., chloroquine) for chemoprophylaxis of malaria; very well tolerated drugs, show tendency to provoke resistance, which was widely reported

**Malariacidal Drugs. Table 1** Classification of antimalarial drugs according to the stages of *Plasmodium*-affected (Continued)

<b>DISEASE</b> <i>Plasmodium</i> species (other information)	<b>STAGE AFFECTED</b> (location), other information	<b>CHEMICAL CLASS</b> (other information)	<b>INN</b> (preferable oral route) (*Tradename)	<b>COMMENTS</b> (toxic reactions and other comments)
EE forms of human malaria  (parasites are believed to be affected by the drug)	<b>primary tissue schizonts</b> (hepatocytes)	<b>diaminopyrimidines</b> (antifolate Type 2) interferes with dihydrofolate reductase; drug shows tendency to provoke resistance	<b>pyrimethamine</b> (*Daraprim, others) used only in combination with sulphas (see below)  pyrimethamine may cause skin rashes, megaloblastic anaemia (at higher doses), in rats, evidence of teratogenicity	prophylactic use of combinations may be obsolete because of widespread drug resistance and potential severe adverse effects;
EE forms of human malaria  (parasites possibly affected by sulphas)	<b>primary tissue schizonts</b> (hepatocytes)	<b>sulphonamides</b> <b>sulfones</b>	<b>sulfadoxine</b> (*Fanasil) <b>sulfalene</b> (*Longum) <b>dapsone</b> (used in combinations only, see above)	in rodent plasmodia sulphas exhibit definite causal prophylactic activity at somewhat higher doses than for blood schizontocidal activity
<i>P. falciparum</i> (action on EE forms of other species of human malaria has been inadequately investigated) tetracyclines are active against EE stages of <i>P. vivax</i> in chimpanzees	<b>primary tissue schizonts</b> (hepatocytes) <b>doxycycline</b> has been recommended for chemoprophylaxis	<b>tetracyclines</b> (causal prophylaxis is not advised on general principles) (may be used for nonimmune patients in areas with high prevalence of multidrug-resistant <i>P. falciparum</i> )	<b>doxycycline</b> (*various)  <i>P. falciparum</i> infections in conjunction with quinine only; hypersensitivity reactions: erythema multiforme, antibiotic-associated colitis; tetracyclines discolor teeth in growing children	use is strictly limited to <i>treatment</i> of multiresistant
<b>DRUGS ACTING ON LATENT TISSUE STAGES OR HYPNOZOITES IN THE LIVER (ANTIRELAPSE DRUGS):</b>				
are used in conjunction with an appropriate blood schizontocidal drug to achieve a radical cure of <i>P. vivax</i> and <i>P. ovale</i> infection; primaquine is the prototypical drug to prevent relapse caused by hypnozoites; pyrimethamine may also reveal some of this type of activity against <i>P. vivax</i>				
<i>P. vivax</i> , <i>P. ovale</i>  highly active during relapse or during latency against latent tissue stages	<b>hypnozoites</b> (hepatocytes)  gametocytes see below (erythrocytes)	<b>8-aminoquinolones</b>  clinical trials under way	<b>primaquine</b> (PMQ) (*Malirid, others) radical cure of benign tertian malaria <b>tafenoquine</b> (GSK) <b>elubaquine</b> (= bulaquine)	tissue schizontozide preventing relapse with poor effect on blood schizonts; for toxicity see under drugs with causal prophylactic action; PMQ interaction with quinacrine see → <a href="#">Giardiasis/Man/Therapy</a>
<b>DRUGS ACTING ON ASEXUAL BLOOD STAGES (BLOOD SCHIZONTOCIDES):</b>				
used for clinical or suppressive cure; these agents interrupt erythrocytic schizogony and terminate clinical attacks (clinical cure)				
<i>P. falciparum</i> , <i>P. vivax</i> , <i>P. ovale</i> , <i>P. malariae</i> clinical cure of all types of human malaria	<b>asexual blood stages:</b> ring stage, trophozoite, schizonts containing merozoites (erythrocyte)	<b>4-aminoquinolines</b> (rapidly acting) had replaced older schizontocides as treatment of choice for of all types of human malaria susceptible to the drug	<b>chloroquine;</b> (*Resochin, others) <b>chloroquine resistance</b> seems to have selective advantage and stability, and is consistently high in East Africa, Western	provides simple treatment and effective safe suppressive prophylaxis generally well tolerated after the oral route; following long-term administration there may be skin lesions

**Malariacidal Drugs. Table 1** Classification of antimalarial drugs according to the stages of *Plasmodium*-affected (Continued)

DISEASE <i>Plasmodium</i> species (other information)	STAGE AFFECTED (location), other information	CHEMICAL CLASS (other information)	INN (preferable oral route) (*Tradename)	COMMENTS (toxic reactions and other comments)
<i>P. falciparum</i> , <i>P. malariae</i> : cure of infections by suppressive action of 4-aminoquinolines	4-aminoquinolines have no effect on primary EE forms or latent EE forms		Pacific, and Southeast Asia	and ocular damage as reversible
		<b>4-aminoquinolines</b> (rapidly acting) (close analogue of chloroquine) may be effective against some chloroquine-resistant <i>P.</i> <i>falciparum</i> strains	<b>amodiaquine</b> (*Basoquin, *Amodiaquine, others) there are reports of resistant <i>P. falciparum</i> in Brazil, Pakistan, and elsewhere and cross- resistance between chloroquine and amodiaquine	showing superior antimalarial activity over chloroquine; it can cause frequent neutropenia, which may be associated with severe agranulocytosis and toxic hepatitis in one of every 220–1,700 users
amodiaquine is not recommended as first-line treatment of uncomplicated falciparum malaria; its potent toxicity renders it unsuitable (contraindicated) for chemoprophylaxis (see column 4)				
<i>P. falciparum</i> (chloroquine- or mefloquine-resistant strains)  in the 50s, quinine has widely been replaced by chloroquine for the radical cure of <i>P. falciparum</i> or <i>P. malariae</i> infections, and for treatment of acute <i>P. vivax</i> or <i>P. ovale</i> infections	<b>asexual blood stages:</b> ring stage, trophozoite, schizonts containing merozoites (erythrocyte)  quinine is structurally similar to the other quinolines, especially to mefloquine, see below	<b>chinchona alkaloids</b> (rapidly acting) not suitable for causal prophylaxis <b>quinidine</b> (D-stereoisomer of quinine; may be used for treatment of severe <i>P. falciparum</i> malaria because of its greater antimalarial action than quinine)	<b>quinine</b> (*various) has its origins in Peru in the early 17th century; drug has remained an effective antimalarial for 350 years  infusion, p.o.); “general protoplasmic poison”, relatively toxic in therapeutic doses: hypersensitivity reactions, intravascular hemolysis; hemoglobinuria, anuria (blackwater fever); agranulocytosis; abortion (overdose), asthma, tachycardia, CNS symptoms, ocular toxicity, tinnitus	old-timer, now used increasingly in the therapy of falciparum malaria resistant to chloroquine, mefloquine, and other drugs (i.m., i.v.:
<i>P. falciparum</i> sulphas may produce clinical cure of falciparum malaria; asexual blood forms of other human malaria parasites seem to be less affected by them; sulphas should not be used alone because of rapid development of drug resistance in plasmodia	<b>asexual blood stages:</b> ring stage, trophozoite, schizonts containing merozoites (erythrocyte)	<b>sulphonamides</b> (slow acting) <b>sulfones</b> (slow acting);  because of their slow action sulphas must be administered with other synergistic acting antimalarials	<b>sulfadoxine</b> (*Fanasil) <b>sulfalene</b> (*Longum) dapson (various)  may be used in therapy of uncomplicated <i>P. falciparum</i> malaria resistant to chloroquine in combination with pyrimethamine	antifolate Type 1, which blocks incorporation of PABA to form dihydrofolic acid; potentiating effect with pyrimethamine, a Type 2 inhibitor, (see causal prophylactics, above); sulphonamides can cause hypersensitivity reactions (Stevens- Johnson type), agranulocytosis; sulphas may rarely cause hemolysis and methemoglobinemia in D6PD-deficient patients (see primaquine); teratogenicity risk
<i>P. falciparum</i> , <i>P. vivax</i> , <i>P. ovale</i> , <i>P. malariae</i>  drugs should be combined with chloroquine or	<b>asexual blood stages:</b> ring stage, trophozoite, schizonts containing merozoites (erythrocyte)	<b>biguanides</b> (slow acting) antifolate Type 2 (see above) treatment of acute malarial attack is not recommended	<b>proguanil</b> (*Paludrine) (= chloroguanide) <b>chlorproguanil</b> (*Lapudrine); drugs may be used as a	biguanides are usually used as causal prophylactics (see above) combined with rapidly acting drugs to retard occurrence of

**Malariacidal Drugs. Table 1** Classification of antimalarial drugs according to the stages of *Plasmodium*-affected (Continued)

DISEASE <i>Plasmodium</i> species (other information)	STAGE AFFECTED (location), other information	CHEMICAL CLASS (other information)	INN (preferable oral route) (*Tradename)	COMMENTS (toxic reactions and other comments)
amodiaquine because their clinical response is slow; cross-resistance with pyrimethamine may occur	<b>primary tissue schizonts</b> (hepatocytes)	*Lapdap (GSK) fixed dose combination for treatment of uncomplicated falciparum malaria (see also Table 2)	partner with other drugs in treating chloroquine-resistant falciparum malaria, e.g., with dapson (*Lapdap)	drug resistance; proguanil may quickly induce resistance in <i>P. falciparum</i> ; <i>P. vivax</i> has also been reported to be resistant to biguanides
<i>P. falciparum</i> , <i>P. vivax</i> , <i>P. ovale</i> , <i>P. malariae</i>  have widely been used drugs; they may be used for standby treatment only and may cause suppressive (radical) cure in <i>P. falciparum</i> infection	<b>asexual blood stages:</b> ring stage, trophozoite, schizonts containing merozoites (erythrocyte) <b>primary tissue schizonts</b> (hepatocytes)	<b>diaminopyrimidines</b> (slow acting) widespread occurrence of plasmodia resistant to pyrimethamine limited its use as a prophylactic drug though synergy with sulphas should reduce rate of appearance of drug resistance	<b>pyrimethamine</b> combinations: plus <b>sulfadoxine</b> (P/S), (*Fansidar); plus <b>sulfalene</b> (*Metakelfin); plus <b>dapsone</b> (*Maloprim) combinations can cause neutropenia and agranulocytosis and Stevens Johnson syndrome, other serious adverse reactions	P/S has previously been used extensively for prevention of malaria but is no longer effective in Southeast Asia, South America, and Africa; an effective treatment; for nonsevere malaria is the most important malaria control strategy in Africa and elsewhere
<i>P. falciparum</i>  (other human malarial parasites have not been adequately documented)	<b>asexual blood stages</b> ring stage, trophozoite, schizonts containing merozoites (erythrocyte)	<b>tetracyclines</b> (slow acting)  potent antibacterial agents; use should be restricted	<b>doxycycline</b> (various) (concurrent use with quinine for treatment of multiresistant falciparum malaria)	tetracyclines discolor teeth in growing children; skin toxicity; photosensitivity; hepatotoxicity in high doses; is contraindicated in pregnancy and children < 8-years old
		<b>macrolide antibiotic</b> (slow acting) potent antibacterial agents; use should be restricted	<b>clindamycin</b> (concurrent use with quinine for treatment of multiresistant falciparum malaria)	lincomycin derivative, side effects may be allergic reactions, diarrhea (enterocolitis, ulcerous colitis), hepatotoxicity, occasionally hypotension, ECG changes
<b>BLOOD SCHIZONTOCIDES ACTING ON MULTIDRUG-RESISTANT FALCIPARUM MALARIA</b>				
<i>P. falciparum</i> has developed resistance to chloroquine, sulpha/pyrimethamine combinations and, to some extent, quinine effective in the treatment of severe and complicated disease; chloroquine resistance of various levels is now common in all endemic countries of Africa, and in many of them, particularly in eastern Africa, high levels of resistance pose increasing problems for the provision of adequate treatment; among the countries with endemic falciparum malaria, only Central America and the Caribbean appear to have no serious problems with chloroquine resistance; mefloquine and halofantrine, which have been introduced in the 1980s are effective against multidrug-resistant strains of <i>P. falciparum</i> are being used increasingly for the treatment and prevention (especially mefloquine) of falciparum malaria in many parts of the world, particular Southeast Asia ; since then there have been reports of decreasing sensitivity and resistance to both these drugs and to the structurally related quinine; in some areas, such as on the Thai/Cambodian and Thai/Myanmar borders, high levels of resistance to mefloquine led to the introduction of artemisinin derivatives in 1993; treatment failure rates in children with acute falciparum malaria after administration of high-dose mefloquine (25 mg/kg) had exceeded 50%; examples that parasites may lose their resistance after discontinuing use of chloroquine have been observed in Thailand and Hainan, China				

**Malariaicidal Drugs. Table 1** Classification of antimalarial drugs according to the stages of *Plasmodium*-affected (Continued)

DISEASE <i>Plasmodium</i> species (other information)	STAGE AFFECTED (location), other information	CHEMICAL CLASS (other information)	INN (preferable oral route) (*Tradename)	COMMENTS (toxic reactions and other comments)
<i>P. falciparum</i> resistant to chloroquine and antifoletes <i>P. vivax</i> (other human malarial parasites)  as with prophylaxis women reported more side effects than men; patients with recrudescence following initial *Lariam treatment were at > 7-fold increased risk of severe neuropsychiatric reactions when treated again with high-dose mefloquine 25 mg/kg	<b>asexual blood stages</b> ring stage, trophozoite, schizonts containing merozoites (erythrocyte)  ineffective against EE forms in liver	<b>4-quinolinemethanols</b> (rapidly acting)  a prospective study of nonserious adverse effects in 3,673 patients with acute falciparum malaria revealed that high-dose mefloquine was well tolerated when given as a split dose	<b>mefloquine</b> (*Lariam); combinations with <b>pyrimethamine</b> and <b>sulfadoxine</b> (*Fansimef)  *Lariam as prophylaxis (250 mg/week, starting 1 week before departure) should not be recommended for short-term travellers (up to 3 weeks) because of possible suppressive drug concentration	mefloquine is a therapeutic and suppressive prophylactic drug that should be reserved for treatment of multiple drug-resistant falciparum malaria; side effects may be frequent vertigo, lightheadedness, nausea, GI and visual disturbances, nightmares, headache, insomnia, occasional confusion, and rare psychosis, convulsion, paresthesias, hypotension, and coma
<i>P. falciparum</i> (other human malarial parasites)	<b>asexual blood stages</b> ring stage, trophozoite, schizonts containing merozoites (erythrocyte)  ineffective against EE forms in liver	<b>9-phenanthrene-methanols</b> (rapidly acting) have potent blood schizontocidal activity but bioavailability is variable; should not be used in combination with drugs known to prolong QTC interval	<b>halofantrine</b> (*Halfan)  there was partial cross-resistance with <b>mefloquine</b> (warning see Table 2)	has been used for treatment (or standby medication) of acute malaria of children and adults (today obsolete); can cause severe (fatal) cardiac arrhythmia as serious prolongation of QTc and PR interval; interaction with mefloquine leads to further prolongation of QT interval (contraindication)
the herb <i>Artemisia annua</i> L. (sweet wormwood, annual wormwood) has been used for many centuries (over 2000 years) in Chinese traditional medicine as treatment for fever and malaria. In 1971, Chinese chemists isolated from the leafy portions of the plant the substance (crude ether extract) responsible for medicinal action; qinghaosu's poor solubility stimulated Chinese scientists to synthesize more soluble derivatives by the formulation of dihydroqinghaosu (DHQHS); its secondary hydroxy group (-O-H) provides the only site that has been used for derivatization; etherification or esterification of DHQHS led to artemether and artesunate, respectively, and other derivatives; all these derivatives proved to be more effective against plasmodia than the parent compound and seem to be the most rapidly acting of all antimalarial compounds developed so far; the spectrum of activity in all derivatives is similar to that of the parent compound qinghaosu or artemisinin; the efficacy of artemisinin and its derivatives against multiple-drug-resistant <i>P. falciparum</i> has been shown in Southeast Asia, sub-Saharan Africa				
artemisinin-based combination therapies on malaria treatment (ACTs): WHO recommends (Jan. 2006, Facts on ACTs) in countries experiencing resistance to conventional monotherapies (e.g., chloroquine, amodiaquine or sulfadoxine-pyrimethamine = SP) to use combination therapies, preferably those containing artemisinin derivatives (ACTs) for falciparum malaria: 1) artemether/lumefantrine, 2) artesunate plus amodiaquine (areas: cure rate of amodiaquine >80%), 3) artesunate plus mefloquine (insufficient safety data to recommend its use in Africa), and 4) artesunate plus SP (areas: cure rate of SP >80%; Note: amodiaquine plus SP is considered as an interim option where ACTs cannot be made available, provided that efficacy of both drugs is high; there are other ACTs in clinical development (see below, and MMV = Medicines for Malaria Venture websites)				
<i>P. vivax</i> and <i>P. falciparum</i>  the most striking results achieved with QHS and	<b>asexual blood stages</b> ring stage, trophozoite, schizonts containing merozoites (erythrocyte EE forms)	<b>sesquiterpene lactones</b> (very rapidly acting)  (QHS bears a peroxide	<b>qinghaosu</b> (QHS) (=O) = <b>artemisinin</b> (micronized; sparingly soluble in oil and water) Chinese	in 1987 approved for marketing in China; recrudescence rate in <i>P. vivax</i> and <i>P. falciparum</i> patients



**Malariacidal Drugs. Table 1** Classification of antimalarial drugs according to the stages of *Plasmodium*-affected (Continued)

DISEASE <i>Plasmodium</i> species (other information)	STAGE AFFECTED (location), other information	CHEMICAL CLASS (other information)	INN (preferable oral route) (*Tradename)	COMMENTS (toxic reactions and other comments)
its derivatives are seen in treatment of cerebral falciparum malaria	are not affected)	grouping appearing to be essential for the antimalarial activity)	formulations: suppositories, tablets, capsules, and solution containing groundnut oil for i.m. injection	may be frequent though multiresistant asexual blood stages of <i>P. falciparum</i> are highly sensitive to the drug; QHS is remarkable well tolerated; it appears to be safe in cases complicated by heart, liver, and renal diseases of pregnancy
DERIVATIVES OF QINGHAOSU (DQHS) OR ARTEMISININ are now also being produced by pharmaceutical companies outside China				
<i>P. vivax</i> and <i>P. falciparum</i> the most striking results achieved with DHQHS and its derivatives are seen in treatment of cerebral falciparum malaria	<b>asexual blood stages</b> ring stage, trophozoite, schizonts containing merozoites; (erythrocyte)	<b>sesquiterpene lactol</b> (retains function of peroxide bridge linkage and is more potent than QHS) PQP is a bisquinotone used extensively in China and Indo-China	<b>dihydroqinghaosu</b> (=dihydroartemisinin = DHA) (DHQHS) (-O-H) Chinese oral formulations DHA plus <b>piperazine</b> (PQP) (*Duo-Cotecxin)	semisynthetic compounds of QHS synthesised are more potent than QHS: listed in order of overall antimalarial activity QHS < ethers < esters < carbonates
DERIVATIVES OF DIHYDROQINGHAOSU (DHQHS) retain the potent bloodschizontocidal activity of parent compound with rapid clearance of fever but have a greater solubility than DHQHS				
<i>P. vivax</i> and <i>P. falciparum</i>  artemether and arteether recent research in Vietnam and other countries of Southeast Asia; DHA ethers are active against trematode infections (cf. → Trematodocidal Drugs)	<b>asexual blood stages</b> ring stage, trophozoite, schizonts containing merozoites (erythrocyte)	<b>ethers</b> (some 32 ether derivatives) (very rapidly acting) for treatment of cerebral malaria and drug-resistant falciparum malaria	<b>artemether</b> [-O-CH <sub>3</sub> ] (*Artenam Arenco, Belgium, no EU registration) oral and parenteral (i.m.) formulations (ampoules) and tablets  <b>arteether</b> [-O-CH <sub>2</sub> -CH <sub>3</sub> ] (short half-life) (oily solution for i.m. injection) (*Betamolil, *Rapither AB) (Ipca Labs Mumbai)	Artemisinin derivatives should not be used in pregnancy; may cause prolonged QT intervals as quinine and halofantrine; there is no evidence of severe neurotoxicity
<i>P. vivax</i> and <i>P. falciparum</i> clinical studies in China; compound is more toxic than QHS but less toxic than artemether; acts rapidly in restoring to consciousness comatose patients with cerebral malaria; recrudescence rate is relatively high	<b>asexual blood stages</b> ring stage, trophozoite, schizonts containing merozoites (erythrocyte)	<b>sodium hydrogen succinate monoester</b> (very rapidly acting) development of a fixed dose combination of *Lapdap (chlorproguanil + dapsone, GSK) plus artesunate is under way, and Phase IV clinical trials (post-licensure) have started, filing will be done in late 2007 or early 2008	<b>sodium artesunate</b> [-O-COCH <sub>2</sub> CH <sub>2</sub> CO <sub>2</sub> Na] tablets, capsules for local use; suppositories, parenteral formulations (i.v.; water soluble powder; dual-pack dosage form) (Guilin No. 1 Factory, Guangxi, China)	in Africa, TDR/WHO examined rectal artesunate in children with "nonsevere" falciparum malaria, but whose condition prevents use of oral medication; this might reduce the proportion of children whose condition deteriorates to severe disease

**Malariaicidal Drugs. Table 1** Classification of antimalarial drugs according to the stages of *Plasmodium*-affected (Continued)

DISEASE <i>Plasmodium</i> species (other information)	STAGE AFFECTED (location), other information	CHEMICAL CLASS (other information)	INN (preferable oral route) (*Tradename)	COMMENTS (toxic reactions and other comments)
<i>P. berghei</i>	<b>asexual blood stages</b> ring stage, trophozoite, schizonts containing merozoites (erythrocyte)	<b>carbonates</b> (very rapidly acting) experimental drug	[–O–C(=O)–O–alkyl or aryl] (oil solubility is similar to that of esters; a-epimer predominates in the products)	most potent derivatives against <i>P. berghei</i> in mice; no detailed study of their therapeutic properties has been published
<i>P. falciparum</i>	<b>asexual blood stages</b> ring stage, trophozoite, schizonts containing merozoites (erythrocyte)	<b>artelinic acid</b> (very rapidly acting) till an experimental drug, which has no clear benefits over other artenusate and artemether; it has a lower rate of neurotoxicity than arteether and artemether but is more toxic (×3) than artesunate	–OCH <sub>2</sub> –(phenyl) COOH i.v. formulations	has been developed by Walter Reed Army Institute for Research (WRAIR) as the most water-soluble drug of this group
<i>P. falciparum</i>  Malarone appears to be a safe drug during pregnancy and in children; fixed-dose combination is licenced for treatment of uncomplicated malaria and prophylaxis of <i>falciparum</i> malaria	<b>asexual blood stages</b> ring stage, trophozoite, schizonts containing merozoites (erythrocyte)	<b>hydroxy- naphthoquinone</b> plus biguanide	<b>atovaquone</b> (*Mepron, GSK) plus *Matarone, GSK *Mepron is also used to treat and prevent <i>Pneumocystis carinii</i> <i>pneumonia</i>	used as a monotherapy, 30% of patients showed recrudescence; coadministration of atovaquone and proguanil revealed synergistic antiplasmodial activity and a dramatic effect on cure rates of patients with <i>falciparum</i> malaria
<i>P. falciparum</i>  to date, no resistance to ACTs has been reported in patients; if used alone, the artemisinins will cure <i>falciparum</i> malaria in 7 days, ACTs will produce high cure rates in 3 days with higher adherence to treatment; for more information see Facts on ACTs (WHO websites)	<b>asexual blood stages</b> ring stage, trophozoite, schizonts containing merozoites (erythrocyte)	<b>fluorene derivative (racemate)</b> synthesized by Institute of Military Medical Sciences (IMMS), Beijing in the 1970s, registered as antimalarial drug in China in 1987 *Coartem belongs to the essential drugs (WHO list)	<b>benflumetol</b> plus <b>artemether</b> (*Coartem or *Riamet, Novartis); the ACT may cause up to 95% cure rates in children in Africa infected with multiresistant strains of <i>P. falciparum</i> (also standby therapy for travellers)	lumefantrine is poorly soluble in water and oils but soluble in unsaturated fatty acid (oleic or linoleic acid); the latter was used for oral formulation (tablets, capsules) in clinical studies in China since 1979 and coadministered orally with artemether; preclinical trials showed synergy between the two drugs
<i>P. falciparum</i> a new ACT (pyronaridine plus pyronacridine) for treatment of drug- resistant <i>falciparum</i> malaria	<b>asexual blood stages</b> ring stage, trophozoite, schizonts containing merozoites (erythrocyte) <b>gametocytes</b> (DNA topoisomerase II inhibitor)	<b>benzonaphthyridine</b> synthesized in China in 1970 (acridine-type Mannich base)	<b>pyronaridine</b> tablets, capsules (*Malaridine) combination with artenusate (*Pyramax, Shin Poong Pharm, Korea)	has been used clinically in China since the 1970s and is marketed in that country and Korea, it may have potential as replacement for oral formulations of chloroquine in many areas for treatment of uncomplicated <i>falciparum</i> malaria

**Malariacidal Drugs. Table 1** Classification of antimalarial drugs according to the stages of *Plasmodium*-affected (Continued)

DISEASE <i>Plasmodium</i> species (other information)	STAGE AFFECTED (location), other information	CHEMICAL CLASS (other information)	INN (preferable oral route) (*Tradename)	COMMENTS (toxic reactions and other comments)
<b>DRUGS ACTING ON GAMETOCYTES (GAMETOCYTOCIDES)</b>				
may inhibit gametocytogenesis or kill mature gametocytes (sexual erythrocytic stages) of plasmodia, thereby preventing transmission of malaria to mosquitoes; damaging effects on gametocytes include severe alterations of morphology, and a marked decrease in numbers of gametocytes; the only drugs that have the potential to interrupt transmission of falciparum malaria are the 8-aminoquinolines (primaquine, pamaquine, and tafenoquine) and pyronacridine (see above); gametocytogenesis takes place when critical parasite density has been achieved in the blood of host; hence, malaria may be transmitted during the recovery phase of the acute falciparum malaria despite successful eliminating of the asexual stages of the infection by blood schizontocidal drugs having little or no activity against mature gametocytes; patients whose infection recrudesced were nearly 5-times more likely to become gametocyte carrier than those who were treated successfully				
<i>P. falciparum</i> , <i>P. vivax</i> , <i>P. ovale</i> , <i>P. malariae</i>	<b>gametocytes</b> (immature and mature stages) (erythrocyte)	<b>8-aminoquinolines</b> (direct and fast action)	<b>primaquine</b> <b>tafenoquine</b>	only drugs with fast and direct action on gametocytes of <i>P. falciparum</i> ;
			high gametocytocidal action on all species of human malarial parasites, rendering the gametocytes incapable of development in mosquitoes	
<i>P. falciparum</i>	gametocides (stage II and III)	benzophthiridine	pyronacridine	proved active against young gametocytes <i>in vitro</i>
<i>P. vivax</i> , <i>P. ovale</i> , <i>P. malariae</i>	<b>gametocytes</b> (immature and mature stages) (erythrocyte)	<b>4-aminoquinolines</b>	<b>chloroquine</b> <b>amodiaquine</b> *Flavoquine, others	effective against immature but ineffective against mature gametocytes of <i>P. falciparum</i>
<i>P. falciparum</i>	precursors of sexual stages and early (I–II) gametocytes (erythrocyte)	<b>artemisinin derivatives</b>	<b>artemether</b> , <b>artesunate</b>	do not kill mature gametocytes but reduces transmission of falciparum malaria
<b>DRUGS AFFECTING FORMATION OF MALARIAL OOCYSTS AND SPOROZOITES IN INFECTED MOSQUITOES</b>				
have little or no apparent effect on gametocytes but cause inhibition of subsequent development of sporogonic forms in the mosquito; agents with sporontocidal action can reduce transmission of malaria				
<i>P. falciparum</i> , <i>P. vivax</i>  sporogony is inhibited for varying periods (dose dependent)	<b>oocysts</b> (midgut wall of mosquito)	<b>biguanides</b> (highly active)  may be valuable for sporontocidal prophylaxis	<b>proguanil</b> (*Paludrine) (= chloroguanide)  <b>chlorproguanil</b> (*Lapudrine)	mosquitoes fed on gametocyte carriers receiving therapeutic doses do not develop intact oocysts, i.e., drugs ablate transmission of malaria by preventing or inhibiting formation of oocyst and sporozoites in infected mosquitoes; infection to man may be interrupted or decreased
<i>P. falciparum</i> , <i>P. vivax</i> (drug appears to inhibit sporogony)	<b>oocysts</b> (midgut wall of mosquito)	diaminopyrimidines	<b>Pyrimethamine</b> (*Daraprim, others)	no apparent effect on the production, number or morphology of gametocytes
<i>P. berghei</i> (experimental rodent malaria)	<b>oocysts</b> (midgut wall of mosquito)	<b>sulphonamides sulfones</b>	<b>sulfadoxine dapsone</b>	dapsone may cause increased gametocyte production in falciparum malaria; these gametocytes may not be infective to mosquitoes

Data given in this table have no claim to full information. Comments on adverse effects and other properties of drugs cited in this table refer to data from literature, labels of sponsors, suppliers, or manufacturers, and various websites (e.g., WHO, MMV, others)

Abbreviations: INN = International Nonproprietary Names

*P. yoelii*, or *P. chabaudi* infecting mice, rats, and other rodents) met with great interest. These malaria parasites are uncomplicated and easy in handling and available all over the world. The biology of rodent malaria is very similar to that of human malaria parasites, particularly →*P. falciparum*, so that results obtained by drug screening in these models have a certain predictive value for the antimalarial activity of drugs against human parasites. Recently, the *in vitro* cultivation of *P. berghei* has been further optimized now offering new possibilities in molecular screening but also more insight into the conventional screening for chemotherapeutic agents. Today, a variety of *in vitro* and *in vivo* models provide a broad basis to investigate a drug's mode of action and potential mechanisms leading to drug resistance in rodent and human malaria. Targets may be malarial hemozoin/β-hematin supporting hem polymerization or sequence variations in the *P. vivax* dihydrofolate reductase-thymidylate synthase gene and their relationship with pyrimethamine resistance. Owing to improved *in vitro* cultivation techniques, large numbers of different *Plasmodium* developmental stages may be helpful to find out new chemotherapeutic targets. One of these targets is the cytoplasmic ribosomal RNA of *Plasmodium* spp., as it seems to be quite different from the mechanisms in other eukariotic cells. Macaque monkeys are now used extensively not only for →AIDS research but also malaria research, involving rhesus monkeys (*Macaca mulatta*) compared to other macaque species (*M. fascicularis*). Rhesus monkeys are highly susceptible to most of the malarias (especially *P. knowlesi*, *P. coatneyi*, and *P. fragile*, distinctively less *P. cynomolgi*, *P. fieldi*, and others) whereas *M. fascicularis* is not. So a comparison of response to malaria in susceptible rhesus monkey and resistant *M. fascicularis* might be a good starting point. Molecular-genetic studies on their hemoglobins and innate red blood cell polymorphisms would be probably of more value than research on immunity to *P. falciparum* in such artificial hosts as owl monkeys, *Aotus* and *Saimiri*.

## Malaria of Humans

### Clinical Forms

Malaria is a mosquito-borne infection caused by 4 species of obligate intracellular protozoan parasites of the genus *Plasmodium* of which *P. vivax* is the most common and *P. falciparum* the most pathogenic. Each species has distinguishing morphological characteristics and the disease caused by each is also distinctive. *P. vivax* occurs north and south of the Equator within the 15°–16°C summer isotherms whereas *P. falciparum* is limited to, but widely distributed in,

the tropics and subtropics, particularly Africa and Asia. *P. falciparum* causes “Falciparum or malignant tertian malaria” (incubation time 7–14 days), the most dangerous form of human malaria. It can produce a foudroyant infection in nonimmune individuals that, if not treated, may result in rapid death. If treated early, the infection usually responds to appropriate antimalarial drugs in chloroquine-sensitive or chloroquine-resistant areas, and recrudescence will not occur. If treatment is inadequate, however, recrudescence of infection may result from multiplication of parasites in the blood. Delay in treatment, especially in patients already having parasites in the blood for a week or so, may lead to irreversible state of shock, and death may occur though the peripheral blood is free of parasites. *P. vivax* causes ‘Vivax or benign tertian malaria’ (incubation time 12–17 days, sometimes several months or >1 year); the disease produces milder clinical attacks than those seen in →falciparum malaria. It has a low mortality rate in untreated adults and is characterized by relapses, which may occur as long as 2 years after primary infection. *P. ovale* causing “Ovale or benign tertian malaria” (incubation time 16–18 days or longer) occurs primarily in tropical Africa (especially in West Africa) and in some endemic areas of New Guinea and the Philippines and Southeast Asia. Clinical manifestations are similar to that of *P. vivax* infections (including periodicity and relapses), but are more readily cured. *P. malariae* causing “Quartan malaria” (incubation time 18–40 days) is not found below the 16 °C summer isotherms and has a variable and spotty distribution in the tropics and subtropics. Clinical signs are similar to that of “benign tertian malaria,” the febrile paroxysm occurring every 72 hours. Symptomatic recrudescence can occur several years after primary infection and is due to persistent undetectable parasitemia, and not due to →hypnozoites as in case of *P. vivax* infections.

### Biology

Though malaria can be transmitted by transfusion of infected blood, humans are naturally infected by **sporozoites** inoculated by the bite of female anopheline →mosquitoes. Sporozoites rapidly leave the circulation and initiate →schizogony in the parenchymal cells of the **liver** (so-called preerythrocytic or exoerythrocytic = EE stage of infection), which is asymptomatic and lasts for 5–16 days depending on the *Plasmodium* spp. In *P. falciparum* and *P. malariae* infections primary tissue schizonts burst simultaneously within a certain period, leaving no parasite stages in the liver. In *P. vivax* and *P. ovale* infections, some tissue parasites remain “dormant” (latent forms or hypnozoites) before they proliferate and produce relapses of erythrocytic infection months to years after primary infection.

Mature tissue schizonts rupture in the liver thereby releasing thousands of merozoites; thence, they enter the circulation, and invade erythrocytes (erythrocytic stage or cycle of infection). In red blood cells, parasites undergo asexual development from young ring forms to trophozoites and then to mature schizonts that release several merozoites after erythrocytes being ruptured more or less synchronically. This process produces the febrile clinical attack. The released merozoites invade other naive erythrocytes to continue the cycle, which may proceed until death of the host or interruption by antimalarials or modulation by acquired immunity will occur. Some erythrocytic parasites differentiated into sexual forms, male microgametocytes and female macrogametocytes.

During the blood meal, the female mosquito ingests gametocytes, and syngamy (fertilization of the macrogamont by a microgamont) occurs in the mosquito's gut. The resulting sedentary zygote transforms to a motile ookinete. Ookinetes are specialized cells able to actively leave the packed blood bolus and invade the mosquito midgut epithelial tissue to reach the hemolymph side and develop as oocyst. In the oocyst, the parasites multiply to sporozoites, which later invade the salivary gland and are subsequently inoculated into another human host during blood meal. Ookinete motility, secretion of chitinase, resistance to the digestive enzymes, and recognition/invasion of the midgut epithelium all may play crucial roles in the transformation to oocyst. A number of target ookinete-stage antigens are currently on the list of malaria transmission-blocking vaccines, and monoclonal antibodies to both Pfs25 and Pfs28 block oocyst development. Pfs25 is at the initial stage of human trials.

### Global Control Programs

The **prevalence** of malaria is increasing, and in 1998, more patients suffered from malaria than in 1958. According to the World Health Organization (WHO), more than 500 million people are infected with malaria parasites each year and more than 2 million – mostly **children** living in sub-Saharan Africa – die of it. These often quoted figures of malaria-related deaths per year among African children under the age of 5 years originated from analyses of malaria transmission intensities in sub-Saharan Africa, which are typically 1 or 2 orders of magnitude greater than those that occur in most other malaria-endemic regions of the world. With the attainment of age- and exposure-acquired protective immunity, there is a rapid decline in the incidence of malaria infection associated with high clinical tolerance and virtually no case fatalities after the ages of 10–15 years. In south Asian regions malaria **transmission intensities** are not only typically much

lower than those in much of tropical Africa, leading to a very different age distribution of disease, but the health systems for managing the malaria problems are also substantially different. Rapid case treatment appears to be the most suitable measure to save lives at risk under virtually all circumstances of malaria transmission. Where effective early treatment is the main tool in reducing malaria mortality, the emergence of **resistance to antimalarial drugs** is a major concern. High levels of resistance (RIII), especially to drugs such as chloroquine, pyrimethamine-sulfadoxine, and mefloquine (Fansidar, Fansimef, [Table 1](#)), for example, in Vietnam, have been associated with increases in malaria-related deaths. Meanwhile, drug resistant strains of *P. falciparum* are spreading to new territories, including India, South America, and the Far East; also the *Anopheles* mosquito vector is gaining greater resistance to insecticides. Antimalarial drugs such as chloroquine, antifolates, and mefloquine ([Table 2](#)) are becoming frequently less effective against *P. falciparum* and *P. vivax*, the principal infectious agents of malaria. To successfully tackle these serious problems, **malaria research** appears to be drastically underfunded compared to other diseases, such as HIV or asthma. It is suggested that the results of research have not been sufficiently exploited. On the other hand, obstacles to better exploitation, according to the survey, include poor orientation of research programs to practical problems and public needs. Topics having the best prospects for advancing understanding over the next years were the genetics and biology of *Plasmodium* and disease epidemiology. Thus many **vaccine projects** have failed after promising starts and malaria researchers say prospects for a workable vaccine are still a long way off.

The **new global strategy** for malaria control moves away from several outmoded concepts inherited from the times when eradication of malaria still seemed feasible. Particular attention is given to the need for disease-oriented programs, with a reduction of mortality and morbidity. Technical elements of these programs include the provision of **early diagnosis and prompt treatment**, the selective use of sustainable preventive measures, the prevention and control of epidemics, and the strengthening of local capacities in basic and applied research. Some of these issues are development of drug packaging systems at a district level to improve dosing and compliance, better collaboration between public and private sectors to improve case management of malaria particularly childhood illness and improved supervision of drug vendors by district pharmacies. One issue is to replace chloroquine by inexpensive drugs such as pyronaridine and short half-life antifolate drugs ([Table 1](#)). Evaluation and development of pyronaridine up to registration including

**Malariacidal Drugs. Table 2** Treatment and prevention of malaria in humans

Nonproprietary name	Brand name other information	Adult dosage/*pediatric dosage (mg/kg b.w., or total dose/individual, oral route), miscellaneous comments (for adverse effects of drugs see also Table 1)
<b>Malaria parasites:</b> <i>Plasmodium falciparum</i> (malignant tertian malaria), <i>P. vivax</i> , <i>P. ovale</i> (benign tertian malaria), <i>P. malariae</i> (quartan malaria)		
<b>TREATMENT OF CHLOROQUINE-RESISTANT FALCIPARUM MALARIA</b>		
chloroquine-resistant <i>P. falciparum</i> occur in all malarious areas except Central America west of the Panama Canal Zone, Mexico, Haiti, the Dominican Republic, and most of the Middle East (chloroquine resistance has been reported in Yemen, Oman, Saudi Arabia, and Iran); a detailed guide to the management and treatment of different forms of malaria is given in 'Practical Chemotherapy of Malaria'		
<b>atovaquone</b> plus <b>proguanil</b>	<b>drugs of choice:</b> <b>*Mepron</b> (GSK) <b>*Paludrine</b> (Wyeth Ayrest, Astra Zeneca)	atovaquone: 1,000 mg qd × 3d; *11–20 kg: 250 mg; 21–30 kg: 500 mg; 31–40 kg: 750 mg; adverse effects may be frequent rash, nausea, and vomiting, occasionally diarrhea proguanil: 400 mg qd × 3d; *11–20 kg: 100 mg; 21–30 kg: 200 mg; 31–40 kg: 300 mg; occasional
	adverse effects may be oral ulceration, hair loss, scaling of palms and soles, urticaria, rare: hematuria: (large doses), vomiting, abdominal pain, diarrhea (large doses), thrombocytopenia	
<b>atovaquone/proguanil (A/P)</b> should not be given to pregnant women	<b>*Malarone</b> (GSK, Cascan) dose regimen for adults: 1g A/400 mg P, single dose daily for 3d; pediatric dose is based upon body weight	Malarone: atovaquone/proguanil may be available outside the USA in a fixed dose combination tablet (250 mg atovaquone/100 mg proguanil for adults; pediatric tablets: 62.5 mgA/25 mg P)
<b>quinine sulfate</b> plus <b>doxycycline</b> or tetracycline (TC)	<b>drugs of choice</b> (many manufacturers)  dose/regimens for TC: 250 mg qid × 7d; *6.25 mg/kg qid × 7d	quinine: 650 mg q8h × 3–7d; *30 mg/kg/d in 3 doses × 3–7d; in Southeast Asia, relative resistance to quinine has increased and the treatment should be continued for seven days doxycycline: 100 mg bid × 7d; *4 mg/kg/d × 7d (slow acting drug); drug is contraindicated in pregnancy and in children less than 8 years old; doxycycline can cause GI disturbances, vaginal moniliasis (candidiasis), and photosensitivity reactions
<b>quinine sulfate</b> plus <b>clindamycin</b> <b>contraindications:</b> quinine: G-6-PD deficiency, optic neuritis, tinnitus, history of blackwater fever, pregnancy, thrombocytopenic purpura	<b>drugs of choice</b> many manufacturers	quinine: 650 mg q8h × 3–7d; *30 mg/kg/d in 3 doses × 3–7d; in Southeast Asia, relative resistance to quinine has increased and the treatment should be continued for 7 days clindamycin: adult and children: 20 mg/kg/d in 3 doses × 7d; side effects may be allergic reactions, diarrhea (enterocolitis, ulcerous colitis), hepatotoxicity, occasionally hypotension, ECG changes
<b>quinine sulfate</b> plus <b>pyrimethamine-sulfadoxine</b> do not use if you are: • allergic to pyrimethamine • pregnant or breast feeding • or you have kidney or liver/ blood problems (anemia due to folate deficiency) • or patient is <2 months of age	<b>alternatives:</b> (many manufacturers) <b>*Fansidar</b> (Roche) it may cause low blood sugar in diabetes patients; common side effects are diarrhea, dizziness, headache, nausea, vomiting	quinine: 650 mg q8h × 3–7d; *30 mg/kg/d in 3 doses × 3–7d; in Southeast Asia, relative resistance to quinine has increased and the treatment should be continued for 7 days Fansidar: 3 tablets at once on the last day of quinine; *<1 year: ¼ tablet; 1–3 yrs: ½ tablet; 4–8 yrs: 1 tablet; 9–14 yrs: 2 tablets; Fansidar tablets contain 25 mg of pyrimethamine and 500 mg of sulfadoxine; resistance to pyrimethamine–sulfadoxine has been reported from Southeast Asia, the Amazon basin, sub-Saharan Africa, Bangladesh, and Oceania
<b>ALTERNATIVE DRUG REGIMENS FOR TREATING MULTIDRUG-RESISTANT FALCIPARUM MALARIA</b>		
for treatment of multidrug-resistant <i>P. falciparum</i> in Southeast Asia, especially Thailand, where resistance to mefloquine and halofantrine is frequent, a 7-day course of quinine and tetracycline is recommended, artesunate plus mefloquine, artemether		

**Malariacidal Drugs. Table 2** Treatment and prevention of malaria in humans (Continued)

Nonproprietary name	Brand name other information	Adult dosage/*pediatric dosage (mg/kg b.w., or total dose/individual, oral route), miscellaneous comments (for adverse effects of drugs see also Table 1)
<p>plus mefloquine or mefloquine plus doxycycline are also used to treat multiple-drug-resistant <i>P. falciparum</i>; at a single high dose (1250mg) of mefloquine for adults (see below), adverse effects including nausea, vomiting, diarrhea, dizziness, disturbed sense of balance, toxic psychosis, and seizures can occur; mefloquine is teratogenic in animals and has not been approved for use in pregnancy; mefloquine prophylaxis appears to be safe when used during the second half of pregnancy and possibly during early pregnancy as well; it should not be given together with quinine or quinidine, and caution is required in using quinine or quinidine to treat patients with malaria taken mefloquine for prophylaxis; in the USA and elsewhere, the pediatric dosage has not been approved by government regulatory agencies; this may be also true for other alternative drugs as doxycycline, clindamycin, or atovaquone, including the adult dosage</p>		
<p><b>mefloquine</b></p>	<p><b>*Lariam</b> (Roche)</p>	<p>mefloquine: 1250 mg once (750 mg followed 12 hours later by 500 mg); *25 mg/kg once (15 mg/kg followed 8–12 hours later by 10 mg/kg (&lt; 45 kg b.w.); tablets: in the USA, = 250 mg = 228 MEF base, other countries 275 mg = 250 mg MEF base; resistance to MEF has been reported in some areas, such as the Thailand-Myanmar border, where 25 mg/kg should be used (adverse effects see Table 1)</p>
<p><b>halofantrine</b> <b>Warning:</b> it is not recommended for use in combinations with drugs or clinical conditions known to prolong QTc interval or in patients who have received mefloquine or known or suspected ventricular dysrhythmias</p>	<p><b>alternatives:</b> <b>*Halfan</b> (GSK) <b>Warning:</b> there have been rare reports of serious ventricular dysrhythmias sometimes associated with death, which may be sudden; should be prescribed only by physicians who have special competence in diagnosis and treatment of malaria</p>	<p>halofantrine: 500 mg q6h × 3 doses; repeat in 1 week; *8 mg/kg q6h × 3 doses (&lt; 40 kg); repeat in 1 week; halofantrine may be effective in multiple-drug-resistant <i>P. falciparum</i> malaria, but treatment failures and resistance have been reported; in adults and children, a single 250 mg dose can be used for repeat treatment in mild to moderate, there is variability in absorption; thus it should not be taken 1 hour before and 2 hour after meals because food increases its absorption; cardiac adverse reactions may be lengthening of PR and QTc intervals and fatal cardiac arrhythmias and is contraindicated in patients with cardiac conduction defects (cardiac monitoring is recommended)</p>
<p><b>atovaquone</b> plus <b>doxycycline</b></p>	<p><b>alternatives:</b> <b>*Mepron</b> many manufacturers</p>	<p>atovaquone: 1000 mg qd × 3d; *11–20 kg: 250 mg; 21–30 kg: 500 mg; 31–40 kg: 750 mg; adverse effects may be frequent rash and nausea, occasionally diarrhea</p>
<p><b>artesunate</b> plus <b>mefloquine</b></p>	<p><b>alternatives:</b> Guilin No. 1 Factory, Guangsi, China (Mepha, Aesch Basle Switzerland/Vietnam) <b>*Lariam</b> (Roche)</p>	<p>4 mg/kg/ × 3d (adult and pediatric dose); very rapidly acting drug, which may occasionally produce ataxia, slurred speech, neurological toxicity, possible increase in length of coma in severe falciparum malaria, increased convulsions, prolongation of QTc interval; for artesunate formulations see Table 1</p>
<p>mefloquine: 1,250 mg once (750 mg followed 12 hours later by 500 mg) (adverse effects see Table 1) *15 mg/kg followed 12 hours later by 10 mg/kg</p>		
<p><b>TREATMENT OF CHLOROQUINE-RESISTANT VIVAX MALARIA</b></p>		
<p><i>P. vivax</i> with decreased susceptibility to chloroquine has been reported in Papua-New Guinea, Indonesia, Myanmar; India, Irian Jaya, and the Solomon Islands</p>		
<p><b>quinine sulfate</b> plus <b>doxycycline</b></p>	<p><b>drugs of choice</b> many manufacturers</p>	<p>quinine: 650 mg q8h × 3–7d; *30 mg/kg/d in 3 doses × 3–7d; in Southeast Asia, relative resistance to quinine has increased and the treatment should be continued for 7 days</p> <p>doxycycline: 100 mg bid × 7d; *4 mg/kg/d in 2 doses × 7d (slow acting drug); drug is contraindicated in pregnancy and in children less than 8 years old; doxycycline can cause GI disturbances, vaginal moniliasis (candidiasis), and photosensitivity reactions</p>

**Malariacidal Drugs. Table 2** Treatment and prevention of malaria in humans (Continued)

Nonproprietary name	Brand name other information	Adult dosage/*pediatric dosage (mg/kg b.w., or total dose/individual, oral route), miscellaneous comments (for adverse effects of drugs see also Table 1)
<b>mefloquine</b> (for other side effects see Table 1)	<b>drug of choice</b> <b>*Lariam</b> (Roche) at this dosage there is increased risk for still birth; therefore, it should not be used for treatment of malaria during pregnancy	mefloquine: 750 mg followed 12 hours later by 500 mg; *15 mg/kg followed 8–12 hours later by 10 mg/kg (<45kg b.w.); tablets: in the USA, = 250 mg = 228 mefloquine (MEF) base, other countries 275 mg = 250 mg MEF base; resistance to MEF has been reported in some areas, such as the Thailand-Myanmar border, where 25 mg/kg should be used (adverse effects see Table 1)
<b>quinine sulfate</b> plus <b>pyrimethamine-sulfadoxine</b>	<b>drugs of choice</b> <b>*Fansidar</b> (Roche) Fansidar: 3 tablets at once on the last day of quinine; *<1 year: ¼ tablet; 1–3 yrs: ½ tablet; 4–8 yrs: 1 tablet; 9–14 yrs: 2 tablets; Fansidar tablets contain 25 mg of pyrimethamine and 500 mg of sulfadoxine; resistance to the combination has been reported from Southeast Asia, the Amazon basin, sub-Saharan Africa, Bangladesh, and Oceania	quinine: 650 mg q8h × 3–7d; *30 mg/kg/d in 3 doses × 3–7d; in Southeast Asia, relative resistance to quinine has increased and the treatment should be continued for 7 days
<b>chloroquine</b> plus <b>primaquine</b>	<b>alternatives:</b> many manufacturers	chloroquine: 25 mg base/kg in 3 doses over 48 hours; *25mg base/kg in 3 doses over 48 hours; primaquine: 30 mg base daily × 14d; *0.6 mg/kg/d × 14d; African, Asian and Mediterranean peoples, patients should be screened for glucose-6-phosphate dehydrogenase deficiency to prevent hemolytic anemia; it should not be used during pregnancy
<b>TREATMENT OF ALL PLASMODIA</b> (except chloroquine-resistant <i>P. falciparum</i> and <i>P. chloroquine</i> resistant <i>vivax</i> , see above)		
<b>CHLOROQUINE-SENSITIVE AREAS</b>		
chloroquine-resistant <i>P. falciparum</i> occur in all malarious areas except Central America west of the Panama Canal Zone, Mexico, Haiti, the Dominican Republic, and most of the Middle East (chloroquine resistance has been reported in Yemen, Oman, and Iran; <i>P. vivax</i> with decreased susceptibility to chloroquine has been reported Papua-New Guinea, Indonesia, Myanmar; India, Irian Jaya, and the Solomon Islands)		
<b>chloroquine (phosphate)</b>  ORAL ROUTE (uncomplicated or mild malaria may be treated with oral drugs)	<b>drug of choice</b> <b>*Aralen, *Resochin</b> , many others  (many manufacturers)	1g (600 mg base), then 500 mg (300 mg base) 6 hours later, then 500 mg (300 mg base) at 24 and 48 hours; *10 mg base/kg (max. 600 mg base), then 5 mg base/kg 6 hours later, then 5mg base/kg at 24 and 48 hours; if chloroquine is not available, hydroxychloroquine sulfate is as effective; 400 mg hydroxychloroquine sulfate is equivalent to 500 mg chloroquine phosphate; occasional adverse effects may be pruritus, vomiting, headache, confusion depigmentation of hair, skin eruption, corneal opacity, exfoliative dermatoses, eczema, myalgias, photophobia; rare side effects are irreversible retinal injury (may occur when total dosage exceeds 100 grams), nerve-type deafness, peripheral neuropathy and myopathy, heart block, blood dyscrasias, hematemesis (vomiting of blood)
<b>ALL PLASMODIA (ESPECIALLY SEVERE FALCIPARUM MALARIA)</b>		
exchange transfusion may be helpful for some patients with high-density (>10%) parasitemia, altered mental status, pulmonary edema, or renal complications		
<b>quinidine gluconate</b>  PARENTERAL ROUTE or	<b>drug of choice</b>	10 mg/kg loading dose (max. 600 mg) in normal saline slowly over 1–2 hours, followed by continuous infusion of 0.02 mg/kg/min until oral therapy can be started; *same as adult dose;



**Malariacidal Drugs. Table 2** Treatment and prevention of malaria in humans (Continued)

Nonproprietary name	Brand name other information	Adult dosage/*pediatric dosage (mg/kg b.w., or total dose/individual, oral route), miscellaneous comments (for adverse effects of drugs see also Table 1)
	<b>precautions:</b> continuous EKG, blood pressure, and glucose monitoring are recommended, especially in pregnant women and young children; quinidine may have greater antimalarial activity than quinine; thus the loading dose should be decreased or omitted in those patients who have received quinine or mefloquine, if >48 hours of parenteral treatment is required, the quinine or quinidine dose should be reduced by 1/3 to 1/2	
<b>quinine dihydrochloride</b> PARENTERAL ROUTE	<b>drug of choice</b>	20 mg/kg loading dose i.v. in 5% dextrose over 4 hours, followed by 10 mg/kg over 2–4 hours q8h (max 1,800 mg/d) until oral therapy can be started; *same as adult dose; for <b>precautions</b> , which should be taken see quinidine above
<b>artemether</b> PARENTERAL ROUTE (for i.m. use only)	<b>alternative drug</b>  <b>*Artenam</b> (Arenco, Belgium, other manufacturers and suppliers)	3.2 mg/kg i.m. then 1.6 mg/kg qd; *same as adult dose; occasional adverse effects may be neurological toxicity, possible increase in length of coma in severe falciparum malaria, increased convulsions, prolongation of QTc interval; <b>precautions:</b> it should not be used in pregnancy and in nursing mothers; for artemether formulations see Table 1; the artemisinin derivative has been produced by Sanofi-Aventis and Kunming Pharmaceutical Factory in China, and the UNDP/World Bank/WHO Special Program for Research and Training in Tropical Diseases (TDR), others
<b>PREVENTION OF RELAPSES</b>		
<i>P. vivax</i> and <i>P. ovale</i> (radical cure of benign tertian malaria) (cf. Table 1: hypnozoites in liver)		
<b>primaquine phosphate</b>  (it can be also used for prophylaxis, see below)	<b>drug of choice</b>  various manufacturers (in some countries not directly available in pharmacies)	26.3 mg (15 mg base)/d × 14d or 79 mg (45 mg base)/wk × 8 wks; *0.3 mg base/kg/d × 14d; some relapses have been reported with this regimen, especially in strains from Southeast Asia; relapses should be treated with a second 14-day course of 30 mg base/day;
	the drug can cause hemolytic anemia, especially in patients whose red cells are deficient in glucose-6-phosphate dehydrogenase; this deficiency is most common in African, Asian, and Mediterranean peoples; patients should be screened for G-6-P deficiency before treatment; it should not be used during pregnancy and in lactating women; occasional adverse effects may be neutropenia, methemoglobinemia, GI disturbances, rare are CNS symptoms, arrhythmias and hypertension	
<b>MALARIA PREVENTION</b>		
no drug regimen guarantees protection against malariae; if fever develops within a year, especially within the first 2 months after travel to malarious areas, travelers should be advised to consult a specialist for tropical medicine; insect repellents, insecticide-impregnated bed nets, and proper clothing are important adjuncts for malaria prophylaxis; for prevention of attack after departure from areas where <i>P. vivax</i> and <i>P. ovale</i> are endemic, which includes almost all areas where malaria is found (except Haiti), some experts prescribe in addition primaquine phosphate 26.3 mg (15 mg base) or, for children, 0.3 mg base/kg/d during the last 2 weeks of prophylaxis; others prefer to avoid the toxicity of primaquine (see above) and rely on surveillance to detect malaria cases when they occur, particularly when exposure was limited or doubtful		
<b>PREVENTION IN CHLOROQUINE-SENSITIVE AREAS</b>		
chloroquine-resistant <i>P. falciparum</i> occur in all malarious areas except Central America west of the Panama Canal Zone, Mexico, Haiti, the Dominican Republic, and most of the Middle East (chloroquine resistance has been reported in Yemen, Oman, and Iran; <i>P. vivax</i> with decreased susceptibility to chloroquine has been reported Papua-New Guinea, Indonesia, Myanmar; India, Irian Jaya, and the Solomon Islands)		
<b>chloroquine (phosphate)</b>	<b>drug of choice</b>  <b>*Aralen, *Resochin,</b> many others (many manufacturers and suppliers)	500 mg (300 mg base) once/week; *5 mg/kg base once/week, up to adult dose of 300 mg base; prophylaxis should be started one week prior to travel and continued weekly for the duration of stay and for 4 weeks after leaving; in pregnancy chloroquine prophylaxis has been used extensively
	and safely; the safety of other prophylactic antimalarials in pregnancy is less clear; for this reason, travel during pregnancy to chloroquine-resistant areas (see above) should be considered carefully	

**Malariacidal Drugs. Table 2** Treatment and prevention of malaria in humans (Continued)

Nonproprietary name	Brand name other information	Adult dosage/*pediatric dosage (mg/kg b.w., or total dose/individual, oral route), miscellaneous comments (for adverse effects of drugs see also Table 1)
<b>PREVENTION IN CHLOROQUINE-RESISTANT AREAS</b>		
chloroquine-resistant <i>P. falciparum</i> occur in all malarious areas except Central America west of the Panama Canal Zone, Mexico, Haiti, the Dominican Republic, and most of the Middle East (chloroquine resistance has been reported in Yemen, Oman, and Iran; <i>P. vivax</i> with decreased susceptibility to chloroquine has been reported in Papua-New Guinea, Indonesia, Myanmar; India, Irian Jaya, and the Solomon Islands)		
<b>mefloquine</b> is not recommended for patients with cardiac conduction abnormalities, and patients with a history of seizure or psychiatric disorders should probably avoid mefloquine; resistance to mefloquine has been reported in some areas, such as Thailand; in this areas, <b>doxycycline</b> should be used for prophylaxis; in children <8 years old, proguanil plus sulfafurazole has been used; several studies have shown that daily primaquine provides effective prophylaxis against chloroquine-resistant <i>P. falciparum</i> ; malaria prophylaxis with <b>primaquine</b> was also evaluated in Irian Jaya using 0.5 mg/kg primaquine base daily for 1 year by 126 Javanese men with normal G-6-PD activity; primaquine was well tolerated and effective for prevention of falciparum malaria (94.5%) and vivax malaria (90.4%); for prevention of attack after departure from areas where <i>P. vivax</i> and <i>P. ovale</i> are endemic, which includes almost all areas where malaria is found (except Haiti), some experts prescribe in addition primaquine phosphate 26.3 mg (15 mg base) or, for children, 0.3 mg base/kg/d during the last 2 weeks of prophylaxis; others prefer to avoid the toxicity of primaquine (see above) and rely on surveillance to detect malaria cases when they occur, particularly when exposure was limited or doubtful; <b>atovaquone/proguanil</b> (Malarone: available in the USA, Europe and elsewhere) can be used for oral prophylaxis and treatment of malaria due to blood forms of all human plasmodia, exoerythrocytic forms of <i>P. falciparum</i> , and <i>P. falciparum</i> resistant to pyrimethamine-sulfadoxine = Fansidar (SE Asia, the Amazon basin, sub-Saharan Africa, Bangladesh and Oceania) or mefloquine (significant problem in Thailand along the borders with Myanmar and Cambodia); co-administration of tetracyclines reduces plasma concentrations of atovaquone by 40 to 50%, proguanil has no known drug interactions		
<b>atovaquone/proguanil</b>	<b>drug of choice</b> <b>Malarone or Malarone</b> <b>Pediatric (GSK)</b>	250 mg/100 mg (1 tablet) daily; *11–20 kg b.w.: 62.5 mg/ 25 mg (1 tablet) daily; 21–30kg: 125 mg/50 mg daily; 31–40kg: 187.5 mg (75 mg daily; >40 kg: 250 mg/100 mg daily beginning 1–2 days before travel and continuing one week after leaving the malaria zone; it is generally well tolerated
<b>mefloquine</b> or	<b>drug of choice</b> <b>*Lariam</b>	250 mg once/week; *<5 kg: no data; 5–10 kg: 1/8 tablet; 11–20 kg: ¼ tablet; 21–30 kg: 1/2 tablet; 31–45 kg: 3/4 tablet; >45 kg: 1 tablet; tablets: in the USA, = 250 mg = 228 MEF base, other countries 275 mg = 250 mg MEF base; prophylaxis should be started one week prior to travel and continued weekly for the duration of stay and for 4 weeks after leaving; the pediatric dosage has not been approved in the USA and elsewhere, and the drug has not been approved for use during pregnancy; it has been reported to be safe for prophylactic use during the second-half of pregnancy and possibly during early pregnancy as well; however, these may be increased for stillbirth if used for treatment of malaria; women should take contraceptive precautions while taking mefloquine and for 2 months after the last dose
<b>doxycycline</b> or	<b>drug of choice</b>	100 mg daily; *2 mg/kg/d, up to 100 mg/day; drug is contraindicated in pregnancy and in children less than 8 years old; prophylaxis should be started one week prior to travel and continued weekly for the duration of stay and for 4 weeks after leaving; doxycycline can cause GI disturbances, vaginal moniliasis (candidiasis), and photosensitivity reactions
<b>primaquine</b>	<b>alternatives</b>	0.5 mg/kg base daily; *same as adult; the drug can cause hemolytic anemia, especially in patients
whose red cells are deficient in glucose-6-phosphate dehydrogenase; this deficiency is most common in African, Asian, and Mediterranean peoples; patients should be screened for G-6-P deficiency before treatment; it should not be used during pregnancy and in lactating women; occasional adverse effects may be neutropenia, methemoglobinemia, GI disturbances, rare are CNS symptoms, arrhythmias and hypertension		
<b>chloroquine phosphate</b> plus	<b>alternatives</b> <b>*Aralen</b> <b>*Resochin, others</b>	chloroquine phosphate: 250 mg once/week; *< 5 kg: no data; 5–9 kg: 1/8 tablet; 10–19 kg: ¼ tablet; 20–30 kg: 1/2 tablet; 31–45 kg: 3/4 tablet; >45 kg: 1 tablet

**Malariacidal Drugs. Table 2** Treatment and prevention of malaria in humans (Continued)

Nonproprietary name	Brand name other information	Adult dosage/*pediatric dosage (mg/kg b.w., or total dose/individual, oral route), miscellaneous comments (for adverse effects of drugs see also Table 1)
pyrimethamine/sulfadoxine (for presumptive treatment) or	*Fansidar (Roche)	Fansidar: carry a single dose (3 tablets) for self-treatment of febrile illness when medical care is not immediately available; * <1 yr: ¼ tablet; 1–3 yrs: ½ tablet; 4–8 yrs 1 tablet; 9–14 yrs 2 tablets; Fansidar tablets contain 25 mg of pyrimethamine and 500 mg of sulfadoxine; resistance to the combination has been reported from Southeast Asia, the Amazon basin, sub-Saharan Africa, Bangladesh, and Oceania
proguanil widely available in Canada; England (not in the USA and elsewhere)	*Paludrine (Astra Zeneca, others)	Proguanil: 200 mg daily; * < 2 yrs: 50 mg/daily; 2–6 yrs: 100 mg/d; 7–10 yrs: 150 mg/d; >10 yrs: 200 mg; proguanil is recommended mainly for use in Africa south of the Sahara; prophylaxis is recommended during exposure and for 4 weeks afterward; proguanil has been used in pregnancy without evidence of toxicity
chlorproguanil/dapsone	*Lapdap (GSK)	fixed dose combination has been introduced in 2003; there is yet no resistance reported, however, up to now there is only limited experience on safety and efficacy
SELF-PRESUMPTIVE TREATMENT		
a traveller can be given a course of atovaquone/proguanil, mefloquine or quinine plus doxycycline for presumptive self-treatment of febrile illness; therefore the drug given should be different from that used for prophylaxis. Self-treatment should be used only if a traveller cannot promptly get to medical care		
atovaquone/proguanil	drug of choice *Malarone (GSK)	4 adult tabs daily × 3d; * < 5 kg: not indicated; 5–8 kg: 2 peds/tabs once/d × 3d; 9–10 kg: 3 peds/tabs once/d × 3d; 11–20 kg: 1 adult tabs once/d × 3d; 21–30 kg: 2 adult tabs once/d × 3d; 31–40 kg: 3 adult tabs once/d × 3d; >40 kg: 4 adult tabs once/d × 3d
OR quinine sulfate <b>plus</b> doxycycline OR plus tetracycline OR plus clindamycin	drug of choice *various manufacturers and suppliers	quinine: 650 mg 98 h × 3–7 d; *30 mg/kg/d in 2 doses × 7d; in Southeast Asia treatment should be continued for 7d (increased resistance to the drug) doxycycline: 100 mg bid × 7d; *4mg/kg/d in 2 doses × 7d tetracycline: 250 mg qid × 7d; *6.25 mg/kg qid × 7d clindamycin: 20 mg/kg/d in 3 doses × 7d; *same dosage as adults
mefloquine	alternative drug	mefloquine: 750 mg followed 12 hrs later by 500 mg; *15 mg/kg followed 12 hrs later by 10mg/kg
artesunate plus mefloquine	alternative drugs	artesunate: 4 mg/kg/d × 3d; × same dosage as adults mefloquine: 750 mg followed 12 hrs later by 500 mg; 15 mg/kg followed 12 hrs later by 10 mg/kg

**Abbreviations:** the letter <d> stands for day (days); qd = daily (quaque die); qh = each hour every hour; qd= each day, every day; bid = twice daily; tid = 3 times per day; qid = 4 times per day (quarter in die); p.c. (post cibum) = after meals

Data given in this Table have no claim to full information. Comments on adverse effects and other properties of drugs cited in this table refer to data from literature, labels of sponsors, suppliers, manufacturers, websites such as Drugs.com, MMV, or others, and The Medical Letter: Drugs for parasitic infections, Vol 46 (issue 1189) 2004

technology transfer to Malaysia was planned targeted year 2000.

→**Vector control** is an essential component of the “Global Malaria Control Strategy,” adopted in 1992.

Existing tools for vector control, if appropriately used, can help prevent or reduce the transmission of malaria and other mosquito-borne diseases (e.g., →**Lymphatic Filariasis**). There are detailed guidelines for the use

of 4 main options: indoor residual spraying; personal protection, including **insecticide-impregnated bed-nets** and other materials (Table 2/Malaria Prevention), larviciding and →biological control, and →environmental management. Thus, efficacy trials with insecticide-treated bednets for preventing childhood mortality are on the track, thereby checking promotion of technology, implementation, definition of areas for bednets use, and cost-effectiveness consideration.

### Antimalarial Drug Development

New antimalarial agents (targets) with novel modes of action are urgently needed because of increasing drug resistance of malaria parasites in endemic areas, including cities, and islands. In recognition of this need the WHO/TDR Steering Committee on Drugs for Malaria (CHEMAL, NIH/NIAID, and MMV = 'medicines for malaria ventures') support studies from the identification of new biochemical targets for drug development to the registration of a drug, usually in partnership with a commercial company. **New drug leads** have included selection for development of one lead from 2nd generation peroxidic drugs, phospholipid and antiplasmodial protease (proteinase) inhibitors, or protein prenyl transferase inhibitors. The funding agencies have screened a series of compounds (10 mg quantities) or compound libraries against 3 malaria →proteinases, including 2 aspartic proteinases (plasmepsin I and II, similar to human cathepsin D, and 1 cysteine proteinase, →falcipain, analogous to human cathepsin L). For combinatorial libraries, enzymatically active recombinant enzyme may be provided by CHEMAL. In a study, cDNA coding for *P. falciparum* hypoxanthine-guanine-xanthine phosphoribosyltransferase has been cloned in *Escherichia coli* and purified to homogeneity to allow detailed kinetic and structural studies. Significant differences between the human and parasitic enzymes indicate that parasite-specific inhibitors are feasible. →Tubulin as a potential drug target is of interest and several microtubule inhibitors are potent blockers of various stages of development of *Plasmodium*. Most compounds have been derived from anticancer screening programs as cholchicine-site binders (e.g., cholchicine, colcemid, and anthelmintic benzimidazole carbamates, cf. →Nematocidal Drugs, Man), vinblastine-site binders (vinblastine and vincristine), taxoids (taxol, taxotere), and others (*cis*- and *trans*-tubulazole, and trifluralin). Though trifluralin proved much less toxic than the other microtubule inhibitors, indications of carcinogenicity and modest tolerability preclude its development as an antiprotozoal drug.

**Currently used drugs** (Table 2), particular successors to chloroquine have not always met the expectations

left by this remarkable compound characterized by low price, low toxicity, optimal pharmacokinetic properties providing safe prophylactic and therapeutics antimalarial activity against all 4 species of *Plasmodium* that infect humans. Derivatives of artemisinin and new formulations of them (artemether, arteether, and sodium artesunate, Table 1) with potent activity against erythrocytic stages of *P. falciparum* and *P. vivax*, which is at least as effective as the parent compound, are on the target list for further clinical development. Applied field research with artemether has been performed in developing countries (and France) for use of the drug in childhood →cerebral malaria, and clinical development of injectable (i.m.) arteether is going on with promising results concerning efficacy, tolerability, and pharmacokinetics in patients with severe malaria. Some artemisinin-type compounds (artelinic acid, trioxane, and tetraoxane analogues) and combinations of benflumetol (a fluoromethanol synthesized in China) plus artemether or mefloquine plus artesunate are at an advanced stage of preclinical or clinical development or already in use for chloroquine-resistant *falciparum* malaria. The development of arteflene was discontinued because of a disappointing blood schizontocidal activity against *falciparum* malaria (Table 1). Alternative antifolate combinations with sulfonamides and sulfones exhibiting shorter half-lives than pyrimethamine-sulfadoxine have been studied, e.g., proguanil analogue WR 250417 showing high activity against pyrimethamine-resistant strains of *P. falciparum*. Atovaquone, a hydroxynaphthoquinone (Tables 1, 2), which has novel mode of action, can be used in coadministration with either tetracycline or proguanil to cure multiresistant *falciparum* malaria. A new 8-aminoquinoline (WR 238605 tafenoquine) proved to be more active but less toxic than primaquine. Several plant (root) extracts isolates in China protected mice against *P. berghei* and *P. yoelli* infections, and revealed shikimate pathway in *P. falciparum* may give some hope to new selective therapeutic options and possibly targeted drug development.

In addition, existing validated targets of antifolates such as pyrimethamine or proguanil (e.g., resistance of *P. falciparum* resulting from point mutations of the DHFR domain of the bifunctional thymidylate synthase with mutations at residues 51, 59, 108, and 164), and still unknown targets of →quinoline antimalarials (e.g., precise mode of action and mechanism of parasite resistance to these drugs are still not completely understood), or several other identified enzymes from a number of biochemical pathways in *P. falciparum* have been proposed to be potential drug targets, though few of them have been validated. Possibly **new tools and technologies** (e.g., transfection, DNA microassays, and proteomic analysis) and the availability of

DNA sequences generated by the Malaria Genome project along with more classic approaches (*in vitro* and *in vivo* screening of compounds) will facilitate the development of new antimalarials as well as the generation of a deeper understanding of the molecular mechanism(s) of drug resistance in malaria.

---

## Malarial Parasites

→ [Plasmodium](#), → [Malaria](#).

---

## Malarone

→ [Malariacidal Drugs](#).

---

## Malate Dismutation

→ [Energy Metabolism](#).

---

## Malathion

### Chemical Class

Organophosphorous compounds (dithiophosphate).

### Mode of Action

Acetylcholine esterase inhibitor. → [Ectoparasiticides – Agonists and Antagonists of Cholinergic Transmission](#), → [Insecticides](#), → [Ectoparasitocidal Drugs](#).

---

## Male Male Competition

→ [Behavior](#).

---

## Mallophaga

Group of → [Lice](#) feeding on skin, keratinous substances of feathers and hairs, and dermal secretion fluids, while → [Anoplura](#) suck blood. Biting lice (from Greek: *mallos* = Kiefer, *phagein* = eat) are found in the hair of vertebrates and in/on the feathers of birds. Important species are listed in ([Table 1](#)) → [Mallophagidosis](#). Morphologically they can be easily differentiated from blood-sucking → [Lice](#) by the fact that their head is broader than the breast (thorax), ([Figs. 1–5](#), pages 770, 771). In humans Mallophaga are only occasionally found in those working with infected animals.

### Symptoms of Disease

Itching, loss of hair or feathers.

---

## Mallophagidosis

Disease due to infestation with species of → [Mallophaga](#), see ([Table 1](#), page 772).



**Mallophaga. Figure 1** LM of *Trichodectes canis* (dog).

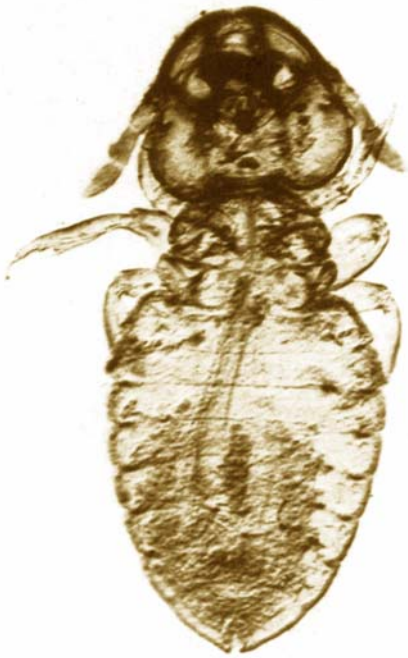

**Mallophaga.** Figure 2 DR of *Bovicola bovis* (cattle).



**Mallophaga.** Figure 4 SEM of *Stenocrotaphus* sp. (chicken, birds).

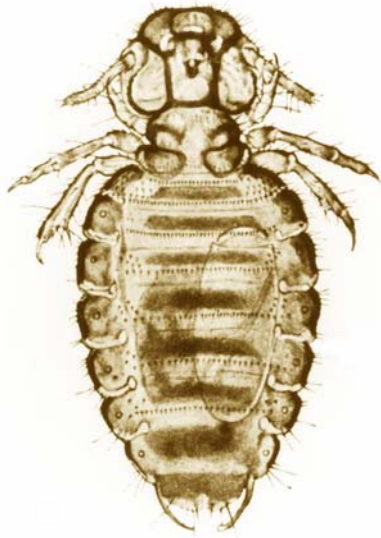

**Mallophaga.** Figure 3 LM of *Werneckiella equi* (horse).

## Malnutrition

Symptom mostly seen in children infected with  
 → *Giardia*, → *Ascaris*, → hookworms, → trichuriasis,  
 marasmus, kwashiorkor.



**Mallophaga.** Figure 5 SEM of *Menopon gallinae* (chicken, birds).

**Mallophagidosis. Table 1** Important Mallophaga and control measurements

Parasite	Host	Vector for	Symptoms	Country	Therapy		
					Products	Application	Compounds
<i>Trichodectes canis</i>	Dog	<i>Dipylidium caninum</i>	Alopecia, eczema, secondary bacterial infections	World-wide	Advantage (Bayer)	Spot on	Imidacloprid
					Defend Just-For-Dogs Insecticide (Schering Plough)	Spray	Pyrethrin + Permethrin + Piperonylbutoxid + N-octyl bicycloheptene dicarboximide
					Bolfo Flohschutz-Puder (Bayer)	Dermal powdering	Propoxur
					Front line (Merial)	Spot on	Fipronil
<i>Felicola subrostratus</i>	Cat	<i>Dipylidium caninum</i>	Alopecia, eczema, secondary bacterial infections	World-wide	Advantage (Bayer)	Spot on	Imidacloprid
					Defend Just-For-Dogs Insecticide (Schering Plough)	Spray	Pyrethrin + Permethrin + Piperonylbutoxid + N-octyl bicycloheptene dicarboximide
					Bolfo Flohschutz-Puder (Bayer)	Dermal powdering	Propoxur
					Elector (Elanco)	Pour on	Spinosad
<i>Bovicola bovis</i>	Cattle		Skin secretion; host-specific; strong reproduction only possible in ill or weak cattle; constant irritation	World-wide	Tiguvon Cattle Insecticide Pour on (Bayer)	Pour on	Fenthion
					Elector (Elanco)	Pour on	Spinosad
					Asuntol-Puder 1% (Bayer)	Dermal powdering	Coumaphos
<i>Bovicola caprae</i>	Goat		Itching, constant irritation	Worldwide	Sebacil Lösung	Wash, Spray	Phoxim
<i>Bovicola limbatus</i>	Goat			Rare in Europe			
<i>Lepikentron ovis</i>	Sheep		Itching, wool loss through rubbing	Worldwide	Sebacil Lösung (Bayer)	Wash, Spray	Phoxim
<i>Werneckiella equi</i>	Horse	Infectious anaemia?	Itching, strong concern, bite, and rubbing wounds	Worldwide			
<i>Lipeurus caponis</i>	Chicken	–	Loss of feathers	Worldwide	Sebacil (Bayer)		Phoxim Neem extract
<i>Menopon gallinae</i>	Chicken	–	Loss of feathers	Worldwide	Mite-Stop (Alpha-Biocare)		

## Malpighamoeba mellificae

These  $5\ \mu\text{m} \times 15\ \mu\text{m}$ -sized [amoeba](#) are found in the intestine of bees. They may show a flagellum, often they introduce diarrhoea, and thus lead to weakening or death of the infected bee. Transmission occurs via cysts ([Fig. 1](#)) during feeding of the larvae bees by worker-bees.

### Therapy

unknown.

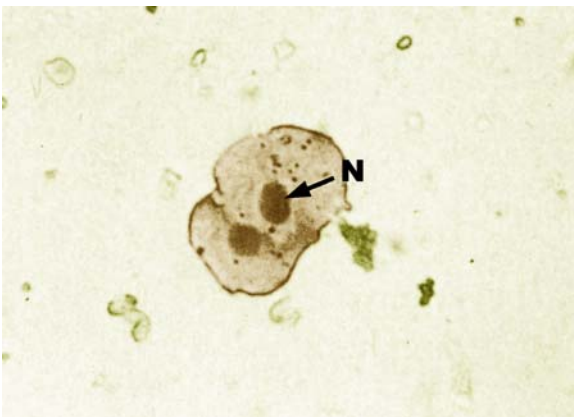

**Malpighamoeba mellificae.** [Figure 1](#) LM of an encysted amoeba with 2 nuclei from a honey bee.

## Malpighi, Marcello (1628–1694)

Italian physician, one of the founders of the scientific microscopy, describer of many parasites, and of the excretory system of insects (Malpighian tubes).

## Malpighian Tubes

Excretory system of [insects](#), [mites](#), [ticks](#).

## MALT

Mucosa associated lymphoid tissue ([Immune Responses](#)).

## Maltese Cross Stage

Dividing stage of small [Babesia](#) species (e.g., *B. divergens*) giving rise simultaneously to 4 merozoites inside the host erythrocytes.

## Mammillae

Conical or truncated integumental elevations covering the body and the legs of [Ornithodoros ticks](#).

## Mammomonogamus laryngeus

[Nematode](#), [Respiratory System Diseases](#), [Ruminants](#).

## Mandibulata

### Classification

Subphylum of [Arthropoda](#).

Arthropods with antennae have been placed within the subphylum Mandibulata, thus named because the first postoral appendages are mandibles ([Arthropoda/System](#)).

## Mange, Animals

Skin disease in animals caused by digging [mites](#) such as [Sarcoptes](#) spp. which make funnels in the skin that become inflamed due to secondary bacterial invasion ([Acariosis, Animals](#)) of other mites (see below).

### Cheyletiellosis

See [Table 1](#).

### Demodicosis

See [Table 2](#).

### Trombiculidiasis

See [Table 3](#).



**Mange, Animals. Table 1** *Cheyletiella* species

Parasite	Host	Symptoms	Country	Therapy		
				Products	Application	Compounds
<i>Cheyletiella yasguri</i>	(young) Dog	Blood loss, dermatitis	Worldwide	Many	Bathing	Pyrethroids
<i>Cheyletiella blakei</i>	(young) Cat			Stronghold	Spot on	Selamectin
				Advocate/ Advantage Multi (Bayer)	Spot on	Moxidectin + Imidacloprid

**Mange, Animals. Table 2** *Demodex* species of animals

Parasite	Host	Symptoms	Country	Therapy		
				Products	Application	Compounds
<i>Demodex canis</i>	Almost only young Dogs	Local - generalized dermatitis/alopecia	Worldwide	Ectodex (Intervet)	Bathing	Amitraz
				Mitaban pfizer	Bathing	Amitraz
				Advocate/ Advantage Multi (Bayer)	Spot on	Moxidectin + Imidacloprid
<i>Demodex bovis</i>	Cattle	Often subclinic, no itching, pea-sized nodules, leather damages (economic loss)	Worldwide			
<i>Demodex ovis</i>	Sheep	Often subclinic, hardly itching, often round the eyes, vulva and prepuce	Worldwide			
<i>Demodex caprae</i>	Goat		Worldwide (Switzerland, France)			
<i>Demodex equi</i>	Horse	Often subclinic, hardly itching; transfer only from mother to foal; starts at head, then possibly generalization, (secondary bacterial infections)	Worldwide			
<i>Demodex caballi</i>	Horse	Primarily eye (Meibom gland)	Worldwide			
<i>Demodex suis</i>	Pig	Rare; hardly itching, transfer via contact	Worldwide	Point-Guard Miticide/ Insecticide	Pour-on	Amitraz

**Mange, Animals. Table 3** Trombiculid species

Parasite	Host	Symptoms	Country	Therapy		
				Products	Application	Compounds
<i>Neotrombicula autumnalis</i>	Dog, cat, <b>man</b> , horse, ruminants	Itching, secondary bacterial infections	Worldwide	Kiltix (Bayer)	Collar	Flumethrin/ Propoxur
				Bayticol (Bayer)	Spray	Flumethrin
<i>Neotrombicula desaleri</i>	Ruminants	No transfer from contact, transfer from plant to animal; often under the tail (cattle), nose (sheep), ears (goat); red stains	Worldwide			
<i>Neoschöngastia xerothermobia</i>	Ruminants					
<i>Trombicula akamushi</i>	Dog, cat, cattle, <b>man</b>	Rare, itching, secondary bacterial infections	India, Japan, China, Pacific Islands, North Australia			

**Mange, Animals. Table 4** *Otodectes* species and control measurements

Parasite	Host	Symptoms	Country	Therapy		
				Products	Application	Compounds
<i>Otodectes cynotis</i>	Dog, cat	Ear mange, itching, inflammation, "Otitis externa parasitaria" (ear cancer), sometimes generalized	Worldwide	Ultra Ear Miticide (A.H.A.)	otic	Rotenone
				Advocate/ Advantage Multi (Bayer)	Spot on	Moxidectin + Imidacloprid

**Mange, Animals. Table 5** *Notoedres* species and control measurements

Parasite	Host	Symptoms	Country	Therapy		
				Products	Application	Compounds
<i>Notoedres cati</i>	Cat	Head, all ages, mange symptoms	Worldwide	Stronghold Revolution (Pfizer)	Spot on	Selamectin

### Otodectic Mange

See [Table 4](#).

### Notoedric Mange

See [Table 5](#).

### Sarcoptic Mange

See [Table 6](#).

### Psoroptic Mange

See [Table 7](#).

### Chorioptic Mange

See [Table 8](#).

### Psoergatic Mange

See [Table 9](#).

### Pneumonyssoidic Mange

See [Table 10](#).

## Mange, Man

Skin disease in animals caused by digging →mites such as →*Sarcoptes* spp. which make funnels in the epidermis that becomes inflamed due to secondary bacterial invasion (→*Acariosis, Animals*, →*Scabies*).

## Mange Mites

The parasitic →mites of the families →*Sarcoptidae* and →*Psoroptidae* which generally give rise to well-defined dermatoses (→*Skin Diseases, Animals/Arthropods*, →*Mange, Animals*).

## Mannitol Cycle

→*Energy Metabolism*.

## Manson, Patrick, Sir (1844–1922)

English physician ([Fig. 1](#), page 778), who described in 1878 in China that the →*Wuchereria-larvae* are transmitted by mosquitoes and in 1881 that →*Paragonimus* has snails as intermediate hosts. In 1899 he became the first director of the London School of Tropical Medicine.

## Mansonella

Genus of the nematode family →*Filariidae* (subfamily *Onchocercinae*). The unsheathed microfilariae (200 μm × 4 μm) of *Mansonella perstans* occur in the blood of humans and dogs in South and Central America as well as in Africa. The adults (7 cm) live in the body cavity. The microfilariae of *M. streptocerca* are found in the subcutaneous tissues of humans in Central Africa.

**Mange, Animals. Table 6** *Sarcoptes* species and control measurements

Parasite	Host	Symptoms	Country	Therapy		
				Products	Application	Compounds
				Advocate/ Advantage Multi (Bayer)	Spot on	Moxidectin + Imidacloprid
<i>Sarcoptes canis</i>	Dog, <b>man</b>	Head, ear (peripheral), ridge of the nose, eye, lower abdomen, area inside the thigh, itching, later hyper- and parakeratosis, secondary bacterial infections	Worldwide	Rotenone Shampoo (Goodwinol)	Shampoo	Rotenone
<i>Sarcoptes bovis</i>	Cattle	Starts often at head, then generalization; alopecia, hyperkeratosis, wrinkling, secondary bacterial infections economic loss	Worldwide	Ivomec 1% Injection For Cattle (Merial)	Injection	Ivermectin
				Dectomax (Pfizer)	Injection	Doramectin
				Sebacil Lösung (Bayer)	Wash, Spray	Phoxim
<i>Sarcoptes ovis</i>	Sheep	Often only head, secondary bacterial infections	Worldwide	Cydecetine injectable (Fort Dodge)	Injection	Moxidectin
<i>Sarcoptes rupicaprae</i> (= <i>S. caprae</i> )	Goat	Head mange	Worldwide			
<i>Sarcoptes equi</i>	Horse, <b>man</b> (pseudoscabies)	Starts often at head, then generalization; alopecia, hyperkeratosis, wrinkling, secondary bacterial infections	Worldwide			
<i>Sarcoptes suis</i>	Pig, <b>man</b> (pseudoscabies)		Worldwide	Ivomec 0.27% Sterile Solution (Merial)	Injection	Ivermectin
				Point-Guard Miticide/ Insecticide (Intervet)	Pour-on	Amitraz
				Sebacil Pour-on (Bayer)	Pour-on	Phoxim

Vectors are →biting midges, →Culicoides. The genus *Mansonella* is named in honour of Patrick →Manson in 1891, who also discovered in 1878 that the mosquito is involved in the transmission of lymphatic filariasis (in South America). Infections with *M. perstans* and *M. ozzardi* mostly do not lead to symptoms of disease, while *M. streptocerca* induces pruritic dermatitis.

## Mansonia

Genus of the dipteran family Culicidae (mosquitoes). In Europe *Mansonella richiardii* occurs, reaching the size of *Culex* spp. The species of this genus are

characterized by the fact that the larvae and pupae do not come at the surface of their water habitat in order to take up oxygen, but they take up oxygen by biting into air capillaries of water plants. Biting time of the females is late afternoon until 11 p.m. There is in general, only one generation per year. The adults are easily recognised by their speckled wings, the veins being covered with broad, asymmetrical, pale and dark scales (Fig. 1, page 778), and by their white-banded legs. *M. titillans* is in Central and South America the most important man-biter. It acts as vector of the virus of the Venezuelan equine encephalomyelitis. *M. uniformis* (belonging to the subgenus *Mansonioides*) occurs from West Africa through India eastwards to Japan till the Australian region. This species is the vector of the Brugian →filariasis in India and Southeast Asia (together with *M. annulata*, *M. indiana*). The agents

**Mange, Animals. Table 7** *Psoroptes* species and control measurements

Parasite	Host	Symptoms	Country	Therapy		
				Products	Application	Compounds
<i>Psoroptes ovis</i> (syn. <i>P. bovis</i> )	Ruminants	Cattle-sheep transfer possible, itching, symptoms see <i>Sarcoptes bovis</i> , large economic significance in sheep	Europe	Co-Ral 25% Wettable Powder (Bayer)	Dip or Spray	Coumaphos
				Ivomec 1% Injection For Cattle (Merial)	Injection	Ivermectin
				Dectomax (Pfizer)	Injection	Doramectin
				Sebacil Lösung (Bayer)	Wash, Spray	Phoxim
				Cydectin (Bayer)	Injection	Moxidectin
<i>Psoroptes cuniculi</i>	Goat	Ear Mange, often young (>3 weeks) lambs	Worldwide			
	Horse	Ear				
<i>Psoroptes equi</i>	Horse	Primarily in thick hair, protected areas (e.g., beginning of tail, under the mane), itching, symptoms see <i>Sarcoptes bovis</i> , large economic significance in sheep	Worldwide			

**Mange, Animals. Table 8** *Chorioptes* species and control measurements

Parasite	Host	Symptoms	Country	Therapy		
				Products	Application	Compounds
<i>Chorioptes bovis</i> (Leg mange, tail mange)	Ruminants	Starts often at tail, eat flakes; foot mange in sheep	Worldwide	Sebacil Lösung (Bayer)	Wash, Spray	Phoxim
	Horse	Clinical symptoms rare (foot mange)				

**Mange, Animals. Table 9** *Psoergates* species and control measurements

Parasite	Host	Symptoms	Country	Therapy		
				Products	Application	Compounds
<i>Psoergates ovis</i>	Sheep	Loss of wool (economic problem)	Australia, New Zealand, South Africa, South America	Sebacil Lösung (Bayer)	Wash, Spray	Phoxim

**Mange, Animals. Table 10** *Pneumonyssinus* species and control measurements

Parasite	Host	Symptoms	Country	Therapy		
				Products	Application	Compounds
<i>Pneumonyssoides caninum</i> (Nasal mite)	Dog	Chronic sneezing, epistaxis	Worldwide	Intercepton (Novartis)	Oral	Milbemycin, Oxime

of Bancroftian filariasis may also be transmitted by *M. uniformis* in Western Papua New Guinea. → [Diptera](#), → [Filaridae](#), → [Mosquitoes](#).

## Manubrium

From Latin: *manubrium* = grip, handhold; mouthpart in different organisms (e.g., fish lice).



**Manson, Patrick, Sir (1844–1922).** Figure 1 Painting of Sir Patrick Manson, the discoverer of the microfilariae of human filariae.

## Margaropus

Genus of poorly coloured, one-host ixodid tick, the pedipalps of which have no ridges, while the very tiny males show massive leg segments. These species do not possess festoons, their stigmal plates (peritremata) are spherical or ovoid.

## Maritrema subdolum

Very common (infestation rates of up to 50%) microphallid trematode of birds of waddens (e.g., in the Baltic Sea) using (among others) mainly *Hydrobia* snails as first and the 1–10 mm-sized amphipod *Corophium volutator* as second → [intermediate host](#). The abundance of the latter within a biotope is regulated (besides abiotic factors) via the infestation/penetration of *M. subdolum*.

## Marshallagia

Genus of trichostrongylid nematodes; *Marshallagia marshalli* lives in the rennet-bag of small ruminants in warm countries.

## Martini, Erich (1880–1960)

German physician, famous for his intensive examinations of oxyurid worms.

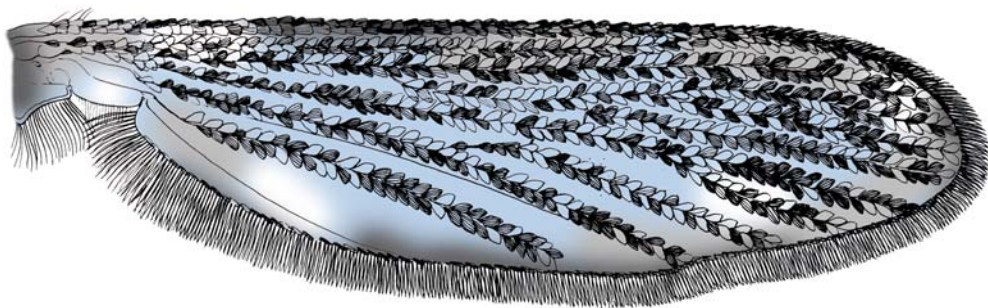

**Mansonia.** Figure 1 DR of a wing of *Mansonia* sp. showing the typical scales, which are used for diagnosis.

## Mass Screening Program

Systematical diagnosis in most individuals of a village or of a whole region, in order to get informations on the spreading of infections, e.g., on the occurrence of alveolar echinococcosis, hookworms, amebae, etc.

## Mass Treatment Program

Action to treat all inhabitants of a village or of a whole region with the same medicament in order to reduce the parasitic load by decreasing the number of excreted infectious stages, e.g., → [Schistosomiasis](#), → [Soil Transmitted Agents of Diseases](#).

## Mastigophora

### Synonym

→ [Flagellata](#).

### Classification

Subphylum of → [Sarcomastigophora](#).

### General Information

Of the heterotrophic members of this group, a large number of species have entered upon a parasitic career inside or on the surface of hosts belonging to practically all phyla of the animal kingdom. Members of the orders → [Kinetoplastida](#), → [Diplomonadida](#) and → [Diplomonadida](#) are of great medical importance for man and animals.

### System

- Subphylum: Mastigophora (Flagellata)
  - Class: Phytomastigophorea (autotrophic species)
  - Class: Zoomastigophorea (heterotrophic species)
    - Order: → [Kinetoplastida](#)
    - Order: → [Proteromonadida](#)
    - Order: → [Retortamonadida](#)
    - Order: → [Diplomonadida](#)
    - Order: → [Oxymonadida](#)
    - Order: → [Trichomonadida](#)
    - Order: → [Hypermastigida](#)

## Mate Choice

→ [Behavior](#).

## Maternal Immunity Transfer

In malaria infections newborn children are protected during the first 6 months of life as a result of the passive transfer of maternal immunity. During this period they start to develop their own immunity, if exposed to infection.

## Mathematical Modeling of Diseases

→ [Mathematical Models of Vector-Borne Diseases](#).

## Mathematical Models of Vector-Borne Diseases

Using simple mathematical → [transmission models](#) of infectious diseases, one can create and investigate dozens of epidemics in an afternoon, and nobody becomes ill and nobody dies, a feature that makes this an informative and rewarding line of epidemiologic research. Simulation programs on personal computers quickly draw pictures of epidemics and allow rapid explorations of the interactions of populations of hosts and parasites. Even simple host–parasite systems have complex dynamic behavior which initially may appear counterintuitive, but with mathematical models it is possible to educate the intuition and learn about the general behavior of an infectious agent in a particular population. Using these systems one can explore the dynamic behavior of hosts and parasites that is an inherent characteristic of the system.

In particular one can learn to anticipate particularly good or particularly unfortunate behavior of the system for human health. How might the system respond to changes in nature or acts of man? What might be the short- and long-term effects of interventions of various types at different times? Initially, one needs to learn to avoid an action that inadvertently may cause a perverse outcome, such as provoking an epidemic. Then one can explore the possible beneficial effects of different

interventions, and compare their applicability, acceptability, costs, and possible adverse effects.

There has been a curious dichotomy in the acceptability of mathematical models in sciences such as physics and engineering, where the use of such models is universal, and infectious disease epidemiology, where mathematical models have only recently been used. Newton's laws of motion are simple differential equation models that are easily tested, and every student in an introductory course in physics in secondary school verifies one of Newton's laws as a first laboratory exercise. Similarly, these mathematical models, expressed as Newton's three body problem, were essential in planning our explorations of the moon.

Scientists make predictions on the basis of theories expressed in mathematical models, and as quickly as possible seek to verify these predictions with experiments in the real world. Mathematical methods were first applied to infectious disease epidemiology by Daniel Bernoulli, who was also the author of the [→Bernoulli trial](#) in probability theory and of the Bernoulli principle in physics. The transmission of infectious agents (parasites) in populations of hosts was modeled beginning much more recently, after the development of the [→germ theory of disease](#). Until the book of Anderson and May that became an instant classic, there was little effort to gather the vast body of observational data on the occurrence of infectious diseases and epidemics and the mathematical models that might help explain them. Indeed, there is no explanation why, in most areas of science, theories expressed in mathematical models are tested against real data as soon as possible, while in the infectious disease arena such empirical testing has only recently been conducted. In this chapter we will provide readily available modern references that contain the citations to a number of the older original papers.

It is the purpose of this chapter to illustrate the use of mathematical models in understanding and controlling vector-borne diseases. This chapter is intended for biologists and field practitioners who have no special training in mathematics. We will use [→malaria](#) as the main example and we will begin with the simplest models, and add more realistic features in a stepwise fashion so the reader can understand how these models evolved over time, and begin to understand the literature.

### Vocabulary of Mathematical Modeling

Microbiologists have not used the words "microparasite" and "macroparasite" as they are used in modeling (in the Anderson and May sense), so these terms will be described here. A microparasite is not a type of creature. Rather, microparasites are whole categories of organisms, usually bacteria or viruses, that have

direct reproduction in the host, usually at high rates. Hosts are either infected or not, but a parasite burden usually has no meaning for microparasites. Microparasites generally are small, have short generation times, and usually produce long-lasting immunity against reinfection, as in measles. The duration of infection with microparasites is usually short compared with the expected lifespan of the host, so the host sees the infection as transient.

Macroparasites such as worms and one-celled organisms like malaria have no direct reproduction in the definitive host. They are larger, and have longer generation times, which may be a substantial fraction of the life expectancy of the host. When an immune response is elicited by a macroparasite, it is usually transient, and will rapidly disappear when the parasite is removed, as with chemotherapy. These infections are usually persistent, with hosts being continually reinfected, as in malaria.

By direct transmission modelers mean that the infection moves from person to person directly, with no environmental source, intermediate vector, or host. To a modeler direct transmission may take place by contact between mucous membranes as for sexually transmitted diseases, or by droplets aerosolized by a cough or sneeze, as for colds or measles. This may seem very imprecise to a biologist, but what is implied is that for directly transmitted infections one need only model the behavior of the parasites in people.

In contrast, transmission of malaria by [→mosquitoes](#) would be an example of indirect transmission. The fundamental difference is that if one is modeling malaria transmission, one has to include equations for the behavior of parasites in populations of mosquitoes and also in populations of humans. As a result, modeling indirect transmission is fundamentally more complex.

Modelers use one other term that seems odd to an epidemiologist. In epidemiology we commonly use the word density in a particular way, as in probability density or incidence density. When a modeler uses the concept of density-dependent functions it means number-dependent. If a modeler says that the occurrence of an epidemic is density-dependent, that means it depends, for example, on the actual number of susceptibles present in the population.

A concept from ecology that is central to thinking about the transmission of infectious diseases is the basic reproductive number,  $R_0$ .  $R_0$  represents the average number of secondary infections produced when a single infectious individual is introduced into a host population in which every individual is susceptible. The time implied is the entire period of infectiousness for the infected case.

For directly transmitted microparasites one is considering a system that includes infectious and

susceptible humans, but for indirectly transmitted macroparasites such as malaria, one must consider a system that includes infectious and susceptible mosquitoes as well as infectious and susceptible human populations. For indirectly transmitted infections like malaria, the value of  $R_0$  is for human to human transmission via mosquitoes.

If this reproductive number,  $R_0$ , is less than unity (one) then the infection will eventually die out and not persist in that community. There may be some secondary cases, but these will decrease with time, and eventually the infection will become extinct. If this reproductive number is exactly unity, then the infection just barely succeeds in reproducing itself, and there will be a similar number of cases at any later time. If this reproductive number is larger than unity, then the number of cases will increase with time, at least initially, and there may be an epidemic. The nature of the parasite, the nature of the host(s), and the behavior of host(s) all help determine the value for  $R_0$  for a particular infectious disease and community.

When there are some already infected, or immune, or resistant individuals in the population, then not everybody is susceptible. At that point there is a value of  $R$ , the reproductive number for the system at that point, but it is not  $R_0$ .  $R_0$  is the upper bound for the value of  $R$ , which is usually less than  $R_0$ , and the value of  $R$  may vary widely during the course of an infectious disease through a population. Remember,  $R_0$  is a characteristic of the system assuming that everybody is susceptible, while  $R$  is the value of the quantity at a particular moment, when some or possibly even most individuals are already infected, immune, or resistant.

Timing is a crucial aspect of the study of the epidemiology of infectious diseases, but symptomatology is less so. Transmission can only take place during the period when a host is infectious. There may be no symptoms associated with infection, and when symptoms do occur, they may be apparent in no particular relation to the period of transmissibility. Individuals infected with Human Immunodeficiency Virus (HIV) are asymptomatic but infectious for an average of about 10 years before they become clinically ill. In contrast, most infected with tuberculosis (TB) organisms may remain noninfectious for their entire lifetimes, while a few will develop clinical pulmonary TB after a period of months or years. Individuals infected with TB only become infectious to others when they begin to cough. These extreme differences in the behavior of HIV and TB underline the need to separate the latent and infectious periods of a disease from the →incubation period and the period of clinical disease. Infectiousness may have little to do with symptoms; an individual newly infected with →*falciparum malaria* will become symptomatic after 7–10 days, but will not become infectious to vector mosquitoes for 3 weeks.

Timing determines if transmission of an infectious disease will take place at all, and if it does, timing determines the nature of transmission. While the clinician treats the symptomatic patient, the epidemiologist seeks the infectious individual, who may not be symptomatic, or may be symptomatic at a time when he is not particularly infectious.

The incubation period is the interval from the time a person is infected until he develops clinical disease. The period of clinical disease is the period of symptoms. An infected person may never develop clinical disease, and the period of infectiousness may not correspond very well with the period of symptoms. For many childhood infections, for example, the period of greatest infectiousness is just prior to the appearance of clinical symptoms. This has important implications for control.

The latent period is the interval from the time a person is infected until he becomes infectious to others. The infectious period is the interval during which an individual can transmit an infection. As was noted above, the latent and infectious periods are variably related to clinical symptomatology, but are crucial in the study of the epidemiology and transmissibility of infectious diseases.

In this chapter we will explore mathematical models of disease transmission, as a model can represent aspects of human behavior as well as measurable demographics. As must be evident, mathematical transmission models are totally dependent on knowledge of the latent and infectious period for an infectious disease. The first model we will investigate is the classic SEIR (Susceptible, Latently infected, Infectious, Resistant or immune) model made up of 4 differential equations. There are different systems of notation used in modeling but in this chapter we will use the most common and point out confusing and conflicting notation (3–5). (FIRST CONFUSING NOTATION WARNING: the  $R$  and  $R_0$  used to represent reproductive numbers are distinct from the  $R$  used to indicate the immune or recovered state for a host.)

## Systems of Differential Equations

A differential equation is an algebraic equation that includes a derivative, which is simply a slope. A slope can do one of 3 things: it can go up, in which case it is positive; it can go down, in which case it is negative, or it can do neither or stay the same, in which case it is zero (no change). With modern simulation programs we can always look at pictures of the performance of differential equations, which translates into pictures of slopes, which in turn means one repeatedly has to answer the question, is this going up, down, or straight sideways?



As those who have studied differential equations know, writing a differential equation is easy; it is the solution that is difficult. Most interesting differential equations remain analytically insoluble for the amateur. What has made mathematical modeling readily accessible in the last decade is the existence of the personal computer with a simulation program for numerical solutions to differential equations. The program does not actually solve the equations, it just presents a picture of what they do, which is what we wanted to know anyway.

One solves an algebraic equation by solving for  $x$  in terms of  $y$  and  $z$ , and then one can draw the picture or graph. One solves a differential equation by integration in order to produce an algebraic equation which one then solves for  $x$  in terms of  $y$  and  $z$ , and then one can draw the picture or graph. The simulation program goes from the differential equations directly to the picture without any intermediate stops. We will present the 4 differential equations of the [SEIR model](#) below to describe the movement of individuals from the Susceptible state to the Latent state to the Infectious state to the Resistant or immune state. We have used this model and the SEIR notation because it is the oldest in the literature and the most commonly used (5), although Anderson and May have used X Y Z instead of S I R throughout their book. In parallel we will also consider the SEIS model as well, a model for an infection with no long-lasting immunity, that will become part of our malaria model later. In the SEIS model individuals that have recovered from the infectious stage do not become immune, and revert back to being susceptible again. That is, after recovering from infection they move back into the S compartment again.

### The SEIR Model

The classic SEIR model uses 4 derivatives or slopes with respect to time ( $t$ );

$dS/dt$  = the change in the numbers of Susceptibles (S) over time,

$dE/dt$  = the change in the numbers of Latents (E) over time,

$dI/dt$  = the change in the numbers of Infectious (I) over time, and

$dR/dt$  = the change in the numbers of Resistant (R) or immune over time.

Other quantities are used as well;

$b$  = the probability of transmission of infection per unit time,

$G$  = the duration of the latent state, in units of time,  
 $g = 1/G$  or the rate of leaving the latent state per unit time,

$D$  = the duration of infectiousness of this disease, in units of time,

$d = 1/D$  or the rate of leaving the infectious state per unit time,

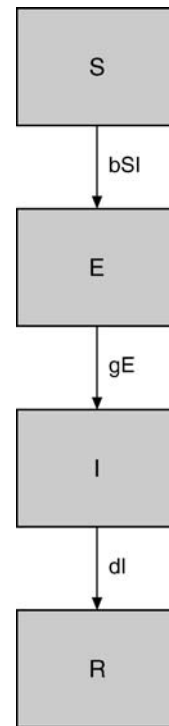

### Mathematical Models of Vector-Borne Diseases.

**Figure 1A** The compartment diagram for the 4 state SEIR model. All individuals are born susceptible into the S compartment. As they become latently infected they progress to the E compartment, and after they have passed through the latent stage they move into the infectious or I compartment. After the infectious period is over and they have developed immunity, they enter the R stage.

$m$  = birth rate or death rate or rate of entering or leaving life per unit of time.

The movement of individuals from state to state is illustrated in the accompanying compartmental diagram (Fig. 1A). Those who leave one compartment must progress into the next. Entries are (+), departures are (-), and the total number  $N = S + E + I + R$  remains constant. In the first model there are no births, no deaths, and there is no migration. The susceptibles become latently infected, the latently infected become infectious, the infectious recover, and become immune. In an epidemic the number of susceptibles will decrease as they become infected, the number of latents will increase (initially) and the infectious will follow, and the number of immune will increase as the infected recover.

$$dS/dt = -b \times S \times I$$

$$dE/dt = +b \times S \times I - E \times g$$

$$dI/dt = +E \times g - I \times d$$

$$dR/dt = +I \times d$$

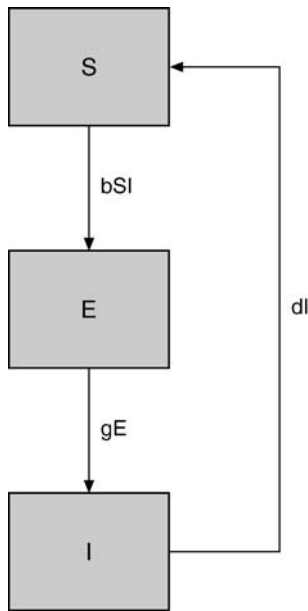

**Mathematical Models of Vector-Borne Diseases.** **Figure 1B** The compartment diagram for the 3 state SEIS model. All individuals are born susceptible into the S compartment. As they become latently infected they progress to the E compartment, and after they have passed through the latent stage they move into the infectious or I compartment. After the infectious period is over there is no long lasting immunity and they revert back to the susceptible or S stage again.

In simple algebra this set of differential equations for the SEIR model can be written as,

$$\begin{aligned} dS/dt &= -bSI \\ dE/dt &= bSI - gE \\ dI/dt &= gE - dI \\ dR/dt &= dI \end{aligned}$$

If this were a disease that produced no long-term immunity, then there would be no R state, and those who recovered from the infectious or R state would reenter the S or susceptible state. The SEIS model is given below. Here those recovering leave the infectious state as  $-dI$ , and reenter the susceptible state as  $+dI$ .

$$\begin{aligned} dS/dt &= -bSI + dI \\ dE/dt &= bSI - gE \\ dI/dt &= gE - dI \end{aligned}$$

In order to add births and deaths (vital dynamics) to the SEIR model, one would add all of the births to the susceptible state, as  $mN$  (the total population), and then subtract deaths from each state. Those dying in the S state would be  $-mS$ , those dying in the E state would

be  $-mE$ , those dying in the I state would be  $-mI$ , and those dying in the R state would be  $-mR$ .

$$\begin{aligned} dS/dt &= mN - bSI - mS \\ dE/dt &= bSI - gE - mE \\ dI/dt &= gE - dI - mI \\ dR/dt &= dI - mR \end{aligned}$$

Similarly one could add vital dynamics to the SEIS model. When exact timing is not important it is common to drop the equation relating to the latent period, and to describe epidemics in terms of SIR and SIS models. In these models without latent periods, the newly infected proceed directly from the S state to the I state. The initial malaria model created by Ross did not use latent periods, but as the need for realism increased the latent period for malaria in mosquitoes was added by MacDonald and the latent period in people was added by Anderson and May.

**An Intuitive Explanation of Rates of Entering or Leaving States**

An essential concept for modeling is the rates at which subjects enter and leave various compartments or states. If  $D$  is the duration of infection or the duration in the state I for example, and  $D$  is 7.0 days, then there is one complete turnover in the I compartment every 7 days. On average, one-seventh of those in the compartment must come out each day. That is, if the average stay in the compartment is 7.0 days, then the daily rate of recovery from infection must be  $1/7.0$ . In general the parameter for leaving that state is  $1/\text{the average duration in that state}$ . For a state with a duration  $D$ , on average  $1/D$  individuals leave per unit time.

The last change in convention is that we will call the rate of leaving,  $d = 1/D$ . This leads to the mortality rate  $m = 1/\text{average age at death}$ , or  $1/\text{age at leaving life}$ . In a stationary population when births equal deaths  $m$  is also the birth rate. Also we will have  $g = 1/\text{average duration of } \rightarrow \text{latency}$ , and  $d = 1/\text{average duration of infectiousness}$ . All must be in the same units of time. If we model in units of years, then all parameters must be in years. For example, 7 days is  $7/365$  or 0.02 years, and the transition parameter is  $1/0.02$  or 50 per year.

If the average age at death is 74 years, then  $1/74$  of the living will leave the living state and die in one year.

If the average age at infection for a disease like measles is 5 years, then one-fifth of the uninfected will leave the uninfected state and become infected in one year.

If the average latent period for *falciparum* malaria in people is 21 days, then  $1/21$  of people in the latent state will leave this state (and become infectious) in one day.

If the average duration of infectiousness for untreated TB is 5 years (60 months) then one-fifth

of the untreated will leave the infectious state by recovering or dying each year, and  $1/60$  will do so in one month. With appropriate treatment the duration of infectiousness can be reduced to 2 months, so that half will leave the infectious state in one month. If the average duration of infectiousness for untreated *falciparum* malaria is 9 months,  $1/9$  will leave the infectious state in one month. With appropriate treatment the duration of infectiousness can be reduced to one month, and all will leave the infectious state in a month. For infectious diseases chemotherapy can shorten the duration of infectiousness. This is also an example of how treatment may also be prevention for an infectious disease.

### The Law of Mass Action and Thresholds

The above models are based on the law of mass action from chemistry, in that we assume that any individual in a population is equally likely to bump into (and infect) any other individual, like gas molecules moving about in a balloon. Also, we have used S and E and I and R to represent absolute numbers of individuals rather than proportions, because this is most common in the literature, and leads to the evaluation of thresholds, or the minimum number of individuals in a population that could support an epidemic, a topic that is beyond the scope of this chapter.

### Deterministic Models versus Random Variation

All of the models in this chapter are deterministic models, meaning that they will do the same thing every time they run. Models that include random variation are called stochastic models, but stochastic models are more complex and are beyond the scope of this chapter. Stochastic models are important when populations are small.

### Expressions for $R_0$

Using algebra it is possible to show that for the SIR or SIS models without births and deaths,  $R_0$  is,

$$R_0 = bN/d,$$

from the steady-state SIR or SIS model with vital dynamics we have

$$R_0 = bN/(m + d),$$

and from the steady-state SEIR or SEIS model we have

$$R_0 = bgN : (d + m)(g + m)$$

When both the duration of the latent state,  $1/g$ , and the duration of the infectious state,  $1/d$ , are small (a few days) compared to the length of life or  $1/m$  (50 or 70 years), then all 3 expressions for  $R_0$  can be approximated as

$$R_0 \simeq bN/d.$$

## Short-Term Observation of Populations Two Kinds of Epidemics in Closed Populations

Epidemiologists who deal with acute or short-term outbreaks tend to think of these epidemics as occurring in closed populations, because few individuals are born or die, or move into or out of a community in a matter of weeks. We are faced with differentiating 2 fundamentally different types of epidemics in closed populations; propagated epidemics, and, point source epidemics.

Propagated epidemics must always result from some self-reproducing agent such as an infectious agent, while point source epidemics may be either of infectious or noninfectious etiology. Epidemics of measles are propagated epidemics as each infected individual acquires the measles virus from a person in the infectious stage who was infected in the previous generation of infection. An outbreak of salmonellosis from eating contaminated turkey at a hospital party would produce a point source epidemic with an infectious agent that all of the exposed acquired within a period of a few minutes (eating the main course). In fact, parents with salmonellosis from a point source epidemic may then go home and begin a propagated epidemic among the children in their own families.

In contrast, poisonings must all be point source epidemics, as a toxin cannot reproduce itself. This is true of bacterial toxins (staphylococcal food poisoning) as well as chemical toxins (pesticides) not of microbial origin. Staphylococcal food poisoning often takes place in the absence of living organisms because the toxin is heat stable while the bacteria are not. Cooking may well kill the bacteria and effectively sterilize the food while leaving the toxin unchanged.

### The Classical Theory of Happenings

This distinction between propagated and point source epidemics was first formulated by Ross (of malaria fame), who described propagated epidemics as “dependent happenings” because the number affected per unit time depended on the number already affected. In contrast, the number affected per unit time during an episode of poisoning was independent of the number of individuals already affected, so these Ross termed “independent happenings.”

### Indirectly Transmitted Diseases – Vectors

Consider malaria as an example of an indirectly transmitted disease, an infection transmitted to humans by a mosquito vector. Both humans and mosquitoes are considered to be born uninfected. An uninfected female mosquito has a blood meal from an infected human and becomes infected with malaria herself. After a suitable latent period she becomes infectious and has another blood meal, this time on an uninfected human, and can transmit malaria to the previously uninfected human.

The human infects the mosquito, then the mosquito infects the human. Humans do not infect other humans (except by blood transfusion), and mosquitoes do not infect mosquitoes.

### The Malaria Parasite's Guide to the Mosquito–Human Cycle

The mosquito is the definitive host for the malaria parasite. That is, sexual reproduction takes place in the mosquito. Only asexual reproduction takes place in humans. Humans can be thought of as warm, friendly, wet reservoirs in which the malaria parasite can survive during hard times for adult mosquitoes. Tropical climates have a wet season and a dry season, and during the dry season adult mosquito populations are greatly reduced, and may disappear altogether. In more temperate climates there is also substantial temperature variation and the cold season is similarly hard on adult mosquitoes. Human reservoirs are essential to tide malaria parasites over until the next season of abundance for adult mosquitoes.

Malaria parasites persist in humans waiting for those wonderful mosquitoes to return, so that the parasites can get back to sexual reproduction. In an evolutionary sense, malaria parasites are just treading water with asexual reproduction in the human. However, natural selection pressure is exerted on humans, so the gene frequency that is sampled by mosquitoes is that in surviving humans. Meanwhile, mosquitoes survive in the form of fertilized eggs, waiting to hatch into larvae when water and warmth return to their part of the earth. Both the human part and the mosquito part of the cycle are essential, but for different reasons. Both offer opportunity for intervention. Mosquitoes are seasonal in most places, so that there is usually a 6-month dry season when there are few mosquitoes and little or no malaria transmission. There are, however, some places where malaria transmission occurs throughout the year without respite.

The form of the malaria parasite that is infectious for the mosquito is the →gametocyte in man. For →falciparum malaria, gametocytes only appear in the human bloodstream about 21 days after infection, so there is a relatively long latent period from infection to infectiousness in the human. The incubation period, or time until clinical disease in a naive human is about 7–10 days for *P. falciparum* malaria, so the infected human may become severely clinically ill and die a week or more before becoming infectious to mosquitoes.

The form of the malaria parasite that is infectious for man is the →sporozoite, which is delivered from the →salivary gland of the female mosquito. After a female mosquito has a blood meal on an infectious human, sexual reproduction between ingested gametocytes takes place in the gut of the mosquito. When a human has been infected by multiple mosquitoes (a frequent →happening in endemic areas) then multiple different

broods of parasites are circulating in a single human and gametocytes from different broods are taken by a mosquito in a single blood meal. After recombination, sexual reproduction then results in sporozoites with different combinations of genes from those in either of the parent broods. There is an approximate 10-day latent period in the mosquito between the time the mosquito has an infectious blood meal from a human, and the time (after sexual reproduction) when infectious sporozoites appear in the salivary glands of the mosquito. Since this latent period may be longer than the average length of life for a mosquito, it is a relatively old and rare (lucky) mosquito that is able to infect a human.

Most malaria mosquitoes are shy, night-biting creatures that go relatively unnoticed by their human prey. While feeding, a female mosquito loads up like a tank truck, and can barely fly to the nearest vertical surface, where she spends some hours diuresing most of the fluid she has taken in so that she can move more freely and go about her business and lay eggs. It is during this period that a mosquito is most vulnerable to control measures. This is the time when residual →insecticides, such as DDT, are most effective.

To model malaria, Ross used 2 differential equations: one showing the infection of the human, and the other showing the infection of the mosquito. The simple Ross 2-differential equation model appears in textbooks, and illustrates some of the important features of malaria. At this point we have to change our conventions and our constant names to make them consistent with the malaria literature.

For SEIR, and SEIS processes described above we have used the absolute numbers of individuals in models so that we could consider eradication and numerical thresholds. With growing or shrinking populations, however, proportions are easier to manage, and for vector-borne diseases there are usually so many vectors that human thresholds do not assume much importance. Furthermore, the mosquito vector has elaborate mechanisms to locate prey, thus the name vector, so that the law of mass action is not operative for mosquito–human interactions. As you will recall, if you are enclosed in a tent or a bedroom at night with a hungry female mosquito, she will definitely find you before morning. Chance and the law of mass action are not operating here.

In the Ross model the proportion of infected humans is  $H$ , so that the proportion of uninfected humans is  $1 - H$ . The proportion of infected mosquitoes is  $m$ , so the proportion of uninfected mosquitoes is  $1 - M$ .

Absolute numbers of people and mosquitoes do not enter this equation, only the ratio,  $m$ , between the numbers of female mosquitoes and the numbers of people (CONFUSING NOTATION WARNING: unfortunately, this is another use for the letter  $m$ ,

which was used for the death rate before.) The initial value of  $m = 40$ , which would be reasonable for the rainy season.

The man-biting rate,  $a$ , is the number of bites by a female mosquito delivered on humans per day. This is determined by how often the mosquito needs to feed (the gonotrophic cycle), and whether the mosquito feeds on a human or on another mammal, like a cow or a pig. A common value is 0.25 human bites/day, or 1 meal on a person every 4 days.

The proportion of bites by infected mosquitoes on susceptible humans that produce infection in the human is  $b$ , that has been measured at 0.09.

The human recovery time is the duration of disease in a human or the time during which an infected human can infect a susceptible mosquito. For *falciparum* malaria this is in the range of 9.5 months or 285 days. The recovery rate is thus  $1/285$  or 0.0035/day.

Not all bites on infected humans produce infection in the mosquito. The fraction that do is  $c$ , or 0.47.

Although humans spontaneously recover from malaria, mosquitoes do not, and the only way mosquitoes leave the infected pool is by dying. Since an average mosquito lifetime is about eight days, the rate of leaving life for a mosquito is  $p_m$  (daily probability of dying for a mosquito) so  $p_m = 0.12$ /day.

The Ross model consists of 2 equations, one for humans and one for mosquitoes. Each equation is conceptually similar to the  $dI/dt$  equations for SIR models in that each describes entries and departures from the infectious stage.  $dH/dt$  is for infection in humans and  $dM/dt$  is for infections in mosquitoes. Also in direct analogy to the  $dI/dt$  equations, the first part of each equation describes those humans or mosquitoes becoming infectious, and the last part of each equation describes those humans or mosquitoes becoming uninfected because they recover (humans) or die (mosquitoes). The Ross model does not include latent periods so the equation for human infections represents an SIS model as humans who have recovered return to the susceptible pool, while the equation for mosquito infections represents an SI model as all infected mosquitoes die in that state. As you look at the models you will see that these are models of mosquito-human interaction (Fig. 2). The key difference between malaria models of indirect (vector) transmission and our previous models of direct transmission is that with malaria, humans infect mosquitoes and mosquitoes infect humans, but humans do not infect humans nor mosquitoes infect mosquitoes.

**The Ross Malaria Model**

$$dH/dt = a \times b \times m \times M \times (1 - H) - g \times H$$

$$dM/dt = a \times c \times H \times (1 - M) - p_m \times M$$

The Ross model is presented below in simple algebra,

$$dH/dt = abmM(1 - H) - gH$$

(This is an SIS model for people)

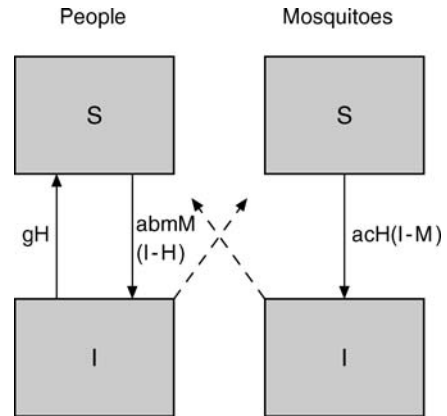

**Mathematical Models of Vector-Borne Diseases. Figure 2A** A compartment diagram for the →Ross malaria model which is an SIS model for humans and an SI model for mosquitoes. The dotted lines indicate that transmission is from infectious mosquito to susceptible human and from infectious human to susceptible mosquito.

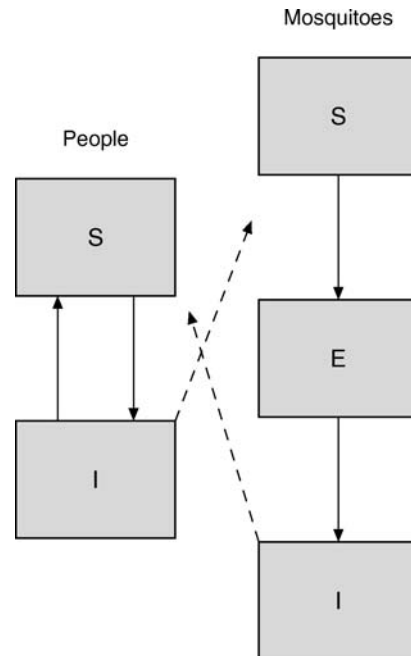

**Mathematical Models of Vector-Borne Diseases. Figure 2B** A compartment diagram for the MacDonal malaria model which is an SIS model for humans and an SEI model for mosquitoes. The dotted lines indicate that transmission is from infectious mosquito to susceptible human and from infectious human to susceptible mosquito.

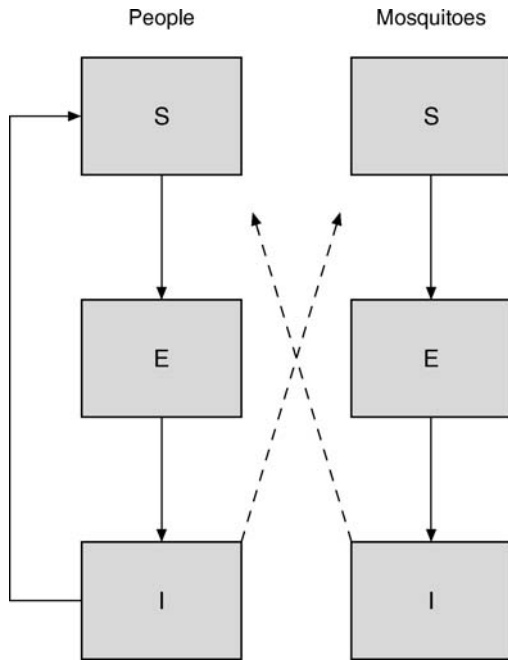

$$dM/dt = acH(1 - M) - p_m M$$

(This is an SI model for mosquitoes).

For the Ross model,

$$R_0 = ma_0^2 bc / gp_m$$

Notice that the female mosquito has to bite twice to complete the cycle, so that the  $a$  term is squared. The simple Ross model outlines the basic features of malaria, but does not consider the approximate 10-day latent period in mosquitoes nor the exponential survival of mosquitoes. As a result, the Ross model predicts a too rapid progress for a malaria epidemic in people, and much too high an equilibrium prevalence of infectious mosquitoes. The results of the Ross Model of the progress of *P. falciparum* infection when one infectious person is introduced into a community of 100 susceptible individuals is presented in Fig. 3A.

Mosquitoes that can transmit malaria have a survival pattern that is represented almost perfectly by the exponential distribution in continuous terms, or the geometric distribution in discrete terms. Models built on both distributions are common in the literature, and will be explained in parallel below. In general terms, a fixed proportion of mosquitoes survive each day (or die each day), so that a minority, even a tiny minority, survive as long as the latent period and have the potential to become infectious for humans. To transmit

**Mathematical Models of Vector-Borne Diseases.**

**Figure 2C** A compartment diagram for the Anderson and May malaria model which is an SEIS model for humans and an SEI model for mosquitoes. The dotted lines indicate that transmission is from infectious mosquito to susceptible human and from infectious human to susceptible mosquito.

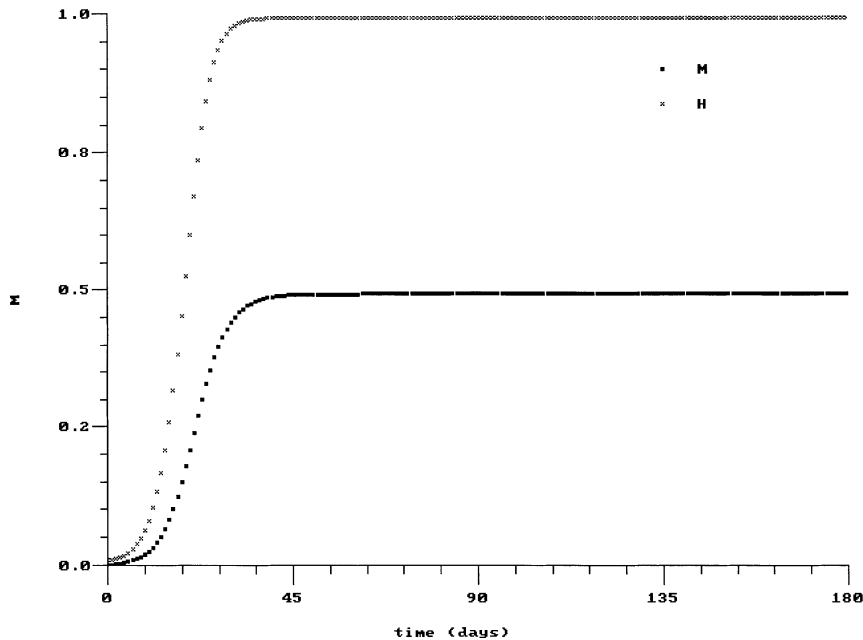

**Mathematical Models of Vector-Borne Diseases. Figure 3A–C** Results of the Ross Model, the MacDonald Model, and the Anderson and May Model using the same set of parameters listed in the text. In each setting one person infectious with *P. falciparum* malaria was introduced into a community of 100 susceptible people, and the results in the community followed for a 6-month rainy season. In each setting eventually virtually the entire human population becomes infected in 6-months, at which point the mosquito density would decrease in the following dry season. **A** The Ross Model without latent periods. Here the progress of the epidemic is far too rapid and the final prevalence of infectious mosquitoes too high.

malaria a mosquito must have a first blood meal on an infected human, become infected herself, and then survive as long as the latent period to become infectious, and then have a second blood meal on an uninfected human. The Anderson and May formulations of the malaria models include the latent period for mosquitoes and the death rate for mosquitoes using continuous distribution.

In continuous terms, if  $p_m$  is the constant mosquito death rate per day and  $\tau_m$  (Greek letter tau, m for mosquito) is the latent period for mosquitoes, then the proportion of mosquitoes that is infectious follows the exponential distribution and is approximately,

$$\exp(-p_m \tau_m),$$

and this is the multiplier for the expression for the number of infectious mosquitoes.

The discrete counterpart to the exponential distribution is the geometric distribution, where  $P$  would be the probability of dying per day and  $q = 1 - p$ , is the probability of surviving, which would usually be described in probability terms as the distribution of  $q^{\tau_m}$ , where  $q$  is the probability of surviving per day.

In the discrete model terminology MacDonald has used  $p$  for  $q$  and  $n$  for  $\tau_m$ , and  $-\ln(p)$  is the daily mortality for mosquitoes, similar to  $p_m$  in the continuous model. Thus the proportion of infectious mosquitoes in the discrete model as formulated by MacDonald becomes

$$p^n.$$

The equivalent continuous and discrete expressions for  $R_0$  for malaria models are,

$$R_0 = \{ma^2bc[\exp(-p_m \tau_m)]\} / gp_m, \text{ and}$$

$$R_0 = ma^2bcp^n / -g \ln(p).$$

They are comparable, with the daily mosquito mortality rate,  $p_m$  or  $-\ln(p)$  in the denominator, and the proportion of mosquitoes surviving the latent period,  $\exp(-p_m \tau_m)$  or  $p^n$ , in the numerator.

In the [MacDonald model](#) the lags are for the latent period in mosquitoes, as it is the mosquitoes which have survived the latent period which are infectious now, and they, in turn were infected one latent period ago. For the description below, the first line over an equation is the usual word model, and the second line is an attempted analogy to the familiar  $dE/dt$  and  $dI/dt$  equations of the SEIR model.  $dH/dt$  is analogous to  $dI/dt$  for humans,  $dML/dt$  is analogous to  $dE/dt$  for mosquitoes, and  $dMI/dt$  is analogous to  $dI/dt$  for mosquitoes. This is an SIS model for humans and an SEI model for mosquitoes. The results of the MacDonald Model of the progress of *P. falciparum* infection when one infectious person is introduced into a community of 100 susceptible individuals is presented in [Fig. 3B](#).

$$dH/dt = +a * b * m * MI * (1 - H) - g * H$$

$$dML/dt = +a * c * H * (1 - ML - MI)$$

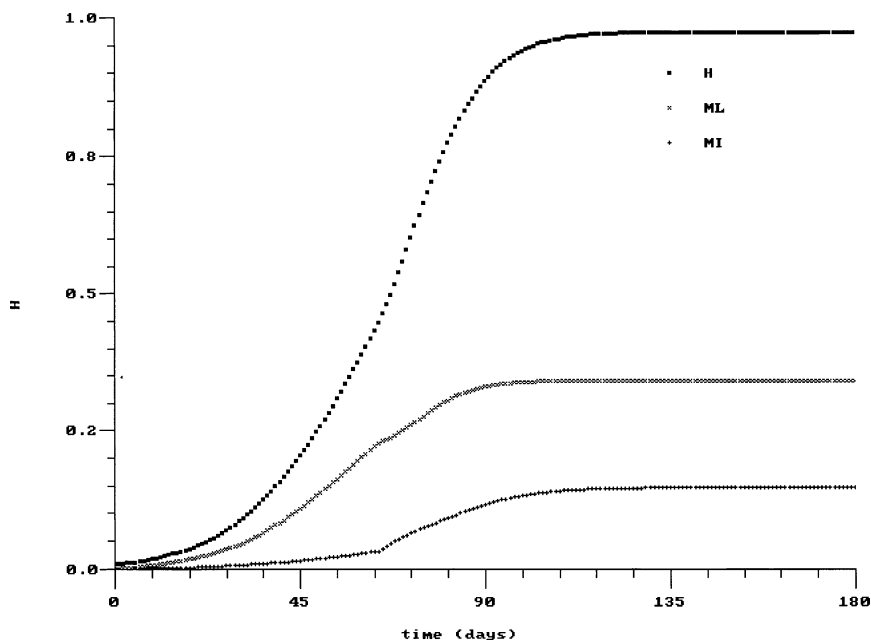

**Mathematical Models of Vector-Borne Diseases. Figure 3B** The MacDonald Model with a 10-day latent period for mosquitoes. The progress of the epidemic is slower and the final prevalence of infectious mosquitoes lower.

$$dMI/dt = + a * c * lag\_H\_tau\_m * (1 - lag\_ML\_tau\_m - lag\_MI\_tau\_m) * exp(-p_m * tau_m) - p_m * MI$$

To review, the MacDonald model does include the latent period in mosquitoes and the known exponential survival of mosquitoes during the latent period. MacDonald’s original form of the model was based on the discrete form as the geometric distribution,  $p^n$ , where  $p$  was the daily probability of survival for the female mosquito,  $n$  was the latent period or time before infectious sporozoites appear in the salivary glands of the infected mosquito, and  $-\ln(p)$  was the daily mortality for mosquitoes, similar to  $p_m$  in the Ross model. Measured values of  $p$  range from 0.76 to 0.95, and measured values of  $-\ln(p)$  range from 0.05 to 0.28. For *falciparum* malaria,  $n$  is about 10.

In contrast, the continuous form of the MacDonald model as presented in Anderson and May is based on the exponential distribution. The latent period in mosquitoes of 10 days is represented by the Greek letter spelled out as tau, and the fact that it is for mosquitoes is indicated by the suffix m. Thus,  $tau_m$  is the 10-day latent period in mosquitoes. One way to insert the 10-day difference in time is to lag a variable, so that, for example,  $lag\_H\_tau_m$  is the proportion,  $H$ , from 10 days ago. However, the discrete and continuous forms give similar results for the basic reproductive

number. The results of the →Anderson and May Model of the progress of *P. falciparum* infection when one infectious person is introduced into a community of 100 susceptible individuals is presented in Fig. 3C. Note that in Fig. 3 each successive model adds a latent period, and the apparent progress of the infection through the community is slower. The Ross model (Fig. 3A) contains no latent periods, the MacDonald Model includes a 10-day latent period for mosquitoes (Fig. 3B, and the Anderson and May Model includes a 10-day latent period for mosquitoes and a 21-day latent period for humans.

These systems come to equilibrium because there is a continuous supply of susceptible humans and susceptible mosquitoes. Infected humans recover and reenter the susceptible pool, and new broods of uninfected adult female mosquitoes continue to hatch.

Setting the derivatives equal to zero, in the steady state it is possible to find the equilibrium proportions for infected humans ( $H^*$ ) and infected mosquitoes ( $M^*$ ). For the Ross model;

$$H^* = (R_0 - 1) / [R_0 + (ac/p_m)].$$

The equilibrium proportion of infected mosquitoes predicted by the Ross model is much too high, so the relation from the MacDonald model is given below:

$$M^* = [(R_0 - 1) / R_0] [(ac/p_m) / (1 + ac/p_m)] \exp(-p_m tau_m)$$

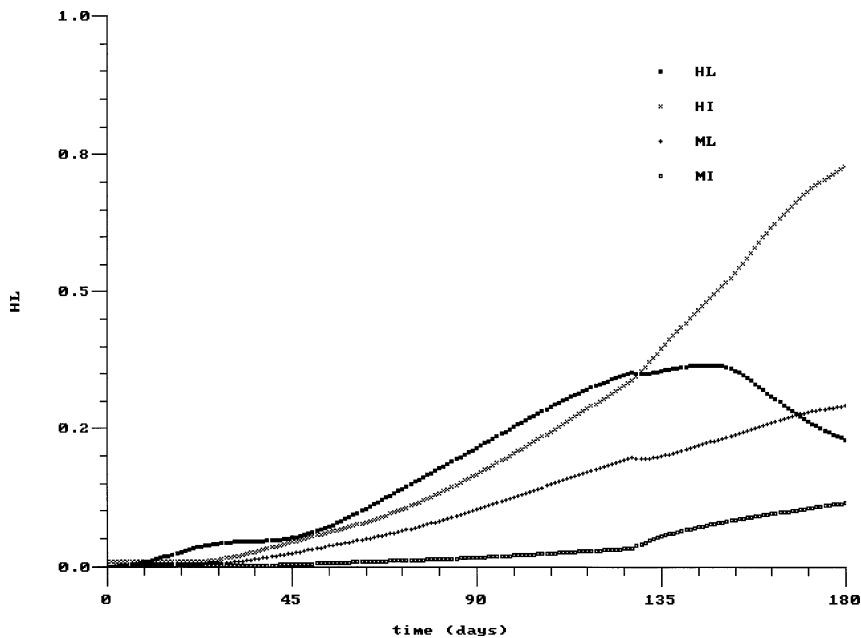

**Mathematical Models of Vector-Borne Diseases. Figure 3C** The Anderson and May Model with a 10-day latent period for mosquitoes and a 21-day latent period for people. The progress of the epidemic is slower still. Note that the total number of people infected is the sum of those in the latent state and the infectious state, which together add up to virtually 100% infected in 6 months. This model appears to be reasonably realistic for the short term with no immunity in the population.



MacDonald defined the quantity  $ac/p_m$ , the number of bites on humans per day that produced infection in the mosquito, as the stability index. High levels of  $ac/p_m$ , in the range of 2–4, indicate that mosquitoes bite man often and have relatively long lifespans, and produce continuous endemic malaria. Macdonald called this stable malaria. Where  $ac/p_m$  is low, in the range of 0.5, malaria tends to occur in repeated outbreaks. Macdonald called this unstable malaria (3, 6). One needs also to appreciate that vector density changes orders of magnitude with the seasons, so that malaria occurs in annual epidemics in the rainy season when the mosquito density is high.

### Details of a Complex Malaria Model Including Latent Periods for Humans and Mosquitoes

Below is a model of malaria modified from that published by Anderson and May that deals with the complexities of humans as well as mosquitoes. In addition to the 10-day latent period in mosquitoes and mosquito mortality, the complex model includes the 21-day latent period in humans (until the appearance of infectious gametocytes), the recovery of humans from both latent and infectious stages, and the death of humans in both latent and infectious stages. This appears to be a reasonably realistic model. The modification of the Anderson and May model was to allow infected humans to recover from the latent stage before they became infectious to mosquitoes. This happens if medical treatment is readily available and individuals who become newly symptomatic at the end of the incubation period (7–10 days) are treated before they pass through the latent period (21 days) and become infectious to mosquitoes. This is an SEIS model for human infection and an SEI model for mosquitoes.

$$\begin{aligned} dHL/dt = & a * b * m * MI * (1 - HL - HI) \\ & - a * b * m * \text{lag\_MI\_tau}_h * (1 - \text{lag\_HL\_tau}_h \\ & - \text{lag\_HI\_tau}_h) * \exp\left(\left(-p_h - p_g\right) * \text{tau}_h\right) \\ & - p_g * HL - p_h * HI \end{aligned}$$

$$\begin{aligned} dHI/dt = & a * b * m * \text{lag\_MI\_tau}_h * (1 - \text{lag\_HL\_tau}_h \\ & - \text{lag\_HI\_tau}_h) * \exp\left(\left(-p_h - p_g\right) * \text{tau}_h\right) \\ & - p_g * HI - p_h * HI \end{aligned}$$

$$\begin{aligned} dML/dt = & a * c * HI * (1 - ML - MI) \\ & - a * c * \text{lag\_HI\_tau}_m * (1 - \text{lag\_ML\_tau}_m \\ & - \text{lag\_MI\_tau}_m) * \exp\left(-p_m * \text{tau}_m\right) - p_m * ML \end{aligned}$$

$$\begin{aligned} dMI/dt = & a * c * \text{lag\_HI\_tau}_m * (1 - \text{lag\_ML\_tau}_m \\ & - \text{lag\_MI\_tau}_m) * \exp\left(-p_m * \text{tau}_m\right) - p_m * MI \end{aligned}$$

For this malaria model the basic reproductive number is

$$R_0 = \left\{ ma^2bc[\exp(-p_h\text{tau}_h - p_m\text{tau}_m)] \right\} / p_g p_m$$

(continuous)

Malaria does produce some immunity, and malaria models including immunity have been developed, but are beyond the scope of this chapter.

### Interventions in the Transmission of Malaria

A number of interventions have been developed to limit the transmission of malaria, and it is useful to review how these will appear in the Anderson and May model. A reduction in the number of larvae that will hatch into adult mosquitoes will reduce  $m$ , the number of adult female mosquitoes per person. This can be accomplished by eliminating standing water, killing larvae, or putting larva eating fish into ponds that breed mosquitoes. A reduction in the human-biting rate,  $a$ , can be effected by screening windows and doors, using a plain bednet, using insect  $\rightarrow$  repellents, or introducing alternative animals like cows or pigs on which hungry mosquitoes will feed (zoophylaxis). The duration of life of an adult mosquito can be shortened by increasing the daily mortality of adult mosquitoes ( $p_m$ ) through the use of residual insecticides on vertical indoor walls. Use of an insecticide-impregnated bednet will combine the last 2 and both lower  $a$  and increase  $p_m$ . Chemotherapy, or treating infectious people, will shorten the duration of the infectious period and increase the rate of human recovery, or  $p_g \rightarrow$  Chemoprophylaxis, the taking of drugs (by short stay residents like tourists) to prevent malaria infection reduces  $b$ , the probability of infection in a susceptible human from an infectious bite. Note that the dangerous mosquito is the female mosquito who has fed at least once on an infectious human, survived for the 10-day latent period, and has now become infectious herself when she feeds on a susceptible human. Preventing second bites by these infectious mosquitoes would interrupt transmission.

### Observing Infection Dynamics and the Effects of Interventions

One reason to run this complex model is to observe the dynamics of the 2 host parasite relationships and appreciate rapidly with which a vector-borne disease can run through a population, and the level of infection in humans at which it is stable. Another reason is to try out the effects of various interventions and observe the results on the progress of the disease through the community. In Fig. 4 we present the results of 4 different interventions, one at a time, so that the effects of each can be observed independently, and the relative efficacy observed.

In Fig. 4A we present the baseline Anderson and May Model, identical to Fig. 3C, but here the results of infections in mosquitoes are not visible, and a third line

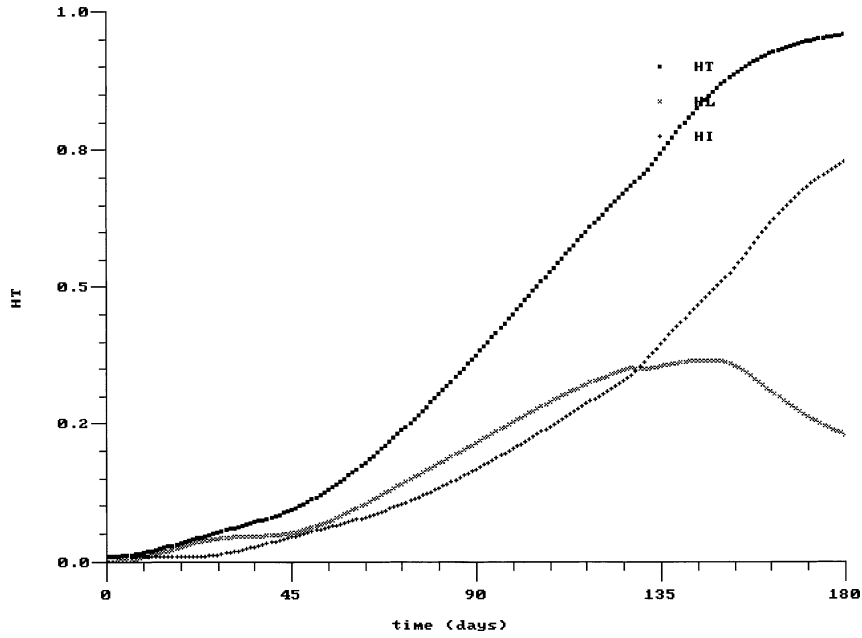

Mathematical Models of Vector-Borne Diseases. Figure 4A

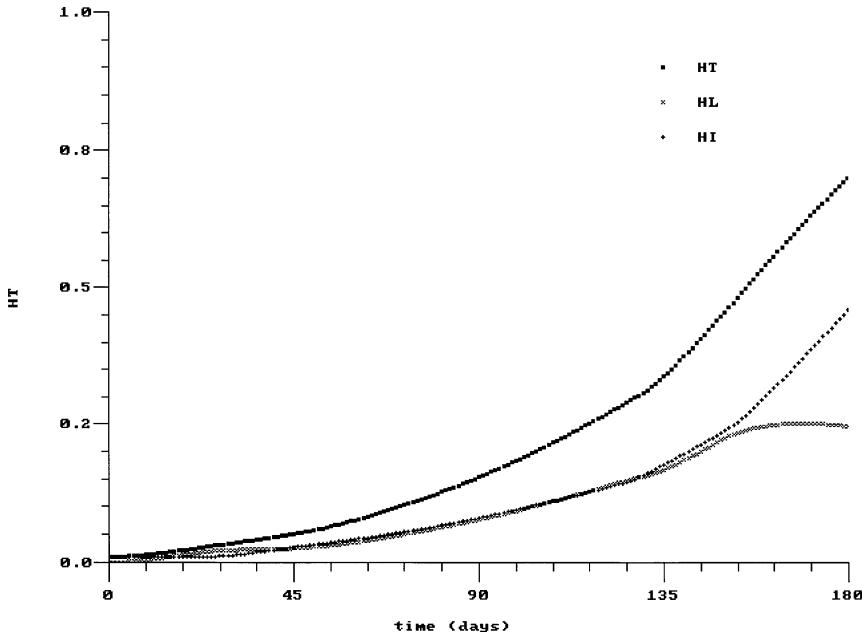

Mathematical Models of Vector-Borne Diseases. Figure 4B

for human infection is added, the sum of both latent and infectious people. In this baseline it is evident that in a 6 month rainy season almost the entire population will become infected.

In Fig. 4B we present the result of an intervention on the model in Fig. 4A that reduced  $m$ , the number of adult mosquitoes per human by half, from 40 to 20. Reducing  $m$  by half resulted in about a 20% decrease in

the final prevalence of human infection at the end of the rainy season in that community.

In Fig. 4C we present the result of an intervention on the model in Fig. 4A that reduced  $a$ , the human-biting rate of adult mosquitoes by half, from 0.25 to 0.125. Reducing  $m$  by half resulted in about an 80% decrease in the final prevalence of human infection at the end of the rainy season in that community.

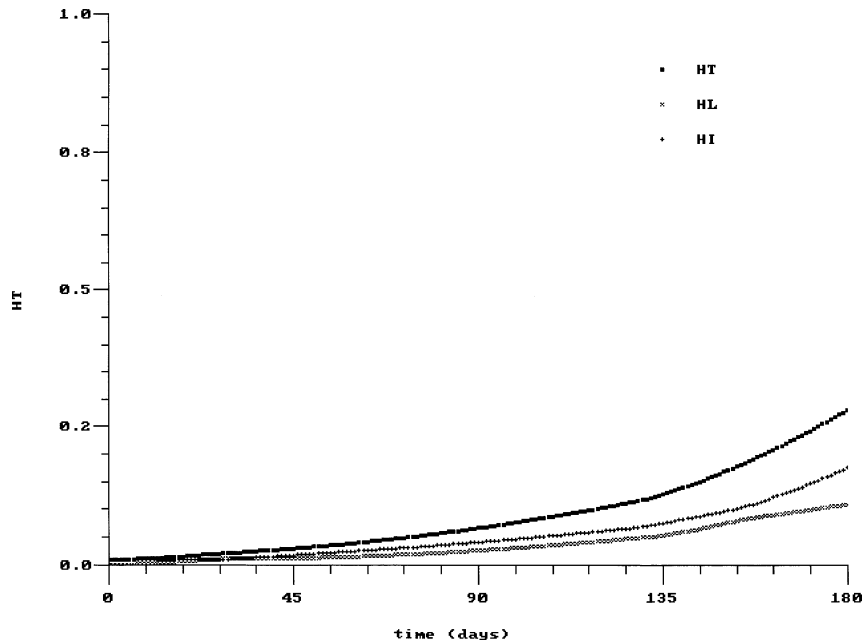

Mathematical Models of Vector-Borne Diseases. Figure 4C

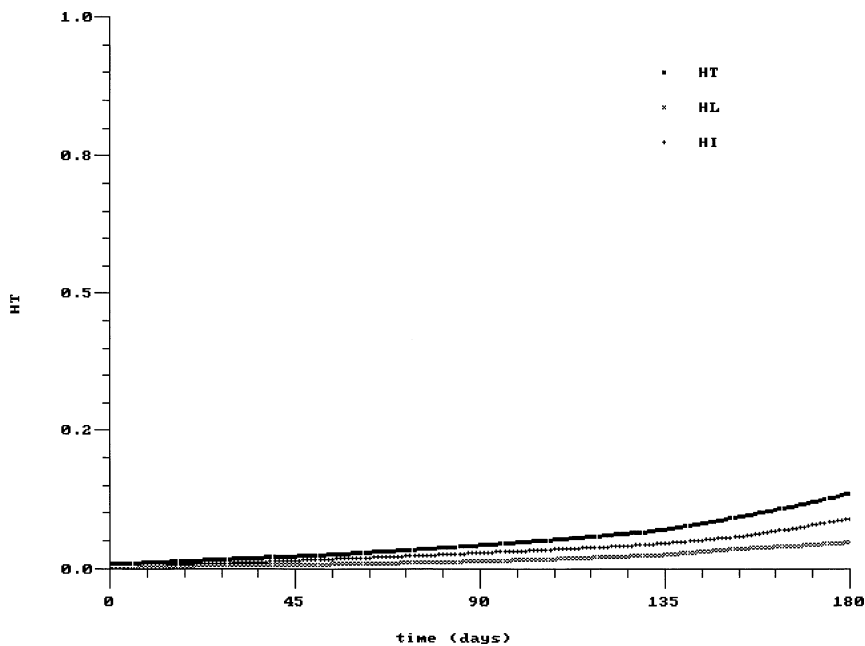

Mathematical Models of Vector-Borne Diseases. Figure 4D

In Fig. 4D we present the result of an intervention on the model in Fig. 4A that doubled  $p_m$ , the mosquito mortality per day from 0.12 to 0.24. This reduces the survival of adult at the end of the latent period. Doubling  $p_m$  resulted in about a 90% decrease in the final prevalence of human infection at the end of the rainy season in that community.

Comparing the relative effects of different interventions aimed at reducing one or another factor by a similar amount did not reduce the prevalence of malaria equally. Reducing  $m$  was least effective, reducing  $a$  was substantially more effective, and reducing the length of life of adult mosquitoes (increasing daily mortality) was most effective. Note that this model is nonlinear,

and that the relative effectiveness of these different interventions is not necessarily intuitively apparent without examination of model results.

Remember that the dangerous mosquito is the female mosquito who has fed at least once on an infectious human, survived for the 10-day latent period, and has now become infectious herself when she feeds on a susceptible human. Preventing second bites by these infectious mosquitoes interrupts transmission. Insecticide-impregnated bednets work well because they affect both  $a$  and  $p_m$ , but, ironically, kill the fewest mosquitoes. Impregnated bednets simply kill or exclude the most dangerous mosquitoes. This is the sort of insight that can be gained from looking at mathematical models of malaria.

### Effects of Interventions and $R_0$

The relative effects of various interventions can also be appreciated by examination of the expression for the basic reproductive number, or  $R_0$ .

$$R_0 = \{[ma^2bc[\exp(-p_h\tau_{h_i}-p_m\tau_{m_i})]]\}/p_g p_m.$$

Values for  $R_0$  for malaria in endemic areas where transmission is intense are commonly in the range of 100 but may be lower where malaria is unstable and occurs in the form of periodic epidemics.

From the above, it is evident that  $R_0$  is linear in  $m$ , but varies as  $a^2$ , so any decrease in  $a$  will have a larger effect than a similar-sized decrease in  $m$ . Further, it is clear that  $p_m$  appears as an exponent, so that a change in  $p_m$  of similar magnitude will be more effective still. These observations have focused attention on spraying indoor vertical walls with insecticide and dipping bed nets in insecticide in order to increase  $p_m$  and to the use of screens, bednets and repellents to decrease  $a$ .

Also, note that  $R_0$  is linear in  $p_g$ , the human recovery rate, so that chemotherapy for individual infected and sick people, while important and lifesaving, is not as effective as a community intervention as some of the entomological actions mentioned above. Because malaria transmission can only take place when there are adult mosquitoes feeding, there is a 6-month hiatus in transmission in locations where a dry season intervenes. This temporary halt in transmission can serve to allow a health-care system to catch up and use chemotherapy as a community intervention during the dry season. Seasonality in transmission thus allows chemotherapy to be used as an intervention in some communities where transmission is not continuous.

### Historical Use of Malaria Interventions

Eliminating water sources where the larvae of malaria mosquitoes hatch has been effective in eradicating malaria in locations as diverse as Italy, Greece, Spain and parts of the USA. Impregnated bednets have reduced mortality in areas like the Gambia, where

transmission is most intense. Human chemotherapy saves lives and has been effective in interrupting the spread of malaria where there is a dry season during which there are no mosquitoes and transmission naturally stops.

Naive meddling with malaria can be dangerous, however. In endemic areas infants are born with maternal antibodies against disease (not infection) and they begin being bitten and infected immediately. Continuous infection in the individual produces continuous protection from severe clinical disease. If that cycle of continuous infection is broken by an attempt at eradication that drives the prevalence of infection in humans to low levels (but not to zero), a cohort of individuals is created that is susceptible to severe clinical disease. If the eradication program is abandoned and malaria again becomes endemic, the susceptible individuals (now adults) experience severe clinical disease with much excess avoidable mortality. Boom and bust cycles must be avoided in malaria control. The key concept here is that interventions must be sustainable, and once implemented, must never be stopped if they will leave populations of older individuals susceptible to severe clinical disease.

### Vectorial Capacity

We have spent a considerable amount of time looking at the basic reproductive number for the propagation of infectious diseases in humans, or  $R_0$ . It is fitting to end with the same idea from the vector's point of view,  $\rightarrow$ Vector Capacity, or  $V_c$ . The vectorial capacity is the daily rate at which new infections will occur in humans from a single currently infected human. This depends entirely upon the vector and is simply the basic reproductive number without the duration of infection in the human. For the discrete form of the MacDonald model below,  $R_0$  is the number of humans that will become infected from a single infected human during the entire infectious period for the human, and  $V_c$  is the number that will become infected by the vectors in a single day.

Remember here we have switched back to the discrete system where  $p$  is the probability of survival and  $-\ln(p)$  is mortality;

$$R_0 = ma^2bcp^n / -g \ln(p) \text{ and}$$

$$V_c = ma^2bcp^n / -\ln(p)$$

If the average case of *falciparum* malaria is infectious for 285 days, then the recovery rate or  $g = 1/285$  days = 0.0035/day. Thus the magnitudes of  $R_0$  and  $V_c$  for this disease differ by a factor of 285, and the vectorial capacity may be smaller than unity while the basic reproductive number is high and virtually all persons in the community are continually infected. In the above example, if  $R_0$  was 100 then  $V_c$  would be 0.35, and  $R_0/V_c = 100/0.35 = 285$ .

### Incompletely Thought Out Interventions

Antibodies induced by malaria infection have relatively short-term effects and primarily protect infected persons from becoming physically ill. In an area where malaria is endemic neonates are born with antibodies from their mothers that keep them from becoming ill with malaria. These neonates begin being bitten and infected as soon as they are born, and they develop their own antibodies from their own infections as the antibodies from their mothers decline. As these individuals age they are repeatedly infected, remain perpetually parasitemic, but rarely become seriously ill with malaria. An adult that has been infected all of her life is at little risk for illness in an endemic area, while a naive adult would become severely ill very quickly. Malaria mortality is highest among naive young children and women during their first pregnancy.

In 1957 Senators John F. Kennedy and Hubert Humphrey attached worldwide malaria eradication to the Mutual Security Act. This provided substantial funds to produce zero prevalence of malaria in 5 years, that is, by 1961. In Sri Lanka the prevalence went from approximately one million cases in 1957 to 100 by 1961 and 18 in 1963. Then DDT resistance began to appear, and DDT use in Sri Lanka was dramatically reduced from the initial rate of 2 million pounds per year. Malaria rates began to creep up and in 1968 there was a huge outbreak involving about half a million cases, and the prevalence kept climbing until it was back to a million cases in 1994.

Before 1957 when malaria was endemic children were infected at birth and most of the population was perpetually infected and relatively asymptomatic. By 1961 there was virtually no malaria, and all of the previously infected adults had lost their protective antibodies. As was mentioned, malaria infection in a naive adult produces severe illness, so when the huge outbreak began in 1968, most of the half million cases were seriously symptomatic. This produced a devastating effect on the economy, and there were hundreds of excess deaths among the adults who had lost their protective antibodies.

Malaria interventions must be carefully thought out so that one does not cause epidemics. Devastating epidemics have occurred as the result of well-intentioned failures. Minimalist interventions cause no epidemics. →Malaria containment involves ignoring the mean prevalence but eliminating outbreaks. Reduce the variance about the mean and prevent new cases in naive adults. →Malaria suppression involves attempts to lower the prevalence. These interventions must be sustainable in the community without outside help, otherwise, when the aid expires, malaria epidemics will occur again in naive adults. Creation of boom and bust behavior introduces chaos.

### Other Indirectly Transmitted Infections

→African trypanosomiasis or →sleeping sickness is another protozoan parasite transmitted by an insect vector, the →Glossina or tsetse fly. There are two features of this disease that make control difficult. There are nonhuman →animal reservoirs for the parasite. Also, the parasite populations with an individual human undergo cyclic →antigenic variation. The parasite is able to express something on the order of 100 different variable surface antigens (VATs). Every time the host develops antibodies to control one →VAT, a different VAT emerges.

→Leishmania spp. are protozoans transmitted by →sand flies, and are thought of as New World trypanosomes. There are important nonhuman animal reservoirs such as dogs.

→Arboviruses are viruses transmitted by insect vectors, and almost 100 arboviruses are known to infect man. Two of the most important are →yellow fever and →dengue.

Yellow fever is transmitted either person to person by mosquitoes, or primate to person, and tends to occur in epidemics. It is still a considerable problem in parts of Asia, tropical Africa, and South America. Immunity in humans is lifelong, suggesting control by vaccination, although herd immunity is defeated by primate reservoirs and →vertical transmission within mosquito vectors.

Transmission of dengue is similar to yellow fever, except that there are 4 major types of dengue that all occur together so that a vaccine must be effective against all 4 types. Infection with one type of dengue is uncomfortable, but infection with a second type after recovery from the first is 20 times as likely to produce the syndrome of Dengue Hemorrhagic Fever that may be fatal.

#### A Model for Dengue

A Dengue model (or a yellow fever model) would be structurally similar to a malaria model, but since humans infected with Dengue develop long-lasting immunity to that strain of virus there would be an extra equation for infectious humans who recover and enter the immune or R state. In addition to the latent period in mosquitoes and mosquito mortality, the complex model includes the latent period in humans (until the appearance of viremia), the recovery of humans from both latent and infectious stages, and the death of humans in both latent and infectious stages.

#### A Model for Eastern Equine Encephalitis

The basic dengue model can also be used for →eastern equine encephalitis with birds replacing people in the dengue model. The behavior of the system depends on whether the birds die with the infection or develop long-term immunity, whether immune birds return to the same roost repeatedly, and the numbers of birds in a roost.

## Conclusion

It was shown how basic reasoning was developed beginning with the SIS, SIR, SEIS, and SEIR compartment models, how the reasoning evolved to include vectors in the malaria models without immunity, and ultimately how the same logic can be extended to other vector-borne diseases. The value of mathematical models is that they can educate the public health practitioner about quantitative aspects of host parasite interactions in populations and help guide the choice and application of effective interventions.

## Mathevotaenia

Genus of anoplocephalid cestodes, which are found in humans, if they had eaten infected beetles either as food or medical remedies.

## Mating Behavior

→ [Behavior](#).

## Mating Swarms

Males of → [Culicidae](#), e.g., genera → [Anopheles](#), → [Aedes](#), → [Culex](#) join into large swarms to wait for females which are taken during flight. The copulation period lasts 5–60 seconds.

## Mattesia

→ [Chromosomes](#), → [Gregarines](#).

## Maurer's Clefts

Cisterna-shaped membranous vesicles inside *Plasmodium*-infected red blood cells. These structures are involved together with the included protein SPP-1 in the trafficking of the virulence factor → [PfEMP-1](#) and

are named in honour of their discoverer, the German physician Georg Maurer (1895–1956) when diagnosing malaria in Sumatra.

## Maxicircle

→ [Guide RNA](#), → [Kinetoplast](#).

## Mebendazol

→ [Nematocidal Drugs](#).

## Mediterranean Coast Fever

Severe disease due to an infection with → [Theileria annulata](#), which is transmitted by ticks of the genus *Hyalomma* spp. (e.g., *Hyalomma anatolicum anatolicum*).

The agents of disease are found in countries around the Mediterranean Sea, Near and Middle East, India, Central Asia upto China.

The mortality of sensible cattle strains reaches up to 60% (often are 90% of the erythrocytes infected). The acute disease starts after a prepatency of 7 days with intermittent fever, lacrimation, swelling of eyelids and especially of lymph nodes (due to parasitic schizonts), anaemia, bloody-slimy diarrhoea, and often death after 8–15 days. Surviving cattle will remain lifelong infected, and other ticks may take up the parasitic stages during blood meal.

## Diagnosis

Microscopical analysis of Giemsa-stained smears of lymph node punctions and blood smears.

## Therapy

Parvaquone ( $2 \times 10$  mg/kg b. w., within 2–4 days has a success in 61% of the cases, buparvaquone reaches cure rates of 89%, but never a complete healing. → [Theileriacidal Drugs](#).

## Mefloquine

→ [Malariacidal Drugs](#).

## Megabothris turbidus

Flea of mice (*Microtus* species).

## Megacolon

Symptom of disease, e.g., in Chagas' disease. → [Pathology](#).

## Megalodiscus temperatus

### Synonym

→ [Diplodiscus temperatus](#).

Amphistome fluke of frogs.

## Meglumine antimoniate

→ [Leishmaniacidal Drugs](#).

## Mehlis' Glands

Usually of 2 types (serous and mucous) of unicellular glands which surround the → [ootype](#); in → [Platyhelminthes](#). Their contents probably form an outer → [eggshell](#) membrane and supply material to keep eggs slippery on their way into the uterus (→ [Digenea/Gametogenesis](#), → [Digenea/Morphology](#)).

## Meiospores

→ [Amblyospora](#), → [Gametes](#).

## Melanization

The black pigment melanin is produced in the body of many ticks and insects (e.g., mosquitoes) and deposited on invading pathogens in order to hinder their

development and/or propagation; e.g., microfilariae of → [Dirofilaria immitis](#) are often completely melanized in non-susceptible mosquitoes.

## Melarsamin

Therapeuticum against adult filariid worms (arsene compound), → [Nematocidal Drugs](#).

## Melarsoprol

→ [Trypanocidal Drugs](#).

## Melophagus ovinus

→ [Hippoboscidae](#), → [Insects](#), → [Diptera](#).

## Membrane Transport

There are several systems for transporting substances through the → [cell membrane](#) into the → [cytoplasm](#). Passage may occur by → [permeation](#) (non-mediated transport), a process that is dependent upon concentration gradients. Active transport (mediated transport), using motile carriers, may also occur. In this system a protein binds the molecule to be transported and then the complex moves actively from one side of the membrane to the other. The movement depends on changes in the electric charge that are linked with the binding and release of the transported molecule. The → [fixed pore](#) is a protein structure that stretches through the membrane. The molecules to be transported pass through the space, or channel, formed between the subunits of the pore. All forms of active transport require energy, which is derived from various metabolic reactions.

## Membrane-Function-Disturbing Drugs

### Amphotericin B

#### Synonyms

Ampho-Moronal, Amphozone, Fungillin, Miaquin.

### Clinical Relevance

Amphotericin B is used as an antifungal drug against human systemic mycoses, deep organ mycoses, *Candida* spp., *Torulopsis* spp., *Cryptococcus* spp., *Aspergillus fumigatus*, *Mucor* spp., *Coccidioides immitis*, *Histoplasma capsulatum*, *Sporothrix schenckii*, and *Blastomyces* spp.

### Molecular Interactions

The →mode of action relies on a complete abolishment of the barrier function of the plasma membrane in →fungi. Amphotericin B has no antibacterial activity, because bacteria lack membrane sterines. The anti-protozoal activity of Amphotericin B is directed against antimony-resistant →*Leishmania* spp. (→DNA-Synthesis-Affecting Drugs II/Table 1), and there is some activity against →*Trypanosoma* spp. and →*Entamoeba histolytica*. The antiprotozoal mechanism of action does not rely on the inhibition of ergosterol biosynthetic activity. The action of Amphotericin B is directed against intracellular →amastigotes of *L. brasiliensis* and *L. mexicana* in mucous tissues of nose and mouth probably by an interaction with leishmanial ergosterol. Ergosterol is a membrane component of leishmanial →promastigotes. The Amphotericin B-ergosterol interaction results in an enhanced leakiness and permeability of the plasma membrane for ions and small molecules (amino acids and thiourea).

### Polyether Antibiotics Important Compounds

Monensin, Lasalocid, Salinomycin, Narasin, Maduramicin, Semduramicin.

### Synonyms

Monensin: Coban, Elancoban, Romensin, Rumensin.  
Lasalocid: Avatec, Bovatec (Fig. 1).  
Salinomycin: Coxistac, Sacox.  
Narasin: Monteban.  
Maduramicin: Cygro, Prinocin.  
Semduramicin: Aviax.

### Clinical Relevance

**Monensin** is the first member of the so-called polyether antibiotics. It is a →fermentation product of the fungus *Streptomyces cinnamonensis* introduced in 1971 for the control of →*Eimeria*-infections in poultry (→DNA-Synthesis-Affecting Drugs IV/Table 1 and 2). Other polyether antibiotics of veterinary importance are **lasalocid** (produced by *S. lasaliensis*), **salinomycin** (by *S. albus*), **narasin** (by *S. aureofaciens*), **maduramicin** (by *Actinomadura yumaense*), and **semduramicin** (by *A. roseorufa*).

Monensin is especially effective against the asexual stages of the parasites, the extracellular sporozoites and

free merozoites. It has an additional activity against schizogenous and gametogenic stages of →*Toxoplasma gondii* in the cat. Maduramicin and alborixin are reported to cause also a reduction of →oocyst excretion in human cryptosporidiosis by 71–96%.

### Molecular Interactions

Polyether antibiotics form complexes with Na<sup>+</sup> and to a lesser extent with K<sup>+</sup>. The complexes have a lipophilic surface and move within the lipid regions of membranes, which results in an exchange of sodium ions by H<sup>+</sup> ions. In sporozoites of *Eimeria tenella* 5-fold increased Na<sup>+</sup>-concentrations can be measured after exposure to monensin, followed by an increase of the activity of Na<sup>+</sup>/K<sup>+</sup>-ATPase to restore the physiological electrochemical Na<sup>+</sup>-gradient. In addition, a depletion of the →amylopectin stores in sporozoites, enhanced lactate formation, and decrease of ATP-levels can be observed. The increase of intracellular Ca<sup>++</sup>-concentrations is due to an enhanced Na<sup>+</sup>/Ca<sup>++</sup>-exchange and an enhanced liberation of these cations from →mitochondria. The increased intracellular cation levels are followed by a quick entry of H<sub>2</sub>O, alteration of intracellular pH, swelling of cells, vacuolization, and damage of intracellular structures. The other anticoccidial polyether antibiotics are suggested to act in the same way.

### Resistance

In *E. tenella* strains the resistance against monensin is due to reduced drug uptake. There is cross-resistance between monensin and ionophoric polyethers such as narasin, salinomycin, and occasionally lasalocid. The resistance is characterized by a great stability throughout many parasite generations. Maduramicin is effective also against monensin-resistant *Eimeria* strains, which is indicative for another mode of action of this drug. The mechanism of resistance is explained by membrane alterations interfering with the penetration of the ionophores into the membranes of the parasites. In resistant strains 20–40-fold higher drug concentrations are necessary to achieve effectivity. There are reports that four overexpressed peptides in sporozoites are associated with ionophore resistance in *E. tenella*. Multidrug resistance genes coding for an energy-driven efflux mediated by P-glycoprotein are presumably responsible for cross-resistance. Polymerase chain reaction (PCR) methods are now used for the detection of resistance of different *Eimeria* spp. against polyethers and a variety of synthetic anticoccidial drugs.

### Mepacrine

#### Synonyms

Acricline, Acriquine, Atabrine.diHCl, Atebrin.HCl, Chinacrin.HCl, Erion, Italchin, Metoquine, Palacrin, Quinacrine.HCl, Acranil (Fig. 1).



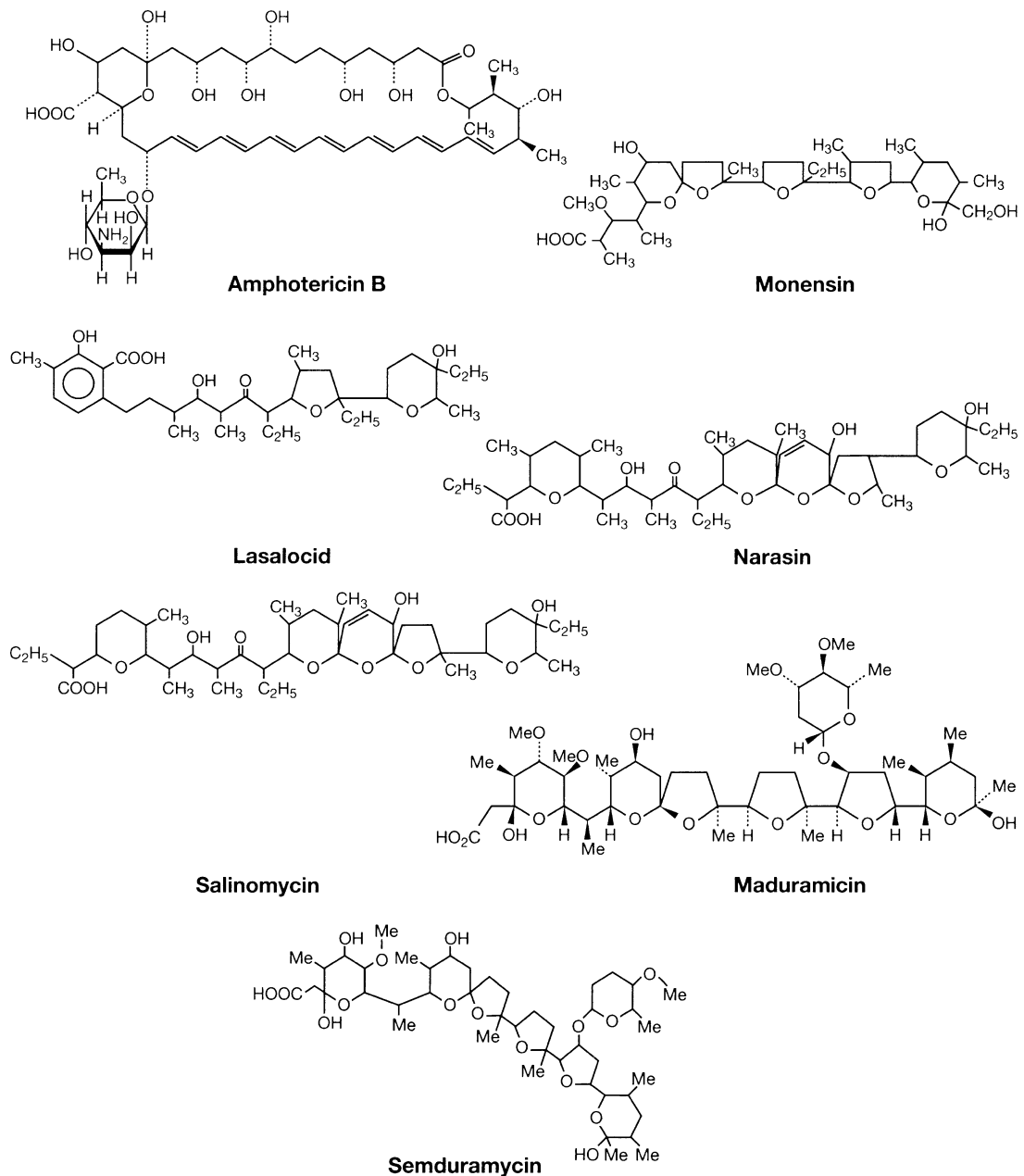

**Membrane-Function-Disturbing Drugs. Figure 1** Structures of drugs acting by disturbance of membrane function.

### Clinical Relevance

Mepacrine was introduced in 1930 as the first synthetic antimalarial compound. It has additional activity against  $\rightarrow$ *Giardia lamblia*, *Entamoeba histolytica*, and *Leishmania* spp.

### Molecular Interactions

Mepacrine is an acridine derivative, and acts as an inhibitor of the respiration in *E. histolytica* and *G. lamblia*. A competitive inhibition of trypanothione reductase but not of  $\rightarrow$ glutathione reductase

( $\rightarrow$ DNA-Synthesis-Affecting Drugs III/Fig. 1) may be responsible for the anti-leishmanial action. Mepacrine specifically interacts with protein side chains. Recently it could be shown that acridine derivatives may have an influence on oxido-reduction mechanisms involving disulfide reductases. The formation of complexes between DNA and quinacrine, which was believed to be the action of this drug for many years, is presumably not the true mechanism of action. Indeed, there is no accumulation of quinacrine in the nuclei or any structure in  $\rightarrow$ trophozoites of *G. lamblia*. Instead, blebs of

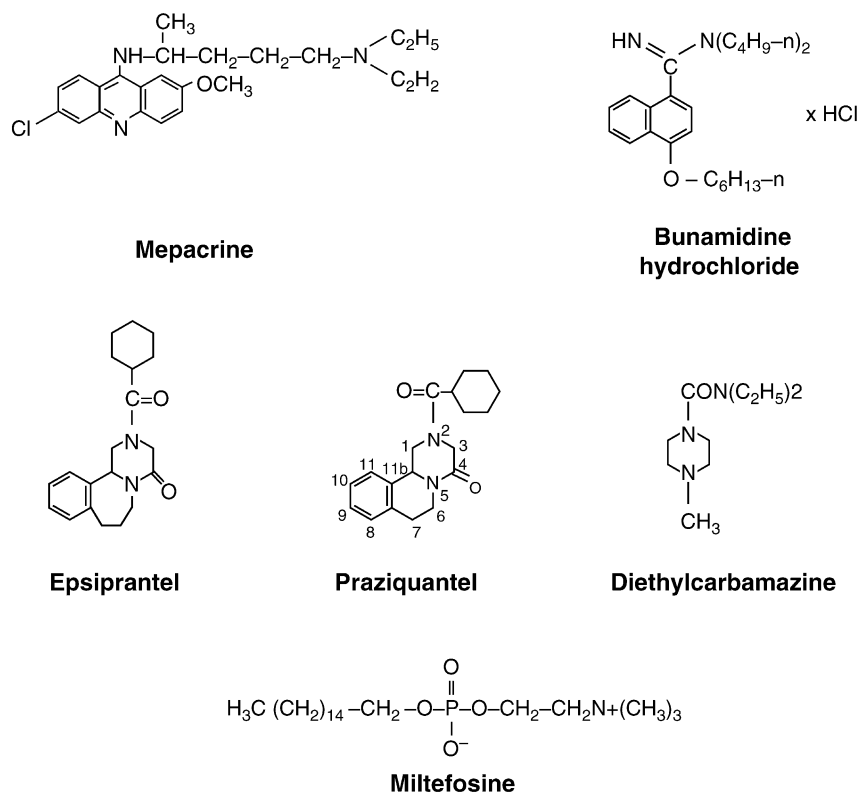

**Membrane-Function-Disturbing Drugs. Figure 1** Structures of drugs acting by disturbance of membrane function. (Continued)

concentrated drug appear prior to the disintegration of the membrane in drug-sensitive trophozoites. The membrane is now believed to be the site of the quinacrine action. In addition, DNA- and RNA-synthesis are inhibited probably by the induction of lesions in the macromolecules.

The antimalarial activity of mepacrine is directed against erythrocytic schizonts and gametocytes ( $\rightarrow$ Hemoglobin Interaction/Fig. 2). It has an influence on erythrocytic schizonts of all four  $\rightarrow$ *Plasmodium* species. An intercalation of mepacrine into the DNA of the parasites is discussed. Indeed, a binding of quinacrine to DNA *in vitro* could be demonstrated, but the real mechanism in plasmodia remains unknown. There are other mepacrine-induced biochemical changes such as inhibition of replication, damage of ribosomes, inhibition of protein synthesis, and also inhibition of respiration.

Besides its antiprotozoal activities, mepacrine exerts anticestodal activity against *Taenia saginata*,  $\rightarrow$ *T. solium* and *Diphyllobothrium latum*. The anticestodal action of mepacrine on the molecular level against  $\rightarrow$ tapeworms is unknown.

### Resistance

In *G. lamblia* strains resistant to furazolidone are more readily resistant to quinacrine indicating a

multidrug-resistant phenotype resulting in an active exclusion of quinacrine by resistant trophozoites. Mepacrine resistance in  $\rightarrow$ malaria is not as actively researched as that of the newer antimalarials. There is a report on mepacrine treatment failures and the appearance of atebriane-insusceptible or atebriane-resistant *Plasmodium* strains from New Guinea. There is not always cross-resistance between quinacrine and other closely related  $\rightarrow$ quinoline containing antimalarials indicating a different mode of action.

### Miltefosine

#### Synonyms

Hexadecylphosphocholine.

#### Clinical Relevance

Miltefosine is very likely the most significant recent advance in the treatment of visceral leishmaniasis by oral application. This drug was originally developed as an anticancer drug. The antileishmanial activity was discovered in the mid-1980s, since the mid-1990s it is in clinical trials for this indication ( $\rightarrow$ DNA-Synthesis-Affecting Drugs II/Table 1). After a phase 3 trial, 94% of patients suffering from visceral leishmaniasis were cured with an oral dosage of 2.5 mg/kg of miltefosine daily for 28 days. In India over 700 patients, including

many who were refractory to antimonials, have been successfully treated. The major limitation of miltefosine is teratogenicity. This excludes the use of this drug in women of childbearing age. Miltefosine is also considered for treatment of canine leishmaniasis. This would be important for reducing an animal reservoir of the parasites that could be transmitted to humans by means of sandflies as vectors.

### Molecular Interactions

The primary target of miltefosine is uncertain at present. A possible inhibition of ether remodelling, an impairment of phosphatidylcholine biosynthesis, signal transduction and calcium homeostasis are discussed.

### Bunamidine

#### Synonyms

Buban, Scolaban.

#### Clinical Relevance

Bunamidine was discovered in 1965. It possesses anticestodal activity against →*Taenia* spp., →*Dipylidium caninum*, →*Mesocestoides*, →*Diphyllobothrium* and *Echinococcus granulosus* (Table 2).

### Molecular Interactions

Bunamidine is a naphthamidine-derivative acting by a disruption of tegumental outer layers of *Hymenolepis nana*. This results in a decrease in the rate of glucose uptake, increase in the rate of glucose efflux and interference with the absorptive surface of the →cestodes. The drug also inhibits the fumarate reductase in the mitochondria of →*H. diminuta*, thereby interrupting ATP-synthesis (→Energy-Metabolism-Disturbing Drugs/Fig. 4).

### Praziquantel

#### Synonyms

Biltricide, Caniquantel, Cesol, Cestocur, Droncit; in combinations: Caniquantel Plus, Drontal, Drontal Plus.

#### Clinical Relevance

Praziquantel was discovered in 1972. It was first developed as a veterinary cestocide (Droncit). It is the drug of choice for human and veterinary cestode and →trematode infections (Table 1, Table 2, →Energy-Metabolism-Disturbing Drugs/Table 2). It possesses broad-spectrum activity against cestodes and →trematodes including *Taenia solium*→neurocysticercosis, but has low efficacy against larval →*Echinococcus* spp. (→Hydatidosis) and →*Fasciola hepatica*.

Importantly, praziquantel is the drug of choice for the treatment of all forms of schistosomiasis (Table 2) in a single oral dose. Praziquantel is now achievable at almost the same price or even cheaper than oxamniquine in South America and the rest of the world. It is applied in extensive control programs in many endemic countries in Africa, South America, and Asia, and there are now clinical experiences over the last 20 years. A great advantage is the lack of serious short- or long-term side effects. The drug is safe, effective, and easy-to-handle for treatment of schistosomiasis. Multicenter clinical trials were performed by WHO and Bayer in Africa, Japan, the Philippines, and Brazil. Praziquantel gained a quick dominant role in antischistosomal therapy until today.

Praziquantel has also activity against intestinal, liver, and lung →flukes (→Energy-Metabolism-Disturbing Drugs/Table 2), but has only low efficacy against infections with *F. hepatica* and →*Paramphistomum*. Against *Dicrocoelium* praziquantel is only effective at very high dosages.

**Membrane-Function-Disturbing Drugs. Table 1** Degree of efficacy of important cestodocidal drugs in current use

Year on the market	Drug	Cestodes	Trematodes	Nematodes	Protozoa
Energy-Metabolism-Disturbing Drugs					
1973	Nitroscanate	xx		xxx	
1960	Niclosamide	xx	immature <i>Paramphistomum</i>		
Microtubule-Function-Affecting Drugs					
1979	Albendazole	xx	<i>F. hepatica</i> , <i>D. dendriticum</i>	xxx	<i>Giardia</i>
1971	Fenbendazole	xx	<i>D. dendriticum</i>	xxx	<i>Giardia</i>
	Flubendazole	xx		xxx	
1972	Mebendazole	xx	<i>F. hepatica</i> , <i>D. dendriticum</i>	xxx	<i>Giardia</i>
	Oxfendazole	xx		xxx	
Membrane-Function-Disturbing Drugs					
1965	Bunamidine	xx			
1975	Praziquantel	xxx	flukes (blood, lung, liver, intestine)		
	Epsiprantel	xxx	?		

xxx = high efficacy at least against some developmental stages and diverse species; xx = partially effective (regarding developmental stages and diversity of species); x = slightly effective

**Membrane-Function-Disturbing Drugs. Table 2** Degree of important antischistosomal compounds in current use

Year on the market/ or discovery	Drug	<i>S. mansoni</i>	<i>S. haematobium</i>	<i>S. japonicum</i>	Other parasites
DNA-Synthesis-Affecting Drugs I : Alkylation Reactions					
1973	Oxamniquine	xxx	-	-	
Hem(oglobin) Interaction					
1994–1996	Artemether	xxx	xxx	xxx	
2003	Praziquantel/artemether	xxx <sup>1</sup>	xxx <sup>1</sup>	xxx <sup>1</sup>	
Acetylcholine-Neurotransmission-Affecting Drugs					
1955	Metrifonate (= trichlorfon)	x	xx	x	Cestodes, nematodes (microfilariae)
Membrane-Function-Disturbing Drugs					
1972	Praziquantel	xxx	xxx	xxx	Protozoa, cestodes
Drugs with Unknown Antiparasitic Mechanism of Action					
1981	Cyclosporin A	xxx			Protozoans, cestodes, filariae

<sup>1</sup> Praziquantel/artemether combination is under evaluation in China, Egypt, the Philippines, and other countries

xxx = high efficacy at least against some developmental stages and diverse species; xx = partly effective (regarding developmental stages and diversity of species); x = slightly effective

In the mean time, praziquantel is used in a variety of combinations with different antinematodal drugs (→[Microtubule-Function-Affecting Drugs/Table 2](#)).

### Molecular Interactions

The →[tegument](#) and the musculature of the parasites are at least two targets of the action of praziquantel (chemically a pyrazino-isoquinoline derivative), and the action is furthermore partially (or fully) mediated or supported by the host immune system.

1. The action of praziquantel against the tegument of cestodes and trematodes: Praziquantel induces an almost instantaneous vacuolization of the tegument of →*Schistosoma mansoni* and cestodes (*Hymenolepis nana* and *T. taeniaeformis*). The vacuolization occurs at the base of the syncytial layer. →[Vacuoles](#) increase in size, protrude above the surface resulting in a final bursting of the blebs. Furthermore changes in ion- and small molecule-permeability across the tegumental membrane can be observed. Indeed, damaged parasites loose glucose, lactate, and amino acids into the surrounding medium. In addition, there is an indirect inhibition of some membrane-associated transport proteins (serotonin- or glucose- uptake protein or Ca<sup>++</sup>-ATPase) by disruption of tegumental environment. The Ca<sup>++</sup>-ATPase is unable to control the rise of Ca<sup>++</sup> ion concentration by praziquantel. It was also postulated that different calcium channels might be involved in the impairment of the calcium homeostasis within the parasites. *In vitro* a disruption of the bilayer structure of synthetic phospholipid

vesicles (phosphatidylserine, phosphatidylethanolamine) can be induced in presence of calcium by praziquantel resulting in the formation of hexagonal structures ([Fig. 2](#)). The appearance of such hexagonal structures in the tegumental membranes may thereafter facilitate Ca<sup>++</sup> entry into the worms leading to a disturbance of Ca<sup>++</sup>-homeostasis and overall changes in membrane integrity. Responsible for the perturbations of membranes are presumably interactions between negatively charged phospholipids, Ca<sup>++</sup> ions and the electrically neutral praziquantel. However, membrane actions of praziquantel are obviously not alone responsible for the drug's action, since the effects on the phospholipids are presumably mediated by a receptor protein. This idea is supported by the finding that there are differences in the anthelmintic activity between two stereo-isomers of praziquantel. A candidate for such a receptor may be a 200 kDa surface glycoprotein.

2. The action of praziquantel against the parasite musculature: Praziquantel also induces alterations of parasite's muscle physiology/biochemistry. At lower concentrations (below 1 µg/ml) a stimulation of motility of *H. diminuta*, →*H. microstoma*, *H. nana*, and preadult *Echinococcus multilocularis* is induced, followed by a contraction of the parasite musculature within 10–30 sec. The threshold concentration of praziquantel-induced contraction is between 1–10 µg/ml and is the same as that of drug-induced tegumental alterations. In addition, these changes are strongly dependent on the presence of Ca<sup>++</sup>. Ca<sup>++</sup> ions as second messengers are responsible for the further contraction of worms and →[glycogen](#) breakdown.

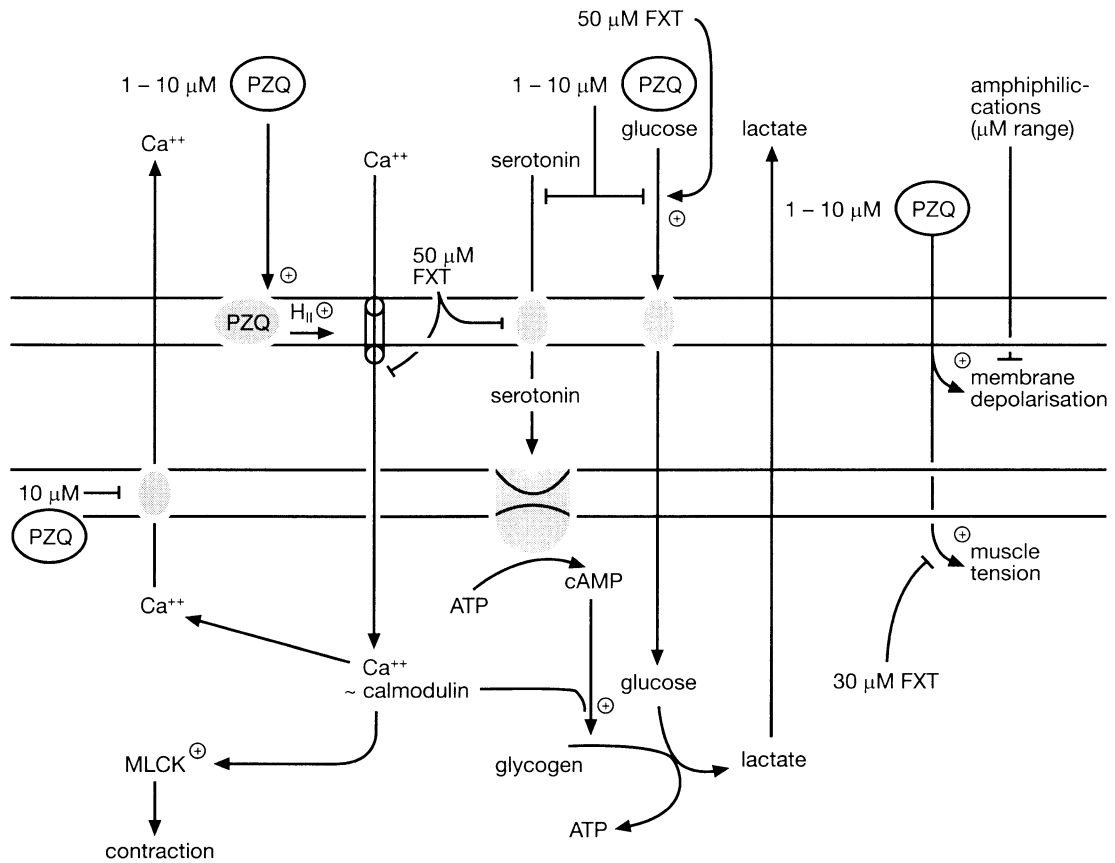

**Membrane-Function-Disturbing Drugs. Figure 2** Model of the antischistosomal action of praziquantel.

3. Involvement of the host immune system in the praziquantel action: The observed vacuolization of the parasite's tegument alone is not lethal. Responsible for the lethal effects may be immune mechanisms of the host. Indeed, an invasion of phagocytic cells into parasite occurs within 17 h after treatment of the host and a lysis of parasite tissues can be observed within a few days. Therefore, it is assumed that praziquantel induces a facilitated host immune attack following the tegumental damage and a loss of the ability to repair the tegumental surface lesions. This is caused by the disruption of tegumental membranes resulting in an exposure of proteins or enzymes, e.g., alkaline phosphatases, in female worms, and direct reactions of parasite antigens at the surface of adult male *S. mansoni* with host antibodies. In this context, it may be important that there are stage-specific capacities of repair mechanisms in schistosomes. Thus, young schistosomules and adult schistosomes have the lowest phospholipid synthesis rate, whereas 11-day-old juveniles possess the highest phospholipid synthesis rate. Praziquantel is most active against 7-day-old schistosomules and schistosomes older than 5 weeks. By contrast,

2- to 4-week-old juveniles are less susceptible to praziquantel. The repair of drug-induced lesions is presumably prevented by the interaction of the immune system with the parasite. Thus, in this model the tegumental damage as the first event of praziquantel's action favors the immune attack by the host. This view is supported by the observation that in immunosuppressed animals praziquantel treatment is less effective than in immune competent animals.

### Resistance

There are some reports on low cure rates after praziquantel treatment of schistosome-infected humans in Brazil. There is a most alarming case of low cure rate of only 18% after praziquantel treatment from Senegal patients. The mechanism for praziquantel failure is completely unclear and also the molecular mechanism of praziquantel resistance. There are two reports on laboratory selection of praziquantel-resistant *S. mansoni*. Praziquantel treatment of mice with bisexual *S. mansoni* infections and successive passage of eggs from worms lead to a strain that had survived treatment.

## Diethylcarbamazine (DEC)

### Synonyms

Tenac, Banocide, Caricide, Carbam, Caritol, Cypip, Decanine, Dicacid, Dicarocide, Difil, Digacid, Dirocide, Diro-form, Ethodryl, Filaribits, Filariosan, Franocide, Hetrazan, Loxwran, Luwucit, Nemacide, Neo Paul-vermin, Notezine, Pet-Dec, Pulmocid, Supatonin, Unicarbazan.

### Clinical Relevance

The microfilaricidal efficacy of DEC had been detected in 1947. DEC has antifilaricidal activity against *→Onchocerca volvulus*, *→Loa loa*, *→Wuchereria bancrofti*, and *→Brugia malayi* in man (*→Inhibitory-Neurotransmission-Affecting Drugs/Table 1*), *Mansonella ozzardi* is not affected. DEC can also interfere with *→embryogenesis* in female worms. The microfilaricidal effects are generally accompanied in man by severe, in dogs often lethal, side effects (Mazzotti reaction). In the past few years a combination of DEC with ivermectin has been approved for the control of *→lymphatic filariasis*.

### Molecular Interactions

The mode of action of DEC is unclear. There are reports on inhibitory effects of DEC on the motility of *→Dirofilaria immitis*. Interestingly, there is a general lack of *in vitro* activity of DEC indicating that the efficacy *in vivo* is mediated by host immune factors. An early trapping of life *Litomosoides carinii* microfilariae by polymorphnuclear cells, macrophages, and lymphocytes is observable, also a phagocytosis of microfilariae. The microfilarial sheath becomes destructed by lysosomal enzymes resulting in a final cell-mediated degradation of larvae. This cell-mediated mechanism, however, is not clear on the molecular level. *In vitro* an activation of complement on the sheath or the microfilarial surface via the alternate pathway by DEC can be observed. There is also an enhancement of antibody-mediated adherence of cells to larvae, but this seems not to be important for DEC action. Microfilariae become eliminated by a mechanism of DEC which is independent of immune status of the host. Antibodies directed against DEC potentiate the microfilaricidal activity of subcurative DEC doses in *Seteria digitata* infected *Mastomys coucha*. There is also a participation of other nonantibody mediated mechanisms for DEC action. Thus, there are reports on an inhibition of arachidonic acid pathway *in vitro* in DEC treated endothelial cells, an enhancement of macrophage, eosinophil and neutrophil adherence to microfilariae after DEC treatment, a platelet mediated cytotoxicity to microfilariae of *L. carinii* probably by free oxygen radicals and clearance of microfilariae in nude mice.

## Membranocalyx

The syncytial *→tegument* of *→Platyhelminthes* is usually limited by a single cell (*→Platyhelminthes/Integument*). Only in a few platyhelminthic species (e.g., *→Schistosoma* spp.) are there 2 membranes along the outer surface. The second membrane, which does not always appear to be complete, is known as membranocalyx and apparently protects the organism against the host's defense system.

## Menaquinone

*→Quinones*.

## Mendel, Gregor (1822–1884)

German monk and scientist, who discovered the rules of heritage redescribed in the year 1900 by Carl Correns (1864–1933), de Vries (1848–1935), and Erich Tschermak (1871–1962).

## Meningoencephalitis

*→Pathology*, *→Tick Bites: Effects in Man*.

## Menopon gallinae

Biting louse of birds (*→Mallophaga/Fig. 5*), which reaches a size of 1.8 mm and leads to itching and loss of feathers *→Mallophagidosis*, *→Lice*.

## Mepacrine

Acridine-derivative used against, e.g., flagellates in animals, which are not used for food production, e.g., in ornamental fish.

## Mermis nigrescans

Species of the family Mermithidae ([→Nematodes](#)). These worms live inside the gut of insects and are often found hanging (filament-like) out of the anus, since the adults leave the insect to start reproduction in water [→Nematodes](#).

## Merogony

Asexual division phase: a meront (= [→schizont](#)) gives rise to cytomere-like stages or forms merozoites, [→Coccidia](#), [→Microsporidia](#).

## Meromyaria Muscle Type

[→Nematodes](#).

## Meronts

[→Amblyospora](#), [→Coccidia](#).

## Merozoite

Motile stage of [→Coccidia](#) that is formed during [→schizogony](#) ([→merogony](#)) inside the [→parasitophorous vacuole](#) of a host cell. It is limited by a 3-layered [→pellicle](#) and equipped with an [→apical complex](#) in order to enter host cells ([Fig. 1](#), page 805), [→Coccidia/Host Cell Invasion](#)). The merozoites of eimerids (e.g., genus [→Eimeria](#), [→Toxoplasma](#), [→Sarcocystis](#)) possess a [→conoid](#), while it is lacking in haemosporideans and [→piroplasms](#). Merozoites initiate either another schizogonic process or become gamonts.

## Merozoite Surface Protein

[→Malaria](#), [→MSP-1](#), [→Vaccination](#).

## Mesa Protein

[→Knobs](#), [→Plasmodium](#), [→Malaria](#).

## Mesembrina meridiana

Fly of the family Muscidae (9–13 mm long, black body with yellow wings), which is found on faeces, where the larvae feed (thus this fly may become a facultative vector of bacteria); common in Europe.

## Mesocercariae

[→Alaria canis](#).

## Mesocestoides

### Name

Greek: *meso* = middle, *cestos* = belt.

### Classification

Genus of [→Eucestoda](#) ([→Platyhelminthes](#)).

### Life Cycle

[Fig. 1](#) (page 806).

### General Information

The species of this genus live as adults in the intestine of carnivores ([Fig. 1](#)). The regular (second, if a first one is present) intermediate host are small mammals; however, cattle might also be carriers of the infectious tetrahyridium larva. The adult worms reach a length of up to 40 cm and are characterized by a typical thick-walled paruterine organ inside the terminal proglottids ([Fig. 2](#), page 807) and by the scolex ([Fig. 3](#), page 807) with 4 flat suckers but without a rostrum or hooks. The paruterine organ contains the typical eggs with the oncosphaera larva ([Fig. 5](#), page 808). Infected dogs show after an incubation period of 14 days only slight symptoms of disease, such as intestinal rumour. Human cases are rare, but these patients showed abdominal pain and slight anaemia.

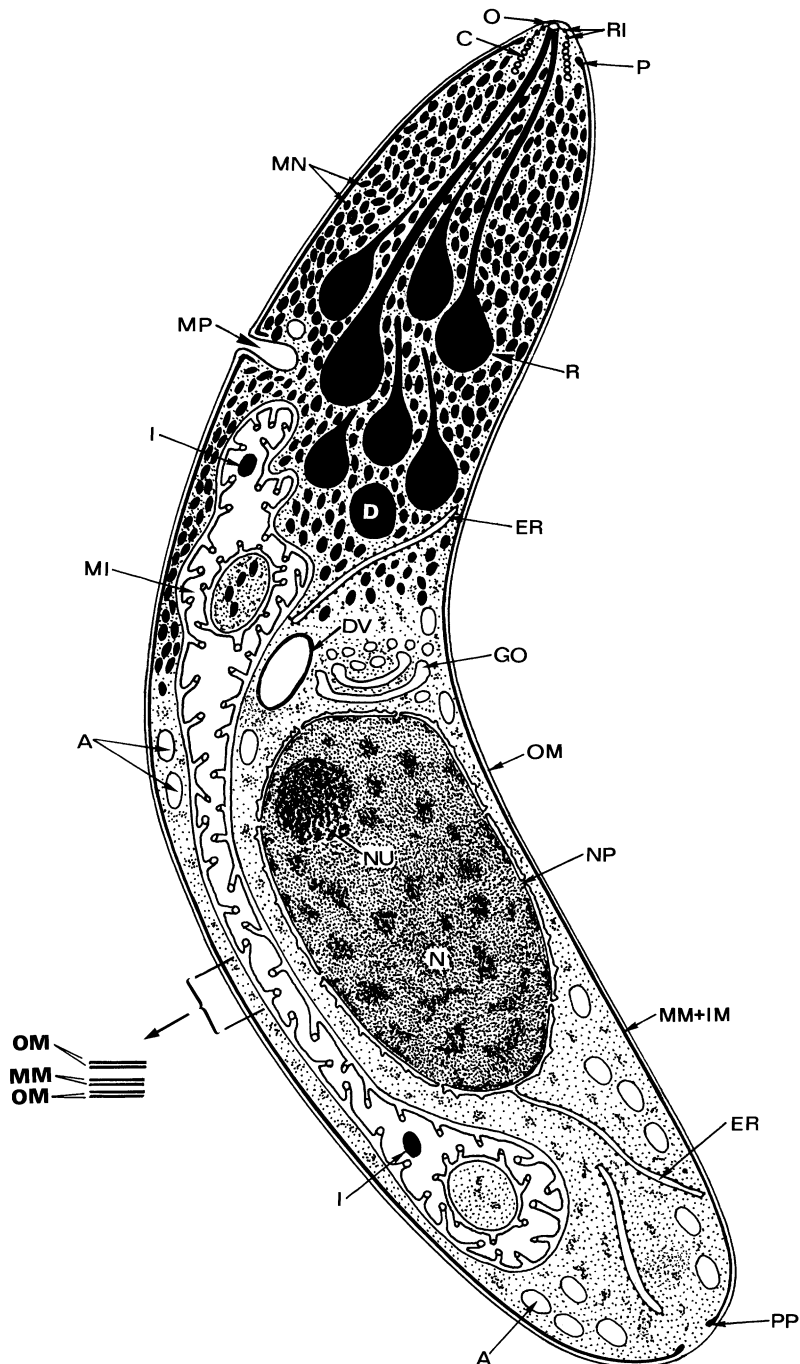

**Merozoite. Figure 1** Diagrammatic representation of a motile stage ( $\rightarrow$ merozoite, cyst merozoite) of  $\rightarrow$ coccidia (e.g., *Sarcocystis ovifelis*) in longitudinal section. *A*,  $\rightarrow$ amylopectin; *C*,  $\rightarrow$ conoid; *D*, dense, spherical bodies; *DV*, double-walled vesicle; *ER*, endoplasmic reticulum; *GO*,  $\rightarrow$ Golgi apparatus; *I*, dense inclusion; *IM*, inner membrane; *MI*, mitochondrion; *MM*, middle membrane; *MN*, micronemes; *MP*, micropore; *N*, nucleus; *NP*, nuclear pore; *NU*,  $\rightarrow$ nucleolus (karyosome); *O*, opening of the conoid; *OM*, outer membrane of  $\rightarrow$ pellicle; *P*, anterior  $\rightarrow$ polar ring; *PP*, posterior polar ring; *R*,  $\rightarrow$ rhoptries; *RI*, ring-like elements of the conoidal canopy.



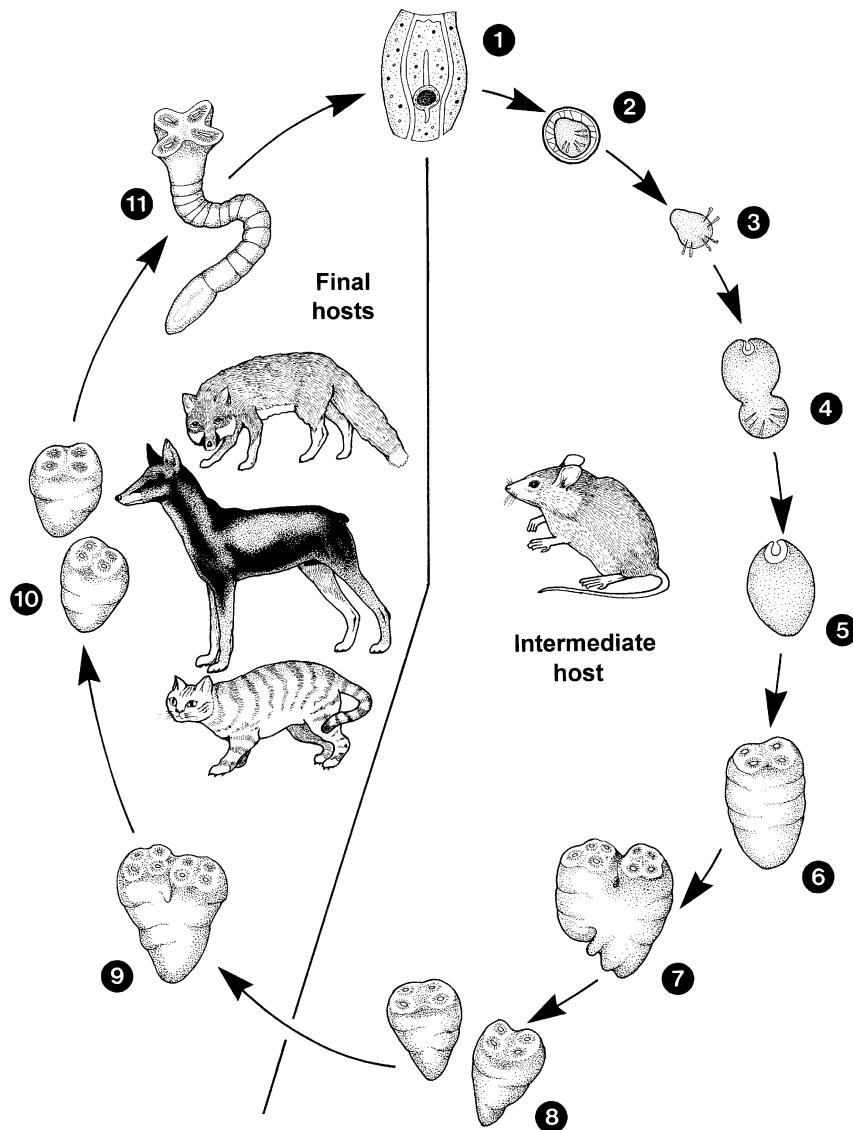

**Mesocestoides.** Figure 1 Life cycle of *Mesocestoides* sp. in its hosts. 1 Terminal →proglottids with the characteristic, thick-walled →paruterine organ (PO) which is filled with eggs. 2 Egg with →oncosphaera larvae which are ingested by the first →intermediate host. 3–6 Suggested development in the first intermediate host. To date it is not known whether oribatid →mites may be first intermediate hosts. 7–9 Development in the second intermediate host which cannot be infected directly by eggs (2). Larvae, so-called tetrathyridia (7), occur in the body cavities of several animals (mainly mice, but also dogs, cats, and snakes). The →tetrathyridium reaches a size of  $1.5 \times 1$  mm and is provided with 4 suckers (SU). Reproduction of these tetrathyridia is common and proceeds as longitudinal division (DI, fissiparity). 10–12 Final hosts such as foxes, dogs, cats, and other carnivores become infected by ingesting infected tissues of the second intermediate hosts (and perhaps by swallowing first intermediate hosts (6–10)). Inside the small intestine divisions (10) may be repeated. Finally, the tetrathyridia grow (12) to be adult worms with many →proglottids (reaching about 40 cm in length) or they may leave the intestine and enter tissues or body cavities where another asexual →binary fission may occur. DI, direction of division; EX, excretion canal; PO, paruterine organ (filled with eggs); PR, proglottids; SU, sucker; UT, uterus.

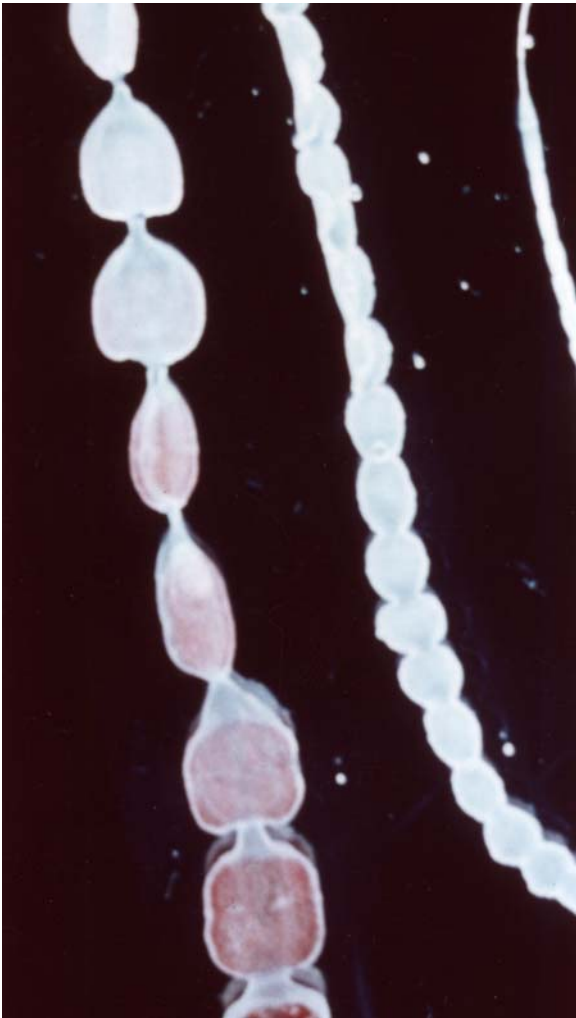

**Mesocoestoides.** Figure 2 LM of typical proglottids (right = anterior, middle = midbody, left = terminal proglottids).

### Diagnosis

Microscopical studies of the faeces of the final hosts show proglottids and eggs (Figs. 2, 4, 5, page 808).

### Therapy

→ Cestodocidal Drugs.

---

## Mesocoestoides leptothylacus

→ Eucestoda, → Mesocoestoides.

---

## Mesocoestoides litteratus

Common tapeworm of red foxes and other carnivores in Europe. This species – formerly kept as nomen



**Mesocoestoides.** Figure 3 Scolex.

dubium and redescribed as *M. leptothylacus* – apparently is valid according to molecular data. The species *M. lineatus*, however, is clearly different.

---

## Mesostephanus

Genus of seabird trematodes reaching a length of 1.7 mm, with water snails as first and fish as second intermediate hosts.

---

## Mesostigmata

→ Acarina.



**Mesocestoides.** Figure 4 Proglottids showing testes and the early uterus.



**Mesocestoides.** Figure 5 Typical paruterine organ filled with eggs.

---

## Mesulfen

→[Coccidiocidal Drugs](#).

---

## Metabolism

The metabolic organization of parasitic →[Protozoa](#) and helminths is different from that observed in other forms of life. Endoparasites show a most unusual molecular structure and function within the whole animal kingdom. Each species and its developmental stages possess their own distinct metabolic pattern, which obviously has evolved to suit the complex and often peculiar →[environmental conditions](#) within the host. Besides this great biochemical diversity, groups of

closely related parasites and species occupying the same or a similar type of habitat often show close similarities in their central metabolic routes. These wide-spread and more general biochemical concepts must be differentiated from those properties which are unique to particular species or families of parasites. Considering the molecular basis of antiparasitic drug action, the specific catabolic and biosynthetic capabilities of these organisms are described in detail under the following entries: →[Energy Metabolism](#), →[Amino Acids](#), →[Lipids](#), →[Purines](#), →[Pyrimidines](#), →[Deoxynucleotides](#), →[Folic Acid](#), →[Polyamines](#), →[Thiols](#).

---

## Metacercariae

→[Alaria canis](#), →[Apophallus muehlingi](#), →[Heterophyes heterophyes](#), →[Digenea](#).

## Metacestode

Larval stage of → [Cestodes](#) prior to transmission and maturation into an adult worm (→ [Platyhelminthes/Asexual Processes](#)).

## Metacyclic Forms

Final stages that have developed in a vector and are ready for transmission to the vertebrate host (e.g., → [Trypanosoma](#), → [Leishmania](#)).

## Metaflumizone

### Chemical Class

Carboxamide (hydrazine carboxamide).

### Mode of Action

Voltage gated sodium channel modulator. → [Ectoparasitocides – Blockers/Modulators of Voltage-Gated Sodium Channels](#).

## Metagenesis

Type of life cycle during which asexually produced generations are followed by sexually active generations of individuals (→ [Platyhelminthes/Asexual Processes](#), → [Echinococcus](#), → [Eucestoda](#)).

## Metagonimus

### Name

Greek: *meta* = back, *gone* = gonad.

Genus of trematode flukes (→ [Digenea](#), → [Platyhelminthes/Fig. 18E](#)). The East Asian worm *M. yokogawai*, which measures 1–2.5 mm × 0.4–0.7 mm is characterized by a scaly tegument and the posterior position of the 2 testes ([Fig. 1](#), page 810). First intermediate hosts (IM) are snails, second IM are cyprinid fish, which contain the infectious metacercariae. The **incubation period** is 1–2 weeks like the **prepatent period**.

### Symptoms

Mainly diarrhea.

### Diagnosis

By microscopical determination of eggs in the feces.

### Therapy

→ [Trematocidal Drugs](#).

## Metamonada

Phylum of former subkingdom Protozoa including the orders Diplomonadida, Enteromonadida, Retortamonadida.

## Metamorphosis

Period of (rapid) transformation from the larval to the adult form without enclosed further reproduction (e.g., → [Monogenea](#), → [Digenea](#), most → [Cestodes](#), → [Eucestoda](#), → [Acanthocephala](#), → [Pentastomida](#), arthropods).

### Related Entries

→ [Hemimetabolous Development](#), → [Holometabolous Development](#).

## Metanephridia

Excretory organs of → [leeches](#) → [Hirudo medicinalis](#).

## Metaphylaxis

Method and term are used in veterinary medicine: killing of parasites after an outbreak of disease before serious damage may occur.



**Metagonimus. Figure 1** SEM of an adult worm showing the scaly surface and the laterally from the midline situated small ventral sucker (the sexual opening is close by).

## Metapopulation

This term comprises all →[infrapopulations](#) of parasitic species in the individuals of a host species within a given ecosystem.

## Metastasis-Like Infiltration

Undifferentiated cells from →[Echinococcus multilocularis](#) cysts (= →[alveococcus](#)) may give rise to new cysts in many organs, when disseminated during surgery or biopsy.

## Metasoma

The body of →[Acanthocephala](#) consists of 2 major parts, the →[praesoma](#) and the metasoma. The tube-shaped metasoma (= trunk) is bounded by a solid body wall, enclosing the pseudocoel, which is mainly filled with male or female sexual organs.

## Metastasis-Like Propagation

The undifferentiated cells within the alveolar cysts of →[Echinococcus multilocularis](#) propagate like tumor cells, in case they are set free during surgery. They may initiate a new cyst formation in other organs and thus lead to death if the patient is not treated, e.g., with albendazole.

## Metastigmata

→Acarina.

## Metastricata

Ixodid →ticks are subdivided into 2 groups, the →Prostricata and the Metastricata (→Ticks/System).

## Metastrongylus

### Name

Greek: *meta* = behind, *strongylos* = cylindrical.

Genus of the worldwide occurring nematode family Metastrongylidae, which are lungworms of pigs. In *Metastrongylus apri* (syn. *M. elongatus*) the males reach a length of 15–26 mm, while the females measure 35–44 mm. This species is most common and lives in the bronchioles of pigs. The females deposit larvae containing eggs. Often the larvae occur already in the faeces. The life cycle is indirect using earthworms as intermediate hosts. The **prepatent period** is 4–5 weeks long and includes a phase of larval wandering through lymph nodes, heart, and finally lung. →Lungworms, →Nematodes.

### Patency

About 6–9 months.

### Therapy

→Nematocidal Drugs.

## Metazoa

### Classification

Subregnum of Animalia.

### General Information

The group Metazoa comprises all eukaryotes that consist of many cells functioning in a highly integrated fashion. In protozoans the individual cell has to perform all tasks needed for living, survival, and reproduction. Metazoans have developed specialized organs that are fully adapted for different functions.

In parasitic animals the systems described in the following section are most important, since the dysfunction of any one would lead to the inevitable death of the parasitic aggressor. Because there are many functional similarities, these main systems will be dealt with here in a comparative manner.

Metazoa retain vestiges of their unicellular origin, as shown by their development from unicellular “eggs,” some of which may develop even if they are not fertilized. They also have the ability to reconstruct their whole bodies from a single cell, as the sponges easily do, as well as the fertilized →oocytes of vertebrates.

### Musculature

Among metazoan parasites a variety of different types of muscles has developed. In general either smooth or striated muscle fibers occur but intermediate forms can also be found. Muscles of the smooth type are usually observed in parasites with a relatively soft →body cover (e.g., →Platyhelminthes, acanthocephalans), whereas parasites with a relatively stiff **exoskeleton** have strong, striated muscle bundles and additional smooth filaments along the intestine, etc. There are many basic differences in shape, arrangement, and fine structure of muscles within the different systematic taxa (→Platyhelminthes, →Nematodes, →Acanthocephala, →Pentastomida, →Insects, →Ticks, →Crustacea, →Leeches, →Hirudo medicinalis).

### Integument

The parasite–host interface is the place where nutrients are taken up and is the site of the attacks on the host’s defense system. In the parasites considered here, 2 main types of body cover exist:

- An acellular filamentous →cuticle (excreted by an underlying cellularly organized hypodermis) is found, for example, in →nematodes, pentastomids, and arthropods (→ticks, →mites, insects, crustaceans).
- A syncytial cytoplasmic →tegument, where giant nuclei or nuclear fragments may occur, covers the surface of larval monogeneans, digeneans, →cestodes, and acanthocephalans, whereas the tegument (i.e., →neodermis = new skin) of adult parasitic platyhelminths lacks nuclei.

The surface of both types of outer body cover (→cuticle or tegument) may be lined by more or less thick layer(s) of carbohydrates, mucopolysaccharides, or even membranous material depending on the species and the site of parasitism. This →surface coat that fulfils its tasks in defense against environmental influences while covering normal and parasitic cells is thought to be the ancestor of all cuticular systems of the whole animal and plant world. Apparently during evolution the →glycocalyx, while situated between

body and/or cell protrusions (e.g., →[microvilli](#), protuberances) became fortified by enclosure of fibers of →[collagen](#), →[chitin](#), cellulose, and/or calcium carbonate components, etc. Thus, the original protection system received a second function, i.e., the preservation of the body shape as a system belonging to the exoskeleton. However, the uptake of nutrients through this increasing outer surface remained possible using a variety of mechanisms and carrier systems. Thus, for example, schistosomes are able to take in huge amounts of glucose through their surface membranes and nematodes may be decimated by several drugs due to their cuticular uptake, too (→[Chemotherapy](#), →[Mode of Action](#)).

### Intestine and Food Uptake

Among the parasitic metazoans 2 groups lack an intestine in all developmental stages: →[cestodes](#) and →[acanthocephalans](#). In other groups only the larval stages may not develop an intestine (e.g., microfilariae of filariae) or the intestine may lose its function during a developmental phase; e.g., unsheathed larvae of →[hookworms](#) and even some motile pupae of →[Insects](#) (e.g., →[mosquitoes](#)) do not feed. In other cases adult worms lose their intestinal functions by partial or total degeneration of the alimentary system (e.g., →[Dracunculus medinensis](#) and relatives; →[Onchocerca volvulus](#)). The intestinal tract is blind-ending in monogeneans and digeneans, whereas in other groups an anus is present although it may become closed secondarily (e.g., Philometridae, Dracunculidae).

The feeding but intestineless groups (which in general are parasites of the host's alimentary system) are obliged to take up whatever food their structures allow. The smooth-walled →[tapeworms](#) are able to feed by →[endocytosis](#) and additional active →[membrane transport](#), whereas the latter is probably the only possible method for the stiff-walled acanthocephalans. In general, parasites are adapted to different ways of feeding and to different foods. For detailed information on many groups please refer to the respective headwords.

---

## Methanolquinolines

→[Malariaicidal Drugs](#).

---

## Methomyl

### Chemical Class

Carbamate.

### Mode of Action

Acetylcholine esterase inhibitor. →[Ectoparasiticides – Agonists and Antagonists of Cholinergic Transmission](#).

---

## Methoxychlor

### Chemical Class

Organohalogenide.

### Mode of Action

Open state voltage-gated sodium channel blocker. →[Ectoparasiticides – Blockers / Modulators of Voltage-Gated Sodium Channels](#).

---

## Methoprene

### Chemical Class

Juvenile hormone agonist (juvenile hormone analogue).

### Mode of Action

Insect growth regulator (IGR, juvenile hormone mimics). →[Ectoparasiticides – Inhibitors of Arthropod Development](#).

---

## Methyl Farnesoates

→[Juvenile Hormones](#).

---

## Metorchis

### Name

Greek: *meta* = behind, *orchis* = testis.

Genus of the digenetic →[trematode](#) family Opisthorchiidae. *M. bilis* (2.3–4.3 mm × 1.0–1.4 mm) is found in Europe and North America in dogs, cats, foxes, and other carnivores inside the bile duct and bile bladder. Intermediate hosts are at first snails and later fish.

### Therapy

→[Trematocidal Drugs](#), →[Digenea](#).

## Metrifonate

Organophosphate, →Ectoparasitocides.

## Metrocytes

In other words mother cells; these stages are ovoid and are situated in tissue-cysts of →Sarcocystis species. While they fill young cysts completely, they are found at the periphery of old ones. In any case they give rise by →endodyogeny to 2 daughter cells.

## Metronidazole

→Antidiarrhoeal and Antitrichomoniasis Drugs.

## Metschnikow, Ilya (1845–1946)

Russian zoologist, creator of the knowledge of phagocytic cells, describer of amoebae, and of the syphilis bacterium. 1908 winner of the Nobel Prize (together with the German Paul →Ehrlich).

## MHC-Complex

Short for Major Histocompatibility Complex. The different components (MHC I, MHC II) are presented in combination with degraded antigen-material in order to start the specific immune reaction cascade.

## Microaerophiles

→Energy Metabolism.

## Microbodies

Microbodies are ubiquitous in eukaryotic cells; they are bounded by a single membrane and contain electron-dense, often crystalline, inclusions. The microbodies are probably pinched off from the ER at sites, where the ~40 enzymes (e.g., oxidases, catalases) contained in microbodies accumulate (when synthesized at free ribosomes). The often spherical microbodies may attain diameters of 0.2–1.7 μm, depending on their type. The 4 general types are the →hydrogenosomes, the →peroxisomes, the →glyoxisomes, and the →glycosomes. It is not completely decided whether the so-called →dense bodies of the coccidians also belong to the group of microbodies.

## Microfilaria

Plural = microfilariae; i.e., first larva (= L1) of →Filariidae found in blood (Figs. 1, 2, page 814; e.g., →Wuchereria bancrofti) or in the lymph fluid of skin (e.g., →Onchocerca volvulus) of their vertebrate hosts. It may be ensheathed (e.g., →Loa loa, →Wuchereria, →Brugia) or not (e.g., →Onchocerca).

### Diagnosis

Giemsa stained blood smears, →Knott test.

## Microflora

The bacterial microflora (*Micrococcus*, *Staphylococcus*, *Corynebacterium*, and →fungi) of human skin plays a role in the production of odorous components that might function as kairomones for →mosquitoes in attracting them.

## Microgametes

→Gametes containing only small amounts of cytoplasmic material being formed by division of a microgamont.



Species	<i>Wuchereria bancrofti</i>	<i>Brugia malayi</i>	<i>Loa loa</i>	<i>Mansonella perstans</i>	<i>Mansonella ozzardi</i>
Shape					
posterior end					
anterior end					
size	300 x 8 μm	220 x 6 μm	270 x 8 μm	180 x 4 μm	200 x 4 μm

**Microfilaria. Figure 1** Diagrammatic representation of characteristics of microfilariae. *E*, invagination; *EN*, terminal knob; *N*, nucleus; *S*, sheath; *ST*, stiletto-like thorn.

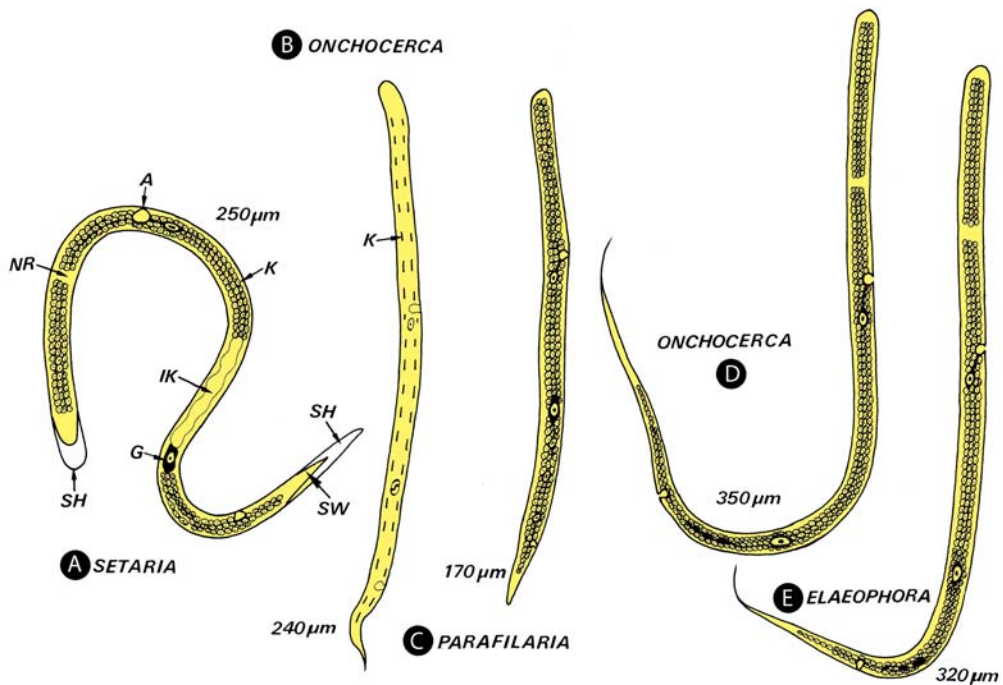

**Microfilaria. Figure 2** DR of the microfilariae of several genera of filariae of horses. *A*, anal porus; *EX*, excretory porus; *G*, genital anlage; *IK*, inner body complex; *K*, head; *NR*, nerve ring; *SH*, sheath; *SW*, tail.

## Microgametocytes

Other name for microgamonts, which in [→Coccidia](#) give rise to species-specific numbers of few ([→Plasmodium](#) spp.) or up to hundreds ([→Eimeria](#)) of microgametes (male gametes).

## Microgamonts

[→Cell Multiplication](#), [→Eimeria](#), [→Coccidia](#).

## Micromastigotes

[→Amastigotes](#), [→Trypanosoma](#).

## Micronema

### Name

Greek: *micros* = small, *nema* = filament.

Genus of free-living [→nematodes](#). Some species may become accidentally parasites of vertebrates. One of those species is *Micronema deletrix* (syn. [→Halicephalobus](#)) in horses and man (♀ = 445 µm long).

## Microneme Protein TRAP

[→Apicomplexa](#).

## Micronemes

Micronemes are small rod-like structures, 50–90 × 300–600 nm, with rounded ends. These structures usually occupy the anterior regions of the motile stages of the sporozoans and are often arranged in bundles

([→Kinete/Fig. 2](#), [→Pellicle/Fig. 4A](#), [→Merozoite/Fig. 1](#)). Most of the functions of micronemes are not clear. They disappear during the reproductive process in [→meronts](#), macrogamonts, and [→microgamonts](#). This is in accordance with the finding that some of the 7 proteins included in the micronemes are used during adhesion of the parasites to their host cell. Thus the so-called circumsporozoite-protein was found in micronemes of [→Plasmodium](#) sp. as well as proteins used for erythrocyte attachment. The contents of the micronemes are formed along the ER (close to the nucleus), become transported to the [→Golgi apparatus](#) (being situated just prior to the nucleus, [→Merozoite/Fig. 1](#)) and are released from there as promicronemes. Ultrastructural findings showed [→exocytosis](#) of the micronemes at several places of the [→pellicle](#) as well as within the micropore ([→Apicomplexa/→Host Cell Invasion](#)).

## Micronemiasis, Man

Micronemiasis is an infection by a free-living microscopic nematode, *Micronema* sp., which can give rise to disseminated infection after contamination of wounds with soil or horse manure. This [→oviparous](#) worm multiplies in the body, building up huge numbers, with the larvae found in many tissues. Only a few cases have been described in humans, in all of whom [→meningoencephalitis](#) was present. Similar lesions and granulomatous masses with many worms have been observed in horses.

### Therapy

[→Nematocidal Drugs, Man](#).

## Micronucleus

In ciliates, 2 morphologically distinct nuclei occur: a generative micronucleus and a somatic [→macronucleus](#) ([→Nucleus](#)).

## Micropores

Small [→cytostomes](#) found in sporozoans ([→Endocytosis/Fig. 1C–F](#)).

## Micropyle

In parasites there are 2 meanings:

- thin region in the →oocyst wall of →Coccidia (→Cyst Wall);
- thin place in the eggshell of insects and →ticks (used for entry of the spermatozoon).

## Microsatellite DNA-Analysis

Molecular method used to resolve taxonomic questions in those cases, where morphology or zymodemes offer not enough information, e.g., in *Leishmania* spp., *Cryptosporidium* spp.

## Microscopic Diagnosis of Parasites in Human Blood

Microscopic examination of blood used to be the routine procedure in the diagnosis of malaria, African and American trypanosomiasis, and lymphatic filariasis. The introduction of antigen detection methods, immunodiagnostic tests and PCR has increased the range of diagnostic approaches, but has not necessarily replaced the microscopic blood examination as best seen on the example of malaria.

### Malaria

Examination of the →Giemsa-stained thick blood film is the standard procedure of the microscopic routine examination for the presence of plasmodia. While thin blood films may be useful in the context of species differentiation, they are less suitable for routine diagnosis since the probability of missing low parasitaemias is high. After preparation, the thick film is thoroughly dried without fixing it. Subsequently it is stained, for 30–45 minutes, with a 1–2 % dilution of a commercially available Giemsa stock solution at pH 6.85–7.15. After drying, the thick blood film is examined under the microscope, using 1,000-fold magnification (eye-piece 10× and oil immersion objective 100×). A total of 100 microscope fields, corresponding to 1,000–2,000 white blood cells or 0.13–0.25 μl, should be screened for the presence of parasites before the blood sample can be declared negative.

Rapid diagnostic tools (RDT), usually based on the detection of HRP2 or LDH, are available for the diagnosis of falciparum and vivax malaria. These are useful for laboratories inexperienced in the microscopic diagnosis of malaria, and in the rapid detection of epidemic outbreaks in remote areas with low communal immunity. However, they are useless in hyper- and holo-endemic areas due to the massive presence of oligosymptomatic carriers of plasmodial infections. In the detection of infections with *Plasmodium vivax* the acuity of the RDT is relatively low. With approximately 16% the frequency of false negatives is too high for reliable routine diagnosis.

Giemsa-stained thick blood films can also be used for the determination of the parasite density (parasitaemia), differentiating between asexual parasites and gametocytes. For this procedure, the number of asexual parasites is counted against 200 or 500 white blood cells and the number of gametocytes against 500 or 1,000 white blood cells. Parallel determination of the white blood cell count (WBCC) will permit a precise calculation of the asexual parasite density (APD) or the gametocyte density (GD), respectively, using the formula:

$$\text{APD per } \mu\text{l} = (\text{parasites counted} \times \text{WBCC}) / \text{WBC read}$$

An approximation can be obtained by using the communal average leukocyte count instead. This count varies according to geographical area and ethnic features, but an average of 8,000 WBC/μl is considered a practical approximation. In this case the above formula is modified to:

$$\text{APD per } \mu\text{l} = (\text{parasites counted} \times 8,000) / \text{WBC read}$$

Parasite counts are particularly useful in the determination of severe malaria requiring special therapeutic management, and in the monitoring of the patient's response to treatment.

### African Trypanosomiasis

Unstained wet blood preparations, chancre fluid, CSF or lymph node aspirate can be used for the demonstration of motile trypanosomes. Giemsa-stained slides should also be prepared from the same material. With native blood samples it will be usually possible to demonstrate trypanosomes of *Trypanosoma brucei rhodesiense*, but less frequently those of *T. b. gambiense* since parasitaemia is usually much lower with this parasite. Here, concentration techniques may be successful, such as blood centrifugation and subsequent examination of the buffy coat, also in the form of the quantitative buffy coat technique (QBC). Mini anion-exchange and centrifugation is another useful method. Antibody detection methods proved to be too insensitive or unspecific for a reliable diagnosis of African trypanosomiasis.

## American Trypanosomiasis (Chagas Disease)

In the acute stage of Chagas Disease, the direct examination of anticoagulated blood or its buffy coat will usually reveal the presence of motile trypanosomes. Giemsa-stained thin or thick blood films are useful for confirmation. Direct visualization of trypanosomes is much more difficult in the chronic stage of the disease, where culture in NNN medium, blood inoculation into mice or xenodiagnosis with uninfected reduviid bugs are used to propagate the causative parasite which then becomes detectable by microscopic examination. Where appropriate facilities are available, PCR may be useful for detecting *T. cruzi* in blood.

For epidemiological or individual screening, the indirect fluorescent antibody test (IFAT) proved to be highly sensitive. However, cross-reactivity with *Leishmania* spp. co-endemic with *T. cruzi* in various areas of Latin America limits the usefulness of the IFAT.

## Filariasis

Microfilariae of → *Wuchereria bancrofti*, *Brugia malayi*, *B. timori*, *Loa loa* and of the commensalic species *Mansonella perstans* and *M. ozzardi* are detectable in the peripheral blood, subject to the particular periodicity of the parasite species. The detection can be attempted in thick blood films stained with haematoxylin-eosin or with Giemsa. Higher sensitivity of the blood examination is achieved by the use of concentration techniques. For this purpose a blood sample (1–2 ml) is obtained by venupuncture, lysed in 2% formalin, followed by centrifugation. The stained sediment is examined under the microscope. Another concentration method consists of lysing the blood sample (1–2 ml) with 10–15 ml of distilled water and passing the lysate through a Nucleopore® filter. The stained membrane can then be examined for the presence of microfilariae, followed by the morphological species classification.

PCR-based diagnosis is available for *W. bancrofti* and *B. malayi*. For field investigations an antigen test for *W. bancrofti* has shown encouraging results. The results of antibody detection tests are subject to cross-reactivity with other helminths and therefore of very limited usefulness in the diagnosis of filarial infections.

## Limitations of Microscopy

In endemic areas chronic infections with *Plasmodium malariae*, *P. falciparum* or *Trypanosoma cruzi* may persist in apparently healthy individuals at parasitaemias below the threshold of detection by microscopic examination. Such infections may endanger the life or aggravate the clinical condition of recipients of blood or tissue and organ transplants originating from apparently oligosymptomatic carriers. Even PCR

techniques may fail to demonstrate the presence of parasites in prospective donors. However, the use of a pan-specific ELISA test for antibodies against human-pathogenic plasmodia and the IFA for American trypanosomiasis permits the identification of potentially infected prospective donors. Cross-reactivity of the IFA for American trypanosomiasis with leishmanial infections is an advantage in this case since leishmaniasis may also be transmitted with blood and transplantation material.

## Microspora

### Classification

Phylum of →Protozoa.

→Microsporidia or Microspora (syn.) are one of the oldest groups of unicellular organisms and are placed together with archiamoebae and dinoflagellates at the base of the eucaryotic tree. Due to the presence of chitin in the spore wall and with respect to other morphological peculiarities they were considered as fungi by some authors.

### System

- Phylum: Microspora
  - Order: →Microsporidia
    - Suborder: Apansporoblastina
    - Suborder: Pansporoblastina

## Microsporidia

### Classification

Order of →Microspora.

### General Information

Microsporidia are widespread small unicellular, obligate intracellular parasites which are transmitted via resistant double-walled (→chitin containing) →spores normally ingested by their hosts (Fig. 1, →Amblyospora/ Fig. 1, →Encephalitozoon/ Fig. 1, Table 1). When these spores hatch under suitable stimuli, a hollow →polar tube (→Polar Filament) is everted, enabling the tip to penetrate a host cell. The →sporoplasm passes through the tube and enters the host cell →cytoplasm, inside which asexual reproduction (→Schizogony = →Merogony, →Sporogony) is initiated (Fig. 1). Microsporidia lack →mitochondria and Golgi, but are typically eukaryotic.

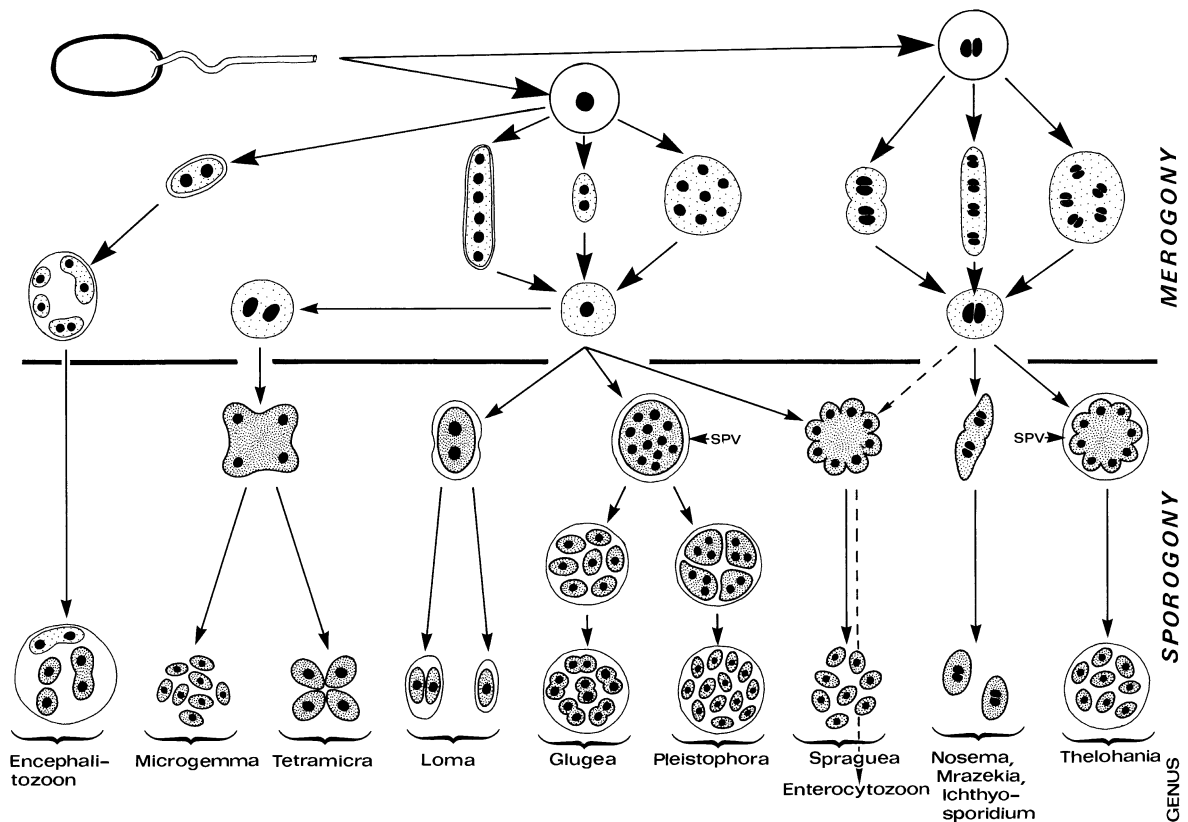

**Microsporidia. Figure 1** Development of some microsporidian genera. Sporoplasms are shown without stippling, merogonic stages are shown with a simple surface membrane and light stippling, and sporogonic stages are shown with a dense → surface coat. In → *Encephalitozoon* spp. all stages are included in a host cell vacuole. In other genera the merogonic stages are free in the host cell cytoplasm or are found there within → sporophorous vacuoles (SPV), the borders of which derive from the surface of the sporogonial plasmodia.

→ Nuclear division occurs in the absence of centrioles with spindles being anchored to dense plaques along the inner nuclear membrane. The systematic position of the Microsporidia is under discussion, since several authors consider them as → fungi. Just recently a large number of Microsporidia turned out to be → opportunistic agents and they are found in many → AIDS patients, where often generalization occurs, i.e., the parasites are found in many organs.

## System

Phylum: → Microspora

- Order: Microsporida
  - Suborder: Pansporoblastina
    - Genus: → *Pleistophora*
    - Genus: → *Thelohania*
    - Genus: *Glugea*
  - Suborder: Apansporoblastina
    - Genus: → *Nosema*
    - Genus: → *Ichthyosporidium*

- Genus: → *Enterocytozoon*
- Genus: *Septata*
- Genus *Mrazekia*

## Important Species

Table 1, → *Encephalitozoon*, → *Nosema*.

## Reproduction

Figs. 1, 2.

## Host Cell Invasion

Although rather poorly known, the mechanism of cell invasion by Microsporidia has very peculiar characteristics. Microsporidia self-inject into their host cell by devaginating a membranous organelle (polar tube) which forces its way through the host cell → plasma-lemma and through which the parasite cytoplasm moves into the recipient cell (→ Host Cell Invasion/Fig. 1). Invasion is thus intrusive: this is the only case known

**Microsporidia. Table 1** Some common microsporidian species

Species	Host	Habitat	Size of pore (µm)	Geographic distribution
<i>Glugea anomala</i>	Fish ( <i>Gasterosteus</i> spp.)	Connective tissue	2 × 6	Holarctic
<i>G. fennica</i>	Fish ( <i>Lota lota</i> )	Subcutaneous tissues, fins	2.6 × 7	Finland
<i>G. truttae</i>	Fish ( <i>Salmo trutta</i> )	Yolk sac	1.5 × 5	Europe
<i>Nosema apis</i>	Bees ( <i>Apis mellifica</i> )	Intestine	5 × 9	Worldwide
<i>Microsporidium ceylonensis</i>	<b>Humans</b> (AIDS)	Cornea	3 × 5	Worldwide
<i>M. africanum</i>	<b>Humans</b> (AIDS)	Cornea	3 × 5	Worldwide
<i>N. ocularum</i>	<b>Humans</b> (AIDS)	Cornea	3 × 5	USA
<i>Vittaforma corneae</i>	<b>Humans</b> (AIDS)	Cornea	3 × 4	Europe
<i>Brachiola vesicularum</i>	<b>Humans</b> (AIDS)	Muscles	2 × 2.9	USA
<i>B. connori</i>	<b>Humans</b> (immuno-defectives)	All organs	2 × 4	USA
<i>Pleistophora typicalis</i>	Fish (several marine species)	Skeletal muscles	2.3 × 4.4	Europe
<i>P. anguillarum</i>	Fish (eels)	Skeletal muscles	3 × 5	Japan/ Taiwan
<i>P. danilewski</i>	Reptiles, frogs	Skeletal muscles	4 × 2	Europe
<i>Trachipleistophora hominis</i>	<b>Humans</b> (AIDS)	Muscles	2.4 × 4	Europe
<i>T. anthropophthera</i>	<b>Humans</b> (AIDS)	Many organs	2 × 3.7	Europe, USA
<i>Loma branchilis</i>	Fish ( <i>Gadus</i> spp.)	Gills	2.3 × 4.8	Boreo-artic
<i>Thelohania californica</i>	Mosquitoes ( <i>Culex</i> spp.)	Fat body, intestine	3 × 6	America
<i>T. baueri</i>	Fish (brackfish)	Oocytes/ovaries	2.7 × 5.4	Gulf of Finland
<i>Ichthyosporidium giganteum</i>	Fish (marine species)	Connective tissue	4 × 7	Atlantic Coast
<i>Microsporidium cotti</i>	Fish (marine species)	Testis	9 × 3	Atlantic Coast
<i>M. schuetzi</i>	Frogs ( <i>Rana</i> spp.)	Oocytes	7 × 2	USA
<i>Encephalitozoon lacertae</i>	Lizards ( <i>Podarcis</i> sp.)	Epithelium of intestine	3.5 × 1.5	France
<i>E. cuniculi</i>	Rabbits, rats, mice <i>Mastomys</i> spp., guinea pigs, hamsters, goats, sheep, dogs, foxes, felids, mustelidae, monkeys, <b>humans</b>	Intestine + many organs; tissue cultures	2.5 × 1.5	Worldwide
<i>E. helleri</i>	<b>Humans</b> (AIDS)	Many organs	2.4 × 1.5	Worldwide
<i>E. intestinalis</i>	<b>Humans</b> (AIDS)	Many organs	2.0 × 1.5	Worldwide
<i>Enterocytozoon bieneusi</i>	<b>Humans</b> (AIDS)	Intestine, lung	1.5 × 0.5	Worldwide

among intracellular parasitic → protozoa. Parasite development may occur either in the cytoplasm of the cell or within a → parasitophorous vacuole; but whether this vacuole forms at invasion or later is not known.

No recognition mechanisms have been described so far in this group. However, the signalling for polar tube extrusion is likely to be driven by recognition of a suitable target in the vicinity of the spore, and the

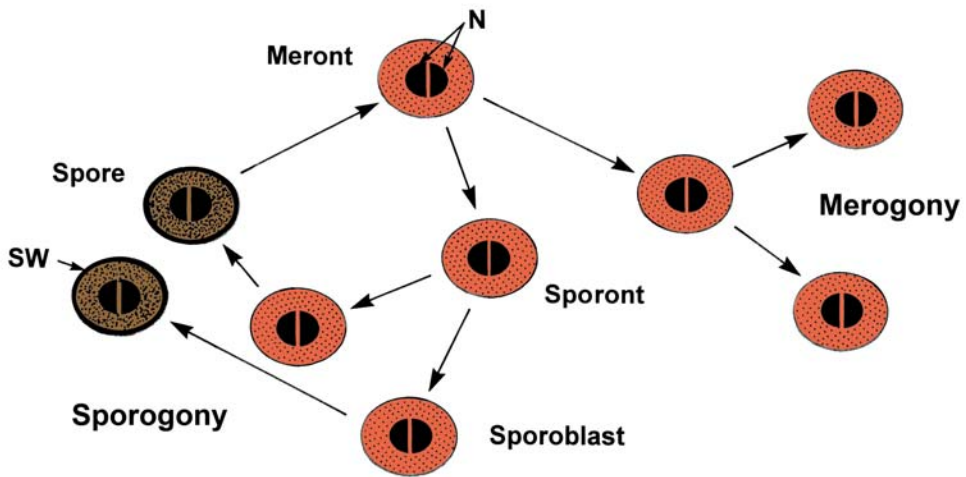

A: *Nosema*-type

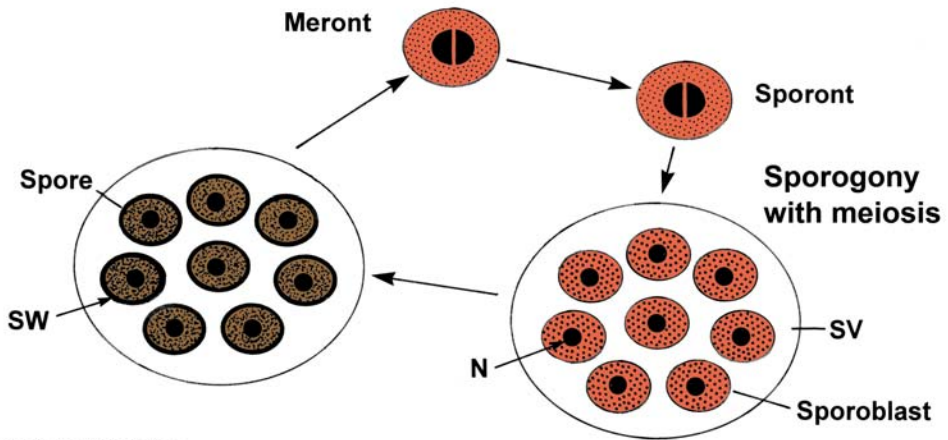

B: *Thelohania*-type

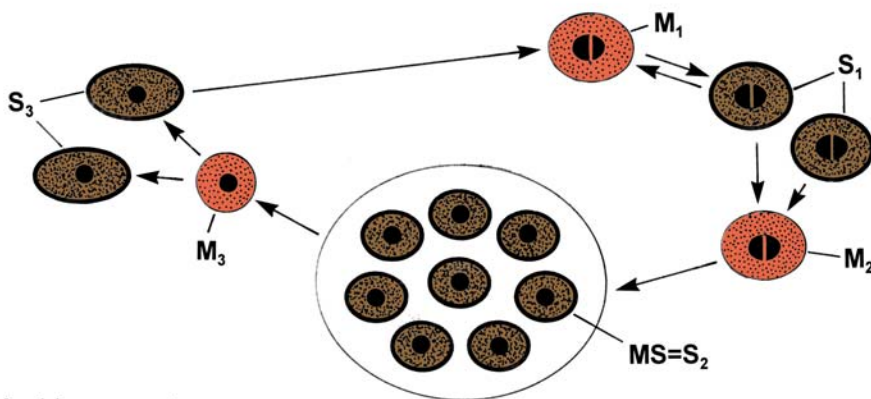

C: *Amblyospora*-type

**Microsporidia.** Figure 2 Three types of propagation in microsporidia (A = *Nosema*-type, B = *Thelohania*-type, C = *Amblyospora*-type). *M*, types of meronts; *MS* = meiospore; *N*, nucleus; *S*, types of spores; *SV*, sporophorous vacuole; *SW*, wall of spore.

detailed study of this phenomenon will certainly lead to identifying →receptor–ligand interaction in this process.

### Disease

→Microsporidiosis.

---

## Microsporidiosis

Immunosuppressed humans have been sentinels of microsporidial infection, with enteric, neurologic, ocular, and pulmonary manifestation being recognized (→Microsporidia). Their symptomatology, pathology, and differential diagnosis, based on ultrastructure and the polymerase chain reaction, has been stated by many authors. Microsporidiosis appears to be a common asymptomatic infection, that is not clinically recognized; about 10% of animal handlers were reported to have antibody to →*Encephalitozoon* sp. The organism grows intracellularly, destroying the infected cells. There is little inflammation. The →Brown-Brenn stain (Gram stain for tissues), basic fuchsin, toluidin blue, Azur II-eosin, the →Warthin-Starry silver impregnation and polarization facilitate recognition of →microsporidia in tissue sections. Tissue imprints (smears), dried, fixed, and stained as for blood smears, are useful for diagnosis of corneal and conjunctival lesions. Stool and sputum smears can be stained with a modified →trichrome stain employing chromotrope 2R or with a fluorochrome →chitin stain, such as Calcofluor.

A fatal disseminated infection of a 4-month-old thymic alymphoplastic baby with *Nosema connori* involved the smooth musculature, skeletal muscles, the myocardium, parenchymal cells of the liver, lung, and adrenals. *Encephalitozoon* sp. was isolated from the cerebrospinal fluid of a 9-year-old Japanese boy with →meningoencephalitis who recovered. Intestinal microsporidiosis has been described in a high percentage of patients with →AIDS due to →*Enterocytozoon bieneusi* also with cholangitis and due to *Encephalitozoon (Septata) intestinalis*. The patients had →diarrhoea, with →weight loss from →malabsorption. Inflammation was minimal and the diagnosis was made ultrastructurally. Disseminated →*Encephalitozoon cuniculi* infection was described and *E. hellem* has been isolated from AIDS patients with nephritis and prostatitis and from others with keratoconjunctivitis, bronchitis, and sinusitis. Microsporidial myositis due to →*Pleistophora* and →*Trachipleistophora hominis* was reported in patients with AIDS. Intraocular microsporidiosis was diagnosed from the cornea next to Descemet's membrane with a subacute to granulomatous →inflammatory reaction. Other HIV-negative cases with corneal stromal

infection were linked to *Nosema ocularum* (possibly *Vittaforma corneum*). For further information see →Microsporidia.

**Main clinical symptoms:** →Abdominal pain, diarrhoea, loss of weight.

**Incubation period:** 1 week.

**Prepatent period:** 1 week.

**Patent period:** More than 5 months.

**Diagnosis:** Microscopic determination of →spores in fecal samples.

**Prophylaxis:** Avoid contact with human/animal feces.

**Therapy:** Curative treatment unknown; see →Treatment of Opportunistic Agents.

---

## Microsporidium ceylonensis

Species found in immune-suppressed people in Asia. →Microsporidia.

---

## Microtriches

The microvilli-like structures (however with electron-dense tips) of the →tegument of →cestodes (→Integument/Cestodes).

---

## Microtubule-Function-Affecting Drugs

### Structures

(Fig. 1).

### Benzimidazoles

#### Important Compounds

Phenothiazine, Tiabendazole, Cambendazole, Oxibendazole, Albendazole, Fenbendazole, Oxfendazole, Mebendazole, Flubendazole, Parbendazole, Febantel, Netobimin, Thiophanate, Triclabendazole.

### Synonyms

Phenothiazine: Contraverm, Coopazine, Fenopur, Helmetina, Neoavilep, Phenovis, Phenoxur, Radiol.  
Tiabendazole: Bovizole, Coglazol, Equizole, Helmintazole, Hyozole, Mintezole, Nemapan, Omnizole, Polival, Soldrin, TBZ, Thibenzole, in: Equizole A, Equizole B, Ranizole, Suiverm, Thiprazole, Tresaderm, Tricocefal.



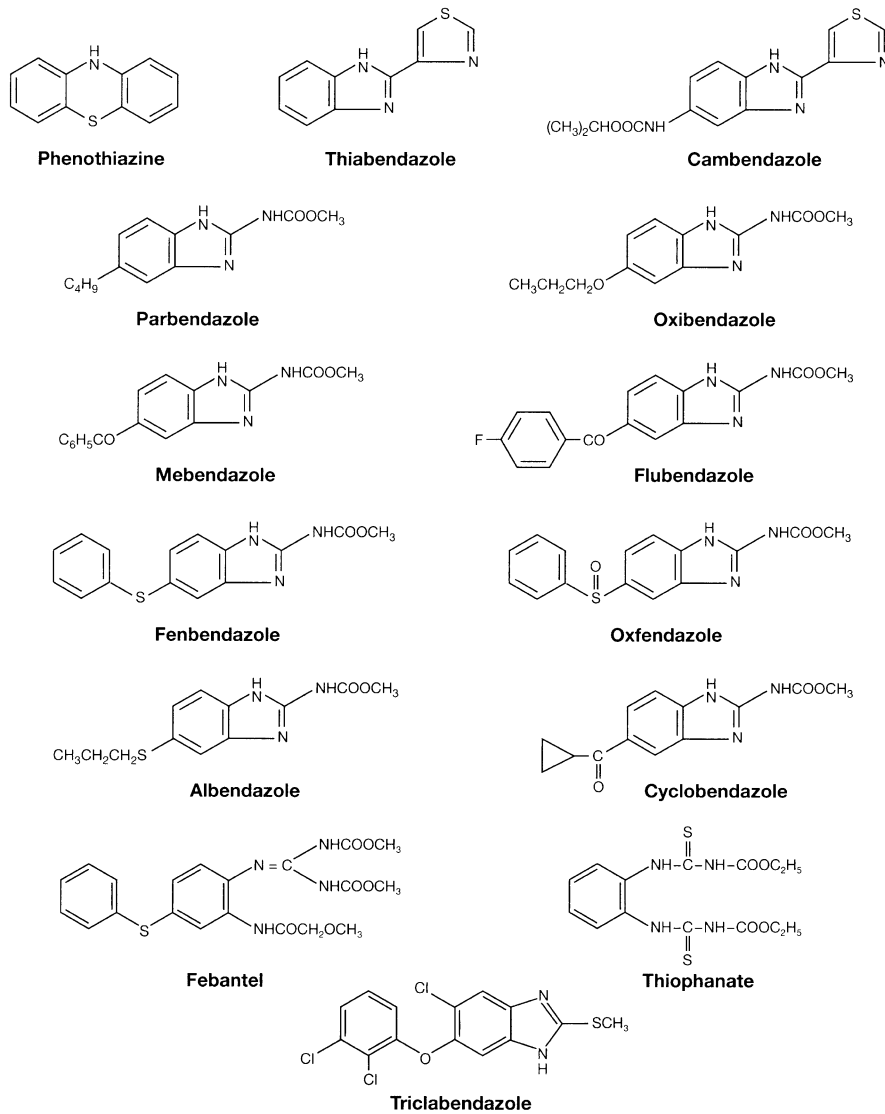

**Microtubule-Function-Affecting Drugs. Figure 1** Structures of drugs against parasites affecting microtubuline integrity.

Cambendazole: Ascapilla, Bonlam, Camvet, Equiben, Equicam, Novazole, Noviben, Porcam.

Oxibendazole: Anthelcide, Anthelworm, Equipar, Equitac, Loditac, Verzine, Widespec.

Albendazole: Albazine, Valbazen, Zentel.

Albendazole sulphoxide: Rycoben.

Fenbendazole: Panacur, Safe-Guard.

Oxfendazole: Benzelmin, Synanthic, Systemex.

Mebendazole: Equivurm, Fugacar, Mebenvet, Mebutar, Multispec, Nemasole, Ovitelmin, Pantelmin, Parmeben, Rumatel, Sirben, Telmin, Telmintic, Vermirax, Vermox.

Flubendazole: Flubenol, Flumoxal, Fluvermal.

Parbendazole: Helmatac, Topclip, Triban, Verminum, Worm Guard.

Febantel: Amatron, Bayverm, Combotel, Provet, Rintal.

Netobimin: Hepadex.

Thiophanate: Helminate, Wormalac, Nemafox; in: Flukembin, Vermadax.

Triclabendazole: Fasinex.

### Clinical Relevance

**Phenothiazine**, an old-timer, has been used since the 1930s as antinematodal drug in ruminants. In the 1960s it was replaced by the broad-spectrum benzimidazoles for several reasons: resistance had appeared against phenothiazine, benzimidazoles can be applied at much lower dosages, and the latter have a much broader anthelmintic spectrum.

The anthelmintic benzimidazoles can be divided into 4 different subgroups: (1) the **benzimidazole-thiazolyls** (cambendazole, thiabendazole (explored 1961)), (2) the **benzimidazole-methylcarbamates** (albendazole (1979), cyclobendazole, fenbendazole (1971), flubendazole, luxabendazole, mebendazole, oxfendazole (1975), oxibendazole (1973), parbendazole (1966), ricobendazole), (3) the **halogenated benzimidazole-thiole** triclabendazole, and (4) the **prebenzimidazoles** febantel, netobimin, and thiophanate. Febantel (1978) is converted to the active forms fenbendazole and oxfendazole, netobimin is converted to the active form albendazole, and thiophanate is metabolized to the active form lobendazole.

The benzimidazoles can be used against a wide variety of parasitic pathogens. The antiprotozoal activity of albendazole and mebendazole can be used in the treatment of infections with *→Giardia lamblia*. The mechanism of action against *Giardia* is presumably directed against the ventral disc *→microtubules* (*→DNA-Synthesis-Affecting Drugs I/*Table 1).

Albendazole has activity against the *→microsporidia Encephalitozoon intestinalis*. There is, however, only symptomatic improvement achievable in *→Enterocytozoon bieneusi* infections in *→AIDS* patients.

The benzimidazole carbamates (mebendazole, flubendazole, albendazole, fenbendazole) have anticestodal activity against larval stages of *→Echinococcus* spp. (*→Hydatidosis*). Albendazole and mebendazole are first line drugs for medical treatment of hydatidosis. Flubendazole exerts activity in *→Taenia solium*-neurocysticercosis. Fenbendazole, flubendazole and mebendazole are effective against *→Taenia* spp. infections in dogs and cats. Albendazole, mebendazole, fenbendazole, oxfendazole, and prebenzimidazoles (febantel, netobimin) show activities against *→cestode infections* of ruminants (*→Membrane-Function-Disturbing Drugs/*Table 1). However, in general high dosages of benzimidazole carbamates are necessary and they have no activity against adult *→Dipylidium caninum*, *E. granulosus* or *→Mesocostoides* spp., or *→Diphyllobothrium*.

Thiabendazole, albendazole, mebendazole, and triclabendazole also exert antitrematodal activities. Thiabendazole is the first broad-spectrum anthelmintic benzimidazole with some activity at high dosages against *→Dicrocoelium dendriticum*, but no activity against *→Fasciola hepatica*. Albendazole and mebendazole possess an anthelmintic spectrum inclusive mature *→liver flukes* in sheep and cattle. Higher dosages are required compared to their nematocidal activity.

Triclabendazole is a benzimidazole-derivative with an unusual chemical structure because of the chlorinated benzene ring. Its efficacy is restricted to *F. hepatica* (chronic and acute fasciolosis; *→Energy-Metabolism-Disturbing Drugs/*Table 1) and paragonimiasis, it has minor activity against other *→trematodes*

such as *D. dendriticum*, *→Schistosoma mansoni*, and *→Paramphistomum* spp., but it has no activity against *→nematodes* and *→cestodes*. Triclabendazole is an important fasciolicidal drug with high efficacy against adult and juvenile *→flukes*. Furthermore, it is the drug of choice for human fasciolosis. It is very safe and used at a single dose of 12 mg/kg to be repeated 12 h later.

The main indication for benzimidazoles relies on their broad-spectrum activity against nematodes in human and veterinary medicine (Table 1). With the exception of triclabendazole, all other (pre)benzimidazoles broad-spectrum anthelmintics have a main action against gastrointestinal and tissue nematodes. Benzimidazoles are mainly orally ingested by nematodes. Of special importance is the efficacy of thiabendazole and albendazole against *→Strongyloides stercoralis* in AIDS.

In addition, benzimidazoles have antifilarial activities exerting adulticidal effects, e.g., against *Litomosoides carinii* and *Brugia pahangi*. Several compounds have been introduced into clinical trials for human onchocerciasis. They have higher effects against adult and developing parasites than against microfilariae. The need for parenteral application, however, prevented the broad usage of benzimidazoles in human filariasis (*→Inhibitory-Neurotransmission-Affecting Drugs/*Table 1). There are severe local intolerabilities after subcutaneous application of flubendazole with intolerable pains. Moreover, after oral administration in man embryotoxic effects have been reported. Flubendazole is the most active filaricidal benzimidazole. There is the following ranking with decreasing activity: flubendazole > mebendazole > oxfendazole, cyclobendazole > albendazole > cambendazole > fenbendazole. All benzimidazoles exert the same type of efficacy with only minor variations. There are additional microfilaricidal effects after the first and second week against *L. carinii* and *→Acanthocheilonema viteae* or after the third week against *Brugia* spp. Such a delayed effect on microfilariae is a common phenomenon with all benzimidazoles. Last but not least, thiabendazole and mebendazole are also tried against *→Dracunculus medinensis*.

### Molecular Interactions

The *→mode of action* of benzimidazoles relies on the impairment of microtubular function. For evaluation of the mode of action most experiments have been performed with nematodes, and there are only few data for cestodes. Very early a disturbance of microtubule shape and function could be observed in *Ascaris suum* intestinal cells by mebendazole as a result of the inhibition of microtubuline polymerization. The mebendazole-induced damage of intestinal cells in *→Ascaris* and the damage of tegumental cells are caused by a loss of cytoplasmic tubules. The loss of cytoplasmic tubules is associated with a loss of transport of secretory vesicles

**Microtubule-Function-Affecting Drugs. Table 1** Antiparasitic spectrum of modern nematocidal drugs

Year on the market	Drug	Nematocidal activity	Additional antiparasitic activity
<b>Acetylcholine-Neurotransmission-Affecting Drugs</b>			
<b>Tetrahydropyrimidines</b>			
1966	Pyrantel	<i>Ascaris</i> , <i>Enterobius</i> , <i>Necator</i> , <i>Ancylostoma</i> , <i>Trichinella</i> , <i>Trichostrongylus</i> , ruminant nematodes, pig nematodes, horse nematodes	Horse cestodes
1975	Oxantel	<i>Ascaris</i> , hookworms, <i>Trichuris</i>	
	combination Oxantel/pyrantel	<i>Ascaris</i> , hookworms, <i>Trichuris</i> , <i>Enterobius</i>	
	Morantel	Ruminant nematodes	
<b>Imidazothiazoles</b>			
	Tetramisole	Pig nematodes	
1965	Levamisole	<i>Ascaris</i> , hookworms, <i>Strongylus</i> , nematodes of pigs, ruminants, poultry	Microfilariae
	Butamisole		
<b>Inhibitory-Neurotransmission-Affecting Drugs</b>			
<b>Piperazines</b>			
1949	Piperazine	<i>Ascaris</i> , <i>Enterobius</i>	
<b>Avermectins and milbemycines</b>			
1973	Milbemycin		Microfilariae, ectoparasites
1985	Abamectin	Ruminant nematodes	Microfilariae, ectoparasites
1980	Ivermectin	Strongyloides, nematodes of ruminants, pigs, horses	Microfilariae, ectoparasites (head lice, scabies)
1990	Milbemycin-oxim	Nematodes of ruminants, dogs	Microfilariae, ectoparasites
1992	Moxidectin	Ruminant nematodes	Microfilariae, ectoparasites
1993	Doramectin	Ruminant nematodes	Ectoparasites
1996/97	Eprinomectin	Ruminant nematodes	Ectoparasites
1999	Selamectin	Dog nematodes	Fleas, ticks, microfilariae
2005	Latidectin	Heartworms, roundworms, hookworms in dogs	Scabies, mites
<b>Cyclic Octadepsipeptides</b>			
2005	Emodepside	Cat nematodes	
<b>Microtubule-Function-Affecting Drugs</b>			
<b>Benzimidazoles</b>			
1961	Thiabendazole	<i>Strongyloides</i> , <i>Capillaria</i> , <i>Trichostrongylus</i> , pig and horse nematodes	<i>Angiostrongylus cantonensis</i> , <i>A. malaysiensis</i> , cutaneous larva migrans, <i>Dracunculus medinensis</i>
	Cambendazole	<i>Strongyloides</i> , <i>Trichostrongylides</i> (cattle, sheep, pig) horse nematodes	
1966	Parbendazole	<i>Trichostrongylides</i> , pig nematodes,	
1973	Oxibendazole	<i>Trichostrongylides</i> , horse nematodes	
1971	Mebendazole	<i>Ascaris</i> , <i>Enterobius</i> , <i>Necator</i> , <i>Ancylostoma</i> , <i>Trichuris</i> , <i>Trichinella</i> , <i>Strongyloides</i> , <i>Capillaria</i> , <i>Trichostrongylides</i> , horse nematodes	<i>Dracunculus medinensis</i> , <i>Giardia</i> , trematodes, cestodes, macrofilariae
	Flubendazole	<i>Enterobius</i> , pig nematodes	Cestodes, macrofilariae
1971	Fenbendazole	<i>Trichostrongylides</i> , pig and horse nematodes	<i>Toxocara canis</i> larvae, cestodes, trematodes
1975	Oxfendazole	<i>Trichostrongylides</i> , horse nematodes	<i>Toxocara canis</i> larvae, cestodes
1979	Albendazole	<i>Ascaris</i> , <i>Enterobius</i> , <i>Necator</i> , <i>Ancylostoma</i> , <i>Trichuris</i> , <i>Trichinella</i> , <i>Strongyloides</i> , <i>Trichostrongylides</i>	Cutaneous larva migrans, <i>Giardia</i> , cestodes, trematodes, macrofilariae

**Microtubule-Function-Affecting Drugs. Table 1** Antiparasitic spectrum of modern nematocidal drugs (Continued)

Year on the market	Drug	Nematocidal activity	Additional antiparasitic activity
	Cyclobendazole		
<b>Benzimidazole prodrugs</b>			
1978	Febantel	Trichostrongylides, pig and horse nematodes	
1970	Thiophanate	Trichostrongylides, pig nematodes	

**Microtubule-Function-Affecting Drugs. Table 2** Anthelmintic combinations used in veterinary and human medicine

<b>Anthelmintic combinations in veterinary medicine</b>		
Levamisole/Niclosamide	Dog nematodes, cestodes	
Pyrantel/Oxantel	Dog nematodes	
Pyrantel/Oxantel/Praziquantel	Dog nematodes, cestodes	
Mebendazole/Praziquantel	Dog and cat nematodes, cestodes	
Albendazole/Praziquantel	Dog nematodes, cestodes	
Praziquantel/Fenbendazole	Cestodes, nematodes in dogs and cats	
Oxibendazole/Praziquantel	Dog and cat nematodes, cestodes	
Febantel/Praziquantel	Dog and cat nematodes, cestodes	
Pyrantel/Epsiprantel	Nematodes, cestodes in dogs	
Praziquantel/Pyranterlembonate	Cestodes, nematodes in cats	
Praziquantel/Pyranterlembonate/Febantel	Cestodes, nematodes in dogs	
Pyrantel/Febantel	Dog nematodes	
Emodepside/Praziquantel	Cat nematodes, cestodes	
Ivermectin/Pyrantel	Dog nematodes, <i>Dirofilaria</i>	
Moxidectin/Imidacloprid	Dog and cat nematodes	Ectoparasites
Milbemycinoxim/Praziquantel	Dog and cat nematodes, cestodes	Dirofilariae
Milbemycinoxim/Lufenuron	Dog nematodes	Ectoparasites, Dirofilariae
Thiabendazole/Rafoxanide	Cattle nematodes, liver flukes	
Ivermectin/Clorsulon	Cattle nematodes, liver flukes	Arthropods
Triclabendazole/Levamisol	Cattle nematodes, liver flukes	
Thiabendazole/Piperazine	Horse nematodes	
Thiabendazole/Trichlorfon	Horse nematodes	<i>Gasterophilus</i>
Febantel/Metrifonate	Horse nematodes	<i>Gasterophilus</i>
Mebendazole/Metrifonate	Horse nematodes	<i>Gasterophilus</i>
Oxibendazole/Dichlorvos	Horse nematodes	<i>Gasterophilus</i>
Ivermectin/Praziquantel	Horse nematodes, cestodes, filariae	<i>Gasterophilus</i>
Abamectin/Praziquantel	Horse nematodes, cestodes	
<b>Anthelmintic combinations in human medicine</b>		
Albendazole/Ivermectin	Lymphatic filariasis	
DEC/Albendazole	Microfilariae	
DEC/Ivermectin	Microfilariae	
Albendazole/Mebendazole + Praziquantel	Soil-transmitted helminths, schistosomes	
Albendazole/Mebendazole	Soil-transmitted helminths	

and impairment of glucose uptake in intestinal cells. This is, in addition, an indication for an oral ingestion of benzimidazoles by nematodes ( $\rightarrow$ Acetylcholine-Neurotransmission-Affecting Drugs/Fig. 3).

The great selectivity of benzimidazoles is due to differences in the binding affinity between  $\rightarrow$ helminth

and mammalian tubulins. There is a correlation between LD<sub>50</sub> values in developing  $\rightarrow$ *Haemonchus contortus* L3-larvae and inhibition of binding of radioactively labelled mebendazole to  $\rightarrow$ tubulin. Cestodes are generally less susceptible to benzimidazoles compared to nematodes, and dose rates against *T. pisiformis*

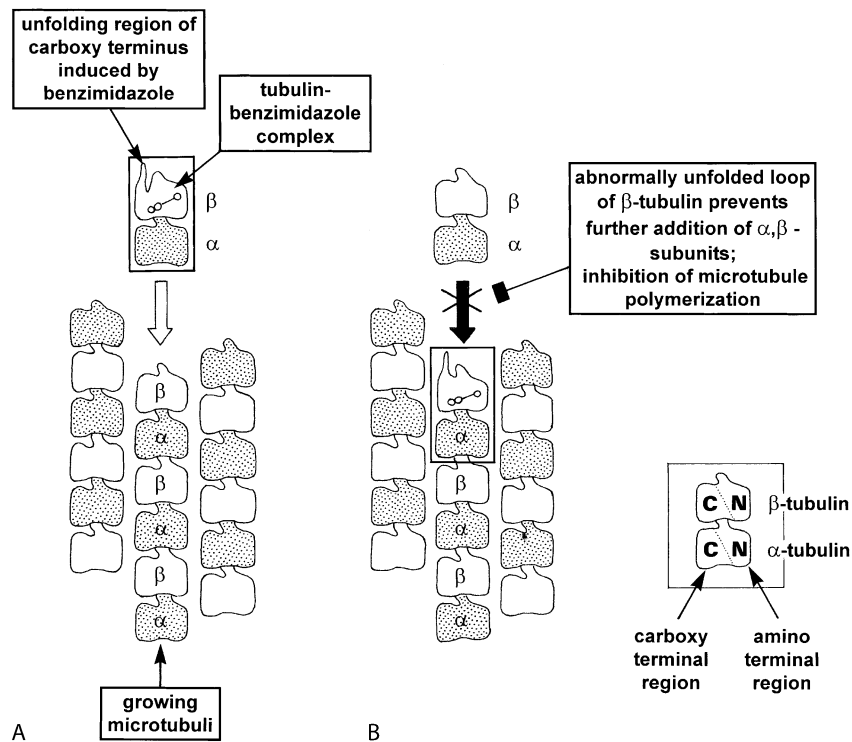

**Microtubule-Function-Affecting Drugs. Figure 2** Model of the mechanism of action of benzimidazoles (Roos MH (1997) Parasitol. 114: S137–S144).

and *T. hydatigena* are more than 10–15 times higher compared to those necessary for nematodes. This is in line with the binding affinities of mebendazole to the nematode tubulin, which is 2–7 times higher than that to cestode tubulin, and even 10–35 times higher compared to sheep brain tubulin.

On the molecular level benzimidazoles are bound to  $\beta$ -tubulin (Fig. 2). Normally dimers of  $\beta$ - together and  $\alpha$ -tubulin polymerize to form microtubule structures inside the cells of nematodes and the hosts. Benzimidazoles compete for the binding site on  $\beta$ -tubulin with colchicine, an inhibitor of  $\rightarrow$ cell division in the metaphase. Thereby, the formation of the microtubules by polymerization of tubulin at one end (= positive pole) is inhibited by benzimidazoles. The result is a starvation of the nematodes by intestinal disruption and inhibition of their egg production. The onset of the anthelmintic action of benzimidazoles is in general slower than that of the anthelmintics interfering directly on ion channels. Embryotoxic effects of benzimidazoles can also be explained by interference with the formation of microtubuli, since rapidly dividing tissues like intrauterine developmental stages are primary targets of benzimidazoles.

In cestodes additional mechanisms besides the inhibition of microtubuli formation are probably responsible for the action of benzimidazoles. There is

a reduction in glucose uptake and a decrease in  $\rightarrow$ glycogen content of parasites observable. In  $\rightarrow$ *Moniezia expansa* a diminished *in vitro* and *in vivo*  $\rightarrow$ ATP synthesis and/or turnover of adenine nucleotides by mebendazole can be measured. The effects are observed 30 minutes after exposure to mebendazole.

The action of benzimidazoles against flukes are characterized by long-term effects with a gradual decrease of activity of these parasites. Immature flukes are more sensitive to triclabendazole than adult flukes. A gradual hyperpolarization of the tegumental membrane potential is induced without the involvement of ATP-driven ion pumps. There is a binding of triclabendazole to cytoplasmic microtubules and induction of depolymerization, which is similar to that of the other benzimidazoles by interruption of microtubule-dependent processes in helminths. There is also progressively severe damage of the surface resulting in a total loss of the  $\rightarrow$ tegument within 24 h in the adult flukes. Furthermore, an inhibition of mitotic division of spermatogenic cells, an inhibition of protein synthesis in the tegumental cells, a decline in the number of secretory bodies in the tegument and disappearance of the Golgi complex can be observed.

Recently a model for the mechanism of benzimidazole action on the molecular level has been published (Fig. 2). Thereby,  $\beta$ -tubulin is regarded as a

GTP-binding protein. GTP is needed for assembly of the microtubules. Benzimidazoles as nucleotide analogues are bound in the neighborhood of the nucleotide-binding domain II near the codon 200. It is now suggested that the binding results in a slight conformational change and induces an alteration of the properties of GTP binding. Thereby, an unfolding region appears at the  $\beta$ -tubulin carboxy terminus while rest of the  $\beta$ -tubulin remains unaltered. Once added to the microtubule the abnormally unfolded loop of  $\beta$ -tubulin prevents further addition of subunits and causes an inhibition of further microtubule polymerization (Fig. 2). Interestingly in *Cryptosporidium parvum* the lack of activity of benzimidazoles correlates with the absence of Glu-198 and Phe-200. This may explain why benzimidazoles have no activity against these [→sporozoa](#).

### Resistance

Resistance of a variety of nematodes in different host animals (sheep, goats, cattle, horse, swine) against benzimidazoles has appeared worldwide. The control of benzimidazole-resistance in *Haemonchus contortus* is recessive. The  $\beta$ -tubulin gene and the gene products of  $\beta$ -tubulin isotype 1 and isotype 2 are involved in benzimidazole resistance in *H. contortus*. At lower resistance levels the specific isotype 1 gene becomes selected, and at higher resistance levels there is a selection of worms with isotype 2 genes. The  $\beta$ -tubulin isotype 1 and 2 are encoded by separate genes and numerous alleles. Up to 6 alleles encode for isotype 1 and up to 12 alleles for isotype 2. In benzimidazole-resistant nematodes a reduction in the number of isotype alleles for  $\beta$ -tubulin can be observed resulting in a progressive loss of alleles for isotype 1 and a total loss of alleles for isotype 2. Thus, benzimidazole resistance is presumably characterized by a loss of susceptible phenotypes of  $\beta$ -tubulin and simultaneous survival of resistance phenotypes.

Benzimidazole resistance in [→fungi](#) is due to the appearance of a different form of  $\beta$ -tubulin. Phenylalanine, present in position 200 on  $\beta$ -tubulin in benzimidazole-susceptible fungi, is replaced in benzimidazole-resistant fungi and in normal mammalian  $\beta$ -tubulin by tyrosin. In *H. contortus* there is a correlation between benzimidazole resistance and a conserved mutation at amino acid 200 in  $\beta$ -tubulin isotype 1. In an interesting experiment a benzimidazole-resistant [→Caenorhabditis elegans](#) strain (ben-1) could be transformed with a  $\beta$ -tubulin isotype 1 gene isolated from a benzimidazole-susceptible *H. contortus* population. The expression of this *H. contortus* gene in this formerly resistant *C. elegans* strain switched the phenotype from resistant to susceptible. Thus, the substitution at position 200 in the  $\beta$ -tubulin plays a crucial role in determining benzimidazole susceptibility.

## Microtubules

[→Flagella](#), [→Nuclear Division](#), [→Pellicle](#).

## Microvilli

These structures represent more or less long protrusions of intestinal cells of, e.g., mammals, digenean [→Platyhelminthes](#), [→nematodes](#), and pentastomids; they contain [→actin](#) filaments that are interconnected by another protein (villin); furthermore calmodulin occurs. The actin filaments reach into the apical zone of the cells (terminal web). Microvilli are used to increase the space for import and export of materials. The [→microtriches](#) at the surface of [→cestodes](#) look similar.

## Midges

[→Ceratopogonidae](#), [→Culicoides](#).

## Miescher-His, Johann-Friedrich (1811–1887)

Swiss biologist and physician, discoverer of the [→Sarcocystis](#) cysts in muscles of a mouse in the year 1843.

## M.I.F.C.

Merthiolate-Iodine-Formaldehyde-Concentration (Fig. 1), method to concentrate parasitic stages (protozoans/worm eggs) from fecal samples using 2 solutions:

- A** 250 ml Aqua dest  
200 ml Thimerosal (1:1000 in Aqua dest)  
25 ml Formaline (40%)  
5 ml Glycerine
- B** 5% Fresh Lugol's solution  
(7.5 g Iodine potassium in 18 ml Aqua des, plus 5 g iodine plus Aqua dest ad 100 ml).

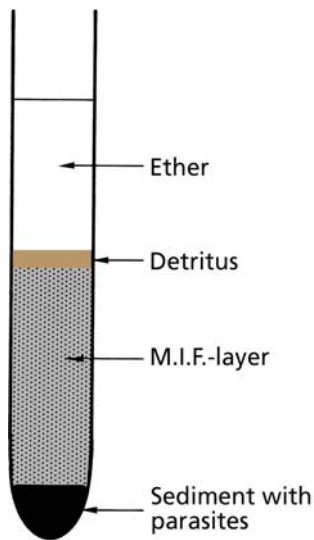

**M.I.F.C. Figure 1** Zonation in the tube after centrifugation.

Prior to use 4 ml **A** plus 1 ml **B** are mixed with 1 g feces, filtrated and added with 7 ml cold ether. After shaking, the solution is centrifugated for 5 minutes at 500–1600 g. Then the zonation of Fig. 1 is obtained. The sediment is studied by means of light microscopy.

## Milbemycin-Oxime

### Chemical Class

Macrocyclic lactone (16-membered macrocyclic lactone, milbemycins).

### Mode of Action

Glutamate-gated chloride channel modulator → [Nematocidal Drugs](#), → [Ectoparasiticides – Antagonists and Modulators of Chloride Channels](#), → [Ectoparasitocidal Drugs](#).

## Milk Spots

Symptom of → [Ascariasis](#) = white dots, which occur on the surface of the liver of infected animals (Fig. 1, page 829).

## Miltefosin

→ [Leishmaniacidal Drugs](#).

## Mimicry

Camouflage of an animal in order to become invisible for a predator. Parasites use host components to evade immune reactions (e.g., immunologic mimicry occurs in schistosomes or nematodes when absorbing host proteins and including them into their own surface).

## Minchinia nelsoni

Old name for the microsporidian parasite of the American oyster *Crassostrea virginica*.

## Miner's Disease

Disease due to infection with Old World or New World, → [hookworms](#).

## Minicircle

→ [Guide RNA](#), → [Kinetoplast](#).

## Miracidium

First larval stage of → [Digenea](#), e.g., → [Apophallus muehlingi](#).

## Mites

### Synonym

→ [Astigmata](#).

### Classification

Suborder of → [Acarina](#).

### General Information

Mites belong to the order → [Acarina](#) within the phylum → [Arthropoda](#) (subphylum → [Chelicerata](#)), and include about 30,000 species in a worldwide distribution. While fed, → [ticks](#) can reach a length of up to 30mm, but mites



**Milk Spots. Figure 1** Liver of a pig that had been infected with *Ascaris suum* showing milkspots.

are relatively small arthropods with a body length of 0.2–4 mm. In contrast to ticks, mites often possess relatively long hairs (Fig. 1, →*Neotrombicula autumnalis*/Fig. 1).

The shape of the body, as well as of the extremities and mouthparts, may differ considerably between the different groups of mites. In general, the →*chelicerae* are adapted to piercing, sucking, or chewing. In members of the Acarina the prosoma and →*opisthosoma* are fused, forming a more or less rounded body (Fig. 1, page 830, →*Acarina*/Fig. 1). If present, eyes are on the surface of the prosoma. The exoskeleton, which contains →*chitin*, can be more or less sclerotized; there are species with soft skin, while the body of others can be covered by sclerotized shields of different size. Three developmental stages can be distinguished: the larva with only 3 pairs of legs, the (mostly) 2 →*nymphal stages*, and the adults (all with 4 pairs of legs).

Some mites are of medical importance. Those that feed on food stocks, dust, etc. can cause allergies in humans since parts of their bodies may act as allergens if sensitive persons get into contact with the mites or

inhale part of them (Table 1). As vectors of pathogens mites play a minor role. Some feed on dead skin and can cause dermatitis (via bacterial infections). Other mites are harmful to men and animals by sucking body fluids (blood, lymph). During their meal the host may become infected with viruses, rickettsiae, or filarial →*nematodes* (Table 1).

Digging mites such as →*Sarcoptes* spp. produce →*scabies* in humans and mange in animals (→*Skin Diseases, Animals/Arthropods*) by making funnels in the skin that become inflamed due to secondary bacterial invasion. Some mites are parasitic on invertebrates, such as →*Varroa jacobsoni* which can cause death of bee colonies by damaging the brood.

### Important Species

Table 1 (pages 831, 832).

### Life Cycle

Fig. 2 (page 832).



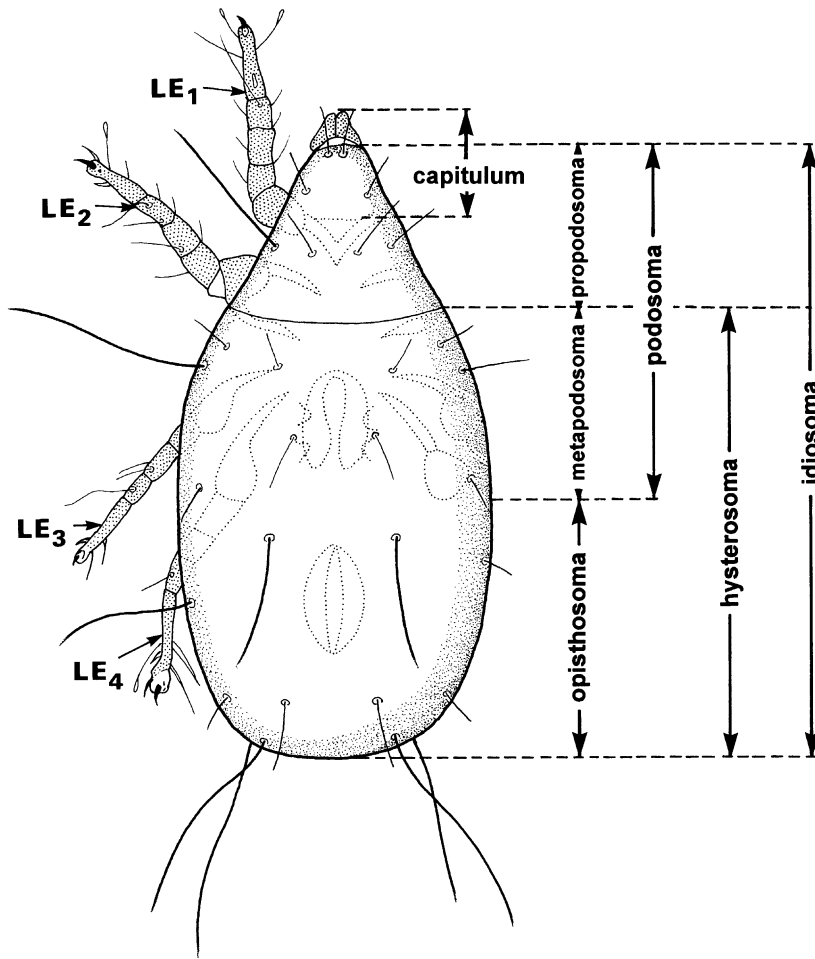

**Mites. Figure 1** Diagrammatic representation of the body of a typical mite. *LE*, leg.

## Reproduction

Reproduction of mites is usually bisexual, but facultatively →parthenogenesis may occur.

## Reproductive Organs

The reproductive systems of mites are in general very similar to those of ticks (→Ticks/Reproduction). As there is considerable variation with regard to fusing and fragmentation of parts, only the general organization is given here. In females the ovaries may be paired, single, or clustered and are connected with the single uterus by 1 or 2 oviducts (Fig. 3, page 833). The uterus in most cases opens through the genital pore, but a vagina exists in some species. The →receptaculum seminis; and the accessory glands are usually connected to the uterus. The genital pore is situated ventrally between the first and second pair of legs and covered by the genital plate.

The male reproductive systems consist of testes, either single or paired organs (Fig. 3). Paired or fused vasa deferentia lead the →spermatozoa to the ejaculatory duct.

The accessory glands are assumed to function at least partly as seminal vesicles.

If males possess a copulatory apparatus, the sperm is injected by the →aedeagus into the genital opening or, if present, into the →bursa copulatrix. In groups where males lack an aedeagus the sperm is transferred directly from the male into the female genital opening. Other male mites, e.g., members of the Gamasida (= →Mesostigmata), use specialized chelicerae to transfer the sperm. In some groups of the Actinedida (= →Prostigmata) males produce spermatophores whose shape varies depending on the group. A thin thread of a substance is produced that hardens when it is exposed to air. On its tip a sperm packet is placed, which is then picked up by the genitalia of the female.

## Ontogeny

Compared with ticks, only scarce information exists on the →embryogenesis of mites, but it is assumed that there is great uniformity in the structure of acarine eggs. Parasitic mites are often →larviparous. Those which lay

**Mites. Table 1** Some important mites

Family/Species	Length (mm)	Hosts/Habitat	Disease (pathogens <sup>a</sup> )
<b>Tyroglyphidae</b>			
<i>Acarus</i> (= <i>Tyroglyphus</i> ) <i>siro</i>	f 0.4–0.6 m 0.4	<b>Humans</b> /Skin	Allergy: grocer's itch
<i>Tyrophagus putrescentiae</i>	f 0.4 m 0.4	<b>Humans</b> /Skin	Allergy: copra's itch
<i>Glycyphagus domesticus</i>	f 0.4–0.75 m 0.3–0.5	<b>Humans</b> /Skin	Allergy: baker's itch
<b>Pyroglyphidae</b>			
→ <i>Dermatophagoides pteronyssinus</i>	f 0.4 m 0.4	<b>Humans</b> /Skin	Allergy: dermatosis
<b>Dermanyssidae</b>			
→ <i>Dermanyssus gallinae</i>	f 0.7 m 0.6	Chickens, <b>humans</b> /Skin	St. Louis encephalitis (V), anemia of chickens
<i>Ornithonyssus</i> ( <i>Bdellonyssus</i> , → <i>Liponyssus</i> ) <i>bacoti</i>	f 1.1 m 0.7	Rats, <b>humans</b> /Skin	Filariæ of rats (N)
<b>Laelapidae</b>			
<i>Ophionyssus natricis</i>	f 1.0 m 0.6	Snakes/Skin	Anemia/Dermatosis
<i>Liponyssus lacertinus</i> (= <i>Neoliponyssus lacertarum</i> )	f 1.0 m 0.6	Lizards/Skin	Anemia/ <i>Karyolysus</i> (P)
<b>Trombiculidae</b>			
<i>Trombicula akamushi</i>	Larvae 0.25–0.5	Larvae suck on <b>humans</b>	Tsutsugamushi fever (R)
→ <i>Neotrombicula autumnalis</i>	Larvae 0.2–0.5	Larvae suck on <b>humans</b> , cattle, pigs, dogs, cats	Dermatosis
<b>Pterogossomidae</b>			
<i>Pterygossoma</i> sp.	f 0.55 × 1 m 0.3 × 0.5	Lizards/Skin	?
<b>Demodicidae</b>			
→ <i>Demodex folliculorum</i>	f 0.4 m 0.3	<b>Humans</b> /Hair follicle	Acne, rosacea
<i>Demodex canis</i>	f 0.3 m 0.25	Dogs, <b>humans</b> /Skin, hair follicle	Dermatosis, mange
<b>Sarcoptidae</b>			
→ <i>Sarcoptes scabiei</i>	f 0.3–0.45 m 0.2–0.3	<b>Humans</b> /Epidermis	Scabies
<i>S. bovis</i>	f 0.3–0.5 m 0.2–0.3	Cattle/Epidermis	Mange
<i>S. suis</i>	f 0.4–0.5 m 0.25	Pigs/Epidermis	Mange
→ <i>Notoedres cati</i>	f 0.2–0.3 m 0.15–0.18	Cats/Epidermis	Mange
<b>Knemidocoptidae</b>			
→ <i>Knemidocoptes mutans</i>	f 0.4 m 0.2–0.25	Chickens/Epidermis	Scaly legs
<b>Psoroptidae</b>			
→ <i>Otodectes cynotis</i>	f 0.4–0.5 m 0.3–0.4	Dogs/Skin, ear	Dermatosis
→ <i>Psoroptes</i> sp.	f 0.6–0.8 m 0.5–0.65	Ruminants, rabbits/Skin	Dermatosis
→ <i>Chorioptes</i> sp.	f 0.4–0.6 m 0.3–0.45	Ruminants/Skin	Dermatosis
<i>Caparinia</i> sp.	f 0.3–0.4 m 0.3–0.35	Hedgehog/Skin	Dermatosis
<b>Cytoditoidea</b>			
→ <i>Cytodites nudus</i>	f 0.45–0.65 m 0.45–0.55	Chickens/Trachea, lung	Bronchitis

**Mites. Table 1** Some important mites (Continued)

Family/Species	Length (mm)	Hosts/Habitat	Disease (pathogens <sup>a</sup> )
<b>Halarachnidae</b>			
<i>Pneumonyssus caninum</i>	f 0.6 m 0.5	Dogs/Lungs	Bronchitis
<b>Harpyrhynchidae</b>			
<i>Harpyrhynchus nidulans</i>	f 0.4 m 0.3–0.4	Pigeons/Feather follicles	Dermatitis
<b>Syringophylidae</b>			
<i>Syringophylus bipectinatus</i>	f 0.8–1.0 f 0.5–0.8	Chickens/Feathers	Dermatosis
<b>Varrooidea</b>			
→ <i>Varroa jacobsoni</i> (syn. <i>V. destructor</i> )	f 1.8 m 0.8	Honeybees/Surface	Death, slimming
<b>Tarsonemidae</b>			
→ <i>Acarapis woodi</i>	f 0.1–0.2 m 0.1	Honeybees/Tracheal system	Death by O <sub>2</sub> shortage
<b>Cheyletiellidae</b>			
→ <i>Cheyletiella parasitivorax</i>	f 0.5 m 0.4	Rabbits, <b>Humans</b> , dogs, cats/ Skin	Dermatosis

<sup>a</sup> N, Nematodes; P, Protozoa; V, Viruses; m = male, f = female

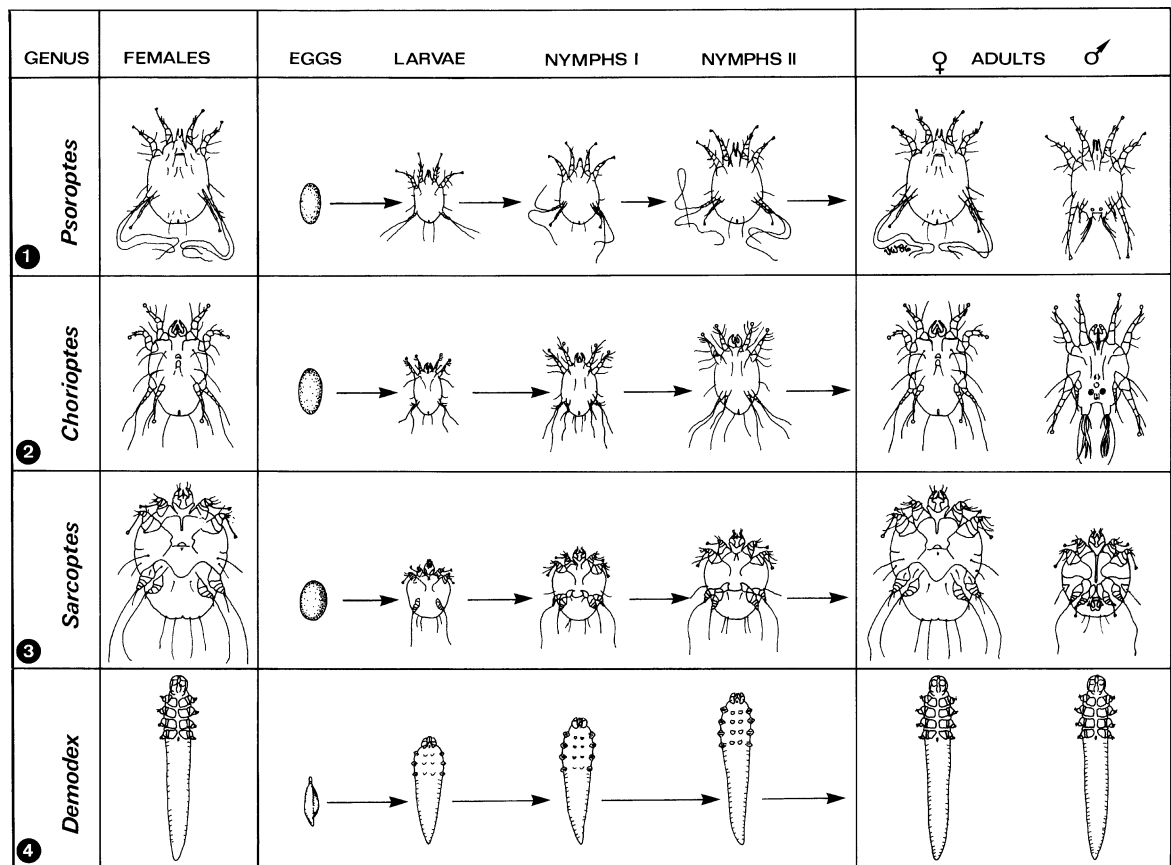

**Mites. Figure 2** Developmental stages in the life cycle of important groups of mites (for species see Table 1). All stages live on/in the skin of their hosts. Note that larvae have only 3 pairs of legs. Feeding larvae and nymphs increase in size and →molt. In some species there is clear →sexual dimorphism. 1 →*Psoroptes* spp. feed (as piercing mites) on the lymph fluid and occasionally on the blood of their hosts. 2 →*Chorioptes* spp. feed (as chewing mites) on the epidermal products. 3 *Sarcoptes* spp. penetrate the epidermis, forming canals. 4 →*Demodex* spp. feed within the epidermis on hair follicles or on sebaceous glands.

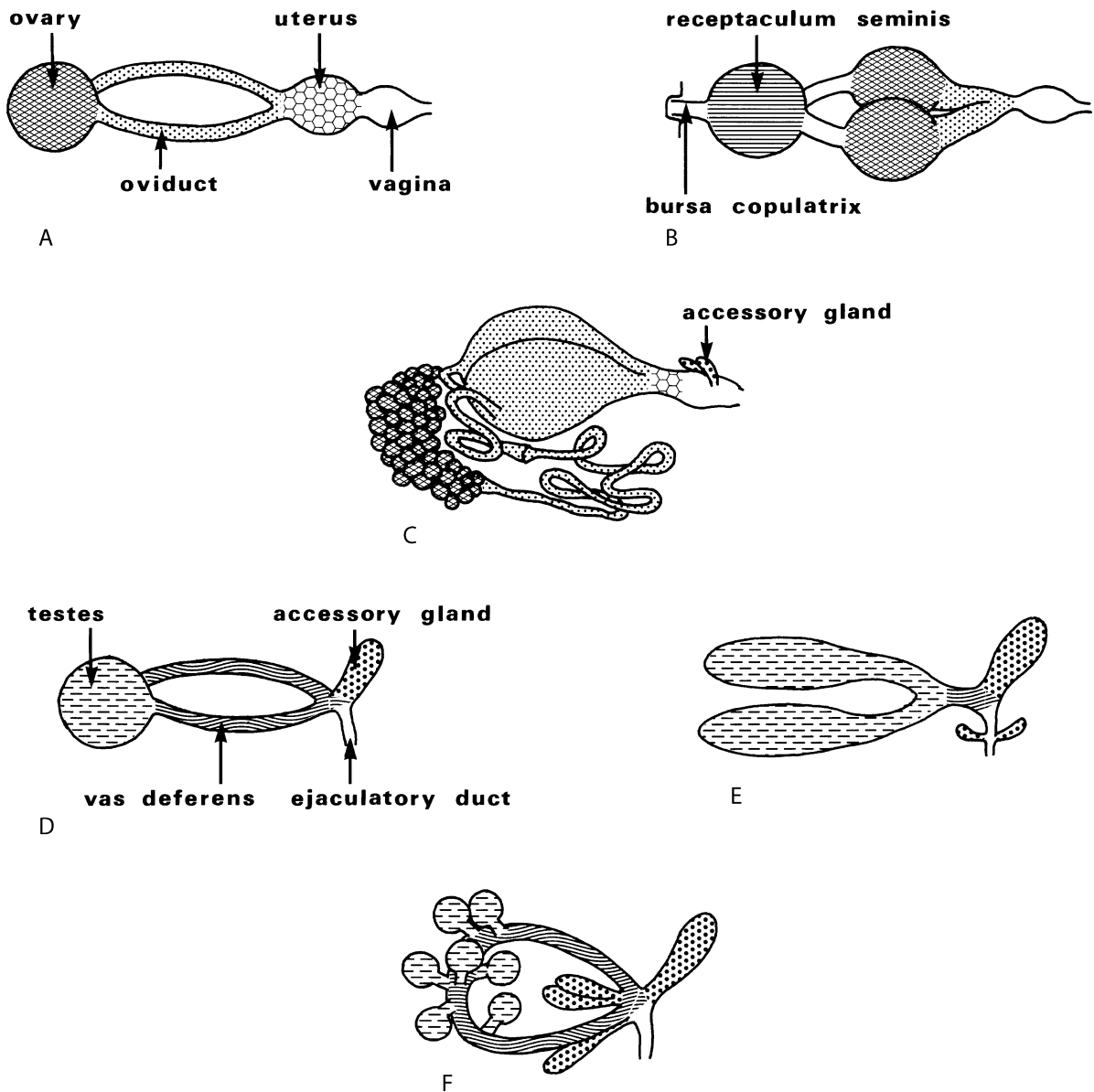

**Mites. Figure 3** Diagrammatic representation of acarine reproductive systems. A–C Females, D–F Males. **A** Generalized system Gamasida and Actinedida; **B** Acaridida – [→Acaridae](#); **C** Ixodida – [→Argasidae](#); **D** Gamasida – Parasitidae; **E** Gamasida – Uropodidae; **F** Actinedida – Erythraeidae.

eggs often place them on particular host tissues. Parasitic mites such as *Myocoptes musculus* (Listrophoridae) fix their eggs to the hairs of their hosts like [→lice](#). Others use places for egg deposition where the eggs are protected and access to the next host is ensured.

The time of development from the egg to the adult mite may be very short (e.g., 4–5 days); the entire life cycle of the common [→itch](#) mite [→Sarcoptes scabiei](#) may last only 10 days. More often it takes up to several weeks to complete the life cycle. The period of a life cycle is greatly affected by humidity, temperature, and

supply of food, and the life span of mites is very variable.

Most acarines have to pass through several developmental stages: a larval stage and several nymphal stages (mostly 2). The larvae are characterized by the existence of only 3 pairs of legs, although vestiges of the fourth pair of legs do appear during embryogenesis, as has been described in [→Ticks](#). The larval [→cuticle](#) is not or only partly sclerotized and external genitalia are absent. Larvae may feed on the same diet as adults or be nonfeeding. Others, e.g., larvae of members of the [→Trombiculidae](#), are parasites. Nymphs in general

possess 4 pairs of legs. Three stages, a proto-, deuto- and →tritonymph, can be distinguished. All 3 nymphal stages are found only in some members of the Actinedida and Acaridida (= Astigmata), whereas in most members of the Gamasida only proto- and deutonymphs occur.

Normally the →protonymph represents a free-living active stage; it is usually found on the same (or similar) substrate as the subsequent stages, but nonfeeding protonymphs may also occur. In most members of the Parasitengonae and in the family Pterygosomatidae proto- and tritonymphs develop within the skin of the preceding stage (e.g., the protonymph in that of the larva, the tritonymph in the skin of the →deutonymph). These →pharate stages remain inactive; thus only free, active larvae and deutonymphs are found. The appearance (phenotype) of deutonymphs is very similar to that of adult mites, except for the sexual characteristics, size, and degree of sclerotization.

In members of the Acaridida the deutonymph is completely different from the preceding and the following stage with respect to morphology and behavior. This so-called →hypopus stage has no functional mouthparts and is a facultative developmental route which may be present in the life cycle of a mite generation. This special phenotype of a deutonymph can survive bad environmental influences much better than the normal form. The hypopodes are able to attach themselves to animals by ventral suckers or claspers and are thus transported to new environments or hosts (→Phoresis). In the genus →*Glycyphagus* inert hypopodes occur, which remain within the exuvia of the protonymphs; they are not provided with organs to fix themselves and thus can be carried by air currents. In certain members of the family Glycyphagidae (e.g., *Rodentopus sciuri*) the hypopus lacks organs for attachment, too. The hypopus forms of these mites are found in the subepidermal tissues of various animals.

Deutonymphs may be absent in the life cycle of males of some parasitic mites. As the males may have larval and nymphal characteristics, this represents a form of →neoteny. In most cases the deutonymph molts to the adult stage. The third nymphal stage (i.e., →Tritonymph) develops only in a few acarine groups; it is usually an active stage, but may be pharate in some members of the Actinedida.

## Integument

The epidermis of mites secretes a cuticle which in principle is a typical arthropod →cuticle, i.e., it is composed of a distinct epicuticle exhibiting sublayers (outer and inner epicuticle), a cover of secretory material of varying thickness (= cerotegument) perhaps corresponding to the cement and wax layers present

in other arthropods, and the procuticle (→Ticks/Fig. 8). The latter only in some species shows a clear differentiation into endo- and exocuticle. However, often a distinct lamellation with wavy microfibrils is obvious. Microfibrils are arranged more regularly in the flexible parts of the cuticle. Large pore canals, which mostly extend up to the epicuticle are widespread in the procuticle; only in the tick genus *Ixodes* have wax canal filaments been observed within the epicuticle.

The most uniform cuticle corresponding to the general scheme given above and exhibiting only little variation can be found in the order Parasitiformes. Epicuticle and cerotegument, however, show great variation in the order Acariformes, in particular in the Prostigmata (= Actinedida). Occasionally the procuticle is reduced (for instance, in the free-living *Alycus roseus*) or a cuticular network may be found within the epidermis (e.g., *Calypstostoma* sp.).

The cuticle can protect the mite against mechanical stress, especially in species with sclerotized shields. Flexible areas of the cuticle allow considerable changes of volume after excessive feeding (e.g., blood meals in the tick genus *Ixodes* and the mite genus *Dermanyssus*). In addition, the cuticle may be involved in osmoregulation by preventing a large influx of water into the body of mites inhabiting fresh water. Furthermore, the cuticle allows respiration, which is indicated by the number and arrangement of pore canals and the reduction of thickness of the epicuticle arching these structures. The complex cerotegument is believed to act as a →plastron in aquatic mites and, depending on habitat and species, as a barrier against evaporative water loss. Differentiations of the cuticle are shown in Figs. 4–6 (pages 835–837).

## Intestine and Food Uptake

The intestine of mites (Fig. 7, page 838) consists of several definite compartments. The mouth and the buccal cavity are followed by a muscular pharynx which is connected with the midgut (→Ventriculus) by a tubular esophagus. The midgut may be enlarged by up to 7 ceca. From the ventriculus a short intestine leads to the hindgut. The last part of the alimentary tract is the rectum, which opens at the anus. The organization of the alimentary tract can vary in the different groups of mites. For example, in the Trombidiformes the midgut is blind-ending, while the hindgut functions as an excretory organ. One or two pairs of Malpighian tubules may insert at the posterior intestine. Digestion proceeds both intra- and extracellularly, depending on the region of the midgut. For instance, in *Dermatophagoides farinae* digestion is obviously intracellular in the anterior region whereas it proceeds extracellularly in the posterior portion of the ventriculus. The food

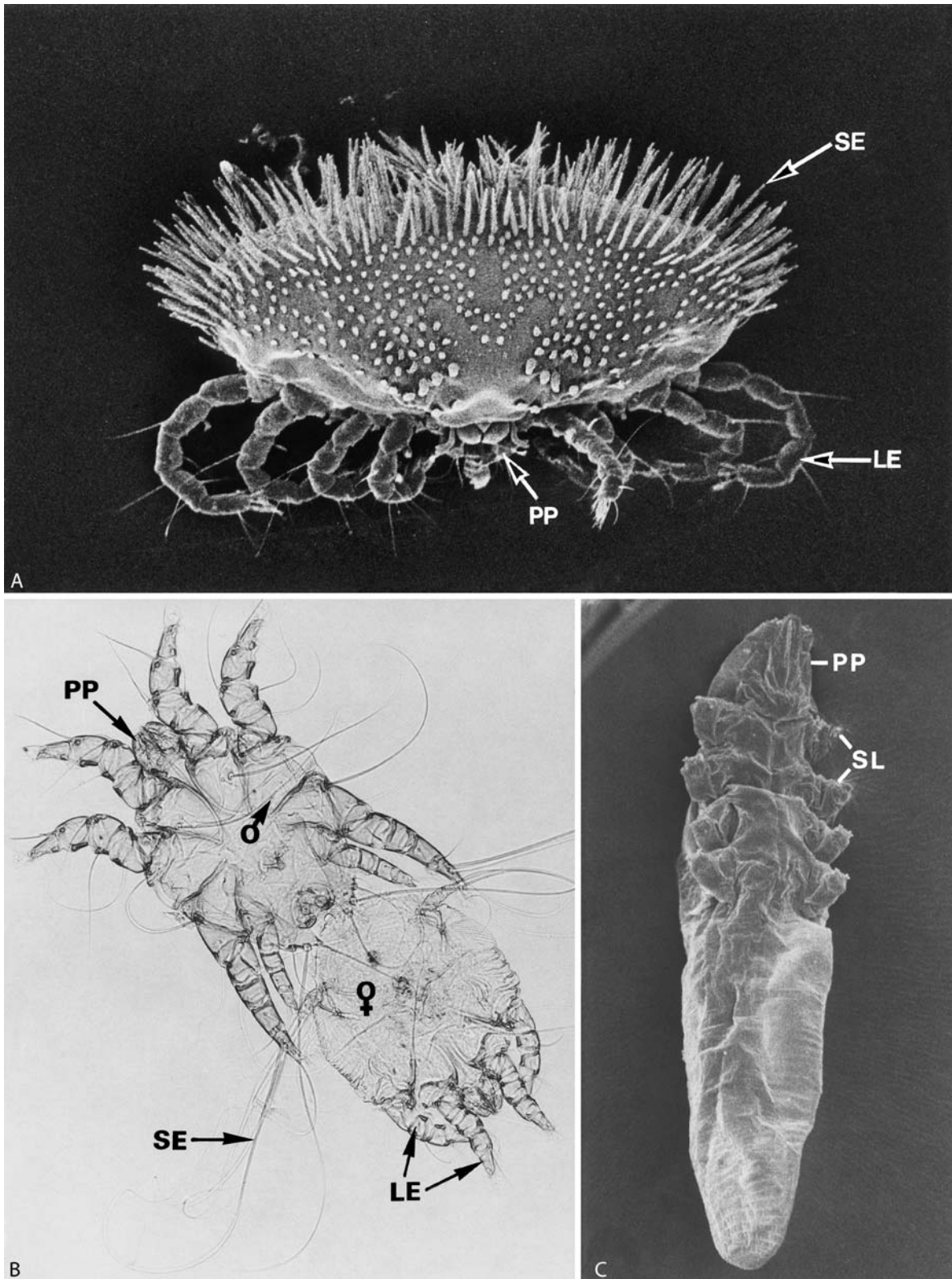

**Mites. Figure 4 A–C** External morphology of mites. **A** → *Pterygosoma* sp. from skin of reptiles (SEM × 85). **B** → *Caparinia tripilis* (from skin of hedgehog) in copulation (LM × 90). **C** → *Demodex folliculorum* from hair follicles of man (SEM × 600). *LE*, legs; *PP*, → pedipalps; *SE*, setae; *SL*, stumpy legs.

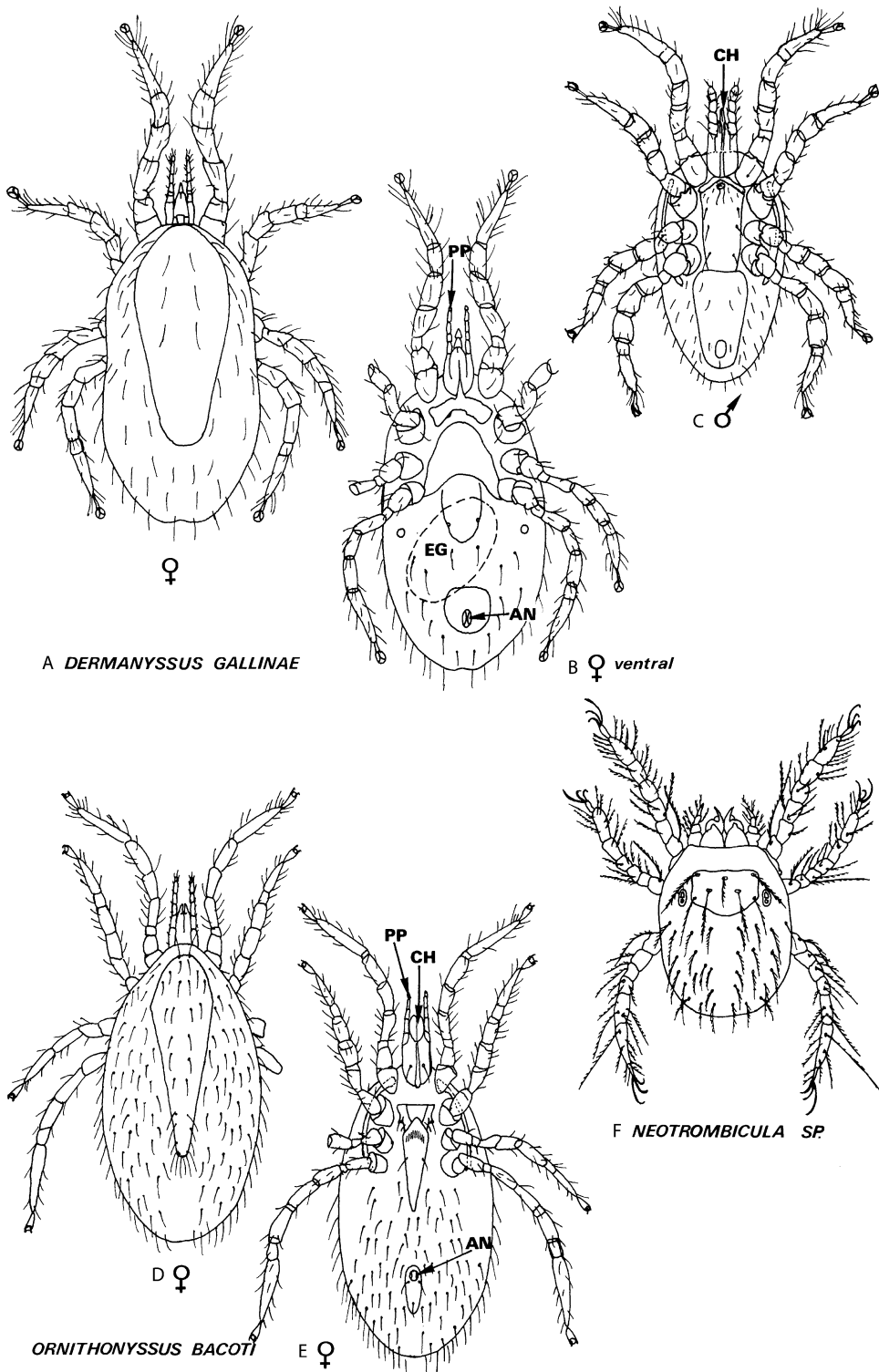

**Mites. Figure 5 A–F** Diagrammatic representation of the mouthparts and the cuticular hairs in different mite species. *AN*, annulus; *CH*, →chelicera; *EG*, egg; *PP*, pedipalpus.

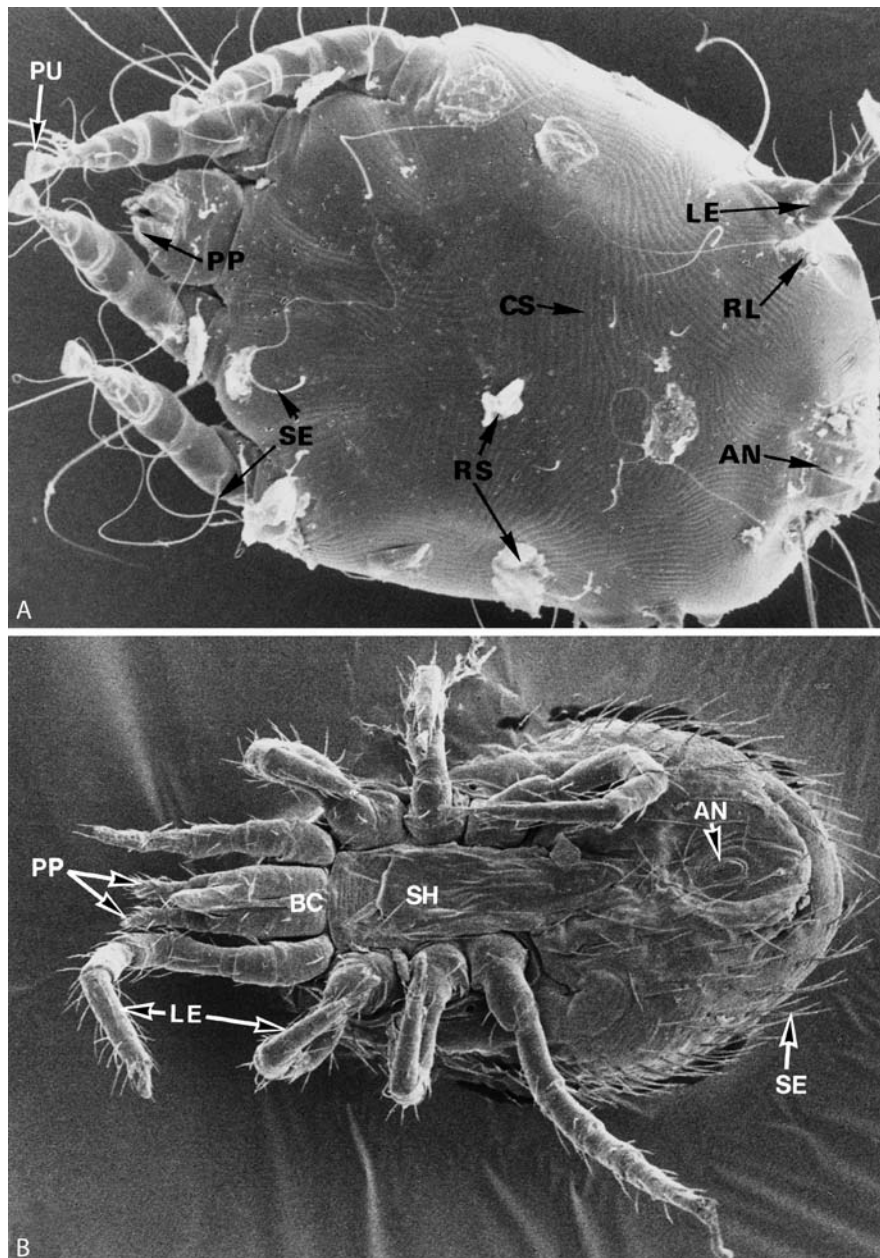

**Mites. Figure 6 A, B** External morphology of different mites (SEMs). **A** (*→Caparinia tripilis*) female from skin of hedgehogs as an example of *→mange mites* ( $\times 80$ ). **B** *→Ornithonyssus bacoti* from rodents as an example of bloodsucking mites ( $\times 120$ ). *AN*, anus; *BC*, *→basis capituli*; *CS*, cuticular striations; *LE*, legs; *PP*, pedipalps; *PU*, pulvillus of tarsus; *RL*, rudiment of legs; *RS*, remnants of host's skin; *SE*, *→seta*; *SH*, sternal shields.

is enclosed in some sort of peritrophic membrane which has been described in various arthropod groups.

### Excretory System

The organs involved in excretion vary between species. In most species midgut cells serve as excretory organs by absorbing excreted during digestion and discharging them later into the lumen of the ventriculus, from where

they are passed with the feces. In addition, there may be several Malpighian tubules, a single median excretory tube, and/or coxal glands. Malpighian tubules (Fig. 7) arise from the border between the mid- and hindgut and may be present in 1 or 2 pairs; in some species they may be reduced or even absent. Prostigmatid mites possess a median excretion tube originating from the hindgut, whereas their midgut terminates blindly. Coxal glands consist of a coelomic sac and a coiled



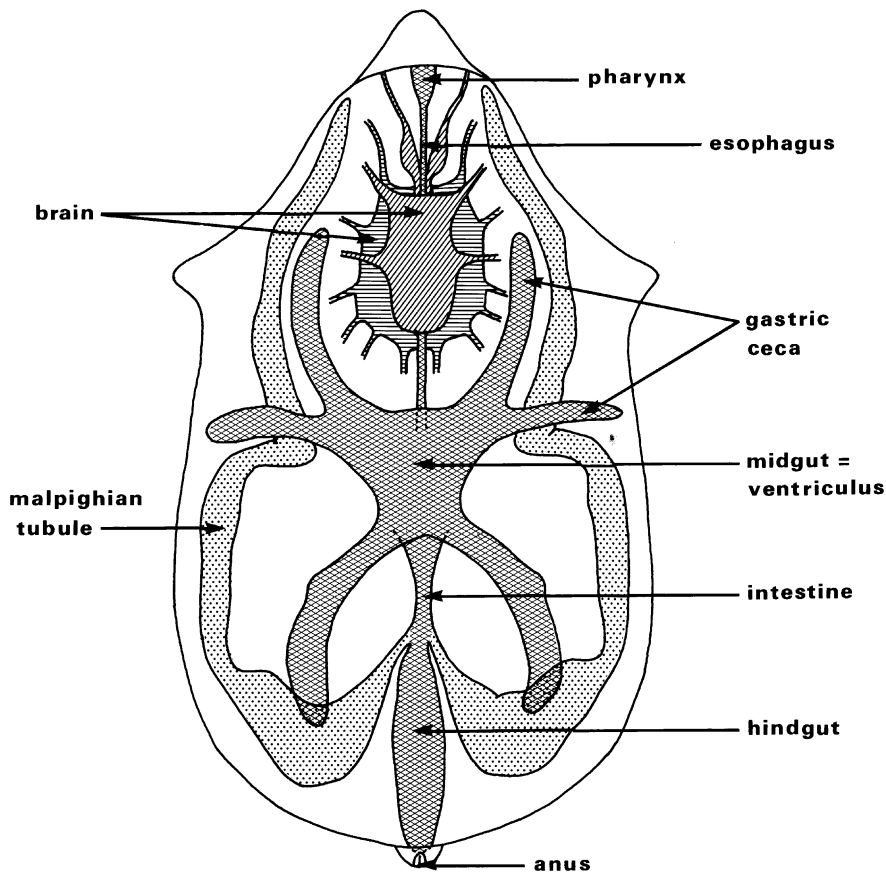

**Mites.** Figure 7 Diagrammatic representation of the alimentary tract and the brain of a mite (*Caminella*, Gamasida).

canal which opens on or near the coxae inside a definite porus. Some excretory systems are involved in osmoregulation.

### Nervous System

Mites possess a well-developed central nervous system, formed by ganglia encircling the esophagus (Fig. 7). Nerves of the subesophageal ganglia innervate musculature, legs, alimentary systems, and reproductive organs. Starting from the ganglia and situated dorsally to the esophagus, nerves arise which supply the mouthparts and, if present, the eyes. There are different sensory structures on the body surface of mites. Setal receptors occur in various shapes and with different internal structures. Tactile and chemosensory setae are to be distinguished; the latter are often optically active, too. The *trichobothria* are a type of tactile sensory organ that is solid internally in contrast to other tactile setae. Some mites possess ocelli, whereas in some eyeless groups photosensitive areas have been described on the dorsum. Further photosensitive spots have also been discovered on the pulvillar membrane of the first legs of the mite *Ophionyssus natricis*.

### Diseases

→Mange, Animals, →Mange, Man, →Scabies.

## Mitochondria

Mitochondria contain the enzymes for *oxidative phosphorylation* and the *tricarboxylic acid cycle* and are bounded by 2 membranes. Mitochondria reproduce by division and are therefore termed semi-autonomous organelles. This form of reproduction is possible because mitochondria have their own DNA (i.e., a second genome of about 6 Kb). In most mitochondria this DNA is composed of 2 circular strands arranged in a supercoil. Most parasitic *Protozoa* have one of 3 basic types of mitochondria, distinguished by characteristic infoldings of the inner membrane, which may be tubular, sack-like, or cristae-like (Fig. 1). Some species have a single, large mitochondrion that contains some extra DNA, e.g., species of *Trypanosoma* and *Leishmania*. These organisms have 5% of their DNA

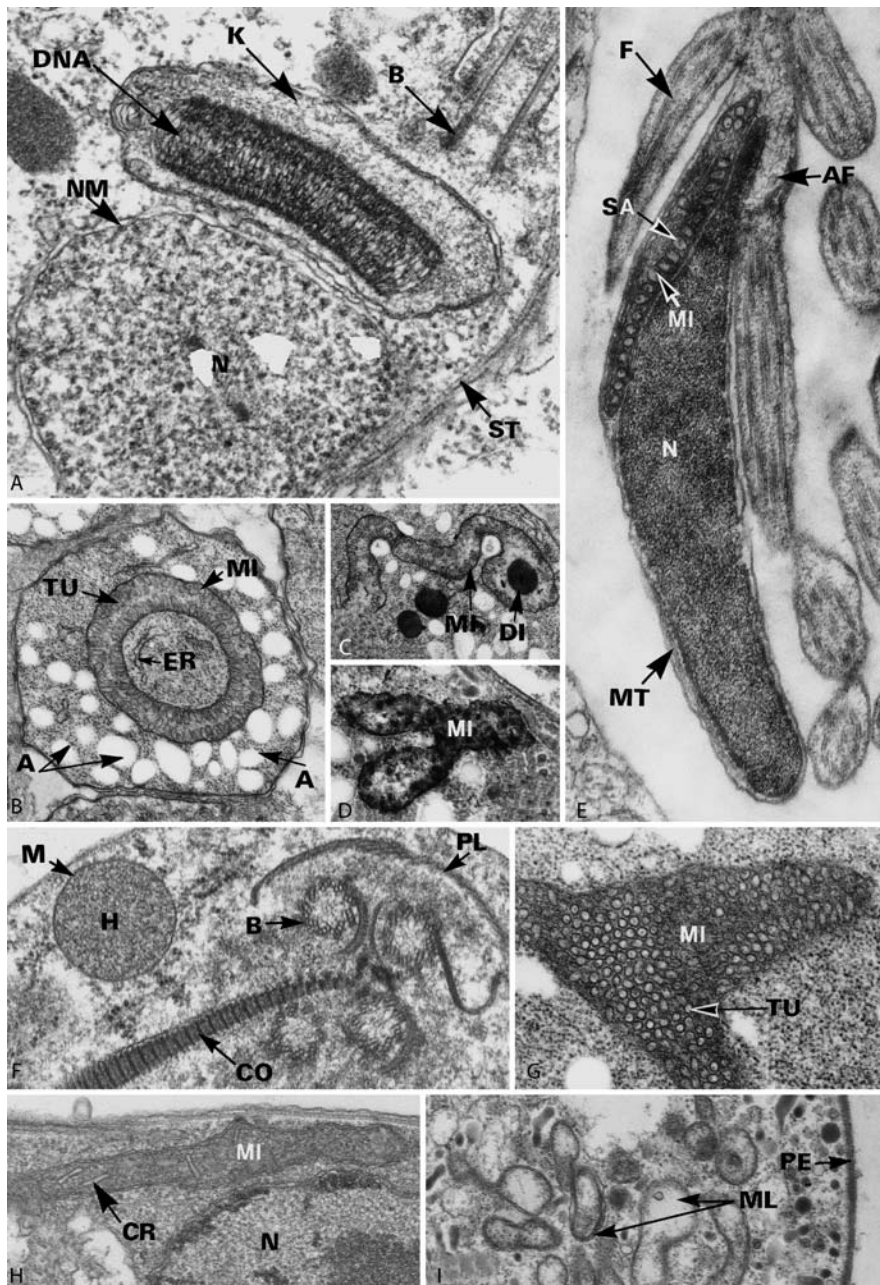

**Mitochondria. Figure 1 A–I** Transmission electron micrographs of different types of mitochondria. **A** → *Blastocrithidia triatomae*; the → kinetoplast (K) is a special part of the mitochondrion ( $\times 60,000$ ). **B–D** *Sarcocystis ovis felis*; tubular-sacculi type mitochondria of cyst merozoites may be ring-shaped (B); they may contain dense inclusions (C) and show acid phosphatase activity (D) ( $\times 25,000$ ). **E** Sacculi-like mitochondrion in a microgamete of → *Eimeria maxima* ( $\times 35,000$ ). **F** → *Trichomonas vaginalis* has no mitochondria, but → hydrogenosomes instead (H) ( $\times 40,000$ ). **G** Tubular mitochondrion in gamonts of → *sarcosporidia* ( $\times 38,000$ ). **H** Mitochondrion with cristae in a flagellate, → *Trypanosoma vivax* ( $\times 24,000$ ). **I** Mitochondrion-like structures (MC) as in → *Plasmodium* spp. and → piroplasms ( $\times 17,000$ ). A, → amylopectin; AF, → attached flagellum; B, basal body; CO, → costa; CR, → crista; DI, dense inclusion; DNA, DNA; ER, endoplasmic reticulum; F, flagellum; H, hydrogenosome; M, membrane; MI, mitochondrion; ML, mitochondrion-like structures; MT, → microtubules; N, nucleus; NM, nuclear membranes; PE, → pellicle; PL, → pelta; SA, sacculus; ST, → subpellicular microtubules; TU, tubules.

in a single structure called the →kinetoplast (Fig. 1A, →*Blastocrithidia triatomae*/Fig. 2A, →*Trypanosoma*/Fig. 5A) which is located close to the basal body of the flagellum.

→Trichomonads, some ameba including →*Entamoeba histolytica* and the species of the →Microspora have no mitochondria, but some ameba contain symbiotic bacteria that may function as mitochondria. The trichomonads, which are anaerobic, have →microbodies called →hydrogenosomes. They are limited by 1 or 2 closely attached membranes surrounding a granular matrix (→Trichomonadida/Fig. 1C, E). The enzyme system of these bodies differs from that of mitochondria, as they metabolize pyruvate from →glycolysis into acetate, CO<sub>2</sub>, and H<sub>2</sub>. In ciliates, similar →hydrogenosomes with double membranes are present, in addition to regular mitochondria (Fig. 1).

---

## Mitochondrial DNA

→Nucleic Acids.

---

## Mitochondrial Respiratory Chain

→Energy Metabolism.

---

## Mitochondrial-Like Compartment (MLC)

*Cryptosporidium* stages show MLC, which do not have a genome, but are entirely dependent on nuclear-encoded proteins.

---

## Mitosis

→Nuclear Division.

---

## Mitosome

Organelles which derived from mitochondria, but reduced their activity, e.g., in →*Entamoeba*, →*Giardia*.

---

## Mode of Action

→Chemotherapy, →Drug.

---

## Models

→Mathematical Models of Vector-borne Diseases.

---

## Modes of Infection

→Disease Control, Epidemiological Analysis.

---

## Molecular Chaperones

Product (cpn60) of mitochondria, also present in the mitochondria-less *Entamoeba histolytica* together with pyridine nucleotide transhydrogenase. Cpn60 is located in 2 small types of vesicles (1–2 μm) in the cytoplasm, probably representing mitosomes.

---

## Molecular Mimicry

→Mimicry.

---

## Molecular Taxonomy

→Phylogeny.

---

## Molluscicides

Products that control the development of snails, which may be vectors of →schistosomes or other trematodes (e.g., niclosamid, sodium pentachlorophenate).

## Molt

→ [Arthropoda](#).

## Monensin

→ [Coccidiocidal Drugs](#).

## Moniez, R. L. (1852–1936)

French helminthologist.

## Moniezia expansa

Name honors R.L. Moniez (1852–1936).

### Synonym

English: Sheep Tapeworm.

### Classification

Genus of → [Eucestoda](#), family Anoplocephalidae.

### Life Cycle

→ [Eucestoda/Life Cycle](#), → [Dipylidium caninum/Fig. 1](#).

### Morphology

*Moniezia expansa* worms occur worldwide in the small intestine of ruminants, reach a length of 10 m, and their posterior proglottids are very broad (~2.5 cm) (Figs. 1, 2, page 842). These proglottids are characterized by the presence by a double set of sexual organs being situated at the 2 lateral sides of the proglottids. Intermediate hosts are oribatid mites, which are fed together with grass. The **prepatent period** takes about 30–52 days, **patency** lasts 3–8 months. Anaemia, diarrhoea, loss of weight are the most common **signs of disease**. **Diagnosis** is done by finding the characteristic proglottids around the anus or by the determination of eggs in the faeces.

### Therapy

→ [Cestodocidal Drugs](#). *M. benedeni* is smaller 4 m × 1.6 cm, but has the same host range and a similar life cycle.



**Moniezia expansa.** Figure 1 Adult *Moniezia*-worm in the gut of a cow (courtesy Dr. Düwel), SEM see page 842.

## Moniliformis moniliformis

→ [Acanthocephala](#), name from Latin: *monile* = necklace.

## Monobothrium wageneri

Tapeworm of fish (e.g., *Tinca tinca*) possessing → [microtriches](#) (→ [Platyhelminthes/Fig. 19D](#)).

## Monocercomonadina

→ [Trichomonadida/Table 1](#).

## Monocercomonas Species

### Name

Greek: *monas* = individual, *kerkos* = tail.

Species like *M. cuniculi* are found in the terminal region of animals feeding on plants. They include life cycle stages with and without flagella.

## Monocercus ruminantium

→ [Trichomonadida](#), name from Greek: *monos* = one, Latin: *cercus* = tail.

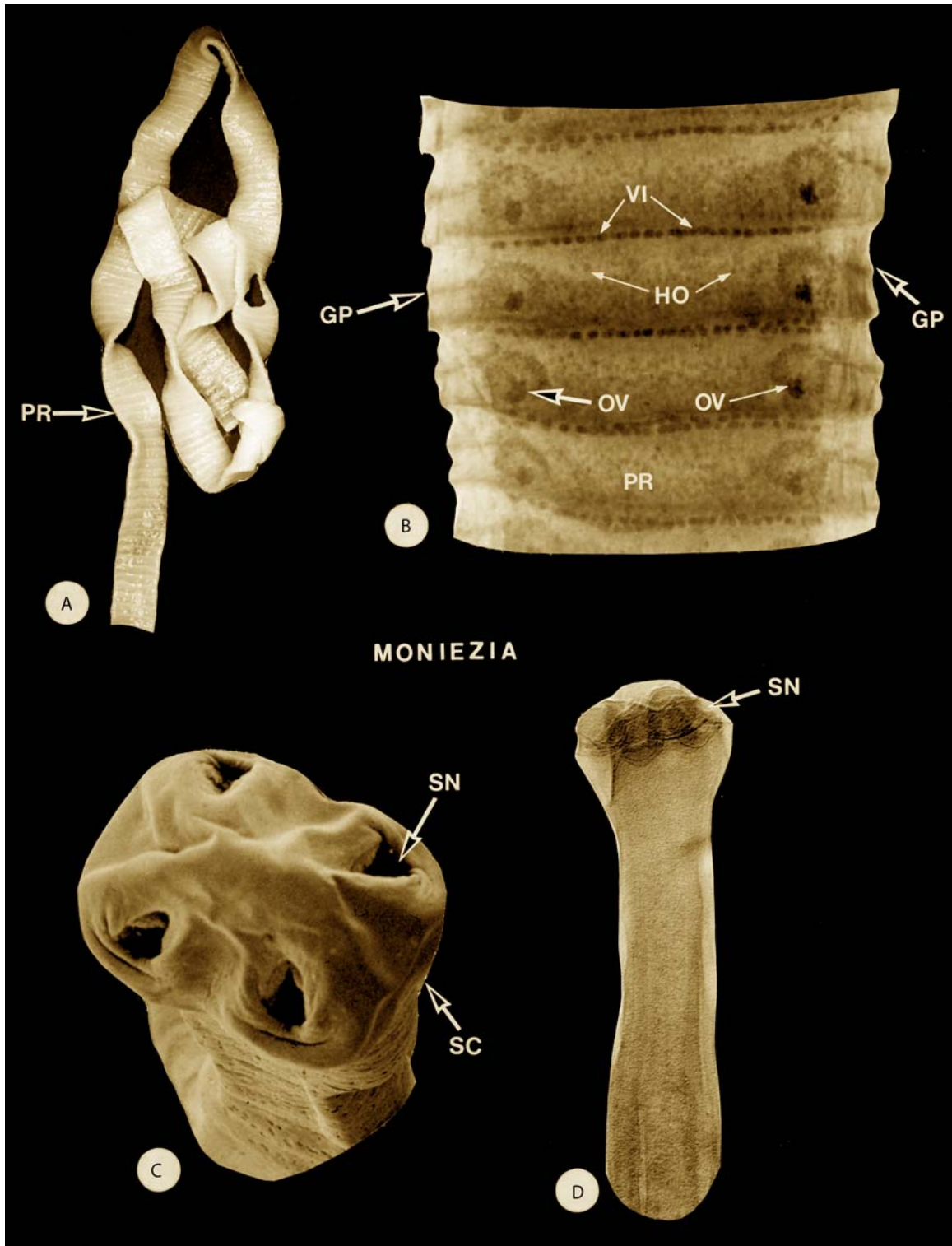

**Moniezia expansa.** Figure 2 Morphology of *Moniezia*. **A**, Strobila (mid-portion); **B**, LM of proglottids; **C**, SEM of the scolex; **D**, LM of the anterior end; *GP*, genital pore; *HO*, testis; *OV*, ovary; *PR*, proglottis; *SC*, scolex; *SN*, sucker; *VI*, vitellarium.

## Monoculicoides

Subgenus of →*Culicoides*, which includes the most important vectors of bluetongue virus in the USA: *C. variipennis* and among others the important European species *C. nubeculosus*.

## Monocystis agilis

→Gregarines.

## Monogenea

### Classification

Class of →Platyhelminthes.

### General Information

The monogeneans are typically (often economically important) ectoparasites of the skin and/or gills of fish, amphibians, reptiles, cetaceans, or cephalopods; some species become endoparasitic by inhabiting the nose, the pharynx, →cloaca, bladder, etc. (Table 1). In all cases they are attached to the host's surface by a characteristic →opisthaptor which is species-specific and provided with hooks and hooklets (order →Monopisthocotylea) or clamps (order →Polyopisthocotylea; Fig. 2). With the exception of the members of the →viviparous family Gyrodactylidae, monogeneans usually have a simple life cycle involving hermaphroditic adults, eggs, and larvae (e.g., oncomiracidia, →Diplozoon paradoxum/Fig. 1, →Polystomum integerrimum/Fig. 1). Unlike the other monogeneans (Fig. 1), which produce eggs, →Gyrodactylus spp. are viviparous. The larva is retained in the uterus until it develops into a functional preadult, inside which a second larva is already formed, with a third larva inside that and a fourth inside the third (→Gyrodactylus/Fig. 1). The steps of this sequential polyembryogony are only poorly understood. After its birth, this preadult larva begins feeding on its host and gives birth to the second larva remaining inside it. Only then may an egg from its own

**Monogenea. Table 1** Some important species of the Monogenea

Species	Size (mm)	Host	Habitat
<b>Monopisthocotylea</b>			
<i>Gyrodactylus elegans</i>	0.9 × 0.2	Carp	Gills, fins
<i>Paragyrodactylus iliensis</i>	0.4–0.08	Spotted stone loach	Gills
<i>Dactylogyrus vastator</i>	1.3 × 0.3	Carp	Gills
<i>Falciunguis parabramis</i>	0.6 × 0.16	Bream	Gills
<i>Ancyrocephalus paradoxus</i>	4.0–0.8	Perch	Gills
<i>Alconpenteron nephriticum</i>	0.9 × 0.15	Gray loach	Ureter
<i>Nitzschia sturionis</i>	20 × 5	Sturgeon	Gills, oral cavity
<i>Calicocotyle kroyeri</i>	3 × 2.5	Rays	Cloaca
<i>Entobdella soleae</i>	5 × 2.2	Common sole	Skin
<i>Capsala martinieri</i>	22 × 23	Ocean sunfish	Gills
<i>Pseudodactylus anguillae</i>	0.6–1.1	Eels	Gills
<b>Polyopisthocotylea</b>			
<i>Diplozoon paradoxum</i>	7 × 1.8	Bream	Gills
<i>Polystomum<sup>a</sup> integerrimum</i>	10 × 2	Frogs	Urinary bladder
<i>Oculotrema hippopotami</i>	12 × 2	Hippopotamuses	Eyes
<i>Rajonchocotyle prenanti</i>	8 × 0.4	Rays	Gills
<i>Diclidophora merlangi</i>	9 × 3	Whiting	Gills
<i>Axine belones</i>	6 × 1.3	Garfish	Gills
<i>Discocotyle sagittata</i>	7 × 2	Trout	Gills
<i>Mazocraes alosae</i>	11 × 2.2	Herrings	Gills
<i>Kuhnna scombri</i>	2.8 × 0.6	Mackerel	Gills
<i>Hexastoma lintoni</i>	9 × 3.2	Tunny	Gills

<sup>a</sup> Some authors prefer *Polystoma*

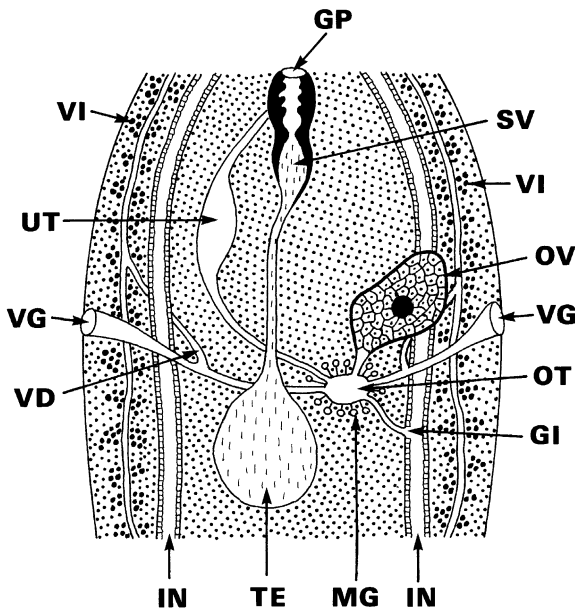

**Monogenea.** Figure 1 Diagrammatic representation of the reproductive system. Polyopisthocotylean monogenean. *GI*, genitointestinal duct; *GP*, genital pore; *IN*, intestinal branch; *MG*, →Mehlis' glands; *OT*, →ootype; *OV*, ovary; *SV*, seminal vesicle; *TE*, →testis; *UT*, uterus; *VD*, vitelloduct; *VG*, vagina; *VI*, →vitellarium.

ovary become fertilized, repeating in a short time the development described above. Since this peculiar →embryogenesis does not involve a free infectious →oncomiracidium, Gyrodactylidae depend on transmission of adults or preadults from one host to another (apparently by body contact in closely filled ponds, etc.).

**Important Species**

Table 1.

**Monomycin**

→Antibiotic compound to be used as topical treatment in →cutaneous leishmaniasis.

**Monophyletic Situation**

All taxa of a →clade derive from a single ancestor.

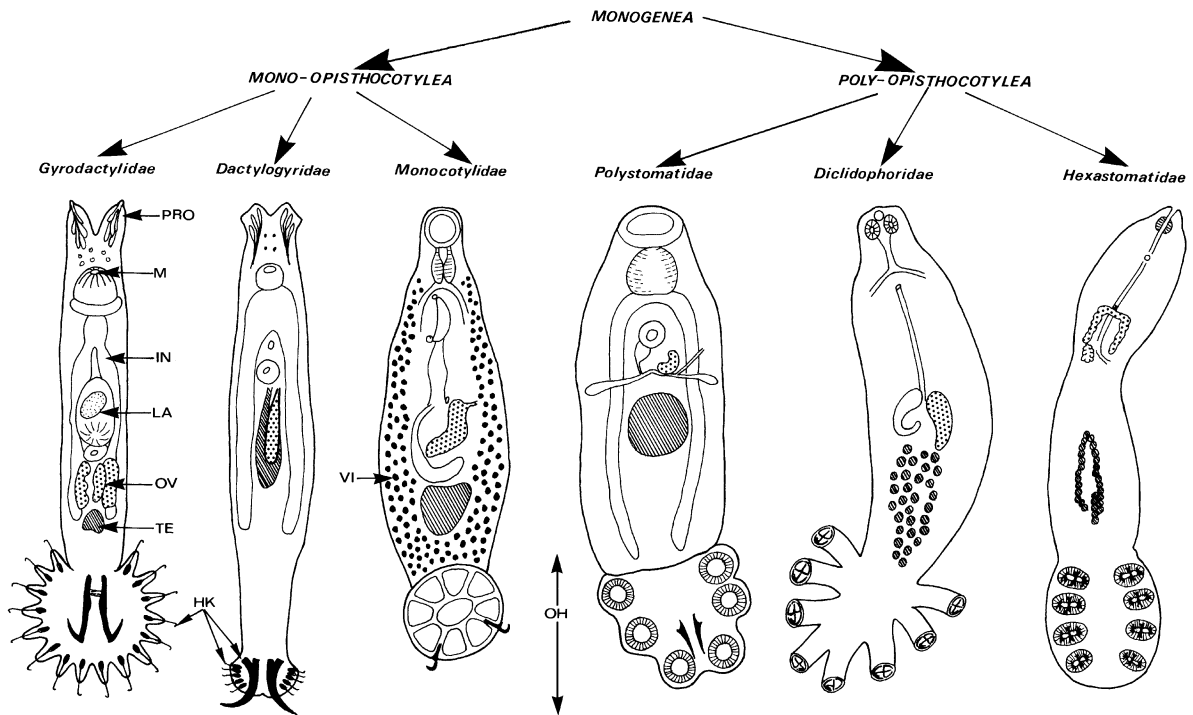

**Monogenea.** Figure 2 Diagrammatic representation of specimens of different monogenean families and their relations. *HK*, hooks; *IN*, intestine; *LA*, larva; *OH*, →opisthaptor; *OV*, ovary; *PRO*, →prohaptor; *TE*, testis; *VI*, vitellarium.

## Monopisthocotylea

→ [Monogenea](#).

## Monorchidism

Presence of only one → [testis](#) (→ [Acanthocephala/Reproductive Organs](#)).

## Monoxenous Development

In many parasitic groups the whole development is restricted to the tissues of one host individual. The species may be strictly host-specific (using only a single host species) or not (e.g., → [Eimeria](#), → [Coccidia](#)).

## Monoxeny

### Name

Greek: *monos* = alone, *xenos* = guest.

A parasite, that attacks only one host during its development, has a monoxenous life cycle.

## Monthly Biting Rate (MBR)

Rate to calculate the bites an individual could receive by tentially *Onchocerca*-infected simuliids at the site of the house.  $MBR = \text{number of black flies caught} \times \text{number of days in month} / \text{number of catching days per month}$ . The annual biting rate (ABR) is the sum of the 12 MBRs.

## Monthly Transmission Potential (MTP)

Method to calculate the infection risk in onchocerciasis (and other vector-transmitted worm diseases).  $MTP = \text{Monthly biting rate (MBR)} \times \text{number of } Onchocerca \text{ larvae 3 observed} / \text{divided}$

through number of simuliids dissected. The annual transmission potential (ATP) is the sum of the 12 months.

## Morantel

A pyrimidine compound, → [Nematocidal Drugs](#).

## Morbidity

The state of being diseased or the rate of disease of sick individuals (persons/animals) within a given population.

## Morellia

Genus of the fly family Muscidae *M. hortorum*.

## Mortality

This term (Latin: *mortalitas* = dying) describes the reduction (frequency) of individuals in a given population due to death (with respect to different reasons).

## Mosgovoyia

Genus of anoplocephalid → [cestodes](#).

## Mosquitoes

### Classification

Family of → [Diptera](#).

### Synonym

→ [Culicidae](#), mosquito is the portuguese name of biting flies.



## General Information

Fossil mosquitoes are about 50 million years old, which is much time to adapt to the later developing human. All human populations are affected by mosquitoes, mainly by bites but also by the transmission of diseases. About 3,500 mosquitoes belong to the family Culicidae, the most important genera →*Anopheles* and →*Culex*, →*Mansonia* and →*Aedes* belonging to the subfamilies Anophelinae and Culicinae, respectively. Mosquitoes were the first insects in which a causative agent of a disease, →*Bancroftian filariasis*, was observed (1877). Meanwhile they are known as vectors of many diseases, e.g., viral, and bacterial diseases, but are mostly known as vectors of →*malaria*.

Mosquitoes are holometabolous insects; larvae and pupae live aquatically. Adults are about 5 mm long, holding their wings flat above their body. In this dipteran group, only females suck blood. The adults can be distinguished from nonbloodsucking Nematocera, e.g., →*chironomids*, by scales on the wing veins and especially by the long, forwardly directed →*proboscis*.

## Life Cycle

Normally embryonic development is completed within a few hours after egg laying, and the first →*instar* larvae hatch. Fully developed larvae of →*Aedes* remain in the eggshell until eggs are flooded, and can thereby be stored for a long period of time (depending on temperature and humidity up to 4.5 years). Larvae are aquatic, mainly occurring in fresh water, but some species also develop in salt water. The size of the habitat can be very small, e.g., tree holes. The total duration of the 4 larval instars varies greatly, even within one species, especially depending on temperature and food supply. In the tropics it can be completed within one week, in temperate regions many months, and even longer if a larval diapause exists. Some species are even frost-tolerant while others live at 50°C. The larvae feed on debris or plankton (filter feeders) or predate other larvae. The development of the also aquatic →*pupa* is also temperature-dependent, lasting between 1 day or up to 3 weeks. If the pupae are disturbed, they actively swim downwards with their paddles at the end of the abdomen. The longevity of the adults strongly varies according to the climatic region, on average 1–2 weeks in the tropics and 4–5 weeks in temperate regions, but up to several months for females of hibernating or aestivating species. Thereby, the whole developmental cycle (egg to egg) can last about 7 days or up to several months in diapausing species.

## Distribution

Mosquitoes are found almost worldwide in almost all types of ecological zones, being absent only from Antarctica and some islands.

## Morphology

The generally 3–6 mm long adult flies possess long slender legs. The head is globular, possessing 2 large compound eyes (no ocelli) and long filamentous antennae which contain sensory organs to recognize host and →*oviposition* sites and the Johnston's organ in the basic segment by which males recognize wing beats of the females. The prominent mouthpart is equal in length to the head/thorax region and formed by the labium ensheathing the stylets which have developed from the labrum (building the food channel), the 2 mandibles and laciniae and the unpaired hypopharynx, the latter containing the salivary channel. The length, shape, and hairiness of the 5-segmented maxillary palps differ according to species and sex, being reduced in males which do not feed blood, but only sugars, e.g., honeydew or nectar. In addition, males and females can usually be separated according to the antennae, which are brush-like in males, the weaker developed mouth parts of males and the external genitalia of males, jointed claspers. In both sexes only the veins of the wings are covered with scales. After emergence, male genitalia rotate by 180°, thereby making a copulation during flight easier.

The elongated larvae possess a well-sclerotized head capsule, bearing pairs of heavily sclerotized mandibles and maxillae and mouth brushes, the latter helping to scrape vegetation from surfaces or sweeping food particles towards the mouth. One pair of →*spiracles* is located on the fused segments 8/9, almost flush with the surface in Anophelinae or at the end of a sclerotized siphon in Culicinae. In all species, the last segment has a sclerotized saddle with a ventral brush which is used for swimming.

On the →*cephalothorax* of the comma-shaped pupae, a pair of respiratory trumpets is located through which the pupae breathe at the water surface. The pupae also possess paddles at the end of the abdomen.

There are several criteria to distinguish Anophelinae and Culicinae (Fig. 1A–D): Anopheline eggs are boat-shaped, laid singly, and remain at the water surface by air-filled floats. The larvae are surface filter feeders, siphonless and, when not disturbed, they lay parallel to the water surface. Especially adults of the genus *Anopheles* have at rest all parts (proboscis, head, thorax, abdomen) in a straight line, holding an angle of 30°–45° to the surface. The wing veins are covered in a characteristic pattern by dark and pale scales. Scales are usually totally absent from the abdominal sternites. Both sexes possess long, black palps. In contrast to the Anophelines, the Culicines show the following: The larvae hang down at an angle of about 40° to the water surface or water plants (→*Mansonia*) on which the siphon is located. In resting adults, the body is nearly parallel to the surface or directed back towards the surface. Sternites and tergites are densely covered with scales and the palps of females are not more than one-third as long as the

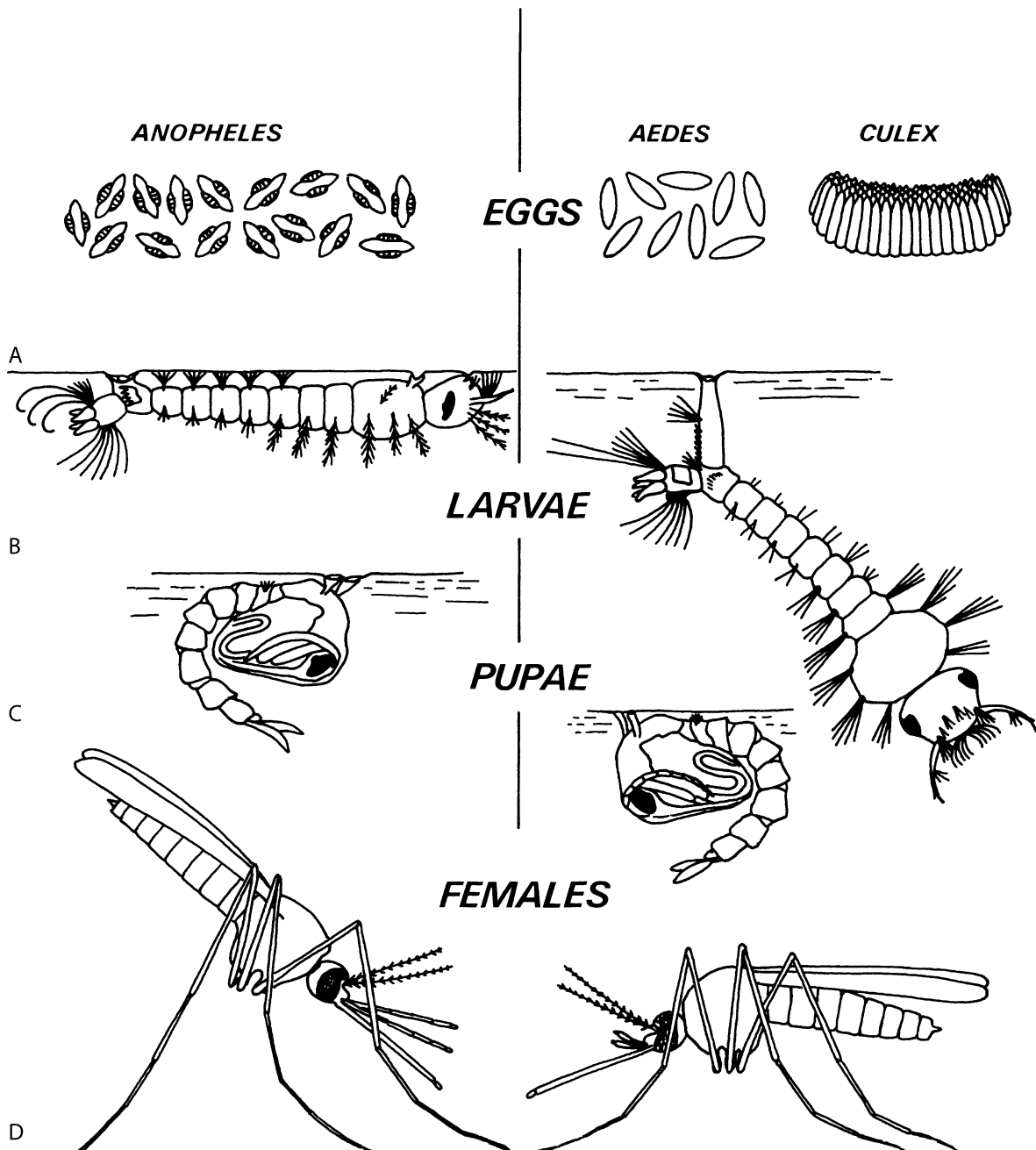

**Mosquitoes. Figure 1 A–D** Life cycle stages of 3 important genera of mosquitoes. **A** Shape of eggs which were laid on the water's edge (*Aedes*, → *Culex*) or on the water itself (→ *Anopheles*). **B** Respiring larvae at the water surface; the 4 larval stages feed by filtering organic particles in the water. **C** Respiring pupae; pupae (described as tumblers) do not feed and remain at the surface unless disturbed. **D** Sitting females; males (with brushed antennae) and females are good flyers and feed on nectar, but females of most species suck blood (vessel feeder) before depositing eggs. The latter are laid in a clutch of about 200 individuals (A). Eggs require 48–72 hours to develop within the females, which thus take blood every 2–4 days and consequently provide good opportunities for the transmission of pathogens.

proboscis. Within Culicines, eggs of the 3 genera can also be distinguished: The black *Aedes* eggs are laid singly, those of *Culex* grouped to egg rafts, those of *Mansonia* glued to the undersurfaces of plants.

### Genetics

In cross-mating experiments and by morphometrics or ecological investigations, genetically distinct groups of populations and sibling species have been found for

many species. Important species complexes are the *Anopheles gambiae*-, *Anopheles maculipennis*-, *Aedes scutellaris*-, and *Culex pipiens*-complex. Within such complexes, species can be separated according to differences in nonmorphological techniques.

## Reproduction

Breeding of mosquitoes in the laboratory is possible for many species without great difficulties.

In nature, a few hours to one day after emergence, adults are ready for mating which occurs in flight. Males swarm above special locations, seizing passing females. In some species, males introduce secretions of their accessory glands during copulation, thereby inducing refractoriness of females and changing their behavior. Most females require a blood meal for egg development ([→Anautogeny](#)), whereas sugars, ingested by males and females, are mainly used for flight. Egg development is induced by the distension of the midgut. Sometimes especially the first ovarian cycle can be completed without a blood meal ([→Autogeny](#)). The number of ovarian cycles (egg layings) and thereby the number of blood meals and also the risk of transmission of parasites is indicated by changes in the ovarioles. Each female has 2 ovaries and each of these 50–200 ovarioles. In each ovarian cycle, only one egg develops per ovariole. In nature usually 4 or 5 ovipositions occur, each of them with 30–500 eggs. Oviposition sites are chosen species-specifically according to the water chemistry and a circadian rhythm.

## Biochemical/Molecular Data

Biochemical techniques, e.g., enzyme electrophoresis and gas chromatography of cuticular hydrocarbons, and DNA probes have been successfully used to distinguish between morphologically similar species in a species complex. Since mosquitoes are the most important vectors, many biochemical and molecular biological investigations have been performed, e.g., on inhibitors of blood coagulation, the interaction of the malaria parasite and digestion or [→immune reactions](#) of the vector, insecticide resistance, vitellogenesis, etc.

## Transmission

Mosquitoes usually occur near their emergence sites. Depending on the distance between breeding place and host the flight range can be up to several km.

## Feeding Behavior and Transmission of Disease

Mosquitoes are attracted to the hosts by many stimuli, e.g., lactic acid and carbon dioxide. Blood feeding follows a species-specific circadian rhythm, mainly nocturnal. Mosquitoes are capillary feeders, some

[→pool feeders](#), finishing the blood meal (4–10  $\mu$ l) within a few minutes. Some species deposit clear urine during and after feeding, but others apparently unchanged blood. The saliva contains many compounds, e.g., to increase the flow of blood, to prevent blood clotting, for local anaesthesia and the enzyme apyrase which facilitates the location of blood vessels. Cibarial and pharyngeal pumps transport the blood directly through the esophagus into the midgut. Sugar liquids are first directed into the crop and to kill bacterial contaminations then into the midgut.

Mosquitoes transmit many different [→arboviruses](#), [→Protozoa](#), and helminths (see [→Diptera/Table 1](#)).

Of the arbovirus diseases, [→Yellow fever](#) is common in Africa, Central and South America, and [→Dengue](#) widely distributed in all tropic regions. Both are also transmitted transovarially within mosquito populations.

However, mosquitoes are most widely known as vectors of [→Plasmodium](#), the causative agent of malaria, the most important tropical disease. This disease is also potentially endemic to all subtropical and temperate regions. It has been eradicated from Australia, USA, Chile, Israel, and Europe (except Turkey), but potential vectors are still present.

Mosquitoes are also vectors of another important tropical disease, filariasis. The [→helminth](#) [→Wuchereria bancrofti](#) which causes elephantiasis is transmitted by different *Aedes*-, *Anopheles*-, or *Culex*-species and especially present in tropical America and Africa, South Asia, and Polynesia while [→Brugia malayi](#) is mainly transmitted by *Mansonia*-species, but also by different *Aedes*- or *Anopheles*-species and occurs in South Asia.

## Interaction of Vector and Parasite

After blood ingestion [→arboviruses](#) multiply in the cells of the midgut or penetrate them and multiply in the hemolymph before invading the salivary glands.

After ingestion of blood containing erythrocytes with male and female *Plasmodium* gametocytes, the drop in temperature and a mosquito gametocyte-activating factor induce the development to micro- or macrogametes, respectively. After fertilization, the resulting [→zygote](#) changes the surface properties during transformation to the elongated [→ookinete](#), indicated by the sensitivity of the latter to the proteases in the gut. The ookinete produces a chitinase to digest a way through the [→peritrophic membranes](#), penetrates the wall of the midgut intra- or extracellularly, and remains below the basal lamina of the intestinal wall. There it develops into an [→oocyst](#) and therein to thousands of sporozoites until the oocyst bursts. The sporozoites are carried throughout the body by the hemolymph and also to the salivary glands. The recognition/penetration of the [→salivary gland](#) cells (and also that of the midgut cells) seems to be regulated

by lectin–sugar interactions. Only sporozoites from the salivary gland – not those released from the oocyst – can infect hepatocytes. The induction of the single steps of this development seems to vary in different parasite/vector systems and was often obtained in investigations of nonhuman malaria.

After ingestion of blood with the microfilariae, these exsheath, penetrate the wall of the stomach, migrate to the flight muscles in the thorax, grow and molt twice, and migrate then to the fleshy labium of the mouthparts which they rupture during feeding.

Effects of the parasite on the vector differ according to the transmitted disease. In virus-infected mosquitoes, longevity and overwintering capacity is reduced. In *Plasmodium*-infected mosquitoes, many effects are obvious, e.g., changes in the amino acid composition of the hemolymph, reduction of flight endurance, longevity, and fertility. Some of these effects seem to be caused only in infections of certain strains of mosquitoes by certain strains of *Plasmodium*. Conspicuous is a modification of the feeding and probing behavior. Presumably due to the destruction of cells of the salivary glands, the apyrase concentration is reduced and thereby, the recognition of blood vessels is affected, and infected mosquitoes probe much more often than uninfected specimens.

In infections with filariae, high parasite burdens can reduce the flight ability and the longevity.

### Prophylaxis

Bed nets and screens offer mechanical protection against the night-active mosquitoes. *Repellents* can be applied to bed nets and clothing. The application onto the skin is only of reduced value, since the sweat usually sweeps it off. UV lamps attract only the nonbloodsucking males.

In addition to the efforts during the permanent risk, exposition should be reduced during the periods of the day when the respective vectors of diseases are active: Many species of *Aedes* are active in the morning and evening. Most *Culex*, *Mansonia*, and *Anopheles* usually bite during the night. Therefore, evening walks are risky. Anti-mosquito coils which produce an insecticidal smoke are widely used in bedrooms.

### Control

Control campaigns can be directed against larvae or adults. In attempts to control larvae, the best results have been obtained in Europe by draining marshes. This is without success if the vector species also breed in other habitats, if the high costs cannot be covered, or if environmental arguments exist. Other physical methods have to be used according to the respective vector species, e.g., intermittent irrigations, deforestation, or planting vegetation. In many tropical countries,

education reduced the number of breeding places created by discarding old tyres, cans, or jars. Chemical control includes the spraying of mineral oils on the water surface, or applying the copper acetoarsenite (Paris Green) dust, or many *insecticides* (carbamates, organophosphates, pyrethroids). Insect growth regulators arrest larval development or interfere with the formation of the *cuticle*. In ecologically sensitive regions, *biological control* is performed, based mainly on *Bacillus thuringiensis* var. *israelensis*. The *spores* contain a crystalline endotoxin which induces the lysis of midgut cells of the larvae. *Bacillus sphaericus* and, to a lesser extent, the insect nematode *Romanomermis culicivorax* are also used for the biological control. Very effective and widely used in the USA is *Gambusia*, a larvivorous fish. Control of adult mosquitoes includes methods mentioned in the *prophylaxis* section, e.g., the use of mosquito nets which can be impregnated with insecticides, the use of insect repellents, and anti-mosquito coils. Insecticides are often used against adult mosquitoes, e.g., in community treatments being applied by helicopters. Residual insecticides can also be sprayed in the house, but thereby populations of mosquitoes survive which leave the house directly after feeding and do not rest inside the house on the insecticide-impregnated walls (cf. *Insecticides*, *Arthropodicidal Drugs*).

### Resistance

Meanwhile resistances to various insecticides have developed, often due to the use of these insecticides in protection campaigns of agricultural crops.

### Host Finding

*Host finding* in female mosquitoes is only one of many behavioral patterns, such as dispersal, microhabitat selection, predator avoidance, water drinking, sugar feeding, mate finding, copulation, and oviposition. Whether mosquitoes seek a host or not, and how intensely their host-finding behavior is expressed, depends on their physiological state. In many species a large blood meal is essential for egg production, but when there is no urgent need for a blood meal the host-finding behavior can be inhibited. This may be an adaptation to the high mortality of mosquitoes, caused by the host's defensive behavior. In species with high gut capacity the host-finding behavior can be inhibited after a blood meal. An immediate inhibition is achieved via abdominal stretch receptors. After the blood meal is digested by trypsin and chymotrypsin and the abdominal distension is reduced, host finding remains inhibited by the developing eggs. This inhibition is the result of a complex interplay between the ovaries, fat body, neurosecretory cells, and substances contributed by the male during mating. Also, the antennal

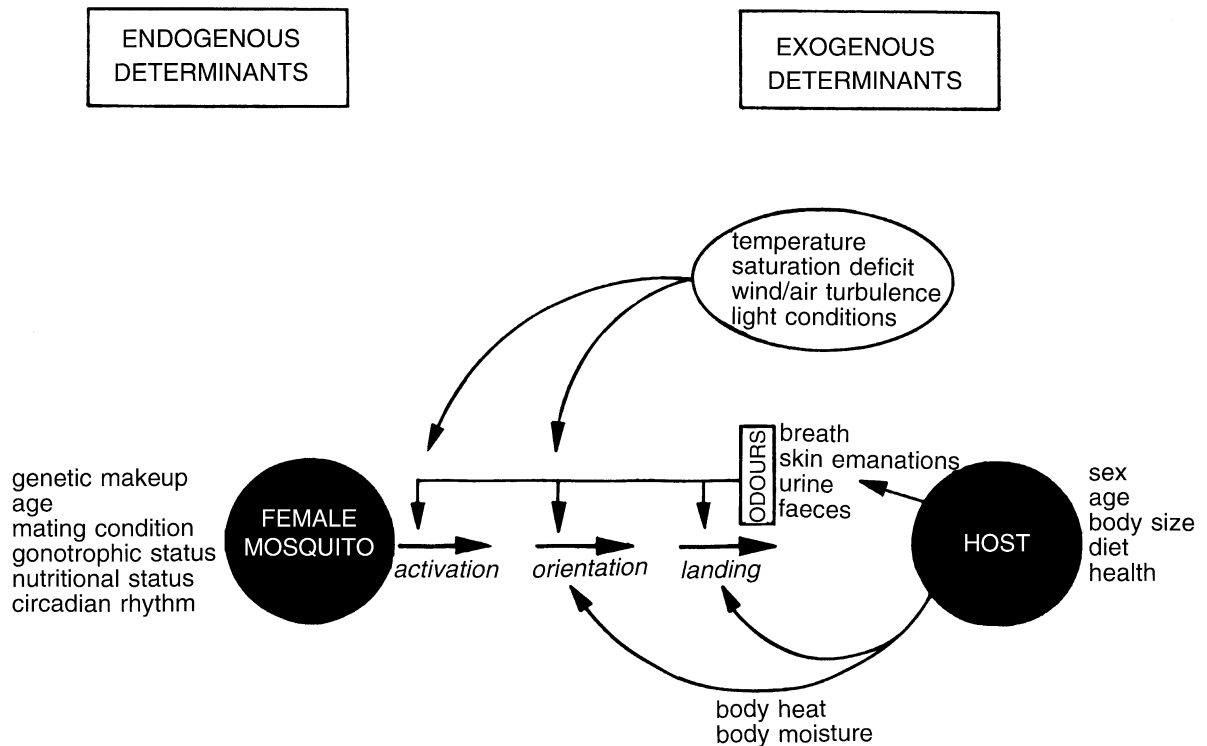

**Mosquitoes. Figure 2** Diagram of endogenous and exogenous factors affecting mosquito host location (from Takken 1996; Copyright John Wiley & Sons Limited; reproduced with permission).

chemosensory neurons which respond to host signals may be inhibited in this gravid phase. Other physiological factors such as age, nutritional state, mating condition, circadian rhythmicity, and the number of gonotrophic cycles completed can also modify host-finding behavior (Fig. 2). Therefore, it is not surprising that some of the experimental work on mosquito host finding has resulted in conflicting views.

Different mosquito species may display different host-finding behavior; they may prefer different host types and select different biting sites on the hosts. Even within the same species, large geographical variations in host preferences may occur and this different host selection is genetically determined. Mosquito host-finding can be divided into successive phases: activation, oriented flight to the host, alighting on the host, probing, imbibing, withdrawal, and takeoff. The stimulating host cues are best studied for the oriented flight.

### Oriented Flight

Mosquitoes locate their hosts by anemotaxis, they fly upwind in the plume of host emanations. Their movements are controlled by optomotor responses to the apparent movement of the ground under the insect. Opportunistic feeders with a broad host range seem to be attracted mainly by exhaled air, with carbon dioxide

as the most stimulating component, whereas species with a higher host specificity seem to respond more strongly to particular skin emanations. →Orientation over long distances (up to 70 m) is achieved by odor cues, whereas carbon dioxide attracts insects over medium distances of about 20 m (Fig. 2). At short distances of 1–2 m body heat and humidity have additional attractiveness. Carbon dioxide in pulsing concentration not only acts as a kairomone itself, it in addition may modulate the effect of other host odors. Some odors are only attractive when presented together with carbon dioxide. These stimuli seem to be integrated with the carbon dioxide stimulus (and also with the effect of humidity) at the central nervous level, and not by a modification of the electrical responses of receptors. Many chemicals have been identified which attract mosquitoes in artificial conditions or concentrations. However, little is known of the chemical nature of the real host attractants. L-lactic acid in combination with unknown skin odors attracted *Aedes aegypti*, and 1-octen-3-ol in combination with carbon dioxide certain species of zoophilic mosquitoes. The anthropophilic *Anopheles gambiae* was attracted by artificial combinations of ammonia, lactic acid, and fatty acids, but the combination of volatiles which is responsible for the attraction of human odor remains largely unknown.

### Alighting, Probing and Imbibing

Alighting of mosquitoes on the host involves (in addition to the attractants carbon dioxide and odors) visual stimuli, and above all the warm, moist convection currents rising from the body surface of the host. Some other chemicals such as amino acids also seem to have an effect. The responses to visual stimuli differ in different species of the same genus. Most species seem to prefer dark colors with low reflectivity. Probing is stimulated by thermal gradients, humidity, carbon dioxide, the mechanical quality of the surface, and chemicals such as short chain fatty acids. Ingestion of blood is evoked by platelets, and various adenine nucleotides in combination with osmotic conditions isotonic to blood have been identified as phagostimulants for certain *Aedes* and *Culex* spp. In anophelines isotonic conditions alone seem sufficient to stimulate engorgement. Complex mechanisms which are already understood in some detail ensure that the blood meal is taken into the midgut and not, as in the water-drinking or sugar-feeding modes, into the crop. Finally, termination of feeding is controlled by segmental stretch receptors in the abdomen.

### Motility

→Apicomplexa, →Locomotory Systems.

### Moulting Hormones

→Ecdysteroids.

### Moving Junction

→Apicomplexa, →Host Cell Invasion.

### Moxidectin

#### Chemical Class

Macrocyclic lactone (16-membered macrocyclic lactone, milbemycins).

### Mode of Action

Glutamate-gated chloride channel modulator. →Nematocidal Drugs, →Ectoparasiticides – Antagonists and Modulators of Chloride Channels, →Insecticides.

### Mrazekia Species

→Microsporidia.

### MSP

(1) →Merozoite surface proteins (→*Plasmodium*, →Malaria/Vaccination) and (2) major sperm protein (→Vaccination Against Nematodes). (1)–(5) Merozoite surface protein of *Plasmodium* merozoites.

### MSP 1

Merozoite surface protein, which is considered as a candidate for vaccine formation against →*Plasmodium* infections.

### MSX

Multinucleate sphere X, originally an unknown microsporidium of oysters, later named *Minchinia nelsoni* and now *Haplosporidium nelsoni*.

### MTOC

Microtubuli organizing centers, →Nuclear Division, →Gametes.

### Mucocutaneous Leishmaniasis

→Cutaneous Leishmaniasis.

## Mucopolysaccharides

The cortical outer layer of ascarid eggs contains mucopolysaccharides, which give protection in addition to the included chitin components. In adult tapeworms the outer layer (glycocalyx) contains also mucopolysaccharides as main components.

## Mucosa – Associated Lymphoid Tissue (MALT)

Type of a specialized mucosal immune system protecting the intestinal wall from penetration of agents of diseases.

## Muellerius

→Lung Worms, →Nematodes.

## Multiceps multiceps

### Name

Latin: *multum* = much, many, *caput* = head.

### Synonym

→*Taenia multiceps*.

### General Information

The adult tapeworms live worldwide in the small intestine of canids, reach a length of 20–120 cm within a prepatent period of 5–6 weeks. If ruminants or (seldom) humans ingest the typical →*Taenia*-eggs, the oncosphaera larva migrates into the brain, and forms there the →*coenurus larva* (up to 5 cm in size, Fig. 1) including many small protoscolices, which each grow into tapeworms. →Cestodes, →Coenurosis, Man.

### Therapy

Cestodocidal Drugs.

## Multicotyle purvisi

→*Aspidogastrea*.

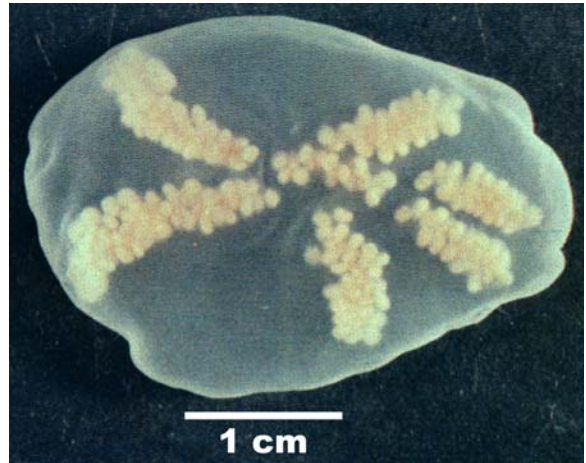

**Multiceps multiceps. Figure 1** Coenurus stage from the brain of a sheep containing several protoscolices.

## Multilocular Cyst

Cyst of →*Echinococcus multilocularis* in →intermediate host (→*Alveococcus*, →*Eucestoda*).

## Multiple Divisions

→Cell Multiplication.

## Multiple Fissions

→Gregarines.

## Multiplication

→Cell Multiplication.

## Murine Spotted Fever

Disease due to *Rickettsia typhi* bacteria transmitted by rat →fleas.

## Murine Typhus

Disease in humans due to infection with *Rickettsia typhi* transmitted by bite of →Fleas and →Lice.

## Murrina

Disease of horses due to *T. brucei evansi*: transmitted by →Vampire bats in Panama.

## Musca

Genus of flies. *Musca domestica* (Fig. 1), the so-called housefly, has a worldwide distribution and measures about 6–7 mm in length. The female lays 4–6 times, batches of 100–150 white eggs (1 × 0.26 mm) on faeces. The time for hatching of the larva depends on the temperature (mostly 24 hours after egg deposition). The 3 larvae have 13 segments (2 are fused) and are characterized by 2 spiracle tubes, each with 3 openings.

The threshold for larval development until pupation is about 8°C and it takes about 8–10 days at a temperature of 20°C, but is considerably shorter (3–4 days) at 35°C. The pupal rest to adult emergence is again



**Musca.** Figure 1 LM of an adult fly from dorsal.

temperature-dependent. While it takes 10–11 days at 20°C, only 3–4 days are needed at 35°C. Since the adults occur on faeces of several animals and humans, the housefly is an important vector of agent of diseases (e.g., all important bacteria) →Muscidosis.

## Relations of Important Flies

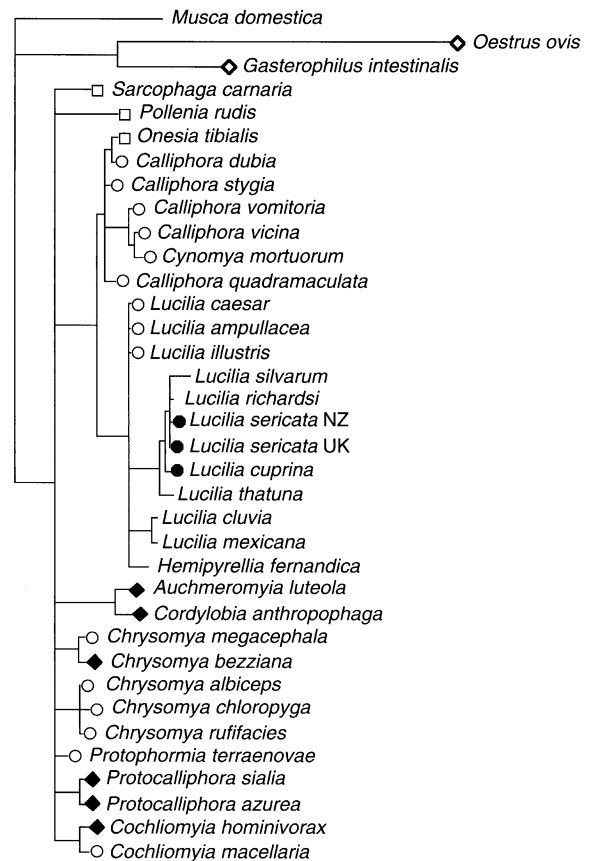

→Myiasis, General.

## Muscidae

### Name

Latin: *musca* = fly.

Family of flies. →Diptera.

## Muscidosis

Disease due to infestation with muscid flies, see Table 1.



**Muscidosis. Table 1** Muscid flies and control measurements

Parasite	Host	Vector for	Symptoms	Country	Therapy		
					Products	Application	Compounds
<i>Musca autumnalis</i> (Face fly)	Ruminants, horse, pig	<i>Corynebacterium pyogenes</i> (Summer mastitis); horse: infectious anaemia, infectious bovine keratokonjunctivitis ( <i>Moraxella bovis</i> )	Bothering	Worldwide	Rabon 3% Dust (Agri Labs)	Self Treating Dust Bags	Tetrachlorvinphos
					Vigilante Insecticide (Intervet)	Bolus	Diflubenzuron
					Bayofly Pour-on (Bayer)	Pour on	Cyfluthrin
					Neporex (Novartis)	Spray	Cyromazine
<i>Musca domestica</i> (House fly)	Ruminants, horse	Horse: Infectious anaemia and <i>Habronema muscae</i> and <i>Draschia megastoma</i>	Bothering	Worldwide			
<i>Stomoxys calcitrans</i> (Stable fly)	Ruminants, horse, pig	Horse: Infectious anaemia and <i>Habronema majus</i>	Blood loss, irritation	Worldwide			
<i>Haematobia irritans</i> (Horn fly)	Ruminants, horse	Infectious anaemia (Horse), <i>Stenofilaria stilesi</i> (Cattle)	Blood loss, irritation	Worldwide	Rabon 3% Dust (Agri Labs)	Self Treating Dust Bags	Tetrachlorvinphos
					Co-Ral 25% Wetable Powder (Bayer)	Dip or Spray	Coumaphos
					Commando Insecticide Cattle Ear Tag (Fermenta)	Ear tag	Ethion
					Vigilante Insecticide (Intervet)	Bolus	Diflubenzuron
					Moorman's IGR Cattle Concentrate	Feed additive	Methoprene
					Bayofly Pour-on (Bayer)	Pour on	Cyfluthrin
					Topline (Merial)	Pour on	Fipronil
					Electro (Elanco)	Pour on	Spinosad
<i>Haematobia irritans exigua</i> (Buffalo fly)	Ruminants, horse		Blood loss, irritation	Northern Australia, New Guinea, Asia			
<i>Haematobia stimulans</i> (Big Meadow fly)	Ruminants, horse	Horse: Infectious anaemia	Blood loss, irritation	Europe, Asia, North America	Bayofly™ Pour-on (Bayer)	Pour on	Cyfluthrin
<i>Hydrotaea</i>	Ruminants,	<i>Corynebacterium</i>	Blood loss,	Northern	Bayofly	Pour on	Cyfluthrin

**Muscidosis. Table 1** Muscid flies and control measurements (Continued)

Parasite	Host	Vector for	Symptoms	Country	Therapy		
					Products	Application	Compounds
<i>irritans</i> (Head or Plantation fly)	horse	<i>pyogenes</i> (Summer mastitis); horse: infectious anaemia	irritation	Europe (Denmark, Great Britain)	Pour-on (Bayer)		
<i>Hydrotaea albipuncta</i>	Horse	Horse: infectious anaemia	Blood loss, irritation				
<i>Glossina</i> spp. (Tsetse fly)	Animals, man	<i>Trypanosoma</i> spp., “Sleeping sickness”; Nagana ( <i>T. vivax vivax</i> und <i>T. congolense congolense</i> ) in cattle	Blood loss, irritation	Africa			

## Muscina stabulans

This species of muscid flies is also called “false stable fly”, but is no bloodsucker like →*Stomoxys*. The legs are partly red-gold cinammon, while those of a related species (*M. assililis* = *M. levida*) are black. The larvae of *M. stabulans* prey on other fly larvae.

## Mutualism

→Parasitism vs. Mutualism.

## Mycetomes

Organs of the →lice containing symbiotic organisms which were transmitted to the next generation by including them into the eggs.

## Myiasis, Animals

Disease due to skin infestation with fly larvae, see Table 1 (page 856).

## Related Entries

→Dermatobia, →Insects, →Skin Diseases, Animals.

## Myiasis, General

In general different types of myiasis are induced by fly larvae: ocular, dermal, subdermal, nasopharyngeal, intestinal, and urogenital forms (see list below). The fly species do it obligatorily or facultatively. While the obligate-producing species can complete their life cycle only by parasitizing live hosts, facultative species develop as well on dead organic material as on live hosts. The facultative way of myiasis is described as **primary myiasis**, the obligate as **secondary myiasis**. →Myiasis, Man, →Myiasis, Animals.

Fly species that may induce myiasis in humans and animals with their phylogenetic relations by parsimony analysis of 28SrRNA according to JR Stevens are shown on page 853:

1. black diamonds characterize obligate parasites of vertebrates (Calliphoridae),
2. white diamonds: obligate endoparasites of vertebrates (Oestridae),
3. black circles: facultative primary myiasis species,
4. white circles: facultative secondary myiasis species,
5. white squares: obligate parasites of invertebrates, e.g., earthworms (Calliphoridae, Sarcophagidae).

**Myiasis, Animals. Table 1** Flies causing myiasis in animals

Parasite	Host	Symptoms	Country	Therapy		
				Products	Application	Compounds
<i>Lucilia sericata</i> (Blowfly)	Sheep (Pig)	Blowfly-strike; eggs in wounds, larvae move around, destroy skin; skin inflammation, strong secretion, bact. sec. inf.; large economic loss	Great sheep reproduction countries: Great Britain, Australia, New Zealand, South Africa	Clik (Novartis) Zapp (Bayer)	Spray on Pour on	Dicyclanil Triflumuron
<i>Lucilia cuprina</i> (Blowfly)	Sheep (Pig)		Australia, South Africa	(Mechanical remove, wound disinfection)		
<i>Chrysomya chloropyga</i>	Sheep		South Africa			
<i>Chrysomya bezziana</i> (Old World screw-worm, Oriental fly, or Bezzi's blowfly)	Cattle Sheep	Screwworm disease; blowfly-strike; eggs in wounds, larvae move around, destroy skin; skin inflammation, strong secretion, bact. sec. inf.; big economic loss	Tropic and subtropic areas; screwworm disease (in Africa and Southeast Asia)			
<i>Sarcophaga</i> spp. (Flesh flies)	Ruminants	Blowfly-strike; eggs in wounds, larvae move around, destroy skin; skin inflammation, strong secretion, bact. sec. inf.; big economic loss	Temperate areas			
<i>Wohlfahrtia</i> spp. (Flesh flies)	Cattle		Africa, Asia			

## Myiasis linearis

Human myiasis due to skin penetration of →*Gasterophilus* larvae.

## Myiasis, Man

Myiasis is an infection with various fly larvae (→*Diptera*). Some of these are of species with an obligatory life cycle stage in man or animals (e.g., →warble fly →*Hypoderma*; →human botfly →*Dermatobia hominis*). The eggs are deposited either into open wounds, the nose, the ear, scalp, or on normal skin. The larvae burrow into the skin and become surrounded by a microabscess 2–3 cm in diameter with acute and chronic inflammatory cells, including eosinophils and granulation tissue surrounded by fibrosis. The mature

larvae escape from the →abscess to pupate in the soil, with the lesion healing slowly. A second type of myiasis is produced by opportunistic fly species giving rise to similar, but less persistent lesions. Aseptically reared fly maggots used to be employed to clean necrotic debris in chronic osteomyelitis during the preantibiotic era (e.g., *Lucilia serricata*). Microscopically the fly larvae can be distinguished by the presence of segmentation, a striated musculature, a tracheal system composed of rings, leading to 2 species-specific posterior →stigmata.

The specimens of 80 species of fly larvae are able to enter the body of living and dead humans. According to the place of parasitism the following types of myiasis are differentiated:

- **Intestinal myiasis:** 15 families of →*Diptera* have been found in human intestine apparently on passage, however some parasitize in the region of the rectum.
- **Urogenital myiasis:** larvae of the fly families →*Muscidae*, *Sarcophagidae*, and *Calliphoridae* as well as →mosquitoes of the families *Anisopodidae* and *Scenobinidae* are found here.

- **Nasal-pharyngeal myiasis:** 8 families of flies are described which are able to enter the eyes, too (e.g., →*Oestrus ovis* into the nose and within the eye).
- **Dermal and subdermal myiasis:** This type is most common, since the eggs or larvae are placed onto wounds or may even enter healthy skin regions. Some larvae (e.g., Hypodermatidae) are able to wander around (→*Creeping Eruptions*).
  - **Africa:** →*Cordylobia anthropophaga* (= Tumbu fly); eggs are laid on sand.
  - *Auchmeromyia luteola*; larvae suck at night on humans (Congo floor maggot).
  - **America:** →*Cochliomyia* (syn. *Callitroga hominivorax*) (Screwworm); eggs are laid in wounds, →*Wohlfartia* species attack wounds and healthy skin.
  - →*Dermatobia hominis*; eggs are placed on blood-sucking insects which transmit them.

These larvae introduce furuncle-like skin swellings which mostly are superinfected by bacteria.

### Therapy

Surgical withdrawal of the larvae and antiseptic treatment of the regions. *Lucilia serricata* larvae are used for wound cleaning, since they feed exclusively on necrotic tissues and do not touch healthy ones.

## Myobia

### Name

Greek: *mys* = mouse.

Genus of mites, e.g., the species *M. musculi* is found in the hair of mice and laboratory rats.

## Myocarditis

Clinical symptoms in case of infection with, e.g., →*Entamoeba histolytica*, *Trypanosoma cruzi*, →*Toxoplasma gondii*, *Echinococcus granulosus* or →*Dirofilaria immitis*. →*Cardiovascular System Diseases, Animals*.

## Myocoptes

→*Mites*.

## Myosin

Globular protein forming filaments, motility in →*Apicomplexa*, muscles of →*Platyhelminthes*, →*Nematodes*, →*Acanthocephala*, →*Pentastomida*, →*Arthropoda*.

## Myxidium

→*Myxozoa*.

## Myxobolus cerebralis

New name for →*Myxosoma cerebralis*.

## Myxobolus Species

→*Myxozoa*.

## Myxomatosis Virus

→*Fleas*.

## Myxosoma cerebralis

### Name

Greek: *myxa* = slime, *soma* = body.

### Synonym

→*Myxobolus cerebralis*.

### Classification

Species of →*Myxozoa*.

### Life Cycle

Figs. 1–3.

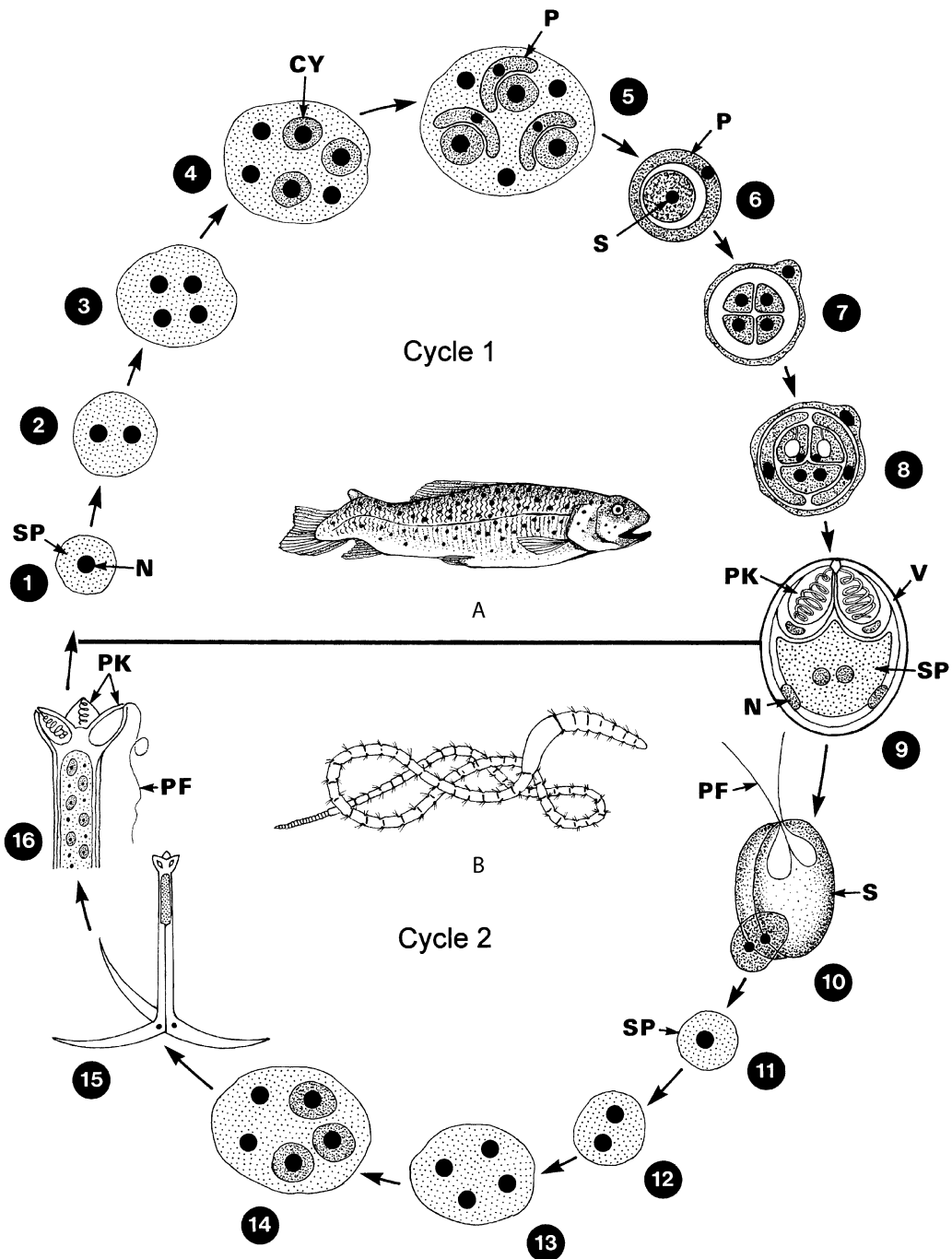

**Myxosoma cerebrialis.** Figure 1 Life cycle of *Myxobolus (Myxosoma) cerebrialis*. 1–3 The tricapsulate spore of the *Triactinomyxon ignotum* stage contains several uninucleate sporoplasms (amoebic stage). If these stages are eaten by trouts with their hosts (a tubificid worm, e.g., *Limnodrilus*), they give rise to multinucleate *trophozoites* within the cartilage (3). 4 Occurrence of uninuclear cytomeres (CY) within the trophozoites. 5, 6 One cell (*pericytic cell*, P) surrounds the other (*sporogonic cell*, SP). 7, 8 The sporogonic cell divides and gives rise to 2 valvogenic cells, 2 capsulogenic cells and 1, 2-nucleate *sporoplasm*. 9 Fully differentiated multicellular *spore (Myxobolus stage)* which becomes free after death of fish. 10 If a tubificid worm eats such *Spores*, the 2 valves open in its intestine and the sporoplasm (SP) creeps into the body cavity of the worm. 11–16 Formation of the *Triactinomyxon* stage inside the worm which is infective for fish. CY, *cytomere*; N, nucleus; P, *pericytic cell*; PF, *polar filament*; PK, *polar capsule*; S, *sporogonic cell*; SP, *sporoplasm*; V, valves of spore.

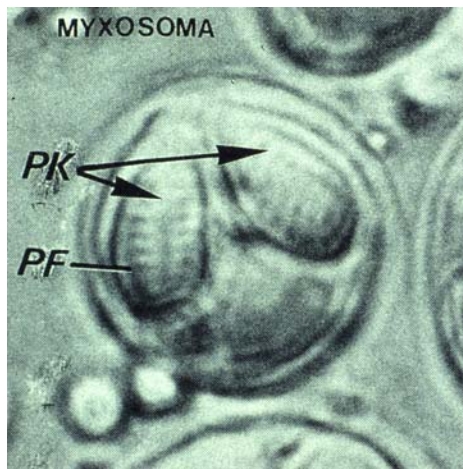

**Myxosoma cerebrialis.** Figures 2, 3 LM and diagrammatic representation of the spore of *Myxosoma cerebrialis*. Note the presence of 2 polar capsules (PK) containing each a polar filament (PF); the sporoplasm has two nuclei.

## Myxosporidiacidal Drugs

The efficacy of **fumagillin** against different species of fish-parasitizing myxosporidians (i.e., *Sphaerospora oenieola*, *Myxidium giardi*, and *Hoferellus carassii*) has been known for a number of years. The deleterious effects of **toltrazuril** (a symmetric triazine) and of an asymmetric triazine (HOE 092V) on developmental stages of gill parasitic *Myxobolus* sp., *Henneguya* sp., and *H. laterocapsulata* have been clearly demonstrated in ultrastructural investigations.

In laboratory trials, **quinine** was found to act on *Myxobolus cerebrialis* in rainbow trouts (*Oncorhynchus mykiss*) and in addition, against a gill parasitic *Henneguya* sp. in the tapir fish, *Gnathonemus petersii*. Actually, there is no information on the specific *mode of action* of the actinomyxosporean chemotherapeutics mentioned above.

## Myxozoa

### Classification

For many years the Myxozoa were considered a peculiar phylum of the Protozoa (*→Classification*). This was due to their small size of only a few  $\mu\text{m}$ , which hid the fact that the spore is composed of several nucleated cells (*→Myxosoma cerebrialis/Figs. 2, 3*). Thus e.g., each of the polar capsules represents a cell. These findings and other peculiarities led to the interpretation that the Myxozoa are true metazoans, which became dedifferentiated due to parasitism. It was suggested that they

were former cnidarians (e.g., polypes/phylum Coelenterata/Anthoza).

### General Information

Myxozoa are mainly parasites of invertebrates and poikilothermic vertebrates (*Table 1*); they are characterized by multicellular *→spores*, the walls of which consist of 1, 2, or (rarely) 3–6 valves (*→Myxosoma cerebrialis/Fig. 1*) and which are occasionally provided with long protuberances. The spores are developed within multinucleate plasmodia (*→Pansporoblasts*) and are characterized by the presence of 1–6 polar capsules, each of which contains a coiled solid *→polar filament*. By means of the latter the spores are attached to the intestinal wall when ingested by the host. The *→sporoplasm* leaves the spore and enters the intestinal wall and may be distributed to many organs (see *Table 1*) where asexual reproduction is initiated. The myxozoans are diagnosed and classified according to the arrangement of spore valves and the location of their polar capsules:

### System

- Phylum: Myxozoa
  - Class: Myxosporea
    - Order: Bivalvulida (with 2 valves)
      - Suborder: Bipolarina (polar capsules at opposite ends of spore)
        - Genus: *→Myxidium*
        - Genus: *Myxoproteus*
        - Genus: *Sphaeromyxa*
      - Suborder: Eurysporina = Unipolariina (2–4 polar capsules at one pole perpendicular to sutural plane)

**Myxozoa. Table 1** Some common species of the Myxozoa

Species	Hosts	Habitat	Size of spore ( $\mu\text{m}$ )
<i>Myxosoma (Myxobolus) cerebralis</i>	Salmonid fish	Cartilaginous parts	10 × 8
<i>Myxidium oviforme</i>	Salmonid fish	Gallbladder	11 × 7
<i>M. lieberkühni</i>	Pike fish	Urinary bladder	19 × 6
<i>M. serotinum</i>	Frogs, toads	Gallbladder	17 × 9
<i>Ceratomyxa blennius</i>	Butterfly fish	Gallbladder	26 × 10
<i>C. shasta</i>	Salmonids	Intestine + many organs	16 × 7.5
<i>Leptotheca parva</i>	Mackerel fish	Gallbladder	9 × 3
<i>Myxobolus notemigoni</i>	Golden shiner fish	Various inner organs	12 × 9
<i>M. pfeifferi</i>	Barbel	Skin	12 × 8
<i>Sphaerospora divergens</i>	Many fish species	Urinary bladder	10 × 10
<i>Thelohanellus notatus</i>	Minnnow fish	Subdermal tissues	20 × 9
<i>Henneguya exilis</i>	Catfish	Skin	70 × 3 (with spines of valves)
<i>Chloromyxum trijugum</i>	Crappies	Gallbladder	5 × 5
<i>Kudoa histolyticum</i>	Mackerel	Muscles, gut, kidney	13 × 8

- Genus: *Ceratomyxa*
- Genus: *Leptotheca*
- Genus: → *Sphaerospora*
- Suborder: Platysporina (spores with 2 polar capsules at one pole in sutural plane)
  - Genus: *Myxosoma*
  - Genus: *Myxobolus*
  - Genus: *Thelohanellus*
  - Genus: *Henneguya*
- Order: Multivalvulida (spore with 3 or more valves)
  - Genus: *Trilospora*
  - Genus: *Kudoa*
  - Genus: *Hexacapsula*
- Class: Actinosporea
  - Order: Actinomyxida
    - Genus: *Triactinomyxon*

### Important Species

Table 1.

---

## Myzostomida

→ *Annelida*; parasites of Crinoidea (Echinodermata).

## N-acetylglucosamine

→Chitin.

## Naegleria spp.

→Amoebae/Fig. 1, →Opportunistic Agents.

## Naegleria fowleri

The trophozoites of *Naegleria fowleri* (→*Naegleriasis*/Fig. 1) are characterized by blunt pseudopodia called lobopodia. They reach a size of 15–30  $\mu\text{m}$  and live in general as other members of the *Limax*-group in fresh water. These amoebae engulf their food by so-called amoebostomes. They are able to form 2 flagella (→*Ameba*/Fig. 1). The cysts of *N. fowleri* are spherical, often clump closely together, and reach diameters of 7–15  $\mu\text{m}$ . *Naegleria* is able to become an opportunistic agent of disease: →*PAME*, →*Naegleriasis*.

## Naegleria gruberi

→Amoebae, →Flagella.

## Naegleriasis

*Naegleria fowleri*, a free-living amoeba is found in lakes, especially warm ones, and in swimming pools (→*Amoebae*). It infects healthy young people. In a small percentage of those exposed, it invades the nasopharynx and reaches the brain where it gives rise

to acute →*meningoencephalitis* with →*trophozoites* but without cysts. Because of the fast multiplication of the amoebae, clinical infection usually leads to death in a few days. Large numbers of amoebae are present in the subarachnoid space, penetrating into the underlying cortex, but there is little (neutrophilic or monocytic) or no →*inflammatory reaction* (→*Pathology*/Fig. 4). Mobile amoebae are often found in the cerebrospinal fluid. Uncal herniation is the usual cause of death. A thick “exudate,” mostly amoebae, covers the brain and spinal cord and is most apparent over the sulci, major fissures, and basal cisterns.

**Main clinical symptoms:** Meningoencephalitis (= primary amoebic meningoencephalitis = →*PAME*), often leading to death within days.

**Incubation period:** 1–3 days.

**Prepatent period:** 12–14 days.

**Patent period:** 3 weeks (if infection is survived).

**Diagnosis:** Culture techniques, immunohistological methods (Fig. 1).

**Prophylaxis:** Avoid bathing in eutrophic lakes.

**Therapy:** →*Treatment of Opportunistic Agents*.

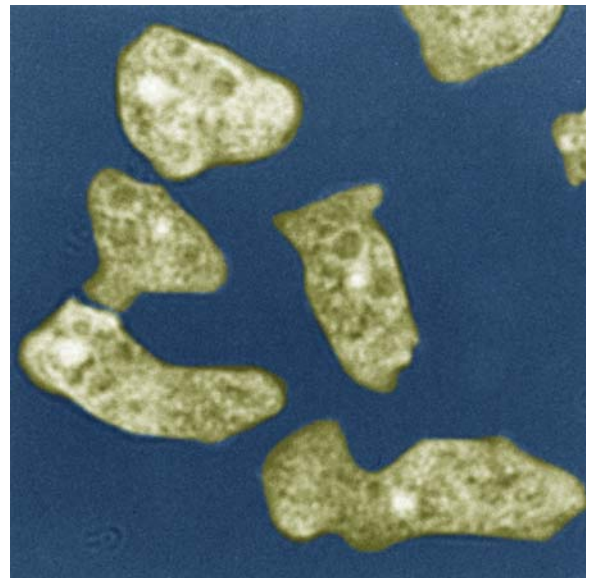

**Naegleriasis. Figure 1** LM of cultured *Naegleria* amoebae with their loboid pseudopods.



## Naftalos

→Ectoparasitocidal Drugs.

## Nagana

### Synonym

→African Trypanosomiasis, →Sleeping Sickness of Animals.

### General Information

Nagana is a very important disease of domestic livestock. According to the Food and Agriculture Organization of the United Nations (FAO), it is probably the only disease which has profoundly affected the settlement and economic development of a major part of a continent. Today, it is still endemic in more than 35 African countries and causes huge economic losses (→*Trypanosoma*).

### Ruminants

In cattle the pathogenesis is dominated by 3 features: anemia, tissue lesions, and immunosuppression. The cause of anemia is complex and involves a variety of mechanisms. Although hemolysins are released by trypanosomes, intravascular haemolysis is not a prominent feature, and anemia is rather attributed to erythrophagocytosis by cells of the mononuclear phagocytic system in the spleen, bone marrow, lungs, and lymph nodes. These cells are stimulated by the formation of complexes between immunoglobulin specific for trypanosomes and antigen or complements attached to red cells. Other possible contributing factors include increased hemodilution and fragility of the red cells, and a depression of erythropoiesis. Although *T. congolense* and *T. vivax* are mainly intravascular parasites they cause significant tissue lesions, notably myocarditis and myositis. The aetiology of these lesions is unknown but is probably related to the damage induced by parasite products, immune complexes, and vasoactive amines to capillary endothelial cells. Finally, chronically infected animals show immunosuppression which, in association with other factors of stress such as malnutrition, pregnancy, or lactation, leads to a higher susceptibility to other diseases. African trypanosomiasis may follow an acute course, mainly in exotic breeds of cattle which tend to be more susceptible than local

breeds. Animals suffer from intermittent fever, quickly lose weight, and may die within 3–4 weeks. However, the disease more frequently follows a relatively chronic course characterized by intermittent fever, anemia, lymphadenopathy, and progressive emaciation. Animals which have been infected for many months or even years become cachectic, their precrucial and prescapular lymph nodes being visible from a distance. African trypanosomiasis is usually a herd problem. It reduces the general herd productivity and affects fertility.

*T. brucei* has more affinity for tissues than for blood, and may cause severe lesions in the tissues it invades. The myocardium is more commonly affected, with degenerative changes and focal →necrosis of myocytes, and fibrosis. Lesions due to long-standing infection have also been observed in the pituitary, adrenals, kidneys, and gonads. *T. brucei* is generally considered as being of little clinical importance in cattle, but may be responsible for acute and →chronic infections in goats and sheep. Mixed trypanosome infections are very common in endemic areas.

### Horses

Horses are very susceptible to trypanosomiasis. *T. brucei* is certainly the most pathogenic, while *T. congolense* and *T. vivax* produce diseases similar to those seen in cattle. The earliest signs of infection are a stumbling gait, a harsh hair coat, and →relapsing fever. As the disease progresses, subcutaneous →edema of the limbs, thorax, abdomen, and genitalia appears. Anemia is a constant feature and →lymphadenitis is usually present. Keratitis and corneal opacity may develop in horses affected by *T. brucei*.

### Pigs

Pigs are refractory to infection with *T. vivax*, and are only mildly affected by *T. congolense*, *T. brucei*, and *T. suis*. In contrast, they are highly susceptible to infection with *T. simiae*. The latter is highly virulent and may cause death in a few days.

### Dogs

African dog breeds are very resistant to most species of trypanosomes. Only *T. brucei* appears to be highly pathogenic and often produces acute disease. Clinical signs include anemia, weakness, loss of weight, and development of subcutaneous edema. Parasitic invasion of the eyes causes inflammatory reactions with pain and lacrimation. Invasion of the central nervous system with ataxia and paralysis has been reported.

### Therapy

→Trypanocidal Drugs, Animals, →Leishmaniacidal Drugs.

## Nairobi Sheep Disease

The Nairobi sheep disease (NSD) virus is transmitted by the tick species *Rhipicephalus appendiculatus* and causes severe losses in sheep in East Africa. The causative virus is passed transovarially by the female tick to the larvae, where it can survive for over 3 months.

## Naled

### Chemical Class

Organophosphorous compounds (organophosphate).

### Mode of Action

Acetylcholine esterase inhibitor. → [Ectoparasiticides – Agonists and Antagonists of Cholinergic Transmission.](#)

## Nannomonas

Subgenus of the genus → [Trypanosoma](#) with the species *T. congolense* and *T. simiae*.

## Nanophyetus

Genus of digentic trematode family Nanophyetidae. *Nanophyetus salmincola* (0.8 × 2.5 – 0.3–0.6 mm) occurs in northern USA and northern Russia in the small intestine of carnivores (dogs, cats, foxes, coyotes, etc.) and even occasionally in humans. Intermediate hosts are at first, river snails and then freshwater fish (e.g., salmon). These tiny worms (Fig. 1) are the vector of the so-called → [salmon-poisoning disease](#) due to infections with *Neorickettsia helminthoeca*, which induces in canids a severe (often lethal) haemorrhagic enteritis. This *Rickettsia* species is not pathogenic to humans. Furthermore, another *Rickettsia* may be transmitted: the less pathogenic so-called Elokomin agent.

### Therapy

→ [Trematocidal Drugs](#), → [Digenea](#).



**Nanophyetus.** Figure 1 LM of a colored adult fluke.

## Nanophyetus salmincola

→ [Digenea](#).

## Narasin

→ [Coccidiocidal Drugs](#).

## Nariz de Anta

Common Spanish name; English = tapir nose, for a stage of → [cutaneous leishmaniasis](#).

## Nasicola klawei

Capsaline monogenean worm of the noses of the yellowfin tuna (*Thunnus albacares*).

## Natural Resistance

Some diseases or even variations of the normal physiologic status of some people may have benefits during some parasitic infections, since these persons may become naturally resistant. For example, *Plasmodium vivax* and *P. knowlesi* merozoites are unable to enter red blood cells lacking the →Duffy blood group antigens or →*P. falciparum* may not develop in red blood cells of persons suffering from →sickle cell anaemia, from alpha- or beta-thalassaemias, or from G6PD deficiency. Thus these negative haemoglobin variations have apparently been maintained in endemic →malaria regions due to the selection pressure of the parasitic disease.

## Nauplius

Larva of primitive crustaceans, characterized by 1 eye and 3 pairs of extremities (→*Lepeophtheirus salmonis*).

## Nearctic

Most northern fauna region in North America.

## Necator americanus

From Latin: *necator* = killer, describes the New World →hookworm of humans (but is also found in Africa). Characteristic are the 2 teeth-blades (Fig. 1). The worm reaches a size of about 10 × 0.3 mm as female and 7 × 0.3 mm as male, which is attached to the female (constantly in copula) by means of its posterior bursa



*Necator americanus*. **Figure 1** SEM of the anterior end of an adult worm.

copulatrix. Each female produces up to 10,000 eggs per day, while drinking up to 0.02 ml blood. Chronic hookworm disease causes anaemia and malnutrition.

### Diagnosis

By microscopical analysis of the faeces for eggs (→*Ancylostoma*).

### Therapy

→Nematocidal Drugs.

---

## Necatoriasis

→Hookworms.

---

## Neck

→Eucestoda.

---

## Necrosis

→Pathology.

---

## Neem

Common name for the Indian plant (tree) *Azadirachta indica*, extracts of which are used as insecticides (among other targets). Neem trees are now present in many regions of the tropics and subtropics.

---

## Nematocidal Drugs, Animals

### Chemical Classes of Compounds

#### Phenothiazine and Piperazines

Phenothiazine was the first “broad-spectrum” anthelmintic agent brought into general use at the end of the 1930s. Structure-activity studies created no useful

analogues. In the following years it was extensively used in livestock against a fairly wide range of gastrointestinal →nematodes. However, toxicity limits its use to ruminants, horses, and chickens and prevented its use in pigs, dogs, cats, and humans.

For 50 years (discovery of its anthelmintic action in 1949), **piperazine (PPZ)** chemically, diethylenediamine) has been in use as an inexpensive and popular anthelmintic in particular for the treatment of →*Ascaris* and *Enterobius* (→*Oxyuris*) infections in humans (→Nematocidal Drugs, Man/Table 1) and animals (Tables 3–5). Numerous substituted PPZ derivatives have been synthesized and exhibit anthelmintic activity, but apart from diethylcarbamazine none has found a place in animal and human therapeutics. The instability of the PPZ base in the presence of moisture (PPZ hexahydrate: very unstable) is absent in other salts (PPZ adipate, chloride, dihydrochloride, citrate, phosphate, and sulfate, all soluble in water). The amount of PPZ base and that of salt moiety differs among the compounds, and hence, doses of compounds to be effective on a same level too. In veterinary practice, the anthelmintic spectrum of PPZ is good for ascarid and nodular worm infections of all species of domestic animals, moderate for →pinworm, and variable to zero for other helminths. PPZ compounds has a wide safety index in all animals.

**Diethylcarbamazine (DEC)**, chemical: N, N-diethyl-4-methyl-1-piperazinecarboxamide, has a high action on microfilariae of →*Wuchereria bancrofti*, →*Brugia* spp. (→lymphatic filariasis of humans), and microfilariae causing onchocerciasis in humans (→Nematocidal Drugs, Man/Table 1) as well as against microfilariae of →*Dirofilaria immitis* producing →heartworm disease in dogs (Table 5). DEC had been used also for treatment of lungworm infections caused by →*Dictyocaulus viviparus* in cattle (Tables 1 and 6).

DEC produces alterations in the microfilarial surface membranes, thereby rendering them more susceptible to damage by host immune mechanisms. Massive destruction of the parasites can result directly or indirectly in severe adverse reactions if dose regimen scheme is inadequate. DEC is very useful as a prophylactic treatment for heartworm disease of dogs (Table 5). It acts not only on infective larvae from the vector mosquito but also against microfilariae residing in the blood of host. This is also true for the prophylactic action of DEC to control →lymphatic filariasis in humans; severe adverse reaction being effectively reduced by a standard treatment scheme (cf. →Nematocidal Drugs, Man/Table 1). However, in dogs that are microfilariae-positive at the time of drug administration shock type reaction may occur infrequently and erratically (sometimes fatal). Therefore, use of DEC is contraindicated in microfilariae-positive dogs.

The predominant effect of PPZ on *Ascaris* is to produce a flaccid paralysis, which results in expulsion of the worm by peristalsis. As in other cholinergic compounds the anthelmintic action of PPZ and DEC may depend upon activation of a GABA-gated Cl<sup>-</sup> channel on muscle membrane and/or upon nonspecific blockage of ACh receptors.

### Benzimidazole Compounds

Subsequent modification to the benzimidazole (BZ) molecular structure in the 1960s and 1970s created improved compounds that were safe and had a wide spectrum of activity (Tables 1, 3–6 and →Nematocidal Drugs, Man/Table 1). After the discovery of **thiabendazole** in 1961 (still used in animals and humans), several thousand of BZs for screening for anthelmintic activity have been synthesized by pharmaceutical companies (work is documented in patent literature only) but less than twenty of them have been used commercially (Tables 3–6 and →Nematocidal Drugs, Man/Table 1). BZ compounds in general, and **BZ carbamates** in particular, are crystalline materials with relatively high melting points and are almost insoluble in water. BZ prodrugs include several compounds (e.g., netobimin, febantel, thiophanate: latter no longer used as anthelmintic) that possess little or no anthelmintic activity by themselves, but are designed to undergo either relatively simple (benomyl →**carbendazim**) or a complex series (netobimin →**albendazole**) of enzymatic and/or non-enzymatic reactions in the organism to form the active drug. Prodrugs increase the water solubility and therefore the absorption, which renders them suitable for use against systemic infections. In contrast to prodrugs, BZs are more frequently used for intestinal and gastrointestinal nematodes and particularly in veterinary practice because of their broad anthelmintic spectrum and low toxicity. In human practice, only 3 BZ compounds, albendazole, flubendazole and mebendazole, are currently in use (cf. →Nematocidal Drugs, Man/Table 1 and human →**hydatid disease**: →**Cestodocidal Drugs**). The low aqueous solubility of BZs requires their formulations as oral suspensions or other oral formulations that deposit the drug directly and wholly within the intestinal tract of humans, or within the rumen of cattle, sheep, goats, or other ruminants. In the latter animals, the residence time of the drug-digesta complex is shortened if the dose should bypass the rumen due to esophageal groove closure and a proportion of the dose being directed to the abomasum. This physiological phenomenon contributes to treatment failure. Thus drug must be entirely administered over the tongue to reduce esophageal-groove effects and maximize the reservoir action of the drug in the rumen. Time is a crucial element of BZ action and is dependent on the kinetics of the →**tubulin** BZ interaction and parasite expulsion. If the mechanism(s) of removal of the parasite by the

host requires a longer period than the residence time of the anthelmintic drug, then selection for drug-resistant nematodes may emerge. Two major enzyme systems of the liver, the cytochrome P 450 family and the microsomal flavin monooxygenases are primarily responsible for the biotransformation of BZs. These processes transform the lipophilic xenobiotic compounds into more polar hydrophilic products that can be easily eliminated. The →**mode of action** of BZs can be directly linked to various interactions of BZs with tubulin. The various aspects of the drug–parasite interaction include structure-activity relationships, species selectivity, drug resistance on a basis of chemical/pharmacological studies and studies on a genetic basis. Benzimidazoles not considered, include **cyclobendazole**, **dribendazole**, **epibendazole**, **parbendazole** and **luxabendazole**. Co-administration of bromsalans (active against *Fasciola* infections) within 7 days of BZs treatment can cause severe (fatal) adverse effects in cattle.

### Levamisole, Pyrantel, Morantel

Levamisole (**LEV**), an imidazothiazole, is the **S (-) isomer** of **tetramisole**; the latter drug was introduced as an anthelmintic in 1966. Following marketing of racemic tetramisole, it was found that antinematodal action of the racemate based almost solely on the **S (-) isomer**; as a result of the separation of the enantiomers, the dose could be halved for the **S (-) isomer**. Levamisole is a highly accepted and widely used antinematodal drug in veterinary practice (Tables 1, 3–6). It is also a good drug for the treatment and control of *Ascaris* infections in humans. LEV has besides its antinematodal effect, **immunomodulatory actions**, which have been demonstrated in animals and humans (e.g., cancer patients). It has been shown to enhance immune responsiveness by stimulating the activity of T-lymphocytes and “correcting” immunological imbalance. Thus the drug may potentiate the rate of T-lymphocyte differentiation, and hence, the promotion and maturation of precursor →**T-cells** into fully functional lymphocytes, which increase the response to antigens and mitogens. The drug induces spastic contraction of worms and then paralysis of nematodes. Several nematode ion channels regulated by →**neurotransmitters** are targets for anthelmintics. A nicotinic acetylcholine receptor (= ACh = primary excitatory transmitter in nematodes) on nematode muscle cells is associated with a cation channel sensitive to LEV.

Like LEV, the related tetrahydropyrimidines **pyrantel** (**PYR**) and **morantel** (**MOR**) are cholinergic agonists with a selective pharmacology for nematode receptors. **PYR** (salts: tartrate (is obsolete) and pamoate = embonate) was introduced as a broad-spectrum anthelmintic in 1966 for use in sheep and has subsequently come to be used in cattle, swine, horse,

**Nematocidal Drugs, Animals. Table 1** Drugs used against gastrointestinal (GI) nematode infections in ruminants

CHEMICAL GROUP nonproprietary name of active substance (single oral dose, mg/kg body weight = b.w.), other information	*DRUG PRODUCT dose form (formulation), withdrawal time (WT) days (d) before slaughter, manufacturer, supplier, other information	CHARACTERISTICS miscellaneous comments on pharmacokinetics, metabolism, mode of action, toxicity, and limitations
<b>BROAD-SPECTRUM ANTHELMINTICS</b>		
<p><i>life cycle</i> of nematodes is direct; eggs hatching with adequate warmth and moisture can accumulate in dry weather leading to heavy infections after rain; young larvae feed on bacteria in the feces, molting to give infective third-stage larvae; infective larvae can survive for many months on pasture; ingested larvae normally develop into adults in about 3 weeks while larvae, which were inhibited in autumn, resume development in spring or at time of parturition; a number of measures have been recommended to delay the development of resistance to broad-spectrum anthelmintics in major gastrointestinal (GI) nematodes particularly in small ruminants; the sparing use of appropriate drugs and doses (avoidance of underdosing) will help to kill parasites thus preventing the escape of resistance survivors; the use of integrated control systems coordinating anthelmintic treatment with appropriate management strategies appears to be suitable measures to reduce parasite numbers on pasture and the frequency of the strategic treatment; in some programs, in which sheep and cattle graze in rotation, have been shown to provide more effective parasite control than a continuous grazing program for sheep; these programs all may effectively reduce the need for anthelmintic treatment; the timing of treatment and weather conditions would also play an important role in the integrated control; during dry and hot periods there may be high mortality of free-living infective stages, whereas rainfall in the spring or autumn favors the survival and transmission of free-living larvae; thus, a good knowledge of the parasite's epizootiology and the use of efficient anthelmintics will effectively prevent the development of multiple resistant GI nematodes especially in sheep and goats</p>		
<b>BENZIMIDAZOLES (BZs)</b>		
<p>exhibit high activity against drug-sensitive GI nematodes of importance; their efficacy against ruminant whipworms, filarial worms (<i>Onchocera</i>, <i>Setaria</i>), tapeworms, and flukes is limited, however; <b>pharmacokinetics</b>: except thiabendazole, albendazole, oxfendazole, only limited amounts of a dose of any of the BZs are absorbed from the GI tract of the host; thus BZs usually are more effective at low dosage regimen for several days (multiple dosing) than at a singly high dosage; in most tissues of treated animals, residues of BZs approach low levels only; however, residues quantities of [<sup>14</sup>C] labeled parent compounds and its metabolites are detectable in the liver and other organs (&lt;0.3 µg/g tissue) at 2 weeks following a single dose; as a result of detected radioactivity, withdrawal times of BZs before slaughter are necessary for edible tissues and milk intended for human consumption (cf. Table 2.); <b>metabolism</b> of BZs occurs in the liver; phase I reactions involve hem-associated cytochrome P450 and microsomal flavin monooxygenase (MFMO) system catalyzing reactive groups into organic substrate (hydroxy, carboxy, amino and sulphhydryl groups); phase II reactions often occur at site of the new functional groups and enable conjugation of the deactivated molecule to amino acids, carbohydrate, sulfate, bile salts and/or glutathione; species of conjugate may relate to route of elimination; <b>mode of action and resistance</b> of BZs may be due to interruption of microtubular function, i.e., tubulin polymerization; widespread drug resistance can be attributed to mutations in the tubulin molecule, and possibly to enhanced active cellular efflux of the drugs</p>		
<p><b>thiabendazole (TBZ)</b> (66–75, cattle, 110 <i>Cooperia</i> spp. and severe infections by other species), (44, sheep) (44–66, goats) cattle, sheep, goat, no use class stated or implied; <b>limitations</b> for Type A Medicated Articles: do not use in Type B or Type C medicated feed containing bentonite; drug products are not available in Australia</p>	<p>*Omnizole (Merial) drench, *Thibenzole Premix (Merial); Type A Medicated Articles (medicated feed) or other drug forms of TBZ, e.g., pellets, medicated feed block for pasture in USA, elsewhere (WT cattle 3d; milk 96 hours cattle, goat, sheep) *Tiabendazol (CEVA), powder (drug form), drench or in feed, Germany, elsewhere (WT 6d; milk 4d)</p>	<p>first drug with broad-spectrum activity against adult gastrointestinal (GI) nematodes; developing trichostrongylid nematodes are not so greatly affected (75–90%); it has no activity against arrested (inhibited) larval stages in cattle at regular dose (cf. enhanced dose for <i>Cooperia</i> spp. infections); indications for <b>cattle</b>: control of infections of gastrointestinal roundworms: <i>Ostertagia</i> spp., <i>Trichostrongylus</i> spp.,</p>
<p><i>Haemonchus</i> spp., <i>Nematodirus</i> spp., <i>Oesophagostomum radiatum</i> and control of infections of <i>Cooperia</i> species (cf. higher dose); indications for <b>goats</b> and <b>sheep</b>: <i>Trichostrongylus</i> spp., <i>Haemonchus</i> spp., <i>Ostertagia</i> spp., <i>Cooperia</i> spp., <i>Nematodirus</i> spp., <i>Bunostomum</i> spp., <i>Strongyloides</i> spp., <i>Chabertia</i> spp., and <i>Oesophagostomum</i> spp.; also active against ova and larvae passed by sheep from 3 hours to 3 days after the feed is consumed (good activity against ova and larvae of <i>T. colubriformis</i> and <i>T. axei</i>, <i>Ostertagia</i> spp., <i>Nematodirus</i> spp., <i>Strongyloides</i> spp.; less effective against those of <i>Haemonchus contortus</i> and <i>Oesophagostomum</i> spp.); TBZ-resistant nematodes are known and frequent; the drug is well tolerated at higher doses, e.g., 100 mg/kg (88 mg/kg for treatment of nematodiriasis in sheep, dose is not approved); the upper dose (cattle 110 mg/kg, and sheep 66 mg/kg) is required for treating successfully lungworm infections (not approved indication); it is rapidly metabolized into various degradation products (&lt;1% of TBZ is excreted intact, excretion occurs in feces and urine within 72 and 48 hours, respectively)</p>		

**Nematocidal Drugs, Animals. Table 1** Drugs used against gastrointestinal (GI) nematode infections in ruminants (Continued)

CHEMICAL GROUP nonproprietary name of active substance (single oral dose, mg/kg body weight = b.w.), other information	*DRUG PRODUCT dose form (formulation), withdrawal time (WT) days (d) before slaughter, manufacturer, supplier, other information	CHARACTERISTICS miscellaneous comments on pharmacokinetics, metabolism, mode of action, toxicity, and limitations
<b>BENZIMIDAZOLE CARBAMATES</b>		
<b>mebendazole (MBZ)</b> *1 (15–20, sheep) *2 (1mL/4kg b.w.= 12.5mg/kg bw sheep, lambs) <b>limitations:</b> do not use in ewes which are producing or may in future produce milk (or milk products) for human consumption	1*Ovitelmin (Janssen-Cilag), suspension (50 mg MBZ/1mL), Germany, elsewhere, WT 7d; 2*Benzicare (drench) 2*WDS MBZ, oral suspensions (50 g MBZ/ L) Australia, elsewhere, WT 7d	for control of mature and immature MBZ-sensitive roundworms, lungworms ( <i>Dictyocaulus filaria</i> ), and tapeworms ( <i>Moniezia</i> spp.) in sheep, also reduces output of viable worm eggs; MBZ is highly effective against adult GI (trichostrongylid) nematodes (for worm species cf. thiabendazole ↑)
<p>in sheep (and goats: not approved) with somewhat erratic effect (50–90%) against developing stages and only negligible activity against arrested larval stages; MBZ is poorly metabolized (most is excreted unchanged in feces within 1 to 2 days, 5–10% in urine, and a small portion as decarboxylated derivative of MBZ); in studies, the drug was embryotoxic in rats at 10 mg/kg b.w.; there is no embryotoxic effect in sheep at labeled dose; MBZ may be used for control of nematode and cestode infections (not approved indications) of <b>zoo animals</b>; currently there seems to be a lack of suitable drug forms (formulations) of MBZ like powder or premix; equines (zebra, tapir), and ruminants (giraffe, antelope, gazelle, elk, deer, camel) have been treated with medicated feed (630 ppm) for 14 consecutive days (equivalent dose: 1 mg/kg/d in equines, or 5 mg/kg/d in ruminants); MBZ treatment of cestode infections: Pinnipedia and Proboscidae 10 mg/kg/d × 2–3 d, primates (with fruit) 5–10 mg/kg/d × 5d, in Rodentia and Marsupialia 15 mg/kg single dose, carnivores (with fish) and Artiodactyla 15 mg/kg/d × 2d, <i>Strongyloides stercoralis</i>, is sometimes fatal in primates: long-term treatment, total 21 days: (25), (50), (25) mg/kg twice daily each dose regimen for 7d, alternating with 7d rest between each dose regimen; <b>zoo birds</b>: 60 ppm in-feed × 7d in chicken, turkeys, guinea fowl, and 120 ppm in-feed × 14 d in pheasants, partridges, geese, and ducks against <i>Syngamus trachea</i>, ascarids, heterakids, <i>Capillaria</i> sp. (dose limiting parasite), and cestodes (about 100% removal of worms)</p>		
<b>fenbendazole (FBZ)</b> (5–7.5, cattle) (sheep, goats, 5) (5, *Safe-Guard Enproal Feedblocks: total dose for 3 days, <b>limitation:</b> cattle, not breeding age) (10, cattle, beef. 4th-stages larvae/type II ostertagiasis, tapeworm, <i>Moniezia benedeni</i> ) (12 g per animal = single *Panacur SR Bolus/ animal): SR Bolus contains 12 g FBZ and consists of 10 flat-faced tablets in 2 magnesium alloy joined and enclosed by plastic rings; it releases FBZ continuously in reticulo-rumen of cattle for up to 140 days (20 weeks): it controls GI round- and lungworm	*Panacur, 10% Suspension or paste; *Safe-Guard 10% paste or suspension (OTC), Type A medicated Article, or Enproal Feedblocks (Intervet Inc) WT: 6–16d, milk: not required, it depends on drug product (cf. label), USA and elsewhere; *Panacur Suspension, 2.5% (sheep), 10% (cattle, horse), Granulat (cattle, horse), SR Bolus (cattle, WT 200d), Boli 250 (sheep), other products, WT: cattle/ sheep: 7/10–21, milk 6/5–7, Germany, elsewhere; *Virbac Fencare 100, *Panacur 100, *WSD FBZ 100 (all: 100 g FBZ/L), WT: 14d, milk nil = 0, other products (cattle, horses), Australia, elsewhere	first broad-spectrum drug with high efficacy against lungworms ( <i>Dictyocaulus viviparus</i> ) and GI nematodes of cattle and sheep (efficacy against adult stages: 95–100%, developing stages: 95–100%, and arrested stages: 80–90%); indications ( <b>cattle</b> , single dose 5–7 mg/kg; 10 mg/kg see ←): for removal and control of lungworm ( <i>Dictyocaulus viviparus</i> ); stomach worm (adults), brown stomach worm ( <i>Ostertagia ostertagi</i> ); stomach worms (adults and 4th-stage larvae); barberpole worm ( <i>Haemonchus contortus</i> and <i>H. placei</i> ) and small stomach worm ( <i>Trichostrongylus axei</i> ); intestinal
<p>worms (adults and 4th-stage larvae); hookworm (<i>Bunostomum phlebotomum</i>), threadnecked intestinal worm (<i>Nematodirus helvetianus</i>), small intestinal worm (<i>Cooperia punctata</i> and <i>C. oncophora</i>), bankrupt worm (<i>Trichostrongylus colubriformis</i>), and nodular worm (<i>Oesophagostomum radiatum</i>); indications (<b>goat, sheep</b>): for removal and control of stomach worms (adults) <i>Haemonchus contortus</i> and <i>Teladorsagia circumcincta</i> (products USA) and other species (e.g., drug products in Germany, Australia, elsewhere: at regular dose) such as <i>Chabertia</i>, <i>Haemonchus</i> spp., <i>Ostertagia</i> spp., <i>Bunostomum</i> spp., <i>Trichostrongylus</i> spp., <i>Gaigeria pachyscelis</i>, <i>Cooperia</i> spp., <i>Trichuris</i> spp., <i>Nematodirus</i> spp., <i>Strongyloides</i> spp., <i>Oesophagostomum</i> spp., <i>Dictyocaulus filaria</i>, and <i>Moniezia</i> spp.; <b>limitations:</b> retreatment may be needed after 4–6 or 6–8 weeks (feed blocks); do not use in lactating goats, and in dairy cattle of breeding age (USA); *Panacur SR bolus administered at the beginning of the grazing season will prevent establishment of patent infections throughout the grazing season; reduced pasture contamination in autumn will lower the risk of 4th stage-larvae/type II ostertagiasis; inhibited <i>Ostertagia</i> larvae may, however, accumulate in abomasum and cause winter ostertagiasis (inhibited L4 are not killed); effect of SR bolus (following administration) will last for about 140d and should be considered in case of heavily infected pastures (<b>limitations:</b> pasture cattle weighing 100–300 kg); FBZ appears to cause no embryotoxic or teratogenic effects in rats, sheep, and cattle and is well tolerated at labeled or higher doses (safety index is reported to be more than 500); FBZ suspension 10% and approved forms of <i>trichlorfon</i> (cf. Table 3), when used concomitantly have been shown to be compatible and not to interfere with one another;</p>		

**Nematocidal Drugs, Animals. Table 1** Drugs used against gastrointestinal (GI) nematode infections in ruminants (Continued)

CHEMICAL GROUP nonproprietary name of active substance (single oral dose, mg/kg body weight = b.w.), other information	*DRUG PRODUCT dose form (formulation), withdrawal time (WT) days (d) before slaughter, manufacturer, supplier, other information	CHARACTERISTICS miscellaneous comments on pharmacokinetics, metabolism, mode of action, toxicity, and limitations
<p><b>contraindication:</b> do not administer FBZ within 7 days of a <i>bromsalans</i> flukicide: simultaneous use of FBZ with <i>bromsalans</i> causes severe (fatal) adverse effects in cattle; indications (incl. experimental studies) in <b>zoo animals</b> (cf. Table 5: labeled doses): lion tiger, cheetah, panther, puma, leopard, jaguar, and bears (black, polar, or grizzly bear) infected with <i>Toxocara cati</i>, <i>Toxascaris leonina</i>, <i>Ancylostoma</i> spp., and <i>Taenia</i> spp. can effectively be treated with certain formulations of FBZ (10 mg FBZ/kg/d for 3 days, granules); wild ruminants infected with <i>Haemonchus</i> spp., <i>Nematodirus</i> spp., <i>Trichostrongylus</i> spp. may be treated with medicated feed (2.5 mg FBZ/kg/d for 3 days), also so feral swine infected with <i>Ascaris suum</i>, <i>Oesophagostomum</i>, <i>Stephanurus</i> (3 mg FBZ/kg/d for 3 days), and wild sheep infected with <i>Protostrongylus</i> spp. (10 mg FBZ/kg/d for 3 days); other zoo and park animals seem to tolerate overdoses of FBZ products equally well, e.g., primates (2 mg FBZ/kg/d for 5 days) against acanthocephalan <i>Prosthenorchis</i> and <i>Physaloptera</i>; 30–50 mg FBZ/kg/d for 2 days or 50–100 mg FBZ/kg as single dose, suspension or granules in food against GI parasites, spirurids, oxyurids, or reptiles and amphibians (<i>Capillaria</i> infections) or zoo birds (chickens, turkeys, guinea fowl, pheasants, partridges, geese, and ducks: 60 ppm FBZ in-feed for 7d result in 100% removal of worms such as <i>Syngamus trachea</i>, ascarids, heterakids, cestodes, or <i>Capillaria</i>, being dose limiting parasite)</p> <p><b>drug combinations</b> for sheep and lambs in Australia and elsewhere: <b>fenbendazole/levamisole HCl</b> = LEV, oral suspension, drench, WT 14d, milk 3d, e.g., *Combimax LV Combination Pharmtech, *Virbac Duocare (Virbac) or *WSD Combination (25 g FBZ/L //40 g LEV/L: 1mL/5 kg bw = 5 mg FBZ/kg // 8 mg LEV/kg b.w., Western Stock Distributors) and many other drug products containing different amounts of active constituents (see example *WSD combination ↑) <b>indications:</b> for control of benzimidazole (BZs) and LEV sensitive gastrointestinal roundworms and lungworms; products may be also particularly useful in cases of single resistance strains to either BZs or LEV; aids in control of ovicidal activity in sheep and lambs; allow 7 days or greater between dosing with combinations and bromsalans; milk from treated ewes should not be fed to lambs; <b>fenbendazole/levamisole HCl/praziquantel (PZQ)</b>, oral solution/suspension drench, WT 14d, milk 3d, e.g., *First Duodrench Combination Oral Antiparasitic Solution for sheep and lamb (25 g FBZ /L //40 g LEV/L //18.8 g PZQ/L: 1mL/5 kg b.w. = 5 mg FBZ/kg // 8 mg LEV/kg b.w.// 3.76 mg PZQ/kg b.w., Virbac) and other products; indications: for control of LEV and/or FBZ sensitive mature and immature roundworms and lungworms and the treatment of tapeworms (<i>Moniezia</i> spp.) in sheep and lambs; aids in control of ovicidal activity in sheep and lambs; do not drench horses or dogs; this product is ineffective against roundworms resistant to both BZs and LEV compounds; overdosing can cause temporary excitement, tremor and salivation; <b>fenbendazole/levamisole HCl + naphthalophos</b>, oral solution/suspension, WT 14d, *Rametin Combo Sheep Drench, mix pack for mass treatment (50 g FBZ/L//67.9 g LEV/L + 800 g naphthalophos/kg, application rate see label Bayer); pack contains 2 sheep drenches, which may be mixed or used alone; combination of drenches is recommended in order to control or prevent onset of resistance; indications: for control of gastrointestinal roundworms and lungworms in sheep and lambs; do not treat severely debilitated, thirsty or exhausted sheep; do not use in female sheep, which are producing, or may in future produce, milk or milk products for human consumption</p>		
<p><b>oxfendazole (OFZ)</b> (4.5, cattle) (5, sheep) *Bomatak Pour-On (Bomac Labs), topical solution, WT: cattle 21d, milk 7d; *Virbac Combat White (Virbac), oral liquid, WT: cattle, sheep, goats 10d, cattle: milk nil, not approved for sheep, goats; *Oxazole (90.6 g/L OFZ), (Jurox), oral suspension, WT: cattle 8d, milk nil, horse 28d, many other drug products in Australia, elsewhere</p>	<p>*Synanthic Bovine Dewormer (Forte Dodge AH), paste: WT 11d, or oral liquid (suspension): WT: cattle 7d, USA, elsewhere; *Systemex (Essex), oral suspension, WT: sheep 12d, cattle, 10d, 5d milk; *Oxfenil 2.265% (Virbac), oral liquid, WT: cattle 14d, milk 5d, sheep 14d, *Systemex Intervall Bolus (and forte: cattle 200–400 kg) (Essex) intraruminal devices releasing 5 and 6 ring tablets, respectively, every 23d (WT 180d) Germany, elsewhere</p>	<p>broad-spectrum drug as fenbendazole (for details concerning worm species see FBZ ↑), <b>indications</b> (cattle, sheep, goats: see products): for removal and control of susceptible mature and immature GI worms (incl. developing larvae and inhibited <i>Ostertagia</i> larvae in cattle), lungworms (<i>D. viviparus</i>, <i>D. filaria</i>) and tapeworms (<i>Moniezia</i> spp.), and aids in control of ovicidal activity in sheep and lambs (except <i>Nematodirus</i> spp.); <b>limitations:</b> treatment may be repeated in 4 to 6 weeks, do not use in female dairy cattle of breeding age (USA);</p>
<p><b>contraindication:</b> do not administer OFZ within 7 days of a <i>bromsalans</i> flukicide: simultaneous use of these drugs may cause severe (fatal) adverse effects in cattle; <b>FBZ metabolism:</b> initial sulfur oxidation step of FBZ to the sulfoxide (= OFZ) is reversible in sheep and resulted in a 4:1 ratio of sulfoxide to sulfide (FBZ) in plasma; establishment of equilibrium is rapid relative to rates of absorption, excretion or further oxidation to the sulfone; however, total bioavailability of both BZs has been found to be ~40% less when the same sheep were dosed with FBZ compared to OFZ; thus administration of FBZ relative to OFZ should not be considered as equivalent; no effects on the fetus were reported following maternal exposure to OFZ during pregnancy in pigs (4 doses of 4.5 or 13.5 mg/kg at 7-day intervals between</p>		



**Nematocidal Drugs, Animals. Table 1** Drugs used against gastrointestinal (GI) nematode infections in ruminants (Continued)

CHEMICAL GROUP nonproprietary name of active substance (single oral dose, mg/kg body weight = b.w.), other information	*DRUG PRODUCT dose form (formulation), withdrawal time (WT) days (d) before slaughter, manufacturer, supplier, other information	CHARACTERISTICS miscellaneous comments on pharmacokinetics, metabolism, mode of action, toxicity, and limitations
<p>gestation days 12 and 37), cattle (8 doses of 13.6 mg/kg at 4-day intervals between gestation days 11 and 39) or horses (3 doses of 20 mg/kg on gestation days 26, 180 and 280); however, doses of 20 mg/kg had been reported to cause embryotoxic effects in ewes</p> <p>OFZ-resistant <i>H. contortus</i> are known and widespread and may be controlled by <b>drug combination</b> *Hatrack Drench oral broad spectrum antiparasitic for sheep (Ancare, Australia), oral solution/suspension, WT: sheep 14d, active constituents: 33.9 g/L <i>levamisole</i> HCl//22.7 g/L <i>oxfendazole</i>//1g/L <i>abamectin</i> + 0.5 g/L <i>selenium</i> (Se) as sodium selenate//2.2 g/L <i>cobalt</i> (Co) as cobalt EDTA, <b>indications</b>: control and removal of internal parasites of sheep including those with single or dual resistance to BZs or imidazothiazoles (<i>levamisole</i>/morantel), also provides a Se and Co supplement for sheep raised in Se and/or Co deficient area (limitations and contraindications see label)</p>		
<p><b>albendazole</b> (ABZ) (cattle, 7.5–10) (sheep, 4–7.5) *Valbazen (Schering-Plough) or *Alban Broad Spectrum, oral liquid, WT: sheep, lamb, goats 10d, *Extender 100 (Captec Merial Australia and elsewhere), oral capsule for sheep weighing 40–80 kg, WT: sheep nil (other products, Australia, elsewhere)</p>	<p>*Valbazen (Pfizer), oral liquid, WT: sheep, cattle 7d, paste WT: cattle 27d, (USA, elsewhere) *Valbazen (Pfizer), oral liquid 10%, WT: cattle 28d, milk 5d, oral liquid 1.9%, WT sheep 10d, milk 5d, *Vermitan (CEVA), liquid 2.5%, WT cattle 21d, sheep 14d (other products, Germany, elsewhere)</p>	<p>broad-spectrum drug with activity against GI nematodes, lungworms, tapeworms (cf. fenbendazole and oxfendazole ↑), and trematodes parasites; some varying results concerning efficacy against inhibited larvae of <i>O. ostertagi</i> have been reported (<i>O. circumcincta</i> is dose limiting species, i.e., ~0.5 mg/kg/day when using *Extender 100 capsule</p>
<p>(slow release of ABZ from cap. that may contain 3.85 g ABZ delivering 36.7 mg/d for ~105 days); <b>indications</b> for cattle and sheep may vary in various countries: for the removal control of BZ-sensitive mature and immature gastrointestinal roundworms (including inhibited type II <i>Ostertagia</i> larvae), lungworms, tapeworms; to aid in the control of adult liver fluke (<i>Fasciola hepatica</i>), also reduces the output of viable worm and fluke eggs; <b>limitations</b>: do not administer to ewes during first 30 days of pregnancy or for 30 days after removal of rams and do not administer to female cattle during first 45 days of pregnancy or for 45 days after removal of bulls, and do not use in female dairy cattle of breeding age (USA, Germany, and elsewhere); during early part of ewes' pregnancy all medication should be administered with care and do not exceed recommended dose at this time; do not use in sheep, which are producing or may in future produce milk or milk products for human consumption (Australia, elsewhere); <b>pharmacokinetics/metabolism</b>: in ruminants, oral doses of ABZ are readily absorbed (about 50%) from gut; primary metabolism of ABZ is rapid first pass oxidation of its sulfide group to the active ABZ sulfoxide (also known as ABZ oxide and ricobendazole ↓), and then to inactive metabolites as ABZ sulfone and ABZ-2-aminosulfone; ABZ sulfoxide (syn. ABZ oxide) is also a metabolite of netobimin (see probenzimidazoles ↓); sulfoxide-sulfide interconversion is evident (cf. oxfendazole) and equilibrium (ratio of sulfoxide: sulfide) heavily favors the sulfoxide; <b>toxicological studies</b>: in rats, teratology studies showed that high doses of ABZ oxide were embryotoxic and lower doses as 7 mg/kg b.w. caused impairment of fetal development; thus, ABZ and also netobimin were both clearly teratogenic and produced adverse effects on reproduction; there was an embryotoxic effect (skeletal abnormalities) in lambs at 2 times the recommended dose of ABZ that may limit use in pregnant animals (see limitations); <b>drug combinations</b>: various drug products on the Australian market and elsewhere may control frequently occurring BZs (ABZ)-resistant <i>H. contortus</i> strains as *Combi Oral Drench for sheep and lambs (Novartis AH), oral solution/suspension, WT: 21d, (active constituents: 70 g/L <i>levamisole</i> as hydrochloride //34 g/L <i>albendazole</i> as ABZ oxide: 1 mL/10 kg b.w.); for the control of gastrointestinal roundworms, sensitive to benzimidazoles and levamisole including those <i>resistant</i> to either benzimidazoles or levamisole; for the control of lungworm and tapeworm, reduces the output of worm eggs; do not use in ewes producing milk or milk products for human consumption (other precautions see label), *Triton Multiphase Liquid (Captec, Merial) for sheep: broad-spectrum oral antiparasitic with selenium and cobalt, oral solution/suspension, WT: 14d, active constituents: 20 g/L <i>albendazole</i> //25.5 g/L <i>levamisole</i> as hydrochloride //0.8 g/L <i>ivermectin</i> + 0.4 g/L <i>selenium</i> (Se) as sodium selenate //1.76 g/L <i>cobalt</i> (Co) as cobalt EDTA: 1 mL/4 kg bw), a combination antiparasitic effective against GI worms, lungworm, itch-mite, and nasal bot of sheep, and provides a selenium and cobalt supplement; do not administer within 7 days of a <i>bromsalans</i> flukicide (see label for more precautions and contraindications), or another intraruminal device (cf. *Extender 100 ↑) e.g. *Optamax (Captec (Merial) 100 day sequential release capsule for 40–80 kg sheep, formulation: misc. intraruminal device, WT: 126d, (active constituents: 2.76 g/Cp <i>albendazole</i> //81.2 mg/Cp <i>ivermectin</i>), for 100 days continuous protection of 40–80 kg sheep against <i>susceptible</i> helminths and for 100 days continuous prevention of pasture contamination with nematode eggs of <i>susceptible</i> parasites; as an aid in the control of dags caused by internal parasites, do not use in ewes that are producing or may in the future produce milk or milk products for human consumption</p>		

**Nematocidal Drugs, Animals. Table 1** Drugs used against gastrointestinal (GI) nematode infections in ruminants (Continued)

CHEMICAL GROUP nonproprietary name of active substance (single oral dose, mg/kg body weight = b.w.), other information	*DRUG PRODUCT dose form (formulation), withdrawal time (WT) days (d) before slaughter, manufacturer, supplier, other information	CHARACTERISTICS miscellaneous comments on pharmacokinetics, metabolism, mode of action, toxicity, and limitations
<b>ricobendazole</b> (albendazole sulfoxide) (7.5, cattle, beef) (5, sheep, meat production)	*drug products may be available in states of South America (e.g., Argentina) and elsewhere	identical anthelmintic activity to that of ABZ (see ↑), though its action on trematodes is uncertain; ABZ sulfoxide and inactive ABZ sulfone metabolite
dominate plasma profile and are the major compounds in the urine; ABZ sulfoxide (syn. ABZ oxide) is the pharmacological and embryotoxic active agent (cf. ABZ) whereas the sulfone is inactive and non-toxic; residue depletion is virtually identical to that after administration of ABZ		
<b>PROBENZIMIDAZOLES</b>		
prodrugs of some BZs become active after metabolic processing; they undergo a complex series of enzymatic and/or nonenzymatic reactions in the gastrointestinal tract, particularly in the liver; these include complex reactions as nitro group reduction and cyclization in <i>netobimin</i> and <i>febantel</i> to form <i>albendazole</i> (ABZ), and <i>fenbendazole</i> (FBZ), respectively, and their subsequent metabolites ABZ sulfoxide (active), ABZ sulfone (inactive) and ABZ-2-aminosulfone, or the thiourea derivative <i>thiophanate</i> (today obsolete), a benzimidazole precursor that may be converted by cyclization into the 2-benzimidazole carbamic acid ethyl ester showing marked activity against adult and developing stages of GI nematodes, and fungi; prodrugs have higher water solubility than BZs and may overcome absorption problems seen with the “directly” active drugs; in all cases, the antiparasitic activity lies with the BZs itself, and in particular with one of the primary metabolites (e.g., ABZ→ABZ sulfoxide or FBZ→FBZ sulfoxide), rather than the parent prodrug; this may be also true for the toxicity, with exception of some reports of embryotoxicity with febantel		
<b>febantel</b> (FBT) (guanidine derivative) (prodrug of FBZ) (7.5, cattle, increased for arrested larvae) (5, sheep)	*Rintal 1.9% Pellets (Bayer Vital), pellets (100 g contains 1.9 g FBT), in-feed, WT: sheep, cattle 14d, milk (sheep, cattle), 2d, horse 20d, swine 6d (Germany, elsewhere, not approved for ruminants: USA, Australia, elsewhere)	FBT (Annex 1 of Council Regulation of EEC) is a prodrug rapidly metabolized by cyclization to fenbendazole in the liver, which is then converted to oxfendazole (= fenbendazole oxide cf. probenzimidazoles ↑); in addition, FBT oxidation at sulfur atom of FBT results
in corresponding sulfoxide undergoing hydrolytic cleavage and cyclization to produce oxfendazole; <b>indications:</b> (cattle, sheep): for removal and control of GI nematodes, and lungworms; it is effective against adult stages (more than 90%), developing stages (more than 90% in cattle; 75–90% in sheep), and arrested (inhibited) larval stages (50–90%); there is cross-resistance with thiabendazole- and other benzimidazole-resistant <i>H. contortus</i> or <i>T. colubriformis</i> strains; <b>contraindication:</b> do not administer within 7 days of a <i>bromsalans</i> flukicide; simultaneous use of febantel and bromsalans may cause severe (fatal) adverse effects in cattle <b>toxicological studies:</b> FBT is well tolerated, even at 3–5 times the recommended dose; in pregnant Long Evans rats, at a dose of 100 mg/kg bw (daily from day 6 to 15 of gestation) it is fetotoxic causing an increased incidence of resorptions and reduced fetal weight; teratogenic effects (anophthalmia, micropthalmia and multiple axial skeletal effects) were reported in 4 out of 25 fetuses following treatment of dams at 100 mg FBT/kg b.w.; no-effect-level for maternal toxicity and teratogenicity was 30 mg FBT/kg b.w./day (EMEA/MRL/867/03-Final, June 2004)		
<b>netobimin</b> (NTB) (guanidine derivative) (7.5 or 20, cattle, sheep) (20 mg/kg bw may be given against liver fluke, tapeworm, and heavy inhibited L4 of <i>O. ostertagi</i> infections)	*Hapadex, orale Suspension, oral suspension 5% (sheep, WT: 5d, milk 5d, liver 20d) or oral suspension 15% (cattle, WT: 10d, milk 5d, liver 20d) (Provet AG, Switzerland, elsewhere)	to become pharmacological active, it needs to be converted to albendazole in the ruminant gut, by splitting off a side-chain and formation of a BZ-group; its <b>spectrum of activity</b> (and indications) may be similar to that of albendazole (see ↑): it removes
and controls GI nematodes, lungworms, tapeworms ( <i>Moniezia</i> spp.), and aids in control of adult liver fluke ( <i>Fasciola hepatica</i> ) in sheep and cattle; at 7.5, 15, and 20 mg/kg it is highly effective (more than 95%) in cattle against adult and immature <i>T. axei</i> and adults of <i>O. ostertagi</i> , <i>Haemonchus</i> spp., and <i>Cooperia</i> spp.; 20 mg/kg is active (90%) against developing larvae and inhibited L4 larvae of <i>O. ostertagi</i> in cattle as shown in experimental studies, NTB is highly effective against <i>Oesophagostomum</i> spp. in sheep, and <i>Toxocara</i> (syn. <i>Neoascaris</i> ) <i>vitulorum</i> , <i>Moniezia benedeni</i> , and developing larvae/adults of <i>Dictyocaulus viviparus</i> in cattle; NTB shows reduced activity against BZ-resistant nematodes ( <i>H. contortus</i> ); there is high efficacy against 12-week-old <i>F. hepatica</i> and <i>D. dendriticum</i> at 15–20 mg/kg in sheep and cattle; NTB <b>limitations:</b> do not administer to ewes/female cattle during first 30/45 days of pregnancy, or for 30/45 days after removal of rams/bulls; <b>contraindication:</b> do not administer within 7 days of a <i>bromsalans</i> flukicide; simultaneous use of NTB and		

**Nematocidal Drugs, Animals. Table 1** Drugs used against gastrointestinal (GI) nematode infections in ruminants (Continued)

CHEMICAL GROUP nonproprietary name of active substance (single oral dose, mg/kg body weight = b.w.), other information	*DRUG PRODUCT dose form (formulation), withdrawal time (WT) days (d) before slaughter, manufacturer, supplier, other information	CHARACTERISTICS miscellaneous comments on pharmacokinetics, metabolism, mode of action, toxicity, and limitations
bromsalans may cause severe (fatal) adverse effects in cattle; <b>toxicology</b> : because NTB is converted in target animals (cattle, sheep) to albendazole safety data from testing of albendazole and its metabolites (especially active albendazole sulfoxide) are relevant to safety assessment of NTB; however, NTB may have additional toxic properties of its own; developmental studies in mice, rats, rabbits, and sheep showed all 3 compounds (NTB, albendazole, albendazole sulfoxide) to be teratogens with similar potencies (malformations, included visceral, craniofacial, and bone defects as shortened limbs: EMEA/MRL/556/99-Final, April 1999)		
TETRAHYDROPYRIMIDINES		
<p>*1 <b>morantel</b> tartrate (MOT) (0.4 g/100pound bw, cattle, goat, Type A med. Article), (4.4 mg/ pound bw, cattle, or one bolus/500 pound of b.w.) (*Paratect: 1 cartridge to each animal at the start of the grazing season, cattle, grazing)</p> <p>*2 <b>morantel</b> citrate (MOC) (10, goat, sheep) in 2005, MOT has been included in Annex I of Council Regulation (EEC) (actually no drug products on German market, elsewhere)</p>	<p>1*Rumatel Cattle Wormer (Pfizer), bolus, WT: cattle 14d, 1*Rumatel (Phibro AH), Type A medicated article, WT: cattle 14d, goats 30d; 1*Paratect Flex, sustained release cylinder, WT: cattle 102d (USA, elsewhere)</p> <p>2*Oralject goat and sheep wormer (Vet-Search Intern.), oral liquid (30 mg MOC/mL: 1mL/3 kg b.w.), WT: sheep, goats 7d (Australia, elsewhere)</p>	<p>methyl ester analogue of pyrantel (↓) with good efficacy against GI nematodes, e.g., adult trichostrongyles (<i>Haemonchus</i>, <i>Trichostrongylus</i>, <i>Cooperia</i>, and <i>Nematodirus</i>), which is somewhat greater than that of pyrantel; its effect against developing stages of trichostrongyles is less pronounced (75–90%) in cattle and sheep; the activity against arrested larvae is less than 50% (cattle); the drug is not ovicidal; cross-resistance was found in levamisole-resistant <i>Ostertagia</i> spp. strains and other trichostrongyle</p>
<p>nematodes; <b>indications</b> (cattle): *Rumatel, Type A medicated article and bolus for removal and control of mature GI nematode infections of cattle including stomach worms (<i>Haemonchus</i> spp., <i>Ostertagia</i> spp. <i>Trichostrongylus</i> spp.), worms of the small intestine (<i>Cooperia</i> spp., <i>Trichostrongylus</i> spp., <i>Nematodirus</i> spp.), and worms of the large intestine (<i>Oesophagostomum radiatum</i>), goats/sheep (*Type A medicated article and *Oralject suspension) for removal and control of mature GI nematode infections (<i>Haemonchus contortus</i>, <i>Ostertagia</i> (syn. <i>Teladorsagia</i>) <i>circumcincta</i>, and <i>Trichostrongylus axei</i>, <i>Chabertia ovina</i>, <i>Cooperia curticei</i>, and <i>Oesophagostomum venulosum</i>), including strains resistant to BZ chemicals (*Oralject); limitations: permanent worm exposure may require re-treatment in 2–4 weeks; do not use in Type B or Type C medicated feeds containing bentonite (*Rumatel); *Paratect Flex consists of a tri-laminated, perforated, plastic sheet formed into a cylinder having plastic plugs in its ends; core lamina contains 19.8 g of MOT equivalent to 11.8 g of morantel base; effectiveness is dependent upon continuous control of GI parasites for approx. 90 days following administration; treated cattle should not be moved to pastures grazed in the same grazing season/calendar year by untreated cattle; it will control adult stage of GI nematode infections (<i>Ostertagia</i> spp., <i>Trichostrongylus axei</i>, <i>Cooperia</i> spp., and <i>Oesophagostomum radiatum</i>) in weaned calves and yearling cattle weighing a minimum of 200 pounds, i.e., it will prevent establishment of patent infections throughout the grazing season; reduced pasture contamination in autumn will lower the risk of inhibited <i>Ostertagia</i> larvae accumulating in abomasum to cause winter ostertagiasis (inhibited <i>Ostertagia</i> larvae, L4, are not killed); it does not sufficiently control <i>Dictyocaulus viviparus</i> in lungs of cattle but it may reduce risk of parasitic bronchitis by preventing ingested larvae from becoming established; drug is well tolerated (better than pyrantel) and can be used in pregnant and young animals; pharmacological properties, and hence, adverse reactions as well as mode of action are similar to that of pyrantel (cf. Table 3 and below)</p>		
<p><b>pyrantel</b> (PYR) differs chemically from morantel (↑) by the absence of methyl group on the thiophene ring; actually it is approved as PYR pamoate (syn. embonate) or PYR tartrate for use in <b>equines</b> and <b>swine</b> (cf. Tables 3 and 4) and no longer approved for use in ruminants (USA, Member States of EU, Australia, and elsewhere); in Member States of EU the pamoate salt is restricted to equines; in ruminants it was usually administered as a drench or in-feed against adult GI nematodes of cattle, sheep, and goats; it is not ovicidal and its efficacy against immature and larval stages of GI nematodes is not consistently good or unknown; there is only minor activity against arrested larvae; activity in sheep is similar to that in cattle although greater activity has been found against developing larvae of <i>Haemonchus</i> spp., <i>Trichostrongylus</i> spp., and <i>Nematodirus</i> spp. in sheep; in developmental studies in rats and rabbits there was no evidence of teratogenicity, fetotoxicity, or maternal toxicity; the drug was well tolerated and could be used in pregnant and young animals; PYR acts as a potent agonist at the acetylcholine receptors on muscle cells of nematodes leading to spastic paralysis of worms and expulsion from host; in experimental studies it proved to block neurotransmission in vertebrates, to possess nicotine-like properties and to mimic acetylcholine at receptors in automatic ganglia, adrenal medulla, and respiratory tissues</p>		

**Nematocidal Drugs, Animals. Table 1** Drugs used against gastrointestinal (GI) nematode infections in ruminants (Continued)

<b>CHEMICAL GROUP</b> nonproprietary name of active substance (single oral dose, mg/kg body weight = b.w.), other information	<b>*DRUG PRODUCT</b> dose form (formulation), withdrawal time (WT) days (d) before slaughter, manufacturer, supplier, other information	<b>CHARACTERISTICS</b> miscellaneous comments on pharmacokinetics, metabolism, mode of action, toxicity, and limitations
<b>IMIDAZOTHIAZOLES</b>		
<p><b>levamisole</b> hydrochloride (LEVH) doses refer to LEVH: (8, cattle: drench, gel, or 7.92, cattle, Type A medicated Article); (8, sheep: drench, bolus) (10, cattle, topically to back of animal) <i>phosphate for injection</i>: dose equivalent to LEVH: (6, cattle, subcutaneously in the neck)</p>	<p>*Ripercol L (Fort Dodge), powder: drench, WT: sheep 3d, *Levasole Sheep Wormer, bolus, WT: sheep 3d; *Levasole soluble Drench Powder (Schering Plough AH), powder: drench, WT: cattle 2d, sheep 3d, *Tramisol Gel, oral gel, WT: 6d; *Tramisol Pour-on, topical liquid, WT: 9d, *Tramisol injectable Solution (Fort Dodge AH), injectable solution, WT: 7d, several other products (USA, elsewhere)</p>	<p>drug products may be approved for use in cattle and/or sheep and other target animals (swine cf. Table 4 and various birds) infected with GI nematodes and lungworms; LEV exhibits high efficacy against lungworms, <i>Dictyocaulus viviparus</i> and <i>D. filaria</i> (cf. Table 6) and good efficacy (more than 90%) against GI nematodes (adult and developing stages of trichostrongyles) as stomach worms <i>Haemonchus</i>, <i>Trichostrongylus</i>, and <i>Ostertagia</i> (abomasum), and</p>
<p>intestinal worms as <i>Trichostrongylus</i>, <i>Cooperia</i>, <i>Bunostomum</i>, <i>Nematodirus</i> (small intestine), <i>Oesophagostomum</i> and <i>Chabertia</i> (adult stages: large intestine); its effect against arrested stages (L4) of <i>Ostertagia</i> is minimal (less than 50%) in cattle, although the drug has activity against many arrested larvae in sheep; there is no ovicidal effect; benzimidazole (BZ)-resistant <i>H. contortus</i> strains may be sensitive to LEV and vice versa, LEV-resistant nematode strains appear to be susceptible to BZs; <b>toxicity</b>: drug has a moderate to high acute toxicity rate in rats and mice (LD50 values: 20 mg/kg intravenously, 200–500 mg LEVH/kg orally); hemolytic anemia was the major effect seen in dogs in a 1-year study (no-effect-level: 5mg/kg daily per os); LEV-induced agranulocytosis is idiosyncratic in humans and may be associated with HLA-B27 seropositive rheumatoid arthritis or other abnormalities of immune system; it occurred at relatively low therapeutic doses even when given on nonconsecutive days; LEV does not affect fertility in male and female rats, and was not embryotoxic or teratogenic to pregnant rats or rabbits when given over various stages of gestation; therefore, it appears to be a safe drug in pregnant animals; the therapeutic index of LEV is lower than that of BZs; although toxicity in target animals is rarely seen, dosage should be carefully calculated in lambs, particularly with the subcutaneous (s.c.) route (e.g., injectable LEV phosphate causes higher blood concentrations than does drenching with LEVH); as a cholinergic drug, it may produce typical side effects such as salivation, bradycardia, muscular tremor, or death from respiratory failure; in nematodes, it appears to act on the neuromuscular junction; first it may act as a ganglion-stimulating compound (type of nicotinic ganglionic receptor) and then it may induce a neuromuscular inhibition of the depolarizing type causing spastic contraction and then paralysis of muscles; <b>drug products in Australia, Germany, elsewhere</b>: on the Australian and German market, there are too numerous drug products to give detailed information; they may contain different amounts of sole active constituent LEVH as oral powder or oral liquid (in feed or drench: chiefly for sheep) for use in cattle and/or sheep, and liquids/solutions for injection or topical application (pour-on) for use in cattle only; in addition, there is an arsenal of drug products (<b>drug combinations</b>) on the Australian market that contain LEV/ <i>fenbendazole</i>, LEV/<i>oxfendazole</i>, LEV/<i>albendazole</i> and others (see this table ↑); they may particularly be used for removal and control of BZs resistant strains of stomach worms and others</p>		
<b>MACROCYCLIC LACTONES</b>		
<p>endectocides with activity against both internal and external parasites such as nematodes and arthropods; they exhibit no activity against cestodes, trematodes, or protozoans</p>		
<p><b>AVERMECTINS</b> are fermentation products of an actinomycete <i>Streptomyces avermitilis</i> first isolated in Japan at the Kitasato Institute from a soil sample in 1975; avermectin itself consists of a mixture of 4 major components (avermectin A1a, A2a, B1a, and B2a) and 4 minor components (A1b, A2b, B1b, and B2b); there are several major avermectins which slightly differ in their structure; first avermectins available were a mixture of B1 avermectins; <i>ivermectin</i>, derived from this B1 mixture of avermectins, is a highly potent <math>\alpha</math>-L-oleandrosyl-<math>\alpha</math>-L-oleandroside macrocyclic lactone (dose rates may be micrograms) consisting of 2 components, the 22,23-dihydroavermectin B1a (at least 80%) and 22,23-dihydroavermectin B 1b (not more than 20%); other avermectins on the market are <i>abamectin</i>, a naturally occurring fermentation product of <i>Streptomyces avermitilis</i>, <i>doramectin</i>, and <i>eprinomectin</i> prepared by mutational biosynthesis; <b>milbemycins</b> are fermentation products of <i>Streptomyces hygroscopicus aureolarimosus</i>; they are similar in their structure to avermectins (lack C-13 disaccharide substituent); <i>milbemycin oxime</i> consisting of a mixture of 2 components (80% A4 and 20% A3 milbemycin oxime) is the only milbemycin currently marketed for use in dogs (cf. Tables 5, 6); macrocyclic <b>nemadectins</b>, fermentation products of <i>Streptomyces cyaneogriseus noncyanogenus</i>, are classified as milbemycins in that</p>		

**Nematocidal Drugs, Animals. Table 1** Drugs used against gastrointestinal (GI) nematode infections in ruminants (Continued)

CHEMICAL GROUP nonproprietary name of active substance (single oral dose, mg/kg body weight = b.w.), other information	*DRUG PRODUCT dose form (formulation), withdrawal time (WT) days (d) before slaughter, manufacturer, supplier, other information	CHARACTERISTICS miscellaneous comments on pharmacokinetics, metabolism, mode of action, toxicity, and limitations
<p>they also lack the disaccharide moiety at C-13; however, owing to a trisubstituted double bond at C-26 in their side-chains, nemadectins differ in their structure from milbemycins proper; <i>moxidectin</i> (principal component of LL-F28249 antibiotic complex produced by <i>Streptomyces cyaneogriseus noncyanogenus</i>), is a chemically modified derivative of nemadectin; it is more lipophilic, and hydrophobic than ivermectin (results in longer effective tissue levels); <b>pharmacokinetics</b> and <b>toxicity</b> of macrocyclic lactones are influenced by various physiochemical and biologic factors such as the specific formulation used, the route of administration, and animal species to which the product is administered; parenteral administration (e.g., subcutaneous injection) may principally result in a greater bioavailability than oral administration; often the parent compound is the major liver residue for up to 7 and 14 days after dosing in sheep and cattle, respectively (e.g., in case of ivermectin); fecal excretion is the main route of elimination of most macrocyclic lactones (e.g., ivermectin, up to 98% in feces, remainder in urine); however in lactating animals up to 5% of the dose may be excreted in the milk; an exception makes the topically applied <i>eprinomectin</i> (in 1996 introduced avermectin into the market, which may have a zero withdrawal time for milk intended for human consumption; macrolide endectocides have a substantial margin of safety in ruminants, swine, horses and dogs, although in certain Collie dogs and toys about one-fourth of the animals appear to be particularly susceptible to these compounds; <i>selamectin</i> (latest avermectin B1 derivative on the market), which is structurally related to doramectin (selamectin is a monosaccharide oxime derivative of doramectin), has a unique combination of safety in all dog breeds (including Collies) and potency against both external and internal parasites of dogs and cats (cf. Table 5), its major route of elimination via the feces (48–68% in cats, 18–20% in dogs, 1–3% in the urine: cats and dogs, and partially via sebaceous glands in the skin); tight binding of selamectin to organic matter (main degradation processes will occur in feces and in soil to reduce residues levels) will limit bioavailability and prevent entry into ground water or into surface waters by runoff.</p>		
<p><b>ivermectin (IVM)</b> (0.2, subcutaneous (sc) cattle) (0.5, topical cattle) <b>limitations</b> for all products in the USA: do not use in female dairy cattle of breeding age and in calves to be processed for veal (there is no established WT for milk) (one SR-bolus: 1.72 g IVM per calf), <b>limitations</b>: calves must be older than 12 weeks of age, and ruminating, body weight: minimum 125 kg, max. 300 kg, (0.2, sheep), no use class stated or implied, <b>limitations</b>: for use in sheep only (e.g., severe adverse reactions, including fatalities in dogs, may result)</p>	<p>*Ivomec (=*I) injection 1% (Merial Ltd) for cattle, sterile solution, WT: cattle 35d, milk not established, reindeer 56d, *I pour-On, liquid, WT: cattle 48d, *I Cattle paste, WT: cattle 24d, *I Sustained-Release Bolus, (calves: 125–300 kg b.w.), WT: calves ruminating 180d, *I liquid, drench, WT: sheep 14d, other suppliers in the USA and elsewhere) drug/dose forms of other suppliers in Australia, Germany and elsewhere are identical/similar to *I product line, unlike *I Maximizer controlled Release Capsules for sheep, oral caps., WT: sheep (40–80 kg b.w.) 126d (Australia elsewhere) *I SR-Bolus for cattle (Germany) has been withdrawn</p>	<p>has high efficacy (&gt;98%) against GI nematodes adult, developing, and arrested stages of almost all important GI nematodes of cattle and sheep as <i>Ostertagia</i> (including inhibited larvae in cattle), <i>Trichostrongylus</i>, <i>Haemonchus</i>, <i>Cooperia</i>, <i>Bunostomum</i>, <i>Nematodirus</i> (only adults, <i>N. helvetianus</i> is dose-limiting species for both IVM and doramectin ↓), <i>Trichuris</i>, <i>Oesophagostomum</i>, ovine <i>Chabertia ovina</i>, and lungworms (cf. Table 6), <i>Dictyocaulus viviparus</i>; BZ-resistant strains of <i>H. contortus</i> and <i>T. colubriformis</i> in sheep are highly susceptible to IVM and may be still unaffected by cross-resistance with other drugs; because IVM is highly persistent in tissues it may protect against the development of</p>
<p>infective larvae of several nematode genera for a period of about 2 weeks (see indications: *Ivomec Plus ↓); ivermectin is highly active against <b>arthropods</b> as biting and sucking lice (<i>Linognathus vituli</i>, <i>L. pedalis</i>, <i>Haematopinus eurysternus</i>), mange mites (<i>Psoroptes ovis</i>, <i>Sarcoptes scabiei</i> var. <i>bovis</i>, and others), and grubs (<i>Hypoderma bovis</i>, <i>H. lineatum</i>, <i>Oestrus ovis</i>), and less active against chewing (biting) lice (<i>Damalinea</i> spp.), and <i>Melophagus ovinus</i>; <b>adverse reactions</b> have been seen in cattle treated when large numbers of larvae of <i>Hypoderma</i> spp. have been present in the esophageal wall or the spinal canal (escape of cytotoxic material from dying grubs can produce anaphylactic reactions and severe paraplegia); the drug has activity against dung-breeding flies (e.g., face fly, <i>Musca autumnalis</i>, and hornfly, <i>Haematobia irritans</i>) and ticks (interrupt feeding, molting, and egg production); <b>approved indications for sheep</b> (FDA, USA): for treatment and control of the adult and fourth-stage larvae of GI roundworms as <i>Ostertagia circumcincta</i>, <i>Haemonchus contortus</i>, <i>H. placei</i> (adults only), <i>Trichostrongylus axei</i>, <i>T. colubriformis</i>, <i>Cooperia oncophora</i> (adults only), <i>C. curticei</i>, <i>Oesophagostomum columbianum</i>, <i>O. venulosum</i> (adults only), <i>Nematodirus battus</i>, <i>N. spathiger</i>, <i>S. papillosus</i> (adults only), <i>Chabertia ovina</i> (adult only), <i>Trichuris ovis</i> (adults only); lungworms (<i>D. filaria</i>), and all larval stages of the nasal bot <i>Oestrus ovis</i>;</p>		

**Nematocidal Drugs, Animals. Table 1** Drugs used against gastrointestinal (GI) nematode infections in ruminants (Continued)

<b>CHEMICAL GROUP</b> nonproprietary name of active substance (single oral dose, mg/kg body weight = b.w.), other information	<b>*DRUG PRODUCT</b> dose form (formulation), withdrawal time (WT) days (d) before slaughter, manufacturer, supplier, other information	<b>CHARACTERISTICS</b> miscellaneous comments on pharmacokinetics, metabolism, mode of action, toxicity, and limitations
<b>toxicity:</b> IVM is generally well tolerated in ruminants, with occasional coughing in sheep and goats after oral administration; neurotoxic effects (ataxia, bradypnoea, and tremor) similar to those seen in laboratory animals occur in overdosage; teratogenic effects were produced only at doses similar to those causing severe maternal toxicity in mice, rats, rabbits, and dogs (no-effect-level in CF-1 mouse: 0.2 mg/kg b.w., dog: 0.5 mg/kg b.w. every 5 or 10 days from days 5–40 of gestation); studies on mutagenicity and carcinogenicity (with abamectin) were negative; at recommended dose IVM is safe in breeding and pregnant ruminants		
<b>ivermectin/clorsulon</b> (0.2/2, cattle, subcutaneously) (10 mg IVM 100 mg clorsulon/mL: 1mL/50 kg b.w.)	*Ivomec Plus (A) *Ivomec F(U) for cattle (Merial, USA=U, and Australia=A, elsewhere), solution for injection, WT: cattle 28d A, 49d U	clorsulon controls trematode infections (adult <i>F. hepatica</i> ); <b>indications:</b> for treatment and control of GI nematodes (adults and fourth-stage larvae): <i>Haemonchus placei</i> , <i>Ostertagia</i>
ostertagi (including inhibited larvae), <i>O. lyrata</i> , <i>Trichostrongylus axei</i> , <i>T. colubriformis</i> , <i>Cooperia oncophora</i> , <i>C. punctata</i> , <i>C. pectinata</i> , <i>Nematodirus helvetianus</i> (adults only), <i>N. spathiger</i> (adults only), <i>Oesophagostomum radiatum</i> , <i>Bunostomum phlebotomum</i> , lungworms (adults and fourth-stage larvae): <i>Dictyocaulus viviparus</i> ; liver flukes (adults only): <i>Fasciola hepatica</i> , grubs (parasitic stages): <i>Hypoderma bovis</i> , <i>H. lineatum</i> ; lice: <i>Linognathus vituli</i> , <i>Haematopinus eurysternus</i> , <i>Solenopotes capillatus</i> ; mites: <i>Psoroptes ovis</i> (syn. <i>P. communis</i> var. <i>bovis</i> ), <i>Sarcoptes scabiei</i> (var. <i>bovis</i> ); it is also used to control infections of following nematodes for days (d) after treatment: <i>D. viviparus</i> : 28d, <i>O. ostertagi</i> : 21d, <i>H. placei</i> , <i>T. axei</i> , <i>C. punctata</i> , <i>C. oncophora</i> , and <i>O. radiatum</i> : 14d; <b>limitations:</b> for subcutaneous use only (do not use i.v. or i.m. injection); withdrawal time in milk has not been established, therefore do not use in female dairy cattle of breeding age; do not use in other animal species because severe adverse reactions, including fatalities in dogs, may result; do not use in calves to be processed for veal (WT has not been established for this product in preruminating calves); combination is well tolerated (safety index of ivermectin is ~30, and safety index of clorsulon ~80); (for <b>other drug combinations</b> , e.g., albendazole/ivermectin or albendazole/levamisole/ivermectin cf. <b>albendazole</b> )		
<b>abamectin</b> (ABA) (0.2 s.c., cattle, sheep) <b>ABA/praziquantel</b> (0.2/3.76, sheep, lamb as drench) *1 <b>ABA/oxfendazole/ levamisole</b> HCl (0.2/4.5/8, sheep as drench) *2 <b>ABA/closantel</b> (0.2/10, sheep as drench) *3 <b>ABA/ triclabendazole</b> (0.2/30 topical, cattle) <b>limitations:</b> do not use in dairy animals producing or which may in future be producing milk for human consumptions; do not treat calves/lambs less than 50/15 kg b.w. or calves <16 weeks of age (injectable solution)	*Genesis Injection Abamectin for cattle and sheep (Ancare), sterile solution (10mg ABA/mL), WT: cattle 49d, sheep 35d, *Virbamec injection for cattle (Virbac), sterile solution, (10 mg ABA/ mL) WT: cattle 30d, *Virbamec Pour-On for cattle, topical solution (5 mg ABA/mL), WT: cattle 35d, *Genesis Tape oral ABA/PZQ for sheep, lamb (Ancare), oral liquid, WT: sheep 14d, 1*Hatrack Drench for sheep (Ancare), oral liquid, WT: sheep 14d; 2*Genesis XTRA for sheep (Ancare), oral liquid, WT: sheep 49d, 3*Genesis Ultra Pour-On (Ancare), topical liquid, WT: cattle 49d (all products in Australia, elsewhere)	ABA was introduced in Australia in 1985; it consists of a mixture of avermectin B1a (at least 80% and B1b (~20%) and has a broad spectrum of activity against nematode and arthropod parasites of animals and plants (also sold as pesticide with broad spectrum of activity against insect and mite pests of agronomic crops); actually, there are various ABA-products for cattle and sheep on the Australian market and elsewhere; they either contain ABA alone or are <b>drug combinations</b> (ABA/praziquantel = PZQ, ABA/oxfendazole = OFZ/ levamisole or others with a flukicide such as closantel or triclabendazole which are active against the liver fluke, <i>Fasciola hepatica</i> (cf. Trematocidal Drugs/Table 1) or resistant strains of
Barber's Pole Worm, <i>Haemonchus contortus</i> as ABA/closantel (cf. 2*Genesis XTRA); ABA-products (including combinations) are neither available in the USA (no products approved) nor in Germany (other Member States of the European Union ?) though ABA entered into Annex I of Council Regulation (EEC) No. 2377/90; MRLs have been established for sheep (target tissues: muscle, fat, liver, and kidney), and beef cattle (MRLs for liver/fat); ABA exhibits high efficacy (>98%) against adult, larval, and arrested stages of almost all important GI nematodes such as <i>Ostertagia ostertagi</i> , <i>O. lyrata</i> , <i>Haemonchus placei</i> , <i>H. contortus</i> , <i>Trichostrongylus axei</i> , <i>Cooperia oncophora</i> , <i>C. punctata</i> , <i>C. curticiei</i> , <i>C. pectinata</i> , <i>Nematodirus helvetianus</i> , <i>N. battus</i> , <i>N. spathiger</i> , <i>Bunostomum phlebotomum</i> , <i>Chabertia ovina</i> (adult only), <i>Oesophagostomum radiatum</i> , <i>O. columbianum</i> , <i>O. venulosum</i> (adults only), <i>Toxocara vitulorum</i> (adults only), adult <i>Trichuris</i> spp. (adults only), <i>Strongyloides papillosus</i> and lungworms, <i>Dictyocaulus viviparus</i> and <i>D. filaria</i> (cf. Table 6); in cattle, ABA-injection products exhibit <b>persistent activity</b> against certain GI worms (prevent reinfection with <i>Ostertagia</i> spp., <i>Haemonchus</i> spp., <i>Trichostrongylus</i> spp. <i>Oesophagostomum</i> spp. and <i>D. viviparus</i> for up to 14 days, and <i>Cooperia</i> spp.		

**Nematocidal Drugs, Animals. Table 1** Drugs used against gastrointestinal (GI) nematode infections in ruminants (Continued)

CHEMICAL GROUP nonproprietary name of active substance (single oral dose, mg/kg body weight = b.w.), other information	*DRUG PRODUCT dose form (formulation), withdrawal time (WT) days (d) before slaughter, manufacturer, supplier, other information	CHARACTERISTICS miscellaneous comments on pharmacokinetics, metabolism, mode of action, toxicity, and limitations
<p>for up to 7 days: periods of sustained activity may vary) and also suppress fecal egg production for up to 21 days and pasture contamination is limited for up to 42 days after treatment; ABA is highly effective against <i>arthropods</i>, such as biting and sucking lice (<i>Linognathus vituli</i>, <i>L. pedalis</i>, <i>Haematopinus eurysternus</i>, <i>Solenopotes capillatus</i>), mange mites (<i>Psoroptes ovis</i>, <i>Sarcoptes scabiei</i> var. <i>bovis</i>, others), itch mite (<i>Psorergates ovis</i>), and grubs (<i>Hypoderma bovis</i>, <i>H. lineatum</i>), nasal bot (<i>Oestrus ovis</i>); it is less active against chewing (biting) lice (<i>Damalinia</i> spp.) and <i>Melophagus ovinus</i>; <b>adverse reactions</b> have been seen in cattle treated when large numbers of larvae of <i>Hypoderma</i> spp. have been present in the esophageal wall or the spinal canal (released cytotoxic material from dying grubs can cause anaphylactic reactions and severe paraplegia); ABA has activity against dung breeding flies (e.g., face fly, <i>Musca autumnalis</i>, and hornfly or buffalo-fly, <i>Haematobia irritans</i>: may give protection for 14 days after treatment) and ticks (e.g., <i>Boophilus microplus</i>, interrupts feeding, molting, and egg production); <b>adverse reactions</b>: abamectin should not be administered by intramuscular injection and should not be used in calves aged 1 week to 4 months because of possible adverse reactions; infrequent side effects at site of injection may be swelling, and pain; ocular contact of drug should be avoided; it is safe in breeding and pregnant animals; <b>environment</b>: in ruminants, ABA is excreted to a large degree unchanged in the feces; thus it may be effective against larvae of some dung-breeding insects (diptera and beetles) via feces; outside, it is rapidly degraded by air (oxygen) and light (<math>t_{1/2}</math>: 0.4–20 hours) but slowly, if bound to soil particles and protected from light (<math>t_{1/2}</math> = 20–48 hours)</p>		
<p><b>doramectin</b> (DO) (0.2 s.c., cattle, sheep) (0.5 topically, cattle) (0.15 drench, sheep) <b>limitations</b>: not for use in female dairy cattle 20 months of age or older and in calves to be processed for veal (USA); do not use during lactation or less than 60 days before calving when milk or milk products are to be used for human consumption or processing; animals must not be repeat treated within 4 weeks of a previous treatment</p>	<p>*Dectomax injectable (Pfizer, Germany, USA, Australia, elsewhere) sterile solution for injection, WT: Germany, cattle 60d; sheep 70d, USA, cattle 35d, Australia, cattle 42d; *Dectomax Pour-on (Pfizer, Germany, USA, Australia, elsewhere) topical solution, WT: Germany cattle 35d, USA cattle 45d, Australia 42d; *Dectomax oral Drench, (Pfizer, Australia) oral liquid, WT: sheep 14d</p>	<p>introduced in 1993; DO has broad spectrum of activity (up to 99%) against GI nematodes (adults and L<sub>4</sub> larvae, including inhibited larvae of <i>Ostertagia</i> spp., <i>Haemonchus placei</i>, <i>Trichostrongylus</i> spp., <i>Cooperia oncophora</i>, <i>Oesophagostomum radiatum</i>, <i>Nematodirus helvetianus</i>) and lungworms (cf. Table 6), <i>Dictyocaulus viviparus</i>; there is high activity (up to 98%) against adult stages of <i>Ostertagia lyrata</i>, <i>Cooperia pectinata</i>, <i>C. punctata</i>, <i>C. surnabada</i>,</p>
<p><i>Trichuris</i> spp., <i>Nematodirus spathiger</i> (<i>N. helvetianus</i> is dose-limiting species for both ivermectin and doramectin), <i>Bunostomum phlebotomum</i>, <i>Strongyloides papillosus</i>, and eyeworms (<i>Thelazia</i> spp.); it is highly effective (up to 100%) against <b>arthropods</b> as cattle grubs (<i>Hypoderma bovis</i>, <i>H. lineatum</i>), sucking lice (<i>Haematopinus eurysternus</i>, <i>Linognathus vituli</i>, <i>Solenopotes capillatus</i>, less effective against biting lice, <i>Damalinia bovis</i>), tropical warble fly (<i>Dermatobia hominis</i>), New World screwworm (<i>Cochliomyia hominivorax</i>), mange mites (<i>Psoroptes communis</i> var. <i>bovis</i>, <i>Sarcoptes scabiei</i> var. <i>bovis</i>), and <i>Boophilus microplus</i>; the <b>pharmacokinetic property</b> of DO is characterized by a larger area under plasma concentration vs. time curve (AUC) and thus a longer mean residual time compared to that of ivermectin allowing prolonged contact between drug and parasites; sustained activity of injectable and pour-on products varies; it controls infection/infestations and protects from reinfection/reinfestation of internal/external parasites: infective nematode larvae may fail to establish infection in host for prolonged periods (protection in days = d after treatment with *Dectomax injectable in cattle: for <i>C. oncophora</i>, <i>D. viviparus</i>, <i>O. ostertagi</i>, <i>O. radiatum</i> 28d, and <i>C. punctata</i>, <i>H. placei</i> 35d, and <i>Linognathus vituli</i> 42d and <i>Bovicola (Damalinia) bovis</i> 77d; these periods are longer than those seen with ivermectin after treatment)</p>		
<p><b>eprinomectin</b> (EP) (0.5 topically, cattle) cattle, no use class stated or implied <b>limitations</b>: apply topically along backbone from withers to tailhead</p>	<p>*Eprinex Pour-On for Beef and Dairy cattle (Merial, Germany, USA, Australia, elsewhere), topical solution (5 mg EP/mL), WT for edible tissues/milk of cattle: Germany 15d/0d, USA, Australia 0d/0d</p>	<p>introduced in 1996 as topical formulation; compound selection was based on toxicological and efficacy data in sheep and on a milk residue profile in cattle; it has a unique plasma/milk partitioning coefficient, rendering the drug useful for treating beef cattle, and</p>
<p>dairy cattle; <b>indications</b>: EP is used in beef and dairy cattle (deer, Australia, elsewhere) for treatment and control of GI nematodes and various ectoparasites; it has a broad-range of activity against GI nematodes: there is high activity (&gt;98%)</p>		

**Nematocidal Drugs, Animals. Table 1** Drugs used against gastrointestinal (GI) nematode infections in ruminants (Continued)

CHEMICAL GROUP nonproprietary name of active substance (single oral dose, mg/kg body weight = b.w.), other information	*DRUG PRODUCT dose form (formulation), withdrawal time (WT) days (d) before slaughter, manufacturer, supplier, other information	CHARACTERISTICS miscellaneous comments on pharmacokinetics, metabolism, mode of action, toxicity, and limitations
<p>against immature (L<sub>4</sub>) and mature stages of <i>Ostertagia</i> spp., <i>Cooperia</i> spp., <i>Bunostomum phlebotomum</i>, arrested larvae of <i>O. ostertagi</i>, and <i>Cooperia</i> spp., <i>Haemonchus</i> spp., <i>Oesophagostomum</i> spp., <i>Nematodirus helvetianus</i>, <i>Strongyloides papillosus</i> (only adults), <i>Trichostrongylus</i> spp. (adults: appears to be less active, 85%), <i>Trichuris</i> spp. (only adults), lungworms (<i>Dictyocaulus viviparus</i>), and <b>arthropods</b> as biting lice (<i>Damalinea (Bovicola) bovis</i>), sucking lice (<i>Haematopinus eurysternus</i>, <i>Linognathus vituli</i>, <i>Solenopotes capillatus</i>), mange mites (<i>Chorioptes bovis</i>, <i>Sarcoptes scabiei</i>), grubs (<i>Dermatobia hominis</i>, <i>Hypoderma bovis</i>, <i>H. lineatum</i>) and hornflies or buffalo flies (<i>Haematobia irritans</i>); EP may control and protects from reinfection of certain parasites for a prolonged period (in days =d) after treatment: <i>Ostertagia</i> spp., <i>Oesophagostomum radiatum</i> and <i>D. viviparus</i> up to 21–28d, <i>Cooperia</i> spp. and <i>Trichostrongylus</i> spp. up to 21d, <i>H. placei</i> and <i>N. helvetianus</i> up to 14d, and <i>H. irritans</i> 7d; however, sustained activity may considerably vary; <b>toxicology</b>: it is well tolerated and safe in cattle; no drug-related abnormal clinical observations nor side effects were observed in cattle after treatment at 3 and 5 times the therapeutic dose, 3 times at 7-day intervals or by cows treated at 10 times the therapeutic dose; no evidence of fetotoxicity or teratogenicity were noted in studies carried out in rats and rabbits; <b>pharmacokinetics</b>: most drug absorption is within 7–10 days postdose; very low (billionth) peak plasma concentrations of 22.5 ng/ml are reached 2–5 days post-dose, and then decline to approx. 1 ng/ml by 21 days post-dose (mean residence time 165 hours); drug is not extensively metabolized (parent compound &gt;90% in liver, kidney, fat, muscle, plasma, and 85% in feces); safety and pharmacokinetic profile of eprinomectin may allow for zero preslaughter withdrawal times for consumption of milk and meat</p>		
<p>MILBEMYCINS/NEMADECTINS: in contrast to avermectins, they lack the oleandrosyl moiety (C-13 disaccharide substituent) while the macrocyclic lactone ring system is similar to that of avermectins (for differences between milbemycins and nemadectins see avermectins ↑); the broad range of biological activities of the milbemycin/ nemadectins is generally equal to that of the avermectins; to date, <b>milbemycin oxime</b> is the only substitute of the milbemycins proper currently marketed for use in dogs (cf. Table 5); <b>moxidectin</b>, a chemically modified derivative of nemadectin (contains at C-23 a N-oxime methyl ether and at C-5 a hydroxyl group) is more lipophilic, and hydrophobic than ivermectin; moxidectin is the only substitute of endectocide nemadectins marketed for use in cattle, and sheep</p>		
<p><b>moxidectin (MOX)</b> (0.2 s.c., cattle, sheep) or (0.5 s.c., cattle beef, sheep: long acting = *LA injection) <b>limitations</b>: (do not use in goats, or lamb under 25 kg b.w.), (0.5 topically, cattle (beef, dairy, red deer) <b>MOX/triclabendazole</b> *1 (0.2/10, sheep as drench) <b>limitations</b>: do not use in female sheep producing or may produce milk (products) for human consumption <b>MOX/praziquantel</b> *2 (0.2/3.76, sheep, lamb as drench), additional action against <i>Moniezia expansa</i> <b>limitations</b> (↑ ↓)</p>	<p>*Cydectin (Fort Dodge, Germany, Australia, USA, elsewhere), *injectable solution (1%) for cattle, WT: cattle, Germany 65d, USA 21d, Australia 14d, sheep 28d; *LA injection, (10% or 20% solution) WT: cattle 108d Germany, sheep 91d Australia; *Pour-On solution for cattle (beef, dairy), WT: cattle Germany edible tissues (ET) 14d, milk (M) zero, USA ET zero, M zero, Australia, ET zero, M zero, red deer ET 7d; *oral liquid (drench) (1g MOX/L) for sheep, WT: Germany sheep ET 14d, M 5d, Australia ET only 7d</p>	<p>introduced in 1990 (Argentina), it is produced by a chemical modification of nemadectin and structurally similar to abamectin, ivermectin, and milbemycin; therefore its biological activity is similar to that compounds; it exhibits in cattle and sheep a broad spectrum of activity against GI nematodes and is highly effective (&gt;99%) against adult and larval stages (L<sub>4</sub>) of <i>H. placei</i>, <i>H. contortus</i>, <i>O. ostertagi</i> (including inhibited L<sub>4</sub>), <i>Trichostrongylus axei</i>, <i>T. colubriformis</i>, <i>Nematodirus</i> spp. (<i>N. helvetianus</i>, <i>N. spathiger</i> only adults &gt;95%), <i>C. surnabada</i>, <i>C. pectinata</i>, <i>C. punctata</i>, <i>C. oncophora</i> (cooperids all 92–100%, <i>C. curticei</i> adults only),</p>
<p><i>Strongyloides papillosus</i>, <i>Oesophagostomum</i> spp., e.g., <i>O. circumcincta</i>, <i>Chabertia ovina</i>, <i>Trichuris</i> spp. (only adults), <i>Chabertia ovina</i> (only adults), <i>Bunostomum phlebotomum</i> (only adults), and lungworms (Table 6), <i>Dictyocaulus viviparus</i>, <i>D. filaria</i> (adults and L<sub>4</sub>); it is highly effective against <b>arthropods</b>: cattle grubs (99%: <i>Hypoderma bovis</i>, <i>H. lineatum</i>, all parasitic stages), sucking lice (99–100%) <i>Linognathus vituli</i>, <i>Haematopinus</i> spp., e.g., <i>H. eurysternus</i>, <i>Solenopotes capillatus</i>, biting lice, <i>Damalinea bovis</i> (markedly suppressed after pour-on), mange mites <i>Sarcoptes scabiei</i>, <i>Psoroptes ovis</i> (100%), itchmite <i>Psorergates ovis</i>, <i>Chorioptes bovis</i> (markedly suppressed) and hornflies or buffalo flies (<i>Haematobia irritans</i>), and cattle tick <i>Boophilus microplus</i>; <b>persistent activity</b> of MOX products (period in days = d, which prevents reinfection), e.g., *LA injection for sheep: <i>H. contortus</i>, <i>T. (O.) circumcincta</i> 91d (cf. WT), <i>T. colubriformis</i> 49d, *LA injection for cattle: <i>D. viviparus</i>, <i>O. ostertagi</i> 120d, <i>H. placei</i> 90d, <i>O. radiatum</i> 150d, <i>T. axei</i> 90d, <i>L. vituli</i> 133d; at regular dosage (cf. 0.2: s.c. injection, topical administration, or drench) protection periods are fairly long (see label) but markedly reduced compared to those result after 0.5 (=*LA): s.c. infection; *Cydectin and its <b>drug combinations</b> (Australian market, elsewhere: 1*Cydectin Plus Fluke, WT: 21d, and 2*Cydectin Plus Tape, WT: 7d) have shown efficacy</p>		



**Nematocidal Drugs, Animals. Table 1** Drugs used against gastrointestinal (GI) nematode infections in ruminants (Continued)

CHEMICAL GROUP nonproprietary name of active substance (single oral dose, mg/kg body weight = b.w.), other information	*DRUG PRODUCT dose form (formulation), withdrawal time (WT) days (d) before slaughter, manufacturer, supplier, other information	CHARACTERISTICS miscellaneous comments on pharmacokinetics, metabolism, mode of action, toxicity, and limitations
<p>against a number of ivermectin, levamisole, and BZ-resistant strains of <i>H. contortus</i> and <i>Ostertagia</i> spp. in sheep, but they should be used with caution because of similar mechanisms of action to the avermectins; <i>toxicity</i>: injectable solution is well tolerated by cattle and sheep with only some transitory nervous symptoms at 3 times the therapeutic dose; <i>metabolite profile</i>: in studies, MOX remained the main metabolite of 7 metabolites (hydroxylation compounds) identified; in cattle, after s.c. administration, the fraction absorbed was 100%; in sheep (after the oral route); 23% of the dose was bioavailable; the main elimination route is via feces, in cattle and sheep, MOX represents 40% of the total radioactivity in liver, 50% in muscle, 60–75% in kidney and 90% in fat; MOX appears to be safe in breeding animals (no adverse effects on reproductive performance of bulls and pregnant cows at 3 times the recommended dose; calves under 100 kg b.w. may be susceptible to overdosing (use of correct dose is absolute); <i>limitations</i> for *Cydectin products in the USA: do not use in female dairy cattle of breeding age or on calves to be processed for veal (a withdrawal period has not been established for preruminating calves), Australia, and Germany: do not treat lactating cattle or sheep less than in certain intervals specified in respective labels, limitation for all *Cydectin injection products: subcutaneous administration only</p>		
<b>NARROW-SPECTRUM ANTHELMINTICS</b>		
<p>Substituted salicylanilides and phenols (cf. →<i>Cestodes</i>, Anticestodal Drugs, and →<i>Trematodes</i>, Antitrematodal Drugs) may be used for control of highly pathogen GI nematodes as <i>Haemonchus contortus</i> and other trichostrongylid nematodes of ruminants that have developed resistance to the broad-spectrum anthelmintics, particularly benzimidazoles (BZs), levamisole, and macrocyclic lactones (e.g., ivermectin)</p>		
<b>PHENOL DERIVATIVES</b>		
<p><b>nitroxylin</b> as eglumine (salt) (8.5 s.c. sheep) = (0.25 mL/10 kg b.w.) (10.2 s.c. cattle) = (1.5 mL/50 kg b.w.)</p>	<p>*Trodax Injectable Anthelmintic (Fort Dodge/Merial, Australia) injectable liquid (340 g nitroxylin/L) WT: sheep, cattle 28d (not approved: USA elsewhere, not available on German market, though MRLs established, EEC)</p>	<p>is of similar chemical structure to the herbicides ioxynil and bromoxynil and has a good efficacy against adult stages of liver flukes <i>Fasciola hepatica</i> and <i>F. gigantica</i> in sheep and cattle (cf. →<i>Trematodes</i>, Antitrematodal Drugs); drug is more than 99% effective against ivermectin- and BZ-resistant</p>
<p><i>Haemonchus contortus</i> (adults) of sheep and has also efficacy against <i>Parafilaria bovicola</i>, adult stages of <i>Oesophagostomum</i> spp. and <i>Bunostomum phlebotomum</i> in these hosts; it may cause some yellow staining of fleece in sheep, and local reactions at injection site; maximum tolerated dose in sheep is approx. 40 mg/kg; it is slowly reduced to an inactive metabolite in the rumen and is therefore preferably given by s.c. injection; drug is slowly eliminated from body into urine and feces (for 31 days), and milk as well (contraindicated in lactating animals)</p>		
<b>SALICYLANILIDES</b>		
<p><b>closantel</b> (sodium) (CS) (7.5–10, sheep, cattle); <b>drug combinations</b>: *1 closantel/<b>oxfendazole</b>; *2 closantel/<b>albendazole/levamisole/abamectin</b> *3 closantel/<b>albendazole</b> *4 closantel/<b>abamectin</b></p>	<p>*Flukiver (Janssen-Cilag), oral liquid (54.4 g CS/L, 1 mL/5 kg b.w.) WT: cattle 28d, sheep 42d (Germany); *Closamax (Pharmtech, Australia) for lambs, sheep, oral liquid (37.5 g CS/L, 1 mL/5 kg b.w. (drench), others, WT: 28d</p>	<p>CS is an effective flukicide (cf. →<i>Trematodes</i>, →<i>Antitrematodal Drugs</i>) with high activity also against bloodsucking nematodes as <i>H. contortus</i> other GI nematodes, including strains with single or multiple resistance to BZs, imidazothiazoles (levamisole, morantel) or macrocyclic lactones (e.g., ivermectin), and nasal</p>
<p>botfly (<i>Oestrus ovis</i>) and itch mite (<i>Psorergatus ovis</i>); <i>limitations</i>: do not use in female sheep, which are producing or may produce milk or milk products for human consumption; CS is primarily excreted via feces (80%, urine &lt;1%); the drug is well tolerated in sheep and cattle (also in reproduction studies in rams, ewes, and bulls); safety index in sheep and cattle is about 4 times the recommended dose; occasionally, CS may cause visual disorders; mode of action is uncoupling of oxidative phosphorylation <b>drug resistance</b> of GI nematodes is an increasing problem in sheep and goats worldwide and is an emerging problem in cattle; it is reported to occur mainly in trichostrongyles of sheep and goats (e.g., <i>Teladorsagia circumcincta</i> and <i>Haemonchus contortus</i>) and, to a lesser extent, in liver fluke (<i>Fasciola hepatica</i>) in sheep; there are various <b>closantel drug combinations</b> (approved by APVMA Australia for use in sheep, cf. left column): may control drug-tolerant and -sensitive strains of the Barber's Pole Worm (<i>H. contortus</i>), other trichostrongyles, and liver fluke, but also lungworms, tapeworms, nasal botfly (<i>Oestrus ovis</i>) and itch mite (<i>Psorergatus ovis</i>), and may be used in a strategic worm control program or as a quarantine drench to prevent the introduction of resistant strains of <i>H. contortus</i> into a property: 1*<i>Closicomb</i> (Virbac, Australia) for</p>		

**Nematocidal Drugs, Animals. Table 1** Drugs used against gastrointestinal (GI) nematode infections in ruminants (Continued)

CHEMICAL GROUP nonproprietary name of active substance (single oral dose, mg/kg body weight = b.w.), other information	*DRUG PRODUCT dose form (formulation), withdrawal time (WT) days (d) before slaughter, manufacturer, supplier, other information	CHARACTERISTICS miscellaneous comments on pharmacokinetics, metabolism, mode of action, toxicity, and limitations
<p>sheep and lamb, oral liquid, drench (37.5 g <i>closantel</i>/L //22.6 g <i>oxfendazole</i> /L: 1 mL/5 kg), WT: 28d, for the control of susceptible mature and immature GI roundworms and tapeworms, lungworms, liver fluke including 4 week old immature stages, all stages of nasal bots and sustained control of susceptible Barber's pole worm in sheep, <i>limitations</i> see →<i>closantel</i>; 2*Q-Drench (Jurox, Australia) a multicomponent drench for sheep and use in a strategic worm control program, oral liquid (37.5 g/L <i>closantel</i> //25 g/L <i>albendazole</i> //40 g/L <i>levamisole</i> hydrochloride, //1 g/L <i>abamectin</i>: 1 ml/5 kg b.w.), WT 28d for the treatment and control in sheep of susceptible GI roundworms; it is also effective against lungworm, tapeworms, mature and late immature liver fluke, nasal bot, and itch mite; 3*Closoal Broad Spectrum (Coopers, Schering-Plough, Australia), flukicide and sustained action haemonchicide for sheep, oral liquid, drench (37.5 g/L <i>closantel</i> as the sodium salt// 19 g/L <i>albendazole</i>: 1.5 mL/5 kg b.w.), WT: 28d, <i>indications</i>: for control of Closoal susceptible mature and immature GI roundworms, lungworms, tapeworms, nasal bots, liver fluke, and to reduce the output of viable worm and fluke eggs; for sustained control of Barber's Pole Worms (<i>Haemonchus contortus</i>) in sheep, <i>limitations</i>: do not use in lactating ewes where milk or milk products may be used for human consumption; 4*Genesis XTRA Drench (Ancare, Australia), oral liquid (50 g/L <i>closantel</i> //1 g/L <i>abamectin</i>: 1.5 mL/5 kg b.w.), WT: 49d, <i>indications</i>: for control and treatment of roundworms, nasal bot, itch mite and mature and late immature liver fluke in sheep with sustained activity against <i>resistant</i> strains of barbers pole worm (<i>H. contortus</i>) in sheep (including strains resistant to macrocyclic lactones), <i>limitations</i>: do not use in ewes, which are producing or may in the future produce milk or milk products for human consumption, do not use in lambs under 6 weeks of age or in lambs under 10 kg b.w.</p>		
<p><b>rafoxanide</b>, recommended oral dose may be 7.5 mg/kg b.w. for cattle/sheep and parenteral dose (s.c.) 3 mg/kg for cattle; is no longer available on the German Market (elsewhere) and not approved for anthelmintic indications in ruminants in the USA, Australia and elsewhere; as flukicide, it exhibits good activity against liver flukes and adult stages of ivermectin- and BZ-resistant <i>Haemonchus contortus</i> (Barber's pole worm) in sheep; it may reduce adult stages of other trichostrongyle nematodes in cattle and sheep; the drug may be used in a similar fashion to all other phenols or closantel, to provide specific control of <i>H. contortus</i> in sheep, thus reducing the selection pressure for resistance by broad-spectrum compounds; at recommended dose, it is well tolerated in sheep and cattle of all ages; drug is extensively bound (&gt;99%) to plasma proteins and has a long terminal half-life (~17 days), and consequently an extremely long withdrawal time (several months) for edible tissues; it is contraindicated in lactating animals; its mode of action is uncoupling of oxidative phosphorylation</p>		
<p><b>ORGANOPHOSPHATES</b></p>		
<p>many organophosphates have been tested for anthelmintic activity and several of them have been marketed for use in sheep, cattle, pigs, and horses; in some countries, a few of these chemicals may still be available for deworming medications (anthelmintics); their spectrum of activity is not as wide as that of broad-spectrum drugs (particularly in ruminants), and they have a relative narrow range of safety, especially in sheep; toxicity and mode of action are by the same mechanisms, and are attributable to acetyl-cholinesterase inhibition; typical toxic signs are salivation, diarrhea, and exaggerated symptoms; death may result from respiratory failure; worms show spastic paralysis and are removed by normal peristaltic action of the bowel; <i>coumaphos</i>, <i>haloxon</i> or <i>naphthalophos</i>, for example, may preferably be used against GI nematodes of cattle and sheep (chickens); these chemicals affect principally adult stages (&gt;90–75 %) and less developing larvae (50–75%) of GI nematodes in the abomasum and small intestine; they exhibit no activity against arrested larvae, and only variable effects (20–90%) on adult stages of GI nematodes parasitizing in large intestine; however organophosphates principally control infections due to <i>Haemonchus contortus</i>, <i>Ostertagia</i> spp., and <i>Trichostrongylus</i> spp.; they may be used either as a single drug in cattle (chicken) or in dual <i>combination</i> with different anthelmintics (see mix pack drenches ↓) in sheep particularly against BZs, levamisole and/or macrocyclic lactones <i>resistant</i> trichostrongyles; in general, therapeutic indices of organophosphates are significantly lower than those of broad-spectrum anthelmintics; therefore, exact dosing of drug products is a must in target species; <b>drug products</b>: *Purina 6 Day Worm-Kill Feed (Virbac, USA), Type A Medicated Article (contains 1.12% <i>coumaphos</i> as active constituent) for use in cattle (beef, dairy) and calves (3 months and older), <i>indications</i>: control of GI roundworms (<i>Haemonchus</i> spp., <i>Ostertagia</i> spp., <i>Cooperia</i> spp., <i>Nematodirus</i> spp., <i>Trichostrongylus</i> spp.), <i>limitations</i>: feed 0.0002 pounds (0.091 g)/100 pound b.w./day for 6 consecutive days in normal grain ration to which animals are accustomed but not in rations containing more than 0.1% <i>coumaphos</i>, do not feed to animals less than 3 months old; *Combat Oral Drench (Virbac Australia) for use in sheep and lambs (&gt;6 kg b.w.), oral liquid (800 g/L <i>naphthalophos</i>: 2–22 mL prepared drench/head, for exact doses see label), WT: sheep 7d, for control organophosphate-susceptible strains of GI roundworms (mature and immature stages) including strains of barber's pole worm (<i>H. contortus</i>) resistant to ivermectin and moxidectin; *Halox Bolus (Schering-Plough AH, USA) for cattle (dairy, not breeding age), 1 bolus for 500 pounds b.w., WT: 7d, for GI round worms (<i>H. contortus</i>, <i>Ostertagia</i> spp., <i>Trichostrongylus</i> spp., <i>Cooperia</i> spp.); *Rametin ML Sheep Drench MIX PACK (Bayer Australia), 2 oral drenches, which may be mixed or used alone (800 g/L <i>naphthalophos</i>; 2 g <i>abamectin</i>: 2–22 mL prepared drench/head, for exact doses see label), WT: sheep 14d, when combined as directed controls susceptible and resistant GI nematodes, lungworms, itch mite (<i>Psorergatus ovis</i>) and nasal bot (<i>Oestrus ovis</i>), or *Rametin Combo Sheep Drench MIX</p>		

**Nematocidal Drugs, Animals. Table 1** Drugs used against gastrointestinal (GI) nematode infections in ruminants (Continued)

CHEMICAL GROUP nonproprietary name of active substance (single oral dose, mg/kg body weight = b.w.), other information	*DRUG PRODUCT dose form (formulation), withdrawal time (WT) days (d) before slaughter, manufacturer, supplier, other information	CHARACTERISTICS miscellaneous comments on pharmacokinetics, metabolism, mode of action, toxicity, and limitations
PACK (Bayer Australia), two oral drenches, which may be mixed or used alone (800 g/kg naphthalophos; 67.9 g/L levamisole HCl/ 50 g/L fenbendazole: 2–22 mL prepared drench/head, for exact doses see label), WT: sheep 14d, when combined as directed controls organophosphate and benzimidazole/levamisole susceptible strains of GI roundworms and lungworms in sheep and lambs, <b>limitations</b> (for drug products containing naphthalophos): do not use in female sheep which are producing or may in the future produce milk or milk products for human consumption, <b>limitations</b> for drug products that contain <i>coumaphos</i> or <i>naphthalophos</i> : do not feed to sick animals or animals under stress, such as those just shipped, dehorned, castrated, or weaned within the last 3 weeks; do not feed in conjunction with oral drenches or with feeds containing <i>phenothiazine</i> ; should conditions warrant repeat treatment at 30-day intervals; adequate directions and warnings for use must be given and shall include a statement that coumaphos (naphthalophos) is a cholinesterase inhibitor and that animals being treated with coumaphos (naphthalophos) should not be exposed during or within a few days before or after treatment to any other cholinesterase-inhibiting drugs, insecticides, pesticides, or chemicals		

Data of drug products (approved labels) listed in this table refer to information from literature, manufacturer, supplier, and websites such as the European Medicines Agency (EMA), Committee for Veterinary Medicinal Products (CVMP), the US Food and Drug Administration (FDA), Center for Veterinary Medicine (CVM), the Australian Pesticides and Veterinary Medicines Authority (APVMA), and associated Infopost (search for products), VETIDATA, Leipzig, Germany, and Clini Pharm, Clini Tox (CPT), Zurich, Switzerland  
Data given in this table have no claim to full information

**Nematocidal Drugs, Animals. Table 2** Withdrawal time of some antinematodal drug products (German market)

TRADEMARK NAME (substance)	EDIBLE TISSUES days (target species)	OTHER EDIBLE PRODUCTS days (target species)
Piperazincitrate (powder) <b>(piperazine citrate)</b>	2 (chicken); 4 (swine)	5: eggs
Thiabendazol paste Thiabendazol powder <b>(thiabendazole)</b>	6 (cattle, goats) 6 months (horse: MRLs is not yet established)	4: milk (cattle, goat) (horse is classed as a food animal in EEC)
Systemex suspension Systemex interval bolus <b>(oxfendazole)</b>	10 (cattle, sheep) 180 (cattle, calves)	5: milk (cattle)
Albendazol 10% suspension Valbazen 10%/1.9% <b>(albendazole)</b>	21/14 (cattle/sheep) 28/10 (cattle/sheep)	5: milk (cattle) 5/5: milk (cattle/sheep)
Panacur 10%/2.5% suspension Panacur SR bolus <b>(fenbendazole)</b>	7 (cattle, horses)/10 (sheep) 200 (cattle)	6/7: milk (cattle/sheep)
Levamisol spot-on Levamisol 10 for injection Concurat L 10% (powder) <b>(levamisole)</b>	22 (cattle) 8 (cattle, sheep, swine) 14 (poultry, swine) 21 (cattle, sheep)	not approved
Banminth horse paste <b>(pyrantel embonate)</b>	0 (horses)	not approved
Ivomec premix/S for injection Ivomec P (paste)/pour-on <b>(ivermectin)</b>	7/14 (swine) 21/15 (horses/cattle)	not approved
Eprinex pour-on <b>(eprinomectin)</b>	15 (cattle)	0 (milk)
Dectomax for injection Dectomax pour-on	60/70 (cattle/sheep) 35 (cattle)	not approved

**Nematocidal Drugs, Animals. Table 3** Drugs used against gastrointestinal nematodes in horses

CHEMICAL GROUP nonproprietary name of active substance (single oral dose, mg/kg body weight = b.w.), other information	*DRUG PRODUCT dose form (formulation), withdrawal time (WT) days (d) before slaughter, manufacturer, supplier, other information	CHARACTERISTICS miscellaneous comments on pharmacokinetics, metabolism, mode of action, toxicity and limitations
<p>basic information on antinematodal anthelmintics used in horses are given in text; in equines, anthelmintics should be used strategically; this means that the epizootiology of nematode infection, and local management conditions have to be considered in the treatment program; drug tolerance of small strongyles (cyathostomes) is now widespread and common; anthelmintic resistance in horse parasites generally reveals a close association between the prevalence of resistance in cyathostomes and the frequent use of benzimidazoles in their full bloom (1970s and 1980s); life cycles among GI nematodes may differ considerably in their generation length and thus generation time and can be influenced through local weather conditions and pasture conditions in certain climate zones; it has been suggested that the rotation of anthelmintics belonging to chemical different groups shall retard or even avoid selection of resistance; however, rotating drugs may cause selection of multiple drug resistance in strongyles if chemically different anthelmintics are used against parasite populations of the same generation; therefore anthelmintic classes should rotate on an annual basis; an alternative to rotation might be the simultaneous use of 2 or more chemically different drugs; the use of effective drugs against target parasites and the correct dose have to be strictly observed to safeguard the efficacy of drugs; fecal egg counts should performed twice weekly postdosing to get information on egg reappearance period and thus best intervals between treatments; particular attention should be paid to large strongyle eggs because of the high pathogenicity of large strongyles (<i>Strongylus vulgaris</i> and <i>S. edentatus</i>) to horses</p>		
<p><b>phenothiazine</b>, old-timer, which is active against adult stages of small strongyles (more than 90%); as a single drug, it has little or no effect on large strongyles, immature stages of small strongyles, and <i>Parascaris equorum</i>; at therapeutic dose, there may be side effects, such as anorexia, muscular weakness, icterus, anemia, but seldom mortality; it was used for treating large roundworms and BZ-resistant strains of cyathostomes (small strongyles); phenothiazine-resistant strains of small strongyles were reported as soon as the early 1960s and markedly reduced its use in subsequent years; current drug products for use in horses are dual or triple <b>drug combinations</b> that contain <i>phenothiazine/piperazine</i> (*Parvex Plus, Pharmacia &amp; Upjohn, oral liquid) or <i>phenothiazine/piperazine/trichlorfon</i> (*Dyrex TF, Fort Dodge, powder, oral liquid); they are still available in the USA (elsewhere) but federal law restricts these drugs to use by or on the order of a licensed veterinarian; <b>indications</b>: *Parvex, for removing ascarids (large roundworms, <i>P. equorum</i>), bots (<i>Gasterophilus</i> spp., small strongyles, and large strongyles (<i>Strongylus</i> spp.)), *Dyrex, for removal of bots (<i>G. nasalis</i>, <i>G. intestinalis</i>), large strongyles (<i>S. vulgaris</i>), small strongyles, large roundworms, (ascarids, <i>P. equorum</i>), and pinworms (<i>Oxyuris equi</i>); <b>limitations</b> (for both products): administer by stomach tube, do not administer to sick, toxic, or debilitated horses or mares in late pregnancy (not recommended), treatment of debilitated or anemic animals is contraindicated, not to be used in horses intended for use as food; *Dyrex that contains <i>trichlorfon</i> is a cholinesterase inhibitor and should not be used in horses simultaneously with, or within 2 weeks before or after treatment with, or exposure to, neuromuscular depolarizing agents (e.g., succinylcholine) or to cholinesterase-inhibiting drugs, pesticides, or chemicals</p>		
<b>AMINES</b>		
<p><b>piperazine</b> (base) (~90 base, horse) (as base it easily absorbs water) *1 piperazine salts (carbon disulfide complex = *Parvex: horse, pony no use class stated or implied, treatment of debilitated or anemic animals is contraindicated) *2 piperazine citrate or phosphate/ <b>thiabendazole</b> *3 piperazine citrate/<b>dithiazanine</b> iodide *4 piperazine 2HCL/<b>levamisole</b> HCl *5 piperazine 2HCL/<b>oxfendazole</b></p>	<p>1*Parvex Suspension or Bolus (Pharmacia &amp; Upjohn USA), 1*Piperazin citrate, powder (Bela Pharm Germany), 1*Piperazine 2HCl (Australia), powder 2*Equizole A, liquid or powder (Merial USA), 3*Dizan Suspension (Boehringer- Ingelheim, USA), 4*Ripercol L Piperazine, powder or liquid (Fort Dodge USA), for details cf. levamisole ↓ *5Worma Paste, oral paste (Farnam, Intern. AH Products Australia)</p>	<p>old-timer, anthelmintic activity was recognized in the 1950s; piperazine (various salts) has been widely used in horses; it is effective (&gt;90) against adult stages of small strongyles and ascarids (<i>Parascaris equorum</i>, adults, developmental stages: because of the 12-week patency period, repeated doses at 10-week intervals are needed in young animals); there is only moderate effect (60–70%) against adult pinworm <i>Oxyuris equi</i> and only weak-to-zero efficacy against adult <i>Strongylus vulgaris</i>; it has no effect against stomach worms (<i>Habronema</i></p>
<p><i>microstoma</i>); piperazine is well tolerated in horses; at higher doses (13 times the therapeutic dose) transient softening of the feces occurs; mode of action is anticholinergic action at myoneural junction in worms causing neuromuscular block leading to paralysis and expulsion of worms; <b>drug combinations</b>: piperazine is combined with other anthelmintics to enhance spectrum of activity against <i>Gasterophilus</i> bots, adult stomach hair worm (<i>Trichostrongylus axei</i>), adult stomach worm</p>		

**Nematocidal Drugs, Animals. Table 3** Drugs used against gastrointestinal nematodes in horses (Continued)

CHEMICAL GROUP nonproprietary name of active substance (single oral dose, mg/kg body weight = b.w.), other information	*DRUG PRODUCT dose form (formulation), withdrawal time (WT) days (d) before slaughter, manufacturer, supplier, other information	CHARACTERISTICS miscellaneous comments on pharmacokinetics, metabolism, mode of action, toxicity and limitations
<p>(<i>H. microstoma</i>), small strongyles (Cyathostomes) and large strongyles (<i>Strongylus</i> spp. incl. migrating stages), ascarids, and pinworms; examples for <b>approved indications</b> (piperazine carbon disulfide complex = *Parvex): for removing ascarids (large roundworms, <i>P. equorum</i>), large strongyles (<i>Strongylus</i> spp.), bots (<i>Gasterophilus</i> spp.: see also drug combinations phenothiazine (↑), small strongyles, and pinworms (<i>O. equi</i>); <b>approved indications</b> (piperazine//thiabendazole): treatment of infections of large strongyles (genus <i>Strongylus</i>), small strongyles (genera <i>Cyathostomum</i>, <i>Cylicobrachytus</i>, and related genera <i>Craterostomum</i>, <i>Oesophagodontus</i>, <i>Poteriostomum</i>), pinworms (<i>Oxyuris</i>), threadworms (<i>Strongyloides</i>), and ascarids (<i>Parascaris</i>); similar indications are approved for piperazine//levamisole or piperazine//oxfendazole; <b>limitations</b> (drug combinations, USA): federal law restricts these drugs to use by or on the order of a licensed veterinarian, not for use in horses intended for food purposes; treatment of debilitated or anemic animals is contraindicated, do not administer to animals that are or were recently affected with colic, diarrhea, or infected with a serious infectious disease; as with most anthelmintics drastic cathartics or other gastrointestinal irritants should not be administered in conjunction with this drug, animals in poor condition or heavily parasitized should be given half the recommended dose and treated again in 2 or 3 weeks;</p>		
<p><b>ORGANOPHOSPHATES</b> had their origin as pesticides and their main effect on animal parasites is inhibition of nematodal acetylcholinesterase; they have activity against some benzimidazole resistant nematodes and arthropods (e.g., bots <i>Gasterophilus</i> spp.)</p>		
<p>*1 <b>trichlorfon</b> (approx. 35–40, horse, mule) (drug is not approved in Germany, elsewhere) <b>combinations:</b> *2 trichlorfon//thiabendazole *3 trichlorfon//mebendazole *4 trichlorfon//oxfendazole</p>	<p>1*Dyrex Bolus, Capsules, Granules, Tablets (Fort Dodge USA) 1*Neguvon (Bayer Australia), powder; 2*Equivet (Farnam USA), liquid, 3* Telmin B (USA), paste, powder 3*Telmin Plus (Australia), granules, paste; 4*Benzelmin Plus Paste (Fort Dodge USA)</p>	<p>its spectrum is rather narrow; more than 90% efficacy against adult and immature <i>P. equorum</i> (adult and immature stages), adults pinworms (<i>O. equi</i>) and against bots (larvae of <i>Gasterophilus nasalis</i> and <i>G. intestinalis</i>); at higher doses (60 mg trichlorfon/kg) it is active against <i>S. vulgaris</i> and small strongyles; at therapeutic dose there may be mild</p>
<p>adverse effects (transient softening of feces and mild colic for several hours though horses may tolerate 80 mg/kg in-feed); the conversion of trichlorfon at physiological pH to dichlorvos is believed to contribute to its activity (cf. also → <a href="#">Trematodocidal Drugs/Table 2: Schistosoma haematobium</a>); <b>approved indications</b> (USA) for removal of bots (<i>Gasterophilus nasalis</i>, <i>Gasterophilus intestinalis</i>), large strongyles (<i>Strongylus vulgaris</i>), small strongyles, large roundworms (ascarids, <i>Parascaris equorum</i>), and pinworms (<i>Oxyuris equi</i>), <b>limitations</b>: treatment of mares in late pregnancy is not recommended, do not administer to sick, toxic, or debilitated horses; not to be used in horses intended for food, federal law restricts this drug to use by or on the order of licensed veterinarian, trichlorfon is a cholinesterase inhibitor, do not use this product on animals simultaneously with, or within two weeks, before or after treatment with or exposure to, neuromuscular depolarizing agents (i.e., succinylcholine) or to cholinesterase-inhibiting drugs, pesticides, or chemicals; <b>drug combinations</b> (↑) enhance anthelmintic spectrum in horse; addition of BZs provides higher activity against ascarids, pinworms, small strongyles (cyathostomes), and large strongyles (there is insignificant effect against migratory larvae of <i>S. vulgaris</i> in walls of mesenteric arteries) (details for dose forms, conditions of use, specifications, dosage see respective labels); <b>withdrawal time</b> (USA): do not apply to horse, Australia: 28 days (horse meat)</p>		
<p>*1 <b>dichlorvos</b> (DCV) (31–41, top dressing, horse, pony, mule; not for use in foals: young weanlings, suckling) (20, gel, horse) DCV is not approved in Germany, elsewhere *2 dichlorvos//oxibendazole</p>	<p>1*Equigard, top dressing, 1*Equigel, gel (Boehringer Ingelheim, USA) 2*Oximinth Plus Boticide (5 g DCV/ Sg//5 g oxibendazole/Sg: 5 ml/100 kg b.w.) (Virbac Australia), paste, WT: 28d, do not administer on an empty stomach</p>	<p>its spectrum of activity is basically similar to that of trichlorfon: the drug is active (&gt;90%) against mature and immature <i>P. equorum</i> (adults and L4), large strongyles (<i>Strongylus vulgaris</i>, <i>S. equinus</i>, <i>S. edentatus</i>), small strongyles (of the genera <i>Cyathostomum</i>, <i>Cylicocercus</i>, <i>Cylicodontophorus</i>, <i>Triodontophorus</i>, <i>Poteriostomum</i>),</p>
<p><i>Oxyuris equi</i>, and bots (<i>Gasterophilus intestinalis</i>, <i>G. nasalis</i>: 1st, 2nd, 3rd instar bots); there is no effect against stomach worms (<i>T. axei</i>, <i>Draschia megastoma</i>, and <i>Habronema muscae</i>), which cause summer sores, and cutaneous habronemiasis; at therapeutic doses there may be side effects such as soft feces, salivation, muscle tremors, and incoordination with the paste; treatment causes no ill-effects in mares and foals; for general <b>limitations</b> for DCV (USA: horses not for meat production) see trichlorfon (↑)</p>		
<p><b>haloxon</b> (60 mg/kg b.w.) another organophosphate is no longer available for use in horses (USA), it is highly effective (more than 90%) against adult stages of <i>S. vulgaris</i>, most small strongyles (also benzimidazole-resistant strains), <i>P. equorum</i>, and</p>		

**Nematocidal Drugs, Animals. Table 3** Drugs used against gastrointestinal nematodes in horses (Continued)

CHEMICAL GROUP nonproprietary name of active substance (single oral dose, mg/kg body weight = b.w.), other information	*DRUG PRODUCT dose form (formulation), withdrawal time (WT) days (d) before slaughter, manufacturer, supplier, other information	CHARACTERISTICS miscellaneous comments on pharmacokinetics, metabolism, mode of action, toxicity and limitations
<p><i>O. equi</i>; at 3 times the recommended dose there are no ill-effects; at recommended dose it was a safe drug for pregnant mares; it also exhibits moderate activity against <i>Schistosoma mattheei</i> as does trichlorfon; repeated high doses of haloxon (300 mg/kg × 2) are necessary to affect this trematode; haloxon is approved for use in cattle (*Halox Wormer drench, or *Halox Bolus, Schering Plough AH, USA) for control of gastrointestinal roundworms of the genera <i>Haemonchus</i>, <i>Ostertagia</i>, <i>Trichostrongylus</i>, and <i>Cooperia</i> (see Table 1)</p>		
<p><b>BENZIMIDAZOLES (BZs)</b> at regular therapeutic (recommended dose), BZs have little or no activity against migrating larvae of <i>Strongylus vulgaris</i> in adventitia of arteries or against stomach worms (<i>Habronema muscae</i>, <i>Draschia megastoma</i>, and others) and bots (<i>Gastrophilus intestinalis</i>, <i>G. nasalis</i>); efficacy of BZs against lungworms (<i>Dictyocaulus arnfieldi</i>) is evident after repeated and enhanced doses; widespread resistance of small strongyles (cyathostomes) against BZs has limited their use in horses in time (action on tapeworms cf. → <b>Cestodocidal Drugs</b>)</p>		
<p><b>thiabendazole</b> (44–50 regular dose, horse) (88, horse: ascarids) <b>combinations</b> (cf. ↑): thiabendazole/ <b>piperazine</b> citrate or phosphate <b>thiabendazole/trichlorfon</b></p>	<p>*Equizole (Merial USA), various drug/ dose forms: granules/top dressing; top dressing/top dressing, liquid, paste; *Tiabendazol (CEVA AH Germany), powder or paste; <b>limitations</b> all products: horses not for meat production</p>	<p>is highly effective (more than 90%) against adult stages of large and small strongyles (to a lesser extent immature stages), <i>Oxyuris equi</i>, small pinworms (<i>Probstmayria</i> <i>vivipara</i>) and <i>Strongyloides westeri</i>; at recommended dose, efficacy against</p>
<p><i>Parascaris equorum</i>, <i>Trichostrongylus axei</i>, and <i>O. equi</i> (L<sub>4</sub>) is insufficient and dose must be enhanced or given twice to provide sufficient activity against these parasites; at extremely high dose levels (440 mg/kg × 2) the drug is effective against 14-day-old larvae of <i>Strongylus vulgaris</i> and <i>S. edentatus</i> (reduced appetite; thiabendazole-resistant small strongyles show side-resistance to related BZs); <b>approved indications</b> (regular dose, USA): for control of large and small strongyles, <i>Strongyloides</i>, and pinworms of the genera <i>Strongylus</i>, <i>Cyathostomum</i>, <i>Cylicobrachytus</i>, and related genera, <i>Craterostomum</i>, <i>Oesophagodontus</i>, <i>Poteriostomum</i>, <i>Oxyuris</i>, and <i>Strongyloides</i>; it appears to be a safe drug for mares (also during pregnancy) and foals; depression, and mild colic may occur at 24 times the recommended dose</p>		
<p><b>cambendazole</b> (20, horse) <b>limitations</b>: horse not for meat production, and restricted during pregnancy</p>	<p>*Camvet (Merial USA), liquid (suspension), pellets (top dressing), paste; <b>limitations</b>: not for use in horses intended for food (WT do not apply to species listed)</p>	<p>has a broad spectrum of activity; it is effective (more than 90%: BZs sensitive strains) against adult stages of <i>Parascaris equorum</i>, <i>Probstmayria</i> <i>vivipara</i>, <i>Strongylus vulgaris</i>, <i>S. edentatus</i>, small strongyles,</p>
<p><i>Strongyloides westeri</i>, and <i>Oxyuris equi</i>; it is particularly effective against stomach worm <i>Trichostrongylus axei</i> but ineffective against <i>Draschia megastoma</i>; at therapeutic dose it is less active (75–90%) against immature stages of small strongyles; there is side-resistance to related BZs; <b>approved indications</b> (USA): for control of large strongyles (<i>S. vulgaris</i>, <i>S. edentatus</i>, <i>S. equinus</i>); small strongyles (genera <i>Trichonema</i>, <i>Poteriostomum</i>, <i>Cylicobrachytus</i>, <i>Craterostomum</i>, <i>Oesophagodontus</i>); roundworms (<i>Parascaris</i>); pinworms (<i>Oxyuris</i>); and threadworms (<i>Strongyloides</i>); <b>limitations</b> (USA): for animals maintained on premises where reinfection is likely to occur, re-treatments may be necessary, for most effective results, re-treat in 6–8 weeks; <b>caution</b>: do not administer to pregnant mares during first 3 months of pregnancy, federal law restricts this drug to use by or on the order of a licensed veterinarian; <b>tolerability</b>: the drug appears to be well tolerated at 8 times the recommended dose (30 times may cause transient depression and softening of feces); in studies, cambendazole has been found to be teratogenic limiting its use in pregnant animals; in Australia, Germany (and elsewhere), the drug is not approved for use in horses or ruminants</p>		
<p><b>BENZIMIDAZOLE CARBAMATES</b> differ in their structure from thiabendazole, cambendazole (and thiophanate) in having a carbamate substitution on C5 of the benzene ring increasing anthelmintic activity</p>		
<p><b>mebendazole (MBZ)</b> (8.8, horse) <b>combination</b>: (8.8 MBZ/40 <b>trichlorfon</b>, horse): *Telmin plus, paste, granules, Australia cf. trichlorfon (↑), *Telmin B, paste, powder (liquid), Schering-Plough USA, (horse over 4 months of age)</p>	<p>*Telmin (Schering-Plough USA) various drug forms: powder, liquid, paste; horse not for meat production (WT not applied to species listed) *Telmin (Boehringer-Ingelheim Australia), granules, or paste, WT: horse 28d *Telmin (Janssen-Cilag Germany) paste, WT: horse 7d</p>	<p>has a broad spectrum of activity; efficacy is directed against adult stages of large strongyles (&gt;90%) and small strongyles (75–90%) as well as against <i>O. equi</i> (also immature stages) and <i>P. equorum</i> (both more than 90%); it is less active (about 75%) against immature stages of small strongyles; migrating</p>

**Nematocidal Drugs, Animals. Table 3** Drugs used against gastrointestinal nematodes in horses (Continued)

CHEMICAL GROUP nonproprietary name of active substance (single oral dose, mg/kg body weight = b.w.), other information	*DRUG PRODUCT dose form (formulation), withdrawal time (WT) days (d) before slaughter, manufacturer, supplier, other information	CHARACTERISTICS miscellaneous comments on pharmacokinetics, metabolism, mode of action, toxicity and limitations
<p>larvae of <i>S. vulgaris</i> were affected by 13.6 times the recommended dose (120 mg/kg × 2); it is poorly effective against <i>T. axei</i>, <i>S. westeri</i>, as well as against <i>Habronema muscae</i> and <i>Draschia megastoma</i>; a single dose of 20 mg/kg is effective against <i>Dictyocaulus arnfieldi</i>; there is side-resistance to other benzimidazoles; <b>approved indications</b> (MBZ): for treatment of infections caused by large roundworms (<i>Parascaris equorum</i>); large strongyles (<i>Strongylus edentatus</i>, <i>S. equinus</i>, <i>S. vulgaris</i>); small strongyles; and pinworms (<i>Oxyuris equi</i>: mature and immature L<sub>4</sub>), <b>combination</b> MBZ/trichlorfon includes treatment of infections of bots (<i>Gasterophilus intestinalis</i> and <i>G. nasalis</i>), large roundworms, large strongyles, small strongyles, and pinworms; <b>limitations</b> (MBZ/trichlorfon): do not treat sick or debilitated animals, foals under 4 months of age, or mares in the last month of pregnancy, trichlorfon is a cholinesterase inhibitor, do not administer simultaneously or within a few days before or after treatment with, or exposure to cholinesterase-inhibiting drugs, pesticides, or chemicals, do not administer intravenous anesthetics, especially muscle relaxants, concurrently; in the USA and elsewhere, federal law restricts this drug to use by or on the order of a licensed veterinarian; <b>tolerability</b> of MBZ: from 5 times the recommended dose upward there may be slight side effects (fecal softening, diarrhea); in toxicological studies, the drug has been found to be teratogenic which may limiting its use in pregnant animals during early pregnancy</p>		
<p><b>fenbendazole</b> (FBZ) (5–10 horse) (10: <i>P. equorum</i>) *Panacur 100, liquid, *Panacur Equine Guard, paste: horse WT: 28d (Australia), others, *Panacur: paste, suspension 10%: horse, donkey WT: 7d, granules, horse WT: 20d (Germany), others</p>	<p>*Panacur (Intervet): suspension 10%, paste, granules 22.2%, *Safe-Guard, Type A (B) medicated Article: horse not for meat production: all products, WT do not apply to the species listed for these products (USA), other species, e.g., swine WT 14d, wildlife (ruminants) WT 14d</p>	<p>has a broad spectrum of activity; it is highly effective (more than 90%) against adult stages of large and small strongyles and adult and immature stages of <i>Oxyuris equi</i>, <i>Probstmayria</i> <i>vivipara</i>, and <i>Parascaris equorum</i> (10 mg/kg × 1 or 5 mg/kg × 2); higher doses (e.g., 60 mg/kg) or repeated doses (7.5 mg/kg daily for</p>
<p>5 days) give good control of larval stages of small strongyles in the gut lumen and in the mucosa, and of migrating larvae of <i>Strongylus vulgaris</i>, <i>S. edentatus</i>, and <i>S. westeri</i>; repeated (10 mg/kg × 5) or high doses (30–60 mg/kg) affect <i>Habronema muscae</i> and <i>Draschia megastoma</i>, and <i>Trichostrongylus axei</i>; a single dose of 50 mg/kg is effective against <i>Dictyocaulus arnfieldi</i>; <b>approved indications</b> (paste USA): for control of large strongyles (<i>S. edentatus</i>, <i>S. equinus</i>, <i>S. vulgaris</i>), small strongyles, pinworms (<i>O. equi</i>), and ascarids (<i>P. equorum</i>) in horses, for treatment of encysted mucosal cyathostome (small strongyle) larvae including early third-stage (hypobiotic), late third-stage, and fourth-stage larvae in horses: *Safe-Guard Type A Medicated Article: horse, USA: amount (horses): 4540 g/ton, indications: 5 mg/kg b.w. (2.27 mg/pound) for control of large strongyles (<i>S. edentatus</i>, <i>S. equinus</i>, <i>S. vulgaris</i>, <i>Triodontophorus</i> spp.), small strongyles (<i>Cyathostomum</i> spp., <i>Cylicocycylus</i> spp., <i>Cylicostephanus</i> spp.) and pinworms (<i>O. equi</i>); 10 mg/kg b.w. (4.54 mg/pound = 10 mg/kg b.w.) for the control of ascarids (<i>P. equorum</i>), <b>limitations</b>: feed at the rate of 0.1 pound of feed/100 pounds to provide 2.27 mg FBZ/pound b.w. in a 1-day treatment or 0.2 pounds of feed/100 pounds b.w. to provide 4.54 mg FBZ/pound b.w. in a one-day treatment; all horses must be eating normally to ensure that each animal consumes an adequate amount of the medicated feed; regular deworming at intervals of 6–8 weeks may be required due to the possibility of reinfection, do not use in horses intended for food; <b>tolerability</b>: FBZ has no teratogenic effects and does not interfere with reproductive function of stallions; it is well tolerated and shows no adverse effects at 500 mg/kg b.w. and higher doses; there is side-resistance to the other BZ compounds</p>		
<p><b>oxfendazole</b> (OFZ) (10 horse) oxfendazole/ <b>trichlorfon</b>: (2.5/40) = *Benzelmin Plus Paste (Fort Dodge, USA, cf. trichlorfon ↑) oxfendazole/<b>pyrantel</b> pamoate = *Strategy-T Paste (6 g OXF/Sg// 7.8 PYR/Sg: 5 mL/100 kg b.w.), WT: 28d (Vetsearch Internat. Australia)</p>	<p>*Benzelmin, *Synanthic (Fort Dodge USA), powder (liquid), top- dressing, suspension, paste: horse not for meat production: all products, WT do not apply to these species listed for these products; *Oxazole (Jurox), liquid (drench), WT 28d, *VR Benzelmin Paste, WT: 28d (Fort Dodge Australia) others</p>	<p>has broad spectrum of activity; it is highly effective (more than 90%) against adult stages of large strongyles and those of small strongyles (including their immature stages in the gut lumen or in the mucosa) and against <i>Parascaris equorum</i> and <i>Oxyuris equi</i> (including immature stages of the latter species); the drug is particularly effective against <i>Trichostrongylus axei</i>;</p>
<p>its action against migrating <i>Strongylus vulgaris</i> appears to be more variable; it shows poor efficacy against <i>Strongyloides westeri</i>, <i>Habronema muscae</i> and <i>Draschia megastoma</i>; <b>approved indications</b>: *Benzelmin, *Synanthic suspension, USA: for removal of large roundworms (<i>P. equorum</i>), mature and 4th-stage larvae pinworms (<i>O. equi</i>), large strongyles (<i>S. edentatus</i>, <i>S. vulgaris</i>, and <i>S. equinus</i>), and small strongyles; <b>limitations</b>: administer 9.06% suspension by stomach tube or dose syringe, horses maintained on premises where reinfection is likely to occur should be retreated in 6–8 weeks, administer drug with</p>		

**Nematocidal Drugs, Animals. Table 3** Drugs used against gastrointestinal nematodes in horses (Continued)

<b>CHEMICAL GROUP</b> nonproprietary name of active substance (single oral dose, mg/kg body weight = b.w.), other information	<b>*DRUG PRODUCT</b> dose form (formulation), withdrawal time (WT) days (d) before slaughter, manufacturer, supplier, other information	<b>CHARACTERISTICS</b> miscellaneous comments on pharmacokinetics, metabolism, mode of action, toxicity and limitations
caution to sick or debilitated horses, do not use in horses intended for food; if administered by stomach tube: federal law restricts this drug to use by or on the order of licensed veterinarian (no restriction if administered by dose syringe only); <b>drug combinations</b> (← cf. left column) will enhance anthelmintic spectrum against bots <i>Gasterophilus nasalis</i> and <i>G. intestinalis</i> ( <b>trichlorfon</b> ) or tapeworm <i>Anoplocephala perfoliata</i> ( <b>pyrantel</b> pamoate (PYR): >70% efficacy); for oxfendazole/ <b>piperazine</b> 2HCL = *Worma Paste, oral paste, WT: 28d (Farnam, Intern. AH Products, Australia) cf. piperazine (↑); <b>tolerability</b> : at 10 times the recommended dose transient softening of feces may occur; OFZ has been found to be teratogenic, which may limit its use in pregnant animals in early pregnancy; there is side-resistance to the other members of BZs		
<b>oxibendazole (OXZ)</b> (10 horse) (15 foals, horse: <i>Strongyloides westeri</i> = threadworms) <b>combination</b> : oxibendazole/ <b>dichlorvos</b> (*Oximinth-plus Boticide, Virbac Australia), paste, WT: 28d (for details cf. dichlorvos ↑)	*Anthelcide EQ (Pfizer USA), suspension, paste: (horse not for meat production) *Anthelcide EQ (Ranvet Australia), liquid, horse, foals WT: 28d, *Oximinth (Virbac Australia), paste, WT: 28d (OXZ products for horse are not approved in Germany, elsewhere)	has a broad spectrum of activity; it is highly effective (more than 90%) against adult stages of large strongyles and those of small strongyles (including immature L <sub>4</sub> stages in the gut lumen and it is ovicidal, i.e., kills worm eggs) and against threadworms ( <i>Strongyloides westeri</i> : at enhanced dosage), <i>Parascaris equorum</i> ,
<i>Oxyuris equi</i> , and <i>Probstmayria vivipara</i> ; OXZ exhibits poor efficacy against <i>Trichostrongylus axei</i> , <i>Habronema muscae</i> , and <i>Draschia megastoma</i> , and migrating stages of <i>Strongylus vulgaris</i> ; it may be active against strongyles resistant to other BZs; <b>approved indications</b> (USA; similar: Australia): for removal and control of large strongyles ( <i>S. edentatus</i> , <i>S. equinus</i> , <i>S. vulgaris</i> ); small strongyles (genera <i>Cylicostephanus</i> , <i>Cylicocyclus</i> , <i>Cyathostomum</i> , <i>Triodontophorus</i> , <i>Cylicodontophorus</i> , and <i>Gyaloccephalus</i> ); large roundworms ( <i>P. equorum</i> ); pinworms ( <i>O. equi</i> ) including various larval stages; and threadworms ( <i>S. westeri</i> ), <b>limitations</b> (USA): horses maintained on premises where reinfection is likely to occur should be retreated in 6–8 weeks, not for use in horses intended for human consumption; <b>tolerability</b> : OXZ appears to be safe for horses: at 3 times the recommended dose there were no side effects, at 4 times the recommended dose; it was found to be embryotoxic in rats and sheep but it is safe to use in foals, pregnant mares, and breeding stallions (label *Anthelcide EQ, Ranvet Australia)		
<b>albendazole</b> is not approved for use in equines (USA, Australia, Germany, elsewhere); in experimental studies, albendazole (5 mg/kg b.w.) proved to be effective (>90%) against adults of large and small strongyles, <i>Oxyuris equi</i> (more than 90% against immature stages), and <i>Parascaris equorum</i> ; its effect against immature larvae (L <sub>4</sub> ) of small strongyles in the gut lumen was moderate (about 70–90%); at 25 mg/kg b.w. (3x/d for 5 days) the drug showed excellent efficacy against 30-day-old migrating larvae of <i>S. vulgaris</i> ; however, this regimen could cause unpredictable side effects such as severe diarrhea, and infrequently mortality; dose regimen of 25 mg/kg 2x/d is effective against lungworm <i>D. arnfieldi</i> ; the drug has been found to be teratogenic in lambs, limiting its use in pregnant animals		
<b>PROBENZIMIDAZOLES</b>		
<b>febantel (FBT)</b> (6) *Rintal Paste, paste, WT: horse 20d, *Rintal 1.9% Pellets, top dressing, WT: horse 20d (Bayer Vital Germany and elsewhere); (drug products not approved for horses in Australia)	*Rintal Suspension (liquid: top dressing) *Rintal,*Cutter Paste, oral paste: all products: horse not for meat production (Bayer AH USA elsewhere) <b>tolerability</b> : FBT is well tolerated showing no side effects at higher doses	has a broad spectrum of activity; it exhibits high efficacy (>90%) against adult stages of <i>Strongylus vulgaris</i> , <i>S. edentatus</i> , small strongyles, <i>Oxyuris equi</i> , and <i>Parascaris equorum</i> , and their immature stages; there is only poor activity against migrating larvae of large strongyles, <i>Habronema muscae</i> and
<i>Draschia megastoma</i> , <i>Trichostrongylus axei</i> (elimination at 20 mg/kg), and <i>Strongyloides westeri</i> (elimination at 60 mg/kg); as with the other benzimidazole there exists resistance of horse nematodes against FBT; <b>approved indications</b> (*Rintal Suspension, USA): for removal of ascarids ( <i>P. equorum</i> , adult and sexually immature), pinworms ( <i>O. equi</i> -adult and L <sub>4</sub> stage), large strongyles ( <i>S. vulgaris</i> , <i>S. edentatus</i> , <i>S. equinus</i> ), and the various small strongyles in horses, breeding stallions and mares, pregnant mares, foals, and ponies; <b>limitations</b> : administer by stomach tube or drench, or by mixing well into a portion of the normal grain ration; for animals maintained on premises where reinfection is likely to occur, re-treatment may be necessary; for most effective results, retreat in 6–8 weeks; not for use in horses intended for food; federal law restricts this drug to use by or on the order of a licensed veterinarian. FBT suspension may be used in <b>combination</b> with trichlorfon oral liquid when combining 1 part FBT suspension with 5 parts trichlorfon liquid (*Combotel, *Negabot Plus		



**Nematocidal Drugs, Animals. Table 3** Drugs used against gastrointestinal nematodes in horses (Continued)

CHEMICAL GROUP nonproprietary name of active substance (single oral dose, mg/kg body weight = b.w.), other information	*DRUG PRODUCT dose form (formulation), withdrawal time (WT) days (d) before slaughter, manufacturer, supplier, other information	CHARACTERISTICS miscellaneous comments on pharmacokinetics, metabolism, mode of action, toxicity and limitations
Paste), ingredients: FBT 6 mg/kg b.w./trichlorfon 30 mg/kg b.w. have been voluntarily withdrawn by Bayer AH USA: drug products were highly effective (>99%) against adult and immature horse nematodes ( <i>S. vulgaris</i> , <i>S. equinus</i> , <i>S. edentatus</i> , small strongyles, <i>P. equorum</i> , <i>O. equi</i> and <i>Gasterophilus</i> spp.; combination was well tolerated; side effects were salivation and restlessness)		
<b>TETRAHYDROPYRIMIDINES</b>		
<p>*1 <b>pyrantel</b> pamoate (19 = 6,6 base, horse, pony) *2 (1.2 mg/pound = 2.64 mg/kg b.w. horse, foals, pony, in-feed on a day-to-day basis in foals: may be started at 2–3 months of age) <b>combinations:</b> *3 pyrantel/ <b>oxfendazole</b> (cf. oxfendazole ↑) *4 pyrantel pamoate/<b>praziquantel</b> (PZQ)/<b>ivermectin</b> (IVM)</p>	<p>1*Strongid T, liquid (suspension) 1*Banminth P, Strongid Paste, oral paste (Pfizer USA), others, 1*Banminth Paste, WT: 0d (Pfizer Germany, elsewhere, others), Banminth, Strongid, top dressing in feed (Pfizer USA), Purina (Virbac USA), top dressing in feed, 2* Strongid 48 or CW 48, Type A medicated Article, top dressing (Pfizer or Farnam Companies USA)</p>	<p>whether it is the tartrate or pamoate, both salts of pyrantel (PYR) exhibit almost similar activity on GI parasites; the pamoate (=embonate) may be used in horses because of its low solubility, thus providing higher concentrations and activity against worms inhabiting the colon and cecum (e.g., small strongyles); the two salts are highly active (&gt;90%) against adult stages, also early larval stages of <i>Strongylus vulgaris</i>, <i>S. equinus</i>, small strongyles,</p>
<p><i>Parascaris equorum</i> and only moderately (variably: 33–90%) against adult stages of <i>S. edentatus</i> and <i>Oxyuris equi</i> (50–75%); effect against larval mucosal stages of small strongyles (cyathostomes and others) is minimal; drug is inactive against stomach worms (<i>Trichostrongylus axei</i>, <i>Habronema</i> spp., <i>Draschia megastoma</i>), <i>Strongyloides westeri</i>, and bots (<i>Gasterophilus</i> spp.); PYR is active against ileocecal tapeworm <i>Anoplocephala perfoliata</i> at double the regular dose (13.2 mg/kg); it shows efficacy against BZ resistant strains of small strongyles; it has been reported that in-feed medication on a day-to-day basis appears to render foals more susceptible to parasite challenge than previously untreated animals with greater exposure to parasites; <b>approved indication (paste USA)</b>: for removal and control of infections from the following mature parasites: large strongyles (<i>S. vulgaris</i>, <i>S. edentatus</i>, <i>S. equinus</i>); small strongyles; pinworms (<i>O. equi</i>); and large roundworms (<i>P. equorum</i>); <b>limitations (paste USA)</b>: administer as single dose by depositing paste on dorsum of the tongue using the dose syringe, not for use in horses intended for food; it is recommended that severely debilitated animals not be treated with PYR; 2*<b>approved indication (in-feed USA)</b>: prevention of <i>S. vulgaris</i> larval infections; control of adult large strongyles (<i>S. vulgaris</i>, <i>S. edentatus</i>); adult and L<sub>4</sub> small strongyles (<i>Cyathostomum</i> spp., <i>Cylicocycclus</i> spp., <i>Cylicostephanus</i> spp., <i>Cylicodontophorus</i> spp., <i>Poteriostomum</i> spp.), <i>Triodontophorus</i> spp.; adult and L<sub>4</sub> pinworms (<i>O. equi</i>) and adult and L<sub>4</sub> ascarids (<i>P. equorum</i>), 2*<b>limitations (in-feed USA)</b>: administer either as a top-dress (not to exceed 20,000 g/ton) or mixed in the horse's daily grain ration (not to exceed 1,200 g/ton) during the time that the animal is at risk of exposure to internal parasites; not for use in horses intended for food and not for use in severely debilitated animals; <b>tolerability</b>: PYR is well tolerated at recommended dose and may be used in pregnant mares, in foals, and in stallions (reproductive performance is not affected); at higher and repeated doses (free base 50 mg/kg) severe toxic reactions (dyspnea, muscular tremor, even death) may occur; <b>combinations</b>: 3*Strategy-T, oral paste (Vetsearch Australia) will enhance anthelmintic activity against GI nematodes; 4*Horse Wormer and Boticide (Virbac Australia, elsewhere); oral paste (39.8 mg PZQ/g //345.1 mg PYR/g //5.3 mg IVM/g: 3.3 mL/100 kg b.w.), WT: horse 28d enhances anthelmintic activity including tapeworms and roundworms (including arterial larval stages of <i>S. vulgaris</i> and BZ resistant small strongyles), lungworms (<i>Dictyocaulus arnfieldi</i>), stomach bots (horse bot flies), and skin lesions caused by summer sores and microfilariae (<i>Onchocerca</i> spp.)</p>		
<p><b>morantel</b> tartrate (10, horse, foals) *Equiban is safe to use in pregnant mares, or foals over 1 week of age and debilitated animals</p>	<p>*Equiban Granules, oral granules, pellets, WT: horse 28d, *Equiban Paste, oral paste, WT: horse 28d (Pfizer Australia)</p>	<p>is the methyl ester analog of pyrantel with similar pharmacological properties to parent compound; <b>approved indications</b>: for the control of large strongyles (<i>Strongylus</i> spp.), small strongyles (cyathostomes), large</p>
<p>roundworm (<i>Parascaris equorum</i>), and pinworm (<i>Oxyuris equi</i>); good activity has also demonstrated against tapeworm (<i>Anoplocephala perfoliata</i>) and lumen dwelling immature forms of <i>Cyathostomum</i> spp., <i>Triodontophorus</i> spp., and <i>Strongylus vulgaris</i>; treatment should be carried out every 6–8 weeks throughout the year (in Australia (elsewhere), morantel is combined with abamectin for use in horses, cf. abamectin ↓)</p>		

**Nematocidal Drugs, Animals. Table 3** Drugs used against gastrointestinal nematodes in horses (Continued)

<b>CHEMICAL GROUP</b> nonproprietary name of active substance (single oral dose, mg/kg body weight = b.w.), other information	<b>*DRUG PRODUCT</b> dose form (formulation), withdrawal time (WT) days (d) before slaughter, manufacturer, supplier, other information	<b>CHARACTERISTICS</b> miscellaneous comments on pharmacokinetics, metabolism, mode of action, toxicity and limitations
<b>IMIDAZOTHIAZOLES</b>		
<b>levamisole</b> hydrochloride/ <b>piperazine</b> dihydrochloride (approved dose see \)	*Ripercol L-Piperazine soluble powder (liquid) * Ripercol L-Piperazine Soluble, liquid (drench) (Fort Dodge AH, USA)	levamisole (alone) is not marketed for use in horses; it has a too narrow therapeutic index and spectrum of activity; it is particularly effective (more than 90%) against adult stages of
<p><i>Parascaris equorum</i>, and <i>Oxyuris equi</i> and <i>Strongylus vulgaris</i> (oral doses of 7.5–15 mg/kg as a drench or in-feed); lung worms (<i>Dictyocaulus arnfieldi</i>) are also effectively removed (&gt;90%); its efficacy against large stages of <i>S. edentatus</i> and small strongyles is limited; the drug is ineffective against migrating larvae of <i>S. vulgaris</i>, <i>Trichostrongylus axei</i>, <i>Habronema</i> spp., and <i>Probstmayria vivipara</i>; oral administration (nasogastric intubation) of over 20 mg levamisole HCl/kg b.w. (~2 times the therapeutic dose) have caused adverse effects as sweating, increased respiration, hyperexcitability, and sometimes death; at therapeutic dose (5 mg/kg i.m., 10 mg/kg p.o.) after intramuscular injection the drug may cause local reactions and signs of a colic; <b>approved combination</b>: administer by stomach tube or drench: 1 fluid ounce/125 pounds b.w. (powder: each fluid ounce 0.45 g levamisole HCl/ piperazine 2HCL = 5.0 g piperazine base) or 1 fluid ounce/100 pounds bw (liquid: in each fluid ounce 0.36 g levamisole HCL and piperazine 2HCL = 3.98 g piperazine base), if reinfection occurs, retreat animals at 6–8-week intervals, <b>indications</b> (combination): an anthelmintic effective against infections of large strongyles (<i>S. vulgaris</i>, <i>S. edentatus</i>), small strongyles (<i>Cylicocercus</i> spp., <i>Cylicocyclus</i> spp., <i>Cylicodontophorus</i> spp., <i>Cylicostephanus</i> spp., <i>Cylicotetrapedon</i> spp.), ascarids (<i>P. equorum</i>), and pinworms (<i>O. equi</i>), <b>limitations</b>: do not treat animals intended for food, federal law restricts this drug to use by or on the order of a licensed veterinarian</p>		
<b>MACROCYCLIC LACTONES</b>		
endectocides with broad spectrum of activity against nematodes and arthropods; they are effective against nematodes resistant to other classes of antinematodal drugs, such as benzimidazoles (BZs); resistance of nematodes to macrocyclic lactones has been observed; effects of macrocyclic lactones on dung-destroying insects and other environmental impact is discussed below		
<b>AVERMECTINS</b>		
<p>*1 <b>ivermectin</b> (IVM) (0.2 i.m. horse) (0.2 p.o. horse) (0.3 horse in feed single dose): *Zimecterin-EZ, meal, top dressing (Farnam Comp. USA) *2 <b>ivermectin/praziquantel</b> (PZQ): (0.2/1–2.5 horse, p.o): 2*Eqvalan Gold (Merial Australia), 2*Genesis Equine (Ancare Australia): paste, WT: horse 28d (other suppliers); 2*Equimax (Virbac), 2*Zimecterin Gold Paste (Merial): paste (horse not for food, WT not applied: USA)</p>	<p>1*Eqvalan Injection, 1*Eqvalan Oral Liquid, 1*Eqvalan *Equimectrin *Zimecterin: oral paste 1.87% (all Merial USA, other sponsors): horse not for food (WT not applied) 1*Ivomec P (Merial) *Furexel (Janssen-Cilag): oral paste, WT: horse 21d, other suppliers in Germany, elsewhere 1*Equimec (Merial Australia): oral liquid, paste: WT horse 21d (other suppliers)</p>	<p>IVM has a broad-spectrum of activity with a prolonged persistent action on reproductive system of worms (reduction in fecal egg counts may be 2 months or longer); IVM is highly active (&gt;95%) against adult and most early and late 4th-stage larvae of all pathogenically important small strongyles (cyathostomes adults, including those resistant to some BZ compounds, genera: <i>Coronocyclus</i> spp. including <i>C. coronatus</i>, <i>C. labiatus</i>, and <i>C. labratus</i>, <i>Cyathostomum</i> spp. including <i>C. catinatum</i> and <i>C. pateratum</i>, <i>Cylicocyclus</i> spp.</p>
<p>including <i>C. insigne</i>, <i>C. leptostomum</i>, <i>C. nassatus</i>, and <i>C. brevicapsulatus</i>, <i>Cylicodontophorus</i> spp., <i>Cylicostephanus</i> spp., including <i>C. calicatus</i>, <i>C. goldi</i>, <i>C. longibursatus</i>, and <i>C. minutus</i>, and <i>Petrovinema poculatum</i>), large strongyles: <i>Strongylus equinus</i> (adults), <i>S. edentatus</i> (adults and tissue stages), <i>S. vulgaris</i> (adults and arterial larval stages: efficacy approx. 99% against early and late 4th-stage larvae: their elimination reduces markedly acute signs of acute verminous arteritis within 2 days of treatment; resolution of lesions may occur in approx. 1 month postdosing), adult <i>Triodontophorus</i> spp. (including <i>T. brevicauda</i> and <i>T. serratus</i>, and <i>Craterostomum acuticaudatum</i>), ascarids (<i>Parascaris equorum</i>, adult/immature stages), pinworms (<i>Oxyuris equi</i>, adult/immature stages), intestinal worms: hairworms (<i>Trichostrongylus axei</i>, adults), and threadworms (<i>Strongyloides westeri</i>, adults), lungworms (<i>Dictyocaulus arnfieldi</i>, adult and larval stages), bots (<i>Gasterophilus intestinalis</i>, <i>G. nasalis</i>, oral migrating and/ or stomach-attached stages), so-called neck threadworms (<i>Onchocerca</i> spp.: microfilariae may cause skin lesions or cutaneous onchocerciasis), large-mouth stomach worms (<i>Habronema</i> spp. and <i>Draschia</i> spp.: adult and cutaneous L<sub>3</sub> produce skin lesions or so-called summer sores: they do not resolve until after administration of a second therapeutic dose of IVM 1 month after initial treatment); IVM has high activity against lumen-dwelling cyathostomes (adult and larvae stages) but its activity against cyathostome <i>hypobiotic</i> or <i>encysted</i></p>		

**Nematocidal Drugs, Animals. Table 3** Drugs used against gastrointestinal nematodes in horses (Continued)

CHEMICAL GROUP nonproprietary name of active substance (single oral dose, mg/kg body weight = b.w.), other information	*DRUG PRODUCT dose form (formulation), withdrawal time (WT) days (d) before slaughter, manufacturer, supplier, other information	CHARACTERISTICS miscellaneous comments on pharmacokinetics, metabolism, mode of action, toxicity and limitations
<p>larvae proved to be basically poor in naturally infected ponies; there is no activity against horse ticks; it exhibits full activity against strains of BZ-resistant strongyles particularly against those of small strongyles; <b>combinations</b>: (see left column ↑) e.g., *Genesis Equine (IVM 0.2/PZQ 2.5 mg/kg b.w.) controls round worms, bots and <i>tapeworms</i> <i>Anoplocephala perfoliata</i>, <i>A. magna</i>, <i>Paranoplocephala mammillana</i> (adult and immature, heads and segments); IVM and IVM/ PZQ have a wide safety margin at recommended dose levels (substantial margin of safety, 10-fold); they may be used in horses of all ages; mares may be treated at any stage of pregnancy, and stallions without adversely impacting on their fertility; <b>limitations</b> (products in USA): do not use in horses intended for human consumption; *Eqvalan Oral Liquid or Injection: Federal law restricts this drug to us by or on the order of a licensed veterinarian; <b>limitation</b> (products in Germany, elsewhere): do not use in mares that are producing or may in future produce milk or milk products for human consumption; <b>protection of wildlife fish, crustaceans, and environment</b>: IVM and other macrocyclic lactones are extremely toxic to aquatic species, do not contaminate dams, rivers, streams, or other waterways with such chemicals or used-containers</p>		
<p>*1 <b>abamectin</b> (ABA) (0.2 horse) <b>combinations</b>: *2 abamectin/<b>praziquantel</b> (PZQ) (0.2/ 2.5 horse) *3 abamectin/<b>morantel</b> tartrate (0.2/ 9 horse)</p>	<p>1*Promectin (Jurox), oral paste, WT: horse 28d, other suppliers 2*Equimax (Virbac) oral liquid or paste, WT: horse 28d 3*Moramectin (Nature Vet), paste, WT: horse 28d (these and other products: all Australia, elsewhere)</p>	<p>ABA/PZQ combination was introduced in New Zealand and Australia in 1997; anthelmintic spectrum and activity of ABA are basically similar to those of ivermectin (for details cf. ivermectin ↑): ABA is approved for the treatment and control of roundworms (including arterial larval stages of <i>Strongylus</i></p>
<p><i>vulgaris</i> and benzimidazole resistant small strongyles), lungworms (<i>Dictyocaulus arnfieldi</i>, adult and larval stages), bots (<i>Gasterophilus</i> spp.), skin lesions caused by <i>Habronema</i> and <i>Draschia</i> spp. (summer sores), and microfilariae of <i>Onchocerca</i> spp. (cutaneous onchocerciasis); <b>combinations</b>: ABA/PZQ removes not only roundworm but also ileocecal tapeworms (<i>Anoplocephala</i> spp.) and <i>Paranoplocephala mammillana</i>; it is safe for mares, stallions, and foals; there is a 5-fold margin of safety; ABA/<b>morantel</b> tartrate eliminates and controls <i>tapeworms</i> (<i>Anoplocephala perfoliata</i>) and roundworms (including arterial larval stages of <i>Strongylus vulgaris</i> and benzimidazole-resistant small strongyles), bots and skin lesions caused by <i>Habronema</i> and <i>Draschia</i> spp. and <i>Onchocerca</i> spp. microfilariae; morantel (methyl ester analog of pyrantel, cf. morantel ↑) is active against the ileocecal tapeworm <i>Anoplocephala perfoliata</i>; <b>protection of wildlife fish, crustaceans, and environment</b>: ABA and other macrocyclic lactones are extremely toxic to aquatic species, do not contaminate dams, rivers, streams, or other waterways with such chemicals or used-containers</p>		
<b>MILBEMYCINS (NEMADECTINS)</b>		
<p>*1 <b>moxidectin</b> (MOX) (0.4 horse, foals, pony) <b>combination</b>: *2 moxidectin/<b>praziquantel</b> (0.4/2.5 horse) 1*Equest Oral Gel, WT: horse 32d, and 2* Quest Pramox (Fort Dodge Germany, elsewhere), oral gel, WT: horse 64d</p>	<p>1*Equest 2% Gel: horse, and 2*Quest Plus Gel: horse, pony (Fort Dodge USA, elsewhere), oral gel: (horse, not for meat production, pony, no use class stated or implied) 1*Equest Gel: horse, and 2*Quest Plus (Fort Dodge Australia elsewhere): horse, oral gel, WT (1*/2*): horse 28d</p>	<p>introduced as horse dewormer in 1996; MOX has a broad spectrum of activity with a prolonged persistent action on reproductive system of worms (reduction in fecal egg counts may be 3 months or longer); its <i>anthelmintic spectrum</i> is largely similar to that of ivermectin (cf. ivermectin ↑), except <b>lack of action against lungworm</b> (<i>Dictyocaulus arnfieldi</i>) and a trend</p>
<p>toward “greater” efficacy against encysted cyathostome larvae than a therapeutic dosage of ivermectin (there have been reports in the literature that difference was not always significant); it proved highly efficacious against luminal small strongyle larvae (approx. 100% against L<sub>4</sub>, &gt;92% against L<sub>3</sub>, and aids in control of early encysted EL<sub>3</sub>, including hypobiotic or inhibited larvae, i.e., MOX has some efficacy against these larvae); there is 99–100 % efficacy against adults of <i>Strongylus vulgaris</i> (L<sub>4</sub>/L<sub>5</sub> arterial stages &gt;90%), <i>S. edentatus</i> (adults, L<sub>4</sub> tissue or visceral stages), <i>S. equinus</i> (adults), adults of <i>Triodontophorus brevicauda</i>, <i>T. serratus</i>, and <i>T. tenuicollis</i>, and 22 species of small strongyles (cyathostomes, for genera cf. ivermectin ↑), intestinal threadworm (<i>Strongyloides westeri</i>, adults), pinworms (<i>Oxyuris equi</i>, adults &gt;94%, L<sub>3</sub> and L<sub>4</sub> larval stages, latter 100%), hairworms (<i>Trichostrongylus axei</i>, adults), large-mouth stomach worms (<i>Habronema muscae</i>, adults), ascarids (<i>Parascaris equorum</i>, adults, L<sub>4</sub> larval stages), <i>Onchocerca</i> spp. (microfilaria causing cutaneous onchocerciasis); its activity against horse stomach bots (<i>Gasterophilus intestinalis</i>, 2nd and 3rd instars, <i>G. nasalis</i>, 3rd instars) may be variable (50–100%) and substantial less than that of ivermectin; one dose suppresses strongyle egg production for about 3 months; it exhibits activity against ticks (<i>Amblyomma cajennense</i> and <i>Dermacentor nitens</i>); tolerability of MOX: at recommended</p>		

**Nematocidal Drugs, Animals. Table 3** Drugs used against gastrointestinal nematodes in horses (Continued)

CHEMICAL GROUP nonproprietary name of active substance (single oral dose, mg/kg body weight = b.w.), other information	*DRUG PRODUCT dose form (formulation), withdrawal time (WT) days (d) before slaughter, manufacturer, supplier, other information	CHARACTERISTICS miscellaneous comments on pharmacokinetics, metabolism, mode of action, toxicity and limitations
<p>dose, it is safe for breeding animals (mares and stallions), and foals (at least from 6 months of age: foals below this age, or debilitated animals may infrequently show transient depression, ataxia, and recumbency); there may be a 3-fold margin of safety in adult animals; <i>protection of wildlife fish, crustaceans, and environment</i>: MOX and other macrocyclic lactones are extremely toxic to aquatic species, do not contaminate dams, rivers, streams, or other waterways with such chemicals or used-containers; however, drug residues excreted in feces of treated animals should be less toxic to dung beetle larvae than residues excreted in feces of ivermectin-treated animals; MOX feces may allow survival of dung beetles or their development to maturity; <i>combination</i> (MOX/PZQ) has activity against roundworm (species see this text) and tapeworms <i>Anoplocephala perfoliata</i>, <i>A. magna</i>, <i>Paranoplocephala mammillana</i>: PZQ eliminates adult and immature stages (heads and segments); <i>limitations</i> (USA, all products): for oral use in horses and ponies 6 month of age and older, not for use in horses and ponies intended for food; Australia, Germany (all products): do not use in mares that are producing or may in future produce milk or milk products for human consumption; do not administer full syringe to horse under 400 kg, take care with foals and smaller breeds in calibrating the dose and avoid overdosing: at 2 times (foals) and 3 times (horses) the recommended dose, transient adverse effects may occur (inappetence, fatigue, ataxia, atonic lower lip)</p>		

Data of drug products (approved labels) listed in this table refer to information from literature, manufacturer, supplier, and websites such as the European Medicines Agency (EMA), Committee for Veterinary Medicinal Products (CVMP), the US Food and Drug Administration (FDA), Center for Veterinary Medicine (CVM), the Australian Pesticides and Veterinary Medicines Authority (APVMA), and associated Infopest (search for products), VETIDATA, Leipzig, Germany, and Clini Pharm, Clini Tox (CPT), Zurich, Switzerland; data given in this table have no claim to full information

dogs, and also in humans (Tables 1, 3–6 and →Nematocidal Drugs, Man/Table 1). **MOR**, the methyl ester analogue of pyrantel, has been developed for anthelmintic use in sheep and cattle. The salt of MOR (tartrate) has a greater activity against gastrointestinal nematodes than the parent compound while their pharmacologic effects are similar. Like other anthelmintics (diethylcarbamazine, a piperazine derivative, cf. Phenothiazine and Piperazines and →Nematocidal Drugs, Man/Table 1), LEV, PYR, and MOR can produce nicotine-like paralytic actions in animals that are shared with →acetylcholine (ACh) and act by mimicking effects of excessive amounts of this natural neurotransmitter. However, excess amounts of ACh may result in inhibition of autonomic ganglia, chemoreceptors of the carotid and aortic bodies as well as adrenal medullas and the neuromuscular junction. In severely debilitated animals these pharmacologic effects appear to be enhanced (contraindication for use of LEV, PYR, and MOR). LEV resistance in trichostrongylids is complex and partly polygenic and in *T. colubriformis* it is mainly ascribed to a single recessive gene, or closely linked group of genes, located on the X-chromosome but not so in case of *Haemonchus*.

#### Avermectins and Milbemycins

Avermectin and milbemycin macrocyclic lactones (Tables 1, 3–6 and →Nematocidal Drugs, Man/Table 1), introduced into the antinematodal market in the 1980s,

are structurally related and exhibit endectocide activities for prolonged periods at extremely low doses when administered parenterally. Macrolide “endectocides”, as their name implies, may kill both internal (nematodes) and external (arthropods) parasites by opening chloride channels. **Ivermectin** (a mixture of 80% 22,23-dihydroavermectin B<sub>1a</sub> and 20% B<sub>1b</sub>) is a semi-synthetic derivative widely used in veterinary medicine as a broad-spectrum endectocide and in human practice for controlling onchocerciasis and lymphatic filariasis (→Nematocidal Drugs, Man/Table 1). **Abamectin**, avermectin B<sub>1</sub>, (natural precursor of ivermectin having a double bond at C22–23 position) is used as anti-nematodal drug in cattle and as a foliar spray on various plants against diverse agricultural pests (arthropods). **Doramectin** (25-cyclohexyl-avermectin B<sub>1</sub>) has a close structural similarity to avermectin B<sub>1</sub>. Presumably it is the lipophilic cyclohexyl moiety that causes a fairly long tissue half-life of the drug and thus a high nematocidal and broad spectrum of activity against cattle nematodes (Table 1). **Eprinomectin** (MK-397) consisting of a (90:10) mixture of 2 homologues, 4“-epi-acetyl-amino-4”-deoxyavermectin B<sub>1a</sub> and B<sub>1b</sub>, and **selamectin**, a semi-synthetic monosaccharide oxime derivative of doramectin, are the latest members of the avermectin subfamily selected for development as topical endectocides for use in cats and dogs, respectively. Modifications, especially on the 4th position of avermectin B<sub>1</sub> and ivermectin, that is the

**Nematocidal Drugs, Animals. Table 4** Drugs used against nematode infections of swine

<b>CHEMICAL GROUP</b> nonproprietary name of active substance (single oral dose, mg/kg b.w.), other information	<b>*DRUG PRODUCT</b> dose form (formulation), withdrawal time (WT) days (d) before slaughter, manufacturer, supplier, other information	<b>CHARACTERISTICS</b> miscellaneous comments on pharmacokinetics, metabolism, mode of action, toxicity, and limitations
<b>AMINES</b>		
<p><b>piperazine base</b> (dose may vary, ~110) *1 piperazine citrate, *2 piperazine dihydrochloride or dipiperazine sulfate *3 piperazine dihydrochloride</p> <p>is ~100% elimination of lumen-dwelling (adult) stages of these GI nematodes after a single treatment; piperazine may be still useful for mass treatment; a second treatment 2 months later may be necessary to remove worms that have been in somatic stages at time of initial infection; withholding of feed/water previous night should be observed to make sure that medicated in-feed/in-water is completely consumed; drug is well tolerated at recommended dose levels; no serious form of intoxication has been seen after 4–10 times the therapeutic dose; preslaughter withdrawal/withholding time for edible tissues see (← drug products)</p>	<p>1*Piperazincitrat, WT: 4 (Belapharm, Germany, elsewhere) 2*Pigwormer Wazine, WT: 21 (Fleming Lab. USA, elsewhere) 3*Piperazine Worm Powder, WT: nil (Australia, elsewhere)</p>	<p>dose/drug form for all product is powder/liquid (solution) and for use in drinking water or feed as a sole source for use as 1-day single treatment; <b>indications:</b> for removal of large roundworm (<i>Ascaris suum</i>) and nodular worms (<i>Oesophagostomum</i> spp.); there</p>
<b>ORGANOPHOSPHATES</b>		
<p><b>dichlorvos (DCV)</b> (swine, no use class stated or implied, dose form = medicated feed; dose regimen depends on <b>indication(s)</b> of drug product used: either for removal and control of GI nematodes, as sole ration at certain rate in pounds of feed/head/ day for 2days (see examples below) or (and) an aid in improving efficiency by pigs born alive or for pregnant swine, mix into a gestation feed (e.g., DCV, 334–500 g/t feed) to provide 1g per head daily during last 30 days of gestation</p>	<p>*Atgard Swine Wormer, various products (Type A medicated article, specifications 3.1% and 9.6%) *Atgard C Premix 9.6% (Boehringer Ingelheim Vetmedica, Inc, USA) <b>limitations</b> (see also below): do not use drug products simultaneously or within a few days before or after treatment with other cholinesterase inhibitors, pesticides or chemicals; do not allow fowl access to feed containing this preparation or with feces from treated animals; <i>atropine</i> can be used as an antidote against DCV intoxication</p>	<p>DCV is a nearly colorless liquid and a potent organophosphate with high toxicity potential for mammals and bird (see also ectoparasitides: it is the active ingredient in flea and tick collars for dogs and cats and sprays for control of various arthropods); since the pure compound was relatively toxic in pigs, better tolerated formulation have been developed; as a cholinesterase inhibitor, DCV may cause transient side effects (diarrhea, muscular tremors) if dose regimen is not carefully observed; drug products have a distinguished efficacy against GI nematodes, particularly</p>
<p>against the whipworm <i>Trichuris suis</i> (including mature adults and immature stages, and/or 4th-stage larvae) and a good one against large roundworm <i>Ascaris suum</i> (&gt;90%) against 4th-stage larvae, juveniles, and mature adults); it also removes and controls nodular worms <i>Oesophagostomum</i> spp. (adults, juvenile stages, L<sub>4</sub>) and stomach worms <i>Ascarops strongylina</i> (adults), and <i>Hyostromylus rubidus</i> (adults); its action (&lt;50%) on migrating and mucosal larvae of <i>A. suum</i>, <i>H. rubidus</i>, and nodular worms is moderate, effect against <i>Strongyloides ransomi</i> is variable (65–100%); <b>diversified indication(s)</b> of drug products: either removal and control of GI nematode, or (and) aid in improving efficiency by pigs born alive, birth weight, survival to market, and rate of weight gain, e.g., *Atgard Swine Wormer (specifications: Type A med. articles: 3.1 and 9.6%: various amounts, e.g., 348g (0.0384%) DCV/ton feed for removal/ control of GI worms, for swine up to 70 pounds b.w. as a sole ration for 2 consecutive days and swine from 70 pounds to market weight, feed as sole ration at rate of 8.4 pounds of feed/head until medicated feed has been consumed; for boars, open or bred gilts, and sows, feed as a sole ration at rate of 4.2 pounds of feed/head/day for 2 days); <b>limitations</b> (see also above): do not mix with feed to be pelleted nor with pelleted feed; feed must be dry when administered; preslaughter withdrawal time for edible tissues nil (no data given)</p>		
<b>TETRAHYDROPYRIMIDINES</b>		
<p><b>pyrantel tartrate (PYT)</b> (~22, single feed) (maximum dose: 2 g/head); dose form: medicated feed, Type A medicated articles (specifications: e.g., 9.6, 19.2, 48 or **80 g PYT/pound); amount: e.g., 96 g (0.0106%) or 800 g (0.088%)/ton of feed medicated feed is consumed without unwillingness</p>	<p>**Banminth Premix 80 (Phibro AH, Inc.), *Purina Ban Worm (Virbac AH, Inc); *Q.T. Ban-Tech (Quali-Tech Products Inc), many other products in the USA and elsewhere (not available in Australia, Germany, elsewhere); <i>concurrent use of pyrantel and levamisole at therapeutic doses enhances toxicity (nicotine like drugs)</i></p>	<p><b>indication for continuous use:</b> an aid in prevention of migration and establishment of large roundworm (<i>A. suum</i>, some effect against histotropic stages and freshly hatched larvae from ingested eggs) and nodular worms (<i>Oesophagostomum</i> spp. 95–99% efficacy against lumen stages), <b>limitations</b> for all products (* and**): amount 96 g/ton of feed: feed <b>continuously</b> as sole ration in a</p>

**Nematocidal Drugs, Animals. Table 4** Drugs used against nematode infections of swine (Continued)

<b>CHEMICAL GROUP</b> nonproprietary name of active substance (single oral dose, mg/kg b.w.), other information	<b>*DRUG PRODUCT</b> dose form (formulation), withdrawal time (WT) days (d) before slaughter, manufacturer, supplier, other information	<b>CHARACTERISTICS</b> miscellaneous comments on pharmacokinetics, metabolism, mode of action, toxicity, and limitations
<p>Type C feed and do not mix in Type B or Type C medicated feeds containing <i>bentonide</i> (mineral used as a suspending agent); <b>sole ration for 3 days</b>: for removal and control of the large roundworm, limitations: amount 96 g/ton of feed: feed for 3 days as sole ration in a Type C feed, do not mix in Type B or Type C medicated feeds containing bentonide; <b>single ration</b>: for removal and control of the large roundworm and nodular worms, limitations: amount 800 g/ton of feed: feed as sole ration for a single therapeutic treatment in Type C feed (feed at rate of 1 pound of feed/40 pounds b. w. for animals up to 200 pounds, and 5 pounds of feed/head for animals 200 pounds or over); <i>withdrawal time</i> (all products) for edible tissues is 24 hours before slaughter; as shown in numerous field studies, PYT is also active against <i>Hyostroglylus rubidus</i> (mature stages) infections; it is inactive against whipworms (<i>Trichuris suis</i>), <i>Strongyloides ransomi</i>, and lungworms in heavy infections; drug's efficacy may be variable if used therapeutically at a single dose</p>		
<p><b>morantel</b> citrate (MC) (1/d: into drinking water normally consumed in that day for 7 days or during period for which worm control is required) (30 ppm in pig feed)</p>	<p><i>oral solution</i>: *Bomantel Water soluble (100 mg/mL); <i>oral powder, premix</i>: *Bomantel Premix (Pharmtech PTY), *Wormtec 30 (Phibro AH PTY) (30 g MC/kg: mix 1kg premix with every ton of pig feed), *Australia and elsewhere</p>	<p>MC is the methyl ester analogue of pyrantel, both drugs have similar pharmacologic properties but MC is safer and more efficient than pyrantel tartrate, particularly against <i>A. suum</i>: at 5 mg/kg b.w. it is highly active (&gt;90%) against adults and immature stages of</p>
<p>the large roundworm; <b>approved indications</b>: in water additive for prevention of migration and prevention of intestinal infections of roundworm (<i>Ascaris suum</i>) and as an aid in prevention of nodular worms (<i>Oesophagostomum</i> spp.); treatment for an extended period may be necessary to achieve full control of worm infection; <i>withholding period</i> for meat: do not use less than 7 days before slaughter for human consumption; premix for treatment and control of migrating larvae and adult stages of <i>A. suum</i> and as an aid in prevention of <i>O. dentatum</i>: withholding period for meat: nil</p>		
<p><b>IMIDAZOTHIAZOLES</b></p>		
<p><b>levamisole</b> hydrochloride (LEV) (8 base = 9.44HCL, single injection, i.m. or s.c.) (7–8 HCL single in feed/drinking water: feed or water should be withheld overnight and worming feed or water administered following morning) (*2 Type A medicated article: feed equivalent of 1 pound of 0.08% worming feed per 100 pounds b.w. of pigs to be treated as sole feed or mixed with 1–2 parts of regular feed prior to feeding) swine, no use class stated or implied</p>	<p>1*Ripercol L, 2*Tramisol (Forte Dodge AH) liquid/ solution for in-water and/or in-feed (prepared by tablet, powder, or liquid); 3*Levasole soluble (Schering Plough), 4*Agrotech Avisole; 5*Coopers Nilverm; 6*Sykes Big L wormer; 7*Concurat-L10% (Bayer Vital) <i>solution for injection</i>: 8*Levamisol 10 (WDT), 9* Belamisole 10 (Bela Pharm), other suppliers and brand names: *1–*3: USA; *4–*6: Australia; *7–*9: Germany, and elsewhere</p>	<p>for treatment of following (sensitive strains) nematode infections: large roundworm (<i>Ascaris suum</i>, adults &gt;95% efficacy), nodular worms (<i>Oesophagostomum</i> spp. adults, L<sub>4</sub>, immature adult stages), intestinal threadworm (<i>Strongyloides ransomi</i>, adults, 90–100% efficacy) lung-worms (<i>Metastrongylus</i> spp., adults, L<sub>3</sub>, L<sub>4</sub>, immature adult stages, cf. Table 6), and mature kidney worm in the urinary tract (<i>Stephanurus dentatus</i>, larvae in other parts of body are not affected, cf. doramectin ↓); it is also active against the red stomach worm <i>Hyostroglylus rubidus</i> and less</p>
<p>so (variable efficacy: 75–90%) against adult stages <i>Trichuris suis</i>; there is high efficacy against larvae (L<sub>4</sub>, and immature adult stages) of <i>A. suum</i>; after repeated dosing <i>S. ransomi</i> larvae were no longer excreted in the milk; LEV is highly active (&gt;90%) against hookworms (<i>Globocephalus urosululatus</i>) in wild boars; the parenteral route may be used in cases where appetite is markedly depressed as a result of clinically evident parasitism or against whipworm (<i>Trichuris suis</i>) infections because drug's activity is markedly enhanced by intramuscular or subcutaneous administration; the oral route (in feed or in water) is more convenient on most occasions, but not as a drench; drug products are well tolerated at recommended dose and safe after oral (in feed or in water) and parenteral administration; LEV is a cholinergic and paralyzes nematodes by sustained muscle contractions; it may occasionally cause excessive salivation or muzzle foam, defecation and respiratory distress from smooth muscle contractions (signs similar to those seen in organophosphate poisoning) at higher than the therapeutic dose; pigs infected with mature lungworms may cough and vomit (expulsion of worms from the lungs) soon after medicated feed or water is consumed and will be over in several hours; <i>preslaughter withdrawal time</i> (edible tissues) for products varies: 3 days (Australia, USA, elsewhere), or 8 days (products for injection, Germany, elsewhere), or 14 days (7*) (Germany)</p>		

**Nematocidal Drugs, Animals. Table 4** Drugs used against nematode infections of swine (Continued)

CHEMICAL GROUP nonproprietary name of active substance (single oral dose, mg/kg b.w.), other information	*DRUG PRODUCT dose form (formulation), withdrawal time (WT) days (d) before slaughter, manufacturer, supplier, other information	CHARACTERISTICS miscellaneous comments on pharmacokinetics, metabolism, mode of action, toxicity, and limitations
<b>BENZIMIDAZOLES</b>		
<b>thiabendazole (TBZ)</b> (single paste, baby pigs, 1–8 weeks age: 200 mg/ 5–7 pounds b.w.) or (medicated feed given continuously for 2 weeks or longer)	Type A medicated article: 1*Thiabendazole 20% Swine Premix, 2*TBZ 200 Medicated Feed Premix; <i>paste</i> : 3*Thiabendazole Pig Wormer (Merial Ltd, USA and elsewhere)	<b>approved indications</b> for Type A medicated articles *1/*2: aid in prevention of infections of large roundworm (genus <i>Ascaris</i> ), limitations: administer continuously feed containing 0.05–0.1% TBZ/ton for 2 weeks
followed by feed (0.005–0.02% TBZ/ton) for 8–14 weeks, do not use in Type B or Type C medicated feed containing <i>bentonide</i> (cf. pyrantel ↑); <b>approved indication</b> for product 3*: for control of infections with <i>Strongyloides ransomi</i> commonly found in Southeastern USA, <b>limitations</b> : accurate diagnosis prior to treatment, thereafter administer paste to baby pigs (1–8 weeks of age), treatment may be repeated in 5–7 days if necessary; <i>withdrawal time</i> for edible tissues 30 days throughout (products for swine are not available in Australia, Germany, and elsewhere); numerous field studies with TBZ in swine have demonstrated its high efficacy (>90%) against adults of <i>Hyostromylus rubidus</i> , <i>Oesophago-stomum</i> spp., and <i>Strongyloides ransomi</i> infections (ineffective against larvae passed in colostrum); single TBZ dose exhibits poor activity against adult/immature <i>Ascaris suum</i> , <i>Trichuris suis</i> , larvae of <i>H. rubidus</i> , and nodular worms; concomitant use with <i>piperazine</i> increases efficacy against <i>A. suum</i> ; TBZ is well tolerated in pigs and pregnant sows and may be used as an alternative drug for certain GI nematodes		
<b>flubendazole (FLU)</b> ( <i>powder</i> : 5, as a single in-feed or 1.2 in- feed daily for 5–10 days) (30 mg/kg feed = 30 ppm medicated feed for 5–10 successive days, or 10 ppm for 15 days to control <i>Ascaris</i> ) ( <i>emulsion</i> for drinking water: 1 daily for 5 successive days) preslaughter withdrawal time for edible tissues: 14 days for all in feed drug products, 4 days for *Solubenol	<i>powder</i> 5% (1g contains 50 mg FLU) *Flubenol (Janssen-Cilag), *Flu-bendazole 5% = *Frommex (aniMedica, BelaPharm, Bremer Pharma, others); *Flubendazol 0.5% Premix, *Flubendazol AMV, *Flubenol 5% AMV (1g powder contains 50 mg FLU to prepare medicated feed) <i>emulsion</i> : *Solubenol 100 mg/g (Janssen-Cilag) (all Germany, not approved in the USA, Australia, elsewhere), may be approved for use in poultry	parafluoro-analogue of mebendazole with broad spectrum of activity against various nematodes of pigs, chickens, turkeys, and game birds in form of powder or premix for incorporation into feed or as emulsion in drinking water; its anthelmintic potency is higher and toxic properties are lower than those of mebendazole (narrow safety margin in pigs and teratogenic, excluding it from use in pregnant sows); <b>indications</b> : for removal, and control of following nematode infections: large roundworm: it is highly effective (>90%) against
<i>Ascaris suum</i> (also active against migrating larvae in the lungs), nodular worms, <i>Oesophagostomum</i> spp. and whipworm <i>Trichuris suis</i> ; efficacy is somewhat lower against red stomach worm, <i>Hyostromylus rubidus</i> , and intestinal thread worms <i>Strongyloides ransomi</i> ; it kills migrating larvae of <i>A. suum</i> and is active (75%–90%) against larvae of other gut nematodes; in experimental studies, drug proved active against <i>Trichinella spiralis</i> , including encysted larvae (30–125 ppm for 14 days); FLU has low oral bioavailability in pigs; more than 50% of administered dose may be excreted in feces as unchanged FLU, absorbed portion of drug is rapidly metabolized so that concentrations of parent compound in blood and urine (mixture of metabolites) are very low; main metabolic pathway in pigs involves reduction of ketone functional group and hydrolysis of carbamates moiety; no effects of FLU on fertility and no evidence of teratogenicity were observed in studies in pigs, rabbits, or rats; there was no evidence of carcinogenicity in Wistar rats; drug is well tolerated in gravid sows or in their piglets at recommended dose (there may be no or only slight adverse effects at 40 times the recommended dose)		
<b>fenbendazole (FBZ)</b> *1 → specifications: Type A/B medicated articles: 4% (18.1 g/pound), 8% (36.2 g/pound), and 20% (90.7 g/ pound) FBZ (9, given over 3–12-day period) *2 → (3, feed as a sole ration for 3 consecutive days) *1,*2: swine, no use class stated or implied	1*Safe-Guard (Intervet) Type A medicated article, 2*Purina (Virbac) powder (in feed), 3*Coglazol 4% (CEVA), powder (in feed), 4*Fen-bendazol 5%, powder (in feed) or AMV 5% (ani-Medica), 5*Orystor 1.5% Clusters, granules (in feed), or AMV 4% (bioptivet) *1, *2 approved in the USA, and elsewhere (WT 14 days)	dose form for all drug products is medicated feed; (*1) Safe-Guard's <b>indications</b> for swine: for removal of adult stage lungworms ( <i>Metastrongylus pudendotectus</i> , <i>M. apri</i> ), adult and larvae (L <sub>3</sub> , L <sub>4</sub> stages liver, lung, intestinal forms), large roundworms ( <i>Ascaris suum</i> ), adult stage nodular worms ( <i>Oesophagostomum dentatum</i> , <i>O. quadrispinulatum</i> ), small stomach worms ( <i>Hyostromylus rubidus</i> ),

**Nematocidal Drugs, Animals. Table 4** Drugs used against nematode infections of swine (Continued)

<b>CHEMICAL GROUP</b> nonproprietary name of active substance (single oral dose, mg/kg b.w.), other information	<b>*DRUG PRODUCT</b> dose form (formulation), withdrawal time (WT) days (d) before slaughter, manufacturer, supplier, other information	<b>CHARACTERISTICS</b> miscellaneous comments on pharmacokinetics, metabolism, mode of action, toxicity, and limitations
*3,*4,*5 → (5–7.5, as a sole ration or divided over 10–15 days, <i>T. suis</i> : 5–7.5 daily for 3 consecutive days)	*3,*4,*5 approved in Germany and elsewhere, (WT 5 days)	adult and larvae (L <sub>2</sub> , L <sub>3</sub> , L <sub>4</sub> stages intestinal mucosal forms), whipworms ( <i>Trichuris suis</i> ), adult and larvae kidney
worms ( <i>Stephanurus dentatus</i> ), <b>limitations</b> : feed as sole ration (amount: FBZ, 10–80 g/ton to provide 9 mg/kg b. w.), given over a 3–12-day period); indications for feral swine ( <i>Suis scrofa</i> ): for removal and control of internal parasites, treatment for kidney worm ( <i>Stephanurus dentatus</i> ), roundworm ( <i>Ascaris suum</i> ), nodular worm ( <i>Oesophagostomum dentatum</i> ), limitations: use as complete feed, prior withdrawal of feed or water is not necessary (amount: 3 mg/kg/day for 3 days), retreatment may be required in 6 weeks; do not use 14 days before or during the hunting season: it is also approved for use in antelope, zoo/wildlife, goat/sheep wildlife, Hippotraginae, horse (not meat) and turkey, growing; (*2) Purina: FBZ powder: specifications: each 2-ounce packet contains 2.27 g (4%) of FBZ plus other inert ingredients or each 4-ounce packet contains 1.7 g (1.5%) of FBZ plus other inert ingredients, drug form = premix, indications for swine see *1 Safe-Guard, (amount: 3 mg FBZ/kg b.w. = 1.36 mg/pound/day), limitations: thoroughly mix contents of packet(s) with swine ration and administer according to labeled dosage regimen, can be fed to pregnant sows, no prior withdrawal of feed or water is necessary; indications of FBZ products (*3, *4, *5) on German market: for removal of immature and mature stages (efficacy >90%) of <i>A. suum</i> (also active against migrating larvae), <i>H. rubidus</i> (good efficacy), <i>O. quadrispinulatum</i> , <i>O. dentatum</i> , <i>T. suis</i> (high efficacy), <i>M. pudendotectus</i> , and <i>M. apri</i> (cf. Table 6) and <i>S. dentatus</i> (efficacy 99%, stages in all sites: cf. doramectin ↓), and <i>Strongyloides ransomi</i> (~80% effective, not approved); FBZ is metabolized in mammals to series of other benzimidazoles including oxfendazole with a similar spectrum of activity as FBZ; oxfendazole, oxbendazole (another benzimidazole carbamate), and the probenzimidazole, febantel, metabolized to FBZ (and hence oxfendazole) are no longer used as anthelmintics in pigs (no products approved for swine in the USA, Australia, or Germany containing these drugs); FBZ is well tolerated in gravid sows and their piglets (there may be effects on reproductive parameters caused by its oxidized oxfendazole form); there is a wide therapeutic index in pigs (>500); in a teratogenicity study in Wistar rats groups of 20 mated females were given oral doses of 0, 25, 250, or 2,500 mg FBZ/kg b.w. per day from days 7–16 of gestation: there was no evidence of maternal toxicity, fetotoxicity, or teratogenicity at any dose level; there were no treatment-related effects in offspring of pigs administered FBZ at various times during gestation		
<b>MACROCYCLIC LACTONES AVERMECTINS</b>		
<b>ivermectin (IVER)</b> (0.3 once, <i>subcutaneously</i> ) do not repeat treatment within 21 days of first injection (100 µg/kg b.w. in feed daily for 7 consecutive days): this is achieved for growing pigs by including IVER in complete ration at 2 g per metric ton = 2 ppm of feed and fed ad lib. as the only ration; for pigs up to 100 kg on restricted feeding programs or high protein diets such that their average daily feed consumption is less than 5% of their live-weight, inclusion rate (ppm) of IVER should be increased (and calculated) in order to provide the required dose rate	<i>liquid (solution) for injection</i> : e.g., *Ivomec 27% or 1%; (Merial USA, Australia, Germany, elsewhere ) *Phoentectin (IVX Animal Health) USA, *Bomectin (Pharm Tech), *Virbac (Virbamec LA) Australia, latter also Germany; *Diapec S (Albrecht), *Fermectin (medistar) *Noromectin (alfavet); *Paramectin (IDT), *Qualimec 1% (Janssen-Cilag), *Sumex (CEVA), Germany <i>Type A medicated article</i> 0.6% (*Ivomec-Premix for swine, Merial USA, Australia, Germany, and elsewhere), dose form: medicated feed preslaughter withdrawal time for edible tissues may vary in countries (5–7 days: premix), injectable solution: 14–35 days	<b>approved indications for injectable solution</b> (USA and elsewhere): used in swine for treatment and control of GI roundworms (adults and 4th-stage larvae), large roundworm, <i>Ascaris suum</i> ; red stomach worm, <i>Hyostromylus rubidus</i> , nodular worm, <i>Oesophagostomum</i> spp., threadworm, <i>Strongyloides ransomi</i> (adults only), somatic roundworm larvae: threadworm, <i>Strongyloides ransomi</i> (somatic larvae), and lungworms, <i>Metastrongylus</i> spp. (adults only), lice ( <i>Haematopinus suis</i> ), and mange mites ( <i>Sarcoptes scabiei</i> var. <i>suis</i> ), <b>limitations</b> : for subcutaneous injection in the neck of swine only, do not treat swine within 18 days of slaughter (28 days in Australia, 14–35 days in Germany, elsewhere); do
not use in other animal species as severe adverse reactions including fatalities in dogs, may result; <b>approved indications for medicated feed</b> (USA and elsewhere): <i>swine (growing-finishing)</i> , amount: 1.8 g of IVER/ton, feed to provide 0.1 mg/kg of b.w. per day, or <i>swine (mature and breeding)</i> , amount: 1.8–11.8 g of IVER/ton, feed to provide 0.1 mg/kg b.w./day for treatment and control of GI roundworms <i>Ascaris suum</i> (adults and 4th-stage larvae), <i>Ascarops strongylina</i> (adults), <i>Hyostromylus rubidus</i> (adults and 4th-stage larvae), and <i>Oesophagostomum</i> spp. (adults and 4th-stage larvae), kidney		



**Nematocidal Drugs, Animals. Table 4** Drugs used against nematode infections of swine (Continued)

CHEMICAL GROUP nonproprietary name of active substance (single oral dose, mg/kg b.w.), other information	*DRUG PRODUCT dose form (formulation), withdrawal time (WT) days (d) before slaughter, manufacturer, supplier, other information	CHARACTERISTICS miscellaneous comments on pharmacokinetics, metabolism, mode of action, toxicity, and limitations
worms ( <i>Stephanurus dentatus</i> , adults and 4th-stage larvae), lungworms ( <i>Metastrongylus</i> spp., adults), lice ( <i>Haematopinus suis</i> ), and mange mites ( <i>Sarcoptes scabiei</i> var. <i>suis</i> ), <i>limitations</i> : feed as the only feed for 7 consecutive days; for use in swine only, withdraw 5 days before slaughter (7 days in Australia, Germany, elsewhere); label dosage of IVER provides 98–100% efficacy against immature and adult stages of <i>A. suum</i> , <i>H. rubidus</i> , and <i>S. ransomi</i> (including somatic L3 in pregnant sows), lungworms., kidney worms (in all sites: cf. doramectin↓) and intestinal (not muscular) stages of <i>Trichinella spiralis</i> ; its efficacy against nodular worms and whipworms ( <i>Trichuris suis</i> including larvae) is variable; label dosage, given to pregnant sows for 7 consecutive days starting 2–3 weeks before farrowing effectively controls galactogenic transmission of <i>S. ransomi</i> to piglets; IVER is well tolerated at recommended dose (10-fold safety margin) and is generally safe in breeding and pregnant animals in mammals, acute toxic effects of IVER are central-nervous disorders, such as tremor, depression, ataxia, paresis, paralysis, depending on test species and applied dose (especially mice show an increased sensitivity to acute toxicity); teratogenic effects in laboratory animals occur only at maternotoxic doses; studies on mutagenicity and carcinogenicity (with abamectin) are negative (IVER summary report 1, EMEA)		
<p><b>doramectin</b> (DO) (0.3 intramuscularly *1 Dectomax=0.3 mL/10 kg b.w. or 1 mL/33 kg or 75 pounds b.w.) administer as a single i.m. injection into neck region and preferable high up behind ear; piglets weighing = 16 kg or less should be dosed as follows: 5–7 kg = 0.2 mL; 8–10 kg = 0.3 mL; 11–13 kg = 0.4 mL; 14–16 kg = 0.5 mL</p> <p><b>abamectin</b> (ABA) a single <i>subcutaneous</i> injection: 0.3 g/kg b.w. (= 1 ml Virbamec/33 kg b.w.) in the neck (dosage for piglets weighing 16 kg or less see doramectin ↑)</p>	<p>1*Dectomax (Pfizer, Germany, other European countries, Australia, USA and elsewhere) injectable solution (sterile, contains 10 mg DO/1 mL) 1* <i>limitations</i>: preslaughter withdrawal time for edible tissues may vary in countries (WT 24d USA), (WT 35d Australia), (WT 56d Germany, and elsewhere)</p> <p>Virbamec Antiparasitic infection (Virbac Australia, elsewhere) (sterile solution: 10 mg ABA/1 mL) <i>indications and limitations</i> see below</p>	<p>endectocide with broad-spectrum activity (long acting) for pigs and cattle (cf. Table 1, drugs against nematodes of ruminants) of all ages; indications: for treatment and control of gastrointestinal roundworms, lungworms, kidney worms, sucking lice, and mange mites; efficacy (98–100%) against immature and adult stages of GI parasites is excellent and comparable to that of ivermectin (see ↑); activity against whipworms (<i>Trichuris suis</i>) is variable only (54–87% in mixed infections in the field, in pure infections in laboratory studies up to 95%); DO (as fenbendazole or ivermectin↑) is highly effective against kidney worm,</p>
<p><i>Stephanurus dentatus</i>, in all sites of the sow (levamisole ↑ is effective only against worms located in kidneys); main residing sites of <i>S. dentatus</i> may be in peritoneal area and kidneys, a few stages may be scattered in liver, lungs, abdominal muscles, and peritoneal cavity (TB Stewart et al., <i>Vet Parasitol</i> 66: 95–99, 1996); DO is highly active (98–99%) against sucking lice <i>Haematopinus suis</i>, and the mange mite (<i>Sarcoptes scabiei</i> var. <i>suis</i>); like other avermectins or milbemycins, it does not affect eggs of mange mites; studies have also demonstrated persistent protection against reinfections of <i>Ascaris suum</i> (period of protection following treatment was at least 7 days) and mange mite (at least 18 days); this is due to prolonged maintenance (at least 1 week and longer) of effective plasma concentrations, i.e., systemic availability of *Dectomax after i.m. injection resulting in fairly great area under plasma drug concentration versus time curve (AUC) and so long preslaughter withholding periods; DO is well tolerated at recommended dose (5-fold safety margin) and it appears safe in breeding and pregnant animals at three times the therapeutic dose; <i>indications of ABA</i>: for treatment and control of internal and external parasites of pigs (for details see doramectin ↑) <i>limitations</i>: do not administer by i.v. or i.m. route; withdrawal time for meat: 21 days; precautions DO and ABA: compatibility with all vaccines has not been proven (therefore include exact weight determination of all piglets between 5 and 16 kg); DORA and ABA are extremely toxic to aquatic species like fish, crustaceans, and environment (e.g., adverse impact on dung beetle populations such as increased mortality and impaired development of larvae); therefore, do not contaminate dams, rivers, streams, or other waterways with products containing these chemicals</p>		

Data of drug products (approved labels) listed in this table refer to information from literature, web sites of European Medicines Agency (EMA), Committee for Veterinary Medicinal Products (CVMP), the US Food and Drug Administration (FDA), Center for Veterinary Medicine (CVM), the Australian Pesticides and Veterinary Medicines Authority (APVMA), and associated Infopest product summary, VETIDATA (Leipzig, Germany), and CliniPharm, CliniTox (Zurich, Switzerland); data given in this Table have no claim to full information

**Nematocidal Drugs, Animals. Table 5** Drugs used against nematode infections of dogs and cats

<b>CHEMICAL GROUP</b> nonproprietary name of active substance (single oral dose, mg/kg body weight = b.w.), other information	<b>*DRUG PRODUCT</b> dose form (formulation), withdrawal time (WT) days (d) before slaughter, manufacturer, supplier, other information	<b>CHARACTERISTICS</b> miscellaneous comments on pharmacokinetics, metabolism, mode of action, toxicity, and limitations
<b>CLINICAL FORMS OF HEARTWORM DISEASE, AND CONSEQUENCES TO USE OF DRUGS</b>		
<p><i>Dirofilaria immitis</i> infection occurring in carnivores primarily in warm countries where the mosquito intermediate host abounds (especially in the southern parts of the USA and Japan, or Australia); the use of the proper drug (drug of choice) in treating heartworm disease depends on both the degree (status) of clinical signs developed in the course of infection and the condition of dog, which may be determined by the amount of adult worms and their location in the venous circulation; thus heartworm disease can be classified in <i>class 1</i> (defined as asymptomatic-to-mild heartworm disease sometimes involving occasional listlessness, fatigue on exercise, or occasional cough), <i>class 2</i> (moderate form of disease, characterized by anemia, mild proteinuria, ventricular enlargement, slight pulmonary artery enlargement, or circumscribed perivascular densities plus mixed alveolar/interstitial lesions) <i>class 3</i> (advanced form of heartworm disease with cardiac cachexia, wasting, permanent listlessness, persistent cough, dyspnea, right heart failure associated with ascites, jugular pulse, right ventricular and atrial enlargement, signs of thromboembolism, anemia, and proteinuria), and <i>class 4</i> (severe form with vena cava syndrome, i.e., final stage of congestive right-sided heart failure, <i>D. immitis</i> present in vena cava and right atrium of heart; treatment is questionable or not indicated); unshathed microfilariae (MF) released from female worms into the bloodstream can cause severe adverse effects (anaphylactic-like shock) after being killed by a microfilaricidal drug; as a consequence, dogs with a patent <i>D. immitis</i> infection should be cleared from adults and MF prior to start of any prophylactic dosage regimen; this can be done by using a suitable (adulticidal) drug but only on condition that allows such a treatment, e.g., in animals having mild to significant clinical signs (fall under class 1–3 disease); causal chemoprophylaxis is the most effective measure in preventing establishment of <i>D. immitis</i> infection in dogs and other carnivores</p>		
<b>OTHER EXTRAINTestinal NEMATODES OF VETERINARY IMPORTANCE</b>		
<p>developing stages (larvae) of these parasites traveling through various tissues of the final host(s) mature to adult worms outside the intestinal tract; adults and migrating larvae are fairly refractory to treatment with anthelmintic drugs as it is also seen with all migrating larvae of gastrointestinal nematodes (see below); <i>Spirocerca lupi</i> of Canidae and Felidae frequently occurring in tropical and subtropical areas causes spirocercosis associated with severe damage of esophagus (e.g., granuloma, fibrosarcoma) and aorta (e.g., aneurysm formation); life cycle of this spiruroid includes various intermediate hosts (coprophagous beetles ingesting eggs passed in feces) and paratenic hosts (amphibia, reptiles, domestic and wild birds, and small mammals as hedgehogs, mice, and rabbits ingesting beetles or another paratenic host) in which larval worms become encysted; final hosts (e.g., dog, fox, wolf, jackal) become infected by ingesting either infected beetles or infected paratenic hosts; <i>Filaroides osleri</i> (<i>F. hirthei</i>, and other species) of dog infrequently occurs in the USA, Europe, India, South Africa, New Zealand, and elsewhere (a high prevalence may be in dogs kept under kennel conditions); 1st-stage larva in saliva or feces infects puppies when bitch licks and cleans them (direct life cycle); adult worms living under the mucosa of trachea and bronchi cause development of granuloma and in heavy infections a rasping persistent cough; heavily infected puppies show loss of appetite, emaciation, and hyperpnea, and sometimes mortality may occur in infected litters; <i>Crenosoma vulpis</i> of dog and (farmed) fox, occurring worldwide, is ovoviviparous and 1st-stage larva passes with the feces to be ingested by a land snail containing infective larvae; dogs may eat such snails and, after their digestion, released 3rd-stage larvae migrate to the lungs (trachea, bronchi, bronchioles) where they mature to adults thereby producing occlusion of bronchioles or bronchopneumonia; clinical signs are nasal discharge, coughing and tachypnea; outside the host, <i>Angiostrongylus vasorum</i> (distribution worldwide, except in the Americas; intermediate hosts: land snails, and slugs) has a similar life cycle as <i>C. vulpis</i>; in the host, 5th-stage larvae enter the pulmonary arterioles and capillaries and may cause chronic endarteritis and periarteritis of the larger vessels or even endocarditis involving tricuspid valve if vascular change extend to the right ventricle; in longer established and severe infections clinical signs such as tachypnea, cough, painless swellings of lower abdomen and intermandibular space and limbs are present even in resting dogs (for drugs acting on extraintestinal nematodes see this table: diethylcarbamazine, ivermectin or other macrolytic lactones, nitroscanate, pyrantel, levamisole, and benzimidazoles, and/or Table 6)</p>		
<b>GASTROINTESTINAL (GI) NEMATODES OF VETERINARY SIGNIFICANCE IN DOGS, CATS, AND WILD CARNIVORES</b>		
<p>there are several important nematodes of carnivores, which may reside in the small and large intestine; small worm loads may be asymptomatic whereas large quantities of migrating larvae and adult worms in the gut of especially puppies and kittens produce severe pathogenic effects and thus clinical signs being fatal without use of chemotherapy; in general, adult gastrointestinal (GI) nematodes are highly susceptible to various classes of anthelmintic drugs whereas migrating (developing) larvae of these parasites are fairly tolerant to the majority of anthelmintics even at enhanced and repeated doses; the life cycle of significant GI nematodes is usually direct (without intermediate host), e.g., in hookworms occurring</p>		

**Nematocidal Drugs, Animals. Table 5** Drugs used against nematode infections of dogs and cats (Continued)

CHEMICAL GROUP nonproprietary name of active substance (single oral dose, mg/kg body weight = b.w.), other information	*DRUG PRODUCT dose form (formulation), withdrawal time (WT) days (d) before slaughter, manufacturer, supplier, other information	CHARACTERISTICS miscellaneous comments on pharmacokinetics, metabolism, mode of action, toxicity, and limitations
<p>endemically in the tropics and worm temperate areas in carnivores, such as <i>Ancylostoma caninum</i> of the dog, cat, and fox, <i>A. tubaeforme</i> of cat, and <i>A. braziliense</i> of dog and cat, are responsible for widespread morbidity and mortality, especially in young or debilitated animals due to the bloodsucking activities of these worms in the small intestine (adults are about 1–2 cm long, prepatent period 14–21 days); free-living hookworm 3rd-stage larva hatched from egg infects host by skin penetration and undergoes 2 molts during its migration phase; the oral route of infection by ingestion of infective larva usually occurs with <i>Uncinaria stenocephala</i>, a hookworm of dog, cat, and fox; highly pathogenic <i>A. caninum</i> is characterized by migration 3rd-stage larva via the blood stream through various tissues of host; there is a migratory route through the lungs (3rd-stage larva molts in the trachea and bronchi to 4th-stage larva) and a transmammary route with galactogenic transmission of 3rd-stage larva to nursing pups; this transmammary infection is often responsible for severe anemia in litters of young pups about 3 weeks after whelping; bitches, once infected, can produce transmammary infections in at least 3 consecutive litters; apart from its veterinary importance ascarids, especially <i>Toxocara canis</i> is responsible for the most widely recognized form of visceral larva migrans in humans; egg (ovoid, yellow-brown, thick sculptural shell) containing 2nd-stage larva being infective for dogs and foxes; after hatching of 2nd-stage larva in the small intestine it travels via bloodstream to the liver, heart, pulmonary artery, to the lungs (molts to 3rd-stage larva) and thence to the bronchi, trachea, and via esophagus to the intestine, where 3rd-stage larva matures (2 molts) to adults; in the pregnant bitch prenatal infection of the fetus occurs about 3 weeks prior to parturition by 2nd-stage larvae migrating to fetal lungs where they molt to 3rd-stage larvae; in newborn pups the cycle is completed when larvae travel via the trachea to the intestine; a bitch (once infected) harbors enough larvae to infect all her subsequent litters without being reinfected; suckling pups can also ingest infective 3rd-stage larva via milk during the first 3 weeks of lactation (transmammary infection); adult worms (females up to 18 cm long, males 10 cm long) may cause potbelly in pups and occasionally diarrhea; in heavy infections larval migration can cause pulmonary damage and thus coughing and tachypnea; in pups, which have been heavily infected transplacentally, most mortality may be seen within a few days of birth; rodents or birds may serve as paratenic hosts where L<sub>2</sub> travel to their tissues and remain there until eaten by a dog; prepatent period in paratenic hosts is 4–5 weeks, and in prenatal infection 3 weeks; <i>Toxocara cati</i> (adults 3–10 cm long, prepatent period about 8 weeks) of cat and wild felines is distributed worldwide; the life cycle is similar to that of <i>T. canis</i> but it lacks prenatal infection of the fetus; <i>Toxascaris leonina</i> (adult females up to 10 cm long, males 7 cm long, prepatent period about 11 weeks) occurring in the small intestine of dog, cat, fox, and wild carnivores in most parts of the world is of less significance because its parasitic phase in the host is nonmigratory, i.e., after ingesting the infective larvated egg subsequent development takes place entirely in the wall and lumen of the intestine; whipworm (<i>Trichuris vulpis</i>, 4–8 cm long prepatent period 11–12 weeks, distribution worldwide) occur in the cecum and colon (large intestine) of the dog and fox and is characterized by its whiplike body (posterior part being much thicker than the anterior, about three-quarters of the body being made up by the anterior part, which tunnel into the intestinal mucosa); less common is <i>T. serrata</i> occurring in cats; infective 1st-stage larva within the egg (lemon-shaped with a plug at both ends) needs about 1–2 months for development in temperate climate; after ingestion of larvated egg, released larva molts 4 times within the mucosa and emerging adults lie on mucosal surface (with their posterior part) while their thin anterior part is embedded in the mucosa thereby producing marked damage of tissues; pathogenic effects that may result from location and continuous movement of the anterior part of whipworm are lacerate tissues creating pools of blood and fluid, which the adults ingest; in heavy infections this nematode can produce an acute or chronic inflammation, especially in the cecum of the dog</p>		
<b>DRUGS ACTING ON ADULT HEARTWORMS</b>		
ARSENICALS		
<p>several arsenicals have been shown to have wide biological activity, including toxicity and to kill adult heartworms; female worms are less susceptible than male worms to arsenicals; they show no efficacy against circulating microfilariae (= MF)</p>		
<p><b>thiacetarsamide sodium (TAS)</b> synonyms: arsenamide, thioarsenite (dog, intravenously: 2.2 = 0.22 ml = 0.44 elemental arsenic mg/kg b.w.= b.w., twice daily for 2 days) <b>limitations:</b> absolute rest during first 2 weeks post-treatment is a must and only limited exercise is allowed during the next 2 weeks because of risk of embolism</p>	<p>*Caparsolate sodium (Boehringer Ingelheim, Merial Australia PTY LTD) parenteral liquid/solution (10 mg/mL TAS) <b>precaution:</b> function of liver and kidney must be checked before beginning of treatment; severe toxic reactions to TAS can be treated with <i>dimercaprol</i>: 2.2 mg/kg 4 times per day usually gives relief (<i>dimercaprol</i> is the antidote to poisoning by arsenic, gold, mercury, and other metals)</p>	<p>caution must be exercised to avoid perivascular leakage during intravenous injection; TAS is highly irritating to subcutaneous tissues and may lead to distinct necrosis of tissues (corticosteroids may reduce aggravating inflammatory reaction); it has been the standard adulticidal drug for the past several decades; its efficacy may vary extremely as a function of worm's age and sex; female worms are less susceptible than male worms to TAS,</p>

**Nematocidal Drugs, Animals. Table 5** Drugs used against nematode infections of dogs and cats (Continued)

CHEMICAL GROUP nonproprietary name of active substance (single oral dose, mg/kg body weight = b.w.), other information	*DRUG PRODUCT dose form (formulation), withdrawal time (WT) days (d) before slaughter, manufacturer, supplier, other information	CHARACTERISTICS miscellaneous comments on pharmacokinetics, metabolism, mode of action, toxicity, and limitations
<p>and very young (2 months of age) and very old (2 years of age) worms were more susceptible than the rest of them (4/6/12/18 months of age); host-related variations in drug pharmacodynamics may be another explanation for the extreme variation in efficacy; adult worms gradually die (within 5–7 days, up to 14 days); dead and dying adult worms washed out of the right heart by blood flow lodge in branches of pulmonary artery and are eliminated by phagocytosis within about 2 months, residues (fragments) of damaged and/or phagocytized worms pose a distinct threat to well-being of animals by embolism occurring principally in the first month following treatment; splitting of the daily dose (<math>2 \times 2.2</math> mg/kg b.w.) will markedly reduce most of <i>hepatotoxic</i> and <i>nephrotoxic effects</i> of TAS though its recommended dose should not be reduced in very large dogs; tolerability of TAS seems to be best if it is injected 1–2 hours after feeding in the morning or evening; interest on eating may provide some indication of general condition and regimen of treatment is continued if dog does not vomit, is eating well, and there is no indication of hepatic or renal failure; if treatment must be interrupted because of severe toxic reactions, retreatment (entire regimen) is recommended 6 weeks later to prevent liver damage; <i>mortality</i> during or following TAS therapy seems to be related to the degree of clinical manifestation of heartworm disease (no mortality in asymptomatic class I-animals, 3–5% mortality in mildly symptomatic class 2-animals, and up to 50% mortality in advanced class 3-animals)</p>		
<p><b>melarsomine</b> dihydrochloride (MELDH) for injection regimen for asymptomatic to moderate <i>class 1–2</i> heartworm disease: (dog, <math>2.5 = 0.1</math> ml/kg twice, 24 hours apart, first dose right lumbar muscle, L3–L4, second in the left side): series can be repeated in 4 months and depends on response to treatment, age, use, and condition of dog, or if there is lack of seroconversion or exposure to reinfection; regimen for severe <i>class 3</i> heartworm disease: (dog, <math>2.5 = 0.1</math> ml/kg, single injection followed approx. 1 month later, by <math>2.5</math> mg/kg twice, 24 hours apart; latter schedule reduces risk of complications from pulmonary embolism following treatment; administer only by deep injection in lumbar muscles: details see above)</p>	<p>*Immiticide Sterile Powder (Merial Ltd., US), (drug consists of a vial of lyophilized powder containing 50 mg MELDH reconstituted with 2 ml of sterile water for deep i.m. injection in longissimus dorsi; leakage should be avoided and repeated injection should not occur at the same lumbar site) <b>precautions:</b> after treatment, dogs should be monitored for toxic signs produced by dying worms and residues of dead worms such as aggravating cough, fever, and sudden tachypnea or even orthopnea; dogs should be kept in subdued light and only limited exercise should be allowed (absolute rest post-treatment in the next 2 weeks is a must) <b>limitations:</b> not for use in breeding animals and lactating or pregnant bitches; contraindicated in dogs with class 4</p>	<p>trivalent arsenical of melanonyl thioarsenite group (RM 340) with adulticidal activity against male and female heartworms (<i>Dirofilaria immitis</i>) and 4-month-old heartworms in dogs; MELDH can be used for treatment of stabilized class 1, class 2, and class 3 heartworm disease caused by immature (4-month-old L<sub>5</sub> larvae) or adult stages of <i>D. immitis</i>; <b>contraindication:</b> the drug should not be used in dogs suffering from final stage (<i>class 4</i>) of heartworm disease (<i>D. immitis</i> present in vena cava and right atrium of heart causing vena cava syndrome, i.e., final stage of congestive right-sided heart failure); in class 1 and class 2 of heartworm disease a single 2-dose regimen kills all male worms and about 95% of female worms though complete elimination of all worms</p>
<p>resulted in 60–80% of treated dogs only; elimination of all heartworms results in about 98% of dogs following the sequence of two 2-dose regimens 4 months apart; in severe cases (class 3) initial single dose (see alternative regimen) results in a partial kill of adult heartworms (about 85% of male and 15% of female) leading to some relief of symptoms (e.g., fever, gagging, coughing, tachypnea) thereby reducing the risk (to a certain degree) of embolic shower of whole or partially phagocytized worms in the branches of the pulmonary artery; the 2-dose schedule 1 month apart usually kills all worms in about 85% of dogs; <i>pharmacokinetics</i> of MELDH is characterized by short absorption half-life of 2.6 minutes (peak concentration in blood at 8 minutes); it has a greater bioavailability than thiacetarsamide thus resulting in a adulticidal effect half the arsenic equivalent of thiacetarsamide and about twice the therapeutic index; unlike thiacetarsamide, which binds to erythrocytes, MELDH and its metabolites are free in plasma resulting in higher and longer lasting plasma levels than those seen with thiacetarsamide; i.m. injection (1–5% solutions) of MELDH is well tolerated causing only minor tissue reactions (circumscribed edema); <i>overdosing</i> (e.g., 4.4 mg/kg 3 hours apart) results in adverse effects within 30 minutes after treatment; most toxic signs last about 1 hour (salivation, restlessness, pawing, tachypnea, tachycardia, abdominal pain, hindlimb weakness, recumbency); severe toxicity is characterized by orthopnea, circulatory collapse, coma, and death (<i>antidote dimercaprol</i> 3 mg/kg i.m. given within 3 hours after appearance of first toxic signs can reserve toxicity of MELDH but may reduce its activity against adults); older dogs (&gt;7 years of age) are more sensitive to MELDH treatment than younger dogs; its reproductive toxicity in breeding animals and lactating or pregnant bitches has not been investigated; its mode of action in <i>D. immitis</i> is unknown</p>		

**Nematocidal Drugs, Animals. Table 5** Drugs used against nematode infections of dogs and cats (Continued)

CHEMICAL GROUP nonproprietary name of active substance (single oral dose, mg/kg body weight = b.w.), other information	*DRUG PRODUCT dose form (formulation), withdrawal time (WT) days (d) before slaughter, manufacturer, supplier, other information	CHARACTERISTICS miscellaneous comments on pharmacokinetics, metabolism, mode of action, toxicity, and limitations
<b>DRUGS ACTING ON MICROFILARIAE OF <i>D. IMMITIS</i> (FOR PREVENTIVE USE) AND GI-NEMATODES</b>		
the use of microfilaricidal drugs is contraindicated in dogs with established heartworm infections (adult <i>D. immitis</i> producing microfilariae = MF); inadvertent administration of such drugs to heartworm-infected dogs may cause adverse (sometimes fatal, likely nonallergic) reactions due to substances released from dying or dead MF or fragments of MF, which may initiate symptoms associated with pulmonary occlusion; therefore, dogs with established heartworm infections should not receive the drug until they have been cleared from all adult <i>D. immitis</i> and converted to a negative status either by use of adulticidal (see ↑) and microfilaricidal drugs or by means of surgery (removal of adult worms) in life-threatening conditions such as “vena cava syndrome” or “liver failure syndrome” (class 4 heart worm disease) not amenable to chemotherapeutic treatment		
<b>CYANINE DYES</b>		
<b>dithiazanine</b> iodide (DIIO) (dog, 10 mg/pound b.w., for several days depending on target worm species) <b>limitation:</b> federal law restricts DIIO to use by or on the order of a licensed veterinarian	*Dizan Tablets (Boehringer Ingelheim, Vetmedica, Inc.) (coated tablets contain 10/50/100 or 200 mg DIIO in each tablet); oral tablets should be given immediately after feeding to dogs; others: *Dizan powder or suspension with piperazine	exhibit activity against microfilariae of <i>D. immitis</i> (3 mg/pound = 6.6 mg/kg b.w. for 7–10 days) and was being used as standard microfilaricidal drug for many years in dog (old-timer); it is active against <i>Toxocara canis</i> , <i>Toxascaris leonina</i> (10 mg/pound = 22
mg/kg b.w. for 3–5 days), <i>Ancylostoma caninum</i> , <i>Uncinaria stenocephala</i> (10 mg/pound b.w. for 7 days), <i>Trichuris vulpis</i> , <i>Strongyloides canis</i> , and <i>S. stercoralis</i> (10 mg/pound b.w. for 10–12 days); <b>limitations:</b> treatment with DIIO for heartworm microfilariae should follow 6 weeks after therapy for adult worms; DIIO is contraindicated in animals sensitive to DIIO and should be used cautiously, if at all, in dogs with reduced renal function: side effects of DIIO may be severe diarrhea, vomiting, and anorexia		
<b>AMINES (PIPERAZINES)</b>		
<b>diethylcarbamazine</b> citrate (= DEC) (dog, 6.6, daily dose during heartworm season) for free-choice feeding or broken and placed on or mixed with either dry or wet feed or immediately after feeding (cat, dog, 55–110, as an aid in treatment of immature ascarids; repeat dose in 10 to 20 days) <b>DEC formulations:</b> syrup (60 mg/ml), chewable tablets, chewable wafers, capsules: various amounts, e.g., 12.5, 30, 45, 50, 60, 100, 120, 150, 180, 200, 300, or 400 mg/tablet) <b>limitations:</b> DEC should not be used in dogs that may harbor adult heartworms; federal law (USA) restricts this drug to use by or on the order of a licensed veterinarian	*Dirocide Tablets, Syrup (Fort Dodge); *Filaribits, *Pet-Dec, tablets (Pfizer), *Filban Tablets (Schering-Plough); *Nemacide Tablets (Boehringer Ingelheim), *DEC tablets (Lloyd; Wendt Labs; R.P. Scherer N A), *Difil Syrup or Tablets (Evsco Pharm.), *Carbam Tablets (Cross Vetpharm): for cats and dogs (all USA) *Heartworm Tablets: Mavlab; Nestle Purina Petcare Aristopet; PTY; (Univ. Manufact. & Labs.) for dogs (all Australia), other brand names and sponsors in Australia and elsewhere; DEC has not been considered by EMEA (is not available in Germany or elsewhere)	for <b>prevention</b> of infection with <i>Dirofilaria immitis</i> (heartworm disease) in dogs; DEC acts on both infective 3rd stage larvae and microfilariae (MF) of <i>D. immitis</i> though its action on circulating MF is not safe; it is more active against preadult developing stages; administration of drug should start at beginning of mosquito activity and be continued daily (3 mg/pound = 6.6 mg/kg b.w.) through the mosquito season and for approximately a month thereafter; it may be also used as a preventive for heartworm disease in <i>ferrets</i> (pet ferrets 2.75–5.5 DEC mg/kg b.w. as powder per day) and <i>sea lions</i> ; heart worm disease may frequently occur in amusement parks
though occurrence of patent heartworm infections in cats is infrequent; in warmer climates with all year prevalence of mosquito vector transmitting infective larvae of <i>D. immitis</i> , daily administration of DEC for lifetime should be performed in animals under risk; it can be used as an aid in the <i>treatment</i> of ascarids ( <i>Toxocara canis</i> , <i>Toxascaris leonina</i> ); it prevents the establishment of ascarid infection in cats and dogs though recommended and approved two-dose-regimen (↓) is ineffective against adult ascarids (first dose DEC: 25–50 mg/pound b.w.= 55–110 mg/kg b.w., orally, tablet or pulverized tablet given in feed; repeat dose (amount as first) should be given in 10–20 days to remove immature worms that may enter intestine from lungs after first dose; <b>limitations:</b> dogs with established heartworm infection should not receive the drug until they have been converted to a negative status by use of adulticidal and microfilaricidal drugs; inadvertent treatment of <i>D. immitis</i> infected dogs may cause adverse reactions due to pulmonary occlusion or shock); DEC has been reported to be effective against lungworm <i>Crenosoma vulpis</i> of dog and farmed foxes; <b>pharmacokinetics:</b> it is rapidly absorbed, peak concentration is about 3 hours after oral administration and reach zero level in 48 hours (excretion: 70% in urine within 24 hours, 10–25%		

**Nematocidal Drugs, Animals. Table 5** Drugs used against nematode infections of dogs and cats (Continued)

CHEMICAL GROUP nonproprietary name of active substance (single oral dose, mg/kg body weight = b.w.), other information	*DRUG PRODUCT dose form (formulation), withdrawal time (WT) days (d) before slaughter, manufacturer, supplier, other information	CHARACTERISTICS miscellaneous comments on pharmacokinetics, metabolism, mode of action, toxicity, and limitations
unchanged); DEC as a piperazine derivative is a relatively nontoxic; its side effects are similar to those of piperazine; overdosage may cause vomiting (irritation to gastric mucosa); it has no adverse effects on fertility of male dogs in long term treatment; DEC may be also used as a microfilaricide against <i>Onchocerca volvulus</i> infections in <i>humans</i> (cf. → Nematocidal Drugs, Man/Table 1)		
<b>diethylcarbamazine</b> citrate (DEC)/ <b>oxibendazole</b> (OBZ) (dog, 6.6/5 = 3/2.27/pound; dog, no use class stated or implied)	*Filaribits Plus Chewable Tablets (Pfizer Inc. USA), each tablet contains either 60, 120, or 180 mg of DEC with 45, 91, or 136 mg of OBZ, respectively	for prevention of infection with <i>D. immitis</i> (heartworm disease) and <i>Ancylostoma caninum</i> (hookworm infection) and for removal of <i>Trichuris vulpis</i> (whipworm infection) and
mature and immature stages of intestinal <i>Toxocara canis</i> (ascarid infection); <b>limitations</b> : orally administer daily during heartworm season; for free-choice feeding or broken and placed on or mixed with feed; drug combination should not used in dogs that may harbor adult heartworms (cf. DEC ↑, adverse reactions); federal law (USA) restrict this drug to use by or on the order of a licensed veterinarian		
<b>MACROCYCLIC LACTONES</b> AVERMECTINS		
<b>ivermectin</b> (IVER) (dog, excluding under 6 weeks age: 0.006 = 6.0 µg = 0.00272 = 2.72 µg per pound b.w., once-a-month to prevent heartworm infection) <b>limitations</b> : use once-a-month; recommended for dogs 6 weeks of age and older; initial use within 1 month after first exposure to mosquitoes; final use within 1 month after last exposure to mosquitoes; federal law (US) restricts this drug to use by or on the order of a licensed veterinarian	*Heartgard 30 Chewables (Merial, USA Australia), tablets (68/136 or 272 µg IVER/tablet); *Iverhart (Virbac), tablet (68 µg/tablet); *Ivermectin Chewable Tablets (IVX Animal Health), tablets (68/136 or 272 µg/tablet) (all USA); various products for prevention of heartworm infections in Australia and elsewhere (Heartworm tablets may contain 60, 136, 272, or 408 µg IVER for small, medium and large dogs, respect.; sponsors may be Merial, Bayer, Riverside Vet Prod., MavLab; Jurox, others) *Heartgard 30 FX Chewables for cats (Merial Australia) (165 µgIVER/tablet)	endectocide to prevent canine/feline heartworm disease by eliminating tissue stages of heartworm larvae of <i>D. immitis</i> ; it kills infective 3rd stage larvae transmitted by mosquitoes (vector) and subsequent developing (L <sub>4</sub> ) stages in the subcutaneous or subserosal tissues acquired during the previous approx. 45 days, or over the next few months in fresh infections; elimination of tissue stages of heartworm larvae is usually achieved within 30 days of infection; thus, once-a-month dose given through the mosquito season prevents establishment of heartworm infections in the venous circulation of dogs/cats for 1 month (30 days) after
infection; the drug is also effective against heartworm microfilaria at 0.05 mg IVER/kg b.w. (orally) but not approved for this indication (potential hypersensitivity reactions due to dying or dead microfilariae circulating in blood stream); IVER is ineffective at any dose against adult heartworms; <i>experimental studies</i> have shown that the drug has a wide spectrum of activity against various canine GI nematodes (4th-stage and adults) after a single subcutaneous (s.c.) dose of 0.05 to 0.2 mg/kg b.w.; high reduction rates (approx. 100%) of prenatal and transmammmary transmission of 3rd stage <i>Toxocara canis</i> larvae from the bitch to her puppies have been observed after treating the bitch with 0.5mg/kg (s.c.) 10 days prior to and 10 days after whelping; <i>arthropods</i> (otodectic, sarcoptic, and notoedric mange, <i>Pneumonyssus caninum</i> nasal mites) in dogs and cats are affected by IVER (0.2 mg/kg ×2, s.c., 2 weeks apart), <i>Chyletiella</i> spp. (0.3 mg/kg ×2 s.c., 2 weeks apart) or demodectic mange of dogs (0.6 mg/kg ×5 at 7-day intervals); <b>tolerability</b> : the drug has a wide safety margin though the Collie is susceptible to ivermectin toxicity at oral doses of 0.1 mg/kg and higher doses; adverse reactions in the Collie are not seen at recommended dose for heartworm prevention (6 µg/kg) or even 10 times the preventive dose (0.06 mg/kg, monthly for a year) the drug is safe in breeding and pregnant animals; recommended dose for dogs under 6 weeks of age may cause transient diarrhea		
<b>ivermectin/pyrantel</b> pamoate (IVER/PYR) (dog 0.006/5: once a month) <b>limitations</b> : use monthly; recommended for dogs 6 weeks of age or older; federal law (USA) restricts this drug to use by or on the order of a licensed veterinarian	*Heartgard Plus (Merial), *Iverhart Plus (Virbac), chewable tablets: specifications (68 µg/57 mg, 136 µg/ 114 mg or 272 µg/227mg per IVER/ PYR-tablet) for dogs, excluding under 6 weeks age; for Allwormer products see pyrantel ↓	marketed in the USA, Australia, and elsewhere; IVER for use in dogs to prevent canine heartworm disease by eliminating tissue stages of heartworm larvae ( <i>D. immitis</i> ) for a month (30 days) after infection; PYR pamoate for treatment and control of adult <i>Toxocara canis</i> , <i>Toxascaris leonina</i> , <i>A. caninum</i> , <i>A. braziliense</i>

**Nematocidal Drugs, Animals. Table 5** Drugs used against nematode infections of dogs and cats (Continued)

CHEMICAL GROUP nonproprietary name of active substance (single oral dose, mg/kg body weight = b.w.), other information	*DRUG PRODUCT dose form (formulation), withdrawal time (WT) days (d) before slaughter, manufacturer, supplier, other information	CHARACTERISTICS miscellaneous comments on pharmacokinetics, metabolism, mode of action, toxicity, and limitations
(cf. WL Shoop et al. <i>Aust Vet J</i> 73: 84, 1996), and <i>U. stenocephala</i> (for effects on <i>A. braziliense</i> resulting in nearly 100% reduction of worm load and egg output); the combination is safe for dogs; overdosage may cause vomiting and/or diarrhea within 24 hours postdosing; in puppies, occasionally depression, lethargy, anorexia, mydriasis (anomalous dilation of the pupils), ataxia, staggering, convulsions, and hypersalivation may occur		
<b>ivermectin/imidacloprid</b> *1 (dog, 0.080 = 80 µg/10, topically once-a-month) *2 <b>ivermectin + fipronil</b> <i>limitations</i> : cats, excluding under 3 months of age	1*Advantage DUO (Bayer, USA, Australia) for dogs, no class stated or implied 2*Startgard for Kittens (Merial, Australia), oral tablet + liquid, topically	1* For prevention of heartworm disease ( <i>D. immitis</i> ); kills adult fleas and is indicated for treatment of flea infestations ( <i>Ctenocephalides felis</i> ); federal law (U.S.) restricts this product to use by or on the order of a licensed veterinarian;
2*(cat, 24 µg IVER/kg b.w.), for use by veterinarians as initial treatment for fleas and hookworms, and to prevent heartworm disease; chewable tablet contains 55 µg IVER, topical liquid contains 100 g fipronil/l → net contents: 1 tab IVER + 1 × 0.5ml fipronil		
<b>selamectin (SELA)</b>		
<b>dosage</b> (dog, cat, minimum dose: 6 mg/kg b.w., or 2.7 mg/pound b.w., a single <i>topical application</i> of a unit dose, once a month) <b>limitations</b> : laws restricts this drug to use by or on the order of a licensed veterinarian; do not use on dogs and cats less than 6 weeks of age, do not use in cats suffering from concomitant disease, or debilitated or underweight (for size and age); <b>drug products</b> : available in color-coded, single dose tubes for topical (dermal) treatment of cats and dogs beginning at 6 weeks of age; content of each tube is formulated to provide a minimum of 6 mg SELA/kg b.w.; *Revolution (Pfizer Inc., USA/ Australia Animal Health, and elsewhere),*Stronghold (Pfizer, Ltd., European Union, and elsewhere) for cats and dogs 6 weeks of age and older; liquid (in different tube sizes and pack color) may contain 15, 30, 45, 60, or 120 mg SELA and 0.08% butylated hydroxyl-toluene; (spot-on: single site at base of neck in front of scapulae; do not apply when animal's hair coat is wet); <b>pharmacodynamic properties</b> : novel semi-synthetic avermectin B1 derivative related to doramectin; it interferes with chloride channel conductance in invertebrates causing disruption of normal neurotransmission and thus inhibition of electrical activity of nerve cells in nematodes and muscle cells in arthropods; this leads to paralysis and death of invertebrates; <b>indications</b> of approved drug products for cats, kittens, dogs, and puppies may vary in countries: <i>flea treatment, control, and prevention</i> : SELA has high adulticidal, ovicidal and larvicidal activity (99–100%) against fleas; it effectively breaks flea life cycle of <i>Ctenocephalides felis</i> and <i>C. canis</i> by killing adults (on animal), preventing hatching of eggs (on animal and its environment) and by killing larvae (environmental only), debris from SELA-treated pets kills flea larvae (and eggs) not previously exposed to SELA and thus may aid in control of existing environmental flea infestation in areas to which animal has access; therefore, significant reductions in flea infestations are to be expected after just one monthly treatment; for prevention and long-lasting control of flea infestations, drug should be applied to all cats and dogs in same environment at monthly intervals throughout flea season, starting one month before fleas become active; break of flea life cycles will improve clinical signs associated with flea allergy dermatitis in most animals (some of them may not respond to this treatment alone); <i>prevention of heartworm disease (D. immitis)</i> in dogs and cats, dosage schedule: product may be administered year-round or at least within one month of animal's first exposure to mosquitoes and monthly thereafter until end of mosquito season (final dose one month after last exposure to mosquitoes); SELA at recommended dose may be safely given to animals infected with adult heartworms, however, it is recommended that all animals 6 months of age or more living in countries where a vector exists should be tested for existing adult heartworm infections prior to medication with SELA and thereafter as an integral part of heartworm prevention strategy (drug is not effective against adult <i>D. immitis</i> ); <i>mites, lice, and ticks</i> : a single dose of product(s) is highly effective (~100%) in treating ear mites in cats ( <i>Otodectes cynotis</i> ), in dogs 2 monthly doses are recommended to eliminate 90% of ear mites, and monthly use of the products will treat any subsequent ear mite infestation; a single dose of SELA is highly effective against sarcoptic mange ( <i>Sarcoptes scabiei</i> ) and a second monthly dose may be required for complete elimination of mites in some dogs; this dose regimen is also highly efficacious in treating and controlling biting lice infestation ( <i>Trichodectes canis/Felicola subrostratus</i> ) in dogs/and cats, tick infestations ( <i>Dermacentor variabilis</i> and <i>Rhipicephalus sanguineus</i> ) in dogs; treatment of <i>adult roundworms (Toxocara cati)</i> and adult intestinal hookworms ( <i>Ancylostoma tubaeforme</i> ) in cats, or adult intestinal roundworm ( <i>Toxocara canis</i> ) in dogs; <b>pharmacokinetics</b> : SELA is absorbed from skin reaching maximum plasma concentrations ~1–3 days after administration of a single topical dose at 6 mg/kg b.w. in cats and dog, respectively; it is distributed systemically and is slowly eliminated from plasma, thus terminal elimination half-time is 8 and 11 days in cats and dogs, respectively; systemic persistence of SELA in		

**Nematocidal Drugs, Animals. Table 5** Drugs used against nematode infections of dogs and cats (Continued)

CHEMICAL GROUP nonproprietary name of active substance (single oral dose, mg/kg body weight = b.w.), other information	*DRUG PRODUCT dose form (formulation), withdrawal time (WT) days (d) before slaughter, manufacturer, supplier, other information	CHARACTERISTICS miscellaneous comments on pharmacokinetics, metabolism, mode of action, toxicity, and limitations
<p>plasma and lack of extensive metabolism render possible long interdosing intervals (30 days); [3H] SELA was found in sebaceous glands, hair follicles, and on basal layer of epithelium, thus providing a depot for slow release of the drug to skin surface; there are no interactions with other medicinal products and other forms of interactions; <b>use during pregnancy, lactation or lay:</b> there is no effect on the health or reproductive status of female or male dogs and cats; thus drug products can be used in breeding, pregnant and lactating cats and dogs at recommended dose; <b>adverse reactions:</b> in cats, on rare occasions (~0.1%) mild transient alopecia at site of application, or on very rare occasions (~0.03%) transient focal irritation (pruritus) may occur; alterations are normally self-resolving (symptomatic therapy may be applicable in some cases); <b>toxicity and overdose:</b> the drug was found to be safe and well tolerated under clinical conditions in the field when administered topically at higher doses than the recommended dose; in cats and dogs no adverse effects were observed at 10 times the recommended dose; at 3 times the recommended dose, no undesirable effects occurred in animals infected with adult heartworms, or breeding male and female cats and dogs, including pregnant and lactating females nursing their litters; no adverse effects were observed at 5 times the recommended dose to ivermectin-sensitive collies (strains of Rough-coated Collies); <b>environment:</b> SELA may adversely affect fish or certain water-borne organisms on which they feed (avoid therefore contamination of any water courses); avoid contact with eyes, because it will irritate eyes, drug products are flammable (keep away heat, sparks, open flames, sources of ignition);</p>		
<b>MILBEMYCINS</b>		
<b>milbemycin oxime (MO)</b>		
<p><b>dosage:</b> dog, minimum per os dose 0.5 mg MO/kg b.w., or 0.23 mg MO/pound b.w. (excluding prevention of heartworm disease in the USA: *Interceptor Tabs, approved dose 0.1 mg MO/kg b.w. or 0.045 mg MO/pound b.w.), once a month for control and removal of intestinal nematodes, and prevention of heartworm disease caused by <i>D. immitis</i>; cat, minimum per os dose 2 mg MO/kg b.w. or 0.91 mg MO/pound b.w., once a month for prevention of heartworm disease (<i>D. immitis</i>), and control and removal of intestinal nematodes; <b>limitations:</b> laws restricts this drug to use by or on the order of a licensed veterinarian; do not use in puppies less than 4 weeks of age and less than 2 pounds b.w., and in kittens less than 6 weeks of age or 1.5 pounds b.w.; <b>dosage schedule for heartworm prevention in dogs:</b> first dose given within 1 month after first exposure to mosquitoes and continue regular use until at least 1 month after end of mosquito season; dogs living in heartworm-free regions and traveling to heartworm risk areas should be treated within 1 month of the beginning of the exposure to transmission; initial dose given at 30–45 days post-infection with 3rd-stage <i>D. immitis</i> larvae prevents establishment of infection completely (incomplete prevention if treatment begins 60–90 days postinfection); <b>drug products</b> (Novartis AH, USA or Australia, and elsewhere) (MO has not yet been evaluated by European Medicine Agency, EMEA); *Interceptor, oral tablets for dog/puppy excluding under 4 weeks age or under 2 pounds b.w., and cats/kittens excluding under 1.5 pounds weight or under 6 weeks age; tablet contains 2.3; 5.57; 11.5 or 23 mg MO (in color-coded packs); *Milbemite Otic Solution for cats and kittens 4 weeks of age and older (liquid, each tube contains 0.25 ml of a 0.1% solution of MO; 1 tube administered topically into each external ear canal as a single treatment); *MilbeMite Ear Solution for cats, kittens and dogs, puppies &gt;8 weeks age (liquid, each plastic tube contains 0.25 ml MilbeMite as a 1mg/mL solution of MO); topical administration into external ear canal of cat: 1 tube per ear (0.2 ml delivered, residual volume ~0.05 ml), dog: 2 tubes per ear as a single treatment; <b>contraindicated</b> for use in animals with ruptured tympanic membranes; <b>pharmacodynamic properties:</b> MO is a mixture of macrolides milbemycin A3 oxime (~20%) and milbemycin A4 oxime (~80%); MO is active against nematodes and arthropods (endectocide); like other macrocyclic lactones, MO interacts with GABA receptors of parasites' nervous system leading to paralysis and death of invertebrate; <b>precautions:</b> *Interceptor for prevention of heartworm disease caused by <i>Dirofilaria immitis</i>: dogs should be tested for patent heartworm infection before starting prevention program (check for circulating microfilariae in blood and adult heartworms); it is a potent and fast acting microfilaricide in dogs, and a single oral dose of ≤0.25 mg MO/kg b.w. may result in &gt;98% decline in microfilaremia (blockade of embryogenesis) within a few days, occasionally producing shocklike reactions at the time of treatment; more commonly occur mild reactions such as salivation, coughing, tachypnea, vomiting, and depression; concurrent administration of MO and corticosteroids as well as i. v. fluids will markedly reduce these reactions; dogs given recommended dose for <i>D. immitis</i> prevention (0.5–0.99 mg MO/kg monthly) will become free of microfilariae within 6–9 months and the majority of so treated dogs will remain amicrofilaremic following a 4–6-month intermittence of prevention (mosquito free winter season); in cats, an oral dose of 0.5–0.9 mg MO/kg b.w. (once a month) completely prevents establishment of experimental <i>D. immitis</i> infection; <b>other indications:</b> control of hookworm infections caused by <i>Ancylostoma caninum</i> (MO does not reliably affect <i>Uncinaria stenocephala</i>) and <i>A. tubaeforme</i> (cats, kittens), and removal and control of adult roundworm infections caused by <i>Toxocara canis</i>, <i>T. cati</i></p>		



**Nematocidal Drugs, Animals. Table 5** Drugs used against nematode infections of dogs and cats (Continued)

CHEMICAL GROUP nonproprietary name of active substance (single oral dose, mg/kg body weight = b.w.), other information	*DRUG PRODUCT dose form (formulation), withdrawal time (WT) days (d) before slaughter, manufacturer, supplier, other information	CHARACTERISTICS miscellaneous comments on pharmacokinetics, metabolism, mode of action, toxicity, and limitations
<p>(cats, kittens), and <i>Toxascaris leonina</i> and whipworm infections caused by <i>Trichuris vulpis</i> in dogs and puppies; MO shows efficacy against other nematodes such as lungworms <i>Crenosoma vulpis</i> and <i>Angiostrongylus vasorum</i> (not approved indications); *Milbemite, *MilbeMite: topical treatment of ear mite (<i>Otodectes cynotis</i>) infestation causes effectiveness maintained throughout life cycle of ear mite; follow-up examination 7–10 days post-treatment; retreatment (excluding &lt;1 month after initial treatment) may be indicated in a small number of cases (treat all affected pets in household); otodectic otitis is manifested by copious production of dark cerumen; persistent scratching and head shaking can cause damage to external ear resulting in aural hematoma; protracted infestation with <i>O. cynotis</i> may cause rupture of tympanic membrane leading to disease of middle ear and possibly CNS; in <i>experimental trials</i>, MO showed efficacy against other mites such as <i>Sarcoptes scabiei</i>, <i>Demodex canis</i>, or <i>Pneumonyssoides caninum</i> at higher than recommended per os dose administered daily for longer periods; dose regimen for dogs suffering from demodicosis (<i>D. canis</i>) may be 1–4.6 mg/kg b.w./day for at least 2–3 months causing a temporary cure or improvement of symptoms in most dogs, and nonrelapsing (permanent) cure in &gt;50% of treated dogs; <i>pharmacokinetics</i>: following oral administration, ~90–95% of the dose passes through gut unchanged; absorbed drug (5–10%) may reach maximum plasma concentrations within 4 hours postdosing (half-life: 1–4 days) and is subsequently excreted in the bile, most of the drug is eliminated via feces; <i>use during pregnancy, lactation or lay</i>: there is no effect on the health or reproductive status of female or male dogs and cats; thus drug products can be used in breeding, pregnant, and lactating cats and dogs at recommended dose; 3 times the monthly dose (1.5 mg/kg b.w.) given to pregnant bitches 1 day before whelping, on day of whelping or 1 day thereafter had no adverse effects on the puppies; this dose resulted in measurable drug concentrations in milk of bitches and nursing puppies may show some milbemycin-related adverse effects; <i>adverse reactions</i>: drug products (tablets) are well tolerated by cats and dogs of all breeds, including Collie breeds; some Collies and toys are more sensitive to MO than other dogs (as with ivermectin) though no adverse reactions are seen at 5 mg/kg (10 times the monthly dose); an extreme overdosage of 12.5 mg/kg b.w. (25 times the monthly dose) given to rough coated Collies resulted in ataxia, pyrexia, and periodic recumbency in 1 of 14 treated dogs; topical *MilbeMite has not been tested in puppies or kittens less than 8 weeks of age; in double-blind clinical trials, it was well tolerated with no adverse events reported that can be related to product administration; overdosage of up to 5 times was tolerated without adverse effects; puppies (8-week-old) tolerated several times higher doses than the monthly dose of MO (e.g., 6× 0.5 mg/kg/day for 3 consecutive days); interactions of MO with other medicines used in small-animal practice are not known; <i>environment</i>: MO may adversely affect fish or certain water-borne organisms on which they feed (avoid therefore contamination of any water courses)</p>		
<p>*1 <b>milbemycin oxime/lufenuron</b> (dog, 0.5/10, monthly) *2 <b>milbemycin oxime/praziquantel</b> (PZQ) (dog, 0.5/5; cat 2/5) used every 3 months: treats and controls roundworm, whipworm, hookworm, and tapeworm; used monthly also prevents heartworm infection *3 <b>milbemycin oxime/lufenuron/praziquantel</b> (PZQ) (0.5/10/5, monthly) prevents heartworm infection; controls roundworm, whipworm, hookworm, and tapeworm; prevents and controls fleas long-term; treats flea allergy dermatitis</p>	<p>1*Sentinel Flavor Tabs (USA, Australia, elsewhere) 1*Program Plus (Germany, Switzerland, other European countries) 2*Milbemax (Germany, Switzerland, other European countries, Australia, elsewhere) 3*Sentinel Spectrum Flavor Tabs (Australia, Switzerland, elsewhere) all tablets containing various amounts of active constituents for dogs, cats, puppies and kittens; <i>limitation</i>: laws may restrict drug products to use by or on the order of a licensed veterinarian</p>	<p>all *drug products (Novartis, Animal Health, USA, Australia, Europe, and elsewhere) prevents heartworm infection in dogs (and cats: *Milbemax) and controls roundworm, whipworm, and hookworm (for limitations see milbemycin oxime †); *Sentinel Flavor Tabs: <b>lufenuron</b> acts as an insect development inhibitor by breaking the flea life cycle by inhibiting development of eggs; it interferes with chitin synthesis; it does not kill adult fleas and controls flea populations by preventing development of flea eggs, i.e., from hatching or maturing into adults; it prevents and controls fleas long-term and may so treat flea allergy dermatitis in dogs and puppies; concurrent use of insecticides</p>
<p>may be necessary for adequate control of adult fleas, e.g., <i>nitenpyram</i> (*Capstar, oral tablets for dogs and cats, Novartis Inc., USA); *Milbemax: PZQ (for details see Cestodocidal Drugs/Tables 1, 2) eliminates <i>Dipylidium caninum</i>, the most common tapeworm in cats and dogs; fleas transmit the tapeworm; its life cycle is 2–3 weeks, and it is possible for animals to become reinfected and shed worm segments between monthly doses (flea control is recommended); PZQ eliminates hydatid tapeworms (<i>Echinococcus granulosus</i> and <i>E. multilocularis</i>), which both can pose a severe risk to human health by</p>		

Nematocidal Drugs, Animals. Table 5 Drugs used against nematode infections of dogs and cats (Continued)

CHEMICAL GROUP nonproprietary name of active substance (single oral dose, mg/kg body weight = b.w.), other information	*DRUG PRODUCT dose form (formulation), withdrawal time (WT) days (d) before slaughter, manufacturer, supplier, other information	CHARACTERISTICS miscellaneous comments on pharmacokinetics, metabolism, mode of action, toxicity, and limitations
transmission larvated eggs to humans from infected carnivores; in hydatid tapeworm areas, dogs should be dosed monthly to ensure that newly acquired hydatid tapeworms are expelled before reaching maturity (do not feed dogs offal or allow access to offal); <i>toxicity of lufenuron</i> : it is safe in dogs and puppies; given at 20 times the recommended dose it causes only mild adverse effects in 8-week-old puppies (light depression and lack of appetite); in lactating bitches, at 2 times and 6 times the recommended dose the drug is partially eliminated through the milk; excessive overdosing of drug may produce various adverse reactions such as hypersalivation, vomiting, anorexia, lethargy, diarrhea, pruritus, skin congestion, ataxia, convulsions, and general weakness; for toxicity and margin of safety of milbemycin in breeding and pregnant animals or puppies see ↑		
<p><b>moxidectin (MOX)</b> *1 (oral tablet: dog, 0.003 once a month) prevents heartworm infection <i>subcutaneous injection</i>: *2/*3 suspension of constituted microspheres: *2 (dog, 0.17 once every 6 months, excluding under 6 months of age) *3 (dog, 0.5 once-a-year, excluding under 12 weeks of age) prevents heartworm infection and kills existing larval/adult hookworms <b>moxidectin/ imidacloprid</b> *4 (dog, 2.5/10) (cat, 1/10), <i>topical application</i> monthly; excluding dog/cats under 7/9 weeks of age; *Advocate (Bayer, Australia, Germany, Switzerland, and elsewhere) has been shown to be highly effective in treating generalized demodicosis (<i>Demodex canis</i>) when administered at monthly intervals for 2–4 treatments</p>	<p>1*ProHeart, tablets 2*ProHeart 6 Sustained Release injectable for Dog 3*ProProHeart SR-12 injection once-a-year heartworm preventative for dogs (Fort Dodge, AH, USA, Australia) (*2/*3: 2 separate vials: one with 10% MOX microspheres, other contains a vehicle for constitution of MOX microspheres) (a range of different size single-dose products to cover range of animal body weights) 4*Advocate (Bayer) for dogs or cats, liquid (spot-on) for prevention of heartworm infection and treatment and prevention of fleas (may reduce incidence of flea allergy dermatitis), treatment and control of roundworms/hookworms (its larval/immature/adult stages) whipworms?, sarcoptic mange and ear mites, and lice for up to 6 weeks; <i>limitations</i>: use with caution in sick, under-weight, or debilitated animals</p>	<p>*ProHeart for <i>prevention of heartworm (Dirofilaria immitis)</i> infection in dogs (≤8 weeks of age and younger) for once-a-month, 6 or 12 months; strategic treatment with moxidectin is as with ivermectin or milbemycin oxime; MOX is 100% effective against both 3rd-stage and 4th-stage larvae (1–2-month-old larvae) of <i>D. immitis</i>; it is highly effective against <i>Ancylostoma caninum</i> but less effective against <i>Uncinaria stenocephala</i> at a single oral dose of 0.025 mg/kg; drug may not sufficiently control whipworms even at 300 µg/kg b.w. (Supakorndej et al. Proc 38th Ann Mtg Am Assoc Vet Parasitol 1993); heartworm prevention in dogs should begin 1 month after onset of mosquito season and must be continued at monthly or longer intervals (for details ask the veterinarian); <i>limitations</i> as with other avermectins, it should only be used in dogs, which proved negative for the presence of adult heartworms; its strong microfilaricidal action may</p>
produce shocklike reactions in infected dogs due to dying or dead microfilariae; thus infected dogs should be treated with an adulticidal drug (see ↑) for removal of heartworms and microfilariae before using MOX; at recommended doses, it is safe for a wide variety of dog breeds; MOX tablets were safe at 5 times the recommended (monthly) dose in Collies, and up to 10 times the monthly dose in 8-week-old puppies; <i>adverse effects</i> following overdosing or occasionally recommended dose may be nervousness, vomiting, anorexia, diarrhea, increased thirst; weakness, lethargy, ataxia, and itching; MOX interacts with GABA and glutamate-gated chloride channels, which leads to opening of chloride channels on postsynaptic junction, inflow of Cl ions and induction of an irreversible resting state; the result is flaccid paralysis of affected parasites, followed by their death and/or expulsion; *Advocate: <b>imidacloprid</b> (a chloronicotinylnitroguanidine) has a high affinity for nicotinic acetylcholine receptors in postsynaptic regions of CNS of the flea; ensuing inhibition of cholinergic transmission in insects results in paralysis and death (drug has virtually no effect on mammalian CNS because of poor penetration through blood-brain barrier; it has minimal pharmacological activity in mammals); after <i>topical</i> administration, imidacloprid is rapidly distributed over animal's skin within one day of application; it can be found on the body surface during entire treatment interval (kill adult/larval fleas within 20 minutes of contact by absorption via flea intersegmental membranes); MOX is absorbed through the skin, reaching maximum plasma concentration about 1–2 days after application; it is systemically distributed and slowly eliminated from plasma (detectable concentrations throughout treatment interval of 1 month); <i>use during pregnancy, lactation or lay</i> : no primary embryotoxic, teratogenic, or reproductive toxic effects in laboratory species; however, safety of *Advocate has not been established during pregnancy and lactation in target species		
<p>*1 <b>abamectin (ABA)</b> (dog, 0.01) once every 4 to 6 weeks *2 <b>abamectin/praziquantel (PZQ)/ oxibendazole (OBZ)</b> (dog, 0.01/5/22.5)</p>	<p>1*Vibrac Caniheart, other products; 2*Vibrac Canimax Palatable Allwormer, other products (1*/2*Virbac (others) Australia and elsewhere)</p>	<p>*Caniheart: prevention of heartworm disease (<i>D. immitis</i>) in dogs; tablet contains 0.05, or 0.1, or 0.2 mg ABA for small (5 kg), medium (10 kg), and large (10 kg) dogs, respectively, each</p>

**Nematocidal Drugs, Animals. Table 5** Drugs used against nematode infections of dogs and cats (Continued)

CHEMICAL GROUP nonproprietary name of active substance (single oral dose, mg/kg body weight = b.w.), other information	*DRUG PRODUCT dose form (formulation), withdrawal time (WT) days (d) before slaughter, manufacturer, supplier, other information	CHARACTERISTICS miscellaneous comments on pharmacokinetics, metabolism, mode of action, toxicity, and limitations
provides protection for 6 weeks; *Canimax: oral tablet for small/medium/large dogs, e.g., tablet for medium dog (10 kg) contains 0.1 mg ABA/ 50 mg PZQ/225 mg OBZ for use against <i>T. leonina</i> , <i>T. canis</i> , <i>A. caninum</i> , <i>U. stenocephala</i> , <i>T. vulpis</i> , <i>D. caninum</i> , <i>Taenia</i> spp., and <i>E. granulosus</i> (hydatid tapeworm); when used every 4–6 weeks it prevents infection caused by canine heartworm, <i>D. immitis</i> ; *Canimax is safe for use in pregnant bitches		
AMINES (PIPERAZINES)		
<b>piperazine</b> (45–65 base) product may contain piperazine citrate, phosphate, or monohydrochloride given in animal's food or milk; limitations for dog and cats may be: for animals up to 1 year of age, administer every 2 or 3 months; for animals over 1 year old, administer periodically as necessary	there are several drug products of various sponsors on the market in USA, Australia, and elsewhere for the use in dogs and cats (oral route); dose forms may be syrup (as citrate) for puppies and kittens (excluding under 5 weeks age), other formulations: capsule, tablet, liquid (solution/ suspension) for dogs	piperazine (old-timer) has some erratic efficacy (50–100%) against <b>adult ascarids</b> ; immature stages of ascarids may be affected at increased doses (100 mg/kg piperazine base); there is minimal or no efficacy against intestinal <i>Toxocara</i> spp. larvae and no effect against migrating larvae of <i>T. canis</i> ; it has only a variable effect on <i>Uncinaria</i>
spp.; there is no effect against <i>Ancylostoma</i> spp., whipworm and tapeworm; it may be used in zoo canids and felines for removal of ascarids; nursing pups treated at 10 day intervals till 1 month of age (= 3 treatments) show >95% reduction in their worm burden acquired prenatally and lactogenically; the drug appears to be well tolerated in young (weaning) puppies (not for use in unweaned pups or animals less than 3 weeks of age); doses higher than the therapeutic dose may occasionally cause vomiting, nausea, and muscular tremor; higher doses should be therefore divided and given on two consecutive days; drug products on US market may be *Pulvex Worm Caps. (Virbac AH) for cats and dogs, *Sergeants Worm Away (ConAgra Pet Products) for dogs, or *Thenatol PW Tablets (Schering-Plough AH) for dogs		
ETHANOL AMINES (having a quaternary or protonated nitrogen atom at pH 7)		
<b>thienium closylate</b> *Canopar per os, dogs: ≥10 pounds b.w.: (1 tablet = 500 mg base as a single dose); 5–10 pounds b.w.: (1/2 tablet twice during a single day) <b>thienium closylate/ piperazine phosphate</b> (1:2 ratio); *Thenatol PW (scored tablet per os, dogs): 2–5 pounds b.w.: (1/2: 375 mg tablet); 5–10 pounds b.w.: (1: 375 mg tablet or 1/2: 750 mg tablet); 10 or more pounds b.w.: (2: 375 mg tablets; or 1: 750 mg tablet)	*Canopar Tablets dog, excluding not weaned; dog, excluding under 5 pounds *Thenatol PW Tablets dog, excluding not weaned; dog and puppy, excluding under 5 weeks age (Schering-Plough AH) hookworms necessitates 2 doses in 1 day of treatment (maximum efficacy), administer the first dose in the morning before feeding (interval between doses should not be <4 hours or >24 hours, and feed dogs between doses)	thienium closylate (old-timer, available in the USA and elsewhere) has a good efficacy against hookworms ( <i>A. caninum</i> , <i>U. stenocephala</i> : 90% adults and immature worms and 4th-stage larvae, and eliminating 55% 3rd-stage larvae of <i>Uncinaria</i> from intestine); its activity against canine ascarids is moderate (~75%); it has only weak efficacy against feline ascarids ( <i>Toxocara cati</i> , 50–75%); all *Canopar dosages should be given for 1 day only and treatment should be repeated after 2 or 3 weeks; due to its cholinergic properties
side effects may occur at therapeutic dose (salivation, emesis or vomiting, diarrhea, and depression); though thienium is poorly absorbed from the intestinal tract of the host, sudden death in dogs (especially in Collies and Airedales) has been reported following routine treatment with an obsolete dosage regimen with thienium; <i>limitations</i> : suckling puppies or recently weaned puppies (<5 pounds) must not be treated because there is risk of toxicosis by increased absorption of thienium due to high fat content in the bitch's milk and occurrence of erratic toxicity in recently weaned puppies (also felines must not be treated with thienium); in severely infected animals (intestinal hemorrhage, debilitation, and anemia) supportive treatment should be given; *Thenatol PW ( <i>piperazine/ thienium</i> ) shows increased activity against ascarids and hookworms compared to that of each single drug; it removes immature (4th-stage larvae) and adult hookworms ( <i>Ancylostoma caninum</i> , <i>A. braziliense</i> , and <i>Uncinaria stenocephala</i> ) and adult ascarids ( <i>Toxocara canis</i> ); retreatment may be needed in 7–28 days (fecal examinations, particularly in animals kept in contaminated quarters); do not use the combination to treat dogs weighing less than 2 pounds; do not permit dog to chew tablet, or do not feed milk or other fatty foods during treatment		
HYDROCARBONS/DIPHENYLMETHANES		
<b>toluene</b> (old timer) may not be longer used as a monocompound; it is actually combined with <i>dichlorophene</i> , an anticestodal drug; toluene (or methylbenzene) is chemically an hydrocarbon derived from coal tars and used as an industrial solvent; it has good activity against adult <b>ascarids</b> (95%), hookworms (>90%) in dogs and cats and a minimal activity against the canine		

**Nematocidal Drugs, Animals. Table 5** Drugs used against nematode infections of dogs and cats (Continued)

CHEMICAL GROUP nonproprietary name of active substance (single oral dose, mg/kg body weight = b.w.), other information	*DRUG PRODUCT dose form (formulation), withdrawal time (WT) days (d) before slaughter, manufacturer, supplier, other information	CHARACTERISTICS miscellaneous comments on pharmacokinetics, metabolism, mode of action, toxicity, and limitations
whipworm (about 40%); it is fairly well tolerated; vomiting due to irritation of digestive tract mucosa may frequently occur; puppies and kittens are more sensitive to the drug than older animals (tolerate 5 times the therapeutic dose thereby showing moderate adverse effects such as vomiting, muscular tremor, and unsteady gait)		
<b>toluene/dichlorophene</b> (t/d) (dog, cats: amount single dose 120/100 per pound b.w.); divided dose per 5 pounds b.w. (24/20 mg/ pound) daily for 6 days; cat/dog, no use class stated or implied	*Vermiplex, *Tri-Plex (Schering- Plough) *Difolin (Fort Doge), *Pulvex (Virbac), *Worm Capsules (Farnam Comp.) and many others; soft gelatine capsules containing (60/50 mg t/d or multiple thereof)	toluene combined with rapidly acting taeniocide dichlorophene is highly active against adult ascarids ( <i>T. canis</i> and <i>Toxascaris leonina</i> ); it has a variable efficacy against hookworms ( <i>A. caninum</i> ; <i>U. stenocephala</i> ) and a minimal one against whipworms; dichlorophene may cause partial
removal (only destrobilating action of 70–82%) of common cestodes such as <i>Taenia pisiformis</i> and <i>Dipylidium caninum</i> (insufficient effect against <i>E. granulosus</i> ) in dogs and cats; overdosing may cause vomiting, CNS involvement (incoordination, unsteady gait); <b>limitations:</b> withhold solid foods and milk for at least 12 hours prior to medication and 4 hours afterwards; repeat treatment in 2–4 weeks in animal subject to reinfection		
<b>CHLORINATED HYDROCARBONS</b>		
<b>n-butyl chloride</b> dog (puppy), cat (kitten): various conditions of use (dose regimens) depending on b.w. of animals: see label of drug products	*NBC Kaps Wormer for dogs (Pfizer); *Happy Jack Worm for dogs Capsules (Happy Jack); Sergeants Sure Shot Capsules for cats and dogs (ConAgra Pet Products); other products and sponsors in USA; capsules (221, 227, 442, 816, 884, or 1,768 mg or 4.42 g of n-butyl chloride in each capsule)	old timer, syn. 1-chlorobutane (C <sub>4</sub> H <sub>9</sub> Cl) is a colorless highly flammable liquid (over-the-counter product in the USA (and possibly elsewhere) with somewhat sophisticated dosage regimens); it may be used per os for removal of adult ascarids (90% efficacy) and hookworms (60% efficacy) in cats und dogs; overnight fasting and the use
of a laxative may enhance worm expulsion; at recommended dose there is no action on whipworms (50% effect at 3 times the therapeutic dose) or nematodes of other domestic animals; recommended doses are well tolerated in cats and dogs (sometimes vomiting may occur); <b>limitations:</b> animals should not be fed for 18–24 hours before being given the drug; administration of the drug should be followed in 1/2 to 1 hour with a mild cathartic; normal feeding may be resumed 4–8 hours after treatment; animals subject to reinfection may be retreated in 2 weeks; a veterinarian should be consulted before using in severely debilitated animals		
<b>ORGANOPHOSPHATES</b>		
<b>dichlorvos</b> *1 capsule, pellet (dogs, 12–15 mg/ pound b.w.); dose may b divided; *2 tablet (cats, kittens, dogs, puppies, 5 mg/pound b.w.) <b>limitations:</b> do not administered to puppies showing signs of constipation mechanical blockage of intestinal tract, impaired liver function, or to animals showing signs of infectious disease	1*Task Dog Anthelmintic, capsule, pellet (in food ration, or ground meat) for dog, excluding under 2 pounds; 2*Task Tabs, tablet for cat/kitten, excl. under 1 pound or under 10 days age, and for dog/ puppy, excl. under 10 days or under 1 pound; (Boehringer Ingelheim Vetmedica, USA); greyhounds and whippets appear to be very sensitive to organophosphates	dichlorvos (single dose) causes nearly total expulsion of ascarids ( <i>Toxocara canis</i> , <i>T. cati</i> , <i>Toxascaris leonina</i> ), hookworms ( <i>Ancylostoma caninum</i> , <i>A. braziliensis</i> , <i>A. tubaeforme</i> , <i>Uncinaria stenocephala</i> ), and whipworms ( <i>Trichuris vulpis</i> , efficacy >90%) residing in lumen of gastrointestinal tract; there is little or no effect against migrating larval stages of ascarids or hookworms; because of many
<b>limitations,</b> exact dosage regimen is essential but somewhat “sophisticated” for routine treatment; <b>contraindications:</b> dichlorvos should not be used simultaneously with other, anthelmintics (taeniocides, antifilarial agents), muscle relaxants, tranquilizers, live vaccines, or other cholinesterase-inhibiting drugs, pesticides, or chemicals (before or after treatment), or in dogs (and cats) infected with <i>Dirofilaria immitis</i> : it can cause severe clinical signs resulting from dying or dead microfilariae becoming microembolic thereby producing intravascular coagulation or it may produce enhanced activity of adult heartworms migrating towards the pulmonary artery, thereby obliterating some of its branches; <b>toxic signs</b> resulting from overdosage (failure to observe limitations) may cause salivation, vomiting, watery diarrhea, muscular tremor, and muscular weakness; the margin of safety is narrow in cats and puppies; atropine can be used as antidote; 1*single dosage may be split (other half 8–24 hour later) to reduce side effects in very old, heavily parasitized, anemic, or otherwise debilitated animals		

**Nematocidal Drugs, Animals. Table 5** Drugs used against nematode infections of dogs and cats (Continued)

CHEMICAL GROUP	*DRUG PRODUCT	CHARACTERISTICS
nonproprietary name of active substance (single oral dose, mg/kg body weight = b.w.), other information	dose form (formulation), withdrawal time (WT) days (d) before slaughter, manufacturer, supplier, other information	miscellaneous comments on pharmacokinetics, metabolism, mode of action, toxicity, and limitations
<b>IMIDAZOTHIAZOLES</b>		
<p>use of <i>levamisole hydrochloride</i> (LEV) as a monocompound in carnivores is obsolete today; LEV may produce various potential side effects after the parenteral route even at previously recommended (therapeutic) doses; thus, dogs and cats are much more tolerant of oral than parenteral route of LEV; however, moderate overdosage by the oral route may also cause adverse reactions such as salivation, vomiting, nausea, muscular tremor, anorexia, depression, and infrequently ataxia and disorientation, especially in certain breeds like boxers and very small "toy" that are particularly sensitive to the drug; <i>contraindications</i> for the use of LEV may be functional disorders of the liver and kidneys, or the simultaneous use of organophosphates, and other pesticides (e.g., carbamates or other chemicals), and dogs suffering from heavy heartworm disease; these contraindications limit also use of drug products (see ↓) containing LEV/<i>niclosamide</i> (NIC); NIC is active against <i>Taenia</i> spp. but shows erratic activity against the common tapeworm <i>Dipylidium caninum</i>, <i>Mesocestoides corti</i>, and a poor one against <i>Echinococcus granulosus</i> and <i>M. lineatus</i> in dogs; drug products are therefore not indicated for the treatment and control of <i>Echinococcus</i> infections</p>		
<p><b>levamisole hydrochloride/niclosamide:</b> for the control of roundworm, hookworm and tapeworm (<i>Dipylidium caninum</i>, <i>Taenia</i> spp.) but not hydatid (<i>Echinococcus</i> spp.) in dogs and cats; it has a good expelling effect (&lt;95%) on adult ascarids (<i>T. canis</i>, <i>Toxascaris leonina</i>) and hookworms (<i>Uncinaria stenocephala</i>, <i>Ancylostoma</i> spp., with weak activity against migrating larvae of <i>A. caninum</i>); there is no effect against whipworms; at recommended dose of drug products there may be a weak effect against microfilariae of <i>D. immitis</i> (formerly, LEV was used as a microfilaricide in <i>D. immitis</i> infections in dogs, 11 mg/kg/day orally for 6–10 consecutive days causing various side effects; though drug products does not control heartworm infection they should not be used in dogs heavily infected with <i>Dirofilaria immitis</i>); DRUG PRODUCTS: several approved drug products for dogs (large, medium, small), puppies, cats and kittens in <i>Australia</i> and elsewhere as <i>oral tablets</i> containing different amounts of LEV and NIC per tablet (e.g., LEV 8.5 mg/42/42.5 mg NIC 1000 mg or LEV 21.2 mg/NIC 500 mg); recommended dose may be 4.2 to 7 mg LEV HCL per kg b.w./100–166 mg NIC per kg b.w. (various brand names and sponsors or suppliers) such as *Aristopet (Aristopet), *Fidos's Closasole (MavLab), *Elite Ped (Magic Pet) *I love my pet (Mypet Products Supplies), *Petbarn 3 (Petbarn), *Parid X (Apex Labs), or *Ambex, (Bomac Labs/ Pharm Tech) and others; <i>dosage schedule:</i> breeding animals (bitches, queens) should be treated at mating, before whelping or birth of kittens and then every 3 months; in cats, the dose should be divided (after morning meal and 6–12 hours later)</p>		
<p><b>butamisol</b> hydrochloride (dog 0.1 ml per pound b.w.) subcutaneously *Styquin (USA or elsewhere, Fort Dodge Animal Health and Bayer Healthcare, AH); injectable solution (the product contains 11 mg of butamisol per ml in a solution consisting of 70% propylene glycol, 4% benzyl alcohol and distilled water)</p>	<p>used in dogs (no use class stated or implied) for treatment of infections with adult whipworms (<i>Trichuris vulpis</i>, expelling rate 99%) and the hookworm (<i>Ancylostoma caninum</i> expelling rate 92%), in problem cases, retreatment for whipworm may be necessary in ~3 months; for hookworms, a second injection should be given 21 days after initial treatment; in small dogs &lt;2 kg b.w. exact dosing is necessary (intramuscular injection often produces pain); several <i>contraindications</i> may limit its use such as severely diseased, debilitated or heartworm-positive dogs, animals with renal or hepatic disorders or concurrent use of cestocidal drug bunamidine (*Scolaban, Schering Plough) which may cause mortality as has seen following treatment of heartworm-infected dogs; concurrent use of butamisol and organophosphate-impregnated flea collars is safe; overdosing may cause vomiting, muscular tremor, unsteady gait, ataxia, convulsions, and lateral recumbency; <i>limitation:</i> this drug to use by or on the order of a licensed veterinarian</p>	
<b>TETRAHYDROPYRIMIDINES</b>		
<b>pyrantel pamoate</b>		
<p>recommended dose → pyrantel base: 5 mg/kg b.w. for dog/puppy, 20 mg/kg b.w. for cat/kitten; the drug is highly effective (up to 95%) in eliminating adult hookworms (<i>Ancylostoma caninum</i>, <i>Uncinaria stenocephala</i>) and ascarids (<i>Toxocara canis</i>, <i>Toxascaris leonina</i>) of dogs (nursing or weaning pups from 2 weeks of age); its efficacy against whipworms is minimal, and there is no activity against cestodes; in cats, pyrantel has also good efficacy against adult stages of the common hookworm (<i>A. tubaeforme</i>) and ascarids (<i>Toxocara cati</i>); the therapeutic dose is well tolerated without signs of salivation, vomiting, or diarrhea (in case of overdosing atropine may serve as antidote); it is a safe drug in young puppies, kittens (from 2 weeks of age), pregnant or lactating bitches, or debilitated animals; DRUG PRODUCTS, e.g., *Canex Puppy Suspension pyrantel</p>		

**Nematocidal Drugs, Animals. Table 5** Drugs used against nematode infections of dogs and cats (Continued)

CHEMICAL GROUP nonproprietary name of active substance (single oral dose, mg/kg body weight = b.w.), other information	*DRUG PRODUCT dose form (formulation), withdrawal time (WT) days (d) before slaughter, manufacturer, supplier, other information	CHARACTERISTICS miscellaneous comments on pharmacokinetics, metabolism, mode of action, toxicity, and limitations
	Embonate 14.4 mg/ml Chocolate Flavoured Puppy Wormer (Pfizer Australia) active constituent: 14.4 mg/ml pyrantel pamoate (embonate), <i>formulation</i> : oral solution/suspension (0.5 ml/500 g b.w.), for control of roundworm ( <i>Toxocara</i> spp and <i>Toxascaris leonina</i> ), hookworm ( <i>Ancylostoma</i> spp and <i>Uncinaria stenocephala</i> ) in dogs and puppies, or *Nemex RFD Liquid Wormer (Pfizer US), pyrantel pamoate suspension contains pyrantel pamoate equivalent to 2.27 or 4.54 mg of pyrantel base per ml for dogs (and puppies), amount: equivalent of 2.27 mg of pyrantel base/pound b.w., <i>indications</i> (USA): for removal of large roundworms ( <i>Toxocara canis</i> and <i>Toxascaris leonina</i> ) and hookworms ( <i>Ancylostoma caninum</i> and <i>Uncinaria stenocephala</i> ) and to prevent reinfections of <i>Toxocara canis</i> in puppies, adult dogs, and lactating bitches after whelping (amount: equivalent to 2.27 mg of pyrantel base/pound b.w.), <i>limitations</i> : administer in the animal's feed bowl as a single dose by itself or mixed in a small quantity of food, additional treatment may be required and should be confirmed by examination within 2–4 weeks, administer to puppies at 2, 3, 4, 6, 8, and 10 weeks of age and to lactating bitches 2–3 weeks after whelping; adult dogs kept in heavily contaminated quarters may be treated at monthly intervals; <i>other drug products</i> and formulations containing pyrantel pamoate in USA are *Dog Wormer Chewable Tablets (Farnam Companies Inc.), or *Wormexx Chewable Tablets for dogs (Virbac AH. Inc), or *Pyrantel Pamoate Suspension-2.27 mg or 4.54 mg for dogs and puppies (IVX Animal Health), or *Evict Liquid Wormer for Puppies and Dogs and others (Church and Dwight), or in Australia *Vitapet Wormaway Worming Tablets, pyrantel pamoate (35 mg/tab.) (Masterpet), or in Germany (elsewhere) *Banminth tablets for cats (40 mg pyrantel base/ 1 tab., 20 mg base/kg b.w.), or *Banminth paste for dogs (7.5 pyrantel base/ 1g paste, 5 mg base/mg/kg b.w. = 1 g paste/1.5 kg b.w.) (Pfizer), or *Runcid liquid (suspension) for cats and dogs (Albrecht, CP-Pharma), or *Sepantel 40 tablets for cats (Albrecht)	
<b>pyrantel/oxantel</b>		is highly effective against ascarids, hookworms, and whipworms of dogs; pyrantel is a safe drug in young puppies, kittens (from 2 weeks of age), pregnant or lactating bitches, or debilitated animals; DRUG PRODUCTS (dog, 5 mg pyrantel base and oxantel 54.3 mg/kg b.w.), e.g., *Canatak Wormer for Dogs (Bomac Laboratories, Australia), active constituent(s): 543 mg/Tb oxantel pamoate (embonate), 143 mg/Tb pyrantel pamoate (embonate), <i>formulation</i> : oral tablet (1 tablet/10 kg b.w.), for the treatment and control of roundworms, hookworms and whipworms in dogs
<b>pyrantel/niclosamide</b>		DRUG PRODUCTS for cats and dogs (several on Australian market and elsewhere), e.g., *Felex Plus All Wormer Paste for Cats (Pfizer AH, Australia, and elsewhere), active constituents: 264 mg/g niclosamide monohydrate (micronised)/90 mg/g pyrantel pamoate (embonate) <i>formulation</i> : oral paste (plunger with 1 kg, 2 kg, 3 kg etc. marks, dose according to weight) for control of roundworms ( <i>Toxocara</i> spp. and <i>Toxascaris leonina</i> ), hookworms ( <i>Ancylostoma</i> spp. and <i>Uncinaria stenocephala</i> ), and tapeworms ( <i>Dipylidium caninum</i> , <i>Taenia</i> spp.) in cats, or *Friskies 3 in 1 Worming Tablets for Dogs (Nestle Purina PetCare, Australia, elsewhere), active constituents: 500 mg/Tb niclosamide, 72 mg/Tb pyrantel pamoate (embonate), <i>formulation</i> : oral tablet (1 tablet/5 kg), for the treatment of roundworm, hookworm and tapeworm (not hydatid, <i>Echinococcus granulosus</i> ) in dogs
<b>"ALLWORMER"</b>		containing pyrantel and other active constituents pyrantel combinations have first been developed with other nematocidal drugs and later with cestocidal compounds to broaden its narrow spectrum of activity including adult stages of ascarids and hookworms only (see above); partner substances like oxantel (embonate), febantel, fenbendazole, oxfendazole or oxibendazole with a broader spectrum of activity control also the whipworm, and certain juvenile stages of roundworms; partner substances like praziquantel, or epsiprantel control common tapeworms ( <i>Taenia</i> spp.) and <i>Echinococcus</i> spp. whereas niclosamide does not the latter; various drug products consist of 3 or even 4 active constituents (see below) and serve as so-called "allwormer" involving activity against all relevant endo- and ectoparasites of dogs and cats; these multiple drug combinations are much in demand with pet owners; thus a single application of such kit-products may control not only all <11> gastrointestinal worms but also common ectoparasites (fleas, ticks, and/or biting lice) of dogs; they may contain various <i>macrocyclic lactones</i> , <i>ectoparasiticides</i> (fipronil, imidacloprid, and/or s-methoprene, or lufenuron), and benzimidazoles or their prodrugs, and are not commercially available as OTC products but intended for use by a licensed veterinarian only (prescription); some of these "endectocide-cocktails" contain ivermectin, milbemycin oxime, or abamectin, which prevent heartworm infection in dogs (see ↑) and have various limitations/ contraindications concerning this indication in regions where <i>D. immitis</i> is endemic; various "all control-kits" are available on the Australian or US market and elsewhere

**Nematocidal Drugs, Animals. Table 5** Drugs used against nematode infections of dogs and cats (Continued)

CHEMICAL GROUP nonproprietary name of active substance (single oral dose, mg/kg body weight = b.w.), other information	*DRUG PRODUCT dose form (formulation), withdrawal time (WT) days (d) before slaughter, manufacturer, supplier, other information	CHARACTERISTICS miscellaneous comments on pharmacokinetics, metabolism, mode of action, toxicity, and limitations
<b>ivermectin plus ectoparasitocides, pyrantel and others</b> (for drug products containing <i>milbemycin oxime/lufenuron/praziquantel</i> or <i>abamectin/praziquantel/oxibendazole</i> see this table: MACROCYCLIC LACTONES)		
DRUG PRODUCTS, e.g. *The Complete Parasite Control Kit for Dogs 10–25 kg (Bayer, Australia), active constituents: 0.8 g/L ivermectin, 100 g/L imidacloprid, 250 mg/Tb febantel, 50 mg/Tb praziquantel, 49.8 mg/Tb pyrantel (as pamoate /embonate salt), <i>formulations: oral tablet &amp; topical solution</i> , for the treatment and prevention of heartworms, fleas and all 11 gastrointestinal worms, or *Startgard for Puppies (Merial, Australia), active constituents: 68 µg/Ch ivermectin, 57 mg/Ch pyrantel (as pamoate /embonate salt), 100 g/L fipronil, <i>formulations: oral chewable + topical cream, ointment, paste, gel</i> , for use by veterinarian as initial treatment for fleas, ticks, ascarids, and hookworms and to prevent heartworm disease, do not use on puppies under 3 months of age see safety/precautions sections on leaflet also, or *Startgard plus for Puppies (Merial, Australia), active constituents: 68 µg/Ch ivermectin, 57 mg/Ch pyrantel (as pamoate/embonate salt), 90 g/L s-methoprene, 100 g/L fipronil, <i>formulation: oral bolus/chewable and topical solution /suspension</i> , for use by veterinarians as initial treatment for fleas (all stages), ticks, biting lice, roundworms, and hookworms and to prevent heartworm disease, or *Guardian Complete Worming Chew Monthly Heartworm and Intestinal Allwormer for Dogs (Schering-Plough, Australia), active constituent(s): 60 µg/chew ivermectin, 543 mg/chew oxantel pamoate (embonate), 143 mg/chew pyrantel pamoate (embonate), 50 mg/chew praziquantel, <i>formulation: oral bolus, chewable</i> , for the prevention of heartworm and control of roundworm, whipworm, hookworm, and tapeworm including the hydatid tapeworm in dogs, this product is contraindicated in puppies less than 6 weeks of age (consult a veterinarian before use)		
<b>pyrantel/oxantel/praziquantel</b>		
DRUG PRODUCTS, e.g., *Canex Cube Palatable All Wormer for Small Dogs (also cubes for medium or large dogs) (Pfizer Australia, elsewhere), active constituents: 71.5 mg/cube pyrantel pamoate (embonate), 271.5 mg/cube oxantel pamoate (embonate), 25 mg/cube praziquantel, <i>formulation: oral bolus, chewable</i> , for the control of roundworm, hookworm, whipworm, tapeworm (does not control heartworm), controls all <11> gastrointestinal worms including hydatid tapeworms; *Paragard broad spectrum wormer for dogs (Merial, Australia, elsewhere), 1 tablet per 35 kg b.w., active constituents: 490 mg/Tb pyrantel pamoate (embonate), 1907 mg/Tb oxantel pamoate (embonate), 175 mg/Tb praziquantel, <i>formulation: oral tablet</i> for the treatment and control of roundworms, hookworms, whipworms, and adult tapeworms in dogs, does not control heartworm in dogs, or *Exelpet EZY-Dose Intestinal All-Wormer for Small Dogs & Puppies (Exelpet Products, Australia), active constituents: 72 mg/Ch pyrantel pamoate (embonate), 272 mg/Ch oxantel pamoate (embonate), 25 mg/Ch praziquantel <i>formulation: oral bolus, chewable</i> (1 chew/5 kg b.w.), controls whipworms, roundworms, hookworms, tapeworms plus the hydatid tapeworm, does not control heartworm in dogs		
<b>praziquantel/pyrantel/febantel</b>		
DRUG PRODUCTS, e.g., *Drontal Plus Broad Spectrum Anthelmintic Tablets, *Drontal Plus Tablets, *Drontal Plus Taste Tabs (Bayer Healthcare, AH, USA), ingredients: febantel/praziquantel/pyrantel pamoate, species: dog, excluding under 2 pounds, tablet (chewable), dog and puppy, excluding under 3 weeks age: specifications: each tablet contains either 22.7 mg praziquantel, 22.7 mg pyrantel base, and 113.4 mg febantel ( <i>tablet no. 1</i> ), or 68 mg praziquantel, 68 mg pyrantel base, and 340.2 mg febantel ( <i>tablet no. 2</i> ), or 136 mg praziquantel, 136 mg pyrantel base, and 680.4 mg febantel ( <i>tablet no. 3</i> ), amount: administer as a single dose directly by mouth or in a small amount of food, dose margin mg/kg b.w. may be for pyrantel base and praziquantel (3.3-6.3), and for febantel (16.6-31.5) depending on weight of dogs, <i>indications: for the removal of tapeworms (Dipylidium caninum, Taenia pisiformis, Echinococcus granulosus); hookworms (Ancylostoma caninum, Uncinaria stenocephala); ascarids (Toxocara canis, Toxascaris leonina); and whipworms (Trichuris vulpis) and for removal and control of tapeworm (Echinococcus multilocularis), limitations: do not use in pregnant animals or in dogs weighing less than 0.9 kg (2 pounds) or in puppies less than 3 weeks of age, federal law restricts this drug to use by or on the order of a licensed veterinarian; in Germany and elsewhere: *Drontal Plus XL:1 tablet contains: pyrantel embonate 504,0 mg, praziquantel 175,0 mg, febantel 525,0 mg, or *Drontal flavor Plus: 1 tablet contains pyrantel embonate 144 mg, praziquantel 50 mg, febantel 150 mg, single dose, average values mg/kg b.w. for all product (5 praziquantel), (15 febantel), and (14,5 pyrantel embonate = 5 pyrantel base)</i>		
<b>fenbendazole/praziquantel/pyrantel</b>		
DRUG PRODUCTS, e.g., *Fenpral Intestinal Allwormer for Dogs (Riverside Veterinary Products, Australia), active constituents: 250 mg/Tb fenbendazole, 50 mg/Tb praziquantel, 144 mg/Tb pyrantel pamoate (embonate), oral tablet (1 tablet/10 kg b.w.), for the control of all gastrointestinal worms in dogs including: roundworm, hookworm, whipworm, hydatid tapeworm, and common flea tapeworm, it does not control heartworm		

**Nematocidal Drugs, Animals. Table 5** Drugs used against nematode infections of dogs and cats (Continued)

CHEMICAL GROUP nonproprietary name of active substance (single oral dose, mg/kg body weight = b.w.), other information	*DRUG PRODUCT dose form (formulation), withdrawal time (WT) days (d) before slaughter, manufacturer, supplier, other information	CHARACTERISTICS miscellaneous comments on pharmacokinetics, metabolism, mode of action, toxicity, and limitations
<b>pyrantel/epsiprantel</b>		
DRUG PRODUCTS, e.g., *Exelpet EZY-Dose Intestinal All-Wormer for Cats (Exelpet Products, Australia, elsewhere), active constituent(s): 13.4 mg/Ch epsiprantel, 292.5 mg/Ch pyrantel pamoate (embonate) <i>formulation: oral</i> bolus, chewable (1 chew/ 5 kg b.w.), controls roundworms, hookworms, and tapeworms; *Banminth Plus 1200 for dogs (Pfizer, Germany), active constituent(s): 100 mg/Ch epsiprantel, 261.6 mg/Ch pyrantel embonate (= 90.8 mg pyrantel base) <i>formulation: oral</i> tablet, (1 tablet/ 10–18 kg b.w., according to mg/kg b.w.: 5 mg pyrantel base, 5.5 mg epsiprantel), controls adult stages of roundworms, hookworms, and tapeworms, incl. <i>E. granulosus</i> and <i>E. multilocularis</i> ; effect against <i>T. canis</i> and <i>A. caninum</i> is variable, repeat treatment in puppies 2 weeks after initial treatment		
<b>pyrantel/praziquantel</b>		
effective against common ascarids of <i>cats</i> ( <i>Toxocara cati</i> ), hookworm ( <i>A. tubaeforme</i> ) and cestodes ( <i>Taenia</i> spp., <i>Dipylidium</i> , and <i>Echinococcus</i> spp. of felines; the combination is also used in <i>dogs</i> (cf. *Drontal Dog Wormer ↓) for control of ascarids and cestodes, moderate effect against <i>A. caninum</i> only, and ineffective against <i>Trichuris vulpis</i> , <i>Crenosoma vulpis</i> (living in trachea, bronchioles), and <i>Angiostrongylus vasorum</i> (living in right heart and pulmonary artery) DRUG PRODUCTS for cats and dogs in Australia, USA, Europe, elsewhere, e.g., *Drontal for cats (Bayer, Healthcare, USA), each tablet contains 18.2 mg praziquantel, 72.6 mg pyrantel (as pyrantel pamoate), amount: (1.5–1.9 pounds, 1/4 tablet; 2–3 pounds, 1/2 tablet; 4–8 pounds, 1 tablet; 9–12 pounds, 1 1/2 tablets; 13–16 pounds, 2 tablets: equivalent to 20 mg pyrantel base/praziquantel 5 mg/kg b.w.), <i>indications: removal of tapeworms (Dipylidium caninum, Taenia taeniaeformis), hookworms (Ancylostoma tubaeforme), and large roundworms (Toxocara cati) in cats and kittens, limitations: not for use in kittens less than 1 month of age or weighing less than 1.5 pounds; may be given directly by mouth or in a small amount of food; do not withhold food prior to or after treatment; if reinfection occurs, treatment may be repeated; consult your veterinarian before giving to sick or pregnant animals; *Drontal Large Cat Allwormer (Bayer, Australia), active constituents: 30 mg/Tb praziquantel, 120 mg/Tb pyrantel (as pamoate/embonate salt), formulation: oral tablet (1 tablet/ 4 kg b.w.), controls gastrointestinal worms and tapeworms; *Exelpet All-Wormer Paste for Cats and Kittens (Exelpet Products, Australia) active constituents: 10 mg/ml praziquantel, 40 mg/ml pyrantel (as pamoate/embonate salt), formulation: oral paste (net contents of plunger 5 ml, graduation: 1 ml per 2 kg b.w.), for the control of roundworms, hookworms and tapeworms; *Drontal Dog Wormer (Bayer, Australia), active constituents: 50 mg/Tb praziquantel, 49.8 mg/Tb pyrantel (as pamoate/embonate salt), formulation: oral tablet (1 tablet/ 10 kg b.w.), controls gastrointestinal worms and tapeworms of dogs, does not control heartworm (<i>Dirofilaria immitis</i>) and whipworm (cf. above)</i>		
<b>SUBSTITUTED DIPHENYL ETHERS</b>		
<b>nitroscanate</b> (dog 50: micronized substance) <i>E. granulosus</i> (adults) (dog 100): micronized substance), retreatment may be required; consult veterinarian for assistance in the diagnosis, treatment, and control of parasitism; mode of action in cestodes: drug is believed to act as an uncoupler of oxidative phosphorylation	*Lopatul 100 or 500 (Novartis, Switzerland, and elsewhere), coated tablets *Cananthe 100 or 500 (Werner Stricker AG, Switzerland), coated tablets (no drug product approved in the USA, Australia, and elsewhere) (no drug product on the German market)	broad-spectrum anthelmintic used exclusively in dogs; it has good efficacy against adult (juvenile) gastrointestinal nematodes such as hookworms ( <i>Ancylostoma caninum, Uncinaria stenocephala</i> ), and variable activity against <b>ascarids</b> ( <i>Toxocara canis</i> , <i>Toxascaris leonina</i> ); it proved to be active against <i>Strongyloides stercoralis</i> as earlier shown in a Beagle breeding colony (H Ohder, H Humi Kleint Prax
23: 381, 1978); its action on <i>Trichuris vulpis</i> is poor; it has variable activity against common cestodes such as <i>Dipylidium caninum, Spirometra erinacei, Taenia pisiformis, T. hydatigena</i> , and <i>T. ovis</i> ; enhanced doses (100 mg/kg ×2: 2 day-interval) are necessary to affect <i>Echinococcus granulosus</i> though 100% elimination of adult stages is not always achieved; the drug should be given together with food (fasting, 12–24 hour prior to treatment followed by a small quantity of food); this enhances drug's absorption rate (peak plasma levels occur after 24 hours) and reduces incidence of vomiting (irritation of gut's mucosa in 10–20% of treated animals) within 3–5 hour after treatment; nitroscanate is quickly eliminated in urine and feces, whereas portion bound to plasma proteins has a relative long terminal half-life; <i>limitations: nitroscanate should not be used in cats, as it frequently provokes adverse side effects at therapeutic dose, it should not be used in dogs with hepatic disorders; it may produce tranquilizer-like effects at doses higher than recommended dose (50 mg/kg b.w.)</i>		



**Nematocidal Drugs, Animals. Table 5** Drugs used against nematode infections of dogs and cats (Continued)

CHEMICAL GROUP nonproprietary name of active substance (single oral dose, mg/kg body weight = b.w.), other information	*DRUG PRODUCT dose form (formulation), withdrawal time (WT) days (d) before slaughter, manufacturer, supplier, other information	CHARACTERISTICS miscellaneous comments on pharmacokinetics, metabolism, mode of action, toxicity, and limitations
<b>BENZIMIDAZOLE CARBAMATES</b>		
<p><b>mebendazole (MBZ)</b> (dog, 20–22 daily for 3–5 days; cat 22 daily for 3–4 days: no use class stated or implied in the USA, and nos. of doses may depend upon worm species to be treated) Administer as an oral powder or tablet by mixing with a small quantity of food, preferably before the regular meal</p>	<p>*Telmin KH, 100 mg tablet for cats/dogs, 1 tablet/5 kg b.w. (Janssen-Cilag, Germany); *Telmintic Powder, for dogs, 40 or 166.7 mg MBZ: 100 mg MBZ/10 pound b.w. (Schering-Plough AH, USA); *Telmintic Dog Wormer, 300 mg per tablet (1 tablet/14 kg b.w.) (Boehringer Ingel. Australia, elsewhere), others drug products</p>	<p>for use in dogs and cats with high efficacy (&gt;90%) against adult ascarids (2-day course), hookworms, whipworms (3–5-day course) but less one against <i>Taenia</i> spp. (5-day course), and unsatisfactory one against <i>Dipylidium caninum</i>; the drug can be also used in wild carnivores in such a way that drug is mixed into ground meat or put into a meatball (number of doses see above or longer courses, e.g., 3 mg/kg</p>
<p>for 10 days depending on target parasite); it has similar activity against feline nematodes and tapeworms as it has in dogs; it is effective against other parasites by reducing level of infection such as <i>Echinococcus</i> adults (200 mg twice/day for 5 days), <i>Strongyloides stercoralis</i> (22 mg/kg/day for 14–21 days, also used in primate infections with <i>Strongyloides</i>), and <i>Angiostrongylus vasorum</i> living in right heart and pulmonary artery (22 mg/kg/day for 10 days); it appears not to be embryotoxic or teratogenic in dogs (20 mg/kg: 1st day of pregnancy and continuing for 56 days); MBZ is a safe drug for use in cats and dogs infected with heartworm; in some countries, drug may not be approved for use in cats; in the USA and elsewhere, federal law restricts this drug to use by or on the order of a licensed veterinarian</p>		
<p><b>albendazole</b> is not approved for use in dogs or cats; it shows variable efficacy against common canine nematodes after repeated daily doses; its action is limited when given as a single dose of 15 mg/kg (ascarids 70%, hookworms 20%, and whipworms 10% efficacy); higher doses (20 or 25 mg/kg b.w.) markedly increase action on adult <i>Toxocara canis</i> (elimination rate &gt;95%) but do not on <i>Ancylostoma caninum</i> (60–70% efficacy); nearly 100% efficacy is attained after daily dosing of 15 mg/kg for 3 consecutive days against both ascarids and hookworms; some less common parasites as tapeworm <i>Mesocostoides corti</i>, lung nematodes (<i>Filaroides hirthei</i>, and <i>F. osleri</i>), and urinary bladder worm <i>Capillaria plica</i> of foxes and dogs (rarely cats) are also affected by the drug at repeated high doses in 12 hour-intervals (25–50 mg/kg daily for 5 days); former drug products containing albendazole/praziquantel (dog 50/5 mg/kg b.w.) have been discontinued showing activity against ascarids, hookworms, whipworms, <i>Strongyloides stercoralis</i>., and cestodes (<i>Taenia</i> spp., <i>Dipylidium caninum</i> and <i>Echinococcus</i> spp.); the drug is teratogenic and may produce weight depression in litters when given to bitch at 100 mg/kg b.w. from day 30 of gestation to day of parturition</p>		
<p><b>fenbendazole (FBZ)</b> (dog/cat, tablet, suspension: 50 daily for 3 days) tablets are tasteless, may be mixed into food or dissolved in a little water before mixing into food (paste: dog, cat, 75 daily for 2 days) (granules; top dressing: dog, 50 daily for 3 days; zoo or wildlife animals, 10 daily for 3 days, no use class stated or implied) (withdrawal time: wildlife 14 days before or during hunting season) dry food may require slight moistening to facilitate mixing; <b>limitations:</b> FBZ medicated food must be fully consumed; federal law (USA) restricts certain drug products to use by or on the order of a licensed veterinarian; do not use 14 days before or during hunting season</p>	<p>*Panacur, (Intervet Germany, elsewhere): various Panacur formulations: tablets (250 or 500 FBZ) for dogs/cats; suspension 10% FBZ for dogs, Pet paste (187.5 g FBZ) for dogs/cats *Panacur Granules 22.2% (Rx); in USA: *Panacure-C (Rx), *Safe-Guard Canine (OTC) (Intervet, USA, elsewhere): all drug products in granular form (222 mg/g), top dressing in feed for dogs and various zoo or wildlife animals: bears, leopard, lion, cheetah, jaguar, puma, panther, or tiger (horses not for meat production) *Panacur Vetguard Wormer for Dogs, all states, (Intervet, Australia, elsewhere), suspension (100 g/L FBZ: 0.5 ml/kg b.w. = 50 mg/kg b.w.) for 3 days</p>	<p>for use in dogs and cats with high efficacy (&gt;95%) against adult ascarids, hookworms, whipworms, and common cestodes (e.g., <i>Taenia pisiformis</i>) of dogs and cats (e.g., <i>Taenia hydatigena</i>) and prevention of prenatal and lactogenic roundworm and hookworm infestation in puppies; it has no action on flea tapeworm <i>Dipylidium caninum</i> and <i>Echinococcus</i> spp.; tasteless FBZ can be used for control of GI nematodes and extraintestinal living nematodes of <b>wild carnivores and omnivores</b> (fox, wildcat, bears, other zoo and wild animals: see drug products), by mixing drug products (granules) into food (meat or meatballs or as top dressing): <b>approved indications</b> (in the USA and elsewhere) may be control of internal</p>

**Nematocidal Drugs, Animals. Table 5** Drugs used against nematode infections of dogs and cats (Continued)

CHEMICAL GROUP nonproprietary name of active substance (single oral dose, mg/kg body weight = b.w.), other information	*DRUG PRODUCT dose form (formulation), withdrawal time (WT) days (d) before slaughter, manufacturer, supplier, other information	CHARACTERISTICS miscellaneous comments on pharmacokinetics, metabolism, mode of action, toxicity, and limitations
<p>parasites of Felidae and Ursidae: ascarids (<i>Baylisascaris transfuga</i>, <i>Toxocara cati</i>, <i>Toxascaris leonina</i>), hookworm (<i>Ancylostoma</i> sp., e.g., <i>Ancylostoma caninum</i>), tapeworm (<i>Taenia hydatigena</i>, <i>T. krabbei</i>, <i>T. taeniaeformis</i>); extraintestinal living nematode stages may be affected by FBZ as shown in <i>experimental studies</i>: daily dosing over several days produces nematocidal drug concentration in various tissues capable of eliminating adult worms of different species or even migrating larvae of <i>T. canis</i> at a daily dose of 50 mg/kg given during the entire gestation period of a bitch resulting in helminth-free and healthy litters; at 20–50 mg FBZ/kg daily for 5 days led to reduction of less common parasites, such as the cat lungworm <i>Aelurostrongylus abstrusus</i>, and <i>Crenosoma vulpis</i> (JM McGarry et al. <i>Vet Record</i> 137: 271, 1995), or <i>Angiostrongylus vasorum</i> (living in pulmonary arterioles and capillaries of the dog), the stomach worm <i>Ollulanus tricuspis</i> (a very small trichostrongyle about 1mm long, living under a layer of mucus in the stomach wall), or <i>Strongyloides stercoralis</i> (living in small intestine causing inflammation of mucosa); <b>pharmacokinetics</b>: after oral administration, FBZ is only partially absorbed from the gut and metabolized in liver, serum half-life is about 12–18 hours (in cats, peak plasma levels occur after 4hrs); it is mainly eliminated in feces (&gt;90%) and metabolites can be detected in urine and milk; unchanged FBZ may rapidly passes through intestinal tract of carnivores and for this reason multiple dosage regimens are more effective than a high single dose (e.g., 125 mg FBZ/kg); <b>tolerability</b>: drug products are well tolerated, also at higher than recommended dosage regimens (e.g., once 500 mg FBZ/kg, or 250 mg FBZ/kg/day for 30 days in dogs); since overdosage presents no risk of adverse effects, FBZ can be regarded as very safe for Canidae and Felidae; owing to lack of adequate investigations, the drug should not be used in pregnant bitches or she-cats (queens) during first period of organogenesis though ill effects are unlikely</p>		
<p><b>fenbendazole/ praziquantel</b> (dog, cat 50/5 daily for 3 days) (reptiles, oral <i>suspension</i>: 50 g/L fenbendazole, 5 g/L praziquantel: 0.4 ml/kg b.w. = 20/2)</p>	<p>*Caniquantel Plus (IDT) *aniprazol (aniMedica), others, <i>tablets</i> *Feligel for cats, <i>gel</i> (CP-Pharma) **Reptile Science Repti Worm Controls Parasites in Reptiles (Universal Manufacturing Labs., Australia, elsewhere)</p>	<p>for use in dogs and cats (*drug products available in Germany, **Australia and elsewhere) with activity against ascarids (<i>Toxocara</i>, <i>Toxascaris</i>), hookworms (<i>Ancylostoma</i>, <i>Uncinaria</i>), whipworm (<i>Trichuris</i>), and cestodes (<i>Taenia</i> spp., <i>D. caninum</i>, <i>Echinococcus</i> spp.), or reptiles: **Reptile Science Repti Worm</p>
<p>can be added in correct dosage to food, either live or processed (or directly by use of an administration tube down the snake's throat); it controls safely parasites such as nematodes, (roundworms, hookworms, pinworms, and lungworms), trematodes (flukes), and cestodes (tapeworms); it should not be used on reptiles intended for human consumption; for other drug products containing FBZ, e.g., fenbendazole/praziquantel/pyrantel, cf. Allwormers' &lt;pyrantel&gt; ↑</p>		
<p><b>flubendazole</b> (dog, cat 22 daily for 2–3 days) <i>limitation</i>: do not use in pregnant bitches or queens</p>	<p>*Flubenol Oral Anthelmintic Paste for Dogs and Cats, oral paste (Boehringer Ingelheim, Australia, elsewhere); for *Flubenol and other products in Germany and elsewhere see below</p>	<p>for treatment and control of gastrointestinal worm infections caused by roundworms (<i>Toxocara canis</i>, <i>T. cati</i>, <i>Toxascaris leonina</i>), hookworms (<i>Uncinaria stenocephala</i>, <i>Ancylostoma caninum</i>, <i>A. tubaeforme</i>), whipworms,</p>
<p>and common tapeworms (<i>Taenia</i> spp.) in dogs and cats; it proves ineffective against <i>Dipylidium caninum</i> and <i>Echinococcus</i>; it has larvicidal activity against canine heartworm; in Germany: *Flubenol easy, chewable tablets for dog, *Flubenol easy cat as chewable tablets or *Flubenol P, gel for dog, cat (Janssen-Cilag), *Vermicat, gel for dog, cat (CEVA); flubendazole may adversely affect embryogenesis in cat and dogs; the drug proved teratogenic and embryotoxic in rats</p>		
<p><b>oxibendazole/praziquantel</b> (dog, cat, 22.5/5) studies on reproductive toxicity have not been conducted in pregnant queens or bitches; use of drug products should be carefully considered during early pregnancy</p>	<p>*Virbac Endogard Palatable Allwormer Tablets, e.g., for small dogs, puppies, cats, and kittens, oral <i>tablet</i>: 112.5 mg oxibendazole/25 mg praziquantel/tablet: 1 tablet /5 kg b.w. (Virbac, others, Australia and elsewhere)</p>	<p>for the treatment and control of roundworms, hookworms, whipworm, and tapeworms (<i>Dipylidium caninum</i>, <i>Taenia</i> spp., including <i>Echinococcus granulosus</i>) in small dogs (up to 5 kg) and in cats and kittens; drug products do not control heartworm in dogs or cats; other drug products (oral tablets) for</p>
<p>medium, large, and extra-large dogs (e.g., *Virbac Endogard Palatable Allwormer Tablets containing 787.5 mg oxibendazole/Tb/175 mg praziquantel/Tb: 1 tablet/35 kg b.w.) or for cats and kittens (e.g. *Friskies Tasty Allwormer Tablets, Virbac); drug products with oxibendazole/praziquantel are not available in the USA, Germany and elsewhere; for *Filaribits Plus, Pfizer Inc., USA (= oxibendazole/diethylcarbamazine citrate) with activity against <i>Dirofilaria immitis</i>, or Virbac Canimax Palatable Allwormer (<i>abamectin/praziquantel/oxibendazole</i>) see this table ↑</p>		

**Nematocidal Drugs, Animals. Table 5** Drugs used against nematode infections of dogs and cats (Continued)

CHEMICAL GROUP nonproprietary name of active substance (single oral dose, mg/kg body weight = b.w.), other information	*DRUG PRODUCT dose form (formulation), withdrawal time (WT) days (d) before slaughter, manufacturer, supplier, other information	CHARACTERISTICS miscellaneous comments on pharmacokinetics, metabolism, mode of action, toxicity, and limitations
<b>PROBENZIMIDAZOLES</b>		
<b>febantel</b> (dog, cat <6 months of age: 15) once daily for 3 consecutive days (dog, cat ≥ 6 months of age: 10) once daily for 3 consecutive days	*Rintal Tabs Anthelmintic Tablets (Bayer Healthcare, USA and elsewhere) scored <i>tablets</i> (27.2 mg or 163.3 mg febantel for small or large dogs, and so puppies, cats, and kittens)	highly effective in expelling adult stages of hookworms ( <i>Ancylostoma caninum</i> , <i>A. tubaeforme</i> , and <i>Uncinaria</i> <i>stenocephala</i> >90%), ascarids ( <i>Toxocara canis</i> , <i>T. cati</i> , and <i>Toxascaris leonina</i> >95%), whipworm
<i>(Trichuris vulpis</i> >99%); in pups and kittens the drug is well tolerated and has a wide range of safety; <b>limitations:</b> it should not be used in pregnant animals; consider alternative therapy or use with caution in animals with preexisting liver or kidney dysfunction; administer to puppies and kittens on a full stomach; federal law restricts this drug to use by or on the order of a licensed veterinarian		
<b>febantel/praziquantel</b> (dog, cat <6 months of age: 15/1.5 once daily for 3 consecutive days) (dog, cat ≥ 6 months of age: 10/1 once daily for 3 consecutive days; restricted during pregnancy)	*Vercom Paste Anthelmintic (Bayer Healthcare, USA and elsewhere) (34 mg febantel /3.4 mg PZQ per 1 g <i>paste</i> per 7.5 pounds b.w. > 6 months of age, 5 pounds b.w. < 6 months of age)	highly active against adult and prepatent infections of hookworms ( <i>Ancylostoma</i> <i>caninum</i> , <i>A. tubaeforme</i> , and <i>Uncinaria</i> <i>stenocephala</i> >90%), ascarids ( <i>Toxocara canis</i> , <i>T. cati</i> , and <i>Toxascaris</i> <i>leonina</i> >95%), whipworm ( <i>T. vulpis</i> >95%), and tapeworms. ( <i>T. pisiformis</i> ,
and <i>Dipylidium caninum</i> >99%); in pups and kittens the combination is well tolerated but it is <i>contraindicated</i> in pregnant dogs and cats because of an increase in frequency of early abortion; consider alternative therapy or use with caution in animals with preexisting liver or kidney dysfunction; administer to puppies and kittens on a full stomach; federal law restricts this drug to use by or on the order of a licensed veterinarian		
<b>febantel/pyrantel pamoate</b> (dog 15/5 base equivalent to 14.4 pamoate, as a single dose), fastening prior to exact dosing is not necessary; <i>limitation:</i> restricted during pregnancy	*Drontal Worming Suspension for Puppies (Bayer, Australia) <i>suspension:</i> each mL contains 15 mg febantel/mL, and 5 mg pyrantel/ml base: 1 ml/kg b.w.	combination with synergistic effects; for use in pups, toy, and young dogs; is effective in expelling adult and prepatent infections of all relevant nematodes of dogs such as <i>Toxocara</i> <i>canis</i> , <i>Toxascaris leonina</i> ,
<i>Ancylostoma caninum</i> , <i>A. braziliense</i> (latter occurs in costal areas of north Queensland, Northern Territory, and northern Western Australia), <i>Uncinaria. stenocephala</i> , and <i>Trichuris vulpis</i> ; treatment of pups should be started 2 weeks after parturition and repeated biweekly to control possible prenatal and transmammmary infections of litters, bitches should be treated routinely prior to mating, at end of pregnancy and during lactation to reduce environment contamination by eggs and larvae (daily disposal of droppings); at therapeutic dose, product is well tolerated in puppies, toys, and young dogs		
<b>febantel/pyrantel pamoate/ praziquantel</b> (dog 15/14.4/5) <i>limitations:</i> do not use in pregnant animals or simultaneously with cholinergic drugs (e.g., levamisole), organophosphates or <piperazine> enhancing or <reducing> pyrantel's action (spastic paralysis of parasites)	*Drontal flavor Plus *Drontal Plus XL (Germany and elsewhere) *Drontal Allwormer Chewable or *B-O-Pet (Bayer, Australia): oral <i>tablets</i> for dogs containing different amounts of active constituents for small, medium and large dogs (cf. also pyrantel, allwormer ↑)	for the treatment and prevention of canine parasites such as ascarids ( <i>Toxocara canis</i> , <i>Toxascaris leonina</i> ), whipworm <i>Trichuris vulpis</i> , and tapeworms (approx. 100% efficacy against <i>Dipylidium caninum</i> , <i>Taenia</i> spp., <i>Echinococcus granulosus</i> and <i>E. multilocularis</i> , <i>Mesocostoides</i> spp., and <i>Joyeuxiella pasqualei</i> (a tapeworm occurring in cats and dogs e.g., in
Middle East or Africa)); it is highly effective (<95%) against hookworms ( <i>Ancylostoma caninum</i> , <i>Uncinaria stenocephala</i> ); at higher dosages drug products may also affect the lungworm <i>Crenosoma vulpis</i> , and <i>Angiostrongylus vasorum</i> (living in pulmonary arterioles and capillaries of the dog); pregnant bitches should be treated at mating, then 10 days before whelping and at 2 and 4 weeks after whelping, then every 3 month; dosage schedule for hookworms and roundworms in dogs and puppies: treat at 2, 4, 8, and 12 weeks and then every month until six months of age, thereafter every 3 month or on veterinary advice ( <i>E. granulosus</i> : a single dose is required, however, this dose should be repeated every 6 weeks to ensure that newly acquired hydatid tape worms are expelled); <b>tolerability:</b> drug products may cause intensive vomiting in cats but they may be given safely to all dogs (young pups, working dogs, greyhounds, and pregnant bitches) but is only clinically indicated in last 10 days prior to whelping (see ↑); vomiting may be observed in a small number of dogs after administration of drug products		

**Nematocidal Drugs, Animals. Table 5** Drugs used against nematode infections of dogs and cats (Continued)

CHEMICAL GROUP nonproprietary name of active substance (single oral dose, mg/kg body weight = b.w.), other information	*DRUG PRODUCT dose form (formulation), withdrawal time (WT) days (d) before slaughter, manufacturer, supplier, other information	CHARACTERISTICS miscellaneous comments on pharmacokinetics, metabolism, mode of action, toxicity, and limitations
<b>emodepside/praziquantel</b> (EMO/ PZQ) (cat, 3/12 <i>topical</i> ) equivalent to 0.14ml *Profender/ kg b.w., 1 application on base of skull on visible skin <b>limitations</b> : treated animals should not be bathed until solution has dried; avoid direct contact with application site while it is wet; do not use in kittens under 8 weeks of age or weighing <0.5 kg; for external use only	*Profender for cats (Bayer Vital, Germany, and elsewhere) *Profender Allwormer (Bayer, AH Australia and elsewhere): spot-on solution (21.4 mg/ml emodepside, 85.8mg/ml PZQ), pipette volume: 0.35 ml, 0.70 ml or 1.12 ml for small, medium, and large cats weighing ≥ 0.5–2.5 kg, >2.5–5 kg, >5–8 kg, respectively	EMO is a semi-synthetic depsipeptide active against roundworms <i>Toxocara cati</i> (adults, L <sub>4</sub> and L <sub>3</sub> ), <i>Toxascaris leonina</i> (adults and L <sub>4</sub> ) and <i>Ancylostoma tubaeforme</i> (adults and L <sub>4</sub> ); it stimulates receptors at neuromuscular junction causing paralysis and death of roundworms; cotreatment with other drugs (P-glycoprotein substrate/inhibitors) such as ivermectin and other
macrocyclic lactones, erythromycin, prednisolone, and cyclosporine could give rise to pharmacokinetic drug interactions (EMO is a substrate for P-glycoprotein); PZQ is active against adult tapeworms, <i>D. caninum</i> , <i>T. taeniaeformis</i> , and <i>Echinococcus multilocularis</i> ; it changes permeability of calcium channels in membranes of tegument resulting in paralysis and death of tapeworms; peak serum concentration 32 ± 24 µg EMO/L and 61 ± 44 µg PZQ/L after 3.2 ± 2.7/18.7 ± 47 hours of application; overdose of *Profender (at up to 10–5 times the recommended dose in adult cats or kittens) may cause salivation, vomiting and neurological signs (tremor) and may result from cat licking the application site, there is no specific antidote; it can be used during pregnancy and lactation though studies performed in rats and rabbits suggest that EMO may interfere with embryo-fetal development		

Data of drug products (approved labels) listed in this table refer to information from literature, websites of European Medicines Agency (EMA), Committee for Veterinary Medicinal Products (CVMP), the US Food and Drug Administration (FDA), Center for Veterinary Medicine (CVM), the Australian Pesticides and Veterinary Medicines Authority (APVMA), and associated Infopest product summary, VETIDATA (Leipzig, Germany), and CliniPharm, CliniTox (Zürich, Switzerland); data given in this Table have no claim to full information Abbreviations: AH = Animal Health Division; OTC = over the counter (drug products); RX = symbol for prescription

introduction of amino groups at this position, revealed optimal compatibility with high bio-activities. **Emamectin** is structurally very similar to eprinomectin the only difference being the presence of an epi-methylamino group at the C4'' position instead of an epi-acetylamino group at that position in the case of eprinomectin. The benzoate salt was developed for the treatment of sealice infestations in Salmonidae (fin fish). Based on established "Maximum Residue Limits" (MRLs = 100 µg/kg for muscle and skin in natural proportions) in fin fish, emamectin entered into Annex I of Council Regulation of EEC.

The related milbemycins produced by *Streptomyces* sp. share a common carbon backbone with the avermectins but lack the glycones (structurally equivalent to 13-deoxy-ivermectin aglycones). Semi-synthetic **moxidectin** (23-methoxime LL-F28249α milbemycin), a derivative of naturally occurring **nemadectin** (LL-F28249α →fermentation product from *Streptomyces cyaneogriseus noncyanogenus*) and structurally similar to the milbemycins, differs from them in having an unsaturated C-25 chain. Moxidectin has the same wide spectrum of activity as avermectins but it should be less toxic than abamectin against the dung beetle

*Onthophagus gazella*. Thus concerns about possible adverse environmental impact of the avermectins might be less applicable in the case of moxidectin.

Unlike the avermectins, the nematocidal activity of milbemycins is more potent against intestinal nematodes than against →heartworm. **Milbemycin oxime** (semi-synthetic derivative of milbemycin A<sub>3</sub>/A<sub>4</sub>, narrow-spectrum compound) has been developed for strategic control of both *Dirofilaria immitis* (heartworm) and →*Ancylostoma caninum* in dogs (Table 5).

Both classes of macrocyclic lactone compounds obviously have a similar mode of action, i.e., they mediate their nematocidal effect via interaction with a common receptor molecule. They open →Cl ion channels thought to be associated with glutamate-gated ion channels of muscles of the pharynx and probably the somatic musculature. As a result of this interaction worms become paralyzed and starve to death. Several dose-response (titration) studies with low dose rates of ivermectin and moxidectin against several species of sheep trichostrongylids point to the fact that side resistance between these drugs is present. It is suggested that the 2 drugs act at the same site. However, the extent of lipophilicity may influence the relative efficacy of

**Nematocidal Drugs, Animals. Table 6** Drugs used against extraintestinal nematode infections of domestic animals

<b>DRUG</b> (active chemical) <b>nonproprietary name</b> of drug (dose, mg/kg body weight = b.w.), other information	<b>EXTRAEINTESTINAL PARASITES AFFECTED BY DRUGS</b> indications and dose regimens see also <a href="#">Table 1</a> : ruminants, <a href="#">Table 3</a> : horse, <a href="#">Table 4</a> : swine, and <a href="#">Table 5</a> : dog and cat, experimental doses/data cited refer to data from literature
<b>diethylcarbamazine</b> (various salts) (piperazine derivative) 6.6 per os, daily for prolonged periods (limited administration period cf. <a href="#">Table 5</a> )	it may be used as a preventive microfilaricide in <b>humans</b> suffering from lymphatic filariasis ( <i>Wuchereria</i> spp., <i>Loa loa</i> , and <i>Onchocerca volvulus</i> , cf. (Nematocidal Drugs, Man/ <a href="#">Table 1</a> ) or as drug products (e.g., oral Heartworm tablets) in the USA, Australia, and elsewhere for the prevention of heartworm disease in <b>dogs</b> and <b>cats</b> ,
and as an aid in the treatment of ascarid infection in dogs (cf. <a href="#">Table 5</a> ); this old-timer has also shown some activity against immature stages of lungworms ( <i>Dictyocaulus</i> spp.) in <b>ruminants</b> ; it suppressed early lungworm infection but not patent infection and has been used in cattle and sheep for prevention of verminous bronchitis caused by <i>D. viviparus</i> and <i>D. filaria</i> , respectively; it has shown microfilaricidal action against <i>O. gibsoni</i> and <i>O. gutturosa</i> in cattle and <i>O. cervicalis</i> in horses ( <i>Onchocerca</i> are elongate filariform worms producing microfilariae in the skin and connective tissue spaces causing cutaneous onchocerciasis)	
<b>levamisole</b> hydrochloride (imidazothiazole derivative) (8 per os cattle, sheep) (10 cattle, topical) <b>levamisole</b> phosphate (6 s.c. cattle) (approved dose horse cf. <a href="#">Table 3</a> ) (8: base, i.m. or s.c. swine) (7–8 per os) (all approved doses)	has for a long time been considered to be the most suitable treatment against verminous bronchitis ( <i>Dictyocaulus</i> spp., approved indication, cf. <a href="#">Table 1</a> ); in <b>cattle</b> ; it has a high efficacy (about 99%) against adult and L <sub>5</sub> larvae of <i>D. viviparus</i> ; for efficacy against L <sub>4</sub> larvae it is necessary to increase the dose to 10 mg/kg s.c.; however, the double therapeutic dose of the drug may destroy only some of the immature <i>D. viviparus</i> , causing impaired pulmonary function and gas exchange (treatment of parasitic bronchitis can be associated with exacerbation of clinical signs caused by dying parasites or their fragments releasing proteins inducing allergic reactions and infrequently mortality); it has variable efficacy against L <sub>1</sub> larvae of <i>Protostrongylus</i> spp. in <b>sheep</b>
and <b>goats</b> ; at 2–3 times the therapeutic dose (15 and 24 mg/kg) there is a transient reduction of larvae in the feces; the rapid excretion of the drug may be the reason for the less pronounced activity against L <sub>4</sub> larvae; it was found to be active against <i>Stephanofilaria okinawaensis</i> (filariform parasite in Japan transmitted by flies and causing lesions on muzzle and teat) and filariform worm <i>Setaria equina</i> (common filariform parasite of equines dwelling in body cavities, sometimes eyes and lungs: 7.5 mg/kg for 2 days), or <i>Thelazia</i> spp. (spirurids of conjunctival sac or lacrimal duct of mammals and bird: 5–12 mg/kg); it is effective against large strongyles (arterial larval stages of <i>Strongylus vulgaris</i> and tissue stages of <i>S. edentatus</i> ) of <b>horse</b> (approved indication for levamisole HCl/piperazine 2HCl, cf. <a href="#">Table 3</a> ); it is highly effective against lungworm ( <i>Metastrongylus</i> spp. adults) and kidney worm ( <i>Stephanurus dentatus</i> ) infections of <b>swine</b> at approved dose (cf. <a href="#">Table 4</a> ); levamisole shows activity against <i>Crenosoma vulpis</i> of <b>carnivores</b> at a single dose 8 mg/kg; adults of <i>C. vulpis</i> are fairly short worms dwelling in bronchi of fox, dog, and wolf (snails serve as intermediate hosts); they cause symptoms (rhinotracheitis and bronchitis) similar to those seen in <i>Capillaria aerophila</i> infections; the drug affects <i>C. aerophila</i> (worms of this genus are related to <i>Trichuris</i> and found in the trachea and bronchi of dogs, and foxes) at oral doses of 5 mg levamisole HCl/kg given 3 times in 9-day intervals; it exhibits activity against early heartworm infections ( <i>Dirofilaria immitis</i> , preadults) of <b>dogs</b> (levamisole HCl is not approved for use in dogs as a monocompound; it may cause too much adverse effects in dogs, for contraindications cf. <a href="#">Table 5</a> )	
<b>thiabendazole</b> <b>mebendazole</b> <b>flubendazole</b> <b>fenbendazole</b> <b>oxfendazole</b> <b>albendazole</b> (benzimidazoles = BZs), <b>febantel</b> (PRO-BZ) (administration all per os) for approved drug products and doses cf. <a href="#">Tables 1, 3–5</a> ; anthelmintic efficacy of BZs can be enhanced by dividing the therapeutic dose over several days either by drench or in-feed medication	BZs and febantel (latter converted in liver into fenbendazole) have in addition to their excellent activity against GI nematodes a high efficacy against several extraintestinal nematode infections in <b>ruminants</b> ; they are highly effective against adult and immature stages of lungworms ( <i>thiabendazole</i> is less active) such as <i>Dictyocaulus viviparus</i> in cattle, and <i>D. filaria</i> in sheep (approved indications, cf. <a href="#">Table 1</a> ); treatment of parasitic bronchitis can occasionally be associated with exacerbation of clinical signs caused by dying parasites or their fragments releasing proteins inducing allergic reactions and infrequently death; at higher dose (2–3-fold the therapeutic dose), BZs are active (85–90%) against less common protostrongylid nematodes of sheep and goats such as <i>Protostrongylus rufescens</i> (other species), <i>Muellerius</i> , <i>Cystocaulus</i> , and <i>Neostrongylus</i> (molluscs serve as intermediate hosts); however, their action on fecal larvae of small lungworms appears to be transient and variable, and more information is needed as to whether they kill adult stages; <i>fenbendazole</i>

**Nematocidal Drugs, Animals. Table 6** Drugs used against extraintestinal nematode infections of domestic animals (Continued)

DRUG (active chemical) nonproprietary name of drug (dose, mg/kg body weight = b.w.), other information	EXTRAIESTINAL PARASITES AFFECTED BY DRUGS indications and dose regimens see also Table 1: ruminants, Table 3: horse, Table 4: swine, and Table 5: dog and cat, experimental doses/data cited refer to data from literature
<p>at 1.5–2 mg/kgbw for 5 days not only affects adult protostrongylid nematodes but also inhibits L<sub>4</sub> larvae of <i>D. viviparus</i> in cattle; several other extraintestinal nematodes of <b>wild ruminants</b> may respond to BZ-treatment such as <i>Elaphostrongylus rangiferi</i> (occurring in lungs of reindeer: 6 mg <i>mebendazole</i>/kg × 10) and <i>E. cervi</i> (occurring in connective tissues of breast, thorax, back, and CNS of red deer: 7.5 mg <i>fenbendazole</i>/kg for 5 days); lungworm infections (<i>D. arnfieldi</i>) of <b>donkeys</b> and <b>horses</b> appear to be less susceptible to BZs; <i>Thelazia lacrymalis</i> in horses (spirurids of conjunctival sac or lacrimal duct of mammals and birds) may be affected to some degree by 3 mg <i>fenbendazole</i>/kg for 3 days, or 1.5 mg <i>flubendazole</i>/kg for 5 days, or 10 mg <i>febantel</i>/kg, single dose; BZs are highly effective against adult lungworms of <b>swine</b> (<i>Metastrongylus</i> spp. approved indication, cf. Table 4), e.g., at oral doses of 1.5 mg <i>flubendazole</i>/kg for 5 days, or 5 mg <i>fenbendazole</i>/kg in feed divided over 5–15 days; <i>fenbendazole</i> affects also kidney worm of <b>swine</b> (<i>Stephanurus dentatus</i>, approved indication, cf. Table 4); BZs show some activity against lungworm infections in <b>dogs</b> (<i>Filaroides hirthei</i>: 50 mg <i>albendazole</i>/kg twice daily for 5 days) or <b>cats</b> (<i>Aelurostrongylus abstrusus</i>, snails and slugs serve as intermediate hosts; adult stages of the worm live in terminal bronchioles causing chronic cough with gradual wasting: 50 mg <i>fenbendazole</i>/kg for 3 days); oral doses of 50 mg <i>fenbendazole</i>/kg for 3 days, or 50 mg <i>albendazole</i>/kg for 10 days cause improvement of clinical signs in <i>Capillaria plica</i> infections of dogs; drugs partially control adult stages of this worm dwelling in pelvis of the kidney thereby causing cystitis and urinary disorders (<i>C. plica</i> are related to genus <i>Trichuris</i>)</p>	
<b>MACROCYCLIC LACTONES</b>	
<p><b>IVERMECTINS</b> <b>ivermectin (IVM)</b> (0.2 s.c. or per os cattle) (0.5 topical cattle) (0.2 drench sheep) (0.2 per os horse) (0.3 s.c. swine) (0.006 per os dog). (all approved doses)</p>	<p>has an excellent activity against adults and developing L<sub>4</sub> larvae of <i>Dictyocaulus</i> spp. (approved indication cf. Table 1); subcutaneous administration of the drug produces long persistent plasma and tissue levels (precludes its use in lactating dairy animals); after the s.c. route its prolonged activity exerts an effect on trichostrongyles and lungworms of <b>ruminants</b> for about 3 weeks; residues of the drug persisting in the tissues during this time may provide protection against most GI nematode infections for ~10 days and against <i>D. viviparus</i> infections in cattle for ~3 weeks; it is also active against small lungworms infections in sheep (less common <i>Muellerius</i> spp.</p>
<p><i>Cystocaulus</i>, <i>Neostrongylus</i> and others: mollusks serve as intermediate hosts); the drug proves highly effective against <i>Parafilaria bovicola</i> of cattle (occurring in tropical areas and transmitted by flies feeding on lacrimal secretions or wounds) at 0.2 mg/kg s.c., reducing totally hemorrhagic nodules produced by this filariform worm in the skin within 2 weeks of treatment; IVM exerts its effect via the reproductive organs of female adult filariform worms (it blocks embryogenesis); it is active against microfilariae of <i>O. gibsoni</i> and <i>O. gutturosa</i> in cattle and tissue larval stages of <i>Onchocerca cervicalis</i> in <b>horses</b> (0.2 mg/kg p.o.) and may prevent reinfections with these parasites for a certain period; it is effective against <i>D. arnfieldi</i> of equines (approved indication cf. Table 3), lungworms of <b>swine</b> (<i>Metastrongylus</i> spp. approved indication, cf. Table 4); IVM was the first macrocyclic lactone, which has been used for the prevention of filarial infections in animals and in humans (cf. Nematocidal Drugs, Man/Table 1); in veterinary medicine, it is a common drug for <i>prevention</i> of heartworm disease in dogs; it eliminates tissue larval stages of <i>Dirofilaria immitis</i> for about 30 days after infection (single dose of 6 mcg/kg b.w. per month: approved dose and indication, cf. Table 5); at higher (experimental) doses (0.1–0.2 mg/kg b.w. p.o.), IVM has a wide spectrum of activity for all important GI nematodes, and <i>Capillaria aerophila</i> (a lungworm occurring in the trachea and bronchi of canines efficacy 95% at 0.2 mg/kg b.w. orally)</p>	
<p><b>abamectin</b> (0.2 s.c. cattle, sheep) (0.5 topical cattle) (0.2/ in various drug combination, drench sheep) (0.2 per os horse) (0.3 s.c. swine) (all approved doses)</p>	<p>has wide spectrum of activity for all important roundworms similar to that of ivermectin; it has no approval in the USA but is available on the Australian market and elsewhere (including various combinations, cf. Tables 1; 3; 4 approved indications for roundworms in ruminants, horses and swine, respectively); it is used in cattle as an endectocide and exhibits high efficacy against immature and adult stages of lungworms (<i>Dictyocaulus viviparus</i>) in <b>cattle</b>; for use in <b>sheep</b> abamectin is combined with other drugs (closantel, levamisole,</p>
<p>oxfendazole, praziquantel, or triclabendazole either to enhance anthelmintic activity against drug resistant <i>Haemonchus contortus</i> or to include adult and larval tissue stages of tapeworms or trematodes in spectrum of activity; in <b>horses</b> it may be used as monocompound or as combination (with praziquantel or morantel) both exerting high efficacies against arterial</p>	

**Nematocidal Drugs, Animals. Table 6** Drugs used against extraintestinal nematode infections of domestic animals (Continued)

<b>DRUG</b> (active chemical) <b>nonproprietary name</b> of drug (dose, mg/kg body weight = b.w.), other information	<b>EXTRAIESTINAL PARASITES AFFECTED BY DRUGS</b> indications and dose regimens see also <a href="#">Table 1</a> : ruminants, <a href="#">Table 3</a> : horse, <a href="#">Table 4</a> : swine, and <a href="#">Table 5</a> : dog and cat, experimental doses/data cited refer to data from literature
larval stages of <i>Strongylus vulgaris</i> , tissue stages of <i>S. edentatus</i> , <i>Dictyocaulus arnfieldi</i> and <i>Thelazia spp.</i> (spirurids of conjunctival sac or lacrimal duct of mammals and birds), and ileocecal tapeworms <i>Anoplocephala perfoliata</i> , and other tapeworms when used as abamectin/praziquantel (cf. <a href="#">Table 3</a> )	
<b>doramectin</b> (0.2 s.c., cattle, sheep) (0.3 i.m. swine) (0.5 topically, cattle) (0.15 drench, sheep) (all approved doses)	is a very potent endectocide affecting all economically important nematodes and ectoparasites (grubs, lice, mange mites) in cattle (cf. <a href="#">Table 13</a> ); it is highly effective against adults and 4th-stage larvae of lungworm <i>Dictyocaulus viviparus</i> in <b>cattle</b> (approved indication cf. <a href="#">Table 1</a> ); it also affects adult <i>Thelazia spp.</i> (spirurids of conjunctival sac or lacrimal duct of mammals and birds); in <b>swine</b> , it is effective against <i>Stephanurus dentatus</i> (approved indication, cf. <a href="#">Table 4</a> ); this worm may be found in all sites of the sow as in peritoneal area and kidneys, a few stages may be scattered in liver, lungs, abdominal muscles, and peritoneal cavity; doramectin is also highly effective against the mange mite ( <i>Sarcoptes scabiei</i> var. <i>suis</i> it does not affect its eggs)
<b>selamectin</b> (6 dog, cat topical) (approved dose)	at recommended dose it may be safely given to <i>cats</i> or <i>dogs</i> infected with adult heartworms ( <i>Dirofilaria immitis</i> ); however, it is recommended that all animals 6 months of age or more living in countries where a vector exists should be tested for existing adult heartworm infections prior to medication with the drug (cf. <a href="#">Table 5</a> ); thereafter it can be used as an integral part of heartworm prevention strategy (drug is not effective against adult <i>D. immitis</i> but it eliminates adult intestinal hookworms <i>Ancylostoma tubaeforme</i> in cats, or adult intestinal roundworm <i>Toxocara canis</i> in dogs); it is highly effective against sarcoptic mange ( <i>Sarcoptes scabiei</i> ) and a second monthly dose may be required for complete elimination of mites; it has high adulticidal and larvicidal activity (99–100%) against fleas ( <i>Ctenocephalides felis</i> and <i>C. canis</i> ) by killing adults (on animal), preventing hatching of eggs (on animal and its environment), and by killing larvae (environmental only)
<b>eprinomectin</b> (0.5 topical, cattle, beef, dairy) (approved dose)	for treatment and control of GI nematodes and various ectoparasites; it has an excellent action on lungworms ( <i>Dictyocaulus viviparus</i> ), and arthropods as mange mites ( <i>Chorioptes bovis</i> , <i>Sarcoptes scabiei</i> ), grubs ( <i>Dermatobia hominis</i> , <i>Hypoderma bovis</i> , <i>H. lineatum</i> ) in cattle (for more information cf. <a href="#">Table 1</a> )
<b>MILBEMYCINS</b> <b>milbemycin oxime</b> (0.5 per os dog, puppies) (0.2 per os cat, kittens) (0.1 per os dog): heartworm prevention (2 per os cat): heartworm prevention and removal of roundworms (all approved doses)	is a potent drug for prevention of heartworm disease in <i>dogs</i> and <i>cats</i> (approved indication cf. <a href="#">Table 5</a> ); besides its strong action on microfilariae of <i>Dirofilaria immitis</i> infections it additionally controls intestinal nematodes of dogs and cats; it shows also efficacy against other nematodes such as lungworms <i>Crenosoma vulpis</i> and <i>Angiostrongylus vasorum</i> (not approved indications), and affects mites such as <i>Sarcoptes scabiei</i> , <i>Demodex canis</i> , or <i>Pneumonyssoides caninum</i> at higher than the recommended dose if administered daily for longer periods; experimental dose regimen for dogs suffering from demodicosis ( <i>D. canis</i> ) may be 1–4.6 mg/kg b.w./day for at least 2–3 months causing a temporary cure or improvement of symptoms in most dogs, and nonrelapsing (permanent) cure in >50% of treated dogs; <i>D. canis</i> mites may live as commensals in the skin; they can cause squamous or pustular dermatitis = demodicosis especially in young dogs (for combinations like milbemycin oxime/lufenuron, or milbemycin oxime/praziquantel, others cf. <a href="#">Table 5</a> )
<b>moxidectin</b> (0.2 s.c. cattle, sheep) (0.5 s.c. cattle, beef, sheep long acting) (0.5 topical cattle, dairy, red deer) (0.4 per os horse, foal, pony) (0.003 per os dog) (0.17 s.c. once every 6 months dog) (all approved doses) the drug may be combined with praziquantel, imidacloprid, others	chemically modified derivative of macrocyclic lactones nemadectin, which has been classed with milbemycins; moxidectin exerts high endectocide activities; it exhibits a very high efficacy against early L <sub>5</sub> larvae and adults of lungworms <i>Dictyocaulus viviparus</i> in cattle, <i>D. filaria</i> in sheep (adult, L <sub>4</sub> stages) and arthropods such as grubs (99%: <i>Hypoderma bovis</i> , <i>H. lineatum</i> , all parasitic stages), mange mites <i>Sarcoptes scabiei</i> , <i>Psoroptes ovis</i> (100%), itchmite <i>Psorergates ovis</i> , <i>Chorioptes bovis</i> (markedly suppressed) (approved indications, cf. <a href="#">Table 1</a> ); it also has a microfilaricidal effects against

**Nematocidal Drugs, Animals. Table 6** Drugs used against extraintestinal nematode infections of domestic animals (Continued)

DRUG (active chemical) nonproprietary name of drug (dose, mg/kg body weight = b.w.), other information	EXTRAIESTINAL PARASITES AFFECTED BY DRUGS indications and dose regimens see also Table 1: ruminants, Table 3: horse, Table 4: swine, and Table 5: dog and cat, experimental doses/data cited refer to data from literature
<p><i>Onchocerca gibsoni</i> and <i>O. gutturosa</i> in cattle, and <i>O. cervicalis</i> in horses (cf. Table 3); these elongate filariform worms produce and release microfilariae in the skin and connective tissue spaces causing cutaneous onchocerciasis; there is 99–100 % efficacy against adults of <i>Strongylus vulgaris</i> (L<sub>4</sub>/L<sub>5</sub> arterial stages &gt;90%), <i>S. edentatus</i> (adults, L<sub>4</sub> tissue or visceral stages), <i>S. equinus</i> (adults), and stomach bots of horses (<i>Gasterophilus intestinalis</i>, 2nd and 3rd instars, <i>G. nasalis</i>); the drug seems to be ineffective against the equine lungworms (<i>Dictyocaulus arnfieldi</i>); the drug is highly effective (100%) against larvae (L<sub>3</sub>/L<sub>4</sub>) of <i>Dirofilaria immitis</i> causing heartworm disease of dogs (cf. Table 5); it should only be used in dogs, which proved negative for the presence of adult heartworms because its strong microfilaricidal action may produce shocklike reactions in infected dogs due to dying or dead microfilariae; it shows good activity against mite infestations (sarcoptic mange and ear mites and lice for up to 6 weeks); moxidectin combined with the ectoparasiticide <i>imidacloprid</i> (topical application for dogs and cats) has been shown to be highly effective in treating generalized demodicosis (<i>Demodex canis</i>) when administered at monthly intervals for 2–4 treatments (for more information on treatment and prevention of flea infestation with Advocate, Bayer cf. Table 5)</p>	

Data of drug products (approved labels) listed in this table refer to information from literature (experimental data), manufacturer, supplier and websites such as the European Medicines Agency (EMA), Committee for Veterinary Medicinal Products (CVMP), the US Food and Drug Administration (FDA), Center for Veterinary Medicine (CVM), the Australian Pesticides and Veterinary Medicines Authority (APVMA), and associated Infopest (search for products), VETIDATA, Leipzig, Germany, and Clini Pharm, Clini Tox (CPT), Zürich, Switzerland; data given in this table have no claim to full information

macrolactones in female and male worms. Males with a larger body size than females were more susceptible in an isolate of →*Haemonchus contortus* resistant to ivermectin. Their larger body size and the potential for sequestering a lipophilic compound like ivermectin were believed to promote anthelmintic activity.

### Narrow-Spectrum Drugs Effective Against Drug-Resistant Nematodes

Substituted salicylanilides and phenols can control some nematode species of ruminants, which have developed resistance to the broad-spectrum anthelmintics. Narrow-spectrum anthelmintics as substituted **salicylanilides** and **phenols** are anticestodal (→*Cestodocidal Drugs/*Table 1) or antitrepatodal compounds (→*Trematodocidal Drugs/*Table 1). However, some of these compounds, e.g., **closantel** and **rafoxanide** have not only marked activity against →*liver flukes*, but also against multiple resistant strains of bloodsucking *Haemonchus contortus*, a highly pathogenic nematode of small ruminants (Table 1). If used at appropriate times, taking →*epizootiology* into account, these relatively long-acting drugs may reduce the selection pressure for resistance to the broad-spectrum compounds in *H. contortus* and →*Trichostrongylus* spp., thus reducing the contamination of pastures with these species for the rest of the season. For this reason, closantel may be used in strategic treatment programs for sheep and lambs in which the number of treatments with broad-spectrum

anthelmintics is kept to a minimum. For example, a broad-spectrum anthelmintic and closantel can be coadministered in sheep in the first 2 treatments in the new grazing season, followed by closantel. Thus so-called ‘Wormkill’ programs in Australia demonstrated local eradication of *H. contortus*. However, due to emergence of resistance to closantel and related compounds, this and other programs have been increasingly jeopardized. Closantel and **nitroxynil** (Table 1) are uncouplers of →*oxidative phosphorylation* in mammalian →*mitochondria*. Some of these compounds are fairly toxic and are detoxified in the host by binding the absorbed drug to plasma proteins. Consequently, drugs at therapeutic dose do not affect host’s mitochondria. Therefore, although they may uncouple roundworm mitochondria at low concentration *in vitro*, these drugs are initially inactive against the parasite until blood enriched with the drug is sucked in and digested by the parasite, thereby separating drug from plasma albumin. The other possibility is that the bound drug is separated from the plasma in the liver and is excreted in the bile where it contacts and affects parasites residing in the bile ducts or elsewhere. Actually, several **organophosphorus compounds** discussed here are no longer available (European market and others) because of lack of established ‘Maximum Residue Limits’ (MRLs, see below) for edible tissues and other products or because of lack of approved medications for treatment of a particular animal or parasite species. However, for historical understanding of product evolution and use some of these anthelmintics



will be considered with regard to their activity and adverse effects in livestock.

Organophosphorus compounds had their origin as pesticides and have subsequently been introduced as anthelmintics into veterinary practice. While, **coumaphos**, or **naphthalophos** are preferably used against parasitic infections in ruminants (Table 1), **dichlorvos** and **trichlorfon** are mainly used against parasites of horses (Table 3), pigs (Table 4), or dogs (Table 5). In ruminants the anthelmintic efficacy of organophosphates is somewhat restricted, i.e., only parasites of the abomasum (especially *Haemonchus*) are satisfactorily affected whereas nematodes of the bowel are somewhat refractory to a single treatment. To prevent development of drug resistance these compounds may be rotated with anthelmintics of other chemical classes. When *Trichostrongylus* spp. in sheep are likely to cause resistance problems to both the benzimidazoles and levamisole/morantel, an organophosphorus compound may be used to provide sufficient parasite control. Dichlorvos and **haloxon** exhibit satisfactory efficacy against small and large strongyles of horses, while trichlorfon (it is converted into dichlorvos at physiologic pH) in combination with any benzimidazole, BZ prodrugs (e.g., febantel) or morantel to provide high activity against →*Gasterophilus* (Table 3).

The main effect of organophosphates on worms is ascribed to inhibition of nematodal acetylcholinesterase (AChE). The degree of safety of these compounds for the host is probably related to the host's AChE specificity for a certain drug, and hence, to the "stability" of the formed drug/AChE complex, which may be reversible or not. The "affinity" or susceptibility of the host AChE to the organophosphorus compound should be weak, i.e., the formed drug/AChE complex should be limited in time. Conversely it is desirable if nematodal AChE forms an irreversible complex with the organophosphate. However, the selective toxicity of AChE inhibiting drug to various species of nematode AChE may vary and thus a different degree of parasitic drug action resulted. The absence of AChE leads to accumulation of acetylcholine of the parasite and produces disorders of parasite neuromuscular system resulting in paralysis and expulsion of the worm by peristalsis from the host gut. Therapeutic indices of organophosphates are generally smaller than those indices of the broad-spectrum drugs. Higher doses produce illegal residues in milk and edible tissues as well as toxicity in animals (frequent defecation and urination, →vomiting, salivation and muscular weakness). Cumulating effects were seen after concurrent administration of organophosphates and other AChE-inhibiting drugs such as pesticides (organophosphorus and carbamate →insecticides) or muscle relaxants; the same was true for the use of organophosphates within 4 weeks of parturition, especially in the equine.

### Chemoprophylaxis and Effects on Protective Immunity Against Nematodes and Lungworms

Intraruminal boluses (Table 1) are designed to release nematocidal concentrations of an anthelmintic in the reticulo-rumen of cattle in order to kill ingested infective larvae of GI nematodes and those of the lungworm *Dictyocaulus viviparus* for prolonged periods. Some intraruminal devices may release nematocidal concentrations for up to 20 weeks and also other formulations (e.g., for parenteral injection or pour-on) of macrocyclic lactones (Table 1) may protect animals against infections of gut roundworms and lungworms for several weeks postdosing. Thus, a single treatment with an intraruminal device at turnout may ensure protection against parasitic gastroenteritis for the whole grazing season in temperate regions. The suppression of the output of eggs in the early part of grazing season ensures safe pastures for the remainder of the year. There are 2 strategic regimens, which have been particularly successful in achieving this: repeated treatments with avermectins given 3, 8, and 13 weeks after turnout (Glasgow model) or the use of intraruminal anthelmintic devices given at turnout.

The control of parasitic bronchitis is more difficult because the epizootiology of *Dictyocaulus viviparus* is complex. Therefore the strategic control is not fully effective against bovine lungworms. During the time of drug release, lungworm infections are prevented; however, thereafter (a rough formula considered approximately 50 days after "burnout" of intraruminal bolus as critical period) when drug release is exhausted, infections with clinical signs and even cases of fatal parasitic bronchitis may occur. Reinfections are principally due to external sources, e.g., imported infections from other pastures via vectors or game animals. Under natural conditions, immunity to *D. viviparus* is generated much more rapidly than to GI nematodes. An attenuated vaccine (Dictol) has been available for many years but since benzimidazoles (e.g., oxfendazole and fenbendazole) and various avermectins have potent activity against *D. viviparus*, their strategic use for lungworm control has constantly been explored. The occurrence of hypobiotic lungworm infections during the housing period will effectively stimulate immunity buildup. To what extent sporadic lungworm challenges to animals during →chemoprophylaxis are capable of contributing to the development of protective immunity without producing hypobiotic infections is still unknown.

The strategic use of anthelmintics such as intraruminal anthelmintic boluses and other long-acting formulations, especially those of the avermectins, raised the question as to whether drug-protected animals are exposed to sufficient antigenic challenge to develop →acquired immunity. In general, only first-season grazing calves have to be treated against GI nematodes. During this period substantial reductions in

the exposure of calves to infection is normally evident, and it has been shown that not all animals may acquire satisfactory (“functional”) immunity to prevent clinical disease in their second grazing season. Thus, elevated pepsinogen levels and heavy worm burdens (e.g., inhibited → *Ostertagia ostertagi* L<sub>4</sub> larvae) have been observed during the second grazing season in yearling heifers treated with ivermectin at 3, 8, and 13 weeks after turnout in their first grazing period. An “overprotection” of first-season grazing animals by too strong chemoprophylaxis may result in impaired immunity and therefore to production losses in the second grazing season. It has been shown that ivermectin (possibly other anthelmintics too) may have some direct or indirect immunosuppressive effects in sheep. Lymphocytes from ivermectin drenched lambs had decreased blastogenic activity compared with lymphocytes from control lambs.

As a consequence, prevention of nematode infections in first year grazing calves should be a careful balance between prevention of production loss and support of immunity buildup through mild infections sufficient to ensure protection against heavy infections during the second grazing season. Current control of GI nematodes in cattle is based on preventive methods (proper pasture management, strategic dosing schedules or intraruminal boluses) that provide satisfactory results in preventing production loss in first-season grazing cattle but have evolved towards abolishing parasite contact with these animals and so induction of a solid immunity. Less use of anthelmintics by reducing the number of treatments (targeted treatment) and, hence, prolonged drug-free periods may result in moderate pasture infection and build-up of protective immunity against GI nematodes in yearling heifers during the second grazing season.

### **Gastrointestinal Nematode Infections of Cattle, Sheep, and Goats, Timing of Strategic Drug Treatments, and Biological Control of Nematode Parasites in Livestock**

Ruminants (e.g., cattle, sheep, goats) generally become infected by free-living, infective third-stage larvae (L<sub>3</sub>) entering the host by oral ingestion (e.g., *Ostertagia* or (syn.) *Teladorsagia* spp. and other trichostrongyle nematodes) and/or the skin (e.g., → *Bunostomum* spp.). A variety of other species and their stages (adults, developing and/or inhibited larvae) may reside in the abomasum (e.g., *Haemonchus* spp., *Trichostrongylus* spp., *Ostertagia* spp.), or in the intestine (e.g., *Trichostrongylus* spp., *Cooperia* spp., → *Nematodirus* spp., *Bunostomum* spp. = → hookworms, → *Strongyloides papillosus* in the small intestine; *Oesophagostomum* spp., *Chabertia ovina* in the large intestine, colon) of sheep, goats, cattle, and a number of other ruminants throughout the world. Gastrointestinal nematodes may

disturb the normal functions of the gastrointestinal tract. Gut disorders lead to a disease syndrome involving diarrhea, weight loss, anemia (loss of blood and plasma proteins), mucoid hyperplasia, disorder of pepsinogen production, and other functional and intestinal disorders such as depressed levels of minerals and depressed activity of some other intestinal enzymes. The effects of nematode parasitism on production are well known and will remain one of the major factors limiting animal productivity on farms that rely on grazing animals on pasture. Economic loss may be due to the reduced skeletal growth (mineral deficiencies), to reduced weight gains (reduced incorporation of amino acids into muscle protein), or to suppressed wool production and reduced wool quality (e.g., break in wool growth due to reduced incorporation of amino acids into protein in hair follicles). Clinical parasitism markedly affects milk production in dairy cows, and subclinical parasitism appears to be of economic importance, as it will also reduce animal productivity.

Knowledge of the epizootiology of the parasites permits **strategic timing of drug treatments**. A number of strategies have been suggested to limit the development of drug-resistant nematodes but any strategy must fit the particular characteristics (parasite and host biology, epizootiology, etc.) of the target population within a certain region, and hence, strategy will vary considerably between different regions. Therefore, efficient control programs for grazing ruminants (cattle and sheep) are based on seasonal fluctuations of L<sub>3</sub> on pasture. In temperate countries (e.g., Europe) sufficient L<sub>3</sub> may overwinter on pasture to infect susceptible animals next spring. However, the numbers of larvae, which are acquired in spring are seldom sufficient to produce clinical signs. Non-ingested overwintered L<sub>3</sub> may die off in early summer, and L<sub>3</sub> that are found in midsummer stem primarily from hatching of eggs deposited the same year. Thus, young cattle should be treated with anthelmintics after they start spring grazing. Removal of cattle to “clean” pastures may allow treatment to be delayed until early summer, and in general there will be no requirement for further treatments during the grazing season. L<sub>3</sub> stages of *Ostertagia* spp. ingested during the fall are arrested at the L<sub>4</sub> stage, primarily in the abomasum. To prevent type II ostertagiasis, susceptible cattle should be treated with an effective drug against these stages at housing. Lack of treatment leads larvae to resume their development next spring, causing severe damage of abomasal mucosa.

During the periparturient period ewes are the major source of pasture contamination for **lamb** since their fecal egg output may rise enormously within this period. Ewes may be treated several weeks prior to lambing and up to 8 weeks thereafter. Lamb are particularly susceptible to nematode infections. At weaning, the pasture may be heavily contaminated

even if ewes were drenched before lambing. At this time lambs are usually drenched, followed by a move to a safe pasture. Although the treatment may be effective subsequent contamination with eggs from selected worms on the “clean” pasture cannot be prevented. Subsequent anthelmintic treatment will continue to select **resistant parasites**. However, lambs are marketed within a relatively short period, thus allowing sufficient control. Pasture should then be grazed by cattle or destocked for conservation. Consequently, resistant subpopulations of worms will die off. This practice may be continued each year without causing a major resistance problem. Ewes should not be grazed on pastures after lambs have been moved since resistant larval worms would be carried over, thus infecting lambs in the next year. In this case, resistance problems would inevitably increase, resulting in drug failure.

Attention should be given to movements of small ruminants from farm to farm and to imports of sheep and goats from countries known for multiple-resistant nematodes. Such animals should be examined for anthelmintic-resistant nematodes and/or treated with a fully effective drug before being introduced to a farm. Although such preventive measures (quarantining, monitoring, and treating all new replacement stocks) will help prevent the spread of anthelmintic drug resistance; they are critical and expensive management practices too. Commingling of sheep and goats should be avoided and where practical, alternate grazing of livestock of various species or immune status should be supported.

The aim of any worm control measure is to reduce parasites to levels that have little impact on animal production and to limit resistance development. A corollary strategic use of anthelmintics appears to be the use of only a single class of drugs within a treatment period or parasite generation. The rotation of anthelmintic classes with a different mode of action on a yearly basis may limit transfer of resistance genes tolerant to the previous class but sensitive to the alternative class early in the selection process. Then heterozygous helminths for the trait may reverse to susceptibility again. However, drug rotation is now in question as shown by calculations of statistical models. Calculations revealed that only the concurrent administration of still fully active compounds of different classes and mode of action at that time led to a considerably delayed development of resistant populations. Periodic assessment of resistance status should be performed at regular intervals and should be part of any nematode control strategy using antinematodal compounds. The strategies utilizing anthelmintics may vary according to whether meat, milk, or wool production is desired. Furthermore, the choice of a favorable moment for an integrated control measure, the prevailing weather conditions of the region (rainfall and low temperature favor the development of larvae), the anthelmintic

formulation, and the anthelmintic itself (narrow- or broad-spectrum activity), may all exert a great influence upon the result of the control measure. Suppressive drenching schemes may favor the development of drug-resistance, whereas targeted treatment of weak and highly parasitized animals as well as monitoring parasite population dynamics, and weather conditions may prevent or slow down the selection of drug-resistant nematode strains. Therefore, integrated control coordinating anthelmintic treatment and management strategies (e.g., rotational sheep and cattle grazing programs) is an effective tool in preventing development of drug-resistance in trichostrongyle nematodes of sheep.

There may be a number of **causes of treatment failure**, which are unrelated to drug resistance. Thus, in sheep flocks parasitic gastroenteritis may falsely be associated with anthelmintic resistance. However, inquiries often reveal management deficiencies such as flock has been returned to the same pasture immediately after deworming. Group dosing should be based on the heaviest animal and on label directions that should be followed explicitly concerning dose, route, target parasite, target host, and expiration date. Treatment failures very often result from misdiagnosis (e.g., disease syndromes due to mineral deficiency or plant → **toxicosis**, infections by other parasites), or from use of drugs lacking persistent activity; treated animals may then become rapidly reinfected as a result of local epizootiological conditions (repeated and massive exposure of animals to parasites) and/or poor management. Differences in drug pharmacokinetics may occur between individual animals and between species (e.g., in the order sheep, goat, red deer, higher dosage is needed) or with altered → **environmental conditions** (e.g., reduced drug availability in pastured calves in contrast to housed animals). Another cause of treatment failure may be the use of inappropriate drugs, so in situations or areas where inhibited larvae are the major cause of the disease and animals suffering from the disease are treated with a drug without claim for these larvae.

For the → **biological control** of nematode parasites of livestock hundreds of various antagonistic organisms have been described. Most of these nematode-destroying organisms are found within different groups of microorganisms as viruses, bacteria (*Bacillus* genera) and fungi, or in invertebrates as nematodes, turbellarians, Oligochaeta (earthworm), insects (dung beetles, springtails), or arthropods (tardigrades, → **mites**). In particular certain fungi have shown great potential as biological agent against nematodes pathogenic to livestock. Isolates of **nematode-destroying fungi** can survive ruminant gut passage, germinate, and spread in fresh dung and capture large numbers of infective larvae prior to their migration to pasture. However, infective larvae must be small enough to be trapped by the fungus. *Haemonchus*, *Ostertagia*, *Trichostrongylus*, and *Cooperia* are readily

trapped, others such as the slow-moving and not very active → *Dictyocaulus* and nematodes producing persistent egg stages (*Nematodirus*, → *Trichuris*, and *Ascaris*) are likely to require different antagonistic organisms to act as control agents. Strategic feeding of first-season calves with the fungus *Duddingtonia flagrans* through initial 3 months of the grazing season could prevent severe clinical trichostrongylosis in the late summer. Larval populations of *Ostertagia* and *Cooperia* were significantly reduced on the pasture grazed by the fungus-treated calves. However, lack of consistent success of relative expensive biological control (=BC) products (mass production of the antagonists is too time-consuming, shelf life should be long enough, BC product must be safe to users, consumers, and environment) has left the industry skeptical. Only few companies have shown some interest in developing BC products. Ideally, commercial BC products should be in price and effect similar to that of anthelmintics or consumers will have to accept a higher price of BC products, and hence, higher prices for agricultural products.

#### Incidence of Drug Tolerant Nematodes in the Field

Since the discovery of the 2-(4'-thiazolyl) benzimidazole, thiabendazole, in 1961, the search for new antinematodal compounds within various chemical groups (Tables 1, 3–6 and → Nematocidal Drugs, Man/ Table 1) has resulted from sequential improvement in drug properties (spectrum of activity, tolerability, convenience) but chiefly from the development of drug resistance in the field.

Serious problems with anthelmintic resistance may occur in those countries, which have regions where *H. contortus* is endemic and the cause of major losses in productivity. Although *Trichostrongylus* spp. and *Ostertagia* spp. are not as pathogenic to ruminants as *H. contortus* (known as stomach worm or wireworm) subclinical losses in production attributable to ineffective treatment of resistant *Trichostrongylus* spp. and *Ostertagia* spp. are likely to be substantial. Resistance problems are common in Australia, South Africa, the humid semi-tropical regions of South America and other parts of the world where some 300 million sheep are raised. In general, anthelmintic resistance is clearly linked to the frequency of anthelmintic treatment, to the relative importance of the nematode species (being of greatest importance in the regions endemically infected with *H. contortus*) and the prevailing type of grazing management (set-stocked on permanent pastures).

Resistance was first associated with the benzimidazoles and *H. contortus*, but **benzimidazole** resistance in *Ostertagia* spp. and *Trichostrongylus* spp. is also widespread and common. Also **levamisole** and **morantel** resistance, which at first was slow to be developed, and recently **macrocyclic lactone** resistance (ivermectins and milbemycins, the most widely

used anthelmintic compounds) are well documented in *H. contortus*, *Ostertagia* spp., and *Trichostrongylus* spp. Goat farmers are also confronted worldwide with problems of drug failure against *H. contortus*, *Ostertagia* spp., and *Trichostrongylus* spp., which show multiple resistance to benzimidazoles, levamisole/morantel, and macrocyclic lactones. As a rule nematodes of **small ruminants** (e.g., sheep, goats) develop anthelmintic resistance much quicker than those of large ruminants (e.g., cattle). There are reports on genuine drug resistance in nematode parasites of **cattle** (*O. ostertagi*, *Haemonchus* spp., *T. axei*, *C. oncophora*, *Dictyocaulus viviparus*, and *Cooperia* spp.) to levamisole/morantel or benzimidazoles and sporadically to ivermectin. Slower development of drug resistance in cattle may be due to the less frequent use of anthelmintics (e.g., targeted treatment of weak animals) and the role of larvae's refuge both minimizing the selection pressure on parasites. Thus, the majority of larval stages of nematodes (~95%) living on the pasture are not under selection pressure whereas the rest (about 5%) residing in the intestinal tract of the host are exposed to the drug. Another reason could be that differences in pharmacokinetics of benzimidazoles, as high and long-persisting plasma drug levels in small ruminants, which do not occur in cattle to that extent, may create conditions for a greater selection pressure on nematodes, and hence, more rapid development of resistance in sheep. Also cyathostominae (small strongyle parasites) of horses show throughout the world resistance to phenothiazine, the benzimidazoles to a high degree and to a lesser degree also to pyrantel embonate; however, such multiresistant strains can be controlled by ivermectin and moxidectin.

#### Assays for Detection of Resistance to Anthelmintics

Numerous assays (*in vitro* and *in vivo*) are available to monitor resistance. However, most results obtained with these assays are either poorly predictive and/or none of them is conducive to field use, i.e., suitable as "cow-side" test. Often, anthelmintic resistance is first suspected when a farmer reports a poor clinical response in his livestock to anthelmintic treatment. Since clinical signs associated with gastrointestinal parasites such as diarrhea, weakness, anemia, and even death are nonspecific, it is important to confirm that parasites are the cause. Information on the control program, the anthelmintic used, the frequency of treatment, group dosing management, stock introductions, grazing management, and nutrition is required prior to the use of an assay. There are 3 main groups of *in vitro* tests. In addition to physiological-based *in vitro* tests (egg hatch, larval development, larval paralysis, motility, and larval migration assays), biochemical- (colorimetric tests include tubulin-binding and tubulin-polymerization: benzimidazoles) and PCR-based *in vitro* assays (cloned  $\beta$ -tubulin probes with restriction mapping: benzimidazoles) or

isoenzyme analysis using isoelectric focussing (e.g., ivermectin) have been, or could be used. The latter tests (exception of simplified colorimetric assays applied for organophosphate and carbamate insecticides in aphids – harmful plant parasites that suck plant sap) are not applicable to field use, due to expense and technical requirements.

### Drug Formulations, Routes of Administration

The administration of drugs by injection, dermal application (pour-on, spot-on) or by the oral route (using granules, drenching, or paste and other formulations) may ensure that each individual receives an adequate dose. If a group of animals is to be treated, doses should be calculated for the heaviest animal in the group. This is important to prevent resistance problems. High doses should leave only few, if any, survivors and may retard genetic variation in parasite populations possessing alleles, which may confer resistance to anthelmintics.

A relative simple application technique, which is widely used in **small ruminants** (sheep and goats, also other animal species), is oral drenching of liquid drug formulations (e.g., oral drench of albendazole, oxfendazole, closantel, fenbendazole, febantel, and others).

There may also be the possibility of treating (under controlled conditions) sheep and other animals with in-feed pellets or powdered premix formulations each containing an anthelmintic in a fixed concentration (e.g., fenbendazole).

**Horses, dogs and cats** may be treated with pastes (e.g., fenbendazole, ivermectin, pyrantel, and others), or granules and powder (e.g., in-feed medication with fenbendazole) or oral drench or by nasogastric tube (e.g., ivermectin in horses). In **cattle** oral drenching is more difficult, and therefore other application techniques and formulations are used. Treatment can be carried out by intraruminal injection, by oral suspensions or by subcutaneous injection (levamisole, ivermectin, ivermectin/clorsulon=Ivomec F, and all other avermectin/milbemycin/nemadectin compounds). Pour-on/spot on formulations are widely used as dermal applications (e.g., levamisole, avermectins/milbemycins) in cattle. Minor changes on the composition of a formulation can have a major impact on the pharmacokinetic and efficacy profiles of anthelmintic compounds. When using pour-on, it should be considered that as function of the temperature gradient, there might be higher drug absorption during summer than winter, thus favoring the selection of resistant parasites in winter. Pour-on/spot-on formulations should be weatherproof (not affected by rain, user-friendly in extreme temperatures, cold and warm, consistent efficacy if exposed to the sun/light), effective in long-haired and short-haired animals, easy to apply, adhesive (no “runoff”, i.e., dose should stay on animal), odorless, nonflammable, and highly effective (should provide high levels of efficacy against endo- and ectoparasites). For user safety there should be no special

requirements for use of protective masks, gloves, and aprons.

The use of intraruminal anthelmintic devices as slow (sustained) release boluses (SR boluses) or pulse-release boluses should provide effective control for a period long enough to kill the majority of free-living stages being ingested during the grazing season. The drug release rate must be maintained at a constant level that is high enough to produce a high parasite kill. Furthermore, the release must decline rapidly to zero when the device becomes exhausted. If a significant proportion of worms can survive and reproduce in the presence of the controlled release device there may be the danger of the low drug concentrations allowing resistant worms to emerge. Intraruminal devices are administered via special balling guns in the reticulo-rumen. Slow release cattle dewormer contain anti-nematodal drugs of different classes, such as morantel tartrate (Paratect Flex-Bolus), fenbendazole (Panacur SR Bolus), oxfendazole (Systemex Intervalpulse Bolus), or ivermectin (Ivomec SR Bolus). (For efficacy and other characteristics of SR boluses cf. [Table 1](#)). Composition, and thus design for drug release (sustained or pulse) of intraruminal boluses may differ, but all devices are designed to release nematocidal concentrations of an anthelmintic in the reticulo-rumen of cattle and so to ensure sufficient control of ingested infective larvae of GI nematodes and those of the lungworm *Dictyocaulus viviparus* for prolonged periods. Some intraruminal devices may release nematocidal concentrations for up to 20 weeks (cf. above: effects of chemoprophylaxis with intraruminal boluses on the immune response to GI nematodes in first-season grazing calves).

Self-medication formulations of anthelmintics are available in blocks, licks, or as water additives. However, self-medication generally gives a variable intake of a drug (e.g., if there is depressed appetite in ill animals), and using this technique there is a danger that the low variable doses may favor the development of resistant parasites. For this reason self-medication is not so widely used in livestock, but it appears to be a suitable measure for controlling parasite populations in game-reserves and under modern systems of management. Water medication should only be used if there is a guarantee that nonmedicated water is beyond reach. In intensive pig and poultry systems, water or feed medication are the most practical means of administration. For example, prophylactic self-medication aims to control subclinical infections, thus enhancing productivity (→ [Coccidiocidal Drugs/Table 1](#)).

### Maximum Residue Limits (MRLs) and Withdrawal Time Before Slaughter

The establishment of withdrawal periods is part of the Marketing Authorization procedure of each individual

veterinary medicinal product and not simply substance-related. For food producing animals MRLs must be established in advance for all pharmacological active substances for the concerned animal species and relevant tissues (e.g., muscle, skin, liver, fat) or products (e.g., milk, eggs, and honey). Specific legislation regarding the establishment of MRLs is set up for example, by the US Food and Drug Administration (FDA), the European Medicines Agency (EMA) or the Australian Pesticides and Veterinary Medicines Authority (APVMA). Thus, the EMA Committee for Veterinary Medicinal Products (CVMP) and others developed guidelines concerning the establishment of MRLs and withdrawal times/periods (withholding periods) for edible tissues and other food animal products. However, the EMA does not have information on the withdrawal period established for a certain drug product authorized by the different Member States, and questions regarding withdrawal times should be addressed to the Competent Authority of the Member State concerned (in contrast to that, FDA and APVMA have, published in websites concerned). Table 2 shows some anthelmintic drug products with data on their withdrawal periods before slaughter (data derived from VETIDATA, cf. Table 1, footnote). However, drug products containing the same active substance can differ considerably in their established withdrawal periods. This is due to the public authority (agency), target animal (species), specific indication, drug formulation (dose form), its route of administration, and the dose recommended; all these conditions determine the pharmacokinetics of a drug product, i.e., the way a product becomes absorbed, distributed, localized in tissues, changed, and excreted over a period of time.

### Gastrointestinal Nematode Infections of Horses Epizootiology and Characteristics of Various Nematode Infections

The most pathogenic gastrointestinal nematodes of horses and therefore of economic importance are 2 species of large strongyles (→*Strongylus vulgaris* and *S. edentatus*) and the cyathostomes (small strongyles). In addition, the ascarids (→*Parascaris equorum*) can cause major problems in foals before they develop immunity.

Occasional parasites include, lungworms (→*Dictyocaulus amfieldi*), pinworms (*Oxyuris equi*), and →stomach worms (→*Habronema* spp., *Trichostrongylus axei*), →threadworms (*Strongyloides westeri*) and →tapeworms (*Anoplocephala* spp. cf. →Cestodocidal Drugs). There are also nematodes known to be nonpathogenic, e.g., *Probstmayria vivipara*, a minute nematode living in the colon. The females are →viviparous and produce enormous numbers of larvae without affecting the host. The larvae of several flies (*Gasterophilus* spp., hairy and reduced mouthparts) are parasites of equines and

are known as “bots”. They are attached to the stomach mucosa and other sites, remaining there for several months. *Gasterophilus* larvae may cause pathogenic effects like ulceration of the esophageal region of the stomach though no firm evidence exists that they produce clinical signs.

The life cycle of most GI nematodes is direct though their mode of transmission may differ. Thus, horses ingested infective larvae (L<sub>3</sub>) of small and large strongyles while grazing the pasture. Infections with *Strongyloides westeri* (threadworm residing in the small intestine of horses) may be lactogenic, and/or due to larvae penetrating the skin. Another possibility is that horses may become infected by ingestion of eggs containing infective L<sub>2</sub> or L<sub>3</sub> larvae (e.g., *Parascaris equorum* inhabiting the small intestine and *Oxyuris equi* inhabiting the colon and cecum). There are other nematodes belonging to the family of Spiruridae, which as a rule include an →intermediate host (arthropods). Infections with *Draschia megastoma* or *Habronema* spp. (residing in the stomach of horses or other sites) are acquired from ingesting the intermediate host, e.g., maggots of flies or by chance of adult flies. However, most often horses become infected when the adult fly feeds and infective larvae pass forwards into the →proboscis and are deposited on the lips, nostrils, and wound of horses producing cutaneous habronemiasis. In temperate countries strongyle egg output in horse feces usually shows seasonal variation with a gradual increase of egg output in spring followed by a maximum in summer and a remarkable fall in autumn.

The rise in egg counts in spring/summer usually produces peaks of infective larvae in summer/autumn on horse pastures in Europe and northern parts of the USA. Thus pasture in northern latitudes becomes heavily contaminated with strongyle larvae at this time. Many infective larvae of large and small strongyles will survive subzero temperatures in winter but are likely to be killed by alternate freezing and thawing (>7.5°C) before they reach the more resistant (sheathed) infective stage (L<sub>3</sub>). Numerous third larvae will additionally die off by early spring when rising temperatures lead to increased activity of the larvae thereby exhausting food reserves. On the other hand, high temperatures and desiccation in summer are lethal to both eggs and larvae, and harrowing the pasture supports this killing effect and thus decreases larval numbers. Seasonal variation is a characteristic of small strongyles (Cyathostominae) living in the cecum and colon of equids throughout the world. Infective larvae of large strongyles (e.g., *Strongylus edentatus*, *S. vulgaris*, *S. equinus*) have a long prepatent period and need more than 6 months to grow to maturity inside the host, which is mostly in the spring of the following year. Buildup of L<sub>3</sub> in pasture usually occurs in midsummer and is attributable to the hatching of eggs of large strongyles deposited in spring of

the same year. Because of their relatively short prepatent period of approximately 2 months, small strongyles (Cyathostominae), including various species of different families, may be capable of establishing a second generation of infective L<sub>3</sub> larvae in the same year.

The pathology and clinical signs caused by GI parasites are varied. Larvae of small strongyles (cyathostomes) enter the wall of the large intestine and migrate in the mucosa and submucosa (inhibited or →**arrested larvae**). They injure the gut wall thereby causing numerous →**nodules** containing hypobiotic or encysted larvae that may persist in the tissues for as long as 2.5 years after horses have been removed from infective larvae. This is of practical importance since they can complete their development and cause larval cyathostomiasis and contamination of pastures even after treatment with anthelmintics (including macrocyclic lactones) and movement to clean pastures. The young adult worms (L<sub>5</sub>) then return to the lumen of the colon and/or cecum and mature. Cyathostomes are often found in very large numbers in the colon and cecum, and heavy infections produce a disquamative catarrhal enteritis.

Infective larvae of large strongyles ingested by the host enter the wall of the intestine and migrate inside the blood vessels. Larvae of *S. vulgaris* migrate toward the cranial mesenteric artery causing arteritis and →**thrombosis** (with all pathologic consequences) pass back as L<sub>4</sub> about 6 weeks after infection via the arterial system to the submucosa of the cecum and colon where they mature to L<sub>5</sub> about 3 months after infection. They then enter the lumen to grow to maturity; egg production may occur 6–7 months after infection. Larvae of *S. edentatus* pass to the liver via the portal system and L<sub>4</sub> migrate in the liver for several weeks; they then pass via hepatic ligaments to reach the parietal peritoneum, thereby causing hemorrhagic nodules (up to several centimeters in diameter) in the right abdominal flank. Three to 5 months after infection they then migrate via the hepatorenal ligament to the submucosa of the cecum and colon causing additional hemorrhagic nodules. Some young adult worms reach the lumen and become mature. Eggs are produced about 10 months after infection. Larvae of *S. equinus* have a similar route compared to *S. edentatus*. Larvae pass through the peritoneal cavity to the liver where they wander for several weeks causing hepatopathy. About 3 months after infection larvae leave the liver via the hepatic ligaments and pass via the pancreas to the peritoneal cavity; they may reach the cecum and colon about 4 months after infection (route is unknown). The prepatent period is about 8–9 months. When clinical signs become apparent, therapeutic treatment with suitable drugs (e.g., macrocyclic lactones, cf. Table 3) should be directed chiefly against migrating larval stages of large strongyles although in heavy infections adult worms at aberrant sites should be considered.

A clinical sign produced by *S. westeri* may be a severe acute diarrhea in foals and in the donkey. In heavy infections migrating larvae of *P. equorum* produce coughing and circulating →**eosinophilia**. Adult worms of *P. equorum* may be the cause of severe catarrhal enteritis and so diarrhea, general malaise, and debility. Owing to migration of adult worms to aberrant sites, complications may occur in foals suffering from heavy *P. equorum* infections. Thus, adults can migrate into the bile duct or penetrate the bowel wall thereby causing peritonitis, or they can obstruct the lumen of intestine by “balling up” and thus produce colic-like pain.

### **Epizootiological-Based Control Programs Against Development of Anthelmintic Resistance**

Grazing horses are infected with nematodes to a greater or lesser degree throughout their lives. Cyathostomes are now the major threat to equine welfare. The main purpose of prevention is to reduce the intake of infective larvae or larvated (embryonated) eggs, which are responsible for severe pathological damage.

**Rotation** of horse and cattle grazing programs provide more effective parasite control than a continuous horse-grazing program. Horses should first graze pastures about 8 weeks after commencing spring grazing. Meanwhile, ruminants can safely graze pasture; this procedure should be used whenever parasite populations increase too much. In addition to these rotation-grazing programs, hygienic measures may effectively reduce the risk of parasite infection. Stables should be cleaned frequently, and only clean water and food should be supplied. Another control measure is the strategic use of anthelmintics with the aim of preventing clinical disease and building up protective immunity against GI nematodes. Anthelmintics used strategically mean that parasitic development, epizootiology, local management conditions, and status of drug resistance to cyathostomes must be considered in the integrated control program. This includes the timing of treatments to obtain the maximum benefit from treatments and management of pasture so that horses are grazing pastures with reduced larval contamination. The treatment frequency of horses should be reduced to a minimum. Foals need to be treated only when their fecal egg counts exceed 100 EPG (eggs per gram feces) because it is important that they are exposed to sufficient immune stimulation. An overprotective treatment schedule will select strongly for drug resistance and increase the damage to the environment with avermectins. However, if drug-free intervals are too long pasture contamination will not be controlled. Thus the simplest way is to determine “egg reappearance period” (i.e., ≤200 eggs/g feces, mixed infections with cyathostomes for >50% of a horse population). A more prolonged suppression of egg counts can generally be expected with avermectins/milbemycins

(e.g., ivermectin/moxidectin) and shorter egg reappearance periods in yearlings than in adult horses when using the same drug.

Highly susceptible **young horses** present a major problem in parasite control; they show only weak response to anthelmintic treatment under intensive grazing conditions even when treated with nonbenzimidazole anthelmintics. In spite of treatment, high fecal egg counts may be evident in weanlings and yearlings all the year round. This is at least partly due to lack of immunity in the yearlings to cyathostomes resulting in a greater accumulation of hypobiotic or encysted cyathostome larvae that may emerge and lay eggs after becoming adults soon after treatment. However, good parasite control in these animals will be obtained with simple pasture management strategies such as pasture sweeping or vacuuming twice a week, alternate grazing with ruminants, or prolonged destocking of the pasture, thereby reducing anthelmintic treatments to one treatment per year, still providing satisfactory worm and colic control.

To achieve lasting reduction of infective larvae on pasture in northern latitudes, anthelmintics should be administered at intervals that comply with epizootiological-based strategies (and according to fecal egg counts). Thus, few strategic treatments, i.e., at least during the first months (April to August) of the grazing season, will effectively reduce the spring/summer rise in fecal egg output in adult horses. The strategy of spring/summer treatment has been used successfully in the northern latitudes (Europe, Canada, and northern USA) for more than 15 years with adult horses under intensive grazing conditions. Using this strategic regimen, autumn and winter treatments were found to be unnecessary against nematodes.

Strategic anthelmintic treatment in autumn is directed against inhibited larval stages. However, it is doubtful whether benzimidazoles are capable of affecting inhibited or arrested larval stages of →*Cyathostomum* spp., although they may be effective against lumen-dwelling cyathostome adults and larvae.

**Anthelmintic resistance** in small strongyles is now widespread and common in horses. This phenomenon generally reveals a close association between the prevalence of cyathostome resistance and the frequent use of benzimidazoles. If these drugs had been used on epizootiology-based control programs (minimum number of treatments, epizootiological principles of nematode control, avoidance of introduction of resistant worms in "clean" environment) there would be fewer problems with anthelmintic (benzimidazole) resistance. Besides epizootiological-based control programs, there may be other possibilities of retarding or even avoiding the development of anthelmintic resistance: (1) For treatment, only effective anthelmintics at their full-recommended dose should be used. (2) One should rotate anthelmintic classes on an annual basis. However, use of drug mixture,

that is the concurrent administration of 2 chemically different anthelmintics (e.g., combinations: benzimidazoles plus organophosphates), rather than rotating drugs of different anthelmintic classes, will support the selection of BZ-resistant strains of cyathostomes.

Horses cannot be completely dewormed before they are placed in a clean environment. None of the available anthelmintics is capable of removing satisfactory hypobiotic or encysted cyathostomes. Nevertheless, to avoid introduction of resistant worms, new arrivals or returning mares should be treated with a nonbenzimidazole anthelmintic and kept off pasture for at least 2 days. This policy (if possible) would reduce the risk of contaminating pastures with the progeny of newly introduced resistant worms from another farm.

### Drugs in Current Use Against Nematode Infections in Horses

The spectrum of anthelmintic activity of some old-timers such as phenothiazine, piperazine, and organophosphates (e.g., trichlorfon) is rather narrow and their innate effect on target parasites may be variable though organophosphates are highly effective against bots (larvae of *Gasterophilus*).

Most **benzimidazoles (BZs)** are highly active against drug-susceptible adults and lumen-dwelling larvae of large and small strongyles of horses. Their current use is, however, limited worldwide by anthelmintic resistance to this chemical class. At their recommended dose, BZs are not sufficiently effective against migratory stages of large strongyles. Because of the large safety margin, administration of a single high dose (should be significantly higher than the recommended dose), or administration of several low doses (as total of the high dose) within a day or for consecutive days can raise efficacy in the majority of BZs. The efficacy of BZs against *Trichostrongylus axei* (residing in the stomach), *P. equorum*, and *S. westeri* is varied. Common tolerability of BZs is basically good, with the exception of albendazole, which may be toxic if high doses are given repeatedly.

Small strongyles first developed drug resistance against phenothiazine and later to thiabendazole, the first BZ on the market. Today, there is side-resistance among BZs although **oxibendazole (OBZ)** may still be active against strongyles resistant to other BZs. BZ-resistant strongyles may be affected by a variety of older drugs belonging to different chemical classes, such as levamisole, and pyrantel pamoate (PP). Anthelmintics still considered effective against small strongyles (cyathostomes) include especially ivermectin and moxidectin, and with certain reservations OBZ and PP. Resistance to OBZ has developed in situations where the frequency of use has been high. There may be also a dual resistance of parasites to PP and OBZ.



Nowadays, benzimidazoles are being increasingly replaced by endectocide **macrocyclic lactones** (avermectins and milbemycins) exhibiting broad-spectrum anthelmintic activity against nematodes, including arthropods like bots. For the current use in equines against GI nematodes and arthropods (e.g., bots) **ivermectin**, **moxidectin**, and an **abamectin/praziquantel** combination exhibiting additional efficacy against equine tapeworms (*Anoplocephala* spp.) are available.

Ivermectin and moxidectin show high activity against the lumen-dwelling cyathostome adults and larvae whereas their activity against hypobiotic or encysted larvae appears to be basically poor in naturally infected ponies. However, differences between these observations and others related to experimentally infected foals were such that a therapeutic dose of ivermectin proved to be active (76.8%) against developing mucosal stages (inhibited or arrested in development 35 days postdose). Hypobiotic or encysted cyathostome larvae were not enumerated in this study. Moxidectin demonstrated a trend toward greater efficacy than ivermectin (at recommended dose) against encysted cyathostome larvae. It may be less effective than ivermectin against bots (*Gasterophilus* spp.) and is equally ineffective as ivermectin against the ileocecal tapeworm *Anoplocephala perfoliata*. Ivermectin shows activity against immature and adult stages of the horse →lungworm *Dictyocaulus arnfieldi* and moxidectin does not (cf. Table 3). Besides the combination abamectin/praziquantel, additional drug combinations are on the market, like **ivermectin/praziquantel** and others.

### Biological Control

In future, the use of nematopathogenic or nematode-destroying microfungi as biological control agents against free-living stages of horse strongyles might be an alternative or an adjunct to existing control methods. The potential of the nematode-destroying fungus *Duddingtonia flagrans* and other fungi (e.g., *Arthrobotrys oligospora*, and *Dactylella bembicodes*) to reduce the free-living populations of parasitic nematodes of ruminants, horses, and pigs has been demonstrated. Among the nematopathogenic fungi *D. flagrans* belongs to the group of nematode-trapping fungi producing trapping organs such as constricting (active) or nonconstricting (passive) rings, sticky hyphae, sticky knobs, sticky branches, or sticky networks. Anchoring of the nematode to the traps is followed by hyphal penetration of the nematode →cuticle and once inside trophic hyphae grow out and fill the body of the nematode and digest it. There are also so-called endopathogenic fungi having no extensive hyphal development outside the host's body except fertile hyphae (conidiospores) that release the →spores thereby infecting nematodes by spores. Numerous other antagonistic organisms of nematodes such as earthworm

(consume nematodes present in soil and feces) or dung beetles (reduce infective larvae of strongyles chiefly by indirect effects such as eroding cow pads, burying fresh dung in the soil, and partially dispersing the remainder).

### Gastrointestinal Nematode Infections of Swine Economic Importance and Disease Patterns of Nematode Infections in Swine

Clinical parasitism markedly affects meat production and meat quality in swine, and also subclinical parasitism appears to be of economic importance, as it will reduce animal productivity as well. Condemnation of livers, kidneys, and the necessary trimming of loins and other valuable parts of carcasses have resulted in important economic losses for the swine industry. The importance of the meat production in the swine industry is reflected in some figures: From 1977 to 1998, world pig meat production had nearly doubled in 20 years (1977: 42.9 million tons of pork, 1998: 83.6 million tons of pork, data from FAO review, RDA Cameron, 2000) and since then pig meat production increased further till today, particularly in countries of Asia, e.g., in China. Infections of pigs with nematodes (roundworms) may cause reductions in growth rate, efficiency of feed utilization, and thus marked losses in pig meat production throughout the modern pig industry.

There are several nematode infections, which may be economically important. Nodular worms *Oesophagostomum* spp., which reside in the large intestine, the **red stomach worm**, →*Hyostrongylus rubidus*, which invades gastric mucosa (gastric glands) and sucks blood often occur in breeding animals. *H. rubidus* can produce mild fever, loss of appetite, diarrhea, weakness, and reduced weight gain. Weaners and fattening pigs are often infected with *Ascaris suum* (**eelworm**), which inhabits the small intestine, and *Trichuris suis*, which lives in the large intestine.

The intestinal **threadworm**, →*Strongyloides ransomi*, in the small intestine may produce severe clinical signs in suckling piglets. Initial →anorexia, then diarrhea, which may become continuous and hemorrhagic characterize strongyloidiasis; pulmonary disorders may also be seen. Since infection with *S. ransomi* is acquired from both milk-borne infective larvae (L<sub>3</sub>) entering the host through the mouth (e.g., per os infection with the colostrum) and larvae entering the host through the skin, lesions of the skin, such as →erythema and pustular reactions, may also be seen. In heavy infections mortality can reach 50%. Death is mainly caused by a protein-losing enteropathy.

→**Acanthocephala** (*Macracanthorhynchus hirudinaceus*) occur in the small intestine of the domestic pig and wild boars and are present worldwide. Dung beetles (grubs or adult beetles) of the family Scarabaeidae act as intermediate hosts. Parasites penetrate

with their probosces into the intestinal wall, thereby producing inflammation and a →**granuloma** at the site of attachment; perforation of the intestine may cause peritonitis and death. Severe infections lead to reduction in growth or emaciation, while mild infections are not very harmful.

**Kidney worms** (→*Stephanurus dentatus*), occur in the peritoneal fat, the pelvis of kidneys, and in the walls of ureters (aberrant sites are liver or other abdominal organs, sometimes thoracic organs, and spinal canal; for treatment cf. **Table 4**, doramectin). Infection of pigs with infective larvae occurs per os (earthworms, *Eisenia foetida*, may serve as transport hosts) or through the skin. The kidney worm is widely distributed in tropical and subtropical areas. The general clinical signs are temporary subcutaneous nodules (early stage of infection), depressed growth rate, loss of appetite, and later emaciation; also stiffness of the leg and posterior paralysis may occur.

**Ascariasis** is extremely common in swine, especially in young animals. Infection usually takes place through ingestion of larvated *A. suum* eggs with food or water or from the soiled skin of the sow in the case of suckling pigs. Eggs hatch in the intestine and the larvae (L2/L3) pass through the wall of the gut into the peritoneal cavity and then to the liver where they cause tissue damage and hemorrhage (so-called “milk spots”). Larvae then migrate to the lungs, and break out of the alveolar capillary into the alveoli and bronchioles, causing edema and cellular reactions (infiltration of eosinophils). In heavy infections death from severe lung damage may occur, or piglets may remain stunted for a long period. Larvae then migrate from the trachea to the pharynx and are swallowed; the L<sub>3</sub> larvae then may arrive at the intestine 1-week after infection.

→*Globocephalus* spp. (e.g., the **hookworm** *G. urosubulatus*) occurring in the small intestine of wild boars and occasionally in the domestic pig may cause anemia in heavy infection. The life cycle is probably direct. The infection may be due to oral ingestion of L<sub>3</sub> or to infective larvae penetrating the skin.

→*Trichinella spiralis*, the cause of →**trichinosis** in almost every country, may lead to serious clinical signs produced by newborn larvae being distributed all over the body via the blood circulation. They grow further, particularly in the voluntary muscles of the tongue, larynx, eye, diaphragm, and the intercostal and masticatory muscles. The larvae then enter striated muscle fibers and become encysted. The capsule is formed from the muscle fiber and the structure of muscle cell is modified (enlargement of nuclei, increase in the number of mitochondria). The so-called “nurse cell” probably plays a role in larval nutrition. Although calcification of the capsule begins after 6–9 months, larvae may live in them and remain infective for several years. Mainly the pig disseminates human trichinosis (→**Nematocidal Drugs, Man/Table 1**).

**Nodular worms** (*Oesophagostomum* spp.) occur in the large intestine of pigs (and peccaries piglike mammals of Central and South America) throughout the world and have a high incidence of 50–90% in sows. →**Nodule** formation caused by larval stages (particular *O. dentatum*) is responsible for various clinical signs, such as anorexia and bloodstained feces. In severe infection enteritis may cause death. After ingestion, infective larvae exsheath in the small intestine, causing small nodules (4–5 mm in diameter). The larvae usually reenter the lumen of the large intestine a week after infection, having molted to L<sub>4</sub> larvae. However, some of the L<sub>4</sub> larvae may remain in the nodules for several weeks. →**Patency** is normally reached at about 7 weeks after infection.

The →**whipworm** *Trichuris suis* (morphologically identical to →*T. trichiura* of man, →**Nematocidal Drugs, Man/Table 1**) is cosmopolitan in distribution. Pigs become infected by ingestion of larvated eggs, which may reach the infective stage after about 3 weeks under favorable conditions (correct soil moisture and temperature). The eggs may remain viable for several years. After being ingested the larvae hatch in the small intestine and penetrate the small intestine for several days before moving to the cecum where they grow to adults. Infections with *T. suis* occur chiefly in 2- to 4-month-old fattening pigs, and are less common in piglets, sows, and boars. Pathogenicity may be due to the fact that *Trichuris* spp. are blood feeders. Adult worms tunneling into the mucosa cause damage. The mucosa becomes edematous and necrotic, thus resulting in catarrhal inflammation of the colon and cecum. In heavy infections, diphtheritic inflammation may lead to watery and bloody diarrhea. Pigs kept outside or under extensive conditions may occasionally suffer from clinical trichuriasis.

#### **Control Measures and Drugs in Current Use Against Nematode Infections in Swine (for drugs cf. **Table 4**)**

Since production efficiency is of critical importance in the pig industry, precautionary measures such as the “all in – all out system”, and **strategic herd deworming** must be carried out at regular intervals. Significant worm burdens may be expected when fecal material accumulates and remains accessible to pigs, such as in housings or on pasture in deep litter. Drinking and feeding installations must be kept as clean as possible. Individual treatment has little or no effect on the prevalence of parasites or the degree of infection on the entire stock and most herds are continuously parasitized by several worm species. The sow is thus the most important source of infection for piglets. Reinfection of the entire stock can be markedly reduced by a tactical deworming schedule that should vary with different conditions and the type of farm (e.g., fattening or breeding farm, mixed farm, open or closed,

all in – all out, the type of run, and hygienic conditions). This may be achieved by regularly deworming the whole herd simultaneously in a several-day treatment program. New production of large numbers of eggs can be controlled if all animals are treated again as soon as the larvae have grown to maturity. The prepatent period of the worm species should therefore determine the frequency of treatment, i.e., every 2 months in the case of *A. suum*, *Oesophagostomum* spp., and *T. suis*, every 3–4 weeks for *H. rubidus*, and every 8–10 days for *S. ransomi*.

Treatment of **trichinosis** during the muscle phase of infection is unsatisfactory although several **benzimidazoles** show good activity against early stages of *T. spiralis*. **Flubendazole** may eliminate intestinal and migratory stages in experimental infections in pigs when given in-feed for longer periods. As far as man is concerned, prophylaxis should aim at the thorough cooking of all pork products and the meat of wild animals. The elimination of uncooked garbage such as raw or partly cooked pork and sausages in the feed may prevent infection in domestic pigs.

The old-timer **piperazine** has been used extensively in swine against adult ascarids and nodular worms. Among the organophosphorus compounds, **dichlorvos** has broad spectrum of anthelmintic activity, though its effect against migrating and mucosal larval forms of GI nematodes is little. There is no ovicidal effect but a marked action on a portion of freshly hatched and free-living *Oesophagostomum* spp. larvae.

**Pyrantel** tartrate in-feed is chiefly used for its prophylactic activity against migrating stages of *A. suum*, and *Oesophagostomum* spp. and, hence, to prevent establishment of patent infections of these parasites. Most widely used method for deworming pigs with **levamisole** is administering the drug via drinking water or feed; injectable formulations are also available, which may show higher activity against whipworms (*Trichuris suis*) than oral regimens. The drug is highly active against the majority of other important GI nematodes, including lungworms (Table 6) and kidney worms (*Stephanurus dentatus*) residing in the urinary tract.

**Benzimidazoles** (BZs), such as thiabendazole, flubendazole, fenbendazole, (and febantel, prodrug of fenbendazole) have a broad spectrum of activity against nematodes of swine and also poultry. BZs, in general, exhibit higher activity at low-level medication for several days than at single dosing. There may be several medicated articles (powders, granules) to make medicated feed for weaners/fatteners or sows for “long-term” treatment, in that the therapeutic dose (mg/kg b.w.) is distributed over 5–15 days. Another dosage regimen may be to divide the therapeutic dose in 2 and to administer this dose on 3 or 4 consecutive days thereby enhancing the absorption of the drug from

the intestinal tract and, hence, increase its anthelmintic efficacy. Most BZs are highly active against adult *A. suum*, *H. rubidus* and *Oesophagostomum* spp. The “newer” ones show action against *T. suis*, kidney worms, and lungworms and a few are effective against immature stages of various GI nematodes. BZs appear to be ineffective against spirurid worms (*Macracanthorhynchus hirudinaceus*) occurring in the small intestine of the domestic pig and wild boars (none of BZs claim efficacy for this parasite).

A few avermectins such as **ivermectin** and recently **doramectin** are available as broad-spectrum anthelmintics for use in pigs. The 2 drugs provide high reduction rates in immature and adult stages of common nematodes, including parasitic arthropods (→lice, and mange mite); their action on whipworms (*Trichuris suis*) seems to be variable. While several compounds are effective in treating patent infections of the threadworm *Strongyloides ransomi*, ivermectin appears to be so far the only drug, which exhibits action on somatic third-stages of this parasite in the sow. Thus a premix of ivermectin given to pregnant gilts (daily dose of 0.1 mg/kg per day for 7 consecutive days) prevented shedding of larvae in sow milk, egg output in feces, and the establishment of *Strongyloides ransomi* in piglets.

However, as in ruminants and horses, neither the benzimidazoles, including levamisole (or pyrantel) nor the avermectins (ivermectin and doramectin), are uniformly effective against adult and larval stages of all economically important nematodes in pigs (Table 4). In particular, there is a lack of information on the comparative values of broad-spectrum anthelmintics against the larval and immature fifth-stages of the GI parasites of swine. In general, these compounds cause marked reduction in both larval and adult stages of GI nematodes and lungworms (Table 6).

### Nematode Infections of Dogs and Cats

The veterinary significance of nematode infections of dogs and cats is related to the large number of domestic pet owners in Western industrial countries. In the USA, for example, 63% of households own a pet, which equates to 69.1 million homes, and 45% of households own more than one pet (bird, cat, dog, freshwater or saltwater fish, reptile, small animal). In 2006 the total number of cats and dogs came to about 90.5 millions and 73.9 millions, respectively. Total expenditures of nearly US \$38.5 billion was spent on food, Vet-care, supplies/OTC medicine, live animal purchases, and pet services as grooming and boarding in 2006 demonstrate the economic importance of the US pet industry (web site American Pet Products Manufacturers Association, APPMA).

Puppies and kittens are often infected with gastrointestinal nematodes that may cause zoonotic infections such as visceral or →cutaneous larva migrans in

humans. A special hazard may arise for children who have close contact with young puppies. It is the young puppy preferentially infected with the ascarid *Toxocara canis* causing **visceral →larva migrans** characterized by severe pathogenic effects causing persistent cough, intermittent fever, loss of weight, and eye lesions (for more detail cf. →Nematocidal Drugs, Man especially →Nematocidal Drugs, Man/Table 1). The main types of gut nematodes found in carnivores live in the small intestine. These may be **ascarids** such as *Toxocara canis* of the dog and fox; *Toxocara cati* of the cat and wild Felidae, *Toxascaris leonina* of the dog, cat, fox, and wild Felidae and Canidae, and bloodsucking **hookworms**, which can produce severe anemia in pups and kittens. Common hookworms in the tropics and warm temperate areas are *Ancylostoma caninum* of the dog, fox, wolf, and other wild Canidae, *A. tubaeforme*, the common hookworm of the cat, and *A. braziliense* of the dog, cat, fox, and other wild Canidae. *A. braziliense* can be responsible for **cutaneous larva migrans** or so-called →**creeping eruption**, an intensive itching dermatitis in humans (→Nematocidal Drugs, Man, especially →Nematocidal Drugs, Man/Table 1). Not so common is *A. ceylanicum* of the dog, cat, and wild Felidae occurring in Malaysia and other parts of Asia. *Uncinaria stenocephala* is a hookworm of dogs, cats, and foxes occurring in temperate climates, e.g., the USA or Europe. Canine and feline nematodes living in the large intestine (cecum and colon) are **whipworms** such as *Trichuris vulpis* of the dog and fox; *T. serrata* and *T. campanula* of the cat in South America, Cuba, and the USA. Adult *Trichuris* spp. may cause mucosal damage (→**necrosis**, hemorrhage) by tunneling into the mucosa of the large intestine. *T. vulpis* is a blood feeder and its mouth stylet is used to enter vessels or to injure tissues, giving rise to bleeding; the blood pools thus created are then ingested by the adults. So-called **heartworms** (*Dirofilaria immitis*) belonging to the superfamily Filarioidea and living in the venous circulation of carnivores are responsible for the debilitating heartworm disease, especially of dogs, which may be enzootic in regions with a tropical or subtropical climate.

### Prevention and Treatment of Canine and Feline Nematode Infections

Since almost all gastrointestinal nematodes are harmful to dogs and cats and some of them are a hazard to human health (cf. larva migrans in →Nematocidal Drugs, Man or cf. →echinococcosis in →Cestodocidal Drugs) effective control measures should be performed to protect cats, dogs, and fur-bearing animals from these parasites. Transmission of nematodes can be reduced by hygienic measures in kennels and catteries; these include regular cleaning of baskets and drinking bowls, and destroying or burning the feces and other waste.

Since rodents and birds may serve as paratenic hosts in the life cycle of ascarids, extermination of rodents and attention to potential infected viscera of birds (e.g., of the domestic fowl) must be included in control programs. (→Paratenic host may ingest infective eggs and 2nd-stage larvae travel to their tissues where they remain until eaten by a carnivore). With *Toxascaris leonina* periodic deworming of all animals can eliminate this parasite; this parasite lacks a migratory phase in the host and thus infection of uterus by somatic 2nd-stage larvae and mammae by 3rd-stage larvae. With *T. canis*, and *T. cati* controlling parasite stages is more difficult because of the somatic type of 2nd-larva migration including the liver, lungs, heart, brain, kidneys, and skeletal muscle which is responsible for prenatal and transmammary infection of fetuses or suckling puppies and kittens. Transmammary infection also occurs with *T. cati* but prenatal infection of fetuses is lacking. Long-persisting 2nd-stage larvae of *T. canis* found in various tissues of the body of the bitch and which have undergone no further development are mobilized at each pregnancy, thus transmitting infections to several litters. Puppies should therefore be treated within 2 weeks of birth.

Regular treatment of bitches with effective anthelmintics may prevent prenatal infections (cf. fenbendazole, Table 5). However, the use of anthelmintics for controlling nematode infections in pet animals may be limited because of the lack of suitable formulations and well-tolerated (safe) drugs for young pups and kittens, and for enfeebled and pregnant animals. Most anthelmintics have little or no activity against migratory stages of the ascarids. "Old-timers", in particular such as plant extracts (→Cestodocidal Drugs), dithiazanine, toluene and dichlorophen combinations, n-butyl chloride, disophenol, or piperazine have a narrow spectrum of activity either against adult hookworm or ascarids only, and their toxicity is rather high (Table 5). Some of these older drugs are still used in the USA and elsewhere. The use of anthelmintics with a narrow spectrum of activity may be indicated if a specific infection is diagnosed regularly. Because labor costs are high and correct diagnosis is too time consuming in certain situations it makes sense to deworm dogs and cats with current products showing activity against all common intestinal nematodes and →cestodes. Thus current routine dewormers for dogs and cats are highly effective in eliminating intestinal stages of ascarids (especially *Toxocara canis*), common hookworms, whipworms, and tapeworms (→*Taenia* spp. →*Dipylidium caninum* and →*Echinococcus* spp., for general consideration of tapeworms cf. →Cestodocidal Drugs). Products, which meet all these requirements, are principally drug combinations consisting of benzimidazole carbamates or probenzimidazoles or emodepside and praziquantel (Table 5). These products are

marketed worldwide and most of them being sold in the USA and Europe where many households own pets.

The susceptibility of nematode populations to anthelmintics should be checked regularly on the grounds of the results of parasitological investigations of feces samples. These data may provide the basic information required for preventing the occurrence of nematode resistance and incorporating effective drugs into control programs.

### Dirofilariasis of Dogs, Its Epizootiology and Control

Heartworm disease of the dog caused by *Dirofilaria immitis* (family Onchocercidae) is primarily a problem of warm countries where the mosquito intermediate host abounds (>60 mosquito species belonging to different genera, such as →*Culex* spp., →*Aedes* spp., →*Anopheles* spp., and *Psorophora* spp. are susceptible to *D. immitis*). *D. immitis* appears not to be very host-specific. Female →mosquitoes ingest microfilariae during feeding, and development in the mosquito to infective 3rd-stage larvae takes about 2 weeks. Final host is infected by 3rd-stage larvae when mosquito takes another blood meal. Final hosts are the dog, cat, coyote, dingo, wolf, fox, wild Felidae, sea lions, monkeys, and occasionally humans (→Nematocidal Drugs, Man, especially →Nematocidal Drugs, Man/ Table 1); the domestic cat is not as susceptible to *D. immitis* as the dog. About 6 months following infection of the host, larvae migrate to the subcutaneous or subserosal tissues and undergo 2 molts. Only after the final →molt do the young worms pass to the heart via the venous circulation. →Ovoviviparous female worms release microfilariae (MF) directly into the bloodstream, and patent infection may be evident by microfilaremia between 6–9 months after infection. Besides the daily periodicity of MF in the bloodstream (highest concentrations from late afternoon to late evening), there is a seasonal periodicity with the highest microfilaremia in spring and summer according to behavior of female bloodsucking mosquitoes. Circulating MF in the host may survive up to 2 years and transplacental transmission may occur with MF being found in various tissues of fetuses. The cardiovascular dirofilariasis is a **systemic disease** involving the lungs, heart, liver, and kidneys (→immune complex →glomerulonephritis). The adult filariae reside in the branches of lung artery. In heavy infections they can migrate into the right heart chamber and Vena cava causing severe pathogenic effects, e.g., circular distress (see also Table 5). Large amounts of dying or dead *D. immitis* adult worms (20–30 cm long) as a result of chemotherapy with an adulticidal drug may cause adverse reactions, and pulmonary embolism, which can be fatal in cases of very advanced disease (Table 5). Common clinical signs are cough, blood in

the saliva, dyspnea, and pulmonary hypertension, which may be compensated by right ventricular hypertrophy. In advanced cases permanent pulmonary hypertension may lead to dilatation of the right heart and to congestive heart failure, followed by ultimately chronic passive congestion (abnormal accumulation of blood or fluid) manifested by liver enlargement (hepatomegaly), ascites and edema accompanying symptoms of ascites. At this stage the dog is weak and listless. The high prevalence of heartworm disease may be due to several vector factors and host vectors. They include ubiquity of the mosquito intermediate hosts (makes control of vectors difficult), their high capacity for rapid reproduction, the short development period from MF to infective 3rd-stage larvae in the mosquito, the lack of protective immunity of hosts against *Dirofilaria immitis*, and the long patency period of the disease of up to 6 years during which time circulating MF are present. For this reason, **heartworm** control is based almost entirely on prophylactic medication of dogs or other animals under risk (Table 5).

### Chemotherapy and Chemoprophylaxis of Dirofilariasis of Dogs (cf. Table 5)

Surgical removal of heartworms is usually accompanied by mortality rates of about 10%. Only if treatment is contraindicated in some severe cases, should heartworms be removed surgically. In mild and moderate heartworm infections, chemotherapy with an arsenical followed by a microfilaricide appears to be a reliable and relative safe method and is recommended with the aim of reducing adult filariae and microfilariae (MF) in time. Prior to start of specific treatment animals should be examined physically, including assessment of heart, lung, liver, and kidney function. Pretreatment is indicated in case of cardiac insufficiency. The usual way to treat infected dogs is to administer an **adulticidal drug** to remove the adult worms. The treatment is often associated with **toxic reactions** resulting from dying worms and thereby resultant embolism; therefore treatment should be performed with extreme care, and the activity of dogs must be restricted for 3–7 weeks. About 6–7 weeks later a further treatment with a **microfilaricide** is given to remove the circulating MF from the bloodstream. For this purpose ivermectin or another macrocyclic lactone may be used, which have actually substituted older drugs such as dithiazanine, diethylcarbamazine (DEC) or levamisole, which must be given over several days. With all these drugs, especially with the older ones, there is the risk of adverse reactions to dying MF. Heartworm-free animals are then placed on a prevention program with long-acting macrocyclic lactones, and this is considered under control.

## Lungworm Infections of Domestic Animals

The most pathogenic nematodes in the superfamily Trichostrongyloidea belong to the genus *Dictyocaulus* (family: Dictyocaulidae). Members of this genus do not require an intermediate host and thus are “geohelminths” with a direct life cycle. In contrast to *Dictyocaulus*, nematodes of the superfamily Metastrongyloidea (e.g., families Metastrongylidae and Protostrongylidae) require intermediate hosts to convey infective larvae to the definite host and thus are “biohelminths”. Members of both superfamilies are parasites of the respiratory passages and/or blood vessels of the lungs. For example, →*Angiostrongylus* spp. mostly occur in the pulmonary artery or cranial mesenteric artery of various species of mammals and occasionally of man (→Nematocidal Drugs, Man/ Table 1). Consequently, lungworms causing parasitic bronchitis especially in young livestock necessitate varying control strategies because of their different life cycles, and hence, epizootiology (for other extra-intestinal nematode infections of livestock and wild animals cf. Tables 1, 3–6).

## Dictyocaulus Infections

There are 3 genera of importance, which may cause parasitic bronchitis in young animals and economic losses during the first grazing season. *Dictyocaulus filaria* occurs in the bronchi of small ruminants (sheep, goats, and some wild ruminants) and has a worldwide distribution. Cosmopolitan *D. viviparus* occurs in the bronchi of cattle, buffalo, camel, deer and reindeer and is highly pathogenic to nonimmune calves. *D. arnfieldi* occurs in the bronchi of the horse, donkey, and other equines and is cosmopolitan in distribution; the donkey appears to be the natural host of the parasite.

In order to survive for longer periods or to overwinter larvae of *Dictyocaulus* spp. need sufficiently high rainfall to prevent them from desiccation. Weather conditions favoring the survival of larvae on pasture are found particularly in temperate areas. L<sub>3</sub> larvae deposited in fall and winter may overwinter on pasture to infect susceptible animals grazing the following spring. Other sources of pasture contamination leading to infection in the following spring may be due to small numbers of lungworm stages residing in the host for longer periods. Thus adult *Dictyocaulus* spp. may survive in the host’s lung for several months, and/or inhibited or arrested late L<sub>4</sub> and early L<sub>5</sub> larvae (e.g., of *D. viviparus*) in the local mesenteric lymph nodes or air passages will resume their development in spring. Wind-borne, field-to-field transmission of *D. viviparus* larvae by sporangia of the fungus *Pilobolus* may also play a role in contaminating pastures. The fungus is very common in cattle feces and larvae of

*D. viviparus* may accumulate on the surface of the sporangium. When the sporangium explodes it may catapult the larvae several meters (up to 3 m) through the air, moving them from the fecal pats onto the adjacent herbage. In addition, infections with gastrointestinal nematodes leading to loose feces or diarrhoea may also favor the translation of larvae onto the herbage.

**Parasitic bronchitis** due to *D. viviparus* and *D. filaria* is seen primarily in young calves or spring-born lambs. The outbreaks of disease occur mostly from early summer (July) until early fall (September), or late fall (November) in the northern hemisphere, though the heaviest infections in lambs usually occur in the fall because of the increase of larvae on the pasture at that time. Older animals have usually developed strong immunity to *Dictyocaulus* spp. infections by lasting reinfections. However, adult animals may be susceptible to heavy challenge if the rate of acquisition of infection is not sufficient or immunosuppressive agents, other pathogens (diseases), or emaciation hamper immunity build-up.

*D. arnfieldi* infections in horses may produce coughing, increased respiratory rate, and nasal discharge prior to patent infection. Horses are thought to become infected by contact with donkeys though infections in horses infrequently reach patency and thus diagnosis by fecal examination cannot be made.

In ruminants and horses strategic control measures and biological control of nematode are needed. Thus, rotating sheep and cattle grazing programs as well as ruminants’ and horses’ grazing programs have been shown to reduce markedly the number of infective larvae on pasture. Annual **vaccination** of all calves before commencing spring grazing in April or May (northern latitudes) with attenuated live larval vaccine that contains at least 1,000 viable *Dictyocaulus viviparus* L<sub>3</sub> Stage irradiated larvae (Bovilis Dictol; Vetrinaria AG, Switzerland, Bovilis Huskvac, Intervet UK, Ireland) may be highly effective in preventing clinical disease, though small numbers of lungworms may develop in the bronchioles of vaccinated calves inducing an additional boost for immunity build-up. Thus postvaccination, pasture commonly remains contaminated with small numbers of infective larvae providing an enduring stimulus to protective immunity in vaccinated calves. However, highly susceptible (naive) or debilitated animals can respond to vaccination with parasitic bronchitis.

The evaluation of drug’s efficacy against lungworms (Tables 1, 6) is usually based on monitoring the elimination of L<sub>1</sub> larvae in the feces and on the resolution of clinical signs after treatment. Since L<sub>1</sub> larvae may reappear in treated animals after prolonged periods, monitoring of larvae in fresh feces should be carried out for longer periods. The reappearance of larvae after treatment suggests that the drug apparently

affects the reproductive organs of the adult worm rather than adult worm itself.

Strategic anthelmintic treatment does not always guarantee survival of sufficient parasite stages in the host to ensure an effective immune response during the grazing season. Animals insufficiently protected should be treated as early as possible after parasitic bronchitis has been diagnosed to prevent severe clinical signs often associated with serious pulmonary tissue damage.

**Intraruminal boluses** (Table 1) are designed to release nematocidal concentrations of an anthelmintic in the reticulo-rumen of cattle in order to kill ingested infective larvae of GI nematodes and those of the lungworm *Dictyocaulus viviparus* for prolonged periods. Some intraruminal devices may release nematocidal concentrations for up to several months and other formulations (e.g., for parenteral injection or pour-on) of macrocyclic lactones (Table 1) may protect animals against infections of gut roundworms and lungworms for several weeks postdosing. However, the sole use of anthelmintics directed toward the prevention of parasitic bronchitis appears not always to be a reliable control measure, since the prophylactic treatment is harmed by the unpredictable occurrence of natural infection and reinfection. Long-acting drug formulations may, however, control this challenge to animals. But the action of such drug products may interfere with the fairly rapid acquisition of protective immunity and with the maintenance of sufficient levels of immunity following artificial vaccination and natural exposure to infection in endemic areas. On the other hand, there were results that have indicated compatibility of “concurrent” use of a lungworm vaccine and an **ivermectin** sustained release bolus or an **oxfendazole** pulse release bolus (for more information on SR boluses cf. Table 1). These boluses and other long-term formulations allow development of a protective level of immunity to *D. viviparus*. Thus a **fenbendazole** SR bolus releasing nematocidal concentrations for as long as 4.5 months or parenteral **doramectin** (vaccination + “Zero + eight week” treatment program: 2 vaccinations, each with 1,000 attenuated *D. viviparus* larvae 42 and 14 days prior to spring turnout followed by 0.2 mg/kg b.w. doramectin on DO = day of turnout and D56: the “zero + eight week” treatment) had not interfered with the build-up of protective immunity.

There are indications that strategic use of anthelmintics, i.e., in late *Dictyocaulus* spp. infections in autumn, can lead to arrested (inhibited) larvae in the host. Since these larvae grow to maturity in the following spring, vaccination or prophylactic (metaphylactic) treatment before commencing spring grazing will markedly reduce subsequent pasture contamination.

Anthelmintic killing of parasites in extraintestinal tissues often provokes severe systemic reactions and

lesions (→Nematocidal Drugs, Man/Table 1, filariasis). The severity of the resulting pathological lesions appears to be related to the location of the parasitic stages within the respiratory passages. Also, the treatment of parasitic bronchitis may be associated with severe pathological reactions and exacerbation of clinical signs as a result of the rapid killing of adult *Dictyocaulus* spp. and their larvae in the bronchioles and alveoli. The appearance of new severe histopathological lesions (e.g., severe edema of peribronchial tissue, chronic occlusive bronchitis), which sometimes cause fatalities, is due to large numbers of disintegrating worms and larvae in the deeper air passages. Remnants and still “intact” dead worms and larvae release toxic or antigenic material and cannot be eliminated by the host. As a consequence, these products may elicit severe inflammatory reactions in the host aimed at destroying and eliminating the dead worm material, thereby producing space-occupying lesions occluding vessels, alveoli, and bronchioles.

Only transient reactions (e.g., frequent coughing) are seen following treatment of lungworms and their larvae in the larger bronchioles, the bronchi, and the trachea, e.g., in the case of →*Metastrongylus* spp. infections of swine. Severe host reactions are not seen after treating gastrointestinal nematode infections in which remnants or dead parasites are disintegrated by digestion, or in which remnants and “intact” dead parasites are flushed from the host in the feces.

### Protostrongylid Infections of Small Ruminants

Protostrongylids are hairlike nematodes living in the alveoli, bronchioles, and →parenchyma of the lungs of sheep, goats, wild ruminants (deer), and other species of mammals. *Protostrongylus rufescens* is the most important species, less common are *Cystocaulus* spp., *Muellerius capillaris*, and other genera (Table 6). Eggs released by female worms usually develop in the lungs of the host, and hatched larvae (first stage) are passed via trachea and intestine in the feces. For the further development, the larva requires a snail intermediate host. Prophylaxis against protostrongylid infections is problematic since the extermination of the ubiquitous **snail intermediate host** is impossible. Thus, pastures remain contaminated for a long period because larvae are protected in the snail, probably for as long as the infected snail lives. Lambs should therefore not be allowed to graze on contaminated pastures. Anthelmintic treatment, so far necessary, with benzimidazoles (fenbendazole 20–80 mg/kg, and albendazole 5 mg/kg, orally) or **levamisole** (20 mg/kg subcutaneously), may lead to a marked decrease (>85%) of larvae in the feces. Often, there is only a transient suppression of egg production despite using relatively high doses (not approved)

of suitable anthelmintics. As a rule, the efficacy of common anthelmintic drugs against protostrongylid worms (especially →*Muellerius*) appears to be variable only, particularly with regard to their capability of killing adult worms in sufficient numbers (Table 6).

### Metastrongylid Infections of Swine

Several members of the family Metastrongylidae are parasites of the respiratory passages and blood vessels of the lungs of especially young pigs and wild boar. Outbreaks of disease do not often occur due to in-house pig husbandry. As far as is known, they require **intermediate hosts** for their further development. Common lungworms are →*Metastrongylus elongatus*, *M. pudendotectus*, *M. madagascariensis* or *M. salmi*, all of which occur in the pig and wild boar (and accidentally in man and ruminants). They dwell in the bronchi and bronchioles of domesticated and wild pigs and may produce pathogenic effects. The life cycle of these nematodes includes various species of **earthworm** (e.g., *Eisenia* spp., *Lumbricus* spp., and *Helodrilus* spp.) as intermediate hosts. Larvated eggs of *M. elongatus* passed in the feces may hatch soon thereafter. Hatched larvae may survive in moist surroundings for several months. To proceed with their development, an earthworm must swallow them. After performing 2 molts in the intermediate host the larvae are infective and can pass the winter in the earthworm. Pigs usually become infected by ingesting infected earthworm or by accidentally liberated larvae from an injured or dead earthworm. In the pig, the development of *Metastrongylus* spp. larvae is similar to that of *D. viviparus* and *D. filaria* in ruminants. The larvae pass through mesenteric lymph glands molting once and travel then to the lungs, where they grow adult after a further molt. Eggs are produced about 3–4 weeks after infection. Common clinical signs caused by *Metastrongylus* spp. may be loss of condition and weight decrease though piglets may have marked bronchitis and sometimes →**pneumonia** associated with secondary bacterial infections. In general, pig lungworms are not as pathogenic as *Dictyocaulus* spp. in ruminants. Anthelmintic **treatment** is comparable to that practiced in *Dictyocaulus* spp. infections, though higher doses (not approved) are necessary to affect metastrongylids (cf. Table 1 and Table 6). Anthelmintic killing may lead to moderate and transient bouts of coughing only. To prevent lungworm infection in pigs, the ground should be kept dry, and the feces should be disposed of adequately so that the life cycle is interrupted. Since infective larvae can live in the earthworm for an unknown length of time, paddocks and fields may remain contaminated for a considerable period. Young pigs should therefore be run on clean fields only.

## Nematocidal Drugs, Man

For Overview see Table 1.

### Gastrointestinal (GI) Nematodes of Medicinal Importance

→*Ascaris lumbricoides* (roundworm) is a cosmopolitan nematode common particularly in humid tropical climates. According to most recent estimates 1,200 million people are infected (prevalence 24%). This large roundworm (20–40 cm long) lives in the small intestine and feeds on gut contents. The eggs are passed with the feces, become infective in about 1 month, and can remain infective in the soil for several years. After uptake of infective eggs, e.g., with vegetables, larvae hatch in the small intestine, penetrate the duodenal wall, migrate through the liver parenchyma and travel via the bloodstream to the lungs. Then they break through the alveoli into the bronchioles and bronchi, ascend the trachea, and are swallowed. In the gut developmental stages mature to adults in about 8–10 weeks. Adult females live for about 1 year, and each female may produce about 200,000 eggs per day.

Common →hookworm species are →*Ancylostoma duodenale* (common in the “Old World” and occurring from the Mediterranean countries through India to China and Southeast Asia and Brazil) and →*Necator americanus* (American or New World hookworm) occurring in the Americas, Africa, and East Asia. *Ancylostoma ceylanicum* is only of local importance. Each female *Necator* may produce 10,000 eggs per day, and each female →*Ancylostoma* 20,000 eggs per day. Eggs passed with the feces hatch and develop in soil to infective larvae within 7 days. Infective larvae, which can survive up to 1 month penetrate the skin to infect man (oral route of infection is also possible with *Ancylostoma*). The larvae migrate via the bloodstream to the lungs, molt, and migrate to trachea, are then swallowed and mature to adults in the small intestine. Adult worms are about 10 mm long and attach to the gut mucosa and suck blood (*Necator* 5–10 times less than *Ancylostoma*). Blood loss caused by →hookworms is enormous and especially young children and pregnant women with large worm burdens suffer from severe anemia. It is estimated that approximately 1,100 million people are infected with hookworms worldwide and about 60,000 deaths per year occur as a result of heavy hookworm infections associated with iron-deficiency anemia, protein-loss enteropathy and hypoproteinemia.

About 300–500 million people (especially children) are infected with the cosmopolitan →pinworm →*Enterobius vermicularis* with a high prevalence in



**Nematocidal Drugs, Man. Table 1** Drugs used against nematode infections of humans

DISEASE (alphabetical order) stage(s) of interest (location), other information	International nonproprietary name (INN) (oral dosage: adult = pediatric, d = days), additional information	Characteristics miscellaneous comments
<b>ANCYLOSTOMIASIS</b> (hookworm infection)		
soil-transmitted helminthic infection; hookworms undergo a cycle of development in the soil (limited by the requirements of developing larvae for warmth and humidity: tropics, subtropics), female worms attached to wall of jejunum by buccal capsule, lay large numbers of eggs passed out with the feces; the hatched larvae become infective after undergoing 2 molts in the soil to produce infective, filariform larvae, which penetrate the skin of new host; the classical feature of hookworm disease is severe anemia and edema, and ascites may result from high hookworm loads; each year about 60,000 deaths are directly attributable to hookworm infections; about 44 million pregnant women have hookworm infections, which cause chronic blood loss from intestine and thus predisposition to development of iron deficiency anemia, often of great severity, constituting a major health problem; it is estimated that the hookworms may infect approximately 1,100 million people; cases of morbidity may be between 90 and 130 million worldwide, with high prevalence among pre-school and school-age children		
<p><i>Ancylostoma duodenale</i> (Old World hookworm) <i>Necator americanus</i> (New World hookworm) it is estimated that about a quarter of the world's population is infected with hookworms <b>adults (small intestine)</b> loss of blood per day and adult worm: <i>A. duodenale</i> 0.1–0.2 ml, <i>N. americanus</i> 0.02–0.05 ml) migrating larvae (lungs) most serious outcome of hookworm infection is severe hypochromic anemia due to severe blood loss from mucosa damaged by worm attachment; adult worms suck blood directly after destroying villous tissue</p>	<p><i>drug of choice:</i> <b>albendazole</b> = ABZ (400 mg once: adults/pediatric) or <b>mebendazole</b> = MBZ (100 mg bid × 3d: adults/pediatric) or <b>pyrantel</b> pamoate [11 mg/kg b.w. (max. 1g/d) ×3d] adults/pediatric or <b>endoscopic removal</b> <b>levamisole</b> HCl (5 mg/kg b.w. ×2d) <b>bephenium</b> hydroxynaphthoate (contraction of worms can be blocked by piperazine) tetrachloroethylene (TCE): <i>N. americanus</i> is more sensitive to TCE than <i>A. duodenale</i></p>	<p>benzimidazoles (BZs) may cause infrequent and mild side effects (e.g., epigastric pain, diarrhea): ABZ and MBZ have been shown to be embryotoxic and teratogenic in animals; therefore drugs should not be used during pregnancy; it is advisable to refrain from administering flubendazole during pregnancy although it failed to demonstrate teratogenicity in rodents; its potency and spectrum of activity is similar to that of MBZ; <i>pyrantel</i> (a tetrahydropyrimidine) may produce occasional and mild side effects (e.g., headache, dizziness); although there are no reports on a teratogenic effect, drug should not be given during</p>
<p>pregnancy and to children less than 1 year of age; <i>piperazine</i> antagonized depolarization of neuromuscular system caused by <i>pyrantel</i>; <i>levamisole</i> (a quaternaryamine) has been used principally against <i>Ascaris</i> infections; it is less active against hookworms; occasional adverse reactions are nausea, vomiting, abdominal discomfort, headache, dizziness, and hypertension; <i>bephenium</i> has been used mainly in treatment of <i>A. duodenale</i> (results against <i>N. americanus</i> are unsatisfactory), it may often cause vomiting, diarrhea, dizziness, headache; it should not be used in patients with hypertension, and during pregnancy; old-timer TCE (a halogenated hydrocarbon) has been used specifically in hookworm infections; it shows low intestinal absorption (inhalation causes narcotic effect); major side effects are nausea or vomiting and burning sensation; long-term treatment causes hepatotoxicity; <i>treatment</i> of hookworm disease involves individual treatment or mass treatment; blood values should be restored to normal by proper diet and iron treatment before or during treatment; <i>A. duodenale</i> is more susceptible to MBZ than to <i>pyrantel</i> (however, latter has superior compliance)</p>		
<b>ASCARIASIS</b>		
<p>soil-transmitted helminthic infection; adult female <i>Ascaris</i> worms lay large numbers of unembryonated <i>eggs</i> (thick shell) that are passed out with the feces into soil where they undergo development for 2–3 weeks to larvated eggs that contain infective, 2nd-stage larvae; these eggs are infective for humans and can readily contaminate vegetable when night soil is used as fertilizer; infection of host can be from “hand to mouth”, or undercooked food, or may occur when larvated eggs are swallowed with contaminated food (e.g., not adequately washed green leaf vegetable); infective eggs can survive in areas with temperate or cold climate for longer periods; <i>adult worms</i> (male ~15–30 cm long, female ~20–35 cm long) are very active intestinal parasites and in heavy infections overcrowding effects render them aggressive in that they migrate to aberrant extraintestinal sites thereby causing serious pathological damage; a large bolus of roundworms expelled from intestine of children post-treatment may consist of hundreds of worms; <i>distribution</i> of roundworms is global; it is estimated that some 60,000 deaths are directly attributable to <i>Ascaris lumbricoides</i> infection; <i>Ascaris</i> may infect about 1,200 million people worldwide, and cases of morbidity may amount to 120–215 million people; there is high prevalence of round worm infections among children, particularly in developing countries</p>		
<p><i>Ascaris lumbricoides</i> (“roundworm”) <b>adults (upper small intestine)</b> <b>migrating larvae (liver, lungs)</b>; heavy infections, especially in children, may</p>	<p><i>drug of choice:</i> <b>albendazole</b> = ABZ (400 mg once: adults/pediatric) or <b>mebendazole</b> = MBZ</p>	<p>ABZ and MBZ are suitable for mass treatment; MBZ is as active as levamisole against ascarids but its overall curative action on</p>

**Nematocidal Drugs, Man. Table 1** Drugs used against nematode infections of humans (Continued)

DISEASE (alphabetical order) stage(s) of interest (location), other information	International nonproprietary name (INN) (oral dosage: adult = pediatric, d = days), additional information	Characteristics miscellaneous comments
lead to intestinal obstruction and volvulus, which can be fatal; adult worms are very motile and have a marked tendency to escape through fistulae or any hole in their vicinity and so may block common bile duct and the appendix itself; in cases of <i>additional hookworm infection</i> care should be taken to avoid unusual activity of <i>Ascaris</i> (they can perforate wall of intestine), which may be initiated by therapy; in cases of intestinal obstruction <i>piperazine</i> can be used to paralyze and to relax ascarids, which are then expelled prior to therapy of ancylostomiasis	(100 mg bid × 3d or 500 mg once: adults/pediatric) or <b>ivermectin</b> (150–200 mcg/kg b.w. once: adults/pediatric) or <b>pyrantel pamoate</b> [11 mg/kg once, (max. 1 g) adults/pediatric] or <b>levamisole</b> hydrochloride (150 mg once) <b>piperazine</b> (various salts) (it has been used for mass treatment of ascariasis and enterobiasis and is a useful and inexpensive second-line drug)	soil-transmitted nematodes seems to be superior to that of levamisole; BZs should not be administered during pregnancy (for more information see ancylostomiasis and trichuriasis); in the course of therapy parasites may begin to “walk”; <i>pyrantel</i> is well tolerated (side effects, cf. ancylostomiasis); major disadvantage of pyrantel is its lack of activity against widespread whipworms (cf. trichuriasis); it is a reliable and well-tolerated drug for individual deworming, also in combination with <i>oxantel pamoate</i> , which is closely related to pyrantel and active against <i>Ascaris</i> and <i>Trichuris trichiura</i> , but inactive against hookworms;
<i>piperazine</i> is safe, cheap, and easy to administer; urticarial reactions and fever (obviously due to intoxicated worms) are rare; overdose causes neurological effects; <i>contraindications</i> are epileptic seizures and other neurological abnormalities, and pregnancy in the first trimester or hypersensitivity to the drug; <i>levamisole</i> is highly active against <i>Ascaris</i> ; a single dose gives parasitological cure; in mixed infections (e.g., hookworm) its curative effect is less satisfactory; levamisole is an immunomodulating agent that stimulates parasympathetic and sympathetic ganglia; it is a potent inhibitor of mammalian alkaline phosphatase; <i>symptoms</i> may be due to the migratory phase of <i>Ascaris</i> larvae in lungs (pneumonitis) or to numerous adult worms forming an intestinal bolus, which causes clinical signs of obstruction; adults are also known for aberrant migration, e.g., into bile duct causing hepatic disorders; glucocorticoids (anti-inflammatory, antiallergic, and immunosuppressive effects) may be used as <i>supportive therapy</i> in cases of <i>Ascaris</i> -pneumonia; <i>Prevention</i> of ascariasis in rural areas can be supported by sanitation measures and health education programs		
<b>DRACUNCULIASIS</b> (dracontiasis) or <i>Dracunculus medinensis</i> (guinea worm) infection occurs in parts (semi-desert) of Africa, India, the Middle East, and Brazil where drinking water is drawn from primitive wells or shallow ponds during the rainy season; copepods ( <i>Cyclops</i> , water fleas) containing infective larvae are swallowed by humans with the drinking water; the released larvae penetrate the intestinal wall and migrate for about 3 months through connective tissues where male and female worms mate; females then move to the subcutaneous (SC) tissues; preferable location of adult female worms are the foot or lower limbs; about 7 months later, adult female(s) (50–80 cm long) emerge from SC tissues to the surface of skin to release thousands of rhabditoid larvae from worm’s uterus into the water to be ingested by <i>Cyclops</i> ; heavy infections may cause clinical signs such as local lesion, intensive burning pain, and secondary infections spreading via an ulcerating papule where the adult female worm reaches the skin surface; bacterial infections of SC tissues may induce a phlegmon of leg and arthritis in the vicinity of joints; prevention measures are filtering or boiling the drinking water, chemical treatment of ponds and preventing infected persons with an emerging worm from entering the water source; causal therapy is not yet established and female worm either becomes extracted or is removed by means of surgery (cf. ↓)		
<i>Dracunculus medinensis</i> (Guinea, dragon, or Medina worm) <b>adult female(s) (subcutaneous tissue, usually of legs; gravid female causes an ulcerated lesion in skin to discharge thousands of motile larvae into water)</b>	<b>metronidazole</b> [250 tid × 10d, pediatric 25 mg/kg b.w./d (max. 750 mg) in 3doses] <b>mebendazole</b> (400–800 mg/d for 6d has been reported to kill the worm directly)	traditional treatment ( <i>treatment of choice</i> ) is to extract the worm “alive” by winding it gradually day by day on a small stick; slow extraction of worm is combined with wound care; <i>surgical excision</i> of female worm can exaggerate allergic reactions; <i>metronidazole</i> (5-nitroimidazole) does not kill the
worm; its clinical effect may be due to its potency to reduce inflammatory tissue reactions of the host and so facilitate removal of the worm; it has also antibacterial activity that may control secondary anaerobic infections; action of <i>niridazole</i> (a 5-nitrothiazole, obsolete) was probably due to drug’s metabolites, which suppress enhanced cell-mediated immunity reactions; <i>thiabendazole</i> (a benzimidazole) has also been used as a supportive therapy because of its anti-inflammatory, antipyretic, and analgesic action; the global “Dracunculiasis Eradication Program” (DEP) has accelerated its momentum toward the goal of total eradication; status of the program as of early 2005: by the end of 2004, 9 of the 20 countries that were endemic for dracunculiasis (when the campaign began) had interrupted transmission of this disease (including all 3 affected Asian countries), the number of infected persons had been reduced by more than 99% from an		

**Nematocidal Drugs, Man. Table 1** Drugs used against nematode infections of humans (Continued)

DISEASE (alphabetical order) stage(s) of interest (location), other information	International nonproprietary name (INN) (oral dosage: adult = pediatric, d = days), additional information	Characteristics miscellaneous comments
<p>estimated 3.5 million persons in 1986 to 16,026 cases in 2004, the number of disease-endemic villages had been reduced from more than 23,000 in 1993 to 3,109 in 2004, and the WHO had officially certified 168 of the world's 192 countries as free of dracunculiasis; Asia is now free of guinea worm, and 5 of the remaining disease-endemic countries reported less than 50 cases each in 2004; Nigeria, which reported more than 653,000 cases during its national case search in 1988–1989, reported less than 500 cases, and 3 other countries (Benin, Ethiopia, and Mauritania) reported only 3 indigenous cases each [for more information cf. Hopkins D. R. et al (2005), <i>Am J Trop Med Hyg</i> (2005) 73: 669–675]</p>		
<p><b>ENTEROBIASIS</b> (syn. oxyuriasis, pinworm infection) enterobiasis is very common in day nurseries and institutional settings (conditions of familial and group infection); distribution of <i>Enterobius</i> is worldwide and its prevalence in humans (mainly children) may amount to 300–500 million infected individuals; <i>larvated eggs</i> (elongated, flattened on one side, thick colorless shell) are swallowed by humans; transmission may be ano-oral, or direct to mouth by hands, or caused by dust-borne infection; adult worms are small (females: 8–13 mm long, males: 2–3 mm long), white, and threadlike; preferably at night gravid females emerge to the perianal surface where they lay some thousands of partially larvated eggs (10–15,000 eggs/worm) and then die; eggs on skin are immediately infectious on ingestion, or larvae that hatch on skin can reenter the anus, or larvae that occasionally move to aberrant sites enter the vagina producing peritonitis and/or ovarian infection; therefore, fecal examination for the identification of <i>Enterobius</i> eggs is an unreliable method; eggs are best detected by using cellulose tape preparation, the Graham or scotch-tape test</p>		
<p><i>Enterobius vermicularis</i> (pinworm) <b>adults and larvae</b> (lumen of descending colon and cecum); probably till the most common nematode species in Europe, the USA, and elsewhere because of its ready transmissibility; there is no effective prevention</p>	<p><i>drug of choice: pyrantel</i> pamoate [11 mg/kg once, max. 1g repeat in 2 weeks: adults/pediatric] or <b>mebendazole</b> (100 mg once; repeat in 2 weeks: adults/pediatric) or <b>albendazole</b> (400 mg once; repeat in 2 weeks: adults/pediatric)</p>	<p><i>pyrantel</i> and BZs are highly effective against <i>Enterobius</i> (also in community or mass drug treatment); individual treatment should always include the whole family or group (for side effects cf. ascariasis/ancylostomiasis ↑); <i>piperazine</i> (various salts) is an inexpensive drug; however, repeated administration may limit its use in community or mass drug treatment (side effects see ascariasis); <i>pyrvinium</i></p>
<p>pamoate (red cyanine dye, obsolete) was shown to be highly active in mass drug treatment; however, serious side effects such as Stevens-Johnson syndrome and photosensitization have been observed; it was contraindicated in patients with renal or hepatic dysfunction; it has been replaced by well-tolerated anthelmintics as pyrantel and BZs</p>		
<p><b>CAPILLARIASIS</b> <i>C. hepatica</i> is a global parasite of rodents, Lagomorpha, and Cricetidae, but infections of humans are rare; diagnosis is difficult because of the nature of the parasite's life cycle; adult female worms live in a host-derived capsule within the liver where they feed on cytoplasmic debris and lay unembryonated eggs not passed in the feces (dead end of life cycle in man); unembryonated eggs must be released from the liver by a predator, or by cannibalism or scavenging, and the eggs are passed in the feces of the predator or cannibal; embryonation to infective stage takes about 4 weeks at 30°C; infection take place by ingestion of larvated eggs; human infection may occur in Zaire, Nigeria, and in other parts of West Africa and elsewhere, where people has close contact to numerous definitive hosts as rat (Gambian rat) and mouse or cricetoma; adult worms of <i>C. hepatica</i> can cause severe parenchymal damage of liver (numerous granulomata consisting of mononuclear cells and eosinophils) and finally gradual hepatic fibrosis; <i>diagnosis</i> can only be made by demonstrating the presence of eggs, larvae, and adult (very thin 4–12 cm long) in liver tissue obtained by biopsy</p>		
<p><i>Capillaria hepatica</i> (common parasite of rodents, rabbits, squirrel, muskrat, opossum, rarely dogs cats, man) <b>larvae, adults, eggs (liver parenchyma)</b></p>	<p><b>benzimidazoles</b> (thiabendazole) (albendazole)</p>	<p>anthelmintic therapy is not established; thiabendazole absorbed at relative high concentrations from intestine might be used rather than the BZ carbamate albendazole, which might be effective after long-term treatment</p>
<p><i>Capillaria philippinensis</i> occurs preferably in the Philippines, Thailand, Japan, Egypt, and Iran; capillariasis is diagnosed on demonstration of characteristic-shaped eggs in feces (bipolar, small, long-oval and striated shells); man becomes infected by eating raw or undercooked freshwater fish or shrimps (intermediate hosts) that contain 3rd-stage larvae; <i>Capillaria</i> infection may occur in epidemic form and then prevalence in man may amount to thousands; clinical signs in heavy infections are due to ulcerative enteritis associated with uncontrollable diarrhea and malabsorption syndrome being sometimes fatal</p>		

**Nematocidal Drugs, Man. Table 1** Drugs used against nematode infections of humans (Continued)

DISEASE (alphabetical order) stage(s) of interest (location), other information	International nonproprietary name (INN) (oral dosage: adult = pediatric, d = days), additional information	Characteristics miscellaneous comments
<i>Capillaria philippinensis</i> (parasites of fish-eating birds) <b>3rd-stage larvae, adults (intestine:</b> lumen and epithelium/mucosa of posterior small intestine and anterior large intestine)	<i>drug of choice:</i> <b>mebendazole</b> (200 mg bid × 20d: adults/pediatric) <i>alternative:</i> <b>albendazole</b> (alternative drug, 400 mg daily × 10d: adults/pediatric)	follow-up of patient with intestinal capillariasis is necessary; relapses can occur with either compound and then need retreatment; <i>mebendazole</i> appears to be less active against larval stages and requires a prolonged treatment period; supportive treatment is unsatisfactory in outpatients; <i>thiabendazole</i> has been reported to be effective
<p><b>FILARIAL INFECTIONS</b> caused by arthropod-transmitted nematodes of the lymphatic, subcutaneous, and cutaneous tissues; filarial nematodes (some 8 species infect humans) are tissue-dwelling parasite; adult females produce microfilaria larvae, which are taken up by blood-feeding arthropods to produce infective, larval stages; during next blood feed, vectors transmit infective larvae to humans; the 2 most important filarial infections of humans are lymphatic filariasis (LF) and onchocerciasis; an estimated ~120 million people in &gt;80 endemic countries are infected with LF (the majority of disease burden being due to <i>W. bancrofti</i>) and 40 million have disfiguring symptoms as hydrocele and lymphedema; an estimated ~18 million individuals in 22 countries in sub-Saharan Africa are infected with onchocerciasis (main features are ocular and dermatological damages, rate of blindness ~0.4 million people) and ~50 million people remain at risk to become infected with <i>Onchocerca volvulus</i> (Africa and the Americas ~90 million); the global disease burden (DALYs) due to filarial infections was 0.95 million in 2002 [Molyneux DH et al. (2003) <i>Trends Parasitol</i> 19: 516–522]; the numbers of infected individuals with pathogenic filariae <i>Loa loa</i> (tropical eye worm) and less pathogenic <i>Mansonella</i> spp. are much smaller; the control and treatment of filarial diseases are difficult because radical curative agents are not available</p>		
<p><b>DRUG STRATEGIES TO CONTROL FILARIAL INFECTIONS</b> control and prevention of heartworm disease in dogs and cats are based on drugs acting on adult worms or on larvae of <i>Dirofilaria immitis</i> (cf. →Nematocidal Drugs, Animals), in contrast, control strategies against both LF and onchocerciasis in humans currently rely on drugs that have larvicidal activity only; different drugs are used in mass drug treatment programs for LF and onchocerciasis control: <b>ivermectin</b> is used in African Program for Onchocerciasis Control (APOC) and Onchocerciasis Elimination Program in the Americas (OEPA), <b>albendazole</b> and <b>ivermectin</b> in the Global Program for the Elimination of Lymphatic Filariasis (GPELF) in Yemen, and African countries coendemic for onchocerciasis and LF, and <b>diethylcarbamazine</b> (DEC) and <b>albendazole</b> in areas where LF alone is endemic (<i>W. bancrofti</i>, <i>B. malayi</i>, and <i>B. timori</i>); a constraint on program expansion is the serious adverse effects associated with <b>ivermectin</b> use in coendemic settings in areas with hyperendemic and mesoendemic onchocerciasis and where <i>L. loa</i> is also present; <i>Loa</i> encephalitis is associated with ivermectin treatment of individuals with high <i>Loa</i> microfilaremia; the global LF program currently rely on annual, time-limited treatment (at least 5 years) of DEC and albendazole, ivermectin and albendazole or in coendemic areas of filariasis and onchocerciasis (Africa, Yemen); <b>DEC</b> is contraindicated in onchocerciasis patients because of severe adverse reactions; the drug programs have national, regional, and global partnership components, including extremely generous drug donations programs: Mectizan (ivermectin) has been donated by Merck and Co Inc. since 1988 for as long as needed with the goal of elimination of onchocerciasis as a public health problem and in 1998 a similar commitment has been made by GlaxoSmithKline (GSK) to provide albendazole for the control of LF, including areas where onchocerciasis and LF are coendemic</p>		
<p><b>ALTERNATIVE CHEMOTHERAPEUTIC APPROACHES AND DRUG RESISTANCE</b> studies using <b>doxycycline</b> to eliminate the bacterial endosymbiont <i>Wolbachia</i> have led to a new approach in the treatment of filarial nematodes (<i>Wolbachia</i> is absent in <i>L. loa</i>); thus treatment with <b>doxycycline</b> at 100–200 mg/d for 4–6 weeks leads to long-lasting sterility of adult female <i>O. volvulus</i> (in a large series of extirpated onchocerciasis there was no evidence for reappearance of <i>Wolbachia</i> or resumption of embryogenesis); the antibiotic could therefore be used for individual treatment of LF and onchocerciasis and might be an alternative in cases of ivermectin resistance; there is currently no formal evidence for the development of resistance to any drug used against filariasis, however, the use of a single drug (e.g., ivermectin in APOC and OEPA) and the need for decades of sustained treatment has raised concern over potential development of resistance in onchocerciasis; <b>moxidectin</b> (a milbemycin, cf. →Nematocidal Drugs, Animals) not yet approved for human use may be an alternative to ivermectin in controlling filarial infections of humans; it was found more efficacious than ivermectin in most <i>Onchocerca</i> models (<i>O. volvulus</i> and <i>O. lienalis</i> in mice)</p>		
<p><b>LYMPHATIC FILARIASIS</b> bloodsucking mosquitoes (e.g., <i>Anopheles</i>) transmit infective 3rd-stage larvae of lymphatic filariae; infective larvae penetrate the skin of a new host through the puncture wound made when the mosquito bites and enter the lymphatics where the worms copulate and mature into threadlike adults (adult males of <i>Wuchereria bancrofti</i> are about 4 cm long, females 8 to 10 cm);</p>		

**Nematocidal Drugs, Man. Table 1** Drugs used against nematode infections of humans (Continued)

DISEASE (alphabetical order) stage(s) of interest (location), other information	International nonproprietary name (INN) (oral dosage: adult = pediatric, d = days), additional information	Characteristics miscellaneous comments
<p>adults may live in lymph glands, e.g., in the groin, for many years thereby producing microfilaria (MF); <i>W. bancrofti</i> is widely distributed throughout the tropics (Asia, Africa, Australia, Pacific, and South America), <i>B. malayi</i> is confined to south Asia, and <i>B. timori</i> to Timor and islands of the lesser Sunda group of Indonesia; due to pathological effects of MF and adult worms acute involvement of lymphatic vessels (lymphangitis) is common, especially in the extremities; local lymphadenitis, acute orchitis (associated with hydrocele and fever) may be characteristic in the early stage of the disease; lasting lymphatic obstruction and repeated leakage of lymph into tissues produce lymphedema, thickened skin, and new adventitious tissue (<i>elephantiasis</i>) showing later verrucous growth; injured skin may lead to secondary infections with bacteria and fungi; severe elephantiasis of the scrotum may produce gross and incapacitating deformity, which requires radical surgery to remove the surplus tissue</p>		
<p><i>Wuchereria bancrofti</i>, <i>Brugia malayi</i>, <i>B. timori</i> <b>3rd-stage larvae (L<sub>3</sub>) threadlike adults, microfilariae</b> (MF sheathed) (L<sub>3</sub> enter lumen of <b>lymphatic vessels</b>, i. e., all sites within lymphatic circulation and develop to adults, MF enter <b>bloodstream</b>) <i>clinical features</i> of LF are lymphangitis, dermatitis, cellulitis associated with fever; later, chronic lymphadenopathy, lymphedema, and elephantiasis</p>	<p><i>drug of choice:</i> <b>diethylcarbamazine</b> (DEC): *(6 mg/ kg/d in 3 doses × 14d: adults/pediatric) <i>single dose combinations:</i> they may cause sharply reduced prevalence and intensity of infection by reduction of <i>W.</i> <i>bancrofti</i> MF but does not kill adult worms: <b>albendazole</b> (400 mg once) either plus <b>ivermectin</b> (200 mcg/kg b.w.) or <b>DEC</b> (6 mg/kg b.w.)</p>	<p>DEC (a piperazine derivative) has been used for more than 50 years for prevention and mass treatment of LF; for patients with MF in blood Medical Letter consultants (cf. footnote of this Table) would start DEC treatment as follows: *d1: 50 mg p.c., *d2: 50 mg tid, *d3: 100 mg tid, *d4 through d14: 6 mg/ kg b.w. in 3 doses (full doses may be given from d1 in patients without MF in blood); multidose regimen have been shown to provide more rapid reduction in MF than single dose DEC, but MF</p>
<p>levels are similar 6–12 months after treatment; a single dose of 6 mg DEC/kg is used in endemic areas for mass drug treatment; <b>mode of action:</b> DEC affects directly neuromuscular system causing immobilization and alterations of surface coat of MF; it causes MF to leave circulation for the liver where they are entrapped and destroyed by phagocytosis; its action on adult worms is uncertain; <b>adverse effects:</b> drug itself produces only minor side effects (headache, abdominal pain; during therapy “allergic” reactions may occur (fever, edema, pruritus); <b>supportive treatment:</b> antihistamines or glucocorticoids may be required to reduce allergic reactions due to disintegration of MF; DEC 6 mg/kg b.w. once/year, or ivermectin 400 mcg/kg once per year will reduce density of MF: DEC to 80–90%, ivermectin to 100% (WHO, 1992, Technical Report Series 821, WHO Geneva); ivermectin is extremely effective against MF but does not kill adult worms; additional treatment with albendazole has some effect on adult worms (macrofilariae) and may markedly lengthen return of symptoms after remission [Ottesen EA, CP Ramachandran (1995), <i>Parasitol Today</i> 11: 129–131]; DEC combined with ivermectin appears to be synergistic; <i>mebendazole</i> and <i>levamisole</i> have shown beneficial effects on LF when given over 14–25 days</p>		
<p><b>LOIASIS</b> large, tabanid flies, <i>Chrysops</i> spp. (mango flies), which live in primary rain forests of Africa transmit <i>Loa loa</i> to humans (mandrill may be infected with an almost identical parasite); flies possess powerful mouthparts by which they injure the skin to form blood pools at the site of wound to feed from blood while infective 3rd-stage larvae enter the vertebrate host; blood meals are taken during the daytime; in the host, L<sub>3</sub> mature into adults within about 1 year; adult female worms are about 7 cm long and may live for 4–12 years; they migrate through the subcutaneous tissues, notably the eye under the conjunctiva; microfilariae (MF) develop from larvae in the female and circulate in the peripheral blood during the day; they are picked up by another fly where they mature to infective L<sub>3</sub> to enter a new host; loiasis is confined to Africa (from Gulf of Guinea in the West to the Great Lakes); estimated prevalence in humans may amount to 33 million; “Calabar” swellings indicate the tracks of migrating adults and disappear as adults continue their migration; recurrent large swellings are most frequently seen in the hands, wrists, and forearms and may be accompanied with itching, erythema, and fever; a <i>marked eosinophilia</i> (60–90%) accompanies always this phase of infection; heavy infections may be more common than in other filarial infections because a single <i>Chrysops</i> vector may be the cause for high microfiliaremiams, which enhance the risk of inducing emboli in capillaries of brain, meninges, and retina; degranulation of eosinophils has been reported to be associated with endomyocardial fibrosis; the movement of the adult worm under the conjunctiva may cause considerable irritation and vascular congestion</p>		
<p><i>Loa loa</i> (tropical eye worm) <b>3rd-stage larvae adults microfilariae</b> (MF sheathed) [<b>subcutaneous tissue</b> (SCT): MF migrate from SCT and conjunctiva to bloodstream, adults migrate through SCT across subconjunctival space inducing local reactions which may cause heavy pain]</p>	<p><i>drug of choice:</i> <b>diethylcarbamazine</b> (DEC) *(6 mg/kg/ d in 3 doses × 14d: adults/pediatric) <b>mebendazole</b> (300 mg/d × 45d) <b>surgery:</b> removal of adult worm</p>	<p>adult worm under conjunctiva of eye must be removed <i>surgically</i>; extraction of adult worms is done by means of fine forceps following anesthetizing the conjunctiva; for patients with MF in blood Medical Letter consultants (cf. footnote of this Table) would start DEC treatment as follows: *d1: 50 mg p.c., *d2: 50 mg tid, *d3: 100 mg tid, *d4</p>

**Nematocidal Drugs, Man. Table 1** Drugs used against nematode infections of humans (Continued)

DISEASE (alphabetical order) stage(s) of interest (location), other information	International nonproprietary name (INN) (oral dosage: adult = pediatric, d = days), additional information	Characteristics miscellaneous comments
<p>through d14: 9 mg/kg b.w. in 3 doses (full doses may be given from d1 in patients without MF in blood); multidose regimen have been shown to provide more rapid reduction in MF than single dose DEC, but MF levels are similar 6–12 months after treatment; DEC “destroys” MF and immature stages; more details see <i>W. bancrofti</i>; effect of DEC on adult worm is doubtful; killed MF may cause severe “allergic” reactions, which can be reduced by gradually increasing DEC doses; in heavy infections rapid killing of MF can provoke an encephalopathy; <b>supportive treatment:</b> antihistamines or glucocorticoids may be required to reduce severe allergic reactions due to disintegration of <i>Loa</i> MF, especially in patient with high levels of MF; <i>mebendazole</i> or <i>albendazole</i> (ABZ) and <i>ivermectin</i> (IVM) has been found to reduce microfilaremia [Gardon J et al. (1997), <i>Trans R Soc Trop Med Hyg</i> 91: 593]; ABZ may be useful for treatment of loiasis when DEC is ineffective and cannot be used but repeated courses may be necessary; apheresis has been reported to be effective in lowering microfilarial counts in patients heavily infected with <i>Loa loa</i> [EA Ottesen (1993), <i>Infect Dis Clin North Am</i> 7: 619]; BZs have a more slow onset of microfilaricidal activity and therefore may be better tolerated than DEC or IVM; the effect of BZs against adults is erratic; DEC, 300 mg once weekly, has been recommended for prevention of loiasis [Nutman TB et al. (1988), <i>N Engl J Med</i> 319: 752]; <i>Loa</i> encephalitis is associated with IVM treatment and led to a particular constraint on drug strategy programs if onchocerciasis and <i>L. loa</i> are coendemic in certain areas of Africa (e.g., Cameroon); because <i>Wolbachia</i> is absent in <i>L. loa</i> it is unlikely that the endosymbionts contribute to the encephalopathy reactions in individuals with infections of <i>L. loa</i> unaccompanied by other filarial species</p>		
<p>MANSONELLIASIS (regarded of limited public health importance) blood-feeding midges (<i>Culicoides</i> spp.) and/or blackflies (<i>Simulium</i> spp.) transmit infective 3rd-stage larvae to humans; <i>M. ozzardi</i> and <i>M. perstans</i> infections may be asymptomatic or associated with ‘allergic’ reactions such as cutaneous itching, pruritus, arthralgia, inflammation of subcutaneous tissues, inguinal lymphadenitis, moderate abdominal pain, and <i>marked eosinophilia</i>; <i>M. ozzardi</i> occurs in central and South America (estimated cases 15 million), <i>M. perstans</i> is widely distributed in Africa and South America (estimated cases 65 million), whereas <i>M. streptocerca</i> is confined to Africa; microfilariae of <i>M. streptocerca</i> are found in the skin and may cause pruritus and papules, edema, and dermatitis; symptoms may be similar to those of mild onchocerciasis</p>		
<p>1*<i>Mansonella ozzardi</i> 2*<i>Mansonella perstans</i> 3*<i>Mansonella streptocerca</i> <b>3rd-stage larvae</b> (L<sub>3</sub>), <b>adults:</b> 1*inhabit subcutaneous (s.c.) tissues; 2* body cavities, mesenteries, and perirenal tissues; 3* dermal and s.c. tissues; <b>microfilariae</b> (MF unshathed): probably in visceral adipose and subcutaneous tissue, abdominal, or pericardial cavity, MF enter bloodstream (<i>M. streptocerca</i>: MF in skin, subcutaneous tissue)</p>	<p>1*<b>ivermectin</b> (200 mcg/kg once) <i>drug of choice:</i> 2*<b>albendazole</b> (400 mg bid × 10d: adults/pediatric) or 2*<b>mebendazole</b> (100 mg bid × 30d: adults/pediatric) <i>drug of choice:</i> 3*<b>diethylcarbamazine</b> (DEC) (6 mg/kg/d × 14d: adults/pediatric) 3* <b>ivermectin</b> (150 mcg/kg once: adults/pediatric)</p>	<p><i>Mansonella ozzardi</i>: DEC has no effect; <i>ivermectin</i> (200 mcg/kg once) has been reported to be effective; <i>Mansonella streptocerca</i>: DEC is potentially curative due to activity against both adult worms and MF; <i>ivermectin</i> is only active against MF; most symptoms in <i>Mansonella</i> infections are caused by adult worms; however, chemotherapy may generally exacerbate hypersensitivity reactions due to killed and disintegrating MF (e.g., severe pruritus); <b>supportive treatment:</b> antihistamines or glucocorticoids may be required to reduce severe allergic reactions</p>
<p>ONCHOCERCIASIS (river blindness) blackflies (<i>Simulium</i> spp.) usually feed on plant juices; only adult females feed on blood, and blood meal is repeated for each ovarian cycle; they transmit infective 3rd-stage larvae to humans following the bite of the vector; L<sub>3</sub> penetrate the skin through the wound and migrate to subcutaneous tissues where they mature into threadlike adult males and females in about one year, <i>adult worms</i> (female 35–70 cm long and male 2–4 cm long) are thin and exhibit sluggish movement; they are found subcutaneously in nodules or free in the tissues of humans; nodules consist of fibrous material, which encloses numerous adults of both sexes; in Africa, <i>fibrous nodules</i> in the subcutaneous tissues are found predominantly in the lower parts of the body, while in South and Central America they are more commonly found in the head region and upper parts of body; larvae produced by females develop to unshathed microfilariae (MF), which live in skin and eye; MF picked up by another black fly need about 1 week to become an infective L<sub>3</sub>; <i>aquatic stages</i> of the vector such as eggs, larvae, pupae are attached to all submerged objects (even crabs) and live in fast flowing oxygen-rich water (streams, rivers, and waterfalls) where larvae and pupae extracted oxygen through head filaments; river blindness has a focal <i>distribution</i>, which is closely associated with the biology of vectors; the disease is endemic in West Africa equatorial and East Africa, Sudan, Central America, and in parts of Venezuela and Columbia; an estimated ~18 million individuals in 22 countries in sub-Saharan Africa are infected with onchocerciasis (main features are ocular and dermatological damages, rate of blindness ~ 0.4 million people) and ~50 million people remain at risk to become infected with <i>Onchocerca volvulus</i> (Africa and the Americas ~90 million); <i>clinical</i></p>		

**Nematocidal Drugs, Man. Table 1** Drugs used against nematode infections of humans (Continued)

DISEASE (alphabetical order) stage(s) of interest (location), other information	International nonproprietary name (INN) (oral dosage: adult = pediatric, d = days), additional information	Characteristics miscellaneous comments
<p><i>features</i> of the disease vary according to duration and frequency of exposure as well as geographical location; early <b>lesions of the skin</b> are manifest as a papular dermatitis (so-called <i>craw craw</i> in Africa, i.e., small papules around the MF); in advanced patients a quite common feature of onchocerciasis is thickening and wrinkling of the skin called <i>lizard</i> or <i>elephant</i> skin or dermatitis with lichenification (itching and scratching reactions lead to thickening and hardening of the skin); so-called <i>Sowda</i> usually of lower limbs is characterized by hyperpigmentation and often involves inguinocrural lymphadenopathy; in late cases (burnt-out onchocerciasis) pretibial atrophy and depigmentation (so-called <i>leopard skin</i>) is common; in chronic infections, atrophy of the skin may be evident resulting in <i>tissue paper</i> appearance of the skin; lymphadenopathy of the inguinocrural glands can result in an appearance described as <i>hanging groin</i> and scrotal elephantiasis; <b>lesions of the eye</b> involve early corneal changes due to dead MF such as punctate keratitis, which may clear with time; progressive, sclerosing keratitis commonly producing blindness result from heavy MF infections; chorioretinal lesions (chorioretinitis, iritis, and iridocyclitis) may follow damage by dead MF to anterior segments of the eye; finally optic nerve atrophy may develop; <b>prevention</b> of onchocerciasis may be reduction of man/vector contact (protective clothing, insect repellents), vector control (use of larvicides at black fly breeding sites), nodulectomy, and chemoprophylaxis with <i>ivermectin</i> [mass drug treatment to control onchocerciasis: African Program for Onchocerciasis Control (APOC) and Onchocerciasis Elimination Program in the Americas (OEPA)]; the public health and socioeconomic importance of blindness and skin disease in heavily affected communities are profound; before the initiation of the Onchocerciasis Control program (OCP) in West Africa, blindness prevalence of about 10% were observed in hyperendemic villages; in forest areas skin disease provoked intensive itching thus preventing sleep and work, and reducing educational chances of children</p>		
<p><i>Onchocerca volvulus</i> (tissue-dwelling nematode) <b>3rd-stage larvae adults</b> (found in subcutaneous tissue forming nodules) <b>microfilariae</b> (MF unsheathed) (MF migrate from subcutaneous nodules/tissues to <b>skin</b>, and anterior chamber of <b>eye</b>)</p>	<p><i>drug of choice: ivermectin</i> (150 mcg/kg once, repeated every 6–12 months until asymptomatic: adults/pediatric): annual treatment with 150 mcg ivermectin/kg can prevent blindness due to ocular disease [Mabey D et al. (1998) Ophthalmology 103: 1101]</p>	<p>since 1989, ivermectin is a well-accepted drug (6 mg tablets) for mass drug treatment in onchocerciasis endemic villages and forest areas because of its sustained microfilaricidal effect; onset of eosinophilia and Mazotti-type reaction are delayed and mild compared to now obsolete (contraindicated) diethylcarbamazine</p>
<p>(DEC) used for individual treatments in the past; following treatment with ivermectin, skin MF density decreases to near zero within 1 month, and may increase to 2–10% of pretreatment levels within 12 months; precaution is indicated in children under 5 years or under 15 kg b.w., in pregnancy, or breast-feeding mothers within 1 week of delivery, or in persons with neurological disorders or severe intercurrent disease; there is no evidence that live MF may cause ad hoc host reactions, only dying and dead MF induce chronically pathological changes becoming more severe the longer infection has persisted; <i>nodulectomy</i> (excising nodules containing adult worms) can prevent serious eye changes thereby eliminating production of MF; in Central and South America, surgical removal of nodules has been widely used in young patients with “<i>Erisipela della costa</i>” or older patients with “<i>mal morado</i>”; DEC is a very strong and fast acting microfilaricidal drug and therefore <i>contraindicated</i> for mass treatment of onchocerciasis in humans; prior to introduction of ivermectin, it must be given under medical supervision; doses were increased gradually to reduce severe “<i>allergic</i>” (systemic) reactions; destruction of <i>Onchocerca</i> MF by DEC greatly increases skin pathology and has been the main cause of any inflammatory reaction, so-called <i>Mazotti-type reaction</i></p>		
<p><b>TROPICAL PULMONARY EOSINOPHILIA (TPE) or OCCULT FILARIASIS</b> clinical features and pathological aspects of TPE appears to be predominantly associated with lymphatic filariasis (†) and may be a result of an atypical hypersensitivity of the host to tissue-dwelling parasites; this abnormal host reaction to the presence of a lymphatic filarial infection (other nematodes of animals or humans?) is most commonly seen in southern India, and areas of the Pacific and East Indies (“Meyers-Kouwenaar” syndrome); symptoms are dry coughing resembling asthma attacks and may be due to eosinophilic infiltration of the lungs; other clinical signs may be lymphadenitis, enlargement of spleen and lymphatic nodes (in histological sections hyperplasia, aggregation of tissue eosinophils, and granulomas are evident); eosinophilia in blood and tissues is often present at high levels (cf. <i>Strongyloides stercoralis</i> infections ↓) <b>diagnosis</b>: absence of MF from blood makes diagnosis difficult; it may be established by successful filarial serology, and a positive response to treatment with diethylcarbamazine (DEC); the drug initiates exacerbation of symptoms followed by reduced level of eosinophils; X-ray picture of chest may become clear after a few weeks, MF may be found in various tissues, especially in the lungs in postmortem examination; <b>treatment</b>: drug of choice is DEC (6 mg/kg/d in 3 doses × 12–21d: adults/pediatric); symptoms of TPE may quickly resolve post-treatment</p>		
<p><b>STRONGYLOIDIASIS</b> humans become infected by 3rd-stage filariform larvae (L<sub>3</sub>), which penetrate the skin; infective larvae may arise from free-living rhabditiform larvae outside the body; <i>Strongyloides</i> is unique among nematodes because this parasite is capable to</p>		

Nematocidal Drugs, Man. Table 1 Drugs used against nematode infections of humans (Continued)

DISEASE (alphabetical order) stage(s) of interest (location), other information	International nonproprietary name (INN) (oral dosage: adult = pediatric, d = days), additional information	Characteristics miscellaneous comments
<p>undergo both a parasitic and free living reproductive cycles; parasitic, adult females live threaded into the mucosal epithelium of the small intestine and produce larvated eggs by parthenogenesis, i.e., development from an unfertilized egg; after hatching, larvae may develop through 4 larval stages into free-living adult male and female saprophytic worms; under certain conditions first stage larvae may develop to L<sub>3</sub> within the intestinal tract initiating internal <i>autoinfection</i>, or when larvae emerge to perianal areas and penetrate the skin they can give rise to an external autoinfection; the course of this hyperinfection is often fulminating and sometimes fatal in debilitated or immunosuppressed persons; <i>distribution</i> of strongyloidiasis is global and occurs in subtropical and tropical areas (probably prevalence in humans is about 50–100 million); <i>S. fuelleborni</i>, which is a common parasite in African and Asian primates is also found in humans in several countries (e.g., in Zambia); clinical signs of <i>S. fuelleborni</i> infection are anorexia, dullness, and characteristic watery mucous diarrhea causing malabsorption syndrome as result of severe catarrhal (ulcerate) enteritis; passage of larvae through the lungs (as in hookworms) may produce severe <i>coughing</i>, and marked <i>eosinophilia</i>; autoinfection can lead to severe “<i>creeping eruption</i>” (usually on the back) and may last for many years; deep migration of the larvae may be associated with ‘eosinophilic lung type syndrome’ resembling that of tropical pulmonary eosinophilia (↑)</p>		
<p><i>Strongyloides stercoralis</i> (thread or dwarf worm), <i>S. fuelleborni</i> <b>parasitic, adult females, larvated eggs</b> (rarely seen, most of them hatch already in mucosa of <b>small intestine</b>, egg shape is similar to that of the hookworm) <b>infective intestinal larvae</b> (L<sub>3</sub>; internal autoinfection within intestinal tract of debilitated or immunosuppressed persons)</p>	<p><i>drug of choice:</i> 1*<b>ivermectin</b>, 200 mcg/kg/d × 2d: adult/pediatric) alternative: <b>albendazole</b> (400 mg/d × 7d: adult/pediatric) or <b>thiabendazole</b> (50 mg/kg/d in 2 doses × 2d: adult/pediatric: max. 3g/d), dose regimen is likely to be toxic and may have to be decreased</p>	<p>of all the GI helminthic infections <i>Strongyloides</i> is the most difficult to treat in individuals because of autoinfection and agents have to be given repeatedly; <i>ivermectin</i> has been approved for <i>Strongyloides</i> and may sufficiently effective in a single dose (200 mcg/kg) in patients with an uncomplicated infection; in disseminated disease or immunocompromised patients it</p>
<p>may be necessary to prolong or repeat therapy or to use other agents; veterinary and enema formulations of ivermectin have been used in severely ill patients unable to take oral medication; <i>thiabendazole</i> has been the traditional agent but has significant side effects; all BZs, including mebendazole, may vary in their efficacy (44–98%) against <i>Strongyloides</i>; <i>Strongyloides</i> infections frequently are latent; patients selected for immunosuppressive therapy should be carefully screened for this infection before initiation of therapy; incidental administrations of glucocorticoids or other immunosuppressive agents in immunocompromised and debilitated individuals may lead to exacerbation of <i>S. stercoralis</i> infection with unfavorable prognosis</p>		
<p>TERNIDENS INFECTION (false hookworm infection) <i>Ternidens deminutus</i> (adults ~1 cm long) is a common parasite of simian primates in Asia and Africa; it occurs in some areas of East and Central Africa, Mauritius, South Africa, and Asia; the adult <i>T. deminutus</i> is about the same size as <i>Necator</i> and eggs may be confused with those of hookworms; <i>T. deminutus</i> and hookworm can be differentiated morphologically or by egg volume; the hookworm-related strongyle parasite of the large intestine of primates (baboons, vervet monkeys) may occasionally infect humans; however, infection of humans is of minor importance (estimated cases some thousands) and is due to ingestion of <i>vegetables</i> or <i>fruits</i> contaminated with infective 3rd-stage larvae; in heavy infections, immature stages migrate through mucosa of the small and large intestine; they may cause ulceration (bloodsucking activity of worm?) and enteritis often associated with anemia; nodules containing 4th-stage larvae are found in the colon only; mild infections are usually asymptomatic; <i>treatment</i> relies on medication with benzimidazoles (<i>drugs of choice: albendazole</i> or <b>mebendazole</b>, <b>thiabendazole</b>: at recommended dose, cure rates may be &gt;90%; egg reduction rate with <i>pyrantel</i> pamoate is low)</p>		
<p>TRICHINOSIS (trichinellosis) zoonotic infection with global distribution and an estimated prevalence of about 48 million people; <i>Trichinella spiralis</i> infection may circulate between rats and other carnivores; a common reservoir of infection may be the wild pig or bear, which initiate isolated outbreaks of human infection following hunting parties; pigs may acquire infection by eating infected rats; cycle of infection also exist in wild Canidae that ingest rodents; humans become infected by ingestion of raw or undercooked muscle (sausages) containing encysted larvae from pig, wild boar, polar bear, walrus, seal, and other fur-bearing animals; <i>clinical signs</i> such as diarrhea, fever, myalgia (stiffness and pain in affected muscles), periorbital edema, eosinophilia, and muscular paralysis may occur when females begin to shed newborn larvae 5–21 days after infection; pathogenic effects are produced by larvae in muscles; crisis is usually reached when larvae become encapsulated; <i>encapsulated larvae</i> in muscle tissue may live for several years; their calcification begins already 6–9 months after entering the muscle; they can be detected at biopsy or by serological tests such as fluorescent antibody test, gel-diffusion test, ELISA, PCR or other tests; high antibody titers, which are present in the acute stage of disease, are nonprotective; essential <i>prevention measures</i> against trichinosis should be thorough meat inspection, eliminating of rats as reservoir host, and regulations to ensure that larvae in pork are</p>		



**Nematocidal Drugs, Man. Table 1** Drugs used against nematode infections of humans (Continued)

DISEASE (alphabetical order) stage(s) of interest (location), other information	International nonproprietary name (INN) (oral dosage: adult = pediatric, d = days), additional information	Characteristics miscellaneous comments
killed by cooking or freezing of infected carcasses before marketing; consumer should be instructed that pork or pork products or carcasses of carnivorous game must be cooked sufficiently prior to consumption		
<p><i>Trichinella spiralis</i> <b>intestinal stages:</b> encysted larvae, adults, newborn larvae (lumen and mucosa of <b>small intestine</b>) <b>parenteral stages:</b> [newborn larvae enter the lymph and blood via thoracic duct, and mature in a “modulated” striated <b>muscle cell</b> (termed “nurse cell”) where they rapidly grow and become encapsulated]</p>	<p><i>drugs of choice:</i> corticosteroids (adrenal cortex) as <b>glucocorticoids</b> for severe symptoms plus benzimidazoles (BZs): <b>mebendazole</b> (200–400 mg tid × 3 d, then 400–500 mg tid × 10d: adult/pediatric) alternative: <b>albendazole</b> (400 mg bid × 8–14d: adult/pediatric)</p>	<p>in the acute phase, treatment should begin as early as possible; corticosteroids with high antiphlogistic effects at a high initial dose is recommended to reduce inflammation reactions (due to muscle cell damage and myositis) caused by migrating (parenteral) larvae; BZs may show some anti-inflammatory activity per se and probably a direct action on adult worms (no proof for removal); BZs may reduce the intensity of muscle infection; trials in rodents suggest that long-term treatment with BZs (e.g., flubendazole) will sterilize and kill adult worms</p>
<p>TRICHOSTRONGYLIASIS (trichostrongylosis) several trichostrongylid species are capable to infect humans; they inhabit usually the digestive tract of herbivores; human infections may occur in many countries (e.g., Iran and Japan) but are rare; transmission of infective larvae is due to close contact with ruminants; humans (like herbivores) become infected by ingestion of vegetable contaminated with night soil containing <i>infective 3rd-stage larvae</i>; ingested larvae penetrate the intestinal mucosa forming tunnels beneath the epithelium; infection by the cutaneous route is also possible, especially when persons mold animal dung to “briquettes” to be dried and burnt as fuel; light worm loads of <i>T. orientalis</i> may be asymptomatic but heavy ones may cause enteritis and thus diarrhea, which may be associated with anemia; adult worms may be confused with human hookworms, however, trichostrongylids are smaller in size and more slender in shape, and bursa is different in form from that of <i>Ancylostoma duodenale</i></p>		
<p><i>Trichostrongylus orientalis</i>, <i>T. colubriformis</i> (at least 8 other species) <b>third stage larvae, adults (small intestine):</b> L<sub>3</sub> and head of adults are embedded in mucosa)</p>	<p><i>drug of choice:</i> <b>pyrantel</b> (11 mg/kg b.w. once, max. 1 gram: adult/pediatric) alternative: <b>mebendazole</b> (100 mg bid × 3 d or <b>albendazole</b> 400 mg once: adult/pediatric)</p>	<p><i>Trichostrongylus</i> spp. can be removed also by other drugs such as levamisole, or bephenium hydroxynaphthoate (cf. ancylostomiasis ↑); levamisole appears to be the most effective agent; however, its use is limited because of various adverse effects (the same is true for bephenium)</p>
<p>TRICHURIASIS: soil-transmitted helminthic infection (as ascariasis ↑); female worms lay unembryonated barrel-shaped eggs with thick shells that are passed out with the feces into soil where they undergo development for 2–3 weeks to infective, 1st-stage larvae; <i>larvated</i> eggs (infective L<sub>2</sub> in egg shell may survive up to 6 years) can readily contaminate vegetable when night soil is used as fertilizer; infection of humans may occur from “hand to mouth” or by swallowing eggs with contaminated uncooked food; after ingestion of eggs, hatched L<sub>2</sub> larvae pass from jejunum to colon where they borrow into to the mucosa to develop to adults; development to adults (patency) takes about 3 months; whiplike anterior portion of the adult worm (3–5 cm long) becomes entwined in the mucosa of colon, the female worm is slightly larger than the male, which is coiled; <i>distribution</i> of whipworm infection (<i>Trichuris trichiura</i>) is global and prevalence estimated is about 500–1000 million people (cases of morbidity may be 60–100 million); chronic inflammation of mucosa of large intestine and lacerations of mucosa caused by feeding activities of worms may lead to secondary bacterial infections; in heavily infected infants and young children, rectal prolapse is often seen followed by chronic bloody diarrhea associated with rectal bleeding, iron deficiency anemia and growth deficits; mixed infections of soil-transmitted nematodes (<i>Trichuris</i>, <i>Ascaris</i> spp., and hookworms) are very common and in heavily infected patients dysenteric syndrome (severe chronic diarrhea, colitis, rectal prolapse, anemia) may cause significant growth-stunting in children</p>		
<p><i>Trichuris trichiura</i> (whipworm) <b>larvated egg with infective L<sub>2</sub> in soil adults</b> (transverse and descending <b>colon, cecum</b>; anterior portion of whipworm is embedded in mucosa)</p>	<p><i>drug of choice:</i> <b>mebendazole</b>, (100 mg bid × 3 d or 500 mg once: adult/pediatric) alternatives: <b>albendazole</b> (400 mg × 3d: adult/pediatric) <b>ivermectin</b> (200 mcg/kg b.w. daily × 3d: adult/pediatric)</p>	<p><i>mebendazole</i> is considered to be the safest and most effective drug (it shows also good activity against <i>Ancylostoma</i> spp. and <i>Ascaris</i> spp.); <i>supportive treatment</i>: in anemic patients iron substitution, surgical removal of prolapse and antibiotic(s) in <i>individuals</i> with secondary bacterial infections;</p>

**Nematocidal Drugs, Man. Table 1** Drugs used against nematode infections of humans (Continued)

DISEASE (alphabetical order) stage(s) of interest (location), other information	International nonproprietary name (INN) (oral dosage: adult = pediatric, d = days), additional information	Characteristics miscellaneous comments
treatment of <i>individuals</i> with complex infections relies chiefly on BZs compounds as albendazole and mebendazole, which are widely available; for multiple infections that include <i>Ascaris</i> and hookworms (↑), 2 drugs, levamisole and pyrantel, are still widely used and effective, particularly against <i>Ascaris</i> ; <i>community or mass drug treatment</i> (individuals across the community become treated) now predominates; pyrantel and BZs (albendazole, mebendazole) fulfill the need in mass drug treatment for safe, broad-spectrum and essentially single-dose drugs; however, these drugs remain “suboptimal” for the treatment of <i>Trichuris</i> infections		
<b>ABERRANT (ATYPICAL) NEMATODE INFECTIONS</b> nematodes whose definitive hosts are usually animals can infect humans but are unable to develop to adults in humans		
<b>CUTANEOUS LARVA MIGRANS (CLM)</b> humans become infected by direct contact with <i>3rd-stage larvae</i> of various nematodes such as hookworms, <i>Ancylostoma caninum</i> , <i>A. braziliensis</i> of dog and cats, or <i>Anatrichosoma cutaneum</i> of rhesus monkeys (infective larvated egg); humans become also infected by ingestion of larvated eggs or intermediate host containing L <sub>3</sub> larvae of various animal nematodes (cf. visceral larva migrans = VLM ↓) or by <i>Dirofilaria repens</i> of dogs and cats (vector <i>Aedes</i> , infective microfilariae cause subcutaneous nodules round the eye) or by <i>D. tenuis</i> of raccoons (vector mosquitoes, infective microfilariae cause subcutaneous nodules); infective larvae of <i>Uncinaria stenocephala</i> (dog, cat, fox in temperate climates) or <i>Bunostomum phlebotomum</i> (GI nematodes of cattle and Zebu) may also cause “creeping eruptions” (typical serpiginous tracks in the epidermis); creeping eruptions are usually associated with intense itching, which may be provoked by proteolytic enzymes released from larvae; scratching is often associated with secondary bacterial infection; however, most frequent CLM observed in humans is due to hookworm larvae of <i>Ancylostoma</i> spp. of dogs and cats; infection may occur by larvae from soil that enter the skin and migrate in it, or larvae of <i>A. caninum</i> are accidentally ingested by humans and cause an <i>eosinophilic enterocolitis</i>		
<i>Ancylostoma caninum</i> (dog) it may also cause <i>A. braziliensis</i> (dog, cat) <i>A. ceylanicum</i> (dog, cat, civet) 3rd-stage larvae ( <b>skin</b> : epidermis, deeper dermis, subcutaneous tissue, <b>intestine</b> )	<b>eosinophilic enterocolitis</b> ** <i>drug of choice</i> : <b>albendazole</b> (400 mg once, or <b>mebendazole</b> 100 mg bid × 3d: adult/pediatric), or <b>pyrantel</b> 11 mg/kg b.w. (max. 1 g) × 3d: adult/pediatric), or <b>endoscopic removal</b>	<b>CLM</b> (creeping eruption) <i>drug of choice</i> : <b>albendazole</b> (400 mg daily × 3d: adult/pediatric) <b>ivermectin</b> (200 mcg/kg b.w. × 1-2d: adult/pediatric) <b>*thiabendazole</b> topically (in DMSO or petroleum jelly)*[Davies HD et al (1993), Arch Dermatol 129:588], <b>**</b> [Albanese G et al (2001), Inter J Dermatol 40: 67]
<b>VISCERAL LARVA MIGRANS (VLM)</b> VLM in children is mainly caused by the larval stages of ascarids such as <i>Toxocara</i> though larval stages of other nematodes ( <i>Capillaria hepatica</i> of rodents, and <i>Lagochilascaris minor</i> of wild felines ↓) may also be responsible for the disease; in children the entity is characterized by chronic granulomatous and eosinophilic lesions in various inner organs; migrating tracks of the larva migrans in the liver, lungs, brain, and rarely in the eye are characterized by accumulations of macrophages, foreign-body giant cells, plasma cells, and eosinophils; pathological entity manifest itself in enlargement of the liver (hepatomegaly) and spleen, and/or pulmonary infiltration, which are often associated with bronchospasm; in case of involvement of CNS (encephalopathy) symptoms may be seizures and psychiatric manifestations; other symptoms may be intermittent fever, persistent cough, and high (about 50%) persistent circulating eosinophilia and weight loss; ocular larva migrans (OLM) can cause unilateral vision disorder and strabismus and occur primarily in older children; invasion of OLM in retina produces granuloma formation and retinoblastoma-like masses; the accumulation of cell infiltrates can produce distortion and detachment of retina; other pathologic effects may be diffuse endophthalmitis or papillitis associated with secondary glaucoma that may cause blindness; <i>dying larvae</i> induce formation of granulomata; capacity of granulomata (depending on numbers of dying larvae and the extent of tissues area affected) may be responsible for loss of sight; the condition is most usually seen in children 1–5 years of age; children who own a pet (dog or cat) and have unexplained fever and eosinophilia, might be infected with <i>Toxocara</i> ; adult worms and/or larvae of <i>Gnathostoma</i> spp. and <i>Gongylonema</i> spp. may also cause aberrant infections in humans; <i>Gnathostoma spinigerum</i> of cats, dogs and wild carnivores or <i>G. hispidum</i> and <i>G. doloresi</i> of swine (both live in the stomach wall) can cause gnathostomiasis; unlike <i>G. spinigerum</i> , <i>G. hispidum</i> cannot mature in humans; <i>Gnathostoma</i> has two intermediate hosts (=IH): first IH are cyclops (L <sub>2</sub> , early L <sub>3</sub> ), second IH (early L <sub>3</sub> , adult L <sub>3</sub> ) are freshwater fish and amphibians (e.g., frogs) containing encysted infective L <sub>3</sub> (especially in Japan loaches are infected with <i>G. hispidum</i> ); L <sub>3</sub> larvae encyst again when infected second IH is eaten by a paratenic hosts like reptiles (snakes), birds or mammals; accidental host (e.g., man) becomes infected by ingestion of paratenic hosts or by second IH (raw fish and amphibians) containing infective larvae; early clinical signs produced by migrating larvae may be fever, vomiting, abdominal		

**Nematocidal Drugs, Man. Table 1** Drugs used against nematode infections of humans (Continued)

DISEASE (alphabetical order) stage(s) of interest (location), other information	International nonproprietary name (INN) (oral dosage: adult = pediatric, d = days), additional information	Characteristics miscellaneous comments
<p>pain, and weakness; skin may be also affected showing creeping eruption (associated with erythema) and formation of subcutaneous abscesses of the trunk or extremities; disease patterns of <i>Gnathostoma spinigerum</i> VLM may also include cerebrospinal alterations, or migrating tracks in the liver and/or pulmonary infiltration; <i>Gongylonema</i> spp. parasitize a wide range of ruminants, monkeys, and a variety of other mammals worldwide; adult worms enter mucosa and submucosa of pharynx, esophagus, and stomach of their hosts; accidental ingestion of infected insects (IH are beetles, cockroaches) occasionally results in human infections, which typically involve the mouth and pharynx, including lips, tongue gums, tonsils, but not the esophagus (diagnosis: characteristic eggs in feces); other aberrant infections in humans have been occasionally recorded from ascarid nematodes such as <i>Baylisascaris</i> and <i>Lagochilascaris minor</i> (parasites of wild felines, canids, rodents, and didelphoids, opossum (latter species occur in Surinam and Trinidad); ingestion of their larvated eggs and hatched migrating larvae may cause skin creeping eruption and subcutaneous abscesses; spirurid worms, e.g., <i>Thelazia callipaeda</i> (occurring in the Far East and Europe), a common parasite of dogs, other canids, cat and rabbits, live under the nictitating membrane and in conjunctival sac of their definitive hosts; infected flies (IH) may infrequently place L<sub>3</sub> larvae in the eye region of humans where larvae cause conjunctivitis, pain, excess lacrimation, and occasionally paralysis of the lower eyelid muscles, which may be associated with an ectropion and fibrotic scarring</p>		
<p><b>BAYLISASCARIASIS</b> <i>Baylisascaris procyonis</i> (<i>Baylisascaris</i> spp. of wild felines, carnivores, raccoon, rodents, and didelphoids, e.g., opossum) <b>larvated eggs, 3rd-stage larvae</b> (L<sub>3</sub> migrate through <b>various organs</b>, CNS, eye and become arrested to become gradually phagocytized)</p>	<p><b>albendazole</b> 25 mg/kg b.w./d × 20d started as soon as possible (up to 3d after possible infection) might prevent clinical disease and is recommended in children with known exposure (e.g., ingestion of raccoon stool or contaminated soil [Gavin PJ, Shulman ST (2003), <i>Pediatr Infect Dis</i>: 22: 651])</p>	<p>no drugs have been found to be sufficiently effective; drugs that might be tried include BZs (mebendazole, albendazole, thiabendazole, levamisole, or ivermectin); steroid therapy may be helpful in controlling exaggerate inflammatory reactions, especially in affected eye and CNS; ocular baylisascariasis has been successfully treated using laser photocoagulation therapy to destroy the intraretinal larvae</p>
<p><b>TOXOCARIASIS (VLM)</b> humans (primarily children) acquire infection by ingestion of embryonated <i>Toxocara</i> eggs from soil; children frequently adopt the habit of dirt eating and where soil is heavily contaminated with <i>Toxocara</i> eggs (e.g., in soil around doorsteps, garden soil, playgrounds and sidewalks, rural settings such as farms) the ingestion of even moderate amounts of soil may result in intake of large numbers of infective eggs; the custom of giving young puppies to children as playmates, a special hazard may arise since it is the young puppy, which is preferentially infected with <i>T. canis</i> (clinical signs of VLM and OLM syndrome cf. general discussion ↑)</p>		
<p>VLM (TOXOCARIASIS) <i>Toxocara canis</i> (common host: dog, cat) <i>Toxocara cati</i> (common host: dog, cat) [<b>larvated eggs</b> (L<sub>2</sub>) in soil infective for man, <b>extraintestinal</b> L<sub>3</sub> migrating through various organs including CNS and eye (becomes arrested in tissues to be gradually phagocytized), <b>disintegrated larva</b> induces formation of granulomata causing serious clinical signs] *optimum duration of BZs therapy is not known (others would treat for 20d)</p>	<p>*<i>drug of choice:</i> <b>albendazole</b> (400 mg bid × 5d, or <b>mebendazole</b> 100–200 mg bid × 5d: adult/pediatric) <i>diagnosis</i> of VLM: ELISA (L3 antigen) has sufficient specificity (~92%), and sensitivity (~78%) titer &gt;1:32 suspected of having VLM; OLM is diagnosed on clinical criteria; treatment for OLM include <b>surgery</b> (e.g., vitrectomy, i.e., partial removal of vitreous body)</p>	<p>there were contradictory reports concerning the use of <i>diethylcarbamazine</i> in treating VLM (6 mg DEC/kg/d in 3 doses × 7–10d for adults and children: dose regimen is now obsolete); efficacy of DEC and <i>thiabendazole</i> has been considered doubtful by some authors; patients may improve without treatment within 3 months after infection; careful diagnosis is necessary in OLM; mistaken diagnosis may result (and on several occasions has resulted) in unnecessary</p>
<p>enucleation of the eyeball; administration of <i>glucocorticoids</i> are useful in suppressing intense inflammatory reactions of the eye and may lead to improvement of serious symptoms, including relief from pain; anthelmintics (e.g., BZs) could be tried</p>		
<p><b>ANGIOSTRONGYLIASIS</b> humans acquires infection by ingestion of raw or undercooked intermediate hosts (mollusks: slugs, crustaceans: freshwater prawns) containing infective 3rd-stage larvae; <i>A. cantonensis</i> occurring in Australia, Pacific Islands, Taiwan, Malaysia, the Far East, and India may be the cause of eosinophilic meningitis or meningoencephalitis (threadlike larvae may be found in subarachnoid space); dissemination of the disease in humans is due to one of the best intermediate hosts of <i>A. cantonensis</i>, the giant African land snail, <i>Achatina fulica</i>, which is a popular item of food in some countries; <i>A. costaricensis</i> is widespread in the American continent from the USA to northern Argentina, particularly high in Costa Rica (intermediate hosts are slugs); pathogenesis is attributed to degenerated third stage larvae causing hepatic lesions and thrombus formation destroying arterial walls; adult worms in mesenteric arteries or eggs in the intestinal wall (which fail to hatch in humans) may provoke local</p>		

**Nematocidal Drugs, Man. Table 1** Drugs used against nematode infections of humans (Continued)

DISEASE (alphabetical order) stage(s) of interest (location), other information	International nonproprietary name (INN) (oral dosage: adult = pediatric, d = days), additional information	Characteristics miscellaneous comments
inflammatory reactions and necrosis; principal pathological alterations consist of intestinal eosinophilic granulomata resulting from arteritis, thrombosis and small infarcts; necrotic ulcerations may be found in regional lymph nodes and sometimes peritonitis or involvement of brain with myeloencephalitis may occur; involvement of the eye associated with meningoencephalitis may at times be fatal; other clinical signs may be fever, peripheral eosinophilia, leucocytosis (enhanced when liver is involved), and marked abdominal pain in the right iliac fossa and right flank (palpable tumor-like masses); <i>A. cantonensis</i> disease is self-limiting, and recovery usually occurs within 4 weeks following first symptoms		
<p><i>Angiostrongylus cantonensis</i> rat lungworm: <b>3rd-stage larvae</b> (capillaries of meninges) <i>A. costaricensis</i> (common host, wild rodents) <b>3rd-stage larvae, adults, eggs</b> (cranial mesenteric arterioles and arterioles of cecum) <b>prevention:</b> thorough inspection of vegetable for hidden slugs, avoidance of eating raw or not well-cooked crustaceans or snails</p>	<p>most patients with mild disease have a self-limited course and recover completely; it appears therefore doubtful whether treatment with common anthelmintics will lengthen or shorten the duration of symptoms; in <i>A. costaricensis</i> infections, surgical treatment may be indicated for definitive cure; analgesics, corticosteroids, and careful removal of cerebrospinal fluid (CSF) at frequent intervals can relieve symptoms from increased intracranial pressure [Lo Re III V, Gluckman SJ (2003), <i>Am J Med</i> 114: 217]; no anthelmintic drug (mebendazole: 100 mg bid × 5d against <i>A. cantonensis</i> or 200–400 mg tid × 10d against <i>A. costaricensis</i>, or thiabendazole 75 mg/kg/d in 3 doses × 3d, max. 3g/d) is proven to be effective, and some patients have worsened with therapy [Slom TJ et al. (2002), <i>N Engl J Med</i> 346: 668]; in one report, mebendazole and a corticosteroid appeared to shorten the course of infection [Tsai H-C et al. (2001), <i>Am J Med</i> 111: 109]; levamisole and ivermectin have been used successfully in rats infected with <i>Angiostrongylus</i>; <b>diagnosis</b> is possible by endoscopic resection and examination of biopsy samples; ELISA and latex agglutination have been employed in diagnosis</p>	
<p>ANISAKIASIS (herring worm disease, codworm) common, marine nematodes (distantly related to ascarids) such as adult <i>Anisakis</i>, <i>Contracaecum</i>, <i>Phocanema</i>, and <i>Terranova</i> live in the lumen of the intestinal tract of sea mammals (whales, dolphins, seals, and sea lions); larvated eggs hatch in ocean water, where they are ingested by small crustaceans (krill); they develop in krill to 3rd-stage larvae; krill are eaten by a wide variety of fish, (<i>Anisakis</i>: salmon, herring, mackerel, cod; <i>Pseudoterranova</i>: cod, pollack, halibut, and haddock), and squid; larvae (without further development) may pass up the food chain from fish to fish; when ingested by marine mammals, larvae mature in the stomach causing lesions and ulcers; humans become infected by ingestion of <i>raw fish</i> (smoked, salted, pickled, poorly cooked) containing infective 3rd-stage larvae of marine nematodes; practice of eating raw seafood (sushi, sashimi, lightly salted “green” herrings, Tahitian salad, and others) in Japan and elsewhere (increasingly in Europe and the USA) has led to increased prevalence of larval anisakid infections; the disease is classified into gastric, intestinal, and extra-gastrointestinal (ectopic) anisakiasis; ectopic larvae in abdominal cavity enter various abdominal organs or tissues provoking peritonitis and inflammatory foci; larvae invading gastric mucosa cause acute epigastric pain within a few hours of their being ingested; various symptoms (nausea, vomiting, blood vomitus, ileus, generalized abdominal pain, heart burn, diarrhea and others) following infection depending on the location of the invasive larvae as they move down the intestine</p>		
<p><b>third-stage larvae</b> (about 2 cm long) (more frequently in <b>stomach</b> wall and/or intestinal tissues; <b>extraintestinal sites</b>: mesenteries and abdominal cavity, esophagus, posterior oropharynx)</p>	<p><b>treatment of choice:</b> <b>surgical or endoscopic removal</b> (by means of biopsy forceps of the endoscope, removal of anisakid larvae can cause anaphylactic reaction if larva to be removed becomes injured)</p>	<p>successful treatment of a patient with anisakiasis with <b>albendazole</b> has been reported [Moore DA et al. (2002), <i>Lancet</i> 360: 54] for more information upon treatment of anisakiasis cf. [Repiso Ortega A et al. (2003), <i>Gastroenterol Hepatol</i> 26: 341];</p>
<p><b>ivermectin</b> may be approved for treatment of anisakiasis in some countries (?); <b>endoscopy</b> is a useful tool for diagnosing gastric anisakiasis; X-ray examination (<b>radiology</b>) may reveal coiled or threadlike filling defects, and inflammatory reactions such as eosinophilic granulomata or ulcer(s); <b>immunodiagnosis</b> is essential for patients with a chronic course of infections and those with an extra-gastrointestinal anisakiasis; suitable assays are ELISA using a monoclonal antibody recognizing an epitope of anisakid larvae, or immunoblot using E-S antigens of <i>A. simplex</i> detecting IgA, or IgE antibodies specific for E-S antigens of larvae; <b>preventive measures</b> include the removal of the abdominal viscera of fish as soon as possible after catch (prevents additional larvae migrating into muscles) freezing of fish (20°C for 3–5 days), or thorough cooking prior to consumption (internal temperature at least 60°C for 10 min); anisakid larvae can survive for some days in soy sauce, Worcester sauce, and vinegar</p>		
<p>GNATHOSTOMIASIS and GONGYLOEMIASIS adults of <i>Gnathostoma spinigerum</i> live in the stomach of dogs cats and wild felines or swine (reptiles, birds, or mammals serve as paratenic hosts, i.e., encysted third stage larvae ingested with fish may encyst in paratenic hosts again); humans (accidental host) become infected either by ingestion of raw or undercooked <b>freshwater fish</b> (also amphibians as frog ) or by ingestion of paratenic hosts (life cycle cf. cutaneous larva migrans = CLM↑); gnathostomiasis spinigera has several visceral</p>		

**Nematocidal Drugs, Man. Table 1** Drugs used against nematode infections of humans (Continued)

DISEASE (alphabetical order) stage(s) of interest (location), other information	International nonproprietary name (INN) (oral dosage: adult = pediatric, d = days), additional information	Characteristics miscellaneous comments
forms and cutaneous forms (“creeping eruptions” and subcutaneous abscess cf. CLM↑); the process of <i>larval migration</i> through various organs (wall of small intestine, urogenital tract, striated muscles, liver, lungs, ear, nose, eye, and brain) may produce various <i>pathological reactions</i> around invading worms such as acute and chronic inflammatory reactions (accumulation of round cells), local hemorrhage, necrosis, edema, fibrosis, or tumorlike masses; as a result, there are various disease patterns such as gastrointestinal disorder, infiltration of the lungs and liver, ocular disorders associated with visual impairment, and often eosinophilic meningoencephalitis or there may be eosinophilic myeloencephalitis associated with obstructive hydrocephalus; death may occur when brain stem with massive hemorrhage in this area is involved; <i>diagnosis</i> can be made by morphological (biopsy), and when recovery of worms is not possible, by an ELISA assay using E-S products of advanced 3rd-stage larvae for detecting antigen specific IgG or IgE antibodies in sera or spinal fluid		
<i>Gnathostoma spinigerum</i> (most important species of 12 distinct species, body of worms is entirely covered with cuticular spines) <b>3rd-stage larvae</b> (CLM/VLM) <b>adult stages</b> can develop in man but cannot return to intestinal tract ( <b>extraintestinal sites</b> : skin, subcutaneous tissue, various organs, including brain)	<i>treatment of choice</i> : <b>albendazole</b> (400 mg bid × 21d: adult/pediatric) or ivermectin (200 mcg/kg b.w. × 2d: adult/pediatric) ± <b>surgical removal</b> all patients should be treated with a medication regardless of whether surgery is attempted [de Gorgolas M et al (2003), <i>J Travel Med</i> 10: 358]	<i>corticosteroids</i> , <i>analgesics</i> , and careful removal of CSF at frequent intervals can relieve symptoms; <i>surgical removal</i> of adults (12–33 mm long), and larvae (3–4 mm long) may be necessary for definitive cure; <i>prevention</i> of infections relies on avoidance of raw or inadequately cooked hosts that contain L <sub>3</sub> and avoidance of drinking water containing infected cyclops; use of gloves or frequent washing of hands
while handling food will prevent larval penetration of skin; larvae are killed by boiling food for 5min or freezing at minus 20°C for 3–5 days; increase in world travel and importation of food require greater awareness of potential gnathostomiasis spinigera		
<i>Gongylonema</i> sp. (common in ruminants, monkeys and other mammals) L <sub>3</sub> (infection typically involves <b>mouth</b> and <b>pharynx</b> of humans)	<i>treatment of choice</i> <b>surgical removal</b> or <b>albendazole</b> (10 mg/kg b.w. × 3d: adult/pediatric) [Wilson ME et al. (2001) <i>Infect Dis</i> 32: 1378]	
<b>DIROFILARIASIS</b>		
the common heartworm of dogs and other carnivores, <i>Dirofilaria immitis</i> (adults, about 12–30 cm long, live in arteries of the lungs and right ventricle of heart), is primarily a problem of warm countries where the mosquito intermediate host abounds (cf. → <b>Nematocidal Drugs, Animals</b> /Table 5); aberrant infection of humans occur when the female mosquito (various genera) takes a blood meal and transmits infective larvae L <sub>3</sub> (~ 800–900 μm long); <i>D. tenuis</i> (parasite of raccoons, southern parts of the USA) and <i>D. repens</i> (parasite of dogs and cats in Europe, Southeast Asia, and Africa) are other filariae, which may infect humans; <i>D. immitis</i> infection is usually asymptomatic but may be seen as small peripheral lesions (“coin”-size granulomata, each containing a single worm) in <i>lungs</i> on radiography; <i>D. tenuis</i> and <i>D. repens</i> may occur in <i>subcutaneous nodules</i> on various parts of the body, whereas those of <i>D. repens</i> particularly occur round the eye, in the eyelids, and/or retrobulbar tissues; serodiagnostic tests have shown that occurrence of serum antibody to <i>D. immitis</i> correlated with prevalence of <i>D. immitis</i> infections in dogs (reliable serodiagnostic test are available)		
<i>Dirofilaria</i> spp. <b>migrating larvae</b> , infertile young adults ( <b>extraintestinal sites</b> : subcutaneous tissue, lungs, eye)	chemotherapy in humans is unknown (for drugs used against heartworm disease in dogs, cf. → <b>Nematocidal Drugs, Animals</b> /Table 5)	<b>surgical removal</b> of larvae and infertile adults (microfilariae are not produced) may be indicated if there is harm for patient; diethylcarbamazine (DEC) or ivermectin may have prophylactic action against <i>Dirofilaria</i>
<b>OESOPHAGOSTOMIASIS</b>		
<i>Oesophagostomum</i> spp. occur worldwide and are common parasites of ruminants, swine, and some apes (gorilla, and chimpanzee) and other monkeys (e.g., macaques); human infections are rare and may be most common in Africa ( <i>O. bifurcum</i> ) with some reported cases in Indonesia, China, and South Africa ( <i>O. aculeatum</i> ); humans become infected by oral ingestion (most likely route) of <i>infective 3rd-stage larvae</i> from soil but infection through the skin is also possible; larvae may produce large tumorlike inflammatory masses (helminthoma measuring 1–2 cm) in the intestinal wall, which are usually located in the ileo-cecal region but can be present in other organs and the abdominal wall; such nodules often become abscessed or perforate and hemorrhage and require surgical intervention; major symptoms of the disease are severe abdominal pain, diarrhea, and rectal bleeding with subsequent anemia; rare subcutaneous nodules are due to L <sub>3</sub> larvae that penetrate the skin directly or are disseminated via circulation from the bowel; <i>diagnosis</i> and differentiation from hookworm is difficult because the eggs are similar in size and appearance (serological tests are available for specific diagnosis); oesophagostomiasis principally is a self-limiting infection		

**Nematocidal Drugs, Man. Table 1** Drugs used against nematode infections of humans (Continued)

DISEASE (alphabetical order) stage(s) of interest (location), other information	International nonproprietary name (INN) (oral dosage: adult = pediatric, d = days), additional information	Characteristics miscellaneous comments
<i>O. aculeatum</i> (syn. <i>O. apiostomum</i> ) <i>O. bifurcum</i> ; <i>O. stephanostomum</i> <b>3rd-stage larvae</b> become arrested in cysts or nodule and may calcify ( <b>intestinal wall, skin</b> )	*albendazole *pyrantel pamoate (cure rate obtained with both drugs may be up to >80%) *[Krepel HP et al. (1993), <i>Trans R Soc Trop Med Hyg</i> 87: 87] <i>albendazole</i> or <i>pyrantel</i> may be effective: [Ziem JB et al. (2004), <i>Ann Trop Med Parasitol</i> 98: 385]	larvae burrow deeply into the mucosa up to muscularis mucosae of large intestine (and small intestine: <i>O. bifurcum</i> ) causing marked inflammatory reactions; rupturing of nodules into lumen can give rise to bleeding and bacterial superinfection, often misdiagnosed as carcinoma, ameboma, or appendicitis; diagnosis can be made by barium enema examination, or endoscopic measures (laparoscopy) or ELISA assay (worm- specific IgG4 antibody, specificity >95%)

Abbreviations: bid = twice daily; tid = three times per day; p.c. (post cibum) = after meals

Dosages listed in the table refer to information from manufacturer, literature, WHO web sites, and Medical Letter (2004) "Drugs for parasitic infections" Volume 46 (issue 1198): e1–e12. New Rochelle, New York; Additional information on antinematodal drugs used in veterinary medicine (e.g., drug products, their biological characteristics, adverse effects, manufacturers, and suppliers), cf. →Nematocidal Drugs, Animals, general considerations, and Tables 1–6; data given in this table have no claim to full information

countries of the northern hemisphere. Adult worms live in the lumen of the colon and feed on gut contents. Gravid females leave the anus and deposit eggs around the anus (5,000–10,000 eggs/female). Fully embryonated eggs are infective within a few hours and may infect humans by the oral route or rarely by aberrant routes resulting in peritonitis or adnexitis (Table 1); intestinal larvae mature to adults within about 6 weeks. Reinfections may frequently occur and this should be considered in treatment strategies. A characteristic clinical feature of *Enterobius* infections is the perianal itching occurring preferably at night.

About 500–1,000 million people are estimated to be infected with the cosmopolitan →whipworm →*Trichuris trichiura*, which is common in warm and humid climates. Adult worms (3–5 mm long) live attached to the cecal mucosa. The eggs passed with the feces require about 3 weeks to become infective. Eggs are fairly resistant to the environment and can survive in the soil (and thus remain infective) for more than 1 year. The larvae hatch after eggs have been taken up, e.g., with vegetables or dirt, and mature in the intestine within 2–3 months. Adults live in the host for 3–10 years and may be asymptomatic; moderate and heavy infections lead to considerable pathogenic effects of the mucosa of the large intestine accompanied with clinical signs such as abdominal discomfort, diarrhoea, anemia, retardation of growth and mental development in children.

Nearly 50–100 million people may be infected worldwide with the threadworm →*Strongyloides stercoralis* occurring mainly in tropical and subtropical climates, extending into areas of southern Europe and those of southern USA. Parasitic female worms live in

the small intestine attached to the mucosa on which they feed. They produce larvated eggs by →parthenogenesis passed in feces and hatch rapidly either to become free-living adult and female worms or parasitic larvae infecting humans by skin penetration or ingestion. The development of 3rd-stage larvae in the host resembles that of hookworms and takes about 17 days to become adult females. →Autoinfection is possible if first (filariform) stage hatches in the gut and penetrates mucosa of colon or perianal skin; autoinfection may perpetuate for several years. Strongyloidiasis belongs to the opportunistic infections often being asymptomatic. However, in immunocompromised persons infection can cause serious gastrointestinal symptoms such as catarrhal enteritis associated with severe diarrhoea and central epigastric pain, which may be fatal in heavily infected immunocompromised patients.

Treatment of GI →nematodes of humans is given in detail in Table 1 (note: alphabetical order). There are highly effective drugs that may remove adult worms from the gut after a single dose, though their action is generally limited against migrating larvae even after repeated dosing. Pathological consequences of GI nematodes due to travelling larvae through tissues of the host (cf. →larva migrans below and Table 1) thus remain largely unaffected by chemotherapy.

### Cutaneous/Visceral Larva Migrans Syndrome, Trichinosis, and Dracunculiasis

Nematode infections of the dog and cat may be responsible for several aberrant larva infections in humans such as →echinococcosis (→Cestodocidal Drugs),

cutaneous and/or visceral larva migrans (Table 1). →Cutaneous larva migrans is most frequently seen with *Ancylostoma* larvae, which cause the so-called →creeping eruption, an intensive itching dermatitis. Visceral larva migrans is mainly due to migrating larvae of *T. canis* in children but also to a variety of other nematode larvae (Table 1). Larvae can migrate through the inner organs of humans and may produce mechanical damage in the liver, lungs, brain, and in the eye. The disease entity is characterized by chronic granulomatosis, usually eosinophilic lesions, which may lead to hepatomegaly, pulmonary infiltration, and persistent circulating →eosinophilia. The clinical signs vary greatly and may be persistent cough, intermittent fever, loss of weight, and loss of appetite. Treatment of larva migrans is problematic and prevention is the most effective measure (Table 1).

Ubiquitous →*Trichinella spiralis* (it does not occur in Australia) may infect about 40–50 million people worldwide. In Europe, annual cost for the control of potential →trichinosis of the swine may amount to US \$370 million. In the last 20 years, about 2,600 cases of trichinosis have been recorded chiefly in France, Italy, and other parts of Europe. Humans mainly become infected by consumption of raw or improperly cooked meat (especially pork, also horsemeat) containing encapsulated muscle larvae. After being ingested, larvae become freed in the intestine; they mature to female and male adults, who mate, and females produce larvae (up to 2,000/female) within 2 weeks. Released larvae penetrate the gut wall, enter the lymphatic vessels, disseminate via the circulatory system throughout the body, develop in the muscle, and finally encyst in muscle fibers. Infection is usually asymptomatic during the intestinal phase. The muscle infection may produce fever, characteristic eye edema, myositis, eosinophilia, leucocytosis, and muscular pain. Once the diagnosis is made, the majority of larvae has already been released and become distributed to all tissues, so that removal of adult worms from the small intestine by administering albendazole or mebendazole may be too late because of their expulsion by immune mechanism of the host. Migrating larvae rather than larvae after entering the muscle cell remain unaffected by these drugs (Table 1).

During the last 50 years there has been a sustained and rapid reduction in the reported →dracunculiasis (→Guinea Worm) incidence worldwide. The numbers of humans infected with the Guinea (dragon) or Medina worm, →*Dracunculus medinensis* had gradually been reduced by more than 99% from an estimated 3.5 million persons in 1986 to ~16,000 cases in 2004 (details cf. Table 1). The ingested larvae develop in the body cavity and deeper connective tissue for about 12–14 months before they become mature. Thence adult females migrate to the subcutaneous tissues, preferable

the legs where they emerge thereby causing blisters and ulceration of the skin. When the skin contacts water the emerging female worm releases large numbers of larvae. Copepod crustaceans take them up, and the larvae develop in the body cavity to become infective within 2–3 weeks. Humans are infected by drinking water containing infected copepods. Dogs are known to be reservoir hosts (for more detailed information on traditional treatment cf. Table 1).

### Filarial Nematodes of Medicinal Importance

According to new estimates about 120 million people are infected by filariae causing lymphatic →filariasis. →*Wuchereria bancrofti* is widely distributed throughout the tropics and subtropics, while →*Brugia malayi* occurs focally in India, Southeast Asia, and Japan. *Brugia timori* has only been recognized on islands of Indonesia and Timor. The life cycle of lymphatic filariae involves various mosquito species as intermediate hosts in which infective larvae develop and penetrate the skin of humans when the insect bites. Developing larvae, adult worms, and females producing larvae, which transform to microfilariae (MF), live in the lymphatics and may block lymphatic vessels. Thence MF enter the peripheral circulation and are taken up by →mosquitoes with a blood meal. Lymphatic obstruction by filariae leads gradually to pathological alterations such as lymphangitis, hydrocele, and moderate-to-severe elephantiasis in time. Control of →lymphatic filariasis relies on →chemoprophylaxis with diethylcarbamazine (DEC), albendazole and ivermectin (for mass drug treatment programs and alternative chemotherapeutic approaches using doxycycline to eliminate *Wolbachia* cf. Table 1). Chemotherapy may be problematic if there are already severe chronic pathological changes, e.g., massive elephantiasis, which requires radical surgery to remove new adventitious tissue.

The tissue-dwelling nematode, →*Onchocerca volvulus*, has a focal distribution in Africa and South America and causes the so-called →river blindness or →onchocerciasis, a disease of public health importance. *O. volvulus* infect about 18 million people in Africa and about 140,000 in South America. The life cycle of *O. volvulus* involves black flies (→*Simulium* spp.) as intermediate hosts. Adult worms (→*Macrofilariae*) live in subcutaneous nodules and female worms produce MF. These are located in the superficial layers of the skin, where they are taken up with a blood meal by black flies, in which they develop into the infective larvae. Humans are infected when the fly takes another blood meal. Only dying and dead MF induce pathological changes that gradually increase the longer the infection has persisted. There are a variety of acute and chronic lesions of the dermis and the eye. Thus invasion of the eye leads to →conjunctivitis, keratitis, iridocyclitis, chorioretinitis,

glaucoma, and opacity of the lens resulting in optic atrophy and blindness. Control of onchocerciasis relies on chemoprophylaxis with ivermectin and nodulectomy (for detailed information cf. Table 1).

→*Loiasis* is caused by the African →eye worm, →*Loa loa*, a tissue-dwelling nematode; it infects about 33 million humans in the rain forests of West and Central Africa, where it has a focal distribution. The life cycle involves →*Chrysops* flies, in which infective larvae develop. When a fly bites, these larvae enter the vertebrate host where they mature to adults, which migrate through the subcutaneous tissues and under the conjunctiva of the eye. Adult worms (macrofilariae) produce so-called →Calabar swelling in hand and arms and considerable irritation and congestion of the eye. MF produced by female worms migrate from the subcutaneous tissues to the peripheral circulation where they are taken up with a blood meal by flies. Control of →*loiasis* may rely on chemoprophylaxis with DEC, which destroys MF and thus interrupts transmission of infection to *Chrysops* flies. However, killed MF may cause severe “allergic” reactions, which can be reduced by gradually increasing DEC doses. The adult worm under the conjunctiva of eye must be removed surgically (for detailed information cf. Table 1).

Other filarial infections such as mansonelliasis or tropical pulmonary eosinophilia, and other nematode infections occurring in humans are listed in Table 1.

---

## Nematocystis

→*Gregarines*.

---

## Nematode Infections, Man

### General Information

The vertebrate intestine is most likely one of the major ancestral sites for parasites. Access to the bodies of vertebrate host as well as to the high concentrations of nutrients available locally may account for the fact that intestinal species are, overall, still the commonest although not the most pathogenic of all parasites. However, the gastrointestinal tract should not be considered as a single homogeneous habitat but as series of habitats, each with its own distinct characteristics. Different nematode species prefer certain locations in the intestine to which they are able to actively migrate. In addition, depending on the size and physiology of the worms some species, such as

→*Ascaris* (*Ascariasis*), live in the lumen, while others, e.g., →hookworms, have an intimate association with the mucosa or live wholly or partially in mucosal tissues like →*Trichinella spiralis* (*Trichinelliasis*) or species of →*Trichuris* (*Trichuriasis*). In contrast to older views where it has been thought that worms living in the gut lumen were effectively outside the body and could neither initiate nor be affected by immune responses it has now become evident, that intestinal worms clearly are targets for the host’s immune response.

Exploitation of habitats other than the intestine of the host is common in the Nematoda. Many species that live as adults in the intestine, e.g., *Ascaris* (*Ascariasis*), →hookworms (→Hookworm Disease), *Nippostrongylus*, and *Trichinella* (*Trichinelliasis*) reside and develop as larval stages in parenteral tissues. Other species, such as filariae are wholly confined to the host tissues and have no contact with gastrointestinal tract (*Filariasis*). These fundamental differences in the developmental cycles of the →nematodes must be considered when protection or pathology induced by different immune mechanisms is analyzed.

Important diseases caused by nematodes are listed in Table 3 of chapter on Pathology.

### Immune Responses

For immune responses induced by other nematodes than those listed below please refer to the respective diseases.

→*Heligmosomoides polygyrus* and *Trichuris muris*.

In mice infected with these nematodes host protective effects of IL-4 have been most prominently demonstrated. While treatment with anti-IL-4 or anti-IL-4 receptor antibodies blocked host immunity to challenge infections and allowed the establishment of →chronic infections with *T. muris*, there were apparent differences in IL-4 deficient mice. Such mice failed to control *H. polygyrus* but were still able to expel *T. muris*, suggesting that IL-4-compensating factors, such as IL-13, might be efficient in promoting *T. muris* expulsion, but not *H. polygyrus* expulsion. Treatment of mice with IL-4 complexes displaying a prolonged half-life *in vivo* cured even established *T. muris* and *H. polygyrus* infections.

### *Nippostrongylus brasiliensis*

Infection of mice with *N. brasiliensis* is a well-established model to investigate Th2 responses. Infective third stage (L<sub>3</sub>) larvae are injected through the skin and migrate to the lungs (days 1–2) where a strong eosinophilic inflammatory response is induced. Larvae are coughed up and swallowed (days 2–4) and mature into egg-laying adults in the jejunum (days 5–8). Adult worms are expelled by days 9–11 after inoculation. Independent of the genetic background of mice, infection



is accompanied by blood and lung →[eosinophilia](#), intestinal mastocytosis, and high IgE levels.

It has been recently shown that IL-5 is essential for eosinophilic lung inflammation associated with hemorrhage and alveolar wall destruction. Interestingly, the induction of airway hyperresponsiveness was unimpaired in IL-5-deficient mice, demonstrating that eosinophils are not required for the induction of airway constriction following *N. brasiliensis* infection.

IL-4 appears not to be necessary to protect mice from *N. brasiliensis* infections since IL-4-deficient mice expel this nematode normally. However, treatment with exogenous IL-4 completely cured infected SCID mice, also when the animals were additionally treated with anti-c-kit antibodies. These findings argue for IL-4-induced mechanisms of *N. brasiliensis*-expulsion which are independent of B-, T-, and mast cells. One of the mechanisms involved might be an IL-4-induced increase in intestinal permeability which could result in an inhibition of worm feeding by blocking the nematode contact with the gut mucosa. Expulsion of *N. brasiliensis* from the gut of W/W<sup>v</sup> mice, deficient in mast cells, has been described as slow in some, but not all studies. Since restoration of the mast cell compartment by bone marrow transplantation did not correct for slow expulsion of worms, additional defects in W/W<sup>v</sup> mice, such as the absence of intraepithelial  $\gamma/\delta$  T cells, most likely accounts for the defect in worm expulsion in these mutant mice. The IL-4-independent mechanism(s) inducing *N. brasiliensis* expulsion has not yet been identified but is known to be CD4<sup>+</sup> Th cell dependent and suppressible by IFN- $\gamma$  and IFN- $\alpha/\beta$ . Possible candidates for this are antibody-mediated worm damage, mucus trapping, and lipid peroxidation. Antibody-mediated protection has been demonstrated by the fact that serum transfer from immune mice provides protection against *N. brasiliensis*. Mucus trapping preventing adherence or feeding of the worm is suggested by an increase in mucus production and →[carbohydrate](#) content accompanying *N. brasiliensis* expulsion, although studies in rats have shown that this phenomenon is not essential for parasite expulsion. The possibility that lipid-peroxidation by host-produced oxygen intermediates damages *N. brasiliensis* was suggested by experiments with reactive oxygen scavengers (butylated hydroxyanisole) which suppressed worm expulsion. An interesting hypothesis in this context is that the expression of enzymes such as →[glutathione reductase](#), superoxide dismutase or catalase by nematodes offer some protection against reactive oxygen intermediates produced by the host.

Summarizing the studies with the different rodent models of nematode infections 4 generalizations can be made: (1) CD4<sup>+</sup> T cells are essential for host protection, (2) IL-4 production induces either essential or redundant protective mechanisms, (3) IFN- $\gamma$  and IL-12

inhibit protective immunity, and (4) some cytokines, such as IL-5, that are stereotypically produced in response to gastrointestinal nematode infections appear not to contribute to protective immunity.

## Therapy

→[Nematocidal Drugs](#), [Man](#).

---

## Nematodes

### Name

Greek: *nema* = filament, *zoon* = animal.

### Synonyms

→[Threadworms](#), →[roundworms](#).

### Classification

Phylum of →[Metazoa](#), group of Ecdyzoa.

### General Information

The nematodes are elongate worms ranging in length from 0.3 mm up to the 8.5 m of →[Placentonema gigantissimum](#) in the placenta of whales; they may inhabit soil, freshwater and saltwater habitats, and are frequently encountered as parasites of plants, humans, or animals. In general they are dioecius and in many species clear →[sexual dimorphism](#) exists (Fig. 12, →[Hookworms](#)/Fig. 1). Males are usually smaller than females (Table 1); both may have copulatory organs. The bilaterally symmetrical body of the unsegmented nematodes is covered by a typical →[cuticle](#) which is formed by a hypodermis and must be shed during →[molt](#) (Fig. 8, →[Ecdysis](#)). The pseudocoelomatic body cavity of adults mostly contains a complete digestive tract, the anus of which is subterminally situated (Figs. 11, 12).

Food of various kinds (blood, body fluid, intestinal contents, mucus, etc.) is taken up by means of the species-specific mouth (Figs. 10, 11). The excretory system, if present, empties through an anterior, ventromedial porus. Respiratory and circulatory systems are lacking; movements are brought about by contractions of the typically longitudinally oriented muscle cells (Fig. 8 C,D), with the fluid of the pseudocoel and the pressure of the cuticle working together as a hydrostatic skeleton. Apart from a few species (e.g., →[Strongyloides](#) spp.) the ontogenesis of nematodes runs as →[metamorphosis](#) involving 4 larval stages (L<sub>1</sub>-L<sub>4</sub>; Reproduction). →[Cell multiplication](#) after hatching is very restricted (→[Eutely](#)) except within the reproductive system, midgut, epidermis, and somatic musculature.

**Nematodes. Table 1** Important families and species of the Nematoda

Family/Species	Length of adult worms (mm)		Size of eggs (or larvae) ( $\mu\text{m}$ )	Final host/Habitat	Intermediate host	Prepatent period in final host (weeks)
	f	m				
<b>Trichuridae</b>						
<i>Trichuris trichiura</i>	50–60	50	50	Humans/Colon	–	4–12
<i>T. ovis</i>	35–70	50	70–80 $\times$ 30–42	Ruminants/Cecum	–	12
<i>T. vulpis</i>	75	75	80 $\times$ 35	Dogs, cats/Colon	–	11–15
<i>T. suis</i>	55	45	65 $\times$ 30	Pigs/Colon	–	6–7
<i>T. muris</i>	45	35	70 $\times$ 35	Rodents/Colon	–	8
<b>Capillariidae</b>						
<i>Capillaria annulata</i>	10–50	10–25	60–62 $\times$ 24–27	Chickens/Pharynx	Earthworms	3
<i>C. hepatica</i>	100	15–30	50 $\times$ 35	Lagomorpha, rodents, humans/Liver	–	21–28 (remain in liver)
<i>C. philippinensis</i>	45	3	50 $\times$ 35	Birds, humans/Small intestine	Fish, crustaceans	?
<i>C. aerophila</i>	30	25	60 $\times$ 25	Cats, dogs, hedgehogs/Lung	–	6
<b>Trichinellidae</b>						
<i>Trichinella spiralis</i>	3–4	1.5	Larvae (100 $\times$ 10)	Carnivores, humans/Intestine	–	1
<i>T. pseudospiralis</i>	2	0.9	Larvae (100 $\times$ 10)	Carnivores, humans/Intestine	–	1
<b>Mermithidae</b>						
<i>Mermis nigrescens</i>	125	100	70 $\times$ 30	Adults free-living	Larvae in body cavity of grasshoppers	–
<b>Strongyloidea</b>						
<i>Strongyloides papillosus</i>	<sup>a</sup> 4–6	–	40–60 $\times$ 32–40	<sup>a</sup> Ruminants/Intestine	–	1.5
	<sup>b</sup> 0.7–1.1	0.6	30	<sup>b</sup> Free-living	–	
<i>S. stercoralis</i>	<sup>a</sup> 2	–	40 $\times$ 30	<sup>a</sup> Dogs, humans/Intestine	–	2.5–4
	<sup>b</sup> 0.8–1.0	0.7	30	<sup>b</sup> Free-living	–	
<i>S. ransomi</i>	<sup>a</sup> 3–5	–	40 $\times$ 30	<sup>a</sup> Pigs/Intestine	–	1
	<sup>b</sup> 1	0.7	30	<sup>b</sup> Free-living	–	
<b>Ancylostomatidae</b>						
<i>Ancylostoma caninum</i>	14–18	11–14	53–69 $\times$ 36–53	Dogs/Small intestine	–	2.5
<i>A. duodenale</i>	11–13	8–11	60	Humans/Intestine	–	5–6
<i>Necator americanus</i>	9–11	7–9	55	Humans/Intestine	–	5–6
<i>Globocephalus urosubulatus</i>	8	6	55 $\times$ 35	Pigs/Small intestine	–	4–5
<i>Bunostomum</i> sp.	28	18	95 $\times$ 50	Ruminants/Small intestine	–	7–8
<b>Strongylidae</b>						
<i>Strongylus vulgaris</i>	20–24	10–17	80–93 $\times$ 47–54	Horses/Colon	–	24
<i>S. equinus</i>	36–48	25–35	72–92 $\times$ 41–54	Horses/Colon	–	32–36
<i>S. edentatus</i>	28–40	20–28	72–88 $\times$ 90–92	Horses/Colon	–	4–44
<i>Cyathostomum coronatum</i>	5–25	15	90 $\times$ 60	Horses/Colon, cecum	–	8–20

**Nematodes. Table 1** Important families and species of the Nematoda (Continued)

Family/Species	Length of adult worms (mm)		Size of eggs (or larvae) ( $\mu\text{m}$ )	Final host/Habitat	Intermediate host	Prepatent period in final host (weeks)
	f	m				
<i>Oesophagostomum</i> sp.	20	17	90 × 40	Ruminants/Colon	–	6
<i>Stephanurus dentatus</i>	45	30	43–70 × 90–120	Pigs/Kidney, ureter	Earthworms	12–16
<i>Syngamus trachea</i>	5–20	6	78–110 × 43–46	Chickens/Trachea	Earthworms	2.5–3
<b>Trichostrongylidae</b>						
<i>Trichostrongylus</i> sp. (= <i>T. axei</i> , <i>T. colubriformis</i> )	4–6	3–5	75–90 × 40–43	Ruminants, horses/Stomach	–	3
<i>Ostertagia circumcincta</i>	9–12	7–9	80–100 × 40–50	Sheep/Abomasum	–	2
<i>O. ostertagi</i>	8–9	6–8	65–80 × 30–40	Cattle/Abomasum	–	3 <sup>c</sup>
<i>Haemonchus contortus</i>	18–30	18–21	70–85 × 41–44	Ruminants/Abomasum	–	3
<i>Hyostrongylus rubidus</i>	12	7	80 × 40	Pigs/Stomach	–	3
<b>Metastrongylidae</b>						
<i>Metastrongylus</i> sp.	55	25	55 × 40	Pigs/Lung	Earthworms	4–5
<b>Oesophagostomatidae</b>						
<i>Oesophagostomum dentatum</i>	14	10	75 × 40	Pigs/Cecum, colon	–	5–6
<i>O. radiatum</i>	20	17	70 × 40	Cattle/Colon	–	6
<i>Chabertia ovina</i>	20	14	85 × 45	Ruminants/Colon	–	7
<b>Dictyocaulidae</b>						
<i>Dictyocaulus viviparus</i>	60–80	35–55	L <sub>1</sub> 420, in feces	Cattle/Bronchioles, trachea	–	3–4
<i>D. filaria</i>	30–100	30–80	L <sub>1</sub> 550, in feces	Sheep, goats/Lung	–	4–5
<b>Protostrongylidae</b>						
<i>Protostrongylus</i> sp.	20–40	16–30	L <sub>1</sub> 400, in feces	Ruminants/Lungs	Snails	4–5
<b>Angiostrongylidae</b>						
<i>Para (Angio-) strongylus cantonesis</i>	21–25	18	L <sub>1</sub> 300, in feces	Rodents, <b>humans</b> /Lung, brain	Snails, Crabs	6–7
<i>Angiostrongylus vasorum</i>	25	18	L <sub>1</sub> 330, in feces	Dogs/Lung, arteria pulmonalis	Snails	5
<b>Oxyuridae</b>						
<i>Enterobius vermicularis</i>	8–13	3	50–60 × 20–30	<b>Humans</b> /Colon, cecum	–	4–5
<i>Oxyuris equi</i>	40–180	10–20	80–95 × 40–45	Horses/Colon, cecum	–	16–20
<i>Passalurus ambiguus</i>	8–11	5	100 × 45	Lagomorpha/Colon, rectum	–	8–10
<b>Heterakidae</b>						
<i>Heterakis gallinarum</i>	10–15	7–13	65–80 × 35–46	Chickens/Intestine	–	3–5
<i>H. spumosa</i>	13	10	60 × 45	Rodents/Small intestine	–	6

**Nematodes. Table 1** Important families and species of the Nematoda (Continued)

Family/Species	Length of adult worms (mm)		Size of eggs (or larvae) ( $\mu\text{m}$ )	Final host/Habitat	Intermediate host	Prepatent period in final host (weeks)
	f	m				
<b>Ascaridae</b>						
<i>Ascaris lumbricoides</i>	200–410	150–250	50–75 $\times$ 40–50	<b>Humans</b> , pigs/ Small intestine	–	6–11
<i>A. suum</i>	200–300	150–250	65–85 $\times$ 40–60	Pigs, <b>Humans</b> / Small intestine	–	6–11
<i>Parascaris equorum</i>	60–380	60–280	90–120 $\times$ 60	Horses/Small intestine	–	6–12
<b>Toxocaridae</b>						
<i>Toxocara canis</i>	120–180	100–120	90 $\times$ 75	Dogs/Small intestine	Mice	4
<i>T. cati</i>	100	60	75 $\times$ 70	Cats/Small intestine	Mice	8
<i>T. vitulorum</i>	210–270	150–250	69–93 $\times$ 62–77	Cattle/Small intestine	–	3
<b>Anisakidae</b>						
<i>Anisakis</i> sp.	20	16	80 $\times$ 30	Sea mammals/ Stomach	<sup>a</sup> Copepods <sup>b</sup> Fish, <b>Humans</b>	?
<b>Gnathostomidae</b>						
<i>Gnathostoma spinigerum</i>	25–54	11–31	70 $\times$ 40	Dogs, cats, <b>humans</b> /Stomach	<sup>a</sup> Copepods <sup>b</sup> Fish, reptiles, amphibians	12–15
<b>Dranunculidae</b>						
<i>Dracunculus medinensis</i>	500–1200	29	Larvae 600 $\times$ 20	<b>Humans</b> , dogs/ Subcutaneous tissues	Copepods	40–56
<i>Philometra</i> sp.	50	2–3	60 $\times$ 35	Fish/Body cavity, blood vessels	Copepods	?
<b>Habronematidae</b>						
<i>Habronema muscae</i>	12–32	8–14	85 $\times$ 10	Horses/Stomach	Bloodsucking flies	8
<b>Filariidae</b>						
<i>Onchocerca volvulus</i>	350–700	20–40	Larvae in subcutaneous tissues, unsheathed, 300 $\times$ 7	<b>Humans</b> / Subcutaneous tissues	<i>Simulium</i> spp.	32–52
<i>O. guturosa</i>	40–60	40	Larvae in blood, unsheathed, 260 $\times$ 7	Cattle/ Subcutaneous tissues	<i>Odagmia</i> spp.	28
<i>Wuchereria bancrofti</i>	100	40	Larvae in blood, sheathed, 275 $\times$ 8	<b>Humans</b> /Lymph nodes	<i>Aedes</i> spp., <i>Culex</i> spp.	52
<i>Brugia malayi</i>	80–90	30	Larvae in blood, sheathed, 250 $\times$ 8	<b>Humans</b> /Lymph vessels	<i>Mansonia</i> spp., <i>Anopheles</i> spp.	12
<i>Loa loa</i>	70	35	Larvae in blood, sheathed, 260 $\times$ 8	<b>Humans</b> / Subcutaneous tissues, eyes	<i>Chrysops</i> spp.	52
<i>Litomosoides carinii</i>	60–120	20–25	Larvae in blood, sheathed, 90 $\times$ 7	Rats/Pleural cavity	Mites ( <i>Bdellonyssus</i> )	10–11
<i>Dirofilaria immitis</i>	250–300	120–180	Larvae in blood, unsheathed, 200– 300 $\times$ 8	Dogs, cats, <b>humans</b> / Pulmonary artery	<i>Culex</i> spp., <i>Anopheles</i> spp.	25

**Nematodes. Table 1** Important families and species of the Nematoda (Continued)

Family/Species	Length of adult worms (mm)		Size of eggs (or larvae) ( $\mu\text{m}$ )	Final host/Habitat	Intermediate host	Prepatent period in final host (weeks)
	f	m				
<i>Dipetalonema perstans</i>	70–80	45	Larvae in blood, unsheathed, $150 \times 8$	<b>Humans</b> , dogs/ Body cavity	<i>Culicoides</i> spp.	36
<i>D. viteae</i> ( <i>Acanthocheilonema</i> )	60–100	40	Larvae in blood, unsheathed, $230 \times 7$	<i>Meriones</i> sp./ Subcutaneous tissues	<i>Ornithodoros moubata</i>	10–12

<sup>a</sup> Parthenogenetically (without copulation) produced generation; in some species the larvae already hatch from eggs in the intestine and may then be passed in feces

<sup>b</sup> Heterosexual, free-living generation.

<sup>c</sup> During *summer ostertagiosis*, the required prepatent period is about 3 weeks; this time may be prolonged to 3–5 months in winter, when larvae stop development inside their hosts (hypobiosis)

## System

The classification of the nematodes is still a matter of controversy. In general 2 classes are accepted which are distinguished according to the suggestions of Maggenti (1981).

- Class: → **Adenophorea** (→ **Asphasmidea**)

Phasmids (i.e., minute, usually paired chemoreceptors) generally absent; → **amphids** are postlabial and variable in shape, cephalic organs setiform to papilloid; setae and hypodermal glands usually present, hypodermal cells uninucleate; excretory organ, if present, single-celled; caudal glands mostly present; usually 2 testes in males; cuticle 4-layered; some selected parasitic species belong to the following orders:

- Order: Trichocephalida
  - Family: Trichuridae (e.g., → *Trichuris*/Fig. 1)
  - Family: Trichinellidae (e.g., → *Trichinella spiralis*/Fig. 1)
  - Family: Cystoospiidae
- Order: Mermithida
  - Family: Mermithidae
- Class: → **Secernentea** (→ **Phasmidea**)
 

Phasmids present posterior to the anus; hypodermis uni- to multinucleate; cuticle with 2–4 layers; males have only a single → **testis**; and are commonly provided with caudal → **alae** (known as copulatory bursa); somatic setae or papillae absent on females; amphids usually open to exterior through pores located dorsolaterally on lateral lips or anterior extremity; cephalic sensory organs are pore-like, found on lips (16 in 2 circles with 6 inner and 10 outer), some selected orders with parasitic species are:

  - Order: Rhabditia
    - Family: Rhabditidae (e.g., → *Rhabdias bufonis*)
    - Family: Strongyloididae (e.g., → *Strongyloides*/Fig. 1)
  - Order: Strongylida

- Superfamily: Ancylostomatoidea
  - Family: Ancylostomatidae (e.g., → *Hookworms*/Fig. 1)
  - Family: Uncinariidae
- Superfamily: Trichostrongyloidea
  - Family: → *Trichostrongylidae* (e.g., → *Trichostrongylidae*/Fig. 1)
  - Family: Dictyocaulidae (e.g., → *Lung Worms*/Fig. 1)
  - Family: Heligmosomatidae
- Superfamily: Metastrongyloidea
  - Family: Metastrongylidae (e.g., → *Lung Worms*/Fig. 1)
  - Family: Angiostrongylidae (e.g., → *Angiostrongylus cantonensis*/Fig. 1)
  - Family: Protostrongylidae
- Superfamily: Strongyloidea
  - Family: Strongylidae
- Order: Ascaridida
  - Superfamily: Ascaridoidea
    - Family: Ascarididae (e.g., → *Ascaris*/Fig. 1)
    - Family: Toxocaridae (e.g., → *Toxocara*/Fig. 1)
    - Family: Anisakidae (e.g., → *Anisakis*/Fig. 1)
    - Family: Cosmocercidae
  - Superfamily: Oxyuroidea
    - Family: Oxyuridae (e.g., → *Enterobius vermicularis*/Fig. 1)
  - Superfamily: Heterakoidea
    - Family: Heterakidae
    - Family: Ascaridiidae
  - Superfamily: Dioctophymatoidea
    - Family: Dioctophymatidae
- Order: Spirurida
  - Superfamily: Spiruroidea
    - Family: Spiruridae
    - Superfamily: Physalopteroidea
  - Family: Gnathostomatidae (e.g., → *Gnathostoma spinigerum*/Fig. 1)
  - Family: Physalopteridae

- Superfamily: Filarioidea
  - Family: →*Filariidae* (e.g., →*Filariidae*/Fig. 1)
- Order: Camallanida
  - Superfamily: Camallanoidea
    - Family: Camallanidae
  - Superfamily: Dracunculoidea
    - Family: Dracunculidae (e.g., →*Dracunculus medinensis*/Fig. 1)
    - Family: Philometridae
    - Family: Micropleuridae
- Order: Diplogasterida
- Order: Aphelenchida
- Order: Tylenchida
  - Superfamily: Sphaerularioidea
    - Family: Sphaerulariidae

## Important Species

Table 1.

## Life Cycle

Fig. 1.

## Reproduction

Nematodes are in general →*dioecious* animals; relatively few species are →*hermaphrodites* (e.g., cf. →*Rhabdias bufonis*/Fig. 1) and, in those that are, the female and male gonads are formed consecutively.

## Reproductive Organs

The gonads of nematodes are tubes that are blind-ending on one end. The other end of the female gonad is attached to the body wall and opens immediately outwards, whereas the male gonad opens into the rectum, which thus becomes a typical →*cloaca*. The tubes of the male and female genital system float freely in the fluid of the pseudocoel (Fig. 11).

In general, nematodes have 2 female genital tubes; however, some trichurids and strongylids have only a single gonad. The tubes are subdivided into the ovaries, the oviducts, the receptacula seminis, and the uteri, which join to form the single vagina opening through the vulva to the exterior. The vagina lays on the ventral side, often in the midregion; however, in filariae it is found close to the very anterior end, whereas in strongylids it opens immediately beside the anal pore in the most posterior region.

In most nematodes the ovaries are of the telogonic type, where the oogonia are formed in the very tip of the ovary and descend the tube undergoing the various stages of oogenesis. Transovarially transmitted bacteria, which occur in some filariae, have been found in the epithelium of the cap region and in the oogonia. The →*rachis* may be single or branched and in the former case the germinal cells surround the central rachis in a

characteristic rosette-like pattern (Fig. 2). The →*oocytes* detach from the rachis in the growth zone of the ovary or in the maturation zone just before the end of the ovary (Fig. 8).

The wall of the ovary consists of a basal lamina and a layer of epithelial cells, which in the proximal region of the ovary may contain basally arranged myofilaments. In →*hologonic ovaries*, which are found in trichurid nematodes, the oogonia cover the entire wall of the ovarian tube. The germ cells develop via the various stages of oogenesis while moving from the wall towards the lumen of the ovary.

The oviduct is a short tube lined by epithelial cells which have many myofilaments at their base. The surrounding basal lamina interdigitates deeply with the epithelium, and the myofilaments are attached by →*hemidesmosomes* to these protuberances of the lamina. The luminal surface of the epithelial cells protrudes →*microvilli*. The oviduct forms a constrained tube through which the oocytes pass in a single file.

The seminal receptacle is a widening at the beginning of the uterus storing numerous →*spermatozoa* until fertilization. Maturation of the eggs takes place in the uteri, which are lined by an epithelium covered by a basal lamina and some ring muscle cells. The muscle layer is thin in the wall of the seminal receptacle, but becomes prominent towards the end of the uterus. In the vagina uterina, the distal bifurcated portion of the vagina, the ring muscles are multilayered. In some groups of nematodes this region is modified to a strongly muscled ovjector, which serves as a valve. The surface of the proximal portion of the vagina, the vagina vera, is lined by cuticle.

The male genital tube consists of the blind-ending testis, the seminal vesicle, the vas deferens, and the ejaculatory duct which opens into the rectum (Fig. 11).

The testis of parasitic nematodes belonging to the Secernentae is of the telogonic type, where the terminal portion of the testis contains the spermatogonia (Fig. 3). During their further development in the testis, the germ cells are linked together by a rachis, which is a branched cytoplasmic core (Fig. 5). The wall of the testis consists of a rather thick basal lamina and the epithelial cells which in some species contain smooth muscle fibers in their basal portion. The hologonic type of testis, where the spermatogonia line the wall of the testis, is found in trichurid nematodes; further →*spermatogenesis* occurs during migration towards the lumen of the testis.

The seminal vesicle is a storage organ for spermatozoa and in some species the final development to these stages takes place in this organ. The vas deferens and the ejaculatory duct lead to the cloaca. The wall of these ducts secretes substances that stimulate the transformation of the sperms into the amoeboid form (Fig. 4). The →*spicules* are characteristic copulatory structures of male nematodes (Figs. 12, 13). In most

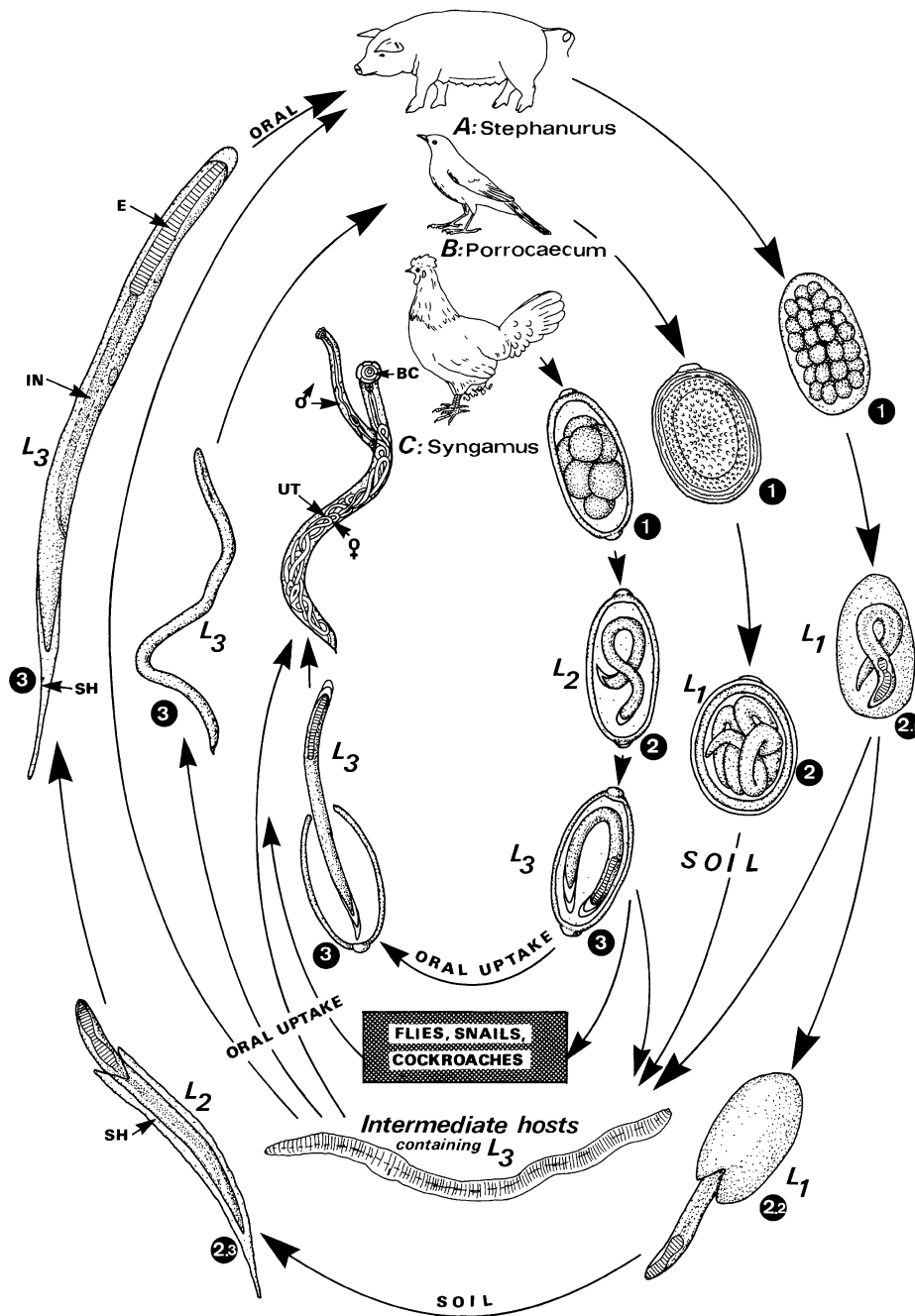

**Nematodes.** Figure 1 Life cycles of nematodes with facultative or obligate intermediate hosts. A → *Stephanurus dentatus*, adults (male 2–3 cm, female 3–4.5 cm) live in cysts of kidneys of swine (final host). B → *Porrocaecum ensicaudatum* (female 4–5 cm) live as adults in the small intestine of blackbirds. C → *Syngamus trachea* (= redworm, gapeworm); males (6 mm) and females (20 mm) suck blood in the trachea of poultry and are permanently attached to each other, thus giving a Y-shape to the pair. 1 Eggs are mainly passed in urine (*S. dentatus*) or feces (other species) of final hosts. 2 On the soil the eggs embryonate, leading to a first stage larva (L<sub>1</sub>). In *S. trachea* development proceeds until the L<sub>3</sub> is formed inside the egg, whereas in *S. dentatus* the L<sub>1</sub> may leave the egg (2.1–2.2). Intermediate hosts may ingest the eggs (in *P. ensicaudatum* it is obligatory), thus initiating the development of infectious larvae (L<sub>3</sub>), which may become accumulated in considerable numbers. 3 Infection of the final hosts always occurs via the oral route. This can be: directly by ingestion of eggs containing a third-stage larva (*S. trachea*) or by uptake of free third-stage larvae (*S. dentatus*) with contaminated food; or indirectly by ingestion of intermediate hosts containing infectious third-stage larvae (possible in all 3 species). BC, buccal cavity; E, esophagus; IN, intestine; SH, sheath (cuticle of first- or second-stage larva); UT, uterus.

nematodes there are 2 spicules, which often differ in length and shape, but in some species only a single spicule is found (Fig. 13). The spicules are needle-shaped and consist of thick cuticular material which surrounds a cytoplasmic core with nerve processes. The nerve endings are covered by cuticular material. In many species the spicule wall is bent to form a hollow needle with an opening at its base and tip. The spicules are formed in a dorsal sac of the cloaca called the

spicular pouch. The spicules can be moved back and forth by accessory muscles and during copulation they are inserted into the female vulva. A thickening of the dorsal wall of the spicular pouch, the →gubernaculum, stabilizes the protruded spicule. Additional copulatory structures are found in some groups. The bursa is a lobular modification of the male posterior end, which is highly elaborated in stronglylid nematodes. The bursa surrounds the vulvular region of the female worm. In

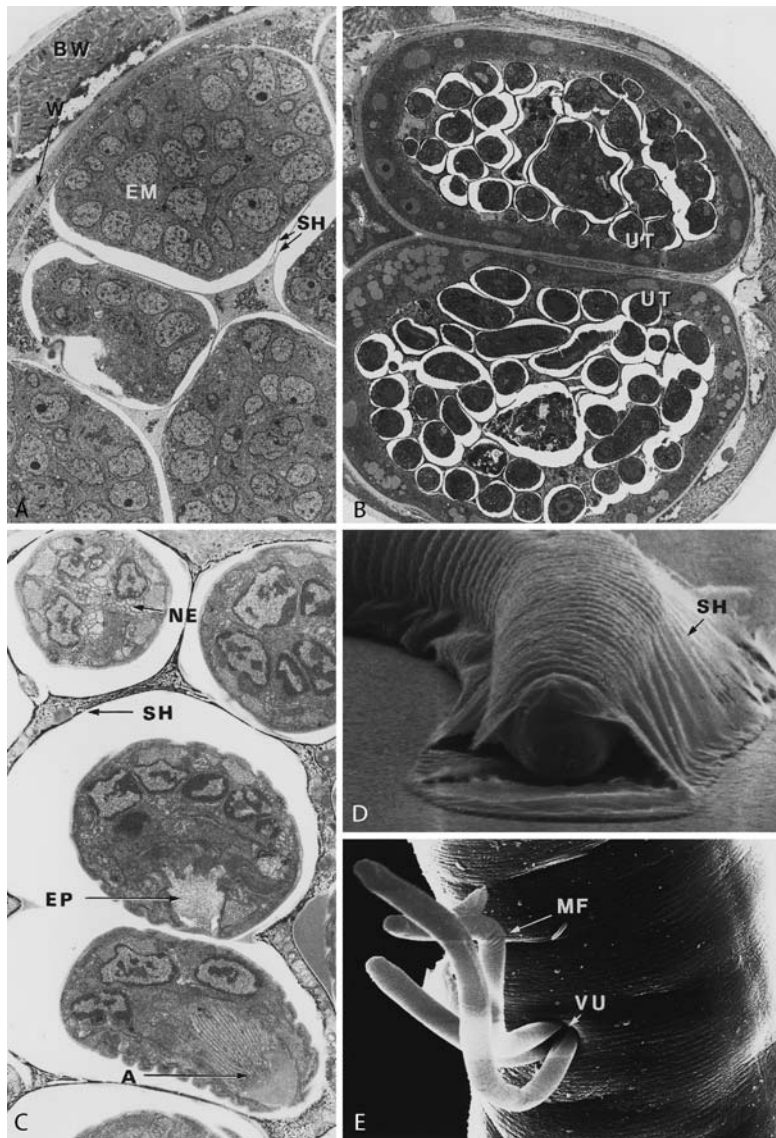

**Nematodes. Figure 2 A–E** Late embryogenesis of →*Brugia malayi* and microfilariae. **A** Embryos in morula stage (EM) inside the uterus. × 2,700. *BW*, body wall; *SH*, sheath; *W*, uterus wall. **B** Cross section of the anterior region of the female worm. The uteri (UT) contain many stretched, mature →microfilaria, a few coiled embryos, and disintegrating embryos mainly in the center of the uteri. × 1,300. **C** Sections of embryos inside the uterus. A stretched microfilaria is cut at the level of the nerve ring (NE), and a coiled embryo is cut at the level of the excretory pore (EP) and at the anus (A). × 2,200. *SH*, sheath. **D** Microfilaria of →*Wuchereria bancrofti*. The anterior end of the larva is seen through an artificial hole in the sheath (SH). × 9,500. **E** →Microfilariae (MF) of *Onchocerca volvulus*, leaving the vulva (VU) of the female worm. The microfilariae of this species hatch from their sheath inside the uterus. × 1,500.





**Nematodes. Figure 2 F, G** LM of developmental stages of *Ascaris suum* eggs, **F** just excreted from uterus, **G** early cleavage.

filarial nematodes the male worm twists its posterior region around the female worm several times. The ventral cuticle of this region carries longitudinal →ridges (area rugosa) which interdigitate with the annulations of the female cuticle for better attachment.

### Gametogenesis

The spermatogonia in the terminal region of the testis multiply by mitotic divisions (Figs. 3, 6A). It remains doubtful whether a cap cell gives rise to the spermatogonia or a population of stem cells lies in the terminal lumen and proliferates the spermatogonia, as has been observed in →*Diriofilaria immitis*. When the cells enter the next region of the testis, they begin the prophase of the first meiotic division. In the diplotene the spermatocytes grow and differentiate the organelles characteristic of the nematode sperms. The meiotic divisions, resulting in 4 spermatids from each spermatocyte, occur either at the posterior portion of the testis or in the seminal vesicle. The chromatin is condensed into one or more bodies which are no longer surrounded by the nuclear envelope (Fig. 6C). Maturation to the fertile spermatozoa occurs in the vas deferens or in the female uterus (Fig. 6D).

Characteristic organelles of the spermatozoa of many nematode species are the membranous organelles which are already formed in the spermatocytes (Fig. 6B,C). In the mature spermatozoon they contain plicated membranes and are situated close to the plasma membrane. In the female uterus they become attached to the outer membrane and release substances (Fig. 6D). Furthermore, the spermatozoa may contain a system of →microtubules, reserve materials such as lipid droplets or refringent bodies, and →mitochondria.

These organelles are not found in the spermatozoa of all species. The spermatozoa of nematodes have no acrosome or axonemal structures. Primitive nematode spermatozoa have a spherical shape, but most parasitic species possess elongated spermatozoa, which are often divided into 2 distinct parts (Fig. 2C). Inside the uterus the spermatozoa become amoeboid. Their organelles and the chromatin are concentrated at one pole, and the organelle-free portion develops the pseudopodium (Figs. 2C, 3D, 5D).

At the tip of the female gonad a syncytial mass or a cap cell may proliferate oogonia. The cap cell of *Aspicularis tetraptera*, however, is morphologically different from the proliferating germ cells in the lumen and it has been suggested that the cap cell does not proliferate oogonia. The cap zone is part of the germinal zone in which the oogonia multiply by mitotic division. The →cytoplasm of all germinal cells is connected to a cytoplasmic strand (rachis) running in the middle of the ovarian lumen. The oogonia have a spherical shape with little cytoplasm surrounding the nucleus (Figs. 2A, 3A, 25). Reaching the growth zone of the ovary the germinal cells cease mitotic activity and begin the prophase of the first meiotic division. The oocytes then remain in the diplotene stage and begin intense synthetic activity. In a first step they increase in size by adding more cytoplasm. The cells often elongate and become arranged radially around the rachis. During further development in the maturation zone, oocytes produce nutrient stores (e.g., lipid droplets, hyaline granules, dense granules, and →glycogen) and materials for →eggshell formation (refringent granules, shell granules, and glycogen). The oocytes continue the first meiotic division as they leave the ovary and pass through the oviduct.

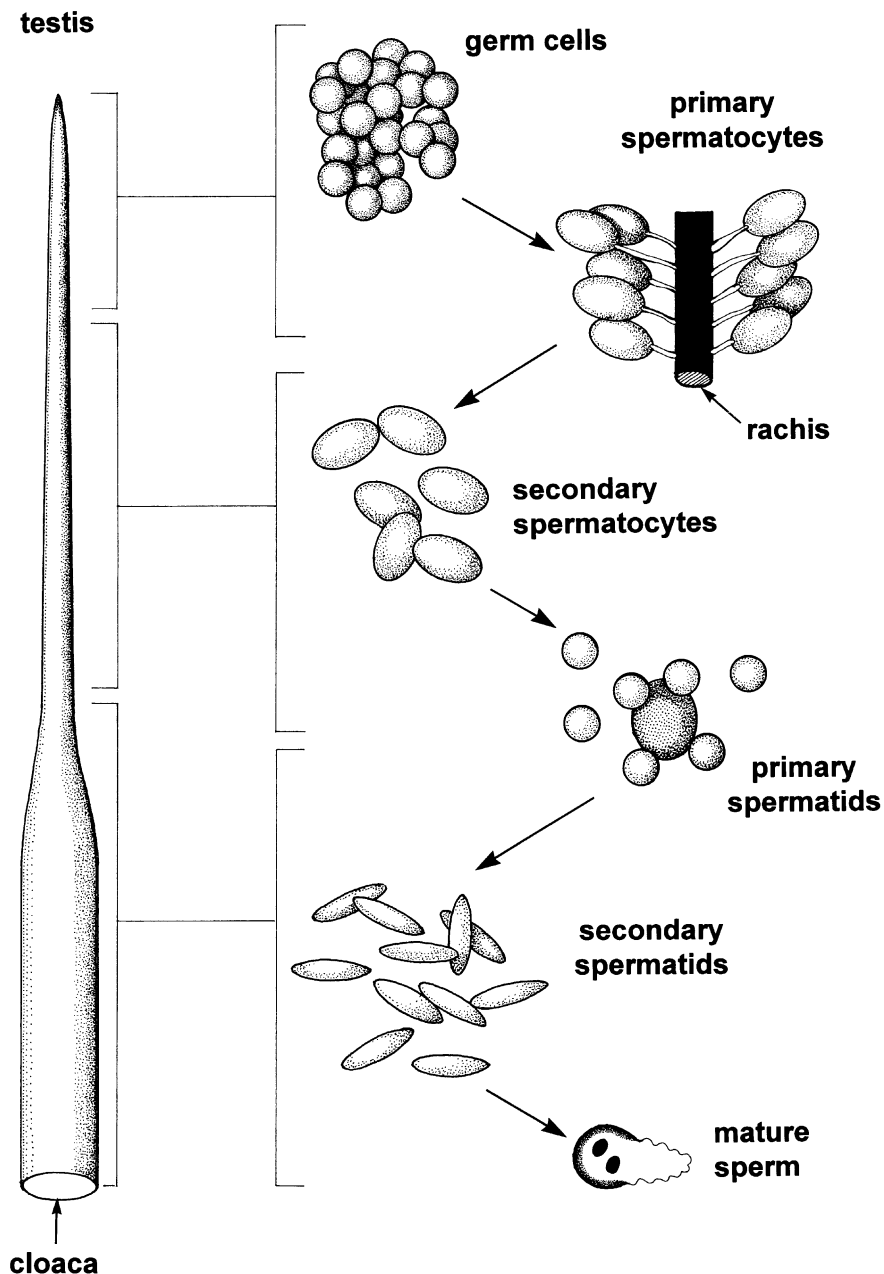

**Nematodes. Figure 3** Diagrammatic representation of the formation of spermatozoa in nematodes in different zones of the testis tube.

### Fertilization

When the oocyte enters the seminal receptacle, fertilization takes place. In *Ascaris* spp. the process has been described in detail; the pseudopodium of the spermatozoon contacts the oolemma and the gamete membranes interdigitate and fuse. The whole sperm then enters the cell. Penetration of the sperm is followed by formation of the eggshell and by completion of the 2 meiotic divisions resulting in expulsion of 2 polar bodies (*Heterakis*).

### Eggshell Formation

The eggshell is formed immediately after fertilization and usually contains 4 layers. The outermost (uterine) layer consists of material that is secreted by the uterine epithelial cells. The next, vitelline, layer originates from the vitelline membrane which is formed after fertilization of the oocyte. The underlying chitinous layer contains *chitin* and is often the thickest layer of the eggshell. The most internal layer is the lipid layer

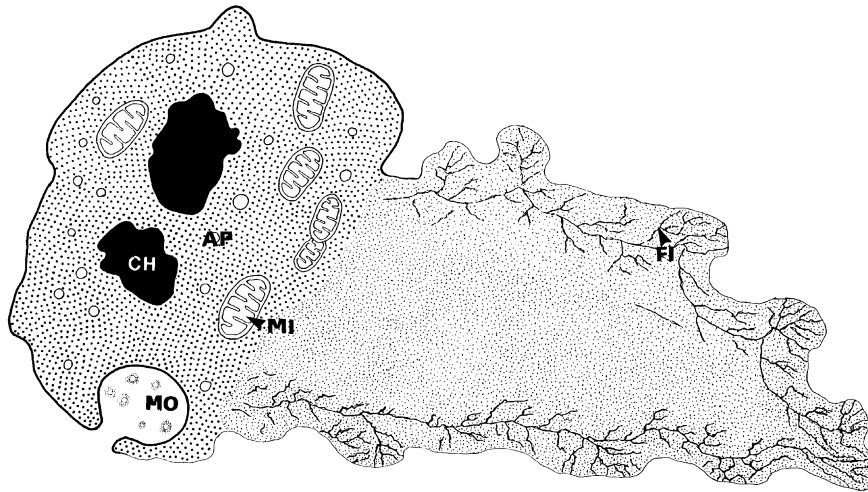

**Nematodes. Figure 4** Diagrammatic representation of the fine structure of an amoeboid mature spermatozoan of nematodes. AP, apical pole; CH, chromatin; FI, filaments; MI, mitochondrion; MO, membranous organelles.

which is responsible for the extreme impermeability of the nematode eggshell. In *Ascaris* spp. it contains the ascarosides as characteristic lipids.

### Embryogenesis

→Embryogenesis is highly determined, and the cell lineage from blastomere to the particular organ can be followed. →Chromatin diminution occurs during early embryogenesis of *Ascaris* spp. and related species where the nuclei of the somatic cell lines lose a large amount of their DNA.

Some nematodes lay eggs which are not embryonated and which need oxygen for further development. In other species embryogenesis occurs inside the uterus and embryonated eggs are laid from which the larvae soon hatch. →Viviparous nematodes complete embryogenesis inside the uterus and larvae hatch before leaving the uterus. The ova of these species (e.g., *Trichinella* spp., filariae) form a very thin eggshell and embryogenesis starts immediately after the oocytes have been fertilized (Figs. 3B,C, 4). The microfilariae of some filarial species (e.g., →*Wuchereria bancrofti*) are born enveloped by the thin sheath (= eggshell; Fig. 3D), whereas others (e.g., →*Onchocerca volvulus*) are already hatched when they are born (Fig. 3E), i.e., they are described as unshathed.

### Integument

In nematodes the →body cover consists of 2 layers. The hypodermis is a cellular or syncytial derivative of the ectoderm. It secretes a thick, mainly proteinous layer, the cuticle, which covers the outer surface of the worm entirely. The term hypodermis is used for the nematode epidermis because of its position below the cuticle.

### Cuticle

The hypodermis secretes the →cuticle, a complex layer which covers the entire surface and lines the buccal cavity, the esophagus, the rectum, the terminal portion of the vagina, and the excretory duct. Depending on the species the cuticle reaches 5–10% of the body's diameter and 10–20% of its volume, thus being an important system that is closely connected to the hypodermis by hemidesmosomes. The main functions of the cuticle are to protect the organism from environmental influences and, together with the high turgor pressure of the pseudocoel, to maintain the shape and serve as an antagonistic system for the somatic muscles. Furthermore, it is active in the uptake of nutrients, a fact which is important in drug application. Considerable diversity is observed in the chemical and morphological composition of the cuticle. Usually it is composed of various layers and often its outer surface is covered with an additional envelope.

Such an external →opisthaptor may consist of a thin polysaccharide-rich layer (e.g., microfilariae of *Dirofilaria immitis*), be overlaid by a coat which consists of 3 distinct lamellae (e.g., *Trichinella* spp., Fig. 8E), or be covered by a coat of irregular thickness (→*Onchocerca* spp. females). Finally, degranulation of host eosinophils on the nematode cuticle may also result in a thick coat. Except for the last example it is not clear which parts of the coat are contributed by the host and which originate from the parasitic nematode.

The outermost layer of the cuticle is a thin epicuticle which is between 6 nm and 60 nm thick and consists of mostly 2 dark lamellae separated by a lighter interspace (Fig. 7B, 8E). In spite of the similarities to a →cell membrane the epicuticle is probably not derived from the outer hypodermal membrane. The epicuticle of →*Trichinella spiralis* differs significantly from

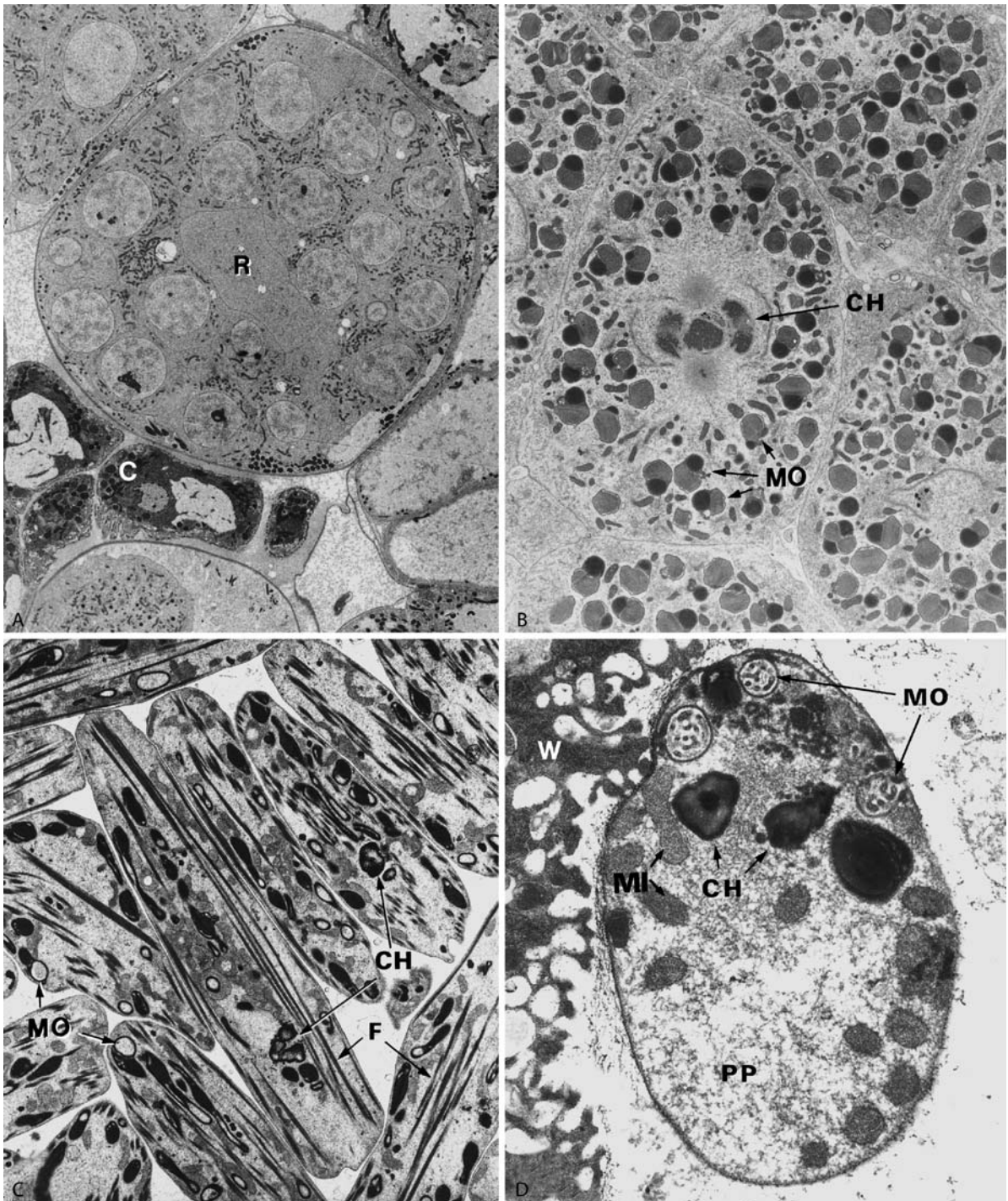

**Nematodes. Figure 5 A–D** Spermatogenesis. **A** Cross-section through the germinal zone of the testis of *Heterakis spumosa*.  $\times 1,400$ . *C*, coelomocytes; *R*, rachis. **B** Spermatocytes in first meiotic division (*H. spumosa*).  $\times 3,000$ . *CH*, chromatin; *MO*, membranous organelles in intermediate stage of development. **C** Elongated spermatids in the seminal vesicle of *Onchocerca volvulus*.  $\times 5,400$ . *CH*, chromatin; *F*, fibrils; *MO*, membranous organelles. **D** Amoeboid sperm in the uterus of the female *O. volvulus*.  $\times 15,000$ . *CH*, chromatin; *MO*, membranous organelles; *PP*, pseudopodium; *W*, uterus wall.

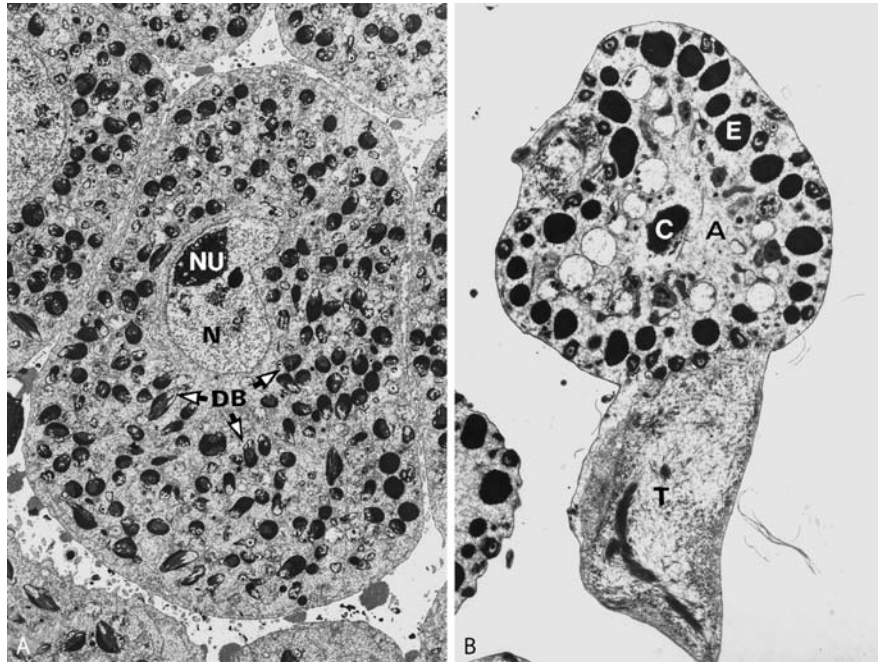

**Nematodes. Figure 6 A,B** TEMs of the male system stages of *Toxocara canis*. **A** Spermatocyte I. **B** Mature sperm cell – note the occurrence of an anterior portion (A) containing the organelles and an organelle-less tail (T). DB, dense body; MO, multivesicular organelle; N, nucleus; NU, nucleolus.

membranes of this parasite (Fig. 8E). The epicuticle does not fracture between the lamellae and it lacks the particles which are characteristic of any type of cell membrane. However, intramembranous particles were found in the epicuticle of *Nippostrongylus brasiliensis* and second-stage larvae (L2) of *Meloidogyne javanica*. Nevertheless, the epicuticle is an extracellular structure which is not at all continuous with plasma membranes. Therefore, Locke proposed the name *envelope* for structures like this which have similar dimensions to plasma membranes and are formed at membrane surfaces.

In most nematodes the epicuticle is smooth, following the pseudometameric annulations of the underlying cuticular layer. However, in members of the genus *Onchocerca* the epicuticle is folded independently of the underlying cuticle (Fig. 8). Additionally the epicuticle of male *O. volvulus* exhibits a honeycomb-like pattern. Female worms of this and other species have long protuberances, regular plications, and piles; it might be expected that a continuous turnover of the epicuticle occurs in these worms.

The cuticle underlying the epicuticle shows great morphological diversity among the various groups of nematodes. Nevertheless, based on fine structural similarities, these layers can be subdivided into 3 major zones, named cortical, median, and basal (Figs. 7, 8). The cortical zone forms the pseudometameric annulations and internally is often amorphous and electron-dense. The median

zone may contain fluids, struts, or globular bodies. The basal zone is in general extremely complex. It may consist of several laminae and contains fibers or striations. The differentiation into these 3 zones can be observed in developmental and adult stages of some nematode species, but is invisible in many others.

During ontogeny nematodes undergo 4 complete molts during which the old cuticle is shed and replaced by a new one (Fig. 9). The new cuticle is formed before molting at the hypodermal surface below the old cuticle. In several nematodes it has been observed that the newly formed epicuticle becomes extensively folded, and these folds smoothen during later intermolt growth. Thus, further elongation of the epicuticle is not necessary before the next molt, although the other cuticular layers and the worm may grow considerably.

After formation of the epicuticle, other cuticular material is released successively for the various layers. The hypodermis serves as a template for the formation of the various layers. During this early phase of cuticular secretion the layers are hardly distinguishable, but already they comprise all the basic structures needed for the layers when self-assembly of the cuticular structures occurs later. The diversity of the mechanical and chemical properties of the various zones results from formation of fibers or lamellae and from the concentration of certain molecules in particular areas. Further growth in length and width of the cuticle occurs by deposition of certain molecules in all layers. Cuticular

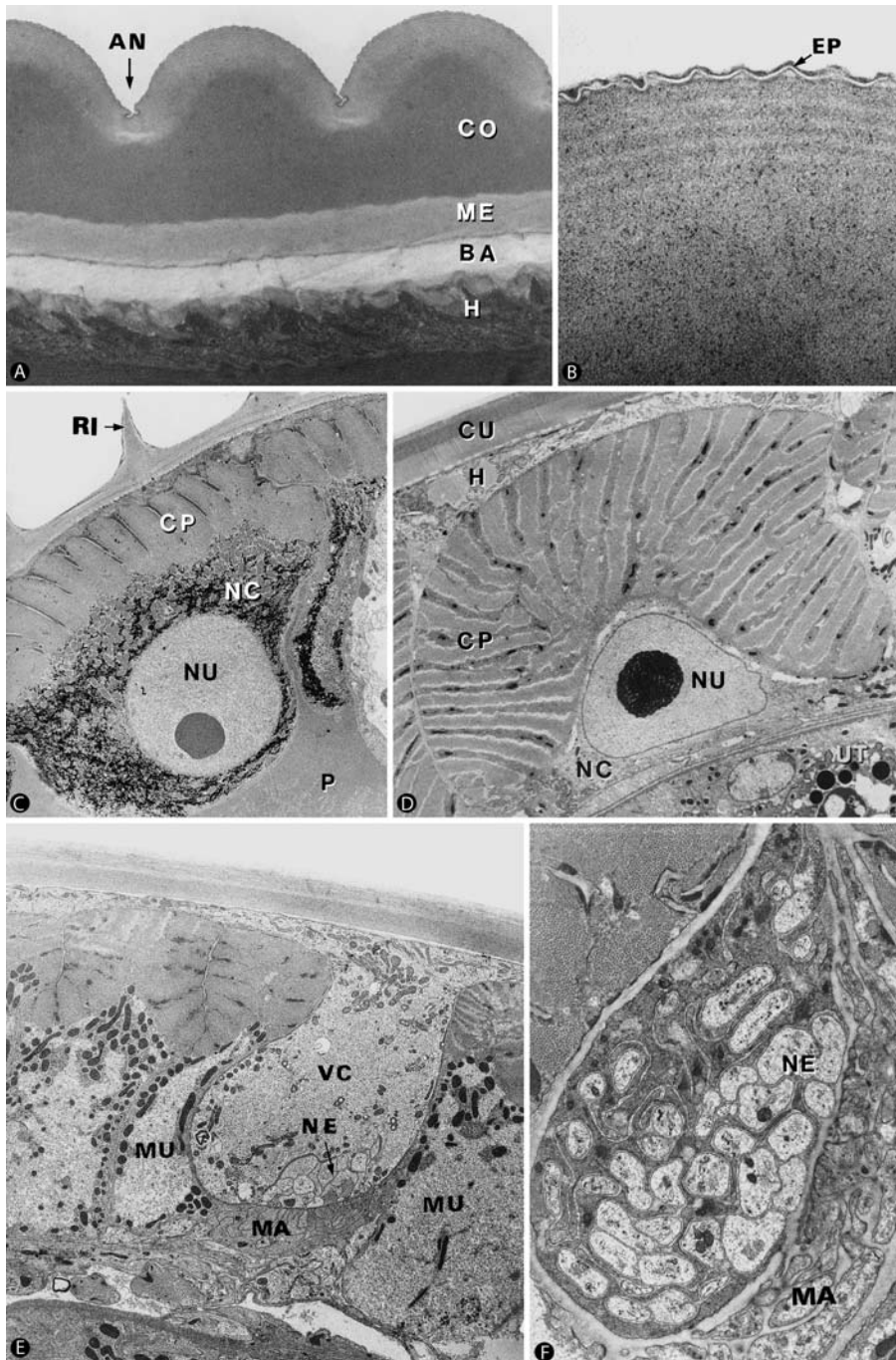

**Nematodes. Figure 7** A Longitudinal section through the →cuticle of the nematode →*Cylicocyclus nassatus*. The cortical zone (CO) exhibits pseudometameric annulations (AN) ( $\times 10,000$ ). BA, basal zone of cuticle; H, hypodermis; ME, median zone of cuticle. B The epicuticle (EP) is formed as a 3-layered lamella (*C. nassatus*,  $\times 82,000$ ). C Platymyarian muscle cell. The contractile portion (CP) covers the outer border of the cell. The glycogen in the noncontractile portion (NC) is histochemically stained (→*Heligmosomoides polygyrus*,  $\times 3,900$ ). NU, nucleus of the muscle cell; P, pseudocoel; RI, longitudinal ridges of the cuticle. D Cross-section through coelomyarian muscle cell. The contractile portion (CP) covers the outer border and the sides of the muscle cell (*Heterakis spumosa*,  $\times 3,900$ ). UT, uterus, for other abbreviations see A-C. E Cross-section through the ventral nerve chord (VC) of *Heterakis spumosa*. Note that the nerves (NE) are situated at the inner surface of the chord (VC) being touched by fingers (MA) of the muscle cells (MU) ( $\times 4,000$ ). F →*Acanthocheilonema viteae*. Section through the nerve chord which is completely filled by axons being touched by fingers (MA) of muscle cells. ( $\times 3,900$ ).

growth is not only found during, but also shortly after the molt. Considerable growth of the cuticle occurs between molts and particularly after the last one, during maturation of the nematode, and is often combined with a thickening of particular zones of the cuticle.

The main components forming the cuticle are collagen-like proteins. In the cortical layer of large ascarids there is a tanned structural protein →(cuticulin) which does not exhibit the striations characteristic of →collagen and is not attacked by collagenase. The fibrillar lamellae of the basal zone include proteins

which are more similar to mammalian collagen and which are lysed by collagenase, but it is characteristic of these proteins that the molecules are linked by disulfide bonds.

Other materials may be enclosed in the cuticle, e.g., large amounts of nonglycogen polysaccharides in →*Trichuris myocastoris* or hemoglobin in *Nippostrongylus brasiliensis*. Numerous modifications of the cuticle may be found (Fig. 10). Alae are keel-like thickenings which follow the lateral lines and support undulating locomotion (Fig. 10C). Stiff longitudinal ridges support

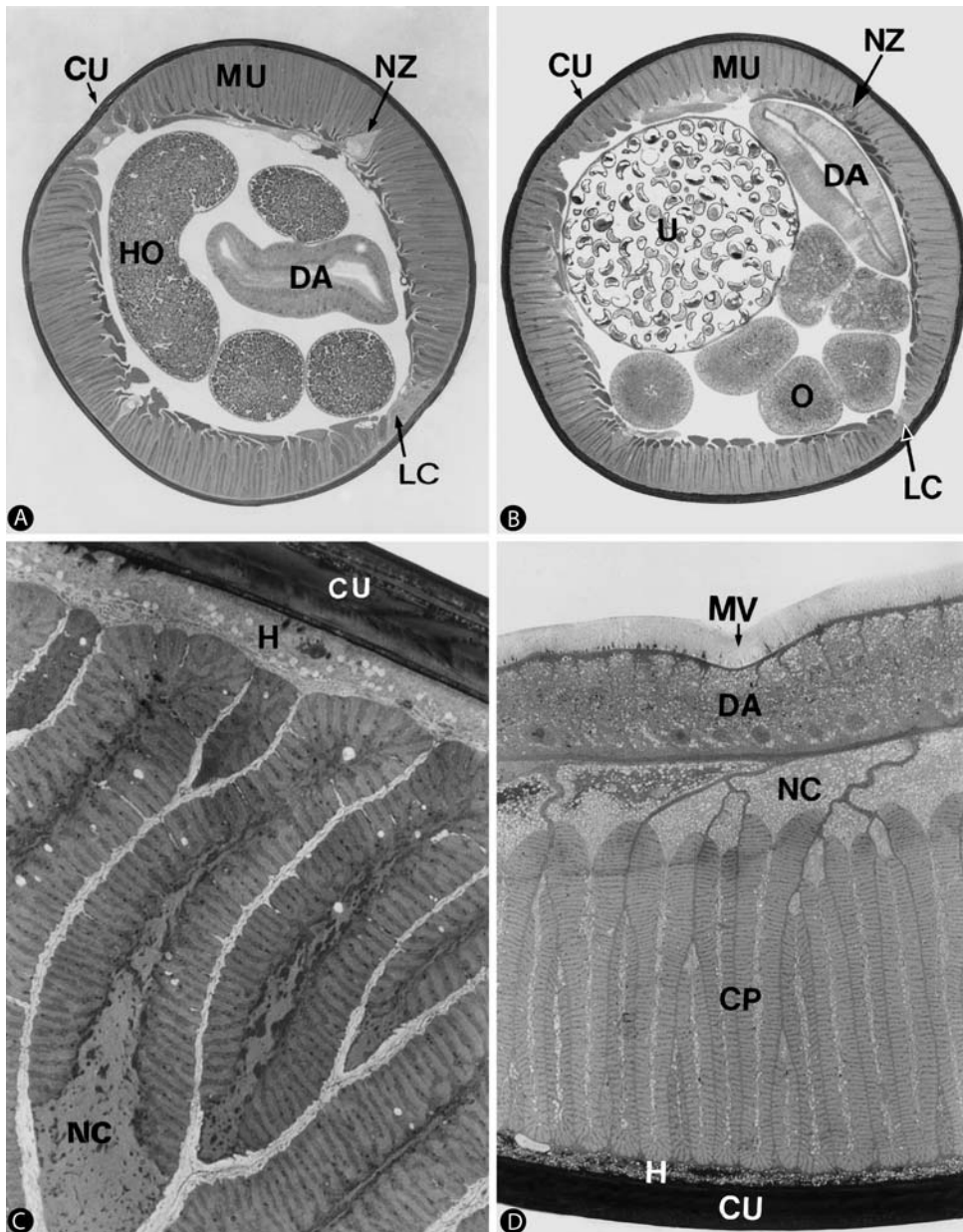

**Nematodes. Figure 8 A–D** Semithin sections through adults of →*Toxocara canis*. **A, B** Cross sections of female (B) and male (A) worms.  $\times 30$ . **C, D** Cross-sections through the periphery showing the arrangement of the muscle cells.  $C \times 300$ ,  $D \times 100$ .

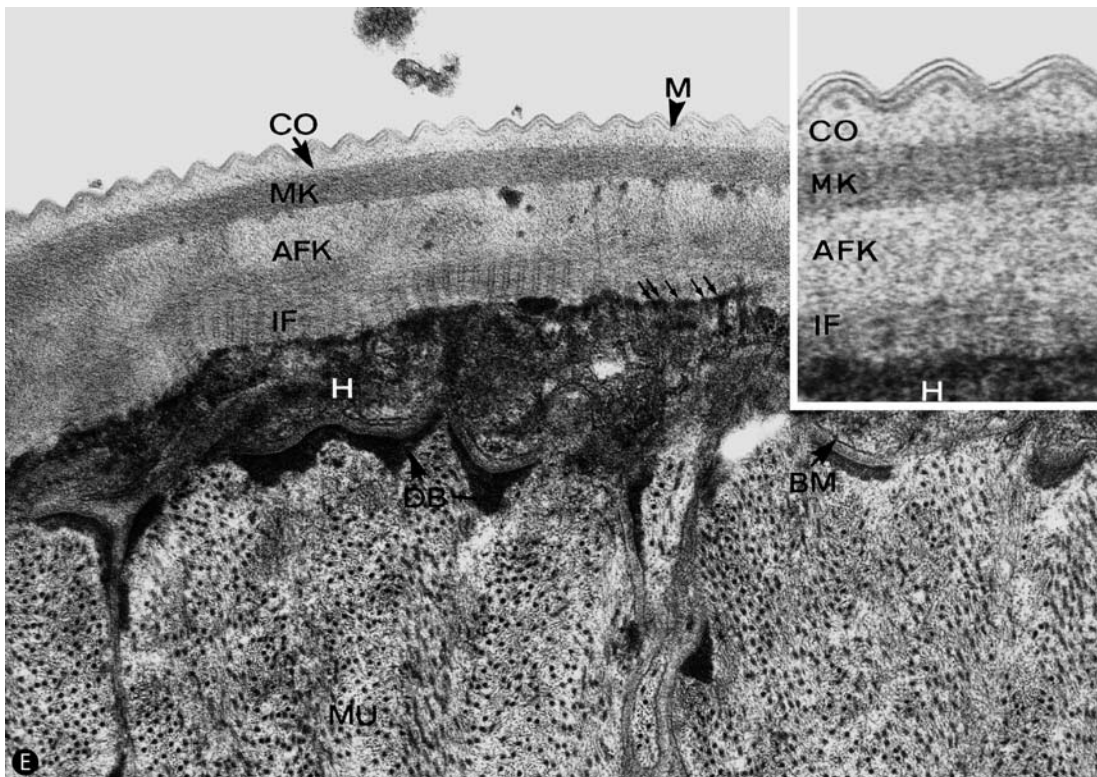

**Nematodes. Figure 8 E** Electron micrograph of a section through the periphery of an adult of *Trichinella spiralis* showing the fine structure of the cuticle layers. Note that the attachment zones of the cuticle and the muscles to hypodermis are fortified by hemidesmosomes (DB, arrows)  $\times 18,000$  (inset  $\times 40,000$ ). *AFK*, outer layer of the basal cuticle; *CO*, cortex; *BM*, basal membrane; *CP*, contractile portion of muscles; *CU*, cuticle; *DA*, intestine; *DB*, desmosome-like densification; *H*, hypodermis; *HO*, testis; *IF*, inner layer of the basal cuticle; *MU*, muscle cells; *LC*, lateral chord including the excretory channel; *M*, epicuticle; *MK*, mesocuticle; *MV*, microvilli; *NC*, noncontractile portion of *MU*; *O*, ovary; *U*, uterus.

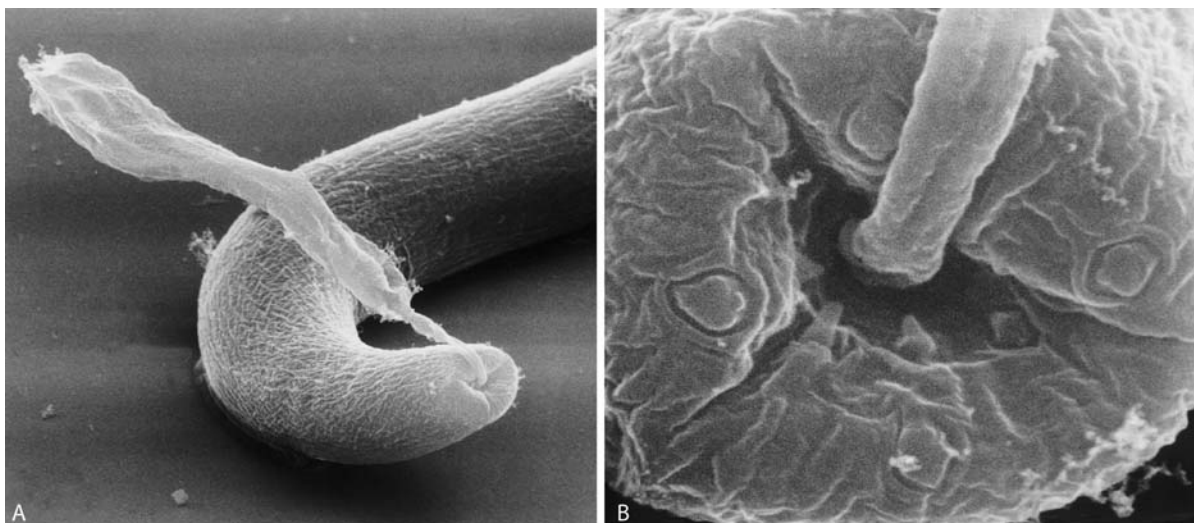

**Nematodes. Figure 9 A, B** SEMs of stages during the second  $\rightarrow$  molt of  $\rightarrow$  *Wuchereria bancrofti*. The old cuticle of the anterior region is shed, but still attached to the cuticular lining of the esophagus (A  $\times 1,200$ , B  $\times 9,500$ ).



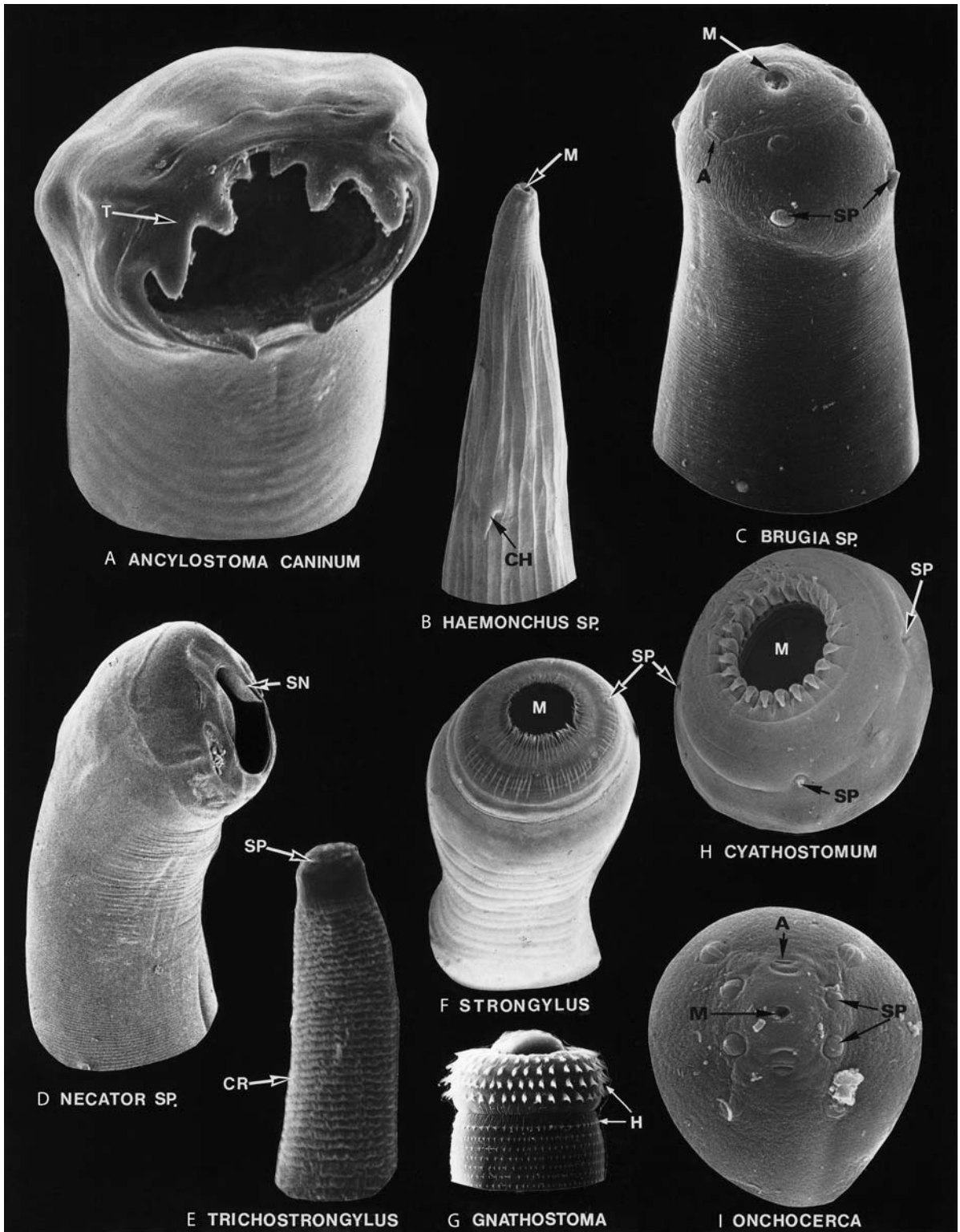

**Nematodes. Figure 10 A–I** SEMs of cuticular peculiarities along the anterior pole of some genera of nematodes (Fig. G by courtesy of Professor Dr. Ishii, Japan). *A*, amphid; *CH*, large cuticular hook; *CR*, cuticular rings; *H*, small cuticular hooks; *M*, mouth; *SP*, sensory papillae; *T*, tooth with hooks.

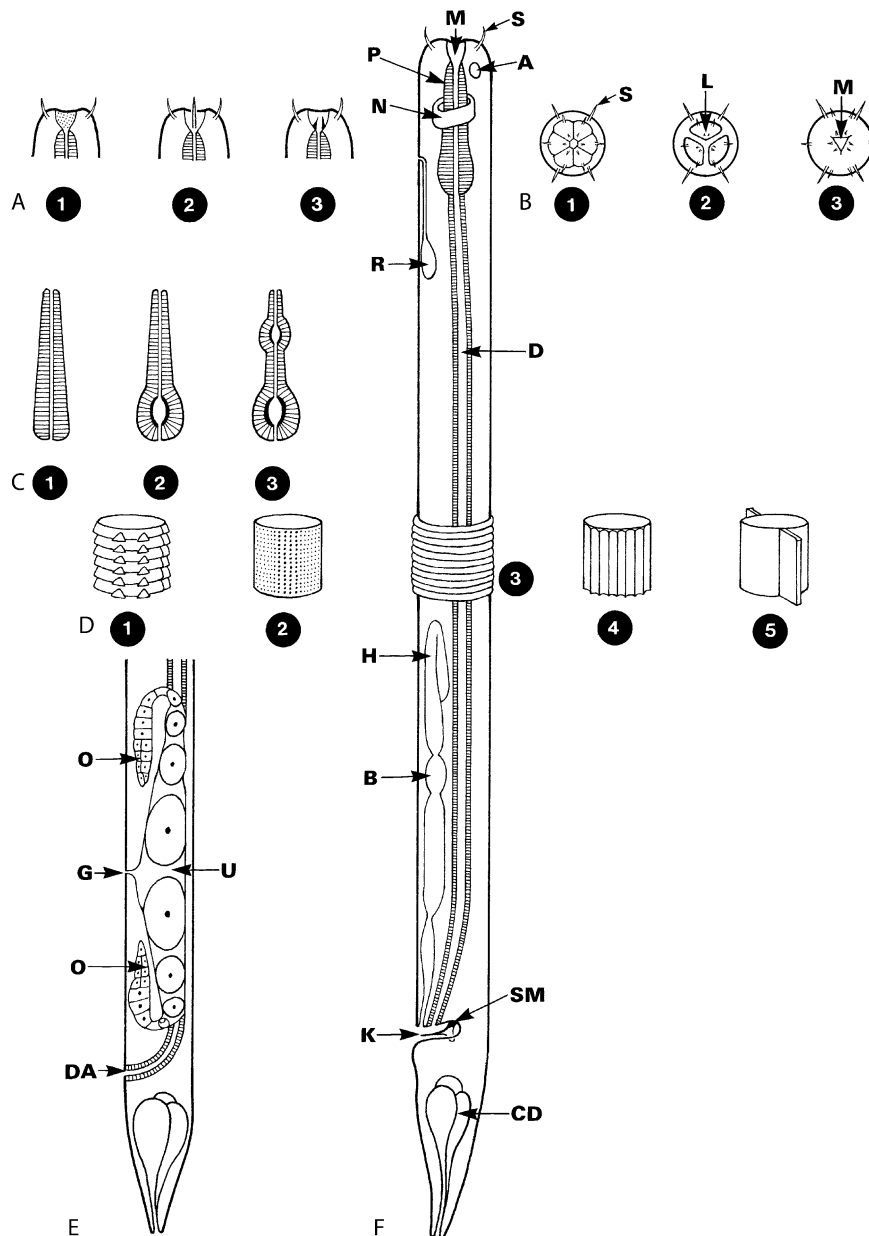

**Nematodes. Figure 11** Diagrammatic representation of the organization of nematodes. **A** Mouth: 1 = unarmed, 2 = with stylet; 3 = with teeth. **B** Lips: 1 = 6 lips, 2 = 3 lips, 3 = without lips. **C** Pharynx: 1 = undivided, 2 = with bulbus, 3 = with 2 bulbi. **D** Cuticular stripings: type 5 shows alae. **E** Posterior ends of females. The intestine runs below the sexual system in the midregion. **F** Males. *A*, amphid; *B*, seminal vesicula; *CD*, caudal glands; *DA*, anus; *G*, genital opening (vulva); *H*, testis; *K*, cloaca; *L*, lip; *M*, mouth; *N*, nerve ring; *O*, ovary; *P*, pharynx; *R*, →renette; *S*, →seta; *SM*, spiculum; *U*, uterus.

attachment by burrowing into the structures around which the worm is twisting (Fig. 7). Many nematodes have →bosses which are scattered over the cuticle and might create a space between the cuticle and the host tissue. Peculiar cuticular formations (e.g., teeth) in or near the buccal opening are used during the uptake of food (Fig. 10). Various copulatory structures are differentiated by cuticular modifications at the posterior end of male worms (Figs. 12, 13).

### Hypodermis (=Epidermis)

The hypodermis underlies the cuticle and covers the somatic muscle cells as a thin cytoplasmic layer. The hypodermis forms thick chords which are in contact with the pseudocoel between the 4 sectors filled by muscle cells. Depending on their position they are called dorsal, ventral, and lateral hypodermal chords (Fig. 7, 14C). The hypodermis consists of multinucleate cells (=syncytia) with nuclei in the chords.

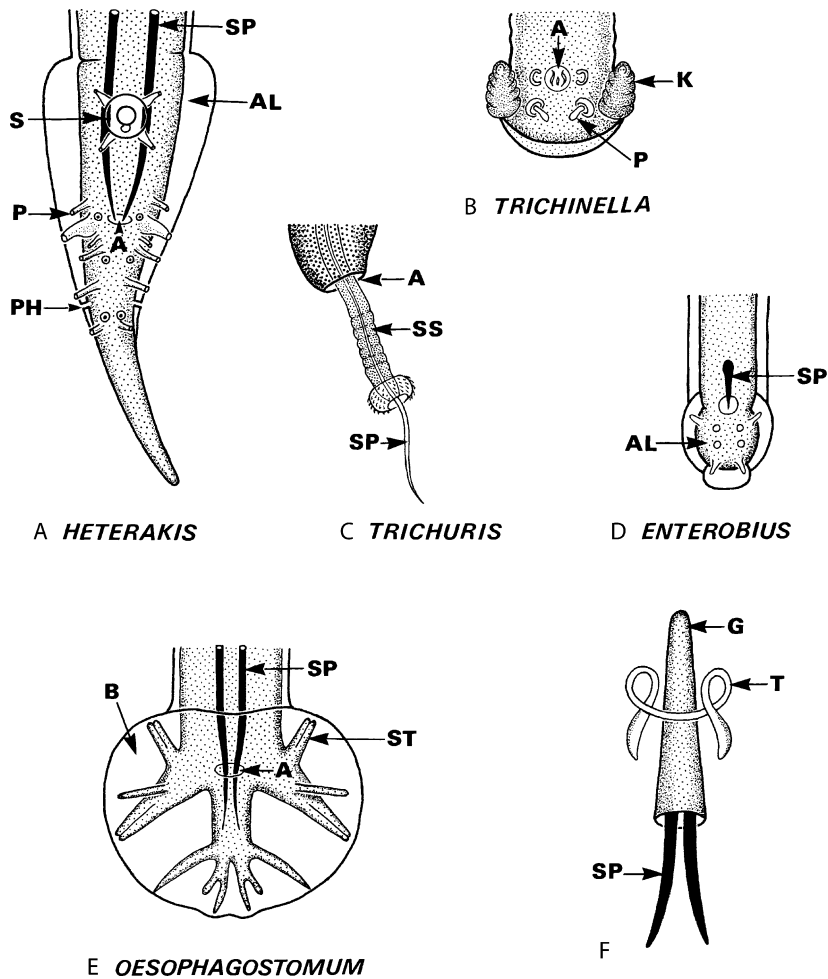

**Nematodes. Figure 12** Diagrammatic representation of the posterior ends of different nematode genera (A–E) and the copulatory system in trichostrongylids (F). A, anus; AL, ala; B, →bursa copulatrix; G, gubernaculum; K, copulatory appendix; P, papilla; PH, →phasmids; S, sucker-like structure; SP, →spiculum; SS, sheath of SP; ST, fortifying rays.

Frequently, there is a row of large dorsal and another row of large ventral syncytia which are in contact in the lateral chords. In the middle of each chord a row of small cells may be situated between the large syncytia.

During secretion of the new cuticle, the hypodermis is modified, showing the morphological features characteristic of intense protein synthesis. The nuclei are enlarged and contain a prominent nucleolus and extended chromatin. The number of the mitochondria is increased. The cytoplasm is filled with rough endoplasmic reticulum and many →Golgi apparatus. The formation of vesicles, their transport to the outer membrane, and their release can be observed.

The hypodermis in the sectors where the muscle cells are (= interchordal hypodermis) is a thin layer crossed by numerous tonofibrils which are attached to the muscle cells by desmosome-like junctions and to the cuticle by hemidesmosomes (Fig. 14B). These fibrils are a stable link between the systems acting antagonistically

in nematode locomotion. Only a few mitochondria, ribosomes, Golgi complexes, and some multivesicular bodies are found in the interchordal hypodermis after molts (Fig. 14A). These organelles are often concentrated in corners where 2 muscle cells abut and the hypodermis is slightly thicker. In middle cells of the lateral hypodermis chords the channels of the excretory system are found.

A basal lamina entirely covers the basal zone of the hypodermis separating the hypodermis from the muscle cells and the chords from the pseudocoel. The adjacent membrane of the hypodermis often forms a basal labyrinth which can be very elaborate, particularly in the lateral chords, increasing the exchange of substances between body cavity and hypodermis (Fig. 15A).

Particular modifications of the hypodermis may be found in female filariae which feed via their body wall. These nematodes have extremely large lateral chords

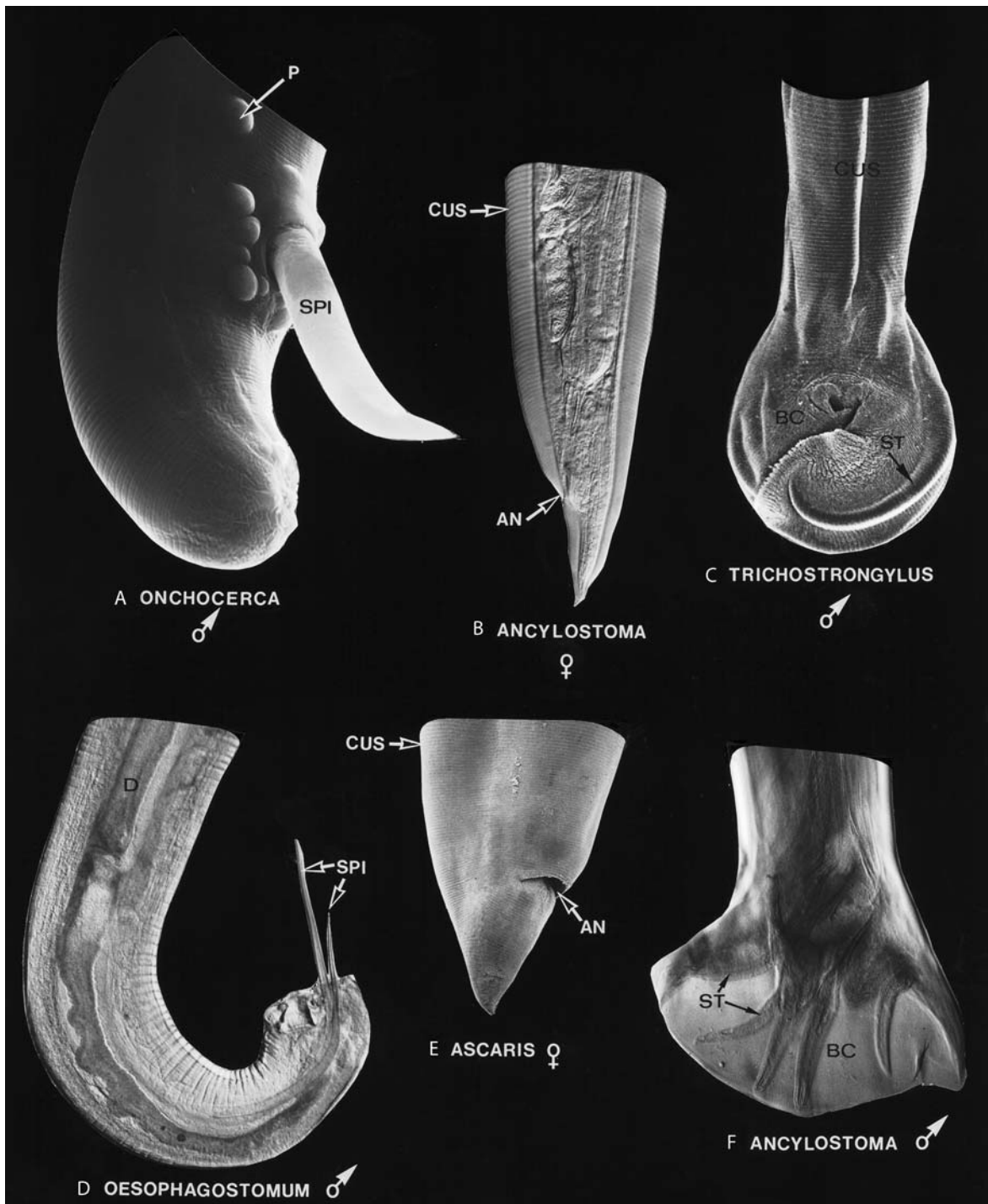

**Nematodes. Figure 13** SEMs of the posterior ends of nematodes. *AN*, anus; *BC*, bursa copulatrix; *CUS*, striation of the cuticle; *P*, papillae; *SP*, →spiculum.

(Fig. 16). The outer hypodermal membrane is plicated into numerous lamellae underlaid by a zone of mitochondria and lysosome-like bodies (Fig. 15B). At the base of the chord the basal labyrinth is extremely elaborate. In female filariae which have changed to

sessile life (and thus reduced their somatic muscles), even the interchordal hypodermis becomes thickened and resembles the hypodermal chords.

In trichurid nematodes the lateral chords contain a particular type of cells which are called hypodermal

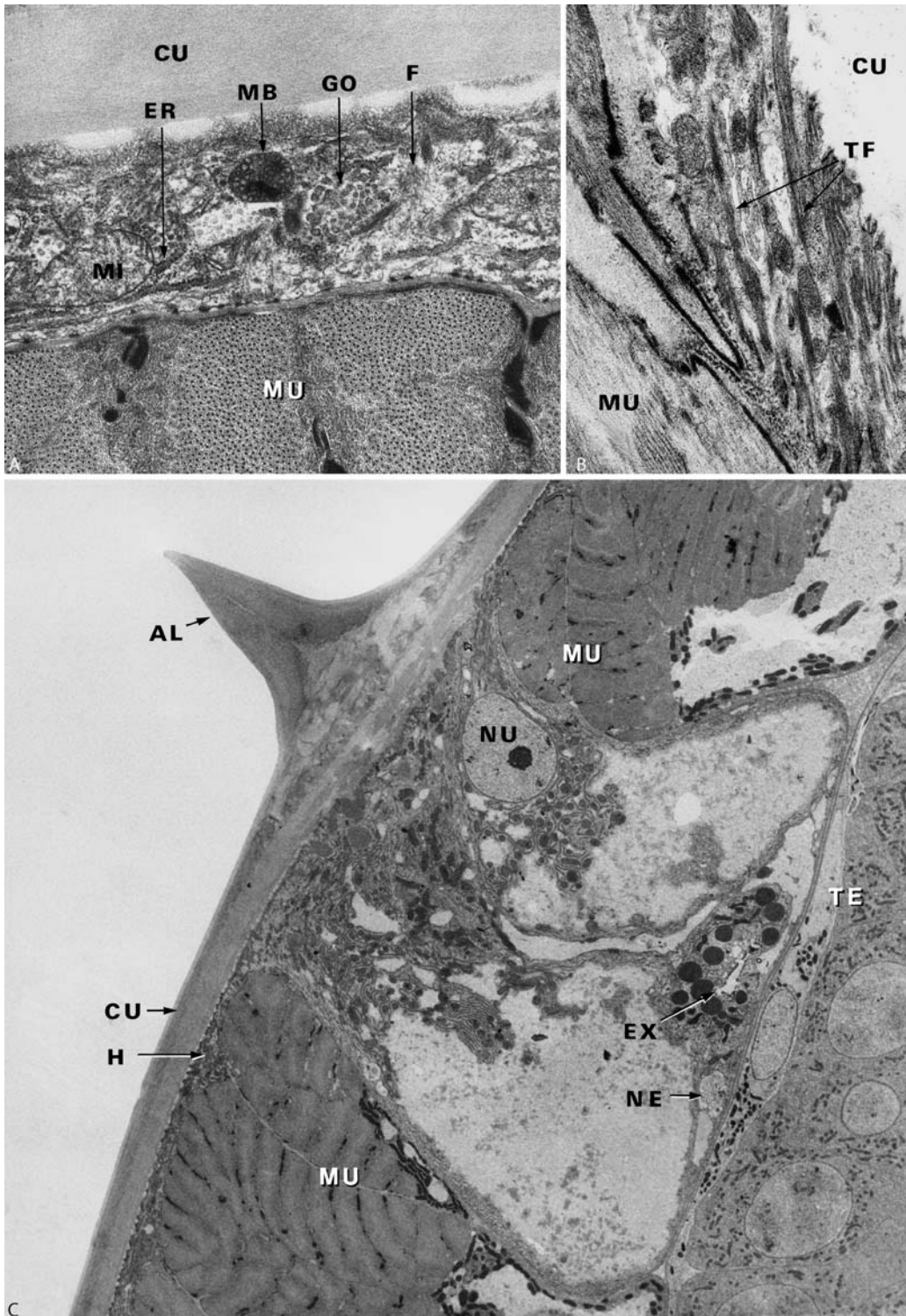

**Nematodes. Figure 14 A–C TEMs.** **A** The →hypodermis between cuticle (CU) and somatic muscle cells (MU) contains multivesicular bodies (MB), Golgi complexes (GO), mitochondria (MI), rough endoplasmic reticulum (ER) and fibrils (F) (*Heterakis spumosa*, × 23,000). **B** Tonofibrils (TF) cross the hypodermis connecting the cuticle (CU) to the muscle cells (MU) (male →*Onchocerca volvulus*, × 17,000). **C** Lateral chord of male *Heterakis spumosa* (× 2,800). AL, alae; CU, cuticle; EX, excretory tube; H, hypodermis between muscle cells and cuticle; MU, muscle cells; NE, nerves; NU, one nucleus of the dorsal →syncytium; TE, testis.

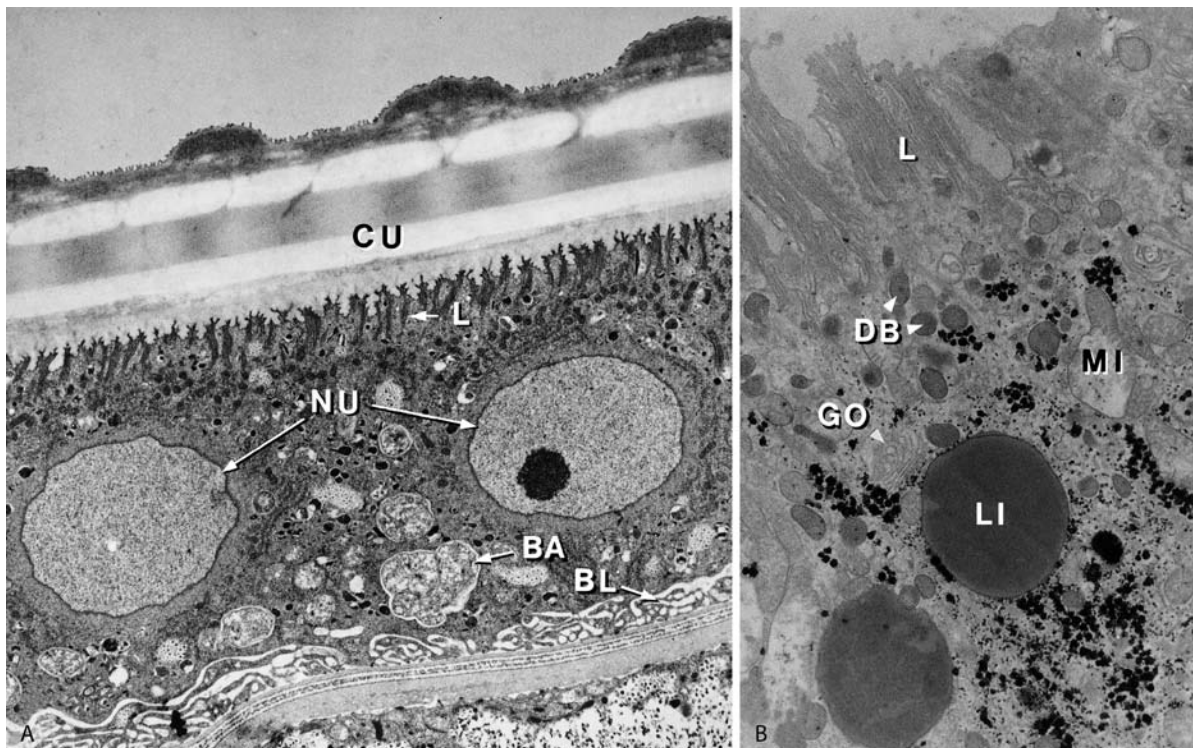

**Nematodes. Figure 15 A, B** TEMs. **A** Longitudinal section through **lateral chord** of male *Onchocerca volvulus*. The outer membrane of the hypodermis is folded into lamellae (*L*) ( $\times 3,700$ ). *BA*, Intraplasmatic bacteria (*Wolbachia* sp.); *BL*, basal labyrinth; *CU*, cuticle; *NU*, nuclei of the syncytial hypodermis. **B** In filariae the outer zone of the hypodermal chords is a zone of high metabolic activity.  $\rightarrow$  **Glycogen** is revealed as dark patches by histochemical staining (female *Onchocerca volvulus*,  $\times 15,000$ ). *DB*,  $\rightarrow$  **dense bodies**; *GO*, Golgi complexes; *L*, lamellae of the outer hypodermal membrane; *LI*, lipid droplets; *MI*, mitochondria.

gland cells or  $\rightarrow$  **bacillary cells** (Figs. 17, 19). The basal portion of these cells contains a large nucleus and many organelles, indicating intense physiological activity. The function of these cells is unknown, but secretory or osmoregulatory functions are assumed.

### Musculature

The somatic musculature of nematodes consists of a single layer of muscle cells which run in a longitudinal direction along the inner margin of the hypodermis. The hypodermal chords group the muscle cells into 4 sectors (Figs. 7, 8, 11, 25).

Each muscle cell consists of a contractile (= fibrillar) portion and of a noncontractile (= afibrillar) portion containing the nucleus (Fig. 7). The basic type of muscle cell is named platymyarian, the contractile portion of which is restricted to a small zone along the outer border of the muscle cell, i.e., running parallel to the hypodermis. In the muscle cells of the coelomyarian type the contractile portion also covers the lateral borders of the cells, whereas in the circomyarian type the whole inner side is covered by fibrillar material, thus surrounding the central afibrillar cytoplasm. Every

muscle cell has at least one process leading to the dorsal or ventral hypodermal chord, where it forms synaptic connections to one of the motoneurons (Figs. 7, 20C) and thus receives its different stimulations.

In the contractile portion of the obliquely striated, supercontractile muscle cells of nematodes the fibrils have a particular arrangement (Fig. 20A,B). Similarly to cross-striated muscles, the A-band ( $\rightarrow$  **actin** and  $\rightarrow$  **myosin** filaments), H-bands (myosin filaments alone), and I-bands (actin filaments alone) can be distinguished. However, in contrast to cross-striated muscles, the Z-planes do not run transversely to the fibrils, but at an oblique angle. This means that the other bands are also arranged at an oblique angle to the fibrils. In muscle contraction, the interdigitation of the myofilaments also leads to shearing forces, resulting in an increased obliquity of the whole system. Therefore, obliquely striated muscle is able to vary in length to a greater extent than cross-striated muscle.

### Intestine and Food Uptake

Nematodes are mostly relatively small organisms; their size is limited by the fact that they do not possess

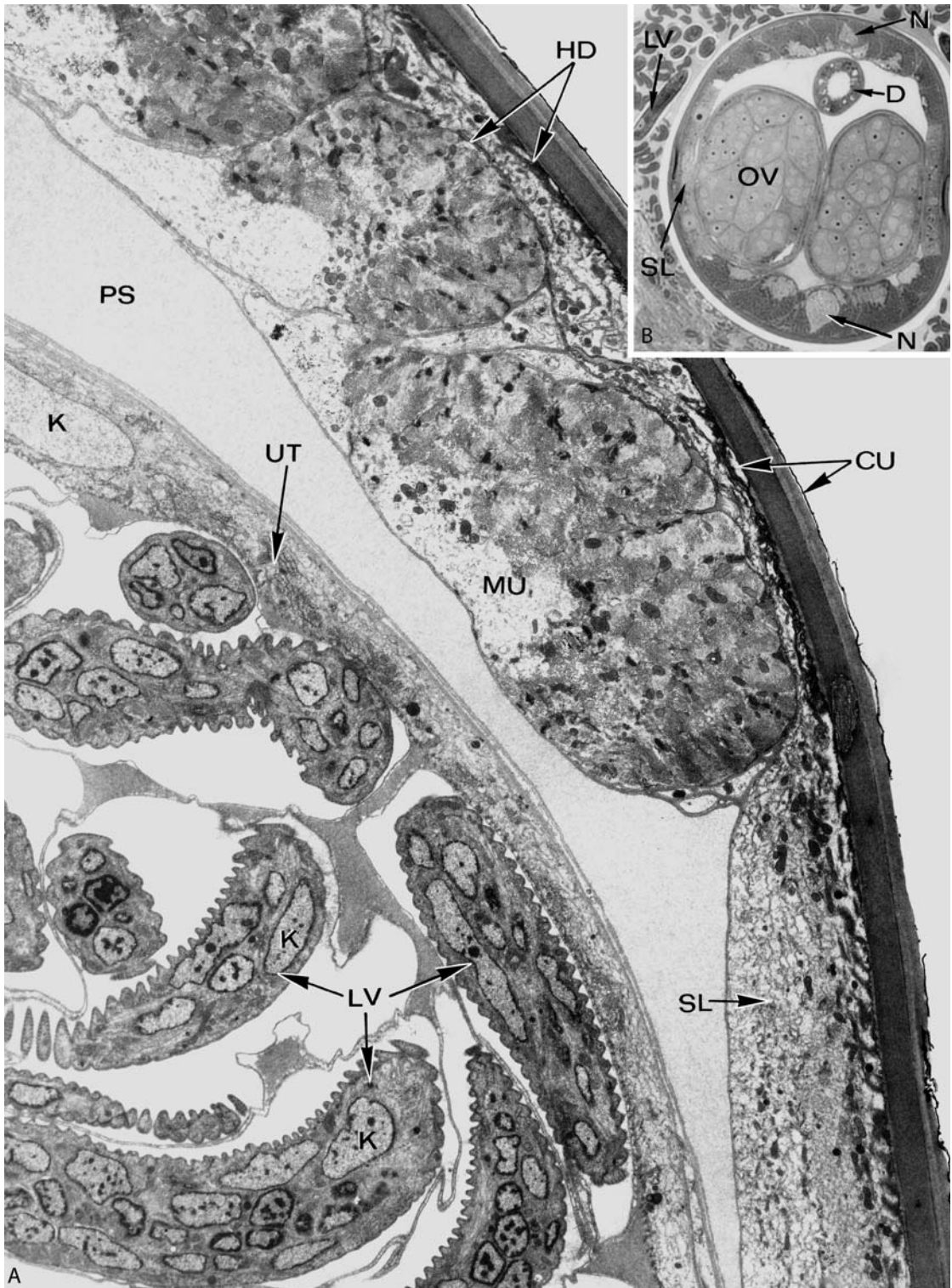

**Nematodes. Figure 16** LEM (B) and TEM (A) of cross sections through an adult female of *Brugia malayi*. **A** Magnification of the region of one of the lateral chords.  $\times 3,500$ . **B** Section through the oviduct (OV)  $\times 600$ . CU, cuticle; D, gut; HD, hypodermis; K, nucleus; LV, larva = *microfilaria*; MU, muscle cell; N, nerve chord; OV, oviduct; PS, pseudocoel; SL, lateral chord; UT, uterus.

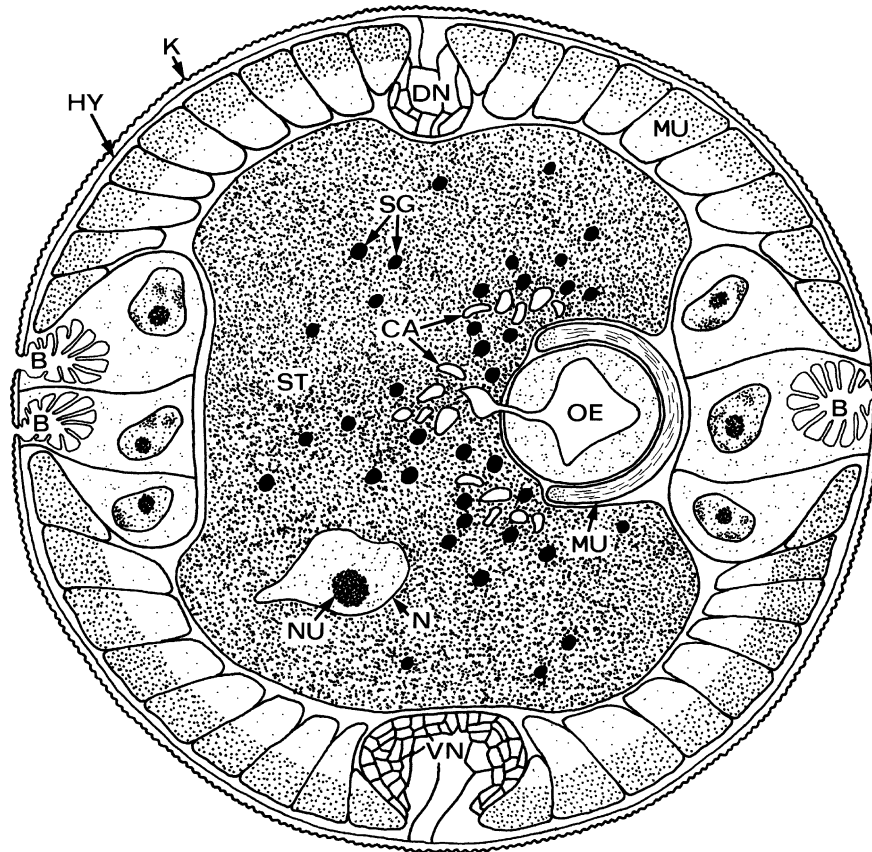

**Nematodes. Figure 17** Diagrammatic representation of a section through the anterior region of an adult *Trichinella spiralis* worm. *B*, →bacillary cells; *CA*, channel; *DN*, dorsal nerve chord; *HY*, hypodermis; *K*, cuticle; *LA*, lateral chords; *LH*, body cavity; *MU*, muscle cells; *N*, nucleus; *NU*, nucleolus; *SG*, secretory granules; *ST*, →stichosome cell; *VN*, ventral nerve chord.

circulatory systems to accelerate the transport of nutrients to the various organs. The alimentary canal and the gonads are surrounded by the fluid-filled pseudocoel, which is not septate (Fig. 11). Movement of the fluid is maintained by movements of the somatic and organ muscles. In many nematodes the genital tubes are twisted around the intestine; this large-scale contact probably accelerates nutritional exchange.

The hydrostatic pressure of the body fluid is necessary (as a padding) to maintain the independence of the pumping movements of the esophagus and the undulating locomotion of the worm. In extremely small nematodes (below 0.3 mm) these functions would interfere with one another and the typical nematode morphology would become inefficient. There may also exist an upper-size limit for effective functioning of the nematode's alimentary canal. The morphology of both extremes can be demonstrated with filarial nematodes. The size of the microfilariae (i.e., the first-stage larvae) is limited by the fact that they have to pass through the food canal formed by the mouthparts of sucking insects

(Fig. 25). These microfilariae do not possess a functional esophagus or intestine, but form them after growing inside their vector. Adult female filariae are extremely long and thin and are able to take up nutrients via their body wall. In some of the longest species reaching up to 70 cm in length (e.g., *Onchocerca* females) the alimentary canal seems to have lost the ability to ingest food (Fig. 23).

The alimentary canal may be subdivided into mouth, buccal cavity, esophagus, intestine, rectum, and anus (Figs. 11, 21–23).

The mouth was originally surrounded by 6 lips on which sensory papillae occur, but this basic pattern is considerably modified in most parasitic species. In strongylids the mouth is surrounded by 1 or 2 leaf crowns, in ascarids there are only 3 lips, and in filariae prominent lips are completely lacking (Figs. 11, 13).

The buccal cavity has a wide lumen in strongylid nematodes. The duct of the dorsal esophageal gland opens into this cavity and enzymes for extracorporeal digestion are released together with other substances



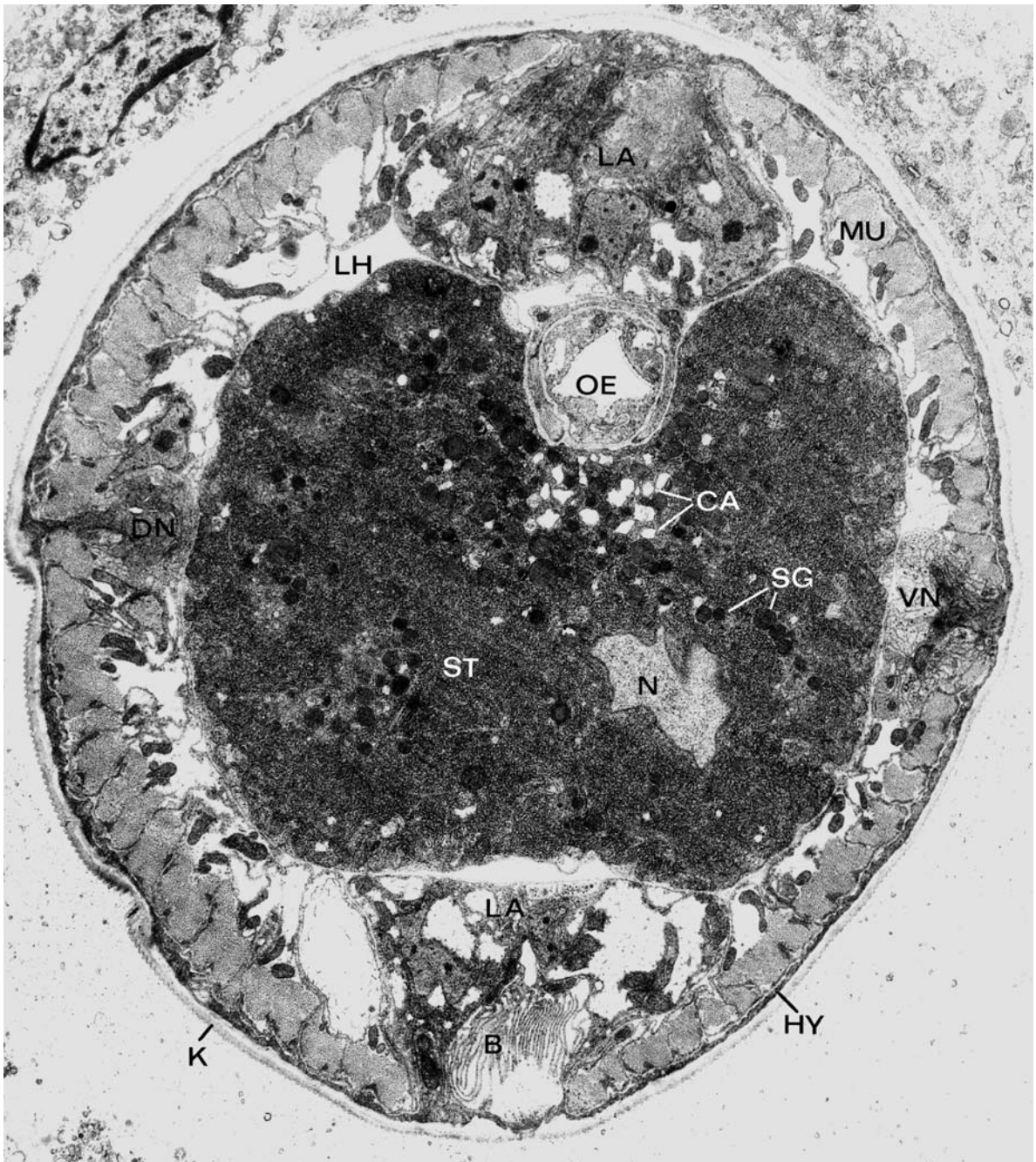

**Nematodes. Figure 18** TEM of a cross section through an adult *Trichinella spiralis* cut at the same level as in Fig. 17; Abbreviations as in Fig. 17.  $\times 2,500$ .

such as acetylcholinesterase, which is thought to have a role in attachment of the worm to the host's intestinal wall. The cutting plates of *Necator americanus* and the teeth of *Ancylostoma* spp. are modifications of the cuticular lining of the buccal cavity, and may even be lacking in many other nematode groups (Fig. 13).

The esophagus is a tube with a characteristic trifurcated cuticle-lined lumen, the outer wall of which is formed by the basal lamina. The tips of the luminal rays are connected to the basal lamina by tonofibrils. Muscle fibrils radiate from the cuticular lining of the lumen to the basal lamina (Fig. 21). The contraction of these fibrils opens the lumen of the esophagus, thus

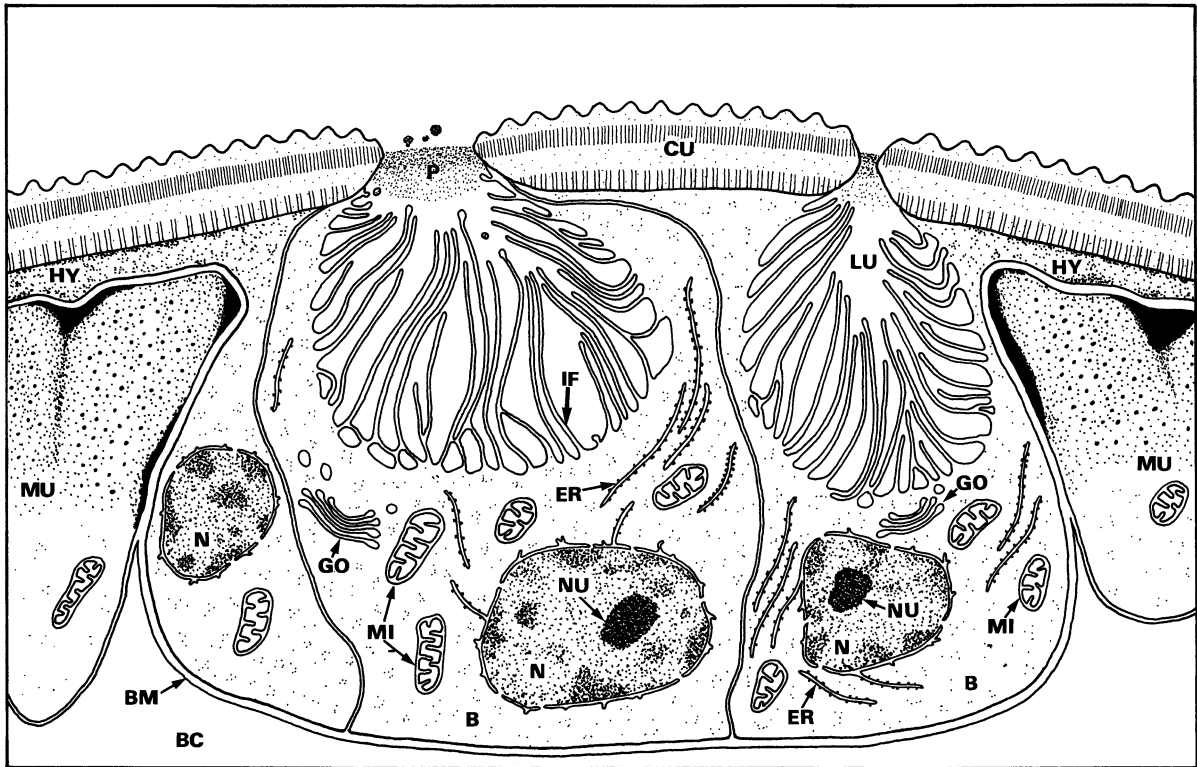

**Nematodes. Figure 19** Diagrammatic representation of the bacillary cells of a female worm of *Trichinella spiralis* from mice. Note that many foldings increase the area of the bacillary cell surface. *B*, bacillary cell; *BC*, body cavity; *BM*, basal membrane; *CU*, cuticle; *ER*, endoplasmic reticulum; *GO*, Golgi apparatus; *HY*, hypodermis; *IF*, intraluminal folds; *LU*, lumen; *MI*, mitochondrion; *MU*, muscle cell; *N*, nucleus; *NU*, nucleolus; *P*, plug.

sucking in nutrients. The hydrostatic pressure of the body fluid closes the esophageal lumen. This pumping mechanism presses the food through the intestine to the anus. At the end of the esophagus there is an additional valve which prevents the reflux of the ingested material. A gland cell is situated in the dorsal and both subventral sectors of the posterior portion of the esophagus. The cells produce digestive secretions which are released through ducts into the lumen. The opening of the dorsal gland cell is situated far anterior, often even in the buccal cavity, while the other openings are further posteriad. Some trichurid nematodes are endowed with a  $\rightarrow$ stichosome (Figs. 17, 18, 22), a multicellular organ that is very prominent in some stages and consists of unicellular stichocytes. It opens into the esophageal lumen and apparently functions as a secretory gland and storage organ.

The intestine is a cylindrical tube and its wall consists of a basal lamina and a single layer of epithelial cells which carry microvilli on their luminal surfaces (Fig. 23A,C). The microvilli stand close together and contain an axial core which is extended into the underlying cytoplasm and is connected to the

terminal web. The terminal web is a porous layer of structural proteins lying below the bases of the microvilli and connected to the core of the microvilli. On its other side numerous microfilaments are continuous with the underlying cytoplasm (Fig. 23B).

The cytoplasm of epithelial cells of the anterior intestine contains mainly mitochondria, rough endoplasmic reticulum, and Golgi complexes producing digestive enzymes which are released into the intestinal lumen. The cells of the middle and posterior region contain more structures which are associated with absorption, intracellular digestion, and storage of reserves and/or waste products. Intestinal cells usually contain energy reserves such as glycogen and lipid droplets. The outer membrane of the intestinal cells is often folded into a basal labyrinth which is covered by the basal lamina as the outer lining of the intestinal cylinder. The intestinal cells of blood-sucking nematodes usually contain large amounts of concentric granules. These granules contain iron originating from the hemoglobin of host erythrocytes. In several species further disintegration leads to the complete disappearance of these granules. Glycogen is rather rare in the intestinal cells of blood-feeding nematodes,

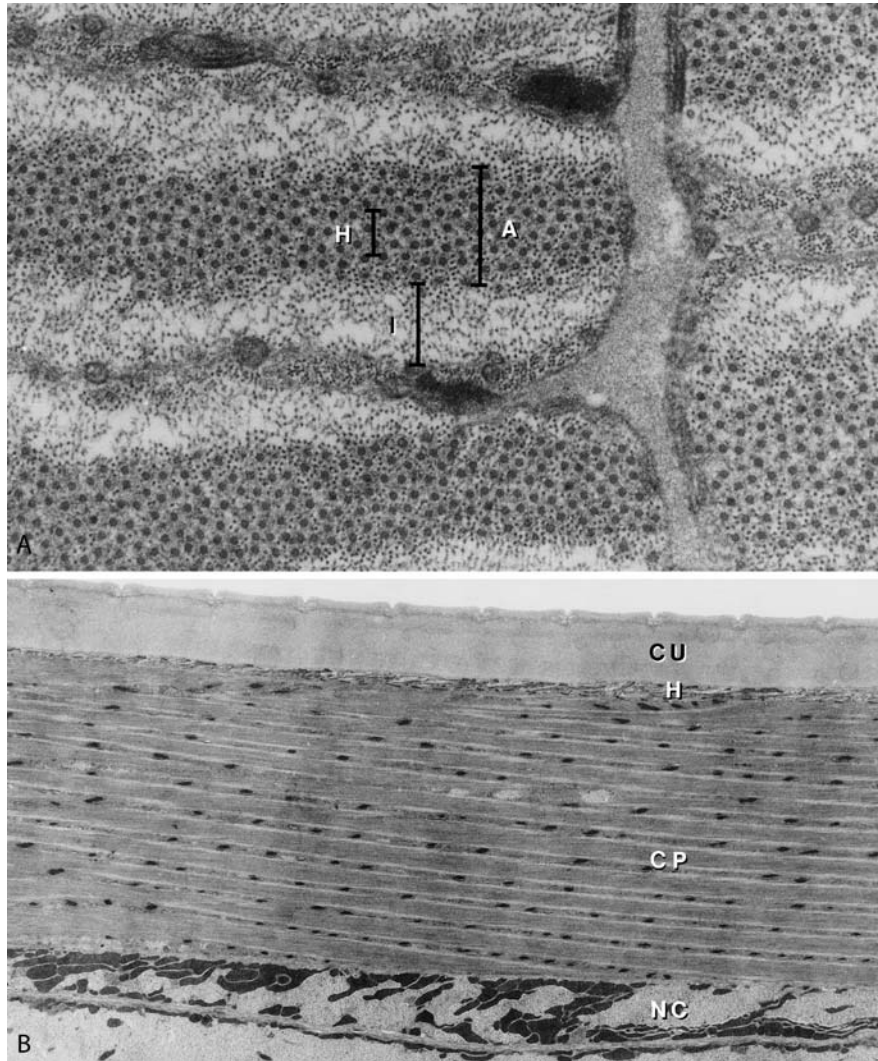

**Nematodes. Figure 20** **A** Cross section through contractile portion of muscle cell. The arrangement of the filament in A, H, and I bands is indicated (*Heterakis spumosa*,  $\times 77,000$ ). **B** Longitudinal section demonstrating the oblique arrangement of fibrils in the contractile portion (CP) of the muscle cell (*H. spumosa*,  $\times 3,600$ ). CU, cuticle; H, hypodermis; NC, noncontractile portion of muscle cell.

whereas in others it forms large aggregations. The intestinal cells of adult females of *O. volvulus* and *O. gibsoni* are extremely thick, thus reducing the intestinal lumen to a system of intercellular clefts (Fig. 23D).

The rectum is lined by cuticle. In male nematodes the germinal tube opens into the rectum, thus giving rise to a cloaca, the wall of which forms retractible copulatory organs (Figs. 12, 13).

### Excretory System

The excretory system of nematodes was named as such from morphological descriptions, but its function is rather osmoregulatory, ion regulatory, and even secretory

rather than excretory. The tubular type of excretory system is the most common type among parasitic nematodes. It consists of a system of tubes and 1 or 2 gland cells which have a joint excretory duct. The lateral tubes run inside the lateral chords of the hypodermis (Figs. 11, 14C, 24D). The hypodermal cytoplasm and the excretory tube are separated by membranes. The cytoplasm of the tube contains numerous canaliculi which open into the main canal (Fig. 24). In the anterior region of the worm, the lateral tubes are connected by a transverse canal. An excretory duct which is lined with cuticle runs from this transverse canal to the excretory pore. The subventral gland cells are connected to the transverse canal (Fig. 24). These

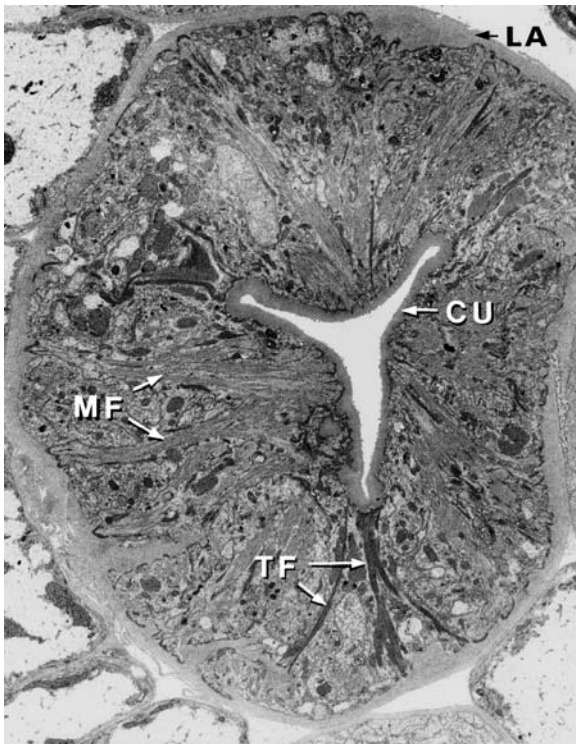

**Nematodes. Figure 21** Cross section through the esophagus of *Brugia malayi*. Muscle fibrils (MF) and tonofibrils (TF) run between the cuticular lining (CU) of the lumen and the basal lamina (LA) ( $\times 4,600$ ).

gland cells have a secretory function, and they have been shown to release acetylcholinesterase and protease in some species.

In the first-stage larvae of filariae (microfilariae) the excretory system consists of a single cell, and adult worms of this group apparently lack excretory systems. The hypodermal gland cells or bacillary cells are thought to have an osmoregulatory or secretory function in trichurid nematodes (Figs. 17, 18).

Single and sometimes branched cells are frequently found in the pseudocoel adjacent to the gonads or other internal organs, and in the anterior or posterior end portions of nematodes. These cells are called coelomocytes and are assumed to be phagocytic and to purify the body fluid (Fig. 24).

### Host Finding

Most research on nematode behavior concerns free-living bacteriophagous or plant-parasitic species. These commonly respond to a variety of different stimuli, e.g., water-soluble and volatile chemicals, temperature, touch, light, and electric potentials. They mainly seem to use chemotactic mechanisms to find their food or

hosts in the soil. In the bacteriophagous nematode *Caenorhabditis elegans*, responses to hundreds of chemicals have been tested and 14 types of sensory neurons described. Alone in the amphids, which are sensory structures in the head, the functions of 11 types of neurons were analyzed using laser microbeam ablation and various genetic methods.

The behavior of infective larvae of animal-parasitic nematodes is not as varied as that of the free-living species. This may be based on the fact that the infective stages do not feed, defecate, oviposit, mate, or undergo morphogenesis. The typical infective larva is enclosed within 2 cuticles. The outer cuticle or sheath originates from an incomplete molt and protects the infective larva from environmental stress. The sheath does not prevent the detection of environmental stimuli by the larvae as the amphids, as complex sensory organs, communicate with the environment via openings in the cuticle.

Much information is available on the behavior and the physiological processes of infective nematodes which must be eaten by their hosts, but several studies dealt also with the behavior of infective larvae which actively penetrate the host's skin. Their behavior has functions in the following phases of host finding:

- Dispersal and **habitat selection**. For some of the vertebrate invading nematodes it would be advantageous to leave their host's feces or the feeding sites where they develop into the infective stages. However, a repellent effect of feces was only described in insect-pathogenic nematodes. They avoided cockroach feces by responding to **ammonia**. The chances to encounter hosts are increased in some of the skin-penetrating infective larvae as they tend to climb to the top of prominent particles of the soil. Infective stages of vertebrate-invading species survive for weeks and it should be expected that their behavior is adapted to support, in addition to host-finding, a long survival. In fact, their vitality depends highly on environmental factors such as humidity, temperature and sun radiation. However, the larvae seem to accumulate passively in optimal habitats, not by active microhabitat selection via directed **orientation** movements. The movement of the larvae is fully dependent on a certain water film. No locomotion is possible when the water film is lacking and only a poor one when the film is too thick. In fact the movement and dispersal of **hookworms** is governed by the given water film, but they seem to not be able to actively select microhabitats with optimal humidity. Most species also seem not to respond to gravity, they move at random in a vertical direction. Only *A. caninum* and

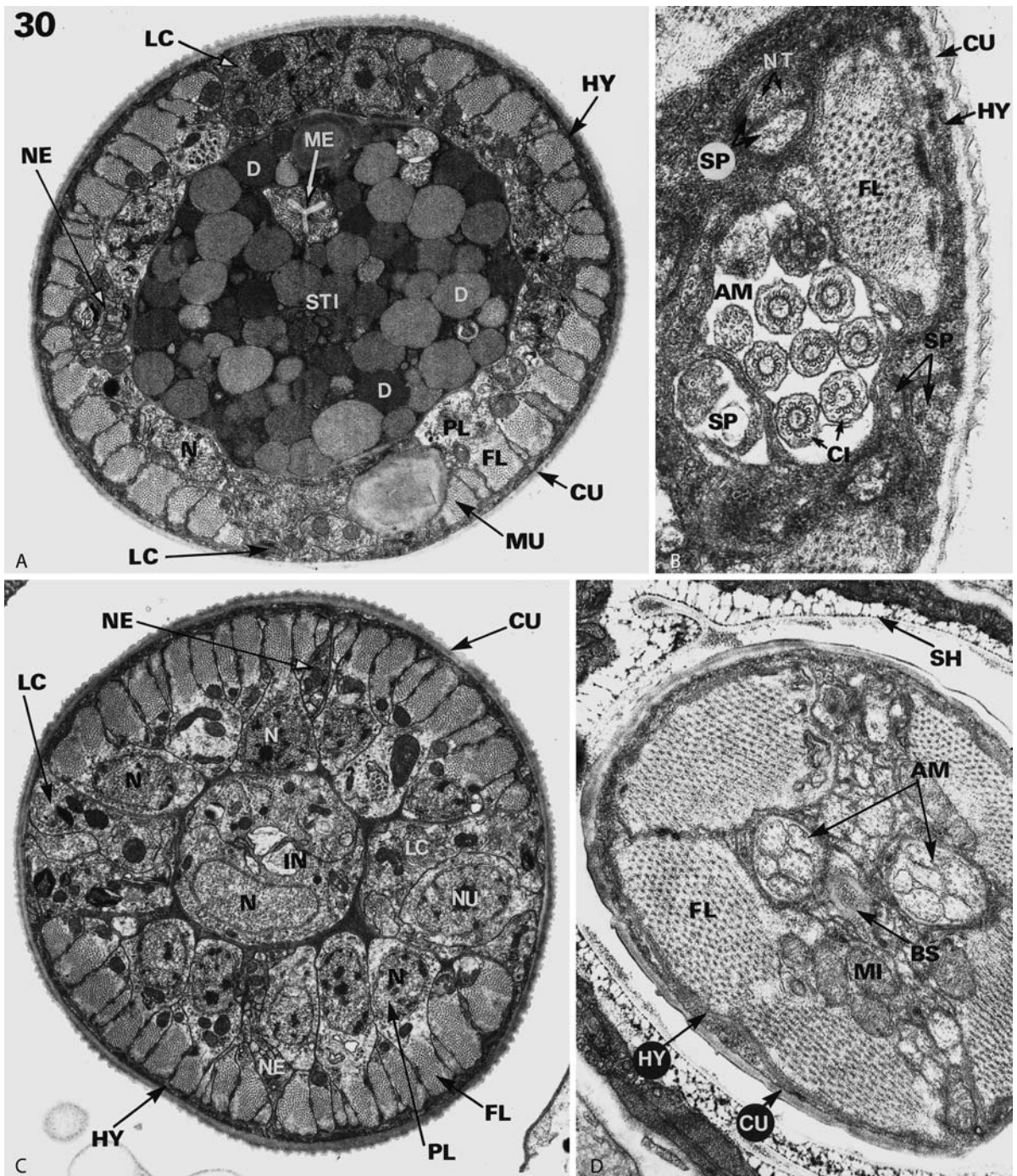

**Nematodes. Figure 22 A–D** Organization of nematodes (TEMs of cross sections). **A, B** Adult females of *Trichinella spiralis*. Note the occurrence of a large *stichocyte* (i.e., unicellular gland) surrounding the muscular esophagus in A. The very end of worms is provided with a pair of amphids (one is cut in B). The amphidal groove, which contains 10 *cilia*, is surrounded by rows of nonciliary sensory papillae, the axonemes of which do not show a ciliary pattern. (A  $\times 1,700$ , B  $\times 9,000$ ). **C** *Litomosoides carinii*; section through the posterior pole of the larva 2 within the *intermediate host* (mite) ( $\times 1,700$ ). **D** *L. carinii*; section through the anterior pole of a microfilaria (= larva 1) within a capillary of the final host (rodent). Note the occurrence of a sheath and 2 amphids with nonciliary papillae ( $\times 9,300$ ). *AM*, amphidal groove; *BS*, buccal primordium; *CI*, cilia; *CU*, cuticle; *D*, droplets of gland; *FL*, fibrillar part of muscle cell; *HY*, hypodermis; *INA*, intestine (posterior region); *LC*, lateral cord; *PL*, cytoplasmic part of muscle cell; *ME*, muscular esophagus; *MI*, mitochondria; *MU*, muscle cell; *N*, nucleus; *NE*, nerve cord; *NU*, nucleolus; *SH*, *sheath*; *SP*, sensory papillae (groove); *STI*, *stichocyte*.

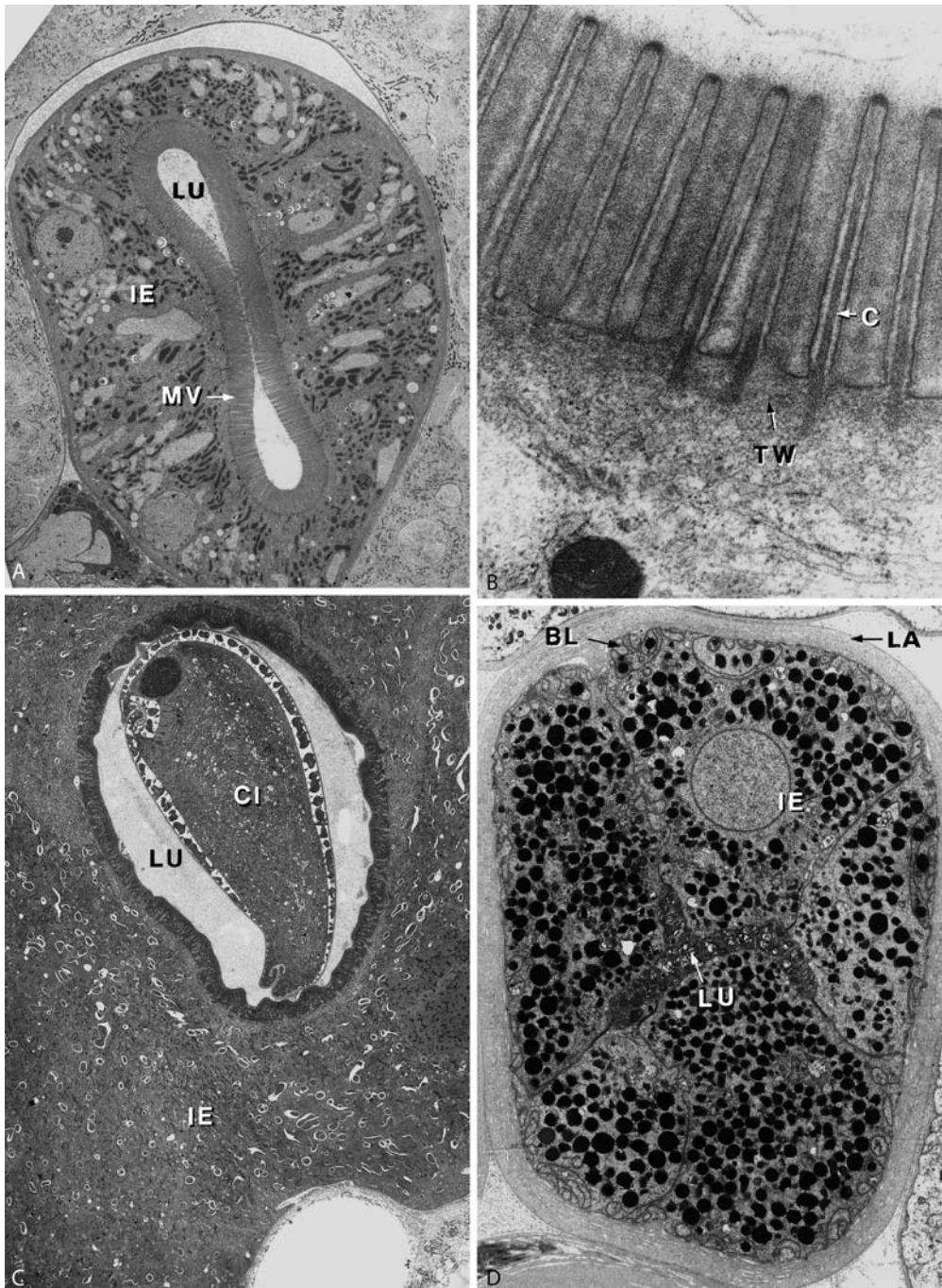

**Nematodes. Figure 23 A–D** TEMs of nematode intestines. **A** → *Heterakis spumosa* ( $\times 1,300$ ). **B** The microvilli have a central core (*C*), which is connected to the terminal web (*TW*) (*H. spumosa*,  $\times 38,000$ ). **C** An ingested entodiniomorph ciliate (*CI*) is found in the intestinal lumen (*LU*) of → *Cylicocyclus nassatus* ( $\times 800$ ). **D** The intestinal lumen (*LU*) of female *Onchocerca volvulus* is reduced to clefts between the cells of the intestinal epithelium (*IE*) ( $\times 5,800$ ). *BL*, basal labyrinth; *C*, central core; *CI*, ingested ciliate; *IE*, intestinal epithelium; *LA*, basal lamina; *LU*, lumen; *MV*, microvilli; *TW*, terminal web.

*Strongyloides stercoralis* infective larvae have been found to exhibit negative geotaxis. Some species disappear into the substrate when exposed to sun radiation and accumulate in shaded areas.

However, most species do not seem capable of an orientation along the direction of light radiation. Only *N. americanus* infective larvae were found to show a weak orientation towards light, whereas this

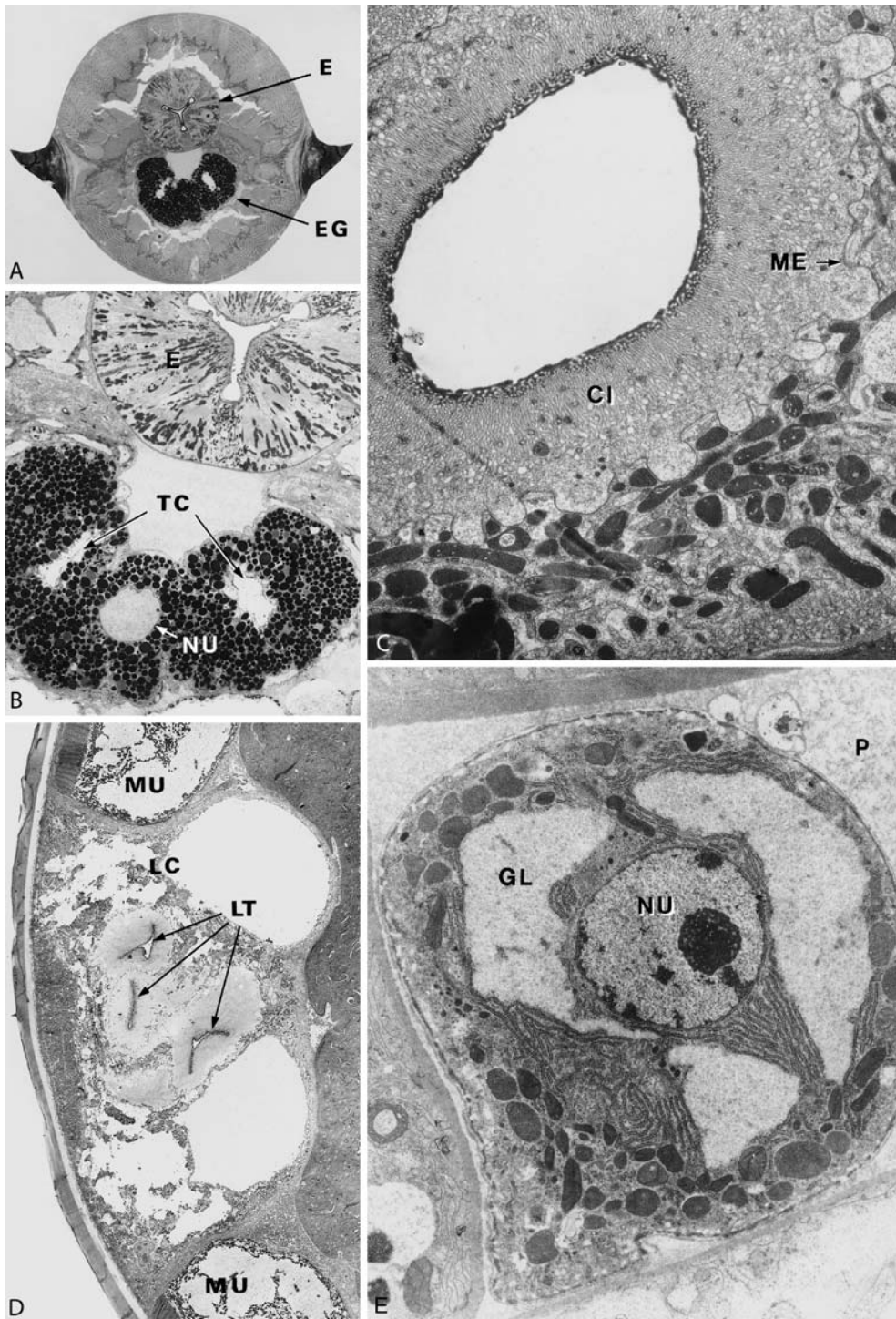

**Nematodes. Figure 24 A–E** **A** Cross section at the level of the →excretory gland of →*Heterakis spumosa* (×250). **B** The cytoplasm of the excretory gland of *H. spumosa* contains many secretory droplets (×900). **C** The lateral tube of *C. nassatus* is surrounded by numerous canaliculi (CI) (×10,000). **D** The lateral tubes (LT) in the lateral hypodermal chords (LC) of *C. nassatus* (×680). **E** Coelomocyte in the pseudocoel of *H. spumosa* (×7,500). CL, canaliculi; E, esophagus; EG, →excretory gland; GL, →glycogen; LC, lateral hypodermal chord; LT, lateral tube; ME, membrane separating hypodermis from the excretory canal; MU, muscle cell; NU, nucleus; P, pseudocoel; TC, transverse canal.

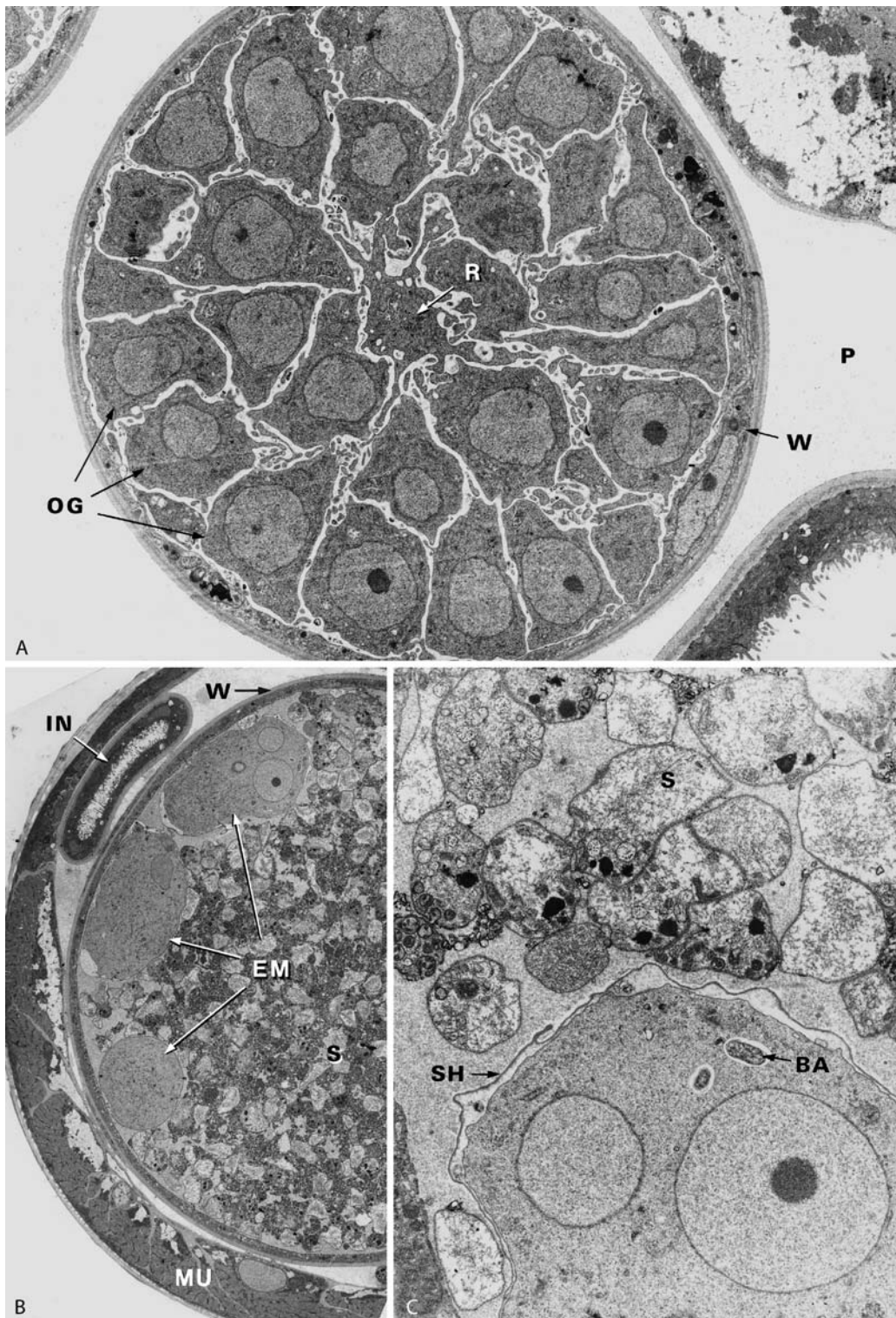

**Nematodes. Figure 25 A–C** Oogenesis and early embryogenesis in *Brugia malayi*. **A** Germinal zone of the ovary ( $\times 5,200$ ). *OG*, oogonia; *P*, pseudocoel; *R*, rachis; *W*, ovary wall consisting of epithelium and basal lamina. **B** Receptaculum seminis containing numerous sperms (*S*) and three early embryos (*EM*) ( $\times 1,600$ ). *IN*, intestine; *MU*, somatic muscle cells; *W*, wall of receptaculum seminis. **C** Detail from the receptaculum seminis with amoeboid sperms (*S*) and an embryo in early cleavage. Embryos of viviparous nematodes contain no  $\rightarrow$  yolk stores and the thin residual of the eggshell is the sheath (*SH*) ( $\times 8,200$ ). *BA*, transovarially transmitted bacterium.



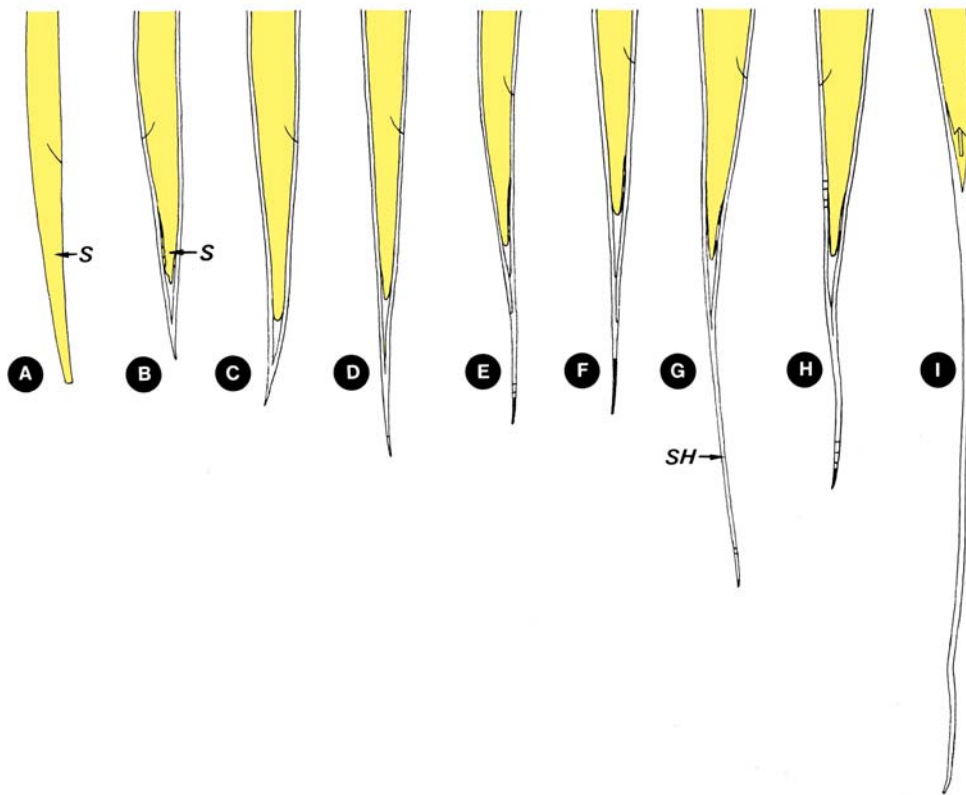

**Nematodes. Figure 26** DR of several infectious nematode larvae of sheep. *S*, tail; *SH*, sheath. **A** *Strongyloides papillosus*; **B** *Trichostrongylus* sp.; **C** *Ostertagia* sp.; **D** *Cooperia* sp.; **E** *Haemonchus* sp.; **F** *Bunostomum* sp.; **G** *Oesophagostomum* sp.; **H** *Chabertia* sp.; **I** *Nematodirus* sp.

photo-orientation was absent in *A. duodenale* larvae. Most of the reported phototactic responses may be explained as responses to the heat produced by the light sources. In fact, the larvae respond sensitively to temperature gradients and this may have functions in the location of the hosts rather than in the selection of habitats.

- Approach towards the host and change over to the host. Plant- and insect-parasitic nematodes follow chemical gradients towards unknown components of host extracts and towards carbon dioxide. However, in insect-pathogenic nematodes such a chemo-orientation seems to be restricted to species that use the cruising strategy by which relatively small hosts or immobile insect larvae are actively searched for. Species that infect fast-moving hosts perform an ambushing strategy of host-finding (i.e., a sit-and-wait strategy) and they seem to respond to chemical signals only on the host's surface. The actively mammal-invading species also use ambushing strategies. Under constantly favorable →environmental conditions they show very low levels of movement, but they can be activated

by host stimuli. Hookworm infective larvae start sinusoidal locomotion when stimulated by vibrations, warmth, unspecific chemicals, and eventually carbon dioxide (Table 2). However, such larvae will not climb on a host's skin surface or hair touching them. A prerequisite for a change over to the host is, that they show a particular behavior by keeping an erect posture and waving their anterior end from side to side. The parasites performing this waving behavior ("nictating") cling passively to touching substrates, and no particular attachment behavior seems to be necessary. Waving behavior is stimulated by carbon dioxide, radiated heat, and sufficient humidity in species such as *A. caninum*, →*A. duodenale*, *Nippostrongylus brasiliensis*, *Trichostrongylus orientalis*, *Necator americanus*, and →*Strongyloides stercoralis*. The dog hookworm *A. caninum* responds, in contrast to the human hookworms sensitively to defined vibrations and carbon dioxide (Table 2). This may be an adaptation to infect dogs when they are sniffing on the ground.

- Creeping on the host and penetration. The skin-invading larvae of 13 species studied so far all

**Nematodes. Table 2** Signaling cues for finding, recognition, and invasion of the mammalian host by hookworm infective larvae. The larvae normally remain in a motionless, energy-saving, resting posture. Host cues activate them to crawl, and other cues attract the crawling larvae (eventually along hairs or material adhering to the skin). The larvae seem not to actively attach to the host, but a passive adherence at the surface of a moving host is greatly enhanced by waving behavior (“nictating”). Penetration into the skin is stimulated by further host cues

	<i>Necator americanus</i>	<i>Ancylostoma duodenale</i>	<i>Ancylostoma caninum</i>
<b>(A) Activation to sinusoidal locomotion</b>			
Light	Yes	Yes	No
Warmth	Yes	Yes	Yes
Vibrations	Poor response	Poor response	Sensitive to defined frequencies and amplitudes
Carbon dioxide	No	No	Yes
Chemicals	Yes	Yes	?
<b>(B) Crawling towards attractants</b>			
Light	Yes	No	No
Heat (threshold of gradients)	0.09°C/cm	0.09°C/cm	0.4°C/cm
Temperature of accumulation (mean [min–max])	39 (38–43)°C	44 (42–46)°C	40 (37–43)°C
Chemicals	No	No	Hydrophilic skin surface extracts
<b>(C) Waving behavior (allows adhering to the host)</b>			
Warmth (as radiated heat and in airstream)	Yes	Yes	Yes
Airstream: moisture	Yes	Yes	Yes
Carbon dioxide alone	No	No	Yes
Carbon dioxide with moisture and/or heat	Yes	Yes	Yes
<b>(D) Penetration</b>			
Warmth	Yes	Yes	Yes
Chemical compounds of the skin	Fatty acids	Fatty acids	Peptides

Data from Granzer and Haas 1991; Haas et al. 2005a, b

migrate in the direction of the warm end of temperature gradients, some of them even moving to lethal temperatures. This thermo-orientation is very sensitive (the human hookworms respond to a slope as low as 0.09°C/cm) and may enable the parasites to reach the skin surface, e.g., by migrating along hairs or along mud or soil adhering to the skin. The hookworms show very different temperature preferences during their thermo-orientation (Table 2), but the adaptive benefits of this diversity are not yet understood. The human hookworms do not follow chemical gradients towards the skin surface, but *A. caninum* is attracted by skin surface peptides (Table 2). The penetration of the skin is stimulated by warmth, but also by chemical cues. The few species studied so far seem to respond to different chemical penetration stimuli. *A. caninum* larvae penetrate in response to skin and serum peptides (Table 2) and *A. braziliense* also responds to serum. But in contrast to *A. caninum* and *Ancylostoma tubaeforme* which do not respond to skin

surface lipids, the human hookworms *N. americanus* and *A. duodenale* use exclusively the fatty acid fraction of the skin surface lipids as cues. They react to other chemical characteristics of the fatty acids than schistosome cercariae, which also respond to fatty acids as penetration cues. This underlines the fact that the response to fatty acids of the skin has evolved independently in nematodes and trematodes and is mediated by different receptors.

## Nematodirosis

Trichostrongylid → trematodes of the genus → *Nematodirus* spp. (→ Trichostrongylidae) infect the anterior third of the small intestine of ruminants (→ Alimentary System Diseases, Ruminants). The most important species are *N. helvetianus*, which infects cattle; *N. spathiger*

and *N. filicollis*, which infect sheep, goats, and cattle; and *N. battus*, which mainly infects sheep. The only species causing disease are *N. battus* in sheep and, to a lesser extent *N. helvetianus* in calves. Nematodirosis, like [→cooperiosis](#), is normally confined to young animals, because of the early development of immunity, partly due to age and partly to experience of infection. Third-stage larvae enter the deeper layers of the mucosa, and larvae emerge at the fourth or fifth stage. The presence of large numbers of adult *Nematodirus* worms is associated with the development of villous atrophy. It is not known how adult worms exactly damage the epithelial cells of the host and cause atrophy of the villi, but it may be related to a cell-mediated immune response. This atrophy is associated with the presence of short, sparse [→microvilli](#) on each individual epithelial cell. Clinical disease usually appears with populations of about 10,000–50,000 or more *Nematodirus* worms. Affected animals may lose their appetite and develop a severe dark green [→diarrhoea](#). There is very rapid loss of weight and [→dehydration](#), as shown by the sunken eyes and the extreme thirst. Lambs may die within 10–14 days of infestation. The clinical signs appear earlier in sheep than in cattle.

### Therapy

[→Nematocidal Drugs, Animals.](#)

---

## Nematodirus

Genus of [→nematodes](#) that parasitize inside the small intestine of ruminants. *Nematodirus filicollis* and *N. battus* are rather common. The females reach a

length of up to 20 mm, males are smaller. The eggs are excreted with the feces. Outside of the host the development until larva 3 occurs inside the egg. Mostly in spring (March – May) the larvae hatch from the egg. This leads suddenly to intense infections with numerous worms. [→Trichostrongylidae/Fig. 1.](#)

### Diagnosis

Eggs in faeces probes ([Fig. 1](#)).

### Disease

[→Alimentary System Diseases, Ruminants,](#) [→Nematodirosis.](#)

### Therapy

[→Nematocidal Drugs.](#)

---

## Nematospiroides dubius

Trichostrongylid nematode of the house, which have spirally coiled bodies. Males (6 mm) and females (13 mm) occur in the small intestine. The eggs measure 75–90 µm × 43–58 µm. The L<sub>1</sub> hatch from the egg and undergo two molts and the ensheathed L<sub>3</sub> are taken orally with the food. The L<sub>4</sub> are usually encysted and embedded in the mucosa, but return after molt to the intestinal lumen and mature. This worm is a common laboratory model (*Meriones*).

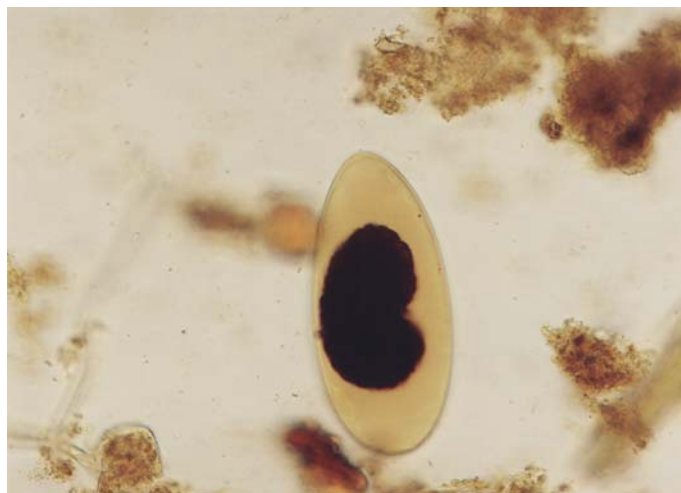

**Nematodirus. Figure 1** Egg from fresh feces.

## Neoascaris

Synonym to → *Toxocara vitulorum* of cattle, reaching a length of 30 cm as females and 25 cm as males.

## Neodermis

### Synonym

→ Tegument.

→ Body Cover, → Metazoa, → Platyhelminthes/Tegument.

## Neodiplostomum

Genus of digenetic trematodes, synonym of → *Diplostomum*. This species, which is commonly found in rats, has also been recorded in humans in Korea. Characteristic is that the body of the fluke is partite with a wide ventrally concave forebody.

## Neoechinorhynchus

### Classification

Genus of → *Acanthocephala*.

### Life Cycle

→ *Acanthocephala*/Life Cycle.

## Neoechinorhynchus cylindricus

→ *Acanthocephala*.

## Neoechinorhynchus rutili

→ *Acanthocephala*.

## Neorickettsia helminthoeca

Rickettsial agent transmitted by the fluke → *Nanophyetus*.

## Neoschneideria

→ Gregarines.

## Neospora caninum

### Classification

Species of → *Coccidia* (phylum Apicomplexa = Alveolata)

### General Information

This species which might be identical with the originally described species → *Hammondia heydorni* runs its life cycle in dogs and coyotes, which excrete spherical, about 10 µm-sized oocysts (Fig. 1), which form outside of the body 2 sporocysts each with 4 sporozoites. Infections of many vertebrate hosts lead to the formation of tachyzoites (Fig. 2) and later to a low number of tissue-cysts of the

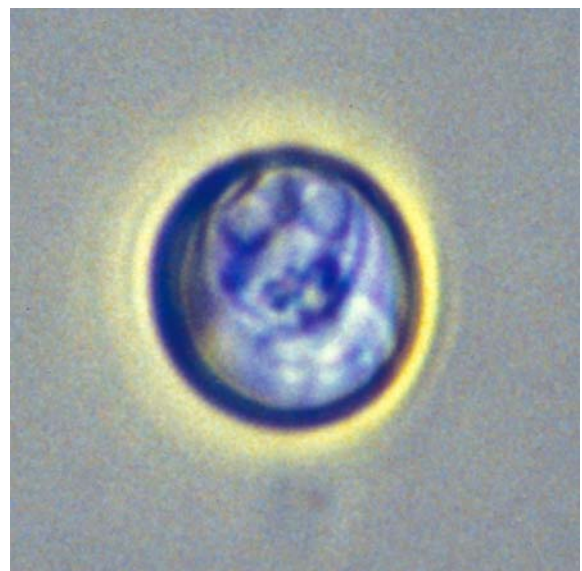

**Neospora caninum.** Figure 1 LM of sporulated oocyst, which is spherical in shape and contains 2 sporocysts with 4 sporozoites.

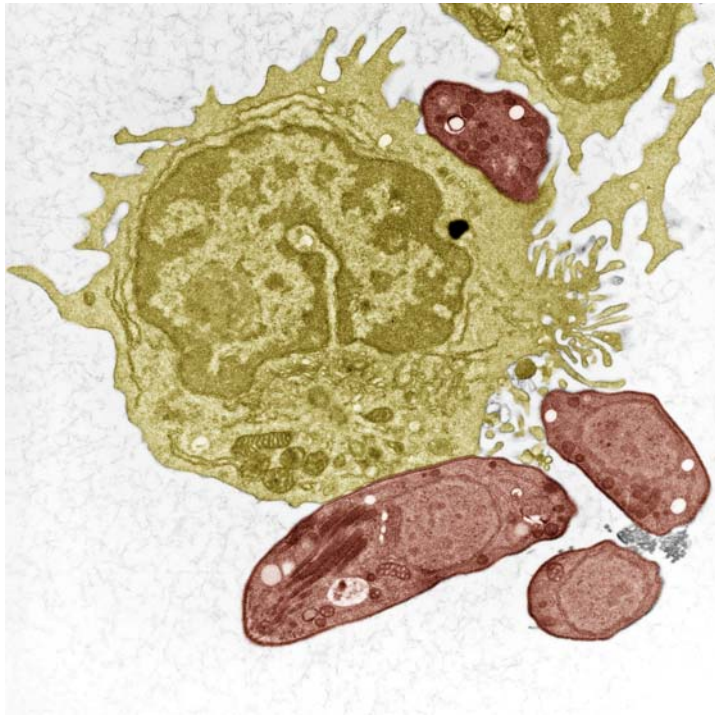

**Neospora caninum.** Figure 2 TEM of tachyzoites being engulfed by a macrophage.

thin-walled *Toxoplasma*-type. Tachyzoites and tissue-cysts are infections for dogs, which, however, excrete extremely low numbers of oocysts. Malformations or death of puppies of dogs or abortions of fetal calves are said to occur due to infections with →*Neospora*, since, e.g., cattle has a wide distribution of high degrees of antibody titers.

### Diagnosis

Microscopical analysis of oocysts (Fig. 1) in fecal samples.

### Disease

→Neosporosis, →coccidiosis.

---

## Neosporosis

*Toxoplasma*-like disease in dogs, cattle, horses, sheep, etc., due to infections with →*Neospora caninum* (syn. →*Hammondia heydorni*) of the brain of the fetus leading often to →abortion. Transmission: Oral uptake of oocysts from the feces of dogs (→Nervous System Diseases, Animals, but mainly intrauterine infection).

### Therapy

Toltrazuril, Ponazuril; vaccines are available, but protection is not proven.

---

## Neostromylus

→Lungworms.

---

## Neoteny

Animals remain in a morphologically underdeveloped stage (e.g., larva), which, however, reaches fertility. →Gyrodactylus, →Eucestoda, →Mites/Ontogeny.

---

## Neotrombicula autumnalis

### Classification

Species of →Mites.

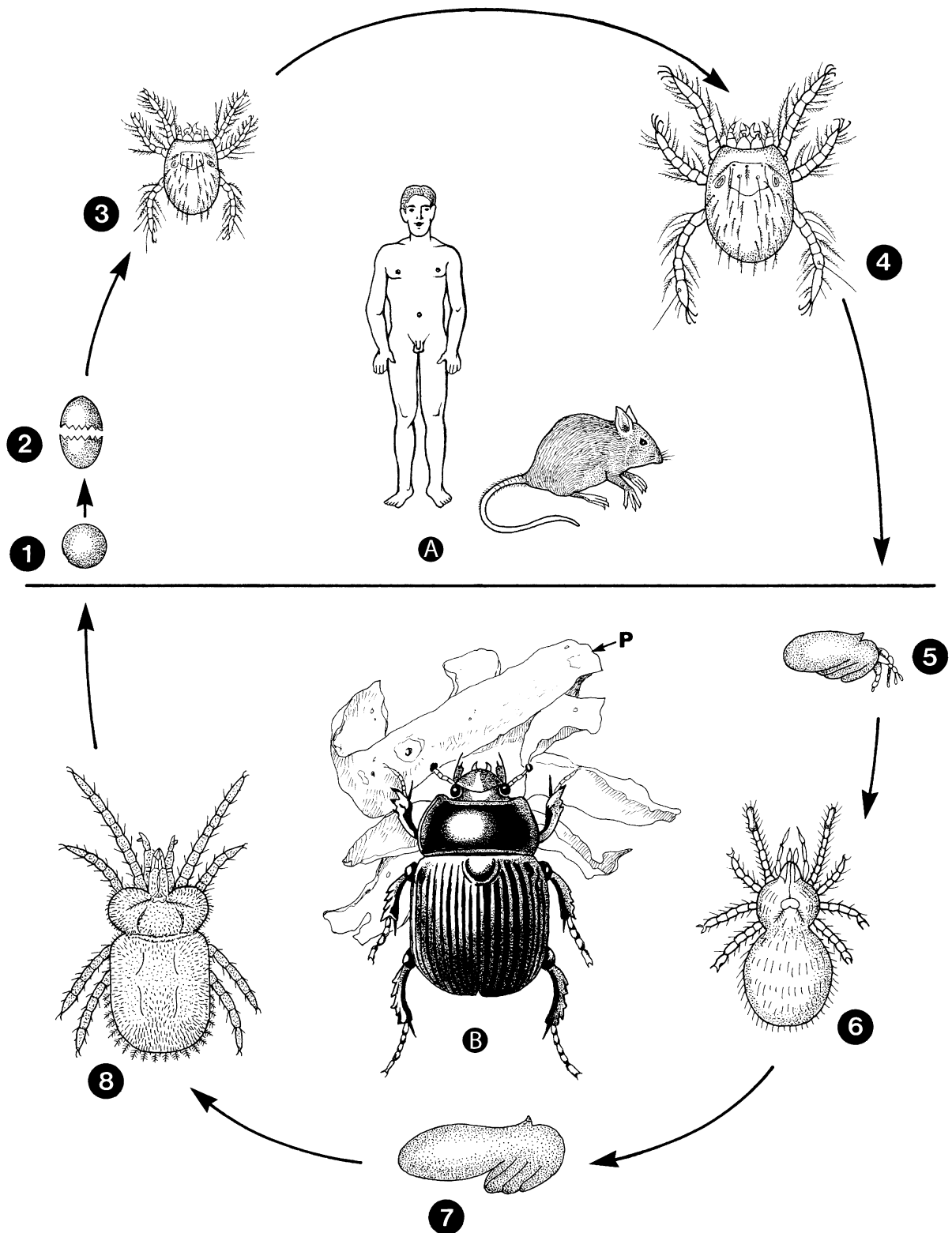

**Neotrombicula autumnalis.** Figure 1 Life cycle of *Neotrombicula autumnalis*. 1–4 A six-legged parasitic larva hatches from the egg and starts feeding by scratching the skin of vertebrates (A). 5–6 Having finished feeding the larva enters the soil and develops into an inactive →protonymph (5), which hatches to become an active predaceous →deutonymph (6). 7–8 After a phase of inactivity as a →tritonymph (7) sexually mature adults (8) are formed, which are found on beetles, potato peels (P), etc.; they finally start copulation.

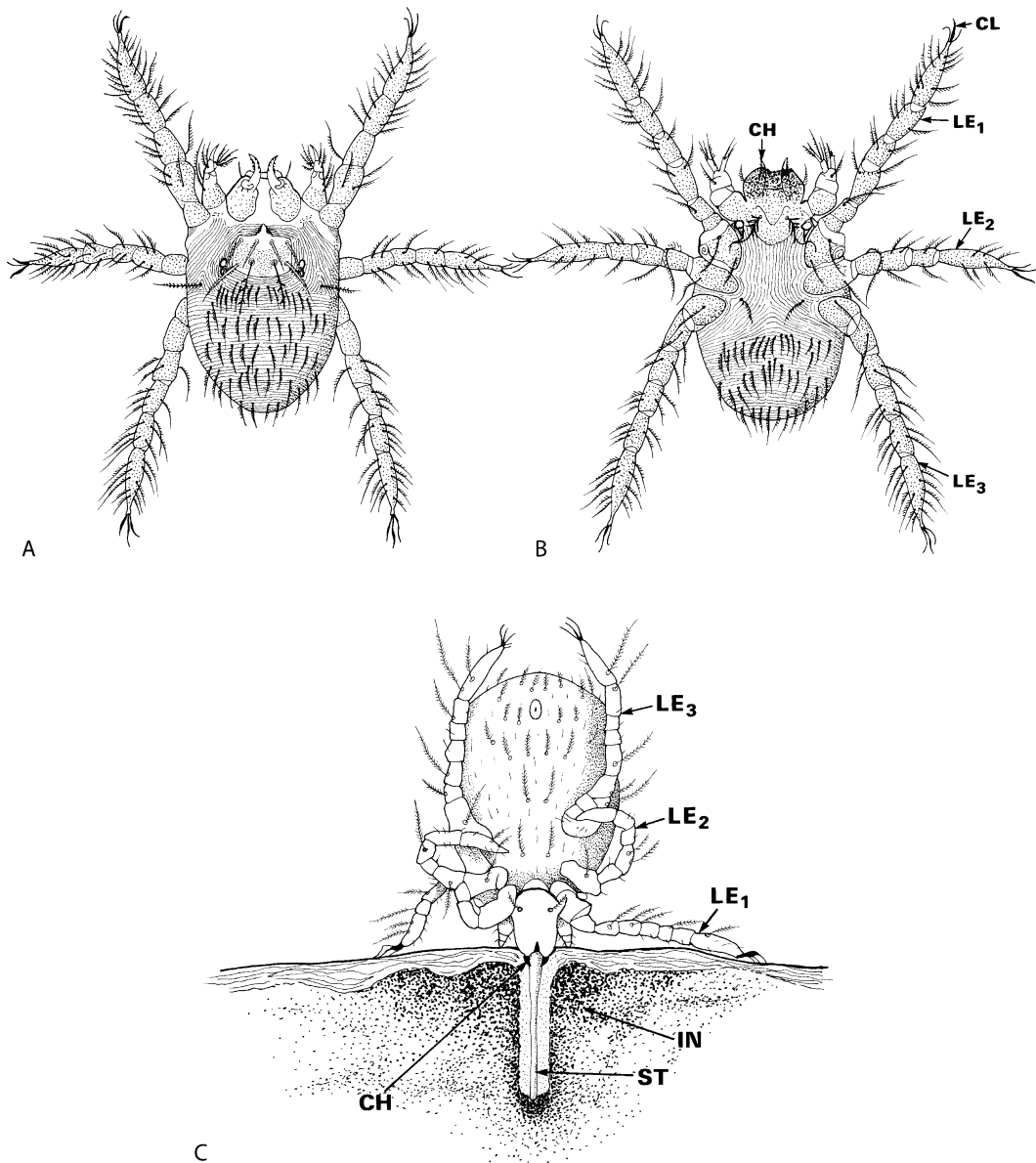

**Neotrombicula autumnalis.** **Figure 2** Diagrammatic representation of a parasitic *Neotrombicula autumnalis* larva. *A* Dorsal view; *B* ventral view; *C* feeding; note that after scratching with the cheliceres (CH) a channel-like structure (ST) is formed reaching from the mouth region into the skin. Through this channel lymph and infiltrated cells (IN) are taken up. *LE*, legs; *ST*, →stylostome.

### Life Cycle

Figs. 1, 2.

The 6-legged larvae (Figs. 3, 4, page 989) of this species reach a size of up to 0.25–0.5  $\mu\text{m}$  after being attached to the skin of many animals or humans. The bites cause in humans the so-called scrub-itch, which is rather painful (Figs. 5, 6, page 989, 990). Since the larvae detach from their hosts after sucking and enter the soil, protection can only be done by spraying harmless insecticides (e.g., neem-extracts, Fa. Alpha-Biocare) onto contaminated grounds/places, →Mites.

### Neotropical Cutaneous Leishmaniasis (NCL)

This disease is a zoonosis (=anthropozoonosis), since at first mainly wild animals are carriers of the leishmanial stages (e.g., *L. braziliensis*). In humans often several skin lesions even after a single bite are found due to the transportation of the leishmanial stages by macrophages to other places of the skin.



**Neotrombicula autumnalis.** Figure 3 LM of biting stages of *N. autumnalis*



**Neotrombicula autumnalis.** Figure 5 Typical skin reactions after *Neotrombicula*-bites.



**Neotrombicula autumnalis.** Figure 4 LM of a biting larva.

---

## Neotropics

From Greek: *neos* = new, *tropikos* = tropic. Faunistic region in South and Central America.

---

## Neozoa

Subkingdom of the former kingdom Protozoa, which includes the unicellular eukaryotic organisms, typically possessing plastids, mitochondria, Golgi, and cytoplasmic inclusions (including hydrogenosomes and peroxisomes).

---

## Nephridiorhynchus Major

Acanthrophalan species in the intestine of hedgehogs (12 × 0.5 cm).



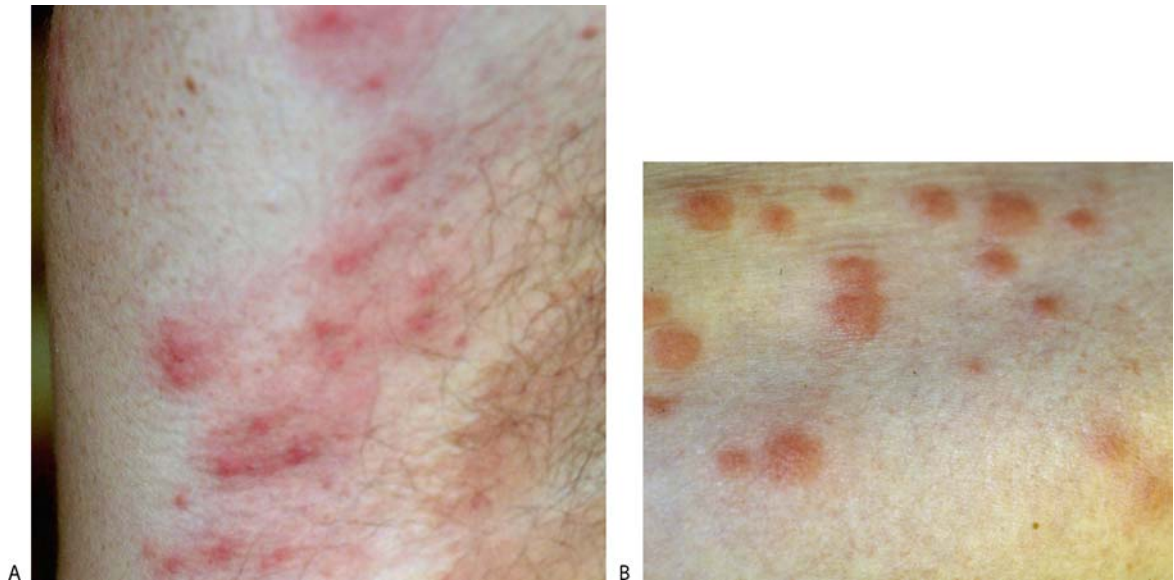

**Neotrombicula autumnalis.** Figure 6 Typical skin reactions after *Neotrombicula*-bites.

## Nephropores

→ *Hirudo medicinalis*.

## Nervous System Diseases, Animals

Nervous symptoms have been frequently associated with parasitic infections in animals. There is an impressive list of parasites that may be located in the meningeal spaces or may penetrate into the tissues of the brain and spinal cord or eye. Many of these parasites wander in the nervous system aberrantly, especially when they are in an alien host.

The pathological changes are influenced by the route of entry, and the size and mobility of the parasite. These changes fall into 3 categories: (1) haemorrhagic, (2) degenerative, and (3) proliferative. Haemorrhagic changes are attributed to parasites in the arterial circulation or to laceration of blood vessels as the parasites move through the tissues. Degenerative changes in neurofilariosis (e.g., → *Setaria* and other nematoda) are characterized by disruption of nervous tissues, swelling of axis cylinders, and degeneration of neurons. Proliferative changes may be diffuse or focal. Diffuse proliferation includes perivascular → hyperplasia of the reticulum, as observed in neurofilariosis and cerebral ascariosis. Focal proliferation usually consists of granulomatous aggregations in the vicinity of the parasite. In some instances the cellular reaction was found to consist

mostly of glial proliferation. In contrast, certain nematode infections of the central nervous system show no evidence of cellular reaction in the vicinity of the parasite. Degenerative changes in the vicinity of the parasite probably appear only if the parasite has become quiescent before the host dies. If the parasite is moving at the moment of the host's death, it may be in relatively normal tissue, while extensive damage may be found in other parts of the central nervous system. It is also common to find lesions similar to those produced by migratory parasites without being able to locate the parasite.

Apart from the purely mechanical damage that the parasites may cause, there has been considerable speculation as to whether they may facilitate the entry of virus infections. Nervous symptoms have also been described in parasitic infections where the parasite had not invaded the central nervous system. For instance intestinal parasitism in young puppies may be associated with convulsions that may be produced by a concomitant hypocalcemia or hypoglycemia, or both.

The lesions generated in the nervous tissue are more likely to produce clinical symptoms than aberrant migrations in other tissues. The clinical signs associated with parasites in the nervous system depend on the neuro-anatomic structure affected (Fig. 1). However, most parasites have no specific selectivity for any part of the nervous system and can therefore produce any clinical signs depending on the area they invade. The pathogenesis of infections of the nervous system is too varied to be considered here in detail. However, when known the common symptoms caused by end-disease will be described.

Only few parasites have the eye as predilection site, e.g., → *Thelazia* spp. (→ Nervous System Diseases,

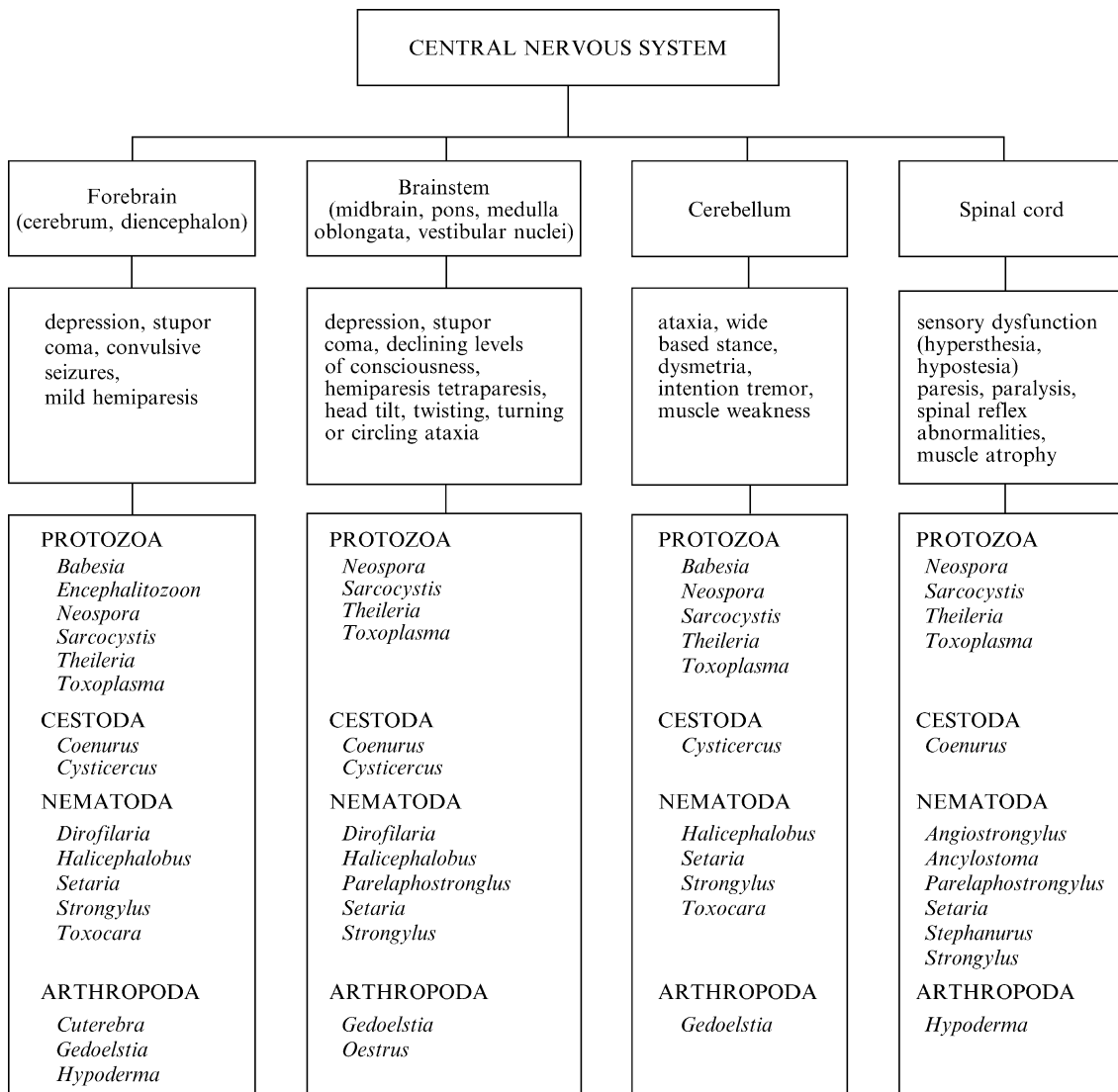

**Nervous System Diseases, Animals. Figure 1** Localisation and clinical signs of parasites affecting the nervous system.

Ruminants). However, several parasites which normally develop elsewhere in the body have been reported to occasionally alter the eye (Table 1) (see also →Eye Parasites).

For detailed information on nervous system diseases in specific host please refer to the following entries:

- Nervous System Diseases, Carnivores
- Nervous System Diseases, Horses
- Nervous System Diseases, Ruminants
- Nervous System Diseases, Swine

## Nervous System Diseases, Carnivores

The common clinical signs and pathology of parasitic infections of the nervous system of carnivores are listed in Table 1.

### Protozoa

Several →Protozoa may cause nervous symptoms e.g., *Babesia canis*, →*Encephalitozoon cuniculi*, →*Toxoplasma gondii*, →*Neospora caninum* and →*Trypanosoma* spp.

Infections with some strains of *B. canis* often terminate with signs of cerebral damage such as paddling of limbs, ataxia, mania and coma. This is the result of brain damage caused by obstruction of the brain capillaries by parasitized red blood cells. There is usually no evidence of neuronal degeneration but there is dilatation of the perivascular spaces and interstitial →oedema.

→*Encephalitozoonosis* (→*Nosematosis*) is caused by the obligate intracellular microsporidian *Encephalitozoon cuniculi*. The disease has been described in rodents, lagomorphs, primates and several species of carnivores. Asymptomatic infection usually occurs in rodents and lagomorphs. In carnivores the neurological signs include repeated turning and circling movements, especially after disturbance, dysmetria, dysergia, →blindness, and a

**Nervous System Diseases, Animals. Table 1** Parasites affecting the eyes of domestic animals (according to Vercruyse and De Bont)

Parasite	Host	Clinical signs and lesions
<b>Protozoa</b>		
<i>Encephalitozoon cuniculi</i>	Cat	Keratoconjunctivitis, characterized by multiple superficial corneal opacities arranged in a stellate pattern
<i>Leishmania infantum</i>	Dog	Conjunctivitis, keratouveitis, blindness
<i>Theileria</i> spp.	Cattle	Lacrimation, photophobia, in prolonged cases corneal opacity, blindness
<i>Toxoplasma gondii</i>	Dog, cat, cattle	Focal retinochoroiditis, anterior uveitis, retinal haemorrhage, exudative detachment, blindness
<i>Trypanosoma</i> spp.	Ruminants, horse, dog	Photophobia, lacrimation, conjunctivitis, keratitis, iritis, retinitis, occasionally total blindness
<b>Cestoda</b>		
<i>Coenurus cerebralis</i>	Sheep	Blindness
<b>Nematoda</b>		
<i>Angyostrongylus vasorum</i>	Dog	Impaired vision, retinal haemorrhages
<i>Dirofilaria immitis</i>	Dog	Anterior uveitis, iritis, blindness
<i>Elaeophora schneideri</i>	Sheep	Keratitis
<i>Habronema</i> spp. <i>Draschia megastoma</i>	Horse	Granulomatous nodules on the nectitating membrane and conjunctivae near the nasal canthus
<i>Onchocerca cervicalis</i> (microfilariae)	Horse	Keratitis, recurrent anterior uveitis, peripapillary choroidal sclerosis, vitiligo of the bulbar conjunctiva at the lateral limbus
<i>Setaria equine</i> <i>S. digitata</i>	Horse	Ocular opacity, photophobia, lacrimation, corneal leucoma, iridocyclitis and hypopyon
<i>Thelazia</i> spp.	Ruminants, horse, cat, dog	Conjunctivitis, lacrimation, photophobia, oedematous eyelids, mild or ulcerative keratitis
<i>Toxocara canis</i>	Dog	Chorioretinal granuloma
<b>Arthropoda</b>		
<i>Gedoelestia</i> spp.	Ruminants	Lesions vary from a mild conjunctivitis to a destructive ophthalmitis with orbital or periorbital oedema and abscessation

terminal semi-comatose state. Lesions described are →encephalitis and segmental →vasculitis. The course of the illness is usually 5–12 days.

The neuropathology associated with canine and feline toxoplasmosis has been described in detail. In these species, toxoplasmosis is characterized by focal →necrosis and vascular damage in acute infections, and by glial →nodules, repair, and scar formation in →chronic infection. Cerebral calcifications, common to chronic toxoplasmosis in children, appear to be rare in animals. In dogs extensive areas of necrosis, gliosis and demyelination are found. Clinical nervous signs include depression, trembling, opisthotonus, head tilt, incoordination, blindness and paraplegia. In puppies, it may resemble distemper, clinical toxoplasmosis occurring sometimes together with this disease. Skeletal muscle atrophy due to damage of lower motor neurons has been associated with a case of clinical canine toxoplasmosis.

Incoordination and spinal paralysis have been reported in dogs infected with *T. brucei brucei*.

→Neosporosis (*N. caninum*) is mainly reported in young dogs. Puppies show a hind limb paresis that develops into a progressive paralysis. Neurologic signs are dependent on the site that is parasitized. The hind limbs are more severely affected than the front limbs, and often in rigid hyperextension. The cause of this hyperextension is not known, but is most likely due to a combination of upper motor neuron paralysis and myositis which results in rapidly progressive fibrous contracture of the muscles that may cause fixation of joints.

### Cestodes

Cerebral coenurosis, due to *Coenurus serialis* and →*Cysticercus cellulosae* has been described in cats and dogs showing neurological disorder.

### Nematodes

Various nematode species may invade the central nervous system. →*Angiostrongylus cantonensis* is a metastrongylid lungworm of the rat. In unnatural hosts,

**Nervous System Diseases, Carnivores. Table 1** Parasites affecting the nervous system (according to Vercruyse and De Bont)

Parasite	Host	Location	Nervous clinical signs	Principal lesions in nervous system
<b>Protozoa</b>				
<i>Babesia canis</i>	Dog	Red blood cells Selectively concentrated in brain	Paddling of limbs, ataxia mania and coma	Distention of the capillaria of the gray matter of the cerebrum and cerebellum, dilatation of perivascular spaces and interstitial oedema
<i>Encephalitozoon cuniculi</i>	Carnivores	Brain, kidney and other organs	Desorientation, circling, behavioral changes, convulsions, blindness	Encephalitis and segmental vasculitis
<i>Neospora caninum</i>	Dog	Cranial and spinal nerves	Limb paresis, paralysis	Encephalomyelitis characterized by gliosis, perivascular cuffs and mild necrosis
<i>Toxoplasma gondii</i>	Carnivores	Forebrain, brainstem, spinal cord	Trembling, opisthotonus head tilt, incoordination, paraplegia, blindness	Focal necrosis and vascular damage, glial nodules and scar formation
<b>Cestoda</b>				
<i>Coenurus serialis</i>	Cat, dog	Brain	Alternated state of consciousness, circling, ataxia, vestibular disturbances	Fluid-filled parasitic cyst, 1.5 to 2 cm in diameter compressing brain tissue
<i>Cysticercus cellulosae</i>	Dog	Brain or meninges	No apparent clinical signs in pigs, in dogs neurological disorders	Chronic inflammatory exudate in Tissue surrounding the cysticerci
<b>Nematoda</b>				
<i>Angiostrongylus cantonensis</i>	Dog	Larvae in spinal cord and brain	Ascending paralysis, lumbar hyperalgesia	Eosinophilic meningoencephalitis, periradiculoneuritis
<i>Ancylostoma caninum</i>	Dog	Spinal cord	Imbalance, torticollis, tetraparesis and death	Haemorrhagic and necrotic tract in the spinal cord
<i>Dirofilaria immitis</i>	Dog, cat	Meningeal arteries, lateral ventricle	Intermittent convulsion, ataxia, circling	Thrombosis of cerebral artery, ventriculitis
<i>Toxocara canis</i>	Dog	Hypophysis, cerebellum in pigs	Rare	Local eosinophilia, granuloma formation
<b>Arthropoda</b>				
Diptera				
<i>Cuterebra</i> spp.	Dog, cat	Brain	Depression, hysteric convulsions	Acute focal haemorrhagic encephalomalacia

such as dogs the parasite develops in the spinal cord and to a lesser extent the brain, and usually dies without reaching the lungs. Infection leads to an eosinophilic meningo-encephalitis and a periradiculoneuritis. Clinical signs are slight paresis of the hind legs, uncertain straddle gait and →hypersensitivity of the skin.

Cerebrospinal nematodosis caused by →*Ancylostoma caninum* has been reported in a dog. A 12-week-old cocker spaniel had signs of imbalance, torticollis and pain on flexion of its →neck that eventually progressed to tetraparesis and death. A young adult female *A. caninum* was found in the haemorrhagic cervical spinal cord.

Adult heartworms →*Dirofilaria immitis* usually inhabit the right side of the heart or pulmonary arteries of

carnivores. Occasionally adult worms have been observed in the brain where they invade the lateral ventricle, or in the meningeal arteries with subsequent occlusion. The clinical course is characterized by intermittent convulsion, blindness, ataxia, behavioral changes and circling. →*Microfilaria* of *D. immitis* have also been reported within the meningeal arteries, deep arteries and capillaries of the brain and extravascularly within the brain.

Larvae of →*Toxocara canis* have been recovered from the brains of experimentally infected dogs, but with little clinical illness. A severe granulomatous inflammation of the hypothalamus and adjacent neurohypophysis caused by *T. canis* larvae have been reported in a dog suffering from diabetes insipidus.

## Arthropoda

The larvae of *Cuterebra* species (→*Diptera*) normally mature in subcutaneous tissue of Rodentia and Lagomorpha, but occasional infection in dogs and cats may occur. In these abnormal hosts the larvae have been observed in the brain, causing neurologic clinical signs.

## Nervous System Diseases, Horses

The common clinical signs and pathology of parasitic infections of the nervous system of horses are listed in Table 1.

### Protozoa

*Sarcocystis neurona* (n.sp.) was proposed as the putative cause of equine protozoal myeloencephalitis (→EPM). Lesions occur in the white and grey matter of the brain, and in the spinal cord. They consist of a proliferative inflammation with a variable degree of →necrosis of myelin, and axonal degeneration usually referred to as “segmental myelitis”. Haemorrhage occurs occasionally. Unlike *T. gondii*, the organisms extensively invade neurons. Clinical signs of EPM are variable in onset and

evolution, and depend on the nervous area involved. The onset is either gradual or sudden. Usually, an impairment of action of one limb is the first sign noted. Eventually, ataxia of both limbs or all four limbs will appear, and sometimes circling and depression has been noticed. Recent evidence indicates that →*Neospora caninum* may also cause EPM.

The later stages of →dourine are characterized by →anaemia and nervous disorders such as paralysis of the hind limbs. It is thought that a “toxin” produced by *Trypanosoma equiperdum* causes inflammation and degeneration of the peripheral nerves. The motor and sensory disturbances are the direct result of these changes. Incoordination and spinal paralysis have been reported in horses infected with *T. brucei brucei*.

### Nematodes

Worms of the genus →*Setaria* are commonly found in the peritoneal cavity of ungulates where they are non-pathogenic. The major pathogenic effects of the cattle parasites *S. digitata* and *S. labiato-papillosa* occur when immature forms migrate erratically in the central nervous system of abnormal hosts such as the horse. The lesions are microscopic and may be overlooked. They are usually single tracts left by migrating worms which may be found in any part of the central nervous

**Nervous System Diseases, Horses. Table 1** Parasites affecting the nervous system of horse (according to Vercruysse and De Bont)

Parasite	Host location	Nervous clinical signs	Principal lesions in nervous system
<b>Protozoa</b>			
<i>Neospora caninum</i>	Cranial and spinal nerves	Limb paresis, paralysis	Encephalomyelitis characterised by gliosis, perivascular cuffs and mild necrosis
<i>Sarcocystis neurona</i>	Brain, brainstem and mainly spinal cord, all other organs	Ataxia, circling, incoordination, opisthotonus	Proliferative inflammation of grey and white matter, with a variable degree of necrosis of myelin, axonal degeneration, organisms frequently in neurons
<i>Trypanosoma equiperdum</i>	Lumbar and sacral regions of spinal cord, sciatic and obturator nerves	Paraplegia	Radiculitis and polyneuritis
<b>Nematoda</b>			
<i>Halickephalobus deletrix</i>	Brain	Posterior weakness, ataxia progressing to recumbence, coma	Vasculitis, haemorrhagia, necrosis and malacia
<i>Setaria</i> spp.	Brain and spinal cord	Muscular weakness, incoordination, ataxia to paralysis, death	Focal encephalomyelo-malacia, which in many cases proceeds to liquefaction and cavitation
<i>Strongylus vulgaris</i>	Brain and spinal cord	Chronic incoordination and acute progressive fatal encephalitic disease	Haemorrhagic malacia, tracks in the brain and spinal cord
<b>Arthropoda</b>			
<i>Hypoderma</i> spp.	Aberrant migration in brain and spinal cord	Muscular weakness, localized paralysis, loss of motor control, convulsions	Haemorrhagic tracks in brain or spinal cord

system. Acute malacia occurs in the track of the worm, with disintegration of all tissues at the centre of the lesion and secondary degeneration of the nerve tracts, with gigantic swellings of the axis cylinders and eosinophilic infiltration. Cavities are occasionally seen. Clinical signs may vary from muscular weakness, incoordination and ataxia, to paralysis and death. The disease in horses is known as kumri.

There are several reports of lesions in the central nervous system, apparently caused by →*Strongylus vulgaris*, and resulting in neurological disorders. Lesions are either due to aberrant migration of larvae in the brain or spinal cord, or the result of *S. vulgaris* embolism. The main clinical syndromes are chronic incoordination, paresis and acute progressive →*encephalitis*.

Eye infections due to →*nematodes* of the genus →*Thelazia* have been reported in horses in different parts of the world. Whereas some reports have associated the infection with a variety of clinical signs, others were inconclusive as to the role played by this parasite in the production of ophthalmia. Mechanical damage to the conjunctiva and cornea by the serrated cuticula of *Thelazia* spp. may predispose to bacterial and viral infections (→*Nervous System Diseases, Animals/*Table 1).

*Halicephalobus (Micronema) delatrix* is a rhabditi-form nematode which may accidentally become a parasite. Massive intracranial invasion is reported in horses. The worms are found in the meninges, in the →*parenchyma* of the brain adjacent to blood vessels, in the walls of the vessels themselves and especially in the Virchow-Robin spaces. Horses show early signs of simple lethargy, posterior weakness and mild ataxia, progressing to recumbency, coma, and death.

### Arthropoda

The larvae of →*Hypoderma bovis* and →*H. lineatus* may invade the nervous system of horses and cause central nervous disorders. Larvae are located in the brain and sometimes in the spinal cord, where they leave haemorrhagic tracks, focal areas of haemorrhagic malacia or small abscesses. Sudden onset of muscular weakness or localized paralysis is the usual clinical picture, which proceeds to profound loss of motor control, convulsions and death within 1–7 days or so.

---

## Nervous System Diseases, Ruminants

The common clinical signs and pathology of parasitic infections of the nervous system of ruminants are listed in *Table 1*.

### Protozoa

Several →*protozoa* may cause nervous symptoms in ruminants, e.g., *Babesia bovis*, *Theileria parva* and *T. mutans*, →*Sarcocystis* spp., →*Toxoplasma gondii*, →*Neospora caninum* and →*Eimeria* spp.

Infections with *B. bovis* often terminate with signs of cerebral damage such as paddling of limbs, ataxia, mania, and coma. This is the result of brain damage caused by obstruction of the brain capillaries by parasitized red blood cells. There is usually no evidence of neuronal degeneration but there is dilatation of the perivascular spaces and interstitial →*oedema*. A similar pathogenesis involving the central nervous system, known as turning sickness, has been recognized with both *T. parva* and *T. mutans*. Regular and characteristic findings in the central nervous system include intravenous accumulations of lymphoblasts which may be infected with schizonts, venous thrombi, effects of venous alterations, and perivascular lymphocytic infiltrations. Turning sickness occurs in adult cattle in enzootic areas (East Africa) when they are subject to stress, such as calving or a heavy infestation with →*ticks*. The disease was common in the past, but seems to be rare nowadays.

Nervous signs have occasionally been mentioned in cattle suffering from coccidiosis (*Eimeria bovis*, *E. zuernii*). Signs include opisthotonus, medial strabismus, nystagmus, →*hypersensitivity*, tetanic spasms and convulsions. The etiology of the nervous signs remains obscure.

*Toxoplasma gondii* causes multisystem dysfunction in all domestic animals. The disease is particularly vicious in the new-born infected in utero and in relatively young animals. The neuropathology associated with ovine and bovine toxoplasmosis has been described in detail. In these species, toxoplasmosis is characterized by focal →*necrosis* and vascular damage in acute infections, and by glial →*nodules*, repair, and scar formation in →*chronic infection*. In sheep and cattle, chronic infections were also associated with vascular mineralisation. Organisms, either free or in cysts, were demonstrated in the majority of cases and, in chronic infections, cysts were most frequently found in the cerebral cortex. Cerebral calcifications, common to chronic toxoplasmosis in children, appear to be rare in animals. In sheep extensive areas of necrosis, gliosis and demyelination are found. Lesions in cattle are mild. Clinical nervous signs include depression, trembling, opisthotonus, head tilt, incoordination, →*blindness*, and paraplegia.

Calves infected with *Neospora caninum* may develop neurological signs such as ataxia, decreased patella reflexes and loss of conscious proprioception. Gross lesions consist of malacia, and deviation or narrowing of the vertebral column.

**Nervous System Diseases, Ruminants. Table 1** Parasites affecting the nervous system of ruminants (according to Vercruyse and De Bont)

Parasite	Host*	Host location	Nervous clinical signs	Principal lesions in nervous system
<b>Protozoa</b>				
<i>Babesia bovis</i>	C	Parasitized red blood cells, selectively concentrated in brain	Paddling of limbs, ataxia, mania, and coma	Distention of the capillaria of the grey matter of the cerebrum and cerebellum, dilatation of perivascular spaces, and interstitial oedema
<i>Eimeria bovis</i> , <i>E. zuernii</i>	C	Intestine	Opisthotonus, strabismus hypersensitivity, spasms, convulsions	Vasodilation vessels in brain
<i>Neospora caninum</i>	C	Cranial and spinal nerves	Limb paresis, paralysis	Encephalomyelitis characterized by gliosis, perivascular cuffs, and mild necrosis
<i>Sarcocystis</i> spp.	C, S	Brain, brainstem and mainly spinal cord, all other organs	Ataxia, circling, incoordination, opisthotonus	Proliferative inflammation of grey and white matter, with a variable degree of necrosis of myelin, axonal degeneration, organisms frequently in neurons
<i>Theileria parva</i> , <i>T. mutans</i>	C	Parasitized blood cells are selectively concentrated in brain capillaries	Turning and circling, dysmetria, dysergia, blindness	Venous thrombi with haemorrhages, perivascular lymphocytic infiltration, oedema
<i>Toxoplasma gondii</i>	C, S, G	Forebrain, brainstem, spinal cord	Trembling, opisthotonus, head tilt incoordination, paraplegia, blindness	Focal necrosis and vascular damage, glial nodules, and scar formation
<b>Cestoda</b>				
<i>Coenurus cerebralis</i>	S, G	Cranial cavity; rarely spinal cord; mostly on the surface of one of the cerebral hemispheres	Dullness, cessation of feeding, habitual resting of the head against any support, blindness, incoordination, turning, and other locomotion abnormalities	Large fluid-containing cyst, 5 cm or more in diameter on surface of brain, compressing brain tissue
<b>Nematoda</b>				
<i>Parelaphostrongylus tenuis</i>	S, G	Spinal cord and occasionally brain	Tetraparesis, hemiparesis, tetraplegia, spastic gait, scoliosis, vestibular strabismus, blindness	Focal asymmetrical areas of necrosis with minimal inflammation, haemorrhages
<i>Setaria</i> spp.	S, G	Brain and spinal cord	Muscular weakness, incoordination, ataxia to paralysis, death	Focal ncephalomyelo-malacia, which in many cases proceeds to liquefaction and cavitation
<b>Arthropoda</b>				
<i>Hypoderma</i> spp.	C	Aberrant migration in brain and spinal cord	Muscular weakness, localized paralysis, loss of motor control, convulsions	Haemorrhagic tracks in brain or spinal cord
<i>Oestrus ovis</i>	S, G	Nasal cavities, sinuses	High stepping gait, incoordination	Erosion of the bones of the skull
<i>Gedoelestia</i> spp.	C, S	Brain	Varies considerably	Encephalomalacia, encephalomeningitis, haemorrhages, and discolorations
<i>Ixodes</i> spp., <i>Dermacentor</i> spp.	C	Adult tick produces a "toxin"	Acute ascending flaccid, motor paralysis	Usually no morphological changes in nerves

\* Host: C, cattle; S, sheep; G, goats

## Cestodes

→*Coenurosis* is caused by the presence in the cranial cavity of *Coenurus cerebralis*, the larva of →*Taenia multiceps*. The infection occurs in sheep and less commonly in other ruminants. It is rare in horses and man.

## Arthropoda

The larvae of →*Hypoderma bovis*, *H. lineatum*, *Gedoelestia* spp. and →*Oestrus ovis* may invade the nervous system of ruminants.

The migration of →*Hypoderma* larvae is sometimes known to cause central nervous disorders in cattle (→*Nervous System Diseases, Horses*).

The symptoms caused by *Gedoelestia* spp. in cattle and sheep vary considerably but three main forms of disease are clearly distinguishable: (1) ophthalmic, (2) encephalitic, and (3) cardiac. The ophthalmic form is characterized by inconspicuous conjunctival and intra-ocular haemorrhages, sometimes with a marked protrusion of the eye ball. The nervous symptoms vary considerably as all parts of the brain can be involved.

*Oestrus ovis* is a common parasite of the nasal cavities and sinuses, especially the frontal sinus in sheep and goats. Erosion of the bones of the skull may occur and even injury to the brain; clinical signs include high-stepping gait and incoordination, which may suggest infection with *Coenurus cerebralis*. For this reason the infection has been called “false gid”.

Tick paralysis is a disease of cattle characterized by an acute ascending flaccid motor paralysis. The condition may be fatal unless the tick(s) are removed before respiratory paralysis occurs. Adult ticks, chiefly females, but sometimes nymphs, are responsible. Ticks of the genus *Ixodes* are particularly associated with the condition, although other genera, especially *Dermacentor* may also be concerned. The paralysis-activating

substance acts on motor and sensory nerves and on neuromuscular transmission. The nature of the toxin is unknown.

## Nervous System Diseases, Swine

The common clinical signs and pathology of parasitic infections of the nervous system of swine are listed in Table 1.

### Protozoa

The neuropathology associated with porcine toxoplasmosis has been described in detail. It is characterized by focal →*necrosis* and vascular damage in acute infections, and by glial →*nodules*, repair, and scar formation in →*chronic infection*. Lesions in porcine toxoplasmosis are strictly focal and small. Clinical nervous signs include depression, trembling, opisthotonus, head tilt, incoordination, →*blindness* and paraplegia.

### Cestodes

→*Cysticercus cellulosae* are commonly found in the brain of pigs. The absence of specific neurologic signs in infected hogs may be related to the absence of hydrocephalus and intracranial hypertension such as is usually observed in affected persons.

### Nematodes

→*Stephanurus dentatus* quite frequently invades the spinal canal and may even encyst in the meninges of pigs.

Larvae of →*Toxocara canis* have been incriminated as a cause of posterior paralysis in experimentally infected pigs, a host in which the larvae appear to show a special predilection for the cerebellum. Clinical nervous signs were not so much associated with the

**Nervous System Diseases, Swine. Table 1** Parasites affecting the nervous system of swine (according to Vercruysse and De Bont)

Parasite	Location	Nervous clinical signs	Principal lesions in nervous system
<b>Protozoa</b>			
<i>Toxoplasma gondii</i>	Forebrain, brainstem, spinal cord	Trembling, opisthotonus, head tilt, incoordination, paraplegia, blindness	Focal necrosis and vascular damage, glial nodules, and scar formation
<b>Cestoda</b>			
<i>Cysticercus cellulosae</i>	Brain or meninges	No apparent clinical signs in pigs, in dogs neurological disorders	Chronic inflammatory exudate in tissue surrounding the cysticerci
<b>Nematoda</b>			
<i>Stephanurus dentatus</i>	Brain, spinal cord	Posterior paralysis	Granulomatous and leucocytic reaction
<i>Toxocara canis</i>	Brain, predilection for cerebellum in pigs	Posterior paralysis in pigs	Local eosinophilia, granuloma formation



trauma caused by the numerous migrating *T. canis* larvae, but rather with the development of exuberant tissue reactions around dead or static worms.

## Nervous System of Platyhelminthes

→Platyhelminthes occupy a position of strategic phylogenetic importance in that they are the most primitive members of Bilateria and constitute the basal stock from which all higher animal phyla are thought to have evolved. The phylum Platyhelminthes is a highly diversified and versatile phylum, a fact that is reflected in the structure of the nervous system (NS), both in its gross morphology and in the cellular types and their secretory inclusions. The absence of a coelom and a proper circulatory system in →flatworms means that any long-distance control of processes, such as growth and development, is likely to be accomplished by a neurosecretory component of the NS. In this way, the flatworm NS may function not only as an NS per se but also as an endocrine system by releasing modulatory substances into the intercellular space close to target cells or organs, in a synaptical or non-synaptical way. Development of the NS in the early bilaterian flatworms would appear to have been dominated by 2 themes: (1) an anterior concentration of sensory and nervous tissue to form a ganglionic mass or primitive brain; and (2) the consolidation of peripheral neurons into a number of large longitudinal nerve cords. The concentration of associative neurons in the anterior end of the early active flatworm arose, it is assumed, with the advent of bilateral symmetry and from selective pressures generated by the expanding need to coordinate the input from the frontal sensory receptors and from the activity of the 2 sides of the body. Thus, the development of bilateral symmetry, rather than cephalisation, most likely necessitated the evolution of the brain, thereby preventing the 2 sides of the ancestral flatworm from engaging in contradictory activities.

The aims in studying the NSs of flatworms are generally twofold. One is the scientific interest, since in the view of the group's unique evolutionary position, information is likely to be forthcoming about the early development of the NS in general; the other aim concerns the parasitological-medical aspect which ultimately seeks a means of controlling or, indeed, eradicating the parasites from their hosts. In targeting the NS, the hope lies in elucidating novel chemotherapeutic agents that act specifically on some neuronal signal substance or receptor of the worm, or along the chain of its synthesis or degradation, with minimal side effects on the host. Parasitic flatworms need to: (1) secure

attachment on or in the host, and (2) produce sufficiently large numbers of progeny to ensure genetic continuity. The NS has developed around these driving forces.

### Orthogon

The plan for the flatworm NS is the so-called →orthogon, a rectilinear, ladder-like configuration of longitudinal nerve cords connected at intervals by transverse ring commissures (Fig. 1). It is thought that the "skin" nerve plexus in the early stem form of flatworms became insunken and condensed into nerve cords. The basic plan of orthogons shows variations both in the number of cords and the overall design. Primitive organisation plans (plesiomorphic features) occur side by side with derived plans (apomorphic features) in both lower as well as higher flatworm taxa. All types of orthogons can be derived from the cord type observed in lower flatworms. The same type of orthogon appears independently in distantly related groups. The main force determining the type of orthogon is believed to be the body shape and the lifestyle of the flatworm species.

### Brain

Flatworms are the first bilaterally symmetrical organisms in evolution. Cephalisation took place in them, and the early metazoan brain began to develop in ancient free-living flatworms. The parasitic members of the Platyhelminthes occupy the three most advanced taxa within the phylum, and their brains are well adapted to their special mode of life on or within a host. The often entertained opinion about a "lazy", ill-defined parasitic brain has proven not to be correct.

The brains of parasitic flatworms are bilobed ganglionic structures, each ganglion consisting of a densely interwoven fibrillar neuropile of axons and dendrites that are frequently coupled by synaptic contacts and gap junctions and surrounded by a rind of loosely packed nerve cell bodies. The lobes are connected by one or more largely fibrous ring-like commissures that originate in the ganglia. Occasionally, the commissures are cellular. The total number of cells in the brain of →*Trienophorus nodulosus* is approximately 80, with 11 cells in the commissure and about 35 cells in each ganglion. About 30 neurons, measuring 6–35 μm in diameter, form the single commissure of →*Diphyllobothrium dendriticum*. In →*Fasciola hepatica*, serial-section reconstruction of the brain has shown that the two cerebral ganglia are not identical in size, and that during their development numerous so-called giant neurons and supporting cells (glia?) appear in the neuropile and come to occupy up to 60% of the adult neuropile volume.

The formation of the flatworm brain from a nerve plexus and/or longitudinal cords will probably always remain an open question. It may have developed (1) from commissures in connection with the nerve net; (2) in

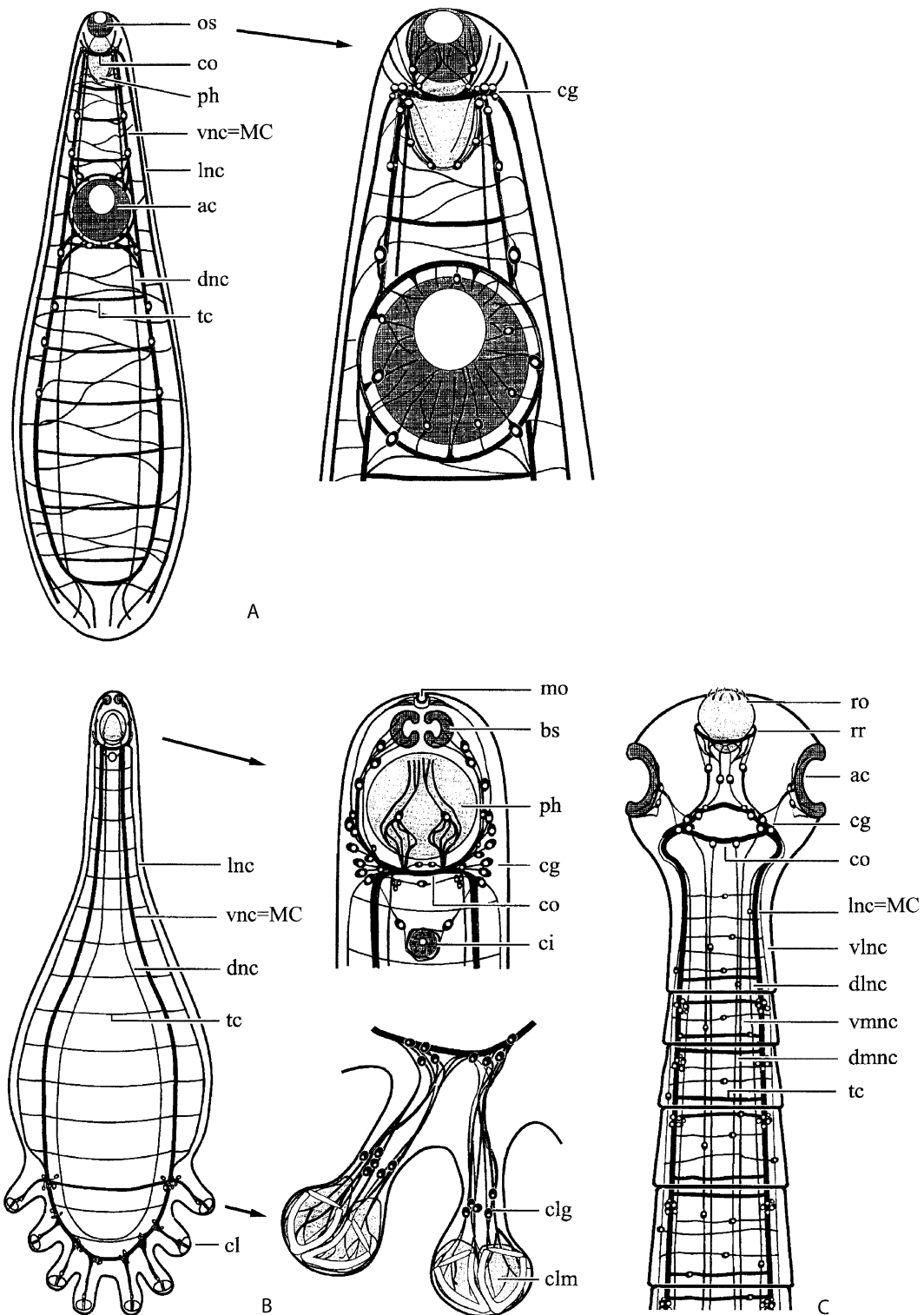

**Nervous System of Platyhelminthes. Figure 1** A generalised schematic pattern of the (A) trematode and (B) monogenean and (C) cestode nervous system. *ac*, →acetabulum; *bs*, buccal sucker; *cg*, →cerebral ganglion; *ci*, →cirrus; *cl*, clamp; *clg*, clamp ganglion; *clm*, clamp muscle; *co*, commissure; *dlnc*, dorso-lateral nerve cord; *dmnc*, dorsal median nerve cord; *dnc*, dorsal nerve cord; *lnc*, lateral nerve cord; *MC*, main nerve cord; *mo*, mouth; *os*, oral sucker; *ph*, pharynx; *ro*, →rostellum; *rr*, rostellar ring; *tc*, transverse connective; *clnc*, ventro-lateral nerve cord; *vmnc*, ventral median nerve cord; *vnc*, ventral nerve cord.

connection with the anterior part of the longitudinal cords, especially the main cords; or (3) as an independent structure. In regenerating free-living flatworms, such as *Girardia tigrina*, the neuropile of the new brain is formed from fibres emanating from the stumps of the old nerve cords, and the actual neurons of the brain arise from undifferentiated cells in the blastema. The ontogeny of the flatworm central nervous system is not well known.

### Main Nerve Cords, CNS and PNS

Recently, new concepts have been introduced into flatworm neurobiology. The nerve cords of flatworms have been named dorsal, ventral, lateral, dorsolateral, ventrolateral, dorsal median, ventral median and marginal – a terminology which has often led to confusion when comparing the NSs in different worms. In order to obviate these difficulties, two terms were coined, the ‘main nerve cords’ the (MCs) and the ‘minor nerve cords’. The MCs are defined as the two most prominent nerve cords in the worm. Irrespective of their disposition as ventral, dorsal or lateral, the MCs originate as multifibre outgrowths or rootlets from each of the cerebral ganglia and are associated with more neurons than any other nerve cords. The minor cords comprise all other longitudinal nerve cords. The concept of MCs provides for the possibility of dividing the flatworm NS into a central nervous system (CNS) and a peripheral nervous system (PNS). The CNS comprises the bilobed brain and the MCs; the PNS comprises all of the minor cords and the nerveplexuses. These concepts provide a common base which greatly facilitates comparative studies.

The NS of *cestodes* is bilaterally and dorsoventrally symmetrical and the two MCs extend through the lateral medullary *parenchyma* from the brain to the posterior end of the worm. The MCs are connected to each other by transverse commissures, thus forming a regular pattern on both sides of the border of the *proglottids*. Connections between the MCs and the minor cords and the ring commissures have also been observed. The presence of a well-differentiated alimentary tract in *trematodes* and monogeneans has led to a dorsoventral asymmetry in the NS. In them, the MCs are located on the ventral side of the worm.

### Nerve Plexuses

In addition to nerve cords, well-developed nerve nets or plexuses can be found in all flatworm taxa. These include subsurface, submuscular, pharyngeal and intestinal (=stomatogastric) and reproductive nerve plexuses. In some places, the plexuses are in continuity with both main and minor nerve cords. Sensory nerves and free nerve terminals penetrate the epithelium or *tegument* and are common to all flatworms examined.

### Innervation of Pharynx and Stomatogastric Systems

Flatworms are the most primitive animals to have an alimentary tract. An anus is lacking. The stomatogastric NS is regarded as a *plesiomorphic character*. The stomatogastric NS of monogeneans and trematodes thus far examined is mainly associated with the musculature of the foregut, i.e., pharynx (when present) and oesophagus, there are relatively few reports of any innervation to the intestine in *flukes*. Cestodes rely solely on their body surface or tegument for the acquisition of nutrients, and the tegumental innervation is often extensive. Commonly, there is a very rich supply of peptidergic nerve terminals just beneath the tegument. However, regional differences along the body surface have been observed. Thus, in *D. dendriticum*, where the worm’s surface embraces the intestinal villi of the host, the subtegumental region is densely innervated, especially with nerve terminals showing immunoreactivity (IR) for neuropeptides (Fig. 2). Along this surface, the worm is in very close proximity to the oxygen carrying capillaries of its host.

Indirect evidence for the presence of the neurons producing nitric oxide (NO) has been obtained by the use of NADPH-diaphorase (NADPH-d) histochemistry. Bipolar NADPH-d-positive neurons (35–30  $\mu\text{m} \times 17\text{--}20 \mu\text{m}$ ) and fibers have been identified in the pharynx of *F. hepatica*. 5-HT-IR was observed in a separate, but adjacent set of neurons in the pharynx of the fluke.

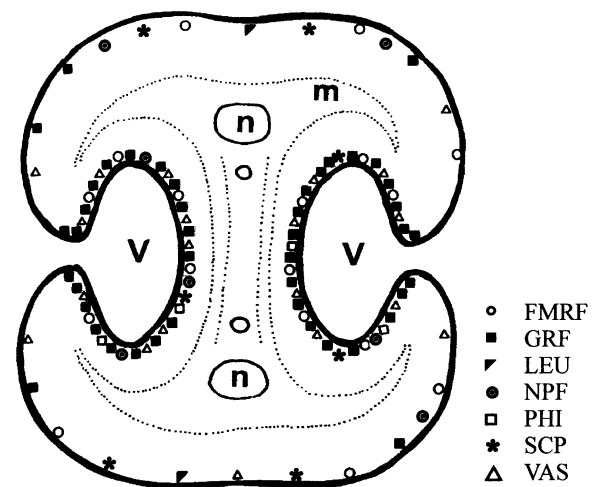

**Nervous System of Platyhelminthes. Figure 2** Diagram of *Diphyllobothrium dendriticum* *scolex* showing the rich supply of peptidergic nerve terminals along the inner border of bothridia. The nerveterminals are immunoreactive to FMRFamide (FMRF), growth hormone releasing factor (GRF), Leu-enkephaline (LEU), neuropeptide F (NPF), peptide histidine isoleucine (PHI), small cardiac peptide B (SCP) and vasotocin (VAS).

## Innervation of Attachment Organs

For a parasite (or a commensal) it is essential to maintain contact with its host. Attachment organs have developed and these are well supplied with nerve plexuses. Cholinergic, aminergic, peptidergic as well as nitrergic nerve fibres innervate the attachment organs. In strigeid trematodes, there are extensive cholinergic, aminergic and peptidergic innervations to the lappets, oral and ventral suckers and holdfast, with fibres branching off directly from the MCs and/or from commissures. Similarly, the oral and ventral suckers of the trematodes *F. hepatica*, →*Haplometra cylindracea*, →*Schistosoma mansoni*, *Corriga vitta* and *Gorgoderina vitelliloba* are endowed with a multiplicity of serotonergic and peptidergic nerves that emanate from the MCs and anastomose as plexuses of fine fibres among the muscle bands (Fig. 1). NADPH-d staining was observed in many bipolar neurons (59–55 µm × 30–40 µm) and fibers in the nerve plexus surrounding the oral sucker, and in many multipolar neurons (49–60 µm × 30–40 µm) and fibers in the ventral sucker of *F. hepatica*. IR for 5-HT and GYIRFamide was observed in separate, but adjacent sets of neurons in the suckers. The ventral sucker in cercaria of *Diplostomum chomatophorum* is well innervated with NADPH-d positive nerve fibres.

Ectoparasitic monogeneans secure attachment to the host by means of posterior haptor organs which are either single or multiple in structure, the innervation of which is well developed and includes elements of both the CNS and PNS. In *Gyrodactylus salaris*, the nerve plexus immediately anterior to the haptor shows IR for 5-HT and several neuropeptides, and within the haptor organ itself there is a network of serotonergic fibres. In the peduncle ganglia of the multiple haptor of *Diclidophora merlangi*, cholinergic, aminergic and peptidergic IRs have been detected, with an overlap of staining for cholinergic and peptidergic elements. The haptor in *Entobdella soleae* contains a network of serotonergic fibres derived from the longitudinal nerve cords and provides innervation to the haptor musculature, including that around the hamuli (hooks) and associated sclerites. A subsurface network of fibres and nerve endings showing IR for 5-HT is concentrated at the ventral surface and is closely associated with the ventral papillae, whose function is believed to be of a sensory nature in contact communications. The tapeworm scolex attaches to the host intestinal mucosa by one of three main types of scolex: the bothriate, the bothridiate and the acetabulate. The muscles of the wing-like bothria of *D. dendriticum* are innervated by a network of peptidergic nerves. Of special interest was the finding of IR to small cardiac peptide B in neurons around the bothrial muscle of the ‘actively working scolex’ of the adult worm, and not in the ‘passive scolex’

of the quiescent →plerocercoid stage. The transmitter gas NO activates the synthesis of the second messenger, cGMP, in the target cell. IR for cGMP was observed in nerve fibers very close to the musculature in the bothridia and the longitudinal muscle layer in the neck of adult *D. dendriticum*. Similar observations were reported for the suckers of adult *H. diminuta*.

The scoleces of trypanorhynch →tapeworms are armed with tentacle-like proboscides that can be drawn into sheaths, each terminating in a muscular bulb. Contraction of the bulbs brings about rapid evagination of the proboscides which, together with a pair of muscular bothridia, provide a broad attachment base for the adult worm. An immuno cytochemical study of neuropeptide- and 5-HT-IRs in the scolex innervation in the plerocercoid stage of *Grillotia erinaceus* has revealed only moderate staining of the fibres innervating the tentacular bulbs, and no immunostaining in the proboscides musculature. Furthermore no evidence of nerve elements in the retractor muscle was found in ultrastructural and experimental studies. Thus the contraction in the worm is likely to be myogenic. In contrast, the bothridial nerves in *G. erinaceus* showed strong IR for FaRPs and NPF, and immunostaining for 5-HT revealed an extensive rectilinear arrangement of anastomosing fibres and associated cell bodies, with IR in nerve endings terminating at the margin of the bothridium. Scanning electron microscopy of the bothridial surface has shown the margins to be richly endowed with unciliated structures reminiscent of sensory organs, suggesting the serotonergic neurons in this region may be sensory in nature.

Very close contact with the host is possible with the acetabulate scolex of tapeworms, augmented with a rostellum or apical gland. Well-developed acetabular nerve plexuses, reactive for cholinesterase, 5-HT and several neuropeptides and derived from fibres originating in the MCs, have been described in all cyclophyllideans examined (Fig. 3). Innervation to the rostellum is well differentiated, as in →*Hymenolepis diminuta* and *H. nana*, and where armed, as in *Echinococcus granulosus*, there is good innervation to the retractile hooks. The sucker musculature of *H. diminuta* is well innervated with NADPH-d-positive nerve fibres. The four acetabula of the proteocephalidean cestode, *Proteocephalus pollanicola*, are similarly well innervated.

## Neuronal Mapping and Co-localisation of Neuroactive Substances

By interfacing immunocytochemistry with confocal scanning laser microscopy (CSLM), it is possible to optically section whole-mount preparations of worms, that is, to collect images as an extended-focus series from a scan in the Z-axis, and then to project these in

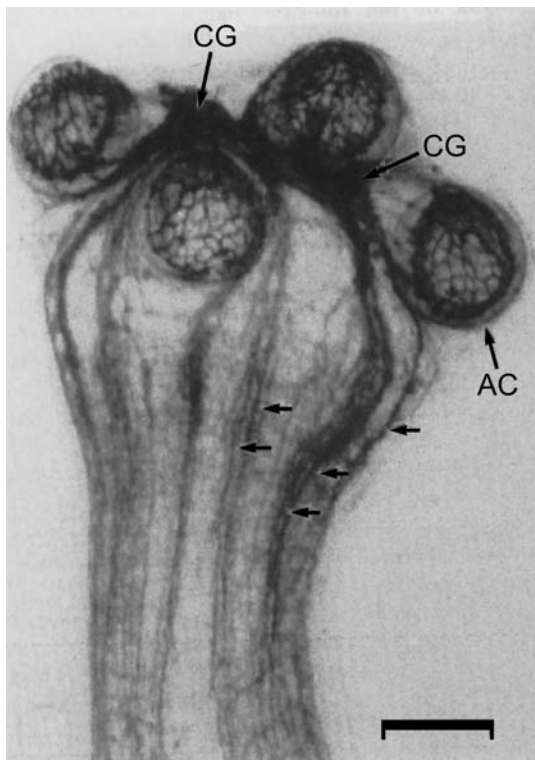

**Nervous System of Platyhelminthes. Figure 3**  
Cholinesterase (ChE) activity in the innervation of the scolex of *Moniezia expansa*. Note the staining in the cerebral ganglia (CG) and connecting commissure, 5 pairs of longitudinal nerve cords (arrows) and innervation of the acetabula (AC). Scale bar, 250  $\mu\text{m}$ .

perfect register to produce accurate spatial resolution of the specimen in three dimensions. Using multiple confocal channels, the detection of two or more neuronal substances in co-localisation studies becomes feasible. Mapping the distribution patterns of the aminergic and peptidergic components in this way has shown that in most flatworms examined there are structural differences in the form and arrangement of the two systems. Thus, in general, and allowing for minor species differences, the peptidergic pathways follow more closely those of the cholinergic system, often with significant overlap in staining, while those of the serotonergic system (as seen by its 5-HT-IR) are often quite separate and distinctive in construction, with the staining localised to different subsets of neurons. NADPH-d positive neurons also occupy a separate subset of nerves in those flatworms studied to date.

Comparative confocal studies have shown that serotonergic fibres are generally much finer in appearance and are less likely to be organised into nerve cords in the CNS than are cholinergic or peptidergic fibres, even allowing for differences in the intensities of

staining; often in the more central regions of the NS they occur in loose array as nerve tracts. Cell bodies that show 5-HT-IR are usually larger and more distinct than the peptidergic neurons and represent a fairly homogeneous population of cells, often exhibiting a marked bilateral symmetry or pairing in their arrangement. Peptide-immunoreactive fibres, in common with those reactive for cholinesterase (ChE), are often closely packed, as in the longitudinal cords, and their somata are somewhat smaller in size and distributed with less symmetry. Beaded fibres, seen at the ultrastructural level as a series of axonal swellings each filled with dense vesicles, distinguish peptidergic neurons and most likely result from the periodic release of neuropeptide secretion from the site of synthesis in the cell body for transport down the  $\rightarrow$ axon; in some instances, the varicosities may reflect the presence of potential sites (paracrine) of secretion.

Relatively little work has been done to investigate the degree of constancy of neuron populations in flatworms by mapping their numbers and disposition, or to compare the cellular distribution of particular neuroactive substances in different species. This contrasts to the situation in  $\rightarrow$ nematodes, where for some species (e.g.,  $\rightarrow$ *Ascaris suum*,  $\rightarrow$ *Caenorhabditis elegans*) the total population of neurons is known and individual neurons have been identified and their IRs for particular peptides categorised. However, while the full complement of neurons in nematodes approximates 300, a figure of some 10 times this number is estimated for flatworms.

Co-localisation of neuronal mediators has been documented for higher vertebrates and work has shown that there are a number of combinations of small molecule transmitters and neuropeptides which can coexist in the same neuron. Their co-transmission and interactions are believed to fine tune the sensitivity of the target cell to the primary transmitter and thereby integrate the information processing properties of the NS. There are many examples in flatworm neurons of apparent co-localisation of IRs for neuropeptides, such as FaRPs, NPF, substance P, and of an overlap of their staining with that of cholinergic elements. Thus, co-transmission of neuroactive substances may also be a feature of the complexity of the platyhelminth NS. Unfortunately, insufficient flatworm-neuropeptide sequences are known at present to either allow firm conclusions to be drawn from immunocytochemical studies using autologous antisera, or to enable the design of rigorous controls to minimise non-specific cross-reactivity through the presence of the same epitopes on multiple molecules. Note that neurons displaying IR for both cGMP and GYIRFamide have been observed in *F. hepatica*. This suggests that cGMP/GYIRFamide positive neurons in the fluke could act as the target cells for NO.

## Neurocytology and Ultrastructure

There is in flatworms a wide range of nerve cells or somata. The multipolar and bipolar somata are distributed throughout both the CNS and PNS; the more unipolar cells are largely confined to the ganglionic portions of the CNS. Somata range in size from  $4.5 \times 3 \mu\text{m}$ , e.g., those in the rostellar ganglia of adult *H. diminuta*, to cells of an order of magnitude larger, exemplified by those in the innervation of the →ootype in *F. hepatica* and measuring approximately  $45 \times 30 \mu\text{m}$ . Somata also occur peripherally along nerve cords and in the plexuses, where the dominant cell type is bipolar; other sites include the innervation of the attachment and reproductive organs. The somata of cholinergic and peptidergic neurons are usually somewhat smaller than those of serotonergic neurons. Both large ( $10\text{--}18 \times 18\text{--}23 \mu\text{m}$ ) and small ( $6 \times 7 \mu\text{m}$ ) NADPH-d positive neurons have been found in *D. dendriticum*. The same holds true in *F. hepatica* where large ( $40\text{--}80 \mu\text{m} \times 20\text{--}49 \mu\text{m}$ ) and small ( $20\text{--}30 \mu\text{m} \times 10\text{--}15 \mu\text{m}$ ) NADPH-d-positive neurons occur in the main nerve cords. These cells are commonly bipolar.

The most striking ultrastructural feature of the flatworm neuron is that of a secretory cell engaged in the synthesis and export of material by axonal transport in vesicles (Fig. 4). The axonal fibres of the cell are typically unmyelinated and contain neurotubules and peripherally arranged →mitochondria. A single vesicle type usually dominates in the neuronal soma, with more variations in vesicle morphologies in the axon where small clear vesicles can be seen alongside a preponderance of electron-dense types. The vesicles are formed by Golgi stacks from an often extensive ribosomal component, much of which is in the form of rough endoplasmic reticulum; unattached ribosomes and mitochondria are abundant in the →cytoplasm, together with parallel arrays of neurotubules. The nucleus is generally centrally placed and euchromatic, with numerous nuclear pores and a prominent →nucleolus. The larger ganglionic cells have irregular nuclei and their somata often display surface outfoldings or cytoplasmic projections that lie in close contact with the fibrous interstitial material and surrounding parenchyma.

A diversity in both size and structure of vesicles can be recognised in flatworm neurons and they have been used as markers for the different neuronal cell types. These are: (1) *small clear vesicles* (20–40 nm in diameter) of the “synaptic” type which are regarded as cholinergic or as vesicles for recapturing membranes or for retrieval of  $\text{Ca}^{2+}$ ; (2) *dense-cored vesicles* (50–140 nm in diameter) of varying types and core densities; (3) *large dense vesicles* or elementary granules (50–200 nm in diameter); and (4) *large lucent vesicles* (60–300 nm in diameter), as seen in sensory neurons and always alongside the large dense vesicles.

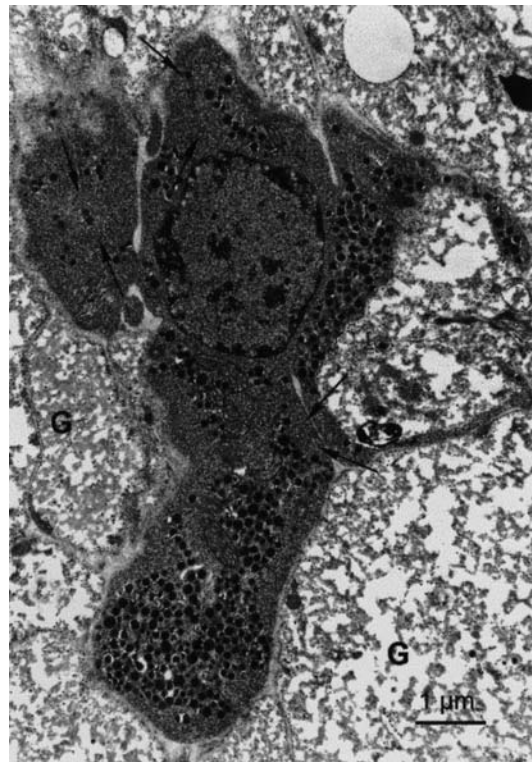

**Nervous System of Platyhelminthes. Figure 4**

Ultrastructure of peptidergic neuron from *Diphyllbothrium dendriticum*. The cytoplasm contains large amounts of large dense vesicles and free ribosomes. Three Golgi systems (arrows) indicate active synthesis of large dense vesicles. G, areas rich in →glycogen ( $\times 10,000$ ).

To simplify matters, small clear vesicles have often been regarded as cholinergic, dense-cored vesicles as aminergic, and large dense vesicles as peptidergic. However, the results from immunogold-labelling experiments at electron microscopic level have shown these broad categories to be unreliable, with IRs for neuropeptides most often observed in dense-cored vesicles. In all probability, vesicle ultrastructure likely depends on the developmental stage observed, the processing state of the neuroactive substances involved, and the coexistence of neuroactive substances (Fig. 5).

The classification of neurons with respect to function is problematic or impossible to establish solely on the basis of ultrastructure. It is nevertheless rational and practical to group the neurons of flatworms into a number of categories. Common to all investigated flatworms are: (1) neurons containing dense-cored vesicles – which may be uni-, bi- or multipolar in form; (2) neurons containing large, dense vesicles – represented by uni- or bipolar neurons, as in microturbellarians, or in those parasitic flatworms examined where they may also be multipolar-heteropolar in form; (3) sensory neurons

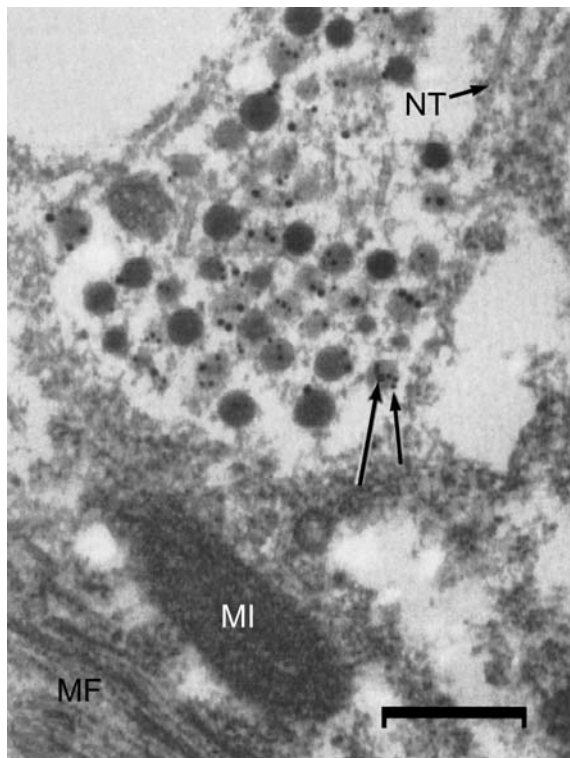

**Nervous System of Platyhelminthes. Figure 5**

Ultrastructure of nerve terminal in CNS of male *Schistosoma mansoni*, following sequential double labelling to demonstrate appa rentco-localization of neuropeptide F and FaRP-IRs, using, respectively, 15 nm and 10 nm size gold probes (large and small arrows, respectively) in dense neuronal vesicles. Note neurotubules (NT), mitochondrion (MI) and adjacent muscle fibre (MF). Scale bar 0.5  $\mu$ m. (<87).

which are usually bipolar; and (4) in advanced large, free-living flatworms, such as planarians and polyclads, highly specialised ganglion cells containing only small clear vesicles.

Neurons containing dense-cored vesicles of varying sizes and densities dominate the ultrastructural picture of flatworm NS. They occur in the cerebral ganglia, along the MCs, in the peripheral plexuses and in the nerve terminations of presumed sensory organs. The dense-cored vesicle-containing neuron may be considered an archaic cell type, operating both neurocrine and paracrine release mechanisms, thereby representing a neuropara-neuronal cell. This cell type has been regarded as the progenitor of functionally different conventional neurons, both in advanced flatworms and possibly also in higher metazoans.

### Glia-like Cells

For a number of flatworms, there are reports of non-neuronal cells occurring in close anatomical association with the NS and which, based on morphological criteria,

resemble invertebrate glial cells. The cells in question lack vesicles, have a thin cytoplasm with very few organelles and are arranged in multilayered sheaths around the cerebral ganglia and interposed between adjacent axons in nerve trunks and plexuses. As in higher phyla, these presumptive glia are believed to perform a largely supporting and isolating role, but may also act as mediators of normal neuronal metabolism. In the trematodes  $\rightarrow$  *Multicotyle purvisi* and *F. hepatica* glia-like elements have been described. These glia cells are believed to have derived from mesenchyme cells within the parenchyma. This view would seem contrary to a major criterion in identifying glia as being derived from embryonic ectoderm. Nevertheless, glia in lower invertebrates may have evolved independently of those found in the Eubilateria. The fact that to date the finding of cellular wrappings of neurons and axons has been confined largely to scattered flatworm taxa may support this view.

Neurons in flatworms are also supported and separated by an extracellular matrix of finely fibrous interstitial material that ramifies between various cell types and around organ systems. Its fibrillar structure and disposition indicate a role as an internal medium for support, transport and exchange of substances.

### Synapses

There is wide variation in the morphology of neuronal release sites in free-living flatworms, and it is often difficult to draw a boundary between those involved in neurocrine or synaptocrine release and those that are paracrine in nature. Unfortunately, there is only relatively little information on synapse structure or release sites in the parasitic taxa.

Several types of true chemical  $\rightarrow$ synapses have been observed in flatworms, and all have morphological characteristics of conventional synapses (Fig. 6). They are either polarised or non-polarised, i.e., the pre- and postsynaptic membranes are structurally similar or different. Polarised synapses can be categorised as: single; shared, with two presynaptic and one postsynaptic elements or, vice versa (i.e., convergent or divergent synapses), axo-axonal or en passant; multiple; and neuromuscular. In many groups, including monogeneans, the presynaptic terminals are characterised by the presence of paramembranous dense projections and associated vesicles. A greater electron density of the synaptic structures as well as serial or multiple chemical synapses occur more frequently in many advanced flatworms, indicating a greater specialisation of their NSs.

Omega profiles, formed by the content release of large dense vesicles, constitute a type of paracrine release of neuroactive substances from peptidergic neurosecretory processes; these are frequently observed between nerve processes and extracellular stroma, as well as facing muscles and neoblasts.

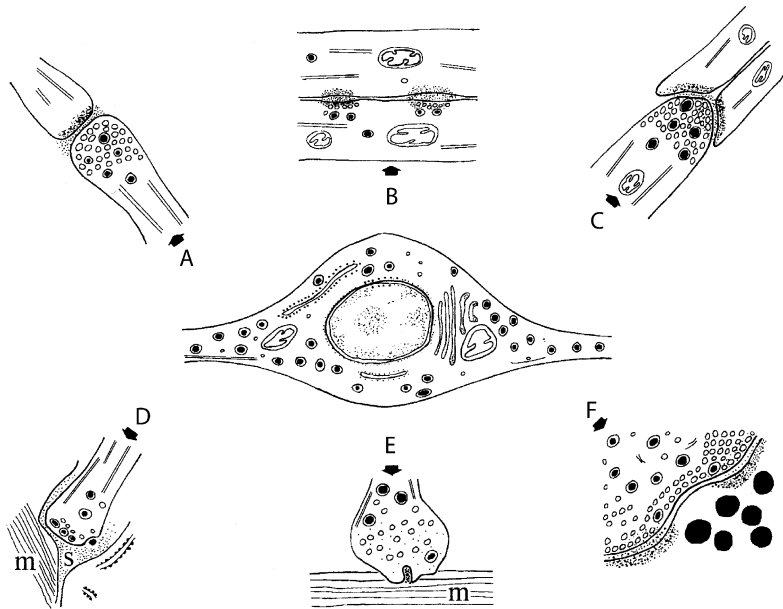

**Nervous System of Platyhelminthes. Figure 6** Schematic interpretation of the various synaptic and non-synaptic release sites observed in flatworms (based on *Diphyllbothrium dendriticum*). **A**, single synapse; **B**, axo-axonal (*en passant*) synapse; **C**, shared (divergent) synapse; **D**, release towards extracellular stroma (s) close to muscle fibre (m); **E**, neuromuscular synapse showing omega figure near muscle fibre (m); **F**, multiple synapses.

Finally, protrusions through the axolemma in neurites containing large dense vesicles have been observed in *D. dendriticum*, where the release of secretory material appears to take place towards the extracellular stroma beneath the fibrous basal lamina and towards muscle fibres in the parenchyma.

The types of release sites observed indicate that chemical signals in flatworms are transmitted as →neurotransmitters or neuromodulators, either directly to their targets at synaptic and non-synaptic release sites, or as local chemical mediators that are delivered via the extracellular matrix.

### Sensory Organs

Putative sense organs are not only numerous in flatworms but the types found in the parasitic taxa are similar in number to those occurring in free-living forms. Each flatworm species has several distinct types of putative receptor to which a variety of functions has been ascribed. An inventory of the sensory organs described from flatworms is beyond the scope of this review. The functional differentiation of flatworm sensory endings into mechanoreceptors (rheoreceptors, tangoreceptors), chemoreceptors, photoreceptors and osmoreceptors on the basis of their fine structure (e.g., presence or absence of →cilia, number of cilia, length of cilia) has often been attempted, as have comparisons with known receptors in other invertebrates. Occasionally, the presence of neuropeptides in nerves that

innervate surface receptors has been demonstrated. In adult male *Schistosoma mansoni*, IRs for substance P (SP), Leu-enkephalin (LEU), and FMRFamide have been reported in sensory nerves. IR for SP has also been reported in larval and adult *D. dendriticum*; SP occurs in a separate set of bipolar neurons with long processes ending at the surface. However, any conclusions on flatworm sensory physiology based solely on the ultrastructural characteristics of presumed sensory organs can be at best only tentative.

### Neuronal Messengers

Most neurons communicate with one another and their environment via extracellular signalling molecules or chemical messengers which they synthesise and secrete. Relatively few of these so-called first-messenger molecules were known until relatively recently and their actions were usually considered as relatively simple. Today, dozens of neuronal messengers are recognised, along with receptor-mediated actions that can bring about not only short- and long-term changes in cellular excitability but which can also influence events such as cellular metabolism, reproductive development, and gene expression. In general, these actions are achieved by: (1) a rapid communication system involving small molecule transmitters; and/or (2) an evolutionarily much older and slower system which uses biologically active peptides as messenger molecules. A third (3) type of messenger has recently been recognised, the transmitter



gases, such as →nitric oxide (NO) and carbon monoxide. From the neurochemical evidence available, it would seem that all these systems operate in flatworms, although as yet no neuroregulatory substance has been found in flatworms that meets all of the criteria used in identifying a “true” neurotransmitter per se.

Notwithstanding the dearth of functional data, recent years have witnessed a renewed interest in the nervous systems (NS) of flatworms, particularly with respect to their neurochemical anatomy and the cellular visualisation of the sites of activity of putative neurotransmitters and neuromodulatory substances. This has arisen largely through: (1) the application of enzyme cytochemical techniques to the study of flatworm NS to demonstrate cholinesterase activity, as indirect evidence for the presence of acetylcholine; (2) the employment of well-characterised antibodies as probes in immunohistochemical (ICC) procedures and the discoveries in invertebrates of homologues to recognised vertebrate messenger molecules, most notably biogenic amines, amino acids and regulatory peptides and, (3) the application of NADPH-diaphorase histochemistry to demonstrate the presence of →nitric oxide synthase and indirect evidence for the transmitter gas NO. Collectively, these approaches have revealed a broad anatomical distribution of several candidate transmitter or modulatory substances in the NS of flatworms (Table 1). These include the classical transmitters acetylcholine, the indoleamine →serotonin (=5-hydroxytryptamine, 5-HT), and the →catecholamines noradrenaline and dopamine, together with →histamine and the amino acids →glutamate and  $\gamma$ -aminobutyric acid, neuropeptides, and the transmitter gas NO.

- →Acetylcholine (ACh): Histochemical studies have shown extensive staining for cholinesterase (ChE)

activity as indirect evidence for the presence of ACh in the NSs of all flatworms examined. In one instance, an ICC study of ACh-like immunoreactivity (IR) in adult *Hymenolepis diminuta* has shown a similar distribution pattern of cholinergic nerves to that recorded for ChE activity, thus confirming the indirect histochemical findings. ChE-reactive neurons account for a significant proportion of both the CNS, including ganglia, commissures and nerve cords, and the PNS, where there is usually staining of the nerves and associated plexuses in most bodies of muscle, including the pharynx, attachment organs and copulatory structures. Other sites of staining include the network of fine nerve fibres that innervate the somatic and subepidermal musculature, and the innervation of the muscularised ducting of the reproductive system. Some examples of flatworms where detailed studies have been made of cholinergic staining in the nervous system are *Diclidophora merlangi*, *Diplostomum pseudospathaceum*, *Fasciola hepatica*, *Schistosoma mansoni* and *Moniezia expansa* (Fig. 3).

- Serotonin (5-HT): ICC studies have verified the presence of 5-HT in all flatworm taxa, with extensive staining in CNS structures and in the PNS. Examples include *D. merlangi*, *F. hepatica*, *S. mansoni*, *Grillotia erinaceus* plerocercoid, *Diphyllobothrium dendriticum* →proceroid, plerocercoid and adult, *H. diminuta*, *H. nana*, *M. expansa*. In many instances, the distribution pattern of 5-HT-IR in flatworms is distinct from that of the cholinergic and peptidergic neuronal pathways, but parallels, where recorded, the staining pattern for catecholamines (Fig. 7).
- Catecholamines: The catecholamines DOPA, dopamine (DA), noradrenaline (NA) and adrenaline (A) have been detected in flatworms. In *D. dendriticum*

**Nervous System of Platyhelminthes. Table 1** Neuroactive substances demonstrated in selected parasitic flatworms

	ChE	NADr	DA	5-HT	HA	Glu	GABA	NO	NPs (n)
<b>Cestoda</b>									
<i>Diphyllobothrium</i>	+	+	+	+	+	.	.	+	+(16)
<i>Hymenolepis</i>	+	+	+	+	+	+	.	+	+(8)
<i>Moniezia</i>	+	.	.	+	.	.	+	.	+(8)
<b>Monogenea</b>									
<i>Diclidophora</i>	+	.	.	+	.	.	.	.	+(12)
<i>Gyrodactylus</i>	+	.	.	+	.	.	.	.	+(5)
<i>Mirocotyle</i>	.	+	+	.	.	.	.	.	.
<b>Trematoda</b>									
<i>Fasciola</i>	+	+	+	+	.	+	+	.	+(8)
<i>Haplometra</i>	+	.	.	+	+	.	.	.	+(14)
<i>Schistosoma</i>	+	+	+	+	.	+	.	.	+(24)

ChE, cholinesterase; NADr, noradrenaline; DA, dopamine, 5-HT, serotonin; HA, histamine; Glu, glutamate; NO, nitric oxide; NPs, neuropeptides (number identified)

\* +, present; ., information not available

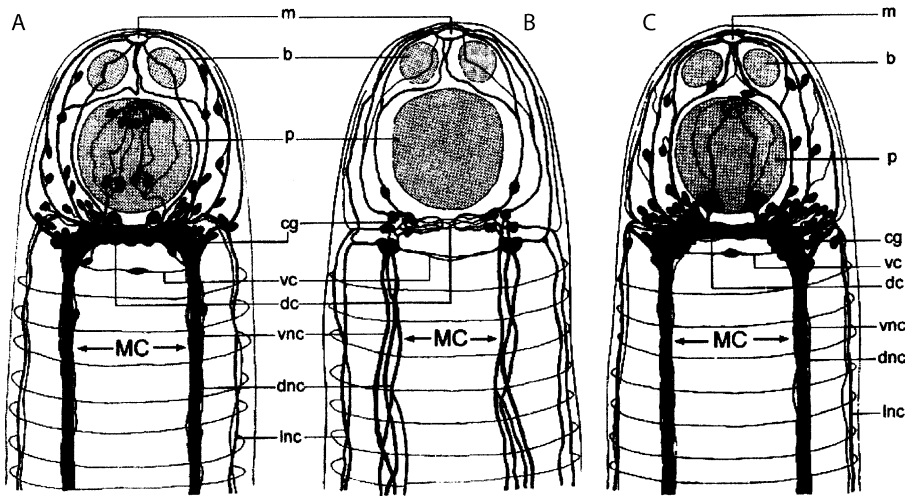

**Nervous System of Platyhelminthes. Figure 7** Diagram of cholinergic (A), serotonergic (B) and peptidergic (C) nervous systems in foregut of *Diclidophora merlangi*. *m*, mouth; *b*, buccal suckers; *p*, pharynx; *cg*, cerebral ganglion; *MC*, main nerve cord; *vc*, ventral commissure; *dc*, dorsal commissure; *vnc*, ventral nerve cord; *dnc*, dorsal nerve cord; *lnc*, lateral nerve cord.

DOPA and DA dominate over NA and A. Small amounts of NA and DA have been shown to be present biochemically and histochemically in *S. mansoni*, *F. hepatica* and *H. diminuta*.

- **Histamine (HA):** HA has only relatively recently become recognised as a neurotransmitter in the classical sense. Histaminergic cells and fibres have been demonstrated in the cestode *D. dendriticum* where they occur along the MCs and along the main excretory ducts. Analysis of HA levels in *H. diminuta* showed the worm does not synthesise the monoamine but likely acquires it from its host by diffusion. Extensive IR for HA has been shown throughout the NS of the blood-feeding frog lung trematode, → *Haplometra cylindracea*, which has been found to contain one of the highest concentrations of HA in the animal kingdom, measuring  $6.49 \pm 1.36$  nmole/mg protein, a figure surpassed only by levels found in the mammalian gastric mucosa. Negligible amounts of HA were found in the host frog lung and blood. *H. cylindracea* is capable of producing endogenous HA by decarboxylation of histidine. These findings, and the fact that another amphibian trematode, *Mesocoelium monodi*, contains rather high levels of HA (520 pmole/mg wet weight) and exhibits a high rate of HA synthesis has prompted Eriksson et al. to suggest that a well-developed histaminergic NS could advantage a parasite of amphibians, in that the latter produce insufficient exogenous HA to interfere with neural function in the flatworm.
- **Glutamate (Glu):** Intense Glu-IR has been demonstrated in cell bodies and fibres in and around the longitudinal nerve cords of adult *H. diminuta*

with somewhat weaker staining in the ring commissures. In *Mesocostoides corti* tetrathyridia and adult *F. hepatica*, a much wider distribution of Glu-IR has been recorded in nerve cells and fibres throughout both the CNS and PNS. There are also reports of Glu-IR in the trematodes → *Trichobilharzia ocellata* and *S. mansoni*.

- **$\gamma$ -Amino Butyric Acid (GABA):** GABA is a recognised important inhibitory neurotransmitter of widespread occurrence in both vertebrates and invertebrates. In *M. expansa* and *F. hepatica*, extensive GABA-IR was demonstrated in fibres in the CNS and the MCs and the minor nerve cords and nerve nets. HPLC analysis confirmed the presence of GABA in the worms and revealed a much higher concentration of the amine in the cestode ( $124.8 \pm 15.3$  picomol/mg wet weight) than in the trematode ( $16.86 \pm 4.9$  picomol/mg). The occurrence of GABA in the CNS of all flatworms thus far examined and the comparatively high concentration and capacity for its synthesis in these animals suggest a functional role perhaps as an inhibitory neurotransmitter.
- **Nitric Oxide (NO):** NO is regarded as one of the first biological signalling molecules and is generated from arginine via NO synthase (NOS). NADPH-diaphorase (NADPH-d) is believed to be identical to NOS in the mammalian NS, and its histochemical demonstration is used widely to identify NO-producing neurons. NADPH-d positive neurons have been reported from about 10 parasitic flatworms, both larvae and adult worms, with reactive fibers in both the CNS and the PNS. The NADPH-d positive nerves are closely associated with all types of musculature in the worms, such as that of the

attachment organs and copulatory structures. In dual-staining experiments, none of the NADPH-d staining was found in cell bodies that showed IR for 5-HT or FMRFamide. The nitroergic neurons form a separate set of neurons in the worms. The presence of NO in flatworms has also been demonstrated with high pressure liquid chromatography (HPLC) and radio-metric methods in *H. diminuta* and *F. hepatica*.

- **Neuropeptides:** A wide range of neuropeptide IRs has been described in the NS of flatworms, using antisera that have been raised largely against vertebrate neuropeptides. So far, immunoreactivities have indicated the occurrence of homologues to at least 26 mammalian and 6 invertebrate peptides, suggesting that there is an abundance of potentially bioactive peptides in platyhelminths (Table 1). However, with few exceptions, the antigens responsible for the IR described are unknown. The exceptions include the 5 native flatworm neuropeptides that have been isolated and their amino acid sequences determined, and the 2 neuropeptides that have been predicted from putative neuropeptide encoding genes. The former have enabled the generation of highly specific autologous antisera. To date, platyhelminth neuropeptides include: (1) neuropeptide Fs (NPFs), 36–39 residue peptides which have been isolated from a tapeworm (*Moniezia expansa*) a turbellarian (*Arthurdendyus triangulatus*) and predicted from putative neuropeptide-encoding genes in schistosomes (*Schistosoma mansoni* and *Schistosoma japonicum*); and (2) four FMRFamide-related peptides (FaRPs) whose primary structures have been deduced to be YIRFamide (from *Bdelloura candida*), GYIRFamide (*Dugesia tigrina*, *Bdelloura candida*), RYIRFamide (*Artioposthia triangulata*) and GNFFRFamide (*M. expansa*) (Table 2). Using antisera to these authentic flatworm peptides has revealed a widespread distribution of peptide-IR

across flatworm species, with intense staining in cells and fibres throughout both CNS and PNS.

It should be noted that all known flatworm neuropeptides possess a C-terminal amide which is generated when a carboxy-terminal glycine is converted to an  $\alpha$ -amide group by the sequential activity of peptidyl  $\alpha$ -hydroxylating monooxygenase (PHM) and peptidyl  $\alpha$ -hydroxyglycine  $\alpha$ -amidating lyase (PAL). To date, PHMs have been characterised from both a trematode (*S. mansoni*) and a planarian (*Dugesia japonica*); in both cases, expression was shown to be neural.

Peptidergic neurons dominate the cerebral ganglia of flatworms and also contribute to the well-developed fibre tracts in the longitudinal cords and cross-connectives; they provide a rich innervation to the musculature of attachment organs, feeding apparatus and copulatory structures. Plexuses of immunoreactive fibres, many of them varicose in appearance, supply the reproductive tracts, notably the ootype or egg chamber, and also appear peripherally in extensive submuscular networks. A neuropeptide involvement in sensory function is suggested by the peptide-rich innervation of putative sensory organs at the body surface.

- **→Growth Factors:** Basic fibroblast growth factor (bFGF) and epidermal growth factor (EGF) have been localised immunocytochemically in *D. dendriticum*. IR for bFGF was found in a separate set of nerve cells and fibres in the CNS but not in the PNS of either plerocercoids or adult worms. IR for EGF was found in cell bodies and fibres in the CNS and PNS of the adult worm, in which very active growth takes place, but not in the non-growing plerocercoid larvae. A correlation between the growth rate of the worm and the presence of EGF-IR in cells is suggested.

**Nervous System of Platyhelminthes. Table 2** Amino acid sequences of neuropeptides identified from platyhelminths

Species	Neuropeptides: amino acid sequences
	<b>Neuropeptide F (NPF)</b>
<i>Arthurdendyus triangulatus</i> NPF	KVVHLRPRSSFSSSEDEYQIYLRNVSKYIQLYGRPRFa
<i>Moniezia expansa</i> NPF	PDQDSIVNPSDLVLDNKAALRDYLRQINEYFAIIGRPRFa
<i>Schistosoma japonicum</i> NPF	AQALAKLMTLFYTSDAFNKYMENLDAYYMLRGRPRFa
<i>Schistosoma mansoni</i> NPF	AQALAKLMSLFYTSDAFNKYMENLDAYYMLRGRPRFa
	<b>FMRFamide-Related Peptides (FaRPs)</b>
<i>Arthurdendyus triangulatus</i>	RYIRFa
<i>Bdelloura candida</i>	YIRFa
	GYIRFa
<i>Girardia tigrina</i>	GYIRFa
<i>Moniezia expansa</i>	GNFFRFa
<i>Procerodes littoralis</i>	GYIRFa

Amino acids represented by single letter annotations. a, C-terminal amide

## Neuronal Mediator Function

Data on the function of neuronal mediators in parasitic flatworms are scarce. The immense technical difficulties of neurophysiological studies on flatworms has long thwarted progress towards understanding their neuromuscular function, although the use of muscle-cell dispersion procedures offers some prospect of success in this regard.

- **Acetylcholine (ACh):** A physiological role for ACh as an inhibitory neurotransmitter in most trematodes and cestodes is indicated by the fact that their muscular activity is reduced by cholinomimetics and by cholinesterase inhibitors, ultimately producing a flaccid paralysis.
- **Serotonin (5-HT):** 5-HT appears to be the dominant biogenic amine in all flatworm species examined, and there is good experimental evidence that it serves a variety of functions, most notably that of excitatory neurotransmission. Thus, application of exogenous 5-HT has been shown to induce motility in muscle preparations of monogeneans, trematodes and cestodes and there are data that indicate the presence of a functional serotonin receptor on the muscle membranes, but one with a pharmacological profile unlike that of any mammalian 5-HT receptor subtype. A major source of 5-HT in *Schistosoma mansoni* is believed to be host-derived, via specific carriers, and in adult *Hymenolepis diminuta* circadian variations in the levels of 5-HT are thought to play a role in the migratory behaviour of the worm in the rat intestine.
- **Nitric Oxide (NO):** Recent data have identified the diffusible gas NO as a novel signalling molecule in the CNS and PNS of mammals, where it is believed to have a neuromodulatory role in synaptic function. Cellular signalling by NO involves the highly regulated synthesis of NO by nNOS, the diffusion of NO into an adjacent target cell, the activation of the soluble isoform of guanylyl cyclase (sGC) in the target cell, and the synthesis of the second messenger cGMP. cGMP is an important intracellular signalling molecule involved in smooth muscle relaxation. To date the NO-cGMP signalling system has been investigated in 4 flatworms: (1) adult *H. diminuta*, (2) cercaria of *Diplostomum chromatophorum*, (3) activated plerocercoids of *D. dendriticum* and, (4) adult *Fasciola hepatica*. Generally, IR for cGMP has been detected in the PNS, in nerve fibers very closely associated to the musculature of the suckers and the body, but also in many terminals beneath the basal lamina of the tegument. Furthermore, IR for cGMP has been detected in nerves surrounding the intestinal ducts of *F. hepatica*. A possible role in the control of muscle activity is suggested.
- **Catecholamines:** In *D. pseudospathaceum*, the time of appearance of catecholamine reactivity in

developing → cercariae has been related to the period of their motility. Catecholamines have been shown to be myoactive in flatworms, inhibiting or exciting motility in *Schistosoma mansoni*, *Fasciola hepatica* and *Diclidophora merlangi*; however, their precise function remains to be determined.

- **Glutamate (Glu):** Glu is a candidate neurotransmitter in at least two cestodes, eliciting strong excitatory responses when examined, i.e., → *Gyrocotyle fimbriata* and *Hymenolepis diminuta*.
- **Neuropeptides:** Although the exact role of FaRPs and NPFs in flatworms is unclear, some evidence has accumulated on their actions in flatworms. Numerous studies document the myoexcitatory effects of FaRPs in flatworms including turbellarians, trematodes and a monogenean. Studies on FaRP myoexcitation in *Fasciola hepatica* indicate that it involves the activation of the phosphatidylinositol signalling pathway and roles for G-protein coupled receptors, phospholipase C and protein kinase C have been implicated. Further data support a role for extracellular calcium in FaRP-triggered myoexcitation in trematodes and turbellarians, although how this is coupled to the phosphatidylinositol pathway is unresolved. Some data also indicate a mild myoexcitatory role for NPF in *F. hepatica* and the larval cestode *Mesocostoides vogae*, although the associated signalling pathway is unclear. NPF signalling in schistosomes has been shown to involve the potent inhibition of cyclic adenosine monophosphate (cAMP) accumulation in tissue homogenates. This is significant because it provides a functional link between NPF and vertebrate neuropeptide Y (NPY) family peptides which act through a so-called universal signalling mechanism to inhibit adenylyl cyclase and lower cAMP levels in cells. The tissue target for the NPF action is unknown. Further understanding of the roles of neuropeptides in flatworms will be achieved once the receptor targets for these signalling molecules are identified. These efforts have uncovered the first known flatworm neuropeptide receptor (a G-protein coupled receptor) from the planarian *Girardia tigrina*.

## Innervation of the Reproductive System

With a few notable exceptions, e.g., schistosomes, flatworms are hermaphroditic and their dual sexual systems are invariably complex. The large egg production represents an important target for chemotherapeutic attack, thereby justifying studies on the innervation of the reproductive system. The host impact on parasite reproduction has also been studied.

Data about the innervation of the ovaries and testes are sparse. In *Diphyllbothrium dendriticum*, immunoreactivities (IRs) to peptide histidine isoleucine (PHI)

and epidermal growth factor (EGF) have been observed in the walls of the testicular follicles. In the same location, positive NADPH-d reaction indicating the presence of nitric oxide synthase (NOS) was observed. In *H. diminuta* and *F. hepatica* NADPH-d positive nerve fibres have been detected in the muscular walls of the ovarium, seminal vesicle and cirrus.

The walls of the system of ducts connecting the gonads and forming the ootype are muscular and innervated by cholinergic, aminergic, peptidergic and nitergic nerve fibres. Confocal scanning microscopic analysis of these neuronal elements has led to a better understanding of the innervation of these complex organs (Fig. 8). In *Diclidophora merlangi*, PP-, PYY and FMRFamide-IRs have been reported to be present along the ootype/Mehlis gland and uterus. The nerve cells showing IR to PP in *D. merlangi* were characterised by a content of dense-cored vesicles (80–100 nm in diameter). Synaptic release sites at the muscle fibres of the ootype were observed. Some staining for cholinergic elements has been reported in the male reproductive tract. Light- and electron-immunocytochemical studies on a number of monogeneans (*D. merlangi*) and digeneans (*Fasciola hepatica*, *Schistosoma mansoni*, *Haplometra cylindracea*, *Gorgoderina vitelliloba*) have shown that a neuronal plexus of cell bodies and associated axonal processes contain neurosecretory vesicles and provide synaptic contacts with the circular and longitudinal muscle fibres and sphincters of the ootype wall and related ducts.

Recently, evidence for neurosecretory control of reproductive functions has emerged from studies of the polystomatid monogenean *Polystoma nearcticum*. This blood-feeding parasite undergoes reproductive synchrony with its tree frog host *Hyla versicolor*, and becomes reproductively active only during the short period of host sexual activity during spawning. In this way, it provides a valuable flatworm model system for investigating the nature of the potential trigger stimuli and factors controlling →oviposition in flatworm parasites. Immunocytochemical studies performed on worms collected from frogs during spawning have revealed extensive IR for FaRPs and for 5-HT in the ootype innervation. In marked contrast, the innervation of the ootype of worms recovered from frogs post-spawning showed little or no demonstrable FaRP IR (Fig. 9); the IR for 5-HT was unaffected by the reproductive state of the worm. Thus, host and parasite sexual activities would appear to be paralleled by neuropeptide expression in the innervation of the egg chamber. Since FaRPs have been shown to be myoactive on isolated flatworm muscle fibres *in vitro*, they may well be involved in the coordinated triggering of contractions of the ootype and adjacent ducting during the period of egg assembly. The recognised ability of 5-HT to stimulate →energy metabolism through elevation of cAMP, and the finding that 5-HT enhances the responsiveness of flatworm muscle fibres to excitatory transmitters, such as FaRPs and glutamate, may mean that its presence in the ootype nerve plexus ensures an

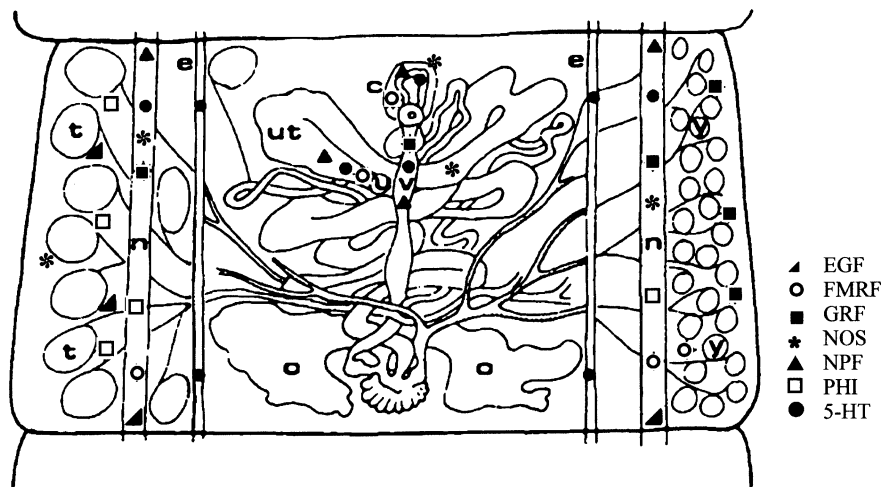

**Nervous System of Platyhelminthes. Figure 8** The serotonergic, peptidergic and NADPH-d-positive innervation of the genital apparatus of →*Diphyllobothrium dendriticum*. In the main nerve cords (*n*), 5-HT, neuropeptide F (NPF), growth hormone releasing factor (GRF), peptide histidine isoleucine (PHI), FMRFamide (FMRF) and epidermal growth factor (EGF) immunoreactive and NADPH-d-positive (NOS) neurons occur. The testicular follicles (*t*) are surrounded by EGF and PHI immunoreactive and NOS nerves. The →vitelline glands (*v*) are supplied by GRF- and FMRF-immunoreactive nerves. In the cirrus sac (*c*) 5-HT-, FMRF- and NPF-immunoreactive and NOS nerves occur. In the wall of the uterine pore (*u*) 5-HT-, FMRF- and NPF-immunoreactive nerves occur. The wall of the vagina (*v*) is supplied by 5-HT-, GRF- and NPF-immunoreactive nerves. *o*, ovary; *ut*, uterus.

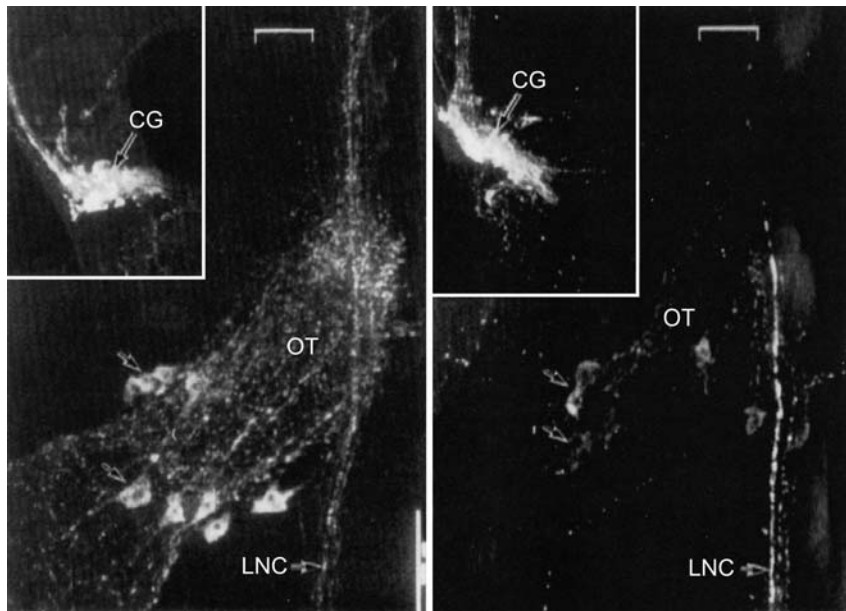

**Nervous System of Platyhelminthes. Figure 9** To the left, the strong GYIRFamide IR in the ootype (OT), the cerebral ganglion (CG) (inset) and the longitudinal nerve cord (LNC) of *Polystoma nearcticum* from a sexually active tree frog. To the right, the same structures, but from a worm recovered from a frog one week after spawning. Note the diminution of the GYIRFamide IR in the ootype (OT) innervation (arrows), but the unchanged staining of the LNC and the CG (inset). Scale bar, 50  $\mu\text{m}$  (inset 100  $\mu\text{m}$ ).

energy level sufficient to support ootype contraction, and that the FaRP when released serves to trigger events.

### Neuroactive Substances and Development

Most parasitic flatworms undergo several developmental stages prior to sexual reproduction in the definitive host, and these transformations are likely to be regulated by a series of endogenous and exogenous cues, the nature of which are largely unknown but may include hormone-like (peptidergic) secretions of the nervous system. This is an interesting area of study, not least since in many cases the larval stages can be grown successfully *in vitro* to adult worms. It would enable not only microscopic observations to be made on the anatomical and neurochemical development of the nervous system (NS) during ontogenesis, but would also facilitate experimental investigations of the effects of potential trigger stimuli on neuronal development and on any stage-specific expression of neuroactive messenger molecules.

Apart from descriptive reports on the localisation of neuroactive substances in the NS of developing stages of trematodes and cestodes, the adaptations of the flatworm NS to environmental stimuli has been documented for only a few species. Perhaps the best recorded example of this is the activation of peptidergic secretion, as stained with paraldehyde fuchsin (PAF), in the NS of the plerocercoid stage of *Diphyllbothrium*

*dendriticum* following its transfer from the poikilothermic fish  $\rightarrow$  intermediate host to the homeothermic avian final host, suggesting a role for neuropeptides in morphogenesis in this tapeworm. A similar activation of a neurosecretory system was witnessed when studying the appearance of immunoreactivity (IR) for the epidermal growth factor (EGF) in *D. dendriticum*. IR for EGF was observed only in adult worms, not in plerocercoids. The cytomorphology of the EGF-immunoreactive neurons conforms with the PAF-positive neurons and they are distributed along the CNS and PNS and especially in regions with active growth. An increase in EGF-IR takes place parallel to the increase in mitotic activity/growth rate, indicating a close correlation between mitotic activity/growth rate and the presence of EGF-IR. The pattern of the nitrergic NS and the IR to cGMP in its target cells have been studied in cercariae of *Diplostomum chromatophorum* and plerocercoid larvae of *D. dendriticum*. In the actively moving cercariae, NADPH-d positive cells were detected close to the ventral sucker and in the tail. In plerocercoid larvae recovered from the whitefish, very weak or no NADPH-d staining was observed. However, after transfer to the final host (seagull) or after a short period of cultivation at 37°C, the NADPH-d staining strengthened and is clearly associated with the musculature of the worm. One possible explanation of the differences in staining intensities between the larval fluke and the larval tapeworm could be the difference in activity patterns of the flatworm larvae. The cercariae of

*D. chromatophorum* swim actively, while the plerocercoid larvae of *D. dendriticum* spend an almost immobile life inside the cyst on the stomach wall of the second intermediate (whitefish) host. There would appear to be little need for movement inside these cysts. However, in the actively moving adult *D. dendriticum*, strong NADPH-d staining and IR to cGMP have been observed in neurons and nerve fibers adjacent to the musculature. IRs for 5-HT and FMRFamide as well as NADPH-d staining have been detected in redia, cercariae and adult *Echinoparyphium aconiatum*.

## Netobimine

Pro-benzimidazol, →Nematocidal Drugs.

## Neurocysticercosis

→*Taenia solium*, →Nervous System Diseases, Animals.

## Neurohormones

→Amino Acids, →Nervous System of Platyhelminthes.

## Neuropeptides

→Nervous System of Platyhelminthes.

## Neurotransmitters

→Amino Acids, →Nervous System of Platyhelminthes.

## Neutrophilic Inflammation

→Pathology.

## New Drugs

### Recently, Several New Drugs Are Under Development

#### Fosmidomycin (C<sub>4</sub>H<sub>9</sub>NPO<sub>5</sub><sup>-</sup>Na<sup>+</sup>)

Fosmidomycin has been isolated and identified from *Streptomyces lavendulae* and was first of interest as an antibiotic compound. It has been investigated in a phase II study, but the clinical development has never been finished. Starting from 1998, fosmidomycin gained interest again, but now specifically as an antimalarial compound. Fosmidomycin is an inhibitor of 1-deoxy-D-xylulose 5-phosphate reductoisomerase, an enzyme in the methylerythritol phosphate (MEP) pathway for isoprenoid biosynthesis. This pathway has been discovered in the 1990s and is responsible for the essential isoprenoid biosynthesis in several bacteria, plastids of higher plants, and algae. In eukaryotes the isoprenoid precursors are produced via the totally different and well-studied mevalonate pathway. The discovery of the existence of 2 independent pathways created the possibility to use the MEP pathway as a new target for antibiotics. Sequencing data of the genome of *Plasmodium falciparum* (<http://www.plasmodb.org>) revealed genes encoding for homologue proteins for the MEP pathway. The functional activity of the MEP pathway for the biosynthesis of isoprenoids in *P. falciparum* has been published.

Fosmidomycin (C<sub>4</sub>H<sub>9</sub>NPO<sub>5</sub><sup>-</sup>Na<sup>+</sup>)

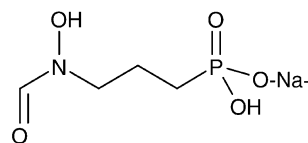

The inhibition of the recombinant protein 1-deoxy-D-xylulose 5-phosphate reductoisomerase from *P. falciparum* by fosmidomycin has been published as well as the *in vitro* inhibition of multiresistant *P. falciparum* strains.

The knowledge obtained previously made possible the fast development of fosmidomycin as an antimalarial drug. The first clinical studies have been performed in Gabon and Thailand giving oral doses of 1.2 g of fosmidomycin 3 times a day for 7 days. A follow-up study was performed in Gabon with treatment of only 4 days. Cure rates of 80% were observed after 2 weeks.

Unfortunately, the use of fosmidomycin as a monotherapy resulted in high percentages of recidives that

Lap-dap: chlorproguanil ( $C_{11}H_{15}N_5Cl_2$ )  
dapsone ( $C_{12}H_{12}N_2SO_2$ )

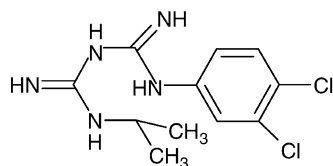

chlorproguanil

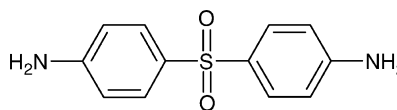

dapsone

demands an application in a combination therapy with another antimalaria drug. Therefore, several other drugs were tested in combination with fosmidomycin. Clindamycin showed a synergistic effect *in vitro* and in animal studies.

Till now, the first clinical trials investigating the combination therapy of fosmidomycin and clindamycin showed promising results for the treatment of malaria caused by *P. falciparum* infectum both in adults and in children, although the treatment for children under 3 years showed to be less effective. More trials are necessary to optimize the combination therapy.

FR-900098, a derivative of fosmidomycin has shown to be even more effective *in vitro* and in mice. Based on this drug prodrugs have been synthesized to increase kinetic behavior of the drug, but this group of drugs is still in a developmental stage.

### Lap-dap: chlorproguanil ( $C_{11}H_{15}N_5Cl_2$ )

#### Dapsone ( $C_{12}H_{12}N_2SO_2$ )

Lap-dap is the fixed combination of chlorproguanil and dapsone. This specific combination has been under investigation as an alternative for the combination sulfadoxine-pyrimethamine (Fansidar). Both compounds have been in use for years already, which makes the development of the therapy less complex and relatively inexpensive. Chlorproguanil is, like proguanil, an antifolate antimalarial drug. After metabolization in the liver by CYP2C19, the metabolite inhibits dihydrofolate reductase in the parasitic biosynthesis of folate. Dapsone has been used for decades already in the treatment of leprosy. The sulphone compound inhibits dihydropteroate synthase, an enzyme in the folate biosynthesis as well. Since both drugs block the folate biosynthesis, they have a synergistic effect. Next to that, the short plasma half-lifetimes of both drugs, compared to other combination therapies, is an advantage as it has proven to result in a slow development of resistance. Nevertheless, the combined drugs use the same target in the parasite and therefore a combination with a third drug, artesunate is now under investigation to

enhance effectiveness and prevent fast development of resistance. This is contrary to other fixed combinations in current clinical use, such as, lumefrantine-artemether (co-artemether) and atovaquone-proguanil (Malerone), both of which seem to be impaired by the existence of resistance.

#### Triclosan ( $C_{12}H_7O_2Cl_3$ )

Triclosan has a broad antibacterial activity and it is often used in products, like soap, toothpaste, and other household products, including plastics and textiles, as an antibacterial agent. Unfortunately, triclosan cannot be used as an oral drug. Nevertheless, it has shown to be active against *P. falciparum* *in vitro* and in mice infected with *P. berghei*. Triclosan inhibits the biosynthesis of fatty acids in bacteria and *Plasmodium* sp. containing a so-called type II system (FAS-II) in the apicoplast of the parasitic cell, which is absent in humans (FAS-I system). More specifically, triclosan inhibits enoyl acyl carrier protein (ACP) reductase in bacteria and *P. falciparum*. The recombinant reductase of *P. falciparum* has been crystallized and modeling studies give basic information of the structural mechanism of inhibition. The findings can be used to optimize the efficacy of triclosan and to develop other antimalarial compounds.

Nevertheless, the general use of triclosan as an antibacterial agent can give rise to a fast development of resistant bacterial strains and subsequently parasites as well. The presence of a triclosan-resistant enzyme in many bacteria, able to catalyze the same reaction as enoyl ACP reductase has been described. The resistance developed by general use has recently been reviewed

Triclosan ( $C_{12}H_7O_2Cl_3$ )

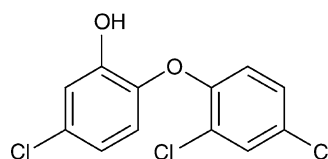



describing the risk for the efficacy of a clinical use of triclosan and other important antimicrobials.

### Artemisone (C<sub>19</sub>H<sub>31</sub>NO<sub>6</sub>S)

Artemisinin and its derivatives are the most potent and effective antimalarial drugs used in therapy today. Moreover there has not been any cases of resistance observed as yet. Because of these reasons the WHO aims at the use of a standard antimalarial drug in combination with an artemisinin derivate. Artemisinin-based Combination Therapy should inhibit the further spread of resistance. Although not proven to be related to artemisinin use in humans, animal models showed neurotoxicity of artemisinins. More recently, toxic brainstem encephalopathy and loss of hearing have been reported for the combination of artemether and lumefrantine. These findings are a major hurdle for further development of artemisinin-based therapies. In a joint program from Bayer Healthcare and the Hong Kong University several artemisin derivatives were synthesized and tested on efficacy, stability, pharmacokinetics, and neurotoxicity to overcome these problems. From this study artemisone was developed as the most promising derivate. Although the artemisone did not show the highest activity of all investigated derivatives tested *in vitro* and in a mice model, neurotoxicity has not been observed nor did the drug show an inductive effect on the metabolizing enzymes CYP3A4 and CYP2B6, as do other artemisinins.

Artemisone (C<sub>19</sub>H<sub>31</sub>NO<sub>6</sub>S)

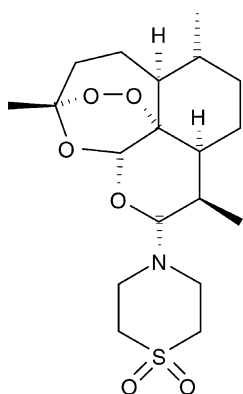

### Isoquine (C<sub>18</sub>H<sub>18</sub>N<sub>3</sub>OCl)

Isoquine is a 4-aminoquinoline structurally derived from amodiaquine. Although amodiaquine has proven to be effective against chloroquine-resistant *P. falciparum* strains, its use is associated with the occurrence of the severe side effects, hepatotoxicity and agranulocytosis. The toxicity is probably related to cytochrome P450-mediated bioactivation of amodiaquine. The

Isoquine (C<sub>18</sub>H<sub>18</sub>N<sub>3</sub>OCl)

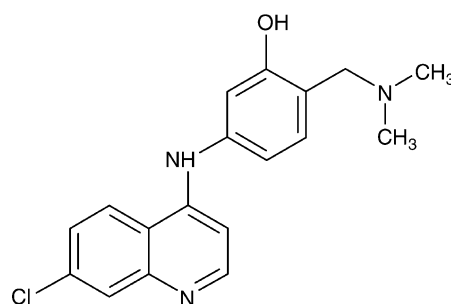

regioisomer isoquine does not show any bioactivation, but the *in vitro* antimalarial activity is maintained. Isoquine seems to be an interesting 4-aminoquinoline for further development as antimalarial drug, not only because of its antiparasitic activity as well as due to its cheap synthesis.

### Imiquimod (C<sub>14</sub>H<sub>15</sub>N<sub>4</sub>)

Imiquimod (Aldarar) is an immunomodulator which has been used extensively for the topical treatment of genital warts, which are caused by the papillomaviruses. The drug is also used in treatment of superficial basal cell carcinoma, in cases where surgery is not possible. There were several publications describing the effectiveness of topical imiquimod for different skin diseases. In this light the drug has become of interest for the treatment of cutaneous leishmaniasis as well. Imiquimod induces a local immune response, resolving the infection. It has an effect on several immune cells including macrophages, which are the host cells of *Leishmania* spp., inducing the production of several cytokines and nitric oxide. Imiquimod have shown to be effective, when it was used in a combination with the standard drug meglumine antimonite, in patients who did not previously respond to meglumine antimonite as monotherapy. A randomized, double blind trial of topical imiquimod as additive to parenteral antimony showed, that imiquimod was well tolerated, accelerated healing of lesions, and improved scar

Imiquimod (C<sub>14</sub>H<sub>15</sub>N<sub>4</sub>)

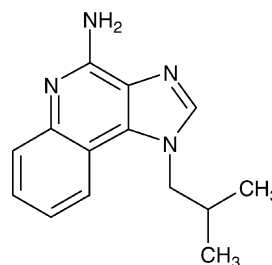

quality. The latter should be of special interest for patients with lesions in the face.

### 8-Aminoquinolines

The earlier efforts toward development of 8-aminoquinoline analogs have been directed to extensive derivatization programs to get more and powerful derivatives of this chemical group. Research led to discovery of tafenoquine for prophylaxis against malaria infections and sitamaquine with utility for treatment of visceral leishmaniasis. Bulaquine, a primaquine prodrug, has shown reduced methemoglobin toxicity and better malaria-transmission-blocking activity than primaquine. Bulaquine (aabaquine, CDRI 80/53), was also developed for treatment of *P. vivax* malaria and it is currently in limited clinical use only in India. Stereo-selective pharmacologic and toxicologic characteristics of chiral 8-aminoquinolines provided the lead for enantiomeric separation of an 8-aminoquinoline analogs with reduced toxicity and potent antimalarial action against blood as well as tissue stages of the parasite. Better understanding of the mechanisms of toxicity and efficacy may help in the development of 8-aminoquinoline analogs with superior therapeutic actions, reduced toxicity, and broader utility. Later, the utility of the 8-aminoquinolines was also applied to the treatment of leishmaniasis, *Pneumocystis carinii* pneumonia (PCP), and other infectious diseases. Prolonged

(7–14 days) treatment with primaquine is essential for a radical cure due to the drug being metabolized rapidly. This leads to higher accumulation of potential toxic metabolites of primaquine, which are primarily responsible for hemolytic effects in individuals with glucose-6-phosphate dehydrogenase deficiencies. Bio-transformation mechanisms appear to be central to anti-infective and hematological toxicities, but are still not well understood. Reactive and unstable properties of potential methemoglobinemic metabolites have hampered studies on the biotransformation mechanisms involved in the toxicity of 8-aminoquinolines. Understanding of these mechanisms, using the model hydroxyl metabolites of primaquine, has provided useful leads for development of analogs with reduced toxicity.

Sitamaquine (WR 6026), which has recently completed phase II clinical trials in India and Kenya as an oral treatment for visceral leishmaniasis, was also discovered in the extensive 8-aminoquinoline derivatization program at WRAIR. Sitamaquine showed extraordinary antileishmanial efficacy in preclinical models, which easily led to its clinical evaluations against visceral leishmaniasis. Initial phase II studies with sitamaquine were undertaken with 0.75 and 1 mg/kg per day for 14 and 28 days in Kenya with only 16 patients. Encouraging results with these trials led to another phase II, open-label, dose-escalating trial in Brazil, but the results were not very encouraging. The dose of 1 mg/kg

### 8-Aminoquinolines

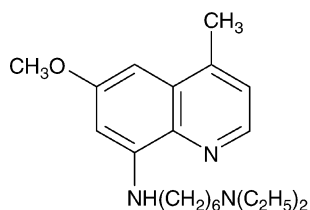

(WR6026, sitamaquine)

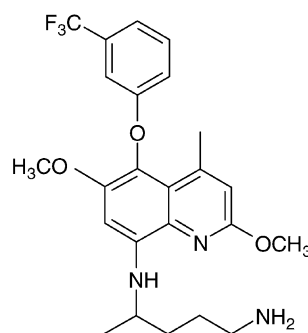

(Tafenoquine)

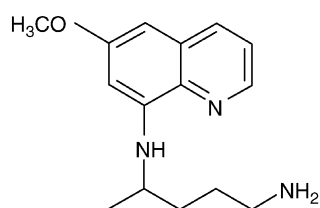

(Primaquine)

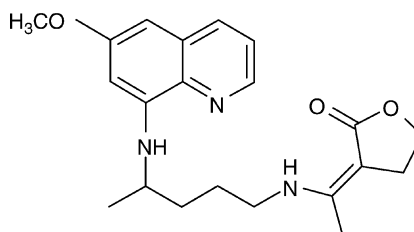

(Bulaquine)

per day for 28 days failed and no dose response was observed at higher doses. Unexpected nephrotoxicity was also observed. Recent randomized, open-label, dose-response phase II clinical trials in India with 120 subjects with visceral leishmaniasis, and another open-label, dose-increasing phase II study in Kenya on visceral leishmaniasis caused by *L. donovani*, have shown that sitamaquine is efficacious and generally well tolerated. The efficacy of topical formulation of sitamaquine, in models both *in vitro* and *in vivo* of cutaneous leishmaniasis, has been reported. *In vitro* activity of sitamaquine against a range of *Leishmania* spp. was confirmed, but it failed to slow lesion progression or reduce parasite burden in BALB/c mice infected with *L. major*. Recently, synthesis of some 5-trifluoromethoxy 2-tert-butyl analogs of primaquine with potent antileishmanial activity against *L. donovani* promastigotes *in vitro* has been reported.

### Paromomycin (C<sub>23</sub>H<sub>47</sub>N<sub>5</sub>O<sub>12</sub>)

The aminoglycoside antibiotic, aminosidine, also known as paromomycin and monomycin, was first shown to be active against experimental cutaneous leishmaniasis in the early 1960s. Later studies showed that it was the most potent among a series of tested compounds derived from microbiological sources. Interest in the antileishmanial properties of this compound has been revived by the development of topical formulations for the treatment of cutaneous infections. It was found that topical application of either paromomycin or gentamicin, together with a transdermal enhancing agent, cured the parasite lesion, and that combined treatment with the 2 compounds had an additive effect. The pharmacology and antiparasitic mechanism of these drug formulations is discussed below.

Paromomycin (Humatin), for African visceral leishmaniasis, is being developed by DNDi under a purely public model (paromomycin is a generic drug). DNDi is covering all R&D costs and conducting regulatory work in conjunction with WHO/TDR. R&D is carried out by public groups on either a paid or in-kind basis: clinical trials are being conducted in Ethiopia, Kenya, and Sudan by Médecins Sans Frontières and the Kenya

Medical Research Institute (KEMRI); clinical trial investigators and monitors were trained by WHO/TDR; and the International Dispensary Association (IDA), a Dutch not-for-profit foundation, is packaging and shipping trial drugs. DNDi will provide the final drug at cost in developing country markets.

### Nitazoxanide (C<sub>12</sub>H<sub>9</sub>N<sub>3</sub>O<sub>5</sub>S)

Nitazoxanide is the parent compound of the thiazolides and was first described in 1975. The drug has proven to be effective in humans against an unusual broad spectrum of microbes and parasites. Recently this broad spectrum of the thiazolide for the treatment of gastrointestinal infection has been reviewed giving an impressive list of the activity of nitazoxanide against bacteria, protozoa, and helminthes as well as activity against hepatitis C virus and anti-inflammatory properties. Nitazoxanide represents the only effective treatment of human cryptosporidiosis with low side effects and the potential for safe treatment of amebiasis, cyclosporiasis, isosporiasis, and microsporidiosis. The efficacy of the drug mostly is equivalent to benzimidazoles in terms of treatment of *Ascaris* and *Trichuris* infection.

An orally given dose of nitazoxanide is rapidly de-acetylated to the active compound tizoxanide via hydrolysis by plasma esterases. Nitazoxanide serves therefore as a prodrug. For its high antimicrobial activity, nitazoxanide has been marketed in 1996 in several countries in Latin and Central America, and in the USA since 2002 as well.

Despite the fact that it is mostly used as broad-spectrum antibiotic, its importance is increasing because of the need of new drugs against protozoan parasites (especially *Cryptosporidium*), intestinal helminthes which infect more than 2 billion people worldwide, and anaerobic bacteria. In December 2002 the US FDA approved the drug as an oral suspension for the treatment of diarrhea caused by *Cryptosporidium* and *Giardia* in paediatric patients. Later in 2004 and 2005 the approval was given for treatment of adults and children  $\geq 12$  years. The status in Europe is different; here the approval was filed but not granted.

Paromomycin (C<sub>23</sub>H<sub>47</sub>N<sub>5</sub>O<sub>12</sub>)

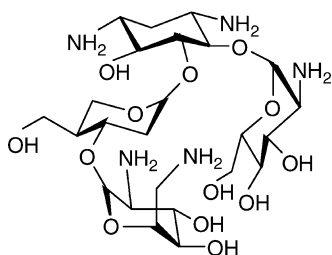

Nitazoxanide (C<sub>12</sub>H<sub>9</sub>N<sub>3</sub>O<sub>5</sub>S)

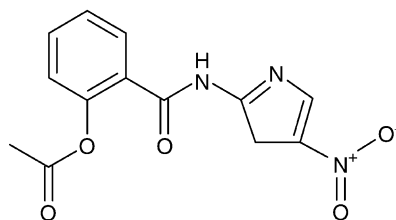

## Cyclooctadepsipeptides

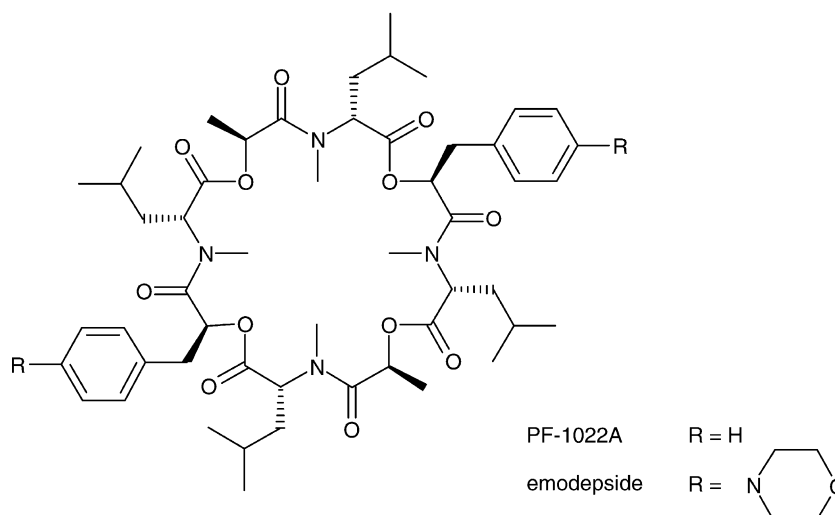
**Cyclooctadepsipeptides**

Anthelmintic activity of the new class of cyclodepsipeptides and the related new novel natural product PF1022A has recently been reported. This molecule demonstrates extraordinary potency against a variety of nematodes *in vitro* and in certain animals. The mechanism of action of PF1022A has not been proven; although radiolabelled PF1022A binds to GABAergic sites in nematodes, the potency of this binding is somewhat lower than the potency of the compound against target parasites in culture. Electrophysiological and biochemical data also suggest that the site of action of PF1022A remains to be elucidated.

PF1022A and its semi-synthetic derivative emodepside are the most important members of this promising group of antiparasitic compounds. The first identified cyclooctadepsipeptide was PF1022A from *Mycelia sterilia*. PF1022A contains a ring structure assembled with 4 alternating residues of *N*-methyl-L-leucine, 2 residues of D-lactate and 2 residues D-phenylacetate. The natural product has been isolated from *Mycelia sterilia* PF1022, a fungus found on the leaves of *Camellia japonica*. The anthelmintic activity was first described in 1992. The total synthesis of cyclooctadepsipeptides has been published by several groups. In 1993, the structure of the derivative emodepside was patented by Fujisawa Pharm. Co. (Japan). The *in vitro* and *in vivo* activity of

cyclooctadepsipeptides against several nematode infections in animals has been investigated intensively and is well reviewed.

In an *in vitro* model it has been shown that PF1022A paralyzes worms by a stimulating effect on GABA receptors and inhibition of the cholinergic system. This pharmacological activity is unique and is not observed for any other antiparasitic drug. The different mode of action of cyclooctadepsipeptides in comparison to other well-known anthelmintics and the low toxicity makes them, especially with the increasing occurrence of resistance, the most promising group of antiparasitic drugs in development at the moment.

A related group of natural products, the cyclohexadepsipeptides (also called enniatins), consists of an 18-member ring structure instead of the 24-member ring of PF1022A. Members of this group of compounds show several biological activities, like antibiotic, antifungal, and insecticidal. Endoparasitic activity of several natural and synthetic cyclohexadepsipeptides has been described as well.

**Miltefosine (C<sub>21</sub>H<sub>46</sub>NPO<sub>4</sub>)**

Miltefosine (hexadecylphosphocholine, Impavido) is a novel antiprotozoal drug for the treatment of both visceral and cutaneous leishmaniasis. The compound is a

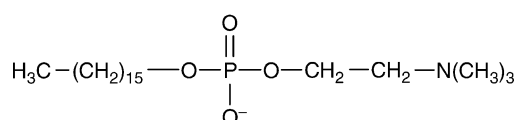
Miltefosine (C<sub>21</sub>H<sub>46</sub>NPO<sub>4</sub>)

phospholipid derivative from which the glycerol backbone has been replaced by an alkyl chain. Originally the drug was developed as an antitumor agent, but the oral bioavailability was too low for antitumor activity. Nevertheless, miltefosine has been approved for topical treatment of cutaneous breast metastases (Miltex).

The *in vitro* antileishmanial activity of miltefosine was first described by Croft et al. in 1987. Followed by *in vivo* models of oral administration of miltefosine in mice, showing activities superior to the standard drug sodium stibogluconate and a phase II study in India. Further clinical development led the approval of miltefosine as the first oral treatment for leishmaniasis. Topical application of Miltex (6% miltefosine ointment) also showed efficacy against cutaneous forms of leishmaniasis. Further research will be focused on other phospholipid derivatives with antileishmanial activity.

For latest literature information please contact the author Professor Dr. Kayser.

### Related Entry

→[Drug Discovery](#).

## New Variant Antigen Types (VAT)

→[Variable Surface Antigens](#), →[Surface Coat](#).

## Nicarbazine

→[Ectoparasitocidal Drugs](#).

## Niclosamide

→[Cestodocidal Drugs](#).

## Nicotine

Nicotine-energic-receptors are targets of →[insecticides](#) (e.g., imidacloprid or nitenpyram).

## Nifedipine

A calcium channel blocker: drug used to treat (besides →[albendazole](#)) microsporidal infections in humans (AIDS, →[Opportunistic Agents](#)).

## Nifursol

Drug against histomonose. →[Trypanocidal Drugs](#).

## Nifurtimox

Drug to treat →[Chagas' Disease](#), →[Trypanocidal Drugs](#).

## Nimorazole

→[Antidiarrhoeal and Antitrichomoniasis Drugs](#).

## Nippostrongylus brasiliensis

→[Nematodes](#).

## Niridazole

→[Antidiarrhoeal and Antitrichomoniasis Drugs](#).

## Nitazoxanide

Drug to treat infections with stages of →[Blastocystis](#), →[Cryptosporidium](#), →[microsporidia](#).

## Nitenpyram

**Chemical Class**  
Neonicotinoide.

### Mode of Action

Nicotinic acetylcholine receptor agonist. → [Ectoparasitocides – Agonists and Antagonists of Cholinergic Transmission](#), → [Ectoparasitocidal Drugs](#).

### Nitric Oxide (NO)

One of the principal effector molecules in killing parasites. → [Nervous system of platyhelminthes](#), → [Amoebiasis](#), → [Toxoplasmosis, Animals](#), → [Toxoplasmosis, Man](#), → [T-Cells](#).

### Nitrofurantoin

→ [Coccidiocidal Drugs](#).

### Nitroimidazoles

→ [Antidiarrhoeal and Antitrichomoniasis Drugs](#).

### Nitroscanate

→ [Nematocidal Drugs](#).

### Nitroxinil

→ [Antidiarrhoeal and Antitrichomoniasis Drugs](#).

### Nits

Eggs of anopluran → [lice](#) attached at hairs.

### NK-Cells

Short for: natural killer cells: type of lymphocytes reaching about 15% of the whole population and attacking many types of antigens (not species of even group-specific).

### N,N-diethyl-m-toluamide (DEET)

#### Chemical Class

Repellent.

#### Mode of Action

Olfactory reception.

### Nocht, Bernhard (1857–1945)

German marine physician ([Fig. 1](#)), 1900 founder and first director of the Hamburg Institute for Ship and



**Nocht, Bernhard (1857–1945).** **Figure 1** Professor Dr. B. Nocht in 1925, when 68 years old.

Tropical Diseases. He introduced the “fractionated application of the chinine” and thus avoided the “black water disease”. Together with the chemists of the institute (→[Giemsa](#)), he invented an apparatus to clean ships from rats (to avoid the import of plague).

---

## N-octyl bicycloheptene dicarboximide (MGK264)

### Chemical Class

Synergist.

### Mode of Action

Cytochrome P-450 microsomal monooxygenase inhibitor.

---

## Node

A point of branching in a systematical tree.

---

## Nodule

Clinical and pathological symptom of infections with skin parasites (→[Skin Diseases, Animals](#), →[Siphonapteridosis](#)), habitat of *onchocerca* – females in the skin of humans, →[Filariidae](#).

---

## Noguchi, Hideyo (1876–1928)

Japanese scientist (bacteriologist) in the service of the Rockefeller Institute ([Fig. 1](#)). He believed to have discovered the agent of the yellow fever in 1919 and described it as a leptospiral bacterium, which was indeed agent of the rat bite fever (Weil’s disease). This disease has as symptom also hepatitis, which introduces yellow eyes. Due to this error he died during a self-experiment in Africa from the true yellow fever (a virus). Now a hospital in Ghana is called Noguchi-Institute.



**Noguchi, Hideyo (1876–1928).** **Figure 1** Professor Dr. H. Noguchi prior to his early death from a self infection with yellow fever.

---

## Northern Fowl Mite

→[Mites \(Ornithonyssus sylviarum\)](#).

---

## Norwegian Scabies

Widespread epidermal scaling in immunosuppressed people due to infections with the mite →[Sarcoptes scabiei](#) (→[Scabies](#)).

---

## No-see-ums

Common African name for →[Culicoides](#) spp.

## Nosema algerae

Microsporidian found in →mosquitoes (genotype 2) and AIDS-patients (genotype 1). Since it is very pathogenic to mosquitoes, it is tested as biological means of eradication of →malaria vectors.

## General Information

The spores of this species measure  $9 \times 4 \mu\text{m}$  and appear ovoid (Figs. 2, 3, page 1022). The infection occurs by oral uptake of the spores. The included infectious stage enters (via injection through the polar tube), (Microsporida) cells of the midgut, within which new spores are formed in about 48–60 hours thus destroying the cells. The disease (→Bee Dysentery, →Nosematosis) may lead to death and collapse of the bee population.

## Nosema apis

### Classification

Species of →Microspora.

### Life Cycle

Fig. 1.

### Disease

→Bee Dysentery.

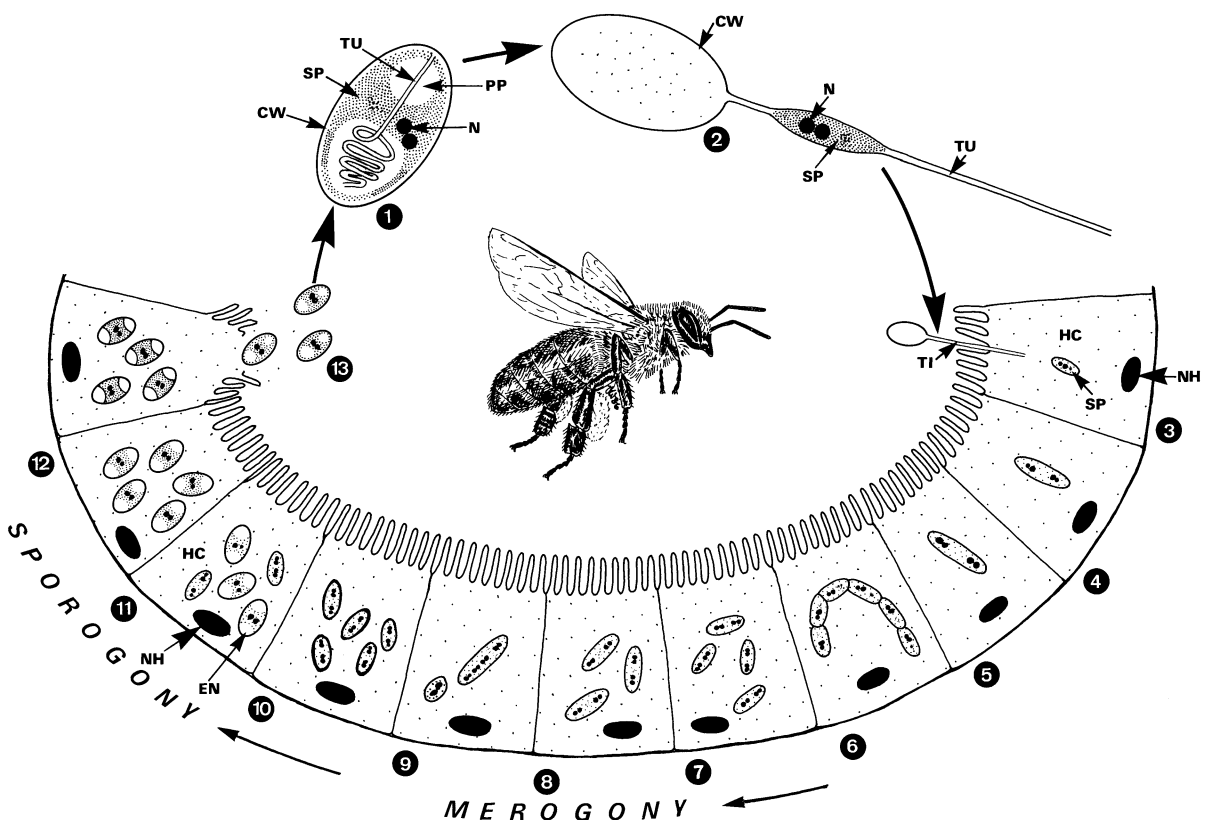

**Nosema apis.** **Figure 1** Life cycle of *Nosema apis*, causing →bee dysentery. 1 Infectious spore ( $4\text{--}6 \times 2\text{--}4 \mu\text{m}$ ) containing a typically dinucleate →sporoplasm; bees become infected by swallowing →spores from the feces of parasitized members of the colony. 2, 3 Inside the intestine the tubular →polar filament becomes extruded, penetrates the peritrophic membrane (not drawn), and enters an intestinal cell. The sporoplasm (SP) is injected into the epithelial cell through the tubular lumen of the polar filament. 4–12 The sporoplasm (9) grows and asexually divides via quadrinucleate stages in its host cell (→Merogony). Finally, →Encystation (i.e., spore formation) is initiated from a diplokaryon stage (10) via a final division (→Sporogony). 13 When mature spores are present, host cells are disrupted and release the infectious spores into the lumen, which are voided with the feces (or infect neighboring cells). At the end of summer, development of *N. apis* may become reduced (→Hypobiosis) and starts again in spring. As well as the intestine, all organs of bees become parasitized. CW, cyst wall; EN, encystation; HC, host cell; N, nucleus; NH, nucleus of host cell; PP, →polaroplast; SP, sporoplasm; TI, tubule-injected; TU, tubule (polar filament).



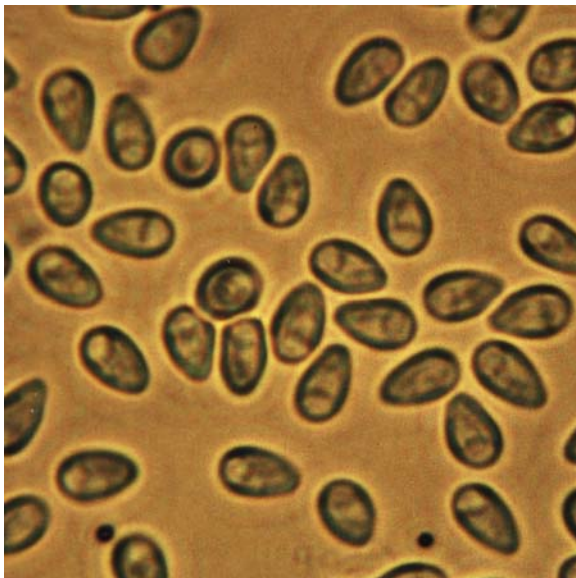

**Nosema apis.** Figure 2 LM of *Nosema* stages from the intestinal tissue of a bee.

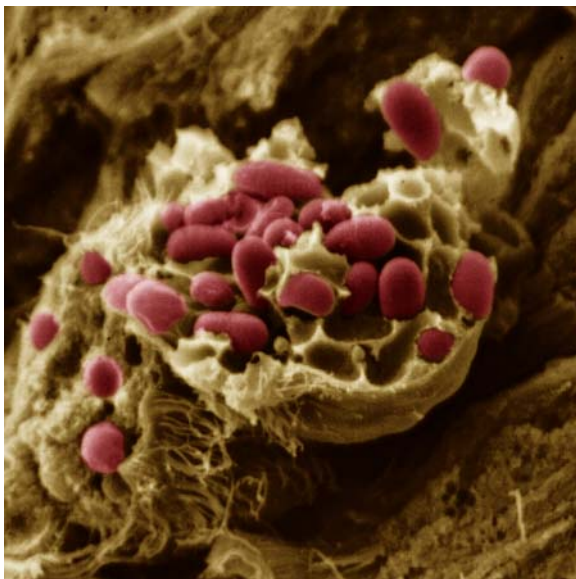

**Nosema apis.** Figure 3 SEM of spores in a broken host cell.

## Nosematosis

### Synonym

→Bee Dysentery.

Disease of honeybees (leading to diarrhoeal feces, drying, and finally to death) due to infection with →spores of the microsporidian species →*Nosema apis*.

### Therapy

Fumagillin and similar compounds.

## Nosology

From Greek: *nosos* = disease; knowledge of diseases.

## Nosophyllus segnis

→Fleas.

## Nosopsyllus

### Name

Greek: *nosos* = disease, *psyllos* = flea.

Genus of fleas. The species *Nosopsyllus fasciatus* is found on rats and mice and is one of the vectors of the plaque bacterium. These fleas need a blood meal in order to reach maturity. Characteristic are the combs (ctenidia) at the pronotum of adults (Fig. 1).

## Nosopsyllus fasciatus

Mouse flea (Fig. 1).



**Nosopsyllus.** Figure 1 Head of an adult flea (DR).



**Nosopsyllus fasciatus.** Figure 1 LM of lateral view of an adult female.

## Notila

→Chromosomes.

## Notocotylus

Genus of notocotyloid flukes; e.g., *Notocotylus attenuatus* (syn. *N. triserialis*) (2 – 5 × 1.5 mm) lives in the caeca and colon of chicken, rodents, or water birds.

## Notocotylus attenuatus

Trematode of the intestinal tractus caecum rectum of birds reaching a size of 5 × 1.4 mm. Its ventral side is provided with spines, while the ventral sucker is lacking. The 20 × 10 μm-sized eggs are characterized by terminal filaments of up to 0.2 mm in length.

## Notoedres cati

From Greek: *noton* = backside, *edres* = seat (means: the anus is dorsal).

## General information

Species of mange mites of cats and other felids (Fig. 1), which reach a size of about 235–300 × 200 μm as females and 150–180 × 120 μm as males. In the life cycle (which takes 3 weeks) one larva and 2 nymphs occur prior to adults. The symptoms of this peculiar mange start at the tips of the ear (Fig. 2) and generalize

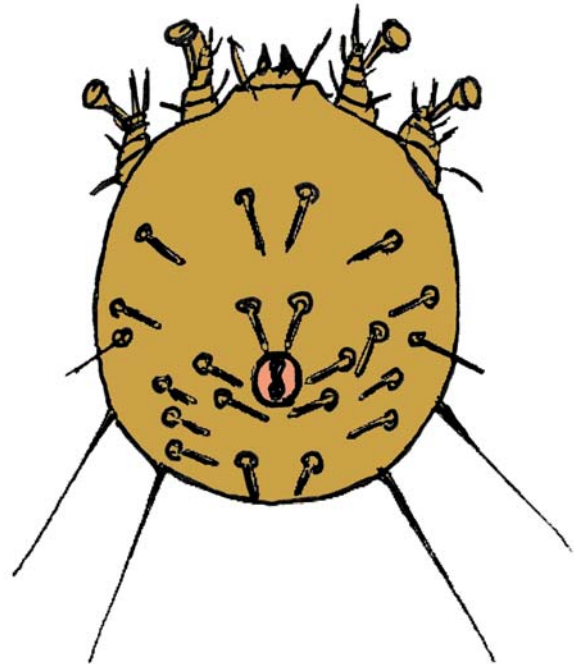

**Notoedres cati.** Figure 1 Diagram of an adult mite. Note that the anus is situated on the backside.

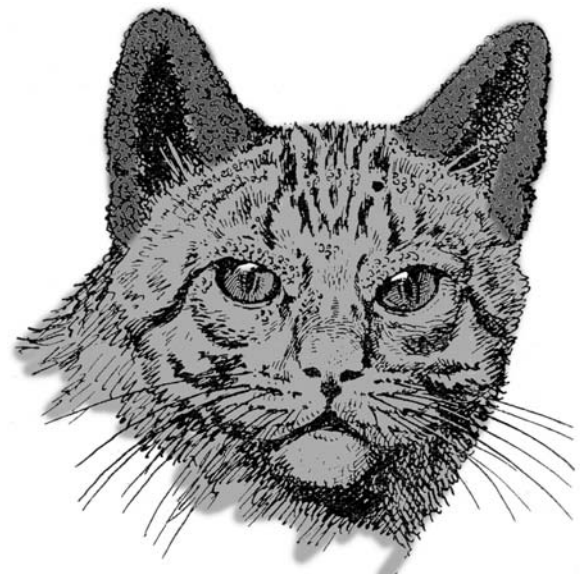

**Notoedres cati.** Figure 2 Head of a cat, the ears of which show *Notoedres* mange. (From Diehl and Weidner 1946).

very often to the whole surface of the head. Young cats may die very soon, but also elder ones lose weight and may die after 4–5 months. Molecular biological assays showed strain variations (e.g., *N. cati* var *cuniculi* of rabbits). →Mites.

### Therapy

→Acaricidal Drugs.

## Notoedric Mange

→Mange, Animals/Notoedric Mange.

## Notonecta

Water bug, swimming on its back, her defensive bites are painful for humans.

## Notostigmata

→Acarina.

## Novel Drugs

→Drug Discovery, →New Drugs.

## NTD

As Neglected Tropical Diseases (NTD) are considered →lymphatic filariasis, →onchocerciasis, →intestinal helminthiasis, →schistosomiasis, and trachoma-disease.

This is due to the slow development of severe symptoms during these diseases and the lack of efficient drugs or the high costs to distribute those, which are available.

## Nuclear Division

In protozoans, nuclear divisions may be mitotic or meiotic, as in other →eukaryonts. In parasitic protozoans, meiotic processes are poorly understood or even unknown since the nuclei are usually too small for chromosomes to be followed in light microscopy (→Chromosomes/Protozoa). On the other hand, the more frequently occurring mitotic divisions have become better known since electron microscopy was introduced.

Mitotic processes are known from all groups of parasitic protozoans. Many modifications have been described, although in general the nuclear membranes are retained during division. Thus this division was called →cryptomitosis in contrast to the →eumitosis of the metazoans, where the nuclear membrane disappears during nuclear division. These 2 types of →mitosis may be subdivided into 2 main groups according to the arrangement and location of the spindle apparatus: →orthomitosis and →pleuromitosis. Orthomitosis is characterized by, among other factors, the occurrence of a central, symmetric, bipolar spindle apparatus, whereas pleuromitosis has laterally arranged or even separate spindle halves (Figs. 1, 2, 5A, page 1025–1029).

→Crypto-orthomitosis is usually dominant in →amoebae (→Cell Multiplication/Fig. 1A), in some trypanosomatids, in ciliates, and in some →microsporidia. The number of spindle →microtubules and filaments varies between genera. In some genera (e.g., *Ichthyophthirius*) the spindle poles lead to minute protuberances of the typical nuclear envelope.

→Crypto-pleuromitosis occurs in diplomonadids, →trichomonads, and some trypanosomatids, and is characteristic of sporozoans. A very basic type of cryptopleuromitosis is found in diplomonadids, trichomonads, and some trypanosomes, where complete extranuclear spindles are formed that run along the nuclear surface (sometimes in grooves or channels; Figs. 1, 5D). These spindles may contain numerous microtubules (→Diplomonadida, →Trichomonadida; Fig. 5D) or only few (Trypanosomatida). In the latter case, this extranuclear spindle apparatus occurs in addition to a centrally situated intranuclear one. In some species (e.g., some →*Crithidia* spp.) the extranuclear microtubules are even lacking. In all groups of →Sporozoa, cryptopleuromitosis occurs; in →gregarines and the classic

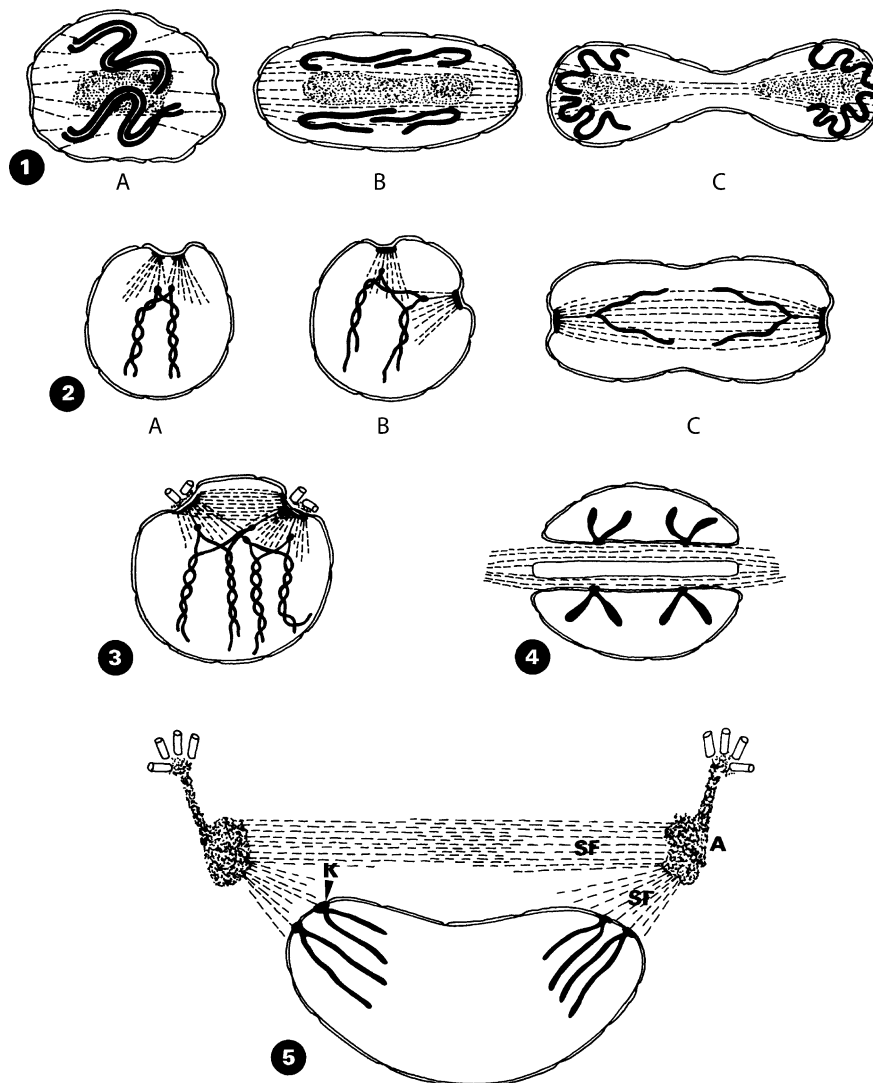

**Nuclear Division.** **Figure 1** Diagrammatic representation of different forms of  $\rightarrow$ mitosis in protozoans (according to de Puytorac et al. 1987). **1** Intranuclear  $\rightarrow$ orthomitosis in 3 steps (a–c). **2** Intranuclear  $\rightarrow$ pleuromitosis in 3 steps. **3** Intranuclear  $\rightarrow$ pleuromitosis with halfspindles and extranuclear centrioles. **4**  $\rightarrow$ Cryptomitosis with spindles in a channel running through the nucleus. **5** Cryptopluromitosis. The spindle tubules (SF) stretch between 2 attractophores (A) and the kinetochores (K) of the surface of the nucleus.

$\rightarrow$ coccidia (e.g., Eimeriidea) divisions of this type are orientated by the appearance and duplication of extranuclear kinetic centres (Figs. 2–4, 5B,C). These structures are non-typical  $\rightarrow$ centrioles since they consist of only 9 single peripheral microtubules surrounding a single central one (Fig. 5A). Such centrioles appear in pairs close to evaginations ( $\rightarrow$ Centrocones, Figs. 2, 5A) of the nuclear membranes. At these places the gap between the nuclear membranes may be larger than usual and filled with longitudinally directed filaments (Fig. 2). Typical gregarines and eimeridean coccidia possess fully developed spindles and are thus provided

with 2 symmetric spindle halves consisting of microtubules and microfilaments (Fig. 3). In  $\rightarrow$ Plasmodium spp.,  $\rightarrow$ Hepatozoon spp., and  $\rightarrow$ piroplasms ( $\rightarrow$ Theileria spp.,  $\rightarrow$ Babesia spp.) independent half-spindles are also found in the nuclei of some developmental stages which start a phase of quick nuclear divisions (e.g., oocysts, sporonts; Figs. 2–5). The tips of these half-spindles when seen with the electron microscope appear to be anchored at densifications on the inner side of the inner nuclear membrane. In these cases outer centriole-like structures are absent. Preliminary studies have shown that these protozoan spindles are apparently

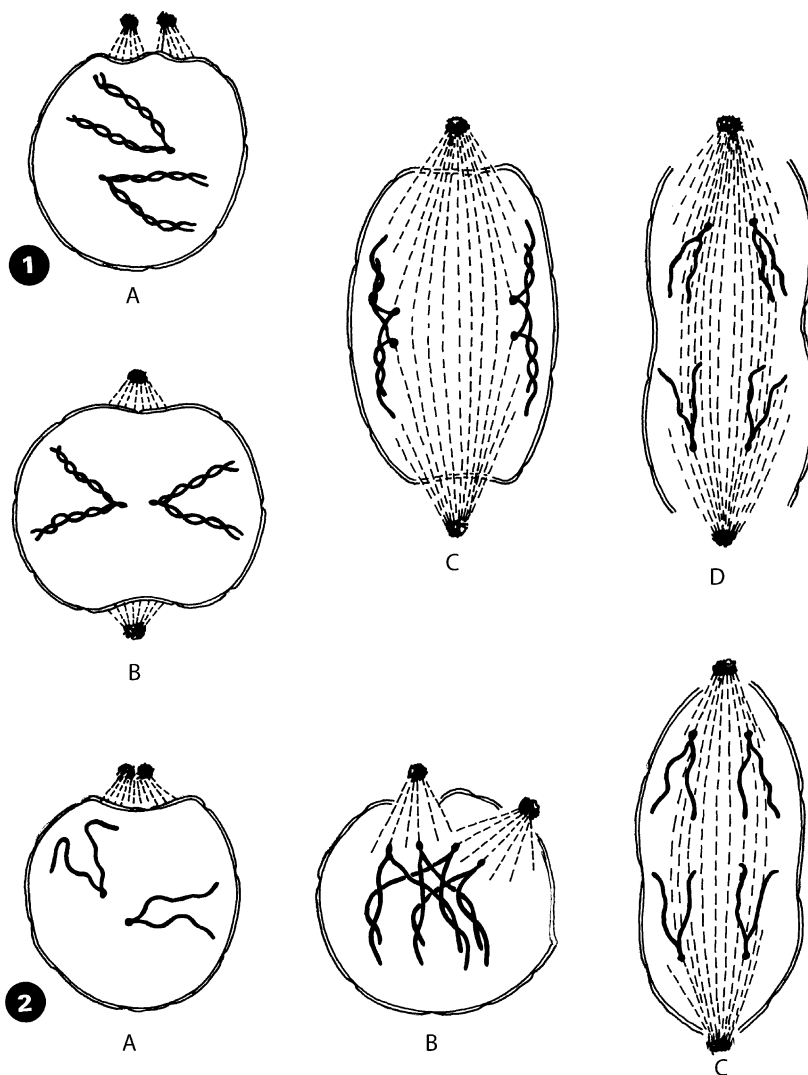

**Nuclear Division.** Figure 2 Diagrammatic representation of the so-called half-open mitosis with extranuclear organization centres (chromosomes: black; spindle: dotted; nuclear membrane: double). 1A–D Half-open orthomitosis. 2A–C Half-open pleuromitosis. In the final stages (C, D) both types of mitosis resemble each other.

regulated by mechanisms similar to those of metazoans and that their action can be stopped by the same cytostatic drugs.

## Nucleic Acids

### Protozoa

Analysis of the genomes of parasites have resulted in an enormous amount of information on the organization and structure of genes and has provided significant

improvements in our understanding of the metabolic capabilities of these organisms. The nuclear genomes of parasitic protozoa are relatively small, generally ranging between 10 and 100 megabase pairs (Mbp) and thus about 50–100 times less than those of mammalian cells and 10 times larger than those of the bacterial genome. The number of chromosomes can show considerable differences among species, with *Theileria parva* containing only 4 and *Plasmodium falciparum* containing 14 chromosomes. Typical features of the protozoan chromosomes are their organization into conserved core domains and variable ends, and their considerable plasticity with extensive size variations. Whether the high frequencies of DNA rearrangements

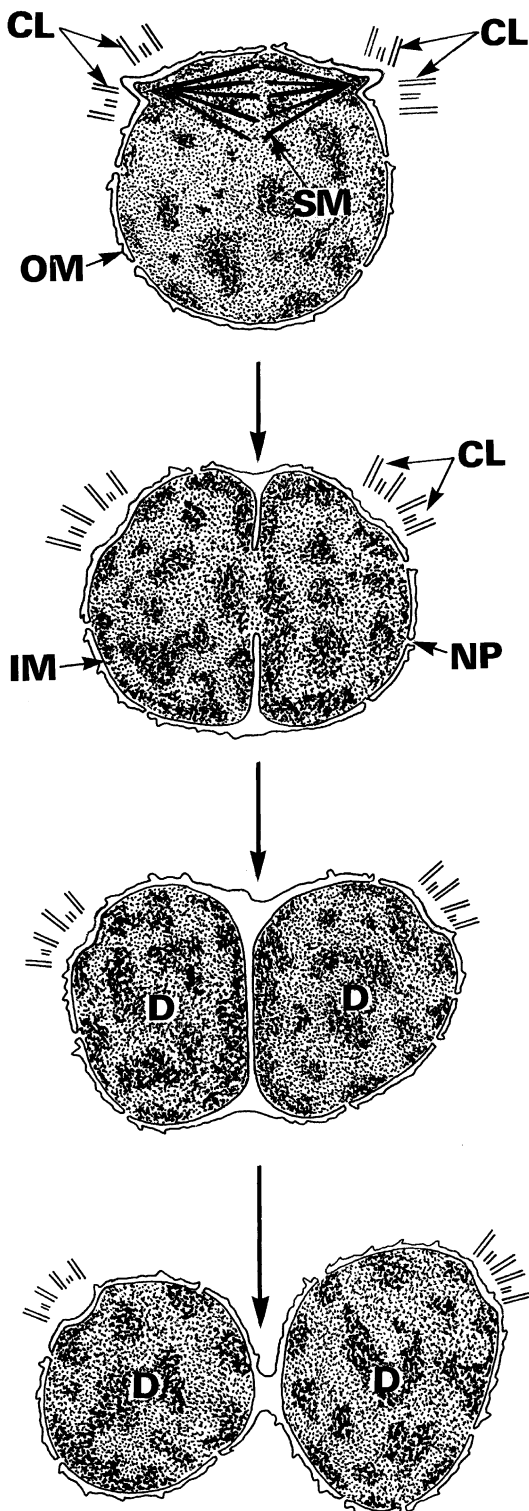

**Nuclear Division.** Figure 3 Nuclear division by constriction in eimerian coccidia. CL, →centriole-like organelle (9 + 1 microtubules) in longitudinal section; D, daughter nucleus; IM, inner nuclear membrane; OM, outer nuclear membrane; NP, nuclear pore; SM, spindle microtubules

are related to the specific adaptive capabilities of protozoan parasites, such as surface antigenic variation, is not yet known. The haploid nuclear genome sizes of *T. parva*, *Cryptosporidium parvum*, *P. falciparum*, *Entamoeba histolytica* and *Trypanosoma brucei* are 8.3, 9.1, 22.9, 23.8, and 26.1 Mbp in length, respectively, with predicted genes varying between 5,000 for *C. parvum* and 10,000 for *P. falciparum*. Only 5 genes of the *C. parvum* genome possess introns, while almost three-quarter of the *T. parva* genes are predicted to contain introns. The composition of the standard bases, expressed as the mole percentage of deoxyguanosine and deoxycytidine (G + C) varies greatly and differs from that of mammalian cells. While *Giardia* and trypanosomatids contain comparatively large amounts of G + C, some *Plasmodium* spp. (*P. falciparum*, 19.4%) have the lowest G + C content of any known class of organisms. Some protozoan species possess an unusual base composition in their DNA. For example, the hypermodified pyrimidine base  $\beta$ -D-glucosyl-hydroxymethyluracil (also termed base J) of kinetoplasts is found predominantly in repetitive DNA sequences where it replaces a fraction of thymidine. In bloodstream form *T. brucei*, the novel modified base may be involved in the transcriptional repression of variant surface glycoprotein gene expression sites and thus antigenic variation. Another example is the hypermethylated cap structure present in kinetoplastid spliced leader RNA (SL) to be utilized in trans-splicing. As in other eukaryotes, protozoa contain repetitive DNA elements within their genomic DNA, whose proportion can vary greatly between different species. Horizontal transfer of genes of bacterial origin has contributed to some of the unique metabolic features observed in protozoan parasites.

Common to other eukaryotes is also the presence in parasitic protozoa of mitochondrial DNA (mtDNA). Usually this DNA differs in base composition, is not associated with histones, and occurs as a circular duplex. Like mtDNA from all other organisms, mtDNA of protozoa codes for mitochondrial tRNAs, rRNAs, and a few mitochondrial proteins. In the protozoan species investigated, the size of mtDNA is larger than the 5–6  $\mu$ m mtDNA rings found in higher animals. In *Plasmodium* spp. and other apicomplexans the putative mitochondrial genome is a tandemly repeated 6 kb element. This unusual small genome contains 3 mitochondrial protein coding genes (cytochrome oxidase subunit I and III and apocytochrome *b*) and highly fragmented large and small subunit rRNAs. Most of the rDNA regions produce abundant small transcripts with strongly conserved portions of conventional rRNAs, suggesting that these fragments are able to associate into functional ribosomes. The unusual form of DNA contained within the single mitochondrion of kinetoplastid flagellates (kinetoplast

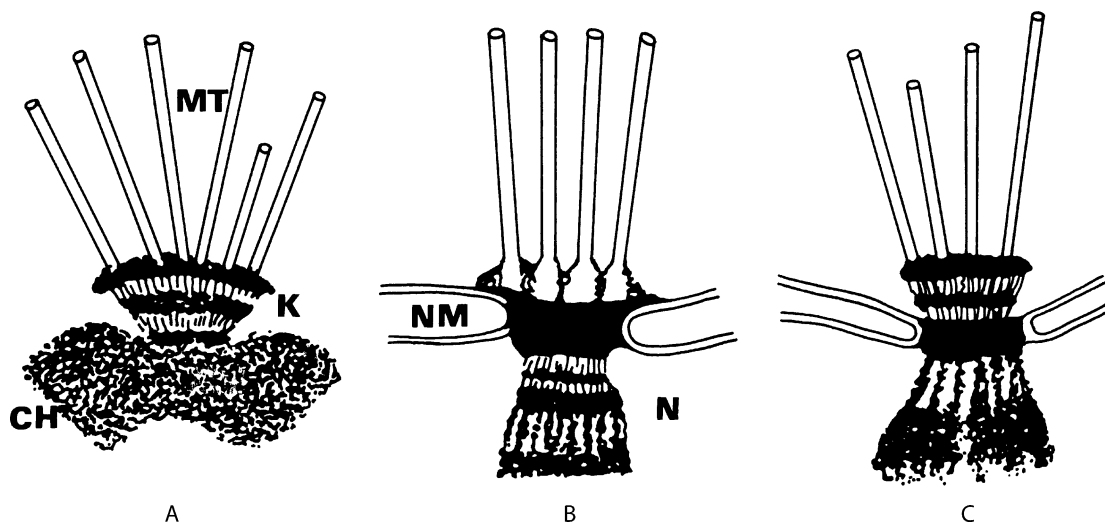

**Nuclear Division. Figure 4** Diagrammatic representation of kinetochores. **A** Types at free chromosomes. **B, C** Types at which the kinetochores are anchored at the nuclear membrane. **B** = *Trichonympha* sp., **C** = *Trichomonas vaginalis*. **CH**, →chromosome; **K**, →kinetochor (centromer); **MI**, microtubule; **N**, interior of nucleus.

DNA) is the most extensively studied protozoan mtDNA and, therefore, is discussed separately.

In addition to mtDNA, in most apicomplexan parasites extranuclear DNA is contained in the form of a 35 kb circular element within an unusual organelle, termed apicoplast, that plays an essential role in metabolism. The small genome resembles the plastid DNA of nonphotosynthetic plants and appears to have been acquired by secondary endosymbiosis of an alga. A 35-kbp apicoplast genome encoding 30 proteins, rRNAs, and tRNAs is present in *Plasmodium*, *Toxoplasma*, and *Eimeria*, but is lacking in *Cryptosporidium*. The *T. parva* apicoplast genome differs from that of other apicomplexans in that it is larger (39.5 kbp) and that all of its genes are transcribed in the same direction. There is no evidence for the general occurrence of nucleic acids in organelles such as hydrogenosomes, glycosomes and mitosomes, although recent data have indicated the presence of DNA within the hydrogenosomes of the anaerobic ciliate *Nyctotherus ovalis* which resides in the hindgut of cockroaches.

Relatively little is known about the mechanism of nuclear DNA and RNA synthesis in protozoan parasites. It is suggested that the major steps in the very complex process of DNA replication are similar to those of other eukaryotic organisms. DNA polymerases were found to be different from the corresponding mammalian enzymes in their utilization of synthetic template-initiator complexes and inhibitory properties toward polymerase inhibitors. The base composition of ribosomal RNA is typically protozoan (35–37% G + C) and thus differs from that found in other eukaryotes. The basal transcriptional machinery of most protozoan

parasite species appears to resemble that of other eukaryotes. In kinetoplastid genomes, the organization of protein-coding genes into long, polycistronic clusters and lack of general transcription factors require transcription mechanisms distinct from those operating in other eukaryotes. Pre-mRNAs in these protozoans become translatable mRNAs only after the addition of a 5' end capped SL and a 3' polyadenylated tail. mRNAs and the SL are transcribed by RNA polymerase II, but there are no consensus TATA boxes or other *cis*-acting elements characteristic of protein-encoding gene promoters in other eukaryotes. A novel feature not encountered in other eukaryotes is that trypanosomes can transcribe also protein-coding genes (e.g., VSG and PARP genes) by the  $\alpha$ -amanitin-resistant RNA pol I, whereas in other organisms this enzyme is responsible only for rRNA gene expression.

## Helminths

There is no evidence for a remarkable base composition or genomic organization of nuclear and mitochondrial DNA in helminths. Their haploid genome size does not exceed about 300 Mbp and their G + C content varies from 43% to 47%, a range similar to that of other invertebrates and of mammals. However, the amount of total nuclear DNA present in these organisms can vary considerably, depending on the degree of polyploidy. Interestingly, the genome size of helminths is much larger than that of their free-living relatives which may be related to the complex morphological and biochemical changes occurring during their developmental cycles. In some nematodes, chromatin diminution

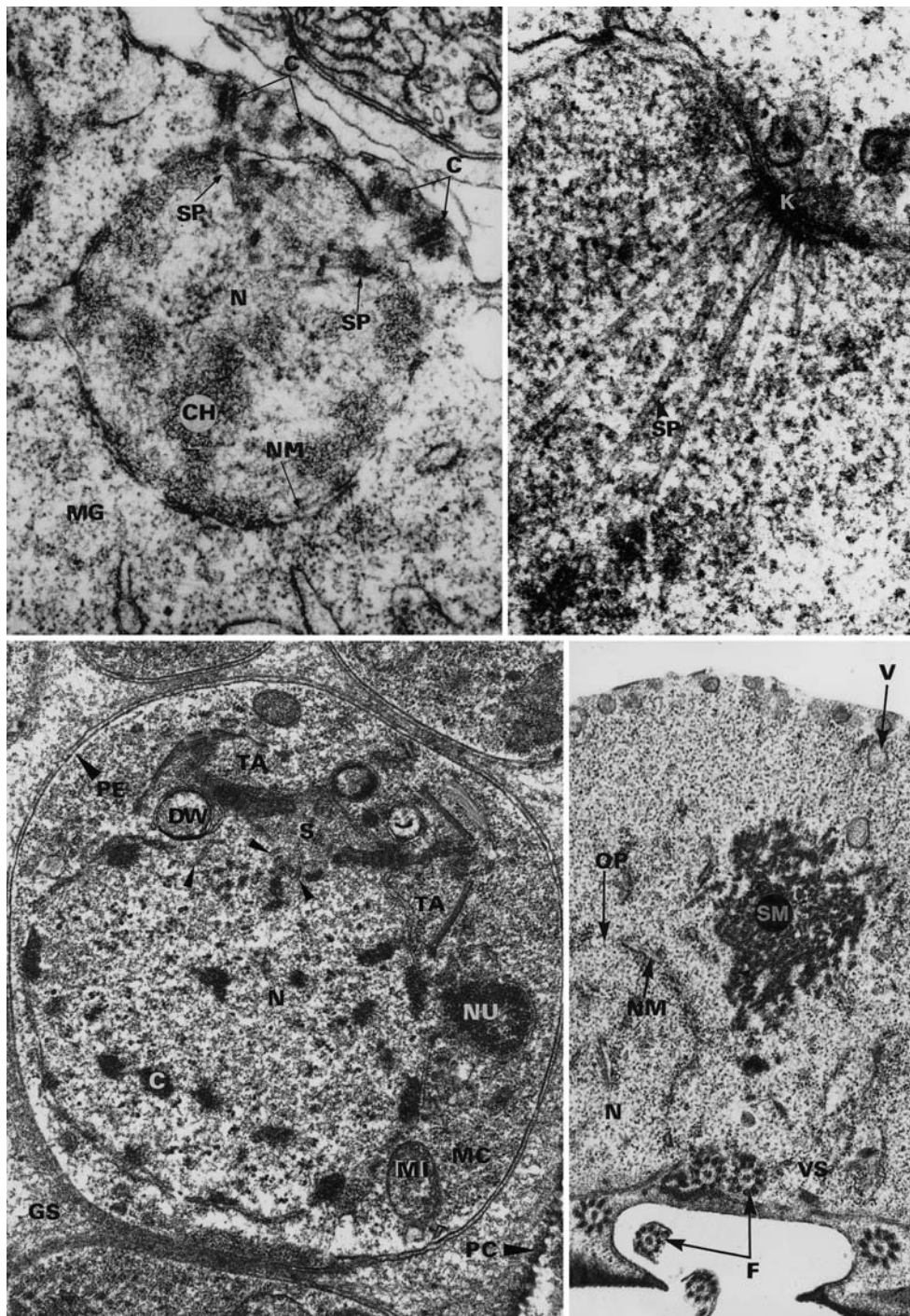

**Nuclear Division. Figure 5** TEMs of spindle-apparatus in dividing nuclei. **A** Cryptopleuromitosis of Eimerian schizonts and →microgamonts. At the spindle poles (outside the nucleus) two coccidian centrioles (C) are situated (cf. Fig. 3). (× 45,000). **B** *Nosema* sp. (Microsporidia). The half-spindle and the kinetochor are anchored at the inner nuclear membrane (× 70,000). **C** Inside this metrocyte from a →tissue cyst of →*Sarcocystis bovis* hominis (cycle man-cattle) →endodyogeny starts. The nucleus shows an initial crypto-pleuromitosis with a striated spindle. The chromosomes are not completely condensed. The arrows indicate the kinetochores. Note the presence of the double-walled organelle (DW) (→Apicoplast) in the rather young daughter cell-anlagen (× 15,000). **D** →*Giardia lamblia*. The spindle microtubules (SM) occur between the nuclei, the membranes of which show large openings (OP) (× 15,000). C, →centriole; CH, chromosome; DW, double walled vesicle (→Apicoplast); F, flagellum; K, kinetochor; MC, metrocyte; MG, microgamont; MI, mitochondrion; N, nucleus; NM, nuclear membrane; NU, →nucleolus; OP, opening; PC, →primary cyst wall; S, spindle; SM, spindle microtubules; SP, spindle pole; TA, daughter cell anlagen; V, vacuole; VS, ventral side.



results in a different content of DNA between germline and somatic cell lineages. In *Ascaris suum*, approximately one-fourth of the total nuclear DNA is eliminated by this complex mechanism of developmentally programmed DNA rearrangement. In addition to some single copy genes, including those encoding tubulin and ribosomal proteins, satellite DNA is the predominant target for this unique DNA elimination process. Like the DNA of other eukaryotes, helminth DNA is highly repetitive ranging from 14% to 50%. The haploid genome of *Brughia malayi* contains a 322-bp fragment repeated 30,000 times accounting for approximately half of the amount of repetitive DNA in this organism. Mitochondrial genes in nematodes and trematodes show a strong tendency to unusual tRNA structure and alternative initiation codons among these groups. Like DNA, the various RNA species of helminths do not seem to exhibit unusual properties. The synthesis of nucleic acids in helminths seem to follow the pattern established for other eukaryotes.

---

## Nucleolus

Within the [→nucleus](#) the nucleolus is the site of synthesis of the large RNAs (28S, 18S, and 5.8S) and of the precursors of the ribosomes. It has 2 zones; one is composed of filaments 5–8 nm in width and the other is composed of granules 15–20 nm in width ([→Nucleus/ Fig. 2](#)). The granular zone is situated at the periphery of the nucleolus. There is usually only one nucleolus but there may be several in some species and in certain developmental stages of other species. During [→nuclear division](#) the nucleoli are often dissolved and the [→chromosomes](#) may condense and become visible (e.g., in ciliates) or they may remain stretched out and invisible (e.g., in the eimerians, the haemosporidians, and the [→piroplasms](#).) The nucleoli are newly formed during the telophase of the nuclear division; this occurs at secondary constrictions of satellite chromosomes, which are thus described as nucleolus organisation regions (NOR).

---

## Nucleus

[→Protozoa](#) are eukaryotes and thus possess at least one well developed nucleus that is usually spherical to ovoid ([→Endocytosis/ Fig. 1A](#), [→Merozoite/ Fig. 1,](#)

[→Pellicle/ Fig. 1A,B](#), [→Trypanosoma/ Fig. 5](#)) and enclosed by a double-layered membrane containing pores (Fig. 3). The pores are *c.* 50–70 nm in diameter with a central opening formed of 8 subunits (Fig. 1A–D). When viewed by light microscopy, the nuclei may appear vesicular or compact. The karyoplasm is composed of structural and enzymatic proteins; the chromatin (DNA) which may be organized into [→chromosomes](#) and the [→nucleolus](#) (Fig. 2). No membranes exist within the nucleus. There is usually only one nucleolus but there may be several in some species and in certain developmental stages of other species. The nuclear membranes are retained in the Protozoa during division and separation of the chromosomes is carried out by a spindle apparatus, the appearance, arrangement, and placement of which is species-specific (cf. [→Nuclear Division](#)). The apparatus always consists of [→microtubules](#) and filaments. In ciliates, 2 morphologically distinct nuclei occur: a generative [→micronucleus](#) and a somatic [→macronucleus](#) ([→Ciliophora](#)). In other parasitic species and in some specific stages such as the [→meronts](#), sporonts, and gamonts of the [→coccidia](#) and [→Haemosporidia](#) and [→Microsporidia](#) ([→Pellicle/ Fig. 1B](#)), there may be 2 up to many nuclei, all of which may have similar a appearance. Morphologically similar nuclei may have similar functions or different functions, as in the Myxosporidia. During binary division the karyoplasm is usually completely distributed between the two daughter nuclei. In some cases, e.g., during the formation of [→microgametes](#) in some Coccidia, only one functional nucleus is produced and a part of the nucleus is left behind (Fig. 1A). The nuclei of metazoans are structured according to the same plan as those of protozoans.

---

## Nurse Cells

*Trichinella* larvae transform their host cells to act as nurse cells. Very often these cells are additionally surrounded by a net (rete) of blood capillaries. [→Nematodes](#), [→Trichinella](#).

---

## Nutall, Georg Henry Falkimer (1862–1937)

American entomologist and discoverer of many vector-transmitted diseases.

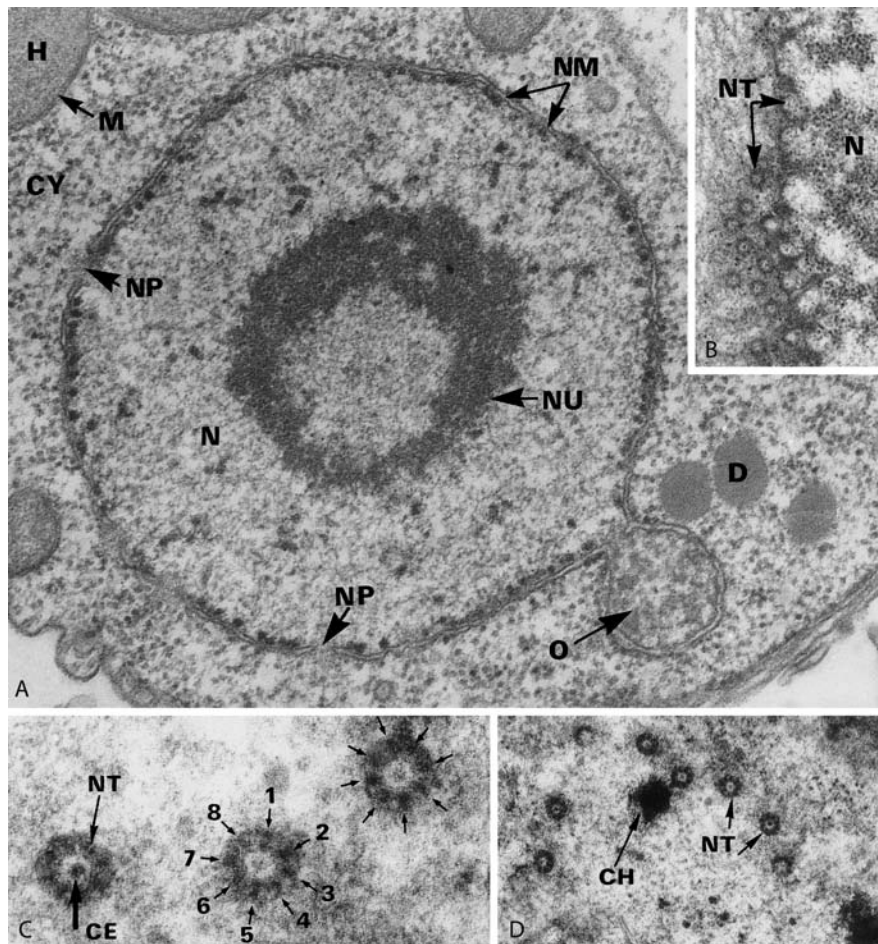

**Nucleus.** Figure 1 A–D TEMs showing fine structure of protozoan nuclei. **A** A “vesicular”-appearing nucleus, e.g., → *Trichomonas vaginalis* ( $\times 60,000$ ). **B** Nucleus with condensed centrally arranged chromatin, e.g., the gregarine → *Gonospora beloneides* ( $\times 30,000$ ). **C, D** → *Sarcocystis bovihominis*, tangentially cut nuclear pores show 8 outer elements and a central dense core. (**C**  $\times 90,000$ , **D**  $\times 35,000$ ). *CE*, central element; *CH*, → chromosome; *CY*, → cytoplasm; *D*, dense inclusions; *H*, → hydrogenosome; *M*, membrane; *N*, nuclear contents (karyoplasm); *NM*, nuclear membranes; *NP*, nuclear pore; *NT*, nuclear pore in tangential section; *NU*, nucleolus; *O*, parts being pinched off.

## Nutrition of Endoparasites

### General Information

Like other animals, endoparasites require a supply of nutrients to support their survival and continued growth and reproduction. However, in contrast to free-living organisms, all of the parasitic stages of protozoa and helminths are nutritionally dependent on another living organism, the host. The fact that parasites inhabit a wide variety of tissues and organs in both invertebrates and vertebrates and that each parasite is faced with a succession of different environments during its developmental cycle makes their nutritional biochemistry highly complex. Most of the knowledge on this subject has derived from studies on parasites that were

maintained in culture, removed from their intimate and delicately balanced relationship with the host. Not many parasite species can be maintained for long periods of time under strictly defined conditions and only very few can be cultured through their complete developmental and reproductive cycles that require complex media and even living cells. This, together with the cumbersomeness of making single omission tests with media usually containing a large number of different inorganic and organic substances, has not yet resulted in reliable information on the precise spectrum and quantities of compounds required by the various parasite species. Nevertheless, the data obtained from *in vitro* culture work and from biochemical studies on the synthetic abilities of parasites have shown that these organisms have specific dietary requirements. In addition to the universal nutritional substances

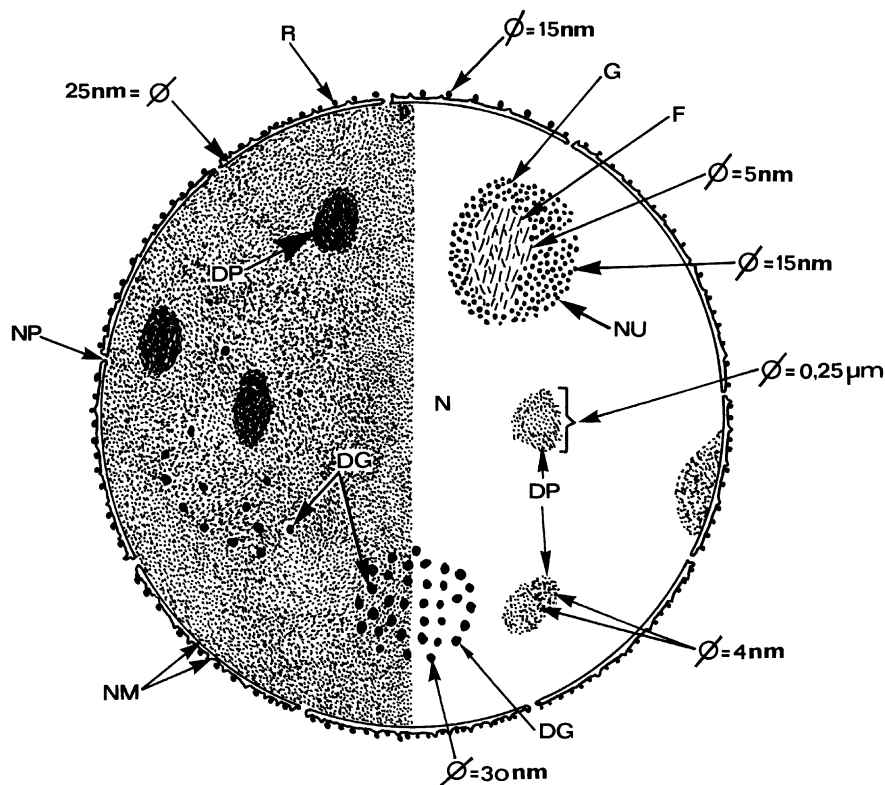

**Nucleus.** Figure 2 Diagrammatic representation of the typical sporozoan nucleus with its contents as seen in electron microscopy after using different cytochemical techniques. *DG*, dense granules (= noncondensed chromosomes in section); *DP*, dense plaques (condensed chromosomes in section); *F*, filaments (pars fibrosa of NU); *G*, granules (pars granulosa of NU); *N*, nucleus; *NM*, nuclear membrane; *NP*, nuclear pore; *NU*, → nucleolus; *R*, ribosome.

(carbohydrates, essential amino acids, vitamins, minerals, and trace elements), these can include purine bases, nucleosides, fatty acids, sterols, and porphyrins. Protozoa and those helminths that possess a digestive tract are also capable of ingesting exogenous macromolecules, in particular proteins, as a source of building-block components (see below). After being absorbed, these incoming nutrients have to be enzymatically hydrolyzed into their constituent amino acids, monosaccharides, nucleotides, or lipid components. Frequently the digestion of exogenous macromolecules may be also possible by enzymes released from the parasite into the surrounding milieu. The resultant hydrolysis products are subsequently absorbed by the parasite via mechanisms discussed below. Since the *in vitro* culture of parasites requires complex media, there is certainly also a need to acquire unusual substances from the host that trigger their growth and differentiation in successive stages of the life cycle. As a consequence of both the limited biosynthetic capabilities and competition with the host for nutrient uptake, endoparasites have elaborated a wide variety of efficient absorptive mechanisms. A relatively slow process is the

movement of molecules by simple diffusion that enables the passage of apolar, lipid-soluble molecules (undissociated fatty acids, hydrophobic drugs). Since all natural membranes are intrinsically impermeable to polar molecules, which constitute the major group of nutrient molecules, only those polar components can pass biological membranes for which transport systems are available (membrane transport). This mechanism is called mediated-transport (or facilitated diffusion) and represents the most common means for the passage of low molecular weight molecules across biological membranes. In many mediated-transport processes metabolic energy is not expended, but they show saturation kinetics and specificity towards a particular compound or group of structurally related compounds. A specialized type of mediated transport is active transport (active mediated transport). This process, like facilitated diffusion, is carried out by distinct transport systems, but takes place against a concentration gradient, and is thus vectorial and energy dependent. Endocytosis, a further mechanism for nutrient uptake, is a way of internalizing molecules from the exogenous fluid, either as solutes (pinocytosis) or as solid particles

(phagocytosis). Following fusion of the food vacuoles with lysosomes, high-molecular weight compounds are hydrolyzed by lysosomal enzymes.

## Protozoa

Detailed studies on the nutritional requirements and absorptive mechanisms of parasitic protozoa have been limited to a few species, primarily the trypanosomatid flagellates and malarial parasites. Most protozoa appear to possess mediated-transport systems located within their cell membranes for the absorption of low molecular weight substances, such as hexoses, amino acids, and nucleosides. On the basis of genome analysis, *Plasmodium falciparum* possesses a relatively limited repertoire of membrane transporters, particularly for uptake of organic nutrients that correlates with the lower percentage of multispinning membrane proteins compared with other eukaryotic organisms. The predicted transport capabilities of *P. falciparum* resemble those of obligate intracellular prokaryotic parasites, which also possess a limited complement of transporters for organic solutes. Genomic analysis of predicted transporters in *Theileria parva* revealed fewer transporters of organic nutrients and inorganic cations than are present in *P. falciparum*. However, *T. parva* has more adenosine 5-triphosphate-binding cassette (ABC) transporters of unknown substrate specificity. Another difference is that *T. parva* encodes an amino acid-cation symporter that is not present in *P. falciparum*. Based on genome analysis it was concluded that *Trichomonas vaginalis* demonstrates a broad range of transport capabilities, facilitated by expansion of particular transporter families, such as those for sugar and amino acids. This parasite also possesses more members of the cation-chloride cotransporter (CCC) family than any other sequenced eukaryote, likely reflecting osmotic changes faced by the parasite in a mucosal environment. The analysis of the complete genomes of *Trypanosoma brucei*, *T. cruzi*, and *Leishmania major* revealed that across these 3 species 633 genes are annotated as transporters or channels. The specificities and kinetics of the transport processes can deviate from those typical of other organisms, but can also vary greatly between different parasite species. Glucose is a preferred substrate for growth of most protozoan parasites, but other hexoses, interconvertible with glucose (mannose, galactose, fructose), can also support the development of these organisms *in vitro*. In both *Leishmania* and *Trypanosoma* spp. proteins are present which seem to be part of the large glucose transporter family. Glucose is the main energy source for *Entamoeba histolytica*; however, in place of the typical eukaryotic glucose transporters those of *E. histolytica* are related to the prokaryote

glucose/ribose porter family, with the amino- and carboxy-terminal domains switched relative to their prokaryotic counterparts.

Nutrient uptake by intracellular protozoans is even more complex than that of other parasites, because they are faced with the problem of obtaining nutrients across 2 cell membranes, their own and that of the host. One possible complication could be that the nutrient-uptake characteristics of the host cell do not allow a sufficient supply of exogenous molecules to satisfy the nutritional requirements of the intracellular parasite. For example, the erythrocyte exhibits a relatively low rate of sugar uptake. It has previously been shown that after invasion of the host's red blood cell, *P. falciparum* alters the structure of the erythrocyte and that after invasion by the malaria parasite new high-capacity permeation pathways are formed that mediate the transport of a wide variety of small solutes. A tubovesicular membrane network extending from the parasite vacuole membrane probably also plays a central role in the movement of nutrients into and waste products out of the cell.

## Amino Acids

For the acquisition of amino acids, parasitic protozoa utilize 2 entirely different principles. One mechanism involves the translocation of exogenous amino acids directly across the membrane, while the other way is accomplished by endocytosis of exogenous protein and its subsequent digestion by hydrolytic enzymes to yield free amino acids. Absorption of amino acids by protozoa occurs primarily by mediated processes, although diffusion components may contribute substantially to the overall rate of uptake of these substrates. A peculiarity of amino acid transport by trypanosomatids concerns the absorption of threonine. Intracellular accumulation of this amino acid, which has been shown to be an important precursor for lipid synthesis in trypanosomes, occurs against a concentration gradient. Another feature of the bloodstream forms of *T. brucei* is that they possess a specific carrier-mediated transport system for the absorption of ethanolamine. The major use of this compound in the bloodstream trypanosome stages is in the architecture of the variant surface glycoproteins where it serves for an unusual linkage to the anchoring C-terminal phospholipo-oligosaccharide structure. Malarial parasites also have the capacity to take up free amino acids from the external environment. Accelerated incorporation of amino acids, but also other nutrient molecules, by *Plasmodium*-infected red blood cells, as compared with uninfected cells, seems to be a general feature of the malarial parasite-erythrocyte system, since this phenomenon has been observed with *P. falciparum* and *P. berghei*.

## Proteins

Besides free amino acids, proteins are also taken up intact and then degraded. During intraerythrocytic growth and multiplication, host erythrocyte hemoglobin (the most abundant reservoir of amino acids available for malarial parasites) is the major source of exogenous amino acids for this parasite. Incorporation of hemoglobin occurs by endocytosis via the special ingestive organelle, the cytostome, which can be formed at any region of the parasite's surface. This process results in the formation of food vesicles into which lysosomal enzymes, primarily proteinases, are transferred. These enzymes degrade the hemoglobin into its constituent amino acids. Protozoans other than plasmodia (*Babesia* spp., *T. cruzi*) also have cytostomes at which proteins are internalized and used for amino acid production. In several species of trypanosomatids, the flagellar pocket has been identified as the principle site for the uptake of macromolecular nutrients, in particular proteins, by an endocytotic process. This mechanism has been suggested to be more important for nutrient entry than direct transport of solutes across the cell membrane. In other protozoa (*Entamoeba*, *Giardia*) endocytosis may occur over the entire cell surface and might satisfy the major portion of the parasite's growth requirements.

## Nucleotides

The absence of the ability of protozoan parasites to synthesize purine nucleotides *de novo* implies that the growth and multiplication of these organisms depend on their ability to assimilate suitable nucleotide precursor molecules from their host environment. The preferred purine sources and the mechanisms of entry for these substances have been examined only in a few species. Since biological membranes are intrinsically impermeable to electrically charged organic compounds and since the protozoan cell membrane does not possess specific carriers for nucleotide transport, purines and pyrimidines must be acquired in the form of their bases or nucleosides. For many kinetoplastid flagellates adenosine is the most important exogenous source for purine nucleotide synthesis. Once inside the parasite cell, adenosine can be interconverted to all other purine bases and ribonucleotides by active salvage pathways (Metabolism). The high affinity transport system of *T. brucei*, allowing this nucleoside to enter the parasite, resembles that present in certain mammalian cells (erythrocytes, heart muscle cells) which also lack the *de novo* purine biosynthetic pathway. A distinct locus for nucleoside transport is also operative in *Leishmania brasiliensis* promastigotes. In *E. histolytica* 2 carrier-mediated transport systems appear to exist for purine bases and nucleosides, one for adenine-adenosine and the other for adenosine-guanosine. Hypoxanthine is the preferred

purine source for malarial parasites which is transported together with adenosine and inosine via a common carrier system.

## Lipids

Since most protozoa are very restricted in their abilities to synthesize lipids *de novo*, they have an obligatory dietary requirement for at least some sort of these compounds. Unfortunately, research on the mechanisms of lipid uptake into protozoa is a largely neglected field. It is unknown whether carrier-mediated systems exist for fatty acid transport like in the tissues of higher animals, or whether passive diffusion of undissociated fatty acids across the hydrophobic core of the membrane lipid bilayer is the major means of fatty acid uptake by these organisms. In any case, it is assumed that protozoans are able to satisfy their lipid needs by absorbing these substances in a relatively selective way from their environments, where most of them are constantly present.

## Trace Elements

Very little data are available on the requirement of protozoa for vitamins and other trace molecules and trace elements, although dietary deficiencies of various vitamins, in particular those that exhibit a coenzyme function, were found to depress protozoan infections in vertebrate hosts. Most interestingly, of major importance for the nutritional physiology of some protozoan parasites may be the integration of microbes into the economy of the host cell.

A further aspect concerns the question as to how endoparasites can acquire those nutrient molecules whose exogenous supply is below that required by the parasite or which are mainly present in a form not suitable for absorption. Intracellular protozoans, such as plasmodia, have apparently solved this problem by altering the host cell membrane in such a way that entry of various substrates into the parasite cell is greatly accelerated (see above).

## Helminths

Considerable efforts have been undertaken to examine the nutritional requirements and the transport of substrates across the absorptive layers of helminths. However, more detailed analyses on this subject relate only to a very few species. Since cestodes, but also the acanthocephalans, lack a digestive tract, the absorbed nutrients must enter these organisms through the body surface, the syncytial tegument, which resembles the mammalian intestinal brush border. In the remaining 2 major, helminth groups, 2 potential absorptive sites are present, the gut epithelium and the body surface. The relative roles of gut and tegument in the nutrition of

trematodes is not completely clear, but these vary between different species and are dependent on environmental and other conditions. For example, the schistosome in the mammalian host actively ingests blood into the intestinal caeca but also absorbs serum components both transtegumentally and across the gastrodermis.

By contrast, nutrient acquisition by the same parasite *in vitro* is apparently almost exclusively transtegumental. The established concept that entry of water-soluble polar substances in parasitic nematodes occurs almost entirely across the microvillous brush border of the intestine rather than through the cuticle is now questioned. Previously, the third-stage larvae of *Trichinella spiralis* and a few other nematode larval stages were the only exceptions to this general rule. In accordance with the assumed absorptive function of the elaborate subcuticular structures of nematodes, transtegumental substrate movement has been demonstrated for various other members of these helminths, although detailed information on the relative roles of the cuticle and intestine in the site and mechanism of nutrient uptake is still lacking. Filarial worms may, in general, be capable of absorbing low molecular weight substances, such as glucose, amino acids, and nucleosides, through their cuticle. The absorption of low molecular weight solutes across the cuticular-muscular system may also play a significant role for *Ascaris* and other intestinal nematodes. On the other hand, the intestine of parasitic nematodes clearly is a major site for the absorption of nutrients through active transport systems. Generally, nutrient transport into helminths requires substrate interactions with different structures and distribution into several separate compartments, and is therefore an extremely complex, multistep process. For example, the external part of the surface membrane of tapeworms is covered by a network of mucopolysaccharides and glycoproteins, the glycocalyx, which is an integral part of the underlying cell membrane and may interact with substrates destined for absorption. Within the absorptive tissue itself, the tegument, there are 2 additional compartments to consider, the outer anuclear syncytium and the inner cellular region. A further complication in the study of substrate absorption by helminths arises from the fact that solutes can often be taken up through more than one absorptive tissue.

Since ingested macromolecules are major constituents of the diet of trematodes and nematodes, these nutrients have to be enzymatically digested within the lumen of the intestinal tract to prepare them for absorption. The nature and composition of the discharged enzymes vary from species to species, but it is reasonable to assume that all major food components can be hydrolyzed by enzymes to yield their building-block components. In schistosomes, an aspartate proteinase appears to be responsible for the digestion of host hemoglobin, a predominant constituent in the

diet of these parasites. In contrast to *Schistosoma mansoni* where red cells are digested solely in the intestinal lumen, *Fasciola hepatica* degrades its proteins both extra- and intracellularly. Within the intestinal lumen of the latter parasite, a distinct protease is also released that is capable of hydrolyzing proteins which apparently derive from both epithelial cells of the bile duct and erythrocytes. Proteolytic enzymes have also been found in the intestine of a variety of nematodes, as exemplified by the presence of a cathepsin D-like enzyme in blood-feeding nematodes and of various specific peptidases in the intestinal tract of *Ascaris suum*. In addition to proteolytic activities, enzymes capable of hydrolyzing polysaccharides, lipids, and nucleic acids are also operative in the intestinal tract of helminths.

Considerable variation seems to exist in the specificities of the systems facilitating the transport of low molecular weight solutes through helminth's tegumental structures and intestinal epithelia and there is some evidence to suggest that the functional properties of substrate transport are related to the types of habitat selected by each parasite species. The reproductive tissues of *A. suum*, which exhibit a high rate of protein synthesis, actively transport amino acids, whereas in the musculature the entry of these substances is by passive diffusion. Most of the information available on substrate transport into helminths has been obtained from studies of only a few species, *Hymenolepis diminuta* being the best characterized system. Under *in vitro* conditions, glucose, amino acids, purine bases, and nucleosides are readily absorbed through the tegument of cestodes and trematodes and the intestinal epithelium of nematodes. Hexose transport across the tegumental syncytium of *H. diminuta* and *S. mansoni* is stereospecific, Na<sup>+</sup>-coupled, and sensitive to the glucoside, phloridzin. Such a Na<sup>+</sup>-linked transport usually requires the presence of an active Na<sup>+</sup>-extrusion mechanism that generates an electrical potential difference across the plasma membrane. This is accomplished by a specialized enzyme, the Na<sup>+</sup>, K<sup>+</sup>-transporting ATPase, which is localized in the plasma membrane. The arrangement of both the glucose transport and Na<sup>+</sup>-extrusion systems in the tegumental structure of *H. diminuta* appears to resemble that present in the mammalian small intestine, with the transport system localized in the surface brush border membrane, and the cation pump situated in the plasma membrane of the tegumental cell. Both the mammalian and cestode absorptive tissues share a common carrier for glucose and galactose uptake, but the tapeworm cannot actively absorb fructose through its tegumental surface. Hexose transport systems are also functional in the nematode *A. suum*, where glucose, but apparently not galactose, enters through the gut by an energy-linked transport mechanism which is Na<sup>+</sup>-coupled and

phloridzin-sensitive. However, in *F. hepatica* tegumental absorption of glucose appears to proceed via Na<sup>+</sup>-independent passive mediated processes. Amino acid transport in tapeworms, but also other helminths, appears to involve multiple transport loci with overlapping affinities. In *H. diminuta*, several distinct energy-dependent amino acid transport sites appear to be present. Another divergence between cestodes and the mammalian small intestine is that amino acid transport in the parasite is not strictly stereospecific, i.e., often both the l- and d-enantiomers can be actively transported through a common site. In addition, high affinity uptake loci specific for d-amino acids can exist, such as in the protoscolex of *Echinococcus granulosus*. In trematodes, the preferred route for amino acid entry is through the tegument. At least 3 separate active mediated sites appear to exist in schistosomes, while in liver flukes these processes occur by simple diffusion. Transport of purine and pyrimidine bases and their corresponding nucleosides through the tegumental syncytium and gut epithelial layers is also vital for helminths, but has been studied in more detail only in *H. diminuta*. In general, absorption of these substrates seems to occur by a combination of passive diffusion and mediated-transport mechanisms the nature of which is extremely complex. The uptake of lipids from external sources, either as fatty acids or sterols, is a prerequisite for helminths since their capabilities for lipid biosyntheses are rather limited. Generally, parasitic worms seem to display selective mechanisms for the absorption of fatty acids from their environments and incorporate them into various lipid fractions thus establishing a distinct lipid pattern. Whereas undissociated fatty acids may readily diffuse through the membrane lipid bilayer of the absorptive surfaces, dissociated acids may enter the parasite by mediated transport. For instance, the multilaminar membrane of adult schistosomes functions in a way similar to a lipid bilayer with regard to correlation of the lipophilic properties of a compound and its ability to penetrate the tegumental syncytium.

A particularly interesting phenomenon concerns the excessive incorporation of vitamin B<sub>12</sub> by certain helminths (*Diphyllobothrium latum*, *Spirometra mansonioides*), obviously by active transport mechanisms. Although this cyanocobalamin, in the form of different analogues, is required for a few enzymatic reactions known to be important in helminth metabolism, the reason for the existence of such exceptionally high concentrations within the parasite tissues remains unknown.

Endocytotic acquisition of macromolecules does not seem to be a favored process in helminths, like it is in many protozoan parasites. However, uptake of macromolecules has been evolved in some cestodes, such as in the plerocercoid of *Ligula intestinalis* and adult *Schistocephalus solidus*, apparently in response to

nutritional demands for rapid and prolonged growth. In the cysticercus of *Taenia crassiceps*, pinocytotic processes are stimulated by proteins, glucose, and other sources in very much the same way as endocytotic systems in mammals. Like the plasma membrane of protozoan parasites, various digestive enzymes are associated with the surface of the tegumental membrane of platyhelminths, which, following hydrolysis, permit the absorption of otherwise impermeable nutrient molecules. An example is again *H. diminuta*, whose brush border plasma membrane carries distinct enzymes capable of cleaving exogenous sugar phosphates, nucleic acids, and nucleotides to yield free sugars, nucleosides, and inorganic phosphate that all can then be absorbed by the parasite. The suggested close proximity of the membrane-bound tegumental enzymes to the elaborate substrate uptake systems of helminths would guarantee a rapid and efficiently functioning absorption of host-derived nutrient molecules.

---

## Nuttalia

Genus of tick-borne protozoans (→Piroplasmids), which reproduce like *Babesia microti* in red blood cells by quadrupel divisions (→Maltese Cross), sometimes used as synonym to →*Babesia*.

---

## Nuttalliella

Genus of xeric African ticks found in nests of birds and small mammals. *Nuttalliella namaqua* is also found on hyraxes. →Ticks.

---

## Nyctotherus

→Ciliophora.

---

## Nymph

- The last larval stage of an →insect with →hemimetabolous development that differs from the →imago, especially with regard to its size and its incompletely developed wings and reproductive organs.

- The 8-legged larval stage of →Acarina (→Mites and →Ticks).

## Nymphomania

### Nymphal Stages

Clinical symptom in horses infected with →*Trypanosoma equiperdum*, see →Genital System Diseases, Animals and, e.g., →Filariasis, Lymphatic, Tropical.

→Mites.





## Obermeier, Otto (1842–1873)

German physician at the Berlin Charité (founded by Robert Koch), discovered in 1868 the agent of the louseborne relapsing fever. He died in 1873 from a cholera infection during his studies on this topic; he was only 31 years old.

## Ocellus

Single eye, e.g., many dipterans possess 3 of this type just above the antennae.

## OCP

Onchocerciasis Control Programme, →[Onchocerca](#).

## Octomitus

→[Diplomonadida](#).

## Ocular Infection

→[Eye Parasites](#).

## Oculotrema hippopotami

Monogenean species, which is the only one to parasitize a mammalian host (the eye of the hippopotamus) (→[Monogenea](#)).

## Odagmia

→[Diptera](#), →[Filariidae](#).

## Odour-Related Mating Responses

Parasites may lead in male rodents to the excretion of peculiar odours. Females refuse copulation with *Mus musculus* males parasitized by, e.g., the coccidian *Eimeria vermiformis*, the nematode *Heligmosoides polygyrus*, or lice like *Polyplax serrata*. On the other hand other parasites increase the attractivity of infected males (e.g., tick-infested *Mus musculus*). However, also males may refuse infected females (e.g., if the latter are infected with *Plasmodium chabaudi*).

## Oecacta

Subgenus of the genus →[Culicoides](#), with the common European species *C. festivipennis*.

## Oeciacus hirundinis

→[Bugs](#) of swallows, →[Environmental Conditions](#).

## Oedema

Clinical symptom in animals and men due to parasitic infections (→[Alimentary System Diseases](#), →[Clinical Pathology, Animals](#)).

## OEPA

Onchocerciasis elimination program for the Americas.

## Oesophagodontus

Genus of small strongylid worms of horses.

## Oesophagostomosis

### Ruminants

Members of the genus *Oesophagostomum* infect cattle, sheep, and goats. In sheep and goats 2 species are present: *O. columbianum* and *O. venulosum*, the former being considerably more pathogenic. Only one species occurs in cattle: *O. radiatum*. The life cycle involves a sojourn in the mucosa of the intestine and it is during this larval histotropic phase that the genus has its most pathogenic effects. *O. columbianum* and *O. radiatum* infections produce lesions principally in the small intestine, while the other species mainly affect the large intestine (caecum, colon). Third-stage larvae penetrate deep into the mucosa and are enclosed into small nodules (1–2 mm) by a fibroblastic reaction. The fourth moult occurs in these nodules. A strong reaction follows superinfection, and larger nodules are produced (1–2 cm) with retention of L4 in the nodules for long periods.

The signs of oesophagostomosis are anorexia, loss of body weight, diarrhoea, and sometimes oedema. A moderately severe normocytic, normochromic anaemia appears, together with a decrease in plasma protein, mainly albumin. Considerable exudation of tissue fluids and plasma proteins from the intestinal lesions and haemorrhages caused by larval emergence contributes to the hypoproteinaemia and anaemia. This is exacerbated by impaired coagulation. Reduced growth or loss in condition is mainly the result of the interaction between protein effusion into the gut and loss of appetite. Diarrhoea presumably results from the loss of absorption capacity of the colon. It would appear that secondary complications and bacterial migration play important parts in the disease.

### Swine

The 2 common species found in pigs are *O. quadrispinulatum* and *O. dentatum*. Though the parasites

themselves are generally highly prevalent, clinical oesophagostomosis is not common in pigs.

### Therapy

→Nematocidal Drugs, Animals.

## Oesophagostomum

### Name

Greek: *oisophagus* = food channel, *phagein* = eat; Latin: *stoma* = mouth.

### General Information

Genus of *Nematodes*. The whitish, about 15–20 mm long species of this genus are found worldwide in ruminants (e.g., *O. radiatum*, *O. columbianum*) and pigs (e.g., *O. dentatum*, *O. quadrispinulatus*), where they form (as larva 3) typical nodules (Fig. 1). They are morphologically characterized by a typical anterior end and thin-shelled eggs with a few blastomeres (Figs. 2–4). The L<sub>3</sub> is found in the nodules of the small

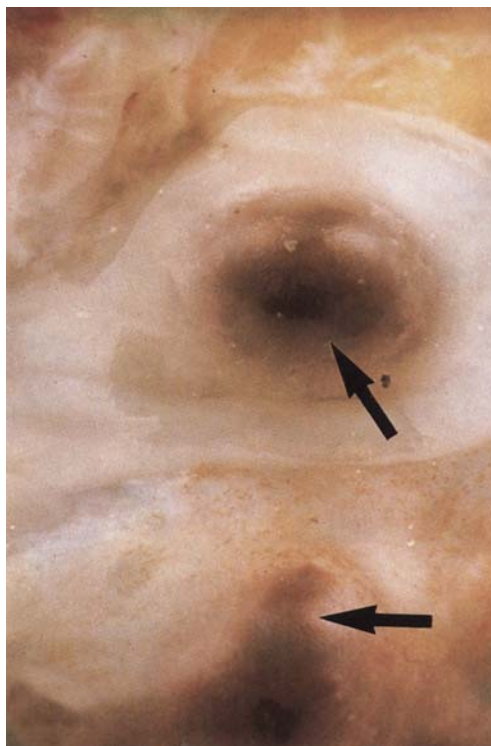

**Oesophagostomum.** Figure 1 Nodules in the rennet-bag of cattle (arrows).

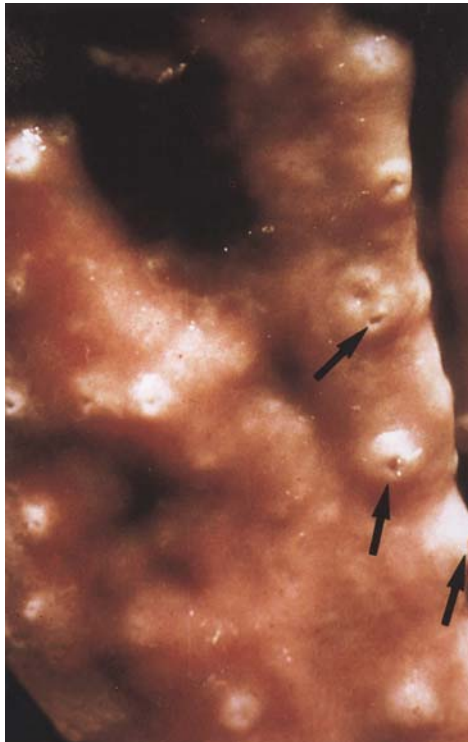

**Oesophagostomum. Figure 2** Nodules in the intestinal wall.

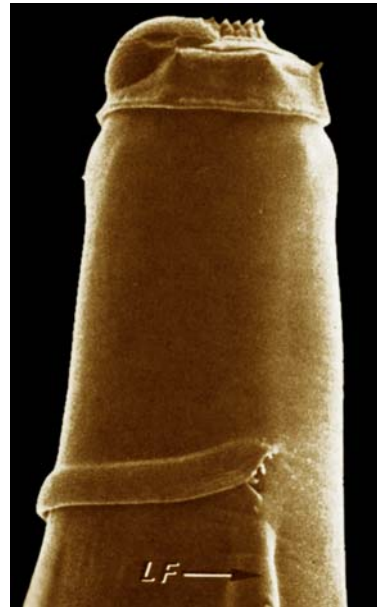

**Oesophagostomum. Figure 4** SEM of the anterior end of an adult. *LF*, lateral wing.

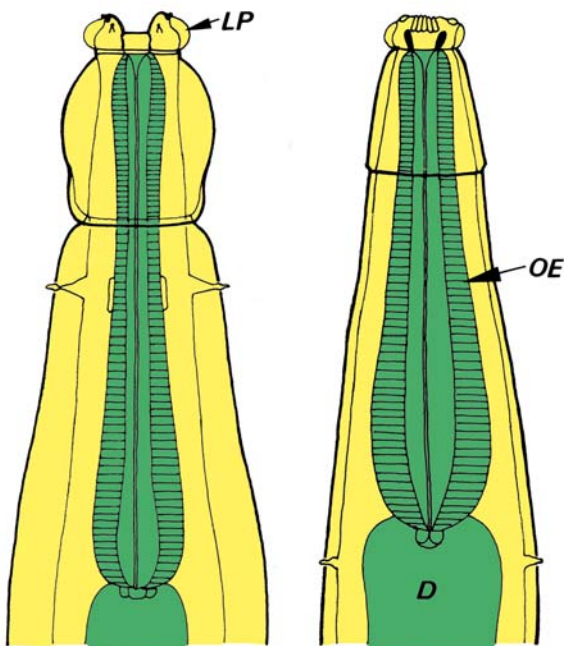

**Oesophagostomum. Figure 3** Anterior ends of adult worms (left: *Oesophagostomum radiatum* of cattle, right: *O. venulosum* of sheep, goat). *D*, intestine; *OE*, esophagus; *LP*, lips.

intestine, caecum or of the colon. Hypobiosis is described. Although they feed only pieces of the intestinal, calcium wall, they introduce a daily blood loss of 0.1 ml/day/worm.

**Prepatent Period**

45 days (*O. columbianum*), 19 days (*O. radiatum*).

**Disease**

→*Oesophagostomosis*, e.g., 250,000 human cases in West Africa, →*Nematocidal drugs*.

---

**Oesophagostomum stephanostomum**

→*Behavior*.

---

**Oestrosis**

Disease due to infestation with →*Oestrus*, see *Table 1*.

**Oestrosis. Table 1** Oestrus and control measurements

Parasite	Host	Symptoms	Country	Therapy		
				Products	Application	Compounds

## Oestrus

### Name

Greek: *oistros* = penetrating fly.

Genus of the dipteran family Oestridae. *Oestrus ovis*, the so-called sheep-, nose-gadfly, is an adult fly about 10–12 mm long (Fig. 1). It is active in Europe from May to August. The adults do not feed; about 12–20 days after copulation the females start to deposit up to 500 larvae, which are placed bomb-like onto the nose/eyes of sheep, but also onto human eyes. The larvae develop inside the nose and later the larvae drop to soil, where pupa-formation and maturation occur within 2–4 weeks; → [Diptera](#).

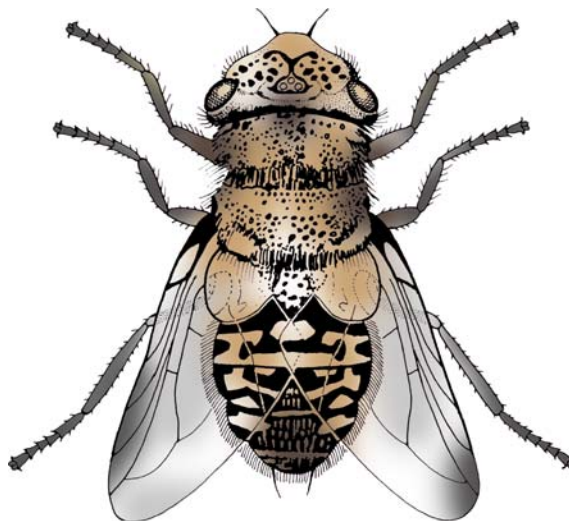

**Oestrus. Figure 1** Diagrammatic representation of an adult female of *Oestrus ovis*.

## Oestrus ovis

→ [Respiratory System Diseases, Ruminants](#).

## Oligacanthorhynchidae

Family of → [Acanthocephala](#).

## Oligoxeny

A parasite species, that is able to use several hosts during its life cycle, is oligoxenous.

## Ollulanus

### Name

Greek: *olla* = pot, jar; *tri* = three and Latin: *cuspis* = thorn.

The name is given with respect to the thorny terminal end of the female worms.

### General Information

The adult stages of *Ollulanus tricuspis* (syn. *O. suis* and *O. skrjabini*) reach a size of about 1 mm (Figs. 1, 2) and parasitize at the stomach wall of cats, dogs, foxes, and pigs. They are transmitted, when their host vomits, they thus are excreted. The new host becomes infected when it feeds on the contents of the stomach of the former host. The **prepatent period** takes about 35 days, the prevalence rate in free-roaming cats is high (up to 40%). The symptoms of **disease** are based often on a severe gastritis, loss of weight, and repeated vomiting. **Diagnosis** is done by artificial induction of vomiting and microscopical investigation (Fig. 2, page 1043).

### Therapy

→ [Nematocidal Drugs](#).

## OLM

Ocular → [larva migrans](#).



**Ollulanus. Figure 1** LM of an adult female of *Ollulanus tricuspis* of cats.

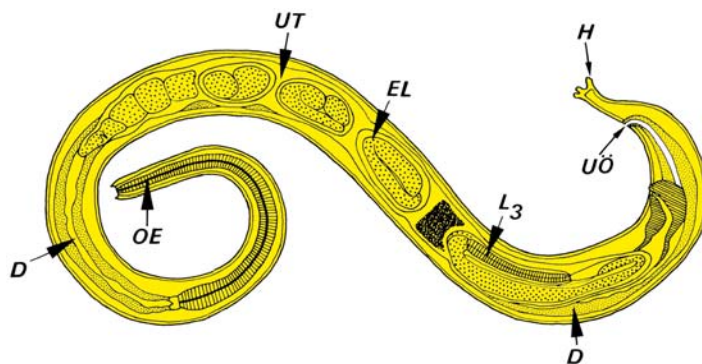

**Ollulanus. Figure 2** DR of an adult female. *D*, intestine; *EL*, eggs (during cleavage); *H*, horn; *L*<sub>3</sub>, larva 3 (in the egg); *OE*, esophagus; *UÖ*, opening of the uterus; *UT*, uterus.

## OMC

→Ovoid Mitochondrial Cytoplasmic Complex.

## Ommatidium

Single eye in the compound eyes of →Arthropoda.

## Omsk Hemorrhagic Fever

### Synonym

OHF.

### General Information

Omsk hemorrhagic fever occurs in Siberia with related diseases possibly occurring in the Ukraine and North Rumania. It is caused by the OHF virus (→*Flavivirus*, group B) and is associated with the tick species *Dermacentor pictus*, →*D. marginatus*, *Ixodes persulcatus*, *I. apronophorus*, and *I. ricinus*. The incubation period is 3–7 days. Frequently, there is atypical bronchopneumonia, hemorrhagic rash, and extensive internal hemorrhage. Mortality rates are 0.5–3%.

## Onchocerca

Genus of filariid nematodes, which are transmitted by biting midges (→*Culicoides*) to horses (e.g., *Onchocerca cervicalis*: male 7–10 cm long, female 50–70 cm): *O. reticulata* (male 15–20 cm long, female 75 cm) and by simuliids to cattle (e.g., *O. gutturosa*: male 2.7 cm long, female 36–40 cm long, *O. lienalis*: male 2.5 cm long, female up to 85 cm). In humans →*O. volvulus* occurs and is transmitted by simuliids. In all cases the unsheathed L<sub>1</sub> microfilariae (→*O. volvulus*/Fig. 2, →*Microfilariae*) occur in the skin. The vectors transmit the L<sub>3</sub> during the biting process. The worm then reaches maturity in about 10–16 months. →*Nematodes*, →*Filariidae*.

## Onchocerca volvulus

### Name

Greek: *onkos* = nodule, *kerkos* = tail.

### Synonym

Nodule worm.

### Geographic Distribution

Central Africa, Yemen, local in Central America.

### Life Cycle

Fig. 1 (page 1045); →*Filariidae*/Fig. 1. Males 4 cm and females up to 70 cm live for 20 years and more in human skin. Often many females lay close together and form

nodules (Figs. 2–5, pages 1046, 1047), within which they are fertilized by the small, wandering males. The females produce unsheathed microfilariae (310 × 6–9 μm), which occur all day long in the skin (Fig. 6, page 1047) and are driven with the lymph fluid to the eyes (→*Eye Parasites*) leading to the so-called River-blindness due to immune reaction after their death. These larvae are taken up by bloodsucking simuliid (→*Simulium* spp.), where they develop into larvae 3 within 6–8 days. The L<sub>3</sub> are transmitted during the next bites. The growing up until maturity needs about 9–14 months. However, symptoms of disease may occur earlier (after 3–4 months). The following symptoms are noted: itching, chronic dermatitis, paper skin, blindness. In South-Central America the disease is called Roble's disease. →*Onchocerciasis*, *Man Eye* →*Eye Parasites*, →*Blackflies*, →*Nematodes*.

### Disease

→*Onchocerciasis*, *Man*, →*Roble's Disease*, →*River Blindness*.

## Onchocerciasis Control Programs (OCP)

This is one of the control programs in Africa which is concentrated on vector control (→*Simulium*), the African programme for Onchocerciasis control (APOC), however, concentrates on chemotherapy, while the program for the Americas (OEPA) employs nodulectomy in addition to chemotherapy (→*Ivermectin*).

## Onchocerciasis, Man

### Synonym

Onchocercosis.

### Pathology

Onchocerciasis is a tissue infection with →*Onchocerca volvulus* transmitted by →*blackflies* (genus →*Simulium*), with microfilariae migrating in the connective tissue. The third or fourth-stage larvae enter with the bite of the fly. Blackfly bites are often identifiable by a small petechial spot, sometimes with blood seepage, surrounded by marked →*inflammatory reaction* and itching, or with a small scab on the surface. The larvae develop subcutaneously and when they become adults they frequently congregate to form subcutaneous →*nodules*.

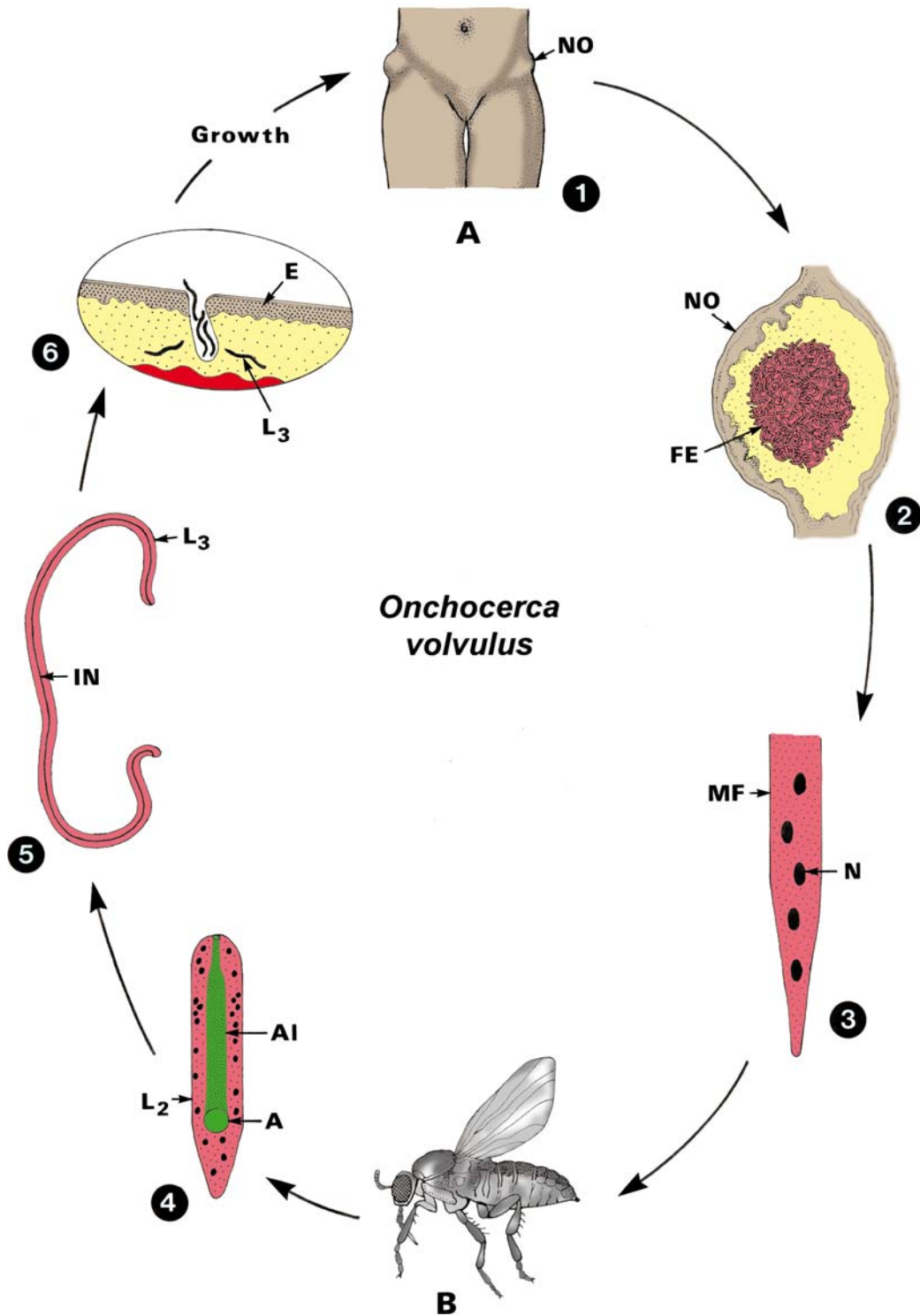

**Onchocerca volvulus. Figure 1** Diagrammatic representation of the life cycle of *Onchocerca volvulus*. A,B Hosts: Humans and *Simulium*. 1 Nodules in skin; 2 section through a skin nodule containing several female worms; 3 Posterior end of microfilariae; 4 Larva 2 in vector; 5 Larva 3 (infectious); 6 Way of entering the skin. A, anus; AI, anlage of intestine; E, epidermis; FE, bundle of females; IN, intestine; L, larva; MF, microfilaria; N, nucleus; NO, nodule.



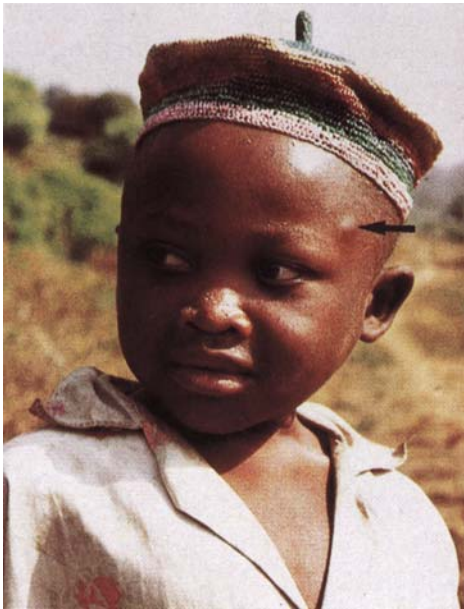

**Onchocerca volvulus.** Figure 2 Boy with small nodule (arrow).



**Onchocerca volvulus.** Figure 3 LM of a bundle of females after experimental digestion of a nodule.

Microscopy shows intertwined worms sometimes surrounded by an eosinophilic coagulate of plasma, suggesting the →[Splendore-Hoeppli phenomenon](#) and separated by connective tissue containing lymphocytes,

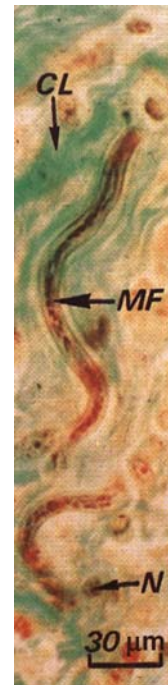

**Onchocerca volvulus.** Figure 4 LM of a section through a region with a microfilaria leaving the surroundings of a nodule.

plasma cells, and eosinophils (→[Pathology/Fig. 18E](#)). The →[microfilariae](#) are born, live and migrate through superficial tissues, especially the skin and the cornea. When they are intact they appear innocuous, but when they die they elicit edema, chronic granulomatous inflammation, and fibrosis. With heavy infections there is marked dermatitis with desquamation. Microabscesses (→[Abscess](#)) or →[granulomas](#) with eosinophils are sometimes found around individual dead microfilariae in the skin. There is a relationship between the number of microfilariae dying and the intensity of the proinflammatory response, and an inverse relationship to specific mechanisms suppressing inflammation. The pathogenesis can be duplicated in an accentuated fashion after an injection of diethylcarbamazine, which kills many of the microfilariae and produces intensified inflammation and itching, followed by desquamation. In Africans and Amerindians the lesions are more benign, but contain more filariae; in Europeans and Yemenites lesions are more inflammatory, although with fewer microfilariae. Onchocercal →[lymphadenitis](#) may give rise to lymphedema with skin swelling and scarring and occasional elephantiasis.

Ocular onchocerciasis results from migrating microfilariae, some of which die in the eye (→[Eye Parasites](#)). This can give rise to punctate keratitis around each dying larva in the cornea, progressing to diffuse sclerosing

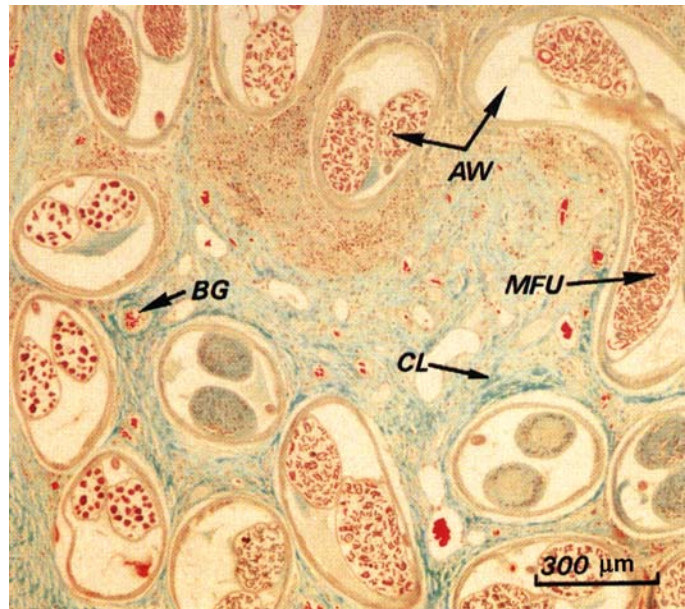

**Onchocerca volvulus. Figure 5** LM of a nodule with several cross-sectioned females. *AW*, adult females; *BG*, blood capillary; *CL*, cartilage; *MFU*, microfilariae in female uterus.

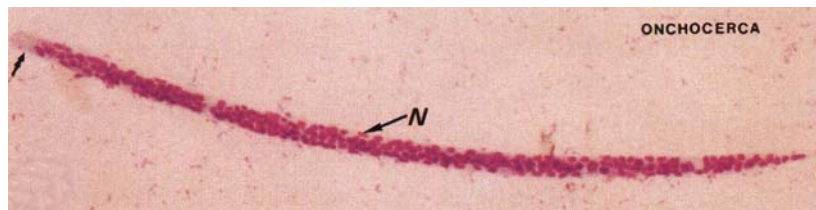

**Onchocerca volvulus. Figure 6** LM of a Giemsa-stained microfilaria from skin. *N*, nucleus.

keratitis with numerous microfilariae, and with the inflammatory reaction followed by vascularization and opacification of the cornea (→[Eye Parasites/Fig. 4](#)). Microfilariae in the anterior chamber give rise to iridocyclitis with a possibility of fibrosis, formation of adhesions, or synechiae, and the development of glaucoma. Microfilariae dying in the retina lead to retinochoroiditis with destruction of retinal cells, and depigmentation alternating with proliferation of the →[pigment epithelium](#). Inflammation of the optic nerve eventually leads to optic atrophy. All of these lesions, especially those in the cornea and retina, impair vision, and sometimes lead to →[blindness](#) (e.g., “→[river blindness](#)”, →[Roble's disease](#)) with heavy or prolonged infections.

**Main clinical symptoms:** Skin nodules, chronic dermatitis, xerodermic →[conjunctivitis](#), keratitis, chorioretinitis, atrophy of the nervus opticus.

**Incubation period:** 3–4 months.

**Prepatent period:** 9–30 months.

**Patent period:** 10–16 years.

**Diagnosis:** Microscopic determination of microfilariae from →[skin-snips](#), serodiagnostic methods.

**Prophylaxis:** Avoid the bite of the vector.

**Therapy:** Treatment see →[Nematocidal Drugs, Man](#).

## Onchocerciasis-Related Epilepsy

Recently it has been found that *Onchocerca*-stages may also induce epilepsy, if stages of pathogenic strains enter the brain and lead to peculiar immune reactions, which are triggered by insomnia due to intensive itching.

## Onchocercosis, Animals

Several species of →*Onchocerca* (→*Filariidae*) occur in horses, donkeys, cattle, sheep, and goats. The adults live in →*nodules* within the connective tissue of the host. The specific location of these nodules depends on the species of *Onchocerca* involved. The adults produce microfilariae which migrate through the connective tissues to the upper dermis. In cattle *O. gibsoni*, *O. dukei*, and *O. ochengi* produces subcutaneous and intradermal nodules in the brisket, and occasionally elsewhere. Infected animals show no other clinical signs. In horses, adult worms live in various ligaments and →*tendons*, and the microfilariae migrate to the dermis. Cutaneous onchocercosis in horses is characterized by pruritis, →*alopecia*, depigmentation, erythema, and crusting. The lesions occur on the face, →*neck*, tail head, and ventral midline. The pathogenicity of microfilariae in horses remains controversial. The lesions may be rather attributed to →*Culicoides* hypersensitivity (Summer Dermatitis or Sweet →*Itch*) which often occurs simultaneously. Ocular lesions such as a periodic ophthalmia are reported.

### Therapy

→*Nematocidal Drugs, Animals*.

## Oncicola canis

Acanthocephalan worm in the intestine of wild carnivores and occasionally in dogs and cats (→*Acanthocephalan Infections*), →*Alimentary System Diseases, Carnivores*.

## Oncicola pomafostomi

→*Acanthocephala*.

## Oncomelania

Genus of snails, intermediate host of important trematodes (e.g., →*Schistosoma japonicum*).

## Oncomiracidium

Larva of →*Monogenea*.

## Oncosphaera

First larva (*Fig. 1*, page 1049) of →*Cestodes*. →*Eucestoda*.

## Oocyst

Stage in the life cycle of →*Coccidia* containing (eventually inside of sporocysts) infectious →*sporozoites*. In fecally transmitted species oocysts are always resistant stages whereas in bite-transmitted groups (e.g., →*Plasmodium*) oocysts are smooth and always located inside the vector.

## Oocytes

Unfertilized female sexual cells of metazoans.

## Oodinium

→*Amyloodinium*, →*Piscinoodinium*, genera of dinoflagellates on the skin of fresh- or saltwater fish.

## Oogamy

→*Coccidia*.

## Oogenotop

Central place of the female reproductive system of platyhelminthic groups where the eggs (→*Cocoon*) become composed (→*Platyhelminthes/Reproductive Organs*).

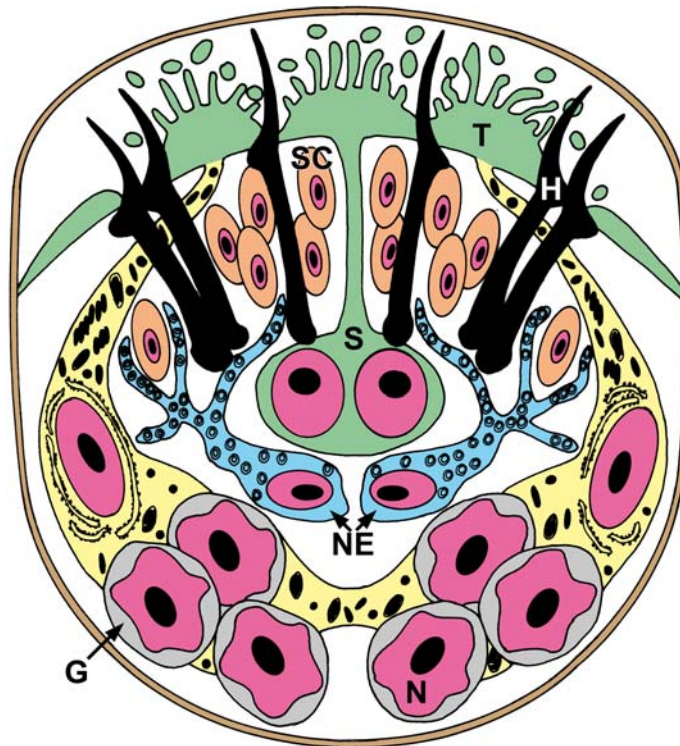

**Oncosphaera. Figure 1** Diagrammatic representation of an oncosphaera showing various cells, which differentiate later into the different tissues. *G*, cells of genital organs; *H*, hooks; *N*, nucleus; *NE*, nerve cells; *S*, *SC*, subtegumental cells (= parenchymal cells); *T*, tegumental cells.

## Ookinete

Diploid stage in the life cycle of [→Plasmodium](#). After fertilization of the [→macrogamete](#) in the gut of the mosquito, the resultant [→zygote](#) quickly elongates ([→Kinete/Fig. 3](#)) and becomes a motile ookinete, which penetrates the peritrophic membrane in the mosquito's gut, migrates through the [→cytoplasm](#) of a gut cell, and begins its transformation into an [→oocyst](#).

## Ootype

Site of egg composition and wall formation in Platyhelminthes ([→Platyhelminthes/Reproductive Organ](#)).

## Opalinata

### Classification

Subphylum of [→Sarcomastigophora](#).

### General Information

These relatively large (up to 1 mm long) [→protozoa](#) are characterized by numerous close rows of short [→flagella](#) which move metachronously. Although these flagella look like [→cilia](#), the basic organization is quite different. Opalinids have 2 to numerous identical nuclei; micro- or macronuclei are always absent. Asexual reproduction occurs by longitudinal-oblique [→binary fission](#) (Figs. 1, 2); in some species, however, additional sexual fusion stages have been reported. In general the opalinids inhabit the colon or [→cloaca](#) of amphibians, reptiles, and fish; their pathogenic effects are low; mostly they feed as commensals on intestinal fluids (by [→pinocytosis](#)). Transmission occurs mainly by oral uptake of [→cysts](#) (Fig. 1).

### System

- Subphylum: Opalinata
  - Class: Opalinata
  - Order: Opalinida
    - Genus: *Opalina* (in frogs)
    - Genus: *Protoopalina* (in fish)
    - Genus: *Cepedea* (in several amphibia)
    - Genus: *Zelleriella* (in *Bufo*)

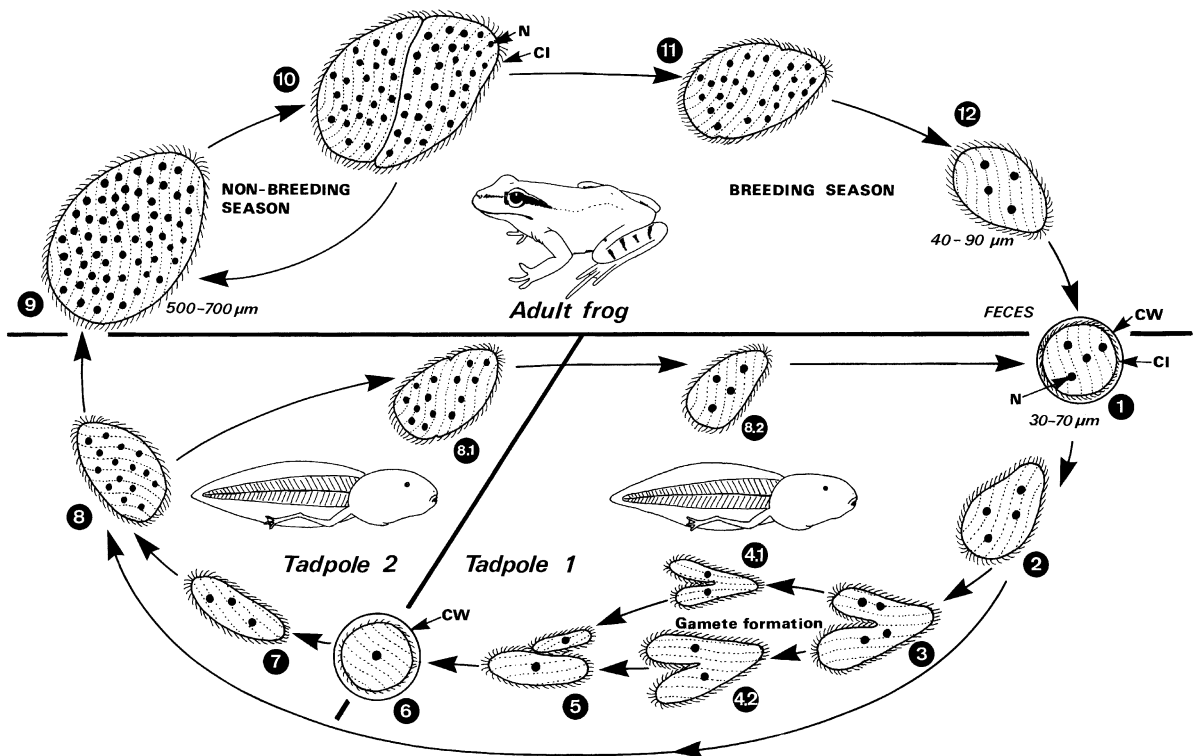

**Opalinata. Figure 1** Life cycle of *Opalina ranarum*. 1 Cysts are excreted by the adult frog and orally ingested by a tadpole. 2 After hatching the young →gamont migrates to the cloaca. 3, 4 Formation of micro- and macrogametes (meiosis). 5 Fusion of the heterogametes. 6 →Encystation of the →zygote and excretion via feces. 7, 8 After oral uptake of a cyst by another tadpole the trophozoite grows up in the cloaca (up to 0.5 mm). 8.1, 8.2 The small trophozoite may start division inside the tadpole, finally leading to formation and excretion of cysts (1) which give rise to new →trophozoites (2 → 8) after ingestion by another tadpole. 9 When →metamorphosis of tadpoles to frogs is completed, the trophozoites (agamonts, trophonts) grow up and form up to 2,000 nuclei. 10 During the nonbreeding season of the frog the trophozoites multiply by binary →fission, the axis of which is either longitudinal or oblique-transverse. 11, 12 During the breeding season hormones released by the frog induce rapid divisions of the trophozoites without compensatory nuclear divisions and growth. Thus the parasites (pre-cystic forms) become successively smaller. These stages, finally having 2–12 nuclei, encyst (1), are set free with the feces of the host, and become infectious for tadpoles. CI, →cilia; CW, →cyst wall; N, nucleus.



**Opalinata. Figure 2** LM of a typically shaped asexual stage of *Opalina ranarum* from the cloaca of frogs.

**Life Cycle**

Figs. 1, 2.

**Operculum**

These are Several meanings:

Opening in the →eggshell that is preformed during the processes of eggshell formation in some platyhelminthic species (e.g., most →Digenea, some →Monogenea, →Heterophyes heterophyes, →Diphyllobothrium); the eggs become operculate; several related species (e.g., schistosomes, →Taenia) have nonoperculate eggs, the wall of which becomes disrupted during hatch of the larva (→Platyhelminthes/Reproductive Organs).

Other meanings are:

1. Cover of eggs of insects, which opens, when larva leaves the egg, e.g., →lice.
2. Plate at the ventral side of mites to cover the sexual opening in some species.
3. Plate at the terminal side of the foot of snails, which may close the shell.
4. Portion of the human brain.
5. Cover of the Bryozoa brood chamber.

---

## Ophionyssus

→Mites.

---

## Ophryocystis

→Gregarines.

---

## Ophyra aenescens

### Synonym

Liquid manure fly or garbage fly.

### General Information

This muscid fly is found in Europe, nearctic, neotropic, and pacific regions, reaching a size of 6 mm and was apparently imported from America. Now it is used for biological control of stable flies (→*Stomoxys*). The *Ophyra* larvae live as predators and may feed up to 20 *Musca* larvae.

---

## Opioids

### General Information

Opioids are small-sized peptide hormones of the endorphin or enkephalin type present both in the brain and the intestinal tract (proenkephalin A also in adrenal cortex) of all vertebrates. The presence of enkephalins in invertebrates was unequivocally demonstrated in a mollusc and a crab and there is also convincing evidence for an endorphin and enkephalins as well as an high-affinity enkephalin binding site in →*Schistosoma mansoni*. This species also produces opiate-like substances

of the morphine and codein type. Both opioids and →opiates have predominantly analgesic and immunomodulatory functions, besides their local activity as paracrine factors in the intestinal tract.

### Pathology

Parasitic infections of mammals are often associated with changes in the endogenous opioid system, but it cannot be decided at the moment whether opioids or opiates from the parasite also contribute to the effects. Infection of the gastrointestinal tract of mice, independently of whether the protozoan *Eimeria vermiformis* or the nematode →*Nippostrongylus brasiliensis* is used, lead to an increase in antinociceptive responses. These responses were blocked by administration of opioid receptor antagonists. In addition to this significant analgesic activity, the levels of infected animals were also reduced and were restored to normal values by application of opioid antagonists. But not all behavioural changes of parasitized mice are mediated via the opioid system: avoidance of predators is less pronounced in parasitized mice but in this case GABA receptors are involved.

---

## Opisthaptor

### Synonym

Ventral sucker or Baer's disc.

### Definition

Posterior holdfast organ of →*Monogenea*. Large hookless holdfast organ which characterizes the plathyelminthic group of →*Aspidogastrea*. In adult worms, it covers nearly the whole of the ventral side.

---

## Opisthoglyphe ranae

Plagiorchid trematode inside the small intestine of *Rana*-frogs.

---

## Opisthorchiasis, Man

→*Clonorchiasis*, an infection with the Chinese liver fluke, and *Opisthorchiasis*, an infection with any of several →*Opisthorchis* spp. are bile duct infections after

ingestion of undercooked fish or crustaceans containing the →*metacercariae*. Luminal infections of the bile duct with a small parasite burden may be asymptomatic (→*Pathology/Fig. 22B*). The worms are attached to the wall of the bile ducts with their 2 suckers giving rise to local inflammation. Large numbers of parasites may introduce heavy biliary obstruction, with resultant jaundice and secondary infection leading to cholangiohepatitis, liver abscesses, cholecystitis, and pancreatitis. The worms survive for 20 years or longer, accompanied by adenomatous →*hyperplasia* of the bile ducts, increased mucus production, and sometimes adenocholangiocarcinoma, usually mucin-producing. In the pancreatic ducts both squamous metaplasia and adenomatous hyperplasia may occur. Eggs pass out of the bile duct and are found in the stools.

**Main clinical symptoms:** →*Abdominal pain*, →*oedema*, →*diarrhoea*, icterus.

**Incubation period:** 2 weeks.

**Prepatent period:** 2–4 weeks.

**Patent period:** 20 years.

**Diagnosis:** Microscopic determination of eggs in faecal samples or PCR – marker for coproscopic analyses.

**Prophylaxis:** Avoid eating raw freshwater fish in endemic regions.

**Therapy:** Treatment: praziquantel, see →*Trematocidal Drugs*.

## Opisthorchis

### Name

Greek: *opisthos* = behind, *orchis* = testis, gonad.

### General Information

→*Clonorchis*, →*Digenea*.

### Classification

Genus of →*Digenea*.

### Important Species

Table 1.

### Distribution

Fig. 1.

**Opisthorchis. Table 1** Important species of the genus *Opisthorchis*

Species	Final host/Habitat	Size of adults (mm)	Size of eggs (µm)	First intermediate host <sup>a</sup>	Second intermediate host <sup>b</sup>	Prepatent period (weeks)
<i>Opisthorchis</i> (= <i>Clonorchis</i> ) <i>sinensis</i>	Humans, fish-eating mammals/ Bile ducts	10–25	15 × 30	<i>Bulimus</i> spp. (= <i>Bithynia</i> spp.)	Fish (cyprinids/salmonids)	2–2.5
<i>O. felineus</i> (= <i>O. tenuicollis</i> )	Humans, fish-eating mammals/ Bile ducts	5–12	11 × 30	<i>Bulimus</i> spp.	Fish (cyprinids/salmonids)	2–3
<i>O. viverrini</i>	Humans, cats/Bile ducts	4–9	15 × 30	<i>Bulimus</i> spp.	Fish (cyprinids)	2–3

<sup>a</sup> Several other species of gastropods may become first intermediate host

<sup>b</sup> There is no reproduction either in the true second intermediate hosts or on water plants

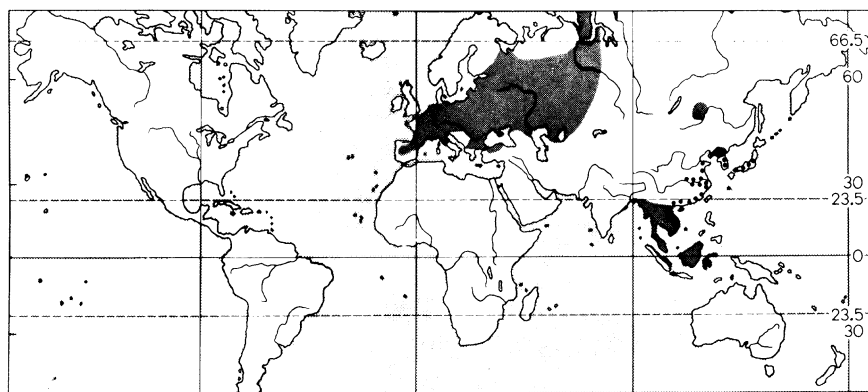

**Opisthorchis. Figure 1** Distribution map of *Opisthorchis felineus* (grey) and *Opisthorchis (Clonorchis) sinensis* (dotted).

**Life Cycle**

→[Digenea](#)/[Fig. 8](#).

**Morphology**

→[Digenea](#)/[Fig. 3](#).

**Diseases**

→[Clonorchiasis](#), →[Opisthorchiasis](#), [Man](#).

**Therapy**

→[Trematocidal Drugs](#).

**Opisthorchis viverrini**

→[Digenea](#).

**Opisthosoma**

→[Acarina](#).

**Opisthotonos**

Symptom (backward bent position) of children with cerebral malaria, which often is mistaken for a sign of tetanus or meningitis.

**Opportunistic Agents**

Those parasites which reach their full pathogenicity only in immunocompromised hosts (e.g., →[AIDS](#) patients, cortisone drug users), while the same parasites lead to no or only to mild clinical symptoms in immunocompetent hosts were considered as opportunists. However, with respect to life cycle only those parasites which have an endogenous reproduction phase in humans, which may give rise to uncontrolled endoautoinvasions, may become opportunists. The most important opportunists in AIDS patients are →[Pneumocystis carinii](#), [Cryptosporidium parvum](#), and →[Toxoplasma gondii](#), which are the main “killers” in American and European AIDS patients comprising of up to 70% of the cases. Other spp., like the following are also found (often together and in large numbers) in such patients: the protozoans →[Giardia lamblia](#), →[Blastocystis hominis](#), →[Naegleria](#)

spp., →[Acanthamoeba](#) spp., →[Entamoeba histolytica](#), →[Isospora belli](#), →[Cyclospora cayetanensis](#), many microsporidian species (→[Microsporidia](#)), →[Balantidium coli](#), the nematode →[Strongyloides stercoralis](#), and the →[mange mites](#) →[Sarcoptes scabiei](#) and →[Demodex folliculorum](#). For more details see →[Opportunistic Agents, Man](#), →[Encephalitozoonosis](#).

**Opportunistic Agents, Man**

Opportunistic infectious agents do not cause obvious symptoms by their presence in immunocompetent individuals, but can proliferate into fulminant infections in immunodeficient or immunocompromised hosts.

→[Immune suppression](#) reactions have increased recently worldwide in humans and animals. This occurs not only due to spreading of virus transmission (inclusive HIV), but also as a result of increasing use of drugs (e.g., cortisone) with immune-decreasing side effects. This deficiency of the immune system enables a broad series of agents – including viruses, bacteria, →[fungi](#) and parasites – to reproduce in a much higher degree than it occurs under normal (i.e., immunocompetent) conditions. Such infections are due to the fact that →[opportunistic agents](#) – especially the parasites →[Pneumocystis carinii](#), →[Cryptosporidium](#) species and →[Toxoplasma gondii](#) are the 3 main reasons for deaths in AIDS-patients. The most common parasites from the recently enlarging group of opportunistic agents are listed in [Table 1](#).

**Related Entry**

→[Opportunistic Agents](#).

**Oral Stylet**

→[Digenea](#), →[Xiphidocercariae](#), →[Nematodes](#).

**Organelle, Double Walled****Synonym**

→[Apicoplast](#), Golgi-adjunct organelle, thick-walled organelle.

Cell organelle which is situated anterior to the nucleus of motile stages of sporozoans (i.e., merozoites,



**Opportunistic Agents, Man. Table 1** Opportunistic agents in immunocompromised humans

Species	Infected organ	Transmission/ stage	Symptoms of disease	Infected humans/deaths per year
→ <i>Blastocystis hominis</i>	Intestine	Oral – cysts	Diarrhoea	30–40 millions/ thousands
→ <i>Pneumocystis carinii</i>	Lung	Inhalation – cysts	Pneumonia	400 millions/ 100 thousands
→ <i>Giardia lamblia</i>	Intestine	Oral – cysts	Diarrhoea	450 millions/thousands
→ <i>Leishmania</i> spp.	Skin, inner organs, generalizing	Bite of sand flies	General destruction of organs	15 millions/thousands
→ <i>Entamoeba histolytica</i>	Intestine, liver	Oral – cysts	Diarrhoea, abscess	500 millions/thousands
→ <i>Naegleria</i> spp.	Liquor, ZNS	Via nose – at bathing	Encephalitis, PAME	Thousands/few
→ <i>Acanthamoeba</i> spp.	ZNS, liquor	Via nose – at bathing	Encephalitis, destruction of cornea	100 thousands/ thousands
→ <i>Isospora belli</i>	Intestine	Oral – oocysts	Diarrhoea	100 thousands/ thousands
→ <i>Cryptosporidium parvum</i>	Intestine	Oral – oocysts	Diarrhoea	40 millions/100 thousands
→ <i>Toxoplasma gondii</i>	ZNS, generalizing	Oral – oocysts, meat	Cerebral destruction	50–60 millions/100 thousands
→ <i>Cyclospora</i> spp.	Intestine, generalizing	Oral – oocysts	Diarrhoea	Thousands/few
→ <i>Microspora</i> (e.g., → <i>Encephalitozoon</i> )	ZNS, kidney, intestine, generalizing	Oral – spores	Destruction of organs	100 thousands/ thousands
→ <i>Balantidium coli</i>	Intestine	Oral – cysts	Diarrhoea	Thousands/few
→ <i>Hymenolepis nana</i>	Intestine	Oral – larvae	Diarrhoea	Thousands/none
→ <i>Strongyloides stercoralis</i>	Intestine	Percutan/oral – larvae	Diarrhoea	100 millions/ thousands
→ <i>Sarcoptes scabiei</i>	Skin	Body contact	Scabies	20 millions/thousands
→ <i>Demodex folliculorum</i>	Skin	Body contact	Rosacea	Thousands/none

sporozoites). Many indications (e.g., ring-like arranged DNA of about 35 Kb) exist that this organelle represents the remnant of a plant → [plastid](#).

## Organophosphorous Compounds

→ [Ectoparasitocidal drugs](#) that block cholinesterases in arthropods.

## Organotropism

Preference of some developmental stages of parasites to settle regularly in organs that are favorable for their further development.

## Oribatids

→ [Mites](#) of the family Oribatidae, vectors of tapeworms (→ [Moniezia](#), → [Paranoplocephala mamillana](#)).

## Oriental Sore

Disease due to infection with *Leishmania major* and *L. tropica* transmitted by bite of → [sand flies](#) (→ [Leishmaniasis, Man](#)).

## Orientation

Many parasites which actively invade or attack their hosts perform an ambushing strategy of → [host finding](#),

i.e., they await their hosts in their selected microhabitats (e.g., many species of trematode → [cercariae](#), infective nematode larvae, and → [ticks](#)). However, other parasites actively approach towards their hosts employing very different types of orientation. Aquatic invasive larvae such as some trematode miracidia and cercariae may reach their hosts by chemo-orientation along gradients of certain host-emitted compounds. In most species, the type of orientation is a chemokinesis (random, undirected changes of the path of swimming in response to an increase or decrease of the stimulus concentration); but chemotaxis (directed movements along the concentration gradient of the stimulus) has also been described (→ [Host Finding](#), → [Miracidium](#), → [Trematodes](#), → [Cercariae](#)). Terrestrial host-searching parasites such as certain nematode larvae and ticks may orientate along thermal gradients, odorous and visual signals of their hosts (→ [Host Finding](#), → [Nematodes](#), → [Ticks](#)), and bloodsucking arthropods such as → [Mosquitoes](#) and → [Tsetse Flies](#) may get to their hosts by an oriented flight toward visual cues or by an upwind anemotaxis in response to odors, moisture and heat (→ [Host Finding](#), → [Mosquitoes](#), → [Tsetse Flies](#)). After attachment to the host many parasites such as *schistosome cercariae*, hookworm larvae, and ticks orientate themselves toward particular sites for penetration or feeding, responding to temperature, mechanical and chemical host cues (for details, → [Host Finding](#)).

## Orientia (*nov. gen*) tsutsugamushi

Rickettsial agent of the mite (*Trombicula akamushi*) transmitted → [Tsutsugamushi fever](#) in Asia (syn. *Rickettsia*).

## Ornidazol

→ [Eflornithine](#), → [Trypanocidal Drugs](#).

## Ornidyl

Other name for difluormethylornithine: DFMO → [eflornithine](#), which acts as → [trypanocidal drug](#).

## Ornithine

→ [Amino Acids](#).

## Ornithobilharzia

Genus of bird schistosomes, the larvae of which may penetrate into the skin of humans and introduce → [dermatitis](#) or → [swimmers itch](#).

## Ornithodoros

### Synonym

Ornithodoros.

### Name

Greek: *ornithos* = chicken, *doros* = leather bag.

### Classification

Genus of the subfamily Ornithodorinae of the leather tick family → [Argasidae](#).

### General Information

The genus *Ornithodoros* includes many species with vector activity. *O. moubata* (male 8 mm, female 10 mm), the “eyeless tampan” lives in corners of the sandy soil of houses in South Africa and during the night attacks the inhabitants, and also chicken (see name). It is the vector of the agent of the rickettsial relapsing fever (*Borrelia duttoni*). The tick *O. moubata porcinus* attacks pigs and transmits the African pig pest (virus), while *O. savigny* (eyed tampan) is found to suck on horses, camels, cattle, and humans (in Africa, Arabia, India), but is apparently not a vector. *O. lahorensis* is found in Southeast Europe up to Asia. *O. hermsi* and other species are found in the Americas.

### Life Cycle

The life cycle comprises the egg, 1 larva, 5 nymphs, and a male and female adult ([Fig. 1](#), page 1056). *Ornithodoros* spp. may live more than 10 years and are able to starve even for years.

### Control

→ [Acarizides](#).

## Ornithodoros megnini

### Synonym

*Otobius megnini*.



**Ornithodoros.** Figure 1 LM of the ventral and dorsal side of *Ornithodoros moubata*. Note the granular surface.

This soft →[tick species](#), known as thorny ear-tick, is found on ruminants in Africa and America, but also on rodents (and wild rabbits). The intensive constant itching and the reaction on poisonous compounds of the saliva lead to reduction of food uptake. Only the nymphs possess the name-giving thorns at their surface. In livestock animals the ticks are seen up to 7 months and larger amounts must be taken out surgically, since they may induce enormous ear pain, named *otobiasis*. Small numbers or just single-tick stages can be killed by oils inoculated into the ear. In North America *O. lagophilus* is found especially on rabbits.

---

## Ornithonyssus bacoti

→[Mites](#).

---

## Ornithostrongylus

Genus of bird nematodes, that live in the intestine of birds (e.g., *Ornithostrongylus quadriradiatus* of doves, direct development with a prepatency of only 5–6 days).

### Therapy

→[Nematocidal Drugs](#).

---

## Oropouche-Virus

This Bunya-virus is transmitted to humans by midges (→[Culicoides paraensis](#) in Amazonia leading to a widely spread infection with high fever).

---

## Oroya Fever

Visceral form of disease starting 15–40 days after injection with *Bartonella bacilliformis* bacteria during the bite of →[sand flies](#). Clinical symptoms are high fever, →[lymphadenitis](#), spleno- and hepatomegaly. The decreasing number of erythrocytes being lysed by the *Bartonella*-stages introduces anaemic symptoms. Months after this acute phase skin symptoms (→[Verruga peruana](#)) may occur. The disease is restricted to the western and eastern valleys of the Andes.

---

## Orthogon

→[Nervous System of Platyhelminthes](#).

---

## Orthomitosis

→[Nuclear Division](#).

## Orthomyxoviridae

### Classification

Family of RNA viruses containing viruses transmitted by arthropods (→[Arboviruses](#)).

### General Information

Negative-sense single-stranded segmented →[segmented RNA viruses](#) (spherical, with envelope).

### Important Species

[Table 1](#).

## Oslerus osleri

### Synonym

*Filaroides osleri*.

### General Information

Worldwide occurring nematodes forming nodules in the mucosa of the bronchioles and trachea of canids. The transmission occurs direct from mother to puppy during care. The males reach a length of 6 mm, the females 12 mm. In cats *O. rostratus* is described. The **prepatent period** lasts 5–6 weeks. The symptoms of **disease** are chronic coughing.

### Therapy

→[Nematocidal Drugs](#) (macrocyclic lactones).

## Ostertag, Robert von (1864–1940)

German veterinarian, founder of official meat control and describer of many nematodes.

## Ostertagia

Named in honour of the German scientist →[Ostertag](#).

### Classification

Genus of the nematode family →[Trichostrongylidae](#).

### General Information

The adult worms (female about 10 mm long) live in the rennet-bag (4th stomach) of cattle. The larvae 1–3 develop within 3 weeks outside of the body. When larvae 3 are taken up with grass, they enter the glands of the rennet-bag and grow there via 2 molts until maturity. Males and females live free in the small intestine. The prepatent period takes 18–23 days in *Ostertagia ostertagia* and *O. circumcincta*.

### Life Cycle

→[Trichostrongylidae](#)/Fig. 1.

## Ostertagia ostertagi

→[Ostertagiosis](#).

## Ostertagiosis

Ostertagiosis is probably the most important parasite in grazing sheep and cattle in temperate climatic zones throughout the world. It causes subclinical losses of production and disease. The clinical disease is characterized by →[diarrhoea](#), →[weight loss](#), decreased production, rough hair coats, partial →[anorexia](#), mild

**Orthomyxoviridae. Table 1** Arboviruses VI. Negative-sense, single-stranded segmented RNA viruses: Family Orthomyxoviridae, genus *Thogotovirus*

Group (no. of members)	Species (selected)	Arthropod host	(Main) vertebrate hosts	Distribution	Disease in Man	Disease in animals
Thogoto (4)	Thogoto	Ixodidae		Europe	Fever, neurological disorders	
	Dhori	Ixodidae		Europe Africa	Fever	
	Batken	Ixodidae		Asia		
	Araguari	?	?	South America		

→[anaemia](#), →[hypoalbuminaemia](#), →[dehydration](#), and in some cases, death. →[Ostertagia ostertagi](#) in cattle and *O. (Teledorsagia) circumcincta* in sheep and goats are the most important species. Related species and genera are *O. leptospicularis*, *Skrjabinagia lyrata* in cattle, and *O. trifurcata*, *Teladorsagia davtiani*, and *Marshallagia marshalli* in sheep and goats.

Clinical ostertagiosis occurs under 3 sets of circumstances called type I, pre-type II, and type II diseases. The type I disease is seen in calves at pasture, shortly after a period of high availability of infective larvae. It is due to the direct development of large numbers of L<sub>3</sub> larvae to adult worms over a relatively short period of time. In contrast, type II disease is due to the synchronous maturation and emergence of large numbers of hypobiotic larvae from the mucosa, and occurs when intake of larvae is likely to be low or non-existent. It occurs in cattle, mainly yearlings or heifers, during the winter in the northern hemisphere, or during the dry summer period in Mediterranean climates. The almost asymptomatic condition which precedes type II ostertagiosis has been called pre-type II. In this phase the abomasum carries a pathogenically adequate burden of inhibited larvae which are still quiescent, but from which disease type II may erupt unpredictably if a sufficiently large number of larvae resume development to maturity. In sheep the same forms occur, but in ewes the course of type II is very rare and more chronic. Clinical signs start at the time the parasites reach maturity; they begin to emerge from the gastric glands (in type I after 18–21 days and in type II after 4–6 months), and marked cellular changes appear. The functional gastric gland mass, particularly the hydrochloric acid (HCl)-producing parietal cells, is replaced by undifferentiated cells. It has also been shown that the secretory activity of parietal cells is blocked. The undifferentiated and hyperplastic mucosa is abnormally permeable to macromolecules following the destruction of the intercellular junctions. This happens not only in the parasitized gastric gland but also in the surrounding glands. These structural changes result in: (1) an elevation of the pH of the abomasal fluid from 2 to 5 or even higher. This leads to a failure to activate pepsinogen to pepsin and to denature proteins. There is also a loss of bacteriostatic activity, which is followed by an increase in the number of bacteria; (2) an enhanced permeability to macromolecules resulting in hypoalbuminaemia, the albumin in the plasma passing into the abomasum. Any loss of protein macromolecules is usually accompanied by loss of electrolytes, mainly Na<sup>+</sup> and Cl<sup>-</sup>. The onset of diarrhoea increases the loss of electrolytes. Continued loss may lead to increased hypoalbuminaemia, retention of fluid, and the development of →[oedema](#); (3) elevated plasma pepsinogen concentrations of more than 3 U tyrosine. The mechanism responsible for this

increase is not yet completely understood. A multifactorial cause has been postulated, involving direct stimulation of zymogenic cells by factors released from the parasite, indirect stimulation via elevated circulating concentrations of hormones such as gastrin (*vide infra*), and leakage from abomasal fluid between poorly differentiated epithelial cells; (4) raised gastrin levels. The gastrin levels have been found to increase considerably during →[Ostertagia](#) infection in sheep and cattle. The consequences are not clear. Gastrin has a multiplicity of actions e.g., stimulating HCl and pepsinogen secretion, inhibiting reticulo-ruminal motility, trophic effects on the gastric and intestinal mucosa. The cause of hypergastrinaemia has not been established but the presence of the parasite seems to be critical.

### Related Entry

→[Hypobiosis](#).

### Therapy

→[Nematocidal Drugs, Animals](#), →[Drugs](#).

---

## Otobius megnini

→[Ticks](#), →[Ornithodoros megnini](#).

---

## Otodectes cynotis

Mite that induces Otitis externa parasitaria in dogs and cats ([Fig. 1](#), page 1059), →[Mites](#), →[Mange, Animals](#).

---

## Otodectic Mange

→[Mange, Animals/Otodectic Mange](#).

---

## Outdoor Feeding

Bloodsucking mosquitoes attack outside of the house →[exophagy](#).

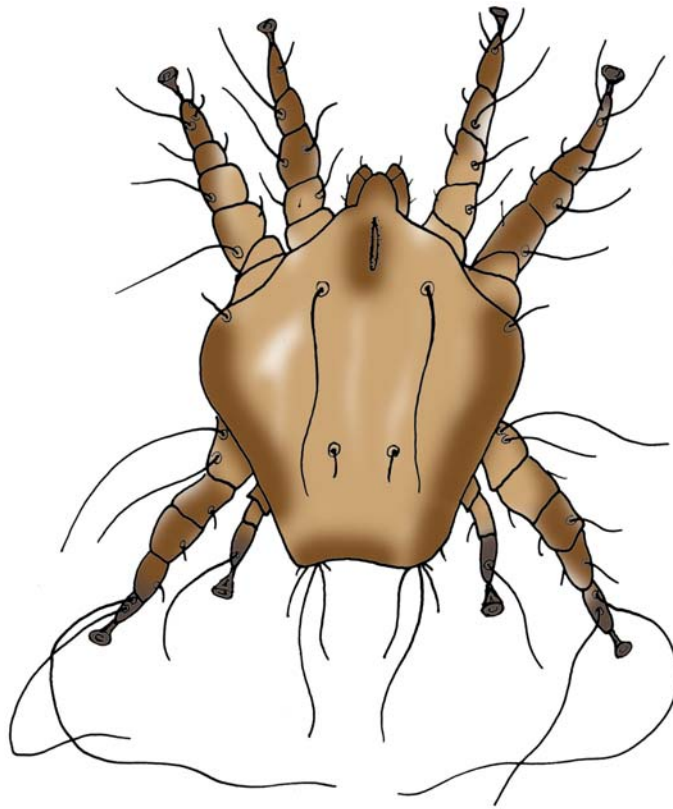

**Otodectes cynotis.** Figure 1 Diagrammatic representation of an adult mite.

## Ovijector

### Name

Latin: *ovum* = egg, *iacere* = throw away.

Muscular portion of the terminal uterus of several nematodes, which helps to excrete the fertilized eggs.

## Oviparous

Laying eggs that embryonate and hatch outside the maternal body, e.g., in →[Platyhelminthes](#), →[nematodes](#), →[ticks](#), →[mites](#), and →[insects](#).

## Oviposition

Process of laying eggs, especially with regard to insects.

## Ovipositor

The vestibular vagina of a tick prolapses, if an ovum nears the genital pore. Thus it acts as ovipositor = egg placing system, when ejecting the eggs.

## Ovoid Mitochondrial Cytoplasmic Complex (OMC)

This is a composite assembling of organelles in tachyzoites of →[Toxoplasma gondii](#) consisting of an enrolled branch of the mitochondrion (showing no inner infoldings in this region, but appearing often with up to 4 membranes – depending on the section) and an enclosed small gap of cytoplasm being situated close to the Golgi-apparatus at the anterior pole of the nucleus. This OMC appears only in growing tachyzoites and is correlated with mitochondrial growth or division. Although nothing is known on its function, it clearly differs from the similarly looking →[apicoplast](#).

## Ovoviviparous

The larvae hatch from the eggshell just during the moment of birth (= egg deponing by flies or worms) (→*Dracunculus medinensis*, →Lungworms, →Filariidae →*Sarcophaga*), →Oestrus.

## Oxamniquine

→Trematocidal Drugs.

## Oxantel

A pyrimidine →Nematocidal Drugs.

## Oxfendazole

A benzimidazole, →Nematocidal Drugs.

## Oxibendazole

→Nematocidal Drugs.

## Oxidative Phosphorylation

→Energy Metabolism.

## Oxpeckers

Local name for →ticks.

## Oxyclozanid

→Trematocidal Drugs.

## Oxymonadida

### Classification

Order of →Mastigophora.

### General Information

These flagellates exclusively inhabit the intestine of wood-feeding insects (apparently supporting their digestion); they are uninuclear and usually have 3 free →flagella and a recurrent one that is inserted laterally at the apical pole. They are characterized by the occurrence of an →axostyle, which consists of many rows of →microtubules and thus differs from that of the trichomonadida, where only a single row is formed (→Trichomonadida/Fig. 1). Due to bridges between the microtubules, a gliding effect is possible, leading to a regular bending of the axostyle; this ultimately produces the cellular movement. Transmission occurs in some species via fecally passed cysts.

## Oxyuridosis

### Synonym

→Oxyurosis.

---

## Oxyuris

### Synonym

*Enterobius*, pinworm.

### Name

Greek: *oxys* = pointed, sharp, *ura* = tail.

### General Information

This genus name is, e.g., retained in *O. equi* in horses, the males of which are small (0.8–1.5 cm), while the females reach up to 15 cm. The latter introduce intense

pruritus, while leaving the anus for egg deposition.  
→ [Nematodes](#), → [Enterobius vermicularis](#).

---

## Oxyurosis

### Synonym

→ [Enterobiasis](#) in humans, furthermore disease due to infections with *Oxyuris equi* in horses, *Passalurus ambiguus* in hares and rabbits, and → [Oxyuris](#) spp. in reptiles and amphibians.

### Therapy

→ [Nematocidal Drugs](#).





## Palaeacanthocephala

→[Acanthocephala](#).

## Palaearctis

From Greek: *palaios* = old, *arctos* = northern faunistic region around the North Pole reaching south until Eurasia and border of the Sahara.

## Pale Mucosa

Clinical symptom in animals due to parasitic infections (→[Alimentary System Diseases](#), →[Clinical Pathology, Animals](#)).

## Palps

Mouthparts of insects and Acari in ticks normally with 4 segments called articles, →[Insects](#), →[Ticks](#).

## Paludisme

French name for →[Malaria](#); from *palustre* = swamp.

## PAME

→[Amoebae](#), →[Naegleria](#).

## Pandemy

Number of infections in a given period (not limited by geographic borders).

## Pansporoblasts

→[Myxozoa](#).

## Panstrongylus megistus

→[Bugs](#).

## Papataci Fever

### Synonyms

Sandfly Fever, →[Phlebotomus](#) Fever.

This disease, which is found around the Mediterranean Sea, in countries in the Near and Middle East regions, in Central Asia, and in East Africa, occurs due to infections with 2 immunologically different →[arboviruses](#) being transmitted during the bite of the sand fly *Phlebotomus papatasi*, which may also infect transovarially its next generation. The →[incubation period](#) is 3 days then the disease starts with sudden and high fever (41°C) for 3 further days, during which the following symptoms may occur: headache, →[vomiting](#), →[diarrhoea](#), myalgia.

## Papula

Clinical and pathological symptom (reactions at the biting site) of infections with skin parasites (→[Skin Diseases, Animals](#), →[Mosquitoes](#), →[Fleas](#)).

## Parabasal Filaments

Fortifying structures in →*Trichomonas* and →*Giardia* trophozoites.

## Parafilaria

### Name

Greek/Latin: *para* = besides; Latin: *filum* = filament.

### Classification

Genus of the nematode family →*Filariidae*.

### General Information

The up to 6.5 cm long females of this genus (e.g., *P. bovicola*) – males reach 3.5 cm – introduce nodules in the subdermal skin of cattle in South Asia, Africa, and in some regions of Europe. Vectors are →*Musca* spp., which transit the L<sub>3</sub>, that reaches maturity in about 6–7 months. The microfilariae are found in wounds of the skin due to the presence of adults and then become licked by the flies. The symptoms of the **disease** are 10–15 cm-sized lesions in the skin, exudations of open wounds.

### Therapy

→*Nematocidal Drugs*.

## Parafilariasis, Parafilariosis

*Parafilaria bovicola* (→*Filariidae*) occurs in cattle and *P. multipapillosa* in horses. Both have a very similar pathogenesis. Adult worms occur in →*nodules* in the skin and subcutaneous tissue. A bloody exudate appears when female worms rupture the nodules to lay eggs, eventually causing a matting of the hair. As erupted nodules regress, fresh ones appear. Infection is highly seasonal, occurring when the weather is warmer.

### Therapy

→*Nematocidal Drugs, Animals*.

## Paraflagellar Rod (PFR)

→*Paraxial* rod, which is present in the flagellum of the →*Kinetoplastida* alongside the microtubules except in flagella of some symbiont-carrying trypanosomatids (e.g., *Crithidia deanei*).

## Paragonimiasis, Man

Paragonimiasis is a lung fluke infection contracted by the consumption of freshwater crabs or crayfish (→*Paragonimus*). The →*metacercariae* penetrate the intestinal wall, migrate through the peritoneum across the diaphragm, and enter the pleural cavity to reach the lungs. The worms develop in bronchioles and when mature shed their eggs into the bronchi (→*Pathology/ Fig. 21D*). The worms elicit an exudate with neutrophilic and eosinophilic granulocytes, generally developing a cyst or an →*abscess* which may be surrounded by a fibrous capsule. Hemorrhage into the cyst often occurs and the brownish mucoid exudate containing eggs is coughed up. Degenerating eggs give rise to a granulomatous →*inflammatory reaction*. Aberrant sites of infection include the abdominal cavity, soft tissues, and the brain, where the birefringent →*Paragonimus* eggs must be differentiated from the nonbirefringent schistosome eggs. In general the metabolic products of the adults give rise to microabscesses, and the degenerating eggs to →*granulomas*. These are accompanied by eosinophils and →*Charcot-Leyden crystals*, and are surrounded by fibrosis or gliosis with scattered plasma cells and lymphocytes. The lesions and symptoms vary by site. In the brain, cavities measuring 10 mm in diameter may be produced, surrounded by a connective tissue capsule.

**Main clinical symptoms:** Hemoptysis, bronchitis, thoracic and/or →*abdominal pain*.

**Incubation period:** 9–12 weeks.

**Prepatent period:** 10–12 weeks.

**Patent period:** 20 years.

**Diagnosis:** Microscopic determination of eggs in sputum or fecal samples (→*Paragonimus/ Fig. 5*).

**Prophylaxis:** Avoid eating raw crustaceans in endemic regions.

**Therapy:** Treatment with praziquantel, see →*Trematocidal Drugs*.

## Paragonimus

### Name

Greek: *para* = besides, *gonimos* = reproducing (since the genital pore is situated somewhat left to the midline of the body).

### Classification

Genus of the trematode family Paragonimidae.

### General Information

These bean-like flukes (Figs. 2, 3) are found as adults (7–12 mm × 4–7 mm × 3–5 mm) in cysts inside of lung of humans and crustacean-eating mammals (Figs. 4, 5), where they induce tuberculosis-like symptoms (haemoptysis, bronchitis, breast pain, fever, breathing problems) in cases of lung invasion. Since metacercariae also penetrate into abdominal organs and brain, other symptoms may derive from there. Important species are *P. westermani* (India, Asia), *P. heterotremus*

(Thailand), *P. africanus*, *P. utero-bilateralis* (Africa), *P. kellicotti* (Americas).

### Important Species

Table 1.

### Distribution

Fig. 1.

### Life Cycle

Figs. 2–5 (pages 1066, 1067), → Digenea/Fig. 8.

### Therapy

→ Trematocidal Drugs.

## Paragonimus kellicotti

→ Respiratory System Diseases, Horses, Swine, Carnivores.

**Paragonimus. Table 1** Important species of the genus Paragonimus

Species	Final host/ Habitat	Size of adults (mm)	Size of eggs (µm)	First intermediate host <sup>a</sup>	Second intermediate host <sup>b</sup>	Prepatent period (weeks)
<i>Paragonimus westermani</i>	Humans, carnivores/Lung	7–12	60 × 90	<i>Hua</i> spp., <i>Thiara</i> spp., <i>Melania</i> spp.	Crabs	8–12
<i>P. kellicotti</i>	Humans, carnivores/Lung	9–16	55 × 85	<i>Pomatiopsis</i> spp.,	Crabs	22–24
<i>P. africanus</i>	Humans, carnivores/Lung	8–12	60 × 90	<i>Brotia</i> spp.	Crabs	8–14

<sup>a</sup> Several other species of gastropods may become first intermediate host

<sup>b</sup> There is no reproduction either in the true second intermediate hosts or on water plants

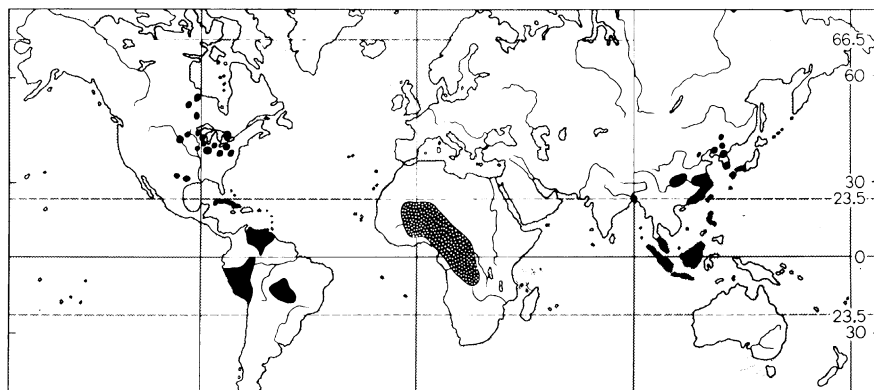

**Paragonimus. Figure 1** Distribution map of → *Paragonimus westermani* in Asia (black), → *P. kellicotti* in America (black), and *P. africanus* in Africa (dotted space).



**Paragonimus. Figure 2** LM of an adult fluke.

---

## **Paragonimus westermani**

→[Digenea](#), →[Pathology](#).

---

## **Paralecithodendrium**

Genus of flukes of the family Lecithodendriidae, which occasionally may also occur in humans, while they normally are found in insectivores (bats).

---

## **Paralysis**

The saliva of some tick species (e.g., →[Argas walkerae](#) in South Africa, →[Ixodes holocyclus](#) in Australia, →[Ixodes rubicundus](#) in South Africa, →[Ixodes ricinus](#) in southern Europe, *Dermacentor andersoni* in USA, etc.) contains toxins that produce paralysis, which often proves fatal in many animals and man if the →[ticks](#) are



**Paragonimus. Figure 3** SEM of an adult fluke.

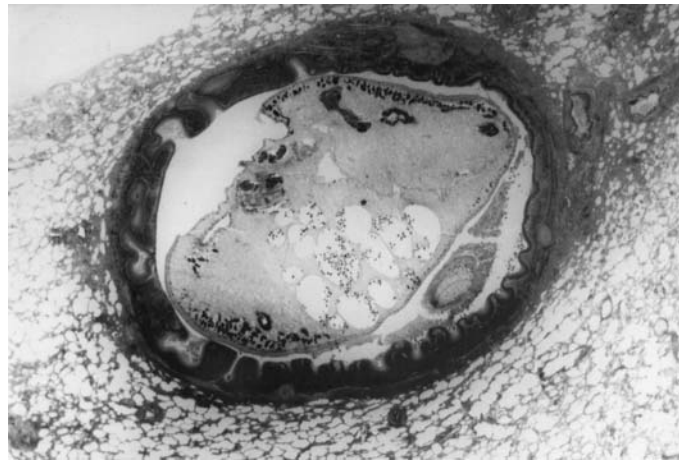

**Paragonimus. Figure 4** LM of a coloured section of 2 flukes in a lung cyst (they mostly occur in pairs and thus are able to inseminate each other).



**Paragonimus. Figure 5** LM of a typical egg.

not removed. The symptoms appear 3–7 days after attachment of the tick. Since the toxin's linkage to the nerves is rather unstable, the effects are completely reversible once the toxin is eliminated. In total, 69 of the 869 valid tick species are considered to lead to paralysis in a broad spectrum of hosts including man.

---

## Paramomycin

→Antidiarrhoeal and Antitrichomoniasis Drugs.

---

## Paramphistomosis

Infections by the digenean genus →*Paramphistomum* may cause significant intestinal problems in ruminants. The adult worms live in the rumen, but the pathological effects of infection are caused by the immature stages within the small intestine. Many genera and species are involved. Their pathogenic processes are similar. The most pathogenic species are thought to be *Paramphistomum microbothrium*, *P. ichikawai*, *P. cervi*, *Cotylophoron cotylophoron*, and various species of *Gastrothylax*, *Fishoederius*, and *Calicophoron*.

Paramphistomosis is largely a disease of young animals, because repeated infections of low intensity generally produce an almost complete immunity. The immunity results not only in a marked reduction in the worm burdens from challenge infections but also protects the host against the lethal effects of these infections. The pathological effects of infection are almost entirely caused by the immature stages within the first part of the small intestine. The immature worms penetrate the mucosa of the small intestine as deeply as the muscularis and become attached, with a plug of mucosa drawn into their acetabula. This causes strangulation and the eventual →necrosis of the piece of mucosa, leading to the development of erosions and

petechiae. These lesions cause intestinal discomfort and a reduction of appetite. At the same time, plasma albumin is lost by seepage and →[hypoalbuminaemia](#) results. Protein loss into the gut, coupled with loss of appetite, seems to be the most important pathophysiological consequence of paramphistomosis. The low plasma protein concentration causes generalized →[oedema](#), seen as hydropericardium, hydrothorax, pulmonary oedema, ascites, and submandibular oedema. Clinical signs are profuse and foetid →[diarrhoea](#), →[anorexia](#), marked weakness, often leading to death. The animals are thirsty and drink frequently. There is no indication of →[anaemia](#). After massive infection, migration of the immature worms to the rumen is delayed, and →[flukes](#) may persist for months in the duodenum prolonging the course of disease.

### Therapy

→[Trematocidal Drugs](#).

## Paramphistomum

### Name

Greek: *para* = besides, *amphi* = two at both sides, *stoma* = mouth.

### Classification

Genus of the trematode family Paramphistomidae.

### General Information

The rumen fluke *Paramphistomum cervi* reaches a size of 5–12 mm × 2–4 mm (Figs. 1, 2), appears reddish, and has suckers at both poles (see name). The colour is due to its own haemoglobin, the eggs (Fig. 3) look like those of →[Fasciola](#) and are also rather big (140–180 μm × 75–95 μm). These flukes are found in Europe in ruminants, where they introduce diarrhoea, loss of weight, and even death (→[Alimentary System Diseases, Ruminants](#)). Other important species are *P. daubneyi* (cattle), *P. ichikawai* (cattle, wild ruminants), and *Gigantocotyle explanatum* in buffaloes (South Africa). →[Digenea](#).

### Life Cycle

Similar to that of →[Fasciola](#), details see in the schematic representation of →[Digenea/Fig. 1](#).

### Disease

→[Paramphistomosis](#).

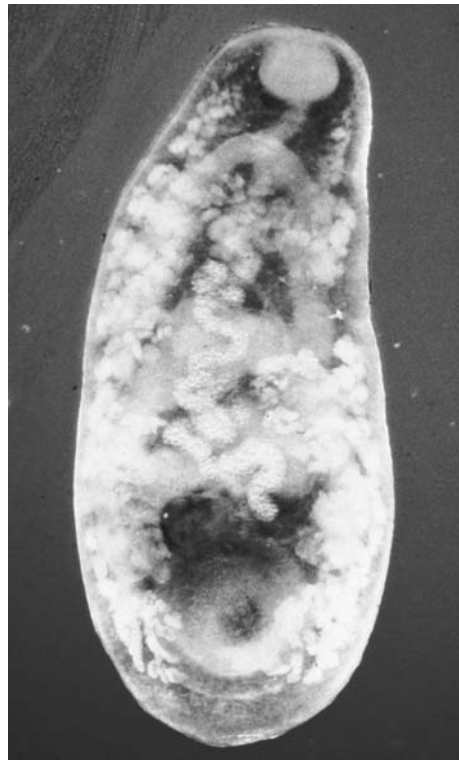

**Paramphistomum.** Figure 1 LM of living, uncolored adult fluke.

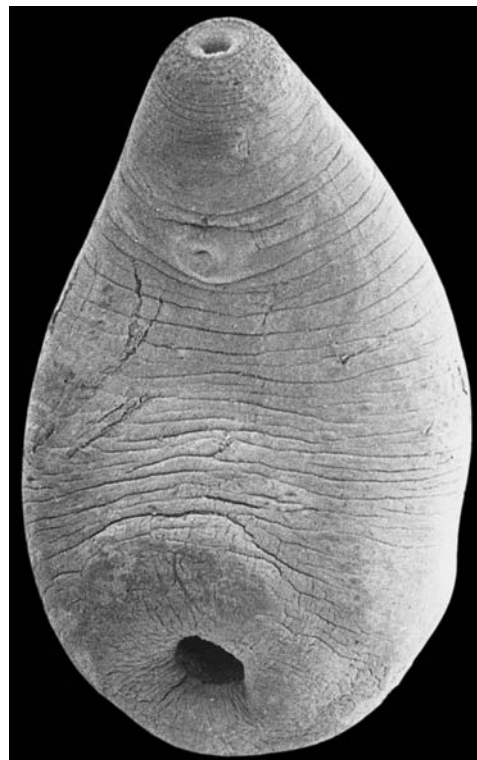

**Paramphistomum.** Figure 2 SEM of an adult fluke; note the anterior and posterior sucker as well as the genital opening.

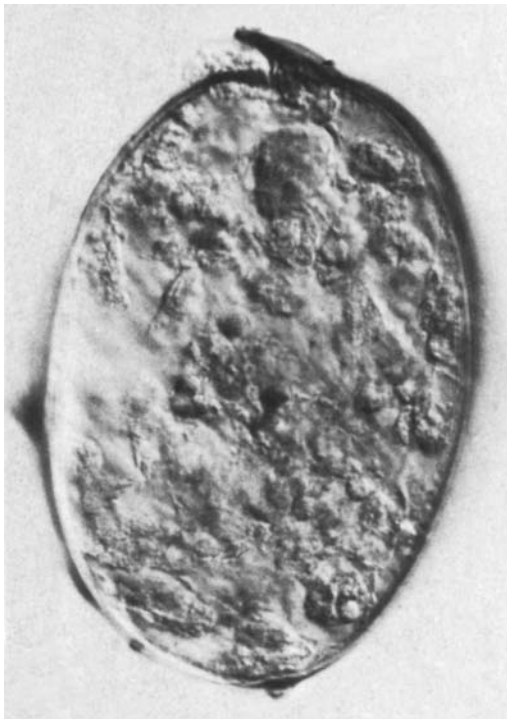

**Paramphistomum.** Figure 3 LM of an egg with a slightly open operculum.

### Therapy

→ [Trematocidal Drugs](#).

## Paramphistomum cervi

→ [Dicrocoelium dendriticum](#)/Fig. 1.

## Paramyosin

Protective antigen in → [Schistosomiasis, Man](#).

## Paramyxa Species

Species of the protozoan phylum → [Ascetospora](#).

## Paranoplocephala

### Name

Greek: *para* = besides, *anaplon* = without arms, *cephale* = head.

### Classification

Genus of the tapeworm family Anoplocephalidae.

### General Information

*Paranoplocephala mamillana* is a 1–4 cm long and 0.6 cm wide tapeworm that occurs worldwide in the small intestine of horses and other equids, → [Cestodes](#).

## Paraphyletic Situation

A given taxonomic group does not include all descendants of an ancestral taxon.

## Parascaris equorum

### Name

Greek/Latin: *para* = besides, *ascaris* = worm, Latin: *equus* = horse.

### Classification

Species of the nematode family Ascariidae (→ [Nematodes](#)).

### General Information

*Parascaris equorum* is the ascarid worm that occurs worldwide in horses, reaches sizes of 40 cm in females and up to 28 cm in males ([Fig. 1](#)). The **prepatent period** is 10–16 weeks, **patency** reaches up to 2 years.

### Diagnosis

By microscopical determination of the eggs in the faeces.

### Disease

→ [Alimentary System Diseases, Horses](#).

### Therapy

→ [Nematocidal Drugs](#).



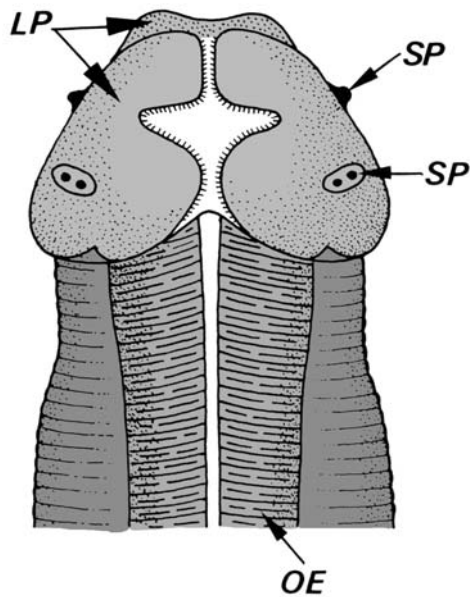

**Parascaris equorum.** Figure 1 DR of the anterior end of an adult worm. LP, lips; OE, oesophagus; SP, sensilla.

## Parasitaemia

Amount of parasitic stages within the blood in percentages of red blood cells.

## Parasite

### General Information

An animal that lives completely at the expense of plants, animals, or humans is defined as parasite. Some authors also consider viruses, bacteria, and [fungi](#) as parasites.

Parasites have to solve several main problems in order to survive in the “struggle for life”:

- They must develop successful strategies for [host finding](#).
- They must find methods for attachment and/or for partial or total penetration into their prospective hosts ([Host Cell Invasion](#)).
- They must become able to feed on their host’s tissues or fluids and must be able to metabolize the nutrients obtained ([Metabolism](#)).

- They must develop mechanisms to protect themselves from the attacks of the host’s defense systems, e.g., mechanisms for [immune evasion](#) ([Immune Responses](#)).
- Last but not least, parasites have to establish a high reproduction rate in places from which the offspring can be transmitted to other hosts ([Reproduction Strategies](#)).

### Related Entry

[Parasitism vs. Mutualism](#).

## Parasite Avoidance Hypothesis

[Behavior](#).

## Parasite Load

The quantity of parasites within a host; this load is mostly responsible for the severity of clinical symptoms ([Clinical Pathology, Animals](#)).

## Parasitic Sterilization

Several parasites are able to sterilize their hosts, e.g., [Nosema apis](#) ([Microsporidia](#)) introduces infertility in bees.

## Parasitiformes

Subclassis of the [Acari](#) (mites) including (according to the position of the paired stigma = opening of the tracheal system):

- Metastigmata (= ixodid and argasid ticks)
- Mesostigmata (gamasid mites: families Dermanysidae, Macronyssidae, Halarachnidae, Laelaptidae, Varroatidae)
- Prostigmata (e.g., Demodicidae, Cheyletiellidae)
- Astigmata (e.g., Sarcoptidae, Psoroptidae)

## Parasitism vs. Mutualism

Although many definitions have been proposed for parasites and mutualists, the simplest is to say that

- a parasite needs its host while the contrary is not true;
- a mutualist needs its host and the contrary is true (or at least the host has a better fitness in the presence of the mutualist).

From an evolutionary point of view, the difference between parasitism and [→mutualism](#) is immense:

- a parasite species and its host species constitute 2 separate units of selection, which compete for the same resources;
- a mutualist species and its host species constitute a single unit of selection, which compete with other units, even if conflicts may subsist between them.

**Mutualism** is a paramount process of the evolution of life: most trees get their mineral compounds thanks to mutualist [→fungi](#), many plants are pollinated by insects or other animals, all herbivorous animals digest cellulose thanks to bacteria and/or protozoans, the eucaryotic cell takes its energy from [→mitochondria](#), etc.

## Parasitoid

### Name

Greek: *para* = besides, *sitos* = food, *eides* = similar.

Organism that lives like a parasite, while it feeds up its host (e.g., the larvae of ichnomomid wasps inside larvae of other insects).

## Parasitophorous Vacuole

[→Apicomplexa](#), [→Coccidia](#), [→Host Cell Invasion](#), [→Host-Parasite Interface](#), [Protozoa](#), [→Microsporidia](#).

## Parastrigea robusta

Strigeid trematode of 0.2–0.9 mm × 3.0 mm in size, which appears spherical with a constriction. They are found in the intestine of ducks and doves.

## Parastrongyliasis

[→Parastrongylus cantonensis](#).

## Parastrongylus cantonensis

### Synonym

[→Angiostrongylus cantonensis](#).

### Disease

[→Angiostrongylosis](#).

## Paratenic Host

A host inside which no development occurs but only an accumulation of infectious stages.

### Related Entries

[→Heteroxenous Development](#), [→Monoxenous Development](#).

## Paratenuisentis ambiguus

[→Acanthocephala](#).

## Paraxial Rod

The [→flagella](#) of most [→Trypanosomatidae](#) contain a similar-sized network of structural proteins along the [→axoneme](#). This is used to stabilize the flagellum in viscous fluids such as blood or intestinal contents ([→Flagella/Fig. 1E](#)).

## Parbendazole

[→Nematocidal Drugs](#).

## Parenchyma

The primary body cavity of →*Platyhelminthes* is filled with the so-called parenchyma, consisting of connective tissue fibers and unattached or fixed cells of various types, which are surrounded by body fluids.

## Paromomycin

Compound to treat →*amoebiasis*, →*leishmaniasis*, →*cryptosporidiosis*.

## Parorchis acanthus

→*Digenea*.

### Life Cycle

Fig. 1 (page 1073).

## PARP

### Synonyms

→*Procylic Acidic Repetitive Protein*, →*Procyclin*.

→*Glycosylphosphatidylinositols*, →*Surface Coat* in procyclic trypanosomes (in the midgut of →*tsetse flies*).

## Parsimony Analysis

→*Phylogeny*.

## Parthenogenesis

Egg production (haploid or diploid) without fertilization, e.g., in schistosomes, several digeneans, monogeneans (→*Gyrodactylus*), →*Strongyloides stercoralis*, some races of →*Haemaphysalis longicornis* →*ticks*.

## Parthenogenetic Female

→*Strongyloides*.

## Partner Choice

→*Behavior*.

## Paruterine Organ

Enlarged portion of the uterus in some tapeworm species (e.g., →*Mesocestoides*, *Avitellina*, *Stilesia*, *Thysanosoma*, *Thysaniezia*). This organ, the wall of which is fortified by chitinous fibrils, contains the eggs (mostly many, but in some species only one).

## Parvaquone

→*Theileriacidal Drugs*.

## Passalurus

### Name

Latin: *passare* = pass, Greek: *ura* = tail.

### Classification

Genus of the nematode family Oxyuridae.

### General Information

*P. ambiguus* (female 8–12 mm, male 3–5 mm) are parasites of the caeca and colon of hare and rabbits (Figs. 1, 2, page 1074). The females have the family typical pointed posterior pole and excrete the asymmetric eggs (100 × 45 μm).

### Prepatency

55–60 days.

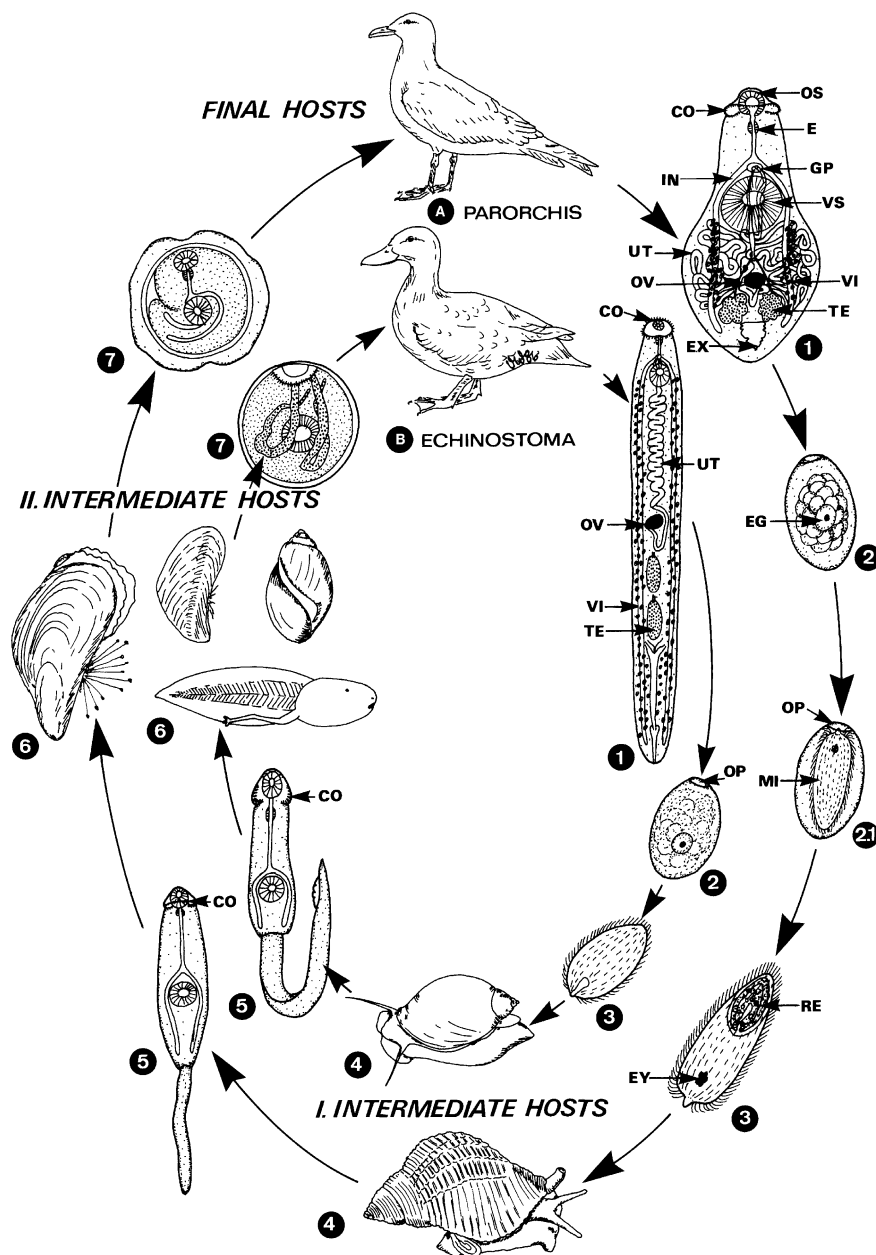

**Parorchis acanthus. Figure 1** Life cycle of the echinostomatid →trematodes, *Parorchis acanthus* (A) and →*Echinostoma revolutum* (B). 1 Adult →flukes; *P. acanthus* (10 mm) lives in the bursa fabricii or rectum of herring gulls; *E. revolutum* (4–22 mm) is found in the rectum and/or ceca of ducks, geese, and occasionally humans. Adults are characterized by their collar head with a characteristic number of spines. 2–4 The operculated eggs are passed unembryonated (*Echinostoma*) or fully embryonated (*Parorchis*) and containing a →miracidium. The hatched miracidium, which in *Parorchis* already includes a well-developed mother redia, finally penetrates the first →intermediate host, water snails of the genera *Nucella* (*Parorchis*, seawater), *Physa*, or *Heliosoma* (*Echinostoma*, freshwater). 5 Within the intermediate hosts reproduction occurs via sporocysts (not present in *Parorchis*) and 2 generations of →rediae, which finally give rise to free-swimming long-tailed →cercariae, which are provided with a spiny collar (CO). 6–7 The cercariae of *E. revolutum* enter a variety of second intermediate hosts (snails, fingernail clams, tadpoles) and encyst inside soft parts as →metacercariae (7), whereas cercariae from *P. acanthus* attach to the surface of snail shells and/or gills and excrete their metacercarial cyst wall (7). The final host becomes infected when ingesting metacercariae, the excystment of which takes place in the duodenum. From there the young worms wander to their final sites. After a prepatent period of about 20 days eggs are found in feces. CO, collar with tegumental spines; E, erythrocyte; EG, egg cell; EY, →eye spot; EX, excretory bladder; GP, genital pore; IN, intestine; MI, miracidium; OP, →operculum; OS, oral sucker; OV, ovary; TE, →testis; UT, uterus; VI, →vitellarium; VS, ventral sucker.

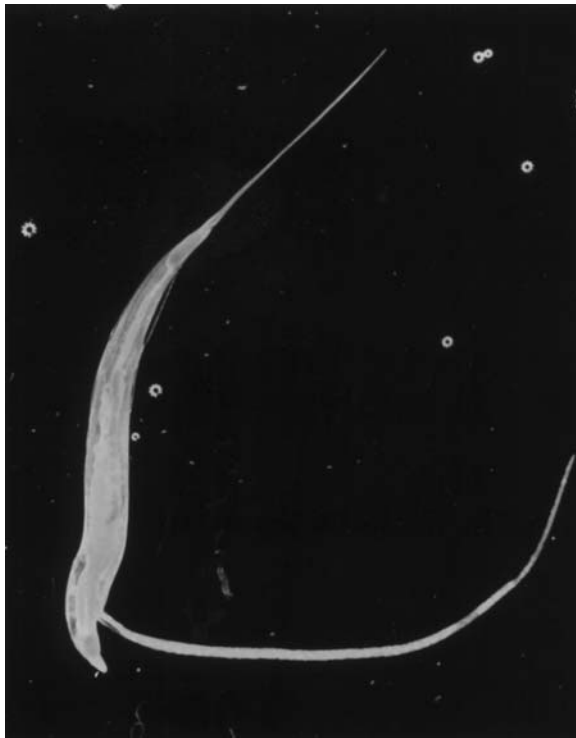

**Passalurus.** Figure 1 LM of a male and a female in copulation.

### Disease

Clinical Symptoms are mainly found in young animals; diarrhoea, loss of weight, neurodisturbances like heavy movements with the legs (drumming).



**Passalurus.** Figure 2 LM of eggs in a fecal smear.

Hongkong epidemic of 1894 in cooperation/concurrence to the work of the famous Japanese co-worker of →Robert Koch →Kitasato.

---

## Pasteur, Louis (1822–1895)

French chemist and microbiologist (Fig. 1, page 1075). His results on cholera, pig diseases, and rabies are the basis of the theory of immunity via vaccination. He is the discoverer of the decontamination of milk due to heating (= pasteurization). He founded the Institute Pasteur at Paris in 1888, which is today a worldwide renowned Research Institute and Center of Vaccination. The AIDS-virus was discovered there in the 1980s.

---

## Pasteurella

Former genus name of the plague bacteria, now named *Yersinia pestis*, honouring →Pasteur's co-worker A. Yersin, who discovered the bacterium in the

---

## Patency

Period during which parasites can be recognized within a host.

---

## Pathogenesis

Ability of parasites (or other agents) to introduce diseases. There are 6 main factors:

- Mechanical destruction: Parasite stages destroy organs while wandering through an organ or while infiltrating it.
- Biological/habitat factors: Number and size of parasites and their final localization in more or less important organs.



**Pasteur, Louis (1822–1895).** Figure 1 Pasteur in his institute.

- Deprivation of food: Some parasites feed on blood or withdraw vitamins or other important substances.
- Excretion of toxic products: The metabolism of parasites leads to the excretion of products which are no longer used, or they secrete enzymes, hormones, etc. to stimulate the host for some activities. Both types of products may have toxic effects on their hosts.
- Immunobiological reactions: There is a large variety of methods, of how parasites may evade host reactions. Important for the introduction of other diseases are the introduction of [→allergy](#), immunosuppression, etc.
- Other factors: [→Superinfection](#) of some parasites with other [→agents of disease](#), e.g., protozoans may contain rickettsiae, viruses.

#### Related Entry

[→Pathology](#).

### Pathogenicity

The ability of a parasite to introduce clinical symptoms in its host.

### Pathology

Pathology describes the effects of the parasite on the host, the morphologic and functional changes produced, and the [→host response](#). While pathology implies a static description, **pathogenesis** refers to the dynamic events and interactions. An overall successful host–parasite interaction occurs in the life cycle of many parasites and generally depends on development of immunity by the host. The infective agent may be eliminated, or persist as a chronic inactive infection. Some parasites have learned to circumvent some of the immune mechanisms that tend to contain or eliminate them.

Examples of unsuccessful interactions include accidental parasitisms where usually the invader, and occasionally the host, is rapidly killed. In contrast to this, successful parasitism implies the ability to persist and to reproduce in a host without giving rise to lesions that prevent survival as a species of either parasite or host.

In order to develop a tolerable relationship it is likely that both parasite and host have evolved together for at least some time, selecting each other for successful parasitism with host survival. Toleration is most advanced in what we call a mutualistic relationship, which exists for example with flagellates in the gut of termites and ciliates in ruminants. No such relationship with protozoan or metazoan parasites is recognized in humans. Microbes that are not injurious we designate as **commensals**; some parasitic examples are listed in [→Protozoan Infections, Man/Table 1](#).

Individuals who are parasitized, may get sick, or with development of immunity, recover. When the capacity to develop and maintain immunity is impaired, as in [→AIDS](#), active infection progresses, and may kill the host.

Many parasite species exert a pathogenic, lesion-producing effect. These lesions may explain clinical symptoms, but more importantly the lesions indicate the pathogenic mechanisms that give rise to disease, and that might be subject to therapeutic intervention. Some species may at times be commensals and at other times parasitic. It is important to differentiate between the biological fact of infection and disease.

[→Host responses](#) to parasite species are varied but a certain “theme and variation” approach can be developed to classify the lesions, with widely varying individual responses. Some of the [→inflammatory responses](#) are associated with protection but in [→hypersensitivity](#) the inflammatory response contributes to the pathogenic effects regularly produced by the parasite. Occasionally, the responses are so typical that they are helpful in the determination of a parasitizing species.

**Pathology. Table 1** Histologic reactions seen in parasitic infections (according to Frenkel)

<b>Minimal histologic reaction:</b>
Immunologic mimicry – <i>Schistosoma</i> adults (Fig. 23A)
Impermeability of living worms – <i>Angiostrongylus</i> adults (in rat) (Fig. 23B)
Impermeability of cysts – <i>Toxoplasma</i> , <i>Sarcocystis</i> , <i>Isospora</i> , and <i>Trypanosoma cruzi</i> (Fig. 5)
Metabolic products drained – <i>Clonorchis</i> in bile duct (Fig. 22B); nematodes, trematodes, and cestodes in gut lumen (Fig. 22A)
Atrophy (enhanced attrition of epithelial cells): giardiasis, cryptosporidiosis (Fig. 6)
Immunosuppressed host – <i>Pneumocystis</i> (Fig. 2A), strongyloidiasis (Fig. 2F), acanthamebiasis (Fig. 4F), toxoplasmosis (Fig. 10), isosporosis (Fig. 5C), cryptosporidiosis (Fig. 6)
<b>Tissue anoxia from obstruction of capillaries:</b> <i>P. falciparum</i> malaria (Fig. 15)
<b>Infection necrosis of parasitized cells:</b> toxoplasmosis (Fig. 10), Chagas' disease (Fig. 13D)
<b>Infection necrosis of adjacent cells:</b> amoebiasis (Fig. 4), cyst rupture in toxoplasmosis and sarcocystidiosis
<b>Histiocytic reaction:</b> diffuse cutaneous leishmaniasis (Fig. 14)
<b>Eosinophilic reaction (often with Charcot-Leyden crystals; Fig. 3B):</b> schistosomiasis (Figs. 1, 24), migratory <i>Ascaris</i> (Fig. 27A), filariasis (Fig. 28A), sarcocystosis, amoebiasis (Fig. 4), cysticercosis, echinococcosis (Figs. 18A, 29E, F), coenurosis, sparganosis (Fig. 18), fascioliasis (Figs. 3, 21A–C), paragonimiasis (Fig. 21 D), trichuriasis, larva migrans (Fig. 28C), capillariasis, anisakiasis (Fig. 28D), trichinelliasis (Fig. 18C, D), gnathostomiasis, <i>Angiostrongylus</i> infection (Fig. 29B–D), dracunculiasis, filariasis (Fig. 28A), onchocerciasis (Fig. 18E), dipetalonemiasis, scabies (Fig. 30B), tick bite (Fig. 18A,B).
<b>Splendore-Hoeppli reaction:</b> schistosome eggs (Fig. 1 B), <i>Wuchereria</i> (Fig. 28A), <i>Onchocerca</i> , <i>Anisakis</i> (Fig. 28D).
<b>Neutrophilic inflammation:</b> <i>Trichomonas</i> , <i>Balantidium</i>
<b>Mixed inflammation:</b> <i>Isospora belli</i> , <i>Toxoplasma</i> tachyzoites (Fig. 12A) and liberated bradyzoites (Figs. 5A,B, 13C).
<b>Abscess:</b> dead adult schistosomes in liver, amoebiasis in liver (Fig. 4D)
<b>Ulcerating lesions:</b> myiasis, tick bite (Fig. 13A,B), dracunculiasis, tungiasis, scabies (Fig. 30B), amoebiasis (Fig. 4), dermal leishmaniasis (Fig. 30A)
<b>Granuloma:</b> schistosome eggs (Fig. 1), migrating worms (Figs. 3, 21A–C), paragonimiasis, filariasis, onchocerciasis (Fig. 18E), larva migrans (Fig. 28C)
<b>Hypersensitivity necrosis:</b> schistosome eggs (Fig. 1) and dead adults disintegrated cysts of <i>Toxoplasma</i> (Fig. 18), <i>Sarcocystis</i> , and pseudocysts of <i>T. cruzi</i> (Fig. 13), tissue migration of <i>Ascaris</i> (Fig. 27 A), <i>Anisakis</i> (Fig. 28D), <i>Enterobius</i> (Fig. 27B), <i>Fasciola</i> (Figs. 3A,B, 21C), tick bite (Fig. 13A,B)
<b>Fibroblastic proliferation (organization or encapsulation):</b> schistosomiasis (Figs. 1D, 24B,C), onchocerciasis (Fig. 18E), filariasis, cysticercosis, echinococcosis (Fig. 18A), pentastomiasis (Fig. 18F), sparganosis (Fig. 18B), coenurosis
<b>Infarction necrosis, after thrombosis of vessel:</b> toxoplasmosis of central nervous system in immunosuppressed and in newborn (Fig. 12A,B), falciparum malaria, dirofilariasis (Fig. 28B)
<b>Lymphadenitis or lymphoreticular hyperplasia:</b> Postprimary toxoplasmosis (Fig. 11), African trypanosomiasis, Chagas' disease, filariasis, pentastomiasis
<b>Placental involvement:</b> toxoplasmosis, Chagas' disease, malaria
<b>Glomerulonephritis (immune complex):</b> malaria, kala-azar, toxoplasmosis (rare), schistosomiasis, scabies with streptococcosis
<b>Meningoencephalitis:</b> <i>Acanthamoeba</i> (Fig. 4F), <i>Naegleria</i> (Fig. 5E), <i>Toxoplasma</i> (Figs. 5A, B, 10A, B, 12A, B), microsporidiosis, African trypanosomiasis, Chagas' disease, <i>P. falciparum</i> malaria (Fig. 15), cysticercosis, echinococcosis, coenurosis, paragonimiasis, schistosomiasis (Fig. 24C), visceral larva migrans, trichinelliasis, micronemiasis, <i>Angiostrongylus cantonensis</i> , gnathostomiasis
<b>Necrosis followed by calcification:</b> neonatal toxoplasmosis in brain, cysticercosis, coenurosis, schistosomiasis, <i>Trichinella</i> in brain, cysticercosis, coenurosis, schistosomiasis, muscular trichinelliasis (Fig. 18D), dracunculiasis, dirofilariasis, pentastomiasis
<b>Hyperplasia and neoplasia:</b> scabies (Fig. 30B); cholangiocarcinoma – opisthorchiasis, clonorchiasis; carcinoma of bladder – <i>S. haematobium</i> schistosomiasis (Fig. 24B)
<b>Accidental parasitism:</b> anisakiasis (Fig. 28D), toxocariasis (Fig. 28B), dirofilariasis (Fig. 28B)
<b>Comparison of histologic reactions in natural and aberrant host:</b> angiostrongyliasis, echinococcosis (Fig. 29)

The relative roles of the parasite and the host in development of lesions are sometimes in doubt. "Opportunistic organisms" are often erroneously cited as giving rise to infections and lesions. However all

organisms should be regarded as opportunistic. The concept of "opportunistic infections" is usually invoked when the host is immunosuppressed. The change in host-parasite effect is therefore caused by a

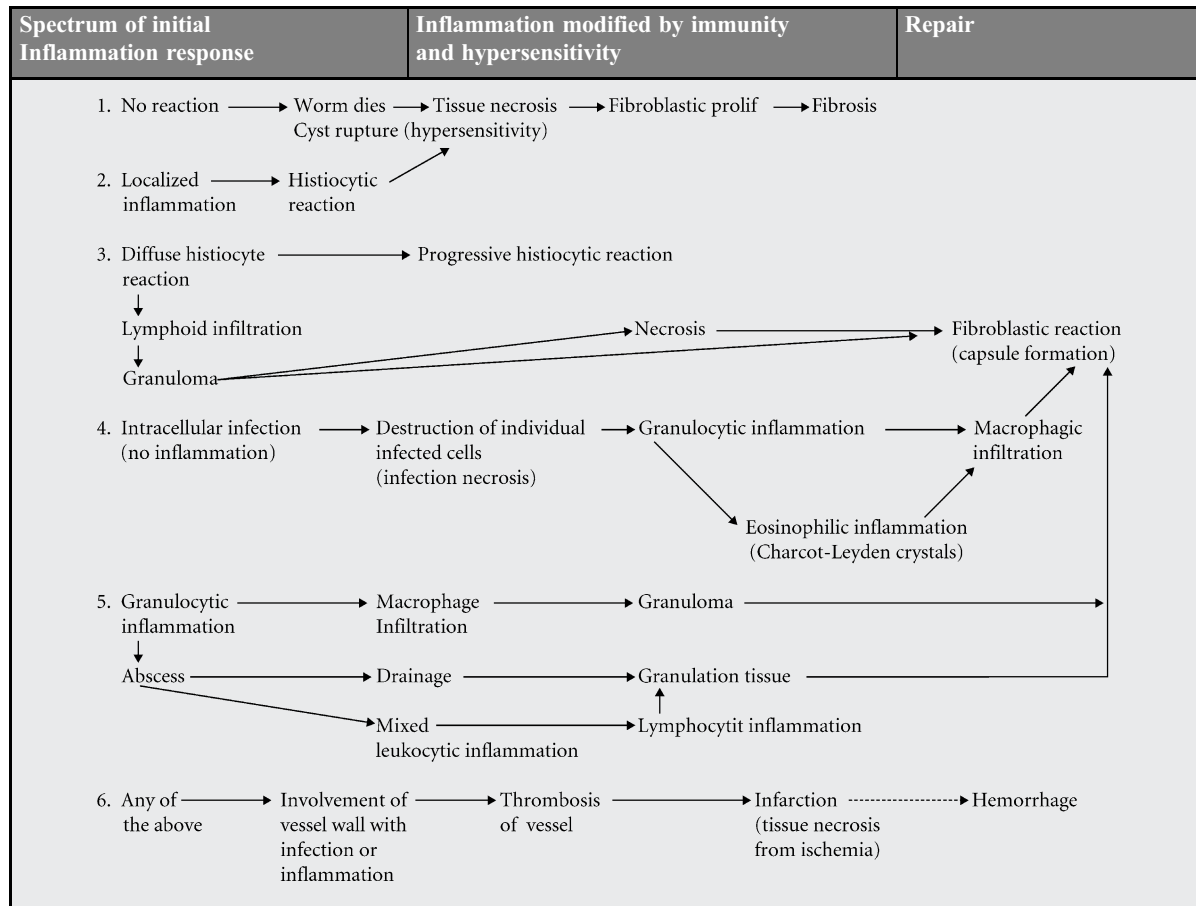
**Pathology. Table 2** Sequential progression of parasite-induced inflammatory reactions over time (according to Frenkel)

compromised capacity to develop or maintain immunity, usually to organisms that are not pathogenic to immunocompetent hosts.

A number of common reactions are listed in Table 1, indicating the limited nature of host response; the same histologic patterns can be elicited by different agents. Also, the character or lesions change with time. In toxoplasmosis the histologic reaction changes from granulocytic to mononuclear (lymphocytic, monocytic, and macrophagic) with the development of immunity, and to hypersensitive inflammation during →chronic infections. Destruction of cells by intracellular parasites, or infection →necrosis, must be differentiated from →hypersensitivity necrosis, mediated by cytolytic T lymphocytes, and from infarction necrosis.

If, during a →chronic infection such as schistosomiasis, new eggs are produced over a long period of time, each egg initiates a histologic reaction with a typical course of development, resulting in a pleomorphic pattern in adjacent tissues affected by eggs of different ages (Fig. 1). The courses of a number of inflammatory reactions are outlined in Table 2. Parasitic infections in an immunosuppressed individual are associated with

a modified and usually diminished inflammatory response (Fig. 2) so that the lesion may be atypical and reflect more microbial damage than host defense or hypersensitivity.

While the histologic picture may be useful to indicate one of several etiologic agents it is rarely diagnostic. Although eosinophils may have evolved as a defense against this wormy world, their presence is not pathognomonic (Figs. 1, 3, 24). Therefore, identification of an etiologic agent itself, whether protozoan, helminthic, bacterial, fungal, viral, etc., is essential; alternatively, assignation of the process as microbial, and inflammatory, degenerative, or neoplastic, are prerequisite to a definitive diagnosis of the process occurring in the tissue, and together with immunologic and serologic information necessary for an interpretation of its pathogenesis.

Pathologic findings, whether from biopsy or autopsy are useful diagnostically because the etiologic agent is generally found in or near the lesion. However, the etiologic organisms may not be frequent enough to be seen in routinely stained sections, so that special staining for suspected organisms may be necessary, or



**Pathology. Table 3** Main groups of parasite pathogens in humans (according to Frenkel)

1. Intestinal Protozoan Infection	12. Trematode Infections
→ Amebic infections	→ Fasciolopsiasis
→ Acanthamoebiasis	→ Fascioliasis
→ Naegleriasis	→ Clonorchiasis
→ [Entamoeba histolytica] Infection	→ Opistorchiasis
2. Lumen-Dwelling Flagellates	→ Paragonimiasis
→ Giardiasis	→ Schistosomiasis
→ Trichomoniasis	13. Intestinal Nematode Infection
→ [Blastocystis hominis] Infection	→ Enterobiasis
3. Intestinal Ciliate Infection	→ Trichuriasis
→ Balantidiosis	14. Intestinal and Tissue Nematode Infections
4. Intestinal Coccidiosis	→ Ascariasis
→ Isosporosis	→ Cutaneous Larva Migrans
→ Cyclosporiasis	→ Hookworm Disease
→ Cryosporidiosis	→ Cutaneous Larva Migrans
→ Intestinal Sarcosporidiosis	→ Strongyloidiasis
5. Tissue Protozoan Infections/Disseminated Tissue Infections	→ Capillariasis
→ Toxoplasmosis	→ Anisakiasis
→ Muscle Sarcosporidiosis	15. Tissue Nematode Infections
→ Microsporidiosis	→ Trichinellosis
6. Leishmaniasis	→ Gnathostomiasis
→ Cutaneous Leishmaniasis	→ Micronemiasis
→ Mucocutaneous Leishmaniasis	→ <i>Angiostrongylus cantonensis</i> Infection
→ Diffuse Cutaneous Leishmaniasis	→ Abdominal Angiostrongylosis
→ Visceral Leishmaniasis	→ Dracunculiasis
7. Trypanosomiasis	16. Blood and Tissue Nematode Infections
→ Gambian Sleeping Sickness	→ Filariasis
→ Rhodesian Trypanosomiasis	→ Loiasis
→ Chagas' Disease	→ Onchocerciasis
8. Pulmonary Pneumocystosis	→ Dirofilariasis
9. Blood Protozoan Infections	→ Zoonotic Dipetalonemiasis
→ Malaria	17. Pentastomiasis
→ Babesiosis	18. Arthropod Infections
10. Helminth Infections	→ Scabies
11. Cestode Infections	→ Tungiasis
→ Taeniasis	→ Pediculosis
→ Cysticercosis	→ Myiasis
→ Echinococcosis	→ Demodicosis
→ Coenurosis	→ Tick Bites
→ Sparganosis	

that cultures or subinoculation to animals must be employed for diagnosis. Histopathologic findings may suggest the mechanisms by which lesions are produced (the pathogenesis), e.g., infection necrosis from microbial destruction of cells, hypersensitivity accentuating the lesions and → histologic reactions, and immunity which tend to delimit or repair them (the immunopathology). However histopathology is rarely specific

and must be complemented by the identification of the organism or its DNA in the lesions, and, if a rare etiologic agent is identified, by if possible fulfilment of Koch's postulates. Serologic reactions are also useful. Parasitologists are focusing on the **pathogenesis** and **immunopathology** of parasitic diseases, because so little is known about them. The experimental analysis of both depends heavily on the use of model infections

**Pathology. Table 4** Survey of the pathology of cestode and trematode infections of man (according to Frenkel)

	Main pathogenic stage	Main lesions, location of the worm	Necrosis	Eosinophilia	Granulomata	Adult site (other hosts)	Larval site (other hosts)	Method of infection
<b>Cestode infections</b>								
Taeniasis	Adult	None, small intestine	–	–	–	Small intestine (carnivores)	(cattle, pigs)	Ingestion of infected meat
Cysticercosis	Larva	Cysts, many tissues	After death of worm	Common	After death of larva	Small intestine (carnivores)	Many tissues, omnivores	Ingestion of eggs from feces
Echinococcosis	Larva (hydatid)	Cysts, many tissues	Especially <i>E. multilocularis</i>	Common	After death of hydatid	Intestine (of dogs, wolves, foxes)	Many tissues	Ingestion of eggs from feces
Coenurosis	Coenurus cyst	Cyst, brain, eye	After death of cyst	Rare	After death of cyst	Intestine (of dogs)	Brain, eye	Ingestion of eggs from feces
Sparganosis	Larval tapeworm	Nodules, subcutaneous or visceral	After death of worm	Common	After death of worm	Intestine (dogs, cats)	Various tissues	Ingestion of eggs from feces
<b>Trematode infections</b>								
Fasciolopsiasis	Adult	None, duodenum, jejunum	Abscesses	–	Ulcers	Intestine (pigs, dogs)	(Water plants)	Eating, drinking
Fascioliasis	Larva, adults	Liver and bile duct dysfunction	Enlarged liver, dysfunction	Common	–	Bile duct (cattle)	Larvae wander through liver	Eating, water plants, drinking
Clonorchiasis	Adult	Obstruction, bile ducts	–	Slight	–	Bile duct	Snails, fish	Ingestion of fish or crustaceans
Paragonimiasis	Adult	Bronchopneumonia, brain abscess	Around adults	Common	Around eggs	Lung (cats, pigs, dogs, etc.)	Snails, freshwater crabs	Freshwater crustaceans
Schistosomiasis	Eggs	Multiple, gut, liver, bladder, brain	Around dead adults	Usual	Around eggs and dead adults	Portal or mesenteric veins	Snails, water	Drinking or skin contact with snail-infested water

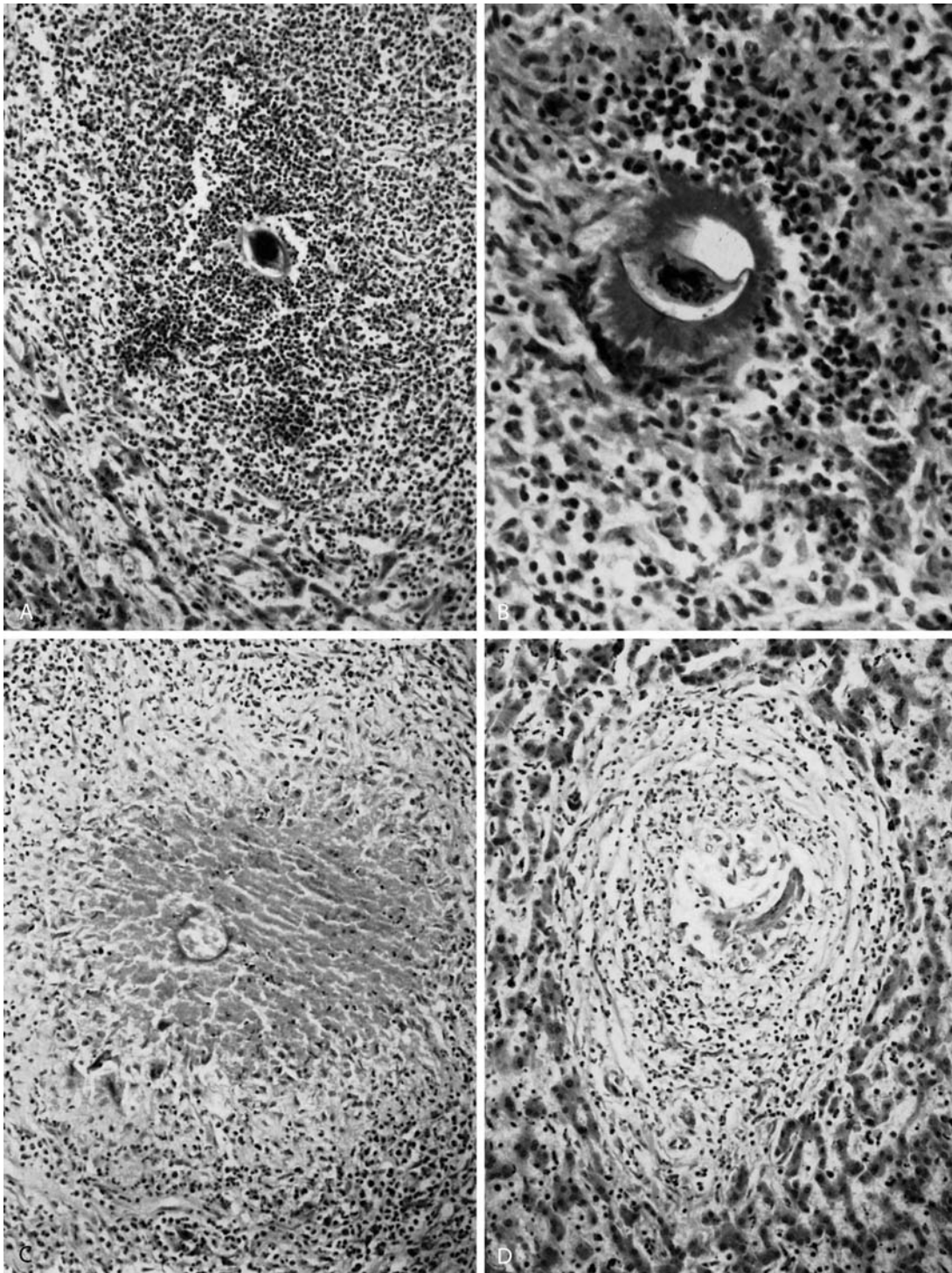

**Pathology. Figure 1 A–D** Development of lesions to schistosome eggs in liver of a patient who died with a 1 month history of *Schistosoma japonicum* infection. **A** Egg with intense infiltration of eosinophilic leukocytes. **B** Egg surrounded by stellate eosinophilic matrix, the Splendore-Hoeppli reaction, and predominantly eosinophilic infiltration. **C** Destroyed egg with Splendore-Hoeppli reaction surrounded by zones of necrosis, epithelioid cells, and eosinophils. **D** Giant and epithelioid cells occupy the center of the *granuloma*; the egg has probably been digested. In the periphery a fibroblastic reaction is depositing *collagen*, loosely infiltrated with eosinophils and a few lymphocytes. The surrounding liver cells are beginning to regenerate as shown by binucleate liver cells. Hematoxylin and eosin (HE): A, C, D  $\times 120$ , B  $\times 300$ .

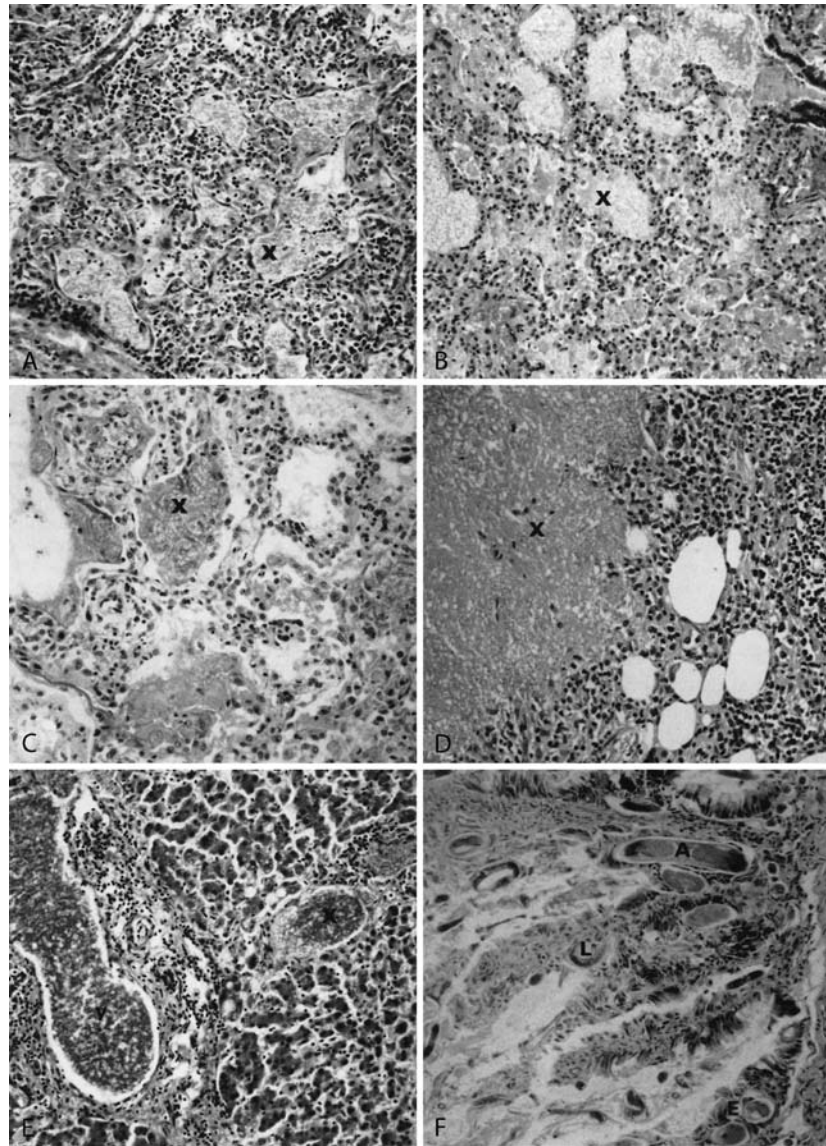

**Pathology. Figure 2 A–F** Lesions with minimal reactions because of suppression of cellular immunity and delayed type hypersensitivity. **A** *Pneumocystis* sp. plasma cell →pneumonia in a malnourished infant. Both →trophozoites and cysts of *Pneumocystis* sp. are present in the alveoli and appear as a “foamy” colony (X). Plasma cells are the predominant cell in the widened alveolar walls. Type 2 pneumocytes are prominently lining the alveoli. This is interpreted as a progressive primary infection. HE × 120. **B** *Pneumocystis* sp. pneumonia in 2-year-old baby with acute leukemia and also immunosuppressed by virtue of treatment with prednisone, methotrexate, and 6-mercaptopurine for 6 months. Foamy colonies (X) are again visible, but only few lymphocytes are present in the alveolar walls. *Pneumocystis* sp. colonies are not present in the bronchiole (upper right). This could be a primary infection or reinfection. HE × 120. **C** *Pneumocystis* sp. pneumonia in 27-year-old male with lymphocytic lymphoma treated with prednisone, methotrexate, and chlorambucil for 3 months. Foamy colonies (X) composed of trophozoites and cysts fill some alveoli. This is either a recrudescence infection or a reinfection. Periodic acid Schiff (PAS)×120. **D** *Pneumocystis* sp. (X) growing free in supraclavicular lymph node extending into fibrofatty tissue. From a 63-year-old woman with chronic lymphocytic leukemia. Slide courtesy of Dr. Michael Coughron. HE × 120. **E** *Pneumocystis* sp. in liver of adult with hypoproteinemia. Groups of organisms are seen both free (X) in the liver and surrounded by fibrosis and lymphocytic infiltration (A). PAS ×120. **F** →*Strongyloides* sp. in the colon of a 31-year-old woman from Central America who had lived in Los Angeles for 17 years. The patient developed acute lymphoblastic leukemia and was treated with prednisone, vincristine, and 6-mercaptopurine. Adults (A), eggs (E), and larvae (L) can be seen. Although there is some postmortem autolysis, it is clear that little →inflammatory reaction is present in this immunosuppressed patient. This is a recrudescence chronic infection. HE × 120.

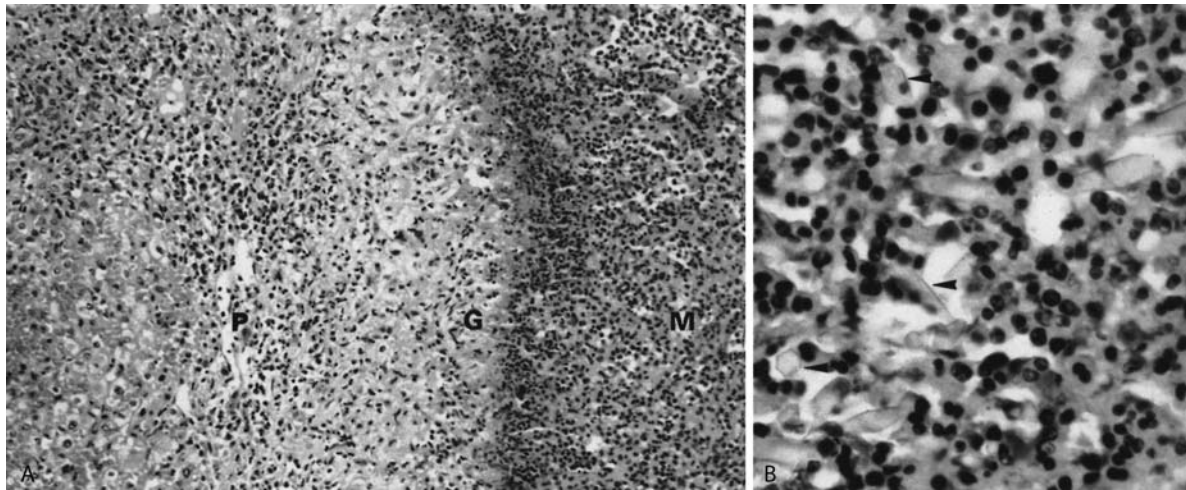

**Pathology. Figure 3 A, B** Eosinophil and basophil infiltration may be accompanied by Charcot-Leyden crystals. Biopsy of liver of a 33-year-old woman from Central America with hepatomegaly, who was passing eggs of *Fasciola hepatica* in the stools, and had a history of the ingestion of watercress. **A** Apparent migration tract (M) in liver, with eosinophilic granulocytes and Charcot-Leyden crystals. This is bordered by an epithelioid cell granuloma (G) and hemorrhagic liver parenchyma (P) infiltrated with lymphocytes and plasma cells. HE  $\times$  128. **B** Rhomboid and hexagonal profiles of Charcot-Leyden crystals (arrowheads) among eosinophil granulocytes. HE  $\times$  510.

or, in absence of a good model, by partial analogies. Sometimes spontaneous animal models in domestic, wild, or laboratory animals are informative, such as for pneumocystosis of rats. Another approach is to compare infection in a variety of inbred strains of mice differing in innate resistance and ability to acquire

immunity, to provide a spectrum of reaction patterns that by analogy may provide information applicable to this infection in the genetically diverse human population.

More detailed information on the lesions and on other pathologic effects are given under the headword of the respective diseases and are summarized in Table 3.

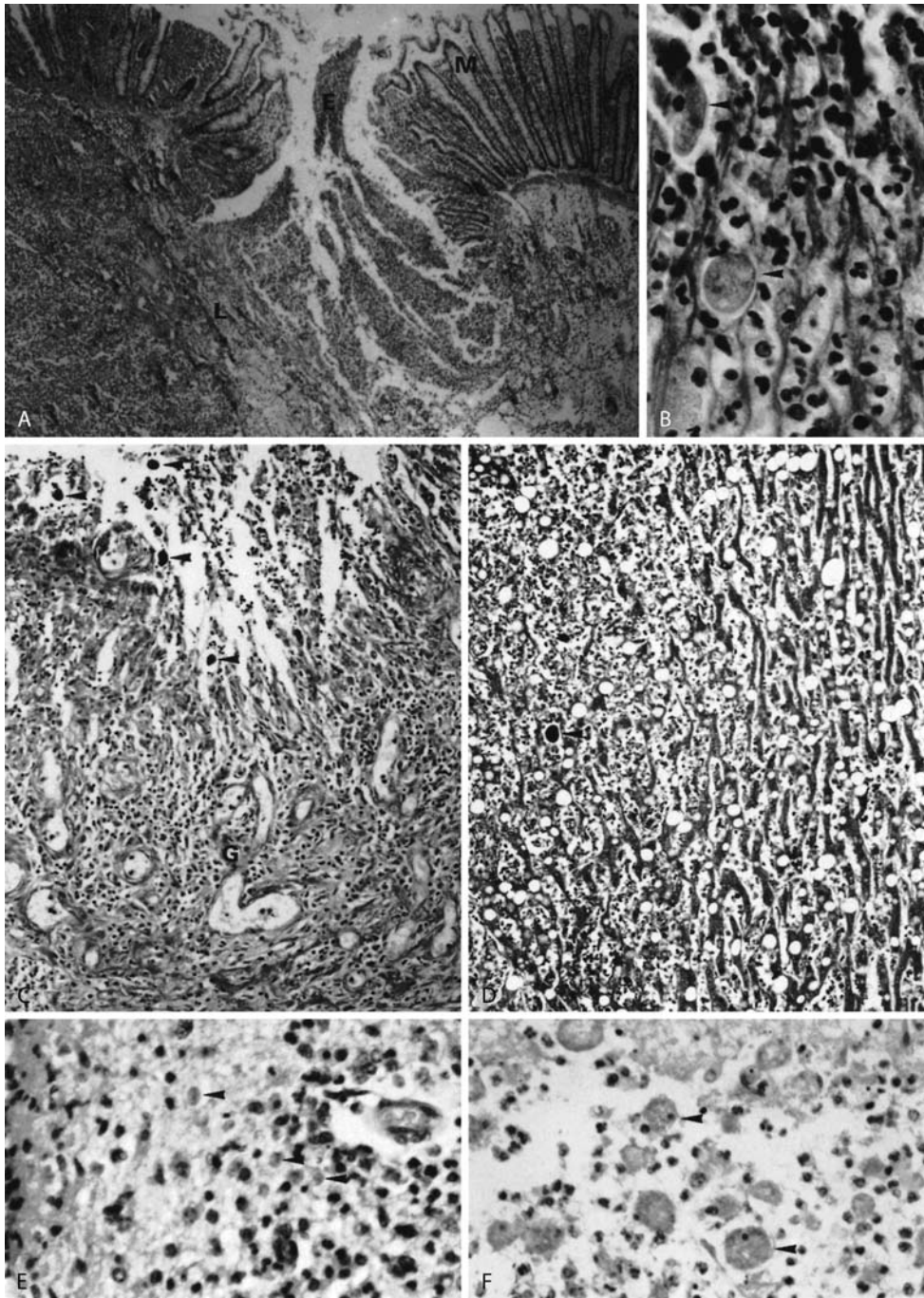

**Pathology. Figure 4 A–F** Infection necrosis of adjacent cells in →**amoebiasis**. **A** Flask-shaped →**ulcer** with narrow →**neck** containing exudate (E) extending through mucosa (M), into lamina propria (L) of colon. HE × 36. **B** Fibrinous exudate with granulocytes and 2 trophozoites of →**Entamoeba histolytica** (arrowheads). HE × 480. **C** Loose granulation tissue (G) forms the base of a deep ulcer extending through the muscularis externa of the colon. Trophozoites (arrowheads) stain intensely with the PAS technique. Several ulcers extended into the serosa and/or several perforated into the peritoneum. PAS × 120. **D** Margin of liver →**abscess** with hepatitis and Fatty change. One trophozoite is embedded in necrotic liver accompanied by neutrophil leukocytes and macrophages. PAS × 120. **E** *Naegleria* sp. →**encephalitis** with trophozoites (arrowheads) infiltrating the outer cortex in which neuronal nuclei undergo early pyknosis accompanied by granulocytes. The meninges are densely infiltrated with granulocytes. HE × 300. **F** Acanthamoebic encephalitis with trophozoites (arrowheads) in necrotic brain accompanied by few granulocytes and macrophages HE × 300.

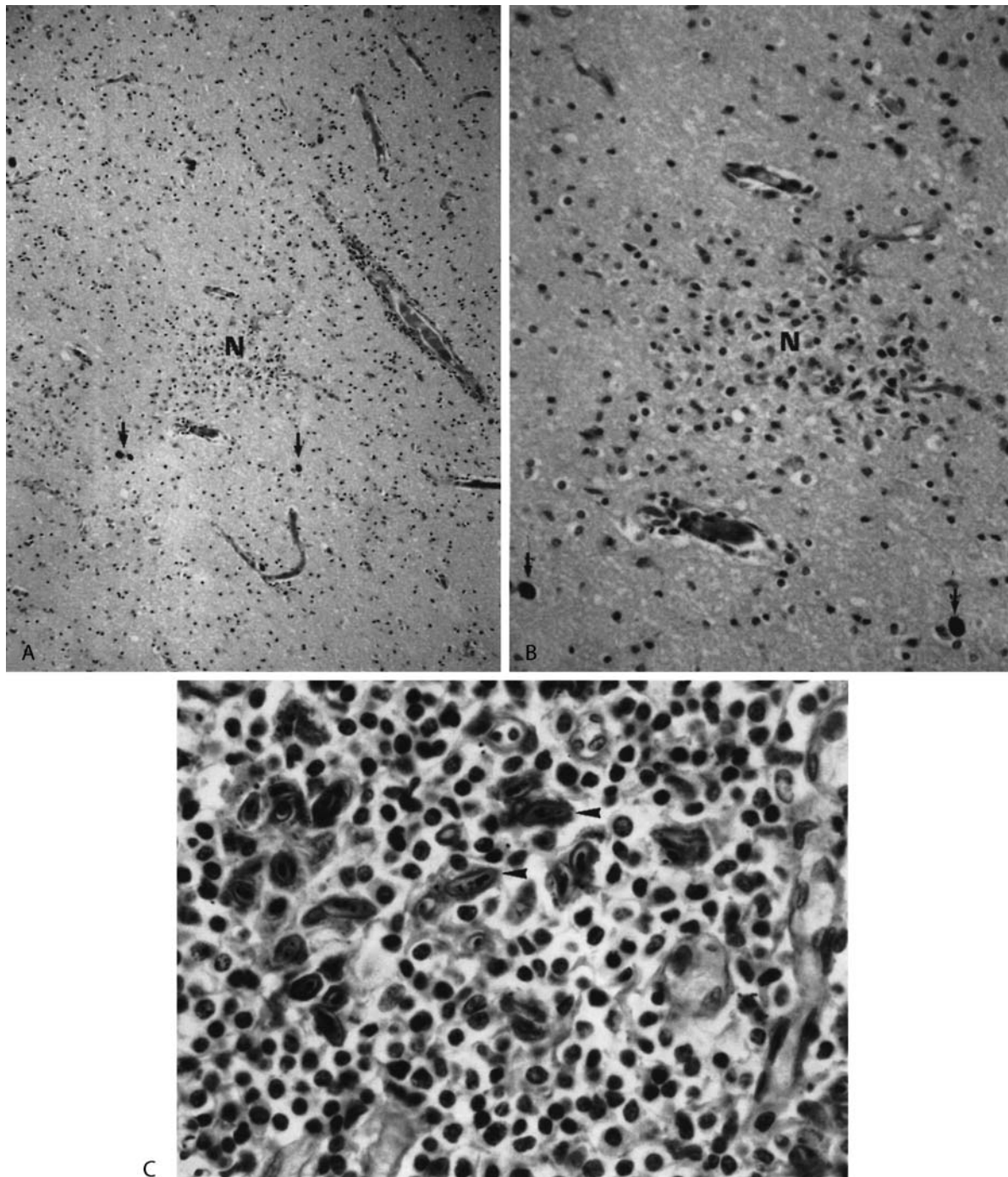

**Pathology. Figure 5** A–C Lack of inflammatory reaction around protozoan cysts indicates impermeability of cyst or →cell membrane to antigen; however, active inflammation follows cyst rupture. **A** Several intact →*Toxoplasma gondii* cysts not accompanied by inflammation are indicated by arrows. A glial →nodule (*N*) and perivascular infiltration are shown in the center PAS × 72. **B** Toxoplasmic encephalitis (enlargement of A). Two *Toxoplasma* cysts devoid of inflammation. The glial nodule (*N*), in the center, is probably formed from the rupture of a cyst. The liberated →bradyzoites have been destroyed by the patient's immunity and no secondary infection with →tachyzoites or young cysts was found. However, similar glial →nodules accompany proliferating tachyzoites. PAS × 180. **C** →Hypnozoites of *Cystoisospora belli* in a PAS positive envelope (arrowheads) in lymphocyte-depleted lymph node of a patient with AIDS. PAS × 480. Slide courtesy of Dr. Carlos Restrepo.

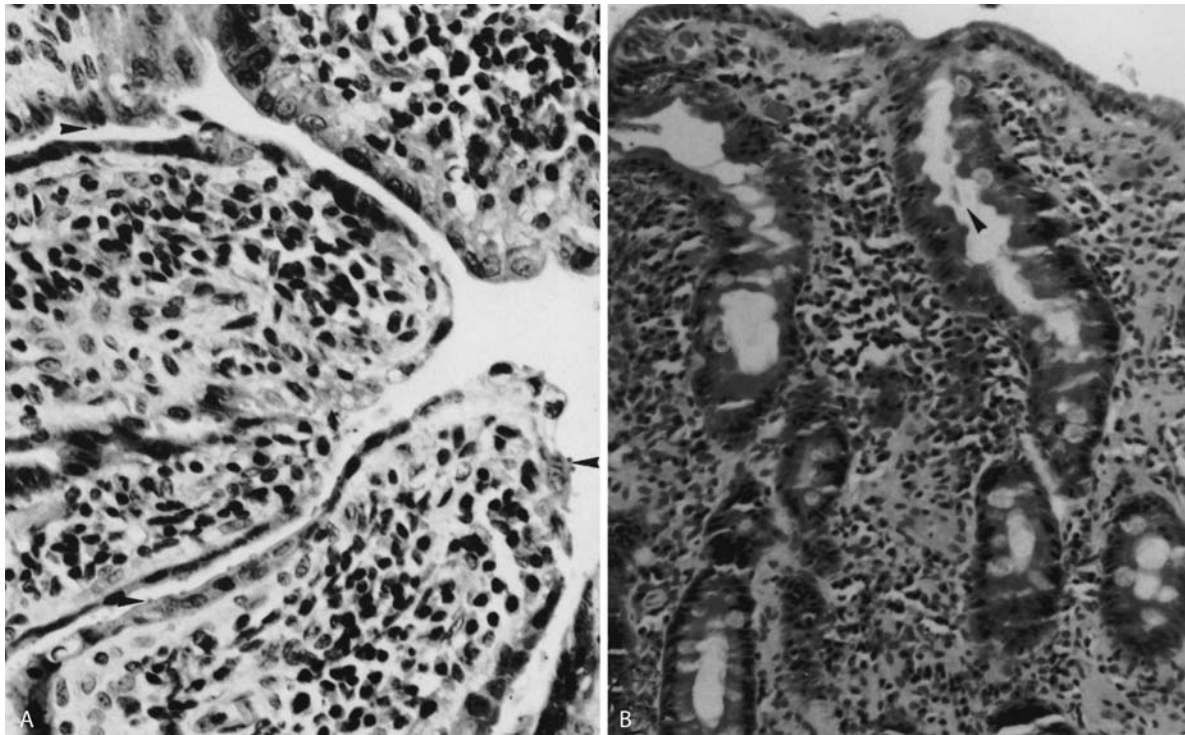

**Pathology. Figure 6 A, B** **A** Atrophy of epithelium due to attrition of cells. Chronic cryptosporidiosis in patient with AIDS, with flattened epithelial cells covering intestinal villi. Cryptosporidia indicated by arrowheads. HE  $\times 375$ . **B** *Giardia* infection in a patient with AIDS shows shortened villi and plasma cell infiltration. HE.  $\times 450$ . Slide by courtesy of Dr. Linda Ferrell.



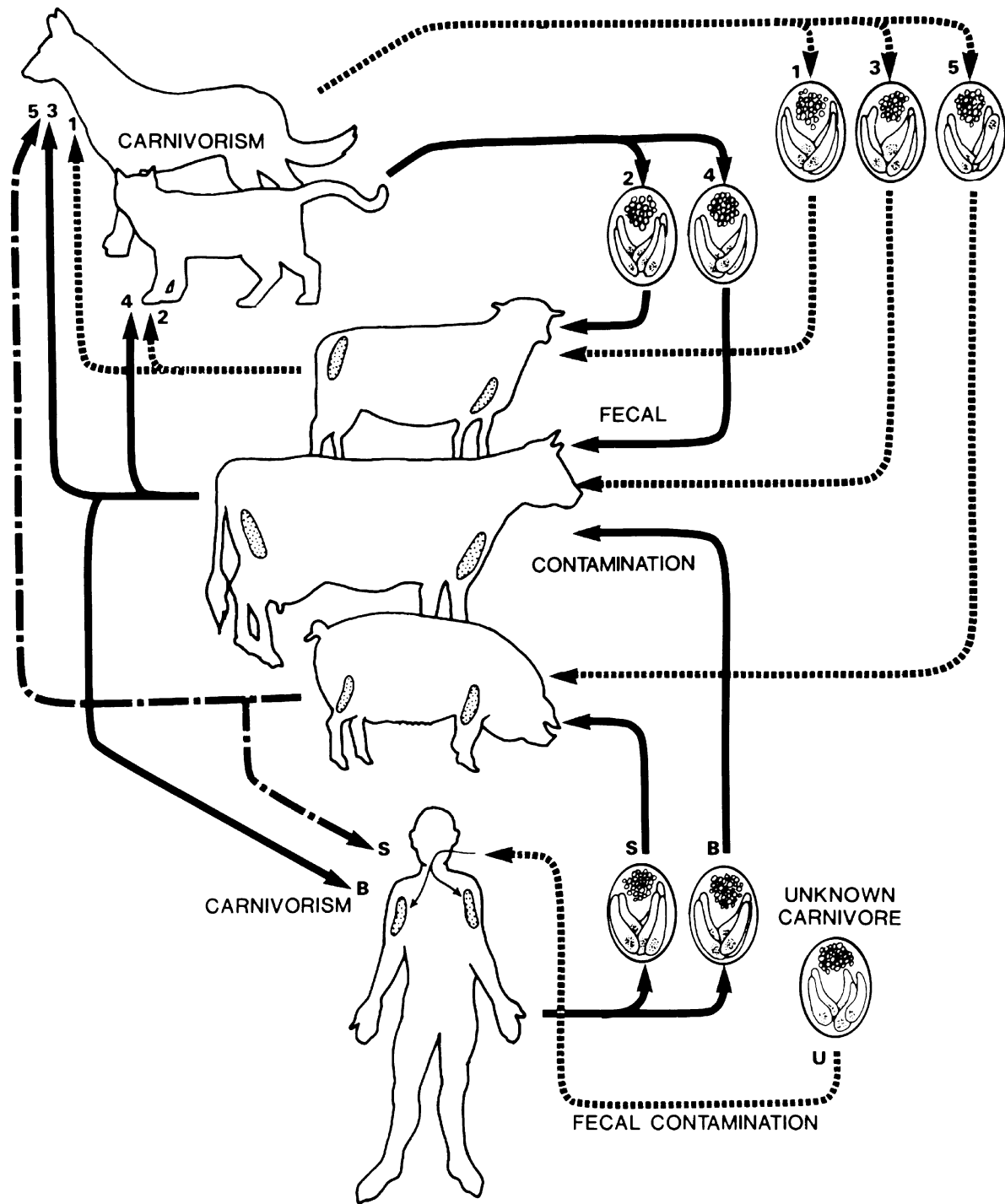

**Pathology. Figure 7** → *Sarcocystis* transmission cycles involve man and some domestic animals. Man is the definitive host of *S. bovis* (B) and *S. suis* (S), the 2 human intestinal sarcosporidians. Man is the accidental → *intermediate host* with *Sarcocystis* of unknown species (U), where skeletal and heart muscles are parasitized. Also indicated are the cycles of *S. ovis* (1), *S. ovifelis* (2), *S. bovis* (3), *S. bovis* (4), and *S. suis* (5). Compare → *Sarcocystis*.

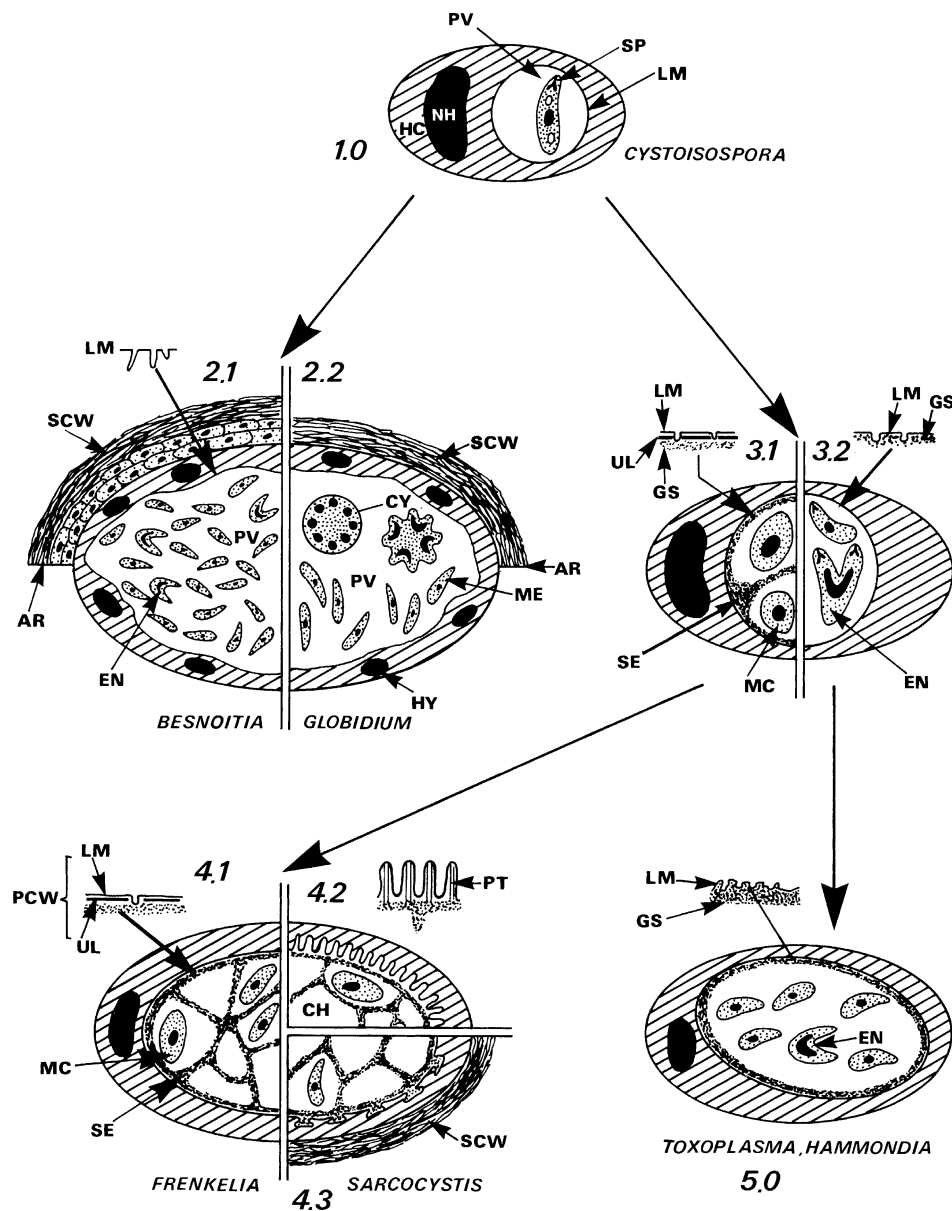

**Pathology. Figure 8** Diagrammatic representation of cysts in different cyst-forming *coccidia*. 1 The simplest cyst formation. A parasite (*Sporozoite*) is included into a *parasitophorous vacuole* (PV) which is bounded by a single cell membrane (LM). This is representative of the “monozoic” cysts of *Cystoisospora felis*, *C. rivolta*, and *C. ohioensis* in transport (i.e., *paratenic*) hosts (such as mice). 2 In *Besnoitia* spp. (2.1) and *Globidium* spp. (2.2) cysts the original parasitophorous vacuole (PV) is enlarged and is filled by numerous parasites reproducing by *endodyogeny* (2.1) or *schizogony* (2.2). Even in old cysts the PV is bounded by a single unthickened cell membrane (LM). A *secondary cyst wall* (SCW) consisting of fibrillar material is always present; the host cell nuclei generally undergo hypertrophy and *hyperplasia*. 3 Young cysts of *Frenkelia* spp. and *Sarcocystis* spp. (3.1), and *Toxoplasma gondii* and *Hammondia* spp. (3.2) show the indicated features. In cysts of *Frenkelia* spp. and *Sarcocystis* spp. (3.1) spherical *metrocysts* (MC) are present (in chamber-like spaces) and divide by endodyogeny, whereas in *Toxoplasma gondii* and *Hammondia* spp. the slender parasites divide by endodyogeny. 4 Mature tissue-cysts of *Frenkelia* and *Sarcocystis* are characterized by typical septa (SE) formed by the ground substance (GS). In *Frenkelia* spp. and some *Sarcocystis* spp. (4.1) the *primary cyst wall* (PCW) never forms long protrusions, whereas in other *Sarcocystis* spp. typical protrusions occur (4.2; 4.3). With cysts of *S. ovifelis*, a secondary cyst wall (ECU) surrounds the parasitized muscle fiber (4.3). 5 The primary cyst wall of mature *Toxoplasma gondii* and *Hammondia* spp. cysts remains smooth; the cysts are tightly filled with cyst merozoites (bradyzoites). Typical septa as well as metrocysts never occur. AR, artificially interrupted SCW; CH, chamber-like space filled with parasites; CY, *cytomere*; EN, endodyogeny; GS, ground substance; HC, host cell; HY, hypertrophied host cell nuclei; LM, limiting single membrane of PV; MC, metrocyst; ME, *merozoite*; N, nucleus; NH, nucleus of host cell; PCW, primary cyst wall; PT, protrusion of PCW; PV, parasitophorous vacuole; SCW, secondary cyst wall; SE, septum formed by GS; SP, sporozoite; UL, underlying dense material. (From Mehlhorn and Frenkel 1980)

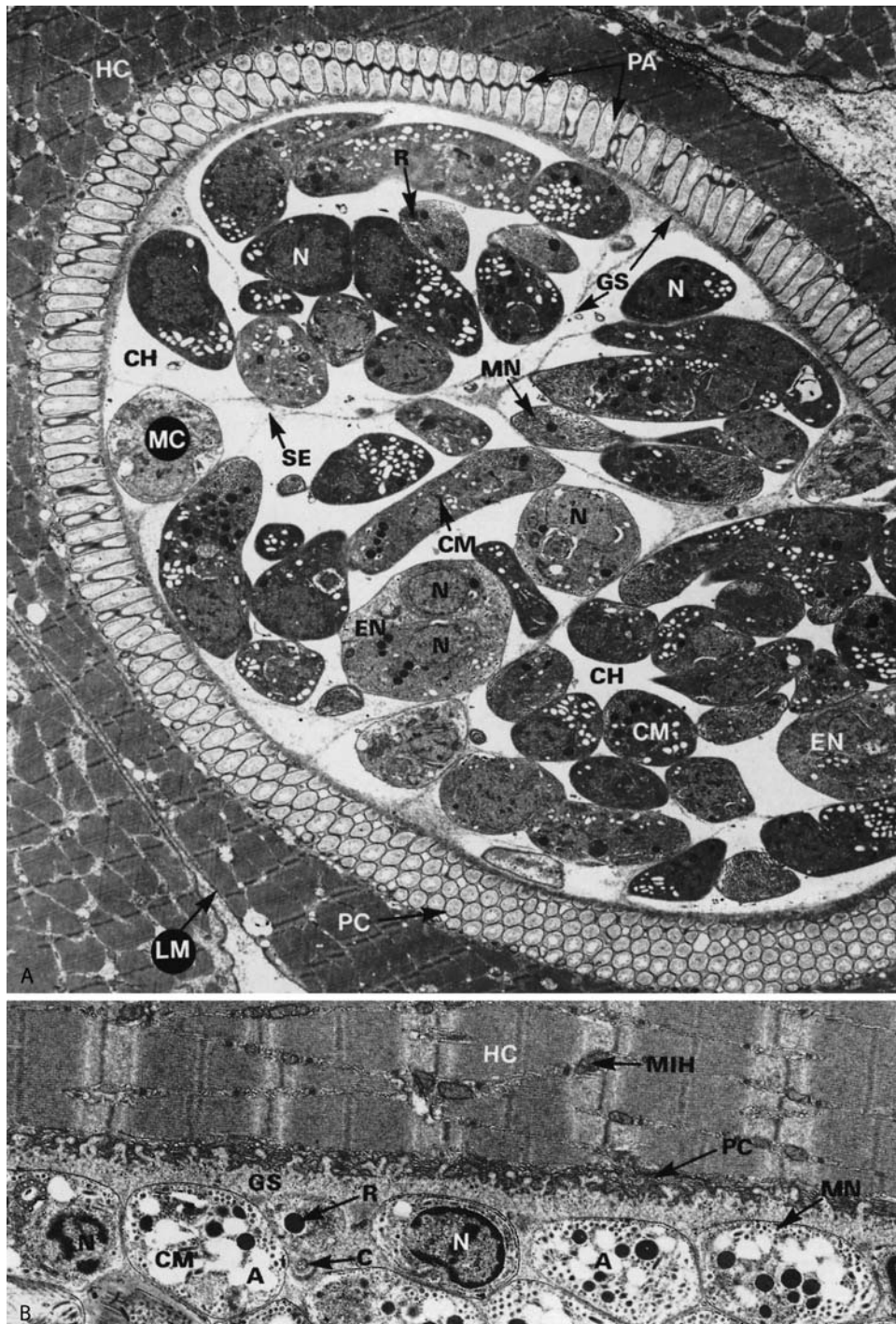

**Pathology. Figure 9 A, B** TEMs of section through tissue-cysts of *Sarcocystis ovis* (A) and *Toxoplasma gondii* (B), which are situated within a host cell (for interpretation compare Fig. 8; from Mehlhorn and Frenkel 1980).  $\times 4,000, 8,000$ . A,  $\rightarrow$  Amylopectin; C,  $\rightarrow$  conoid; CH, chamber-like space; CM, cyst merozoite (=bradyzoite); EN, endodyogeny stage; GS, ground substance; HC, host cell; LM, limiting membrane; MC, merozoite; MIH, mitochondrion of the host cell; MN,  $\rightarrow$  micronemes; N, nucleus; NH, nucleus of the host cell; PA, palisade-like protrusions of the PC; PC, primary cyst wall; R,  $\rightarrow$  rhoptries; SE, septum formed by ground substance.

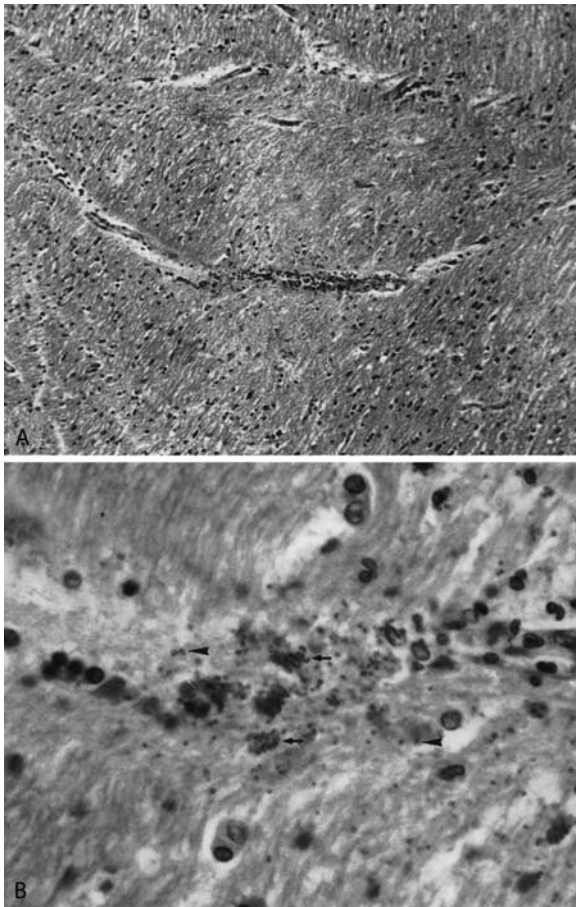

**Pathology. Figure 10 A, B** Necrosis of parasitized cells. **A** Recrudescence toxoplasmic brain in patients with Hodgkin's disease treated with 8–12 replacement doses of prednisone and with cyclophosphamide. The central area devoid of nuclei, above and below the blood vessel, contains numerous *Toxoplasma gondii*. HE  $\times$  90. **B** Enlargement of A showing the area of cell necrosis with intracellular (arrows) and scattered *Toxoplasma gondii* (arrowheads). HE  $\times$  570. (From Frenkel 1971)

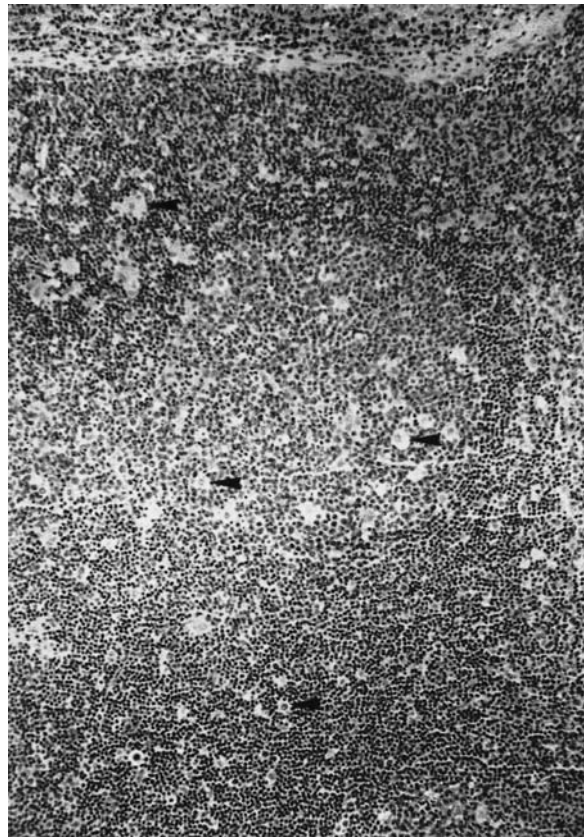

**Pathology. Figure 11** Lymphoreticular hyperplasia accompanying acquisition of immunity. Cervical lymph node of 21-year-old woman who had delivered a toxoplasmic baby 6 weeks earlier. The clear cells are histiocytes (arrowheads). HE  $\times$  100. (From Frenkel 1971)

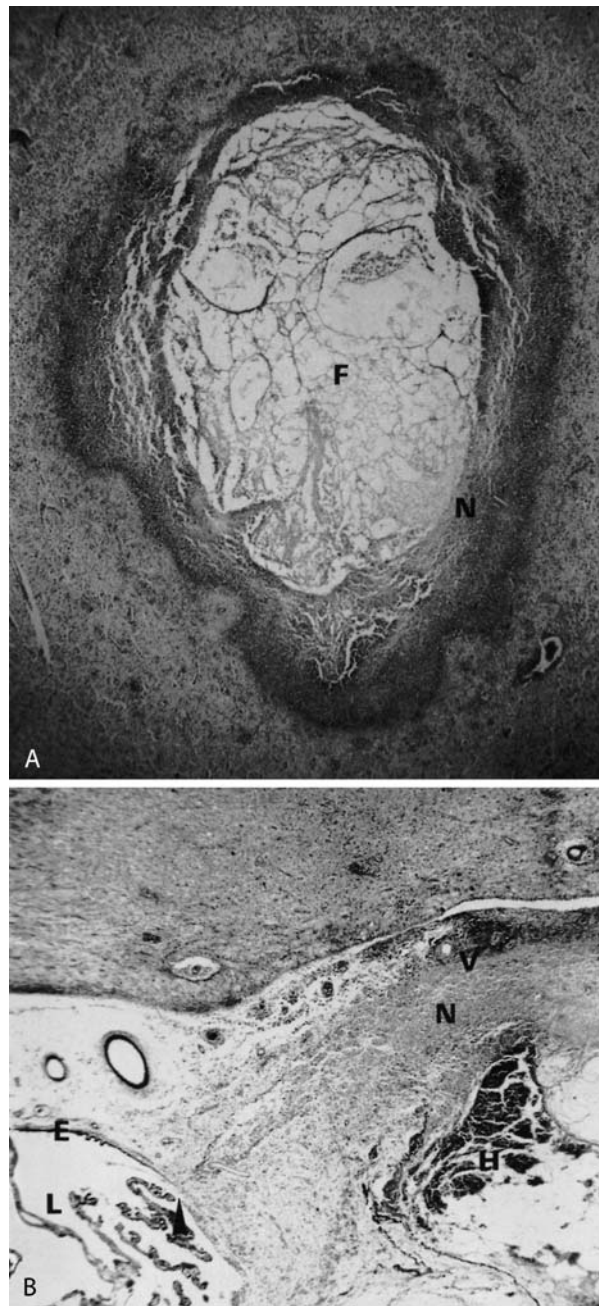

**Pathology. Figure 12 A, B** Periventricular necrosis is a unique and pathognomonic lesion of congenital toxoplasmosis. **A** Aqueductal obstruction with fibrinous (E) exudate and periaqueductal necrosis (N) at level of pons in 6-week-old infant. HE  $\times 17$ . **B** Transition from ependyma (E)-lined lateral ventricle (L) to periventricular  $\rightarrow$ vasculitis (v) and necrosis (N). From the edge of the ependymal epithelium (arrowhead), the ulcer shows an increasing basophilia and vasculitis with necrosis at right. Hemorrhage (H), necrotic brain (N), and vascular leakage account for the yellowish ventricular fluid with high protein content typically found in such babies. Phosphotungstic acid hematoxylin  $\times 17$ . (From Frenkel 1971)

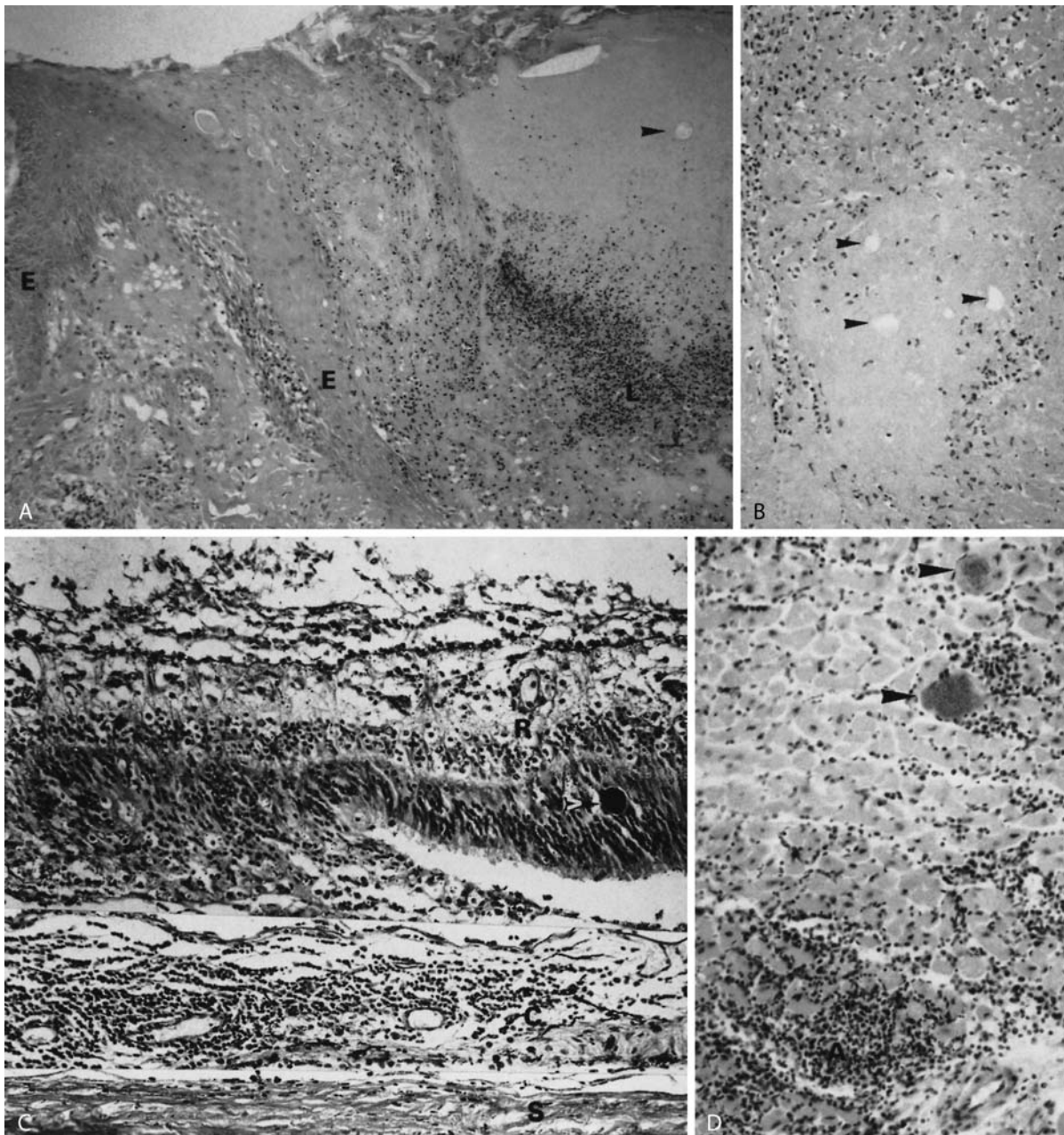

**Pathology. Figure 13 A–D** Delayed-type hypersensitivity inflammation with necrosis of cells and tissue adjacent to antigenic material or parasite. **A** Tick bite lesion 4 months after removal of tick, (probably *Dermacentor variabilis*) from knee of 30-year-old male. The skin ulcer shows a necrotic scab (top right) covering the ulcer which contains a chitinous fragment (arrowhead) from mouthparts of the tick. At the base of the ulcer are leukocytes (L) undergoing necrosis, and at its margin acanthosis of epithelial rete pegs (E), hyperkeratosis, and parakeratosis. Deep in the ulcer chronic inflammation and fibrosis extend through the dermis into the subcutaneous connective tissue. HE  $\times$  85. **B** At a depth of 2 mm, 3 other chitinous fragments surrounded by necrosis (arrowheads) and granulocytic inflammation are found in the same sections. HE  $\times$  128. **C** Toxoplasmic retinochoroiditis (left) probably following rupture of *Toxoplasma gondii* cyst, which when intact (arrowhead) was not chemotactic. R, Retina; C, choroid; S, sclera. PAS  $\times$  128 (From Frenkel 1971). **D** Chagas' myocarditis with 2 intact  $\rightarrow$ pseudocysts (arrowheads) and neutrophilic abscesses (A) and destruction of myocardial fibers probably from rupture of a pseudocyst. There is focal and diffuse lymphohistiocytic infiltration with some plasma cells. HE  $\times$  128. For additional examples see Figs. 1C, 27, 28.

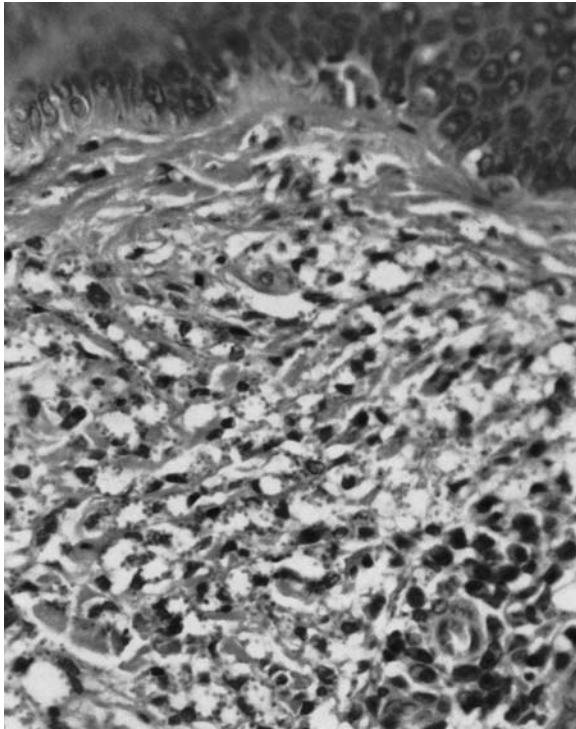

**Pathology. Figure 14** →Histiocytic reaction with relative anergy. Diffuse →cutaneous leishmaniasis gives rise to nonulcerating raised nodules composed of histiocytes each of which contain numerous parasites in each of the many →vacuoles visible. The epidermis is slightly stretched. A plasma cell infiltration is present around the blood vessels. HE × 350.

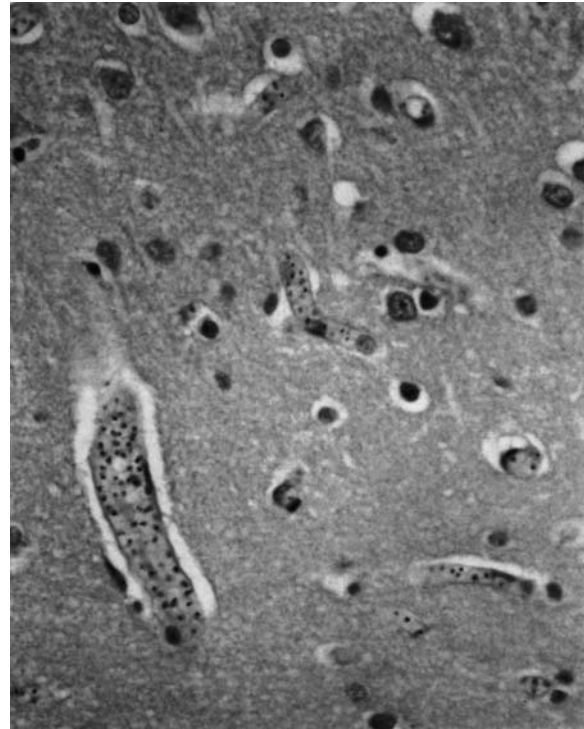

**Pathology. Figure 15** →Tissue anoxia from obstruction of capillaries with erythrocytes infected with *P. falciparum*. The capillaries in the brain of this young male are filled with parasitized erythrocytes each marked by its →pigment granule. The flow of parasitized blood has been compared to the flow of sludge. Hence the brain becomes anoxic and edematous, sometimes weighing 1,700 g instead of the normal 1,200 g. HE × 375.

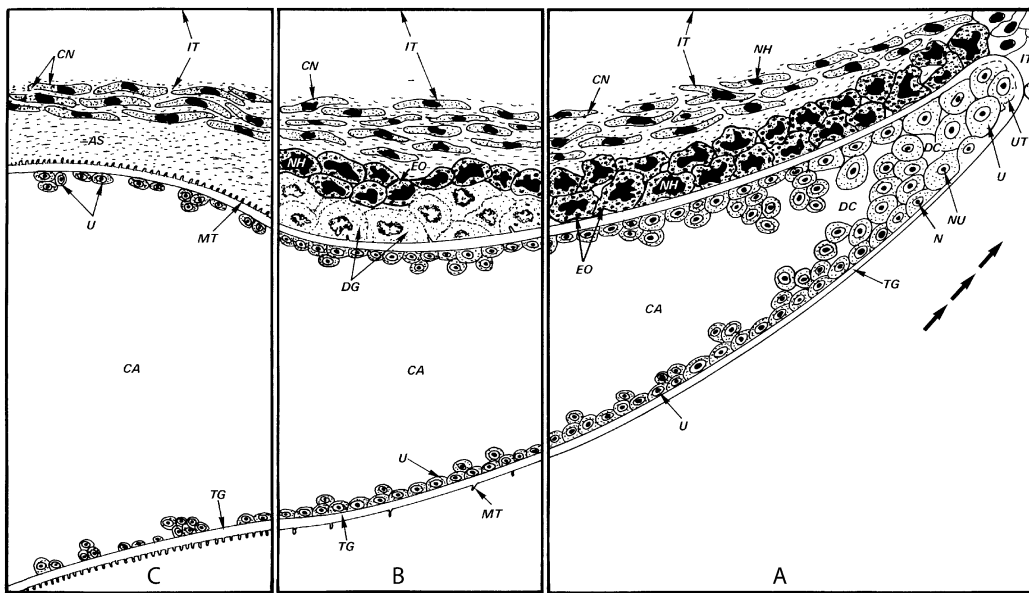

**Pathology. Figure 16 A–C** Diagrammatic presentation of longitudinal section in different regions of parasite protrusions of larval *E. multilocularis*. Such steps of development were observed in all material studied (in experimentally infected rodents and in natural infections of humans). Arrows in **A** indicate the direction of growth. In section **C** formation of →brood capsules may start from accumulation of undifferentiated cells (From Mehlhorn et al. 1983). *AS*, Amorphous substance (=laminated layer); *CA*, cavity; *CN*, connective tissue; *CO*, collagen; *DC*, developing cavity; *DG* degenerating host defense cells; *DI*, division of undifferentiated cells; *KG*, eosinophilic granules; *EO*, eosinophilic granulocytes; *GR*, granules; *IF*, infiltration zone of host's defense cells; *IT*, intact tissues; *M*, membranes of fusing undifferentiated cells; *MI*, mitochondrion; *MT*, →microtriches of →tegument; *N*, nucleus; *NH*, nucleus of host cells; *NU*, →nucleolus; *PT*, protrusion of tegumental surface; *TG*, tegument; *U*, undifferentiated cells; *UT*, undifferentiated cells when fusing with tegument; *V*, vacuole.

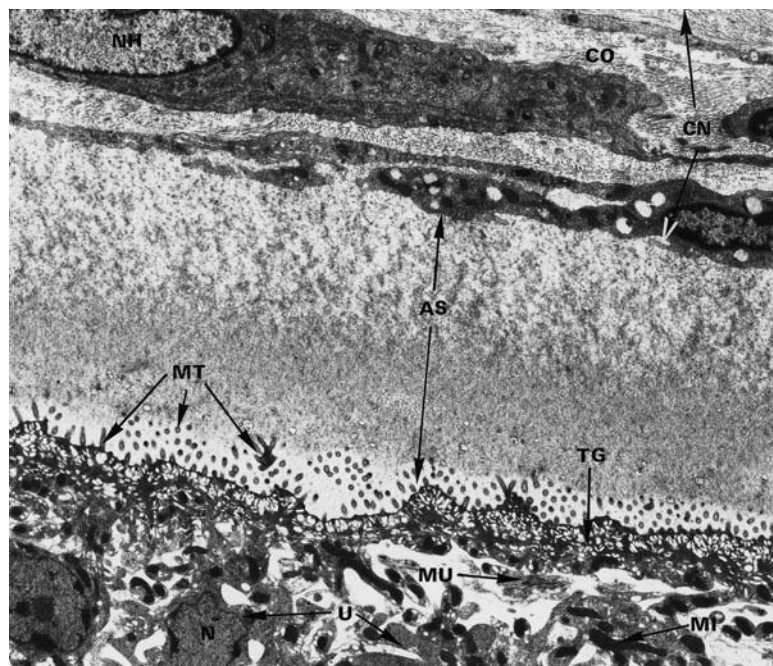

**Pathology. Figure 17** *Echinococcus multilocularis*: TEM of a section through the periphery of a "cyst from rodents." Note the occurrence of 2 surrounding layers of host origin (*AS*, *CN*) (From Mehlhorn et al. 1983).  $\times 2,500$ . *AS*, Amorphous substance; *CN*, connective tissue; *CO*, collagen; *MI*, →mitochondria; *MT*, microtriches; *MU*, muscle cell; *N*, nucleus; *NH*, nucleus of the host cell; *TG*, tegument; *U*, undifferentiated cells.



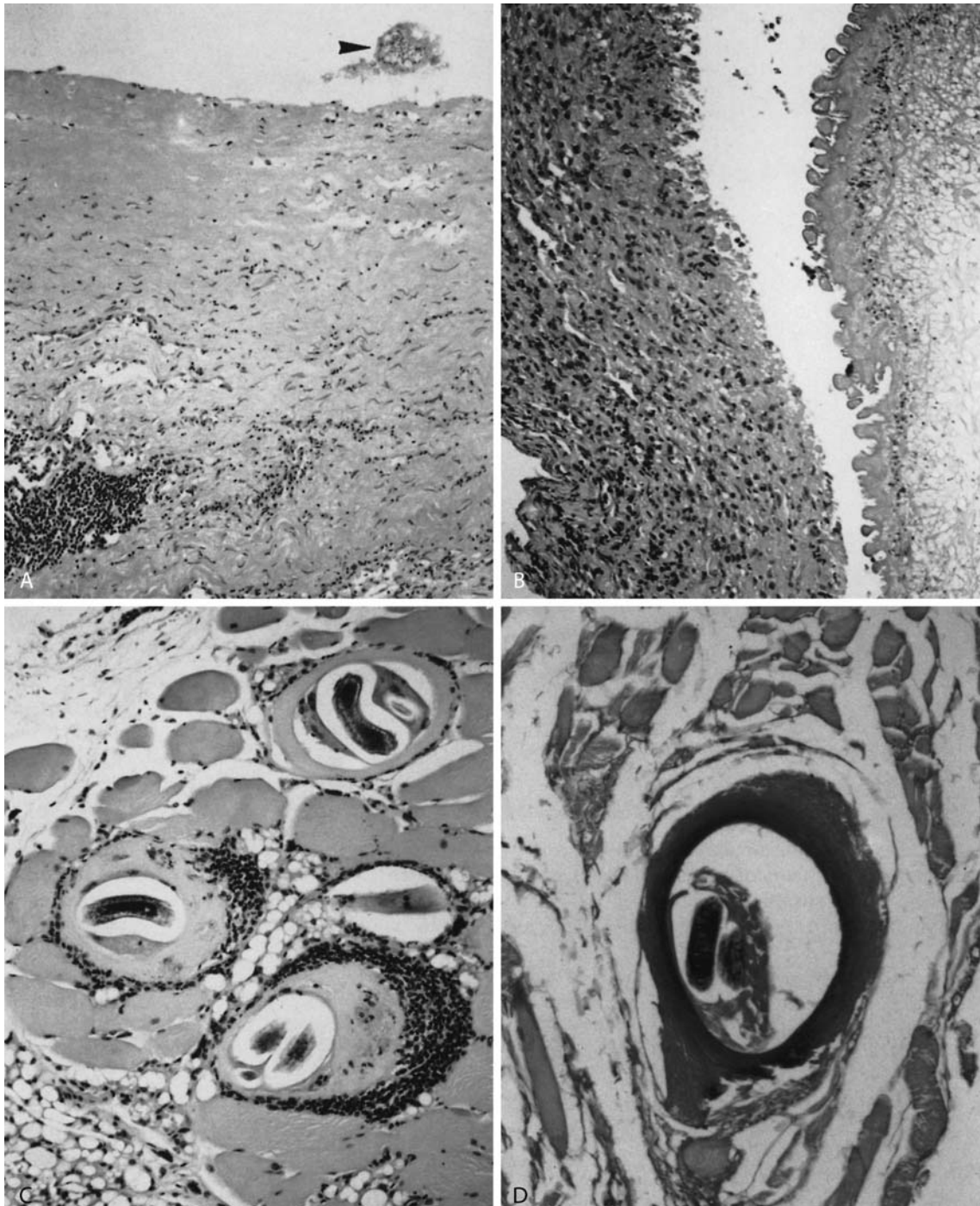

**Pathology. Figure 18 A–D** Encapsulated parasites and the production of fibrosis. **A** The brood capsule of *E. granulosus* in the lung of a 10-year-old Eskimo girl is surrounded by a thick connective tissue capsule. A lymphocytic nodule is present in the outer capsule and a →protoscolex in the lumen (arrowhead). HE × 100. **B** Sparganosis. A →plerocercoid larva is shown in a subcutaneous nodule from the neck of a Mexican male. The thick capsule is collagenous with eosinophil, lymphocyte, and plasma cell infiltration. HE × 120. **C** Intracellular encapsulation of →*Trichinella spiralis* in skeletal muscle of mouse. Some of the larvae are accompanied by slight lymphocytic infiltration. HE × 120. **D** Calcified *Trichinella* sp. and capsule in skeletal muscle of 50-year-old man who died from an unrelated disease. This was found many months or years after a primary infection, of which no history could be obtained. HE × 120.

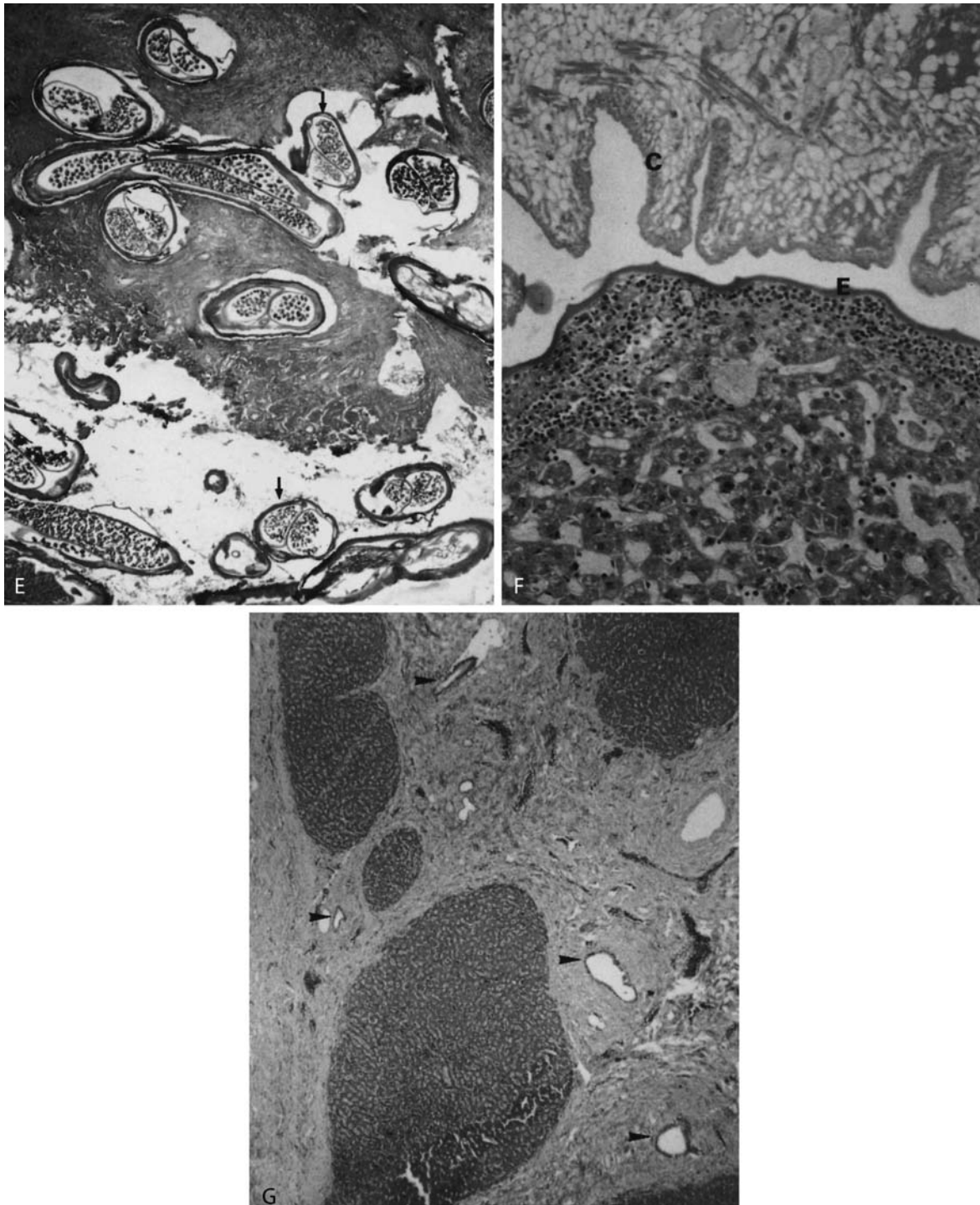

**Pathology. Figure 18 E–G** Encapsulated parasites and the production of fibrosis (continued). **E** A densely fibrotic nodule encloses adult *Onchocerca volvulus* shown in longitudinal and cross sections. Several contain microfilariae (arrows). Such nodules are surgically removed, e.g., in Guatemala, to reduce the load of microfilariae produced. HE  $\times 35$ . **F** *Nymph* of *Porocephalus* sp. thinly encapsulated (*E*) in the liver of a marmoset monkey, accompanied by lymphocytic infiltration. In humans encapsulation in the omentum is more common. Nuclei of cuticular cells (*c*) of parasite stain more weakly than host cell nuclei. HE  $\times 118$ . **G** Pipe stem fibrosis in liver of patient with schistosomiasis of 17-year duration. Regenerating liver lobules are separated by dense fibrous bands containing bile ducts (arrowheads). Masson  $\times 35$ .

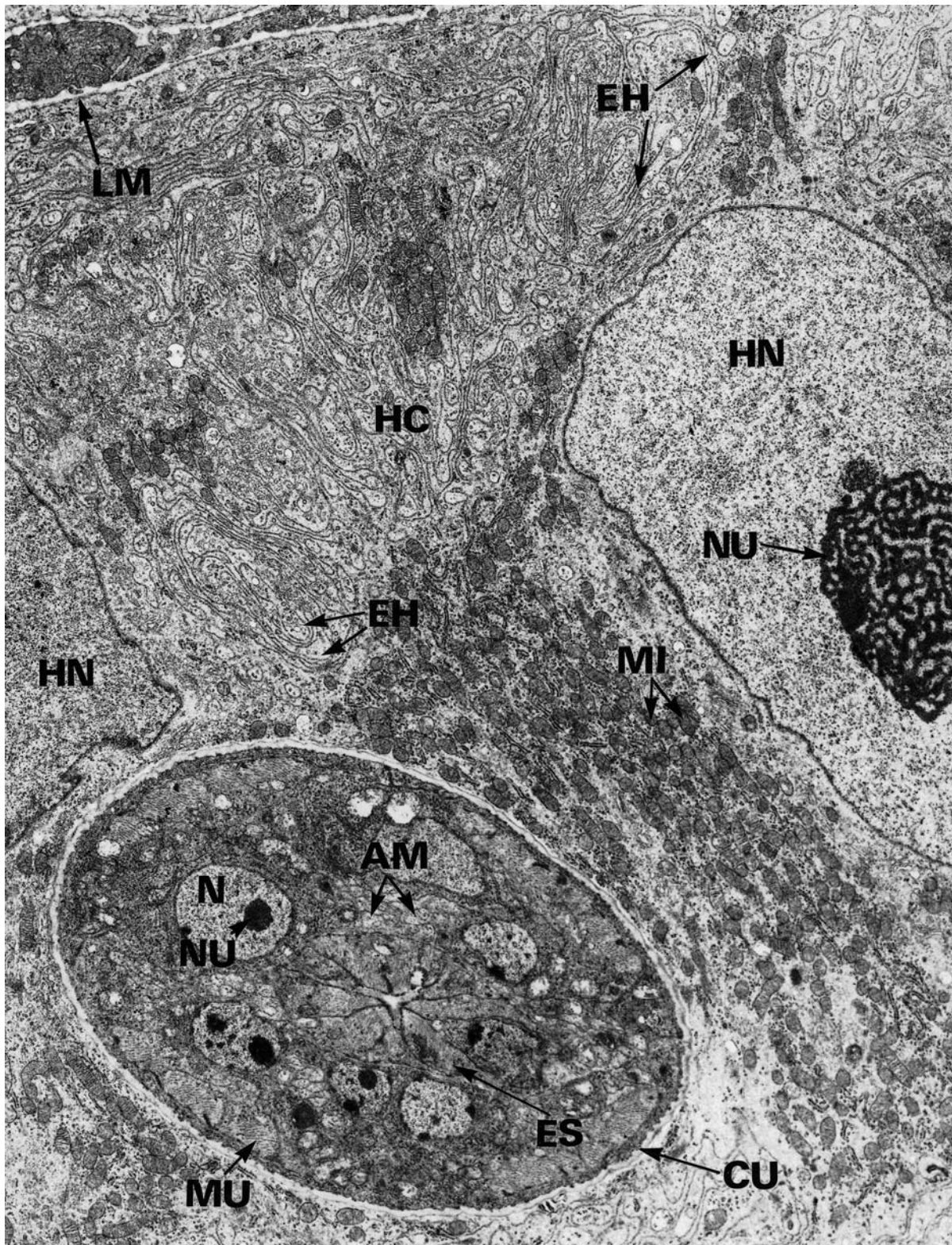

**Pathology. Figure 19** *Trichinella spiralis*: TEM of a larva within an altered muscle fiber, which is not yet surrounded by a capsule of connective tissue. Note the occurrence of large strands of mitochondria (*MI*) and →endoplasmic reticulum. × 7,000 (Original: Mehlhorn and Niechoj). *AM*, →Amphids; *CU*, →cuticle; *EH*, enlarged endoplasmic reticulum; *ES*, esophagus; *HC*, host cell; *HN*, hypertrophied host cell nucleus; *LM*, limiting membrane of the host cell; *MI*, mitochondria; *MU*, muscle cell containing larva; *N*, nucleus; *NU*, nucleolus.



**Pathology. Figure 20** *Trichinella spiralis*: TEM of an encysted larva. Note the complete alteration of the former muscle fiber and the surrounding capsule formed by collagen and layers of the connective tissue. Some host cell nuclei hypertrophied. For size compare the erythrocyte.  $\times 5,000$  (From Mehlhorn and Niechoj). *AG*, gap due to shrinking of larva; *CA*, capillary; *CP*, capsule of host tissue; *CU*, cuticle of the larva; *D*, droplets of  $\rightarrow$ stichosome gland; *E*, erythrocyte; *EH*, enlarged endoplasmic reticulum; *ES*, esophagus; *HC*, host cell; *HN*, hypertrophied host cell nucleus; *MI*, mitochondria; *MU*, muscles of the larva; *N*, nucleus; *NE*, nerve cord; *NU*, nucleolus; *ST*, stichosome.

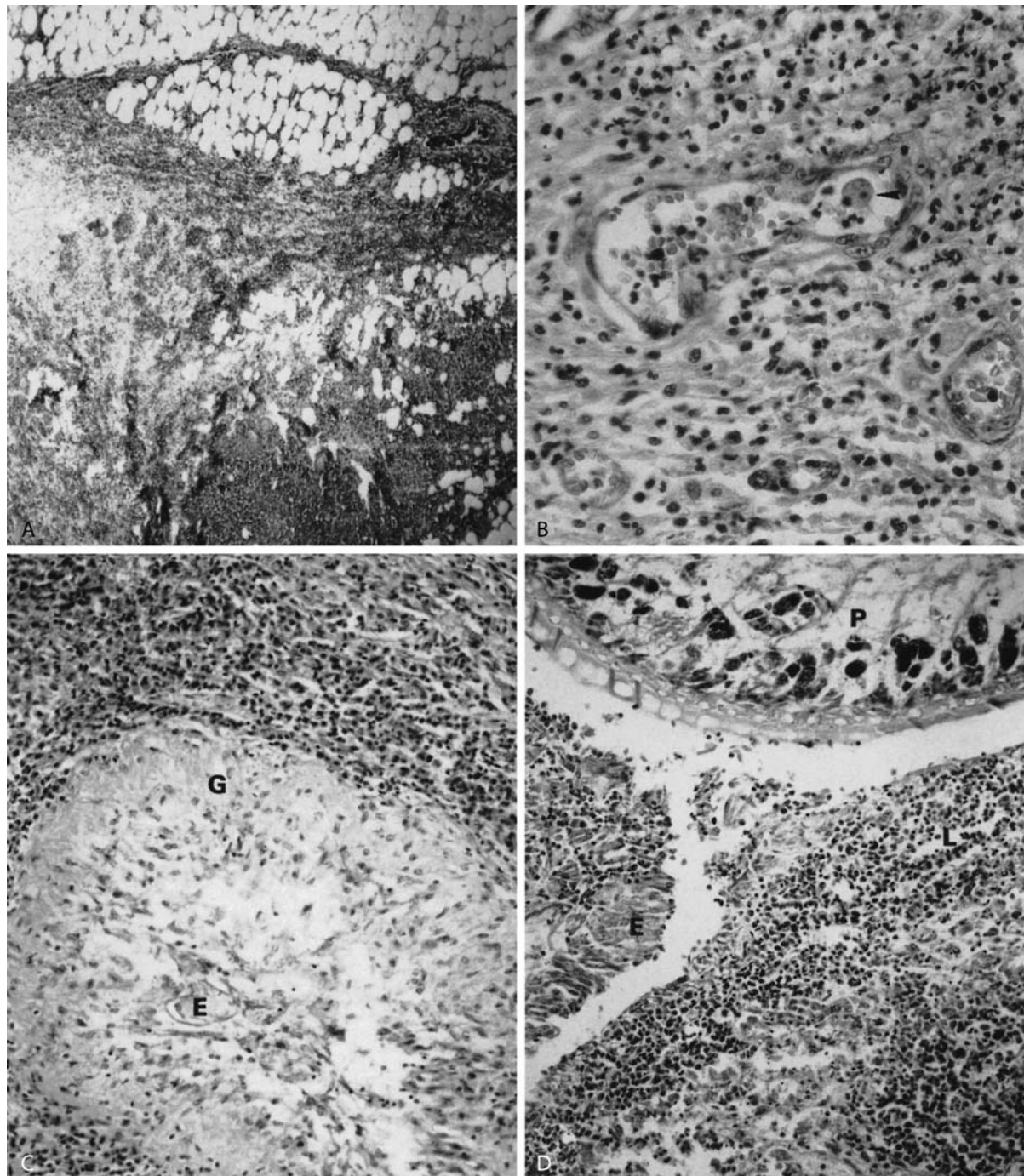

**Pathology. Figure 21 A–D** Parasite migration through tissues. **A** Intense eosinophilic infiltration in subcutaneous tissue of patient from Central America who passed *Fasciola hepatica* eggs, and had a history of eating watercress. HE  $\times$  35. **B** *Entamoeba histolytica* in portal vein radicle near the base of the ulcer shown in Fig. 4A. Such amebae are swept into the liver and may initiate amebic hepatitis and abscesses (Fig. 4D). HE  $\times$  290. **C** Fibrosing granuloma (G) with egg (E) of *F. hepatica* in subcutaneous nodule. HE  $\times$  118. **D** *Paragonimus* sp. (P) in bronchus accompanied by lymphocyte (L) and plasma cell infiltration. The bronchial epithelium (E) was desquamated in the main bronchus occupied by the worm but preserved in a branch bronchus. HE  $\times$  118.

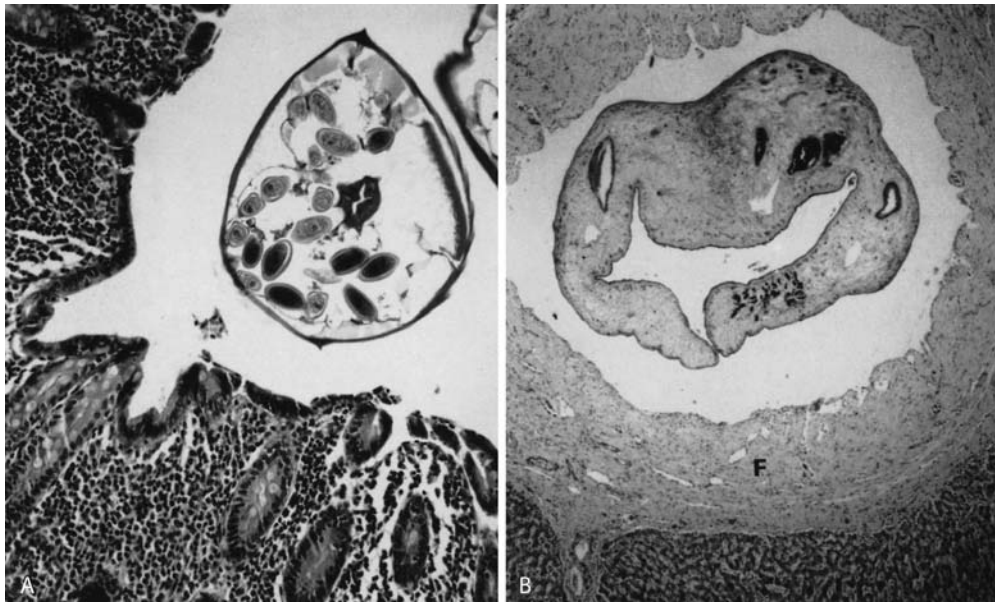

**Pathology. Figure 22 A, B** Absent or minimal inflammatory reaction accompanying luminal worms. **A** → *Enterobius vermicularis* in lumen of appendix. There is no apparent inflammatory reaction in the mucosa. HE × 120. **B** → *Clonorchis sinensis* adult in intrahepatic bile duct showing slight fibrosis (F). Patient had left endemic area 25 years prior to his death. → Giemsa. × 35.

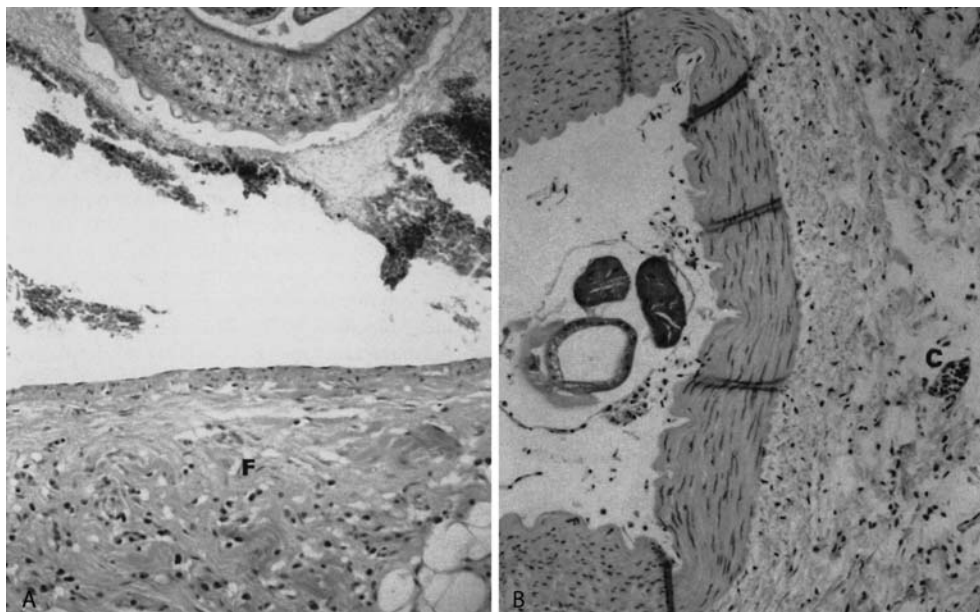

**Pathology. Figure 23 A, B** Intravascular persistence of helminths. **A** → *Schistosoma mansoni* adults in mesenteric vessel showing slight fibrosis (F). HE × 120. **B** *Angiostrongylus costaricensis* adult in mesenteric artery branch which appears normal. However, the capillary (C) is filled with eosinophils. HE × 120.

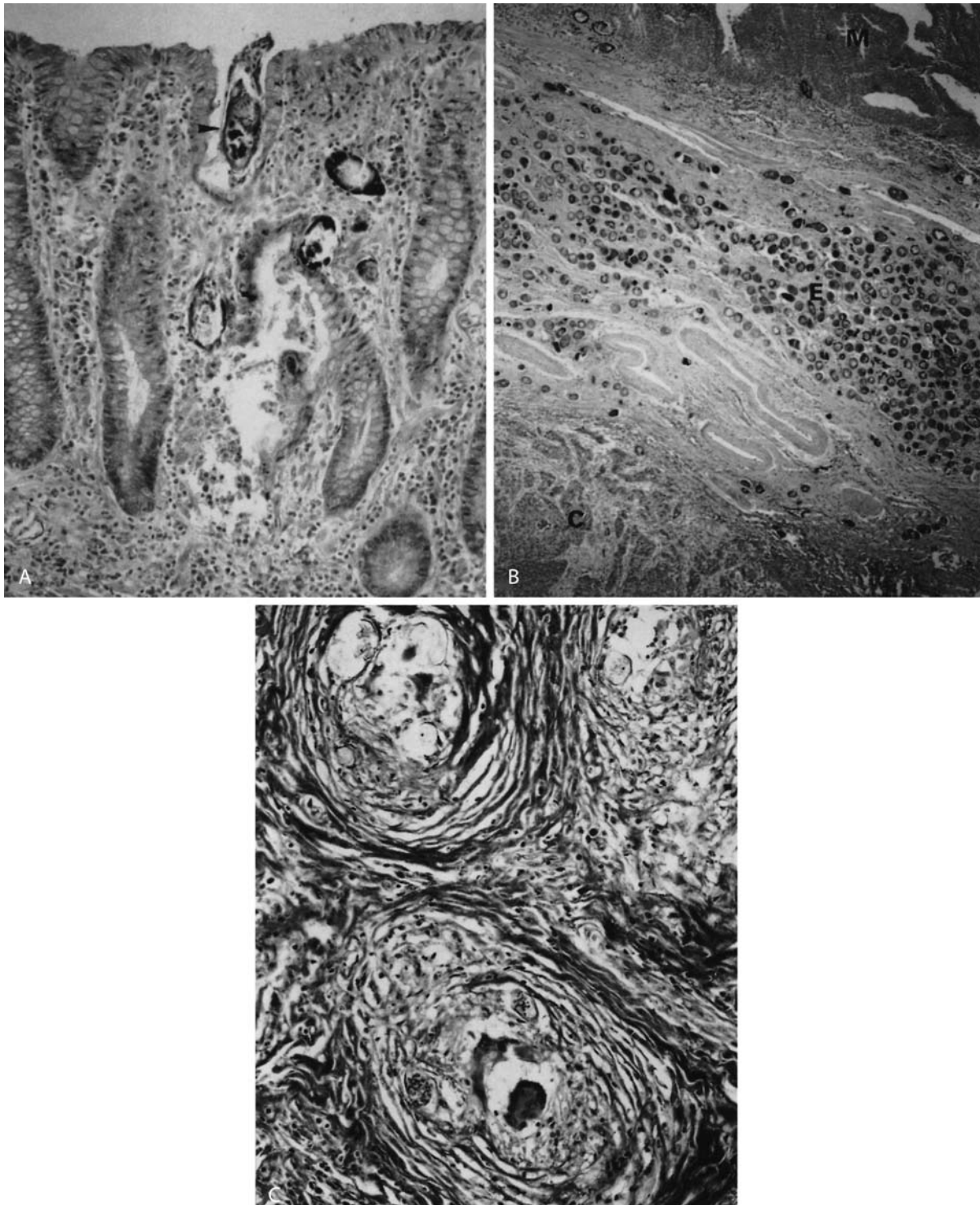

**Pathology. Figure 24 A–C** Fate of schistosome eggs. **A** In the colon several calcified *Schistosoma mansoni* eggs are seen accompanied by mixed inflammation. One egg, although nonviable and surrounded by a giant cell, is seen in a mucosal gland and is about to enter the lumen (arrowhead). Other eggs are in the lamina propria accompanied by mononuclear inflammation and in the submucosa surrounded by giant cells. HE  $\times 120$ . **B** Under the bladder mucosa (M) is a dense plaque composed of masses of calcified *S. haematobium* eggs (E) which are accompanied by fibrosis. A poorly differentiated carcinoma of the bladder (C) is shown below. HE  $\times 35$ . **C** In the brain are seen 3 fibrosing granulomas surrounding *S. haematobium* eggs. Masson  $\times 120$ . For further examples see [Fig. 1](#).

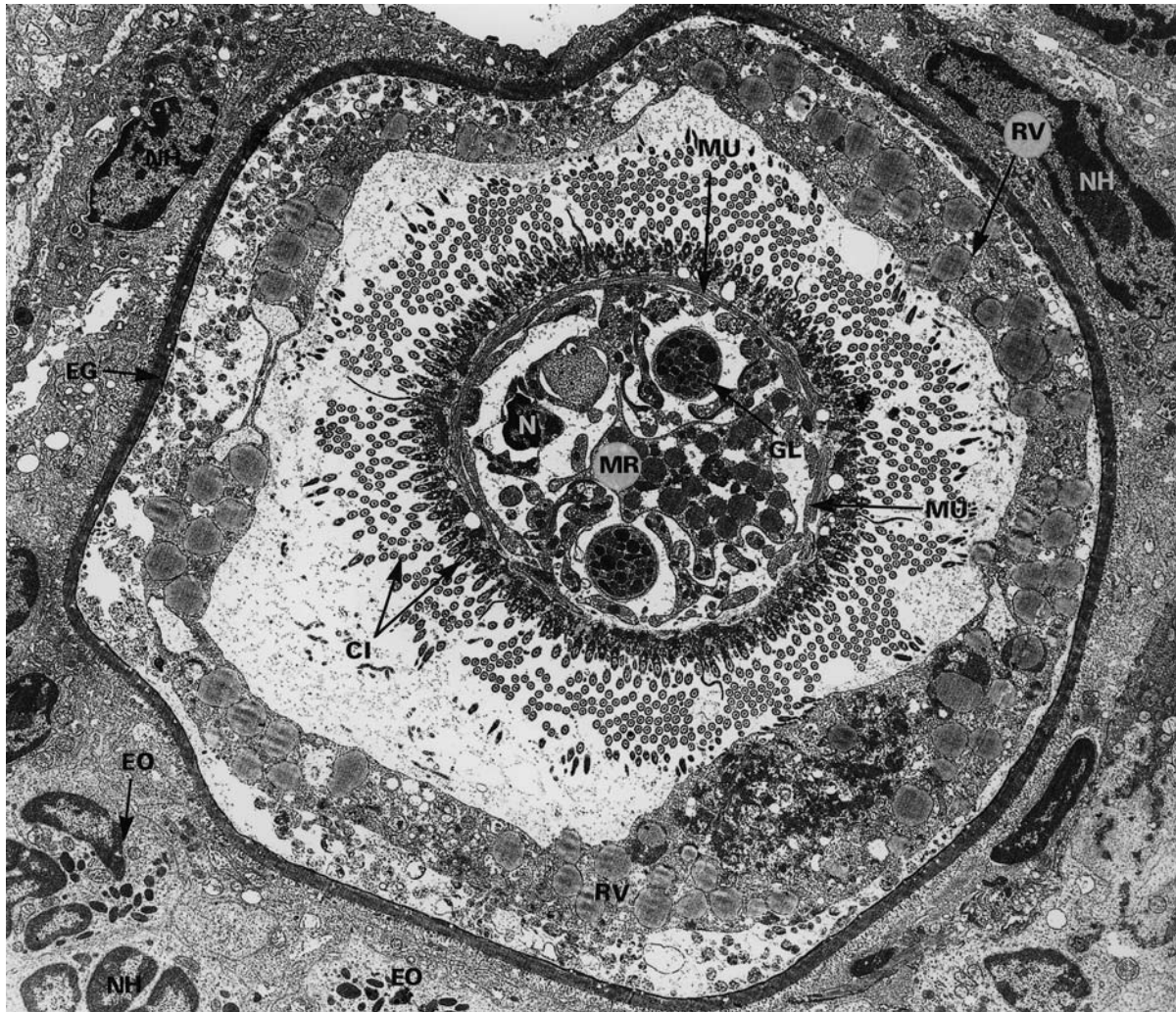

**Pathology. Figure 25** *Schistosoma mansoni*: TEM of a section through an intact egg containing a fully developed →miracidium (MR) within the host's liver. Note that the →eggshell (EG) is closely surrounded by host defense cells (EO), the disintegration of which leads to the formation of the granuloma. × 4,000. CI, →cilia of the miracidium; EG, eggshell; EO, eosinophilic granulocytes; MR, miracidium; MU, muscle cell layer; N, nucleus; NH, nucleus of host cell; RV, remnants of vitelline cells.



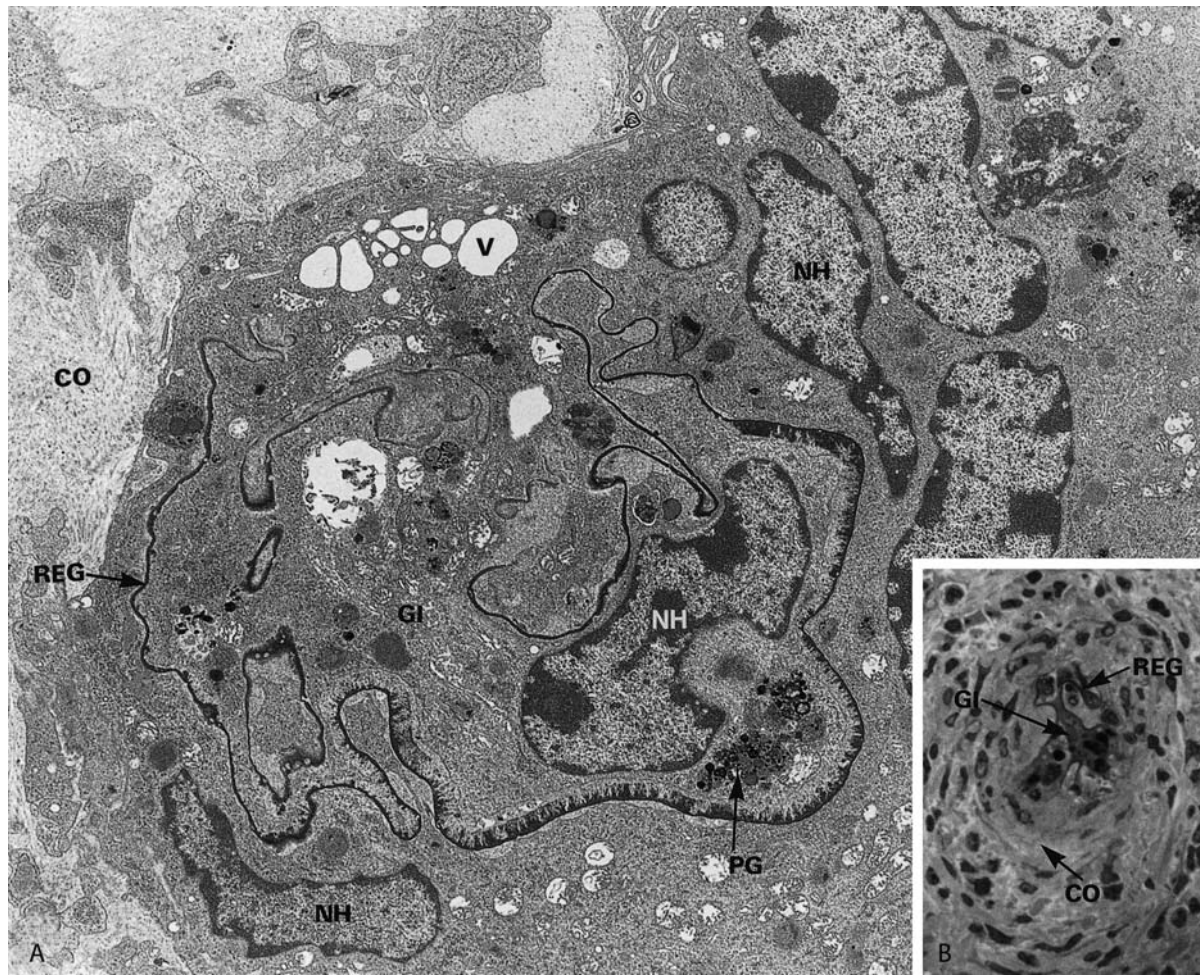

**Pathology. Figure 26 A, B** *Schistosoma mansoni* late stage granulomas. **A** TEM; **B** LM. The egg is nearly completely dissolved. Only remnants of the former eggshell (*REG*) and cytoplasmic residuals (*PG*) are seen within a multinucleate giant cell (*GI*). Note that in the egg remnants are closely surrounded by collagen and concentric layers of host cells. (From Mehlhorn and Bettenhäuser). A  $\times 3,500$ , B  $\times 350$ . *CO*, collagen; *GI*, giant cell; *NH*, nucleus of the host cell; *PG*, pigment (= remnants of egg cytoplasm); *REG*, remnants of the eggshell; *V*, vacuole.

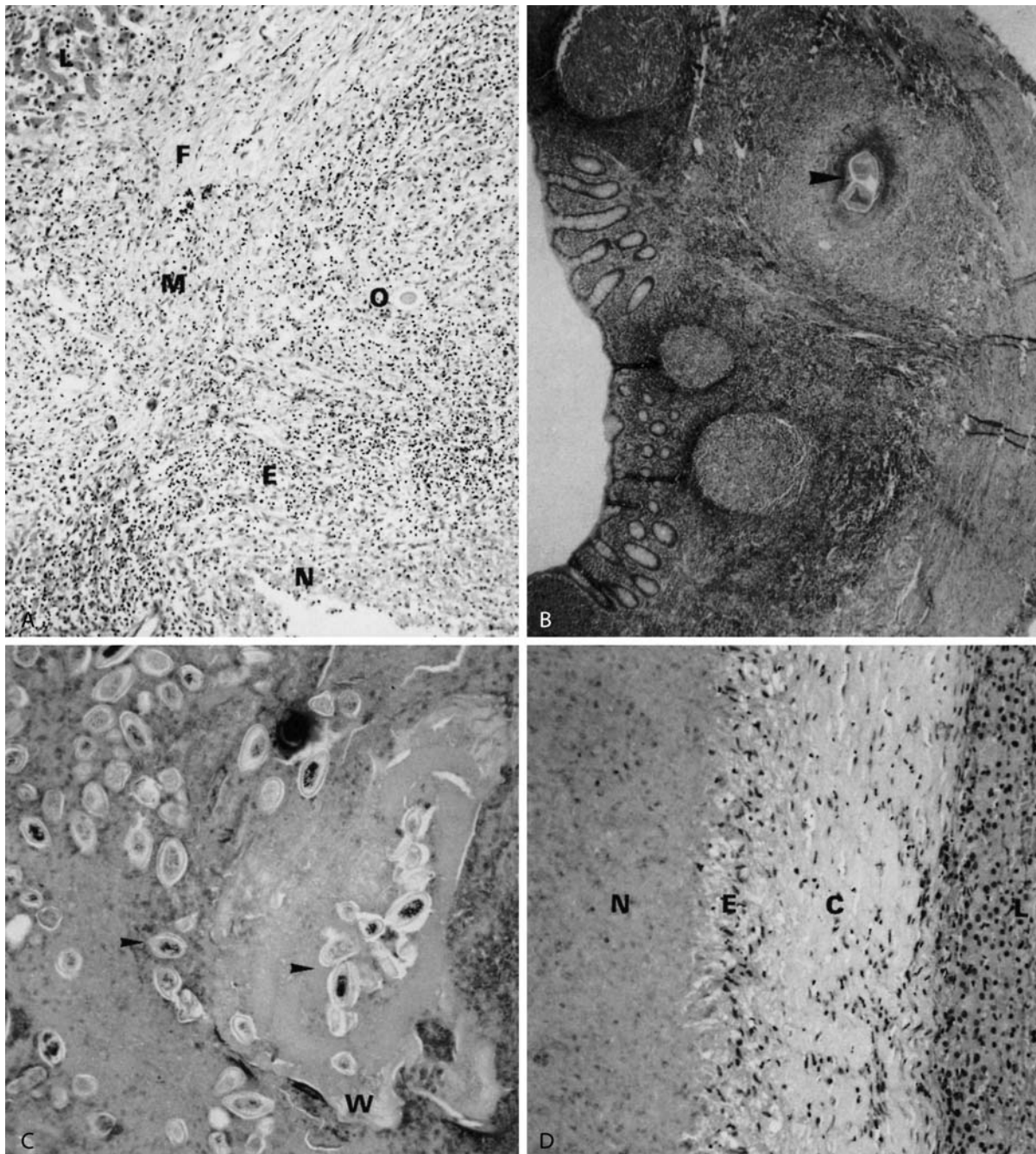

**Pathology. Figure 27 A–D** Aberrant migration of worms. **A** *Ascaris* sp. migration tract through the liver (L) surrounded by necrosis (N), eosinophilic infiltration (E), and mononuclear inflammation (M) with ovum (O) and fibrosis (F) next to liver parenchyma (upper left). HE  $\times 80$ . **B** Aberrant migration probably of adult *Enterobius* sp. in the wall of appendix. Surrounding the dead worm (arrowhead) there is a zone of necrosis, followed by palisading epithelioid reaction, and eosinophils. The rest of the appendix appears normal. HE  $\times 35$ . **C** A later stage of *Enterobius* migrating through liver can be identified by the eggs (arrowheads) deposited. The cuticle of a dead worm (W) can also be seen. This was located in the center of a necrotic nodule 6 mm in diameter, produced by delayed hypersensitivity. See **D** for periphery. HE  $\times 120$ . **D** Periphery of lesions shown in **C**. The central necrosis (N) is surrounded by a thin zone of epithelioid (E) cells and a dense connective tissue capsule (C), separating the dead worm from normal liver (L). HE  $\times 120$ .

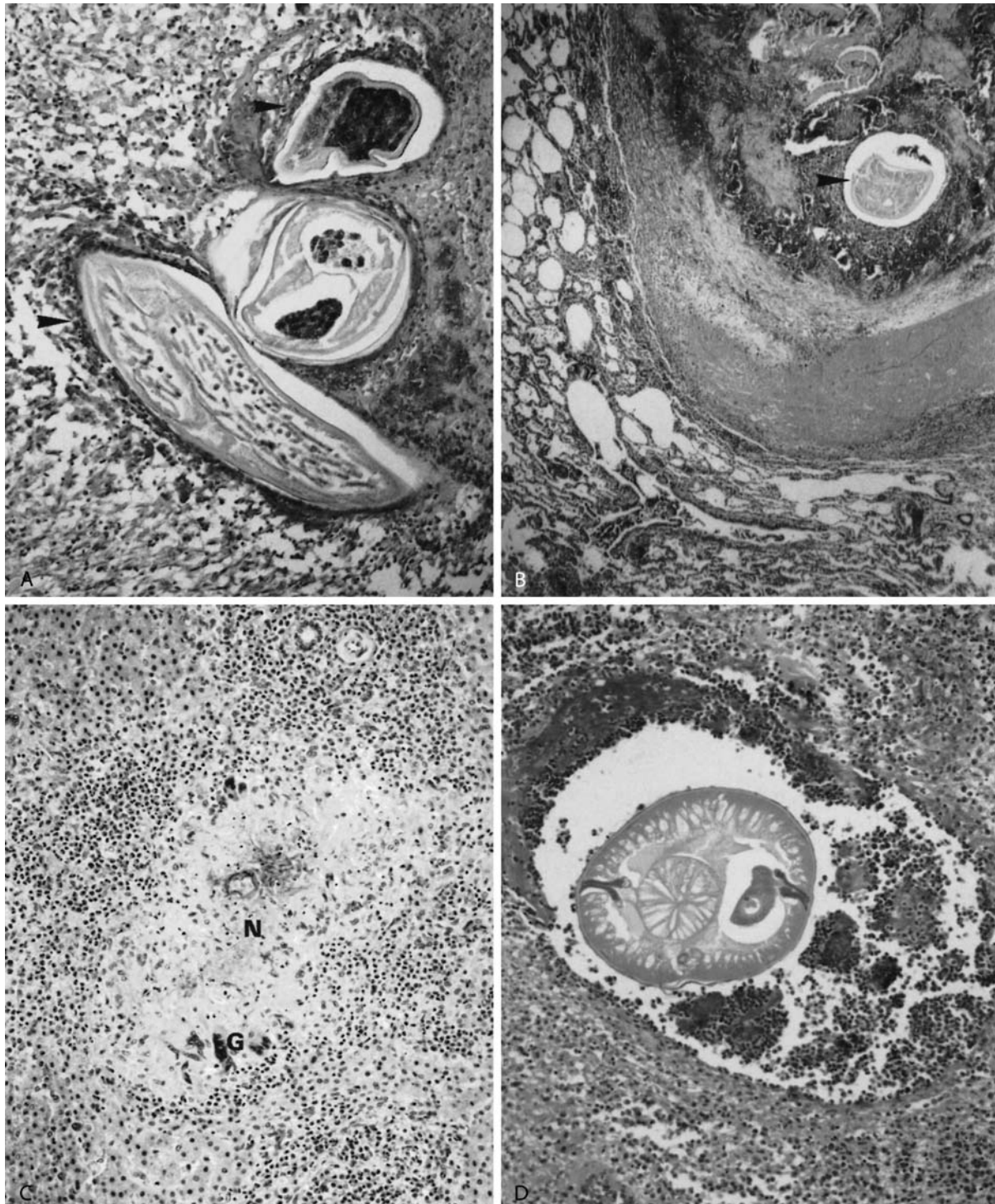

**Pathology. Figure 28 A–D** Dead or dying worms leak antigen and elicit a necrotizing hypersensitivity reaction. **A** → *Wuchereria bancrofti*, 2 dead (arrowheads) and one viable, in lymphnode surrounded by fibrin and necrosis.  $\times 12$ . **B** Dead → *Dirofilaria immitis* (arrowhead) in pulmonary artery embedded in thrombus (T). HE  $\times 35$ . **C** Probable → *Toxocara* hepatitis in child with history of eating soil. Focal granuloma with giant cells (G) and central necrosis (N). Eosinophils are in periphery. HE  $\times 120$ . **D** → *Anisakis*. Dead adult in wall of segment of ileum resected from a 20-year-old man surrounded by eosinophilic abscess. Slide courtesy of Dr. Tomo Oshima. HE  $\times 100$ .

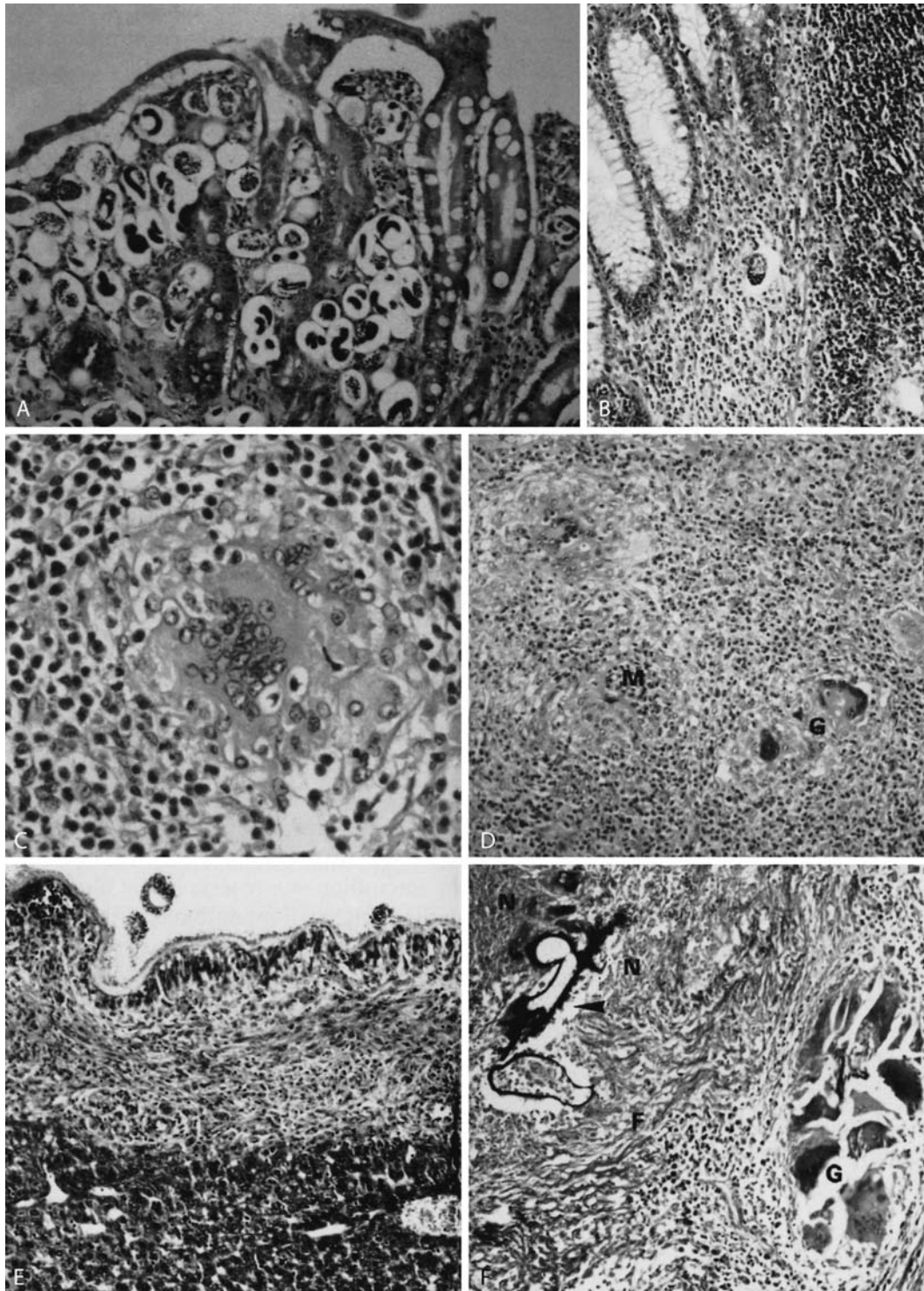

**Pathology. Figure 29 A–F** Contrasting histologic reaction in natural and aberrant host. **A–D** *Angiostrongylus costaricensis*. **A** Infection in rat showing mostly embryonated eggs in lamina propria without inflammatory reaction. (Slide courtesy of Dr. Pedro Morera). HE  $\times$  120. **B** Eggs in appendix of child accompanied by eosinophilic infiltration. (Human slides courtesy of Dr. Jorge Piza). HE  $\times$  120. **C** Two collapsed *Angiostrongylus* eggshells in multinucleate giant cells surrounded by eosinophils, macrophages, and fibrosis in appendix of child. HE  $\times$  300. **D** Egg granuloma with giant cells (G), and eosinophilic microabscess (M) and fibrosis in appendix of child. HE  $\times$  120. **E, F** *Echinococcus multilocularis*. **E** Infection in mouse shows brood capsule with germinal membrane and protoscolices, slight mononuclear infiltration, and thick fibrous capsule. Masson  $\times$  120. **F** In human, germinal membrane (arrowhead) is accompanied by necrosis (N), fibrosis (F), giant cell reaction (G), and compression of liver parenchyma (not shown). PA  $\times$  120.

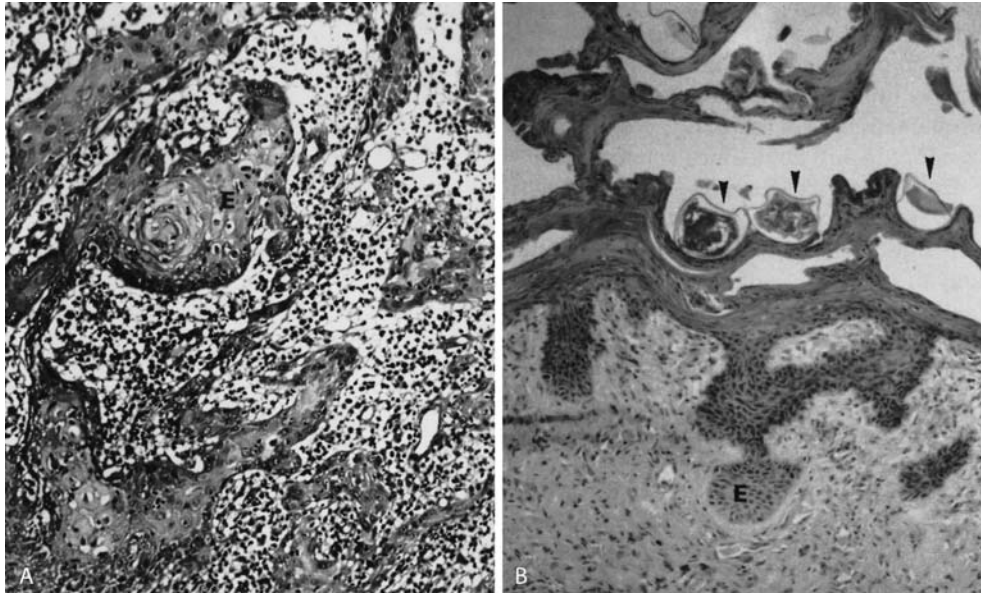

**Pathology. Figure 30 A, B Hyperplasia. A** Pseudoepitheliomatous hyperplasia of epidermis (E) adjacent to ulcerating leishmaniasis. A moderate number of *Leishmania peruviana* (not visible at this magnification) are present in histiocytes accompanied by lymphohistiocytic inflammation. HE  $\times$  120. **B**  $\rightarrow$ Scabies may be accompanied by marked hyperkeratosis, and burrows containing  $\rightarrow$ mites and eggs (arrowheads). Acanthosis of epidermis (E). HE  $\times$  120. For example of neoplasia, see Fig. 23B.

## PCD

$\rightarrow$ Apoptosis.

## PcP

Pneumonitis caused by  $\rightarrow$ Pneumocystis carinii (Pneumocystosis).

## PCR

Polymerase chain reaction.

## Pediculosis, Animals

Several species of  $\rightarrow$ lice infest large and small animals. Domestic animals may suffer from infestations with both biting ( $\rightarrow$ Mallophaga) and sucking ( $\rightarrow$ Anoplura)  $\rightarrow$ lice. Lice are extremely host-specific. Infection is a seasonal problem and the signs associated with

pediculosis are extremely variable. Most lesions result from skin irritation and  $\rightarrow$ pruritus. They include  $\rightarrow$ alopecia alone, papulocrustous dermatitis, and damage to wool or hide caused by rubbing or biting. Sucking lice may induce an  $\rightarrow$ anaemia. Constant irritation during lice infestations causes a loss of weight and a decrease in milk production.

### Therapy

$\rightarrow$ Insecticides.

## Pediculosis, Man

Pediculosis is a superficial skin infection with head or body  $\rightarrow$ lice,  $\rightarrow$ *Pediculus humanus capitis* or *corporis* or crab lice,  $\rightarrow$ *Phthirus pubis*. The lice hold on to the body hairs with specialized claws and attach their eggs to the hair. Lice penetrate the epidermis with their mouthparts and suck blood, giving rise to mild dermatitis, often accentuated by scratching.

### Therapy

Use of  $\rightarrow$ insecticides in wash lotions. Note that repeated washings are needed within 10 days since the drugs have a limited activity on the lice eggs/larvae. Recently obtained plant extracts (neem-Wash-Away) Solve the problem of pediculosis. Complete removal of

the hair is recommended in heavy infestations. In body-  
louse-infections all bed covers and clothes have to be  
cleaned (hot-washed, deep-frozen, etc.).

## Pediculus

Genus of the bloodsucking →lice, →Anoplura, →fleas.

## Pediculus humanus capitis

### Name

Latin: *pediculus* = small foot, *humanus* = human, *caput* =  
head; French: *pou*, German: *Kopflaus*.

### Synonym

Human head louse, *Pediculus capitis*.

### General Information

With a length of about 3 mm the adult head lice  
(Figs. 1, 2) are smaller than the body lice. The eggs are  
glued to the hair and are characterized by an operculum  
with typically placed small pores (Fig. 3). The life cycle



**Pediculus humanus capitis.** Figure 2 LM of an adult female and male (right).



**Pediculus humanus capitis.** Figure 1 LM of an adult female containing an egg.



**Pediculus humanus capitis.** Figure 3 SEM of a nit (egg).

takes about 15–16 days. The females produce about 200–250 eggs within the lifespan of about 1 month.

### Therapy

→[Ectoparasitical Drugs](#), Neem-extract of Alpha-Biocare, Düsseldorf.

## **Pediculus humanus corporis**

### Name

Latin: *pediculus* = small foot, *humanus* = human, *corpus* = body; French: *pou*, German: *Kleiderlaus*.

### Synonym

*Pediculus humanus*, human body louse.

### General Information

This louse is larger than *P. h. capitis* reaching a length of about 4.5 mm (Figs. 1, 2). The mean time for the development of one generation takes about 15–25 days, lower temperatures increase the time needed. Body lice suck all 5 hours, however, they may starve much longer than head lice, which survive 1–2 days at the maximum (mostly much less). Body lice starve for 10 days (at 0–6°C), 7 days (at 10–20°C), 2 days at (25–30°C), but only 1 day at 35–37°C. Body lice are important vector of agents of diseases (e.g., →[Rickettsia prowazekii](#) (louseborne spotted typhus), →[Prowazek](#)).

### Life Cycle

→[Lice](#).

## **Pedipalps**

The second pair of appendages of →[ticks](#), normally with 4 segments termed articles I–IV. While in argasid ticks all 4 articles are visible, in many ixodids the article IV is recessed in a cavity on the ventral side of article III. The pedipalps are covered with chemoreceptors.



**Pediculus humanus corporis.** Figure 1 LM of an adult female.

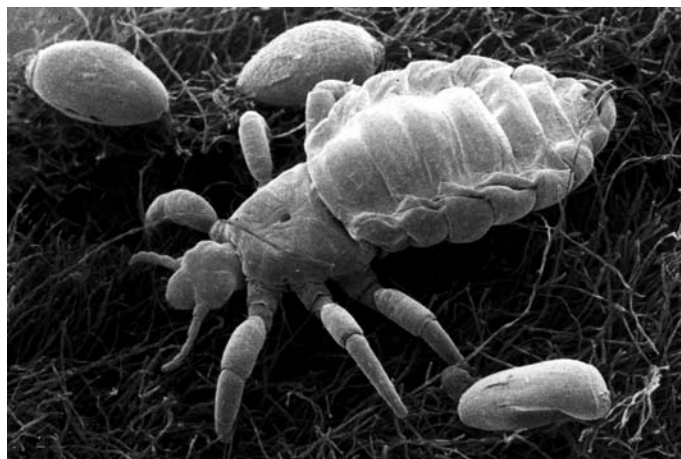

**Pediculus humanus corporis.** Figure 2 SEM of an adult female with eggs attached at clothes.

## Pellicle

Shape-stabilizing cell boundary complex composed of membranes,  $\rightarrow$ microtubules, proteins, and/or polysaccharides (Figs. 1–4,  $\rightarrow$ Kinete/Fig. 2). Many  $\rightarrow$ Protozoa have more than one limiting membrane for at least some of their developmental stages (Table 1). In some groups the main  $\rightarrow$ cell membrane is underlined by one or more inner membranes that are often derived from the endoplasmic reticulum (Fig. 3). This is one of the reasons, why they were grouped into new taxon  $\rightarrow$ Alveolata ( $\rightarrow$ Classification). Like the outer membranes, these inner membranes are species-specific and possess distinct inner and outer surfaces. The characteristics of the inner membranes have been revealed by the methods of freeze fracture ( $\rightarrow$ Apicomplexa/Figs. 2, 3) and negative staining (Fig. 4C). The single

outer membrane and the membranous complexes often have  $\rightarrow$ subpellicular microtubules (approx. 25 nm in diameter) underneath them (Figs. 2–4).

The motile stages of trypanosomes and  $\rightarrow$ Leishmania form a pellicle that consists of one membrane plus underlying microtubules (Fig. 2 A,D), whereas the motile stages of  $\rightarrow$ Coccidia (sporozoites, merozoites, ookinetes, kinetes) have a pellicle consisting of 3 membranes plus underlying microtubules (Figs. 3, 4,  $\rightarrow$ Kinete/Fig. 2).

In ciliates the pellicle is composed of an outer membrane, a system of alveolar sacs, longitudinal microtubules, and kinetodesmal fibers. This complex pellicle produces a stable base to hold rows of  $\rightarrow$ cilia and this is the reason for grouping them together with the coccidians into the taxon Alveolata.

In the free-living euglenids the  $\rightarrow$ plasmalemma is reinforced by longitudinal microtubules and by a dense underlying epiplasm. The number of subpellicular

**Pellicle. Table 1** Types of limiting systems of some parasitic Protozoa

Species	Stage	Single membrane	Two or more membranes	Pellicle with subpellicular microtubules	Cyst wall
<i>Trichomonas vaginalis</i>	Trophozoite	+			
<i>Giardia lamblia</i>	Trophozoite, cyst	+		Ventral disc	+
<i>Trypanosoma brucei</i> group	Epi- and trypomastigotes			+	
<i>Trypanosoma cruzi</i>	A-, epi-, and trypomastigotes	+		+	
<i>Leishmania</i> spp.	A-, promastigotes			+	
<i>Entamoeba histolytica</i>	Magna-form	+			
	Minuta-form	+			+
<i>Pneumocystis carinii</i>	Trophozoite	+			
	Cyst	+			+
<i>Eimeria</i> spp.	Sporozoites			+	
	Merozoites			+	
	Oocysts				+
	Sporocysts	+			+
	Meronts, schizonts	+			
	Male gametes	+			
	Female gametes of some species	+	+		
<i>Toxoplasma gondii</i>	Sporozoites			+	
	Merozoites			+	
	Oocysts	+			+
	Sporocysts	+			+
	Meronts, schizonts	+			
	Male gametes	+			
	Gamonts	+			
	Female gametes		+		
<i>Balantidium coli</i>	Trophozoite			+	
	Cyst	+			+



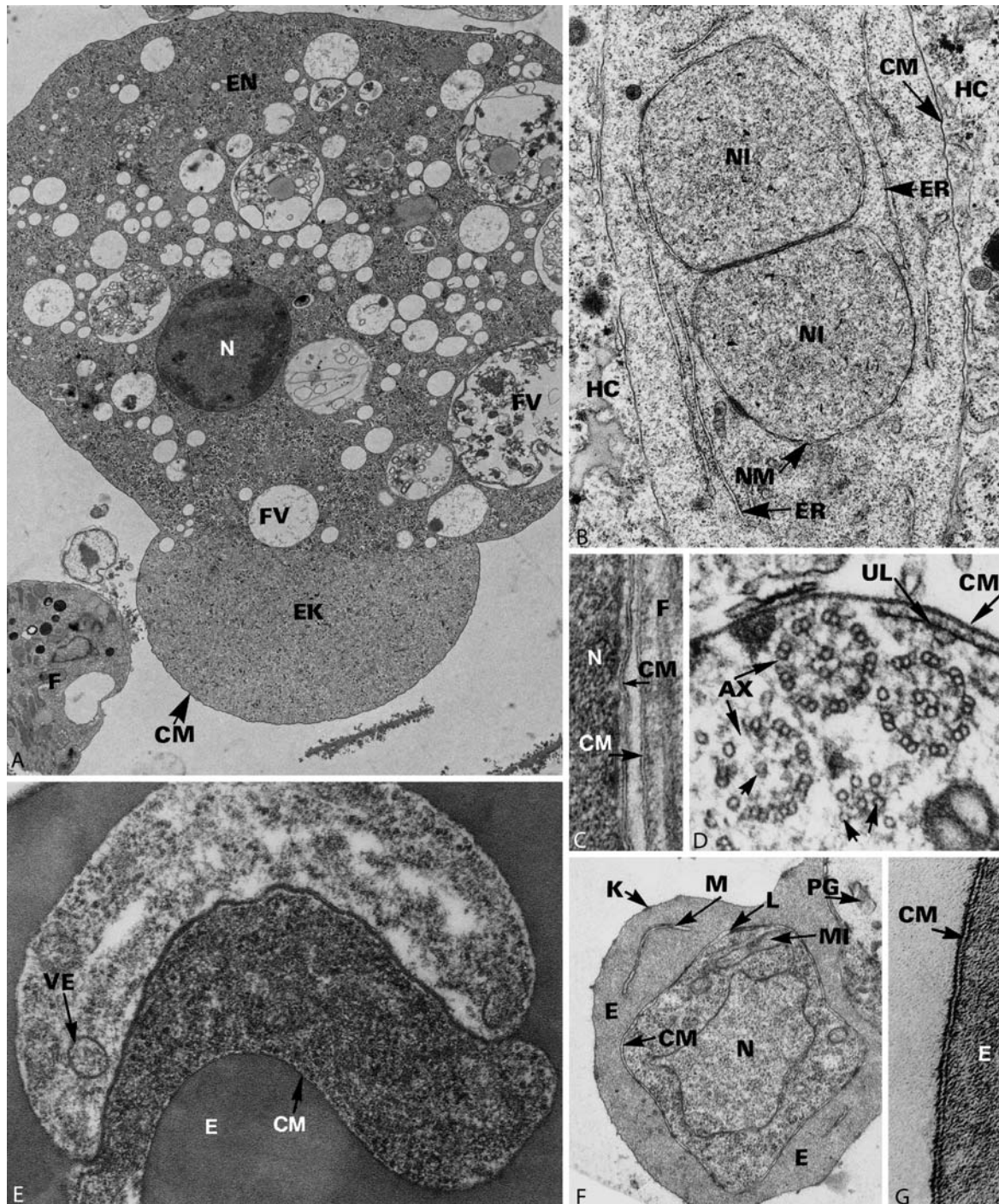

**Pellicle. Figure 1 A–G** TEMs of parasitic stages which are surrounded by a single-cell membrane (CM). **A** Trophozoite of *Entamoeba histolytica* in culture ( $\times 5,000$ ). **B** Dividing stages of *Nosema* sp. in a host cell (*Pimpla* sp.) ( $\times 25,000$ ). **C** Periphery of a microgamete of *Eimeria maxima* ( $\times 60,000$ ). **D** Periphery of a microgamete of *Sarcocystis suis hominis*. Note incomplete axonemes and single microtubules (arrows) ( $\times 40,000$ ). **E** Trophozoites of *Babesia microti*, which are situated in the cytoplasm of the erythrocyte ( $\times 60,000$ ). **F** Trophozoite of *Plasmodium falciparum*, which is surrounded by a narrow membrane-bound parasitophorous vacuole ( $\times 7,000$ ). **G** High magnification of a cell membrane (plasmalemma) showing the typical trilaminar pattern ( $\times 78,000$ ). AX, axoneme of flagellum; CM, cell membrane (plasmalemma); E, erythrocyte; EN, endoplasm; ER, endoplasmic reticulum; ET, ectoplasm; F, flagellum; FV, food vacuole; HC, host cell cytoplasm; K, knoblike structures; L, limiting membrane of the parasitophorous vacuole; M, Maurer's cleft; MI, mitochondrion; N, nucleus; NI, nucleus in division; NM, nuclear membranes; P, pigment; UL, underlying material; VE, vesicle.

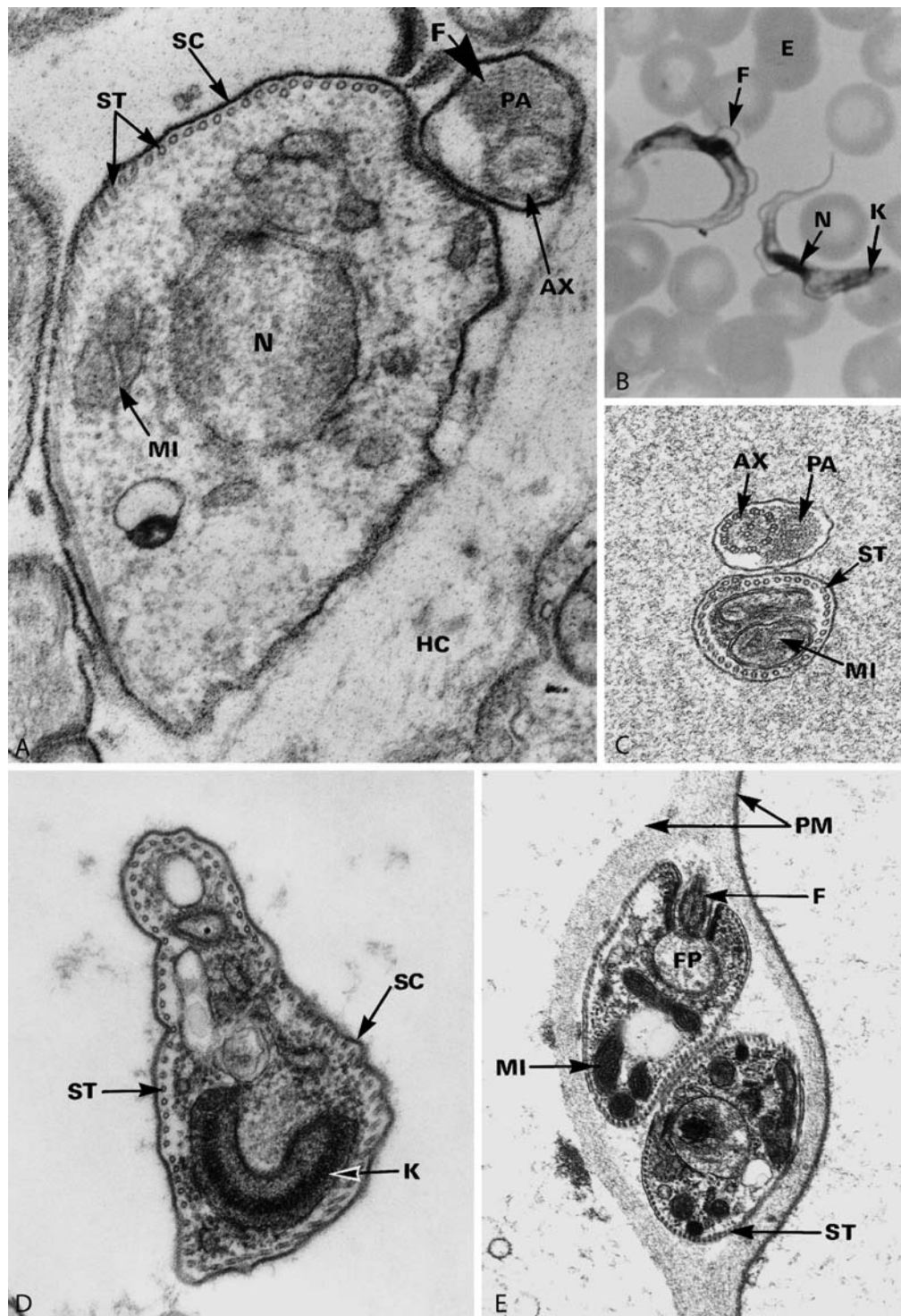

**Pellicle.** Figure 2 A–E Pellicle of trypanosomes under light (B) and electron microscopy (A, C–E). A *Trypanosoma cruzi* trypomastigote stage in a heart muscle cell has developed a surface coat (SC), which is here demonstrated by means of the Thiéry method ( $\times 45,000$ ). B *T. brucei gambiense*;  $\rightarrow$ trypomastigotes in blood smear ( $\times 1,500$ ). C, D *T. vivax*; oblique cross sections through trypomastigotes from mammalian blood. Note that in different regions the number of  $\rightarrow$ subpellicular microtubules is different ( $\times 22,000$ ). E *T. congolense*;  $\rightarrow$ epimastigotes are cut when passing through the peritrophic membrane of the tsetse fly's gut ( $\times 11,000$ ). AX,  $\rightarrow$ axoneme; E, erythrocyte; F, flagellum; FP,  $\rightarrow$ flagellar pocket; HC, host cell; K,  $\rightarrow$ kinetoplast; MI, mitochondrion; N, nucleus; PA,  $\rightarrow$ paraxial rod; PM, peritrophic membrane; SC, surface coat; ST, subpellicular microtubules.

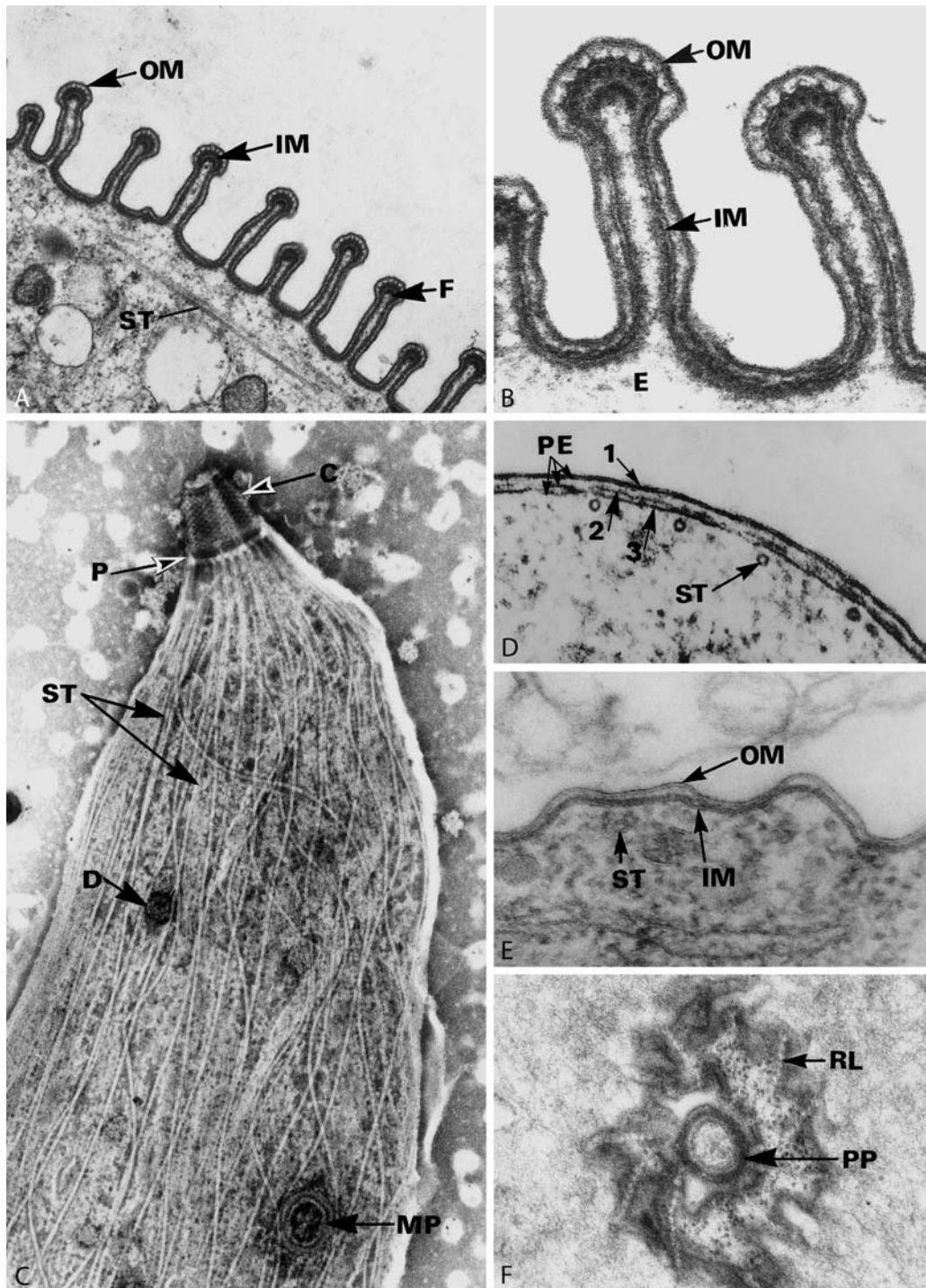

**Pellicle.** Figure 3 A–F TEMs of the pellicle of sporozoan motile stages. A, B Cross sections through a trophozoite of the gregarine *Gonospora beloneides*. Note the typical tegumental folds (A  $\times 25,000$ , B  $\times 78,000$ ). C Negatively stained anterior pole of a cyst merozoite of *Sarcocystis ovifelis*. Note the protruded conoid and the peculiar structure of the pellicle (containing the micropore). The subpellicular microtubules (ST) are apparently only loosely attached to the pellicle ( $\times 30,000$ ). D, E Sections through the pellicles of a merozoite (D) and a sporozoite (E) of an *Eimeria* sp. The inner 2 membranes of the pellicle are not always clearly visible ( $\times 78,000$ ). F Tangential section through the posterior pole of a cyst merozoite of *Sarcocystis ovifelis* showing a characteristic riblike pattern consisting of 11 dotted lines ( $\times 30,000$ ). C, conoid; D, dense body; E, ectoplasm; F, pellicular folds; IM, inner 2 membranes of PE; MP, micropore; OM, outer membrane of PE; P, anterior polar ring; PE, pellicle consisting of 3 membranes (1–3); PP, posterior polar ring; RL, riblike structure; ST, subpellicular microtubules.

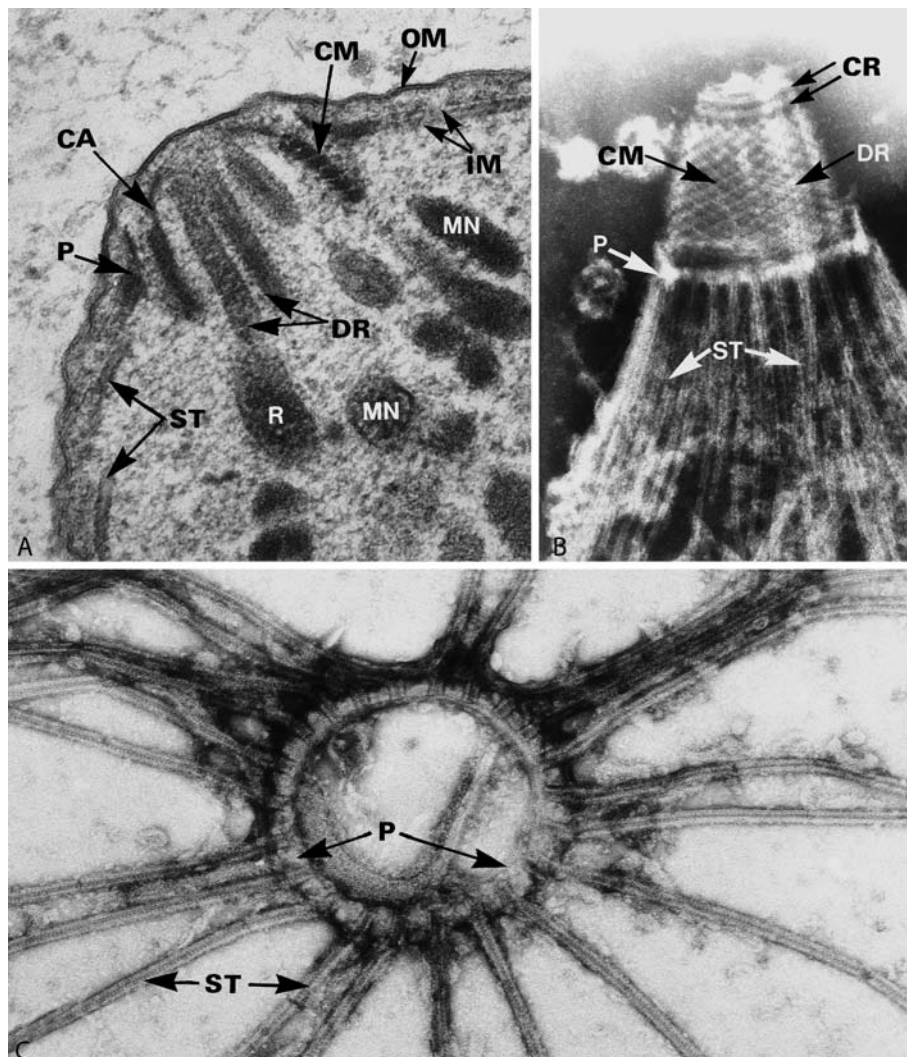

**Pellicle. Figure 4** A–C EMs of the anterior pole of motile stages (→Merozoites, →Sporozoites) of Eimeriidea. Note that the conoid consists of microtubules, and that the subpellicular microtubules are attached to the polar ring. **A** Longitudinal section through a merozoite of *Eimeria falciformis* from mice; the conoid is retracted ( $\times 80,000$ ). **B, C** →*Sarcocystis ovis*; negatively stained cyst merozoites; the conoid is protruded (**B**); the polar ring system (**C**) consists of an inner and outer region (**B**  $\times 68,000$ , **C**  $\times 85,000$ ). CA, canopy-like anterior structure of the →conoid; CM, conoidal microtubules; DR, ductules of →rhoptries; IM, inner 2 membranes of pellicle; MN, →micronemes; OM, outer membrane of pellicle; P, polar ring; R, →rhoptries; ST, subpellicular microtubules.

microtubules is often stable within a species and may thus be used for species definition. For example, the merozoites of the tissue-cyst-forming coccidia (e.g., →*Sarcocystis*, *Toxoplasma*, →*Besnoitia*, →*Frenkelia*) always have 22 microtubules and various →*Eimeria* spp. have 24, 26, 28, 30, or 32 microtubules. In some parasites, such as the trypanosomatids, the number of subpellicular microtubules varies with the size of the individual parasite form, i.e., a long slender form with a small diameter has fewer microtubules than a form of the same species with a larger diameter (Fig. 2D).

The subpellicular microtubules may run from one pole to the other, as they do in →gregarines and trypanosomes, or they may be restricted to limited portions of the pellicle. In ciliates, for example, they may be restricted to the front-half of the cell and in the coccidian motile stages they are localized to the front two-thirds of the cell (Fig. 3C).

In the motile stages of the coccidia the microtubules are anchored to an anterior polar ring (Fig. 4, →Kinete/ Fig. 2). At the attachment point there is an interruption of the 2 inner membranes (Fig. 4C). A similar opening is at the posterior pole (Fig. 3F). The anterior polar rings

may surround the protrusible conoid (Figs. 4B, 5), which is thought to help in cell penetration, however, is absent in →Hemosporidia. If 2 or more polar rings are present, it is the outer one that is connected to the microtubules (Fig. 5). The subpellicular microtubules are usually kept in contact with the inner surface of the pellicular membrane by means of side arms. The exact role of the microtubules in movement has not been identified.

## Pelodera

Order of the nematode family Rhabditidae (→Rhabdias). Some specimens of the genus *Pelodera* sp. are known to penetrate human skin in rare cases introducing symptoms of →cutaneous larva migrans.

## Pelta

→Trichomonadida.

## Penella

→Crustacea.

## Pentamidine isethionate

→Leishmaniacidal Drugs.

## Pentastomiasis, Man

Pentastomiasis is an infection with nymphal pentastomes of several genera, the adults of which are found in dogs or other carnivorous mammals (→*Linguatula*), or in large snakes (→*Armillifer*, →*Porocephalus*). Infections are acquired by the ingestion of eggs from the feces of mammals or snakes such as pythons, or the ingestion of undercooked snake filet. The nymphs of *Linguatula* spp. may be found in the throat, giving rise

to intense allergic inflammation referred to as halzoun in the Middle East, after the ingestion of raw kibbe from mutton containing infected lymph nodes; lesions in cervical lymph nodes of humans, the eye or subcutaneous tissues have also been reported. The larvae of *Armillifer* spp. and *Porocephalus* spp. usually encyst in the abdominal mesentery, liver, and peritoneum. Pentastomids are recognized in sections by the presence of a digestive tract containing ingested blood, by striated muscle, and by a distinctive, often serrated, cuticle, and the absence of tracheal rings. The whole parasite shows 4 claws and a mouth leading to the misinterpreted term pentastomid. These parasites are surrounded by an often hyalinized connective tissue capsule, which may be incomplete, giving way to a segment of granulomatous reaction (→Pathology/ Fig. 18F). The larvae eventually die and may be transformed into an →abscess, later into a hyalinized scar, and eventually into a calcified →nodule.

## Pentastomid genera

The pentastomid host groups are parasitized by the following genera:

1. Ophidia (snakes): *Raillietiella*, *Cephalobaena*, *Kiricephalus*, *Porocephalus*, *Armillifer*, *Waddycephalus*, *Cubirea*, *Gigliolella*, *Ligamifer*
2. Lacartilia (lizards): *Raillietiella*, *Sambonia*, *Elenia*
3. Crocodylia (crocodiles): *Sebekia*, *Leiperia*, *Subtriquetra*, *Alofia*
4. Chelonia (turtles): *Diesingia*, *Butantinella*
5. Aves (birds): *Reighardia*
6. Mammalia (mammals): *Linguatula*

## Pentastomida

### Synonym

Tongue worms.

### Name

Greek: *pente* = five, *stoma* = month

### Classification

Phylum of →Metazoa.

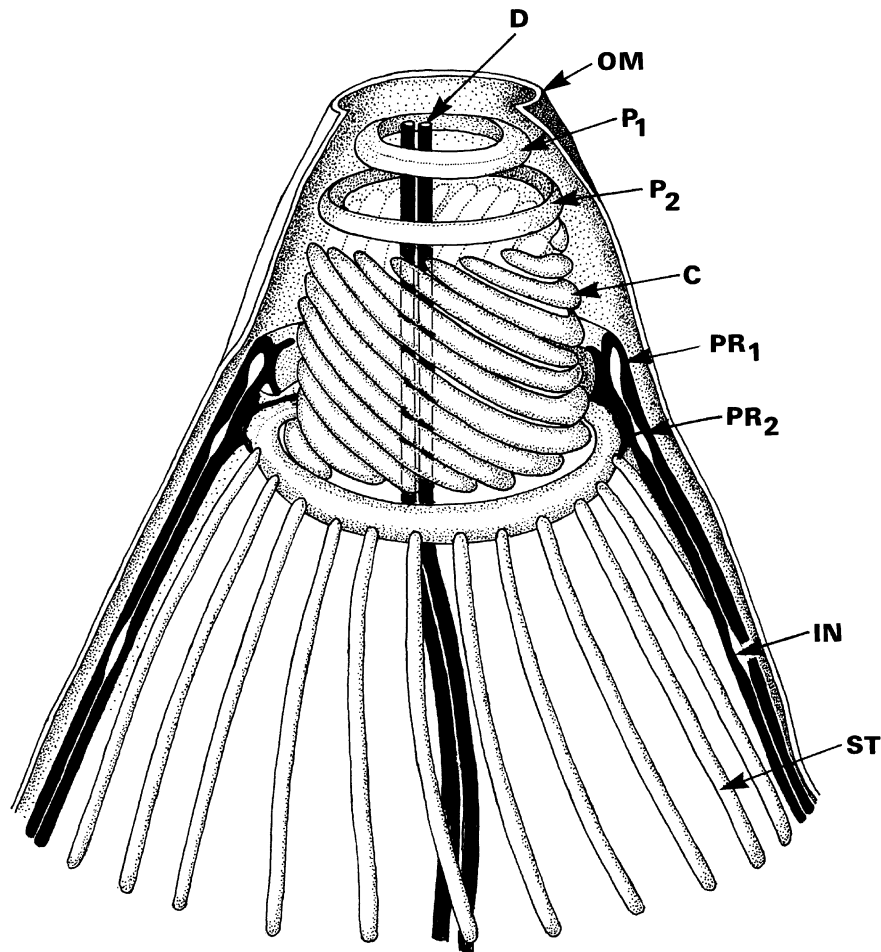

**Pellicle. Figure 5** Diagrammatic representation of the anterior pole of motile coccidia with a →conoid (e.g., *Eimeria*) – this stage has 2 polar ring systems (PR<sub>1</sub>/PR<sub>2</sub>). C, conoid consisting of microtubules; D, ductules of rhoptries; IN, the 2 inner membranes of the pellicle; OM, outer membrane of the pellicle, P<sub>1</sub>/P<sub>2</sub>, pre-conoidal rings; PR<sub>1</sub>/PR<sub>2</sub>, →polar ring system.

### General Information

Pentastomids are →dioecious endoparasites, separated into 2 orders, the primitive Cephalobaenida and the more highly developed Porocephalida; There are more than 120 species described. Up to now tongue worms are taken as phylum, closely related to the arthropods.

At present there exist 2 different interpretations of a number of results.

1. There are striking similarities with certain crustaceans (branchiura) concerning the morphology of sperms and ovaries and the mode of oogenesis. Together with the results of studies on the 18S rRNA and mitochondrial DNA these findings seem to corroborate the placement of pentastomida within the crustaceans as a sister group of the branchiura.
2. Arguments against this close kinship are sharp disparities concerning morphology, embryology, and life cycles; besides that pentastomids lack a nauplius-like larva and possess β-chitin instead of

α-chitin as arthropods normally do. They are classified by these authors as a branch of the stem leading to the arthropods.

At the present state of knowledge the conclusion is to leave the classification of this group unchanged, until new findings permit a better understanding.

The species of *Pentastomida* reach 10–160 mm in length, and their more or less rounded, worm-like body (in some species flattened) can be divided into 2 regions. The shorter head with one pair of apical and one pair of frontal papillae is armed with 2 pairs of chitinized hooks. The outer annulation of the longer trunk is obviously due to a true, but incomplete segmentation. The body is covered by a chitin-containing →cuticle (→Chitin, →Cuticle) which is secreted by a single layer of epidermal cells (Figs. 1, 2). The musculature of the body wall as well as of the internal organs is striated (Fig. 3). At least in the anterior part of the body, the body cavity is a mixocoel.

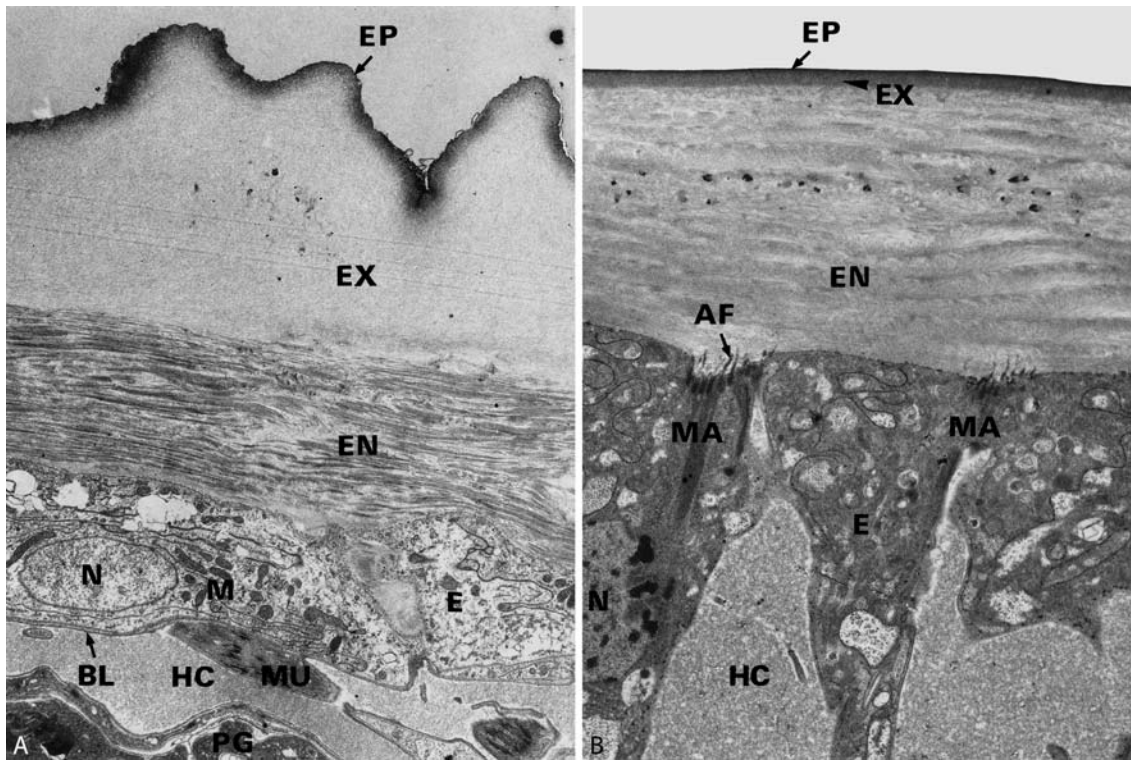

**Pentastomida. Figure 1 A, B** Integument of pentastomids (TEMs). **A** Cross section through the integument of the cephalobaenid *Raillietiella aegypti* ( $\times 5,000$ ). **B** Part of the integument of an infective  $\rightarrow$ nymph of *Armillifer* sp. ( $\times 5,000$ ). *AF*, afferent fiber; *E*, epidermis; *EN*, endocuticle; *EP*, epicuticle; *EX*, exocuticle; *HC*, hemocoel; *M*, mitochondrion; *MA*, muscle attachment; *MU*, muscle fiber; *PG*, parietal gland.

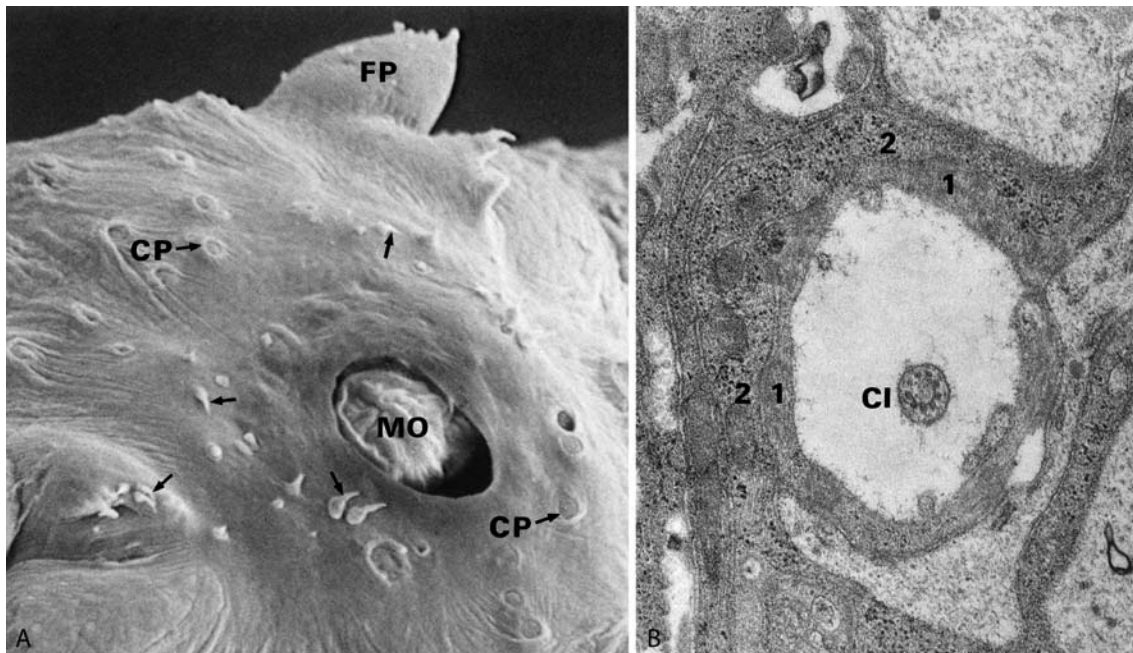

**Pentastomida. Figure 2 A, B** Sensilla of pentastomids (TEMs). **A** Mouth field of a raillietiellid with sensilla (arrows) and pores of chloride cells (SEM  $\times 850$ ). **B** Cross section through the  $\rightarrow$ sensillum. (TEM  $\times 21,300$ ). *CI*, cilium; *CP*, pore of a chloride cell; *FP*, frontal papilla; *MO*, mouth; *1*, *2*, first- and second-sheath cells.

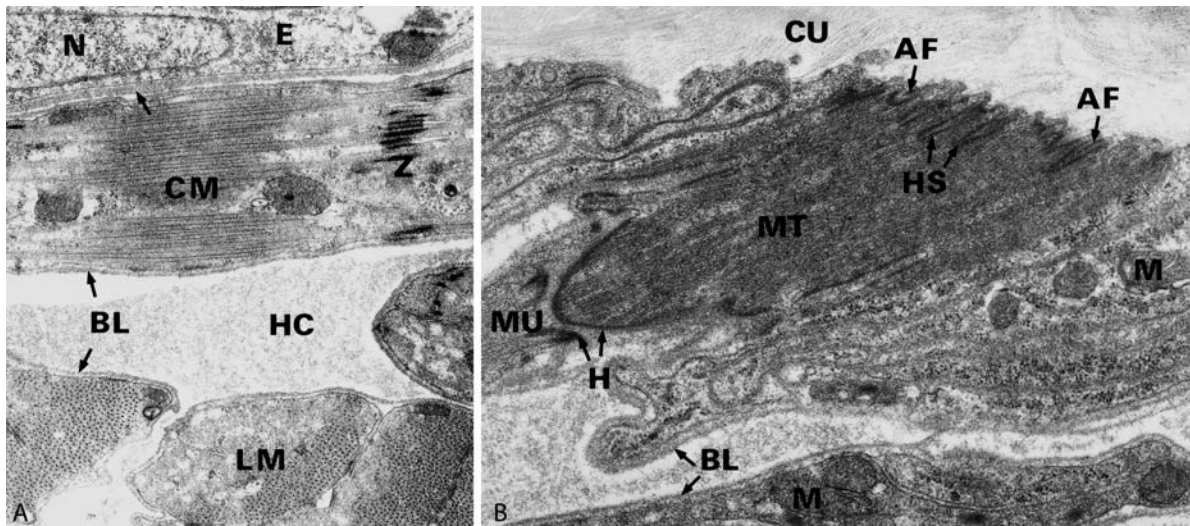

**Pentastomida. Figure 3 A, B** Muscles of pentastomids (TEMs). **A** Circular and longitudinal musculature beneath the epidermis (E) ( $\times 12,200$ ). **B** Muscle attachment at the cuticle ( $\times 21,800$ ). *AF*, afferent fiber; *BL*, basal lamina; *CM*, circular musculature; *CU*, cuticle; *E*, epidermis; *H*, hemidesmosome; *HC*, hemocoel; *HS*, hemidesmosomal socket; *LM*, longitudinal musculature; *M*, mitochondrion; *MT*, microtubules; *MU*, muscle fiber; *N*, nucleus; *Z*, Z-line.

The trunk is almost completely filled with the intestine, the anus, which ends terminally or subterminally, and the reproductive organs (Fig. 4). In females the latter consist of an ovary, an oviduct, 2 receptacula seminis, uterus, and vagina. The males possess one  $\rightarrow$ testis, and a seminal vesicle that opens into 2 ejaculatory ducts, each followed by a vas deferens, a  $\rightarrow$ cirrus (penis), and a spicule (dilator). The genital opening is situated medially and ventrally at the beginning of the trunk in females of the Cephalobaenida and in all males. In females of the Porocephalida it is found in the posterior region of the trunk. So far no excretory organs such as nephridia or Malpighian tubules have been found.

In cephalobaenid tongue worms the nervous system consists of the brain which is connected to ganglia. The trunk is supplied by 2 strong nerve cords which rise from the last ganglion. The nervous system of the more highly developed Porocephalida is much more concentrated and reduced. There are no highly developed sense organs, except for single sensilla or groups of them, which can be compared with those of arthropods. Pentastomida have no circulatory systems and no respiratory organs.

During their life cycle, pentastomids undergo a  $\rightarrow$ metamorphosis ( $\rightarrow$ *Linguatula serrata*/Fig. 1,  $\rightarrow$ *Porocephalus crotali*/Fig. 1,  $\rightarrow$ *Raillietiella frenatus*/Fig. 1), which in most cases proceeds with a facultative or obligatory alternation of hosts. According to the species, arthropods or vertebrates are used as intermediate hosts (cf. Table 1). Adult pentastomids may live in the lungs and respiratory systems of land- and water-living carnivorous vertebrates, in whose organs they are attached by means of their hooks and feed on blood; if they are living in the nasopharyngeal cavity of mammals, they feed on nasal mucus and sloughed cells.

### System

- Phylum: Pentastomida
  - Order: Cephalobaenida
    - Family:  $\rightarrow$ Cephalobaenidae
      - Genus: *Cephalobaena*
      - Genus: *Raillietiella* ( $\rightarrow$ *Raillietiella frenatus*/Fig. 1)
      - Genus: *Rileyiella*
    - Family: Reighardiidae
      - Genus: *Reighardia*
  - Order: Porocephalida
    - Family: Sebekidae
      - Genus: *Alofia*
      - Genus: *Leiperia*
      - Genus: *Selfa*
      - Genus: *Agema*
      - Genus: *Sebekia*
      - Genus: *Pelonia*
      - Genus: *Diesingia*
    - Family: Subtriquetridae
      - Genus: *Subtriquetra*
    - Family: Sambonidae
      - Genus: *Sambonia*
      - Genus: *Elenia*
      - Genus:  $\rightarrow$ *Waddycephalus*
      - Genus: *Parasambonia*
    - Family:  $\rightarrow$ Porocephalidae
      - Genus: *Porocephalus* ( $\rightarrow$ *Porocephalus crotali*/Fig. 1)
      - Genus: *Kiricephalus*
    - Family:  $\rightarrow$ Armilliferidae
      - Genus: *Armillifer*
      - Genus: *Cubirea*
      - Genus: *Gigliolella*



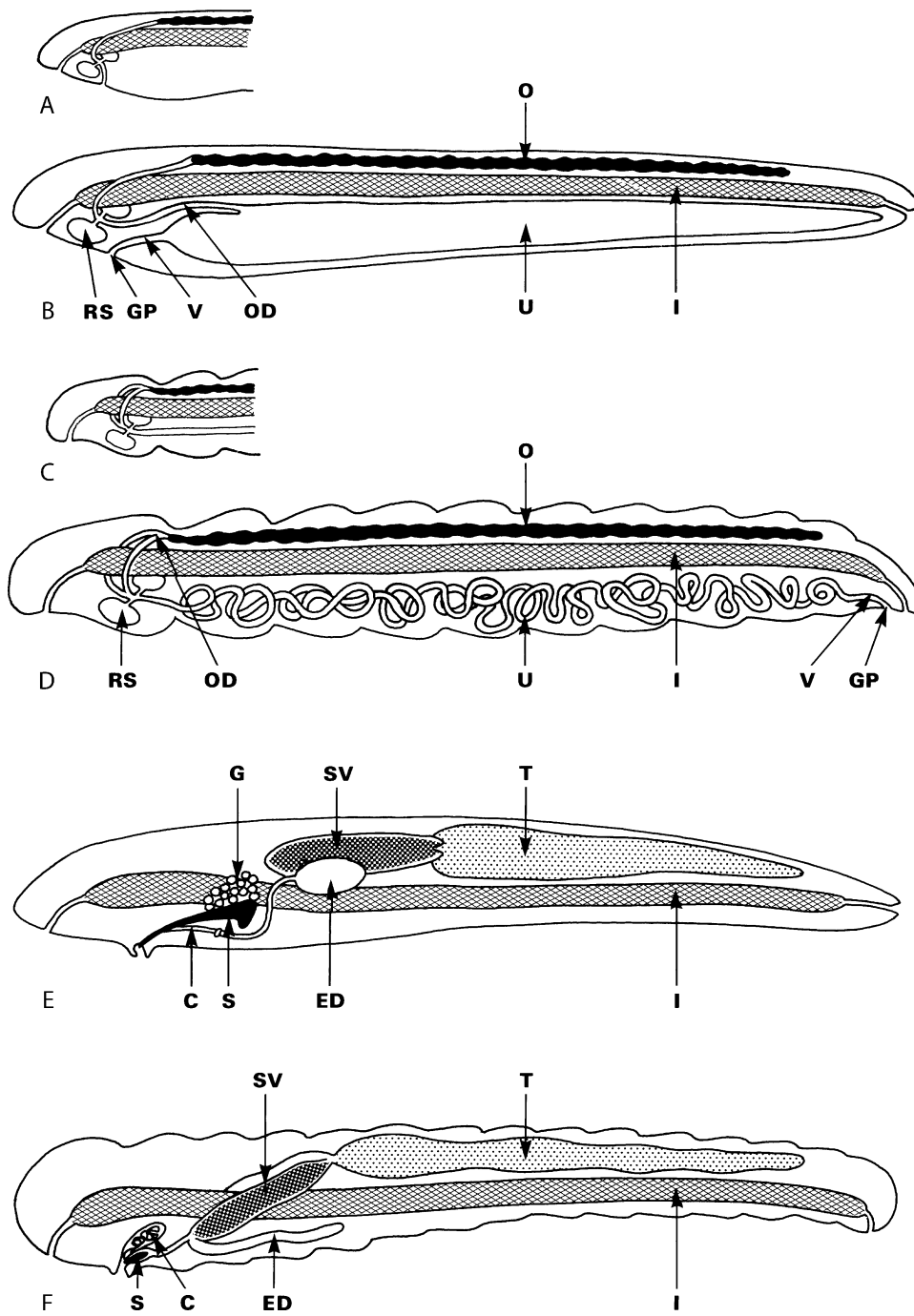

**Pentastomida. Figure 4 A–F** Diagrammatic representation of the reproductive systems of cephalobaenids and porocephalids. **A, B** Cephalobaenid females: anterior region at the time of insemination (A) and mature female (B). **C, D** Porocephalid females: anterior region at the time of insemination (C) and mature female (D). **E** Cephalobaenid male. **F** Porocephalid male. *C*, cirrus; *ED*, ejaculatory duct; *G*, gland; *GP*, genital pore; *I*, intestine; *O*, ovary; *OD*, oviduct; *RS*, →receptaculum seminis; *S*, spiculum; *SV*, seminal vesicle; *T*, testis; *U*, uterus; *V*, vagina.

- Family: →[Linguatulidae](#)
- Genus: *Linguatula* (→[Linguatula serrata](#)/Fig. 1)

## Important Species

Table 1.

### Integument

The soft and flexible →[integument](#) of pentastomids is similar to that of some soft-skinned arthropod larvae (e.g., fly maggots). Its chitin-containing cuticle is excreted by the epidermal cells. Three layers are visible in the cuticle of the cephalobaenid genus *Raillietiella* (Fig. 1). An endocuticle with more or less lamellate-orientated microfibrils is located immediately above the epidermal cell layer. Then an exocuticle follows, which is characterized by relatively short, unorientated fibrils. The exocuticle is covered by an epicuticle consisting of at least 2 layers. The organization of the cuticle in →[Reighardia sterna](#)e (another cephalobaenid) seems to be the same as in *Raillietiella* spp., although the layers of the procuticle (= exo- and endocuticle) are described in other terms in some investigations. Adult females of *R. sterna*e, however, are an exception, as their exocuticle contains tubercular structures.

Ultrastructural studies of infective nymphs of porocephalids (e.g., *Porocephalus crotali* and *Armillifer* spp., Fig. 1) have revealed the same cuticular organization as in the adults of *A. armillatus*, although the exocuticle is relatively thin. The layer between the

endo- and epicuticle is named more with regard to its position than to its functional properties; it should be the subject of further studies to decide whether it is a true exocuticle (similar to the corresponding layer in arthropod cuticle). The ducts of different glands or gland cells open at the surface of the cuticle (Fig. 2). The epidermis includes gland cells (stigmatal or cuticular glands) which closely resemble the →[chloride cells](#) of aquatic insects.

Other glands whose chitin-lined ductules empty on the cuticular surface are described as frontal-, hook- and parietal glands. Frontal and hook glands in cephalobaenids are limited to the →[cephalothorax](#) and appear somewhat diffuse, whereas in porocephalids these glands are well-defined. In the latter case only the hook glands are found in the cephalothorax; the frontal glands, however, extend into the abdomen running along the intestine.

In *Reighardia* frontal and parietal glands produce secretions which are spread over the cuticle; it is assumed that these secretions protect the parasite against the host immune response.

### Musculature

The musculature of pentastomids is usually cross-striated. Beneath the epidermis a thin circular muscle layer occurs, followed by a layer of inner longitudinal muscles (Fig. 3). A basket-like network is formed by parietal circular and longitudinal muscles. Furthermore, each annulus is endowed with transversally orientated muscles. The hooks are equipped with strong

Pentastomida. Table 1 Some common species of the Pentastomida

Family/Species	Length of adult (mm)		Egg size (inner shell) (µm)	Final host/Habitat	Intermediate host
	f	m			
<b>Cephalobaenidae</b>					
<i>Raillietiella gehyrae</i>	6.3–9	3.4–6.4	109 × 80	Geckos/Lung	Cockroaches/Fat body
<i>R. furcocerca</i>	40–60	10–22	102 × 79	Snakes/Lung	??
<b>Reighardiidae</b>					
<i>Reighardia sterna</i> e	30–46	6–8	320 × 210	Birds/Respiratory system	Direct development (?)
<b>Porocephalidae</b>					
<i>Porocephalus crotali</i>	44–78	27–36	102 × 83	Crotalid snakes/Lung	Rodents/Mesenteries, connective tissues, viscera
<b>Armilliferidae</b>					
<i>Armillifer armillatus</i>	70–140	30–50	108 × 80	Pythons, viperid snakes/Lung	Mammals/Mesenteries, connective tissues, viscera
<b>Linguatulidae</b>					
<i>Linguatula serrata</i>	80–120	18–20	90 × 70	Dogs, <b>humans</b> /Nose	Mammals/Mesenteries, connective tissues, viscera

strands of muscles. The intestine and uterus are both surrounded by muscle layers which are separated from the epithelium by a basal lamina (Fig. 7A). Frequent attachments of muscle fibers to the cuticle allow movements of the body wall. These muscular attachments are very similar to those of arthropods, since fibers are connected to the cuticle by modified epidermal cells which contain axially orientated →microtubules. Apically the microtubules are associated with conical →hemidesmosomes from which attachment fibers arise leading to the endocuticle (Fig. 3B). Basal to the microtubules a hemidesmosome is in contact with a hemidesmosome of the muscle fiber.

## Reproduction

### Reproductive Organs

**Female** pentastomids usually possess a single, blind-ending, tubular ovary, which is located dorsally to the intestine (Figs. 4, 5), and attached to the dorsal body wall by a mesentery. The ovary is followed by a single oviduct in cephalobaenids and (as the ovary bifurcates in its front part) by 2 oviducts in porocephalids. In cephalobaenids the oviduct leads ventrally and is connected to 2 receptacula seminis. Ventrally it is

followed by the saccate uterus, which is connected with the genital pore at the anterior end of the female by a short vagina. The two oviducts of porocephalids fuse ventrally to the intestine; at this junction 2 receptacula seminis open via short ductules. The coiled tubular uterus exceeds several times the body length of females and ends in a short vagina, which leads to the genital opening at the posterior end of the female. The lumina of the uterus and vagina are lined by a chitinous intima in both orders of pentastomids.

**Males** of all pentastomids possess a single testis (except for *Linguatula* spp. which have 2) located dorsally. In cephalobaenids the testis is separated from the large seminal vesicle by a sphincter, from which 2 short ducts lead laterally to the muscular ejaculatory ducts or bulbs. These are followed by the vasa deferentia which lead to the copulatory organs (Fig. 4). The genital pore is situated at the anterior end of the body containing chitinized copulatory →spicules (= dilators). By merging with the dilators the vasa deferentia become nonmuscular cuticular tubes (= cirri). At the entrance of the vasa deferentia into the dilators, several glands with unknown functions are usually found. Male reproductive organs of porocephalids are more differentiated than those of the

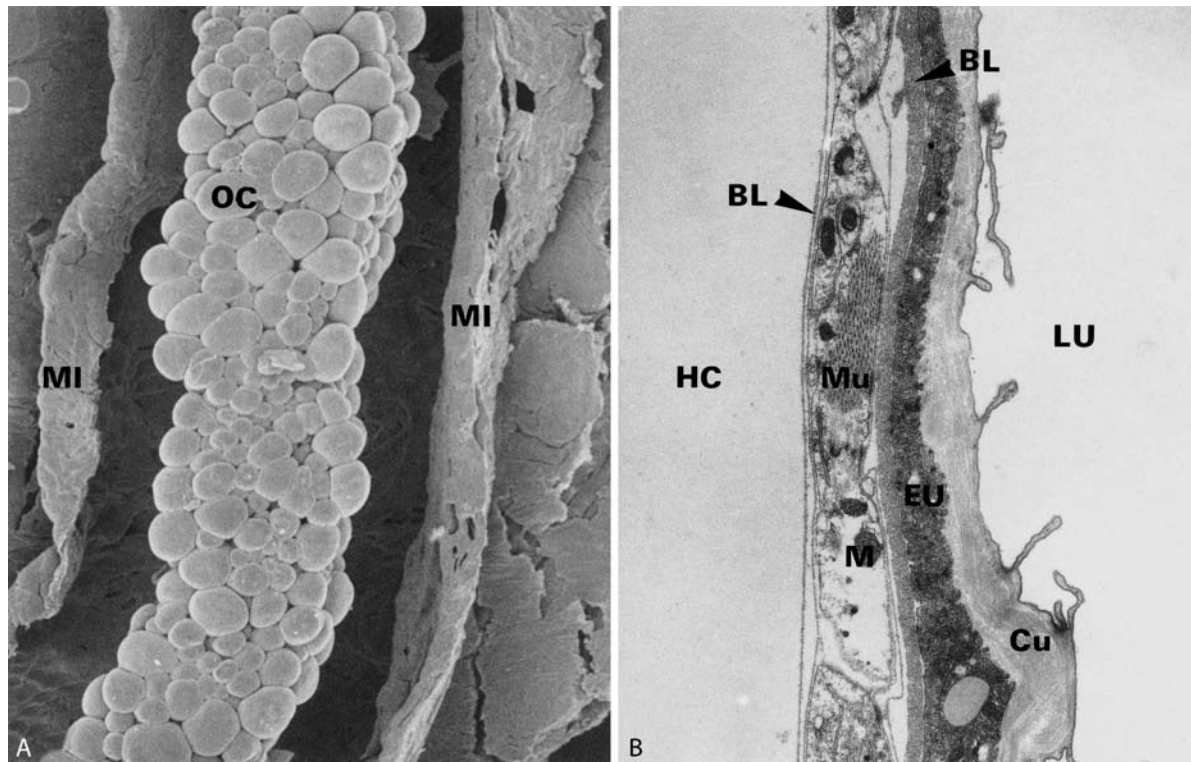

**Pentastomida. Figure 5 A, B** Reproductive organs of pentastomids (*Raillietiella aegypti*). **A** SEM of a ventral view of the ovary ( $\times 200$ ). **B** Part of the uterus wall (TEM) ( $\times 11,700$ ). *BL*, Basal lamina; *CU*, cuticle; *EU*, uterus epithelium; *HC*, hemocoel; *LU*, lumen of the uterus; *M*, mitochondrion, *MI*, mesenteries of the intestine; *MU*, musculature; *OC*, oocyte enclosed within the basal lamina.

cephalobaenids. The arms of the paired or Y-shaped seminal vesicle penetrate through the frontal glands before encircling the gut. They are each followed by a short vas deferens, which is entered at its beginning by an elongate ejaculatory duct. The cirrus threads are extremely long tubes, coiled up within cirrus sacs which join before reaching the genital pore in the anterior region of the body. As in cephalobaenids the vasa deferentia are associated with copulatory spicules, which are heavily sclerotized organs that can be protruded and retracted by musculature. They may act as dilators of the female genital opening, as support, or be involved in the retraction of the cirri after copulation.

### Gametogenesis and Fertilization

Studies on the development of the female pentastomid reproductive organs have shown that copulation can only take place at a particular time, since only in young females are the vagina and the receptacula seminis close enough together for an injection of sperm by the cirri into the →spermatheca to be possible. Later on, when the uterus reaches its final size, the vagina becomes more and more remote from the receptacula. As a consequence pentastomid females have to store the sperm after insemination.

→Spermatogenesis and sperm morphology greatly resemble those of the branchiurian crustacean →*Argulus foliaceus*. The →spermatozoa of *Raillietiella* sp. are filiform, 100–130 μm long, and consist of a pseudoacrosome, a body (with nucleus and 3 →mitochondria), and a sheathed →axoneme (Fig. 6C). During development of the →oocytes they migrate from the lumen to the margin of the ovary and are separated from the hemolymph only by a thin basal lamina (Fig. 6). After reaching maturity the oocyte migrates through the wall of the ovary into the ovarian lumen and is transported to the apical oviduct (Fig. 6).

### Postzygotic Development

After fertilization the eggs reach the uterus, within which further development to the primary larva takes place (Fig. 6). The larvae are enclosed by several layers, 3 in most cephalobaenids, and 4 in porocephalids. The innermost chitinous layer is excreted by the epidermis of the embryo and is covered by mucus which is secreted by the dorsal organ. A very thin layer (chorion) follows. The outermost layer (= outer →eggshell) is the definite shell (Fig. 6). In porocephalids a fourth layer is added as a secretion of the female reproductive tract; this fourth layer swells in water to form a hyaline capsule. Ovulation and egg deposition take place continuously in all known pentastomids except for *Reighardia sterna* where →patency is relatively short compared with other pentastomids and

all eggs develop simultaneously. The uterus is filled with eggs at different stages of development. Studies on several *Raillietiella* spp. have shown that females become patent when about 25% of the eggs are fully embryonated. A chitinous cylinder which has been described in the vagina of *Raillietiella* spp. obviously has the function of a sieve to prevent deposition of unembryonated eggs.

The primary larva (Fig. 6E, F, G) is the infective stage for the next host (which may belong to the same species in the case of direct infections or which may be an →intermediate host when alternation is necessary). Depending on the pentastomid species the intermediate host may be an invertebrate or a vertebrate. Facultative and obligate alternation of hosts may occur. When an intermediate host has been infected orally, the primary larva hatches in the alimentary tract, and penetrates the intestinal wall using its penetration apparatus and hooks (Fig. 6E, F). Upon reaching the body cavity the primary larva may enter various organs (depending on the species). In cockroaches, for example, which serve as intermediate hosts for some *Raillietiella* spp., the larvae are found in the fat body (Fig. 6H). The larvae become encapsulated and develop to the stage that is infective for the final host, although some may die at various developmental stages without reaching infectivity.

In *Raillietiella* spp. that utilize invertebrates as intermediate hosts life cycle studies showed in species parasitizing geckos, the third →instar (i.e., after 2 molts) (Fig. 6I), – but in other species the fourth instar – is the infective stage. In the case of vertebrate intermediate hosts often 4 molts are necessary. In porocephalid genera (e.g., *Porocephalus*, *Sebekia*, *Linguatula*) 6–8 molts are required in the vertebrate intermediate host before the infective stage is developed. The developing larvae are found in different host organs; in invertebrates *Raillietiella* spp. are observed on the surface of the viscera and in the fat body. Porocephalid instars are found in human liver, intestine, and mesenteries (*Armillifer armillatus*); in fatty tissues around reproductive organs and intestinal mesenteries (→*Porocephalus crotali*); in swim bladder of fish (*Subtriquetra*); free in the body cavity among the viscera (*Sebekia*). If an intermediate host or its tissue has been swallowed by the final host, the infective larvae hatch in the alimentary tract. After passing into the body cavity they migrate to the lungs and penetrate them. Larvae of →*L. serrata* make their way directly to the esophagus in order to reach their final location, the nasopharyngeal region.

After several molts (the number of which varies between orders and species) the pentastomids become sexually mature. Copulation takes place when the sexes are of similar size, and obviously only once in the life of females (see above). After reaching patency females

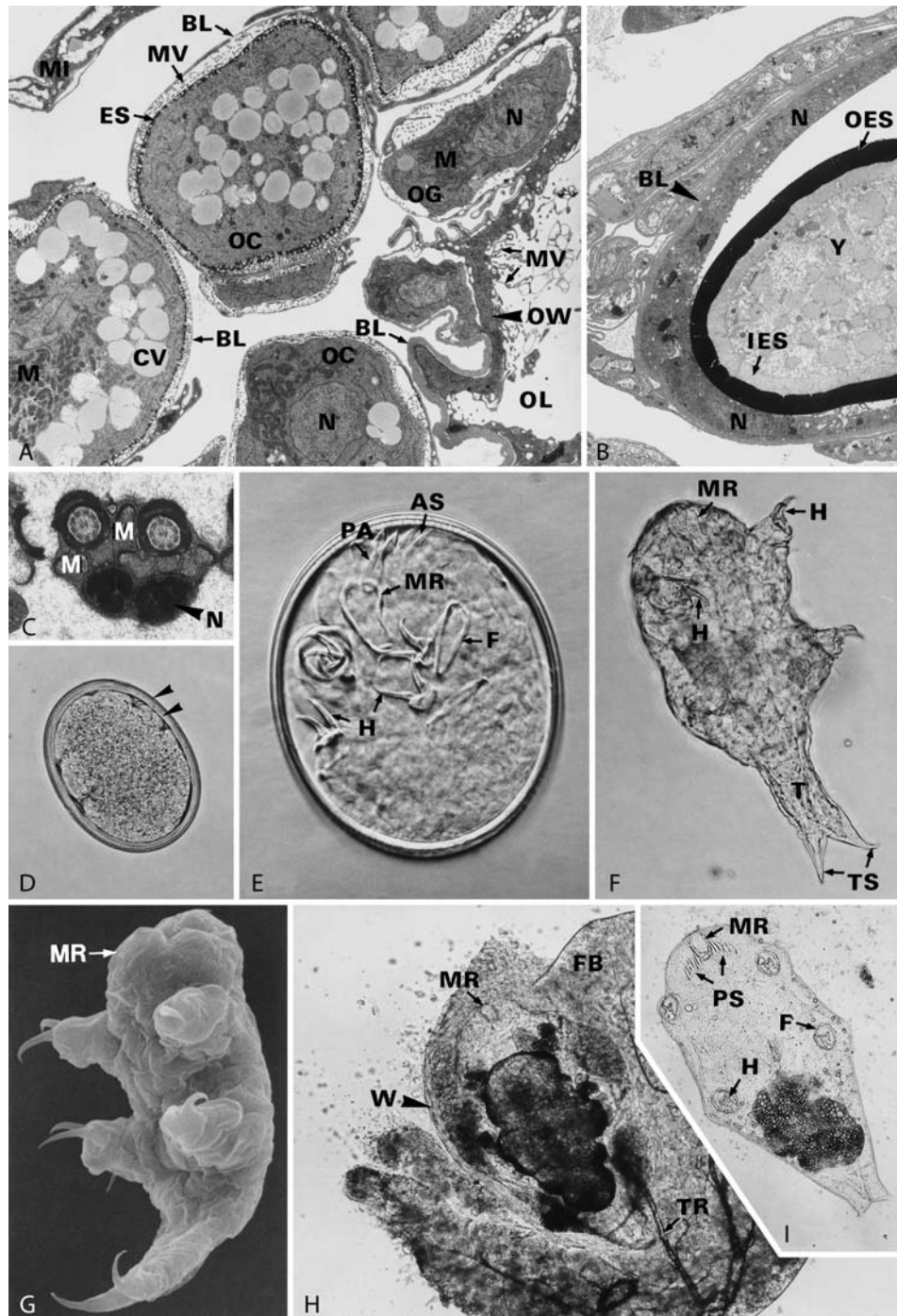

**Pentastomida. Figure 6 A–I** Reproduction systems of pentastomids. **A–C** TEMs, **G** SEMs, **D–F, H, I** LMs. **A** Cross section through the ovary of *Raillietiella aegypti* with oogonia and oocytes at different stages of development.  $\times 2,100$ . **B** Section through the oviduct before reaching the receptacula seminis.  $\times 6,200$ . **C** Cross section through a spermatozoon in the receptaculum seminis.  $\times 21,000$ . **D** Embryonating egg of *Raillietiella* sp.; inner and outer eggshells indicated by arrows.  $\times 200$ . **E** Fully embryonated egg of *Raillietiella aegypti* with primary larva.  $\times 340$ . **F** Primary larva of *Raillietiella* sp.  $\times 300$ . **G** Raillietiellid primary larva.  $\times 350$ . **H** Encapsulated 3rd-stage larva of *Raillietiella* sp. in the fat body of a cockroach (*Blaberus* sp.).  $\times 75$ . **I** Infective 3rd-stage larva of *Raillietiella* sp., the midgut of which is ruptured.  $\times 100$ . *AS*, accessory spines; *BL*, basal lamina; *CV*, cortical vacuole; *ES*, eggshell; *F*, fulcrum; *FB*, fat body; *H*, hook; *IES*, inner eggshell; *M*, mitochondrion; *MI*, mesentery of the intestine; *MR*, mouth ring; *MV*,  $\rightarrow$  microvilli; *N*, nucleus; *OC*, oocyte; *OES*, outer eggshell; *OG*, oogonium; *OL*, ovarian lumen; *OW*, ovarian wall; *PA*, penetration spines; *T*, tail; *TS*, terminal spines; *TR*, trachea; *W*, wall of the capsule.

deposit fully embryonated eggs, which in most cases are swallowed by the host, and thus passed with the feces. The number of eggs produced by a female tongue worm varies with the species from about 2,900 in *Reighardia* spp. up to several million in *L. serrata*. The uterus of small raillietiellids contains relatively few eggs, whereas in the largest species of this genus it has been estimated to contain up to 200,000 eggs. Gravid females of porocephalid genera (e.g., *Porocephalus* and *Linguatula*) may contain 500,000 eggs. In *Porocephalus crotali* the rate of egg deposition has been counted as 520–2,300 per female per day. It must be added that in both pentastomid orders a long patent period is common, for instance at least 6 years in *P. crotali* and 1 year in *Raillietiella gehyrae*.

### Intestine and Food Uptake

The alimentary tract is divided into the fore-, mid-, and hindgut, the fore- and hindgut being lined by a chitinous intima. The foregut consists of the buccal cavity with an oral papilla, plus the pharynx and the esophagus. The mouth is bordered by a V- or ring-shaped chitinous structure which serves as insertion for the musculature of the pharyngeal pump. A valve

between the esophagus and midgut prevents backflow of food. The midgut is not differentiated into functional regions; its epithelium is columnar or cuboidal and separated from the surrounding muscles by a basal lamina (Fig. 7A). There are large storage areas in the muscle cells, which contain lipid and  $\rightarrow$ glycogen. Diverticles or glands do not occur along the midgut. The hindgut is short and in most cases ends with the anus, although it is missing in adult *Reighardia sterna*.

Most adult pentastomids feed on the blood of their hosts by sucking on capillaries, whereas *L. serrata* and larval stages of other porocephalids feed on lymph and lymphoid cells as well. Information on the process of digestion is scarce, since only 2 cephalobaenid species have been investigated with respect to this subject. Cyclic changes in the midgut epithelium during digestion of blood that are distinct in *Reighardia* and less intense in *Raillietiella* have been demonstrated. Digestion seems to be mostly extracellular, although intracellular digestion obviously occurs as accumulation of iron, as has been described in certain cells of the intestine. The apical part of or whole midgut cells that contain iron accumulations and spherocrystals mainly composed of calcium are budded or shed periodically into the gut lumen.

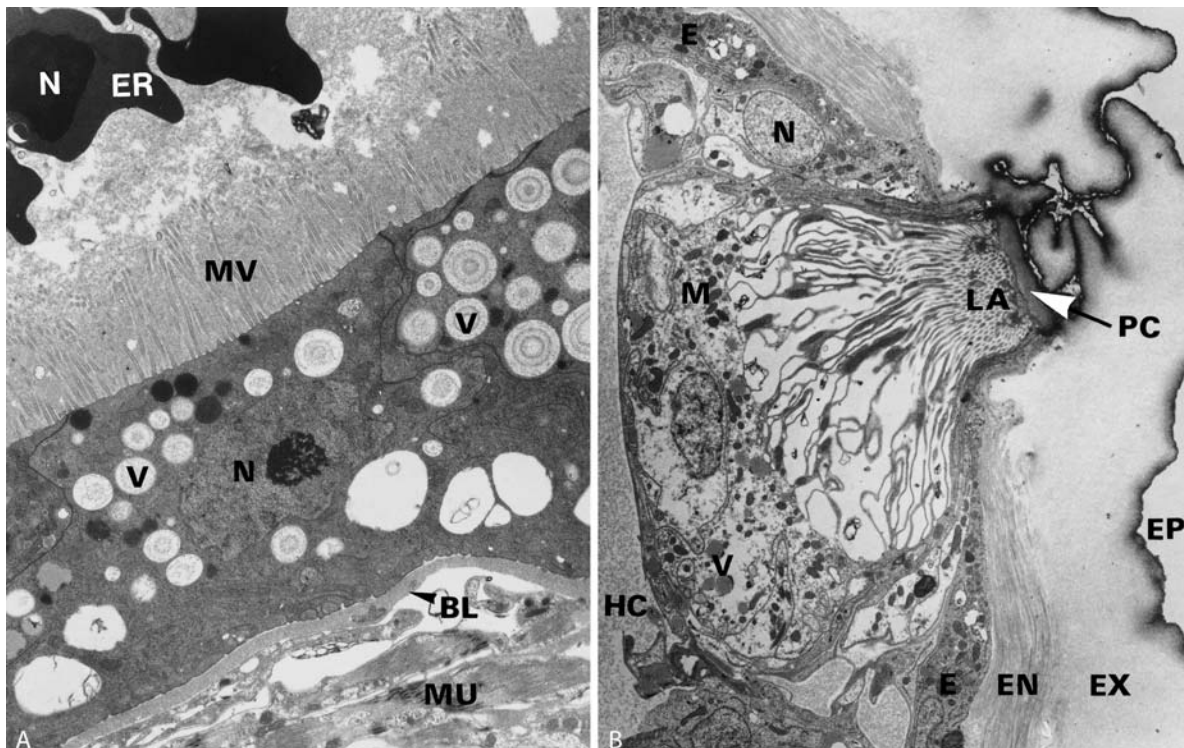

**Pentastomida. Figure 7 A, B** Intestine (A) and ionocytes (B) of pentastomids (TEMs). A Part of the intestinal wall ( $\times 5,100$ ). B Chloride cell within the integument ( $\times 3,100$ ). BL, basal lamina; E, epidermis; EN, endocuticle; EP, epicuticle; ER, erythrocyte from the reptilian host; HC, hemocoel; LA, lamellar apparatus; M, mitochondria; MU, muscle fibers; MV,  $\rightarrow$ microvilli; N, nucleus; PC, pore cap; V, vesicles.

## Nervous System

The central nervous system of pentastomids is formed by initially separate ganglia which tend to fuse during development in a different degree within the 2 orders. The arthropodan character of the nervous system is still visible in the Cephalobaenida. In *Cephalobaena tetrapoda* and *Raillietiella* sp. the first 3 pairs of ganglia are fused to form the subesophageal ganglion or “brain.” Two pairs of these ganglia are situated ventrally and one pair dorsally; the commissure of the latter pair encircles the esophagus. Nerves arising from the brain supply apical and frontal papillae, the first pair of hooks, and other organs of the cephalothorax. The 2 pairs of ganglia following the brain are isolated with the commissures and connectives still present thus showing the arthropodan type. From the first pair of these ganglia nerves lead to the second pair of hooks. The posterior part of the nervous system, which extends up to the genital opening, consists of 3 fused pairs of ganglia. Two nerve cords arising from its posterior end extend into the abdomen. Similar conditions have been described for *Reighardia sterna*. In the higher organized Porocephalida all ganglia are fused to form a compact complex from which, depending on the species, 8–11 pairs of nerves arise innervating the organs of the cephalothorax. The abdomen is supplied by 2 nerves which are smaller than those of cephalobaenids.

Different types of sensory organs of poorly understood function are present on the surface of pentastomids on the cephalothorax (Fig. 2).

## Pentatrichomonas hominis

→Trichomonadida.

## Pepper Ticks

Trivial name for larval →ticks.

## Pepsinogen Increase

Clinical symptom in animals due to parasitic infections (→Alimentary System Diseases, →Clinical Pathology, Animals).

## Peptidases

→Amino Acids.

## Peptides

→Acanthocephala.

## Perforatorium

Tip of gametes in coccidian and piroplasmian parasites to enter the female gamete, →Coccidia.

## Pericystectomy

Method to resect alveolar cysts of →*Echinococcus multilocularis*.

## Pericytic Cell

→*Myxosoma cerebralis*.

## Perikaryon

In →Platyhelminthes the syncytial →tegument is in contact with the underlying parenchymal cells via finger-like protrusions of the latter. Since in former time it was thought that these parenchymal cells belong intimately to the tegument, these “sunken” regions had been called perikaryon since they include the nucleus; from Greek: *karyon* = nucleus.

## Peristome

From Greek: *per* = around, *stoma* = mouth; deepening (mouth channel) in phagocytizing protozoans (e.g., →*Balantidium coli*).

## Peritonitis

### Name

Latin: *peritoneum* = cover of the abdominal cavity, *itis* = inflammation.

### General Information

This term describes any inflammatory infection of the peritoneal cavity, which may also be induced by parasites, e.g., disruption of cysts of →*Entamoeba* and →*Echinococcus* or penetration of worms (e.g., →*Macracanthorhynchus*).

## Peritremea

Plate at the ventral side of ticks, which is provided with the openings of the tracheoles (spiracles).

## Peritrophic Membranes

Peritrophic membranes (PM) are found in several phyla of the animal kingdom and are also characteristic for many ectoparasitic arthropods. In general it is accepted

that the PM, which may consist of several layers, contains proteins, mucopolysaccharides, and definite chitinous microfibrils; the latter appear in species-specific texture patterns, which are often different in larvae and adults of a given species. These microfibrils appear to increase the tensile strength of PMs, which may protect the smooth intestinal epithelium from hard food particles (in hard-food feeders) and to some degree from pathogens (in liquid-food feeders). The latter effect is of importance for the ability of some ectoparasitic arthropods to act as vectors of endoparasites. Thus it is very probable that parasites and other pathogens may pass the PM only at particular times and sites. For example, motile ookinetes of the →*Plasmodium* spp. are formed very soon (4–9 hours) after the uptake of the blood meal of female →*Anopheles* spp. and may then pass the not yet completely formed or incompletely hardened PM (Fig. 1); this process needs, for example, at least 13 hours in *A. gambiae*, but 32 hours in *A. stephensi*, which is a very common vector of human →malaria parasites. The same seems true for trypanosomes in the gut of →tsetse flies (→*Glossina* spp.), where continuous formation of the PM starts only after emergence, so that young flies, which had an infective feed at about 15 hours after emerging from the →puparium, reach →salivary gland infection rates of up to 24%, whereas older flies are infective only at a very low rate (0.04–1%). These effects, which in general lead to a considerable reduction of parasite burden and thus diminish the pathologic effects on the insect hosts, are

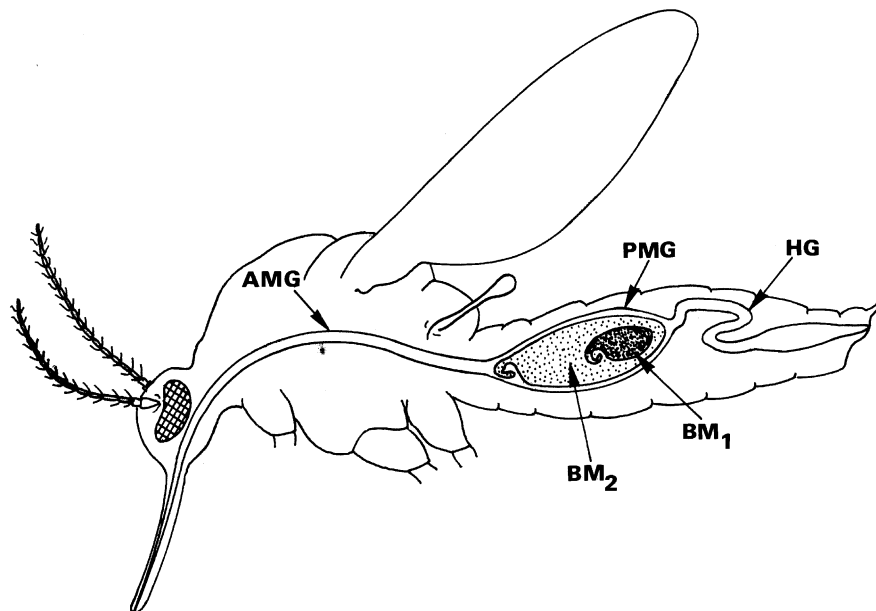

**Peritrophic Membranes. Figure 1** In adult female →*Mosquitoes* different amounts of peritrophic membrane are formed in 2 parts of the midgut. A small amount is secreted by the cells of the anterior region (AMG) and transported to the junction of the anterior and posterior midgut, whereas large amounts are produced by the posterior midgut (PMG) to envelop each blood meal (BM). *BM*<sub>1</sub>, *BM*<sub>2</sub>, first and second blood meals; *HG*, hindgut.



accompanied by the probably more primary action of the PM as a selective ultrafilter, as was shown by many [permeation](#) experiments.

In general there are 2 main processes of PM formation. In the first type, patches of PM are formed by [delamination](#) from the whole midgut epithelium ([Fig. 1](#)), although secretion from the anterior midgut is only minor. This type of PM formation occurs in adults of Tabanomorpha and Nematocera, where an incompletely digested first blood meal is often included in the second one, which again becomes covered by a PM. Thus parasites or pathogens included in the first meal may have to pass 2 peritrophic membranes.

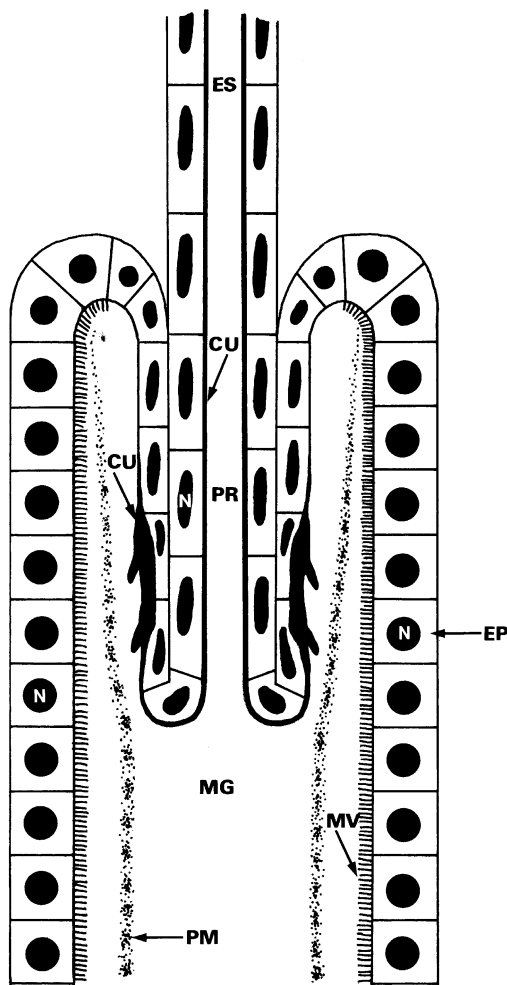

**Peritrophic Membranes.** **Figure 2** Diagrammatic representation of the cardia of those insects in which only a short zone of specialized cells at the beginning of the midgut is able to produce a tubelike peritrophic membrane, which may consist of several layers (after Peters 1976). *CU*, [cuticle](#); *EP*, epithelial cell; *ES*, esophagus; *MG*, midgut; *MV*, [microvilli](#); *N*, nucleus; *PM*, peritrophic membrane; *PR*, proventriculus.

The second type of PM formation is found in larvae of all dipterans and in adult members of the Muscomorpha (e.g., [Muscidae](#), [Hippoboscidae](#), Calliphoridae, Sarcophagidae, Oestridae). Only a short zone with a few separate rings of cells at the beginning of the midgut is able to produce tube-like PM ([Fig. 2](#)). In the majority of nematoceran larvae only a single PM is secreted, whereas adults muscomorphans have several PMs originating from distinct and separate ring zones ([Fig. 2](#)). The formation zone and the valvula cardiaca are usually called the [proventriculus](#), but this is not quite correct since a genuine proventriculus is only part of the foregut. Hence, this region should be called the cardia, which forms the PM without any additional delamination from even the adjacent midgut epithelium.

In several arthropods of medical importance, the PM is completely lacking. For example, all developmental stages of [bugs](#) and [lice](#) as well as adult [fleas](#) have no remnants of such a PM, although their food and feeding behavior are similar.

[Ticks](#) and bloodsucking [mites](#) in general have no PM, except for some *Ixodes* spp. where a PM-like layer is found adjacent to the intestinal cells. The latter do not increase in size during feeding, whereas the intestinal cells of most other ticks phagocytose enormous amounts of ingested blood; this process would be hindered by the presence of a PM or a similar structure. Apparently those *Ixodes* spp., which have a PM-like structure, digest in a way that differs significantly from other ticks.

## Perkinsea

[Apicomplexa](#).

## Perkinsus

Genus of parasites related to dinoflagellates; the developmental stages of this genus are found in clams (*P. marinus* in oysters) and had been erroneously included by Levine in the [Apicomplexa](#).

## Permeation

### Synonym

Nonmediated [membrane transport](#).

## Permethrin

Insecticidal compound, →[ectoparasitocidal drugs](#).

## Pernicious Anaemia

Chronical disease – lack of red blood cells – e.g., due to infections with the tapeworm →[Diphyllobothrium latum](#).

## Peroxisomes

→[Microbodies](#) which are especially numerous in several metazoan cells (e.g., human liver cells include ~200 of such organelles). Their main task is to break down toxic  $H_2O_2$  by the activity of a catalase into  $O_2$  plus  $H_2O$  using the following reaction scheme: substrate plus  $2H_2O_2 =$  oxidated substrate plus  $2H_2O$ . Besides →[metazoa](#) such peroxisomes are found in many protozoans (e.g., Phytomonadina, →[Rhizopoda](#), →[Ciliophora](#)), but are definitively absent in many parasites such as trypanosomatids, →[Plasmodium](#) spp., →[Entamoeba histolytica](#), or →[Microsporidia](#), so that those parasites are not able to break down  $H_2O_2$  in this way.

## Pfcr1

Gene that is responsible of chloroquine-resistance in →[Plasmodium](#) spp.

## PFEMP-1

Variant surface antigen, a virulence factor (*Plasmodium Falciparum* Erythrocyte Membrane Protein), which mediates the cytoadherence of infected red blood cells to endothelial cells. It is associated with the so-called knobs being composed of the histidine rich proteine KAHRP.

## PfHRP-2

→[Plasmodium falciparum](#) histidine rich protein 2 (→[Malaria/Vaccination](#)).

## Phaenicia

Genus of botflies (Calliphoridae), synonym to →[Lucilia](#).

## Phaenicia serricata

### Synonym

*Lucila serricata*, green blowfly, 6–9 mm long with yellowish palps. The related species *P.(L.) cuprina* is 6–8 mm long and has a median longitudinal line on the dorsum.

## Phagocytosis

Internalization of solid particles by a cell via formation of endocytotic vesicles (→[Endocytosis](#), →[Host Cell Invasion](#)).

For example, feeding process in macrophages (of stages of, e.g., *Toxoplasma*, *Leishmania*) and amoebae (→[Entamoeba histolytica](#)).

## Phagolysosomes

→[Lysosome](#).

## Phagosomes

→[Endocytosis](#).

## Phanquinone

→[Malariacidal Drugs](#).

## Phaonia

Genus of the fly family Muscidae. The adults of the species (5–12 mm) are found in animal faeces in Europe.

## Pharate Stages

In many members of the parasitic mites and in the family Pterygosomatidae, →[protonymphs](#) and →[tritonymphs](#) develop within the skin of the preceding stage (e.g., the →[protonymph](#) in that of the larva, the →[tritonymph](#) in the skin of the →[deutonymph](#)). These pharate hidden stages remain inactive; thus only free, active larvae and →[deutonymphs](#) are found (→[Mites/Ontogeny](#)).

## Pharyngobdellida

→[Leeches](#).

## Pharyngobolus

Genus of the fly family Oestridae. *Pharyngobolus africanus* induces myiasis in the pharynx and oesophagus of elephants in tropical Africa.

## Pharyngomyia

Genus of fly family Oestridae leading to myiasis in the respiratory system of deers (e.g., *Pharyngomyia picha* in Europe).

## Phasmidea

### Classification

→[Secernentea](#) (→[Nematodes](#)).

## Phasmids

Minute, usually paired chemoreceptors of →[Secernentea](#) (→[Nematodes](#)).

## Phenamidine

→[Babesiacidal Drugs](#).

## Phenamidineisothionate

Drug of the diamidines which acts as blocker of DNA-synthesis and aerobic glycolysis in →[Babesia](#) and →[Trypanosoma](#).

## Phenol Derivatives

→[Nematocidal Drugs](#), →[Fasciola](#).

## Phenothrin

### Chemical Class

Pyrethroid (type I).

### Mode of Action

Open state voltage-gated sodium channel blocker.  
→[Ectoparasitocides](#) – [Blockers/Modulators of Voltage-Gated Sodium Channels](#).

## Phenotypic Variability

Parasites may change the motor activity of their hosts (e.g., acanthocephalans reduce running speed of cockroaches), their →behavior (e.g., →nematodes introduce loss of dominance in mice) or may have effects on host morphology (e.g., →trematodes lead to size increase in snails or →cestodes lead to alteration of body coloration in host fish).

## Pheromones

→Aggregation-Attachment Pheromones, →Ticks, →Insects.

## Philomethroides

Genus of nematodes of fish, e.g., *Philomethroides cyprinii* of carps.

## Philometra

From Greek: *philos* = loving, *metra* = uterus, describing the fact that they are found in the blood vessels of inner organs.

### Synonym

*Ichthyonema*.

### General Information

They are red-appearing nematodes as females (up to 5 cm × 1 mm) of salt- and freshwater fish. Males reach only 2–3 mm. *Cyclops*-crustaceans are intermediate hosts. They mainly live in blood vessels, but are also found in the body cavity. →Nematodes.

### Therapy

Nematol of Alpha-Biocare, Düsseldorf.

## Philophthalmus

### Name

Greek: *philein* = love, Latin: *ophthalmicus* = belonging to the eye.

### General Information

Trematode worms of the species *Philophthalmus cupensis* occur on the conjunctiva of goose and ducks and induce inflammations. In humans *P. palpebrarum* (Fig. 1) is described to introduce symptoms of disease. This worm reaches a size of 2.4 × 1.3 mm. Intermediate hosts are snails.

### Therapy

Chirurgical discharge.

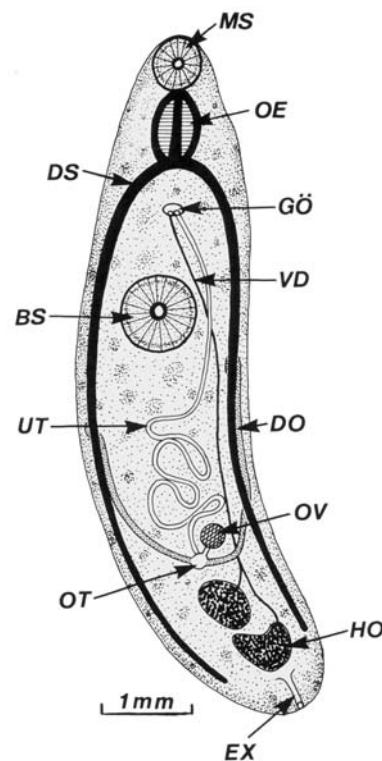

**Philophthalmus.** Figure 1 DR of an adult fluke from human eye. BS, ventral sucker; DO, vitellarium; DS, branch of intestine; EX, excretorial pore; GO, genital opening; HO, testes; MS, oral sucker; OE, oesophagus; OT, ootype; OV, ovary; UT, uterus; VD, vas deferens.

## Phlebotomidae

→ Sand flies, family of → Diptera.

### Life Cycle

→ Sand flies, → Diptera/Fig. 1.

### Control

→ Ectoparasitocidal Drugs.

## Phlebotomidosis

Disease due to infestation with phlebotomids, see Table 1.

## Phobia

Many (mostly elderly) people suffer from the fear of existing pests (such as cockroaches, → spiders, mice, etc.) or from imagined items. In the latter case the disease represents a form of schizophrenia and cannot be cured, since the patients have composed a whole story, which they defend against any rational evaluation.

## Phlebotomus

### Name

Greek: *phlebs*, *phlebos* = blood vessel, *tomos* = cutting.

### Classification

Genus of sand flies (Phlebotomidae, order Diptera), important species: *Phlebotomus perniciosus* (Fig. 1), *P. papatasi* as vectors of stages of *Leishmania*.

### General Information

Very tiny (1–2 mm-sized) specimens of biting mosquitoes, which occur in Africa, Asia, Near East and southern Europe and now also in Central Europe. They breed in detritus of leaves, in corners of houses, nests of rodents. They are active during night, however, suck blood also in day time. Characteristic are their angel-wing-like arrangement of their wings and the hairy appearance of the whole body (Fig. 1). The development goes over 4 larval stages, one pupa to the adults. The pupal rest overwinter in palaeartic regions. *P. papatasi* and *P. sergenti* enter houses being attracted by light. They are vectors of → *Leishmania* stages. → Diptera, → Sand Flies.

## Phocanema sp.

→ Anisakis/Fig. 1.



**Phlebotomus.** Figure 1 LM of an adult sand fly (*P. papatasi*).

**Phlebotomidosis. Table 1** Phlebotomids and control measurements

Parasite	Host	Vector for	Symptoms	Country	Therapy		
					Products	Application	Compounds
<i>Phlebotomus</i> spp. (Sand flies)	Dog, man	<i>Leishmania donovani</i> , <i>Leishmania infantum</i> , <i>Leishmania tropica</i> , <i>Leishmania</i>	Edema, allergic reactions	Tropic, subtropic areas of Asia, Africa, America, Europe (Greece,	1% Vapona insecticide (Durvet)	Spray	Diclorvos

## Phoresis

The females of →*Dermatobia hominis* (human botfly) deposit their eggs on day-flying →mosquitoes (e.g., *Psorophora*), on other flies (→*Sarcophaga*, →*Musca*, →*Stomoxys*), or even on →*Amblyomma* →ticks. Eggs are laid directly on these arthropods or in their vicinity, so that they may become attached with the help of their superficial cement. This peculiar way of transportation is known as phoresis.

## Phormia

Genus of muscid flies.

## Phosmet (PMP, Phtalofos)

### Chemical Class

Organophosphorous compounds (dithiophosphate).

### Mode of Action

Acetylcholine esterase inhibitor. →Ectoparasitocides – Agonists and Antagonists of Cholinergic Transmission, →Insecticides.

## Phosphatidylinositol

→Glycosylphosphatidylinositols.

## Photophobia

From Greek: *phos* = light, *phobia* = aversion. Photophobia is a sign of disease in heavy infections with, e.g., →*Trichinella spiralis*.

## Phoxim

Organophosphate →ectoparasitocides, blocks cholinesterases in insects.

## Phrioxcephalus Species

Parasitic crustaceans.

## Phthiraptera

→Lice.

## Phthirus pubis

### Name

Greek: *phtheir* = louse, Latin: *pubes* = genital region.

### Synonym

*Phthirus inguinalis*, crab louse (English), papillon d'amour (French).

### Classification

Species of the bloodsucking insect order →Anoplura (lice).

### General Information

This louse is small (1.3–1.6 mm), lives mainly in the hair of the primary genital system. The females lay up to 30 eggs during their 30-days lifespan. The development of a generation takes about 20–25 days (Figs. 1–3).

### Life Cycle

→Lice.

## Phyllobothrium

Tetraphyllid tapeworms of sharks. →Eucestoda.

## Phylogenetic Reminiscence

Repetition of a larval migration (e.g., in →*Ascaris*) through liver-heart-lung-trachea to finally return to the intestine, from where the larva started. This migration

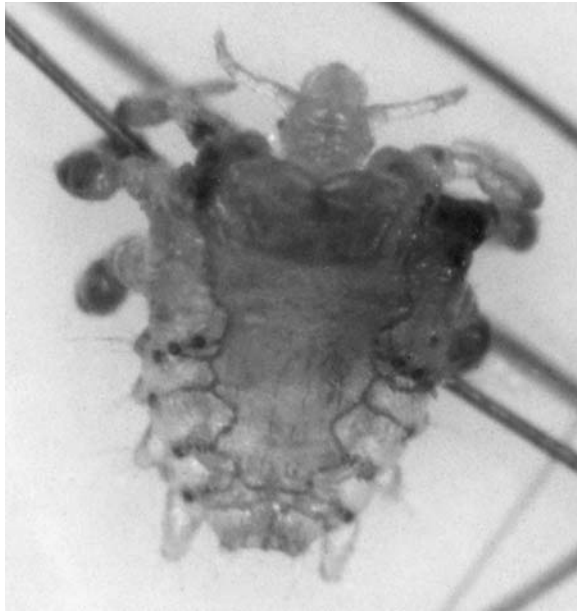

**Phthirus pubis. Figure 1** LM of an adult louse.



**Phthirus pubis. Figure 2** LM of an egg (nit) attached at hairs.

reflects that there was probably a former free-living stage (as in [→Ancylostoma](#)) or an [→intermediate host](#) as in [→Porrocaecum](#) (roundworm of blackbirds).

---

## Phylogenetic Trees

[→Phylogeny.](#)

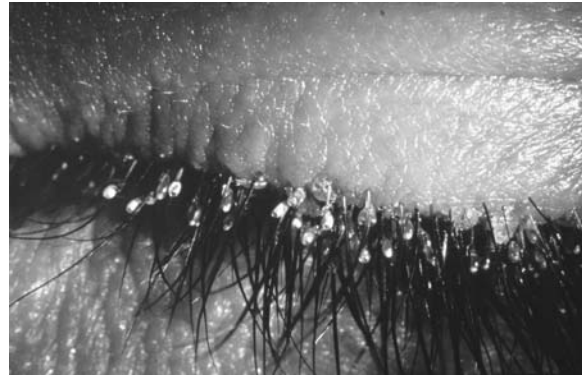

**Phthirus pubis. Figure 3** *Phthirus* stages at eyelashes of a woman.

---

## Phylogeny

### General Information

Only the very early attempts to compare and to describe organisms ([→Systematics](#)) were independent from evolutionary aspects, but, as Mayr pointed out, since Darwin and Haeckel, the [→classification](#) of species considers phylogenetic relationships as well.

Phylogenies presuppose ancestors, i.e., previously living organisms that are now extinct, but whose descendants include actual living species. Thus the final goal of phylogenetic analyses is to find clusters of taxa which have been derived from a more recent ancestor, which is itself nested within taxa or groups of taxa of more distantly derived ancestors. According to the evolutionary species concept, species are lineages following divergent evolution. Species are no fixed entities but consist of populations. If one of the populations acquires a new advanced or [→apomorphic character](#), which separates it from the other populations (populations which still show the ancestral or [→plesiomorphic character](#)), then this population may be regarded as a new species, one which passes the apomorphic character to all of its descendants, thus starting a new lineage of its own. So, if taxa share a derived character state (synapomorphies), it can be assumed that they have inherited this [→synapomorphy](#) from a common ancestor. Phylogeneticists are especially interested in detecting and analysing these synapomorphies. Ancestral or synplesiomorphies are not relevant for the phylogeny of taxa, because they are shared by derived and related lineages as well. According to Morrison “cladistic analysis is simply the search for nested sets (a hierarchy) of synapomorphies among the taxa. Each synapomorphy represents an

ancestral lineage that has diverged from its related lineages, thus being contemporary evidence for a prior evolutionary event.” One way to verify that the character under study represents a derived apomorphic character state is to use outgroup analyses, i.e., to include taxa in the analyses (usually more than one species), which are not part of the ingroup (comprising the taxa of interest), but belong to sister groups. The rationale for outgroup analyses is that if a character state is found in both the in- and the outgroups, it can be assumed that this character represents the ancestral state. For phylogenetic research it is fundamental to include only homologous characters rather than analogous ones. Two character states are homologous if they had been inherited directly from an ancestor which also had that state. This is important because similar character states may have developed independently (called a  $\rightarrow$ homoplasy) which are not the result of shared ancestry. Homoplasy may be due to convergence and parallel evolution or may be based on secondary loss. Homologous characters can be selected on the basis of their morphology, ontogeny, anatomy, embryology, behaviour, physiology, biochemistry, or ecology. However, for molecular data there are only limited possibilities to prove homology. (By comparison, homology of morphological characters can be evaluated by their ontogeny.) Thus the choice of appropriate molecular markers is crucial for further analyses and to assess homology in molecular studies is complicated.

### Gene Sequence Alignment

The comparison or alignment of homologous sequences is the crucial step in phylogenetic analyses, because incorrect alignment may result in establishing phylogenetic relationships which are simply wrong. Philippe and Adouette discussed these so-called pitfalls of molecular phylogeny. The alignment specifies the relationship of each nucleotide among the sequences. Nucleotides at a certain point may be identical or point mutations have occurred (substitutions). To align sequences it is sometimes necessary to include gaps, due to deletions or insertions in one of the sequences (insertion/deletion, i.e., indels). The positioning of indels is difficult, especially if sequences of more distantly related species are aligned and the “cost” of gaps, compared to substitutions, influences the result of phylogenetic analyses. The gap penalty counts the cost of gaps in comparison to substitutions. Substitutions can be valued in different ways: Nucleotides are either  $\rightarrow$ purines or  $\rightarrow$ pyrimidines. If a purine is replaced by another purine (or a pyrimidine by another pyrimidine), this is called a transition, which is more common in some genes than the substitution of a purine by a

pyrimidine and vice versa (transversion). Therefore some models add different weights to transversions versus transitions. If protein-coding genes are analyzed, substitutions can be valued according to their effect on the amino acid composition. If substitutions do not alter the amino acid composition, they are called synonymous substitutions, whereas substitutions that do change the amino acids are non-synonymous ones. Additionally, substitutions may occur only once, i.e., one nucleotide is replaced by another. If the number of substitutions is low, it can be assumed that all substitutions become apparent; this is simply a matter of probability. If multiple substitutions occur, the chance that one nucleotide site will be affected more than once, increases (backmutations). In this case, the alignment of sequences will not reflect the evolutionary history, because the alignment will only reveal the actual degree of differences among sequences and not the prior evolutionary events. Sequences become more and more saturated, because most of the sites had changed frequently before, thus losing a lot of phylogenetically relevant information, e.g., the time of divergence among species. The support for branching orders may be low due to multiple saturations, which occur preferably in fast evolving sequences or, if sequences are compared, ones which have diverged a long time ago. One possibility to check for saturation is split-decomposition. If many character states are inconsistent, split-decomposition will not provide a tree topology but rather network topologies. Different methods have been developed to correct this problem of underestimating the evolutionary change, such as the Jukes-Cantor model, Kimura’s 2-parameter model, Felsenstein’s model, the Hasegawa-Kishino-Yano model, and the general reversible model. These models have been summarized and compared by Page and Holmes. Morrison has discussed 3 different possibilities which are relevant to the difficulty of aligning gene sequences:

- The alignment reveals only few indels and is robust.
- Information about the secondary structure of gene sequences is available. The importance of active sites is known, they have to be maintained because of functional constraints. Information about the secondary structure is available for several rRNA gene sequences (40,79,99,109,115) and Ellis and Morrison have shown, for some organisms, that the double-stranded parts of rRNA contain the most valuable phylogenetic information.
- Information about the gene sequences is not available and the alignment reveals many indels. In this case the optimal alignment based on different mathematical parameters may not be congruent with the ideal alignment.



## Phylogenetic Trees

The goal of phylogenetic analyses is to transfer genetic information into a branching order (a tree) that reflects the evolutionary history; different methods have been developed to do this.

### Different Kinds of Trees

There are different kinds of trees, the →cladogram being the most basic one; it shows how recent the common ancestry is. Additive trees include more information, e.g., the amount of evolutionary change (number of substitutions). Additive trees are also called phylograms. Ultrametric trees (so-called dendrograms) are variations of additive trees, in which the parameter of time is included. Cladograms and additive trees can be either rooted or unrooted, i.e., with or without polarity. One way to change an unrooted tree into a rooted one is to include outgroups as external source into the analyses. Rooted trees elucidate ancestor – descendant relationships and enable monophyletic groups to be identified, i.e., group of taxa which include all descendants of one ancestor. The branching order distinguishes between monophyletic and paraphyletic groups; the latter do not comprise all descendants of the most recent ancestor.

### Methods

Exact methods enable the optimal tree for the given data set to be found. Hendy and Penny established the branch-and-bound strategy, which gives rise to the most efficient method of the exact ones. Heuristic methods do not attempt to find the optimal tree but try to reach a close solution. They are more practical than the branch-and-bound strategy because the latter increases the number of trees immensely. Tree-building methods are divided into distance methods and discrete methods. The former convert the aligned sequences into a pairwise distance matrix, which is the basis for tree-building methods; the latter includes every nucleotide site directly. Distance methods assume that the distance provides an estimate for the evolutionary divergence among taxa. One class of distance methods searches for the best metric tree that takes the observed distances into account. Widely used methods are e.g., UPGMA (unweighted pair-group method using arithmetic average), Neighbour-joining, and the Neighbourliness procedure. UPGMA and Neighbour-joining start by grouping 2 taxa with the smallest distances, then adding more distant taxa. The other group of distance methods uses the optimality criterion, i.e., they search for a tree, the sum of whose branch lengths is a minimum, for example, the minimum-evolution procedure and the distance-Wagner method. The major objections against distance methods are that they lose

information by erecting a pairwise distance matrix for a set of sequences and that it is not possible to interpret the branch lengths estimated by some of these methods.

Discrete methods use the sequences directly, thus avoiding the loss of information due to the conversion of data. The 2 main methods are maximum parsimony and maximum likelihood. Maximum parsimony searches for the tree that requires the fewest evolutionary changes. This method is the most popular one in phylogenetic research. Exhaustive searching (that is the search for every possible tree) and branch-and-bound methods are used to optimize the search for the best tree, but heuristic methods are necessary to study more than 20 taxa. Maximum likelihood selects the tree (trees) that is (are) the most likely one (ones) to have produced the given data set. The major objection to parsimony is due to long branches artefacts. Parsimony methods are inconsistent if sequences evolve at different rates, because they group fast-evolving sequences together.

It is nearly impossible to compare all of the tree-building methods (and additional methods are available which are not addressed in this chapter). Penny selected 5 characteristics which are important for the usefulness of these methods: efficiency, power, consistency, robustness, falsifiability.

Efficiency means, how fast are the results available? Distance methods are more or less efficient, because large data sets do not increase the computer time needed for the analysis of the data. In optimality methods, large data sets are difficult to evaluate as exact methods are inefficient due to the fact that the number of trees increases exponentially with the number of taxa. Therefore large data sets can only be studied using heuristic methods.

Power, that is how much data does the method need to produce reasonable results? This refers to the amount of data which is necessary to generate a single tree and additional information does not change the topology of the tree. The method is powerful if only a few characters are required. Power is also related to the amount of information in the original data set. Distance methods lose a lot of information by converting the original data into distances.

Consistency refers to the ability to converge to the correct tree. All the methods are sensitive to homoplasy.

The robustness of the methods means how much violation of the method's assumption is acceptable before the method becomes inconsistent. This is one of the crucial questions and a popular approach is to use simulated data. Many of the methods are quite robust under different evolutionary models. Morrison believed that the maximum likelihood method is very robust whereas UPGMA are very sensitive. Finally every

method is based on certain theories and assumptions, which are often criticized. Schlegel suggested using distance and parsimony methods to study phylogenetic relationships in order to get reliable results.

One reason for poor results is not related to different methods but to the data set itself. Different methods are available to evaluate the branching order and the monophyly of groups: analytical methods such as confidence limits, branch-length variances, likelihood-ratio tests; resampling methods such as bootstrap, the jackknife; topology-dependent permutation, and non-statistical procedures such as the decay index and spectral signals have been summarized by Morrison. Bootstrapping is a very popular method to verify the quality of the data set. Pseudoreplicates are generated by sampling the data set at random. Pseudoreplicates may vary in the frequency of different sites but not in the number of characters. These pseudoreplicates are then used to build a tree using one of the methods mentioned above. 100 of up to 1,000 replicates are generated randomly, analysed, and the resulting trees are compared with the one generated by the original data set, giving more or less support for branching orders.

Phylogenetic analyses of gene sequences result in the establishment of gene trees and it cannot be assumed that the phylogeny of genes represents the phylogeny of species as well. There are several reasons for this statement. Gene duplication may have occurred in species, resulting in incorrect cladograms which only elucidate the gene history but not the historical relationships of species. Homologous genes are only orthologous if their most recent ancestor did not undergo gene duplication, otherwise they are named paralogous genes. Another reason is that horizontal gene transfer may have occurred from one species to the other. Finally, recombination, i.e., the intermixing of exons and introns might reconstruct the composition of genes and their history. Page and Holmes stated that gene phylogeny matches organismal phylogeny, but only if all sets of genes are known or the analyses are restricted to orthologous genes, and Olsen stated that all gene sequences for which orthology is difficult to establish should be omitted from the analyses. However the cladograms erected on the results of gene analyses are first of all gene trees which can be incongruent with organismal phylogeny due to processes like lineage sorting based on ancestral [→ polymorphism](#), allele variation, and different survival rates of alleles. Pamilo and Nei, Penny et al., Doyle, de Queroz, Donoghue, and Kim have discussed other possible parameters which may prevent gene phylogeny from being organismal phylogeny like introgression, unequal rates of [→ speciation](#), gene mutation, and lateral transfer.

### Choice of the Appropriate DNA for Phylogenetic Analyses

Genomes are prone to mutations, although different regions reveal higher mutation rates than others. Introns and non-coding regions are not affected by functional constraints and evolve rapidly compared to coding regions. Certain genes are highly conserved and have accumulated only few mutations in the course of time, because these genes are important for the survival of the organisms, many mutations are not fixed. In summary, different genes and parts of the genes evolve at different rates and it is important to choose the appropriate gene for different purposes. Slowly evolving genes may not be useful for studying rapid ramifications of species but are most appropriate for elucidating deep phylogenetic branching.

Gene sequences selected for phylogenetic analyses must be common in all the taxa being investigated and ideally the biological function of this gene should be the same. Gene families are not without problems because it is possible that paralogous rather than orthologous genes are investigated. Multi-copy genes, which evolve in a concerted fashion, are suitable for phylogenetic analyses because they act like a single gene. Different molecular markers have been used in phylogenetic analyses. The first ones were the protein-coding genes haemoglobin, cytochrome c, ferredoxin, and superoxid-dismutase.

### Ribosomal RNA Genes

Ribosomal RNA genes are accepted as powerful markers for phylogenetic purposes and huge data sets are available for pro- as well as eukaryotes. Whereas the former RNA-trees relied on partial RNA sequences the actual RNA trees are based on complete sequences of ribosomal RNA genes. Numerous complete sequences of the small subunit ribosomal RNA (ssrRNA) genes of eukaryotes, archaebacteria, and eubacteria have been published and the data sets are increasing rapidly. Additionally complete sequences of the large subunit ribosomal RNA genes (lsrRNA) have also become available. RNA genes are distributed in all organisms including organelles, they serve the same biological function, do not undergo lateral gene transfer and they contain segments which evolve at different rates. Intergenic spacer evolve rapidly, whereas for example, the small subunit rRNA gene (ss rRNA gene) is highly conserved. For phylogenetic analyses of more distantly related species, the ss and ls rDNA are more informative than the small 5 S and 5.8 S rRNAs and comparisons of ssrRNA gene sequences have been used to study the phylogenetic relationships among archaebacteria, eubacteria, and eukaryotes. The impact of RNA analyses on the classification of organisms was immense. This refers especially to the classification of protists. Protists comprise highly divergent organisms and it is generally

accepted that they represent a paraphyletic or polyphyletic assemblage of small organisms. Members of the protists are important parasites of humans and animals and some of them were regarded as very primitive eukaryotes due to the lack of mitochondria, e.g., *Giardia*, *Trichomonas*, *Entamoeba*, and *Microspora*. The phylogenetic analysis of RNA genes indicated, that *Microspora* are highly evolved and specialized fungi rather than primitive eukaryotes. *Giardia* and *Trichomonas* have lost the mitochondrion secondarily as an adaptation to their parasitic life style. Hausmann et al. described *Entamoeba* as a member of the archamoeba, whereas Campbell and Reece still excludes amoebae from the present classification system because of the uncertain position.

Fossil records indicate that most of the invertebrate phyla evolved rapidly within the space of 20 Myr (the so-called Cambrian Explosion, 540–520 Myr ago). It is more than likely that these so-called evolutionary bursts occurred in protist evolution as well. As mentioned before, ss rRNA genes are highly conserved, i.e., they have accumulated few mutations in the course of time. This turns out to be a problem if ramifications of phyla (radiations) occur in relatively short-time intervals. The problem is, that not enough apomorphies evolved within short periods of time, therefore ss rRNA-trees do not confidently resolve branching orders of phyla/taxa which have diverged rapidly. The rationale is that the shorter the time intervals are, the more variable the numbers of positions in a sequence which are required to reconstruct phylogenetic relationships of taxa, and it is doubtful whether certain ramifications may be solved in the near future. Attempts have been made to use combined data sets of large and small subunit rRNA genes and about 5,300 positions have been analysed. Although this effort supported certain branching orders, it did not solve others.

### Protein Coding Genes

As mentioned above, ss rRNA-trees are of limited use if sequences are compared which evolved within 40 Myr. Phylogenetic analyses based on protein-coding genes (elongation factor 1  $\alpha$ ,  $\alpha$ -, and  $\beta$ -tubulin) have been used to solve this problem. However some of the protein-trees are not consistent with rRNA-trees. *Entamoeba* is now regarded as one of the amitochondriate primitive taxa placed at the base of eukaryotes, whereas rRNA-trees support the hypothesis, that the lack of  $\rightarrow$ mitochondria is due to secondary rather than primary loss. Clark and Rogers detected the chaperonin-coding gene in the genome of *Entamoeba* which is usually located on the genome of the organelle. This result supports the results of phylogenetic analysis based on rRNAs. Additionally protein-trees are also inconsistent with regard to  $\rightarrow$ Ciliophora which are known to be monophyletic but not in protein

trees. These discrepancies between protein and rRNA-trees may be related to different substitution rates in different genes. Fast-evolving genes are characteristic for parasites, resulting in wrong tree topologies due to long branching artefacts.  $\rightarrow$ Tubulin genes belong to gene families which are well-known for gene duplications. Thus, the corresponding trees may be based on a comparison of paralogous genes and will not be able to reconstruct the phylogenetic history of the taxa. In summary, protein-trees are not able to solve the evolutionary events of certain groups of eukaryotes.

Interesting candidates for further analyses may be histones and special attention should be given to characteristics like insertion, deletion, duplication, and the order of genes, which can be regarded as apomorphies in monophyletic groups.

### Mitochondrial DNA

$\rightarrow$ Mitochondrial DNA (mt DNA) has been used for the characterization and differentiation of species/subspecies and for evolutionary studies, because it is believed that mitochondria are homologous. The mtDNA is small, maternally inherited, and evolves independently from the nuclear genome. Moreover, it contains no introns and only a few non-coding regions. Thomas and Wilson estimated the mutation rate to be 5–10 times faster than that of nuclear genes. This fact has been successfully used for the phylogenetic analyses of helminths. This fact has been successfully used for the phylogenetic analysis of helminths. Nakao et al. analysed the phylogeny of *Echinococcus* spp. based on the comparison of complete mitochondrial genomes combined with amino acid sequences. They included the species *E. multilocularis*, *E. oligarthrus*, *E. vogeli*, *E. shiquicus*, *E. equinus* (former horse strain G4), *E. ortleppi* (former cattle strain G5), *E. granulosus* sensu stricto, and 3 genotypes of *E. granulosus* (camel strain G6, pig strain G7, cervid strain G8). As a result of their analysis they proposed a new species *E. canadensis* by unifying the 3 genotypes of *E. granulosus*. The number of complete mitochondrial genomes increases, including different helminths (e.g., *Brugia*, *Necator*, *Onchocerca*, *Schistosoma*, *Taenia*, *Echinococcus*), arthropods (e.g., *Aedes*, *Amblyomma*, *Ornithodoros*) and some protists (*Acanthamoeba*, *Eimeria*, *Plasmodium*, *Theileria*, *Toxoplasma*, *Trypanosoma*, *Leishmania*). However some protozoan parasites do not harbour mitochondria, therefore the use of mitochondrial DNA may be of limited use for elucidating the phylogeny of protists.

### Host-Parasite Cospeciation

Host – parasite cospeciation is interesting not only for parasitologists but also for evolutionary biologists because it concerns the long association of at least 2 organisms, which are, in most cases, only distantly related ( $\rightarrow$ *Plasmodium*,  $\rightarrow$ *Anopheles*, human). The

association between parasite and host may be based on either host-switching (association by colonization) or cospeciation (association by descent) and the analyses of these possibilities are important for understanding parasitism in general. Molecular phylogeny provides useful information on cospeciation because homologous genes can be compared in host and parasite. If the host and parasite phylogenies are inconsistent, 2 explanations may be possible: host-switching or multiple lineages. One way to choose between these 2 scenarios is to determine the divergence time for parasites and hosts. The occurrence of multiple lineages is supported if parasites had diverged a long time ago whereas the host separated more recently. If the parasite lineage is younger than the host one, then host-switching is likely. Fossil data are lacking for many species, including many pathogens. Attempts have been made to calibrate the molecular evolution of one species by using the fossil record of the other species with which it is closely associated. If the phylogeny of the 2 species of interest are nearly identical, it can be assumed that they have cospeciated. Nodes in the lineage of the organism without a fossil record may be dated by using the age of the corresponding nodes of the second organism for which fossil records are available. By plotting host divergence time against parasite divergence time, it is possible to describe the rate of evolution as well as the timing of cospeciation, i.e., whether parasites speciated before or after their hosts. These examples indicate the value of molecular phylogeny for gaining an understanding of host – parasite relationships. For example, Hoberg presented data on the phylogenetic relationship between *Taenia* spp. and their hosts: carnivore definitive hosts including humans and the primary intermediate hosts, rodents, and ungulates. Traditionally the appearance of *Taenia* in humans have been associated with domestication of either cattle or pigs. However, the analysis of different sets of data suggests that host-switching from felids and hyaenids to humans occurred prior to establishing animal husbandry. Furthermore their results indicated that pervasive host-switching among carnivore definitive hosts is the major force for the diversification of *Taenia*, whereas host-switching among rodents and ungulates, the primary intermediate hosts, has been a rare event.

## Physaloptera

### Name

Greek: *physa* = bladder, *pteron* = wing.

Genus of the nematode family Physalopteridae (order Spirurida = roll tails). The species of this genus are found

in the stomach of carnivores and rodents, intermediate hosts are beetles, cockroaches, and grasshoppers. *Physaloptera clausa* (syn. *P. dispar*) is found in hedgehogs and reaches a size of 1.5–3.5 cm × 1.5–2.5 mm).

## Physocephalus

From Greek: *physa* = bladder, *hephale* = head. Spirurid worm (Fig. 1) of the stomach of pigs (*Physocephalus sexalatus*).

## Phytomonas

→ Trypanosomatidae.

## Pian-Bois

Form of → cutaneous leishmaniasis (NCL) in French Guyana due to infections with *Leishmania tropica guyanensis* (later described as *L. brazilianensis guyanensis*).

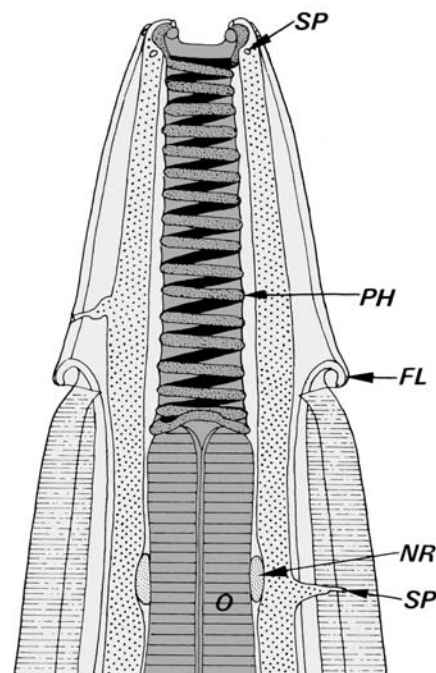

**Physocephalus. Figure 1** DR of the anterior end. FL, lateral alae; NR, nerve ring; O, oesophagus; PH, pharynx; SP, sensory papillae.

## Pigment

→Hemozoin, →*Plasmodium*.

## Pigmentation

Clinical and pathological symptoms of infections with skin parasites (→*Skin Diseases, Animals, →Ectoparasite*).

## Pinocytosis

Internalization of liquids by a cell via formation of endocytotic vesicles (→*Endocytosis*).

## Pinworm

→*Enterobius vermicularis*.

## Pinworm Disease

### Synonym

→*Enterobius vermicularis*, →*Enterobiasis*.

## Piophilidae

Family of flies, larvae of which live in cheese, meat, faeces. For example, *Piophilidae casei* (cheese fly, 3–4 mm long) is found worldwide and may transmit bacteria onto food.

## Piperazine

→*Nematocidal Drugs*.

## Piperonylbutoxide (PBO)

### Chemical Class

Synergist.

### Mode of Action

Cytochrome P-450 microsomal monooxygenase inhibitor.

## Pipestem Fibrosis

Symptom of disease in infections with →*Schistosoma japonicum*, →*pathology*.

## Pirimiphos

### Chemical Class

Organophosphorous compounds (monothiophosphate).

### Mode of Action

Acetylcholine esterase inhibitor. →*Ectoparasiticides – Agonists and Antagonists of Cholinergic Transmission*.

## Piroplasmea

→*Apicomplexa*.

## Piroplasmosis

→*Babesiosis, Man*, →*Babesiosis, Animals*, →*Theileriosis, Animals*.

## Piroplasms

### Classification

Order of →*Coccidia*.

### General Information

Pear-shaped protozoan organisms that live in red blood cells of mammals transmitted by →ticks. The 2 most important genera are →Theileria and →Babesia.

### Piscicola geometra

→Leeches, →Trypanoplasma/Fig. 1.

### Piscinoodinium

Dinoflagellate order of parasites of freshwater fish, which are attached by filaments at the skin of the host, reaching a size of  $150 \times 70 \mu\text{m}$ .

### PITT

Parasite increased trophic transmission of prey hosts to predators thus facilitating transmission. PITT is brought about, e.g., by behavioural changes (→Behavior).

### PKDL

Post-kala-azar dermal →leishmaniasis.

### Placental Involvement

→Pathology.

### Placentonema gigantissimum

→Nematode parasitizing the placenta of whales; it is probably the longest recent nematode reaching 8.5 m in length with a diameter of 0.3 mm.

### Plagiorchis

From Greek: *plagios* = oblique, *orchis* = testis (2 obliquely arranged organs). →Digenea.

### Plague

Flea-transmitted bacterial disease (→*Yersinia pestis*) (→Fleas, →Insects/Fig. 7).

### Planorbis

Genus of snails, intermediate host, e.g., of →*Paramphistomum*.

### Plasmalemma

#### Synonym

→Cell Membrane.

### Plasmids

By plasmid – and cosmid shuttle – vectors parasitic DNA is introduced into bacterial systems.

### Plasmodium

Genus of mosquito-transmitted coccidian blood parasites. The name comes from Greek: *plasmodion* = small organism, and was established by →Laveran 1881.

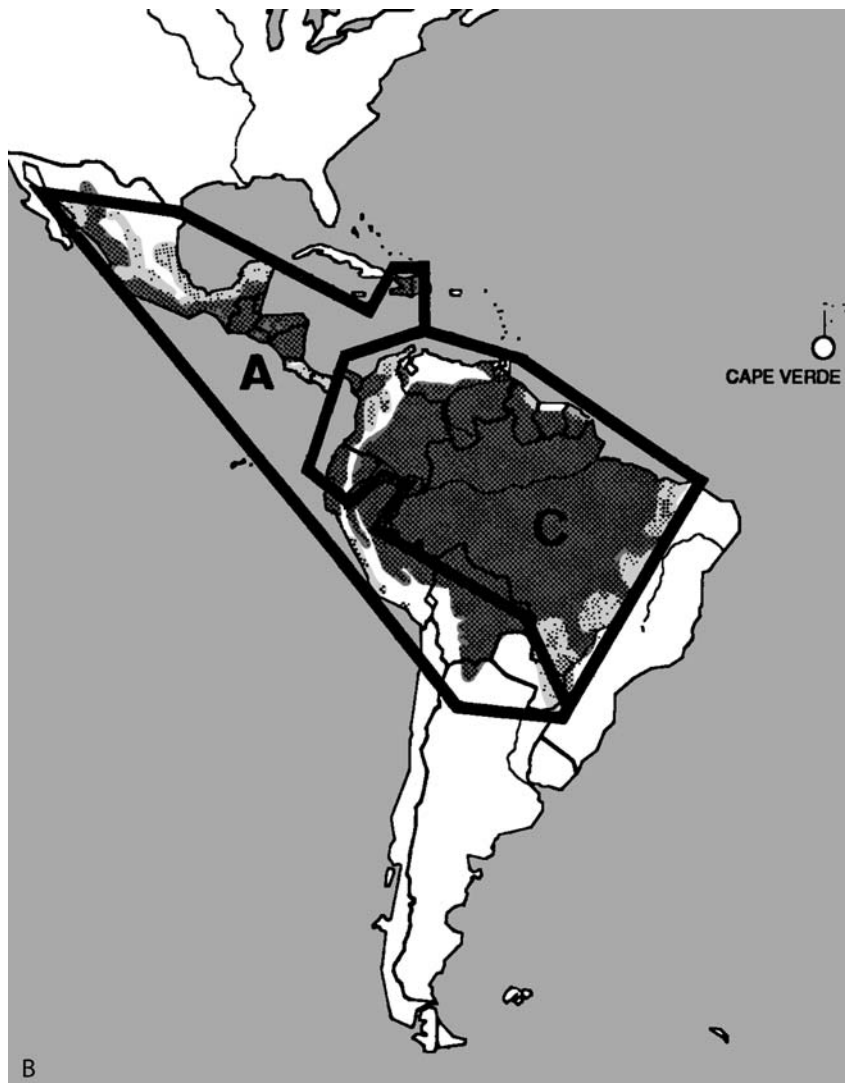
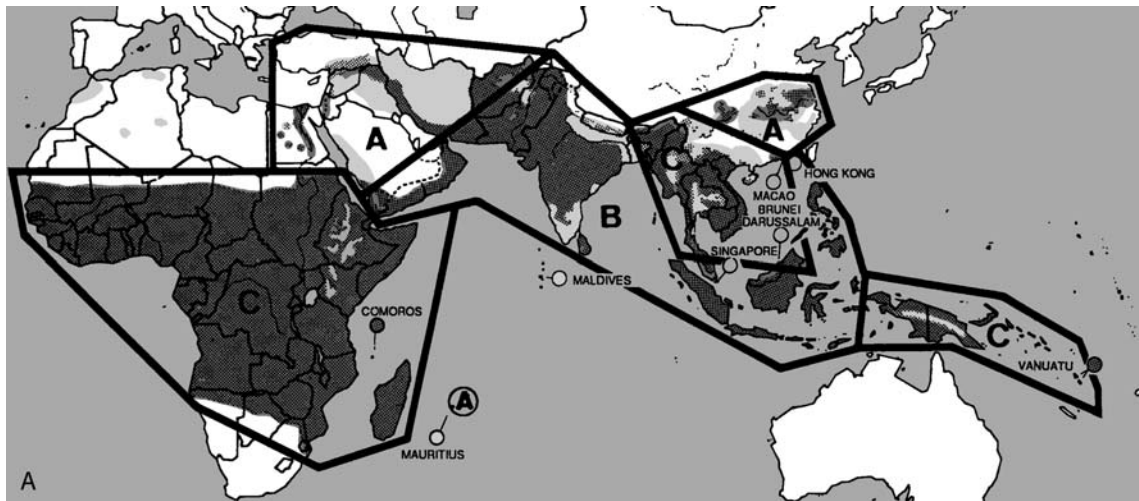

**Plasmodium.** Figure 1 A, B Distribution map of occurrence of chloroquine-resistant strains of *P. falciparum* with increasing severity (A–C) – according to WHO.

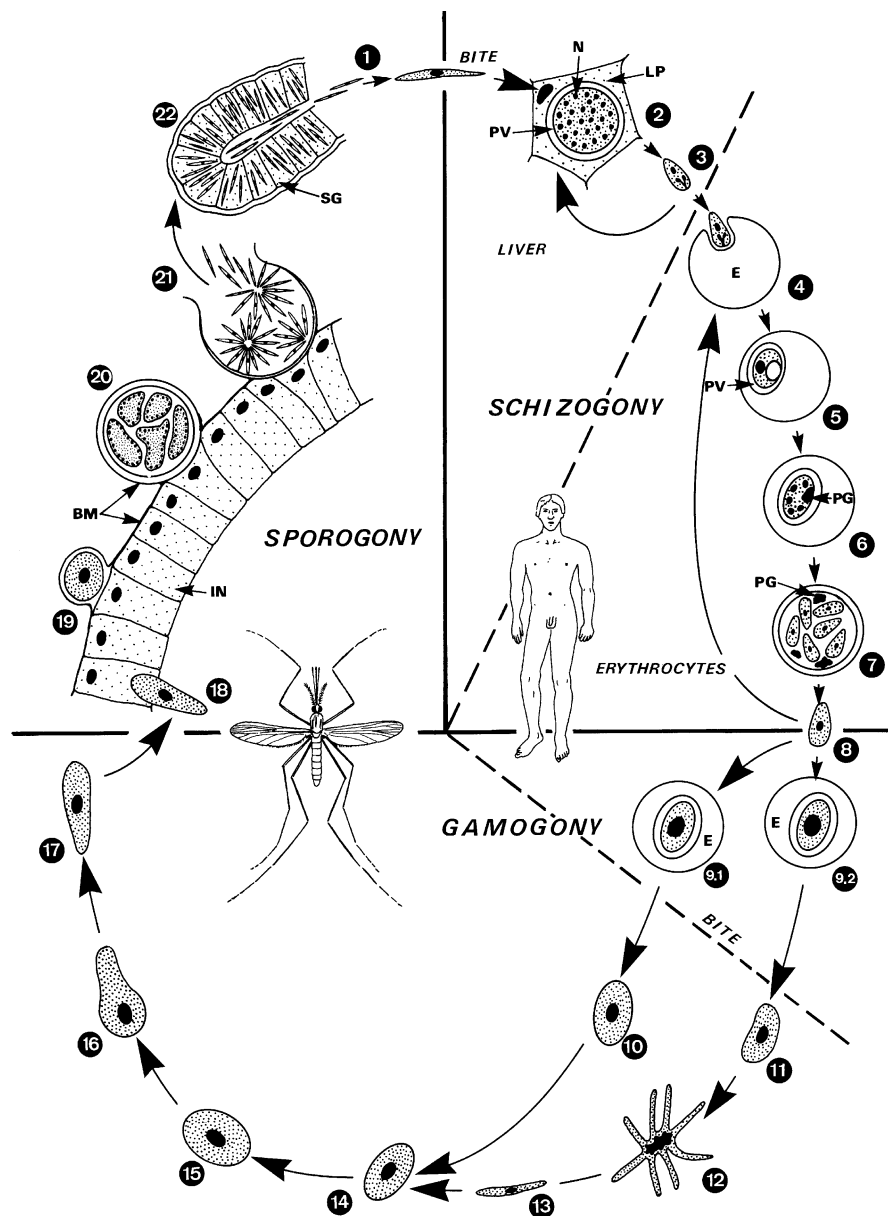

**Plasmodium. Figure 2** Life cycle of human → malaria parasites (*Plasmodium* spp.; see Table 1) without reference to species-specific variations. 1 Elongate sporozoites are injected during bite of the female mosquito (→ *Anopheles* spp.). The → sporozoites are distributed by bloodstream and enter liver cells within 2 minutes after infection. 2, 3 Formation of schizonts and merozoites in liver parenchymal cells (exoerythrocytic phase). In some species this cycle may be preserved intracellularly via → "hypnozoites" (→ *Dormozoites*) for a long time (years) and cause relapses. 4-8 Erythrocytic cycle; liver → merozoites enter (after typical prepatent periods, see Table 1.13) erythrocytes, grow to "signet-ring stages" (5), and finally form, as schizonts (6), several merozoites (7, 8). During the digestion of hemoglobin the parasites produce → pigment granules (6, 7; PG) of → hemozoin. The development of such schizonts becomes synchronous and is repeated (4-8) in a 1-3 day cycle (depending on the species). 9 After an indeterminate number of such asexual generations, some merozoites enter erythrocytes and become macro- (9.1) or → microgamonts (9.2). The size and shape are species-specific (banana-shaped in *P. falciparum*). 10-11 When → mosquitoes bite, they ingest erythrocytes containing such gamonts, which are released inside the gut from their enclosing erythrocytes. 12, 13 The microgamonts develop 4-8 microgametes in 10-15 min. 14 Fertilization of → macrogamete. 15-19 The resultant → zygote quickly elongates and becomes a motile → ookinete (17) which penetrates (the not drawn) → peritrophic membrane in the mosquito's gut, migrates through the → cytoplasm of a gut cell, and begins its transformation into an → oocyst (situated between basal membrane and epithelial cells, 19). 20-22 Formation of multinucleate sporoblasts (20) which give rise to thousands of sporozoites (after 10-14 days). The latter become liberated into the hemocoel (body cavity) and migrate to salivary glands. These slender sporozoites (10-15 × 1 μm), which form a protecting → surface coat, are finally injected into a new host at the next feeding act. BM, basal membrane of intestine; E, erythrocyte; IN, intestinal cell; LP, liver parenchymal cell; N, nucleus; PG, → pigment; PV, → parasitophorous vacuole; SG, → salivary gland. For pathological effects see → Malaria.



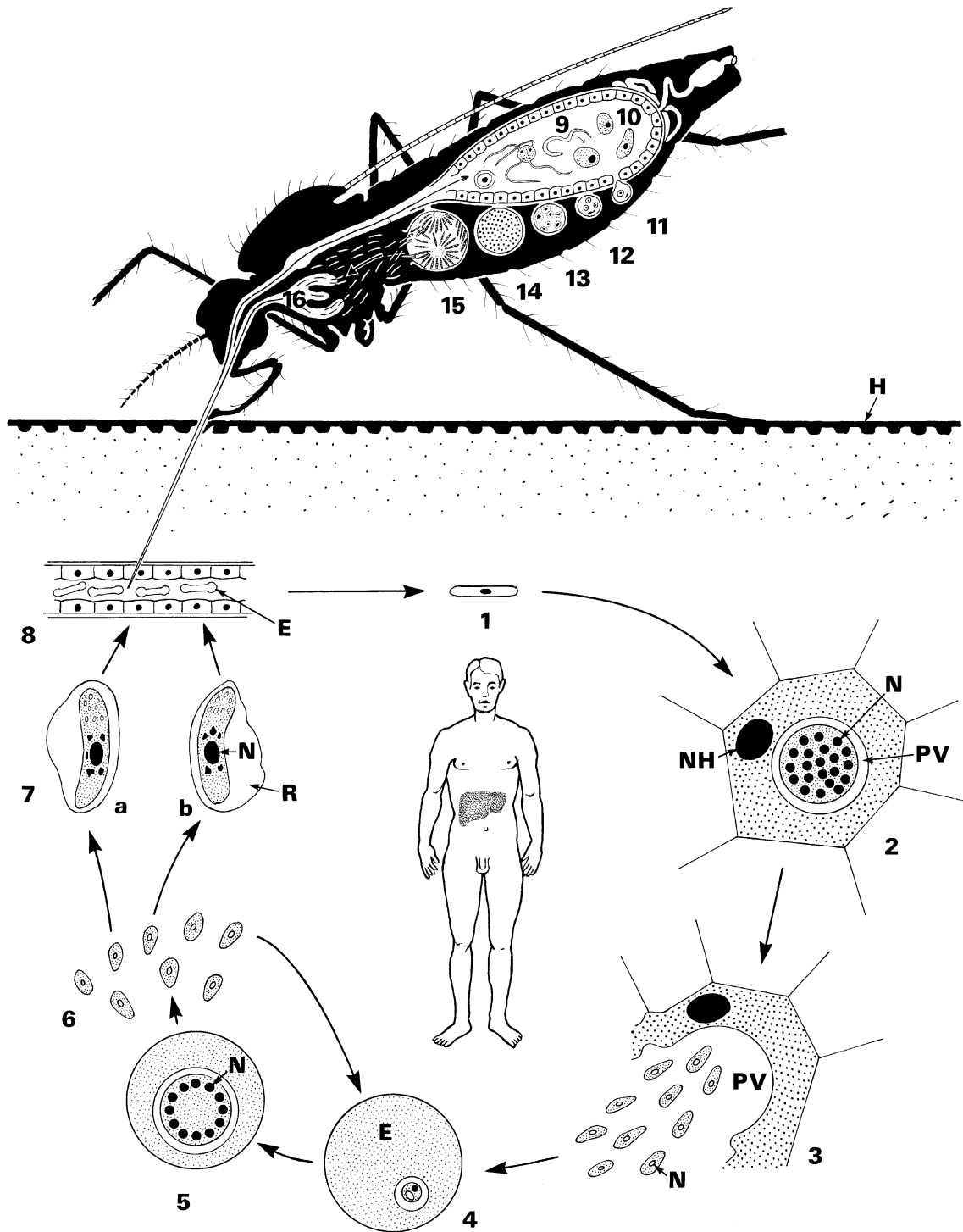

**Plasmodium.** Figure 3 Life cycle stages of *Plasmodium falciparum*, the agent of *Malaria tropica*. 1 The female *Anopheles* injects sporozoites which enter liver cells via the bloodstream. 2, 3 Schizonts develop numerous merozoites (3) which after rupture of the host cell leave the liver and enter erythrocytes. 4 *Merozoite* directly after penetration (so-called *signet-ring stage*) – this stage is very small (one-fifth of the red blood cell's diameter) and is the only stage found in blood cell smears of patients. 5–8 Schizonts, which are blocked within capillaries (e.g., of the brain), give rise to several merozoites (6) which invade other red blood cells and again become schizonts (5) or develop into male or female banana-shaped gamonts (7 a, b) which are taken up by another engorging mosquito (8). 9–16 The processes in the mosquito are described in Fig. 2. E, erythrocyte; H, skin surface; N, nucleus; NH, nucleus of host cell; PV, *parasitophorous vacuole*; R, remnants of the erythrocyte.

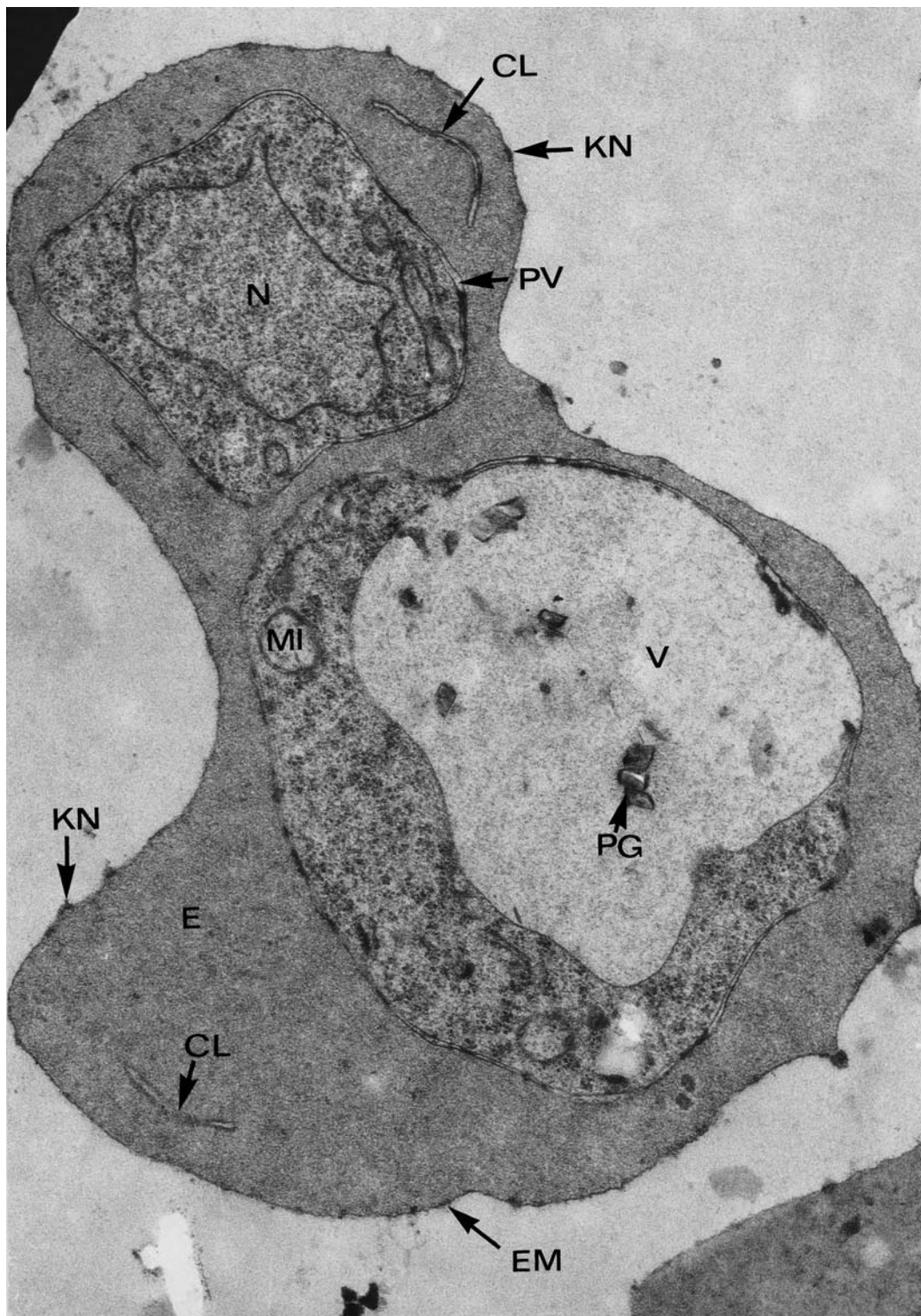

**Plasmodium. Figure 4** TEM of an erythrocyte infected with 2 young schizonts (→Trophozoites) of *Plasmodium falciparum* (agent of human *malaria tropica*). The stages are situated in a very narrow parasitophorous vacuole (PV). Note the typical knobs (KN) at the erythrocyte surface representing residuals of antigenic material. The larger stage represents a so-called signet-ring stage including a large vacuole (V). CL, cleft in the red blood cell plasm; E, erythrocyte; EM, outer membrane of the red blood cell; KN, knoblike structure; MI, mitochondrion; N, nucleus; PG, crystalline pigment; V, vacuole.



**Plasmodium. Figure 5** TEM of a human red blood cell infected with 2 mature schizonts of *Plasmodium falciparum* both being situated in large parasitophorous →vacuoles (PV). The merozoites are built up leaving a large residual body (RB) containing crystalline pigment (PG). × 40,000. L, lipid; ME, merozoite; N, nucleus; PE, →pellicle; PG, pigment; PV, parasitophorous vacuole; RE, remnants of the host cell.

**Plasmodium. Table 1** Some common *Plasmodium* species

Species	Periodicity of fever	Vertebrate host	Vector/mosquitoes	Mortality
<i>Plasmodium falciparum</i>	48 h + irregular	<b>Humans</b>	[ <i>Anopheles</i> ] spp.	+
<i>P. vivax</i>	48 h	<b>Humans</b>	<i>Anopheles</i> spp.	–
<i>P. ovale</i>	48 h	<b>Humans</b>	<i>Anopheles</i> spp.	+/-
<i>P. malariae</i>	72 h	<b>Humans</b> , monkeys	<i>Anopheles</i> spp.	+/-
<i>P. knowlesi</i>	24 h	Asian monkeys, <b>humans</b>	<i>Anopheles</i> spp.	-/+
<i>P. coatneyi</i>	48 h	Asian monkeys, <b>humans</b>	<i>Anopheles</i> spp.	-/+
<i>P. cynomolgi</i>	48 h	Asian monkeys, <b>humans</b>	<i>Anopheles</i> spp.	–
<i>P. simium</i>	48 h	New World monkeys, <b>humans</b>	<i>Anopheles</i> spp.	–
<i>P. gallinaceum</i>	Irregular	Chickens	<i>Aedes</i> spp., <i>Culex</i> spp.	+
<i>P. juxtannucleare</i>	Irregular	Chickens	<i>Culex</i> spp.	+
<i>P. relictum</i>	12–36 h	Pigeons	<i>Culex</i> spp., <i>Aedes</i> spp., <i>Anopheles</i> spp.	+
<i>P. cathemerium</i>	24/48 h	Sparrows, canaries	<i>Aedes</i> spp., <i>Culex</i> spp., <i>Anopheles</i> spp.	+
<i>P. berghei berghei</i>	24 h	Rodents	<i>Anopheles durenii</i>	-/+
<i>P. agamae</i>	Irregular	Lizards	<i>Lutzomyia</i> spp., <i>Culicoides</i> spp.	–
<i>P. wenyoni</i>	Irregular	Snakes	<i>Culex</i> spp.	–

+ = high; +/- = medium; – = none or low

**Classification**

Genus of →Coccidia, →Apicomplexa, →Alveolata.

**Important Species**

Table 1.

**Distribution**

Fig. 1.

**Life Cycle**

Figs. 2, 3.

**Reproduction**

Figs. 4, 5.

**Diseases**

→Malaria, →Malaria tropica.

**Plasmorphism**

From Greek: *plasma* = formed structure, *morphe* = shape; describes the characteristics of the cell plasma.

**Plasmotomy**

From Greek: *plasma* = formed structure, *tomos* = sharp, cutting. Process of subdivision of parasites' plasma into portions in →microsporidia, →Blastocystis.

**Plastid**

→Organelle, Double Walled, →Apicoplast.

**Plasmodium falciparum**

→Malaria, →Plasmodium/Figs. 3–5.

**Plastron**

→Mites.

## Platyhelminthes

### Synonym

→Flatworms.

### Classification

Phylum of →Metazoa.

### General Information

The Platyhelminthes include various dorsoventrally flattened animals that were consequently commonly described as flatworms which are typically bilaterally symmetrical. Their primary body cavity is filled with the so-called →parenchyma consisting of connective tissue fibers and unattached or fixed cells of various types which are surrounded by body fluids. The platyhelminths are thus acoelomate worms which usually lack a definite anus (or even lack an intestine as in →tapeworms = →cestodes), as well as skeletal, circulatory, and respiratory systems. They are covered by a typical, group-specific body wall (→Tegument) through which an active uptake of nutrients regularly occurs; a →cuticle of any kind (suggested in light-microscopic studies) is always absent and would hinder the feeding. →Terminal cells of the protonephritic type (cyrtocytes) function as an excretory system. Except for a few species, the parasitic flatworms are monoecious (→Hermaphrodites), having both male and female reproductive systems in the same individual. Although these organs often function simultaneously, self-fertilization is rare and cross-fertilization between 2 individuals (or two →proglottids) is usual.

The life cycles differ in the systematic groups of the platyhelminths and may proceed directly (Turbellaria), or indirectly involving different larval stages (e.g., →metamorphosis in monogeneans and in most cestodes), or even employing different generations (e.g., digenetic →trematodes, some cestodes).

### System

Due to the diversity of platyhelminths' body structure, life cycles, behavior, transmission mechanisms, and respiratory and nutritional physiology, the classification of this group is far from clear (cf. →Classification). For a long time it has been realized that the systematics of parasitic Platyhelminthes had to be revised. All morphological evidence, especially at the ultrastructural level, suggests that the →Monogenea are more closely related to the Cestoda than to the →Digenea and →Aspidogastrea, so that the term Trematoda, including the digeneans and monogeneans, is thought by some authors to be an artificial grouping. Agreement has not

been reached on which biological and/or morphological characteristics are most important in reflecting natural relationships. On the other hand, students, teachers, and research workers must use an understandable and practical classification. For detailed information on the major groups see →Aspidogastrea, →Monogenea, →Digenea and →Cestodes.

### Reproduction

In all platyhelminthic groups sexual reproduction usually occurs; additional asexual or asexual-like processes like splitting and budding are found in digeneans and rarely in some monogeneans and cestodes. Both types of reproduction, however, initiate the development of a large viable progeny (eggs or developmental stages within the life cycle). Platyhelminths are hermaphroditic (apart from some exceptions like the trematodes →Schistosoma and the cestode →Dioecocestus spp.) with cross-fertilization taking place when other individuals are available. But several species (e.g., long, singly occurring tapeworms, single →flukes) are capable of self-fertilization. Fertilization is not even absolutely necessary, as has been shown experimentally in several digeneans. For example, Schistosoma and →Paragonimus spp. produce haploid ( $n = 8$ ) eggs without fertilization, which nevertheless are able to develop via an active →miracidium into all other stages of the life cycle. Such unisexual development without fertilization is described as →parthenogenesis. It is also thought to occur during the unique development of the monogenean genus →Gyrodactylus.

### Reproductive Organs

Aspidobothreans, monogeneans, and digeneans have, in general, a single set of male and female reproductive organs, whereas in cestodes such sets are repeated along the whole →strobila in each proglottid (→Eucestoda). There are even species which have 2 sets of male and female systems in a single proglottid (e.g., →Dipylidium caninum, Moniezia spp.).

The shape, number, and arrangement of testes is species-specific. One (most monogeneans and aspidobothreans), 2 (many digeneans), 3 (→Hymenolepidae), in general 4 (→Schistosoma haematobium), usually 7 (→S. japonicum), mostly 8 (→S. mansoni), or even more than 100 (e.g., many tapeworms) testes may occur in the different groups of platyhelminths. On the inside of the testes →spermatozoa are formed which are passed via a vas efferens which (eventually) connects with the other(s) to form a vas deferens. This duct courses towards the genital pore which is located at a species-specific site. Just before reaching this pore the vas deferens is often enlarged to form an internal seminal vesicle for sperm storage. From here sperm is

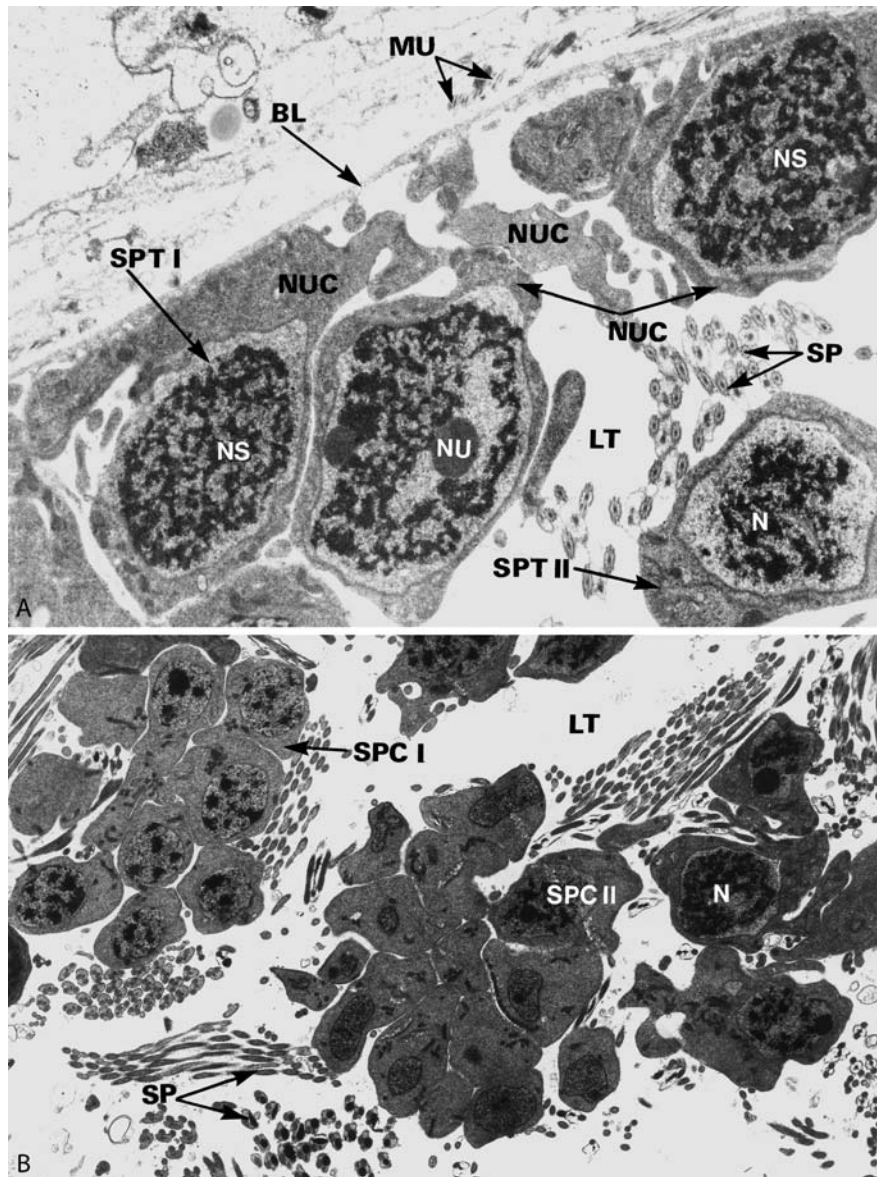

**Platyhelminthes. Figure 1 A,B** TEMs of different steps during the formation of digenean spermatozoa ( $\rightarrow$  *Clonorchis sinensis*) along the wall of the testis (**A**) and inside its lumen (**B**). A  $\times$  8,000, B  $\times$  6,000. BL, basal lamina; LT, lumen of the testis; MU, muscles; N, nucleus; NS, nucleus during division; NU, nucleolus; NUC, nutritive cells; SP, spermatozoa (sections); SPC I, spermatocyte I; SPC II, spermatocyte II; SPT I, spermatogonia I; SPT II, spermatogonia II.

passed via a narrow ejaculatory duct (surrounded by “prostate glands”) into a long muscular, protrusible  $\rightarrow$  **cirrus**; this is inserted into the female system during copulation, thus transferring  $\rightarrow$  **spermatozoa**. This cirrus may be naked or covered with species-specific spines or particular  $\rightarrow$  **microtriches**. In general the modification of the male copulatory system is an important means of species determination.

The female system ( $\rightarrow$  **Oogenotop**) of all platyhelminthic groups consists of a single ovary ( $\rightarrow$  **Germarium**) and several genus-specific associated structures ( $\rightarrow$  **Aspidobothrea**,  $\rightarrow$  **Monogenea**,  $\rightarrow$  **Digenea**,  $\rightarrow$  **Eucestoda**). The

ovary may have a smooth surface or a lobed surface which may make it appear double (e.g., in some tapeworms). As  $\rightarrow$  **oocytes** mature they pass through a single oviduct which in general has a regulating sphincter, the oocapt. The following associated structures occur in some systematical taxa:

- $\rightarrow$  **Ootype** (site of egg composition and wall formation).
- $\rightarrow$  **Vitelline glands** ( $\rightarrow$  **Vitellarium**): a single or double set of relatively large glands producing cells that excrete substances for  $\rightarrow$  **eggshell** formation when packed together (in the ootype) with a fertilized oocyte.

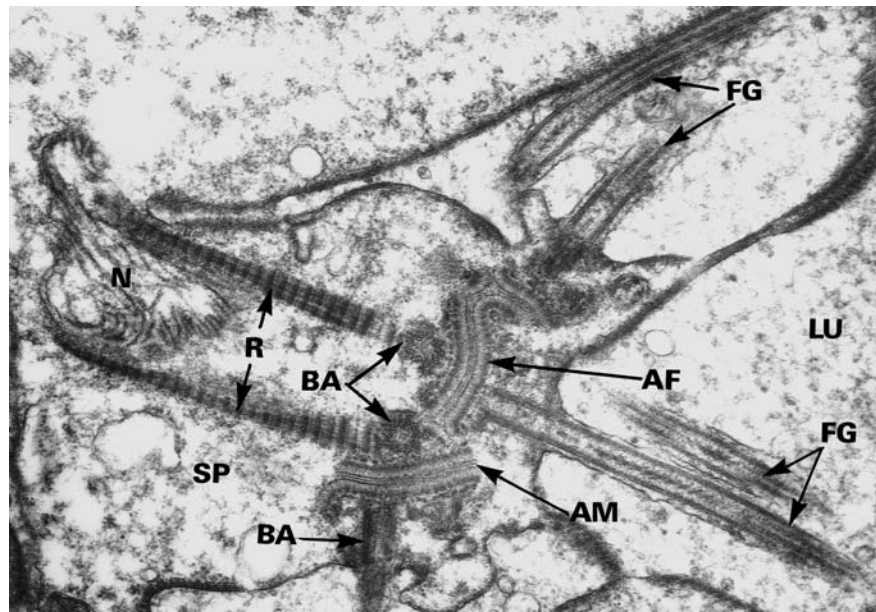

**Platyhelminthes.** Figure 2 TEMs of developmental stages of spermiogenesis in *Paragonimus westermani*. Up to 8 spermatozoa are formed simultaneously. Note the anlage of the final terminal membrane of the sperm (AM). AF, anlage of the fortifying material (UL); AM, anlage of the terminal membrane of the sperm; BA, basal body; FG, flagella of spermatozoa; LU, lumen of testis; N, nucleus (not condensed); R, rootlets; SP, spermatids (cytophores); UL, underlying osmiophilic material.

- Mehlis's glands: usually 2 types – serous and mucous of unicellular glands surround the ootype; their contents probably form an outer eggshell membrane and material to keep eggs slippery on their way into the uterus.
- Uterus: starts beyond the ootype and extends to the female genital pore and serves as vagina in vaginaless species).
- *Receptaculum seminis*: a special organ for storing injected spermatozoa in some digeneans; in other digeneans or in cestodes enlargements of the upper uterus and the upper vagina, respectively, fulfill this function.
- Vagina: typically used in some monogeneans and most cestodes as site of entry for spermatozoa.
- *Laurer's canal*: found in some digeneans and probably representing a vestigial vagina that no longer functions; but it may be used as an excretory system for superfluous sperm, etc.

### Egg Formation

In all cases egg formation finally occurs in the ootype, where the *zygote* becomes packed with vitelline (shell-forming) cells; there may be many of these cells (e.g., Digenea, *Pseudophyllidea*) or only one (e.g., *Echinococcus*, *Hymenolepis*), and in some tapeworms (e.g., *Avitellina* spp.) no vitelline cells are added due to the complete absence of vitelline glands. The ectolecithal egg, the shape of which is species-specific, finally passes through the uterus; on its way the eggshell becomes

stabilized and obtains the physical strength needed for survival outside the worm's and host's bodies. In some species (e.g., most Digenea, *Diphyllobothrium*, Monogenea) an opening (*Operculum*) is preformed during the processes of eggshell formation and the eggs become operculate; related species (e.g., schistosomes, *Taenia*) have nonoperculate eggs (Fig. 8). Their eggshell becomes disrupted when the larva leaves the egg (which in zoological terms is determined as *cocoon*).

### Gametogenesis

The formation of oocytes and spermatozoa is nearly identical in all groups of parasitic platyhelminths. *Spermatogenesis* (Figs. 1–6) starts from a primary spermatogonium which is attached to the wall of the *testis*. The spermatogonium divides mitotically, but the daughter cells (spermatogonia II) remain connected with each other by a cytoplasmic bridge. Two more mitotic divisions lead to the formation of 8 attached spermatocytes I, which already appear in a rosette-like pattern. The spermatocytes I initiate a meiotic division to produce clusters of 16 haploid spermatocytes II, which give rise to 32 attached spermatids by another mitotic division. Each spermatid (i.e., portion of the large lobulated *plasmodium*) differentiates 1, 2, 4 or 8 flagellated spermatozoa (Figs. 1–6). In some monogeneans and in many cestodes another mitotic spermatogonic division leads to the formation of 64 spermatozoa (sperms), whereas the formation of 32 spermatozoa is characteristic for some digeneans and other monogeneans.

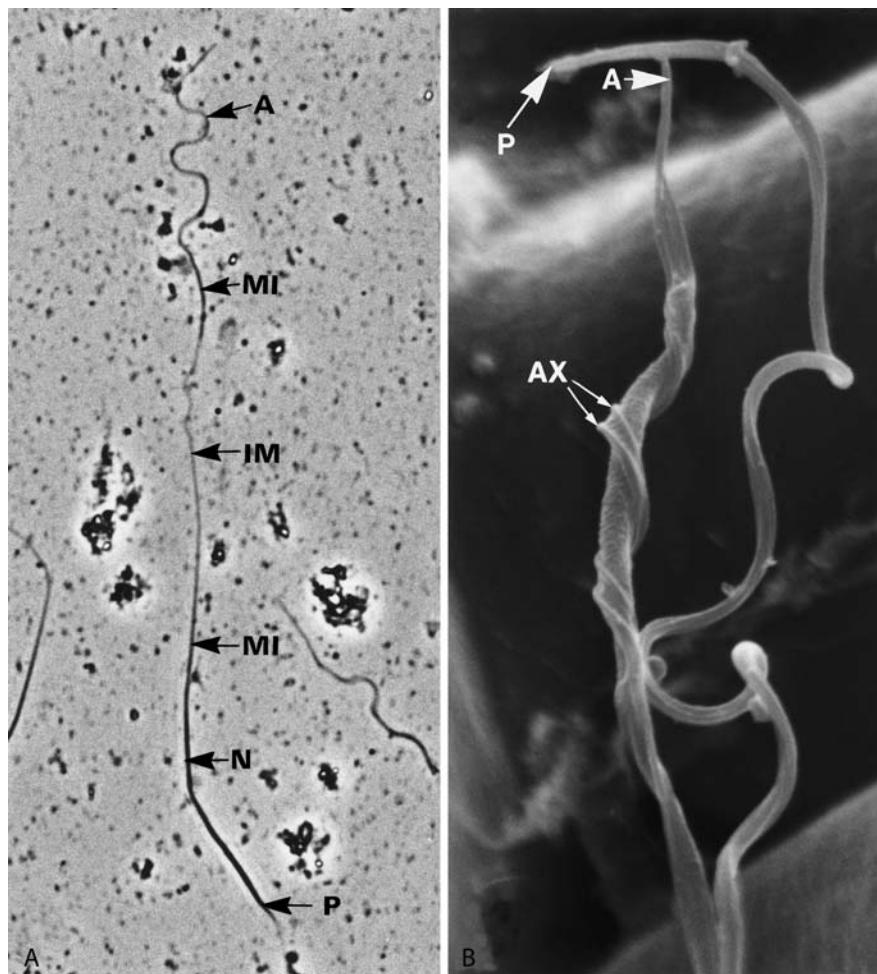

**Platyhelminthes. Figure 3** LM (A) and SEM of sperms of *Paragonimus ohirai* from rats. A  $\times 650$ ; B  $\times 7,000$ . A, anterior pole; AX, axoneme; IM, mitochondrionless middle region; MI, zone of mitochondria; N, nuclear region; P, posterior pole.

Electron microscopic studies have shown that there are basic morphological differences between the extremely long and filariform sperms of the platyhelminthic groups (Fig. 3). The diameters range between  $0.5\ \mu\text{m}$  and  $0.7\ \mu\text{m}$  and the lengths vary between  $40\ \mu\text{m}$  and  $400\ \mu\text{m}$  (e.g., *Baerietta diana* (Cestoda),  $60\ \mu\text{m}$ ; *Gyrocotyle* sp. (*Cestodaria*),  $160\ \mu\text{m}$ ; *H. nana* (Cestoda),  $200\ \mu\text{m}$ ; *Dicrocoelium dendriticum* (Digenea),  $300\ \mu\text{m}$ ; *Fasciola hepatica* (Digenea),  $300\ \mu\text{m}$ ; *S. mansoni* (Digenea),  $200\ \mu\text{m}$ ). All sperms are bound by a single membrane, below which *microtubules* are arranged either concentrically (Figs. 4, 5; in cestodes, schistosomes, and some monogeneans) or in strands (of up to 45 in *D. dendriticum*, 40 in *P. westermani*, 27 in *Opisthorchis* spp., and up to 20 in some monogenean species, Figs. 4, 5).

The sperms of platyhelminths lack an acrosome, although some of them appear to have some sort of

“head.” This occurs in some species of the Monogenea (e.g., *Diclidophora* spp.), Digenea (e.g., *Schistosoma* spp., *F. hepatica*) and Cestoda when the nucleus remains at the apical pole of the young spermatozoon after its separation from the spermatid’s *cytoplasm* (Figs. 4, 5). In other cases where the nucleus is found more centrally no “head” appears.

Among the platyhelminthic groups spermatozoa may develop 1 or 2 flagellar axonemes (Fig. 4). Cestodes have in general a single *axoneme* (Fig. 5); this also occurs in some monogeneans (e.g., *Pseudodactylogyrus anguillae*), but 2 axonemes are formed in most digeneans and *Aspidobothrea*. Schistosomes, however, are again exceptional in being endowed with a single axoneme (Fig. 5C,D). In cross section the axonemes show in general 9 pairs of outer microtubules surrounding an apparently solid central filament which is additionally enclosed by a circular densification



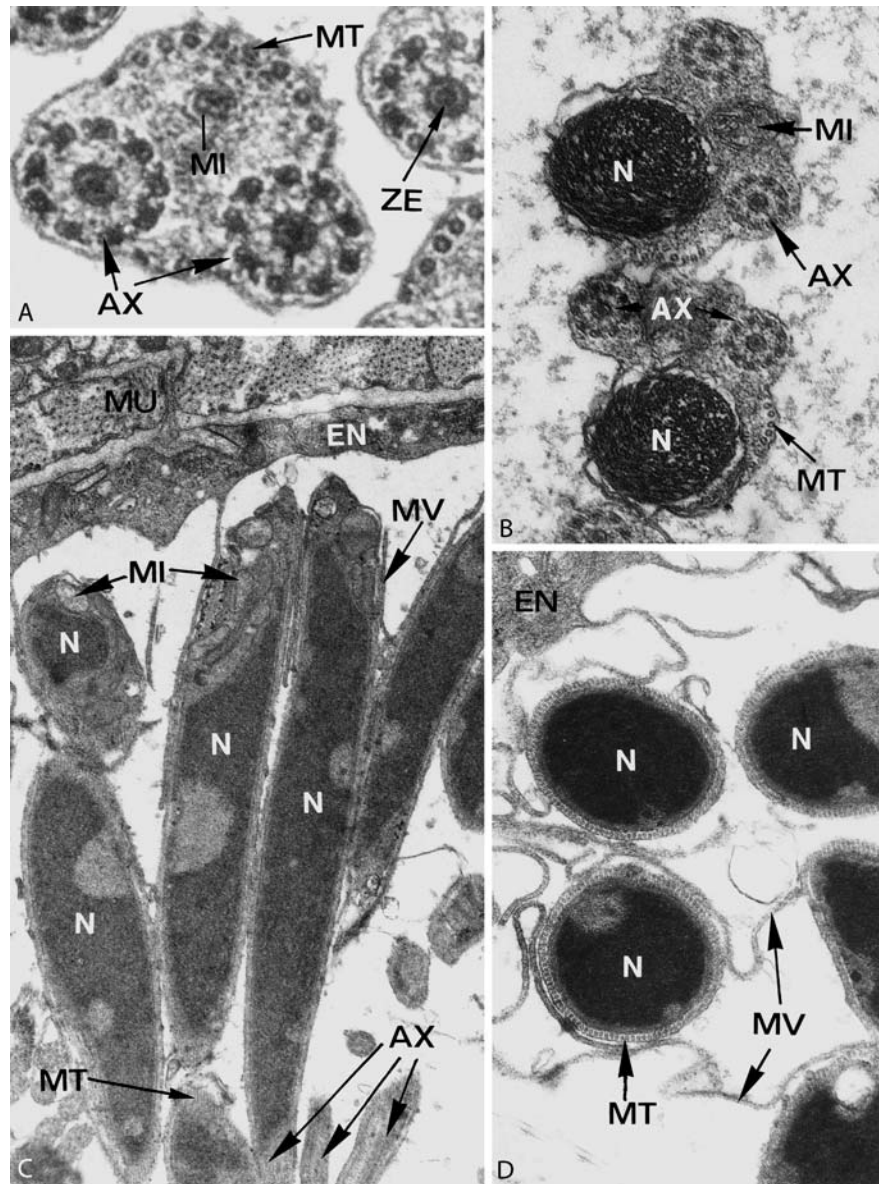

**Platyhelminthes. Figure 4 A–D** TEMs of platyhelminthic spermatozoa in cross and longitudinal (C) sections at different planes. Note the occurrence of 1 or 2 axonemes. **A, B** *Clonorchis sinensis* (Digenea). A  $\times 60,000$ . B  $\times 30,000$ . **C, D** *Schistosoma mansoni* (Digenea), sperms cut cross and longitudinally inside the oviduct. C  $\times 25,000$ , D  $\times 52,000$ . AX, axoneme of flagellum; EN, endothelium; FG, flagellum of  $\rightarrow$ gametes; GL, glycogen; MI, mitochondrion; MT, microtubules; MU, muscles; MV,  $\rightarrow$ microvilli; N, nucleus; OD, oviduct; PT, protrusions of oviduct wall; ZE, central solid element of axoneme.

(Figs. 4, 5). Since platyhelminths are able to form typical  $\rightarrow$ cilia (e.g., on the surface of miracidia, in the excretory systems, in the various ductules of the sexual organs), the unique fine structural differentiation of sperm  $\rightarrow$ flagella is probably due to a functional adaption. In schistosomes and a few other species zero or 2 central elements may occur, indicating that variations are possible without loss of activity.

Monogenean and digenean spermatozoa contain relatively large, cristate  $\rightarrow$ mitochondria, which are missing (or reduced in size) and thus not seen in many cestodes (Fig. 5). The sperms of all platyhelminths contain varying amounts of  $\rightarrow$ glycogen granules (often in close contact to the nucleus and mitochondria; Figs. 4, 5).

Oogenesis (Fig. 6) starts from the marginally situated small oogonium (4–9  $\mu$ m) which develops via a meiotic

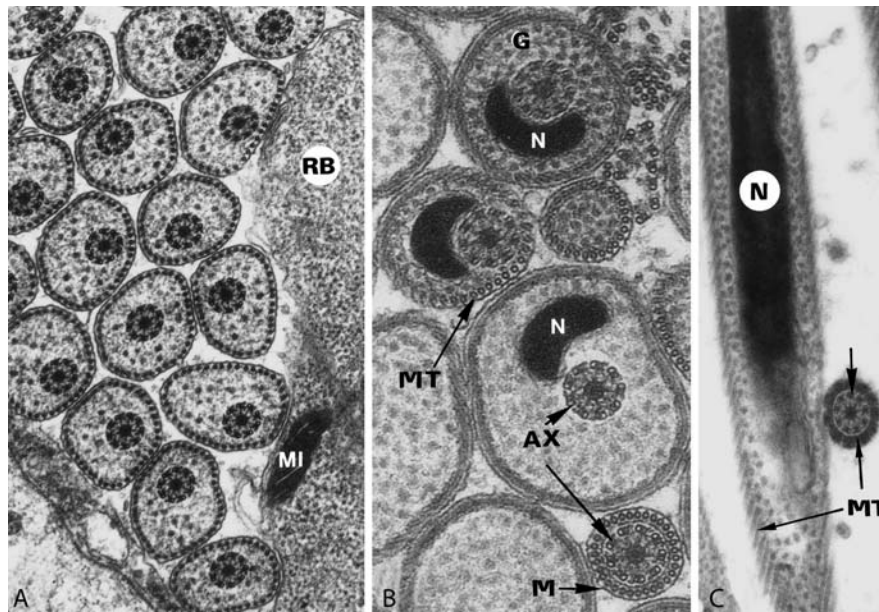

**Platyhelminthes. Figure 5 A–C** TEMs of cross (A, B) and longitudinal sections of sperms of the tapeworm *Hymenolepis nana*. Note the presence of only one axoneme. A  $\times$  25,000, B  $\times$  75,000, C  $\times$  20,000. AX, axoneme; G, glycogen; M, membrane; MI, mitochondrion; MZ, microtubule; N, nucleus; RB, residual body.

division and grows into oocytes (about 10  $\mu$ m). These stages are characterized by electron-dense, randomly scattered granules, and by a large electron-lucent nucleus that includes a typical nucleolus (Fig. 6). When fertilization occurs, the membrane of the entering sperm fuses with that of the mature oocyte, thus introducing the whole cytoplasm, including the axonemes which can be seen for a while coiling inside the zygotes' cytoplasm.

The penetration of the male gamete initiates the formation of the eggshell by fusion of material that was excreted from the vitelline gland cells and added to the fertilized egg on its way to the ootype (Fig. 7). When this eggshell is formed, secretions of the Mehlis' glands cover the egg's surface, inside which the embryonic cell divisions are initiated during the time needed for passing to the uterus (Figs. 9, 10). A varying extent of embryonic development is completed outside the host in most species when eggs have reached the water. In some cases (e.g., *Dicrocoelium dendriticum*), however, eggs that already contain larva may be passed in host feces (Figs. 8, 10).

#### Asexual Processes

Typical asexual reproduction – splitting or budding – is found only in a few platyhelminthic groups. Some digenean species belonging to the superfamilies Brachylaemoidea (e.g., *Postharinostomum* spp., *Leucochloridium* spp.) and Bucephaloidea (e.g., *Bucephalus* spp.)

form branching sporocysts. By constrictions such branches may be cut off and finally grow to their former size. This occurs by mitotic divisions of undifferentiated cells which are found below the body wall (Fig. 10).

The great majority of tapeworms form only a single larva during their life cycle (*Taenia*). Proliferative budding is rarely found, but is typical of some species. In general this asexual reproduction occurs during the second larva stage which originates from the infectious oncosphaera (i.e., in eggs ingested by many intermediate hosts; Eucestoda/Table 1). This second larva (also described as a metacestode because of its infectivity for final hosts) may divide by external or internal budding. External budding or asexual fission is found in the cysticercus of *Taenia crassiceps* (across from the scolex), in the polycercus of *Paricterotaenia paradoxa* (inside earthworms; final hosts are birds) where several cysticercoids are formed, and in the constantly dividing tetrathyridium of *Mesocestoides* spp. In the hydatids of *Echinococcus granulosus* and in the tubular system of *E. multilocularis* external and internal budding is found (*Echinococcus*). Undifferentiated cells which are situated below the tegument divide mitotically and increase the surface tegument when they join it, thus protruding fine, solid columns, and finally long tubules through host tissues (*E. multilocularis*). By invaginations of the surface tegument and further mitotic divisions of such undifferentiated cells, internally

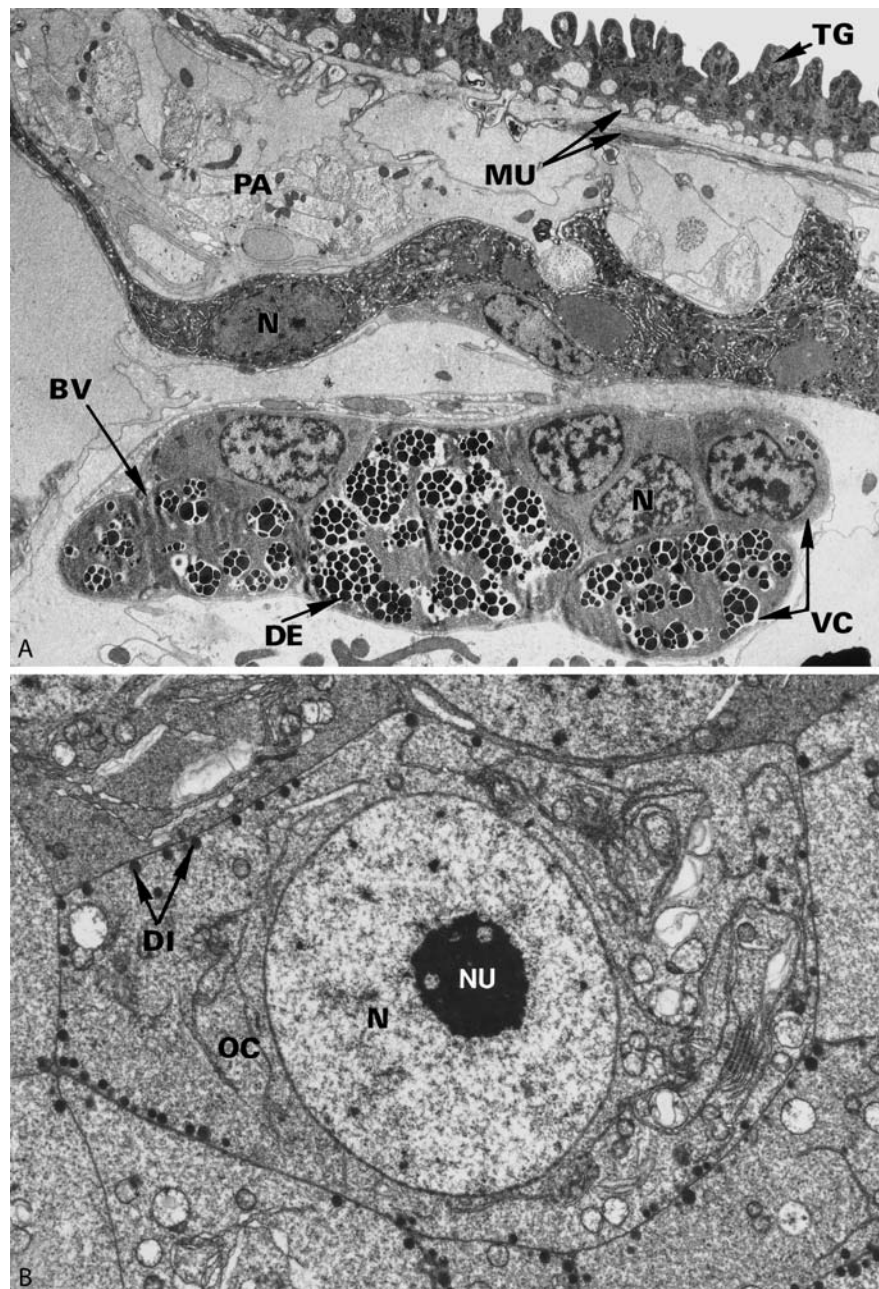

**Platyhelminthes. Figure 6 A,B** Reproductive systems of digeneans (TEMs). **A** → *Opisthorchis viverrini*; section through a branch of the vitellarium (BV) containing vitellary cells at different developmental stages. × 5,000. **B** *Schistosoma mansoni*; closely packed oocytes inside the ovary. × 10,000. BV, branch of the vitellarium; DE, droplet for eggshell secretion; DI, dense inclusion; MU, muscle bundles; N, nucleus; NU, nucleolus; OC, oocyte; PA, parenchymal cells; TG, tegument, VC, vitellary cells.

situated → brood capsules are produced which finally give rise to thousands of protoscolices. In the case of the → coenurus found in the life cycle of *Multiceps* → multiceps a nearly identical, but numerically reduced formation of protoscolices occurs in one step

immediately below the inner tegumental side of the coenurus.

These eucestodean tapeworms thus increase their progeny by the asexual internal or external divisions described above. Their life cycles thus involve

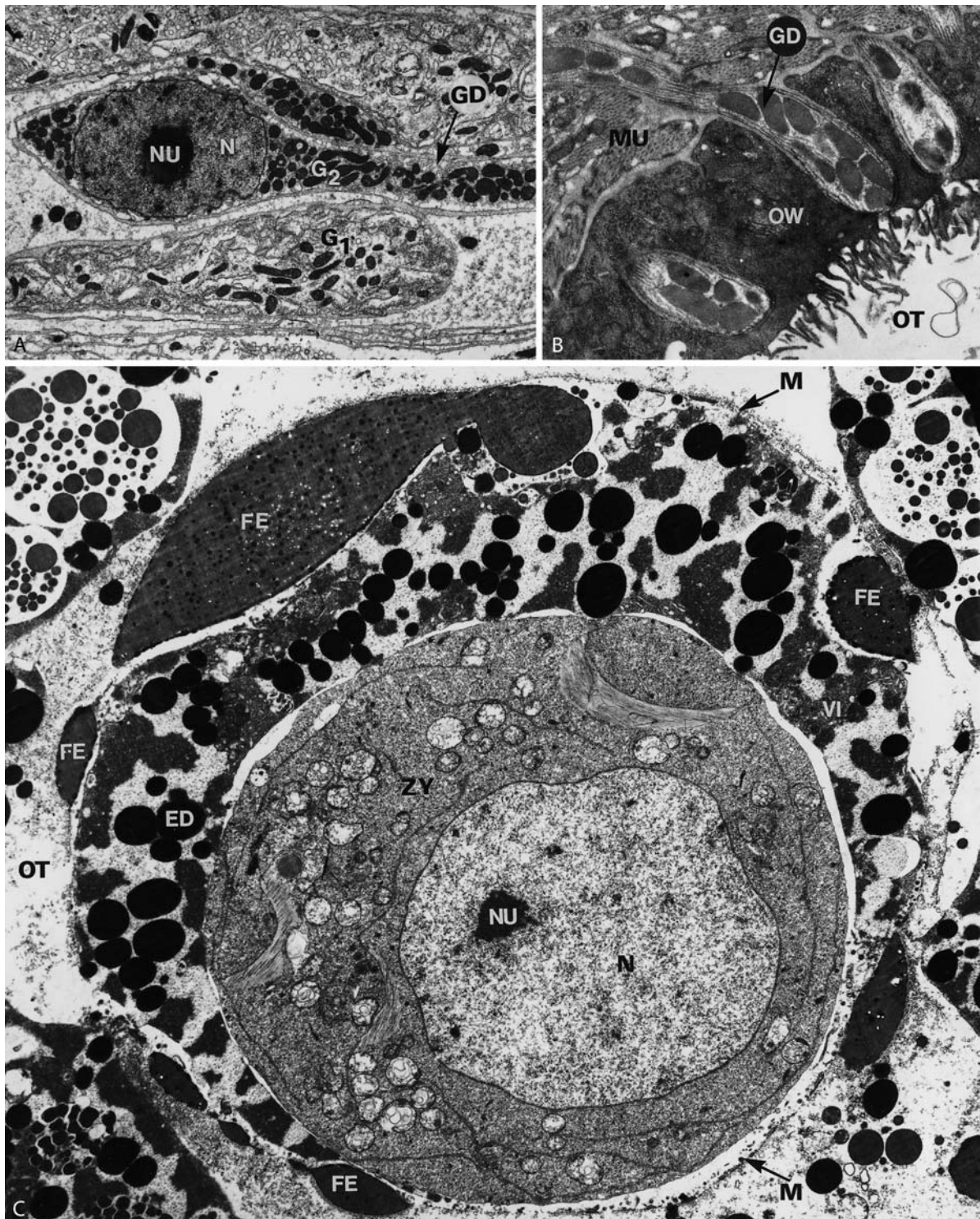

**Platyhelminthes. Figure 7 A–C** TEMs of egg formation in digeneans. **A, B** Mehlis' glands in *Paragonimus westermani* (A) and *Schistosoma mansoni* (B).  $\times 5,000$ . **C** *P. westermani*; inside the ootype the eggshell is formed by fusion of vitellary droplets below a layer ("membrane") deriving from Mehlis' gland excretions.  $\times 8,000$ . *ED*, eggshell droplets of VI; *FE*, fusing droplets form the eggshell; *G*<sub>1</sub>, *G*<sub>2</sub>, glands of types 1 and 2; *GD*, gland ductus; *M*, outer cover of the egg ("membrane"); *MU*, muscles; *N*, nucleus; *NU*, nucleolus; *OT*, ootype; *OW*, ootype wall; *VI*, vitellary cells; *ZY*, zygote.

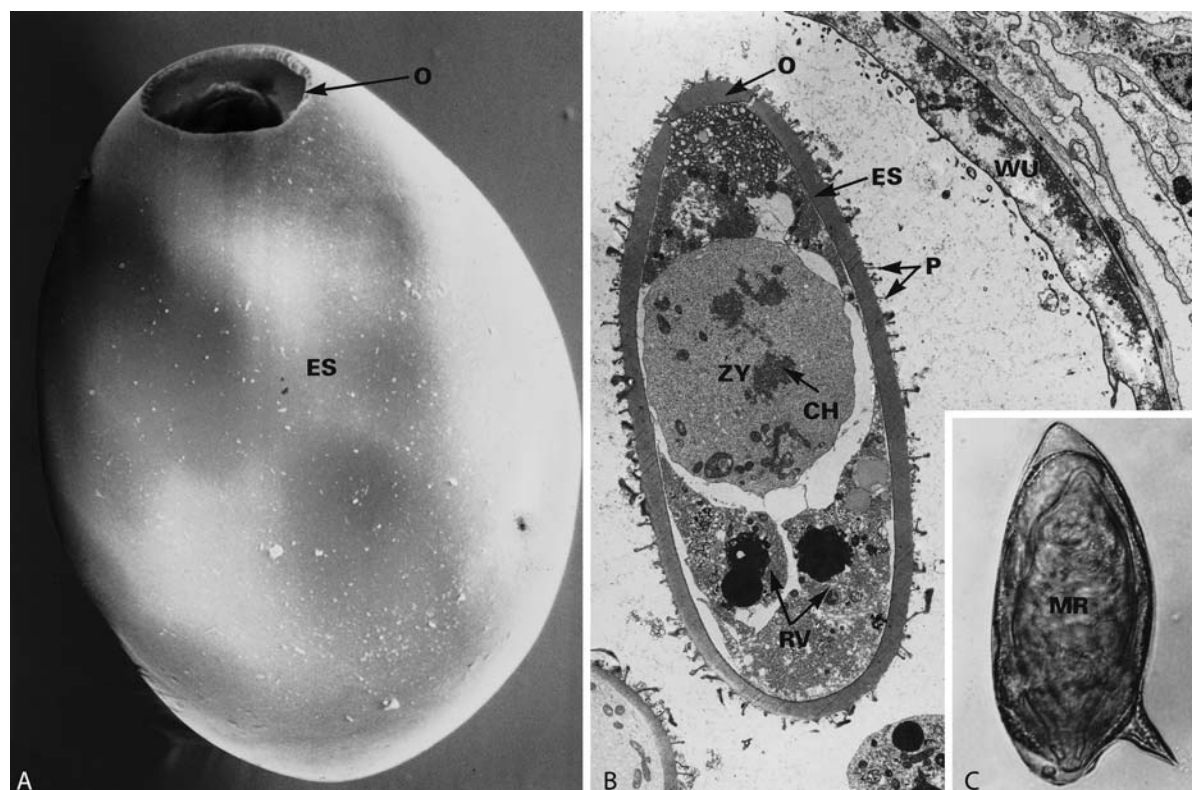

**Platyhelminthes. Figure 8 A–C** Digenean eggs. **A** SEM of an operculated egg of *Fasciola hepatica* (by courtesy of Prof. Køie, Denmark).  $\times 550$ . **B** *Clonorchis sinensis*; TEM of a section through the typical operculated egg inside the uterus. Note that the nucleus of the zygote has started division (absence of the nuclear membrane).  $\times 4,000$ . **C** LM of the nonoperculated egg of *Schistosoma mansoni* from feces (it already contains a miracidium).  $\times 250$ . *CH*, chromatin; *ES*, egg shell; *LU*, lumen of the uterus; *MR*, miracidium; *O*, operculum; *OP*, opening of the eggshell; *PE*, protrusions of the eggshell; *RV*, residual vitellary cells; *WU*, wall of the uterus; *ZY*, zygote.

2 generations: the sexually reproducing adults and the asexually proliferating stage (i.e., the second larval stage). This type of life cycle is described as a  $\rightarrow$ metagenesis.

### Integument

The membrane-bound outer surface of adult aspidobothreans, monogeneans, digeneans, and cestodes is structured according to a common plan (Fig. 11). It seems unbelievable that until about 30 years ago it was generally accepted that the surface of parasitic platyhelminths was a cuticle, a more or less homogeneous, tough secretion product of the epidermis. However, the first electron-microscopic investigations showed that it is in fact a syncytial layer of varying thickness (without nuclei) which is connected by cell processes with parts containing the nuclei.

In the last 30 years the teguments of members of nearly all groups of parasitic platyhelminths and most of their developmental stages have been investigated. However, these investigations dealt mainly with the

morphological peculiarities and the formation of the tegument, and only seldom with the surface coat and its properties. An exception is the extraordinary surface of the blood fluke,  $\rightarrow$ *S. mansoni*. A large amount of evidence has been accumulated which shows that the  $\rightarrow$ tegument is a cilialess (in adult worms), cytoplasmic, but noncellular, *metabolically active layer* which is involved at least in the adsorption of nutrients, in osmoregulation and excretion, and in protection against the effects of host enzymes and immune systems. Secretions of the tegument proved to have a digestive function, or might be involved in the defense against  $\rightarrow$ immune reactions. The second name (i.e.,  $\rightarrow$ neodermis) for the surface cover reflects on the fact that larval stages such as miracidia (Fig. 13) are covered by a cellular, cilia-containing layer (epidermis) which becomes replaced by the noncellular tegument deriving from underlying parenchymal cells (Fig. 12).

Under the light microscope Platyhelminthes appear entirely covered by the tegument which reaches a thickness of 1–30  $\mu\text{m}$  depending on the species, the site

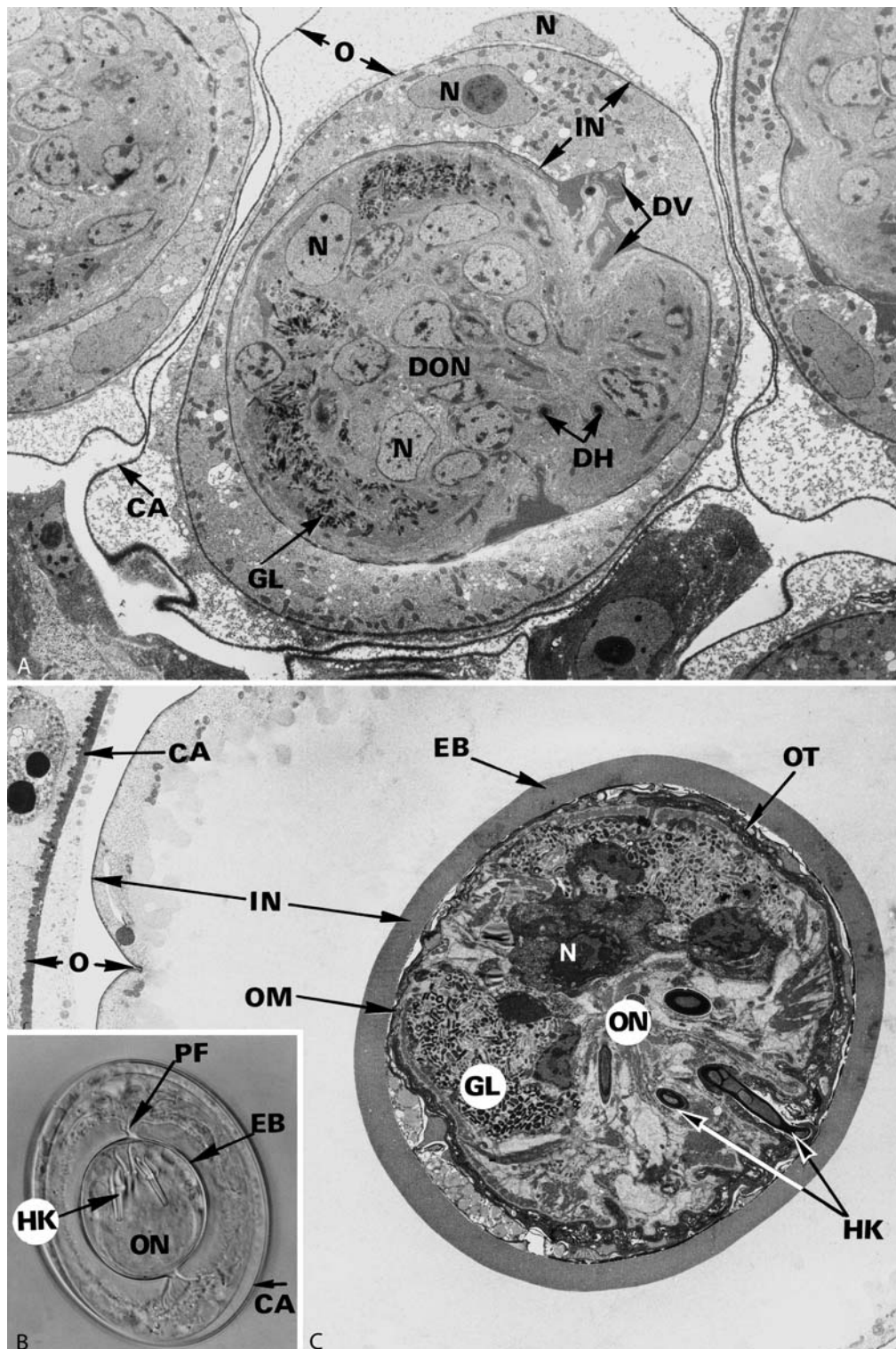

**Platyhelminthes. Figure 9** A–C Embryonic development of cyclophyllidean eggs (*Hymenolepis nana*) inside the uterus. **A, C** EMs.  $\times 3,000$ . **B** LM of a freshly passed egg.  $\times 1,000$ . *CA*, capsule; *DH*, developing hooks; *DV*, developing  $\rightarrow$ embryophore; *DON*, developing oncosphere; *EB*, embryophore; *GL*, penetration glands; *HK*, oncospherical hooks; *IN*, inner envelope; *N*, nucleus; *O*, outer envelope; *OH*, oncospherical membrane; *ON*, oncosphere; *OT*, oncospherical tegument; *PF*,  $\rightarrow$ polar filament (= remnants of inner envelope).

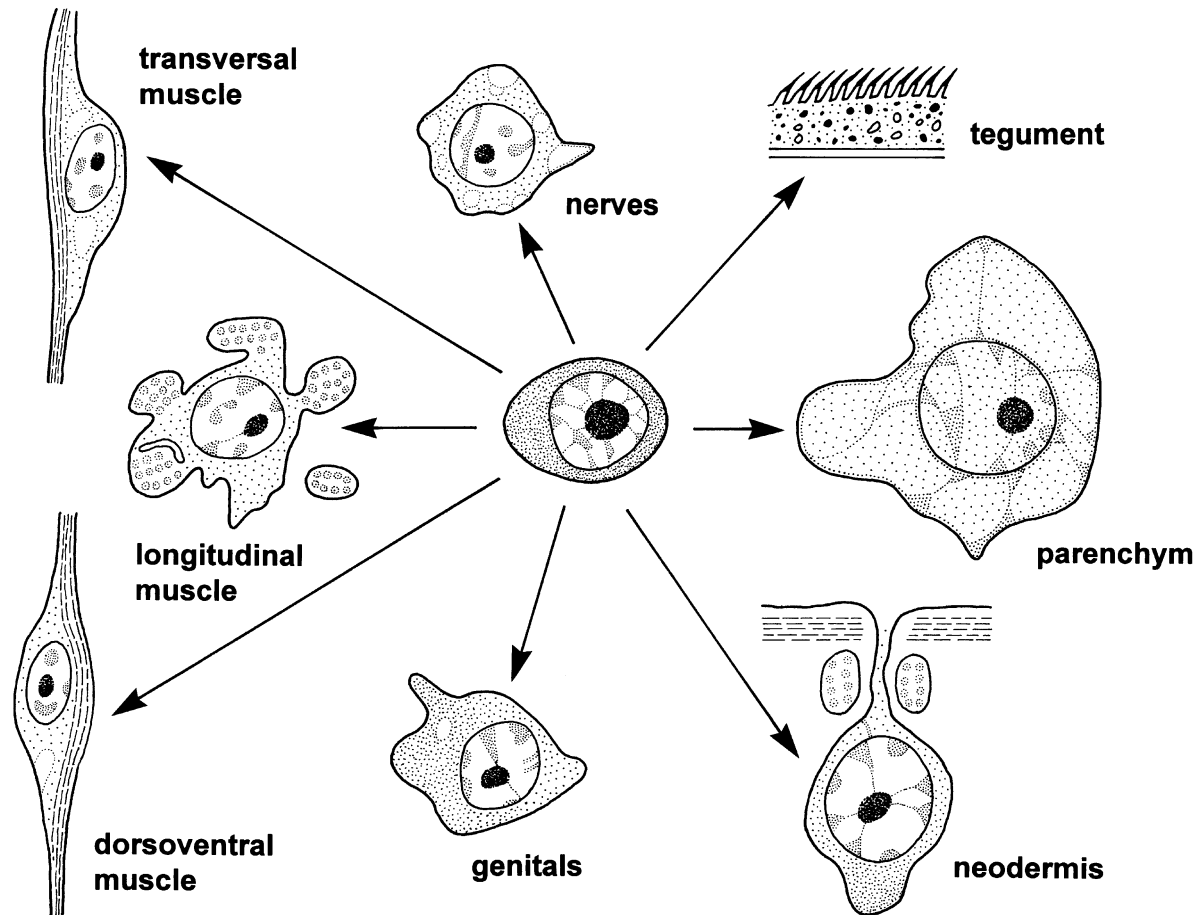

**Platyhelminthes. Figure 10** Developmental possibilities of an →undifferentiated cell (germ cell) in platyhelminths (e.g., cestodes; after Gustafsson's and our own original results). Note that the undifferentiated cells are characterized by a large nucleus with a spherical nucleolus.

along the body, and the individual developmental phase (Fig. 12). In adult worms of *E. granulosus*, for example, the tegument of the suckers measures about 1.6  $\mu\text{m}$ , that of young proglottids 8  $\mu\text{m}$ , and that of gravid proglottids up to 11  $\mu\text{m}$ . The tegument in general shows affinities for basic stains, thus leading to the old, incorrect description as cuticle. In electron-microscopic studies it has been shown that this syncytial tegument is usually limited by a single →cell membrane (Fig. 11); only in a few platyhelminthic species (e.g., *Schistosoma* spp.) 2 membranes may occur along the outer surface. This second membrane, which is not always complete, is known as →membranocalyx, and apparently protects the organism against the host's defense system.

Electron microscopy has revealed further characteristics of the different parasitic groups (Figs. 16–19). The tegument of many aspidobothreans, monogeneans, and digeneans has a wavy surface which is thrown into folds, thus sometimes leading to deeply running

channels (Figs. 17, 18). Especially in aspidobothreans and monogeneans, fingerlike protrusions protrude from the surface of the generally smooth tegument, giving partly the appearance of microvilli, although there is no definite structural similarity (Fig. 17B). In male schistosomes →bosses may occur along the dorsal surface (Fig. 17); their shape is species-specific, and they may be endowed with typical spines.

In cestodes, however, the surface projects into regularly arranged microtriches, the dimensions of which vary among species and location along the individual body (Fig. 19). All microtriches are characterized by an electron-dense, more or less long apical tip that is separated from the more basal (and electron-lucent) region by a multilaminar plate (Fig. 19). The shapes of microtriches, which are more or less circular in cross section, vary depending on their apparently different functions. Three main types of microtriches may be found (even in the same individual):

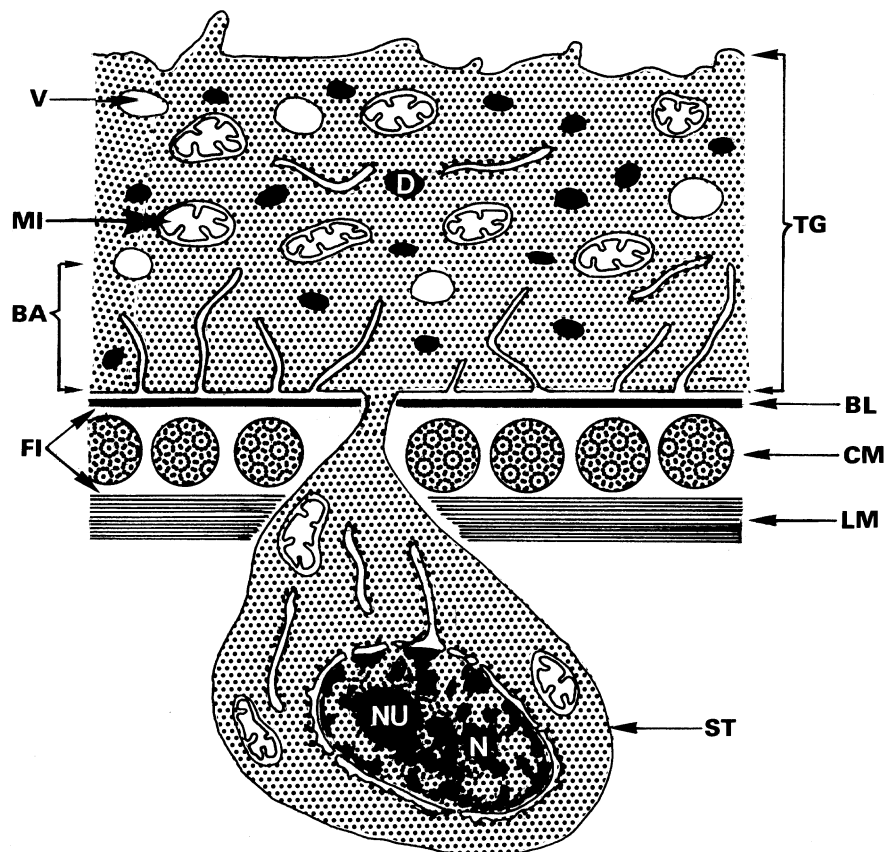

**Platyhelminthes. Figure 11** Diagrammatic representation of the basic tegumental pattern in parasitic platyhelminths. In monogeneans different protrusions may occur, in digeneans additional infoldings or hooks (Figs. 14, 17) are formed, whereas the surface of cestodes is endowed with →microtriches (Fig. 15). BA, basal labyrinth; BL, basal lamina; CM, circular muscles; D, →dense bodies (may appear as disks); FI, fibrous layer; LM, longitudinal muscles; M, mitochondrion; N, nucleus; NU, nucleolus; ST, subtegumental cell (→Perikaryon); V, vacuole.

- Large, stiff microtriches with a spatula-like appearance serve as a means of movement and to keep distance to, e.g., host's surface.
- Short, stiff microtriches with a spinelike exterior serve in hookless tapeworms as a means of anchoring.
- Long, smooth, and flexible microtriches are obviously involved in increasing the surface area and are thus essential for the uptake of nutrients, which also occurs by →endocytosis between the bases of the microtriches.

The cytoplasm of the tegument contains in addition to typical cytoplasmic organelles (such as mitochondria, endoplasmic reticulum, →Golgi apparatus, ribosomes, glycogen granules, lipids, and →vacuoles (Figs. 17–19), specific structures such as electron-dense →tegumental disks, dense bodies, and multilaminar bodies (Fig. 19). These peculiar organelles are needed for steady growth of the tegument and for replacement of the cell membrane and the surface coat

which appears as a fuzzy or filamentous material of varying thickness.

The tegument of different species is endowed with proteinaceous spines (Digenea, Fig. 17), hooklets (Monogenea), or even large sclerotized hooks (Monogenea, Cestoda; Figs. 16, 19), which all serve as →holdfast organs. The shape of these structures is so specific that they can be used for species diagnosis, e.g., the rostellar hooks in *Echinococcus* spp. (Fig. 19A). In all cases these spines, hooks, etc. start at the base of the tegument (Figs. 18F, 20A), which is limited here by another membrane and often forms a basal labyrinthine structure by deep invaginations. This membrane runs along an underlying basal lamina, the thickness of which varies with species (Figs. 18C, 20A, 21A).

The inner cell membrane of the syncytic tegument is connected to finger-like protrusions of parenchymal cells (Figs. 11, 19), the cell body (cyton) of which is situated below the circular and longitudinal muscle



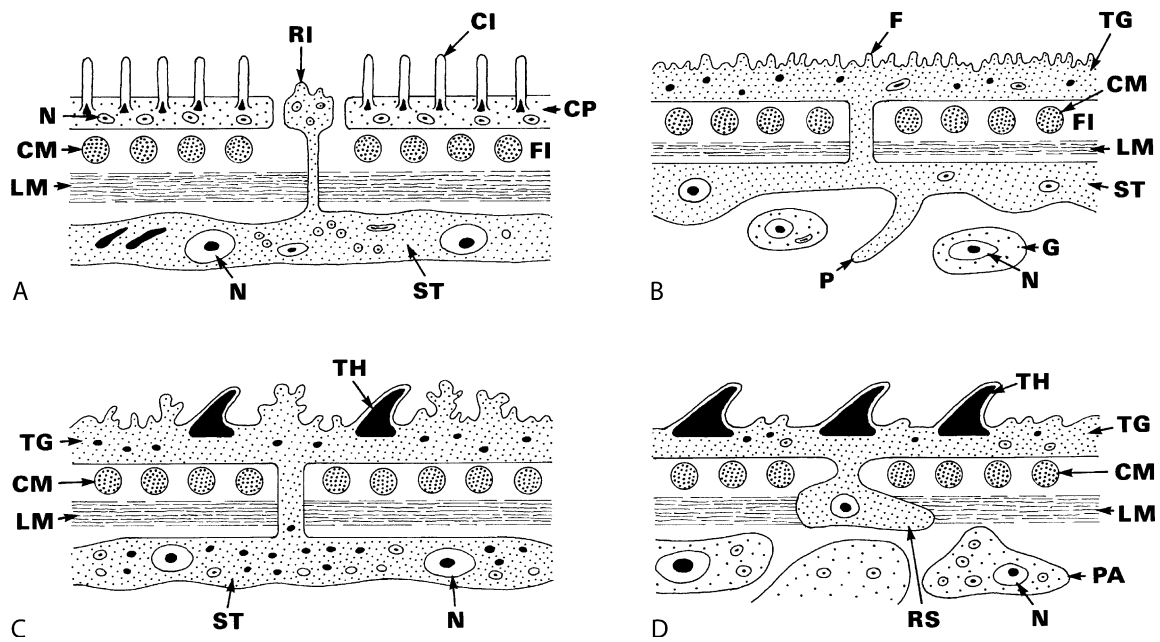

**Platyhelminthes. Figure 12 A–D** Diagrammatic representation of the development of the syncytial →tegument in digeneans (→*Schistosoma mansoni*). **A** →Miracidium which is covered by ciliary plates and →ridges formed by the subtegumental layer. **B** Mother →sporocyst after detachment of ciliary plates. **C** Daughter sporocysts are covered by a syncytial tegument which is connected by bridges with the subtegumental layer. **D** →Cercariae: the subtegumental layer becomes reduced, and later parenchymal cells will contact the syncytial tegument. *CI*, cilia; *CM*, circular muscles; *CP*, ciliary plate; *F*, foldings; *FI*, fibrous layer; *G*, germinal cells; *LM*, longitudinal muscles; *N*, nucleus; *P*, protruding subtegument; *PA*, parenchymal cell; *RI*, ridge; *RS*, remnants of the subtegument; *ST*, subtegumental layer; *TG*, tegument; *TH*, tegumental thorn (hook).

bundles. These connections which pass the basal lamina led in old light microscopic studies to descriptions such as “→sunken epithelium” for the body wall of platyhelminthes. However, electron-microscopic studies of the developmental processes have proven that the primary cellular, ciliate, and nucleate epithelium is lost. An underlying (not ectodermal) →syncytium with degenerating nuclei is formed *de novo* and comes into contact with the underlying parenchymal cells via their finger-like protrusions (Figs. 11, 19). When in connection with the syncytial layer of the tegument, these parenchymal cells are described as cytons, perikarya, or subtegumental cells. They include a large nucleus and all other typical cellular organelles (Fig. 11), but there are apparently 2 different types with respect to the storage of glycogen; one type is closely filled with glycogen granules and the other is not, as can be demonstrated by means of the silver-protein method (Fig. 20A,B).

The tegumental →syncytium covers the whole surface of worms, but is in some places penetrated by ciliate sensory cells and their axons to allow reception and distribution of external stimuli. Especially in the scolex region of some cestodes but also in digeneans the ductules of glands may pass through the tegument

(Figs. 18E, 21) or fuse with the tegument and lead to apocrine, eccrine, or microapocrine secretion of apparently lytic enzymes, as can be inferred from the cellular disintegration of host cell epithelium in the neighborhood.

### Musculature

In platyhelminthes 4 different types of muscles occur, depending on their location inside the body, they mainly appear to be smooth muscles, although there are some exceptions.

- **Muscles of the Body Wall.** Adult platyhelminthes have 2 layers of muscles just below the syncytial tegument and its basal lamina (Fig. 11). The outer bundles of the circular musculature and the inner longitudinally running muscles are both embedded in an electron-lucent amorphous layer of connective tissue (Figs. 18, 19). In some species additional fibers may occur running diagonally between circular and longitudinal muscles. When observed with the light microscope these body wall muscles appear smooth (i.e., not striated); however, the electron microscope reveals that the muscle cells contain thick, thin, and intermediate filaments. The

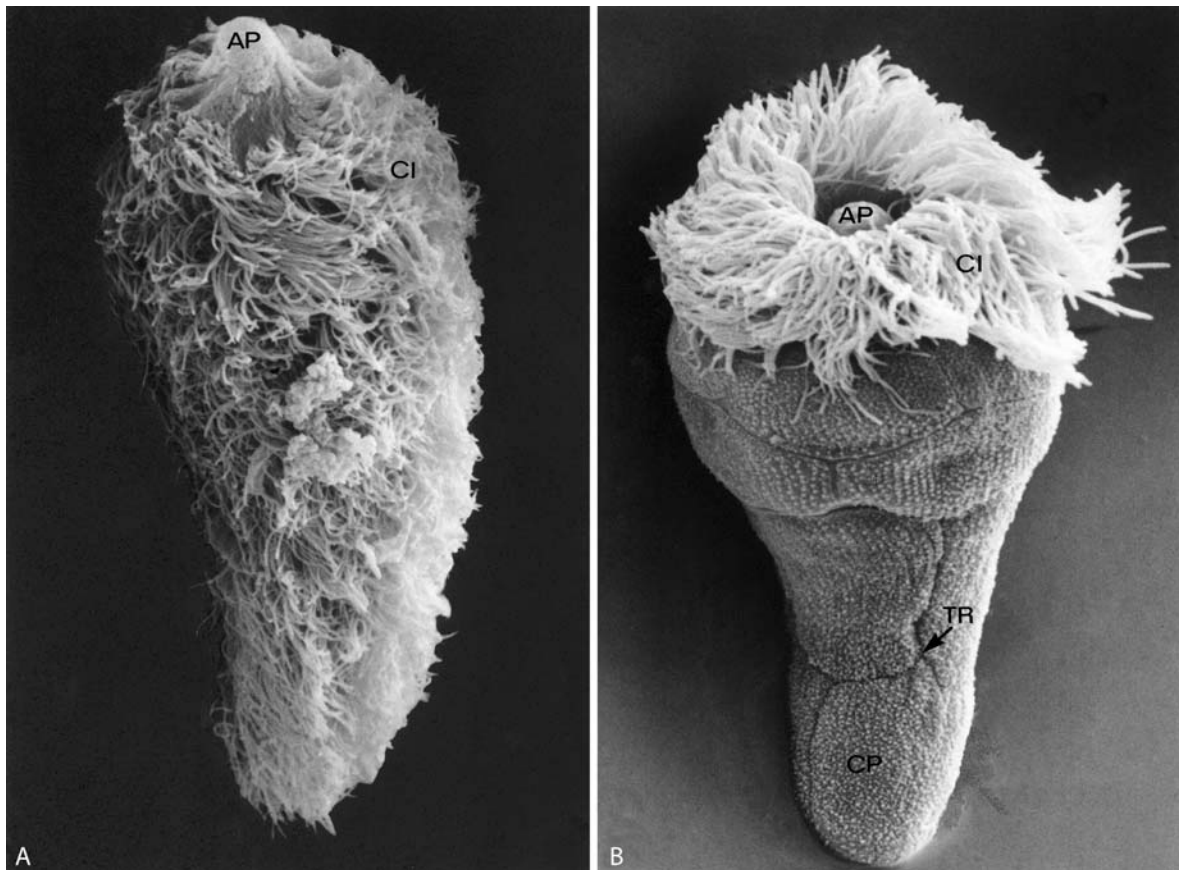

**Platyhelminthes. Figure 13 A,B** SEMs of *Fasciola hepatica* *→miracidia* (from Prof. Koie, Copenhagen). **A** Complete stage. **B** In this stage the *→cilia* were removed to show the ciliary plates (*CP*) representing epithelium cells and the tegumental ridges (*TR*) which finally grow up to the syncytial tegument ( $\times 800$ ). *AP*, apical papilla; *CI*, cilia; *CP*, ciliary plates; *TR*, tegumental ridges.

diameter of the thick filaments corresponds to that of *→myosin* filaments; the smaller-sized filaments, the size of which corresponds to that of *→actin*, run parallel to the thicker ones, and seem to be anchored at dense plaques (Figs. 18, 19). The latter are irregularly (often randomly) distributed and apparently have a function similar to that of the Z-lines in striated muscles. The sarcoplasmic reticulum is very small and marginally situated; a transverse system like the *→T-system* of striated muscle is apparently absent. The tegumental muscles may grow to a considerable size in regions of acetabula (suckers, Figs. 15, 16). In other regions of the body they may be rather feeble; in any case, however, fibers are organized cellularly; the nuclei are found in special perikarya called myoblasts that are located in various sites around the body, often in syncytial clusters. In the tail of cercariae, the characteristic developmental stages of digenean trematodes, longitudinal muscles that are composed of sarcomere-like units occur

(Fig. 22, page 1167). These units show all the elements of typical striated muscle such as A-bands, I-bands, H-zone, Z-line, sarcoplasm, and transverse tubules (T-system). This system of striated muscle was apparently developed since it is functionally superior to smooth muscles and the cercariae need a strong and quickly bending tail for their movements, otherwise they would not be able to penetrate into moving final or intermediate hosts.

- **Parenchymal Muscles.** These muscles are mainly found in cestodes (and some turbellarians) and are generally absent in mono- and digeneans. When seen in cross section, parenchymal muscles form a circle at some distance from the muscles of the body wall, thus dividing the parenchyma into an outer cortical and an inner medullary zone (*→Hymenolepis*). This muscular circle, which has longitudinally and circularly oriented fibers, is interconnected by strands of muscle running dorsoventrally which allow the typical bending movements of proglottids (*→Eucestoda*).



**Platyhelminthes. Figure 14** SEMs of typical platyhelminthic →holdfast organs: →*Gyrodactylus aculeati* attached on fish skin by its →*opisthaptor*. × 150.

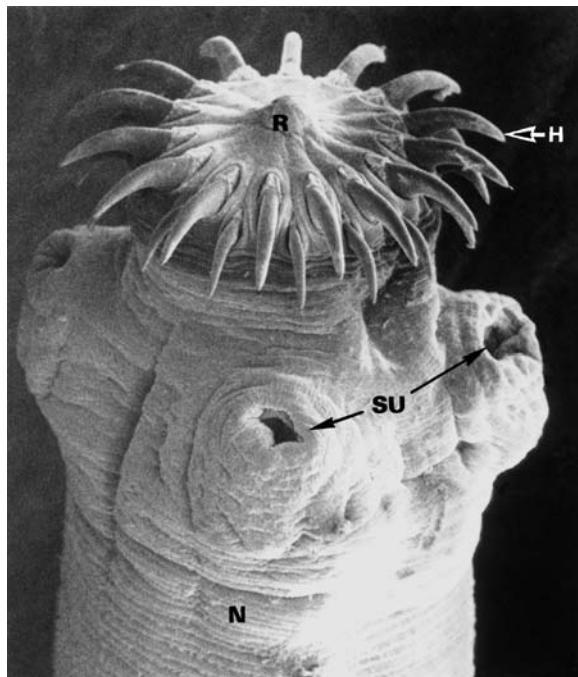

**Platyhelminthes. Figure 15** SEM of typical platyhelminthic →holdfast organs: *Taenia* sp. scolex with rostellar hooks (H) and suckers (SU) (× 150). N, →neck region; R, →rostellum.

- Subtegumentary Muscles. These muscles are characteristic of cestodes and are inserted at the basal lamina of the sucker muscles; bands of crisscrossing fibers improve the function and coordination of the

holdfast process (Fig. 19A). During ontogeny the subtegumentary muscles develop by specialization of tegumentary muscles and not by involving those of the parenchymal complex.

- Muscles of Organs. Some organs (e.g., pharynx, esophagus, intestinal ceca, cirrus, vagina, uterus) may be endowed with radial muscle fibers, often very highly developed, but always of the smooth type.

### Intestine and Food Uptake

Like the acanthocephalans the smooth-walled tapeworms lack an intestine in all developmental stages. They are able to feed by →*endocytosis* and additional active →*membrane transport*. All other systematic taxa of platyhelminthes are provided with an anusless intestine which usually starts in the center of the oral sucker (acceptaculum), can reach a considerable size in some species (Figs. 15, 16, 18), and is generally endowed with a muscular pharynx and esophagus. Apart from the aspidobothreans (and a few other exceptions), the intestine divides after the esophagus into 2 lateral →*crura*. The crura of monogeneans are mostly highly branched and may even connect along their length, whereas in digeneans lateral branches are only seldom found (e.g., *Fasciola hepatica*). In several monogeneans and in schistosomes the crura join (at least near the midbody) and continue posteriadly as a single tube for some distance. Electron microscopy has revealed that the intestine consists of a single layer of epithelial cells which are located on a basal lamina and

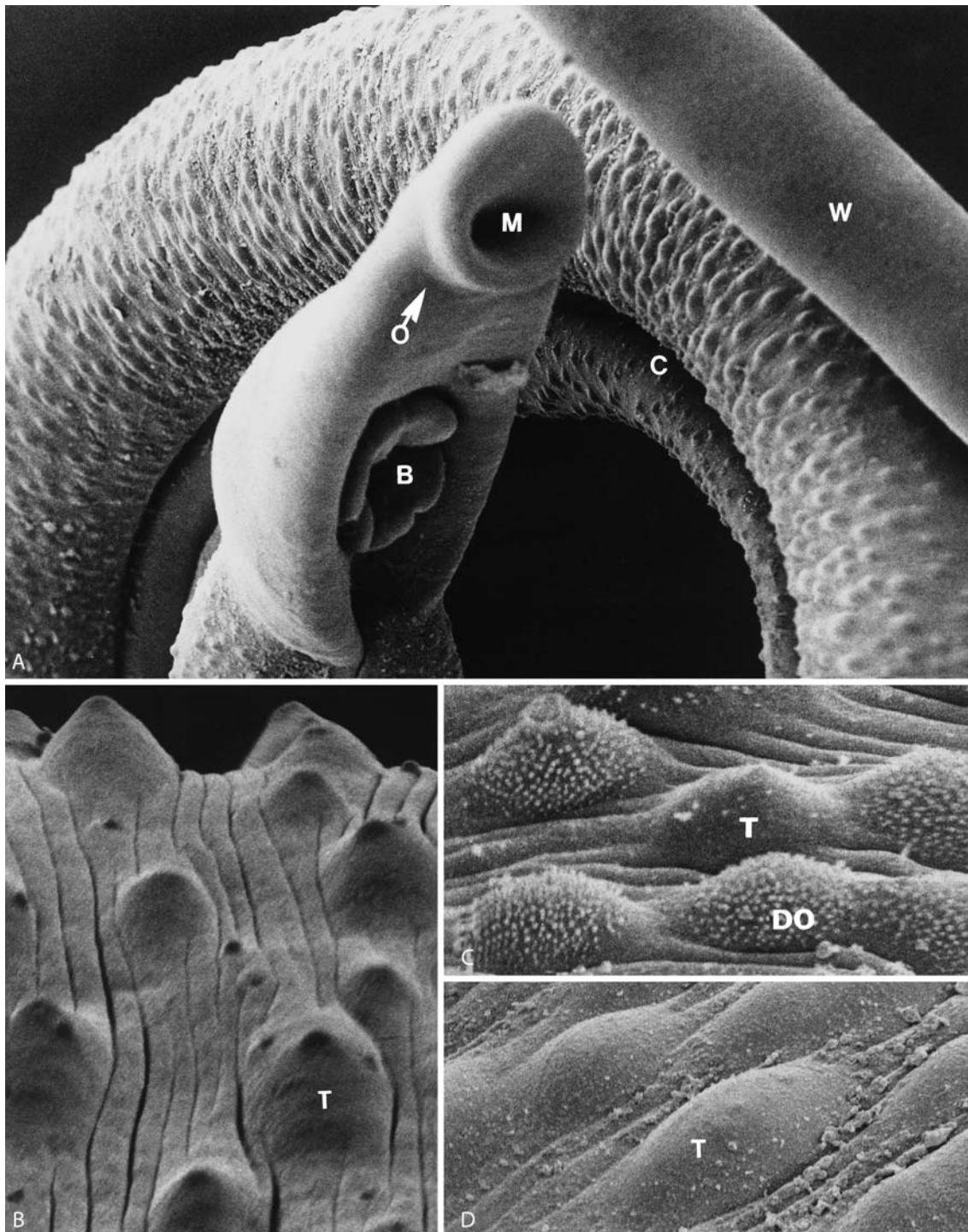

**Platyhelminthes. Figure 16** SEMs on the surface of males of various *Schistosoma* spp. Note the presence or absence of thorns within the tubercles (bosses). **A** A couple of *S. mattheei*.  $\times 100$ . **B** *S. bovis*.  $\times 1,000$ . **C** *S. haematobium*.  $\times 1,000$ . **D** *S. mattheei*.  $\times 1,000$ . *B*, ventral sucker; *C*, *canalis gynaecophorus*; *DO*, tegumental thorns; *M*, mouth, oral sucker; *T*, tubercle (*Boss*).

which are lined in some places by circularly and longitudinally running muscle fibers. The luminal side of the intestinal cells bears a complex reticulum of lamellae which reach a considerable length (Fig. 23, page 1168)

and presumably vastly increase the absorptive surface area. The shape of these lamellae is completely different from that of microvilli. Since platyhelminths feed on a large variety of material (e.g., blood, lymph

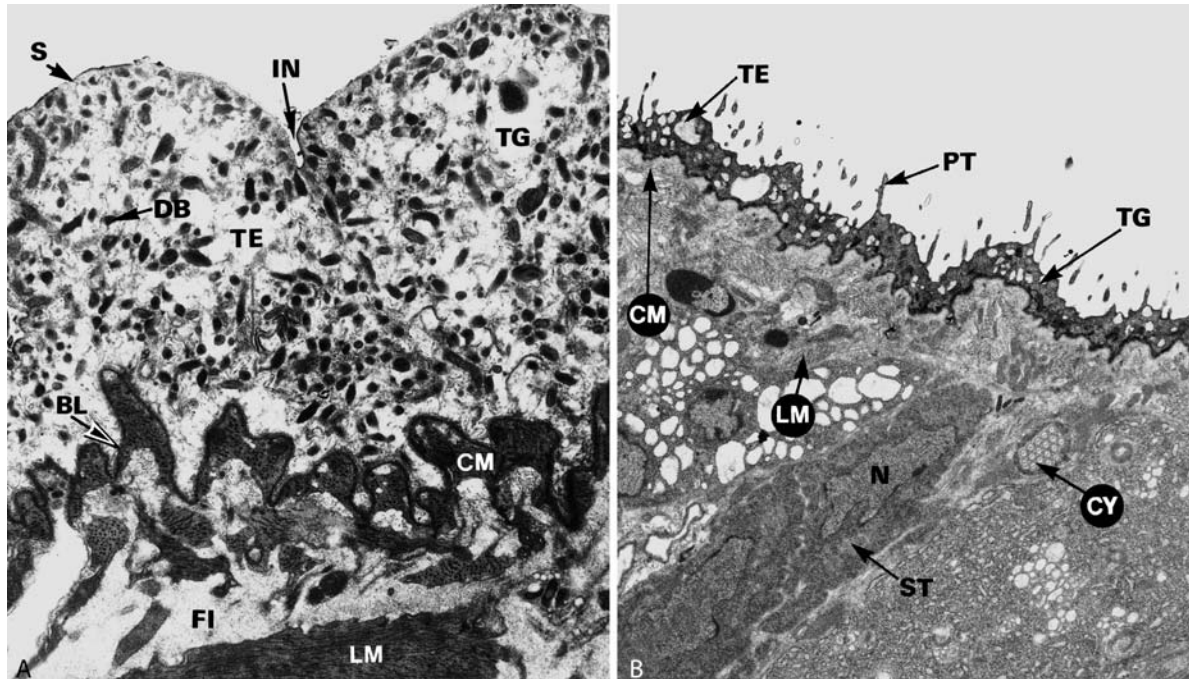

**Platyhelminthes. Figure 17 A, B** TEMs of sections through monogenean teguments. **A** → *Dactylogyrus vastator* has a smooth surface ( $\times 4,900$ ). **B** → *Gyrodactylus aculeati* is endowed with villi-like tegumental protrusions ( $\times 2,500$ ). *BL*, basal lamina; *CM*, circular muscles; *CY*, →cyrtocyte with cilia in cross section; *DB*, dense tegumental bodies; *FI*, fibrous layer; *IN*, invagination, *LM*, longitudinal muscles; *N*, nucleus; *PT*, protrusion of the tegument; *S*, surface coat; *ST*, subtegumental cell (cyton, →perikaryon); *TE*, tegumental vacuole; *TG*, tegument.

fluid, mucus, intestinal fluid, epithelial cells of their hosts), they have developed different pathways for extra- and intracellular digestion as well as different ways of food selection. In addition to taking up nutrients through their intestine, platyhelminths are able to feed via the tegument by acquiring molecular components.

The remnants of digestion, i.e., material which is not taken up by the intestinal cells, are periodically regurgitated as can be seen in worms kept *in vitro*; thus the mouth also has the function of an anus. In cestodes these nutritional residuals are stored as crystalloid-like structures in the tegument and/or parenchymal cells (Fig. 19C,D).

### Excretory System

All platyhelminthic groups have excretory organs of the protonephritic type (Fig. 24, page 1169). The basic component is the →terminal cell (cyrtocyte, →flame cell) which is embedded in the parenchyma of the worms.

Cyrtocytes may have their own excretion channels or lead into a common one. In any case, however, these primary (capillary) ducts join with others to form collecting ducts which unite to form the left and right common collecting tubules (these are double in cestodes,

running dorsally and ventrally); the latter are cross-connected at the base of each proglottid (Fig. 25, page 1170). In aspidobothrean species these collecting tubules may have separate excretory pores or (mostly) a common one located posteriorly on the dorsal surface. In general, monogeneans have 2 main lateral ducts that start anteriorly and make a U-shaped curve in order to empty separately via contractile bladders at the anterior pole. In digeneans the collecting tubules unite at the posterior pole to form an excretory bladder with a single terminally located porus (→Digenea). Cestodes have only 2 excretory pores, although usually at least 4 common collecting tubules are found at the margin of the whole strobila. It has been shown that the dorsal vessels carry the fluid to the scolex, where interconnections lead it into the ventral vessels (Fig. 25A) which finally excrete it via an opening at the end of the last proglottid (Fig. 25B).

Analysis has shown that the excreted fluids of digeneans and cestodes primarily contain →ammonia, but uric acid, →urea, and even amino acids have also been found in some species.

### Nervous System

→Nervous System of Platyhelminthes.

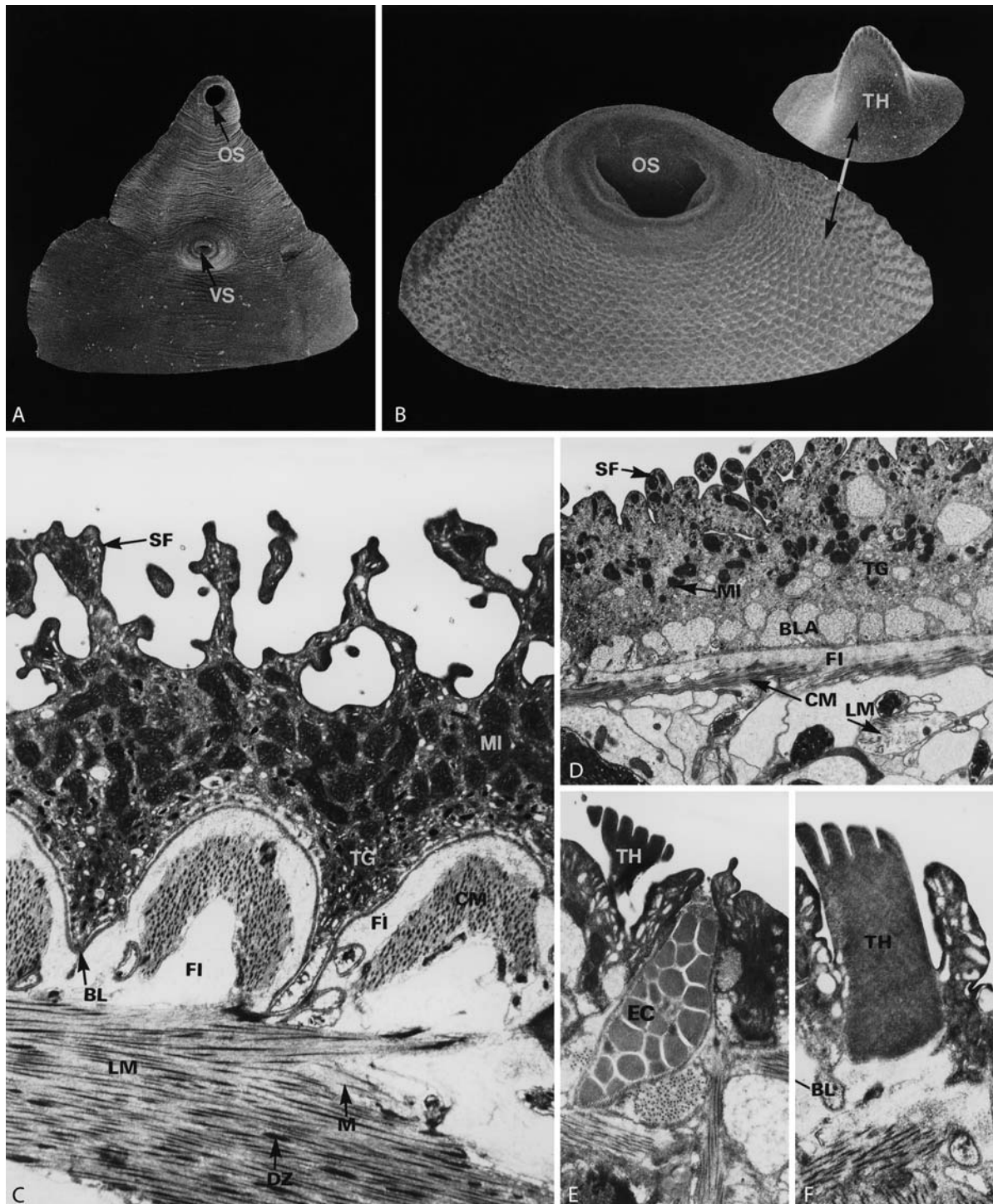

**Platyhelminthes. Figure 18** A–F EMs (A, B) and TEMs (C–E) of rough (B, E) and smooth (i.e., hookless) digenean teguments. **A, D** *Clonorchis sinensis* from humans ( $\times 60, \times 5,000$ ), **B** *Fasciola hepatica* from cattle ( $\times 50$ ), **C** *Dicrocoelium dendriticum* from cattle ( $\times 15,000$ ), **E, F** *Metagonimus yokogawai* from humans ( $\times 20,000$ ). *BL*, basal lamina; *BLA*, basal labyrinth; *CM*, circular muscles; *CO*, connections between tegumental and subtegumental cells; *DZ*, Dense zone (representing a Z-line system); *EC*, eccrine gland duct; *FI*, fibrous layer; *LM*, longitudinal muscles; *M*, myosin filament; *MI*, mitochondrion; *OS*, oral sucker; *SF*, surface folds; *TG*, tegument, *TH*, tegumental hooks; *VS*, ventral sucker.

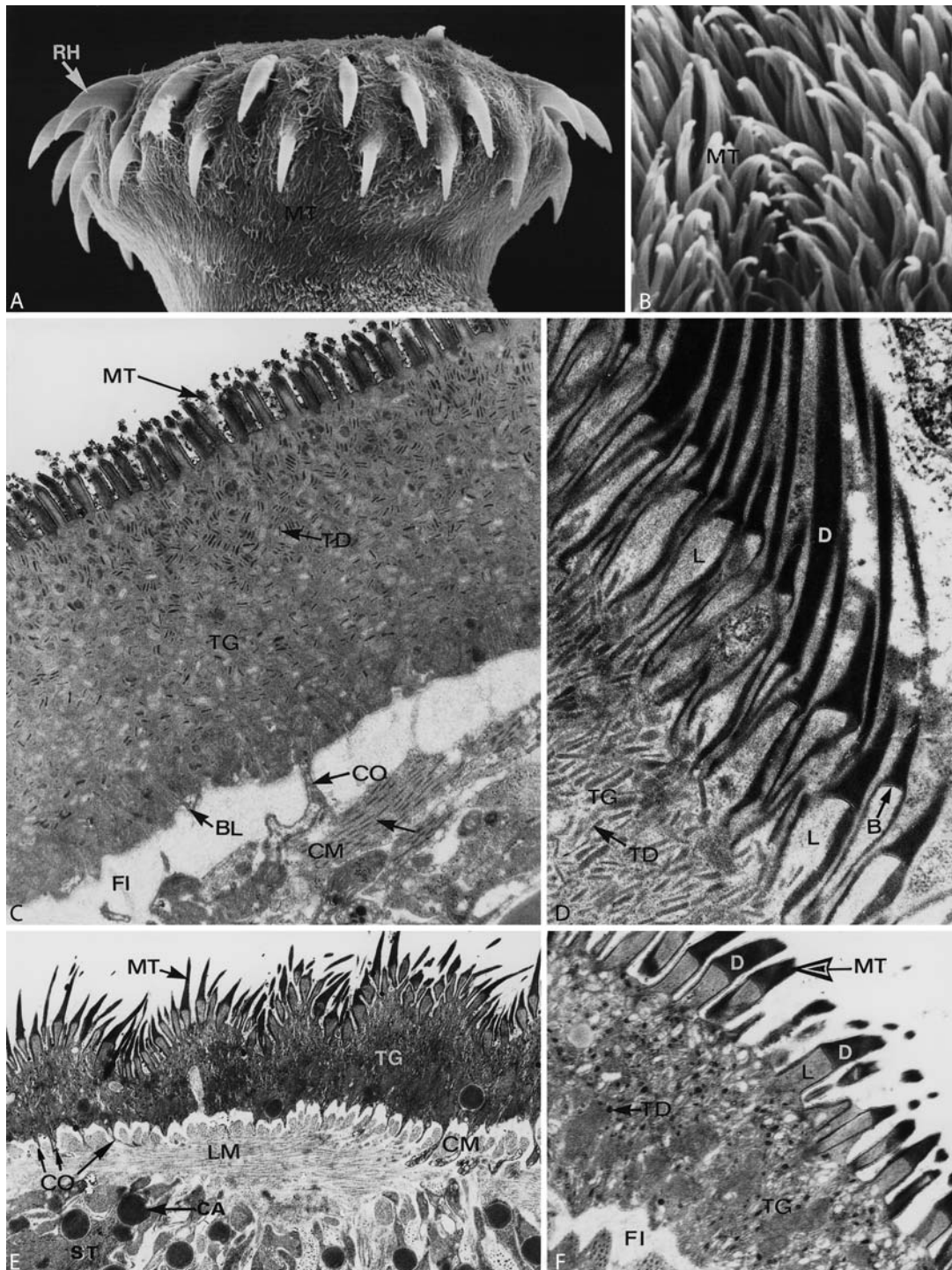

**Platyhelminthes. Figure 19** A–F EMs (A, B) and TEMs of the **→tegument** of various tapeworms. Note that there are considerable variations in size and length of the electron-dense parts of the microtriches (MT). **A, B, F** **→Echinococcus multilocularis** from foxes (A  $\times 1,000$ , B  $\times 10,000$ , F  $\times 20,000$ ). **C** **→Hymenolepis microstoma** from rats ( $\times 13,000$ ). **D** **→Monobothrium wageneri** from fish (*Tinca tinca*) ( $\times 20,000$ ). **E** *E. granulosus* from dogs ( $\times 10,000$ ). **B**, border between electron-dense and electron-lucent parts of microtriches; **BL**, basal lamina; **CA**, **→calcareous corpuscles**; **CM**, circular muscles; **CO**, connections between tegumental and subtegumental cells; **D**, electron-dense part of microtriches; **FI**, fibrous layer; **L**, electron-lucent part of microtriches; **LM**, longitudinal muscles; **M**, myosin filaments; **MT**, microtriches; **RH**, rostellar hooks; **ST**, subtegumental cells (cytons, **→perikaryons**); **TD**, **→tegumental disk**; **TG**, tegument.

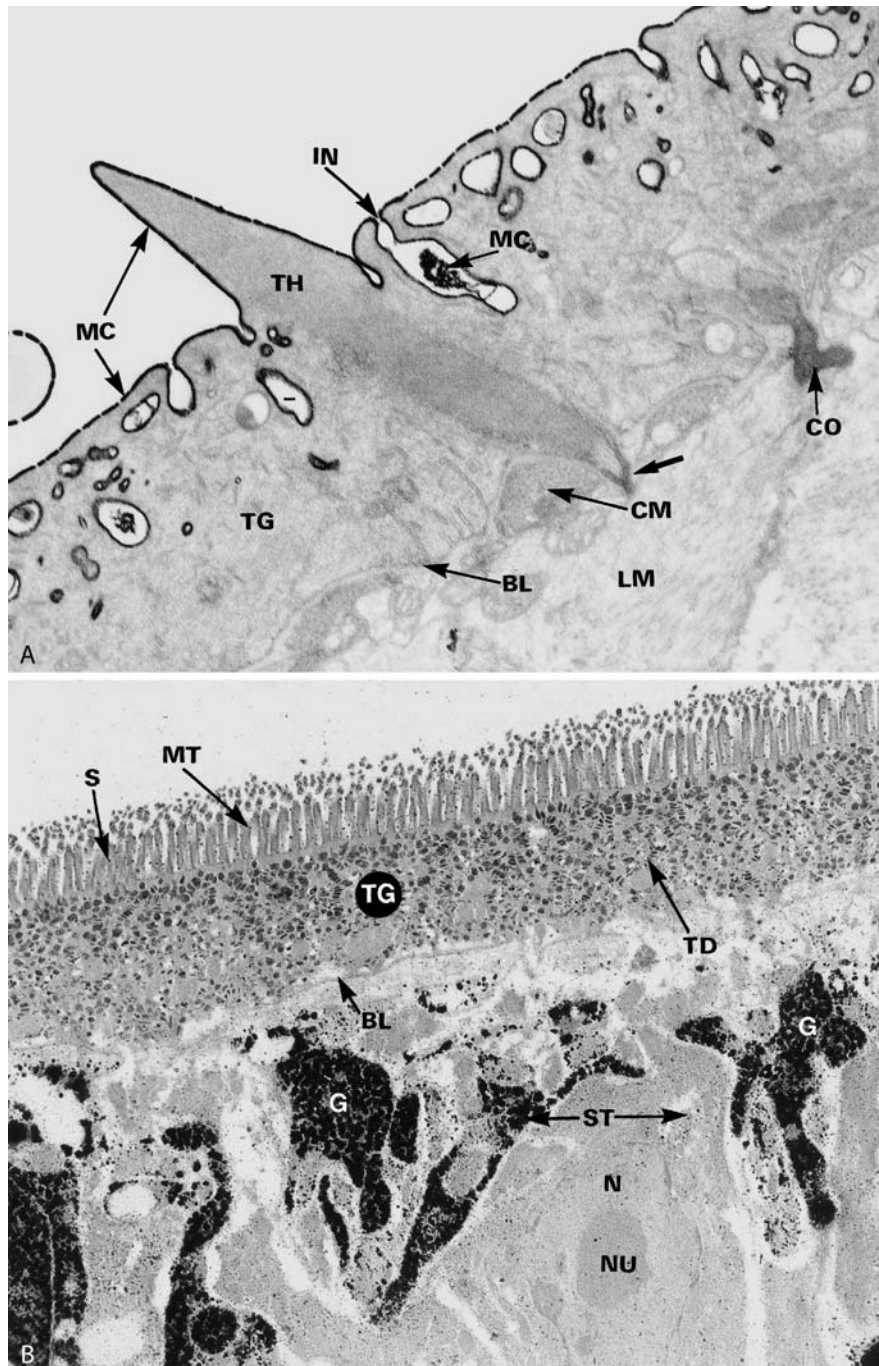

**Platyhelminthes. Figure 20 A, B** TEMs of sections through the **→tegument**, which was stained by silver proteinate (Thiery method) to demonstrate the surface coat and storage materials. This method is specific for polysaccharides. **A** *Schistosoma mansoni* adult male. Note that there is an intensively stained membranocalyx, whereas the tegument is free of stain, except for a slight reaction in the ductules (CO) that form connections to the subtegumental cells. The tegumental hooks (thorns) start from the basal lamina (arrow) and remain completely covered by the tegumental membranes ( $\times 15,000$ ). **B** *Hymenolepis nana* midregion. There is only a slight reaction along the microtriches (S, MT) and the tegumental disks (which are probably delivering the surface coat). Note the existence of 2 different types of subtegumentary cells, one of which is completely filled by **→glycogen** granules ( $\times 8,000$ ). BL, basal lamina; CM, circular muscles; CO, connection between tegument and subtegumental cells; G, glycogen deposits; IN, invagination; LM, longitudinal muscles; MC, membranocalyx; MT, **→microtriches**; N, nucleus; NU, nucleolus; S, surface coat; ST, subtegumental cells; TD, tegumental disks; TG, tegument; TH, tegumental hook.



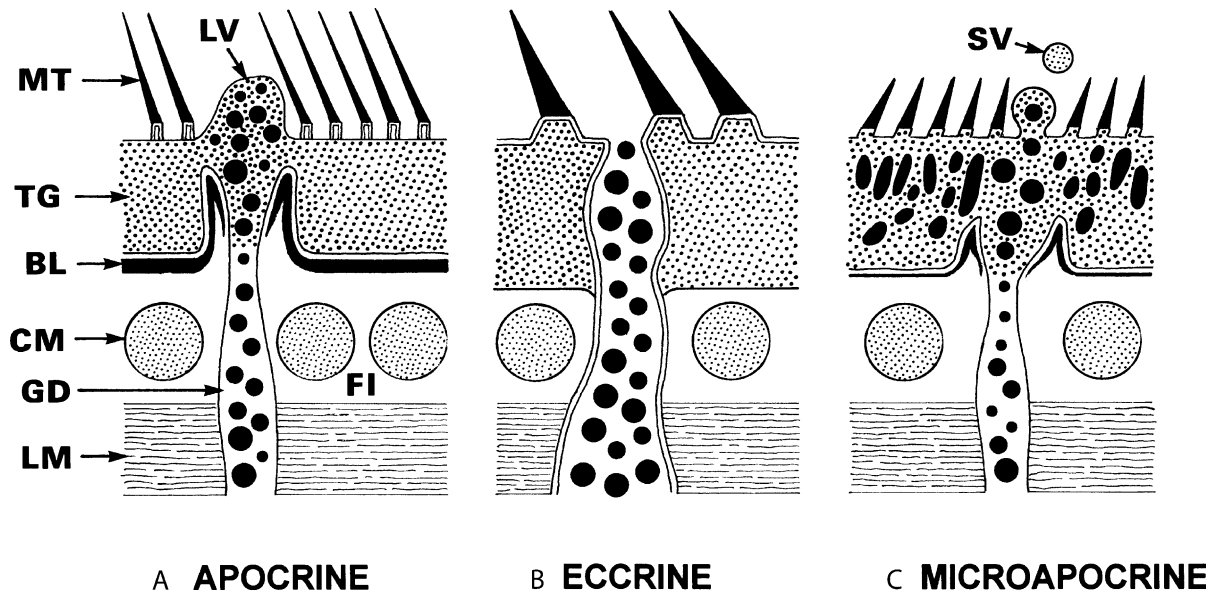

**Platyhelminthes. Figure 21** A–C Diagrammatic representation of →gland cell secretion in cestodes (after Kuperman and Davydov 1982 and own results). **A** Apocrine type (e.g., in →*Eubothrium*, →*Monobothrium wageneri*, →*Bothriocephalus*). **B** Eccrine type (e.g., *Diphyllobothrium latum*, and some digeneans; see Fig. 18E). **C** Microapocrine type (e.g., *Caryophyllaeus*, *Echinococcus*). *BL*, basal lamina; *CM*, circular muscles; *FI*, fibrous layer; *GD*, gland duct; *LM*, longitudinal muscles; *LV*, large vesicles; *MT*, microtriches; *SV*, small vesicles; *TG*, tegument.

## Platyhelminthic Infections, Man, Pathology

→*Trematodes* and →*Cestodes* may lead to severe diseases in man and animals (see separate entries). The clinical symptoms they provoke are mostly correlated to the pathologic effects listed in Table 4 of →*pathology*.

### Treatment

→*Trematocidal Drugs*, →*Cestocidal Drugs*.

## Platymyarian Muscle Type

→*Nematodes*.

## Pleistophora

→*Microsporidia*.

## Pleomorphism

### Name

Greek: *plein* = swim, *morphe* = shape.

This term describes, e.g., stages of →*Trypanosoma brucei gambiense* in the blood, which have a different function, although they look similar: →*trypomastigote* stages appear as stumpy or slender forms. →*Polymorphism*.

## Plerocercoid

Third larva of fish tapeworm (e.g., →*Diphyllobothrium*, →*Eucestoda*).

## Plesiomorphic Character

→*Phylogeny*.

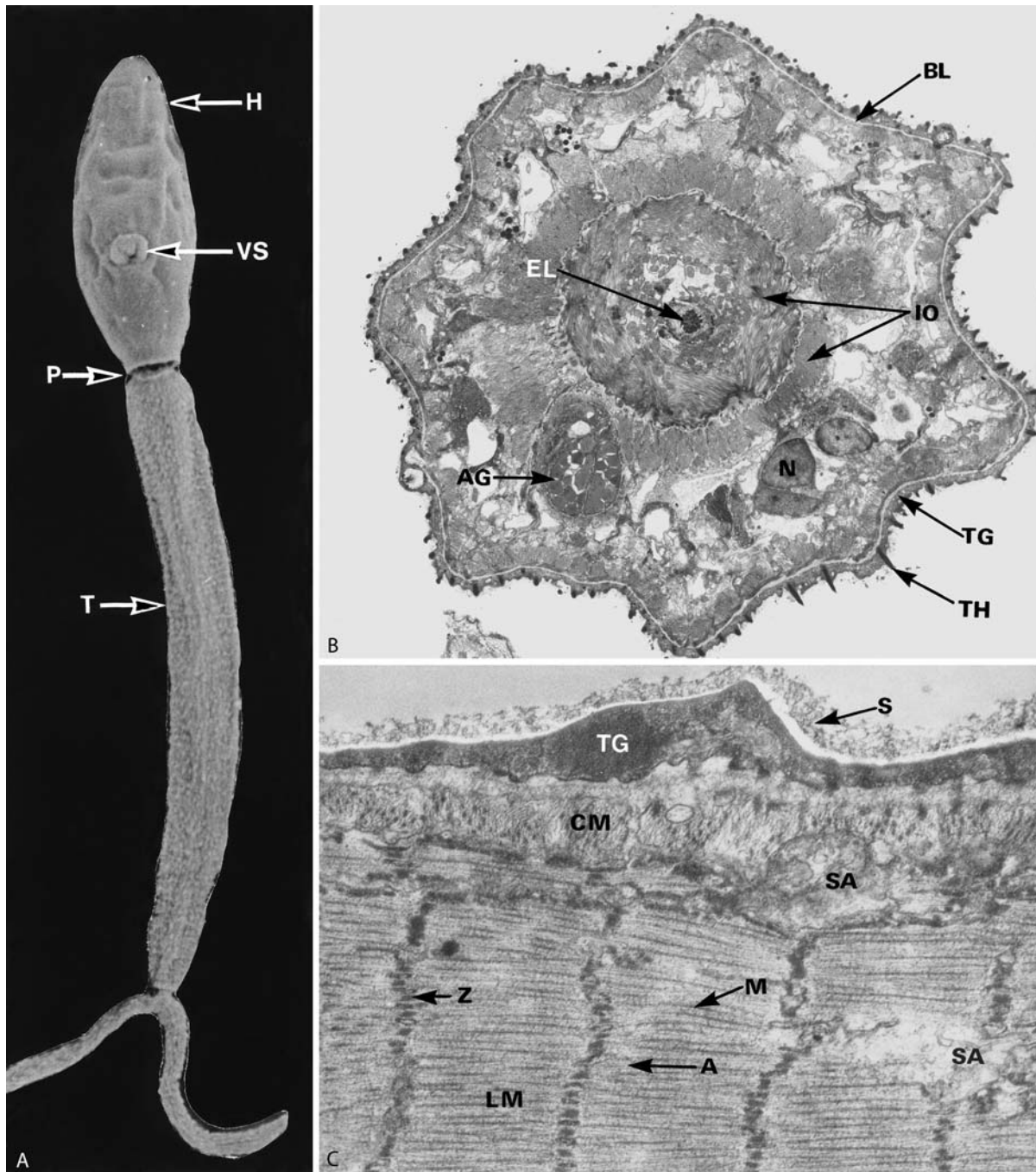

**Platyhelminthes. Figure 22 A–C** → *Schistosoma mansoni*; muscles of the bifurcous cercaria. **A** SEM of a → cercaria ( $\times 200$ ). **B** Cross section through the head (body) showing a tegument similar to that of adults ( $\times 2,000$ ). **C** Longitudinal sections through the tail; note the occurrence of striated strands of muscle fibrils ( $C \times 21,000$ ). *A*, Actin filaments; *AG*, anterior glands (ductules); *BL*, basal lamina; *CM*, circular muscles; *EL*, lumen of the esophagegus; *H*, head (body); *IO*, inner and outer muscles of the esophagegus; *LM*, longitudinal muscles; *M*, myosin filaments; *MI*, mitochondrion; *N*, nucleus; *P*, preformed site of rupture during host penetration; *S*, surface coat; *SA*, sarcoplasm; *SM*, sarcomere-like unit; *T*, tail; *TG*, tegument; *TH*, tegumental hooks; *TM*, tegumental muscles; *VS*, ventral sucker; *Z*, Z-line.

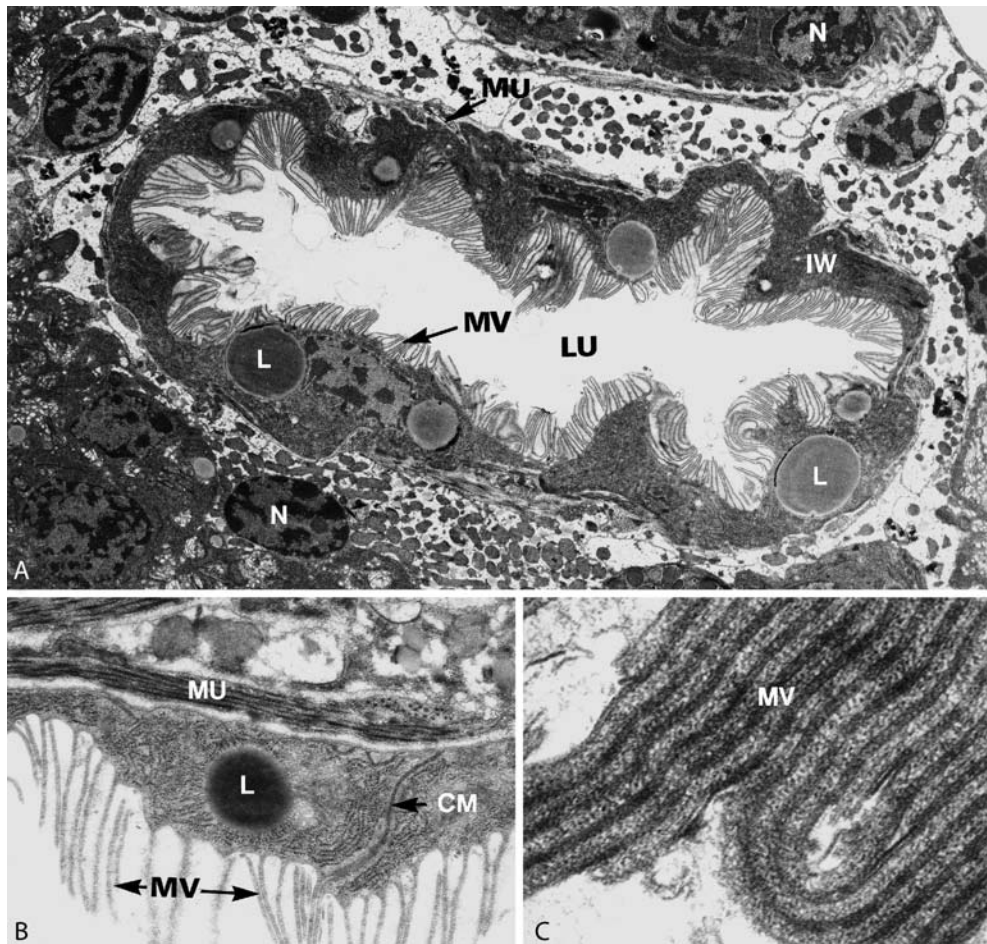

**Platyhelminthes. Figure 23 A–C** TEMs of sections through typical digenean intestines. **A** → *Schistosoma mansoni* (× 3,000). **B, C** → *Paragonimus westermani* (B × 5,800, C × 30,000). *CM*, cell membrane; *IW*, intestinal wall; *L*, lipid; *LU*, lumen of intestine; *MU*, muscular layer; *MV*, → microvilli; *N*, nucleus.

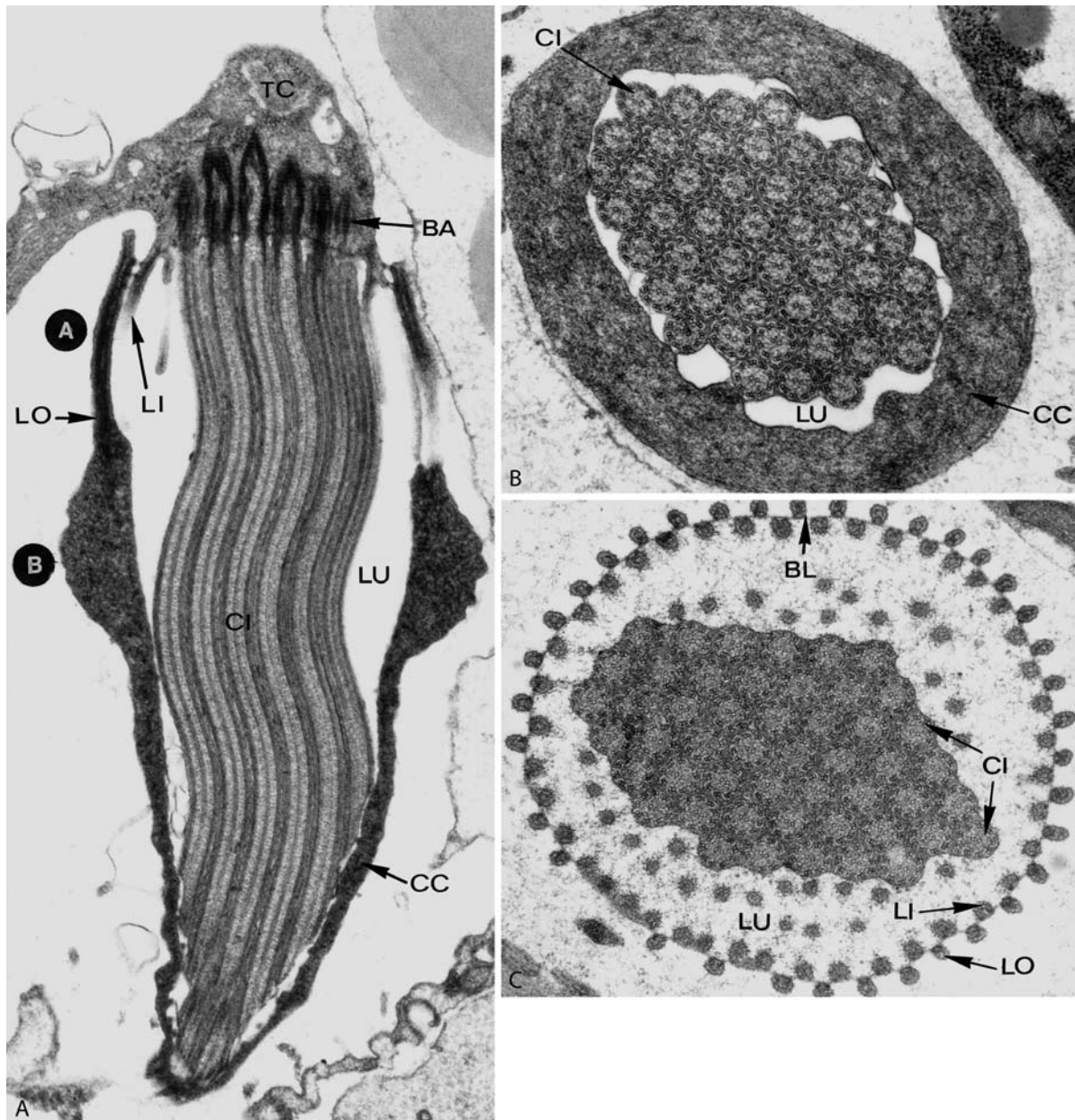

**Platyhelminthes. Figure 24** A–C TEMs of a longitudinal section (A) and 2 cross sections (B, C) through a typical →protonephridium (cyrtocyte) of *Hymenolepis nana*. The arrows in A indicate the plane of sections (A  $\times$  22,000, B, C  $\times$  45,000). BA, →basal bodies of cilia; BL, basal lamina; CC, canal cell; CI, cilia; LI, inner lattice bar; LO, outer lattice bar; LU, lumen of canal cell; TC, →terminal cell.

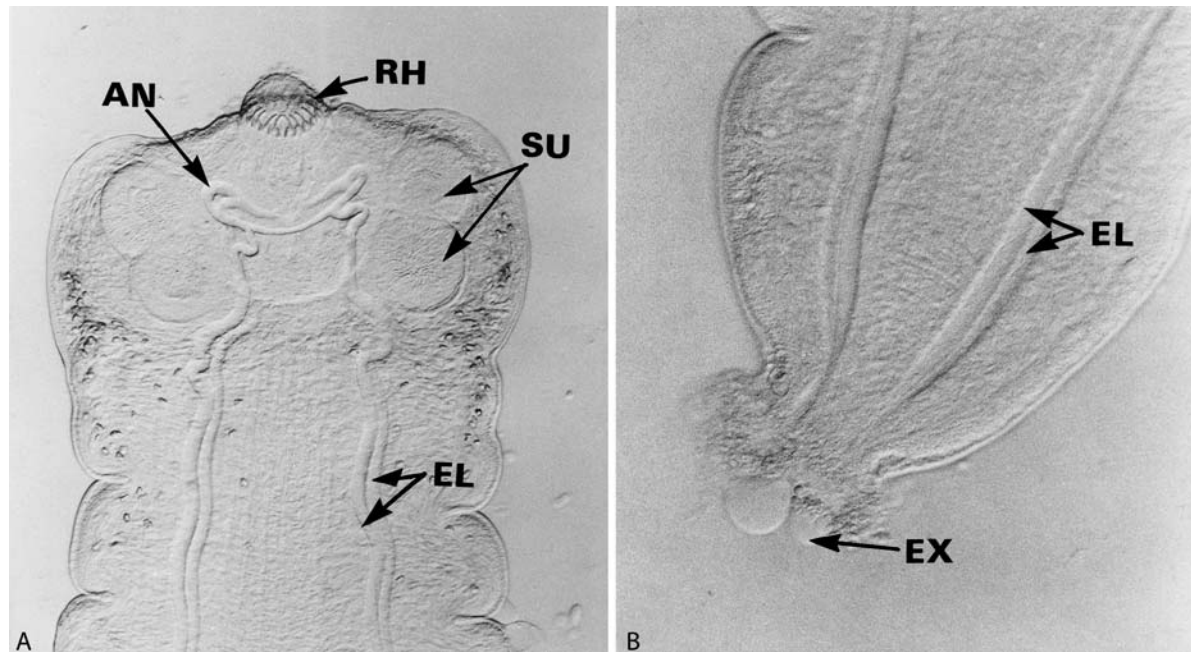

**Platyhelminthes. Figure 25 A,B** Excretory system of a living tapeworm (*Hymenolepis nana*, LMs). **A** Scolex region ( $\times 120$ ). **B** Terminal proglottids; note the appearance of excreted fluids (EX) ( $\times 280$ ). AN, anastomoses of excretory channels; EL, longitudinal excretory channels; EX, excreted fluids; RH, rostellar hooks, SU, sucker.

## Plesiomorphy

The ancestral character state, [→Phylogeny](#).

## Pleuromitosis

[→Nuclear Division](#).

## Ploidy

Status of chromosomal sets in a nucleus, uniploid, diploid, triploid, multiploidy, [→chromosomes](#).

## Pneumocystis

### General Information

*Pneumocystis* is found in the lungs (pneumo-) of mammals where a morphologically characteristic life

cycle stage (cyst) develops. Its discovery in Brazil was reported in 1909 and the genus *Pneumocystis* was established by Delanöe and Delanöe in 1912.

Prior to the AIDS epidemic, the organism was only sporadically reported (e.g., malnourished children and patients undergoing immunosuppressive therapy for cancer or solid organ transplants). In the 1980s as the HIV infection spread and AIDS became a serious public health problem in the USA and Europe; *Pneumocystis* pneumonia (PcP) concurrently emerged as the most prevalent opportunistic infection and the most common immediate cause of death among these patients.

### Classification

Since its discovery, the taxonomic and phylogenetic status of *Pneumocystis* has been debated as it has features in common with some fungi and also some protozoa. While there is no question that it is a protist, the genus is currently classified as an ascomycetous fungus. Thus, terms used for higher fungal structures are appropriate. However, other terms used by protozoologists and other protistologists are commonly found in the literature. The following may be correlates: trophic form (trophozoites); sporocyte (pre-cyst); spore case (cyst, cystic form); spores (intracystic bodies, ICB); spore release (excystation).

The genus *Pneumocystis* is genetically diverse and different species are able to proliferate only in a specific

mammalian species. A few have been formally named and described: *P. carinii* (rat); *P. jirovecii* (human); *P. wakefieldiae* (rat); *P. murina* (mouse). An interim trinomial nomenclature including a term describing the host species as a special form (forma specialis) of *P. carinii* is used for other species not yet formally described; e.g., *P. carinii* f. sp. *suis* (pig), *P. carinii* f. sp. *oryctolagi* (rabbit), *P. carinii* f. sp. *mustelae* (ferret).

### Life Cycle

What is currently known about its life cycle is limited to the distinct forms found in the mammalian lung. The proposals for the life cycle within the lung alveolus are based on morphological features and cytochemical studies, but are restricted to static light and electron micrographs of the forms identified as *Pneumocystis* (Fig. 1). With the possible exception of putative visual observations of spores (ICB) being released from mature spore cases (cysts), no other developmental transformations have been directly observed; how one form develops into the next has not been directly observed.

### Morphology

#### Trophic Forms

Elliptical to pleomorphic irregularly shaped trophic forms ranging in size from 1.5 to 10.0  $\mu\text{m}$  are predominantly found in heavily infected lungs (Figs. 2, 3). These have been subgrouped into small (1–2  $\mu\text{m}$ ) and large trophic forms. It is believed that the small spherical to oval cells are directly derived from spores (ICB), whereas the large cells may be derived from growth of the small forms or by asexual vegetative mitotic division of pre-existing trophic forms. The cortex (pellicle) of the trophic forms is thin (20–30 nm) compared to the spore case (cyst) walls. It is comprised of 2 unit membranes separated by a middle electron-lucent layer, which is very thin in these forms. The cell's exterior is coated with a distinct thick glycocalyx which is of uniform thickness (15 nm) in all life cycle stages found in the lung. Tubular extensions, which are thin, long, tubular evaginations of the cell surface, are distinct features of this life cycle stage, especially of large trophic forms. Tubular extensions may function in anchoring the organisms to type I epithelial cells lining

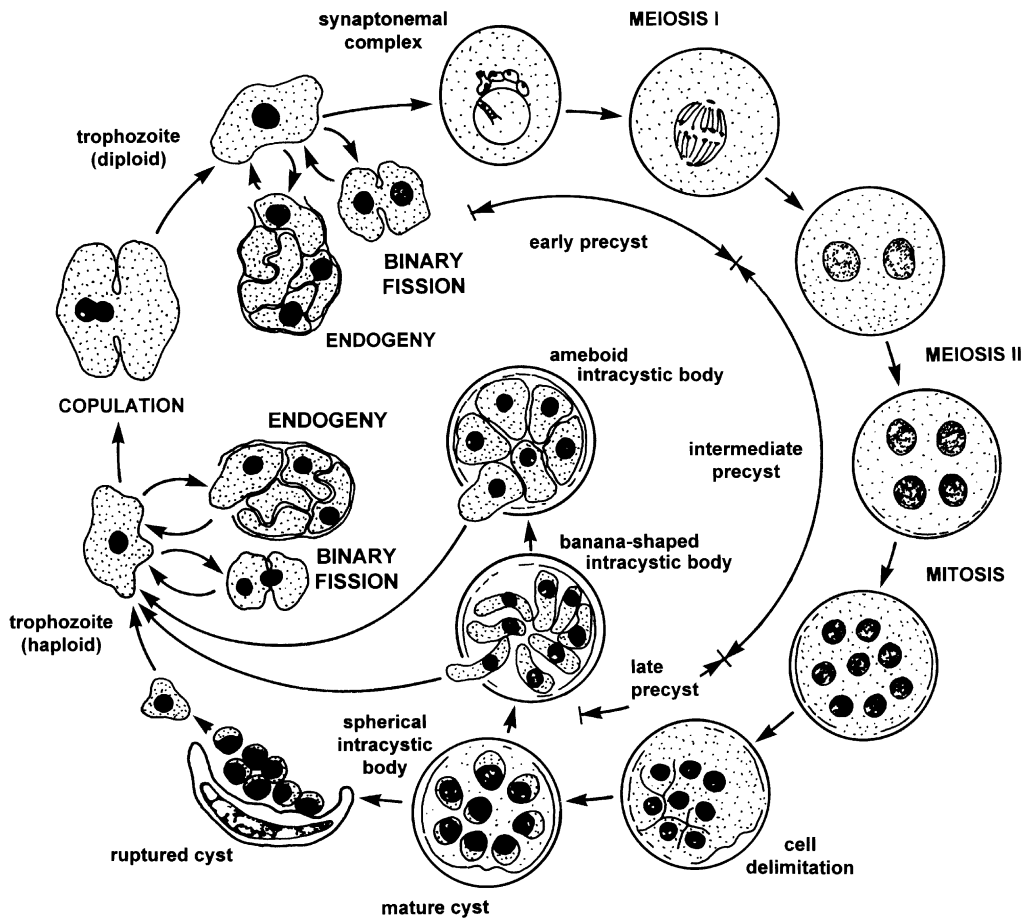

**Pneumocystis.** Figure 1 Proposed intrapulmonary life cycle(s) of *Pneumocystis carinii* suggested by Yoshida.

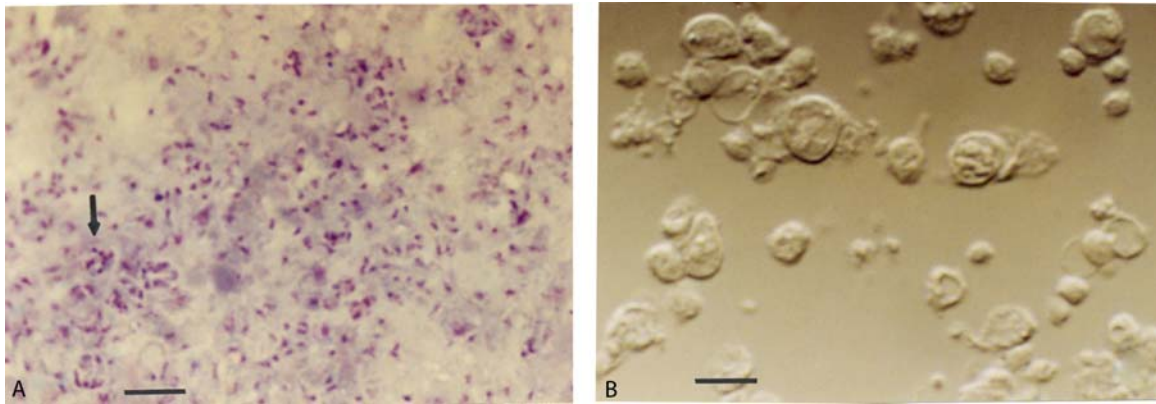

**Pneumocystis.** Figure 2 LMs of *Pneumocystis carinii*. A Lung impression smear of rat lung infected with *P. carinii* and stained with Diff-Quik (modified Giemsa) that stains cell nuclei. Spore case (arrow) and numerous trophic forms are present. B Isolated *P. carinii* organisms viewed by differential interference (Nomarski) optics. Bar = 10  $\mu$ m.

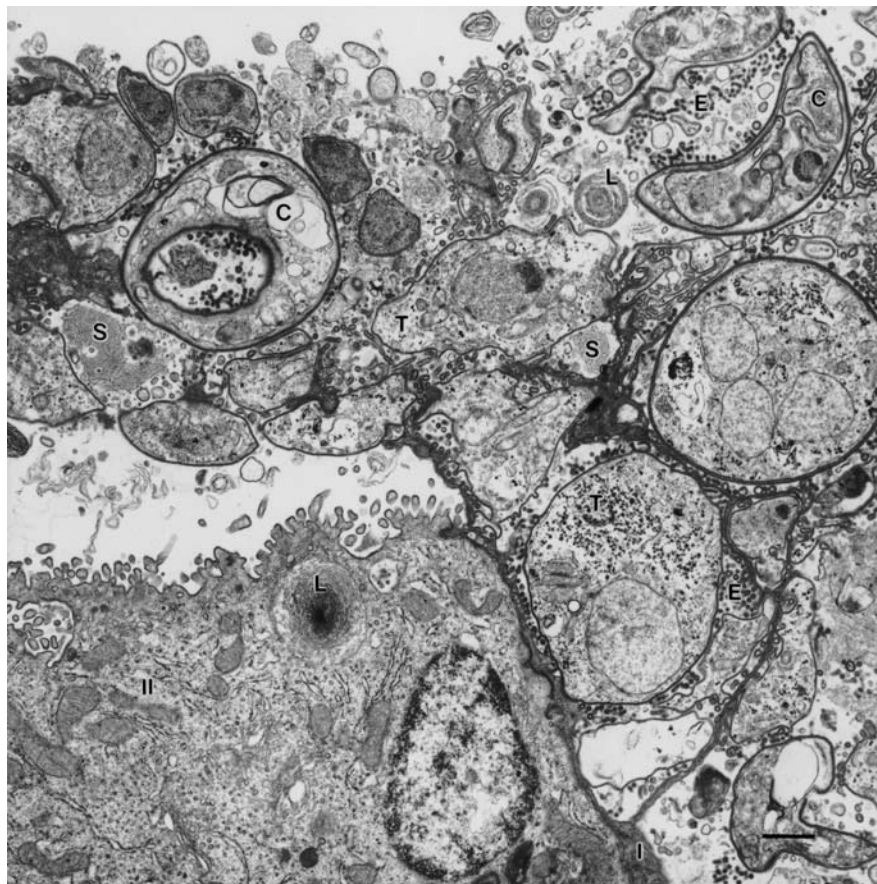

**Pneumocystis.** Figure 3 EM of *Pneumocystis carinii* organisms infecting the lung of a corticosteroid-immunosuppressed rat. The organisms are adherent to type I epithelial cells (I) and to each other, but not to the type II pneumocytes (II). Several layers of adherent pathogens extend into the alveolar lumen, forming a cap over the type II pneumocyte. A loosely coiled lamellar body (L) in the type II cell appears about to be secreted into the alveolar pouch below the cap. Various forms of extracellular surfactant (S) are evident among the masses of *P. carinii* trophic forms (T) and spore cases (C). E, tubular extensions of trophic form surface membranes. Bar = 1  $\mu$ m.

the alveolar sacs, and/or enhancing nutrient uptake by increasing cell surface area.

The organism adheres to thin type I epithelial cells, but not to type II cells (thick surfactant-secreting epithelial cells). In heavy infections, 3–4 layers of organisms can form caps above type II cells, and organisms are found attached to thin elongated outfoldings of the type I cells.

Most organisms in the lung are haploid. The organism has a single nucleus which is distinguished by its small size and represents one among the smallest found in eukaryotic cells; the 1C nucleus is estimated to contain 6.6 fg DNA (8.9 Mbp nucleotides). The nucleus contains a single nucleolus and a nuclear envelope with relatively few (8 pores/ $\mu\text{m}^2$ ), large (95 nm) nuclear pores. Nuclear division with spindle microtubules radiating from electron-dense structures called nucleus-associated organelles (NAO) and condensed chromosomes have been observed in trophic forms. Asexual reproduction by binary fission is believed to produce most of the trophic forms found in infected lungs.

A single mitochondrion with lamellar cristae is probably typical of *Pneumocystis* cells; when several mitochondrial profiles are seen in a section through the cell, this may represent lobes of the organelle. Other cytoplasmic structures include lipid droplets, rough and smooth endoplasmic reticulum, primary lysosomes, glycogen-like granules, and a number of unidentified vacuoles and vesicles present in the cytoplasm. Golgi elements, identified cytochemically, are not elaborate structures with lamellar stacks, but appear as a number of small vesicles. A large smooth endoplasmic saccule takes up a large proportion of the cytoplasm in both trophic forms and spore cases.

### Spores and Spore Cases (Cystic Forms)

1. Sporocyte (Precyst). It is generally assumed that spores (ICB) develop from trophic forms; an intermediate stage sporocyte has been proposed and described. This spherical to oval form is relatively large ( $\sim 4\text{--}5\ \mu\text{m}$ ) and has a rigid pellicle (40–120 nm) which is thicker than that of trophic forms and thinner than that of mature spore cases (cysts). The thicker spore case wall results from the thickening of the middle electron-lucent layer, which is believed to contain  $\beta$ -glucan,  $\alpha$ -glucan polymers, and chitin.

Synaptonemal complexes (pairing of homologous chromosomes) have been reported to occur at this stage, but these structures are rarely observed suggesting sexual reproduction does not frequently occur in the mammalian lung. Nonetheless, since the synaptonemal complex is a hallmark of sexual reproduction, it is generally accepted that meiosis

occurs during this stage. It is presumed that mating of forms that appear to be trophic stages gives rise to the zygotic nucleus. Whether or not all bodies observed within spore cases (those with round, pleomorphic, and motile banana-shaped ICB) are products of sporogenesis remains unknown.

2. Thick-walled spore cases (cysts) containing round spores (ICB). It is assumed that the single nucleus in the sporocyte (precyst stage) divides to give rise to a spore case containing 2 spores, which then gives rise to a 4-spore stage. After division of these 4 spores, the mature spore cases containing 8 spores are formed.

At this stage, most mature spore cases containing round spores are spherical and the middle layer of the spore case wall thickens to 100–160 nm. After digestion of the polysaccharides in the outermost layer with zymolyase transmission electron microscopy revealed a bilayer membrane within that outer layer. In mature spore cases, a specialized area in the middle layer of the wall expands in width. This thickened region is believed to be the site where a pore develops through which spores exit during spore release (excystation). After the spores are released, the collapsed crescent-shaped spore case containing remnants of cytoplasm and organelles is found with a rupture in its wall.

The spore is formed by delineation of its nucleus and cytoplasm by membranes derived from the inner surface membrane of the spore case. These forms resemble the small trophic forms with a thin pellicle containing 2 membranes and a barely visible middle electron-lucent layer; no tubular extensions are present on their surfaces at this stage.

3. Thick-walled spore cases containing banana-shaped spores. Distinct from spore cases with spherical to ovoid spores are thick-walled spore cases containing banana-shaped spores (Fig. 1). Banana-shaped spores in some spore cases clearly exhibit cell motility (wiggling, flexing) and the cytoplasm of these forms is more electron-dense than that of round spores. The spores appear to be attached to the inner membrane of the spore case wall by a stalklike structure. It is not known whether this form represents a stage in a cycle independent from the cycle which gives rise to spherical spores, or whether banana-shaped spores develop from spherical spores.

4. Thin-walled spore cases containing pleomorphic spores. Another form of which even less is understood with respect to its position in a proposed life cycle scheme is described as a thin-walled spore case. These generally do not have walls as thick as those surrounding the more abundant forms with round or banana-shaped spores. The characteristic feature that distinguishes this form from the others is that the spores are irregularly shaped and resemble



trophic forms. The irregularly shaped spores are closely packed and appear attached to each other by their glycocalyxes, resembling adhesions between organisms, and between the organisms and type I pneumocytes. Based strictly on morphology, it has been proposed that these forms arise from mitotic divisions within a parent cell analogous to endogeny, a process known to occur in some protozoans. The number of spores within these spore cases has not been determined.

5. Dormant form. There appears to be a life cycle stage which remains dormant and infective outside the mammalian host. Its morphological features may differ from most other forms described in the lung.

### Reproduction

Evidence for sexual reproduction comes from electron microscopic studies showing synaptonemal complexes in sporocytes (precyst). These structures have been observed in only a few cases, suggesting that sexual reproduction rarely occurs and that most spore cases contain spores that are not products of meiotic events. Detection and identification of *P. carinii* genes homologous to those expressed in other organisms only during meiosis and mating is consistent with sexual reproduction in *Pneumocystis*.

Most experimental studies are done on organisms obtained from infected lungs or bronchoalveolar lavage (BAL) fluid of laboratory animals. Infections are provoked by immunosuppression (mainly rats, mice, ferrets) using corticosteroids. Other animal models include helper T cell-depleted animals treated with anti-CD4 monoclonal antibodies, neonatal rabbits, and genetically immunodeficient animals (e.g., nude and SCID mice).

Development of culture methods for studying the organism in the laboratory has progressed slowly. Most current *in vitro* experimental studies rely on primary cultures initiated by organisms isolated from infected animal models. Some investigators performed experiments on axenic short-term cultures whereas others incubate the organisms with one of several mammalian cell lines.

### Genetics

Broad genetic diversity exists among populations of *Pneumocystis*. Distinct genetic populations have also been found among organisms infecting the same host species (e.g., humans, rats, ferrets); therefore there may be several different species that can inhabit a single mammalian species.

Genetic diversity has been identified by nucleotide sequences, karyotype (chromosomal) patterns, and antigens. The number of chromosomes resolved by pulsed field gel electrophoretic techniques varies even within a population in a single animal. They range from 12 to 16

in number; individual chromosomes are 850–300 kb in size. Analyses of samples from a single infected host in which 22–24 chromosomes are resolved very likely represent a mixed infection of 2 distinct populations.

The fungal assignment of *Pneumocystis* was initially based on the small subunit 16S-like RNA gene and complementary DNA (cDNA). Subsequently, nucleotide sequence analyses of genes encoding for dihydrofolate reductase, thymidylate synthetase, P-type cation-translocating ATPase, pre-chorismate shikimic acid pathway,  $\beta$ -tubulin, the presence of elongation factor 3 required for fungal protein synthesis, and several mitochondrial genes (NADH and cytochrome oxidase) show close homologies to their counterparts in fungi. Sequence analysis from the *Pneumocystis* genome sequencing project (<http://pgp.cchmc.org>) provides additional overwhelming evidence of its fungal nature. However, these data also indicate that *Pneumocystis* is significantly divergent from other extant fungi.

### Biochemical Data

The environment in which *Pneumocystis* can proliferate rapidly in the mammalian host is the lung alveolus. The alveolus is lined with fluid rich in lung surfactant secreted by alveolar type II epithelial cells. Lung surfactant is comprised mainly of lipids dominated by dipalmitoylphosphatidylcholine (saturated PC), but also contains substantial amounts of other molecular species of PC, phosphatidylglycerol, phosphatidylinositol, and cholesterol. Surfactant proteins are minor components, but they potently influence the surface tension of the alveolar lining fluid. Surfactant proteins avidly bind to the surfaces of *Pneumocystis*.

*P. carinii* is unique in its nutritional requirement for *S*-adenosyl-L-methionine (SAM, AdoMet); no other SAM auxotroph has previously been reported. A specific energy-requiring transport system for the uptake of this compound has been identified. SAM consumption by *Pneumocystis* reduces the level of this compound in host plasma.

Unlike most common fungal pathogens of animals, *Pneumocystis* does not contain ergosterol (a C<sub>28</sub> sterol). Like many parasites, cholesterol (C<sub>27</sub>) is scavenged from the host and constitutes ~75% of sterols in freshly isolated organisms. The absence of ergosterol can account for the organism's relative insensitivity to polyene antimycotics (e.g., amphotericin B) that have high binding affinity to ergosterol in fungal membranes. Also, some antifungal drugs that target ergosterol synthesis (e.g., some triazoles) are not effective in clearing *Pneumocystis* infections. Many triazoles that target sterol 14-demethylase are effective against fungi in which demethylation of lanosterol is required prior to alkylation of C-24 of the sterol side chain.

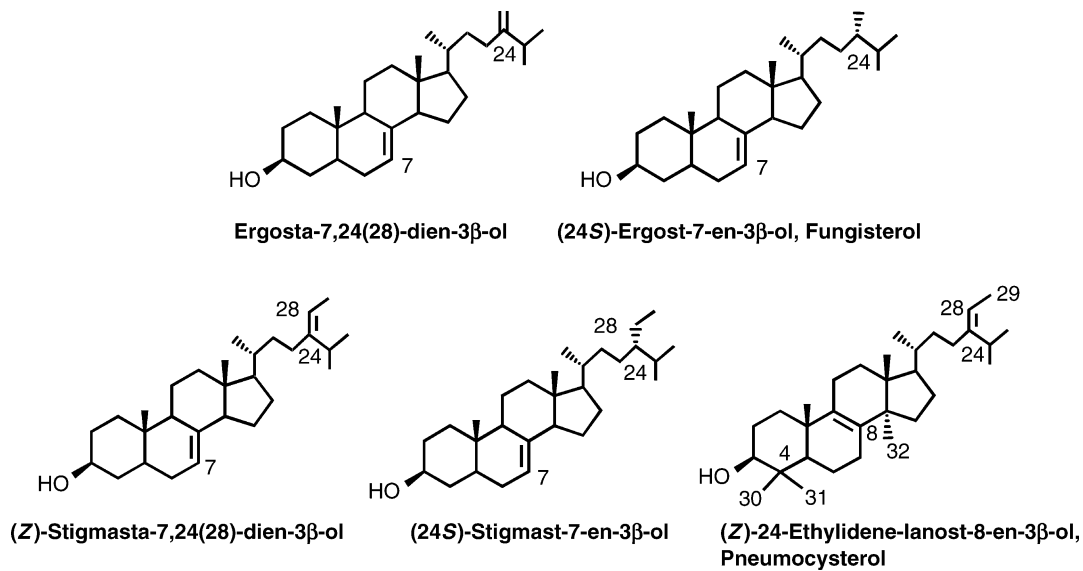

**Pneumocystis. Figure 4** Distinct *Pneumocystis* sterols. The sterols are 24-alkylsterols with a double bond of C-7 of the sterol nucleus. These are not normally found in other microbes that can infect the mammalian lung. Pneumocysterol is a C-24 alkylated lanosterol molecule (methyl groups at C-4 and C-14 and a double bond at C-8) which accumulates in some *P. jirovecii* populations that apparently lack sterol 14-demethylase activity.

Unlike most fungi, and more in common with some plants and rust fungi, the major sterol components have a double bond at C-7 (Fig. 4) of the sterol nucleus. *Pneumocystis* sterols can undergo 1 or 2 methyl transfer reactions at C-24 of the sterol side chain to form C<sub>28</sub> and C<sub>29</sub> 24-alkylsterols.

Some, but not all *P. jirovecii* populations contain high levels of 24-methylenelanost-8,24(28)-diene-3β-ol (C<sub>31</sub>) and 24-ethylidene-lanost-8-en-3β-ol (C<sub>32</sub>, pneumocysterol), which are C-24-alkylated lanosterol molecules. The lanosterol derivatives apparently accumulate in those *P. jirovecii* populations that lack sterol C-14 demethylase activity, an important enzyme in sterol biosynthesis.

*P. carinii* synthesizes ubiquinone (coenzyme Q, CoQ); 2 minor (CoQ<sub>7</sub>, CoQ<sub>8</sub>) and 2 major (CoQ<sub>9</sub>, CoQ<sub>10</sub>) homologs have been identified. The organism synthesizes *de novo* both the benzoquinone ring and the polyprenyl chain moieties of this compound, which plays a pivotal role in mitochondrial electron transport. Hydroxynaphthoquinones such as atovaquone have good anti-*Pneumocystis* activity. As ubiquinone analogs, these drugs disrupt electron transport in the organism.

### Antigens

The most studied *Pneumocystis* antigens are those with M<sub>r</sub> of 95–140 kDa (major protein component in the organism) depending on the species. These antigens termed the major surface glycoproteins (MSG) or glycoprotein A (gpA) are encoded by a multigene family of about 100 different subtelomeric genes clustered at the ends of chromosomes. Only one is

expressed at any given time in an organism; its expression involves transcription at a single site (upstream conserved sequence). The antigen appears to undergo processing by proteolytic action during maturation. These antigens are highly glycosylated, especially with mannose residues, and are involved in adherence to extracellular matrix substrates, host cells, and other molecules (e.g., lung surfactant proteins). The MSGs are exposed at the cell surface.

Circulating antibodies in mammalian serum most frequently recognize a protein complex with apparent molecular mass of 35–45 kDa in *P. jirovecii* and 45–55 kDa in *P. carinii*. One of these lower molecular weight antigens have been characterized in *P. carinii* and was shown to reside within the cell wall of the organism rather than exposed on the surface.

### Disease

Prior to the AIDS epidemic, the organism was only sporadically reported (e.g., malnourished children, and patients undergoing immunosuppressive therapy for cancer or solid organ transplants). In the 1980s as the HIV infection spread, and AIDS became a serious public health problem in the USA and in Europe, *P. jirovecii* was found to be the most prevalent infectious agent and the most common immediate cause of death among these patients. Thereafter, interest and research on *Pneumocystis* accelerated. The pneumonitis, PcP, remains an important AIDS-defining illness in developed countries in those individuals without adequate or timely health care. In addition, it is increasingly

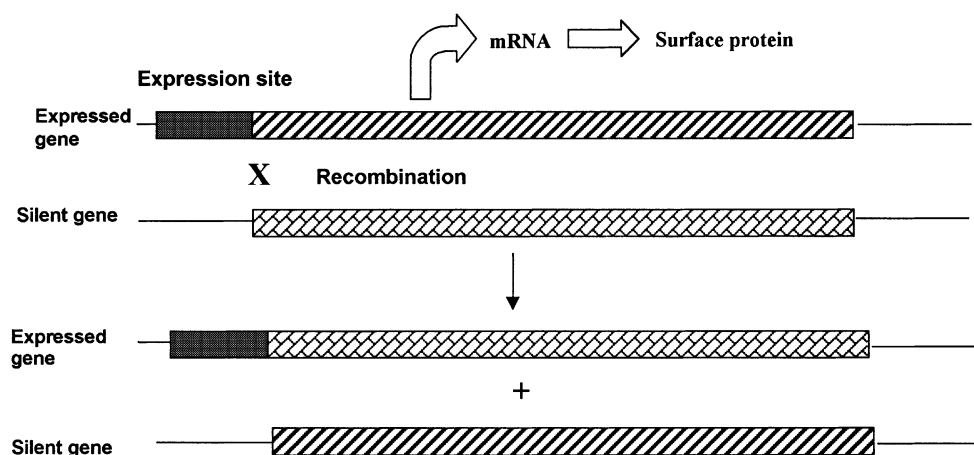

**Pneumocystis. Figure 5** Recombinatorial mechanism for switching surface antigens in *Pneumocystis carinii*. Although there are about 100 different genes for the major surface glycoprotein (MSG) antigen, there is only a single expression site; thus only one MSG is found on the surface of an organism. The MSG that is expressed can be changed by recombination. In the example shown, the MSG gene at the expression site is swapped for a silent gene. Such reciprocal exchanges may occur, but recent evidence indicates that changes at the expression site occur primarily via nonreciprocal recombination events whereby all or part of the MSG sequence at the expression site is erased and replaced by sequence from a silent gene. (Provided by James R. Stringer).

being recognized in developing countries as an AIDS-defining illness. Historically about 80% of AIDS patients in the USA developed PcP at least once. This organism is now known as the paradigm of pathogens referred to as opportunistic infections. Opportunistic infectious agents do not cause obvious symptoms by their presence in immunocompetent individuals, but can proliferate into fulminant infections in immunodeficient or immunocompromised hosts. Person to person (host to host) spread is the most likely mode of acquisition of infection. Hosts with normal immune systems may represent temporary reservoirs and low numbers can be found (colonization) in the lungs of domestic and wildlife mammals although the duration of carriage has not been defined.

It is generally assumed that infection is initiated by the inhalation of the organism into the respiratory system, and the organism escapes upper respiratory defenses. Adhesion to type I epithelial cells is important in the initiation of infection in the lung alveolus, but the organisms do not usually invade the host. Dissemination of the infection to other parts of the body is rare but well documented in the setting of overwhelming infection and severe immunosuppression. Organisms have been found in almost all major organ systems, but have been most often detected in the lymph nodes, spleen, liver, and bone marrow.

#### **Distribution, Epidemiology, and Transmission**

Since over 75% of the population in the USA and Europe are sero-positive to *Pneumocystis* antigens by age 4, it is believed that the organism exists in high

numbers and is ubiquitous worldwide. Airborne transmission has been demonstrated by controlled experiments using laboratory animals, and *Pneumocystis* DNA has been detected in indoor and outdoor air samples. Although possible modes by which organisms could be acquired include an environmental reservoir of infective form(s), or directly from other infected hosts, environmental form(s) remain to be clearly identified and characterized.

Asymptomatic colonization of *Pneumocystis* in mammalian lungs is well documented. Molecular studies suggest that fulminate infections (PcP) most commonly arise from recently acquired organisms. Reinfection as demonstrated by infection with a different genetic population can occur from exposure to other PcP patients, immunocompetent individuals with transient colonizations, or children with primary infection. Other modes of disease may include reactivation by immunosuppression of quiescent organisms residing in the host or organisms growing slowly (colonization).

#### **Pathology**

The primary infection in man usually develops in early childhood and is largely asymptomatic, probably without lesions. Pneumonia occurs only in immunologically compromised individuals. Symptomatic primary infections develop in children who are malnourished, who suffer from one of the primary immunodeficiency diseases such as X-linked agammaglobulinemia or T cell defects, who are treated with antineoplastic agents, or those treated with immunosuppressive drugs because of organ transplants.

In later life immunosuppressed patients may develop pneumocystosis either from reinfection or recrudescence of latent infection. The trophic forms of *P. jirovecii* attach to type I pneumocytes and proliferate and fill the alveoli with foamy, honeycombed, eosinophilic, and PAS-positive material. The trophic forms are visible mainly by their hematoxylin-staining nuclei and the slight PAS positivity of the ground substance surrounding them. Sporocytes (precysts) and spore cases (cysts) develop within the alveoli and their walls stain intensely with PAS, toluidine blue, and Grocott's modification of Gomori's silver impregnation protocol.

The principal effect in the rat and probably also the human infection is degeneration of type I pneumocytes to which the *Pneumocystis* organisms attach; damage is partially repaired by proliferation of type II pneumocytes. The organisms are covered by a liquid alveolar lining layer. The inflammatory reaction is variable but includes neutrophils and macrophages, often accompanied by a transudate containing a variable amount of fibrin. In malnourished children there may be intense plasma cell infiltration of the alveolar walls, giving rise to a form of plasma cell pneumonia. In X-linked agammaglobulinemias the plasma cells are absent and, as in leukemic babies, only a few lymphocytes and monocytes infiltrate. Similarly, in patients immunosuppressed by corticosteroids, cytostatic or alkylating agents, or human immunodeficiency viruses, little monocytic inflammation is found.

Rare cases of disseminated pneumocystosis have been observed in severely immunosuppressed patients, with organisms in the liver, lymph nodes, heart, and other organs. The luxuriant growth of *P. jirovecii* in extrapulmonary tissues of highly immunosuppressed patients suggests that either dissemination is rare or that immunity may suppress growth of the organisms in those who are only moderately immunosuppressed.

The lungs of patients who die from pneumocystosis are diffusely involved, and have a rigid, firm, uniform, pale appearance without necrosis or pleural exudate. After opening the chest cavity and sectioning the lungs, they usually remain expanded, although trapped air can sometimes be seen in alveoli or blebs.

### Immune Responses

The relationship between *Pneumocystis* and the host is complex. Part of the difficulty in determining the interaction is that fulminate infections do not occur in normal hosts, whether humans or other mammals. Therefore, the abnormalities in immunity reported with PcP may be a result of the infection itself, or could be part of the susceptibility of the host for the infection.

The most common immunologic deficiency associated with PcP is cell-mediated immunity. This form of immunity is characterized by the T cell, a critical cell

in the host defense against infections such as tuberculosis, certain viral infections (such as cytomegalovirus), fungal infections (such as *Cryptococcus neoformans*), and *Pneumocystis*. All these infections are more common in conditions where T cells, especially CD4-positive (CD4<sup>+</sup>) T-lymphocytes, are reduced either by the disease or therapy. These include patients with HIV infection and solid organ transplants.

The evidence supporting the role of the T cell as the major host defense against PcP is based on both experimental animal and human epidemiologic studies. In animal studies, the first models of PcP occurred in animals that were treated with corticosteroids and lost weight. This led to a reduction in the number and function of many inflammatory cells, especially lymphocytes. Other investigators have been able to induce PcP in animals with more selective defects, including severe combined immunodeficient (SCID) mice, and mice made more susceptible by CD4 depletion using monoclonal antibodies directed against this cell population. In humans, in both the solid organ transplantation and HIV-infected individuals, the CD4 cell is either depleted by therapy (in transplant patients) or by infection (HIV). In the AIDS population, the risk of PcP correlates strongly with the CD4 cell count in the blood. Patients with a CD4 count >250 cells/ml (normal is >600 lymphocytes/ml) rarely acquire infection and therefore are not considered candidates for prophylaxis treatment. On the other hand, patients with a CD4 count <200 lymphocytes/ml are at risk for PcP and should be treated with a prophylactic regimen.

Infection with *Pneumocystis* leads to an antibody response. Most humans have antibodies to the organism by age 6, many within the first 3 years of life. This information has been cited as demonstrating that the organism is ubiquitous. Since antibodies to *Pneumocystis* are commonly found in the blood of patients infected with the organism, it is obvious that humoral response alone is not sufficient to control PcP. Much of the antibody response is directed against the major surface glycoproteins (MSG) variable antigen that may be important in immune evasion. Although responses to specific regions of the MSG have been demonstrated to be more common in individuals who have recovered from PcP, their role in organism clearance remains unclear. At this stage the use of antibody titers to diagnose clinical infection has not proved useful. Rising titers have been used to detect subclinical reinfection (or reexposure) in healthy subjects.

Although humoral immune responses are not central to protection against disease, they do appear to play some role. Children with agammaglobulinemia and hyperIgM syndrome are susceptible to PcP as are  $\mu$ MT mice with B cell deficits. In animal studies, hyperimmune serum administered to *Pneumocystis*-infected

SCID mice controlled infection and in another study, animals treated with gamma globulin derived from the serum of litter mates infected with *Pneumocystis* were subsequently exposed to *Pneumocystis* and demonstrated a reduced rate of infection.

Alveolar macrophages are the first line of defense against *Pneumocystis* and the primary effector cells in clearing the organism from the lungs. Macrophages interact with organisms via MSG and  $\beta$ -glucans in the organism and mannose, Dectin 1, and Fc receptors on the cells. In addition to degrading *Pneumocystis*, the organisms elicit the release of a variety of chemokines, cytokines, and inflammatory mediators by the macrophages. In the presence of severe PcP, exuberant inflammation comprising neutrophils and CD8<sup>+</sup> T cells is found. The neutrophil response is variable, with some patients having a minimal neutrophil response. An increase in neutrophils has been observed in the bronchoalveolar lavage fluid (BALF) of HIV<sup>+</sup> patients. There is a clear relationship between increased neutrophils and worse prognosis for the HIV<sup>+</sup> patient. This inflammatory response is also seen with eosinophils, a cell not normally found in BALF, and an increase in eosinophils is also associated with increased mortality.

Several cytokines have been associated with this inflammatory response. Interleukin-8 (IL-8) and tumor necrosis factor- $\alpha$  (TNF- $\alpha$ ) are probably the most important mediators. Despite the fact that patients with PcP have an underlying cell-mediated immune defect such as AIDS, they are still able to mount an inflammatory response. These cytokines are mostly released by macrophages, which are not killed by the HIV infection; thus, this inflammatory response remains intact. Outcome from PcP correlates more closely with the extent of lung inflammation than with the organism burden during infection. The use of corticosteroids to treat HIV-infected patients with PcP (see below) is used to reduce this inflammatory response.

### Diagnostics

For any physician, the diagnosis of disease relies on the suspicion of that disease in the patient presenting symptoms. In the case of PcP, some relatively specific features of the history and physical examination can suggest the diagnosis. It is based on these features that the clinician will move on to either more specific tests (sputum induction, bronchoscopy) or an empiric trial of therapy.

In the patient's medical history, the immune status of the patient is crucial. For the HIV<sup>+</sup> patient, the CD4 count has proved predictive of PcP development. In several large studies, the risk for PcP was found to rise dramatically once the patients' CD4 count fell below 200–250 CD4/ml. Current prophylaxis regimens are

based on this principle. In the transplant patient, the maximal immunosuppression therapy usually occurs immediately following transplant. The effect of immunosuppression treatment is that it takes about 6 weeks to deplete the memory T cells. In that time frame, the patient is susceptible to certain infections, e.g., *Pneumocystis* and cytomegalovirus. As the immunosuppression is reduced (usually by a year), the risk decreases. It is only a problem again if the patient has received another round of intense immunosuppression (e.g., for an acute rejection episode).

The clinical history for PcP includes cough, shortness of breath, and fever. Fever is usually present, but is a nonspecific finding. For HIV<sup>+</sup> patients, these symptoms can be prolonged and subsequent weight loss is common. The duration of symptoms until diagnosis of PcP for an HIV<sup>+</sup> patient differs from that of a transplant patient; the HIV<sup>+</sup> patient will often report weeks of symptoms prior to diagnosis of the infection, whereas the transplant patient becomes rapidly ill.

The physical examination is often unrevealing in a patient with PcP. Evidence for immunosuppression such as oral thrush is useful to characterize the patient. The only direct physical finding is crackles, which are heard on auscultation in advanced PcP. Often the patient will cough in deep inspiration, making crackles difficult to appreciate.

Of the routine laboratory tests, the chest roentgenogram and level of oxygenation must be assessed in all patients with suspected PcP or any other form of pneumonia. The classic chest roentgenogram of PcP patients shows diffuse infiltrates (Fig. 6). Patients on aerosol pentamidine may have a predominance of the upper lobe. A normal chest roentgenogram is seen in about 10% of patients diagnosed with PcP. The presence of a pneumothorax is an unusual roentgenographic finding, occurring in up to 5% of PcP cases in HIV<sup>+</sup> patients. Since most other opportunistic and routine pneumonias do not cause pneumothorax, the finding of a pneumothorax in an immunosuppressed patient is an indication for further evaluation to rule out PcP. Oxygenation can be assessed during the noninvasive oximetry testing. However, a patient who is hyperventilating may raise his level of oxygen but still have significant lung disease. The arterial blood gas is more precise and the alveolar–arterial gradient (A–a gradient) should be calculated. Normally, this is less than 15 mmHg. Patients infected with HIV with PcP and with an A–a gradient of greater than 35 have a projected mortality of 35% (prior to the use of corticosteroids).

Lactate dehydrogenase (LDH) has been proposed as a diagnostic marker for PcP, since the lung is one source of LDH, and PcP can cause elevation of the enzyme activity. However, this response is fairly nonspecific since other pneumonias as well as lymphomas can lead to a rise in LDH levels. There is



**Pneumocystis. Figure 6** Chest roentgenogram of a patient with PcP. Diffuse infiltrates are evident, as indicated by the light areas in this x-ray of the lung. (Photo: Baughman and Kaneshiro)

some suggestion that the height of the LDH activity level is positively correlated with mortality from PcP.

Other proposed techniques for diagnosis have been gallium scan, high resolution computer tomography (HRCT) scan, and exercise oxygenation. The gallium scan and HRCT are more sensitive than routine chest roentgenograms, but are not very specific. Both tests are costly, and since they are not definitive, they do not seem worth their cost for the routine diagnosis of PcP. The exercise testing is useful for detecting early interstitial lung disease, such as PcP. However, most pulmonary patients will already have abnormal oxygenation. The desaturation of oxygenation with exercise is not specific for PcP, but may be useful in evaluating unexplained dyspnea in the otherwise healthy HIV<sup>+</sup> patient.

The specific diagnosis of PcP depends on the demonstration of the organism. The organism remains nonculturable, and therefore routine microbiologic techniques are not useful in diagnosing PcP. However, microbiological analyses are important in excluding other pathogens. Fortunately, the organism is relatively unique in appearance and visible organisms in respiratory specimens can give a precise diagnosis.

There are several methods of obtaining respiratory specimens (Table 1). These include sputum, bronchoscopy samples including bronchial wash and biopsy, and open lung biopsy. Bronchoalveolar lavage (BAL) is a specific technique in which the bronchoscope is advanced as far distally in the airways (wedged) and

**Pneumocystis. Table 1** Diagnostic yield of *Pneumocystis* spore cases (cysts) analyzed by silver staining. From (Baughman and Kaneshiro)

Specimen source	Median percentage (range)
Sputum	50 (15–94)
Bronchial wash	65 (60–70)
Single-area bronchoalveolar lavage	90 (60–100)
Two-area bronchoalveolar lavage	95 (85–100)
Transbronchial biopsy	97 (89–100)

fluid is instilled and withdrawn. The yield is much higher than samples obtained by simple washing. It compares favorably with more hazardous biopsy techniques and many clinicians prefer to perform BAL without biopsy to diagnose PcP.

Various methods and stains are used to visualize *Pneumocystis* organisms (Table 1, Figs. 2, 7). The simpler stains such as a modified Wright Giemsa are easy to perform and results can be obtained within minutes. The silver stain is the 'gold standard' of the pathologic diagnosis, which can take up to a day to process. The use of DNA amplification by polymerase chain reaction (PCR) to identify *P. jirovecii* is still restricted to research situations. Overall, the relationship between the samples and the detection method is reciprocal: less sensitive detection methods are needed for samples with more alveolar material (Table 1). For example, PCR may be useful for enhancing the diagnostic yield for PcP if one is looking at induced sputum samples. However, it is probably not a necessary routine technique for examining BALF or open lung biopsy samples.

## Therapy

There are several issues to consider in the treatment of PcP. The first is choosing the correct antibiotic once a diagnosis has been made. Ancillary treatments include oxygen supplementation and supportive care. The use of corticosteroids as an anti-inflammatory drug has been shown to benefit some patients. Finally, one must look for other infections. Up to 20% of patients with PcP will have other infections.

Several antibiotics have been shown to be useful against PcP. Since the organism cannot be readily grown in culture, *in vitro* testing of antibiotic effectiveness is problematic. Antibiotic effectiveness has been shown either by treatment of animal models of PcP or by treatment of humans with PcP. Fortunately, the animal models seem to predict which antibiotic will be effective in the clinical treatment of humans.

Trimethoprim with sulfamethoxazole (TMP-SMX, trim/sulfa) has proved to be the most effective antibiotic for PcP. Available for both intravenous and oral use, the drug is currently regarded as the "gold

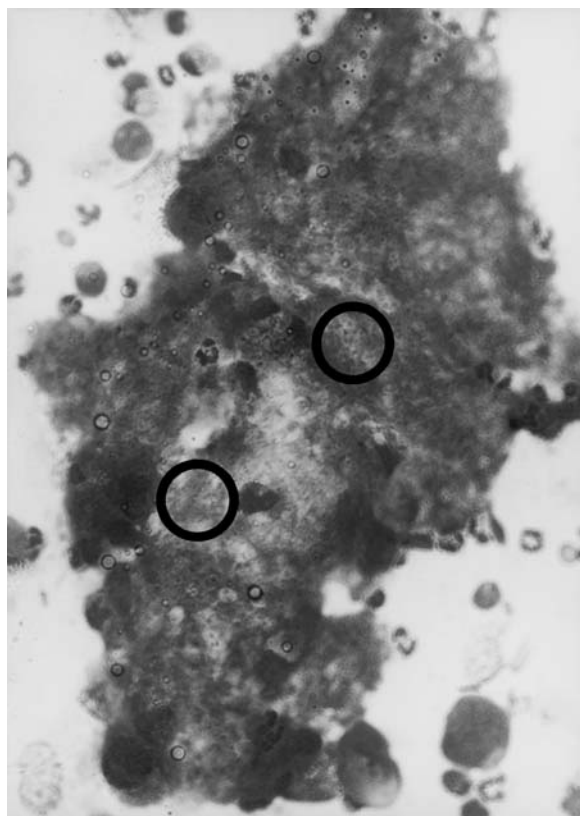

**Pneumocystis.** Figure 7 A modified Wright Giemsa (Diff-Quik) staining of a clump of *Pneumocystis jirovecii* in bronchoalveolar lavage fluid (BALF) taken from a PcP patient. Lung surfactant, host cell, and cell debris are also present in the clump. The *P. jirovecii* organisms are abundant and their nuclei are seen as tiny dots (e.g., within the circled areas). (Photo: Baughman and Kaneshiro).

standard" to which other drugs are compared. The dose recommended is 15 mg/kg trimethoprim. The clinical response rate is greater than 80%. Failures can be due to lack of efficacy of the drug or drug toxicity. Allergic reactions include rash, fever, and myalgias. Most reactions can be surmounted with desensitization and supportive care. However, some cases of reaction are severe, requiring withdrawal of the drug. Patients who are withdrawn from TMP-SMX because of toxicity usually do well with a new agent. However, patients who are changed from TMP-SMX to another agent because of clinical failure have a less than 50% chance of responding to the new agent.

Pentamidine was the first drug shown to have clinical efficacy for PcP. Since there is no oral form of the drug, it is usually administered intravenously. It can also be given by aerosol, which has proved a useful alternative for prophylaxis therapy. For acute disease, it is associated with greater toxicity. The major problems with pentamidine include hypoglycemia and arrhythmias. The drug is also irritating to the vein. Aerosol

pentamidine is less effective than TMP-SMX as a prophylactic agent, and it is usually reserved for the TMP-SMX-intolerant patient.

Trimetrexate is an analogue of methotrexate, and was originally developed as an antineoplastic chemotherapeutic agent. Since it blocks the dihydrofolate reductase enzyme, it was found to have activity in the treatment of PcP in both animals and humans. In a trial comparing trimetrexate to TMP-SMX, there was no significant difference in the efficacy of the 2 agents, although trimetrexate was more difficult to use and was associated with more leukopenia. It has to be given with leukovorin to reverse the potential toxicity to humans from the drug. Its major role is its apparent effect in some of the clinical failures to TMP-SMX who seem to still respond to trimetrexate.

In patients with mild to moderate disease, oral therapy is popular. The definition of mild to moderate disease is based on the A-a gradient. Patients with an A-a gradient of less than 35 mmHg have a good prognosis overall. In the TMP-SMX-intolerant patient, several agents have been studied. Atovaquone is an oral agent which does not have an intravenous form. It has been useful for the mild form of the disease, especially in the TMP-SMX-allergic patient. Clindamycin and primaquine, as a combination, has also been reported as helpful. This combination has also been used in moderate to severe disease and a meta-analysis of reported studies suggests that this combination should be used as the second-line treatment of choice in patients failing TMP-SMX. Dapsone with trimethoprim is another combination used for PcP. Interestingly, many patients who are sulfa-allergic may still be able to take dapsone, although there are some crossover reactions.

Given the effectiveness of many of the agents, especially TMP-SMX, some physicians have proposed empirical therapy in the appropriate patient. In the HIV<sup>+</sup> patient who is not receiving effective prophylaxis and presents with fever, cough, and diffuse pulmonary infiltrates, in at least half the cases, *P. jirovecii* will be found to be the cause of the pneumonia. Therefore, it has been argued that empirical therapy should be given. However, several lines of evidence have shown that this may not be the best policy. For one, up to 20% of HIV<sup>+</sup> patients in that situation will have another infection, either in addition to *P. jirovecii* or as a sole agent. This can lead to a delay in diagnosis. Since a common other agent is *Mycobacterium tuberculosis*, this represents not only a potentially treatable infection, but also a public health hazard. Recent analysis of clinical outcome of groups of patients treated empirically versus patients undergoing bronchoscopy showed that the patients undergoing bronchoscopy had a better clinical outcome.

Treatment and prophylaxis failures are well recognized. Although the lack of culture prevents demonstration of a causal relationship between antibiotic

resistances and resistance with these failures, molecular studies have shed light on the situation. Mutations have been identified within the gene dihydropteroate synthase, the target of the sulfa component of TMP-SMX. These mutations are reported adjacent to the *p*-aminobenzoic acid (PABA) binding site and similar mutations result in sulfa resistance in other organisms such as *Escherichia coli*, *Streptococcus pneumoniae*, and *Plasmodium falciparum*. The presence of these mutations has correlated with failure of prophylaxis but correlation with treatment failure has not been consistently shown. This is likely due to the fact that the reported mutations at positions 55 and 57 in other organisms are associated with a small (2–3x) increase in minimal inhibitory concentration (MIC). This may be sufficient to result in prophylaxis failure but can be overcome with the high doses used for treatment of PcP. Mutations in dihydrofolate reductase (DHFR) are less commonly reported but have been found with the use of Fansidar, which is a combination of sulfadoxine and pyrimethamine. Mutations in *P. jirovecii* cytochrome b have been reported in patients failing both treatment and prophylaxis with atovaquone.

Supportive care of the patient starts with assessing the need for supplemental oxygen. The patient is usually hypoxic, especially with exercise. The need for oxygen may persist for many days despite therapy for pneumonia. Although arterial blood gas measurement is the most accurate method for assessing the level of hypoxemia, oximetry measurements can be used to follow the patient during therapy. Prior to discontinuation of oxygen, it is useful to be sure that the patient is no longer significantly desaturating with ambulation.

At one time, the mortality of PcP in HIV<sup>+</sup> patients in the USA was fairly high, e.g., the patient with an A–a gradient of >35 Torr had a 35% mortality, despite appropriate antibiotic therapy. In a randomized trial, it was shown that corticosteroids given at the time of diagnosis led to a significant reduction in mortality. It has been proposed that part of the cause of morbidity and mortality from PcP is the inflammatory response. This includes the neutrophil response. Corticosteroids reduce this response by directly blocking cytokines such as IL-8 and TNF- $\alpha$ , and hence improving survival of PcP patients. However, steroids increase the risk for other opportunistic infections; patients on corticosteroids who are worsening may have an alternative diagnosis.

The best medicine is preventive medicine. For *P. jirovecii*, this is clearly true. There are several different agents which have been shown to prevent *Pneumocystis* infection. Used in patients at risk for PcP, these can prevent infection. In the HIV<sup>+</sup> patient with less than 250 CD4 cells/ml, several forms of prophylaxis have proved effective. TMP-SMX has been shown to be extremely effective, with less than 1% of patients developing PcP. In patients who are

TMP-SMX-intolerant, other agents have been used. Aerosol pentamidine as a monthly therapy reduces the chances of PcP, but up to 30% of at-risk patients will develop PcP while on aerosol pentamidine. Dapsone is more effective than aerosol pentamidine, but less effective than TMP-SMX. Among the solid organ transplant patients, the use of low-dose TMP-SMX (3 times/week) has essentially eradicated *P. jirovecii* as a cause of pneumonia ([→Pathology](#)).

Overall, *P. jirovecii* infection can usually be treated effectively. The major issue is recognizing the disease. Therefore, improvements in diagnostic testing are needed to make the diagnosis.

---

## Pneumonia

Inflammation of the parenchymal layer of the lungs often as a result of parasitic infections (e.g., [→Pneumocystis carinii](#), [→Paragonimus](#) spp., [→Leishmania](#) spp.).

---

## Pneumonyssoidic Mange

[→Mange, Animals/Pneumonyssoidic Mange](#).

---

## Pneumonyssus

### Name

Greek: *pneuma* = air, *nyssein* = bite.

### Classification

Genus of [→mites](#), [→Acari](#).

### General information

This canine nasal mite (*Pneumonyssus caninum*, [Fig. 1](#)) reaches a length of 1.5 mm, appears yellowish-brown and moves rapidly in the nostril system of dogs in North America, South Africa, Australia, and Europe. **Symptoms:** coughing, sneezing, and watery excretions of the nose. A similar species of monkeys is *P. simicola*.

### Therapy

[→Ectoparasitocidal Drugs](#) (e.g., Selamectin).



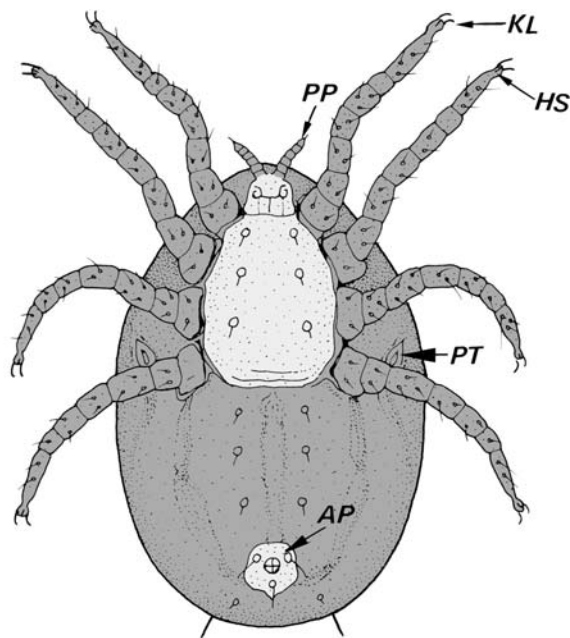

**Pneumonyssus.** Figure 1 DR of the ventral side. *AP*, anal plate; *HS*, attachment leaf; *KL*, claws; *PP*, pedipalps; *PT*, peritreme, stigma.

## Podosoma

→Acarina.

## Polar Capsule

Capsule in →Myxozoa containing a filament, which is used to attach the shell valves to host tissues.

## Polar Filament

→Nosema apis.

## Polar Plugs

Polar characteristics of trichuroid eggs (→Trichuris, →Capillaria).

## Polar Ring

Apical thickening of the 2 inner membranes of motile stages of →Apicomplexa (e.g., sporozoites, merozoites, →tachyzoites, →bradyzoites, kinetes), at which the →subpellicular microtubules are anchored. Except for the stages of →Haemosporidia and →Piroplasma a →conoid is situated in the opening surrounded by the polar ring. In some species several polar rings (being species-specific 2 or 3) may be formed. →Pellicle.

## Polar Tube

Hollow tube that is protruded by microsporidian →spores and injected into the host cell →cytoplasm (→Microspora).

## Polaroplast

→Nosema apis.

## Pollenia rudis

Species (5–12 mm, blackish with yellow stripes) of the fly family Calliphoridae, preferring human feces. The larvae live as parasites in earthworms, the adults may be common vectors of agents of disease in palaeartic, nearctic regions, in South until North Africa and in North India.

## Polyamines

Polyamines are ubiquitous polycations that are essential for cellular processes such as growth, replication, and differentiation. Organisms either synthesize polyamines or acquire them from the environment. The major polyamines are putrescine, spermidine, and spermine. Whereas putrescine and spermidine are the predominant polyamines in protozoan parasites, helminths primarily contain spermidine and spermine. The main substrates for polyamine biosynthesis are ornithine and methionine (Amino Acids/Fig. 1). In some amitochondriate protozoa, including *Giardia* and trichomonads, ornithine derives from arginine via the

arginine dihydrolase pathway (Amino Acids/Fig. 3). Other protozoans use host-derived ornithine as precursor for polyamine production. The enzymes of the polyamine biosynthetic pathway exhibit features that differ significantly between parasites and their mammalian hosts and are therefore of interest as targets for antiparasitic drug design. The first committed step in the biosynthetic pathway of polyamines is catalyzed by ornithine decarboxylase (ODC). As shown in Amino Acids/Fig. 1, this reaction results in the formation of putrescine, which is further converted to spermidine by addition of aminopropyl groups deriving from methionine via S-adenosylmethionine (Amino Acids/Fig. 1). The by-product released after the aminopropyl transfer, 5'-methylthioribose 1-phosphate, is eventually recycled to methionine. A special feature of protozoans is that they appear unable to *de novo* synthesize spermine from spermidine. The observed presence of this polyamine in some species is most likely the result of uptake from their host. *Trypanosoma cruzi*, which lacks ODC, appears to be absolutely dependent upon polyamine uptake for its growth and survival, although there is some evidence to suggest that this trypanosomatid can generate putrescine from arginine via agmatine. Since in helminths the enzymes of the polyamine biosynthetic pathway appear largely absent, these parasites rely on uptake of these molecules from the host. However, like mammalian cells, helminths are capable of interconversions of polyamines via acetylated intermediates.

In trypanosomes, the half-life of the key enzyme of polyamine biosynthesis, ODC, is prolonged compared to that of most other eukaryotes apparently due to the absence of a 36-amino-acid fragment (PEST sequence) that is known to target the enzyme for intracellular degradation. However, *Crithidia fasciculata* turns over ODC rapidly despite lacking the corresponding domain, indicating that other motifs on the protein may mediate the targeting of ODC for rapid degradation. The differential stability between trypanosome and mammalian ODC is suggested to be, at least in part, responsible for the selective action of DL- $\alpha$ -difluoromethylornithine (DFMO), an irreversible inhibitor of ODC and an effective trypanocidal drug. A remarkable feature of the ODC in *Plasmodium falciparum* is that it is expressed together with adenosylmethionine decarboxylase as a bifunctional enzyme complex.

---

## Polyembryony

Mitotic division of germ cells at a very early stage, giving rise to embryos that already contain embryos of the next generation; e.g., in [→Gyrodactylus](#) ([→Monogenea/Reproduction](#)).

Polyembryony sensu strictu—the production of at least 2 or more embryos from the same ovum—is rather common in parasitic Hymenoptera, e.g., in tephritid wasps (e.g., *Tiphia popillivora*) or in other wasps that are used for [→biological control](#).

---

## Polymerase Chain Reaction

Abbreviation PCR, method to reduplicate artificially DNA from small isolates.

---

## Polymorphism

[→Chromosomes/Protozoa](#), [→Trypanosoma](#).

---

## Polymorphus minutus

### Classification

Species of [→Acanthocephala](#).

### Life Cycle

[→Acanthocephala/Life Cycle](#).

---

## Polymorphus paradoxus

[→Behavior](#).

---

## Polyopisthocotylea

[→Monogenea](#).

---

## Polyplax serrata

An about 1.5 mm long louse (Mallophaga) species of mice and rats ([Figs. 1, 2](#)), which may transmit *Rickettsia mooseri* (the agent of murine typhus).



**Polyplax serrata.** Figure 1 SEM of an adult stage from ventral; note that the first legs are smaller.



**Polyplax serrata.** Figure 2 LM of an egg of *P. serrata*.

## Polysomes

→[Ribosomes](#).

## Polystomum integerrimum

### Classification

Species of →[Monogenea](#).

### Life Cycle

[Fig. 1](#) (page 1185).

## Polyxeny

From Greek: *polys* = much, *xenos* = guest. Parasites are able to use several host species during development.

## Pomphorhynchus laevis

→[Acanthocephala](#).

## Pool Feeders

→[Ticks](#) and many →[insects](#) such as several nematoceraans (e.g., →[Simuliidae](#)), some flies (e.g., →[Stomoxys](#) spp., →[Glossinidae](#)), and tabanids are pool feeders. They destroy peripheral blood vessels with their armed mouthparts, wait until sufficient blood has collected inside the wound, and then ingest it rapidly, thus visibly distending their stomach.

## Population Genetics

### General Information

The science of population genetics attempts to measure the degree of genetic variation within populations and to determine the basic factors which are responsible for the origin and further development of genetic diversity. Research in population genetics addresses the impact of time and space on populations, i.e., to analyze whether genetic variation changes through generations and among populations. Central questions to be addressed are: what are the evolutionary forces that push genetic diversity and what is the impact of genetic variation on biological factors? Scientists working with pathogens are especially interested in understanding the influence of genetic variation on drug resistance or virulence for example. Genetic variation can be detected at the level of species, subspecies, and strains, although the latter is taxonomically invalid. Species are the fundamental units in taxonomy and it is essential to agree on a definition what species really are. Unfortunately this is not so easy. The most widely used concept of biological species defines species as “groups of actually or potentially interbreeding natural populations, which are reproductively isolated from other such groups.” This definition causes problems, because it does not apply to organisms which are self-fertilizing or reproduce asexually. The evolutionary species concept, invented by Simpson and Wiley focuses on the whole process, thus including the time factor: “a species is a single lineage of ancestral descendant population of organisms which maintains its identity from other such lineages and which has its own evolutionary tendencies and historical

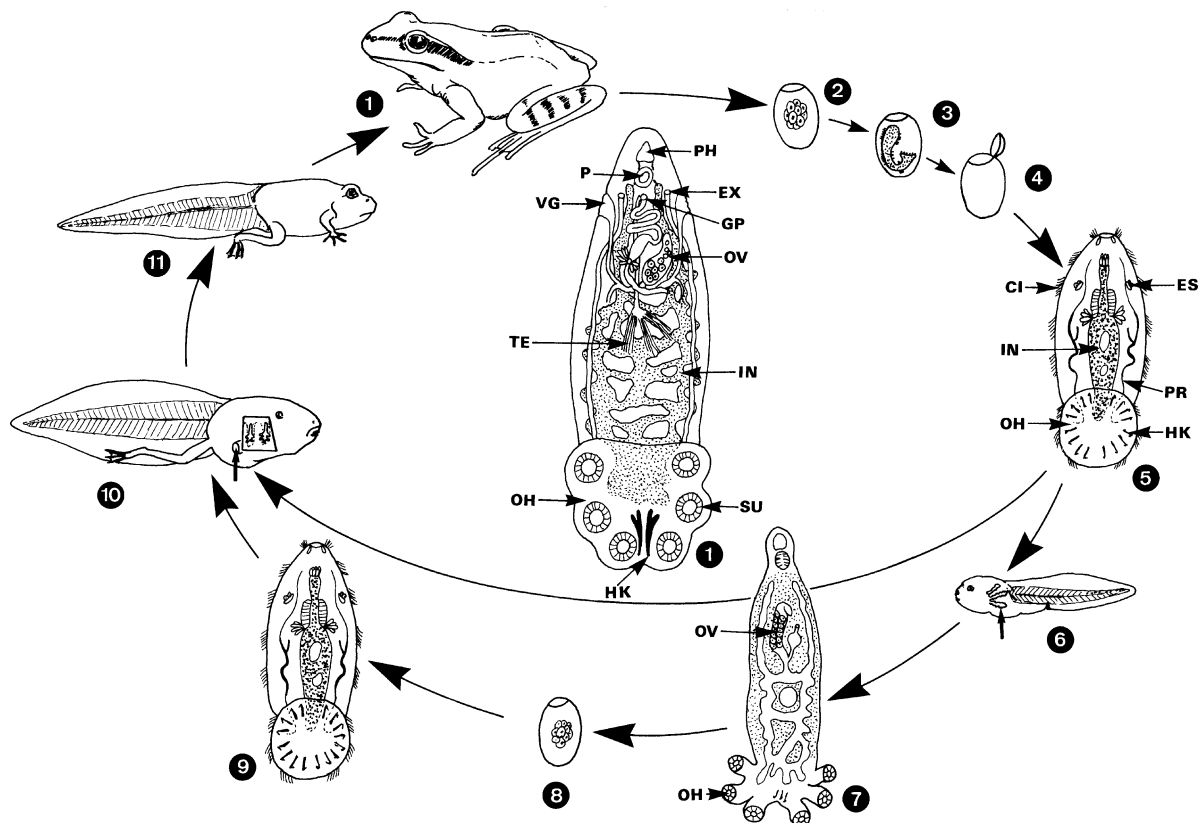

**Polystomum integerrimum.** Figure 1 Life cycle of *Polystomum integerrimum*. 1 Adult fluke inside urinary bladder/cloaca; when frogs become mature, flukes also reach maturity (apparently stimulated by the sexual hormones of the host). 2–5 →Operculated eggs are set free with feces; in water each egg develops a larva with hooks (oncomiracidium) which leaves the egg and may initiate 2 different developmental cycles (6–9 or 10, 11). 6–9 When the oncomiracidia become attached to tadpoles with outer gills (6; arrow), they grow into gill (or branchial) flukes (7) which are thought to represent neotenic forms. These branchial flukes produce a few eggs (8) which give rise to new oncomiracidia (9). 10, 11 When the →oncomiracidium enters inner gills of tadpoles by way of spiracle (10; arrow), the development to the final bladder generation is initiated. When the tadpole undergoes →metamorphosis, the worm passes out of the branchial chamber, migrates down the host's intestine, and may become established in the host's bladder where it reaches sexual maturity within 3 years (in the frog). CI, cilia; ES, →eye spot; EX, excretory pore; GP, genital pore (uterus + vas deferens of testis); HK, →hooks; IN, intestine; OH, →opisthaptor (caudal disk); OV, ovary; P, pharynx; PH, prohaptor (mouth), PR, protonephridia; SU, sucker; TE, multilobed testis with sperms; VG, vagina.

fate." Subspecies (or geographical races) are the only valid intraspecific taxonomic unit. Mayr described subspecies as geographically localized groups which are still capable of interbreeding but differ genetically and taxonomically from other subdivisions of species. However, it is not always easy to distinguish and characterize subspecies. Strains are groups of individuals within species which differ in few characters, but do not warrant subspecies level. They are, however, of great importance for parasitologists, because they are relevant to epidemiological studies and may represent the first indications of →speciation processes. To give an example: A few years ago, only 4 species of *Echinococcus* were accepted: *E. multilocularis*, *E. vogeli*, *E. oligarthrus*, and *E. granulosus*. However, different

strains of *E. granulosus* have been described as the genotypes G1 (common sheep strain), G2 (Tasmanian sheep strain), G3 (buffalo strain), G4 (horse strain), G5 (cattle strain), G6 (camel strain), G7 (pig strain), G8 (cervid strain). These strains have been isolated from different geographic areas and/or vary in the host cycles as well as their ability to infect humans. Additionally the strains have been distinguished using biochemical and molecular methods. In 2002 Thompson and MacManus proposed a new classification of the genus *Echinococcus*, i.e., to grant the horse strain species status as *E. equinus*, additionally they proposed the species name *E. ortleppi* for the cattle strain. In 2006 Nakao et al. studied different *Echinococcus* spp. and genotypes and revealed that the camel strain, the pig strain, and the cervid strain are

monophyletic. Consequently they unified the 3 genotypes into *E. canadensis*. Apart from these genotypes more strains are likely to exist. However they are poorly characterized and reliable molecular methods for strain diagnosis only recently became available.

The family Taeniidae comprises the 2 genera *Echinococcus* and *Taenia*. The status of *T. asiatica* is still a matter of controversy. Some authors accept *T. asiatica* as an independent species whereas others regard *T. asiatica* as a subspecies of *T. saginata*, i.e., *T. saginata asiatica*. To solve this question more samples from different geographical areas are needed as well as reliable molecular methods to distinguish between species/subspecies.

### Genetic Variation

Traditionally the determination of genetic variation in populations is based on the relative frequency of alleles, i.e., different forms of genes. The occurrence of 2 or more alleles is due to mutations and indicates that a population exhibits genetic →polymorphism.

### Hardy-Weinberg Equilibrium

In ideal populations, the allele frequencies and the heterozygosity remain stable during successive generations (→Hardy-Weinberg Equilibrium) if certain assumptions are fulfilled: the organisms are diploid, they reproduce sexually, they mate randomly with other individuals of this population, the population is infinitely large, no mutations and no natural selection occur, and finally there is no migration with other populations. In most cases, however, real populations do not meet these prerequisites; for example bacteria and many →protozoa are haploid, and a lot of them reproduce asexually. However, the extent of deviation from →Hardy-Weinberg equilibrium indicates that evolution of genes in populations do occur. Mutation, recombination, and natural selection are the main forces of evolution and theoretical models have been created to study their influence on the genetic variation of populations.

### Parameters Changing Allele Frequencies

Mutations occur more or less frequently in populations. The evolutionary fate may be that the mutations are either fixed or they get lost. The fate is not always a matter of better or worse but it simply may depend on chance. Genetic drift describes those unpredictable changes in allele frequencies due to stochastic events. Genetic drift is of great importance in small finite populations and eventually decreases the degree of genetic variation. Population sizes influence the genetic variation of populations as well and one of the, dramatic events are population bottlenecks, i.e., the dramatic decrease in the number of individuals within populations due to diseases or other reasons. Only a

small number of individuals survives carrying only few alleles of the main population. As a result, the genetic variation within the remaining population decreases. Founder effects are equally important for the genetic variation of populations. If small numbers of individuals become isolated from the main population, they carry only few alleles. Genetic drift and natural selection may then change the genetic variation and speciation may progress. If individuals do not interbreed randomly, the degree of genetic variation within populations is again affected. Inbreeding is one form of nonrandom mating, i.e., individuals mate more frequently with relatives. Inbreeding increases the number of homozygotes dramatically, because there is a great probability that individuals inherit identical alleles from both parents. Self-fertilization is the extreme form of inbreeding, which is known to occur in parasitic helminths for example. Inbreeding or other forms of nonrandom mating give rise to population subdivisions or demes which do not mate freely any more and become more and more isolated from other subdivisions. Inbreeding and the development of subdivisions decrease the genetic variation within populations whereas gene flow increases genetic diversity. Gene flow describes the change of allele frequencies in populations due to migrations of individuals or →gametes. Although gene flow increases the genetic variation within populations it also means that genes are shared among populations. Finally gene flow homogenizes the genetic diversity among populations, thus preventing speciation.

### Parasitic Peculiarities

The above-listed parameters are essential for understanding microevolutionary events and theoretical models have been developed to study the influence of stochastic events, population sizes, genetic drift, inbreeding, gene flow on population diversity. However, Nadler pointed out that such microevolutionary studies are lacking for many parasites and a lot of parameters must be defined for parasite species. This is due to the association of parasites with their hosts. Many parasites, like →*Plasmodium*, →*Babesia*, →*Theileria* have adopted a heteroxenic life cycle without the production of free developmental stages. Therefore, a lot of parasites are more than other organisms influenced by their hosts and their characteristics respectively. The migration of hosts into a new ecosystem can be accompanied by the introduction of new parasite populations as well. The colonization of new hosts may influence population sizes of the parasite. These 2 examples elucidate the complexity of studying parasite populations.

### Protein-Based Methods

Traditionally allozyme and isoenzyme analysis have been used to study genetic variation in populations of

organisms assuming that differences in allozymes/ isoenzymes reflect differences on the gene level as well. Protein electrophoresis separates molecules on the basis of their net charge and their conformation as well. Differences in migration indicates differences in amino acid composition which can be traced back to differences in gene sequences. However, nucleotide substitutions, which do not alter the amino acid composition (silent substitutions) cannot be detected by protein electrophoresis. Differences in the amino acid composition which do not change the electrophoretic mobility are also undetectable. Additionally certain enzymes show less variability than others due to functional constraints. Therefore the choice of loci used for the detection of genetic variability is important otherwise studies may be biased. Protein electrophoresis reveals advantages and disadvantages, which have been summarized by Andrews and Chilton. They addressed the often raised question about the stability of zymodemes (allozymes), which has been controversially discussed with regard to → *Entamoeba histolytica* / *E. dispar*. Sargeant and coworkers investigated more than 6,000 isolates from different patients and different areas worldwide and described zymodemes which were characteristic for pathogenic *E. histolytica* and others which corresponded to nonpathogenic isolates. On the basis of their results, Sargeant established zymodemes, which can be used as markers to distinguish between pathogenic and nonpathogenic *Entamoeba*. The results of their studies were questioned when the group of Mirelman and Andrews reported about zymodeme switching. However the results of isoenzyme analysis revived the debate about 2 species of *Entamoeba*, originated by Brumpt in 1925, and initiated intensive research, resulting in a wealth of data generated by different methods giving support for Sargeant's hypothesis about the existence of 2 species. In 1993, Diamond and Clark reclassified *E. histolytica* s. l. and it is now generally accepted that the pathogenic *E. histolytica* s. st. is genetically different from the apathogenic *E. dispar*. However, Andrews and Chilton stressed that protein electrophoresis on → protists is not without problems for different reasons: the ploidy level of many protists is unknown and their mode of reproduction is a matter of controversy. Additionally it is also possible, that the small sizes of parasites do not provide enough material for electrophoresis, especially if appropriate *in vitro* systems are lacking. Usually electrophoretic studies on parasitic protists use uncloned isolates, that is a pool of thousands of individuals or different developmental stages, which are not genetically identical. If the ploidy level of the protists is unknown, and this refers to a lot of parasites, it is difficult to interpret the genetic basis of multiple banding patterns. However, very often protein electrophoresis provides the first indications for the existence

of genetically different isolates, populations, or species. Multilocus enzyme electrophoresis have been successfully used to identify species, to compare the genetic diversity within and among populations, to characterize closely related species, and to understand the evolutionary relationships of species. Additionally, this method has been used to address parameters of population genetics: the number of alleles per locus, the frequency of different alleles at one locus, the level of heterozygosity, and the similarity of populations, the detection of hybrid zones, subpopulations, and cryptic species. However protein electrophoresis should always be carried out with care, investigating a number of different loci under different experimental conditions.

### DNA-Based Methods

DNA-based methods have been used to study genetic variation and to identify and characterize species. One of the major advantages of these methods is that they utilize the genetic information directly, not their secondary products, proteins. RFLP analyses (restriction fragment length polymorphisms), sequencing, and PCR-based methods became more and more relevant. PCR-based methods are of special importance, because it is now possible to study small amounts of tissue/organisms. This is essential for parasitologists because *in vitro* systems are lacking for many parasites and it is sometimes not possible to isolate them and/or special developmental stages from their hosts.

Some DNA-based methods used in population genetics are listed below:

#### RFLP Analyses (Restriction Fragment Length Polymorphism)

DNA variation can be elucidated using restriction endonucleases which cut DNA at special recognition sites. Four-base cutters are preferably used because they find more recognition sites, thus being able to reveal more genetic polymorphism. Generated fragments are then separated by gel or acrylamide-electrophoresis based on their size. RFLP analyses may elucidate more genetic variation than protein electrophoresis. However Nadler and Gasser have pointed out that it can only be assumed that fragments of the same size are identical, because they may differ in their sequence (i.e., sequence variants, types of alleles), but do comigrate within one band. This is important to keep in mind if more distantly related species are compared.

#### Sequencing

Sequencing of DNA-fragments, generated for example by PCR-methods, is the most accurate method to detect genetic variation, because it uncovers polymorphisms at the level of single nucleotides. Sequencing reveals

silent substitutions which, for example, do not change the amino acid composition and go undetected in protein electrophoresis. There are some limits of this method and its application. DNA regions with a high level of size and sequence heterogeneity are difficult to read, because PCR products may contain different, but related, sequences, which cannot be separated on a sequencing gel. Usually PCR products are cloned to solve this problem and many clones are then sequenced to address genetic variation.

#### Satellite DNA-Analysis

Satellite DNAs are extremely polymorphic nuclear genomic regions of tandemly repeated sequences. Satellite DNA is hypervariable and may differ among individuals of one species. Jeffries et al. have reported on extremely high mutation rates of about 5% per generation in humans; therefore this method is valuable for parental analyses. Grenier et al. used minisatellites to detect and to identify different entomopathogenic [→nematodes](#) in the same insect. Satellite DNA may be present in all members of the genus, or they are lacking in some species but are present in some closely related species. Additionally the copy number of satellite DNA can vary among related species. Macedo et al. used satellite DNA analyses to distinguish among strains and species of [→Trypanosoma](#) and [→Leishmania](#). Due to the high mutation rate in satellites, they are valuable for taxonomic purposes as well as for population studies.

#### RAPD-PCR (Random Amplified Polymorphic DNA-PCR)

This method is a variation of standard PCR methods because random, nonspecific primers (usually only one very short primer of random sequence) are used to amplify DNA fragments. This is one advantage of RAPD-PCR because special information about the DNA is not necessary. If 2 annealing sites are present within suitable distance, DNA fragments of unknown sequences will be generated and separated on an agarose gel. Using numerous primers, it is possible to screen the entire genome for genetic variation and to generate a fingerprint with polymorphic (bands of certain sizes are present in more than one fingerprint) and monomorphic bands (these fragments are unique for one fingerprint). Monomorphic bands can be used as probes for the detection and/or differentiation of closely related species. However this method is sensitive for contaminations, because random primer are used which are not host-or parasite-specific thus amplifying virtually every DNA. Problems with the reproducibility of band pattern do occur, because this method is sensitive to modifications of the PCR conditions, different qualities of the template DNA, and differences in the DNA concentrations. Species, isolates, or strains are compared and differentiated on

the basis of PCR-fragments, which are not characterized and may be not homologous. Due to these problems, RAPD-PCR has been replaced by more reliable methods.

#### PCR-Based Mutation Scanning Methods

PCR-based mutation scanning methods became more and more important and provides an alternative for the methods mentioned above. These methods depend on physical properties or the modification of DNA-molecules of the same or similar size, which differ in one or more nucleotides. Gasser distinguished between physical methods (heteroduplex analysis, single-stranded conformation polymorphism, denaturing gradient gel electrophoresis) and “mismatch cleavage techniques,” i.e., chemical and enzymatic cleavage techniques. These methods have been successfully used in biomedical research, but studies on parasite populations are rare or even lacking. So, a lot of work needs to be done to estimate the value of these methods for analyses of genetic variation in parasite populations.

---

## Populations

Populations are defined in parasitology as they are in general ecology: a population is a group of individuals of a given species which are supposed to interbreed at random and are isolated from other populations of the same species by physical barriers. However, it is often extremely difficult to define the limit of a population of parasites and to decide to what extent this population exchanges genes (gene flow) with adjacent or more or less remote populations.

When the gene flow between different populations of a given parasite species is limited or null, for instance because of physical barriers, these populations follow the general rules of evolution and may diverge genetically to become different species, i.e., to remain genetically isolated from each other (reproductive isolation) even if they were re-united geographically. With parasites more than with free-living species, it is often difficult to decide whether the genetic divergence between different populations has or has not reached the level of [→speciation](#). This is specially true of parasite species which have a large geographical distribution; an example is the case of the [→cestodes](#) of the genus [→Echinococcus](#), which are widely distributed and exhibit different characteristics in different parts of their area. Because it is difficult to perform experiments, the existence of a number of sibling species is strongly suspected but remains speculative.

Because individual hosts are equivalent to “islands” or “patches,” populations of parasites are always fragmented. The set of parasites of a same species which inhabit an individual host is called an [→infrapopulation](#). It has been suggested to call “xenopopulation” a set of parasites which inhabit a set of hosts of a same host species in a given geographical area; if the different host species which constitute a host spectrum have different behaviours, gene exchange between individuals belonging to different species may be impaired, which leads xenopopulations to diverge genetically and become separate species ([→Speciation](#)).

To summarize: a population of parasites comprises all the individuals of a given parasite species in an ecosystem; a xenopopulation comprises all the parasites of a particular host species of that ecosystem; an infrapopulation comprises all the individuals of a parasite species living in a particular individual host.

---

## Porocephalidae

[→Pentastomida](#).

---

## Porocephalus crotali

### Name

Greek: *poros* = opening, *cephalon* = head.

### Classification

Species of [→Pentastomida](#).

### Life Cycle

[Fig. 1](#) (page 1190).

---

## Porose Areas

Clusters of tiny depressions on the dorsal surface of the basis capituli in ixodid females [→ticks](#).

---

## Porphyrins

[→Amino Acids](#).

---

## Porrocaecum

Genus of ascarid [→nematodes](#) which live as adults in marine mammals and as larvae in fish ([→Anisakis](#)).

---

## Porrocaecum decipiens

[→Anisakis/Fig. 1](#).

---

## Porrocaecum ensicaudatum

[→Nematodes](#).

---

## Portal Hypertension

Symptom of disease due to infections with liver flukes, e.g., [→Fasciola](#), [→Clonorchis](#).

---

## Posthodiplostomum

[→Digenea](#).

---

## Postkala-azar (PKDL)

This is a disease that may occur as consequence of the chemotherapy of *Leishmania donovani* infections (does not occur in *L. infantum* cases). Its onset may be delayed to as much as 2 years. It is reported in about 20% of cured cases in India, but is apparently rare in Africa, with the exception in a Sudanese epidemic in 1994. The symptoms of PKDL are variable. They may start with skin symptoms (e.g., progressive depigmentation or discrete papules on surfaces exposed to light). Disease may go on with the occurrence of skin nodules re-membering at lepromatous leprosy. The duration and the different immune reactions are variable, too.



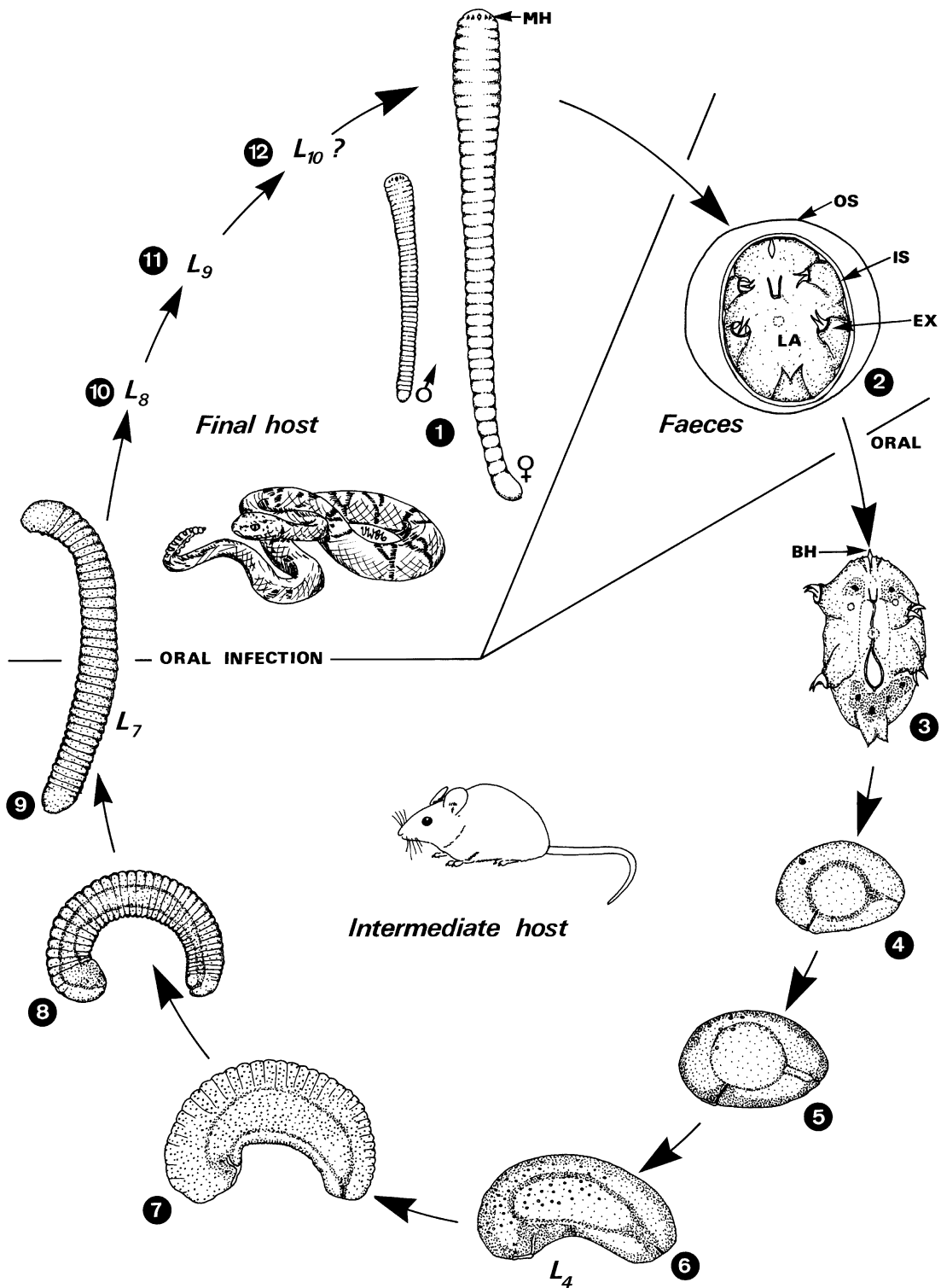

**Porocephalus crotali.** Figure 1 Life cycle of *Porocephalus crotali*. 1 Adults live in the lungs of final hosts (snakes: *Crotalus* spp.). 2 Embryonated eggs are passed with feces. 3-9 If intermediate hosts (mice) swallow eggs, the four-legged primary larva (3) hatches in the intestine, penetrates the intestinal wall, and finally becomes encapsulated in host tissues. In such capsules molts occur until infectivity (L<sub>7</sub>) is reached. 10-12 If the final host (snake) ingests infected mice, the L<sub>7</sub> leaves the intestine after hatching from the host-tissue capsule and enters the lung of the snake. There, maturity is reached after at least 3 more →molts. BH, bore →hook; EX, extremity with a claw; IS, inner eggshell; LA, primary larva; MH, mouth hooks; OS, outer eggshell.

## Postnatal Toxoplasmosis

Primary infection with *Toxoplasma*-stages (eating →[tachyzoites](#), →[bradyzoites](#) in raw meat or by oral uptake of oocysts from cat feces) after birth. In immunocompetent people: mostly no clinical symptoms except of subacute →[lymphadenitis](#) in 1% of the cases. However, in immunodeficient people severe disease may occur (→[Toxoplasmosis, Man](#)).

## Powassan Encephalitis

### Synonym

POWE.

Powassan encephalitis which is caused by the POWE virus (→[Flavivirus](#), group B) is a North American →[RSSE](#)-like disease associated with transmission by bites of *Ixodes* spp. and *Dermacentor andersoni*.

## Praesoma

The body of →[Acanthocephala](#) consists of 2 major parts, the praesoma and the →[metasoma](#). The praesoma comprises the →[proboscis](#), armed with a set of specific hooks (→[Acanthocephala/Fig. 1](#)), a more or less pronounced →[neck](#), the proboscis receptacle, and the 2 →[lemnisci](#), which are cylindrical appendages of the praesomal →[tegument](#).

## Praziquantel

→[Trematocidal Drugs](#), →[Cestodocidal Drugs](#).

## Precyst

→[Entamoeba histolytica](#), →[Blastocystis hominis](#), →[Pneumocystis carinii](#).

## Predator

### Name

Latin: *praedator* = robber.

Animal that feeds by capturing others. For example, →[Sarcocystis](#) life cycle includes predators (where gamogony, sporogony occurs) and preys (plant eater, omnivorous animals: schizogony).

## Premunition

From Latin: *prae* = before, *munia* = duty. Immunity as result of an infection.

## Prenatal Toxoplasmosis

Disease due to transmission of →[Toxoplasma gondii](#) stages from mother to fetus in the case of the mother's first infection during pregnancy. In these cases (0.1–0.7% of the European newborn children), 75% of the infections remain subclinical (with 15% having no damage, but up to 85% with chorioretinitis), 15% have mild symptoms (with 99% chorioretinitis, 1% brain damages), and 10% with severe clinical symptoms (85% brain damages, e.g., →[hydrocephalus](#), 15% perinatal death). The children of the first 2 groups appear mostly healthy after birth, but symptoms may occur later; eye diseases often start after 10 or even 20 years. →[Pathology](#)

## Prepatency

Period preceding first appearance of parasites in a host after transmission/inoculation of infectious stages.

## Prevalence

Indicates the total number of cases.

## Primaquine

→[Malaria](#)cidal Drugs.

## Primary Amebic Meningoencephalitis

→[PAME](#), infection of the brain with stages of the opportunistic amoeba →[Naegleria fowleri](#).

## Primary Cyst Wall

→[Tissue-Cyst](#).

## Prions

Protein-like infectious organizations (agents). They consist of cellular proteins (PrP<sup>c</sup>), that are transformed into an infectious, abnormal isoform (PrP<sup>Sc</sup>). After long incubation periods (years) so-called transmissible encephalopathies (TSE) may occur known under different names (→[BSE](#) = [bovine spongious encephalopathy](#) in cattle, →[Scrapie](#) in sheep, →[Creutzfeldt-Jacob Disease](#) in man). Transmission occurs by feeding undercooked (below 141°C) nerve/brain portions of infected animals or by eating contents of flies, that had fed on such material (experimentally proven in Scrapie-infections).

## Proboscides

→[Haplobothriidae](#).

## Proboscis

The →[praesoma](#) of →[Acanthocephala](#) usually consists of proboscis and →[neck](#).

## Probstmyiaria

Genus of the nematode order Ascaridida. *P. vivipara* is about 2–4 mm long and is found in rare cases in the caeca and colon of horses and was erroneously kept for an oxyurid worm.

## Procamallanus anguillae

Nematode of the family Camallanidae; synonym: *Spirocamallanus anguillae*. This species occurs in the intestine of the Indonesian eel *Anguilla bicolor* reaching a length as male of about 15 mm and 20–50 mm as female and is characterized by wide caudal alae.

## Proceroid

Second larva of fish tapeworm (e.g., →[Diphyllobothrium](#), →[Eucestoda](#)).

## Proctodaeum

→[Arthropoda](#).

## Procyclic Acidic Repetitive Protein

→[Glycosylphosphatidylinositols](#).

## Procyclin

Surface coat-protein developed by trypanosomatids inside their evertbrate vectors (→[Surface Coat/Protozoa](#)).

## Productivity Loss

Clinical symptom in animals due to parasitic infections (→[Alimentary System Diseases](#), →[Clinical Pathology, Animals](#)).

## Progenesis

Development of →[gametes](#) to maturation. If it occurs in larvae, it is called →[neoteny](#).

## Proglottids

→[Eucestoda](#).

## Prohaptor

→[Gyrodactylus](#), →[Polystomum integerrimum](#).

## Prokaryotes

Prokaryotes always occur as functionally single cells with no specialization. If prokaryotic organisms such as mycoplasma and bacteria do aggregate, they occur as chains or clusters of unspecialized cells. In contrast, →[eukaryotes](#) can consist of many cells functioning in a highly integrated fashion (→[Metazoa](#)). There are significant differences between the cellular components of eukaryotic and prokaryotic cells (→[Eukaryota/ Table 1](#)).

## Proleg

Abdominal protrusion (pseudopodium) of larvae of simuliids.

## Proline

→[Energy Metabolism](#).

## Promacyl

### Chemical Class

Carbamate.

### Mode of Action

Acetylcholine esterase inhibitor. →[Ectoparasiticides – Agonists and Antagonists of Cholinergic Transmission](#).

## Promastigote Surface Protease

→[Glycosylphosphatidylinositols](#), →[Proteinases](#).

## Promastigotes

Developmental stages of →[Trypanosoma](#) and →[Leishmania](#) spp.; their single flagellum is anchored at the apical pole.

## Promitochondrion

→[Energy Metabolism](#).

## Propamidine isethionate

Compound to cure keratitis in infections with →[Acanthamoeba](#) and →[microsporidiosis](#).

## Propenidazole

→[Antidiarrhoeal and Antitrichomoniasis Drugs](#).

## Propetamphos

### Chemical Class

Organophosphorous compounds (monothiophosphate).

### Mode of Action

Acetylcholine esterase inhibitor. →[Ectoparasitocides – Agonists and Antagonists of Cholinergic Transmission](#).

## Prophylaxis

### Name

Greek: *pro* = before, *phylax* = protect, prevent.

### General Information

Under this term all measurements, therapies, vaccinations, etc. are included that help to prevent an infection or the outbreak of a disease. Specific details are given in all enlisted diseases.

## Propoxur

→[Insecticides](#).

## Prosimulium

Genus of the dipteran family →[Simuliidae](#) (blackflies). Common species are *P. hirtipes* and *P. tomovaryi*.

## Prosthenorchis elegans

→[Acanthocephala](#).

## Prosthodendrium

Genus of the trematode family Cecithodendriidae, the species of which occur in insectivores, however, are also found in humans.

## Prosthogonimus macrorchis

Species of digenetic trematodes, the name which comes from Greek: *prosthenos* = at the tip, *hegone* = gonad.

### Life Cycle

[Fig. 1](#) (page 1195).

### Therapy

→[Trematocidal Drugs](#).

## Prosthogonimus pellucidus

Trematode of birds as *P. cuneatus*, →[Digenea](#).

## Prostigmata

→[Acarina](#).

## Prostriata

Subdivision of the hard →[tick](#) family →[Ixodidae](#) comprising about 245 species exclusively of the genus *Ixodes*. They are differentiated from the →[Metastriata](#) (= all other hard →[ticks](#) = 425 species) by the presence of anal grooves extending anterior to or surrounding the anus.

## Protandric Hermaphrodite

→[Rhabdias bufonis](#).

## Protandry

Male sexual products reach maturity prior to female ones inside →[hermaphrodites](#). →[Hermaphroditism](#).

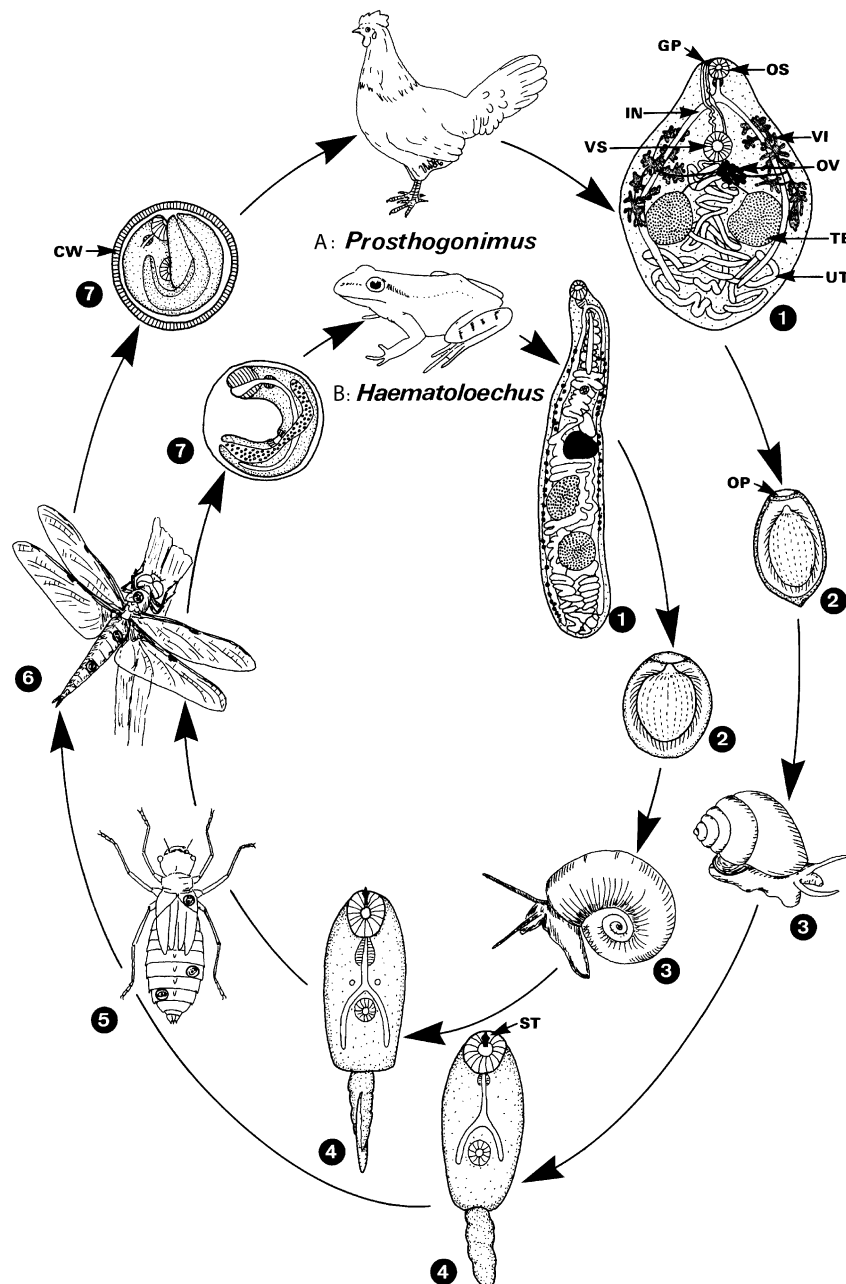

**Prosthogonimus macrorchis.** Figure 1 Life cycles of trematodes with xiphidiocercariae. **A** *Prosthogonimus macrorchis* (7–8 × 5–6 mm) parasitizes in the oviduct, in the bursa fabricii, and in the hindgut of chickens, ducks, and their relatives, and can decrease or even prevent egg laying. **B** *Haematoloechus* spp. (8 × 1.5 mm) are parasitic in the lungs of frogs and toads. 1 Adult worms. 2–4 Eggs are commonly passed with feces. They contain a fully developed miracidium, which, however, does not hatch in water. When they are swallowed by their intermediate hosts (*H. spp.* – *Planorbula*, *Planorbis*, *Lymnaea* spp.; *P. macrorchis* – *Amnicola* spp.) daughter sporocysts produce numerous short-tailed cercariae; their oral sucker is provided with a stylet. 5 When the feebly swimming cercariae pass by the posterior ends of the naiads of dragonflies, they may become sucked into the “anal lung,” from where they penetrate the thin cuticle and encyst nearby (as metacercariae; 7). 6, 7 When the naiad metamorphoses into a teneral and finally into an adult, the metacercariae remain encapsulated in the abdomen. Infections of final hosts occur when they swallow infected juvenile or adult dragonflies. Inside the final hosts the young worms reach the sites of final location by creeping (*H. spp.*, up the esophagus and down the trachea; *P. macrorchis*, from cloaca to the different places). CW, cyst wall; GP, genital pore; IN, intestine; OP, operculum; OS, oral sucker; O, ovary; ST, stylet of OS; TE, testis; UT, uterus with eggs; VS, ventral sucker.

## Proteinases

Like other eukaryotes, parasites require proteinases for the breakdown of exogenous and intracellular proteins as well as for the processing of primary translation products into mature proteins. All parasites contain multiple proteinases that have often unusual features and serve specialized functions related to the parasitic mode of life. These enzymes have been implicated not only with the amino acid supply for the parasite but also with various aspects of host–parasite relationships, including host cell and tissue invasion, parasite survival, and pathogenicity. They also play a role during excystation of protozoans as well as during egg hatching, larval molting, and developmental transitions of helminths. The developmentally regulated expression of various proteinases suggests that they possess specific functions within the individual life cycle stages. Because of their unusual structural features parasite proteinases are considered important as targets for novel antiparasite agents, and the immunodominant nature of many proteinases offers potential for serodiagnosis and vaccine development.

In protozoa, most widely distributed and highly active are the cysteine proteinases possessing cysteine residues at their active sites. Sequence analyses of cysteine proteinase genes have shown that, with a few exceptions, all of the protozoan enzymes resemble more closely mammalian cathepsin L and H than cathepsin B. The enzyme in *Trypanosoma brucei rhodesiense* and *T. b. brucei* is termed rhodesain and brucipain, respectively. Metalloproteinases have been detected in a variety of protozoans, including trichomonads and kinetoplastids, and serine proteinases were found in trypanosomatids and apicomplexans. Amongst parasitic protozoa, aspartic proteinases appear to be largely restricted to species of the latter parasites. A remarkable feature is the expression of proteinases on the surface of *Leishmania* sp. but also related trypanosomatids. The abundance of the major surface proteinase (MSP) of leishmanial parasites, alternatively termed GP63, PSP, and leishmanolysin, has been correlated with parasite virulence and implicated in several steps in the initiation of infection by promastigotes. It may also promote the intracellular survival of the phagolysosomal parasite. MSP is a zinc-containing metalloproteinase that is attached to the surface of the parasite via a glycosylphosphatidylinositol anchor, but is also found as intracellularly and extracellularly released forms. In *Leishmania*, MSP occurs as multiple distinct enzymes that are differentially expressed during the parasite's life cycle. The fact that MSPs are also found in other parasites with quite different lifestyles implies that there may also be

wide variation in their functions. The major proteinase of *T. cruzi* is a cysteine proteinase, called cruzipain, that shares sequence and specificity similarities with cathepsin L and papain. Cruzipain is composed of a family of closely related isoforms that are abundantly expressed throughout the parasite life cycle, accumulate in acidic lysosome-like organelles, and are released into the extracellular milieu by trypomastigotes. Cruzipain activity has been associated with the growth and differentiation of the parasite and the promotion of host cell invasion. The enzyme is also believed to be partially responsible for the mechanism used by the parasite to interfere with the host humoral immune response.

*Giardia* trophozoites contain multiple proteinases, many of which belong to the cysteine type. These enzymes may be required for the transition from cysts to trophozoites and for encystment. The continuous release of proteinases with high activity by trichomonads indicates that proteolysis may be important for the relationship of these parasites with their host tissues, such as the utilization of host proteins for nutrition or the destruction of immune components. *Entamoeba histolytica* produces multiple forms of cysteine proteinases (EhCPs), some of which have been implicated as important virulence factors in the pathogenesis of amebiasis. The major *E. histolytica* proteinases, EhCP1, EhCP2, and EhCP5, are localized in digestive vacuoles, but EhCP5 is also expressed on the surface of the trophozoite. Interestingly, functional genes homologous to genes encoding EhCP1 and EhCP5 are absent in nonpathogenic *E. dispar*. These observations together with several other *in vitro* and *in vivo* studies suggest that EhCP5 plays a major role in *E. histolytica*-induced pathology.

During the intraerythrocytic cycle of malaria parasites, hemoglobin degradation provides an abundant source of amino acids that can be used by the parasite during protein assembly. Hemoglobin digestion is initiated in the digestive vacuole by 2 aspartic proteinases termed plasmepsins I and II that cause the protein to unravel in the acidic environment, facilitating subsequent proteolytic cleavages. Two additional enzymes, a histo-aspartic proteinase and plasmepsin IV appear to contribute with a lower digestive capacity to the early cleavage process. Multiple cysteine proteinases (falcipains) and the metalloproteinase falcilysin are involved in further digestion of hemoglobin fragments into short peptides and free heme. The released toxic heme moiety is not recycled but is stored as an inert polymer, the malaria pigment hemozoin. Several proteinases have also been described for malaria parasites with potential roles in erythrocyte invasion and merozoite release.

All 4 major proteinase types have also been identified in helminths and many of them are found in the excretory/secretory products of nematodes and trematodes. The majority of helminth cysteine proteinases appears to belong to the cathepsin B rather than

cathepsin L class which are the predominant cysteine proteinases in protozoans. Cathepsin L type cysteine proteinases that are secreted by liver flukes may be involved in tissue penetration and nutrition of this parasite, but may also be relevant factors in the pathogenesis of fasciolosis. The major cathepsin B-like proteinase (Sj31) secreted by adult *Schistosoma japonicum* has recently been purified and shown to contain asparagine-linked *N*-glycans that are composed of mannose, acetylglucosamine, and *N*-acetyllactosamine. Sj31 is localized in the gut of the parasite and is believed to play the predominant role in the degradation of ingested proteins. Schistosomes also contain an aspartic proteinase that is capable of digesting hemoglobin and may therefore be responsible for the hydrolysis of this protein obtained from host erythrocytes. Serine and metalloproteinases, frequently secreted by nematodes and trematodes, have the capacity to digest a range of proteins including connective tissue proteins. Proteinases are also present in developmental stages of helminths, e.g., in eggs and cercariae of schistosomes. Molting and development of helminth larvae also depend on the expression and release of proteinases. Major functional aspects of these enzymes may be to assist in tissue invasion and escape from hosts.

## Proteins

Investigations into the nature of parasite proteins still lag far behind our knowledge of bacterial and mammalian proteins. However, an immense number of proteins have been purified from different parasite species and their physical and biochemical properties characterized. These proteins include many enzymes, cytoskeletal and other structural proteins, eggshell and surface proteins, and regulatory proteins. Particular emphasis has been placed on enzymes, surface proteins of protozoan parasites, and tegumental proteins of helminths. A variety of proteins have been crystallized and their three-dimensional structure determined. Studies on parasite membrane proteins not only serve for a better understanding of the intimate interplay that exists between parasites and their hosts but are also of importance because of their potential for serodiagnosis and immunoprophylaxis. Another significant area of research is related to the protein polymorphism which exists within morphologically similar parasite species. This has been frequently applied in differentiating parasite species, strains, and isolates, and estimating parasites' phylogenetic relationships. More details on the structure and properties of specific parasite proteins, including possibilities for their exploitation in antiparasite

chemotherapy, are discussed in other chapters, where their functions are considered. Although few details of protein biosynthesis in parasites are available, the basic mechanism of this process seems to be very similar or identical to that described for higher organisms.

The sequence completion of the genomes of a variety of medically important parasite species has allowed major progress in exploring the proteome of parasites using two-dimensional gel electrophoresis, mass spectroscopy, and database searching. These new sets of tools have offered new information on the protein composition of some parasite species and have enormous potential to further increase our knowledge on the structure and function of proteins and their interactions within living parasite cells. Proteomics may also allow us to better understand the parasite-derived mechanisms of infectivity and virulence and to identify new proteins as targets for drug action.

## Protein-Synthesis-Disturbing Drugs

### Structures

Fig. 1.

### Emetine/Dehydroemetine

#### Synonyms

Cephaeline methyl ether/2,3-dehydroemetine, 2-dehydroemetine, Mebadin.

#### Clinical Relevance

Emetine and dehydroemetine exert activities against a wide variety of pathogens such as bacteria, protozoans, →trematodes, and →fungi. In addition, they have antiviral activities which are directed against *Herpes zoster* infections and those →flaviviridae causing →tickborne encephalitis.

The antiprotozoal activity of both drugs is directed against invasive intestinal and extraintestinal stages of →*Entamoeba histolytica* (Magna forms) resulting in a quick clinical improvement (→DNA-Synthesis-Affecting Drugs I/Table 1). The drug level in the liver is sufficiently high for damaging *E. histolytica* liver stages. However, both drugs possess severe side effects and therefore have only limited medical use. They induce a direct destruction of tissue →trophozoites (intestine, liver), however, they have no effect against "Minuta" forms in the gut lumen or cysts. In general, higher cure rates are achieved by application of combinations of (dehydro)emetine and chloroquine or (dehydro)emetine and 5-nitro-imidazoles. In veterinary medicine there exist positive experiences in the treatment of *E. invadens* infections in reptiles with dehydroemetine. There are reports about some activity of emetine



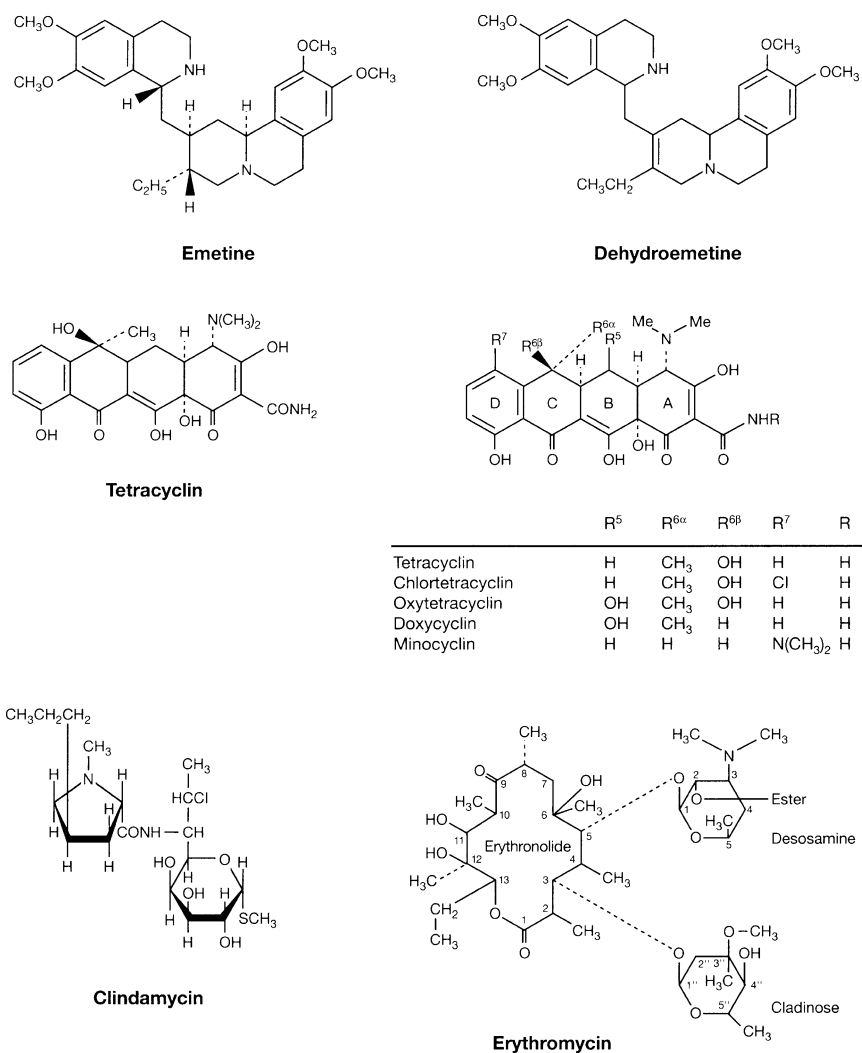

**Protein-Synthesis-Disturbing Drugs. Figure 1** Structures of anti-parasitic drugs affecting protein synthesis.

against *Leishmania tropica* and *L. major* infections as well as *in vitro* activity against *Blastocystis hominis*.

The antitrepatodal activity of emetine is restricted to *Schistosoma japonicum*, *S. haematobium*, and *Fasciola hepatica*. In veterinary medicine both drugs exert activity against *F. hepatica* in sheep at higher dosages. Thereby the drug is more active after intravenous than after intramuscular application. However, the antitrepatodal efficacy is uncertain. Because of a variety of severe side effects the drugs were quickly replaced by safer drugs.

Further indications of (dehydro)emetine are pulmonary aspergillosis and they may be useful against scorpion stings.

#### Molecular Interactions

Emetine as the active principle was isolated from roots of the South- and Central American *Rubiaceae*

*ipeacuanha*. The (-)-emetine enantiomer possesses the specific amoebacidal activity whereas the (+)-emetine is much less effective. Emetine is accumulated in the liver. It is proposed that the eukaryotic protein synthesis becomes inhibited. Indeed, there is a correlation between amoebacidal activity and inhibition of translation by various emetine-derivatives. On the molecular level there is an irreversible, but noncovalent binding to the peptide-chain elongation site of the 60S subunit of ribosomes. It is assumed that a unique region within the emetine molecule may be responsible for its irreversible binding. The selective toxicity against *E. histolytica* compared to the vertebrate host is explained by a more slow recovery of the parasites from inhibition of protein synthesis compared to the situation in mammalian cells. In mammalian cells binding of emetine occurs to protein S14 of the 40S ribosomal subunit. Thereby the elongation factor 2-dependent translocation is prevented.

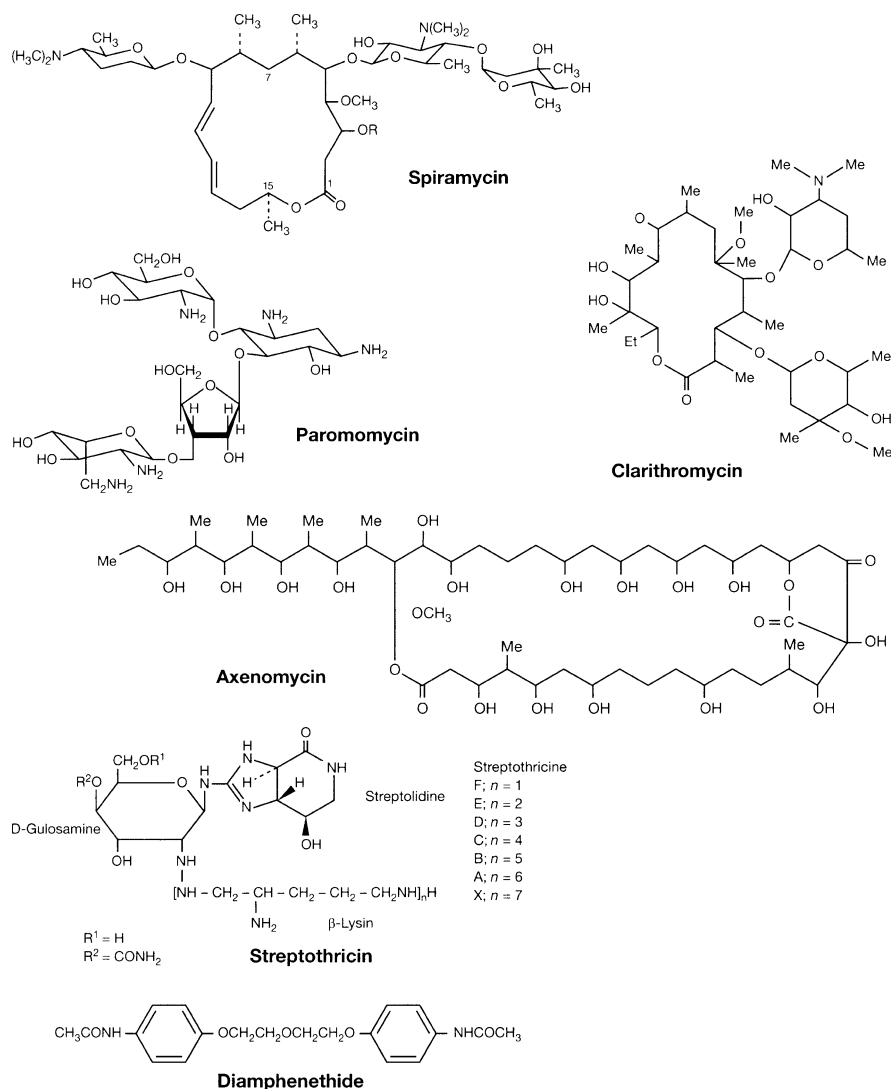

**Protein-Synthesis-Disturbing Drugs. Figure 1** Structures of anti-parasitic drugs affecting protein synthesis (Continued)

### Resistance

There is a correlation between resistance against emetine and resistance to cycloheximide, an inhibitor of protein synthesis. It could be shown that the emetine resistance is due to a mutation and not to any post-translational modification. After cloning and sequencing of mRNA coding for emetine resistance and mutagenization of *E. histolytica* and selection of a clone resistant to emetine it could be shown that overexpression of a P-glycoprotein homologue may be responsible for resistance. This resembles the multidrug-resistance (MDR) phenotype, as there is cross-resistance to hydrophobic drugs, increased efflux of emetine and reversal of resistance by verapamil. Thus, it is very likely that a protozoan P-glycoprotein is involved in emetine resistance. In the meantime, emetine-resistant

mammalian cells could be isolated and an emetine-resistant *Caenorhabditis elegans* strain was detected in which P-glycoprotein genes were overexpressed.

### Tetracyclines

#### Important Compounds

Tetracyclin, Doxycyclin, Minocyclin, Oxytetracyclin, Chlortetracyclin.

#### Synonyms

Tetracyclin: Deschlorobiomycin, Tsiklomitsin, Abricycline, Achromycin, Agromicina, Ambramicina, Bio-Tetra, Bristaclicina, Cefracycline suspension, Criseolicina, Cyclomycin, Democracin, Hostacyclin, Omegamycin, Panmycin, Polycycline, Purocyclina, Sanclomycine, Steclin, Tetrabon, Tetracyn, Tetradecin.

Doxycyclin:  $\alpha$ -6-deoxy-5-hydroxytetracycline monohydrate, GS-3065, Doxitar, Liviatin, Vibramycin, Vibravenös.

Minocyclin: none.

Oxytetracyclin: Glomycin, Terrafungine, Riomitsin, Hydroxytetracycline, Berkmycin, Biostat, Imperacin (tablets), Oxacyclin, Oxatets, Oxydon, Oxy-Dumocyclin, Oxymycin, Oxypan, Oxytetracid, Ryomycin, Stevacin, terraject, Terramycin, Tetramel, Tetran, Vendarcin, Vendracin.

Chlortetracyclin: 7-chlorotetracycline, Acronize, Aureocina, Aureomycin, Biomitsin, Biomyacin, Chrysomykin; (in combinations): Verman, Salmocarp.

### Clinical Relevance

The main indication of tetracyclines is their general antibacterial activity. This is directed against numerous gram positive, gram negative bacteria, mycoplasma, chlamydia, and rickettsia.

**Tetracyclin** is especially used against chronic bronchitis (*Haemophilus influenzae* and others), atypical pneumonia caused by mycoplasma, *Chlamydia psittaci* (=ornithosis) infections, *Coxiella burnetii* (= **Q Fever**) infections, nongonorrhoeic urethritis caused by *Chlamydia trachomatis*, mycoplasmas, ureaplasmas, Lymphogranuloma inguinale, prostatitis, Acne vulgaris, Lyme **→borreliosis** with penicillin **→allergy**, Cholera, heavy shigellosis, yersiniosis, pseudotuberculosis; aerobic-anaerobic mixinfections such as Morbus Whipple or actinomycosis with penicillin allergy and septicemia caused by brucellosis, leptospirosis, tularaemia, rickettsiosis, melioidosis, pest. Tetracyclines have been known of since 1948.

**Doxycyclin** was explored in 1967. It is used for prophylaxis against plasmodia in cases of resistance against the usual drugs as alternative drug to mefloquine or atovaquone/proguanil (**→Hem(oglobin) Interaction/Fig. 2, Table 1**). Moreover, doxycyclin is used for treatment of onchocercosis by killing the symbiotic *Wolbachia* bacteria inside the parasites.

**Minocyclin** was explored in 1967. The antibacterial activity is used against individual forms of acne, nocardiosis, and infections with sensitive atypical mycobacteria. In addition, it is used against plasmodia in cases of resistance against the usual drugs.

**Oxytetracyclin** has been known of since 1950. The antibacterial activity is directed against *Vibrio cholerae* and enteritis bacteria. In addition, oxytetracyclin is used against plasmodia in cases of resistance against the usual drugs. It can also be used against gut lumen forms of *Entamoeba histolytica* because of its low resorption.

**Chlortetracyclin** has been known of since 1947. The antimalarial activity is directed against exoerythrocytic schizonts in the liver (**→Hem(oglobin) Interaction/Fig. 2**). For a long time chlortetracyclin was the only drug

with prophylactic activity on *T. parva* infections. The activity is directed against schizonts in lymphocytes. There is also additional anticoccidial activity.

### Molecular Interactions

It has been known for a long time that tetracyclines inhibit bacterial protein synthesis. Thereby, tetracyclin is bound preferentially to the small ribosomal subunit, but also binds to the 50S ribosomal subunits. The binding of amino acid charged tRNA is inhibited resulting in the prevention of chain elongation of the nascent peptide chain. Tetracyclin interferes with the binding of aminoacyl-t-RNA at the acceptor site of ribosomes at the interphase between the large and small subunit of bacterial 70S ribosomes.

The antiprotozoal activity of tetracyclin is directed against **→Giardia lamblia**. A combination of quinine and tetracyclin is used against chloroquine-resistant plasmodia. Thereby, the action is directed against exoerythrocytic and erythrocytic schizonts (**→Hem(oglobin) Interaction/Fig. 2**). In addition, tetracyclin is active against **→Balantidium coli**. Here the activity is directed against trophozoites in the intestine, which divide by **→binary fission**, and cysts in the feces. The mechanism of antiprotozoal action of tetracyclin may be similar to the antibacterial action, but the real target site(s) and mechanism(s) of action remain(s) unclear.

The action of doxycyclin, minocyclin, oxytetracyclin, and chlortetracyclin is directed against exoerythrocytic schizonts (**→Hem(oglobin) Interaction/Fig. 2**). The **→mode of action** is presumably identical with that of tetracyclin.

### Lincosamides

#### Important Compounds

Clindamycin.

#### Synonyms

Clindamycin: n7(S)-chloro-7-deoxylincomycin, U-21 251, Cleocin, Dalacin C, Sobelin.

### Clinical Relevance

The main indication of lincosamides relies on their antibacterial activity. It is used especially in patients with penicillin/cephalosporin allergy, after an initial therapy with a penicillin/aminoglycoside combination against intraphagocytic persistent bacteria, in chronic osteomyelitis, against anaerobic bacteria accompanying polymicrobial mixed infections (pelveoperitonitis, aspiration **→pneumonia**).

The antibacterial activity of clindamycin comprises furunculosis, erysipelas, tonsillitis, **→abscess** with penicillin allergy, acute infections with anaerobic bacteria (adnexitis, liver abscess, beginning aspiration pneumonia), curative therapy of osteomyelitis, and endocarditis **→prophylaxis** with penicillin allergy.

**Clindamycin** is the only lincosamide which possesses additional antiprotozoal activity. Thus, it has some activity against *Entamoeba histolytica*, and it is effective against →*Neospora caninum* →tachyzoites in cell cultures (→DNA-Synthesis-Affecting Drugs IV/Table 2). The combination clindamycin and sulfonamide is highly effective against →neosporosis. Also the multi-drug combination of pirithrexim, clindamycin, diclazuril, robenidine, and pyrimethamine is experimentally active against neosporosis (→DNA-Synthesis-Affecting Drugs IV/Table 2). In combination with →trimethoprim and →sulfamethoxazole, clindamycin is highly effective against human toxoplasmosis. Clindamycin can also be used as an antimalarial drug, especially in cases of resistance against the common drugs. The combination of clindamycin and quinine exerts antibabesial activity.

### Molecular Interactions

Clindamycin acts as a peptidyl transferase inhibitor. It binds to the 50S subunit of bacterial ribosomes. This mechanism of action is assumed to be the same in plasmodia and →babesia. The activity is directed against erythrocytic schizonts (→Hemoglobin Interaction/Fig. 2). In *in vitro* cell cultures and in *in vivo* assays clindamycin prevents replication of →*Toxoplasma gondii*, but does not inhibit protein labelling as does cycloheximide. However, PCR amplification of total *T. gondii* DNA identified an additional class of prokaryotic-type ribosomal genes, similar to the plastid-like ribosomal genes of the →*Plasmodium falciparum*. Ribosomes encoded by these genes are predicted to be sensitive to the lincosamide/macrolide class of antibiotics, and may serve as the functional target for clindamycin, azithromycin, and other protein synthesis inhibitors in *T. gondii* and related parasites.

### Makrolide Antibiotics

#### Important Compounds

Erythromycin, Spiramycin, Clarithromycin, Azithromycin.

#### Synonyms

Erythromycin: none.

Azithromycin: none.

Spiramycin: Rovamycin, Selectomycin, Suanovil, Sequamycin, RP5337, Foromacidin, Rovamicina, Provamycin.

Clarithromycin: none.

#### Clinical Relevance

The main activity of the macrolide antibiotics is their antibacterial activity. They are used as alternatives for penicillin in A-streptococcosis (tonsillitis, erysipelas, prophylaxis of rheumatic fever, scarlet, diphtheria). They are useful against lues and gonorrhea in cases of penicillin allergy. They are alternatives for aminopenicillin in the treatment of otitis media, sinusitis,

tracheobronchitis, beginning pneumonia; pertussis. In addition they are alternatives for ampicillin in the treatment of listeriosis. As alternatives for tetracyclines they can be used in the treatment of interstitial nonviral pneumonia caused by mycoplasmas, chlamydia, rickettsia, nongonorrhoeic urethritis, Acne vulgaris, *Mycobacterium-marinum*-infections of the skin; *Legionella pneumonia*. Furthermore they can be used in the treatment of *Campylobacter-jejuni*-enteritis.

**Erythromycin** has been known of since 1952. The antibacterial activity is directed against gram positive bacteria, small gram negative bacteria (*Neisseria*, *Haemophilus*, *Bordetella*, *Legionella*, *Brucella*, anaerobic bacteria), mycoplasma, chlamydia, rickettsia, *Treponema*, →*Borrelia*, and *Campylobacter*. The antiprotozoal activity of erythromycin is directed against *Giardia lamblia* (→DNA-Synthesis-Affecting-Drugs II Table 1).

**Spiramycin** has a less antibacterial activity compared to erythromycin or azithromycin. As antiprotozoal drug spiramycin has activity against *Toxoplasma gondii* as only indication. It can be used in the treatment of acute →prenatal toxoplasmosis up to the 20th week (→DNA-Synthesis-Affecting Drugs IV/Table 2).

**Clarithromycin** is used in combination with a sulfonamide with good activity against human toxoplasmosis (→DNA-Synthesis-Affecting Drugs IV/Table 2), however, the tolerability is low. Clarithromycin leads to significant reductions in *Cryptosporidium parvum* burdens in rodent models. A pretreatment with this drug for a possible prevention of cryptosporidiosis is under investigation. Clarithromycin is useful against peptic ulcers caused by *Helicobacter pylori* in combination with metronidazole and amoxicillin, and/or omeprazole (→Antidiarrheal and Antitrichomoniasis Drugs).

**Azithromycin** is used against *Giardia lamblia*, and shows potent activities against *Cryptosporidium parvum* in tissue cultures and in rodent models. Furthermore, this drug is active against →*Plasmodium* spp. It concentrates intracellularly and tissues with a serum half-life of 2.4 days. In mice it is more active against the hepatic stage of *P. yoelii* and against the erythrocytic stage of *P. berghei*. A pilot study from the Walter Reed Army Institute of Research showed the prophylactic efficacy of azithromycin against *P. falciparum* at an oral dose of 500 mg followed by 250 mg daily for seven more days. The drug seems to be as active as doxycycline.

### Molecular Interactions

The molecular level of bactericidal activity of erythromycin and azithromycin is the inhibition of protein synthesis in the elongation phase of polypeptides at the 50S subunit of bacterial 70S ribosomes. Thereby, the translocation of peptidyl-t-RNA from the acceptor to the donor site is inhibited.

The antiprotozoal activity of erythromycin is directed against  $\rightarrow$ *G. lamblia*. Thereby, the action in giardiasis is presumably indirect. The intestinal bacteria, which serve as a food supply for trophozoites in the small intestine, are eliminated by this antibiotic.

The mechanism of action of spiramycin is the inhibition of bacterial protein synthesis similar to that of erythromycin. Thereby, the polypeptide positioning at the exit channel of ribosomes becomes presumably disturbed. The action is directed against the center of peptidyltransferase by inhibition of the peptide bond formation.

The mode of action of clarithromycin is presumably similar to that of erythromycin, spiramycin, or azithromycin.

The mechanism of action of azithromycin is presumably similar to that of erythromycin. In *T. gondii* there is a distinct class of prokaryotic-type ribosomal genes encoding ribosomal proteins which may be a target of azithromycin, clindamycin, and other protein synthesis inhibitors.

### Aminoglycoside Antibiotics Important Compounds

Paromomycin.

#### Synonyms

Paromomycin: Aminosidina, Humatin.

#### Clinical Relevance

Aminoglycoside antibiotics possess a broad-spectrum activity. They have primarily bactericidal activity and are useful in the indications tuberculosis, Endocarditis lenta, gonorrhoea, and acute septic infections.

**Paromomycin** was isolated in 1959. It is a  $\rightarrow$ fermentation product of *Streptomyces rimosus* var. *paromomycinus*. The antibacterial activity is directed against gram-positive and gram-negative bacteria. It is active against *Pseudomonas aeruginosa*, and enterobacteriaceae resistant against other antibiotics. It is used to reduce the aerobic bacterial gut flora preoperatively in patients with granulocytopenia or coma hepaticum.

Paromomycin is the only member of the aminoglycoside antibiotics with useful antiparasitic activity. It is active against *Giardia lamblia* ( $\rightarrow$ DNA-Synthesis-Affecting Drugs I/Table 1) and intestinal *Entamoeba histolytica*, and experimentally active *in vitro* and *in vivo* against antimony-susceptible and -resistant  $\rightarrow$ *Leishmania* strains. In the treatment of cryptosporidiosis a combination of letrozuril and paromomycin shows some promising results ( $\rightarrow$ DNA-Synthesis-Affecting Drugs IV/Table 2). Paromomycin is the most consistently effective anticryptosporidiosis agent, but

its curative effects in  $\rightarrow$ AIDS cryptosporidiosis is erratic. An inhalation therapy with paromomycin is reported to be successful in human respiratory tract cryptosporidiosis. Clinical trials with letrozuril have now been stopped by the manufacturer. Cryptosporidiosis in young and older cats, cattle, sheep, pigs, and poultry can be successfully treated with paromomycin. The particular localization of cryptosporidia is in general responsible for difficulties in treatment since they are located intracellularly but extracytoplasmatically in the striated border of intestinal mucosa cells. Paromomycin exerts some activity against plasmodia, and there are only few reports on effects of paromomycin on  $\rightarrow$ microsporidiosis ( $\rightarrow$ *Enterocytozoon bieneusi*) in AIDS.

Moreover, paromomycin exerts activities against  $\rightarrow$ cestodes (e.g., *Taenia saginata* and *Hymenolepis nana*). The medical application is, however, limited because of the availability of alternative highly effective drugs. The main disadvantages of paromomycin are the long duration of treatment and often side effects.

#### Molecular Interactions

The antibacterial action of paromomycin relies on the binding of paromomycin to 30S subunits of ribosomes. This results in misreading during protein synthesis and the appearance of nonsense proteins.

The antiprotozoal action of paromomycin is presumably the inhibition of protein synthesis. The real mechanism of action is, however, completely unknown in cryptosporidiosis. Paromomycin affects intracellular but not extracellular parasites. This can presumably be explained by the entry of paromomycin into the intracellular cryptosporidia via overlaying apical host membranes.

The anticestodal mechanism of action is unknown. It is assumed that the action against *T. saginata* is possibly due to a disruption of the tegumental membrane thus making the parasite susceptible to the host's digestive system.

### Glutarimide Antibiotics Important Compounds

Axenomycin.

#### Clinical Relevance

Axenomycin is a fermentation product of *Streptomyces lisandri*. It has an anticestodal activity against *Hymenolepis nana*, *Taenia pisiformis*,  $\rightarrow$ *Diphyllobothrium* spp. and  $\rightarrow$ *Dipylidium caninum*.

#### Molecular Interactions

The mechanism of action is due to an inhibition of EF2- and GTP-dependent translocation of peptidyl-t-RNA from the ribosomal A- to the P-site.

## Glycopeptide Antibiotics

### Important Compounds

Streptothricin.

### Clinical Relevance

Streptothricin has been known of since 1943. It is a fermentation product of *Streptomyces griseocarneus*. The anticestodal activity is directed against *Taenia pisiformis*, →*T. taeniaeformis*, *T. hydatigena*, and at higher dosages against *Dipylidium caninum*.

### Molecular Interactions

The mechanism of action is due to an interaction with protein-synthesis.

## Diamphenethide

### Synonyms

Diamphenetide, Coriban.

### Clinical Relevance

Diamphenethide was explored in 1973. It exerts exclusively antitrepatodal activities. It is a unique fasciolidal drug with higher activity against juvenile than against adult *Fasciola hepatica* (→[Energy-Metabolism-Disturbing Drugs/Table 1](#)), being even active against 1-day-old →[flukes](#). The drug also has high efficacy against early immature flukes up to 6 weeks after infection. Thus, diamphenethide is probably successful for suppression of fasciolosis by regular treatments during periods with expected high contamination with →[metacercariae](#) at intervals of 6 weeks. Thereby, much of the liver damage caused by migrating →[liver flukes](#) can be prevented. Diamphenethide is regarded as an alternative drug with respect to resistance against other fasciolicides with activity against immature flukes. In addition, diamphenethide has some activity against →[Dicrocoelium dendriticum](#).

### Molecular Interactions

Diamphenethide is a phenoxyalkane-derivative. It is a prodrug which is converted by deacetylation in the host liver to the active amine compound which exerts flukicidal activity. Locally high concentration in the liver is necessary for activity against juvenile flukes. There is an age-related onset and severity of changes in the tegumental and gut cells of the flukes caused by diamphenethide. Flukes with increasing age become less susceptible to the drug. Paralysis of worms begins within 1.5–2 hours after drug exposure, surface alterations are detectable from 3 hours onwards, internal tegumental changes are seen after 6 hours and →[tegument flooding](#) begins after 9 hours. An inhibition of protein synthesis is measurable from 6 hours onwards. These changes are observable at a drug concentration of 10 µg/ml near the maximum *in vivo* blood level. Indeed,

there is a correlation between inhibition of protein synthesis and high activity of diamphenethide against juvenile flukes. The juvenile flukes are characterized by a very active phase of growth and differentiation accompanied by a higher demand of production of tegumental secretory bodies and glycocalix turnover in juvenile flukes compared to adult flukes. The inhibition of protein synthesis is a novel mode of action for modern fasciolicides. The formerly used emetine is the only other drug against liver fluke infections in rodents, sheep, and man which acts as inhibitor of protein synthesis. Emetine is also only active against intrahepatic juvenile flukes, but not against adult flukes in the bile duct. Thus there are similarities between the diamphenethide and emetine action.

Furthermore, other metabolic events are induced by the diamphenethide action. Thus, malate levels become elevated after 3 hours, end-product formation (acetate, propionate, lactate) is increased between 6–24 hours and ATP levels decrease by 47% after 24 hours. The drug-induced paralysis of the flukes leads to a starvation of the worms. The neuromuscular effect is the quickest event in the diamphenethide action, but the neuromuscular action on the molecular level itself is still unclear.

## Proteinuria

Symptom of disease in →[babesiosis](#).

## Proteocephalus ambloplites

Tapeworm of fish. →[Eucestoda](#).

## Proteromonadida

### Classification

Order of →[Mastigophora](#).

### General Information

The members of this group are found inside the rectum and →[cloaca](#) of reptiles and are characterized by the presence of 1 or 2 pairs of heterodynamic →[flagella](#) which have no →[paraxial rod](#). A large mitochondrion surrounds the single nucleus, being closely related to a rhizoplast and a →[Golgi apparatus](#). Transmission occurs by means of fecally passed cysts.

## Proterosoma

### Name

Greek: *protero* = anterior, *soma* = body.

This term describes the first and second portion (Gnathosoma) and the Propodosoma as anterior portions of the body of →[Acari](#).

## Protists

This group comprises exclusively unicellular eukaryotic organisms that may be phototrophic, autotrophic or heterotrophic (→[Protozoa](#)). Protists have followed many evolutionary paths in the development towards multicellularity and the following protists represent intermediate or remnant steps in this process: (1) protist forms with many nuclei per cell; (2) stable, double-nucleated forms, such as *Giardia*; (3) forms with cell aggregation including some green algae, like *Volvox*; (4) forms with chains of dividing organisms, e.g., →[Microspora](#); and (5) forms that have multicellular stages, e.g., →[Myxozoa](#). It may be preferable to group the Myxozoa with the →[Metazoa](#), rather than with the protists or to use other systematic approaches (→[Classification](#)).

## Protococcidia

Group of →[Coccidia](#) (→[Apicomplexa](#)) that have no schizogonic reproduction according to American authors. In French literature such coccidians are called →[Eucoccidia](#). This term, however, now characterizes the typical Coccidia with →[schizogony](#).

## Protogyny

Female →[gametes](#) reach maturity prior to their male counterparts (→[Hermaphroditism](#)).

## Protomerite

→[Gregarines](#).

## Protonephridium

Excretory organ present in Platyhelminthes, Nematoda, Rotifera, and some trochophore larvae (→[Platyhelminthes/Excretory System](#)). The basic component is the →[terminal cell](#) (→[Cyrtocyte](#)).

## Protonymph

The first of up to 3 →[nymphal stages](#) found in mites (→[Mites/Ontogeny](#)). Normally the protonymph represents a free-living active stage; it is usually found on the same (or a similar) substrate as the subsequent stage, but non-feeding protonymphs may also occur.

## Protophormia terranova

Blue blowfly, →[Muscidae](#). This fly is 8–12 mm long, deep blue with black legs.

## Protoscolex

Spherical larval (= young) stage of →[Echinococcus](#) species formed during asexual budding processes inside the →[hydatids](#) or →[alveococcus](#) cysts inside the intermediate hosts ([Figs. 1, 2](#), page 1205, →[Echinococcus/Fig. 1](#)).

## Protostrongylus

→[Lungworms](#), →[Nematodes](#).

## Protozoa

### Classification

Subregnum of Animalia.



**Protoscolex. Figure 1** LM of an evaginated protoscolex showing the anlagen of the scolex with a hook-crown and the first proglottis.

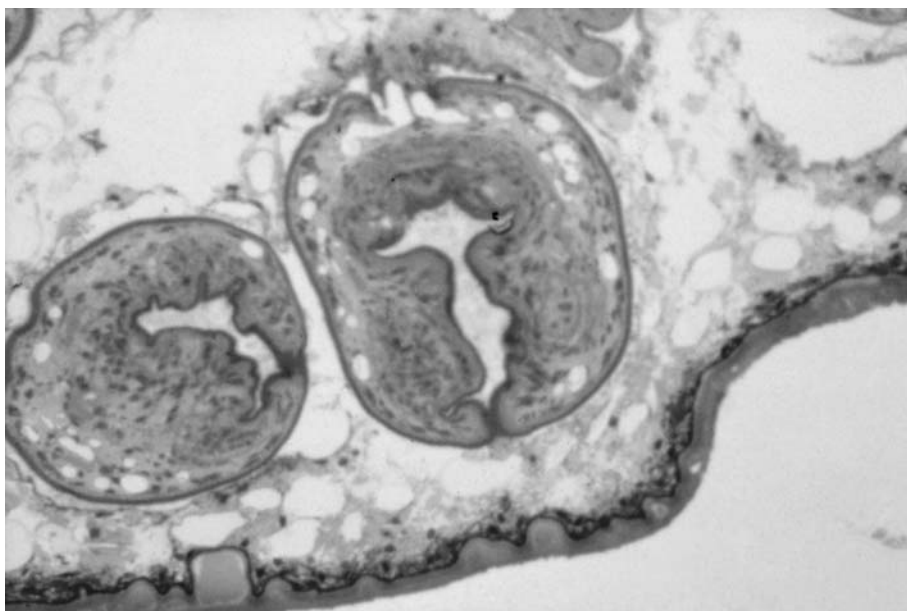

**Protoscolex. Figure 2** LM of a section through the periphery of an *Echinococcus*-cyst showing sections of 2 protoscolices with still invaginated suckers and hooks.



## General Information

The Protozoa are named after the *Greek* term for first (*proto*) and animal (*zoon*). Their size varies greatly, ranging from a few micrometers (e.g., *Cryptosporidium* or →*Plasmodium*) up to several millimeters (e.g., →*gregarines* or opalans). They are all organized according to the basic pattern of the eukaryotic cell, the same type being found in all metazoan cells. They are heterotrophic, lacking the ability to use light and inorganic materials to obtain energy and to synthesize structural components. Therefore, they must obtain preformed organic compounds and on this basis may be considered to be animals. Apart from a few sedentary species, most Protozoa are motile. Because they have difficulty in retaining water, due in part to their small size, most live in aquatic (or at least moist) environments. Although the majority of Protozoa are free-living, many species are mutualists, commensals, or true parasites. Some are highly pathogenic to their plant or vertebrate hosts and hence are relevant to veterinary and human medicine and agriculture.

## System

Classification of the Protozoa remains in flux, as new data continue to be obtained. According to the systematics of Levine et al. which, however, are not generally accepted, the Protozoa are considered as a subkingdom divided into 7 phyla of which only the first 5 include parasitic stages to be considered in this book (recently approaches to classify protozoans see →*Classification*, →*Phylogeny*):

- Phylum: →*Sarcomastigophora* (25,000 recent species)
- Phylum: →*Apicomplexa* (→*Sporozoa*) (4,800)
- Phylum: →*Microspora* (800)
- Phylum: →*Myxozoa* (875)—now considered as metazoa
- Phylum: →*Ciliophora* (7,500)
- Phylum: →*Ascetospora* (30)
- Phylum: →*Labyrinthomorpha* (35)

## Nutrition

→*Nutrition of Endoparasites/Protozoa*.

## Tissues

The lesions produced by tissue protozoan infections generally are not diagnostically distinctive. Morphologic identification of the individual tissue protozoan is necessary, usually by light microscopy or aided by ultrastructural examination. This not only enables the different protozoans to be distinguished, but allows many other pathogenic microbes and non-microbial lesions to be considered histopathologically in the differential diagnosis.

The main distinguishing features of tissue-inhabiting protozoans are reviewed and contrasted in *Table 1* and *Table 2*. *Toxoplasma gondii* (→*Toxoplasmosis, Man*) and →*Sarcocystis* spp. (→*Sarcosporidiosis, Man*) form similar cysts which, when intact, are not accompanied by an →*inflammatory reaction* (→*Pathology/Fig. 5*). The ultrastructural characteristics of the cyst wall can be used definitively to separate the 2 genera (→*Pathology/Figs. 8, 9*). The →*microsporidia* →*Encephalitozoon* and *Nosema* (→*Microsporidiosis*) can be distinguished because their →*spores* are acidfast, Gomori methenamine silver positive (GMS), contain one PAS-positive granule, and a coiled →*polar filament* that can be seen with ultrastructural examination. All these are lacking in →*T. gondii*, which, however, contains as the *Sarcocystis* spp. many PAS-positive granules in each cyst organism. Furthermore, they possess an →*apical complex* visible with ultrastructural examination. The leishmanias (→*Leishmaniasis, Man*) and trypanosomatids (→*Trypanosomiasis, Man*) can be distinguished from all the others by their →*kinetoplast*.

Legend *Table 2*: RES, Reticuloendothelial system; EM, by electron microscopy; + positive finding; – negative finding; ( ) slight or rare; absence of symbol – variable, non-diagnostic; ± variable, diagnostic.

## Proventriculus

→*Insects*, portion of the gut, →*peritrophic membrane*.

## Protozoan Infections, Man

Protozoan parasites (*Table 2*) may introduce in humans and animals a variety of more or less severe diseases, the clinical symptoms of which are strongly correlated to the pathogenic effects (listed in *Tables 1, 2*, pages 1207, 1208) and their location (in tissues, lumens, blood).

## Prowazek, Stanislaus von (1875–1915)

Co-worker of Robert Koch, famous for his works (transmission by lice) of liceborne spotted fever (→*Rickettsia prowazekii*); he died from a laboratory infection with this agent of disease (*Fig. 1*, page 1209).

**Protozoan Infections, Man. Table 1** Intestinal and other lumen-dwelling protozoans of man (according to Frenkel)

	Size ( $\mu\text{m}$ )		No. of nuclei in cyst	Usual location	Pathogenicity	
	Trophozoite	Cyst			Effects	Inflammatory reaction
<i>Entamoeba histolytica</i>	8–30	10–20	1–4	Colon	Ulceration, liver abscess	Eosinophils, Charcot-Leyden crystals; granulation tissue; bloody stool
<i>E. hartmanni</i>	4–12	5–10	1–4	Colon?	None	None
<i>E. coli</i>	15–15	10–35	1–8	Lumen, colon	None	None
<i>E. gingivalis</i>	5–20	None	–	Mouth	None recognized	Suppuration
<i>Endolimax nana</i>	6–15	5–14	1–4	Cecum, colon	None	None
<i>Iodamoeba buetschlii</i>	8–20	5–20	1	Cecum, colon	None	None
<i>Dientamoeba fragilis</i>	3–18	None	1–4	Cecum, colon	Diarrhea (?), abdominal discomfort	Mucus
<i>Blastocystis hominis</i>		5–30	Several		None	
<i>Acanthamoeba</i> spp.	10–45	7–25	1	Exogenous, pharynx	Keratitis, necrosis, meningoencephalitis, abscesses	Macrophagic and granulomatous
<i>Naegleria fowleri</i>	7–20	7–10	1	Exogenous invader	Meningoencephalitis	Hemorrhagic necrosis, little inflammation
<i>Trichomonas tenax</i>	5–12	None	–	Mouth	Commensal, lung abscess?	? None
<i>T. hominis</i>	5–14	None	–	Colon	None	None
<i>T. vaginalis</i>	5–23	None	–	Vagina, prostate gland	Pruritus, discharge, dysuria, cervical erosion, prostatitis, urethritis	Mucus, neutrophils, desquamating epithelia
<i>Giardia lamblia</i> group	5–21	8–12	2–4	Duodenum	Epigastric pain, flatulence, diarrhea, steatorrhea, blunting of villi, microvillar border damage	Neutrophils, lymphocytes
<i>Balantidium coli</i>	40–200	45–75	2	Colon	Diarrhoe, ulceration, abscess, necrosis	
<i>Cystoisospora belli</i>		10–19 $\times$ 20–23 <sup>b</sup>	8 <sup>b</sup>		Abdominal discomfort, fever, diarrhea	Neutrophils, lymphocytes
<i>Cryptosporidium</i> spp.	2–5	4–5	4 <sup>b</sup>	Entire intestine (bile duct, trachea)	Diarrhea	None, or lymphocytes
<i>Sarcocystis sui/hominis</i>		9 13 <sup>c</sup>	4 <sup>c</sup>		Vomiting, diarrhea	Mixed inflammation, with eosinophils
<i>S. bovis/hominis</i>		9 15 <sup>c</sup>	4 <sup>c</sup>		? None	?

<sup>a</sup> Trophozoite<sup>b</sup> oocyst<sup>c</sup> sporocyst

## Pruritus

Clinical and pathological symptoms (itching, scratching) of infections with skin parasites ([→Skin Diseases, Animals](#), [→Ectoparasite](#)).

## Przhevalskiana

Genus of flies that cause myiasis. *Przhevalskiana silenus* is found in goats in South Italy, Greece, in the Near East, and in North Africa with a high prevalence (up to 57%).

**Protozoan Infections, Man. Table 2** Diagnostic features and characteristics of lesions produced by tissue-inhabiting protozoans (according to Frenkel)

	Toxoplasmosis		Sarcocystosis	Microsporidiosis	Pneumocystosis	Leishmaniasis		Trypanosomiasis		Malaria	
						Visceral	Cutaneous	Mucocutaneous	cruzi	African	( <i>P. falciparum</i> )
<b>Diagnostic</b>											
Kinetoplast	-	-	-	-	-	+	+	+	+	+	-
Pigment in RES	-	-	-	-	-				-		+
Conoid (EM)	+	+	+	-	-	-	-	-	-	-	+
Polar granule or filament (EM)	-	-	-	+	-	-	-	-	-	-	-
Silver + cyst wall	+	+	+	-	+	-	-	-	-	-	-
PAS + bradyzoites	+	+	+	-	-	-	-	-	-	-	-
Acid fast spores	-	-	-	+	-	-	-	-	-	-	-
Grocottsilver + spores	-	-	-	+	+	-	-	-	-	-	-
<b>Location</b>											
Heart	+	+	+	+					+		
Lung	+	(+)	(+)	+	(-)						
Liver	+	?	?	+	(-)	+					Enlarged
RE cells	(+)	-	-	+	-	+		+	+		Enlarged
Brain	+			+	-					+	In vessels
Skeletal muscle	+	+	+	+	-						
Kidney	+	-	-	+	-						
<b>Lesion</b>											
With indiv. Organisms	+	±	±	+	+	+	±	+	+	+	-
Cysts	±	±	±	+	+	-	-	-	+	-	-
Neutrophils	+	+	+	-	-	+	+	+	+	+	-
Eosinophils	±	+	+	-	-	?	+	+	+	+	-
Macrophages	+	+	+	-	+	+++	+++	+++	+	+	+
Lymphocytes	+	+	+	+	+	+	+	+	+	+	+
Plasma cells	+	+	+	-	+	+	+	+	+	+	-
Granuloma	(+)	-	-	+	-	+	+	+	-	+	-
Microabscess	+	+	+	+	-	-	+	+	+	+	-
Necrosis	+	+	+	+	-	Rare	Ulcer	Ulcer	+	-	-
Fibrosis	+	+	+	+	+	Late	Late	Late	+	+	-
Anemia and pigment deposition	-	-	-	-	-	+	-	-	-	+	+
Nephritis	(+)			+		+				+	+



Prowazek, Stanislaus von (1875–1915). Figure 1 von Prowazek, just prior to his death.

## Przhevalskiana silenus

Goat warble fly.

## Pseudechinoparyphium

→Digenea.

## Pseudoacanthocephalus

Genus of the trematode family Echinorhynchidae, the species of which look similar to →*Acanthocephala*.

## Pseudoamphistomum

*Pseudoamphistomum truncatum* (2 × 0.5 mm) belongs to the trematode family Opisthorchiidae and occurs in

the bile ducts of dogs, cats, foxes, sea lions, and humans in Europe and North America. →*Digenea*

## Pseudoapolysis

In the tapeworm →*Diphyllobothrium latum* the eggs are discharged from the proglottids already in the intestine. The empty proglottids then detach and degenerate. This process is described as pseudoapolysis.

## Pseudoapolytic

→Eucestoda, →*Diphyllobothrium latum*.

## Pseudocysts

Parasitophorous vacuole inside macrophages closely filled by dividing →*tachyzoites* of →*Toxoplasma gondii*.

## Pseudodactylus anguillae

→*Monogenea*.

## Pseudodiscus

Genus of the paramphistomid trematodes.

## Pseudolynchia canariensis

Hippoboscid fly parasitizing pigeons and transmitting the agents of bird →*malaria* (e.g., *Haemoproteus columbae*).

## Pseudomalaria

Symptom of disease of birds due to infection with [→Haemoproteus](#) spp.

ameboid movement is enhanced by a transformation of the local cytoplasm from a stable gel-form to a more liquid sol-form. Pseudopodia are most prominent in the various types of [→amoebae](#) but may also be found in motile metazoan cells such as leucocytes or in nematode sperms ([→Nematodes/Reproductive Organs](#)).

## Pseudomonas hirudinis

Species of bacteria that is included in the intestine of [→Leeches](#) helping to digest the stored blood meal.

## Pseudoscabies

Disease in humans due to fresh infections with mites of the genera *Notoedres* and *Triacarus* of animals. The symptom (itching) occurs immediately after contact with such mites, while in typical *Sarcoptes*-scabies it takes long, until symptoms occur.

## Pseudophyllidea

### Name

Greek: *pseudos* = wrong, *phyllon* = leaf.

### Classification

Order of the cestode subclassis [→Eucestoda](#) containing the important genera [→Diphylobothrium](#), [→Ligula](#), [→Schistocephalus](#), [→Spirometra](#), [→Bothriocephalus](#), [→Eubothrium](#), [→Triaenophorus](#).

### Life Cycle

[Fig. 1](#) (page 1211).

### Diseases

[→Diphylobothriasis, Man](#), [→Sparganosis, Man](#).

## Pseudoterranova

Genus of ascarid [→nematodes](#) in crustaceans, fish, and mammals, e.g., *P. decipiens* matures in seals, the first [→intermediate host](#) are crustaceans (copepods, amphipods, shrimps, etc.), while fish serve as second intermediate hosts ([→Anisakis](#)).

## Psilotrema

Genus of echinostomatid trematodes.

## Pseudopodia

Some [→Protozoa](#) use pseudopodia (sing. pseudopodium) as locomotory organs. These structures, which may occur as thick [→lobopodia](#) or as fine [→filopodia](#) ([Fig. 1](#), page 1212, [→Pellicle/Fig. 1](#)), are produced by the cytoplasmic movement mediated by the activity of the  $\text{Ca}^{2+}$ -regulated actin-myosin complexes ([→Cytoskeleton](#)). The contraction of filaments of actin-myosin causes pressure on the [→cytoplasm](#) at the posterior pole and this initiates a forward flow of the cytoplasm at the apical pole. At the apical pole the

## Psocoptera

Group of mites living in dust, being vectors of tapeworms of the genus [→Avitellina](#) of cattle.

## Psoroptes

### Name

Greek: *psora* = scabies, mange.

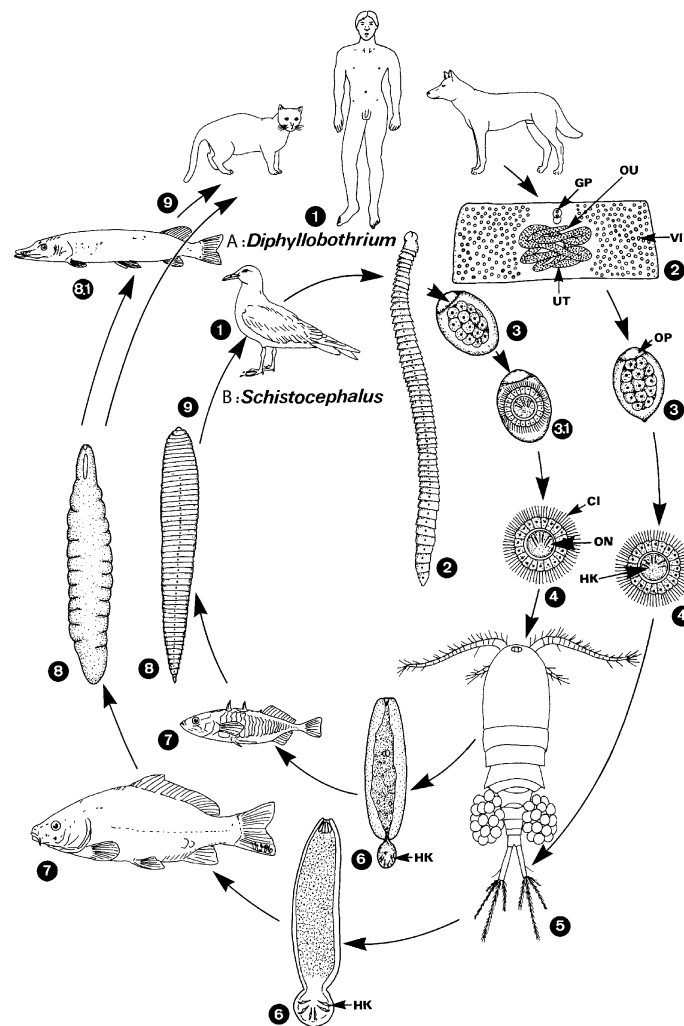

**Pseudophyllidea. Figure 1** Life cycle of pseudophyllidean cestodes. **A** → *Diphyllbothrium latum* inhabits the intestine of humans, cats, dogs, and other fish-eating animals (final hosts), being attached to the intestinal wall with 2 longitudinal bothria. **B** → *Schistocephalus solidus* occurs in the intestines of a wide range of fish-eating birds. *Ligula intestinalis* has a very similar life cycle. 1 Final hosts. 2 Adults. *D. latum* reaches a maximum size of 25 m; its mature proglottids are broader than long; coils of the gravid uterus form centrally located rosette. *S. solidus* is lanceolate-shaped with a size of 5–8 × 1 cm, → bothria-like apical indentations are of poor adhesive power. 3 The operculated eggs are excreted unembryonated; completion of development to coracidium larvae (3.1) takes one to several weeks depending on the water temperature. 4 Free → coracidium larva containing the oncosphaera which is endowed with 6 hooks. 5–6 Having ingested free coracidia several species of copepods are suitable intermediate hosts within which development of second-stage larvae (→ Proceroid; 6) occurs. 7–8 As second intermediate hosts, brackish and freshwater fish become infected by ingesting infected copepods. Inside the intestine the proceroid is released, and eventually bores its way into the body cavity and muscles where it grows rapidly into a plercercoid (→ Sparganum). In *D. latum* the plercercoids remain mainly undifferentiated, whereas in *S. solidus* the plercercoids show the main features of the adults (i.e., division into 62–92 proglottids and the presence of genital Anlagen; however, they are not yet fertile). Unlike *D. latum*, the progenetic plercercoids of *S. solidus* are extremely specific in their host, developing only in the body cavity of the marine and freshwater forms of the 3-spined stickleback (*Gasterosteus aculeatus*). 8.1 In *D. latum* → plercercoids may become accumulated without further development in the muscles (not encysted) of carnivorous fish (paratenic hosts). 9 Infections of final hosts occur by ingestion of raw meat of fish containing plercercoids. Having reached the intestine the plercercoids of *D. latum* grow rapidly and become adult worms in 5–6 weeks, whereas *S. solidus* plercercoids mature rapidly (within 36–48 hours) and release eggs. Humans, who accidentally eat meat of fish containing plercercoids of other nonhuman pseudophyllidea may also become infected; however, plercercoids do not mature, but creep around inside the human body, leading to a disease called → sparganosis. CI, cilia; GP, genital pore; HK, hooks of ON; ON, oncosphaera; OP, → operculum; OU, opening of the uterus; UT uterus; VI, → vitellarium.

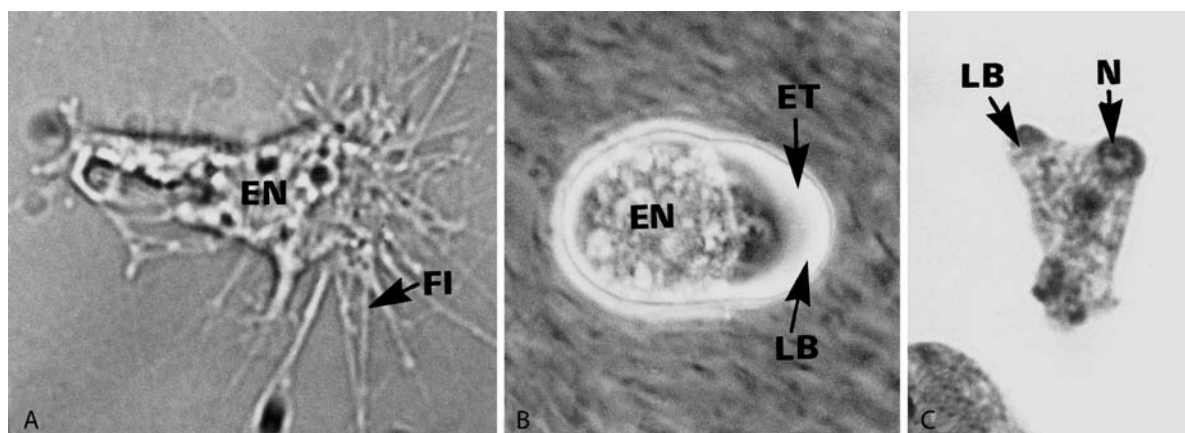

**Pseudopodia.** Figure 1 A–C LMs of typical pseudopodia in living amoeba. A Filipodia in *Acanthamoeba castellanii* ( $\times 2,500$ ). B A single lobopodium in *Entamoeba histolytica* ( $\times 1,800$ ). C A lobopodium in *Naegleria fowleri* ( $\times 1,800$ ). EN, endoplasm; ET, ectoplasm; FI, filipodium; LB, lobopodium; N, nucleus.

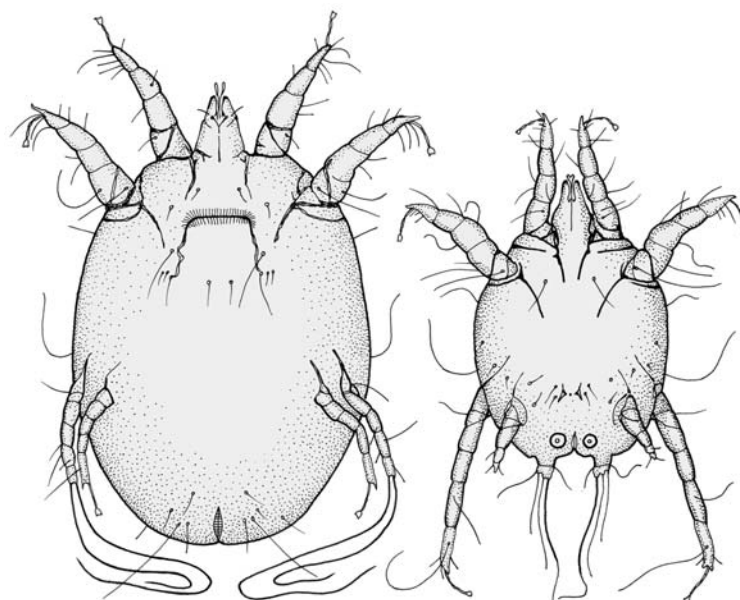

**Psoroptes.** Figure 1 DR of female (left) and male.

### Classification

Genus of the mite family Psoroptidae (sucking and penetrating mites).

### General Information

*Psoroptes* spp. (Fig. 1) are found worldwide in cattle (*P. ovis/bovis*), horses (*P. equi*), rabbits (*P. cuniculi*), cattle/horses (*P. natalensis*), wild ovines (*P. servinus*), and introduce mange of ears and generalize along the whole body. They are up to 800  $\mu\text{m}$  (female) of 550  $\mu\text{m}$  (male) long and thus larger than  $\rightarrow$  *Sarcoptes* or

$\rightarrow$  *Chorioptes*-mites. They are able to move quickly. Development takes 21–24 days, lifespan of females about two weeks (11–42 days). All stages feed on epidermis fluid and blood.  $\rightarrow$  *Acari*.

## Psoroptic Mange

$\rightarrow$  *Mange, Animals/Psoroptic Mange*.

## PSP

Promastigote surface protease. →[Proteinases](#).

## Ptilinum

→[Glossina](#).

## Psychoda

Genus of the fly family Psychodidae. For example, *P. griesescens* (2.4–4.5 mm long) shows hairy wings and lays its eggs in water holes/toilets in the house; this species is common in Europe and may transport bacteria etc. onto food.

## Pulex irritans

### Name

Latin: *pulex* = flea, *irritare* = disturb; English: human flea; French: = *puce*.

### Classification

Genus of the insect order Aphaniptera.

## Pterygosoma

→[Mites](#).

### General Information

The worldwide occurring flea *Pulex irritans* ([Fig. 1](#)) is found besides humans on many hosts, now especially on foxes. It is rather large in size (3.5–5 mm), the females lay up to 450 eggs, which develop within 14 days (at 18–27°C) into pupae, and give rise to adults in about 7–10 days. However, the adults can also wait inside the puparium for half year. They are proven vectors of agents of plaque, erysipeloid, and the tapeworm →[Dipylidium caninum](#). →[Fleas](#).

## Pterygota

Subclass of →[Insects](#) characterized by the primary occurrence of wings.

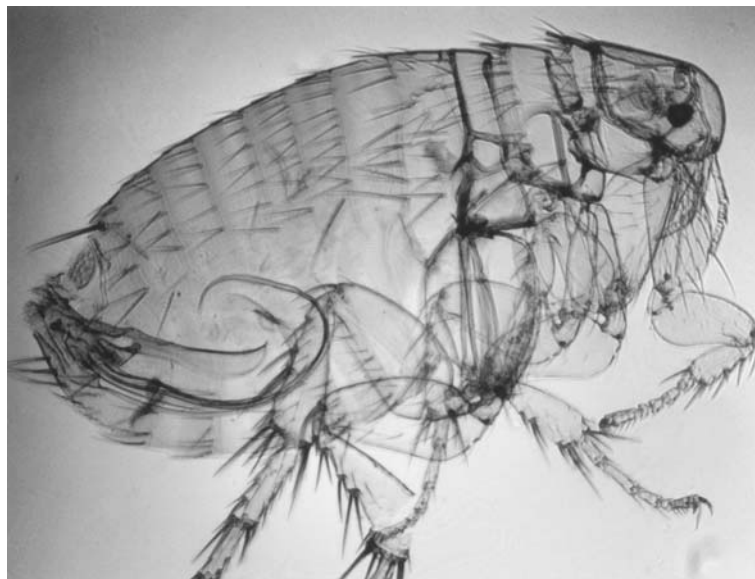

**Pulex irritans. Figure 1** LM of an adult male.



## Pulmonary Oedema

Symptom of disease in infections with →*Plasmodium* and →*Babesia* spp.

## Pulvillus

Portion of the ixodid tick foot (also present in argasid larvae), which helps the 2 claws in attachment at the host (→*Haller's Organ*/Fig. 1).

## Pupa

Developmental stage during →*holometabolous development* which is the most common form of development in insects. The pupae are nonfeeding, very often remain quiescent (an exception are the motile pupae of →*mosquitoes*, see →*Mosquitoes*/Fig. 1), and are in general in a thickened →*cocoon* or →*puparium*. Inside the puparium a complete reorganization of the insect's body occurs, leading to the final production of the adult male or female, which leave the pupa by typical opening mechanisms.

## Puparium

The hardened exoskeleton of the last larval →*instar* (→*Holometabolous Development*).

## Pupiparity

Quality of producing larvae that pupate during deposition from within the maternal body; e.g., in →*tsetse flies*.

## Purine Salvage

→*Energy Metabolism*.

## Purines

All the parasitic protozoa and helminths studied so far are incapable of the *de novo* synthesis of purine nucleotides. These organisms therefore rely entirely on the salvage of preformed bases or nucleosides for their purine requirement. This contrasts with most other organisms which use both *de novo* biosynthesis and recycling pathways. As a consequence of the complete dependence on preformed purines, parasites are equipped with a variety of different purine salvage routes and possess elaborate mechanisms for uptake and interconversion of purines. The major part of these pathways consists of a single reaction, in which the free purine reacts with 5-phosphoribosyl-1-pyrophosphate to yield the corresponding purine mononucleotide as catalyzed by phosphoribosyltransferases (PRTases). As an alternative, but often less preferred route, purine nucleotides can be formed by 2 consecutive enzymatic steps, catalyzed by a nucleoside phosphorylase and a nucleoside kinase. The complexity of these pathways and the specificity of the enzymes involved can vary considerably among different species. Because of their unique properties purine salvage enzymes of parasites have been of interest as targets for antiparasitic chemotherapy.

In kinetoplastid flagellates, all purine nucleotides appear to be interconvertible using PRTases and nucleoside kinases with an apparent branch point at inosine monophosphate (IMP) (Fig. 1). Most frequently responsible for purine salvage in kinetoplastids and many other parasites is hypoxanthine guanine PRTase (HGPRTase) that serves the formation of AMP and GMP. An interesting feature of HGPRTase in many protozoans is its relatively low substrate specificity which allows the recognition of pyrazolopyrimidines as substrate analogs. The conversion of these substances to the corresponding nucleotides has been shown to possess substantial chemotherapeutic implication. The best studied of these compounds is allopurinol, a hypoxanthine analog, that is converted by trypanosomatid HGPRTase to the IMP and further to an AMP analog which finally becomes incorporated into the protozoan's RNA. The integrated error within the RNA fraction results in a net breakdown of mRNA and thus inhibition of protein synthesis that is suggested as one of the major mechanisms of the selective toxicity of allopurinol in *Trypanosoma* and *Leishmania* spp.

Purine salvage in apicomplexan parasites appears similar in many ways to that in trypanosomatids. The various species of malarial parasites appear to contain the complete set of enzymes for purine nucleotide

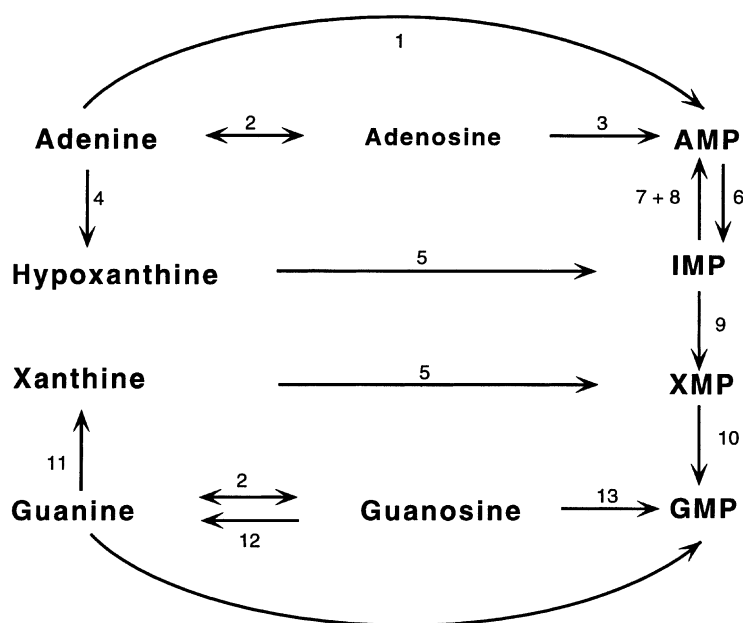

**Purines. Figure 1** Major pathways for purine salvage and interconversion in protozoa and helminths. 1, Adenine PRTase (lacking in *Tritrichomonas foetus*); 2, nucleoside phosphorylase (lacking in *Plasmodium* spp.); 3, nucleoside kinase; 4, adenine deaminase (lacking in many trypanosomatids, except *Leishmania* spp. and *Trypanosoma vivax*, malaria parasites, and helminths, but present in *T. foetus*, *Eimeria*, and *Toxoplasma*); 5, PRTases; 6, AMP deaminase; 7, adenylosuccinate synthetase; 8, adenylosuccinate lyase; 9, IMP dehydrogenase; 10, GMP synthetase; 11, guanine deaminase; 12, nucleoside hydrolase (present in kinetoplastids and *E. tenella*); 13, nucleoside phosphotransferase.

salvage, many of which differ in their structural and kinetic properties from those of the red blood cell. *Toxoplasma gondii* can incorporate all 4 purine bases into the corresponding nucleotides, as catalyzed by PRTases, but adenine nucleotides in this parasite can also be generated from adenosine through an adenosine kinase.

Most anaerobic protozoa are much simpler than kinetoplastids and apicomplexans in their enzymatic machinery for purine salvage (Fig. 2) with the exception of *Tritrichomonas foetus*, whose purine salvage capabilities are similar to those of kinetoplastids and apicomplexans. *Giardia* characterizes a species with a most deficient purine nucleotide metabolism with obviously only a few major enzymes available. This parasite is not capable of utilizing hypoxanthine, inosine, or xanthine for its nucleotide synthesis. It has an absolute requirement for both adenine and guanine which are obtained primarily through hydrolysis of absorbed nucleosides via hydrolases and subsequently directly incorporated into the nucleotide pool via the action of adenine and guanine PRTase, respectively. Nucleotide biosynthesis in *Trichomonas vaginalis* and *Entamoeba histolytica* differs from that in *Giardia* in that these parasites lack purine PRTases. A major entry route into purine salvage metabolism appears to be from ribonucleosides via

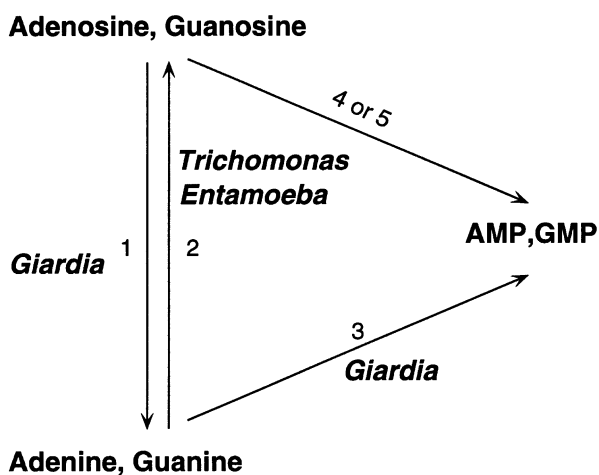

**Purines. Figure 2** Purine salvage pathways in anaerobic protozoa. Purine salvage in *Tritrichomonas foetus* is similar to that in kinetoplastids. 1, Nucleoside hydrolase; 2, nucleoside phosphorylase; 3, PRTases; 4 and 5, nucleoside kinase or nucleoside phosphotransferase.

specific purine nucleoside phosphorylases and kinases (Fig. 2). *T. foetus* can form IMP from other precursors and directly salvage purine bases, except adenine, by PRTases.

Like the parasitic protozoa, helminths also lack the *de novo* purine synthesis and depend entirely on salvage pathways for their purine requirement (Fig. 1). The pattern of purine salvage pathways seems to vary considerably between different helminth species and their developmental stages. An example is the scheme for purine salvage in schistosomules of *Schistosoma mansoni*, which lacks functional purine nucleoside kinases. This suggests that all purine nucleosides taken up from the environment have to be converted to the corresponding purine bases before incorporation into the nucleotide pool by purine PRTases (Fig. 1). A similar purine salvage network, depending primarily on PRTases, appears to exist in the adult parasite, though there seem to be major quantitative differences in adenosine salvage between the 2 developmental stages. Unlike schistosomules, AMP can also be formed from adenosine by an adenosine kinase, and adenosine can be converted to adenine by a nucleoside phosphorylase. Adenosine recycling in the adult schistosome can also be achieved by other pathways, including deamination to inosine (Fig. 1). Because of the lack or minimal extent of purine nucleotide interconversion, the pathway for purine salvage present in *S. mansoni* is much simpler than that in mammalian cells.

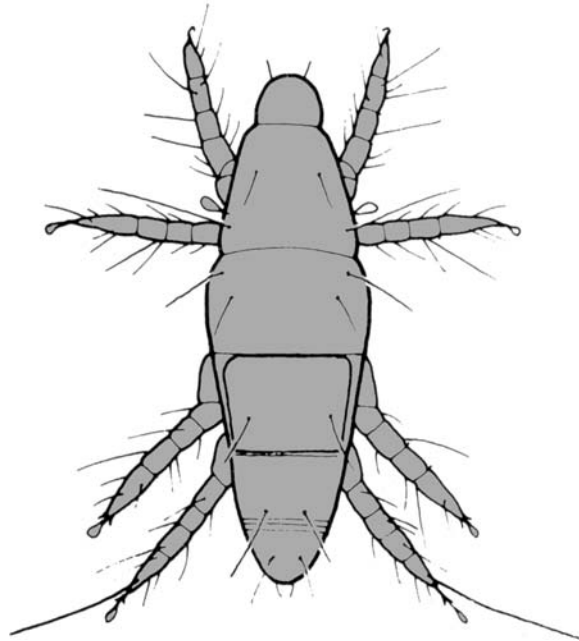

**Pyemotes. Figure 1** DR of an adult mite, unfed stage.

---

## PV

Parasitophorous vacuole, → [Coccidia](#).

---

## Pycnomonas

Subgenus of the genus → [Trypanosoma](#). A common species is *T. suis* of pigs.

---

## Pyemotes

Genus of the mite family Pyemotidae, which includes very tiny (0.1–0.3 mm) mites (Figs. 1, 2), that are living in grains or suck the body fluids of insect. Bites of specimens of the species *Pyemotes ventricosus* and *P. tritici* (= grain or hay itch mite) introduce in summer papules in human skin.

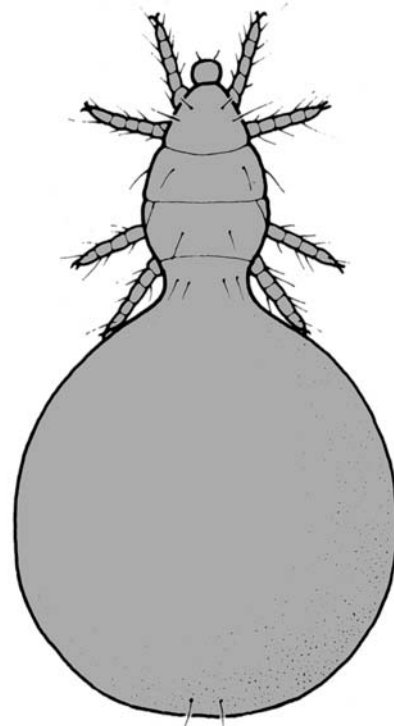

**Pyemotes. Figure 2** DR of an adult mite that had sucked and thus appears with a swollen posterior part.

## Pygidium

→Fleas, →Insects.

## Pyometra

Intrauterine maceration of the fetus of cattle in cases of infections with →*Tritrichomonas foetus*.

## Pyranes

→Nematocidal Drugs.

## Pyrantel

→Nematocidal Drugs.

## Pyrethrin

### Chemical Class

Natural products (terpenoid).

### Mode of Action

Open state voltage-gated sodium channel blocker.  
→Ectoparasiticides – Blockers/Modulators of Voltage-Gated Sodium Channels.

## Pyrethroids

Artificially produced →insecticides.

## Pyrethrum

### Chemical Class

Natural products (mixture of terpenoids).

### Mode of Action

Open state voltage-gated sodium channel blocker.  
→Ectoparasiticides – Blockers/Modulators of Voltage-Gated Sodium Channels, →Insecticide.

## Pyridinols

→Energy Metabolism.

## Pyrimethamine

Drug to control →coccidiosis, babesiosis.

## Pyrimidine Biosynthetic Pathway

→Energy Metabolism.

## Pyrimidine Nucleotides

→Energy Metabolism.

## Pyrimidine Salvage

→Energy Metabolism.

## Pyrimidines

Most parasitic protozoa and all helminths are capable of synthesizing pyrimidine nucleotides via the *de novo* route. This pathway resembles that in higher eukaryotes, although some of the enzymes catalyzing the 6 sequential steps involved in the formation of uridine monophosphate (UMP) possess quite special features. In most eukaryotes, orotate dehydrogenase, which catalyzes the conversion of dihydroorotate to orotate, is

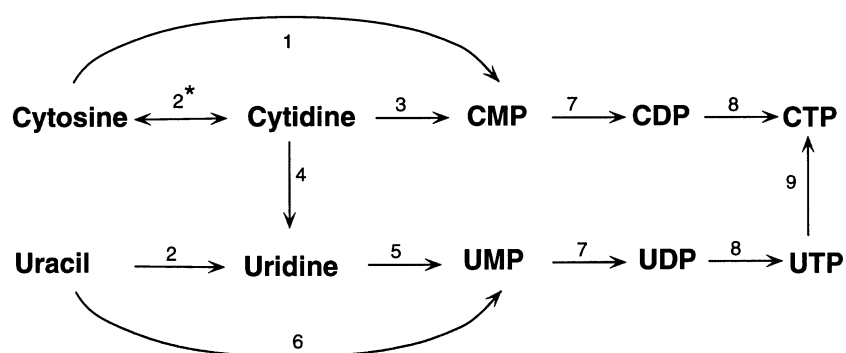

**Pyrimidines. Figure 1** Pathways of pyrimidine salvage and interconversions in an anaerobic protozoa. 1, Cytosine PRTase; 2, pyrimidine phosphorylase; 3, cytidine phosphotransferase; 4, cytidine deaminase; 5, uridine phosphotransferase; 6, uracil PRTase (low activity in *Trichomonas vaginalis*); 7, nucleotide kinase; 8, nucleotide diphosphate kinase; 9, CTP synthetase (lacking in *T. vaginalis*); \*lacking in trichomonads.

associated with the mitochondrial membrane where it donates the substrate-derived reducing equivalents to the respiratory chain. In trypanosomatids, this enzyme is located in the cytosolic compartment and utilizes molecular oxygen and has therefore been termed dihydroorotate oxidase. Another difference concerns the last 2 enzymes involved in kinetoplastid pyrimidine biosynthesis, which are found in association with the external surface of the glycosome, though they are cytoplasmic in all other systems. Parasitic protozoa have also the capacity for pyrimidine salvage and can incorporate exogenous pyrimidine bases via a range of enzymes, including phosphoribosyltransferases (PRTases), nucleoside phosphorylases and kinases, respectively. Apicomplexan parasites are limited in their ability to reincorporate preformed pyrimidines from their environment and therefore rely on the *de novo* synthesis for their pyrimidine supply. In *Plasmodium* the first 3 and last 2 enzymes of the pyrimidine biosynthetic pathway are catalyzed by 3 and 2 separate enzymes, respectively, whereas in other eukaryotes these activities are two functional aspects of a single polypeptide. The observed double deficiency of trichomonads, *Entamoeba histolytica*, and *Giardia* in their *de novo* synthesis of both purine and pyrimidine nucleotides distinguishes these organisms from the rest of the protozoan parasites. As for purine nucleotides these parasites are, however, capable of salvaging preformed pyrimidine bases and nucleosides into the nucleotide pool and possess extensive interconversions among the pyrimidine recycling routes (Fig. 1). PRTases, nucleoside phosphorylases, and nucleotide kinases have been detected in trichomonads and *Giardia*, but each species seems to have its unique metabolic strategy for pyrimidine salvage.

Like most protozoans, helminths are capable of synthesizing pyrimidine nucleotides *de novo*. In *Schistosoma mansoni*, for example, considerably higher levels of the UMP precursor, orotidine 5'-monophosphate

(OMP), are formed than in mammalian cells, possibly because in the parasite the "channeling" of orotate to UMP by the multienzyme complex orotate phosphoribosyltransferase/OMP decarboxylase is not as efficient as in other cells. Pyrimidine nucleotides in helminths can also be formed from exogenous pyrimidine bases and nucleosides. In *S. mansoni*, uridine nucleotides can be synthesized from uracil apparently by a specific uracil PRTase. Other helminths seem to be capable of synthesizing pyrimidine nucleotides either from the corresponding nucleosides via nucleoside kinases or by the sequential action of nucleoside phosphorylases and kinases.

Although most parasites seem to possess both, functional *de novo* and salvage pathways for pyrimidine nucleotide synthesis, it would be difficult to predict which of the 2 alternative routes is more important to any particular species *in vivo*. Generally, each species may be able to make use of a unique network of nucleotide recycling strategies. Within this system, many enzymes and their intracellular location can be distinctly different from those of their counterparts in the mammalian host. During growth and development, parasites may satisfy their pyrimidine nucleotide requirement primarily by the *de novo* synthesis. However, when the demand of a parasite for nucleotides is low and preformed bases are available in the external environment, the *de novo* pathway for pyrimidine nucleotide synthesis may be suppressed.

## Pyriprole

### Chemical Class

Arylpyrazole.

**Mode of Action**

GABA-gated chloride channel antagonist. → [Ectoparasitocides – Antagonists and Modulators of Chloride Channels](#).

**Mode of Action**

Insect growth regulator (IGR, juvenile hormone mimics). → [Ectoparasitocides – Inhibitors of Arthropod Development](#).

---

**Pyriproxyfen**

**Chemical Class**

Juvenile hormone agonist (phenoxyphenyl ether).

---

**Pyruvate Dehydrogenase**

→ [Energy Metabolism](#).



---

## Q Fever

### Synonym

Query-fever, Queensland fever.

Disease of man, cattle, sheep, pigs, goats, and birds due to infection with *Coxiella burnetii*-stages by inhalation or dust-contaminated mouth parts of argasid →ticks.

### Therapy

Tetracyclines.

---

## QBC

→Quantitative buffy coat.

---

## Qinghaosu

Product (→[Malariacidal Drugs](#)) obtained from the Chinese herb *Artemisia* being used already for 2000 years in traditional medicine.

---

## Quanco

Trivial name of the South American argasid tick *Ornithodoros rostratus*, which is an avid biter of humans, domestic animals, and peccaries. It is not able to transmit agents of relapsing fever; however, its bites are very painful and lead to severe inflammations.

---

## Quantitative Buffy Coat (QBC)

Method of diagnosis of →[malaria](#) based on an acridine-orange staining and subsequent centrifugal separation of the buffy coat from the parasites and leukocytes.

---

## Quaranteny

### Name

Italian: *quaranta giorni* = 40 days.

The isolation of infected people for 40 days was first used in Venezia in the 14th century to avoid plaque infections. Today this measurement is used in general until the end of the →[incubation period](#) or until the end of the →[prepatency](#) (depending on the species of the agent of disease in humans and animals).

---

## Quartan Malaria

→[Malaria](#) due to infections with *Plasmodium malariae*.

---

## Quassia

Plant, extracts of which are used in traditional medicine to reduce fever.

---

## Queensland Tick Typhus

Disease of humans, rodents and marsupialia due to infection with *Rickettsia australis* transmitted by *Ixodes holocyclus*.

---

## Quinacrine

Drug to treat →[giardiasis](#).



## Quinapyramine

→[Malariaicidal Drugs](#).

## Quincke's Edema

Symptom of human infections with the pig stomach worm →[Gnathostoma doloresi](#). The signs of disease are: creeping eruption, itch, migratory swellings, eosinophilia. Furthermore, the worm larvae may migrate also into interior organs (→[larva migrans interna](#)).

## Quinine

Oldest drug obtained from the bark of a South American tree (*Chinchona*) to treat →[malaria](#); →[Malariaicidal Drugs](#).

## Quinoline

→[Hemozoin](#).

## Quinolones

→[Energy Metabolism](#).

## Quinones

Quinones are essential lipids in the electron transfer chains (respiratory chains) where they carry electrons from one enzyme complex to the next. In aerobic →[Energy Metabolism](#), where the quinone has to transfer electrons from complexes I and II to complex III, →[ubiquinone](#) fulfills this role. This ubiquinone function is universal and occurs in the respiratory chains of →[prokaryotes](#) as well as of all eukaryotes, including helminths and →[protozoa](#). On the other hand, in anaerobic →[energy metabolism](#) that involves →[malate dismutation](#), and hence fumarate reduction, a quinone

with a lower standard redox potential is required. Prokaryotes use →[menaquinone](#) or dimethylmenaquinone for the reduction of fumarate. These quinones are not present in eukaryotes, but in helminths the coexistence of →[rhodoquinone](#) (RQ) and ubiquinone (UQ) has already been known for a long time. Since rhodoquinone is present mainly in the anaerobic, fumarate-reducing stages of helminths, it was suggested that rhodoquinol functions as an electron donor in fumarate reduction, similar to menaquinol in other organisms. It has been shown that rhodoquinone is indeed an essential component for electron transport associated with fumarate reduction. This electron transfer component is present not only in all the helminths investigated so far, but also in other eukaryotes (including lower marine animals and the freshwater snail *Lymnea stagnalis*) that reduce fumarate under anaerobic conditions. In lower unicellular eukaryotes that reduce fumarate during anoxia (e.g., *Euglena gracilis*), rhodoquinone is also present, whereas those that are not capable of fumarate reduction (e.g., trypanosomatids) do not possess rhodoquinone.

*In vivo*, ubiquinone cannot replace rhodoquinone in the process of fumarate reduction, as ubiquinone can accept electrons only from complex II (succinate dehydrogenase) and is not able to donate electrons to fumarate. Rhodoquinone, having a lower redox potential than ubiquinone, is capable of transferring electrons to fumarate, which occurs via the fumarate reductase enzymatic complex, which is comparable to the respiratory chain complex II (succinate dehydrogenase). Therefore, during the development of the parasite, changes in quinone content occur, parallel to the changes in energy metabolism. Stages with a TCA-cycle-associated aerobic-energy metabolism possess mainly ubiquinone, whereas stages that are dependent on fumarate reduction possess predominantly rhodoquinone. It was also shown that in adult →[Fasciola hepatica](#), rhodoquinone was not synthesized by modification of ubiquinone obtained from the host, but that the parasite synthesizes ubiquinone as well as rhodoquinone *de novo* via the mevalonate pathway.

Rhodoquinone is also an indispensable component of another pathway that functions as electron sink in *Ascaris suum*, i.e., the production of branched chain fatty acids via enoyl-CoA reductase, and quinones in general are known to play a role in protecting membranes against oxidative injury. The reduced form (quinol) acts as an antioxidant and effectively protects both membrane phospholipids from lipid peroxidation and membrane proteins from free-radical-induced oxidative damage. The importance of this antioxidant role of quinones in parasites is not yet known.

Ubiquinone and rhodoquinone are benzoquinones that are equipped with a polyisoprenoid side chain of

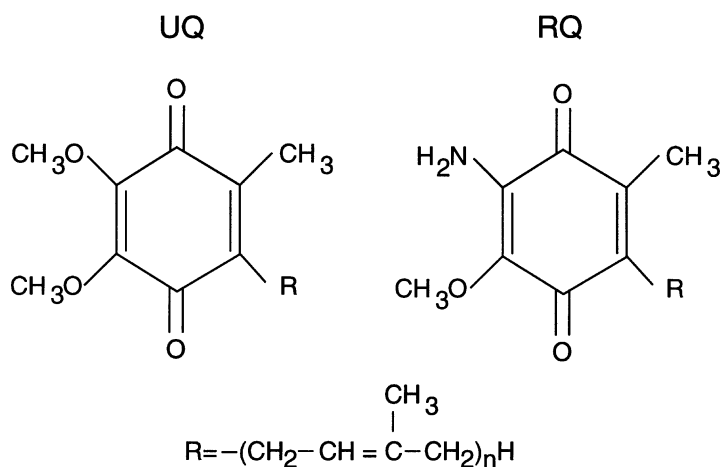

**Quinones. Figure 1** Structures of ubiquinone (UQ) and rhodoquinone (RQ).

varying length (Fig. 1). Ubiquinone with a side chain of 10 isoprenoid units ( $\text{UQ}_{10}$ ) is the predominant quinone form in higher animals, although some species-specific variation can occur. Also in helminths, the length of the side chain varies between species, but as ubiquinone and rhodoquinone are synthesized via the same pathway, the side chains of both quinones have the same length within one species.  $\rightarrow$ *Haemonchus contortus*,  $\rightarrow$ *Schistosoma mansoni* and  $\rightarrow$ *Dictyocaulus viviparus*, for instance, contain mainly  $\text{RQ}_{10}$  and  $\text{UQ}_{10}$ , whereas *F. hepatica* and *A. suum* possess quinones with side chains of 9 isoprenoid units ( $\text{RQ}_9$  and  $\text{UQ}_9$ ).

## Quinone-Tanning

Method of  $\rightarrow$ sclerotization invented by different parasites to protect their propagation stages (e.g., eggs) or their surfaces (arthropodal cuticles, nematode cuticle). During this process tyrosines are oxidized within protein to the catechol (DOPA, dihydroxyphenylalanine). A similar process is the protein-dityrosine-cross-linking, which occurs, e.g., in oocyst walls of coccidians and yeast cells.



## Rabies

→ Vampire Bats.

## Race

Group of individuals in a species, which has some characteristics that are different from other groups of the same species, e.g., races of → *Babesia canis* in dogs.

## Racemose cysticercus

A type of → *cysticercus* in human brain due to an infection with → *Taenia solium*. This type appears either as a large, round, or lobulated bladder circumscribed by a delicate wall or is shaped as a cluster of grapes. It may reach diameters of 20 cm and may contain 60 ml of fluid.

## Rachis

Cellular strand in sexual organs of → *nematodes* to feed developmental stages, e.g., precursors of sperms (→ *Nematodes/Reproduction*).

## Radfordia

Genus of mites (350–500 µm long, Fig. 1) on laboratory mice and rats feeding on tegumental scales. It takes only 12–13 days to accomplish the whole development on a host.

## Radioimmuno Assay (RIA)

Diagnosis method used to detect, e.g., → *amoebiasis*, → *malaria* being based on antigen detection.

## Radiology

Method to detect hidden infections such as → *alveolar echinococcosis*, human infections with → *Macracanthorhynchus*, → *Anisakis* worms, etc.



**Radfordia.** Figure 1 LM of an adult mite.

## Rafoxanide

A derivate of salicylanilide, →[Trematocidal drugs](#), →[Cestodocidal drugs](#).

## Raillietiella frenatus

### Classification

Species of →[Pentastomida](#).

### Life Cycle

[Fig. 1](#) (page 1227).

## Raillietina tetragona

A worldwide occurring, 10–25 cm long tapeworm in the intestine of chicken and related birds ([Fig. 1](#), page 1228). →[Eucestoda/Table 1](#).

## RAPD

Random amplification of polymorphic DNA.

## Ray-Bodies

→[Babesia](#).

## RBM

Roll Back Malaria.

## Receptaculum seminis

A special organ for storing injected →[spermatozoa](#) in many animals (→[Platyhelminthes/Reproductive Organs](#)). See also →[Digenea](#).

## Receptor-Ligand Interaction

→[Apicomplexa](#).

## Recidive

From Latin: *recidere* = to fall back. Comeback of symptoms of a disease after a phase of inapparence and/or of lack of symptoms.

## Recombinant Vaccines

→[Vaccination Against Nematodes](#).

## Recrudescence

→[Malarial fever](#) due to reactivation and new division of persisting intraerythrocytic stages (→[Plasmodium](#), →[Babesia](#)).

## Rectal Bleeding

Symptoms of infection, e.g., with →[Trichuris](#).

## Rectal Prolaps

Symptom of infection with a large number of worms of e.g., →[Trichuris trichiura](#) in humans.

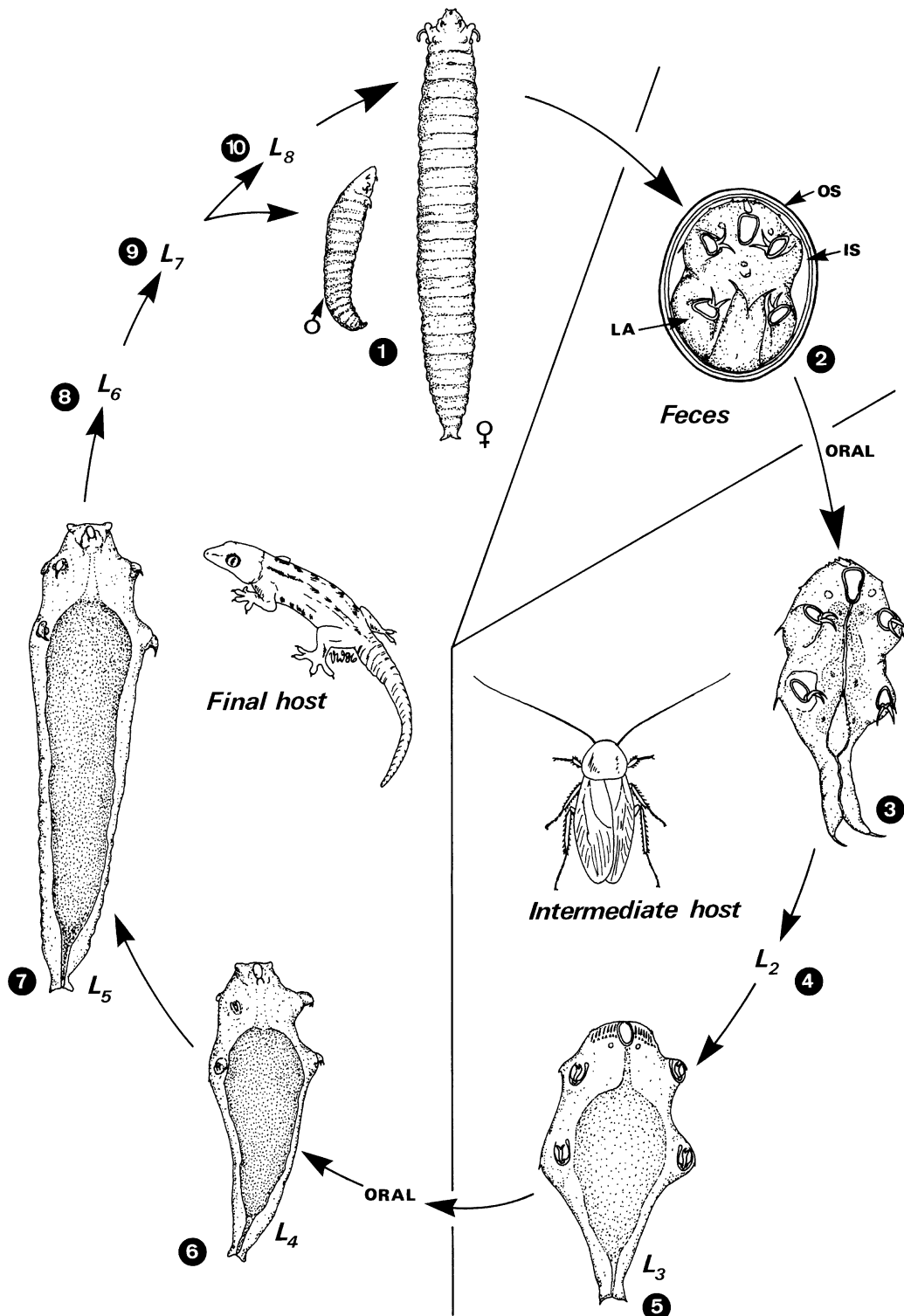

**Raillietiella frenatus.** Figure 1 Life cycle of *Raillietiella frenatus* (→Pentastomida). 1 Adults live in the lungs of geckos. 2 Embryonated eggs are set free via feces. 3–5 Intermediate hosts (cockroaches) ingest embryonated eggs (2). The four-legged primary larva (3) enters the fat body and molts until reaching infectivity as L<sub>3</sub>. 6–10 If final hosts (geckos) ingest infected cockroaches, the L<sub>3</sub> penetrates the intestinal wall and finally enters the lung where it becomes mature. In male pentastomids the L<sub>7</sub> matures, whereas in females the L<sub>8</sub> matures to become a sexually differentiated adult. IS, inner →eggshell; LA, primary larva; OS, outer eggshell.

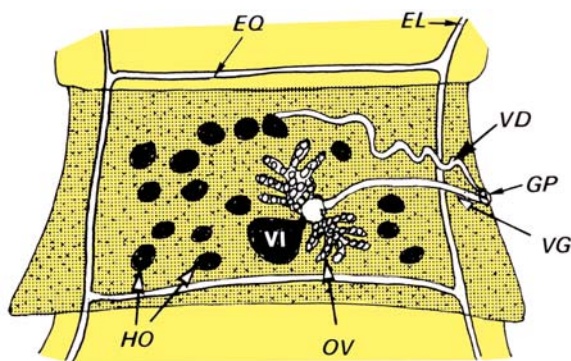

**Raillietina tetragona.** Figure 1 DR of a rather young proglottis of an adult tapeworm. *EL*, excretory channel (longitudinally running); *EQ*, excretory channel (cross); *GP*, genital pore; *HO*, testis; *OV*, ovary; *VD*, vas deferens; *VG*, vagina; *VI*, vitellarium.

---

## Recurrent Flagellum

→ [Flagella](#), → [Trichomonadida](#).

---

## Red Bird Mite

→ [Dermanyssus gallinae](#).

---

## Red Mite

→ [Dermanyssus gallinae](#).

---

## Red Queen Hypothesis

The Red Queen hypothesis was proposed by Van Valen in 1993, in a famous paper entitled “A New Evolutionary Law.” On the basis of a detailed study of the extinction rates of species during geologic times, Van Valen suggested that any adaptation of a species modifies the environment of the other species living with it and constrains them to new adaptations, because of the limitation of resources: species play a “null sum game.” This causes a runaway process which is the cause of the indefinite complexification of species. Van

Valen used the term “Red Queen hypothesis” by reference to the novel of Lewis Carroll where Alice and the Red Queen run “to keep in the same place.”

It is probably in the world of parasites that the Red Queen hypothesis has been most illustrated and discussed.

A first reason why parasites have something to do with Van Valen’s hypothesis is that when a parasite species and a host species coevolve for a long time, each one exerts selective pressures on the other. Thus, the system can last only if any new adaptation of the parasite to better exploit the host is counterbalanced by an equivalent new adaptation of the host to better combat the parasite, and vice versa. New adaptations can be selected indefinitely in the genomes of both partners, without really modifying the situation, provided genetic variability permits. This is a typical illustration of Alice and the Queen running to remain in the same place.

A second reason why parasites and Red Queen hypothesis are so often juxtaposed in scientific papers is that they could explain together why sex exists in life. The difficulty of explaining sex is well known: a sexual species supports what geneticists call the “twofold disadvantage of sex” (in a sexual species, only females produce an offspring whilst in an asexual species, all individuals reproduce). There must be thus some important advantage to compensate the twofold disadvantage. This advantage is very probably represented by the continuous renewal of the genetic diversity (sexual reproduction “creates” new combinations of genes in each generation). But why do the species need a continuously renewed diversity? For various possible reasons. But the one which is preferred by ecologists is that genetic diversity provides the hosts and parasites with the weapons necessary “to keep in the same place,” in their indefinite state of competition. This explains why it has often been stated that the maintenance of sex is the consequence of parasitism. Of course, not all parasites reproduce sexually, but many of them do, and nearly all hosts do.

There are few demonstrations that having sex provides hosts with a decisive advantage in their combat against parasites. However, studies on the rare host species which reproduce both sexually and asexually have shown that:

- where pressure of parasitism is high, the proportion of males of the freshwater snail *Potamopyrgus antipodarum* increases;
- → [metacercariae](#) of → [trematodes](#) accumulate more in clonal than in non-clonal fish of the species *Poeciliopsis monacha*;
- parthenogenetic lizards *Heteronotia binoei* are much more infected by → [mites](#) than sexual conspecifics in the same localities.

Although some of these results have been disputed, they do support quite seriously the existence of a link between parasitism and sex.

### Related Entry

→ [Coevolution](#).

## Red Water Disease

→ [Babesiosis, Animals](#).

## Red Water Fever

→ [Babesiosis](#) due to *Babesia bigemina* (Texas fever) of cattle.

## Rediae

Larval stage of → [Digenea](#) inside intermediate hosts, e.g., see cycle of → [Apophallus muehlingi](#).

## Redi, Francesco (1626–1698)

Italian physician, who discovered and described many worms. Rediae, which are larval stages of flukes that develop inside sporocysts, are named in his honour.

## Reduced Fecundity

Many parasites (e.g., → [ticks](#), → [mites](#), → [bugs](#), → [nematodes](#)) introduce a reduced fecundity in their hosts thus regulating, e.g., wildlife populations.

## Reduced Survival

Parasites apparently regulate the fecundity and survival of wildlife populations. For example, the cliff swallow (*Hirundo pyrrhonota*) is heavily affected by

*Oeciacus*-lice, the barn swallow (*Hirundo rustica*) by *Ornithonyssus*-ticks, the Soay sheep (*Ovis aries*) by the nematode *Teladorsagia circumcincta*.

## Reduviidae

From Latin: *reduvia* = small thing. Predacious → [bugs](#).

## Reduvius personatus

→ [Bugs](#).

## Reed, Walter (1851–1902)

American military physician ([Fig. 1](#), page 1230), famous for his works on yellow fever eradication in North America. The naming of the recent Walter Reed Army Institute at Washington honours his activities.

## Refractile Bodies

→ [Vacuoles](#) with electron dense contents, i.e., inclusion of reserve material (protein) inside the sporozoites of → [Coccidia](#). Depending on the species 1 or 2 of these ovoid to spherical bodies are present which may still be seen in the first generation schizonts.

## Regulation

Regulation is the process by which, when the density of a population increases beyond a certain threshold, → [fecundity](#) and/or survival of individuals are reduced in such a way that the population ceases to grow.

Regulation of parasite populations can be achieved theoretically in 2 principal ways:

– intraspecific competition provokes a decrease of fecundity and/or survival of parasites when the





**Reed, Walter (1851–1902).** Figure 1 Dr. Walter Reed during yellow fever epidemic in Havana.

number of individuals in an [→infrapopulation](#) increases; in certain cases, this process can be “host-mediated” because an increase in the load entails a strong immune reaction which limits the number of parasites;

- host individuals with the highest parasite loads die and cause the death of their parasites; this is possible because most parasites are distributed in their hosts in an aggregate fashion, so that when the total number of parasites increases, aggregation become more frequent.

### Related Entry

[→Competition](#), [Intraspecific](#).

---

## Reighardia sternae

Species of [→Pentastomida](#) with direct development. The female (3–4.5 cm) and male (0.7 cm) parasitize inside the air sacs of birds (see gulls).

---

## Reinfection

In many parasitosis a complete immunity never occurs. Therefore reinfection may happen immediately after an efficacious cure, thus leading to the impression that the drug did not work.

---

## Relapse

Malaria fever due to revival and reproduction of [→hypnozoites](#), [→malaria](#), [→Plasmodium](#) (e.g., *P. vivax*).

---

## Relapsing Fever

Relapsing fever is caused by spirochaetes ([→Borrelia duttoni](#)) and is transmitted by [→Ornithodoros](#) tick species. Mortality in endemic areas (Central and South Africa, Asia, and America) is 2–5%, but can reach 50% in epidemics. Treatment is possible with antibiotics (penicillin, tetracycline). The causative organism is transmitted by the bite of the tick as well as through infected coxal fluid and can penetrate unbroken skin.

Besides this tickborne relapsing fever, there exists the louseborne fever due to infections with *Borrelia recurrentis*. The latter is called epidemic relapsing fever, that of tick origin, endemic relapsing fever. The agents of the louseborne relapsing fever are transmitted by squeezing lice as was shown by [→Obermeier](#).

---

## Renal Disease

Kidney function is disturbed in several diseases due to parasitic infections, e.g., in [→babesiosis](#), [→Encephalitozoon-infections](#), [→falciparum malaria](#), Black water disease/fever due to intensive application of quinine in malaria patients.

---

## Renette

Excretion system of [→Nematodes](#).

## Reoviridae

### Classification

Family of viruses containing the genera Orbivirus, Coltivirus, and Seadornavirus, which are transmitted by arthropods (→[Arboviruses](#)).

### General Information

Double-stranded segmented, →[RNA viruses](#) (icosahedral, double capsid layer, without envelope).

### Important Species

[Table 1](#) Orbivirus (page 1232).

[Table 2](#) Coltivirus, Seadornavirus (page 1233).

## Repellents

### Important Compounds

N,N-diethyl-m-toluamide (DEET), dimethyl-phthalate, icaridin (syn. picaridin), piperidin.

### General Information

Among methods to protect human beings and particularly companion animals against bloodsucking arthropods, repellents play an important role. Different modes of action are discussed for repellents. Electrophysiological observations indicate that inhibitory effects on the arthropod's receptors responsible for host odours recognition or an interference with the olfactory input important for a host-characteristic response pattern might cause the repellent effect.

DEET probably was the most frequently used repellent. In a variety of different formulations it displays a broad repellent efficacy against biting arthropods. DEET is superior to another drug, dimethyl phthalate against some →[ticks](#) and mosquito species. Particularly DEET displays some undesirable properties in that it sometimes causes irritation effects and is incompatible with some synthetic matrices.

Recently a new repellent was discovered and developed, picaridin/hepidamin, an acylated 1,3-aminopropanol, which is even superior with regard to its biological activity against insects and ticks and additionally, does not display adverse solvent action on plastic materials.

In 1998 a new generation repellent (Bayrepel, Picaridin) was introduced. The product has an enlarged period of protection (ticks: 4 hours; →[mosquitoes](#):

6 hours) compared to DEET and better properties upon contact with skin and clothes.

However, many plant extracts show also a repellency, e.g., *Vitex agnus castus* repels ticks very effectively (Viticks-Cool – Alpha-Biocare, Düsseldorf).

### Related Entries

→[Synergists](#), →[Arthropodicidal Drugs](#).

## Repletion

Blood meal of →[ticks](#).

## Reproduction Strategies

In general, parasites must develop means for the mass production of offspring, a common method being asexual divisions of individuals. Another very common means of increasing the biotic potential is the production of numerous eggs after sexual processes, which also enhances the chance of a favorable genetic recombination (→[Chromosomes](#), →[Nuclear Division](#)). There are basic differences between the modes of reproduction of protozoan and metazoan parasites (→[Protozoa/Reproduction](#)).

## RESA

Ring-infected erythrocyte antigen of *Plasmodium* merozoites.

## Reserve Granules

All parasitic →[Protozoa](#) have various types of →[vacuoles](#), the largest of which are the food vacuoles (→[Endocytosis/Fig. 1A,B](#), →[Merozoite/Fig. 1](#)); these disintegrate during digestion. Vacuoles that serve as →[storage elements](#) contain crystalloid proteins ([Fig. 1C](#), →[Cyst Wall/Fig. 2B](#)), lipids, or carbohydrates ([Fig. 1B](#), →[Surface Coat/Fig. 1A](#)). Lipid-containing vacuoles appear slightly gray in electron micrographs and are present mainly in resting stages such as cysts. Large

**Reoviridae. Table 1** Arboviruses VII. Double-stranded segmented RNA viruses: Family Reoviridae, genus *Orbivirus*

Group (no. of members)	Species (selected)	Arthropod host	(Main) vertebrate hosts	Distribution	Disease in Man	Disease in animals
African horse sickness (9)	African horse sickness	Ceratopogonidae ( <i>Culicoides</i> )	Equidae	Africa, Asia (Near and Middle East), Europe		African horse sickness (cardiopulmonary disease, hemorrhagic fever)
Bluetongue (24)	Bluetongue	Ceratopogonidae ( <i>Culicoides</i> )	Sheep, cattle, goat, deer	Worldwide		Bluetongue disease (congenital malformation in ruminants)
Changuinola (12)	Changuinola	Phlebotomines ( <i>Phlebotomus</i> )	?	Panama	Fever	
Chenuda (7)	Chenuda	Argasidae ( <i>Argas</i> ), Ixodidae ( <i>Hyalomma</i> )	Birds	Egypt, Russia		
Chobar Gorge (2)	Chobar Gorge	Argasidae ( <i>Ornithodoros</i> )	Cattle (?), sheep (?)	India		
Corriparta (2)	(Corriparta)	Culicidae ( <i>Culex</i> )	Birds (?)	Australia		
Epizootic hemorrhagic disease (10)	Epizootic hemorrhagic disease	Ceratopogonidae ( <i>Culicoides</i> )	Deer	North America Africa		Epizootic hemorrhagic disease (hemorrhagic fever, rhinitis, stomatitis, encephalitis in horses)
Equine encephalosis (7)	Equine encephalosis	Ceratopogonidae ( <i>Culicoides</i> )	Equines	Africa		
Eubenangee (4)	Eubenangee	Culicidae ( <i>Culex</i> ) Ceratopogonidae ( <i>Culicoides</i> )	Cattle (?), marsupials (?)	Australia		
Ieri (3)	Ieri	Culicidae ( <i>Psorophora</i> )	?	Trinidad, Brazil		
Great Island (35)	Bauline	Ixodidae ( <i>Ixodes</i> )	Birds	Canada, Western Europe		
	Cape Wrath	Ixodidae ( <i>Ixodes</i> )	Birds	Scotland, Wales		
	Kemerovo	Ixodidae ( <i>Ixodes</i> , <i>Hyalomma</i> )	Rodents, birds	Russia, Uzbekistan, Egypt	Fever, encephalitis (?)	
	Lipovnik	Ixodidae ( <i>Ixodes</i> )	?	Czech Republic, Slovak Republic	Fever, encephalitis (?)	
	Mykines	Ixodidae ( <i>Ixodes</i> )	Birds (?)	Denmark		
	Okhotskiy	Ixodidae ( <i>Ixodes</i> )	Birds	Russia		
	Tindholmur	Ixodidae ( <i>Ixodes</i> )	Birds	Denmark		
	Tribec	Ixodidae ( <i>Ixodes</i> )	Rodents, cattle (?)	Czech Republic, Slovak Republic, Germany, Italy, Russia	Fever, neurological disease (?)	
Lebombo (1)	Lebombo	Culicidae ( <i>Aedes</i> , <i>Mansonia</i> )	Rodents	South Africa, Nigeria, Mozambique, Botswana	Fever	
Orungo (4)	Orungo	Culicidae ( <i>Aedes</i> , <i>Culex</i> , <i>Anopheles</i> )	Cattle, sheep (?)	Central Africa, West Africa	Fever	

**Reoviridae. Table 1** Arboviruses VII. Double-stranded segmented RNA viruses: Family Reoviridae, genus *Orbivirus* (Continued)

Group (no. of members)	Species (selected)	Arthropod host	(Main) vertebrate hosts	Distribution	Disease in Man	Disease in animals
Palyam (12)	Chuzan	Ceratopogonidae ( <i>Culiseta</i> )	Vertebrates	Asia		Congenital malformation in cattle
	Kasba	Culicidae ( <i>Culex</i> )	?	India		Abortion in cattle
Umatilla (4)	Umatilla	Culicidae ( <i>Culex</i> )	Birds	USA		
Wad Medani (2)	Wad Medani	Ixodidae ( <i>Hyalomma</i> , <i>Rhipicephalus</i> , <i>Amblyomma</i> , <i>Boophilus</i> )	Cattle (?), pigs (?), rodents (?)	Africa, Asia, Jamaica		
Wallal (2)	Wallal	Ceratopogonidae ( <i>Culicoides</i> )	Marsupials	Australia		
Warrego (3)	Warrego	Ceratopogonidae ( <i>Culicoides</i> ), Culicidae ( <i>Culex</i> )	Marsupials	Australia		
Wongorr (3)	Wongorr	Ceratopogonidae ( <i>Culicoides</i> ), Culicidae ( <i>Culex</i> , <i>Aedes</i> )	Marsupials	Australia		

**Reoviridae. Table 2** Arboviruses VIII. Double-stranded segmented RNA viruses: Family Reoviridae, genus *Coltivirus* and genus *Seadornavirus*

Genus (no. of species)	Species	Arthropod host	(Main) vertebrate hosts	Distribution	Disease in Man	Disease in animals
Coltivirus (2)	Colorado Tick Fever	Ixodidae ( <i>Dermacentor</i> , <i>Otobius</i> )	Rodents	North America	Colorado tick bite fever (fever, meningitis)	
	Eyach	Ixodidae ( <i>Ixodes</i> )	?	Germany, France	Meningoencephalitis (?)	
Seadornavirus (3)	Banna	Culicidae ( <i>Culex</i> , <i>Anopheles</i> )	?	China, Indonesia	Fever, encephalitis	
	Kadapiro	Culicidae ( <i>Culex</i> )	?	Indonesia (Java)		
	Liao-Ning	Culicidae ( <i>Culex</i> )	?	China		

amounts of protein are found in the →refractile bodies of sporozoan sporozoites (→Cyst Wall/Fig. 2B) and in haemosporidian ookinetes. Carbohydrates are generally stored in the form of granules of →glycogen or →amylopectin (→Surface Coat/Fig. 1A). Amylopectin-containing granules appear as brilliant white areas in the electron micrographs of →gregarines, coccidians, and some endoparasitic ciliates (Fig. 1B, →Cyst Wall/Fig. 2B). These granules are scattered throughout the →cytoplasm of sporozoans of all developmental stages except →microgametes, and are particularly numerous in the cytoplasm of macrogametes and oocysts (→Cyst Wall/Figs. 1A, 2B, →Macrogamete/Fig. 1). Glycogen (→Surface

Coat/Fig. 1A) is present as small randomly distributed granules in the cytoplasm of →*Tritrichomonas foetus* and as a large mass in the cytoplasm near the nucleus in *Entamoeba* or *Iodamoeba* cysts as well as in the host cells.

In all helminths glycogen is the predominant storage material. While in the ectoparasitic →*Monogenea* glycogen represents only 1% of the dry body weight, it may increase to 30–36% in →tapeworms and up to 30% in male schistosomes. In female schistosomes, however, only 3.5% of the dry weight is accounted for by glycogen. The glycogen is degraded during →glycolysis and used during many processes. Besides

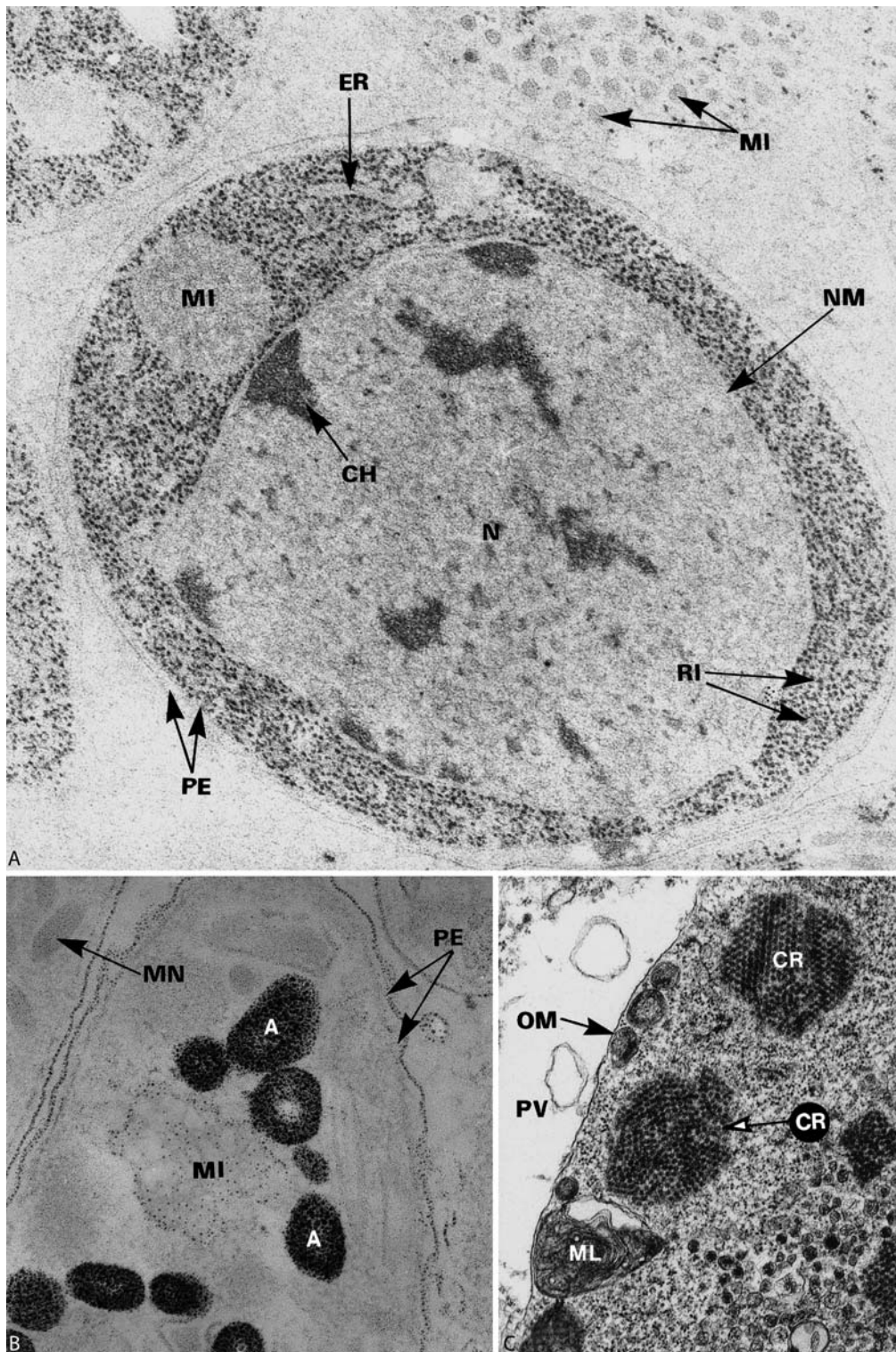

**Reserve Granules. Figure 1 A–C** EMs showing different cytochemical techniques. **A** *Sarcocystis ovifelis*; cyst →merozoite in cross section; using the thallium ethylate method of Mentrö, DNA and RNA components become visible ( $\times 70,000$ ). **B** *Besnoitia jellisoni*; motile stages of eimeridian →Sporozoa contain amylopectin granules, which are stained here (in cyst merozoites) by the Thiöry silver-proteinat method. Note the surface coat of polysaccharides on the →pellicle (PE) ( $\times 65,000$ ). **C** In schizonts of →*Isospora* spp. and in ookinetes and oocysts of →*Plasmodium* spp. lipoproteins appear in a crystalline pattern (normal contrast) ( $\times 45,000$ ). A, amylopectin granules; CH, condensed →chromosomes; CR, crystalline proteins; ER, endoplasmic reticulum; MI, mitochondrion; ML, multilaminar body; MN, →micronemes; N, nucleus; NM, nuclear membrane; OM, outer limiting membrane (of the →schizont); PE, pellicle; PV, →parasitophorous vacuole; RI, ribosomes.

glycogen many lipid droplets and protein inclusions are stored in the cells of the helminths (→ [Tegumental Disks](#), → [Calcareous Corpuscles](#)). The lipids reach up to 16% of the dry weight in tapeworms (e.g., → [Taenia solium](#), [→ [Moniezia expansa](#)]).

## Reservoir Host

Organism in which a parasite that is pathogenic for some other species lives and multiplies without doing serious damage to its host.

## Reservosomes

→ [Glycosomes](#), → [Trypanosoma cruzi](#).

## Resilience

This term describes the ability of an infected animal to withstand the negative pathophysiological consequences of a penetrated parasite.

## Resistance

Resistance is the ability of an organism not to get infected by certain parasites.

One may wonder why hosts, especially the ones which possess a sophisticated immune system, rarely get totally rid of their parasites under natural conditions. There are 2 answers to this apparent paradox. The first is that parasites and hosts are engaged in arms races (→ [Virulence/Evolutionary Aspects](#), → [Coevolution](#)) and that parasites, thanks to a high degree of genetic variation and to short generation times, can rapidly select counter-responses to the weapons selected by the hosts. The second is that there exists a cost of resistance.

A demonstration of the cost of resistance, among others, was indirectly made by a study on the mechanisms by which antelopes fight against their ectoparasites (→ [ticks](#) principally). McKenzie and Weber filled with cement the interdental spaces of one side of the mandible of a series of impalas. Filling the spaces prevented normal grooming in such a way that the antelopes could still remove their ectoparasites with their dental apparatus on one side of the body but not on the opposite side. The

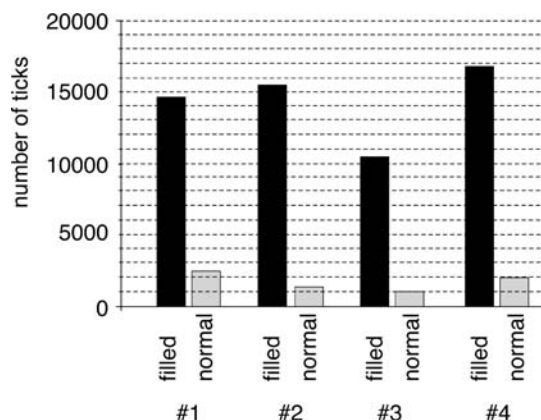

**Resistance. Figure 1** Ectoparasites of antelopes and cost of resistance. An experiment in the field shows that, when antelopes are prevented from normal grooming, the number of ectoparasites is increased in 4 weeks by a factor of 10 or more. Filled = side of the body where interdental spaces of the lower jaw were filled with cement; normal = side of the body where interdental spaces were left unfilled; #1, #2, etc. = different individuals (original, data from McKenzie and Weber).

result was that, after 4 weeks in the wild, the number of ticks was approximately 10 times higher on the “filled side” (up to 15,000 thousands ticks were counted per half-antelope) than on the “normal side” (Fig. 1). An interesting feature is that, even on the “normal side,” not all the ticks were ever removed. There are several possible explanations to that, including the fact that new parasites attach continuously to the skin. But it is also most likely that an individual which would try to remove all or nearly all its parasites, would be constrained to spend less time to forage and would be less attentive to detect predators: the cost of resistance would then outweigh its benefits.

## Resistance Against Drugs

Genetically transmitted decreased sensitivity against drugs. → [Resistance](#), → [Drug](#) and → [Chemotherapy](#).

## Resistance Encoding Genes

In *Plasmodium falciparum* drug-resistant strains the following genes had changed, when treatment was done with:

- Artemisinin: *atp6*, *mdr1*
- Atovaquone: *cytb*

- Chloroquine: *crt, mdr1*
- Chlorproguanil: *dhfr*
- Dapsone: *dhps*
- Doxycycline: *mt protein synthesis*
- Halofantrine: *mdr1*
- Lumefantrine: *mdr1*
- Proguanil: *dhfr*
- Sulfadoxine: *dhps*
- Tetracycline: *mt protein synthesis*
- Trimethoprim: *dhfr*

## Resmethrin

### Chemical Class

Pyrethroid (type I).

### Mode of Action

Open state voltage-gated sodium channel blocker.

→Ectoparasitocides – Blockers / Modulators of Voltage-Gated Sodium Channels.

## Resorantel

→Nematocidal Drugs.

## Respiratory System Diseases, Animals

### General Information

A wide variety of clinical signs and pathological lesions may result from invasion of the respiratory system by parasites. The severity of the clinical manifestations depends largely on the number of parasites present and on which part of the tract they normally invade. It is also determined by individual variations between hosts in the anatomical and physiological features of the respiratory tract, or in the nature of the response to infection. As for many other parasitic diseases, the parasites that cause respiratory problems do not all live in the respiratory system as adults; some (e.g., →*Ascaris*, →*Ancylostoma*, →*Strongyloides*) pass through the lungs in the normal course of their migration whereas others may penetrate the system by error (e.g., *Fasciola*). Finally, parasites residing primarily in other systems may cause syndromes in which respiratory difficulties are one of the foremost presenting signs (e.g., →*Dirofilaria immitis*).

### Manifestations and Pathophysiology

As with other parasitic diseases the clinical signs resulting from infection of the respiratory tract may vary from mild to very severe. The principal clinical manifestations of respiratory dysfunction are hyperpnea, tachypnea, dyspnea, respiratory noises, and nasal discharge. Table 1 provides a list of the different parts of the respiratory tract and of the clinical signs which may be observed when they are affected.

Parasites living in the nasal passages and/or the sinuses induce inflammatory reactions of the mucosa. Rhinitis and sinusitis start as catarrhal inflammations characterized by a nasal discharge which is serous initially, but rapidly becomes mucoid and purulent. Sneezing is also a characteristic (Fig. 1). Wheezing and stertor may be present when both nostrils are partially obstructed. The irritation may cause the animal to shake its head, or rub its nose against the ground or its front legs. Inflammation of the larynx, trachea, and bronchi are characterized by cough, noisy inspiration, and some degree of inspiratory dyspnea (Figs. 1, 2).

→Pneumonia is an inflammation of the lung, usually accompanied by inflammation of the bronchioles, and sometimes by pleuritis (pleuropneumonia). It is manifested clinically by an increase in respiratory rate, cough, dyspnea, and sometimes nasal discharge (Figs. 1, 2). The most important parasites causing bronchiolitis and alveolitis are helminths belonging to the Dictyocaulinae and Metastrongylidae. The reaction to the presence of eggs, larvae, or adults is comparable to the one induced by foreign bodies, with accumulation of masses of eosinophils, macrophages, and giant cells. The lesions may cause the dysfunction of large masses of lung tissue. Emphysema commonly accompanies pneumonia, particularly in cattle. It is presumed to be caused by a combination of blockage of bronchioles and violent coughing so that air retained in the alveoli exerts enough pressure to cause a rupture of the alveolar walls.

**Respiratory System Diseases, Animals. Table 1** Clinical signs associated with specific anatomic involvement of the respiratory tract (according to Vercauteren and De Bont)

Anatomic area	Clinical signs
Nasal cavity	Nasal discharge, snorting, sneezing, nasal rubbing
Sinuses	Nasal discharge
Larynx	Dyspnea, coughing
Trachea	Harsh resonant cough, dyspnea
Bronchi or bronchioles	Coughing, dyspnea
Alveoli	Cough when associated with bronchial pathology, hyperpnea, dyspnea

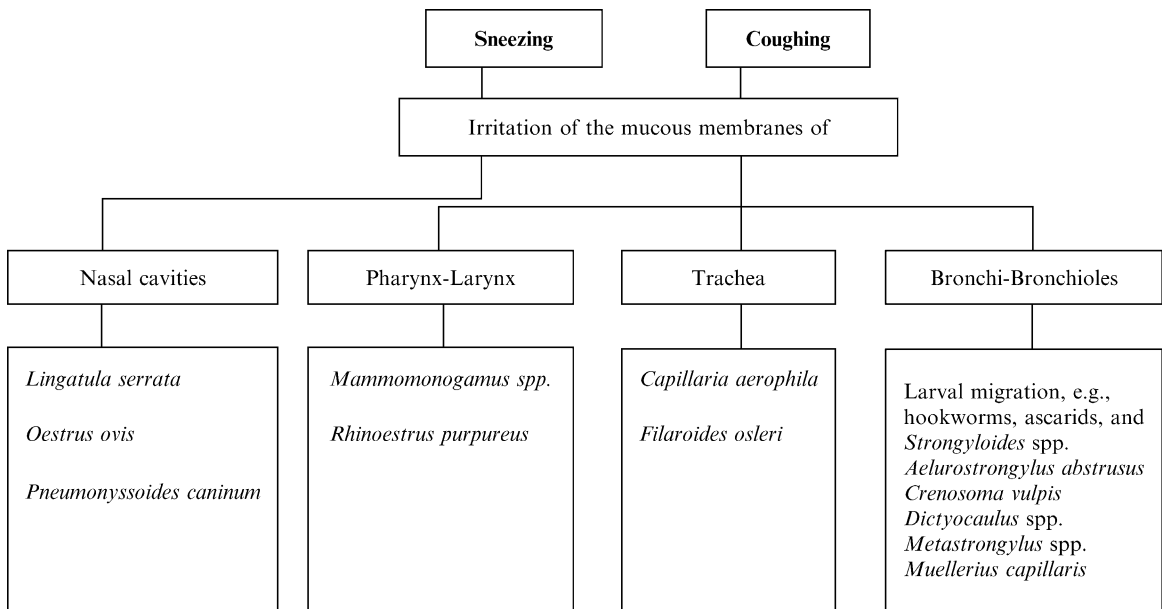

Respiratory System Diseases, Animals. Figure 1 Parasites causing sneezing and coughing.

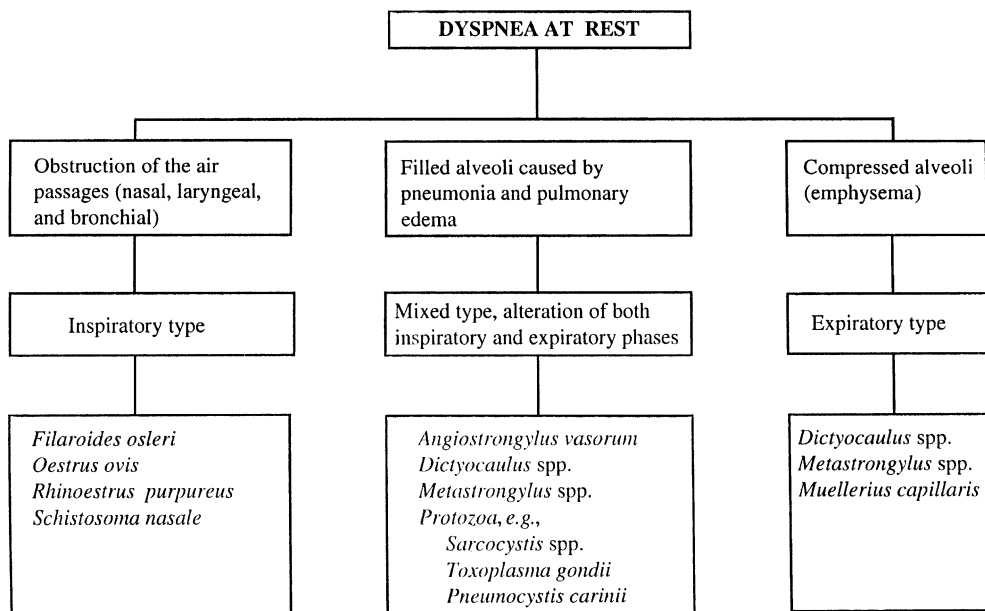

Respiratory System Diseases, Animals. Figure 2 Parasites causing dyspnea at rest.

The larvae of several intestinal [nematodes](#) (e.g., ascarids, [hookworms](#) and *Strongyloides*) normally migrate through the lungs. Once in the bronchioles, they are coughed up and swallowed, to eventually reach the small intestine where they mature. In the lungs, they cause a transitory eosinophilic alveolitis and bronchiolitis. Although the pathogenesis of the lesions is attributable mainly to the physical damage caused by larvae, there is also evidence of [hypersensitivity](#) in the modulation of infection.

Most parasitic infections of the respiratory tract are associated with peripheral [eosinophilia](#).

### Related Entries

[Respiratory System Diseases, Ruminants](#), [Respiratory System Diseases, Horses, Swine, Carnivores](#).

### Treatment

[Chemotherapy](#), [Drugs](#).



## Respiratory System Diseases, Horses, Swine, Carnivores

The common clinical signs and pathology of parasitic infections of the respiratory system of horses, swine, and carnivores are summarized in Table 1.

### Nasal Cavity and Sinuses

→*Linguatula serrata* is a pentastomid which infects the nasal passages of dogs and rarely horse, goat and sheep. The adult parasites are up to 12 cm long and lie on the surface of the nasal mucosa. No symptoms of nasal irritation are apparent except for occasional sneezing, and sometimes epistaxis.

The mite →*Pneumonyssus (Pneumonyssoides) caninum* is occasionally found in the nasal passages and sinuses of dogs. It is usually an incidental finding not associated with clinical signs or the development of lesions. However, there are reports of the →mites causing mild rhinitis, sinusitis, and even bronchitis. Clinical signs include chronic sneezing, head shaking, epistaxis, and impaired scenting ability.

A naso-pharyngeal myiasis of horses, with similar clinical symptoms as →*Oestrus ovis* is caused by →*Rhinoestrus purpureus*, the →Russian gadfly. →Leeches such as *Dinobdella ferox* commonly enter the nasal cavities of domestic animals, mainly in southern Asia. They suck blood, generally induce inflammation, and may impede breathing.

### Larynx and Trachea

→*Capillaria aerophila (Eucoleus aerophilus)* is found mainly in the trachea and the nasal cavity of dogs and cats. Mild infestations are asymptomatic and provoke a mild catarrhal inflammation with nasal discharge and a mild cough. In heavy infestations a persistent dry cough and intermittent dyspnea may be observed.

→*Filaroides (Oslerus) osleri* is an →ovoviviparous, filiform worm parasitizing the dog and related species. The worms cause submucosal →nodules of up to 10 mm in diameter in the region of the tracheal bifurcation. The clinical symptoms are proportional to the severity of infection and the number and size of the tumors. The most frequently recorded symptom is a sporadic but persistent nonproductive cough. The most severe clinical cases, which usually occur in pups under 1 year of age, show persistent coughing, respiratory distress and emaciation, with up to 75% mortality rates in affected litters.

### Lower Respiratory Tract

As for ruminants, some species such as the lungworms use the lower air passages and more rarely the lung

→parenchyma as final habitat. Other species just pass through the lungs during their migration, causing various degrees of damage according to the nature and intensity of the host-parasite interaction.

### Protozoa

→*Toxoplasma gondii* can infect a wide variety of cell types in nearly all warm-blooded animals, and the clinical picture in a particular host species depends on the particular involvement of any one or more of these organs. In dogs and cats, involvement of the lungs is a common feature. In dogs, clinical toxoplasmosis is most frequent in puppies, and is often complicated by the simultaneous manifestations of distemper. The clinical syndrome is variable in course but →anorexia, fever, and lethargy accompanied by dyspnea are the essential features. Proliferation of the organism in the lungs leads to focal areas of coagulation →necrosis adjacent to and involving small vessels and bronchioles and exudation of fibrin.

→*Pneumocystis carinii* is a protist of uncertain taxonomy which inhabits the pulmonary alveoli of dogs, horses, goats, pigs, and humans, and which may give rise to severe respiratory distress in hosts who suffer from immunodeficiency. The onset of pneumocystosis can be acute or insidious. Signs of dyspnea, tachypnea, cough, periodic cyanosis, and →weight loss were noted in otherwise alert animals. The disease may take a progressive course and death can occur in a few weeks if the patient is not treated.

### Nematodes

In contrast with horses, donkeys are only slightly affected by even heavy infections with →*Dictyocaulus arnfieldi*. It has been concluded that donkeys are the natural host of the parasite. Infections in horses are generally nonpatent, but may be associated with clinical signs such as coughing, increased respiratory rate, and nasal discharge.

*Metastrongylus* spp. are transmitted by earthworms and thus only occur in wild boars and occasionally in domestic pigs when kept on pasture. There are three important species of →*Metastrongylus*: *M. elongatus (M. apri)*, *M. pudendotectus*, and *M. salmi*. They are all parasitic in the bronchi and bronchioles of pigs. The lesions caused by the parasites resemble those caused by →*Dictyocaulus* spp. in ruminants but, generally speaking, with much lighter clinical signs. Infected pigs often develop a husky cough which, if infections are heavy, may get superimposed by often fatal bacterial or viral infections.

*Aelurostrongylus abstrusus* is a small metastrongyle that develops in the bronchioles of cats and is capable of eliciting extensive bronchiolitis and interstitial →pneumonia. In clinically-infected cats abnormal respiratory signs with coughing, sneezing, and some degree

**Respiratory System Diseases, Horses, Swine, Carnivores. Table 1** Parasites affecting the respiratory system of horses, swine, dogs (according to Vercruyse and De Bont)

Parasite	Type	Host	Location	Clinical presentation	Principal lesions
<b>Protozoa</b>					
<i>Pneumocystis carinii</i>	1	Dog	Alveoli	Clinical signs when impairment of host resistance: dyspnea, tachypnea, cough, cyanosis	Interstitial pneumonia with massive mononuclear cell infiltration
<i>Sarcocystis</i> spp.	3	Pig (intermediate)	Vascular endothelium	Anorexia, fever, weight loss, anaemia, and dyspnea	Lungs: mild interstitial pneumonitis and vasculitis
<i>Toxoplasma gondii</i>	1	Pig, carnivores	Alveoli	Anorexia, fever, and lethargy accompanied by dyspnea	Lungs: focal areas of coagulation necrosis, adjacent to and involving small vessels and bronchioles
<b>Trematoda</b>					
<i>Paragonimus</i> spp.	1	Cat, dog	Lung parenchyma	Mild intermittent coughing, expiratory wheezing, and on occasion, acute dyspnea	Cystic lesions, eosinophilic granulomatous pneumonia
<b>Nematoda</b>					
<b>Rhabditida</b>					
<i>Strongyloides</i> spp.	3	Pig, dog	Small intestine, larvae migrate through lungs	Light coughing	Transitory eosinophilic alveolitis and bronchiolitis
<b>Strongylida</b>					
<i>Aelurostrongylus abstrusus</i>	1	Cat	Terminal bronchioles	Occasionally coughing, sneezing, oculo-nasal discharge	Light bronchiolitis, hypertrophy of the arterial and arteriolar smooth muscles
<i>Ancylostoma</i> spp. and other hookworms	3	Carnivores	Small intestine, larvae migrate through lungs	Soft cough	Petechial hemorrhages on the lungs with transitory alveolitis and bronchiolitis
<i>Angiostrongylus vasorum</i>	3	Dog	Pulmonary artery and rarely in right ventricle	Dyspnea and dead of cardiac insufficiency	Pulmonary oedema, granulomatous interstitial pneumonia
<i>Crenosoma vulpis</i>	1	Dog, cat	Bronchi, occasionally trachea	Coughing and dyspnea	Catarrhal eosinophilic bronchitis
<i>Dictyocaulus arnfieldi</i>	1	Donkey, horse	Bronchi	Clinical signs mainly in horses: coughing, hyperpnea and nasal discharge	Bronchitis, bronchiolitis, pneumonitis
<i>Filaroides</i> spp.	1	Dog	Alveoli and bronchioles	Usually no clinical signs, respiratory distress has been noted	Foci of granulomatous interstitial pneumonia
<i>Filaroides osleri</i>	1	Dog	Tracheabronchial bifurcation	Nonproductive cough, dyspnea, exercise intolerance, cyanosis	Submucosal, firm nodules
<i>Metastrongylus</i> spp.	1	Pig	Bronchioles, small bronchi	Husky cough, slight dyspnea	Bronchitis, bronchiolitis, pneumonitis
<b>Spirurida</b>					
<i>Dirofilaria immitis</i>	3	Dog, cat	Right heart ventricle, the pulmonary artery	Deep, soft, cough, hemoptysis, dyspnea	Endarteritis, secondary pulmonary parenchymal lesions
<b>Ascaridida</b>					
<i>Ascaris suum</i>	2	Pig	Small intestine, transit of larvae through lung	Coughing	Transitory eosinophilic alveolitis and bronchiolitis, lesions more marked in

**Respiratory System Diseases, Horses, Swine, Carnivores. Table 1** Parasites affecting the respiratory system of horses, swine, dogs (according to Vercruyse and De Bont) (Continued)

Parasite	Type	Host	Location	Clinical presentation	Principal lesions
			parenchyma		repeated infections
<i>Parascaris equorum</i>	2	Horse	Small intestine, transit of larvae through lung parenchyma	Coughing and nasal discharge	Transitory eosinophilic bronchitis and bronchiolitis
<i>Toxocara canis</i>	2	Dog	Small intestine, transit of larvae through lung parenchyma	Coughing, in young dogs dyspnea, death	Transitory multifocal interstitial pneumonitis
Enoplida					
<i>Capillaria aerophila</i>	1	Dog, cat	Nasal cavity, trachea	Nasal discharge, mild cough, in heavy infestations dyspnea	Mild catarrhal rhinitis and tracheitis
<b>Arthropoda</b>					
Acaridia					
<i>Pneumonyssus caninum</i>	1	Dog	Nasal passages, sinuses	Occasionally sneezing	Mild rhinitis, sinusitis
Diptera					
<i>Rhinoestrus purpureus</i>	3	Horse	Nasal passages, sinuses, pharynx	Nasal discharge, sneezing death (larval aspiration)	Rhinitis, sinusitis, pharyngitis
Pentastomida					
<i>Linguatula serrata</i>	1	Dog, more rarely in horse	Nasal cavities, occasionally paranasal sinuses	Occasionally sneezing with mucous discharge	Catarrhal rhinitis

of oculo-nasal discharge appear 6–12 weeks after infection. Most cases show little clinical disturbance, because the lesions regress spontaneously as immunity develops.

*Crenosoma vulpis*, a small metastrongyle, occurs in the bronchi and occasionally the trachea of foxes, dogs, and cats. The adult worms induce a catarrhal eosinophilic bronchitis with heavy coughing and dyspnea.

*Filaroides milski* and *F. hirchi* live in the alveoli and bronchioles of dogs causing interstitial pneumonia. Clinical signs of infection are rare although respiratory distress and even mortality have been reported.

→*Paragonimus kellicotti* is a digenetic fluke that inhabits fibrous cysts in the lungs of wild carnivores and domestic cats and dogs. *P. westermani* occurs in the lungs and more rarely in the brain and spinal cord of dogs, cats, wild animals, and humans. The clinical signs include mild coughing, expiratory wheezing, and on occasion, acute dyspnea. Pneumothorax may be a rare complication in both dogs and cats. Lesions are mainly due to the adult →flukes which are found, usually in pairs, in inflammatory cysts in the pulmonary parenchyma and occasionally the bronchi of predominantly the right caudal lung lobes.

*Angiostrongylus vasorum* occurs in the pulmonary artery and rarely in the right ventricle of the dog and the fox. They cause a proliferative endarteritis comparable

to that induced by →*Dirofilaria immitis*, but the more severe damage is caused by eggs that lodge in arterioles and capillares. Together with the larvae they provoke a chronic inflammation in which fibroplasia predominates. The larvae break into the alveoles and migrate in the respiratory passages. Affected animals suffer from dyspnea and may die of heart failure. The fatal outcome is largely attributable to pulmonary →edema and pneumonia.

Infection with *D. immitis* in dogs generally gives rise to respiratory involvement. The pneumonitis is caused by →granuloma formation around microfilariae trapped in the lung. The clinical signs of heart worm disease are discussed in the section on parasitic →vasculitis (→Cardiovascular System Diseases, Animals). The larvae of several intestinal →nematodes pass through the lungs during the course of their normal migration. Lesions and respiratory signs are most pronounced with the larvae of the ascarids *Ascaris suum*, →*Parascaris equorum*, and →*Toxocara* spp. in pigs, horses, and carnivores, respectively. The migration of *P. equorum* larvae through the lungs provokes an →inflammatory reaction which may result in mild to severe respiratory distress. Larvae of *T. canis* are often present in the lungs of newborn puppies (after transplacental migration), and heavy infections result in substantial hemorrhage into the alveoli during the first day of life. This may prove fatal. Pulmonary

lesions are characterized by granulomas and multifocal interstitial pneumonitis.

Acute respiratory signs (coughing) may appear in young animals a few days after exposure to *Strongyloides westeri* (horses). The respiratory signs caused by migration of →hookworms (dogs) are less pronounced.

Aberrant migrations through the respiratory system of parasites such as *Fasciola* spp. or →*Spirocerca lupi* do not usually cause clinical signs and are only detected post mortem.

### Treatment/Therapy

→Chemotherapy, →Drugs.

## Respiratory System Diseases, Ruminants

The common clinical signs and pathology of parasitic infections of the respiratory system of ruminants are summarized in Table 1.

### Nasal Cavity and Sinuses

The larvae of a number of flies of the family Oestridae are parasites of nasal cavities and sinuses of ruminants. The most ubiquitous is the nasal →botfly of sheep and goats, →*Oestrus ovis*. The flies cause great stress when they attack the sheep to deposit larvae near the nostrils of the host, a process which significantly interferes with grazing and rumination. The larvae which develop in the nasal cavities may get up to 3 cm in length and cause severe discomfort, partly because of the damage caused by the oral hooks and cuticular spines of the larvae, but also because of →hypersensitivity phenomena. Nasal discharge and sneezing are common features in affected sheep, with caked dust obstructing the nostrils. Head shaking and nose rubbing may sometimes be seen. Extension to the cranial cavity via the ethmoid causes nervous symptoms and is usually fatal, but is also very rare.

*Schistosoma nasale* lives in the nasal veins of a variety of domesticated animals on the Indian subcontinent, including cattle, water buffalo, sheep, goat, and rarely horse. The lesions which are granulomatous in nature are caused by the passage of eggs through the wall of the nasal cavity. The condition is associated with cauliflower-like growths on the nasal mucosa causing partial obstruction of the cavity and snoring sounds when breathing. The lesions tend to get more severe in older animals and may become very spectacular in cattle, leading to “→snoring disease”.

→Leeches such as *Dinobdella ferox* commonly enter the nasal cavities of domestic animals, mainly in

southern Asia. They suck blood, generally induce inflammation, and may impede breathing.

*Besnoitia besnoiti* occurs in cattle in Southern Europe, Africa and Southeast Asia. The parasite multiplies mainly in the skin, but may also alter the mucosa of the upper respiratory tract and the lung may appear edematous. The large cysts are identifiable with the naked eye in the nasal mucosa and at necropsy at the respective predilection sites.

### Larynx and Trachea

→*Mammomonogamus laryngeus* occurs in the larynx and the trachea of cattle and humans in Southeast Asia and South America, and *M. nasicola* is found in nasal cavities, trachea, larynx, and bronchi of sheep, goats, and cattle in Africa and South America. In animals there are no apparent symptoms except for a light coughing. There is one record of a fatal infection in sheep believed to be due to a respiratory obstruction initiated by *M. nasicola*.

### Lower Respiratory Tract

Parasitic infections of the lower respiratory tract of ruminants are very common and important. Some species such as the lungworms use the lower air passages and more rarely the lung →parenchyma as final habitat. Other species just pass through the lungs during their migration, causing various degrees of damage according to the nature and intensity of the host–parasite interaction.

### Protozoa

Protozoa that are spread across tissues by parasitemia or induce generalized disease may also affect the respiratory system. For instance, lung edema is often observed during babesiosis, mucosal bleedings occur during theileriosis, coughing and dyspnea may develop during toxoplasmosis in small ruminants. →*Sarcocystis* may occasionally cause dyspnea. A multifocal interstitial pneumonitis and →vasculitis are responsible for the respiratory signs.

### Lungworms

→*Dictyocaulus viviparus* is certainly the most important lungworm of cattle in temperate areas. The severity of the clinical signs depends on the susceptibility of the host and on the number of invading larvae. Cattle are most susceptible to infection when they are first exposed to contaminated pastures. Since the occurrence of the primoinfection varies, dictyocaulosis (husk) can be seen in all age classes. In early infections lesions are mainly found in the alveoli, which the larvae penetrate from lymphatics and blood vessels. An eosinophilic exudate accumulates in the alveoli and the terminal bronchioles. Hyperpnea and coughing may become

**Respiratory System Diseases, Ruminants. Table 1** Parasites affecting the respiratory system of ruminants (according to Verduyck and De Bont)

Parasite	Type	Host	Location	Clinical presentation	Principal lesions
<b>Protozoa</b>					
<i>Sarcocystis</i> spp.	2	Ruminants	Vascular endothelium	Anorexia, fever, weight loss, anemia and dyspnea	Lungs: mild interstitial pneumonitis and vasculitis
<b>Trematoda</b>					
<i>Schistosoma nasale</i>	1	Cattle	Nasal mucosal veins	Muco-purulent discharge, dyspnea, snoring	Granulomas in nasal mucosa
<b>Nematoda</b>					
Rhabditida					
<i>Strongyloides</i> spp.	2	Ruminants	Small intestine, larvae migrate through lungs	Light coughing	Transitory eosinophilic alveolitis and bronchiolitis
Strongylida					
Hookworms	2	Ruminants	Small intestine, larvae migrate through lungs	Soft cough	Petechial hemorrhages on the lungs with transitory alveolitis and bronchiolitis
<i>Dictyocaulus filaria</i>	1	Sheep, goat	Small bronchi	Coughing, hyperpnea, and dyspnea	Bronchitis, bronchiolitis, pneumonitis
<i>D. viviparus</i>	1	Cattle	Bronchi, bronchioles	Coughing, hyperpnea, and dyspnea	Bronchitis, bronchiolitis, pneumonitis, pulmonary edema, emphysema
<i>Mammomonogamus</i> spp.	1	Ruminants	Nasal cavities, larynx, trachea, and bronchi	Light coughing	Chronic inflammation with small ulcerations of the mucosa of upper airways
<i>Muellerius capillaris</i>	1	Sheep, goat	Alveoli, pulmonary parenchyma, subpleural tissue	Usually no clinical evidence, sometimes persistent coughing, dyspnea	Bronchiolitis, pneumonitis with nodular lesions
<i>Protostrongylus</i> spp.	1	Sheep, goat	Bronchioles	Usually no definite clinical signs	Bronchiolitis, lobular pneumonitis
Ascaridida					
<i>Toxocara vitulorum</i>	2	Cattle	Small intestine, transit of larvae through lung parenchyma	Coughing	Transitory eosinophilic alveolitis and bronchiolitis, lesions more marked in repeated infections
<b>Arthropoda</b>					
Acaridia					
Diptera					
<i>Oestrus ovis</i>	3	Sheep, goat	Nasal passages, sinuses	Nasal discharge, frequently sneezing, nasal rubbing	Catarrhal rhinitis and sinusitis

1, A primary parasite of the respiratory system. 2, Affects the lungs through normal migration or proliferation. 3, Parasites of another organ system that produces respiratory symptoms

noticeable as soon as 10–14 days after heavy infections. Occasionally, fatal pulmonary →edema and emphysema develop at this stage, probably as a result of hypersensitivity reactions. During the patent period (25–55 days after infection), adults reside and lay eggs in the bronchi where they induce a →hyperplasia of the

mucosa. Eosinophilic exudate obstructs the lumen of the bronchi, which result in atelectasis of the alveoli distal to the plugs. In addition, eggs aspirated into the alveoli initiate foreign body reactions. The overall consequence of dictyocaulosis is a diffuse consolidation of the lungs. The animals show dyspnea and coughing,

with rapid loss of condition. Harsh respiratory sounds with emphysematous crackling can be heard. The post-patent phase of the disease is often one of gradual recovery in that the respiratory rate decreases, weight gain is resumed, and the coughing abates.

*D. filaria* causes outbreaks of pulmonary nematodosis in sheep and goats in most temperate areas of the world, often with high mortality rates. The pathogenesis and clinical signs appear to be similar to those of *D. viviparus* infections in cattle.

The Protostrongylidae are common lungworms of sheep and goats. They include *Muellerius capillaris*, *Protostrongylus rufescens*, *P. brevispiculum*, *P. kochi*, and *Cystocaulus ocreatus*. These parasites are of minor pathogenic importance. Infections with *Muellerius* and *Cystocaulus* are generally associated with small, spherical nodular lesions in the lung tissue, whereas *Protostrongylus* causes irritation and local inflammatory reactions in the bronchioles resulting in small foci of lobular pneumonitis. Generally animals show no clear symptoms although in the rare heavy infections, and especially with *Protostrongylus* in sheep and *Muellerius* in goats, there may be severe and even fatal disease.

#### Other Parasites

Larvae of *Ascaris suum* may be responsible for an atypical interstitial *→pneumonia* in grazing cattle. Signs of acute respiratory distress such as severe dyspnea, expiratory grunt, hyperpnea and moist cough appear about 10 days after application of contaminated pig manure as a slurry to the pasture.

#### Treatment/Therapy

*→Chemotherapy*, *→Drugs*.

### Retinochoroiditis

*→Toxoplasma* infections may induce severe eye disease; this retinochoroiditis is a progressive recurring disease in immunosuppressed and immunocompetent patients, which can cause severe morbidity (e.g., yearly about 3,000 congenital infections occur in the USA, 1,500 in Germany).

### Retortamonadida

#### Classification

Order of *→Mastigophora*.

#### General Information

These relatively small flagellates have 2–4 free apical *→flagella* and a shorter recurrent one that is attached to the surface; *→mitochondria* and *→Golgi apparatus* are missing; their *→cytoskeleton* is similar to that of the trichomonadids. They inhabit the intestine of many invertebrates and vertebrates, feeding by means of their *→cytostome* on the intestinal fluid; their pathogenicity, if any, is always low. In humans, *→Chilomastix mesnili* and *→Retortamonas intestinalis* are found, which reach in general about 5–10  $\mu\text{m}$  in length, reproduce by longitudinal *→binary fission*, and are transmitted by oral uptake of fecally passed cysts.

### Retortamonas

*→Diplomonadida*.

### Retortamonas intestinalis

Double-flagellated trophozoites (4–9  $\mu\text{m}$  long, one flagellum occurs at the anterior pole, the other is a lateral recurrent flagellum originating in a cytostomal channel, Fig. 1), live inside the caecum and colon of humans. They form pear shaped cysts and are claimed to be apathogenic commensals.

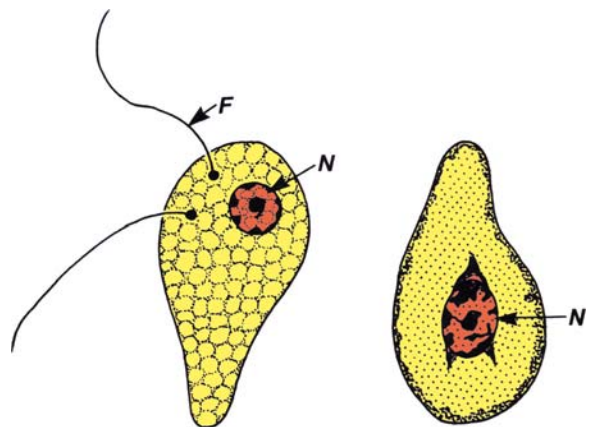

**Retortamonas intestinalis.** Figure 1 DR of a trophozoite and cyst. F, flagellum; N, nucleus.

### Rhabdias bufonis

#### Name

Greek: *rhabdos* = stick (describes the shape of the esophagus).

## Classification

Species of → *Nematodes*.

## Life Cycle

Fig. 1.

## General Information

Family of free-living → *nematodes*, which contains (among others) the genera *Rhabdias* (→ *Rhabdias bufonis* syn. *Rhabdonema nigrovenosum*), *Rhabditis* = (→ *Rhabditis strongyloides*, *R. pellio*), and *Pelodera* (*P. strongyloides*).

## Rhabditidae

### Name

Greek: *rhabdos* = rod.

## Rhabdochona denudata

Spiruroid nematode of 6 mm in length, that lives in the intestine of carps. Intermediate hosts are *Cyclops* spp. and larvae of ephemeropteran flies.

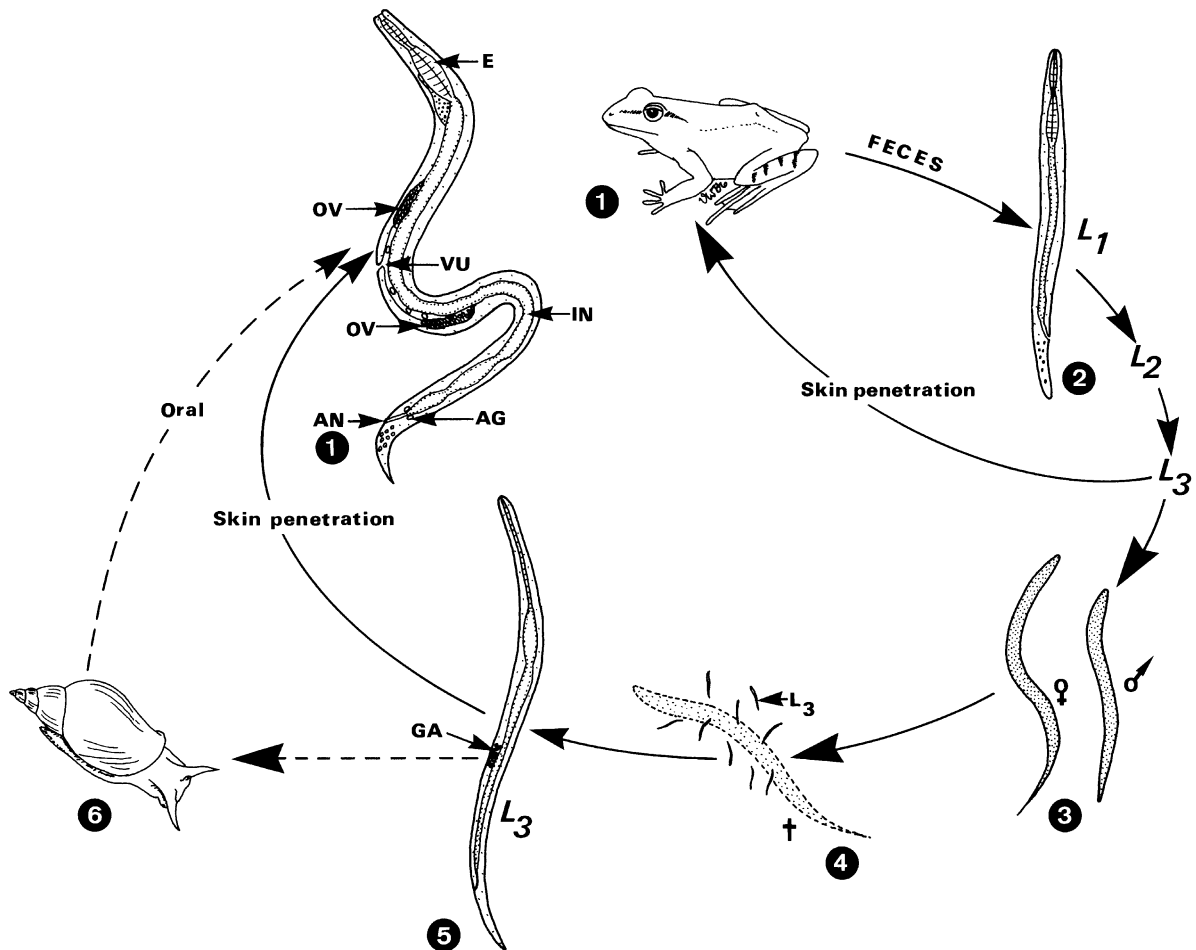

**Rhabdias bufonis.** **Figure 1** Life cycle of *Rhabdias bufonis*. 1 This worm lives as a → *protandric hermaphrodite* in the lung of frogs and feeds on blood. 2 Eggs are freed via lung air spaces, during which the rhabditiform larvae ( $L_1$ ) hatch, are swallowed, and passed with the feces. The filariform  $L_3$  are developed on the soil; some of them may penetrate the skin of the frog (compare 5). 3 Other  $L_3$  grow up to be free-living males and females (about 4 mm long). 4 After copulation numerous larvae are formed inside the uterus; they stay inside their mother, mature to the → *filariform*  $L_3$  stage within 5–6 days, feed on the mother's tissues, and are set free after the death of the female. 5 These free  $L_3$  may penetrate the skin of the frog and mature if they reach the lung. 6 When  $L_3$  larvae enter snails, they become accumulated; snails are thus → *paratenic hosts* which must be swallowed in order to transmit the infectious  $L_3$ . *AG*, anal glands; *AN*, anus; *E*, esophagus; *GA*, genital anlage; *IN*, intestine; *L*, larval stages; *OV*, ovary; *VU*, vulva.

## Rhabdom

This term describes the central region of an ommatidium of a compound eye. In case that the microvilli of the light perceptible cells fuse, a common rodlike central rhabdom is formed (occurs in most insects) or not (unfused = open rhabdom of →*Diptera*). →*Rhabdomer*.

## Rhabdomer

The rhodopsin containing microvilli of the light sense cells of arthropods form a paracrystalline structure directed to the center of each ommatidium of the compound eye. This zone of microvilli of such a cell is called rhabdomer, which is underlined by a layer of cisternae containing reserve  $\text{Ca}^{2+}$ .

## Rhabdoviridae

### Classification

Family of RNA viruses containing viruses transmitted by arthropods (→*Arboviruses*).

### General Information

Negative-sense single-stranded →*RNA viruses* (helical, with envelope). Rabies or lyssa are lethal diseases due to the infection with Rhabdoviridae (which are shaped like bullets). Their RNA is enclosed in a nucleocapsid, while the envelope is covered with spines. These viruses may be transmitted by direct bites of infected foxes, dogs, cats, deers or even by bats (→*Vampire Bats*).

**Rhabdoviridae. Table 1** Arboviruses IX. Negative sense, single-stranded non-segmented RNA viruses: Family Rhabdoviridae

Serogroup (no. of known members)	Species (selected)	Arthropod host	(Main) vertebrate hosts	Distribution	Disease in man	Disease in animals
Vesiculovirus (10)	Algoas	Phlebotominae Culicidae	Vertebrates	North America, Central America, South America	Fever	Stomatitis, lameness, loss of milk
	Vesicular stomatitis New Jersey	Muscidae ( <i>Musca</i> ), Culicidae ( <i>Culex</i> , <i>Mansonia</i> , <i>Culiseta</i> )	Cattle, horses, swines	North America, entral America, South America	Fever	Vesicular stomatitis (stomatitis, lameness, loss of milk)
	Vesicular stomatitis Indiana	Phlebotominae ( <i>Lutzomyia</i> ) Culicidae ( <i>Aedes</i> )	Cattle, horses, swines	North America, Central America, South America	Fever	Vesicular stomatitis (stomatitis, lameness, loss of milk)
	Chandipura	Phlebotominae ( <i>Phlebotomus</i> )	Cattle, horses, sheep, goat	India, West Africa	Encephalitis	
	Radi	Phlebotominae ( <i>Phlebotomus</i> )	?	Europe		
	Yug Bogdanovac	Phlebotominae ( <i>Phlebotomus</i> )	?	Europe		
Ephemerovirus	Bovine ephemeral fever	Ceratopogonidae ( <i>Culicoides</i> ), Culicidae ( <i>Culex</i> )	Bovidae	Africa, Asia, Australia		Bovine ephemeral fever (fever, ruminal stasis, loss of milk)
Sawgrass (3)	Sawgrass	Ixodidae	Rodents (?)	North America		
Hart Park (3)	Flanders	Ceratopogonidae ( <i>Culicoides</i> ), Culicidae ( <i>Culex</i> )	Birds (?)	North America		
Kwatta (1)	Kwatta	Culicidae ( <i>Culex</i> )	?	Surinam		
Mossuril (8)	Mossuril (6)	Culicidae ( <i>Culex</i> )	Birds (?)	Central Africa, Southern Africa		
Ungrouped (9)	Aruac	Culicidae ( <i>Culex</i> , <i>Wyeomyia</i> , <i>Psorophora</i> , <i>Sabethes</i> )	?	Trinidad		



## Important Species

Table 1.

## Rhagionidae

→ Snipe Flies.

## Rhabditiform Larva

→ Hookworms, second larvae, the esophagus of which is provided with a muscular bulbus (Fig. 1).

## Rhinobothrium

→ Eucestoda.



**Rhabditiform Larva. Figure 1** LM of the rhabditiform larva (left), egg (inset) of hookworms, sheathed larva (middle), and filariform larva (right) of *Strongyloides stercoralis*.

## Rhinocystidae

Family of mites in the respiratory tractus of birds.

## Rhinoestrosis

Disease due to infestation with *Rhinoestrus*, see [Table 1](#).

## Rhinoestrus purpureus

### Name

Greek: *rhis*, *rhinos* = nose, *oistros* = biting fly; Latin: *purpureus* = reddish-blue.

The larvae 1 are placed by the flying adult female at the nostrils of horses. They feed portions of the skin and after 2 molts the larvae 3 ([Fig. 1](#)) are excreted with nasal and/or pharyngeal slime. On the soil pupation needs 2–5 weeks to let hatch the adults. If larvae 1 are placed onto the eyes, their feeding introduces eventually an extreme conjunctivitis in humans and animals. → [Respiratory System Diseases](#), Horses, Swine, Carnivores.

## Rhipicentor

Genus of ixodid ticks, the males of which are of medium size, have no ventral plates, but the coxae of the fourth legs are much enlarged. The basis capituli of adults is very strong with pointed lateral angles. Festoons are present at the posterior end.

## Rhipicephalus

### Name

Greek: *rhipis* = fan, *kephale* = head.

**Rhinoestrosis. Table 1** *Rhinoestrus* species

Parasite	Host	Symptoms	Country	Therapy		
				Products	Application	Compounds
<i>Rhinoestrus</i> spp.	Horse	Swelling of nasal and pharyngeal cavity, cough, loss of strength, death	Worldwide	Eqvalan (Meril)	Oral paste	Ivermectin

Genus of hard → [ticks](#) which comprises about 70 species, among which *R. sanguineus* (3-hosts, Brown dog tick or Kennel tick, [Figs. 1–3](#)) in southern Europe, *R. bursa* (a 2-hosts tick around the Mediterranean Sea), and the 3-host tick *R. appendiculatus* (Africa) are most important as vectors of disease (babesiosis, theileriosis, rickettsiosis, anaplasmosis). *R. evertsi* has only 2 hosts. The development of 3 *Rhipicephalus* spp. are summarized in [Table 1](#) (page 1248).

## Rhizopoda

From Greek: *rhiza* = root, *pus/podos* = foot. → [Amoebae](#).

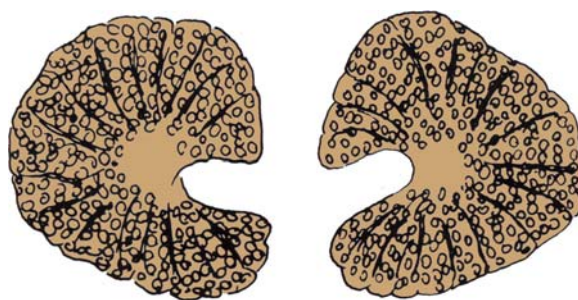

**Rhinoestrus purpureus. Figure 1** Terminal spiracles of the larva 3 (used for diagnostic purposes).



**Rhipicephalus. Figure 1** LM of an adult.



**Rhipicephalus. Figure 2** LM of a female from ventral.



**Rhipicephalus. Figure 3** LM of a six-legged larva.

---

**Rhodnius prolixus**

→Bugs.

---

**Rhodoquinone**

→Quinones.

---

**Rhoptries**

Organelles at the anterior pole of penetrating motile coccidian stages (sporozoites, merozoites). In malarial

**Rhipicephalus. Table 1** Development of *Rhipicephalus* species

Species	Time for larval hatch	Larva (days)		Nymph (days)		Female adults			Days of starvation	Number of eggs
		feeding time	on floor	feeding	on floor	feeding	on floor	egg laying		
<i>R. appendiculatus</i>	28 (up to months)	3-7	4-6 (30°C) 16-24	5-11	10 (30°C) 10-18	6-14	6-23	15-56	682	3,000-5,700
<i>R. sanguineus</i>	17-19 (30°C)	2-8	9-10	11-12	15	7-21	3-6	4-7	570	1,500-3,500
<i>R. evertsi</i>	30	10-14 on the same host		20-30		6-9	4-10	4-8	420	3,000

parasites ([→Plasmodium](#)) there are formed only 2 pear-shaped rhoptries ( $\sim 0.6 \times 0.3 \mu\text{m}$  in size), while they are club-shaped in the genus [→Eimeria](#) (mostly 2 rhoptries) and in the so-called tissue-forming coccidians (*Toxoplasma*, *Sarcocystis*, *Besnoitia*), where many of such rhoptries occur. In *Plasmodium* spp. the rhoptries contain different proteins of high molecular weight (HMW = RhopH 1 – RhopH 3) and low molecular weight (LMW = RAP 1 – RAP 3), which are excreted into the parasitophorous vacuole as in Eimerians.

## Rhynchobdellida

From Greek: *rhynchos* = mouth, *bdellein* = sucking.  
[→Leeches](#).

## Rhynchota

### Name

Greek: *rhynchos* = sucker.

### Synonyms

[→Bugs](#), Hemiptera.

### Classification

Order of insects that includes the bloodsucking bugs, but also plant feeders.

## Ribaga's Organ

[→Berlese's Organ](#).

## Ribeiroa

Genus of [→trematodes](#). Infections with *R. ondatrae* lead to malformations in amphibian development. Thus, this parasite acts teratogenically, e.g., up to 50% of the leopard frogs (*Rana pipiens*) in North America show such a disease.

## Ribeiroa ondatrae

Species of digenetic trematodes, which reach a length of 1.6–3 mm and parasitize in the proventriculus of chickens, fish-eating birds and muskrats. Their testes are situated at the posterior end, the ovary lays before the testes. The eggs measure about  $85 \times 45 \mu\text{m}$ . The disease is named proventriculitis. Infections with *R. ondatrae* lead to malformations in amphibian development. Thus this parasite acts teratogenically, e.g., up to 50% of the leopard frogs (*Rana pipiens*) in North America show such a disease.

## Riberoria

Genus of digenetic [→trematodes](#), the [→cercariae](#) of which enter tadpoles and introduce deformities. The adult frogs are later disabled in their movement and thus are easy prey for birds, which are the final hosts of these [→flukes](#). Since some [→Insecticides](#) may lead to similar deformities, they were suspected as agents of these diseases.

## Riboflavin Deficiency

The vitamin B<sub>2</sub>-deficiency occurs during [→malaria](#). Thus the application of this vitamin offers a kind of protection against the severeness of symptoms.

## Ribosomes

The ribosomes consist of RNA and protein ([→Nuclear Division/Fig. 5](#), [→ReserveGranules/ Fig. 1A](#)). The ribosomal RNA represents about four-fifths of the total cellular RNA. There are several types of ribosomes, depending on the nature of their subunits ([→Eukaryota/ Table 1](#)); these subunits can be released by appropriate treatment of the ribosomal proteins. Several ribosomes often align in a chain to form polyribosomes, or [→polysomes](#), where they are collectively active in protein synthesis. Ribosomes occur along the surface of the rER, either as single forms or as polysomes. They also occur in the [→cytoplasm](#) and inside the [→mitochondria](#). In [→Protozoa](#), cytoplasmic ribosomes have a diameter of ca. 30 nm and are composed of 2 subunits with sedimentation characteristics of 60S

and 40S. The intact ribosome is of the 80S type. Mitochondrial ribosomes are of the 70S type or, in ciliates, 80S. The mitochondrial ribosomes are similar to those of →prokaryotes (→Eukaryota/Table 1).

---

## Richness, Parasitic

Parasitic richness can be defined as the number of parasite species that are found in a given host species. The question may be answered at different scales: total richness (the number of parasite species in the whole area of the host), regional richness (the number of parasite species in a “region,” for instance, a river basin, an island, etc.), the local richness (the number of parasite species in a particular population of the host).

Parasitic richness is very variable; as an example, Caro et al. showed that certain species of Mediterranean fish harbour more than 10 species of monogeneans (the case of certain Sparidae), whereas others harbour none (the case of all Gobiidae, Syngnathidae, and Blenniidae). Hochberg and Hawkins note that one insect species can be attacked by a number of parasitoid insect species ranging from a few to 50 or more. Examples could be multiplied to show that parasitic richness is not a random process: in the same group of hosts, certain species are “rich” in parasites, others are “poor.”

The explanation of the diversity of parasitic richnesses has been looked for in various directions. The method of “comparative analysis” consists in gathering data for numerous host species and trying to determine whether the same factors (e.g., an aquatic environment, a particular type of diet, a large size) produce the same effect on the parasitic richness of the different host species.

Comparative analyses are confronted with 2 difficulties:

One consists in the great differences which usually exist in sampling effort for the different host species.

Another is that the variables used in the analysis are rarely independent. In particular, a part of the parasite richness can be the result of →coevolution and therefore does not necessarily reflect the present-day conditions. For instance, if 2 host species have a common ancestor, their parasitic richness can be inherited in part from this ancestor and its dependence on current environmental factors is limited.

To overcome these 2 difficulties, comparative analyses are corrected both for sampling effects and for phylogenetic effects by mathematical procedures. The validity of comparative analyses and especially of the correction for phylogenetic effects has been the subject of discussions.

There is a general agreement that the following factors influence positively the parasitic richness of host species:

- the host’s body size;
- the diversity of micro-habitats offered by the host organism;
- the geographical area of the host species;
- a diversified diet which implies the ingestion of a variety of potential intermediate hosts;
- gregarious behaviour on the part of the host species.

Other factors influence negatively the richness of parasite communities; they are principally factors opposite to the ones just listed but they also include the existence of “refuges” which act as shields against infective stages.

Parasitic richness can be also measured in individuals within a population of hosts. At this scale again, the distribution of individual parasites is seldom random but is nearly always “contagious” (the variance is significantly greater than the mean): certain host individuals harbour more parasites (sometimes much more) than predicted by a random distribution. Parasitic richness at the scale of individuals is called “parasitic intensity” by most authors. Individual differences in parasitic intensity are explained by differences either in exposures to infective stages (different behaviour of different individual hosts), or in success of parasitic development after infestation (different efficacy of immune systems).

---

## Ricketts, Howard Taylor (1871–1910)

American microbiologist (Fig. 1, page 1251), discoverer of the agents of disease of the Rocky Mountain spotted fever (*Rickettsia rickettsi*) and its transmission by the bite of the tick *Dermacentor occidentalis*. He died in 1910 from this disease during an expedition in Mexico; he was only 39 years old.

---

## *Rickettsia prowazekii*

Agent of the spotted fever disease transmitted by faeces of body lice, named in honour of two scientists →Ricketts and →Prowazek, who both died while working with rickettsiales.

---

## Rickettsiae

Group of minute rod-shaped bacteria which are obligate intracellular parasites of certain arthropods (Table 1, page 1252). Transmitted to man and other



**Ricketts, Howard Taylor (1871–1910).** Figure 1 Ricketts prior to leave to his last Mexico expedition.

mammals via bites ([→Ticks](#), [→Mites](#)) or feces ([→Fleas](#), [→Lice](#)) in which they may cause severe, often fatal disease, e.g., in man, [→Tick Typhus](#), [→Rocky Mountain Spotted Fever](#), [→Boutonneuse Fever](#), [→Heartwater](#).

## Ridges

Modification of the [→cuticle](#) in [→nematodes](#): the stiff longitudinal ridges help attachment by burrowing into the structures around which the worm is twisting ([→Nematodes/Integument](#)).

## RIF

Variant antigen ([→Malaria/Vaccination](#)).

## Rinadia

Genus of trichostrongylid nematodes in wild deer.

## Ring Forms

Malarial trophozoites ([→Malaria](#)) appear inside erythrocytes as rings (are also called signet ring stages, since the nucleus is situated at the periphery).

## River Blindness

[→Onchocerciasis](#), [Man](#), [→Filaridae](#).

## RNA Editing

RNA editing is one of the most striking phenomena observed in the mitochondria of kinetoplastids including *Trypanosoma* and *Leishmania*. In this process, mitochondrial (mt) pre-mRNA, encoded by the [→kinetoplast DNA](#) (kDNA) maxicircles, is posttranscriptionally modified by insertion and deletion of uridine nucleotide (U) residues under the direction of small RNAs, termed [→guide RNAs](#) (gRNAs). It is a form of RNA processing that finally results in the formation of mature translatable mRNA, but it is distinct from the widely occurring RNA splicing and other types of RNA processing, since an additional sequence in the form of U residues is created after transcription. Trypanosome RNA editing is catalyzed by multiprotein complexes (editosomes) and occurs at multiple sites, contributing over half of the protein-coding residues of certain mRNAs. A full-round of editing is composed of three consecutive gRNA specified steps involving pre-mRNA cleavage by a site-specific endonuclease, a terminal uridyl transferase, or an exonuclease for addition or removal of U residues, respectively, and RNA ligases for rejoining the pre-edited mRNA molecules. The number of [→minicircles](#) present in kDNA is sufficient to encode all the gRNAs required for editing of the mitochondrial transcripts. *Trypanosoma brucei* contains roughly 50 identical 22-kb maxicircles and more than 200 1-kb minicircle classes that can encode more than

**Rickettsiae. Table 1** Rickettsiae and related organisms of dogs/cats/man

Species (disease)	Vector
<b>Anaplasmataceae</b>	
<b>Monocytic inclusions:</b>	
<i>Ehrlichia</i> (syn. <i>Anaplasma</i> ) <i>canis</i> (canine monocytic ehrlichiosis)	<i>Rhipicephalus sanguineus</i> (tick)
<i>E. chaffeensis</i> (human monocytic ehrlichiosis)	?
<i>Neorickettsia risticii</i> (equine monocytic ehrlichiosis)	?
<b>Granulocytic inclusions:</b>	
<i>Anaplasma phagocytophilia</i>	?
<b>Thrombocytic inclusions:</b>	
<i>Anaplasma platys</i> (canine infectious cyclic thrombocytopenia)	<i>R. sanguineus</i> (tick)
<b>Rickettsiaceae</b>	
<b>Spotted fever group (SFG):</b>	
TT-118 (tick typhus)	Ixodid ticks
<i>R. felis</i>	Fleas
<b>Typhus group (TG):</b>	
<i>Rickettsiae typhi</i> (murine typhus)	<i>Xenopsylla cheopis</i> (flea)
<i>R. prowazekii</i> (epidemic typhus, <b>man</b> )	<i>Ctenocephalides felis</i> (flea)
<i>R. canada</i>	<i>Pediculus</i> spp. (lice)
Scrub typhus ( <b>man</b> )	
<i>Orientia tsutsugamushi</i> ( <b>man</b> )	<i>Leptotrombidium</i> spp. (mite)
<b>Bartonellaceae</b>	
<i>Bartonella henselae</i>	Fleas
<i>Bartonella clarridgeiae</i>	Fleas
<b>Other bacteria</b>	
Coxiellaceae	Ixodic ticks
<i>Coxiella burnetii</i> (Q-fever)	Ixodic ticks
<i>Borrelia</i> spp. (many hosts)	Ixodic ticks

1,000 gRNAs. The biological relevance of RNA editing is not understood, but it probably functions, for example, to regulate expression of the →mitochondrial respiratory chain during the life cycle of trypanosomatids. It appears to provide a selective advantage to these organisms and thus its early origin in evolution was retained.

## RNA Viruses

→Bunyaviridae.

## Robenidine

A guanidine drug that blocks the oxidative phosphorylation in →*Eimeria* parasites.

## Roble's Disease

→Onchocerciasis, Man, →Filariidae.

## Rochalimaea quintana

→lice, →Rickettsiae, →Trench Fever.

## Rochalimea

Lice-transmitted bacteria now belonging to the genus *Bartonella* (→Trench Fever).

## Rocky Mountain Spotted Fever

Rocky Mountain spotted fever is caused by *Rickettsia rickettsi*. It is found from Canada to South America and is associated with various ixodid →ticks (*Dermacentor andersoni* and *D. variabilis* in North America) which can transmit the pathogen transovarially to the next generation. All tick stages can harbor and transmit agents of the disease. Argasid tick species may also be involved. The disease can be acquired through the tick bite or through contact with tick tissues when the tick is crushed. The →incubation period is 2–5 days in severe cases and up to 14 days in mild cases. In untreated cases, death occurs 9–15 days after onset of symptoms. Mortality was formerly high but has been reduced through antibiotic treatments (tetracyclines).

### Related Entries

→Boutonneuse Fever, →Tick Typhus.

## Rodentolepis

From Latin: *rodere* = feeding by taking small pieces (e.g., *animalia rodentia*), Greek: *lepis* = scale. →Hymenolepididae.

## Rodentolepis nana

→Eucestoda, →Hymenolepididae.

### Disease

→Hymenolepiasis.

## Rodentopus

→Mites.

## Rodenwaldt, Ernst (1878–1965)

German physician, co-worker of →Fülleborn, created hospitals in Togo (1913), Indonesia, Middle East, in order to control infectious diseases. The German military research institute honours his name.

## Roehl, Wilhelm († 1929)

German chemist (Fig. 1), discoverer of the action of diluted chinin and co-developer of the Germanin (Suramin), the (even today) drug of choice against →trypanosomiasis. He died in 1929 from a laboratory infection.



Roehl, Wilhelm († 1929). Figure 1 Dr. Wilhelm Roehl prior to his death in 1929.

## Roll-Back Malaria (RBM)

Strategy proposed in 1997 in a meeting of the leaders of African countries to decrease malaria by accomplishment of several methods.

## Romana Sign

Palpebral oedema (involving the upper and lower eyelid) as a sign of an early infection with *Trypanosoma cruzi* (→Chagom).



---

## Romanomaermis culicivorax

→Mosquitoes.

---

## Ronidazole

→Antidiarrhoeal and Antitrichomoniasis Drugs.

---

## Roost Switching

→Behavior.

---

## Rosacea migrans

First symptom of →Lyme Disease.

---

## Rosette

- Posterior holdfast organ (consisting of wrinkled posterior flaps) of →Gyrocotylidea.
- Multiple division stages in protozoans.
- →Plasmodium falciparum-infected red blood cells are attached to other erythrocytes.

---

## Ross Malaria Model

→Mathematical Models of Vector-Borne Diseases.

---

## Ross, Ronald, Sir (1857–1932)

English military physician (Fig. 1). Discovery of the mosquito-stages of *Plasmodium*, for which he won the Nobel Prize for Medicine in the year 1902. Founder of the Liverpool School of Tropical Medicine.



Ross, Ronald, Sir (1857–1932). **Figure 1** Ross as head of the institute.

---

## Rostellum

→Rostrum.

---

## Rostrum

Protrudable portion (often armed with hooks) at the →scolex of →Cestodes.

---

## Rotenone

### Chemical Class

Natural products (flavonoide).

### Mode of Action

Electron transport chain inhibitor.

## Rothschild, Nathanael Charles (1877–1923)

French zoologist and specialist for fleas, e.g., describer of the pest flea *Xenopsylla cheopis*.

## Roundworm Disease

### Synonym

→*Ascariasis* due to →*Ascaris lumbricoides* (→*Ascaris*).

## Roundworms

### Synonym

→*Nematodes*.

## Roxythromycin

Drug to treat →*toxoplasmosis*, →*Coccidiocidal Drugs*.

## RSSE

Short for →*Russian spring-summer encephalitis*, a disease due to a tick-transmitted virus →*Arboviruses*.

## Ruhr

German common name for a bloody diarrhoea due to infections with →*Entamoeba*, →*Balantidium* or bacteria.

## Russian Gadfly

→*Rhinoestrus purpureus* leads to nasopharyngeal →*Myiasis* in horses and donkeys.

## Russian Spring-Summer Encephalitis

### Synonym

→*RSSE*.

The Russian spring-summer encephalitis which is caused by the RSSE virus (→*Flavivirus*, group B) has a mortality rate of up to 25–30%. It is a complex of viruses with a wide geographical range from East Germany to Siberia and the Soviet Far East, and possibly into North China. It is mainly associated with the tick *Ixodes persulcatus*, but also with *Haemaphysalis concinna* and other tick species, and may also have other arthropod reservoirs. In endemic areas (such as in taiga forests), over 50% of residents may have antibodies without showing symptoms, while newcomers to these areas more frequently exhibit clinical symptoms.



## Sabin's Tetrad

→ [Toxoplasmosis, Man.](#)

## Sacculina

### Name

Latin: *sacculus* = little bag.

Crustacean order (→ [Cirripedia](#)) containing parasites of crabs forming a widespread, rhizoid body, that penetrates all organs of its hosts.

## Saeftigen's Pouch

→ [Acanthocephala/Reproductive Organs.](#)

## SAG

Surface antigens (→ [Toxoplasmosis, Man.](#)).

## Salicylic Acid Anilids

→ [Nematocidal Drugs](#) (e.g., Closantel).

## Salinomycin

Ionophorous-polyether, → [Coccidiocidal Drugs.](#)

## Salivaria

→ [Trypanosoma.](#)

## Salivary Gland

→ [Insects.](#)

## Salmincola

→ [Crustacea.](#)

## Salmon Louse

→ [Crustacea](#), → [Lepeophtheirus salmonis.](#)

## Salmon Poisoning

Disease in dogs with a high mortality rate due to infections with *Neorickettsia helminthoeca* imported into the dog with infections of the trematode → [Nanophyetus salmincola](#) (→ [Alimentary System Diseases, Carnivores](#)).

## SALSA

Sporozoite- and liver-stage antigen of *Plasmodium* sporozoites.

## Sand Flea

### Synonyms

→ *Tunga penetrans*, → jigger.

## Sand Flies

### Synonym

Phlebotominae.

### Classification

Family of → *Insects*.

### General Information

Fossil phlebotomines are about 120 million years old. Of the about 700 phlebotomine sand fly species, only about 70 are anthropophagous, mainly belonging to the 2 genera → *Lutzomyia* (New World) and → *Phlebotomus* (Old World). Only female flies suck blood, but also – like males – plant sugars, e.g., aphid honeydew, nectaries, or fruits. Phlebotomines transmit viral and bacterial diseases, but are mainly known as vectors of → *Leishmania*.

Phlebotomines are holometabolous insects, larvae developing in the soil. Adults are small, hairy → *Diptera*, holding their pointed wings erect in a characteristic manner above their bodies – like a vertical V.

### Distribution

Phlebotomines are found mainly in the tropics and subtropics, but some species also occur in temperate regions. There are no phlebotomines on the Pacific islands and in New Zealand. The habitats vary strongly, e.g., dry hot deserts and tropical rain forests.

### Morphology

The generally <2.5 mm long adult flies possess long slender legs and many long slender scales on the body and wings, giving the hairy appearance. The head is elongated, possessing well-developed eyes and antennae. The mouthparts are at least as long as the head and consist of labrum and mandibles (all building the food channel), laciniae and hypopharynx, the latter containing the salivary channel. The 5-segmented maxillary palps are well-developed. The pointed wings contain

numerous parallel veins. Males and females cannot be separated according to antennae-like nematoceran → *midges*, but by the weaker developed mouthparts of males, in which mandibles are absent, and – more easily – by the long external genitalia of males. The elongated, wormlike larvae possess a well-sclerotized head capsule with chewing mouthparts and on the following segments rows of multibranched setae and caudal bristles which are almost as long as the body. The thoracic segments can be separated from the abdominal segments only by the ventral pseudopods of the latter. The caudal segments of the → *pupa* remain in the skin of the last larval → *instar*.

### Genetics

In cross-mating experiments and by morphometrics or ecological investigations, genetically distinct groups of populations have been found for some species and also sibling species.

### Reproduction

Breeding of phlebotomines in the laboratory is possible for some species, but difficult.

Mating occurs on the host or nearby, and males produce → *pheromones*, and in some species “courtship songs” with their wings. In most species females are gonotrophically concordant, i.e., they require one blood meal for the development of each batch of mature eggs. However, there are also autogenic species or populations laying at least the first batch of eggs without a blood meal. The number of blood meals and egg depositions determines the possibility of transmission of disease. About 3–8 days after a blood meal eggs are laid. Females lay about 30–70 eggs (0.3 mm long and 0.1 mm wide) into soil. Breeding sites are always relatively cool and damp, e.g., rodent burrows or animal pens.

### Life Cycle

After a temperature-dependent embryonic development of about 1–2 weeks, first instar larvae hatch. Larvae feed on organic detritus and its microorganisms. Since diapause occurs in species of temperate regions, and since the development is temperature-dependent, the total duration of the 4 larval instars varies greatly. The development of the inactive pupa usually lasts between 5 and 10 days. The pupae are very sensitive to desiccation. Adults emerge during the night, and activity is also mainly restricted to the night. After emergence male terminalia rotate (see → *mosquitoes*). Females live about 14 days. The whole developmental cycle (egg to egg) lasts about 20–50 days, but up to several months in diapausing species (cf. → *Diptera*/Fig. 1).

## Biochemical/Molecular Data

Biochemical techniques, e.g., enzyme electrophoresis and gas chromatography of cuticular hydrocarbons and DNA probes, have been successfully used to distinguish between morphologically similar species.

## Transmission

Adults rest by day in relatively cool and humid niches. Phlebotomines have a characteristic hopping flight and usually only fly short distances during the night (100–200 m), searching for hosts, resting and breeding sites, but after a few days specimens were found about 2 km away from the place of release.

## Feeding Behavior and Transmission of Disease

Phlebotomines are →pool feeders and feed only under near calm conditions. The blood is pumped directly into the midgut. Sugar liquids are at first directed into the crop for →sterilization and then into the midgut.

Sand flies transmit viruses, bacteria, and →Protozoa.

Sandfly fever (→papataci fever, 3-day fever) is caused by viruses and is common during summer in the Mediterranean basin, Middle East, Pakistan/India, and Central America. These and other fever viruses are transmitted transovarially within phlebotomines.

A fever caused by *Bartonella bacilliformis* is restricted to the Andean Cordilleras.

However, phlebotomines are most widely known as vectors of *Leishmania*, causing cutaneous, mucocutaneous, or →visceral leishmaniasis.

## Interaction of Vector and Parasite

Detailed data are only available for *Leishmania*, not for viral or bacterial infections. If the phlebotomines suck blood from an infected human, →amastigotes are ingested, which transform to the promastigote form and multiply in the lumen of the mid- and hindgut. After penetration of the →peritrophic membranes they attach to the →microvilli of the midgut wall. In established infections, →promastigotes migrate to the foregut and attach there to the cuticular lining. The flagellates secrete and are embedded in a filamentous proteophosphoglycan. Finally, metacyclic promastigotes develop, which can survive in the vertebrate host. Often the diameter of the foregut is reduced or blocked by the masses of parasites.

The flagellates modify the levels of proteolytic enzymes, thereby increasing their survival rate. More conspicuous is a modification of the feeding and probing behavior. Presumably due to the masses of parasites in the foregut, blood ingestion is affected, and infected phlebotomines probe much more often than uninfected specimens. During each of these proings

*Leishmania* can be transmitted. The parasites also seem to affect the duration of adult life.

## Prophylaxis

Only specially fine bed nets offer protection against the night-active phlebotomines. can be applied to bed nets and clothing. In addition, olive oil-soaked paper attracts the females which then stick to the oil and die.

## Control

Residual →Insecticides can be used in the house. In addition, →reservoir hosts for *Leishmania* can be controlled, e.g., rodents in arid regions of the Old World and dogs in the Old and New World (cf. →Insecticides, →Ectoparasitocidal Drugs).

## Sand Tampan

Argasid tick species (→*Ornithodoros savignyi*) that is found in desert regions of Africa and Sri Lanka. These →ticks often suck at night in such huge numbers that animals may die or become paralyzed.

## Sanguinicola inermis

→Digenea.

## Sappina diploidea

Free-living 2-nucleated amoeba, the trophozoites of which live in faeces, hollows of bark of trees, small water ponds, etc., which reaches a size of 25 µm. The trophozoites are able to introduce an amoeba-induced granulomatous encephalitis (→GAE) in humans.

## Saprophagy

From Greek: *sapros* = foul, disintegrating, *phagein* = eat. Organisms that feed dead organisms/faeces, e.g., larvae of flies are saprophagous.

## Sarcocystis

### Life Cycle

Figs. 1–5.

### Name

Greek: *sarx* = meat, *kystis* = bladder, cyst.

### Morphology

→ Cell Multiplication/Fig. 7, → Tissue-Cysts/Fig. 1.

### Classification

Genus of → Coccidia.

### Disease

→ Respiratory System Diseases, Ruminants, → Sarcocystosis.

### Important Species

Table 1.

**Sarcocystis. Table 1** Important *Sarcocystis* species

Species – old name	Species – new name	Intermediate host	Final host	Old name for stages in final host	Pathogenicity
	<i>Sarcocystis bovihominis</i>	Cattle	<b>Humans</b>	<i>Isospora hominis</i>	–
<i>S. cruzi</i>	<i>S. bovicanis</i>	Cattle	Dogs	<i>I. bigemina</i>	+
<i>S. hirsuta</i>	<i>S. bovipfelis</i>	Cattle	Cats	<i>I. bigemina</i>	–
<i>S. fusiformis</i>	<i>S. levinei</i>	Water buffaloes	Dogs	<i>I. bigemina</i>	–
	<i>S. fusiformis</i>	Water buffaloes	Cats	<i>I. bigemina</i>	–
<i>S. miescheriana</i>	<i>S. sui hominis</i>	Pigs	<b>Humans</b>	<i>I. hominis</i>	+
	<i>S. suicanis</i>	Pigs	Dogs	<i>I. bigemina</i>	+
<i>S. tenella</i>	<i>S. ovicanis</i>	Sheep	Dogs	<i>I. bigemina</i>	+
	<i>S. arieticanis</i>	Sheep	Dogs	<i>I. bigemina</i>	+
	<i>S. ovifelis</i>	Sheep	Cats	<i>I. bigemina</i>	–
	<i>S. medusifformis</i>	Sheep	Cats	<i>I. bigemina</i>	–
<i>S. moulei</i>	<i>S. capracanis</i>	Goats	Dogs	<i>I. bigemina</i>	+
	<i>S. hircicanis</i>	Goats	Dogs	<i>I. bigemina</i>	–
	<i>S. moulei</i>	Goats	Cats	<i>I. bigemina</i>	–
<i>S. gracilis</i>	<i>S. gracilis</i>	Roe deer	Dogs	<i>I. bigemina</i>	–
<i>S. bertrami</i>	<i>S. equicanis</i>	Horses	Dogs	<i>I. bigemina</i>	–
	<i>S. bertrami</i>	Horses	Dogs	<i>I. bigemina</i>	–
	<i>S. fayeri</i>	Horses	Dogs	<i>I. bigemina</i>	–
<i>S. sp.</i>	<i>S. neurona</i>	Horses	Horses	<i>I. sp.</i>	+
<i>S. cameli</i>	<i>S. cameli</i>	Camels	Dogs	<i>I. bigemina</i>	–
<i>S. muris</i>	<i>S. muris</i>	Mice	Cats	<i>I. bigemina</i>	+
<i>S. sp.</i>	<i>S. dispersa</i>	Mice	Owls ( <i>Tyto</i> )	<i>I. sp.</i>	–
<i>S. sp.</i>	<i>S. cernae</i>	Mice ( <i>Microtus</i> )	Falconids ( <i>Falco</i> )	<i>I. sp.</i>	+
<i>S. sp.</i>	<i>S. murivipera</i>	Mice	Snakes	<i>I. sp.</i>	+
<i>S. sp.</i>	<i>S. singaporensis</i>	Rats ( <i>Rattus</i> )	Snakes	<i>I. sp.</i>	+
<i>S. cuniculi</i>	<i>S. cuniculi</i>	Rabbit	Cats	<i>I. bigemina</i>	–
<i>S. rileyi</i>	<i>S. rileyi</i>	Duck	Dogs	<i>I. sp.</i>	–
<i>S. horvathi</i>	<i>S. horvathi</i>	Chicken	Dogs	<i>I. bigemina</i>	–
<i>S. sp.</i>	<i>S. falcatula</i>	Birds	Opossums	<i>I. sp.</i>	+
<i>S. sp.</i>	<i>S. podarcicolubris</i>	Lizard	Snakes	<i>I. sp.</i>	–
<i>S. lindemanni</i>	–	<b>Humans</b>	?	?	?
<i>S. nesbiti</i>	–	Monkeys, humans?	?	?	?

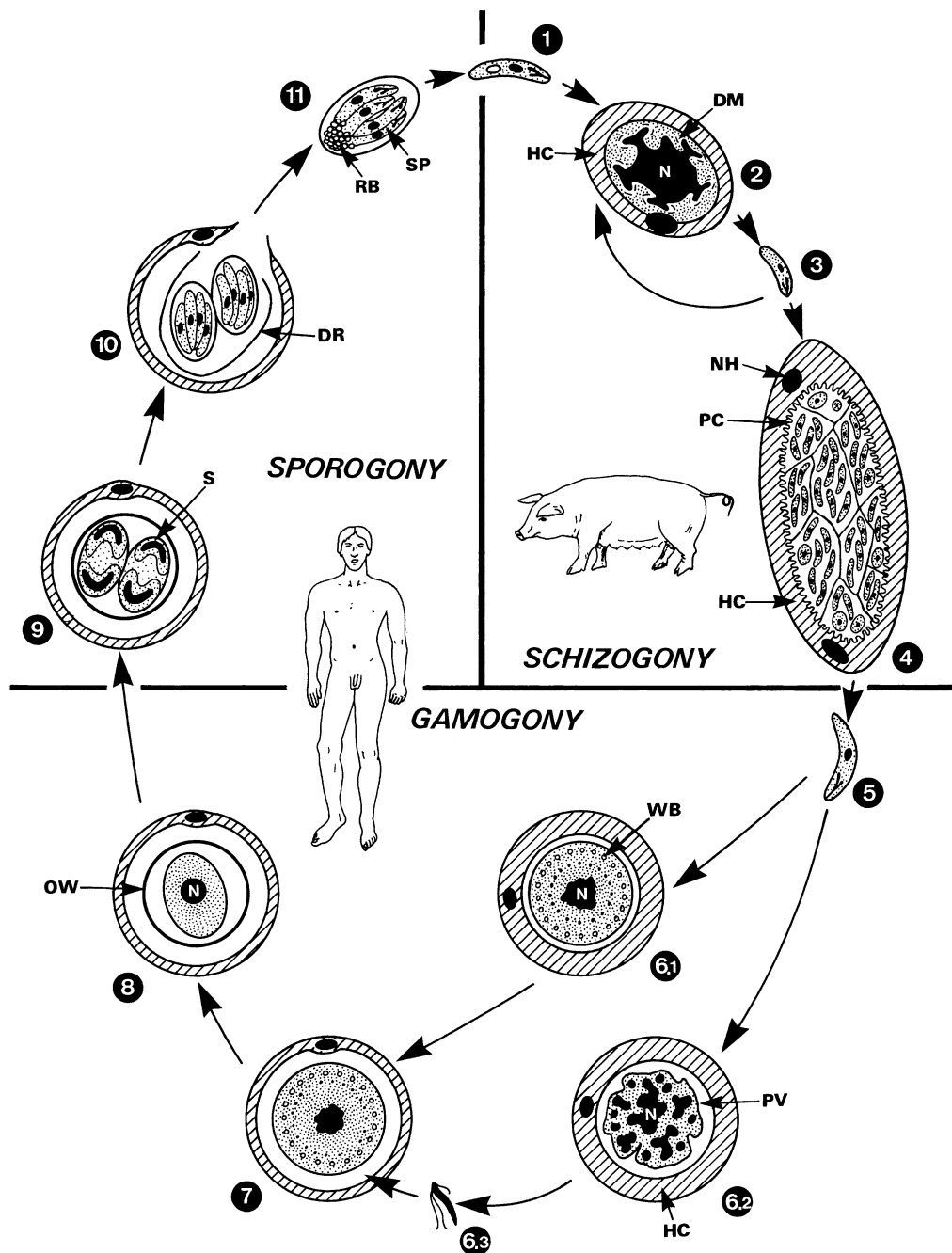

**Sarcocystis.** **Figure 1** Life cycle of *Sarcocystis suis hominis*. 1 Motile sporozoites hatch from the ingested sporocysts inside the intestine of the *intermediate host*, i.e., swine. 2 Two generations of schizonts are formed (5–6 and 12–17 days after infection) inside endothelial cells of blood vessels, giving rise to 60–100 merozoites by *endopolygony*. 3 Free motile merozoites; first-generation merozoites enter other endothelial cells and form schizonts, whereas merozoites of the second generation induce formation of *Tissue-cysts*. 4 Cyst formation inside typical cells (muscle fibers, brain cells); within these cysts the parasites are reproduced by repeated *endodyogeny* leading to thousands of cyst merozoites which are situated inside chamber-like hollows. 5 When the final host man has eaten cyst-containing raw or insufficiently cooked meat, the cyst merozoites are set free and enter cells of the lamina propria. 6 Formation of female (macrogametes; 6.1) via gamonts (6.1; 6.2) within 14 h after infection. 7 Fusion of *gametes*. 8 Formation of the *oocyst* wall around the *zygote*. 9–11 Formation of 2 sporocysts (containing 4 sporozoites each) inside the host cells. The smooth *oocyst* wall often becomes disrupted. Thus, fully sporulated oocysts are found in the feces (11). DM, developing merozoites; DR, disrupted oocyst wall; HC, host cell; N, nucleus; NH, nucleus of the host cell; OW, oocyst wall; PC, *primary cyst wall*; PV, *parasitophorous vacuole*; RB, residual body; S, *sporocyst*; SP, *sporozoite*; WB, oocyst *wall-forming bodies* (for further details see Table 1).





**Sarcocystis. Figure 2** Muscle situs of a mouse with *Sarcocystis muris* cysts (white stripes).

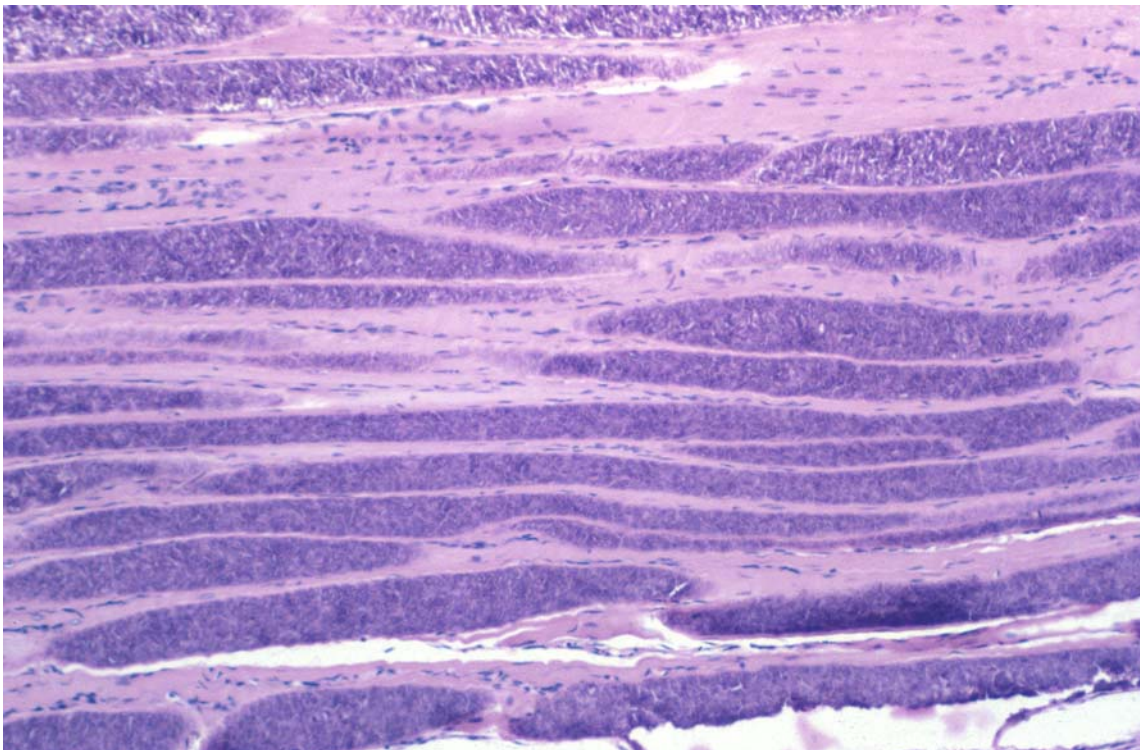

**Sarcocystis. Figure 3** LM of a section through muscle fibers of a mouse with many *Sarcocystis muris* cysts.

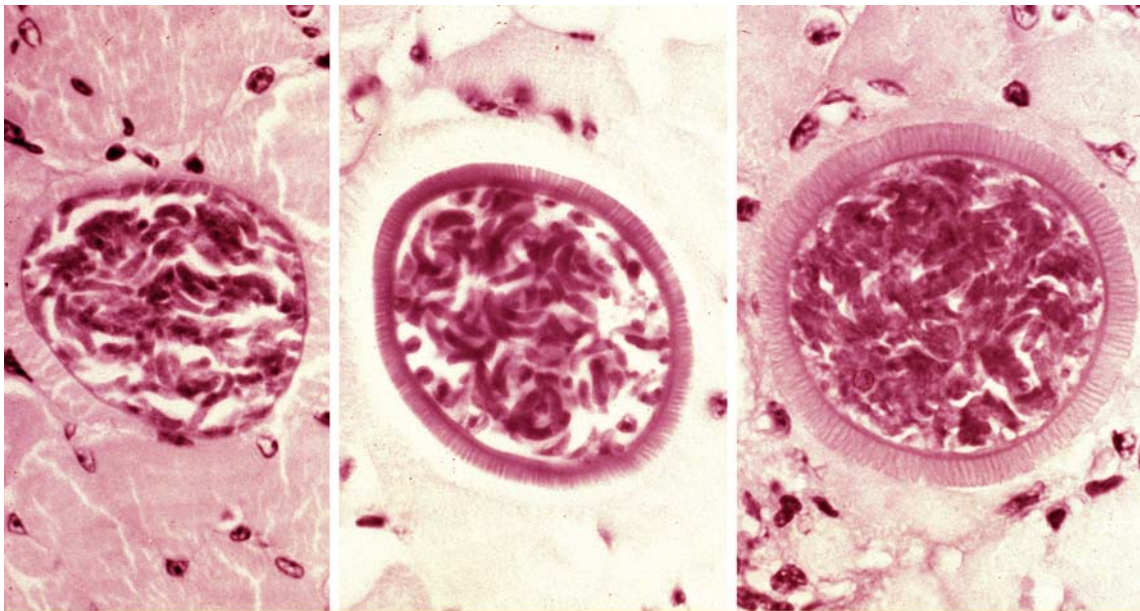
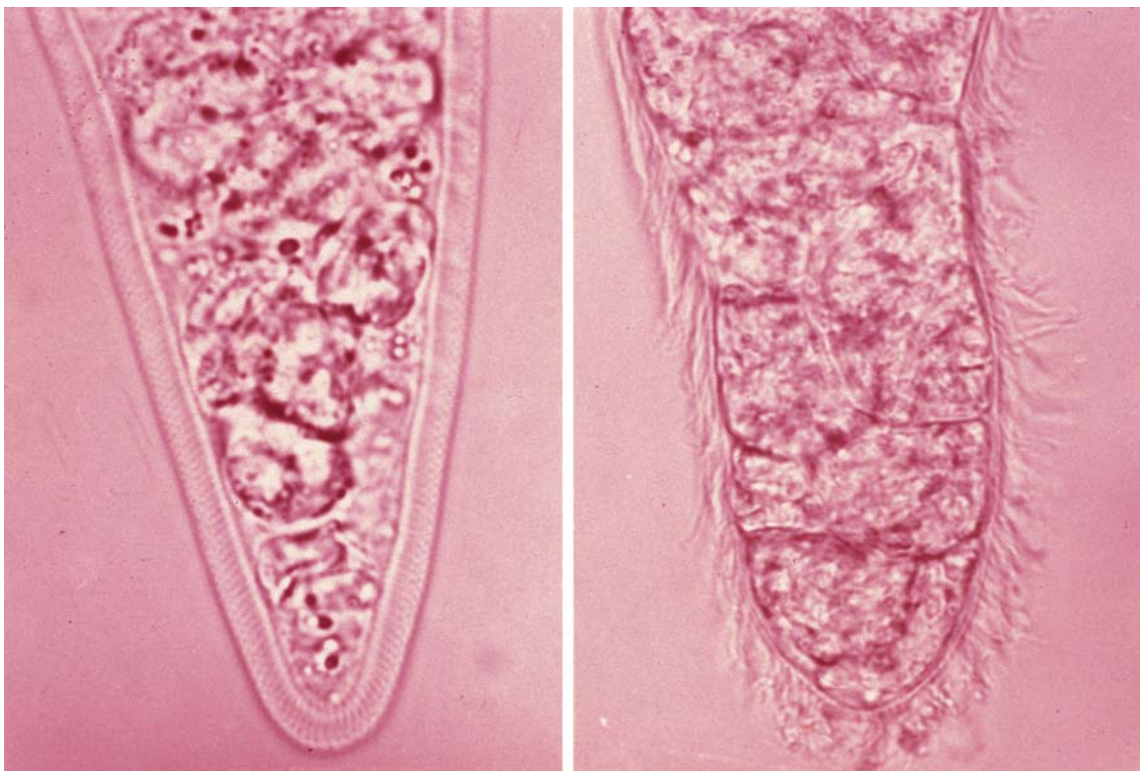
**S. bovicanis****S. bovifelis****S. bovi hominis****S. ovicanis****S. arieticanis**

**Sarcocystis.** Figure 4, 5 LM of sections through different *Sarcocystis* cysts (with different walls) of cattle (Fig. 4, above) and sheep (Fig. 5, below).

## Sarcocystis lindemanni

In the muscles of humans, tissue-cysts were described with a size of about  $120 \times 70 \mu\text{m}$  (Fig. 1). The cyst merozoites (bradyzoites) have a length of up to  $13 \mu\text{m}$ . The final host and the way of infection is unknown. Probably humans are only accidental hosts, since many species of monkeys show such cysts, which may induce myositis. This parasite apparently, has a worldwide distribution, since it was originally described by the German physician Lindemann, who, in the service of the Russian Czar, found these cysts in the tongue-muscles of hanged prisoners.

## Sarcocystis suihominis

### Life Cycle

→Sarcocystis/Fig. 1.

### Disease

→Sarcosporidiosis, Man.

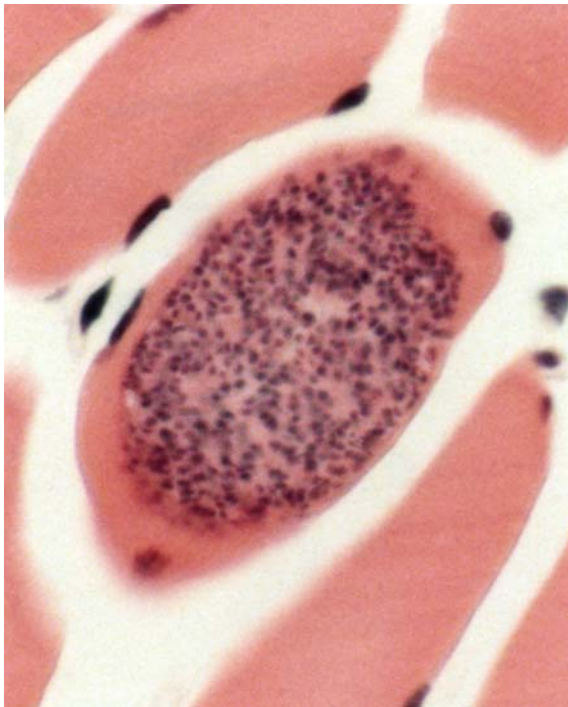

**Sarcocystis lindemanni.** Figure 1 LM of a cross section through a human muscle fiber with a sarcocyst.

## Sarcocystosis

→Sarcosporidiosis, Man, →Sarcocystis.

## Sarcodina

→Amoebae, →Sarcomastigophora.

## Sarcomastigophora

### Name

Greek: *sarx*, *sarcos* = meat, *mastix* = flagellum, *phorein* = transporting.

### Classification

Phylum of →Protozoa.

### General Information

Important characteristics of this group are: locomotion with →pseudopodia, →flagella or both; sexuality, when present, essentially →syngamy; single type of nucleus.

### System

The Sarcomastigophora unite the former taxa →Flagellata and →Rhizopoda, since it has been shown that numerous species may form pseudopods as well as flagella, depending on external influences. The phylum is subdivided as follows:

- Subphylum: →Mastigophora
  - Class: Phytomastigophorea
  - Class: Zoomastigophorea
- Subphylum: →Opalinata
  - Class: Opalinatea
- Subphylum: →Sarcodina
  - Class: Lobosea and 10 other classes

## Sarconema

### Name

Greek: *sarx* = meat, *nema* = filament.



**Sarcophaga. Figure 1** Adult female fly licking at sugar.

### General Information

This term has 2 meanings:

1. Synonym of toxonema and micronema, which are small ovoid inclusions in the apical region of motile stages of →*Coccidia* (merozoites, sporozoites, tachyzoites). Sarconema are the structures in the relevant stages of →*Sarcocystis* stages.
2. Genus of nematodes of the family Onchocercidae in the myocard and walls of blood vessels of birds. These parasites are transmitted by →*Mallophaga*. The sheathed microfilariae are rather short (120 μm) and are found in the blood. →*Sarconema erycerca* was found in swans, goose, ducks in USA, Europe, and Russia. Vector is the feather-eating →mallophag louse *Trinoton anserinum*.

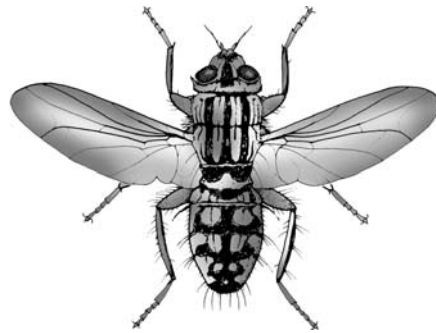

**Sarcophaga. Figure 2** DR of an adult from dorsal.

### Sarconema erycerca

Species of filariae (family Onchocercidae), which is found in the heart muscle of swan, goose, ducks in the USA, Europe, Russia, transmitted by →*Mallophaga* (*Trinoton anserinum*). The microfilariae occur in the blood.

### Sarcophaga

#### Name

Greek: *sarx* = meat, *phagein* = feeding (the larvae feed meat of dead bodies).



**Sarcophaga. Figure 3** Larval stage.

**Classification**

Genus of the so-called flesh flies.

**Morphology**

The European (holarctic) species *S. carnaria* (grey flesh fly) reaches a length of 10–14 mm (Figs. 1, 2); the same size as the worldwide occurring species *S. haemorrhoidalis*. The females are viviparous and place the L<sub>1</sub> directly onto dead or motionless bodies (e.g., drunk people). The larvae (Fig. 3) feed on meat, while the adults lick plant fluids/juices. →Diptera.

since this species leads to true mange in rabbits, too. In humans, *S. canis* introduces a scab-itch.

**Diseases**

→Sarcoptes Mange (→Acariosis, Animals), →Scabies.

**Sarcoptes****Name**

Greek: *sarx*, *sarcos* = meat, *koptein* = beat, cut.

**Classification**

Genus of →mites.

**Important Species**

Table 1.

**Life Cycle**

The life cycle stages are shown in Figs. 1–3 (pages 1267, 1268) and →Mites/Fig. 2. Due to rather recent results *Sarcoptes cuniculi* is a synonym of *S. canis*,

**Sarcoptes Mange**

→Sarcoptes, →Scabies.

**Sarcoptes scabiei****Name**

Latin: *scaber* = rough, bad.

**Diseases**

→Acariosis, Animals, →Scabies, →Mites/Fig. 2.

**Sarcoptic Mange**

→Mange, Animals/Sarcoptic Mange, →Scabies.

**Sarcoptes. Table 1** Important species of the genus *Sarcoptes*

Species	Length(mm)	Hosts/Habitat	Disease
<i>Sarcoptes scabiei</i>	f 0.3–0.45 m 0.2–0.3	Humans/Epidermis	Scabies
<i>S. bovis</i>	f 0.3–0.5 m 0.2–0.3	Cattle/Epidermis	Mange
<i>S. suis</i>	f 0.4–0.5 m 0.25	Pigs/Epidermis	Mange
<i>S. canis</i>	f 0.3–0.4 m 0.2–0.24	Dogs/Epidermis	Mange
<i>S. cuniculi</i>	f 0.3–0.4 m 0.2–0.24	Rabbit/Epidermis	Mange

m = male, f = female

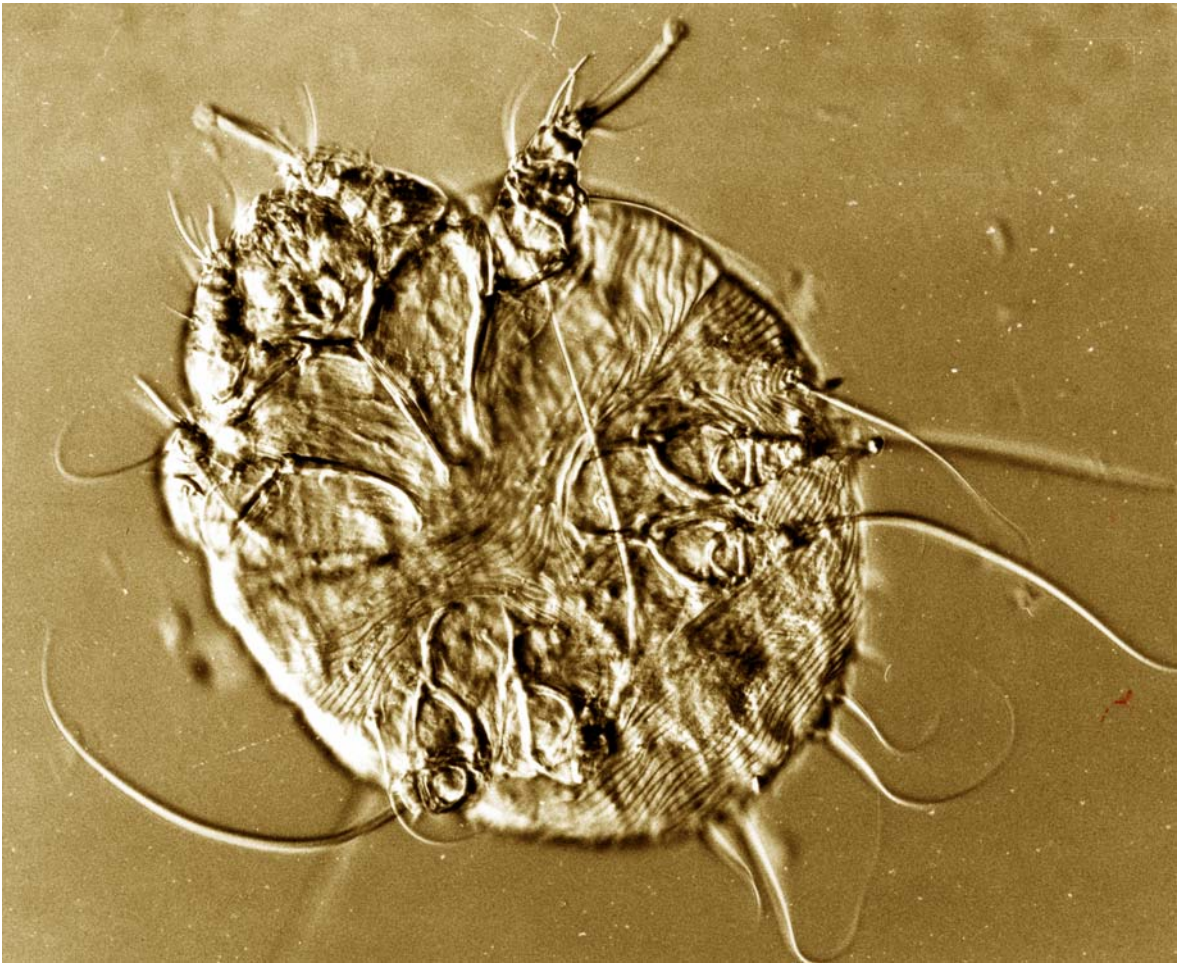

**Sarcptes.** Figure 1 LM of an adult mite.

## Sarcoptidae

Family of →*Acarina*, comprising mites of the genera *Sarcptes*, *Notoedres*, *Trixacarus*.

## Sarcosporidia

→*Cell Multiplication*, →*Sarcocystis*, →*Tissue-Cyst*.

## Sarcosporidiosis, Animals

Animals are hosts of →*Sarcocystis* spp. in different ways.

1. Predator animals (= carnivorous species) like dogs, cats, reptiles, predator birds, etc. develop the sexual and sporogonic stages in their intestinal cells (lamina propria) and excrete the fully sporulated oocysts (→*Sarcosporidiosis*, *Man/Fig. 1*) containing 2 sporocysts (each with 4 sporozoites). In general the predator animals do not show symptoms of disease. Sometimes diarrhoea occurs for one day with abdominal pain.
2. Prey animals (= plant eater of omnivorous species) are the hosts for the schizogonic phase of the life cycle with schizonts in the endothelial cells of inner organs and later with →*tissue-cysts* in muscle fibres (*Figs. 1–6*, pages 1269–1272) and (in some species) in brain cells (e.g., in *S. suicanis* and *S. sui hominis* in the case of pigs). The symptoms and their intensity is species-specific. Acute symptoms may occur during schizogony in the blood vessels of the omentum (with 2 penetrations of schizonts) due to inner bleedings: fever, apathy, dyspnoea, anaemia. Even death may be the consequence. As soon as (after about 1 month) the phase of the formation

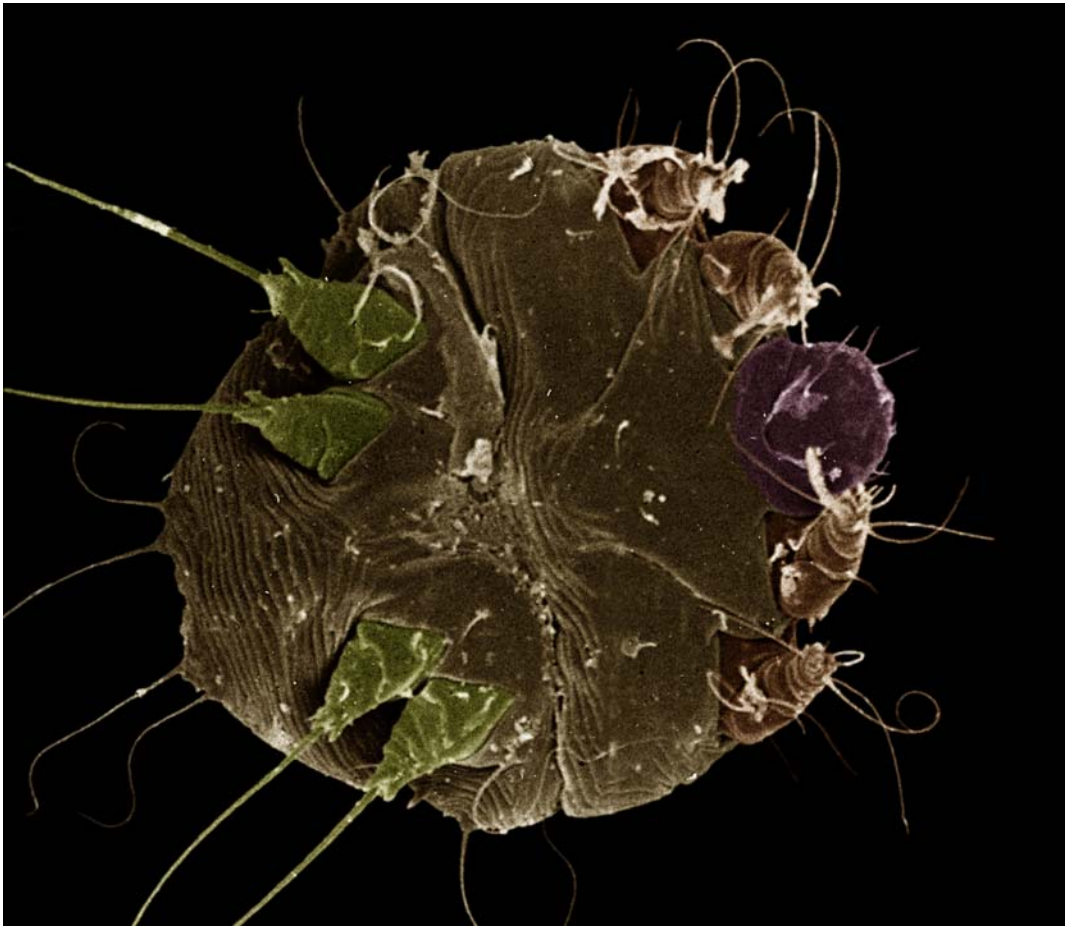

Sarcoptes. Figure 2 SEM of an adult mite from ventral.

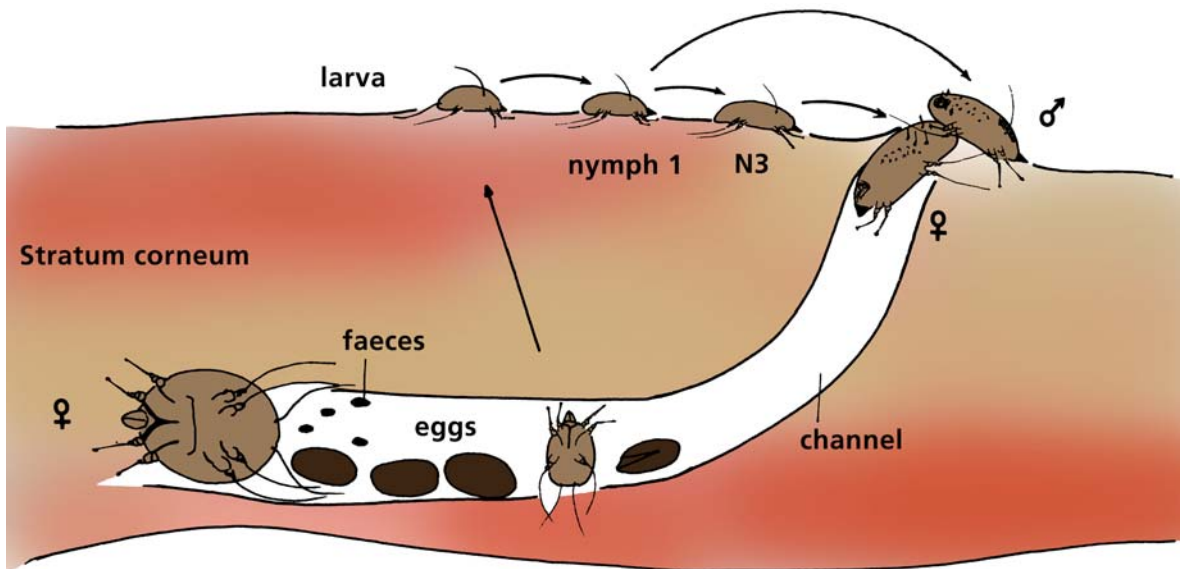

Sarcoptes. Figure 3 DR of the life cycle stages of *Sarcoptes scabiei*.

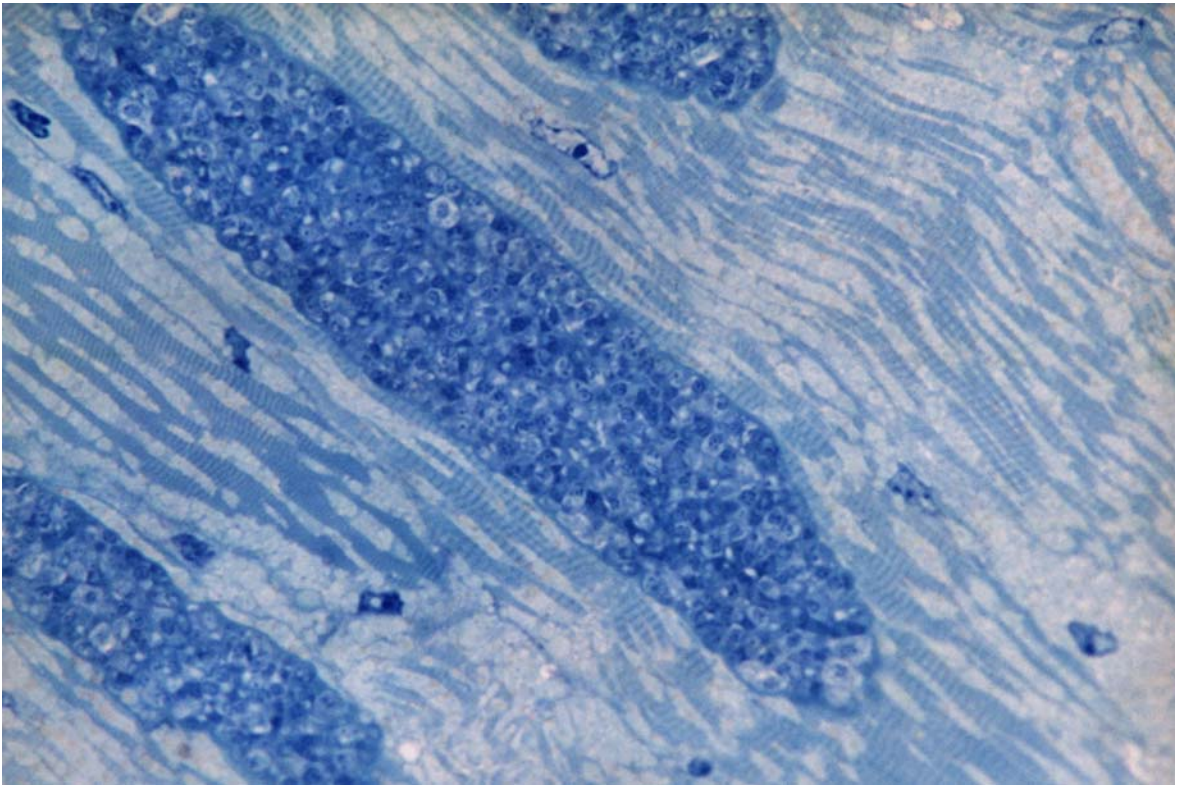

**Sarcosporidiosis, Animals. Figure 1** LM of a thin-walled cyst in the muscles of a dove, which lost complete ability to fly and other movements due to infection of muscles and brain.

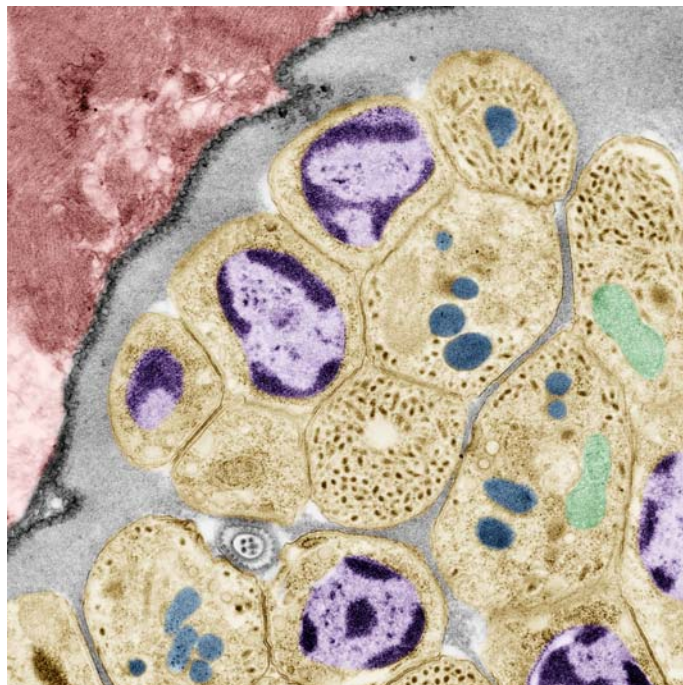

**Sarcosporidiosis, Animals. Figure 2** TEM of a thin-walled cyst in the muscles of a dove.



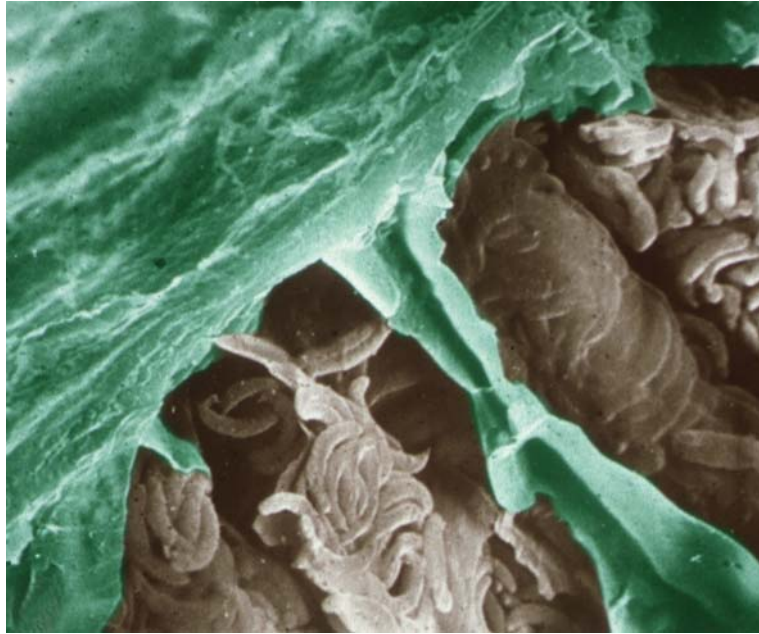

**Sarcosporidiosis, Animals. Figure 3** Thick-walled cyst (*Sarcocystis ovifelis*). SEM of the periphery showing the packages of infectious bradyzoites.



**Sarcosporidiosis, Animals. Figure 4** Thick-walled cyst (*Sarcocystis ovifelis*). SEM of a bradyzoite; note the coiled arrangement of the sub-pellicular microtubules of the apical pole.

of tissue-cysts has been reached, mostly low-graded symptoms are shown, if the number of cysts is not too high. Only in a few cases generalized myositis is seen (Figs. 1, 2).

3. A special case is the so-called Equine-Protozoal-Myeloencephalitis (EPM) in horses. This encephalitis, which occurs as final symptom of a spectrum of diseases, may also be induced due to infection with the

oocysts of *S. neurona*, which are excreted by opossums (*Didelphis* spp.) in North America. In horses no cysts are found, but only the division of sarcosporidian endozoites (= tachyzoites) in brain cells. EPM-like symptoms due to infections with *S. neurona* are found also in cats, sea lions, racoons, etc. Brains of pigs, when heavily infected with *S. suihominis* or *S. suicanis* may show EPM-like degenerations, too.

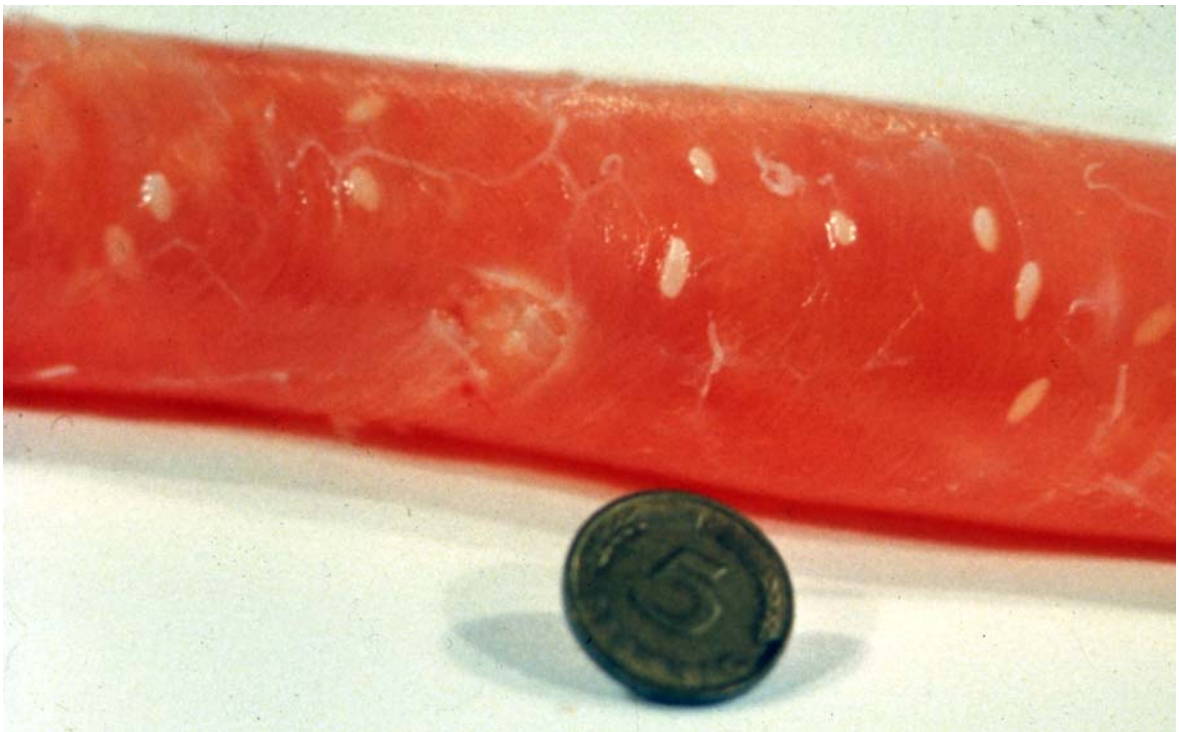

**Sarcosporidiosis, Animals. Figure 5** Oesophagus of sheep infected with cysts of *Sarcocystis ovisfelis*.

## Diagnosis

1. In carnivores: Microscopy of faecal samples shows oocysts (→[Sarcosporidiosis, Man/Fig. 1](#)).
2. In plant eaters and omnivores: Microscopy of biopsies of muscle fibres (starting 1 month after infection) shows cysts ([Figs. 1–4](#)), PCR-techniques.

## Therapy

In cases of sarcosporidiosis of the endothelial cells and of cysts in the muscle the application of →[Toltrazuril](#) was successful.

the gut wall, with 2 sporocysts, each forming 4 sporozoites. Judging from a few isolated observations, where, however, the possibility of the presence of other pathogen could not be excluded, there may be intense mixed →[inflammatory reaction](#) that includes eosinophils. Experimental infections suggest the absence of a strong immune reaction, and the possible →[hypersensitivity reactions](#), resulting in the greater pathogenicity of *S. suis* than of *S. bovis*. Sporulated sporocysts are usually shed in the feces and appear to be infectious only to pigs (*S. suis*) or cattle (*S. bovis*). In older references these 2 organisms were not distinguished and identified as *Isospora hominis*. The →[Sarcocystis](#) stages found in human muscle result from infection with different species.

## Sarcosporidiosis, Man

### Pathology Intestine

→[Sarcocystis suis](#) and *S. bovis* are ingested as →[bradyzoites](#) from cysts in infected pork and beef (→[Pathology/Figs. 7–9](#)). There is no →[schizogony](#) in the human gut. The ingested bradyzoites develop directly into gametocytes in the lamina propria; then fertilization occurs, followed by development of a →[zygote](#) and an →[oocyst](#). →[Sporulation](#) takes place in

### Muscle

Sarcocysts different from those in the intestine are diagnosed occasionally in the myocardium and skeletal muscle of humans (→[Pathology/Fig. 7](#)) who are accidental intermediate hosts for sarcocysts normally found in monkeys and possibly cattle. Mammalian, avian, or reptilian carnivores may be the definitive hosts ingesting bradyzoites in cysts and shedding oocysts in their feces which are accidentally ingested by humans. Intact cysts with bradyzoites measuring up to 100 µm in diameter and 325 µm in length and unaccompanied by inflammation are the usual findings



**Sarcosporidiosis, Animals. Figure 6** Two brother-pigs of same age; the smaller one is infected with *Sarcocystis suicanis*.

(→Protozoan Infections, Man/Table 1). However, cases with young cysts and diffuse lymphocytic and eosinophilic infiltration have been described, probably from recent infections. Whether the inflammation is a consequence of the prior schizogony in blood vessels, or of young cysts that degenerate, or both, has not been determined. Evidence of lesions from cyst rupture has been reported, where an eosinophilic myositis with lymphocytes, and later fibrosis, was diagnosed by biopsy of one of a number of suddenly appearing spontaneous lesions. These events occurring over many years, were accompanied by painful muscle swelling, initially associated with →erythema and occasionally with bronchospasm, and lasted for 2 days to 2 weeks.

### Intestinal sarcosporidiosis

**Main clinical symptoms:** →Vomiting, sweating, →diarrhoea.

**Incubation period:** 4–8 hours.

**Prepatent period:** 5–10 days.

**Patent period:** 6–8 weeks.

**Diagnosis:** Microscopic determination of sporocysts in fecal samples. (Fig. 1, page 1273).

**Prophylaxis:** Avoid eating raw meat of pork or cattle.

**Therapy:** Treatment see →Coccidiocidal Drugs and →Drugs Against Sarcocystosis.

---

## Sarcotaces

Genus of crustaceans, the species of which form cysts in muscles of fish.

---

## SBP-1

A parasite protein associated with →Maurer's clefts in the *Plasmodium*-infected cytosol of red blood cells, which is involved in trafficking the →Pfeme-1.



**Sarcosporidiosis, Man.** Figure 1 LM of two complete oocysts and a free sporocyst of *Sarcocystis bovi hominis*.

## Scabies

Scabies is a human infection of the skin with the →mite →*Sarcoptes scabiei* or a transitory infection with similar species from animals where they produce mange (Figs. 1, 2). The entire life cycle of the mite takes place in the keratinaceous layer of the epidermis which often undergoes →hyperplasia with marked hyperkeratosis around papules or burrows created by the →mites, often on the hands, feet, genitalia, or axilla. Adults create burrows in the keratinaceous layer where they live and lay eggs, which give rise to larvae, nymphs, and new adults (→Pathology/Fig. 30B). Metabolic products of the mites give rise to inflammation with lymphocytes and eosinophils in the dermis. In the absence of a thickened stratum corneum, mites elicit more inflammation, more itching, and often ulcers from scratching, sometimes with secondary bacterial infection. →Glomerulonephritis may result from secondary streptococcal infection of the lesions.

In immunosuppressed individuals there may be confluent infection with thousands of mites and widespread epidermal scaling, so-called →Norwegian scabies, that can be diagnosed by scrapings or skin biopsies.

**Main clinical symptoms:** →Pruritus, exanthemes, skin scaling.

**Incubation period:** 1–2 weeks.

**Prepatent period:** First eggs are laid after 15 days.

**Patent period:** Years, since many generations of females may follow each other.

**Diagnosis:** Microscopic determination of mites in skin scrapings.

**Prophylaxis:** Avoid contact with infested people and exchange of clothes; use fresh bed covers etc.

**Therapy:** Treatment see →Acarizides; use of ivermectin or neem-extract (Wash-Away, Alpha-Biocare, Düsseldorf).

### Related Entry

→Mange, Man.

## Scabies crustosa

### Synonym

→Scabies Norvegica.

Severe skin symptoms in persons with immunodeficiency; highly infectious due to formation of huge numbers of →mites (Fig. 1).



**Scabies.** Figure 1, 2 Typical skin aspects of the initial disease (1, at penis; 2, at head).



**Scabies crustosa.** Figure 1 HIV patient with thick layers of skin due to scabies. This form is highly contagious, since many mites occur on the surface of the skin.

## Scale

Clinical and pathological symptom of infections with skin parasites (→[Skin Diseases, Animals](#), →[Ectoparasite](#)).

## Scatophagidae

Family of flies (→[Diptera](#)). *Scatophaga stercoraria* appears yellowish-brown with hairy body and legs, reaches a length of 9–10 mm, and is found in the whole palaeartic zone. It prefers human faeces as breeding site and thus may be vector of agents of human diseases.

## Scerotization

This is the conversion of soft proteinaceous materials to harder and resistant layers in oocysts of →[coccidia](#), in worm eggs, cocoons, or in other cystlike structures that have contact with the environment. Two main processes may lead to sclerotization: →[quinone-tanning](#) and dityrosine cross-linking. Quinone tanning occurs, e.g., in egg capsules, eggshells of trematodes, insect cuticle, while protein-dityrosine cross-links are found in yeast cell wall, insect resilin, and coccidian oocysts.

## Schaudinn, Fritz (1871–1906)

German physician and biologist ([Fig. 1](#)), who discovered (together with the dermatologist Erich Hoffmann (1868–1959) the syphilis bacterium (*Spirochaeta* – now *Treponema-pallida*) in the year 1905; he died during a self-experiment with →[Entamoeba histolytica](#), at only 35 years of age.

## Schellackia

Genus of blood →[Coccidia](#) of reptiles. The sporozoites parasitize in erythrocytes, the schizogony occurs in the



**Schaudinn, Fritz (1871–1906).** **Figure 1** Photograph taken only months before his early death.

intestine of the same host. Vectors are culicid mosquitoes and bloodsucking mites – the transmission occurs mechanically as soon as the final host ingests the arthropod containing infected blood.

## Scheloribates

Genus of oribatid mites.

## Schistocephalus solidus

### Name

Greek: *schisis* = division, *schizein* = divide, *kephale* = head; Latin: *solidus* = solid.

### Classification

Species of →[Eucestoda](#), parasitic as plerocercoids in salmonid fish, where they reach a length of up to 5 cm. Final hosts are birds, where the worms reach 40 cm in length.

## Life Cycle

→Pseudophyllidea/Life Cycle, →Behavior.

# Schistosoma

## Name

Greek: *schisis* = division, *soma* = body.

## Classification

Genus of →Digenea.

## Important Species

Table 1.

## Life Cycle

Fig. 1.

## Distribution

Figs. 2, 3.

## Integument/Surface Coat

The surface of the blood fluke, →*Schistosoma mansoni*, has been analyzed very intensively in the past few years in order to find antigens for vaccination against this important parasite of man in the tropics (→Platyhelminthes/Integument). As in all →digenea, all

larval stages seem to have a →surface coat containing proteoglycans. In the miracidium even the cilia are covered by a surface coat. Mother sporocysts of *Schistosoma mansoni* (like those of →*Fasciola hepatica*) show an amplification of the surface area by a mixture of branching folds and →microvilli. They are covered by a fuzzy surface coat. Vesicles at the base of the microvilli suggest the occurrence of →endocytosis. →Rediae also have a surface coat. Although there is evidence that they are able to take up nutrients through the mouth into the small digestive system, absorption of nutrients by endocytosis through the →tegument has been observed for glucose, a polysaccharide, and amino acids.

The cercariae of *S. mansoni* have a normal trilaminar outer membrane of the tegument which is covered by a 1 μm-thick fibrillar surface coat. Histochemical investigations have shown that it does not bind cationic colloidal iron at low pH and that it contains at least glycoproteins, glycolipids, and perhaps proteoglycans. After artificial removal of the filamentous surface coat from cercariae, the surface of the tegumentary membrane will bind cationic dyes at low pH. Therefore, it has been assumed that such binding sites are normally masked by proteoglycans or other substances. Discoid bodies are formed by the rough endoplasmic reticulum (rER) and Golgi system and then incorporated into the external membrane system. In this way the membrane is constantly renewed. It has been suggested that it is involved in nutritional, osmoregulatory, and excretory activities, but these functions have still to be substantiated.

The tegumental surface, especially the surface coat, has to protect the cercaria in the snail during the

**Schistosoma. Table 1** Important schistosomal parasites

Species	Final host/Habitat	Size of adults (mm)	Size of eggs (μm)	First intermediate host <sup>a</sup>	Second intermediate host <sup>b</sup>	Prepatent period (weeks)
<i>Schistosoma mansoni</i>	Humans/Liver, intestinal mesenteric veins	m 6–10 f 7–14	50 × 150	<i>Planorbis</i> spp., <i>Biomphalaria</i> spp.	–	5–7
<i>S. haematobium</i>	Humans, monkeys/Veins of urinogenital system	m 10–15 f 20	50 × 150	<i>Bulinus</i> spp.	–	10–12
<i>S. japonicum</i>	Humans, dogs, cats, cattle/Intestinal mesenteric veins	m 12–20 f 20	55 × 90	<i>Oncomelania</i> spp.	–	3–10
<i>S. intercalatum</i>	Humans, rodents, cattle/Intestinal mesenteric veins	m 11–15 f 13–24	36 × 140	<i>Physopsis</i> spp., <i>Bulinus</i> spp.	–	5–7
<i>S. bovis</i>	Ruminants/Intestinal mesenteric veins	m 9–14 f 12–28	60 × 180	<i>Bulinus</i> spp.	–	6
<i>S. mattheei</i>	Ruminants/Intestinal mesenteric veins	m 9–14 f 17–25	72 × 170	<i>Bulinus</i> spp.	–	7
<i>Schistosomatium douthitti</i>	Voies, muskrats/Intestinal mesenteric veins	m 2–6 f 1–5	60 × 150	Lymnaeidae, <i>Physa</i> spp., <i>Stagnicola</i> spp.	–	5

<sup>a</sup> Several other species of gastropods may become first intermediate host

<sup>b</sup> There is no reproduction either in the true second intermediate hosts or on water plants

m = male f = female

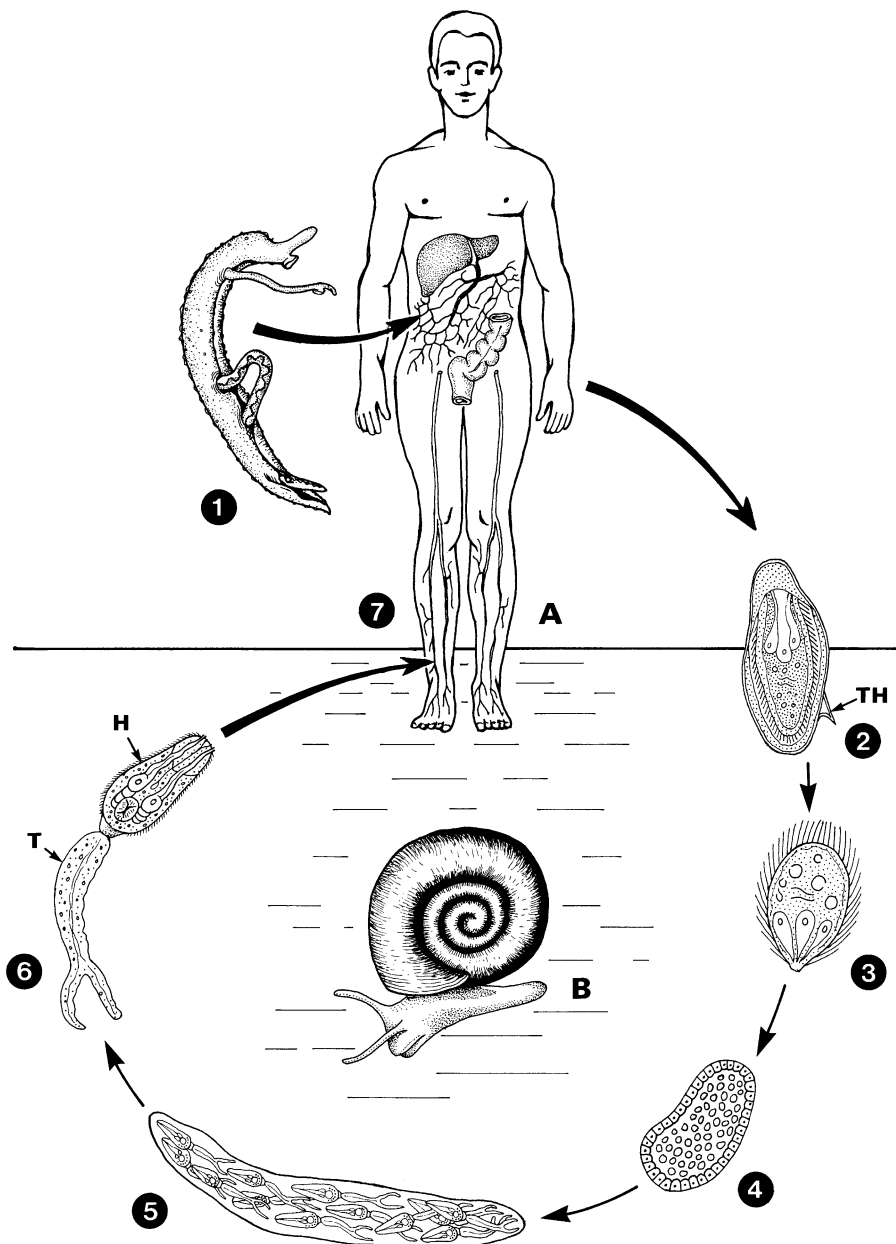

**Schistosoma.** **Figure 1** Life cycle of *Schistosoma mansoni*. 1 The adult couples (males bear females in their *canalis gynaeophorus*) reach a size of about 1 cm and live in the mesenteric veins of the intestine. 2 The typical eggs with a lateral thorn are laid uncleaved by the females within the veins. Some are transported to the liver and block its small venules, thus introducing the formation of 1 mm-sized malign liver *granulomes*. Other eggs migrate through the walls of the blood vessels and the intestine guided by help of *proteinases* that pass the *eggshell*. On the way a ciliated larva (*Miracidium*) is formed inside the egg. 3 Reaching water, the eggshell bursts, the miracidium is set free, and starts swimming. 4–6 Having had contact with an *intermediate host* (B, i.e., water snails of the genera *Planorbis* or *Biomphalaria*), the miracidium enters the shin while leaving behind its *cilia*. The now unciliated miracidium is called mother *sporocyst* (4), which takes its way to the hepatopancreas of the snail. There the mother sporocyst gives rise to several daughter sporocysts (5), which finally produce inside many bifurcated phototropic *cercariae* (6). These stages leave the snail via the respiratory spiracle and swim around (tail forward) for up to one day until touching a convenient final host (man, rodents). 7 Within 2 minutes after attachment the head of the cercaria penetrates the skin and remains as *schistosomulum* for about 3–4 days. Later it enters veins of the host and is finally transported to the vena portae where the small 1 mm-sized worms join to become couples, grow up reaching maturity in about 5–7 weeks, and start egg production (prepatent period). H, head of *cercaria* (i.e., young worm); T, tail of cercaria; TH, thorn of eggshell.



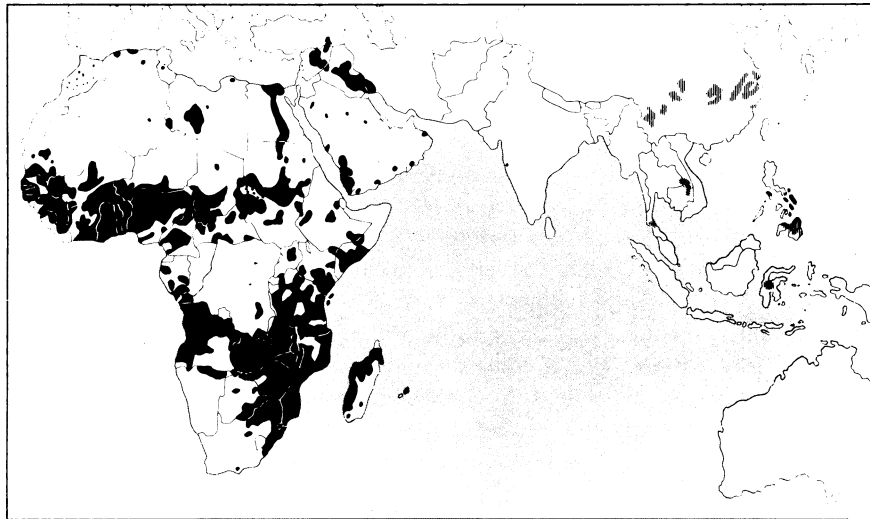

**Schistosoma.** Figure 2 Distribution map of →*S. haematobium* (black) and →*S. japonicum*/*S. mekongi* (grey).

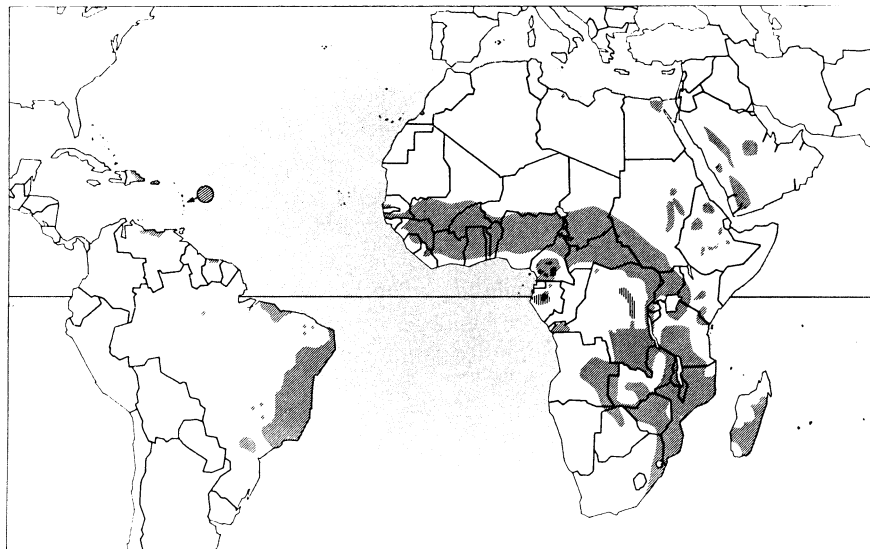

**Schistosoma.** Figure 3 Distribution map of *Schistosoma mansoni*.

free-swimming phase and during penetration into the final host. This is the most dangerous phase. It was already shown by McLaren that about 60% of the stages which are in the host are killed in the skin region of vaccinated mice. When cercariae are placed in homologous antiserum, the filaments of the surface coat react with the antiserum. A conspicuous sheath is formed immediately by this →“Cercarien-Hüllenreaktion.” After penetrating the host’s skin the cercaria transforms into the →schistosomulum. This stage has a thinner surface coat. The loss of surface coat material appears to be concomitant with a dramatic change in permeability during transformation of the cercaria into the schistosomulum. The cercaria is able to live in fresh water, whereas

the schistosomulum undergoes →vesiculation and dies in fresh water. It has been suggested that proteoglycans of the surface coat might act as a permeability barrier which is lost during transformation.

Secretory vesicles, which were called membranous bodies, are formed in the perikarya of the tegument of the schistosomula. They are bound by 2 membranes. Their contents are either electron-lucent or granular or membranous. Carbohydrate-containing material was localized in these vesicles, suggesting that this material is used for the formation of the surface coat. The vesicles tend to fuse with the external tegumentary membrane or with each other, thus forming large vesicles which fuse afterwards with the external tegumentary membrane. In

this way the original, normal plasma membrane of the cercaria is replaced by a heptalaminate external membrane. Microvilli with a bulbous tip are formed which are pinched off. Thus the original membrane of the cercaria seems to be eliminated. This process ends about 60 minutes after skin penetration and the young and adult schistosomes show 2 membranes as →body cover even lining the tubelike infoldings of the surface (→Platyhelminthes/Tegument). Immunological investigations have shown that the cercarial membrane is replaced within 3 hours after skin penetration and that the unique heptalaminate membrane with the surface coat of the schistosomula is exchanged during migration through the host. Chase incubations of adult *S. mansoni* *in vitro* with cationized ferritin in Eagles' medium have shown that by 4 hours most of the label and the external tegumentary membrane to which it is bound have been lost to the medium. Therefore it has been assumed that under these *in vitro* conditions the surface membrane has a half-life of 2–3 hours. However, Ruppel and McLaren used the human complement component C3b to label the

surface of adults, 3-week-old juveniles, and 6-day-old lung stages. C3b is known to bind *in vitro* to the surface of all developmental stages of *S. mansoni*. Its presence on the surface of these stages was shown by fluorescent-labeled antibodies against C3b. Labeled schistosomes were cultured *in vitro* for periods of up to 2 weeks. In contrast to the results of Wilson and Barnes, these authors could demonstrate that *in vitro* the turnover of the external tegumentary membrane is minimal, except at the anterior part of the parasite including the suckers. If labeled viable skin schistosomula were injected intravenously into mice and subsequently recovered from the lungs after varying periods, it could be shown that most of the label was lost in a patchy way, either in only a few minutes or, in most cases, within several hours. This demonstrates clearly that a rapid turnover of surface materials occurs *in vivo*.

Another interesting phenomenon is the change of antigens and their →carbohydrate residues during maturation from cercaria to adult worm (Tables 2, 3). Surface binding of lectins which were either labeled radioactively

**Schistosoma. Table 2** Surface binding lectins to immature and male *Schistosoma mansoni*

Stage	Man/glc	GlcNAc	GalNAc	Fuc
Cercaria	+/-	-	-	-
Schistosomulum				
2 h <i>in vitro</i>	+	+	-	-
18 h <i>in vitro</i>	+	+	-	-
22 h skin	+	+	-	-
6 days lung	+	+	-	-
21 days liver	+	+	-	-
Male	+	+	-	-

Fuc, fucose; GalNAc, N-acetylgalactosamine; GlcNAc, N-acetylglucosamine; Man/glc, mannose/glucose

**Schistosoma. Table 3** Change of surface antigens of *Schistosoma mansoni* stages during maturation

Antigen (kD)	Cercariae	Schistosomula					
		3 h mt	24 h mt	24 h sp	48 h mt	5 days lung	3 weeks lung
>200	++					+/-	+
92–98 <sup>b</sup>						++	++
65 <sup>c</sup>						+	++
40							++
38 <sup>a</sup>	++	++	+/-				
32 <sup>a</sup>	++	++	++	++	++	+	+/-
25						+	+
20		++	++	++	+	+	+
17		++	+	+/-	+		
15 <sup>b</sup>		++	++	++	++	+	+
10 <sup>b</sup>			+	+	+	+/-	

++, dominant; + present; +/- faint; mt, mechanically transformed schistosomula; sp, skin penetrated schistosomula;

<sup>a</sup> glycoprotein; <sup>b</sup> polypeptide; <sup>c</sup> alkaline phosphatase

or with a fluorescent dye revealed the presence of mannose and/or glucose and of [→N-acetylglucosamine](#) residues, and the absence of galactose, N-acetyl-galactosamine, and fucose residues in all stages examined ([Table 2](#)).

The change of antigenic proteins on the surface of different developmental stages of *S. mansoni* was demonstrated by radioiodination and SDS-PAGE followed by autoradiography and by immunoblotting. Two glycoproteins with apparent molecular weights of 38–32 kDa are the major antigenic material in the surface of the cercaria. It has been suggested that they are associated with the surface coat. These glycoproteins are gradually replaced by a single dominant glycoprotein. It has an apparent molecular weight of 38 kDa and expresses identical epitopes to those of the complex with an apparent molecular weight of 38–32 kDa. This reorganization process seems to occur in conjunction with the appearance of and as part of the new heptalaminate membrane. The reorganization is completed 48 hours after infection. Low molecular weight proteins appear on the surface of the schistosomula. The enzyme alkaline phosphatase is expressed on the surface of worms in the liver 3 weeks after infection. It has an apparent molecular weight of 62 kDa and seems to be related to a metabolically very active stage of development. It has been assumed that the polypeptide of 92–98 kDa might be of host origin.

A very interesting phenomenon concerns at least 3 antigens of 32, 22, and 18 kDa. These are exposed on the surface of younger stages, whereas in adult worms they are present but not exposed at the surface. Their sequestration deeper into the membrane has been related to the high lipid content of the external tegumentary membranes and the ability of adult worms to evade the immune mechanisms of the host, however, they are considered promising targets for vaccines, as is the 28 kDa [→glutathione S-transferase](#) of *S. mansoni* (Sm 28 GST). Another important finding was that the surface membranes of all schistosomal developmental stages (even eggs) are provided with specific [→glucose transporter](#) proteins (GTP) recently identified on the basis of cloned cDNAs and designated as SGTP1-SGTP4. The SGTP4 (as integrating part of the [→cell membrane](#)) transports glucose from the bloodstream through the apical double bilayer membrane, which is formed just after penetration of the cercaria into the skin, into the tegument. Then SGTP1 transports the glucose through the single basal cell membrane of the tegumental layer to other cells (muscle, parenchym).

### Disease

[→Cardiovascular System Diseases, Animals](#), [→Schistosomiasis, Animals](#), [→Schistosomiasis, Man](#).

---

## Schistosoma haematobium

[→Digenea](#), [→Schistosoma](#).

---

## Schistosoma japonicum

[→Digenea](#), [→Schistosoma](#).

---

## Schistosoma mansoni

[→Digenea](#), [→Schistosoma](#).

---

## Schistosoma spindale

[→Digenea](#), [→Schistosoma](#).

---

## Schistosomatium douthitti

[→Schistosoma](#).

---

## Schistosome Genome

Nuclear genome size	≥ 270 Mb
Chromosomes	8 pairs (7 pairs of autosomes, 1 pair of sex chromosomes, male ZZ, female ZW = heterogametic)
Gene copies	~14,000
Repetitive content	40–60 %
Mitochondrial genome size	14,500 nucleotides

## Schistosomiasis, Animals

### Important Species

- *S. bovis*: in North and East Africa, Iran. The males reach a length of 15 mm, females 28 mm, eggs: 180  $\mu\text{m}$   $\times$  60  $\mu\text{m}$  with terminal spine, in faeces; intermediate hosts: *Bulinus* and *Planorbis* snails.
- *S. mattheei*: in East, South, Central Africa; males 14 mm, females 25 mm; eggs 170  $\times$  70  $\mu\text{m}$  with terminal spine, found in faeces and urine (10%).
- *S. nasale*: in India in buffaloes and cattle in the veins of the nose (prevalence up to 50%); worms: females 11 mm, males 8 mm); eggs: boomerang-shaped, 350–380  $\mu\text{m}$   $\times$  50–89  $\mu\text{m}$ , are excreted in nasal slime; intermediate hosts: *Indoplanorbis* snails.
- *S. spindale*: in India and Far East; in cattle, buffaloes, small ruminants, and dogs; adults (16 mm) live in mesenteric veins, but also in veins of the whole body; eggs with 2 protrusions (Figs. 1, 2) reach a size of 300  $\times$  80  $\mu\text{m}$ ; intermediate hosts: *Indoplanorbis* snails.
- *S. japonicum*: appearance and occurrence as in humans.

### Pathology

Different species of the genus *Schistosoma* give rise to infection in several domestic animals. *S. japonicum* have been found within the mesenteric and hepatic portal veins of pigs and dogs. Although *Schistosoma* infections in ruminants are highly prevalent in certain regions of the tropics and subtropics. The general level of infestation is often too low to cause clinical disease or losses in productivity. Levels sufficiently high to cause outbreaks of clinical schistosomiasis do occur occasionally and infestation becomes manifest either as an intestinal syndrome which is usually self-limiting, or as a chronic hepatic syndrome, which is usually progressive. The intestinal syndrome is caused by the deposition of large numbers of eggs in the intestinal wall (Figs. 1, 2) and usually follows a heavy infestation in a susceptible animal, i.e., an animal in which the capacity of the host to suppress the egg laying of the parasite has not been stimulated by previous infestations. This has been reported among cattle, sheep, and goats infected with either *S. bovis* or by *S. mattheei*. As the faecal egg counts rise sharply with the onset of egg production the animal develops a mucoid and then haemorrhagic *diarrhoea*, accompanied by *anorexia*, loss of condition, general weakness and dullness, roughness of coat *hypoalbuminaemia*, and paleness of mucous membranes. Death may occur a month or two

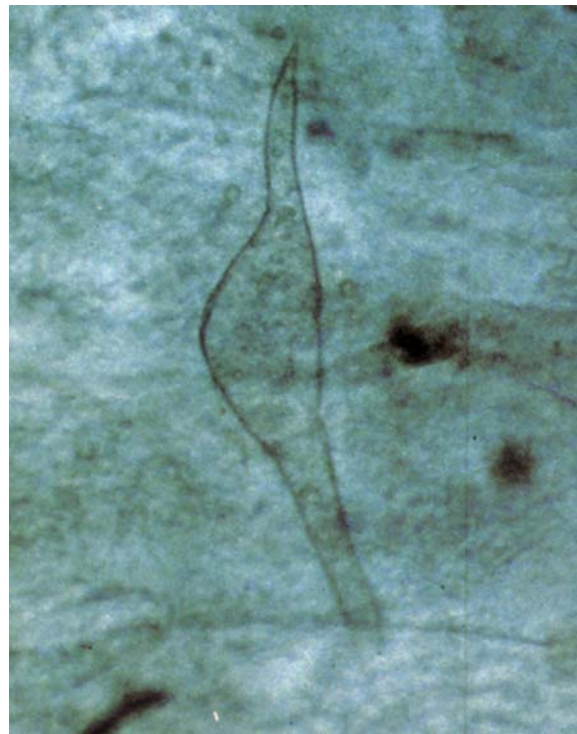

**Schistosomiasis, Animals. Figure 1** Egg of *Schistosoma spindale* from the intestinal wall of a buffalo in Thailand.

after the onset of clinical signs. In most cases, the animal makes a spontaneous but slow recovery. The primary cause of the diarrhoea is the passage of large numbers of eggs through the wall of the intestine. The *anaemia* is usually due to an increased rate of red cell removal from the circulation; while haemodilution and the inability to mount a sufficiently effective erythropoietic response are of secondary importance. The underlying cause of the hypoalbuminaemia is hypercatabolism of albumin due to substantial loss of protein in the gastrointestinal tract (*Cardiovascular System Diseases, Animals*).

### Vaccination

*Schistosomiasis, Man/Vaccination.*

### Immune Responses

*Schistosomiasis, Man/Immune Responses.*

### Therapy

*Trematodocidal Drugs.*

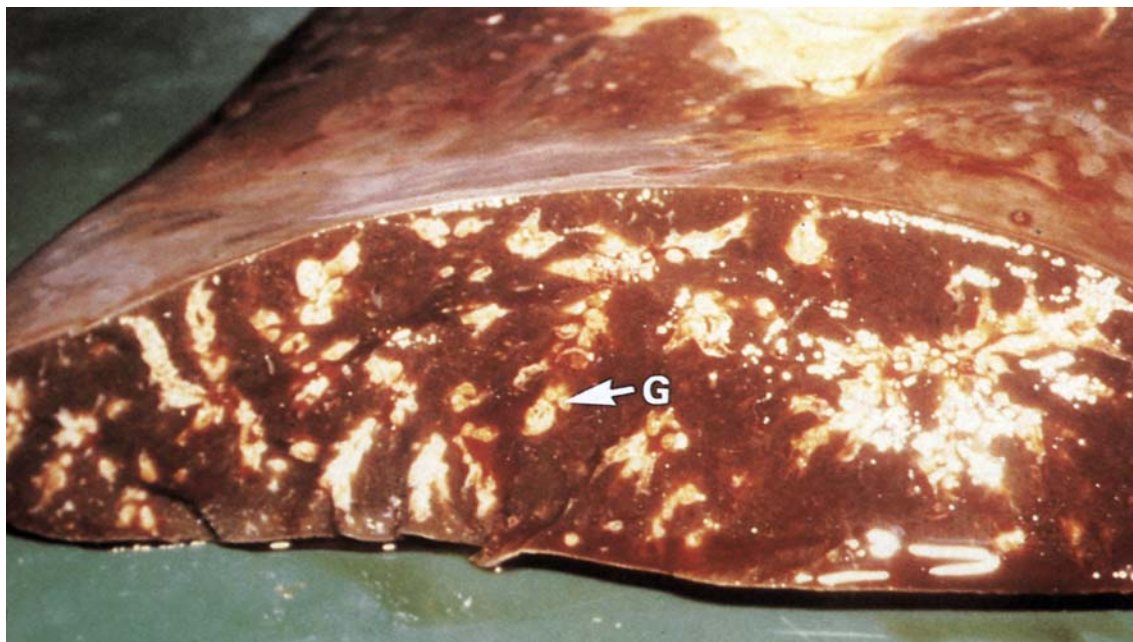

**Schistosomiasis, Animals. Figure 2** Liver of cattle with many granulomes of schistosomal eggs. G, granuloma.

## Schistosomiasis, Man

### Synonym

→ [Bilharziosis](#), Bilharziasis.

### General Information

This complex of diseases is caused by → [Schistosoma haematobium](#), *S. intercalatum*, *S. japonicum*, *S. mansoni*, and *S. mekongi*. Schistosomiasis is acquired from free-swimming freshwater → [cercariae](#) that penetrate the skin or are swallowed with fecally contaminated water from snail-infested sources (→ [Schistosoma](#)). As they penetrate the skin cercariae lose their tails and become **schistosomules**. Growing couples of monogamous male and female migrate to intestinal (*S. mansoni* and *S. japonicum*) or urogenital (*S. haematobium*) venules where females lay hundreds to thousands of eggs per day. The great variety of lesions are superbly described and illustrated by McCulley et al. and Lichtenberg. The granulomatous response is subject to multiple immunologic mechanisms.

### Distribution

There are an estimated 200 million people, in 74 countries, infected with schistosomes. Intestinal schistosomiasis caused by *S. mansoni* occurs widely in tropical Africa, in some parts of North Africa, and

Southwest Asia as well as parts of South America and the Caribbean. *S. intercalatum* is limited to parts of tropical Africa, *S. japonicum* occurs in some countries bordering on the western Pacific, *S. mekongi* is restricted to parts of the central Mekong basin, and *S. haematobium*, the cause of urinary schistosomiasis, is widely distributed in Africa and also found in Southwest Asia. The geographical distribution of the various species follows that of the obligatory snail host in association with suitable environmental temperatures for the parasite's extrinsic development.

### Pathology

Acute schistosomiasis occurs in immunologically naive, previously uninfected hosts, e.g., tourists and peace corp workers, and is characterized by hyperreactivity to schistosome worm and egg antigens. In contrast, chronic schistosomiasis mainly affects people born and residing in endemic areas. Most individuals chronically infected with Schistosomes have few or no symptoms, but 5–10% develop severe disease. Portal hypertension, as a consequence of liver fibrosis, is the major cause of → [morbidity](#) and mortality in *S. mansoni* and *S. japonicum* infection while *S. haematobium* infections often result in mass lesions of the bladder and ureters.

### Dermatitis

Dermatitis starts as a macular, and later papular, rash covering the areas in contact with contaminated water.

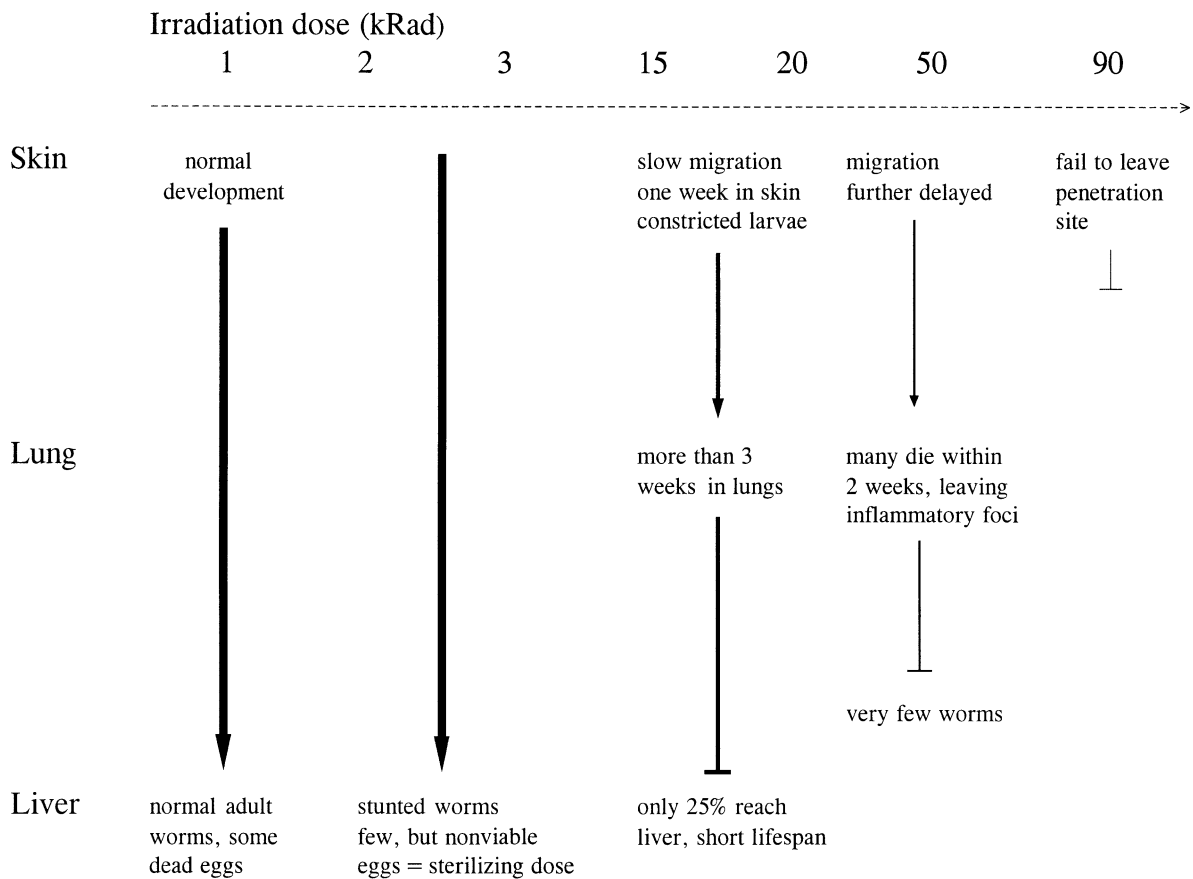

**Schistosomiasis, Man. Figure 1** Impact of the irradiation dose on migration and survival of attenuated *Schistosoma mansoni* in mice.

This persists for 2–3 days if infection is with species which mature in man. However, schistosomules from bird schistosomes may give rise to urticarial eruption with intense itching, vesicles, and, if secondarily infected, pustules. Depolymerization of the interstitial ground substance may be seen surrounding the schistosomules and protein precipitates may be found at their oral and genital pores. Histologically, a mixed inflammatory exudate is present usually with *eosinophilia*, especially with nonhuman schistosomules, most of which probably die in the skin.

The pathology is complex and will be discussed as a central theme, followed by the variations seen in the several organs involved. The variable picture that can be seen in the same patient is explained in part by the chronic active infection; with a continual arrival of new eggs, so that old and recent inflammation may be side by side and intermixed. Differences between patients are believed to depend on usual multifactorial variables of intensity and duration of infection, nutritional state,

and the various elements of immunity and *hypersensitivity*, and the presence of other infections.

### Acute Schistosomiasis

Acute schistosomiasis is acquired from exposure to large doses of cercariae when drinking and swimming in fecally contaminated snail-infested water. It is seen as acute febrile illness 3–4 weeks after exposure, with abdominal symptoms coincident with the onset of *oviposition*. The intestinal mucosa is edematous and hyperemic with small hemorrhages, early granulomas, and shallow ulcers with eosinophils.

Adult schistosome pairs are present in the radicles of the portal vein around the colon, or in the pelvic and vesical plexuses around the urinary bladder. The female is usually surrounded by the male in the lumen of a vessel without an apparent lesion or *inflammatory reaction* (*Pathology/Figs. 23A*). The male attaches to the venous wall and prevents the pair from being swept away by the bloodstream. To lay eggs, the pair migrates

## Humoral Immune Response

Mouse strain	C57BL/6J		CBA/J	
Irradiation dose	15 kRad	50 kRad	15 kRad	50 kRad
Reduction in worm burden	80–90%	50–60%	60–70%	40–50%
Antigens				
97 kDa	—	—	Paramyosin	<b>Paramyosin</b>
70 kDa	<b>HSP-70<sup>a</sup></b>	HSP-70	HSP-70	HSP-70
32 kDa	—	—	<b>Sm32<sup>b</sup></b>	—
31 kDa	<b>Cathepsin B</b>	—	<b>Cathepsin B</b>	—
28 kDa	<b>GST<sup>c</sup></b>	<b>GST</b>	<b>GST</b>	<b>GST</b>
28 kDa	<b>TPI<sup>d</sup></b>	—	<b>TPI</b>	<b>TPI</b>
23 kDa	<b>Sm23<sup>e</sup></b>	<b>Sm23</b>	<b>Sm23</b>	<b>Sm23</b>

**Schistosomiasis, Man. Figure 2** Antigens recognized by antibodies of mice vaccinated with irradiated cercariae of *Schistosoma mansoni*. The experimental groups of mice differed in the degree of protection achieved against a challenge infection. Specific antigens were identified by immunoblot analysis. Enzyme-linked immunosorbent assay (→ELISA) using purified native or recombinant antigens served to determine the intensity of antigen recognition by antibodies. Font size indicates relative intensity. Generally, levels of antibodies specific for these antigens are higher in multiply vaccinated mice than in once-vaccinated mice. <sup>a</sup>Antibodies of vaccinated CBA/J mice detect heat-shock protein (HSP-70) only in ELISA, not in immunoblot. <sup>b</sup>Sm32 is also known as hemoglobinase. <sup>c</sup>IgM antibodies dominate the response to →glutathione S-transferase (GST) and about half recognize carbohydrate epitopes. <sup>d</sup>Triosephosphate isomerase (TPI) is solely recognized by once-vaccinated mice. <sup>e</sup>In response to the integral membrane protein Sm23, C57BL/6J mice vaccinated with 15-kRad irradiated cercariae produce also antibodies of the IgG<sub>2b</sub> isotype that are not detected in other experimental groups.

into the wall of the viscus and the female wedges its body into the small veins to deposit its eggs there. The adult worms are long-lived with reports of persistence for 20–50 years after leaving an endemic area.

### Eggs

Eggs appear in the stools 40–80 days after primary *S. mansoni* infection. Dysentery with blood, mucus, and necrotic tissue may accompany the eggs. Early in the course there is diffuse eosinophilic hepatitis, which is followed by →granuloma formation around individual eggs.

Eggs are found typically in the walls of the gut or the bladder, and atypically in many other organs to which they have usually been swept by the bloodstream (→Pathology/Figs. 1, 23). The eggs become surrounded by inflammatory reaction, usually a granuloma, whether

the embryo is alive or dead (→Pathology/Fig. 24). Antigenic material exudes from the eggs, particularly through the spine when present. The inflammatory reaction is quite variable. The eggs may be surrounded by eosinophils, with a mixed eosinophilic and neutrophilic inflammatory reaction peripherally. These inflammatory cells may undergo →necrosis (→Pathology/Figs. 1C, 26). Other eggs may be surrounded by well-developed epithelioid and occasionally giant cells, followed successively by zones of lymphocytes and fibrosis. The granulomas are larger, more focal, and more structured during the early infections when fewer eggs are present. The granulomas during later infection may be largely necrotic, or may have undergone fibrosis. Some eggs are surrounded by a layer of eosinophilic fibrinoid material, found also around other chronic antigenic sources, the so-called →Splendore-Hoeppli

## Cellular Immune Response

Mouse strain	C57BL/6J		CBA/J	
Irradiation dose	15 kRad	50 kRad	15 kRad	50 kRad
Reduction in worm burden	80–90%	50–60%	60–70%	40–50%
Antigens				
97 kDa	<b>Paramyosin<sup>a</sup></b>	Paramyosin	–	Paramyosin
70 kDa	<b>HSP-70<sup>b</sup></b>	HSP-70	–	HSP-70
32 kDa	–	–	<b>Sm32<sup>c</sup></b>	–
28 kDa	<b>GST<sup>d</sup></b>	<b>GST</b>	<b>GST</b>	<b>GST</b>
28 kDa	<b>TPI<sup>e</sup></b>	TPI	–	<b>TPI</b>
23 kDa	<b>Sm23<sup>f</sup></b>	<b>Sm23</b>	–	–

**Schistosomiasis, Man. Figure 3** Antigens recognized by lymphocytes derived from draining lymph nodes of mice vaccinated with irradiated cercariae of *Schistosoma mansoni*. The experimental groups of mice differed in the degree of protection achieved against a challenge infection. Proliferation assays stimulating lymphocytes of axillary lymph nodes with purified native or recombinant antigens served to determine the intensity of antigen recognition by lymphocytes. Font size indicates relative intensity. Lymphocytes of once-vaccinated mice proliferate more strongly in response to these antigens than do those of multiply vaccinated mice. <sup>a</sup>In response to paramyosin, lymphocytes of C57BL/6J mice vaccinated with 15 kRad irradiated cercariae produce IL-2, but not IL-4. <sup>b</sup>In the presence of heat-shock protein (HSP-70), IL-2 production by lymphocytes of C57BL/6J mice vaccinated with 15 kRad irradiated cercariae decreases after repeated vaccination, while IL-4 production increases. <sup>c</sup>Sm32 is also known as hemoglobinase. <sup>d</sup>Glutathione S-transferase (GST). <sup>e</sup>Triosephosphate isomerase (TPI). <sup>f</sup>Integral membrane protein Sm23.

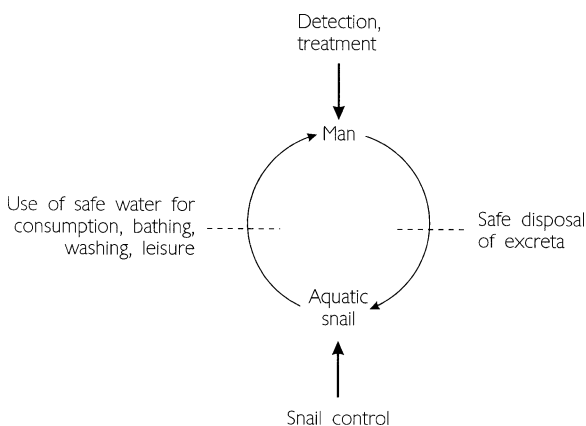

**Schistosomiasis, Man. Figure 4** Targets and approaches for the control of human schistosomiasis.

reaction (→Pathology/Fig. 1B). During →chronic infections of long-standing the inflammation is varied, with lymphocytes, eosinophils, and fibrosis interlaced with various stages of granuloma associated with eggs or egg masses.

Evidence has been presented which shows that together with the spines of *S. mansoni*, *S. mekongi*, and *S. haematobium*, the inflammatory reaction is instrumental in propelling the eggs toward the lumen of the gut or bladder before the contained →miracidium dies. Eggs with dead miracidia gradually lose their inflammatory reaction and their shells often calcify (→Pathology/Fig. 24A,B).

### Intestinal Lesions

Intestinal lesions produced by eggs are either granulomas or diffuse or segmental fibrosis of the submucosa,



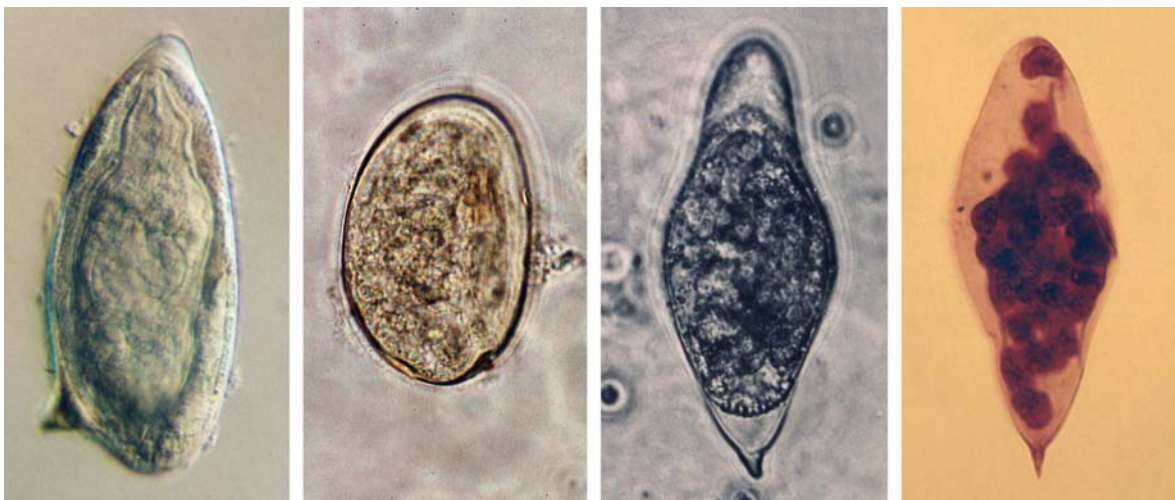

**Schistosomiasis, Man. Figure 5** The eggs of the 4 important *Schistosoma* spp. (from left: *S. mansoni*, *S. japonicum*, *S. intercalatum*, *S. haematobium*).

mainly of the colon. Inflammatory polyps may extend into the lumen, with egg masses forming the nidus. Both fibrosis and polyps may lead to obstruction. *S. japonicum* also gives rise to lesions in the small intestine. Localized masses of eggs trapped in the serosa are sometimes referred to as →**bilharziomas**; they may form polypoid projections into the peritoneum. The mesenteric lymph nodes may be enlarged from lymphoid →**hyperplasia** during earlier infection, or they may be small from lymphocytic depletion during late →**chronic infection**.

### Liver Lesions

Liver lesions are produced by eggs and adult worms carried there in the portal vein. The eggs produce small granulomas similar to those in the gut or bladder wall. However, dead adult worms carried to the liver elicit large lesions, with necrosis and around the worm, accompanied either by a mixed granulocytic inflammatory reaction, a **granuloma**, or both (Fig. 6). Much liver tissue is destroyed. This is particularly so after chemotherapy when the worms dislodge and large numbers are swept simultaneously into the liver. Scarring is seen principally in the portal areas and, when pronounced, is called Symmers' pipe stem fibrosis (→**Pathology/Fig. 18G**) This term alludes to the gross appearance of a cross section of fixed liver, which looked to Symmers (1904), as if "a number of white clay-pipe stems had been thrust at various angles through the organ." This fibrosis leads to portal hypertension with the eventual formation of dilated venous collaterals, or varices, usually around the lower esophagus, connecting the portal with the general venous circulation. The esophageal varices may bleed when ulcerated. The lobular architecture of the liver is

generally preserved and so is liver function, unlike in cirrhosis.

### Splenic Enlargement

Splenic enlargement secondary to the liver fibrosis is often found with chronic schistosomiasis. It is usually characterized by venous congestion rather than specific egg-related lesions.

### Urogenital Schistosomiasis

Urogenital schistosomiasis is usually due to *S. haematobium* which deposits its eggs in the venous plexuses around the bladder, ureter, seminal vesicles, prostate, fallopian tubes, etc. The bladder often contains focal polypoid mucosal lesions (Fig. 7) or plaques of large masses of eggs (→**Pathology/Fig. 24B**) attributed to relatively sessile single pairs of adults. Eggs of *S. haematobium* in the bladder and ureteral wall appear to have a tendency to calcify giving a "sandy" appearance to these focal lesions and making them visible roentgenologically. The microscopic lesions are similar to those described earlier except that diffuse inflammatory reaction and fibrosis are more common than the large granulomas. Ureteral polyps, strictures, and obstruction may lead to pyelonephritis and hydronephrosis. Cystitis with squamous metaplasia and ulceration leading to hematuria are common findings throughout the course of *S. haematobium* infection. Carcinomas of the bladder (→**Pathology/Fig. 24B**), of which half are squamous cell carcinomas, and almost half transitional carcinomas, with a few adenocarcinomas, are late complications.

**Main clinical symptoms:** Unspecific fevers, hematuria, feeling of a burning in the urethra, possibly later development of carcinomas.

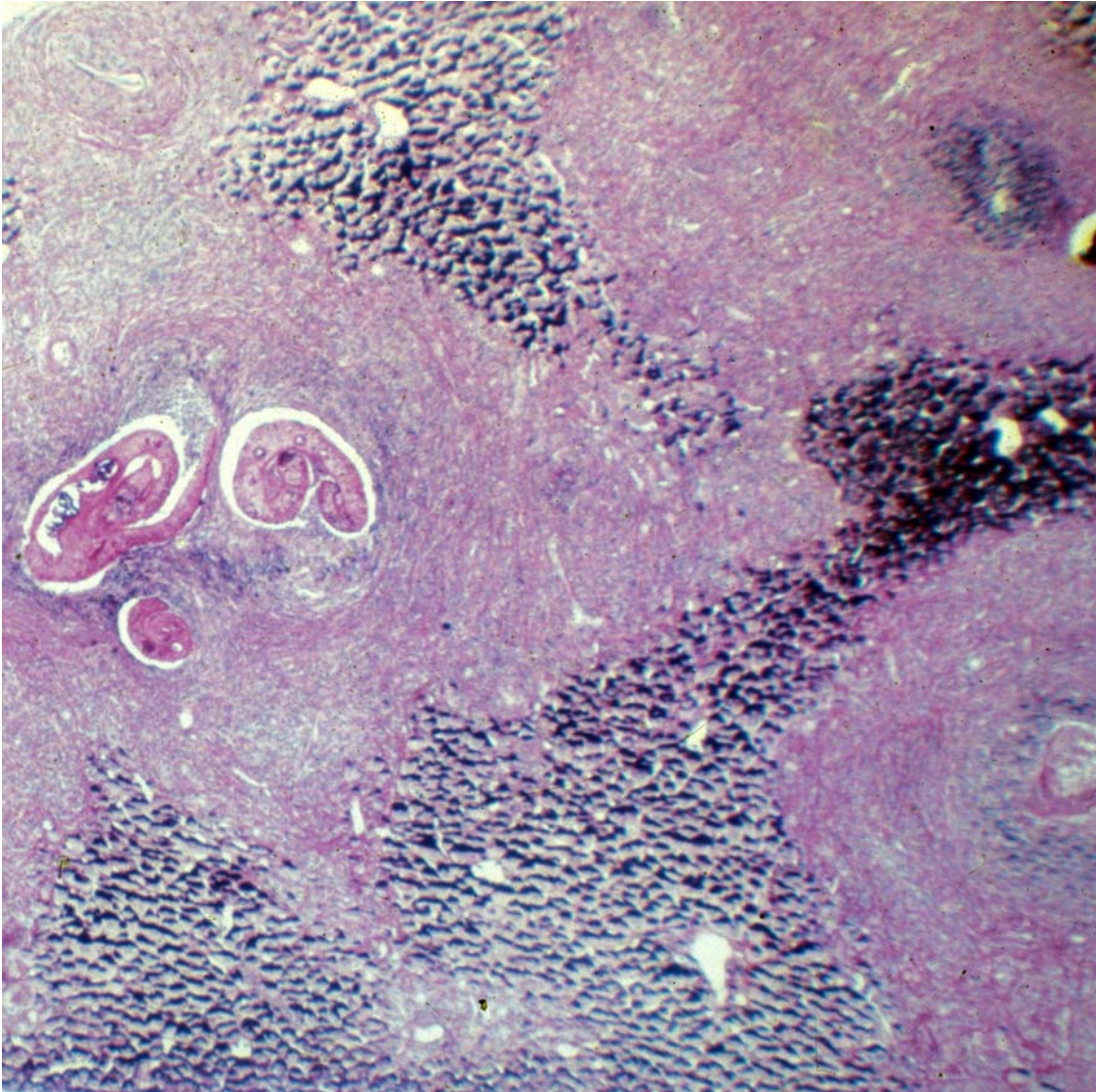

**Schistosomiasis, Man. Figure 6** Liver granulomas around an adult *Schistosoma mansoni* (left) and 2 eggs (right).

**Incubation period:** 4–7 weeks.

**Prepatent period:** 9–10 weeks.

**Patent period:** 25 years.

**Diagnosis:** Microscopic detection of eggs in the urine (Fig. 5).

**Prophylaxis:** Avoid entering lakes and rivers in endemic regions.

**Therapy:** Treatment with praziquantel, see →[Trematocidal Drugs](#).

### **Pulmonary Schistosomiasis**

Pulmonary schistosomiasis is produced by *S. haematobium* eggs escaping into the general venous circulation and by *S. mansoni* and *S. japonicum* eggs that pass

through the portal drainage via the collaterals into the general circulation. These eggs occlude the pulmonary arterioles giving rise to thrombi, granulomas, and →[arteritis](#). With heavy infections there is significant obstruction, with pulmonary hypertension leading to cor pulmonale dilatation and hypertrophy of the right heart.

### **Central Nervous System Granulomas**

Central nervous system granulomas can be produced by any of the schistosome species, but especially by *S. japonicum* due to its proclivity to reach and grow in the cerebrospinal venules. Because of the calvarial exoskeleton, and space-consuming lesion within it impacts on

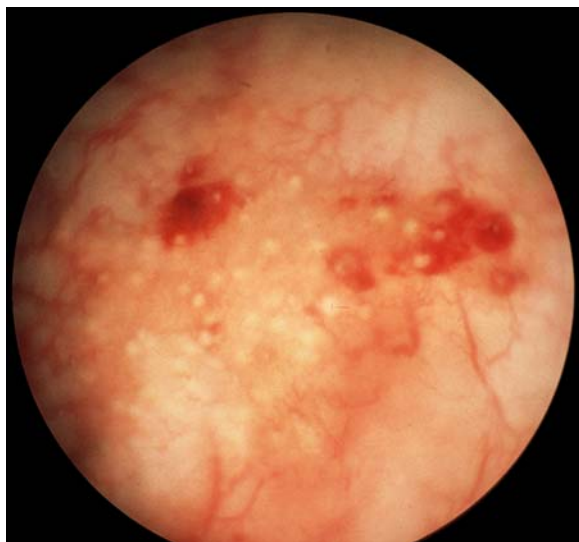

**Schistosomiasis, Man. Figure 7** Granulomas in the wall of human bladder due to *Schistosoma haematobium*; note the bloody fluids around protruding eggs.

the brain. So the cerebral or meningeal granulomas surrounding egg; of *S. japonicum* (→Pathology/Fig. 24C) may give rise to focal epileptic convulsions and those of the cord to transverse myelitis. Because of the association of central nervous system involvement with light, aberrant, or early infections, the expected diagnostic findings of eggs in the stool or urine may be absent.

### Miscellaneous Lesions

Miscellaneous lesions include ectopic eggs which may be found in many other organs, but because the eggs are usually few in number the lesions produced tend to produce few or no symptoms. Development of dilated anastomoses between portal and systemic veins has been commented upon. They may bleed, usually into the esophagus. →Bilharziomas are granulomatous and fibrotic lesions that develop around egg masses away from the mucosa. (Figs. 6, 7). →Glomerulonephritis associated with the deposition of immune globulin in glomeruli has been described in patients with *S. mansoni* infection. Chronic *Salmonella* infection is sometimes associated with schistosomiasis, with bacteria growing within the adult schistosomes. This may resemble a systemic infection or pyelonephritis. Pigmentary deposits of hematin are often found in the sinusoidal lining cells of the liver which resemble those formed in →malaria, or artifactually by acid formalin. The schistosomal →pigment is produced by the breakdown of blood ingested by the adult schistosomes.

Schistosomiasis is often associated with malnutrition and other infectious agents, such as hookworm,

→*Ascaris* spp., malaria, tuberculosis, amebiasis, and bacillary dysentery, and lesions and symptoms may overlap. Infection with *S. mekongi* is often accompanied by →*Opisthorchis viverrini*. Incidentally to the investigation of these other clinical entities, subclinical schistosomiasis may be diagnosed. Because of the long survival of adult schistosomes and the worldwide travel of the human host, chronic infections may be found away from the areas of endemicity. There are several species of schistosomes parasitic in animals which are also capable of giving rise to light infections in humans.

### Intestinal Schistosomiasis in General

**Main clinical symptoms:** Dermatitis due to penetrating cercariae, later intermittent fevers (→Katayama syndrome), →abdominal pain, swellings of liver and spleen, blood in stool, eosinophilia, liver dysfunctions, liver fibrosis.

**Incubation period:** *S. mansoni*: 2–3 weeks, *S. japonicum*: 1–3 weeks, *S. intercalatum*: 4–7 weeks.

**Prepatent period:** *S. mansoni*: 4–7 weeks, *S. japonicum*: 4–5 weeks, *S. intercalatum*: 6–8 weeks.

**Patent period:** 5–25 years.

**Diagnosis:** Microscopic determination of eggs in fecal samples (Fig. 5), →Serology.

**Prophylaxis:** Avoid entering lakes and rivers in endemic regions.

**Therapy:** Treatment with praziquantel, see →Trematodocidal Drugs.

### Immune Responses

One of the main histopathological findings in schistosomiasis is the formation of granulomas around schistosome eggs, which is also frequently found in experimental schistosome infections of mice, monkeys, and other hosts. Although the circumoval granulomas in experimental infections are massive compared to infections in humans, much has been learned about the responsible immunoregulatory processes especially by analyzing granuloma formation in response to *S. mansoni* eggs in mice.

### B Cells and Antibodies

A variety of antibodies can be produced against different antigens of adult worms, but protective immunity against reinfection appears to be mainly operative against larval stages. Numerous *in vitro* studies in experimental and human schistosomiasis have clearly pointed out the essential role played by antibodies in various effector and regulator mechanisms according to their isotypes. However, the course of infection as well as the relative importance of antibodies varies in different experimental hosts. Antibodies of the IgG and

IgE isotypes are directly involved in the *in vitro* killing of schistosome larvae in association with effector cell populations such as eosinophils, macrophages, and platelets. These antibodies also induce protection against a schistosome challenge when transferred to naive rats. In rats and rhesus monkeys there is a short self-limiting infection after which persistent low worm burden is controlled by concomitant immunity. In rats the protective immunity involves antibodies of IgE and IgA isotypes. In humans infected with *S. mansoni* a parallelism of the generation of IgA antibodies against the protective recombinant 28 kDa glutathione-S-transferase and acquisition of resistance to reinfection has been observed. Functional analysis revealed that these IgA antibodies not only inhibited the activity of the glutathione-S-transferase but also markedly impaired schistosome →fecundity, by suppressing both the egg production by adult female worms and the hatching capacity of schistosome eggs into viable miracidia.

Beside these protective antibodies, several blocking antibody isotypes have been reported. In humans, IgM and IgG<sub>2</sub> antibodies specific for glycanic schistosome antigens prevented the eosinophil-dependent killing by the IgG fraction of the same sera. Furthermore, in *S. haematobium*-infected children immunity to reinfection correlated with increased levels of IgE and decreased levels of IgG<sub>4</sub> antibodies.

In addition to their role in antibody production B cells participate in the modulation of granuloma formation as has been demonstrated in *S. mansoni*-infected B cell-deficient ( $\mu$ MT) mice. Due to mechanisms not defined so far, the B cell-deficient mice displayed an increased hepatic fibrosis and an enhanced Th1-type T cell response.

## T Cells

The formation of granulomas surrounding eggs of →schistosoma is clearly T cell-dependent and immune serum was shown to be not important for the formation or modulation of these lesions. Th2 cytokines are of paramount importance for the granuloma development in experimental infections with *S. japonicum* and *S. mansoni*. Seven to 10 days after injection of eggs or 5–6 weeks after infection with *S. mansoni*, the time when egg laying begins, the cytokine response of mice evolves from a Th0 to a Th2 pattern. While in the lung model using *S. mansoni* eggs treatment with anti-IL-4 antibodies markedly reduced the size of granulomas in mice, injection of anti IFN- $\gamma$  mAb enhanced both the granuloma size and the parasite-specific Th2 response. However, the transfer of Th0, Th1, and Th2 clones or cell lines all augmented granuloma formation in naive recipient mice.

In *S. mansoni*-infected mice anti-IL-4 treatment had only a moderate to minimal effect on the size of granulomas but hepatic fibrosis was greatly reduced.

Surprisingly, both the granuloma-formation as well as the development of hepatic fibrosis was not significantly altered in IL-4-deficient mice when compared to wild type mice, suggesting compensatory mechanisms in these knockout mice. Another Th2 cytokine, IL-5, appears to be of importance for the development of tissue eosinophilia, but anti-IL-5 treatment did not significantly influence the granuloma size. A central, nonredundant role of IL-2 is demonstrated by the findings that anti-IL-2 treatment or infection of mice depleted of IL-2 receptor expressing cells by injection of an IL-2-fusion toxin both resulted in the reduction of granuloma sizes and hepatic fibrosis. Since concomitantly there was a reduced Th2 response, IL-2 is most likely essentially involved in the generation of disease-aggravating Th2 cells.

Cytokine treatments of infected mice generally had the effects expected from the anticytokine treatments. While IL-2 and IL-4 administration increased the granuloma sizes, IFN- $\gamma$  application had the opposite effect and reduced hepatic fibrosis. In line with the latter finding, IL-12 dramatically downregulated the granuloma formation, largely through the stimulation of IFN- $\gamma$  production from NK cells.

In summary, the formation of egg-induced granulomas in experimentally infected mice may be viewed as Th2-driven process supported by chemotactic factors derived from the eggs. Although the information on the immune response in humans is much more scarce, the immunoregulatory processes might be similar: There were elevated levels of IL-4 in sera of schistosome-infected patients and IL-4 levels after *in vitro* polyclonal stimulation correlated positively with the intensity of schistosome infection while there was a negative correlation with the amounts of IFN- $\gamma$  produced. However, enhanced production of IL-4 and IL-5 by cells from Egyptian patients in response to *S. haematobium* adult worm antigens correlated with immunity against reinfection.

One of the key features of schistosomiasis in mice is the immune downregulation of the granulomatous response during chronic infection. In *S. mansoni*-infected mice the size of newly formed granulomas peaks at 8 weeks postinfection. The subsequent downregulation of granulomas is accompanied by decreased cutaneous reactions to soluble egg antigens (SEA) and a decreased proliferative response and cytokine production of CD4<sup>+</sup> cells. Several findings are consistent with the idea of active suppression of immune responses. SEA suppresses LPS-induced activation of immature murine dendritic cells, including MHC class II, costimulatory molecule expression, and IL-12 production. SEA-augmented LPS-induced production of IL-10 is in part responsible for the observed reduction in LPS-induced IL-12 production. Diminution of hepatic granulomas was observed upon transfer of

spleen cells from chronically infected (16–24 weeks) mice and this adoptive suppression required the presence of histocompatible CD8<sup>+</sup> T cells. Since adult thymectomy results in almost complete lack of the suppressive T cell population, recent thymic emigrants are obviously required for the maintenance of the suppressor cell population. The mechanisms by which CD8<sup>+</sup> T cells suppress CD4<sup>+</sup> Th populations are still a matter of debate.

An alternative, not necessarily exclusive, possibility for suppressive activity of CD8<sup>+</sup> T cells has been proposed involving IFN- $\gamma$  as key regulatory molecule. In CD8<sup>+</sup> T cells from *Schistosoma*-infected mice the frequency of cells expressing the activation phenotype CD44<sup>high</sup> L-selectin<sup>low</sup> is increased and these cells produce IFN- $\gamma$  in the presence of IL-2 after TCR stimulation. Since some of these CD8<sup>+</sup> T cells are responsive to schistosome antigens and CD8<sup>+</sup> T cells have been found in close proximity with CD4<sup>+</sup> T cells within granulomas it is tempting to speculate that the egg-induced lesions could be the site of CD4 / CD8 T cell interaction. Recently, it was shown that CD4<sup>+</sup> CD25<sup>+</sup> T<sub>reg</sub> isolated from hepatic granulomas and from lymphoid tissues are a main producer of immunosuppressive IL-10 in schistosome-infected mice, thus contributing to an enhanced Th2 cell response.

In infected humans, a failure to develop Immune downregulatory mechanisms has been observed which correlates with clinical disease: Antigen-induced proliferative responses of PBLs *in vitro* were high in the majority of acutely infected patients and amongst ambulatory patients with hepatic or hepatosplenic disease, while asymptomatic chronically infected patients were predominantly low to moderate responders. Interestingly, immune-responsiveness is regained after curative chemotherapy, presumably by removing egg antigens which might be of importance for sustained immunoregulatory constraints.

Fibrosis underlies most of the chronic pathology associated with schistosome infections. While in mice most hepatic fibrosis is associated with granulomas, in humans the relation appears to be less stringent. Type I and III are the predominant  $\rightarrow$ collagen isotypes synthesized in both human and murine infections, and a switch from predominant type I to type III collagen synthesis has been reported to occur during the chronic phase of infection. The fibrogenic process is regulated by T cells and macrophages interacting with cells of the mesenchymal/fibroblast lineage. Cytokines are certainly involved in these interactions, since anti-IL-4 treatment and application of IFN- $\gamma$  decreased fibrosis. At least part of these profibrotic and antifibrotic effects of IL-4 and IFN- $\gamma$  may be directly on the proliferation and collagen synthesis of fibroblasts.

A novel cytokine, fibrosin, which has been recently cloned, together with TGF- $\beta$ 1 is associated with

fibrosis in murine granulomas and downregulation of both cytokines coincided with immune downregulation and reduction of granuloma sizes.

## Vaccination

The best characterized vaccine model for plathelminths is the vaccination of mice with  $\gamma$ -irradiated cercariae of *S. mansoni*. Optimally irradiated cercariae stimulate the host's immune system and confer high levels of resistance without causing the severe pathological symptoms of schistosomiasis. They penetrate the host's skin as successfully as nonattenuated larvae do, but their migration is delayed, causing them to spend a prolonged time in the skin, lymph nodes, and lungs. Because optimally attenuated schistosomes die immaturely during their passage from the lungs to the liver of the host, pathology in the form of egg granuloma is completely circumvented. First studies testing irradiated cercariae as a possible vaccine against schistosomiasis were performed more than 4 decades ago. Although the experimental designs were not comparable among investigations, these early data prompted further research on the vaccine model resulting in a thorough analysis of this method of immunization.

## Conditions for Immunization

The dose of irradiation used to attenuate the cercariae was recognized early on as a parameter affecting the level of resistance. At first, doses of 2.5–10 kRad were regarded as optimal. Later, presumably due to technical improvements, the positive correlation between irradiation dose and level of resistance was found to continue up to and level at a range of 24–56 kRad, decreasing gradually with doses beyond. More recently, irradiation doses of 15–20 kRad have consistently resulted in higher levels of protection than doses of 50 kRad or more.

As with other vaccination protocols, the level of resistance depends on the number of boosts with and the dose of antigenic material, in this case the number of exposures to and the load of irradiated cercariae. Studies comparing levels of protection induced by up to 8 monthly exposures demonstrated that 5 immunizations result in an optimal level of resistance. A 4-week interval generates best results and this regimen is commonly applied. If mice are vaccinated once, the number of immunizing cercariae does not appear to affect the level of resistance. However, the cercarial number has a significant influence in multiply vaccinated mice and when higher irradiation doses are used. Mice vaccinated with 500–1,000 cercariae achieve higher levels of resistance than do those vaccinated with 20–100 cercariae.

Employing the parasite's natural behavior, mice are generally exposed percutaneously to irradiated cercariae. The skin of the shaved abdomen, tail, or ear pinna

serves as entry site. Distant sites are sometimes chosen for penetration of immunizing and challenging cercariae to avoid nonspecific local →inflammatory responses. Such reactions, however, do not appear to significantly influence the level of resistance and any of the 3 entry sites may be used.

Protective immune responses stimulated by vaccination with irradiated cercariae are most effective 7–30 days postvaccination, with the 30-day period between vaccination and challenge considered optimal. If mice are challenged 15 weeks after exposure to immunizing cercariae, their levels of resistance are somewhat reduced. Eighteen months postvaccination, resistance is lost in some mouse strains (CBA/Ca, BALB/c), whereas others maintain partial resistance (CF1). Thus, the immunity induced by irradiated cercariae appears to be relatively long-lasting.

The genetic background of the murine host also influences the absolute level of resistance that may be achieved. Data on resistance of C3H/HeJ (C3H) and CBA/J (CBA) mice are variable, ranking them as non- or moderate responders. In contrast, C57BL/6J (C57) mice are consistently regarded as high responders. Differences in the degree of immunity are caused, in part, by variations in the major histocompatibility complex, as was demonstrated by cross and back-cross experiments of congenic mice differing in their H-2 haplotypes. However, outbred mice are also effectively immunized by irradiated cercariae and may be more representative of natural host populations.

Interestingly, the resistance stimulated by vaccination with irradiated cercariae seems to be species-specific. Mice vaccinated with irradiated *S. mansoni* cercariae and challenged with other *Schistosoma* spp. or vice versa are not protected. However, cercariae of geographically distinct isolates of *S. mansoni* successfully cross-protect mice, indicating that the major antigens relevant to protection are common to these isolates. Similarly, no difference in the ability to stimulate resistance exists in clones of schistosomes, or in parasites that have been passaged selectively for their resistance to the host's immunity. Thus, results obtained using one *S. mansoni* strain may be extrapolated to other strains.

Although percutaneous exposure to irradiated cercariae stimulates the highest levels of resistance, mechanically transformed irradiated schistosomula may be administered instead. Advantageously, schistosomula may be stored by cryopreservation without losing their immunogenicity. The effectiveness of vaccination with irradiated schistosomula varies, however, with the route of injection. Intravenous or subcutaneous injection of irradiated schistosomula is only marginally protective, and intraperitoneal, intratracheal, and intramuscular injection rank intermediate, whereas the intradermal injection of attenuated schistosomula

induces particularly good protection against challenge infection. Intradermally administered schistosomula persist in the skin and are able to migrate to the draining lymph nodes, and the lungs. Only schistosomula administered intradermally share similar migration patterns with penetrating cercariae.

### Migratory Pattern of Immunizing and Challenging Schistosomes

To identify sites where the protective immunity is stimulated, the migratory pattern and the attrition site of irradiated schistosomes have been compared to those of nonattenuated parasites. Various methods were applied such as histological investigations, counting of parasites upon their exit from minced lung tissue, and detection of radiolabeled parasites by compressed organ autoradiography. Generally, the time of survival and the migratory pattern of attenuated larvae depend on the irradiation dose used (Fig. 1). A dose of one kRad seems to have little effect on parasite development, although an increased number of dead eggs are found. At 2–3 kRad, very few and stunted adult worms are recovered from the liver. Because the occasional eggs they produce are not viable, this dose is considered sterilizing. Doses of 4 kRad or higher do not permit survival of parasites to adulthood. Parasites irradiated with a 20-kRad dose migrate more slowly than do their nonattenuated counterparts. They remain in the skin for up to one week, and thus their passage to the lungs is delayed. There, they are observed at least until day 21, at which time nonattenuated parasites have left the lungs and entered the liver. Lying within alveoli, many attenuated schistosomula seem to lose the capacity of onward migration and only a quarter of 20-kRad irradiated parasites reaches the liver. Irradiation with a 50-kRad dose results in further retardation of the parasites' migration from the skin to the lungs, and only few worms are found in the liver. As early as 2 weeks after penetration, the majority of these parasites have died, leaving residual inflammatory foci. Most 90-kRad irradiated parasites fail to leave the skin, indicating that increasing irradiation doses diminish the parasites' ability to migrate through the tissues. Abnormal constrictions are observed in attenuated larvae as early as 6 days after 20-kRad irradiation that are not apparent in nonattenuated parasites. This impairment appears to restrict the motility of irradiated parasites and may explain their prolonged presence in the skin and lung tissue as well as the inhibition of their onward migration.

Excision experiments have been performed to determine for how long, and where within the host, attenuated parasites must be present in order to stimulate resistance. Excising the site of skin penetration within the first 4 days following exposure completely blocks induction of resistance, possibly because most attenuated parasites are

removed before they are able to disseminate in the host. Removal of the penetration site between the fifth and eighth day permits the development of low but significant levels of resistance compared to nontreated mice. Skin excision thereafter fails to affect resistance. If axillary and inguinal lymph nodes draining the abdominal penetration site are surgically removed 5 days before exposure to irradiated cercariae, the level of resistance is reduced by two-thirds. Thus, factors such as the duration of host-parasite contact, maturation of the immunizing parasite, and migration to a postskin site appear to be relevant to the development of a protective immune response.

In vaccinated mice, the migration pattern and attrition site of nonattenuated parasites delivered as challenge infection have been investigated. In mice vaccinated with 20-kRad irradiated cercariae, the migratory pattern of challenge parasites is delayed but otherwise similar to that observed in naive mice. Challenge parasites in mice vaccinated with 50- or 56-kRad irradiated cercariae migrate even more slowly to and from the lungs. Some studies identify the skin as the major site of immune elimination, others the lungs. Differences in methods or mouse strains may cause these variable results. In both sites, inflammatory foci are observed and may be relevant to the immobilization and elimination of challenge parasites. It is generally agreed that in optimally vaccinated mice challenging schistosomes are eliminated before they reach the liver.

Although the morbidity-causing [→host response](#) in the form of egg granulomas does not result from exposure to irradiated cercariae, attenuated cercariae induce inflammatory responses during their migration through the host. The extent of host tissue response depends on the irradiation dose applied to the immunizing cercariae. Whereas 50-kRad irradiated parasites induce dermatitis and [→vasculitis](#), 5- or 2.5-kRad irradiated larvae cause granulomatous foci in lungs or liver, respectively. Cercariae irradiated with 24 kRad induce more lesions than the slightly less protective 48-kRad irradiated cercariae. Unlike granulomas developing around schistosome eggs, the inflammatory foci formed around irradiated parasites appear not to harm the host, because they are not systemic and disappear with time. In fact, inflammatory foci may even benefit the host by trapping challenge parasites. As a result, migration of challenge parasites is slowed; they leave the skin or lungs later than do schistosomes in naive mice, and eventually die within such foci. Thus, focal inflammatory responses in vaccinated mice may be advantageous rather than detrimental to the induction of resistance.

### Humoral Immune Responses

The role of antibodies in the protective immunity induced by irradiated cercariae was demonstrated

early on by passively transferring resistance to naive mice using serum of vaccinated mice. The protective capacity is restricted to sera obtained from multiply vaccinated mice. The serum may be administered one hour before or several days after challenge, depending on whether the skin or lung stage, respectively, is to be targeted. Serum administration by intravenous, intraperitoneal, or subcutaneous injection is equally effective. The IgG isotypes, particularly IgG<sub>1</sub>, appear to be protective and may be enhanced synergistically by the presence of IgM.

The successful transfer of resistance prompted further analysis of the humoral immune response in vaccinated mice. Parasite-specific antibodies are detected as early as 2 weeks after vaccination. Their titers peak at 5–6 weeks, then gradually decline, but antibodies are still detectable 15 weeks after vaccination. Antibody titers are enhanced by repeated exposure to irradiated cercariae or after challenge infection with nonattenuated cercariae, showing a typical anamnestic response.

Although the presence of antibodies is essential, as determined by the failure of B-cell-depleted mice to generate any resistance, no consistent association between overall antibody titer and level of resistance is apparent. Whereas levels of resistance are not affected by the absence of IgM antibodies in x-linked immunodeficient (*xid*) mice, nonprotected mice of the P/N strain produce only small amounts of schistosome-specific IgM antibodies as compared to highly protected mice of other strains. Similarly, upon comparison of 3 mouse strains, titers of antibodies binding to crude antigen mixtures seem not to correlate with levels of resistance. In contrast, overall levels of schistosome-specific antibodies are greater in mice vaccinated with 15- or 20-kRad irradiated cercariae than in less protected mice vaccinated with 40- or 50-kRad irradiated cercariae. Idiotypic regulation may also be important, because anti-idiotypic immunization suppresses the development of resistance. Therefore, antibody specificity rather than quantity appears to be relevant to protective immunity.

In order to examine antibody specificity of vaccine sera, surface- or metabolically labeled antigens of schistosomes have been immunoprecipitated. Although these studies differ in irradiation doses, mouse strains and parasite stages used, various antigens having molecular mass of 15, 17, 19–20, 22–23, 32, 38, 43–45 and 92–94 kDa are consistently detected. A direct comparison of 2 mouse strains (C57 and C3H) as well as 3 irradiation doses (5, 25, and 50 kRad) using immunoprecipitation failed to demonstrate differences in the pattern of antigens recognized.

The antibody specificity in an array of different vaccine sera has been analyzed by immunoblot, probing whole parasite extracts. Antigens of 22–23, 28, 31–32, 70, and 97 kDa were identified as the

integral membrane protein Sm23, glutathione-S transferase = GST, triose-phosphate isomerase = TPI, cathepsin B, hemoglobinase, →heat shock protein 70 (HSP70) and →paramyosin, respectively. In contrast to other studies, immunoblot analysis demonstrated that both the irradiation dose used to attenuate cercariae as well as the genetic background of the mice influence the titer and the specificity of antibodies to particular antigens (Fig. 3).

### Cellular Immune Responses

T cells are essential for the induction of protective immunity in this model, because athymic mice fail to develop resistance following exposure to irradiated cercariae. Proliferative responses of lymphocytes to schistosomal antigens peak during the first 2 weeks after vaccination, waning after the fourth. Lymphocytes derived from draining lymph nodes respond considerably more strongly than those derived from spleen. The relevance of regional rather than systemic stimulation is supported by the observation that attenuated parasites release significant amounts of antigenic material during their passage through skin, lymph nodes, and lungs. As a result, the time and site of lymphocyte priming coincide closely with the parasites' migration, i.e., proliferation is observed first in skin- and later in lung-draining lymph nodes. Because greater amounts of antigens are released over an extended period in axillary and inguinal lymph nodes of vaccinated mice than in other lymph organs or as compared to mice infected with nonattenuated cercariae, lymphocytes in these lymph nodes, as well as in mediastinal nodes, proliferate most strongly. In contrast, no proliferation is detected in cells from brachial, periaortic, or mesenteric nodes. In primed lymph nodes, the number of T cells increases relative to that of B cells. The irradiation dose used to attenuate the cercariae has a profound effect on their lymphostimulatory capacity, because it affects their migratory pattern. Whereas longer-lived 20-kRad irradiated cercariae stimulate extensive proliferation in draining lymph nodes, 50-kRad irradiated cercariae induce modest responses, and nonprotective 80-kRad irradiated parasites that fail to leave the skin penetration site induce only a transient increase in cell number. Therefore, optimally attenuated parasites deliver themselves to sites where antigen processing is intense. While remaining there for a prolonged period, they release antigenic material priming lymphocytes required for successful vaccination.

Removal of draining lymph nodes before vaccination reduces the level of resistance. Because removal a week after vaccination eliminates priming parasites as well as primed lymphocytes, only low levels of immunity develop. Lymphadenectomy at later times does not abrogate resistance, because primed lymphocytes have begun to circulate. The pool of these

peripheral lymphocytes expands vigorously, reaching its maximum 3–4 weeks after vaccination, and persists at an elevated level. Simultaneously, numerous activated lymphocytes infiltrate the pulmonary →parenchyma and airways. Lymphocytes of the draining lymph nodes as well as those recruited to the lungs participate in the induction of immunity. Successful vaccination correlates with percutaneous exposure or intradermal injection of attenuated parasites, because only these routes of administration allow the parasites to migrate through the draining lymph nodes as well as through the lungs.

T-cell subsets have distinct effects on the induction of immunity, as demonstrated by depletion studies. Depletion of CD4<sup>+</sup> T cells decreases the level of resistance. In fact, resistance to challenge falls below that observed in athymic mice, if mice are depleted of CD4<sup>+</sup> T cells before vaccination. In contrast, depletion of CD8<sup>+</sup> T cells reduces morbidity and enhances resistance to a level higher than that observed in nondepleted control mice. The ratio of reactive CD4<sup>+</sup> T-cell subsets is shifted by the number of exposures to irradiated cercariae. Cytokines produced by Th1 cells predominate in once-vaccinated mice and dissipate in multiply vaccinated mice with a concurrent increase in cytokines produced by Th2 cells. Repeated vaccination results in an overall decreased proliferative response. Both observations might explain why CD4<sup>+</sup> T cells are essential to the induction of resistance in once-vaccinated mice, but appear less critical in twice-vaccinated mice.

The Th subsets participating in the induction of protection were further characterized by cytokine studies. Upon *in vitro* stimulation, lymphocytes of mice vaccinated with the more-protective 15-kRad irradiated cercariae secrete significantly more of the Th1 cytokine IFN- $\gamma$  than do mice vaccinated with less protective 50-kRad irradiated cercariae and lymphocytes of the latter mice produce far more IFN- $\gamma$  than nonprotected P/N mice. Further, in vaccinated IFN- $\gamma$ -receptor knockout mice or in vaccinated mice depleted of IFN- $\gamma$  by antibody treatment, protective immunity is abrogated by about 50–90%. In such mice, mRNA expression of Th2 cytokines, such as IL-4, IL-5, IL-10, and IL-13, is elevated and that of Th1 cytokines diminished. The kinetics of IFN- $\gamma$  production in vaccinated mice coincides with the migratory pattern of the immunizing parasites. This cytokine is initially produced in the skin within 24 hours after vaccination and by lymphocytes obtained from axillary and inguinal lymph nodes 4 days later, peaking 2 weeks after vaccination. At this time, lymphocytes from mediastinal lymph nodes only begin secreting IFN- $\gamma$ , while lymphocytes obtained by →bronchoalveolar lavage secrete high titers of IFN- $\gamma$ , coinciding with macrophage activation. In contrast, depletion of cytokines produced by Th2 cells, such as IL-4 and IL-5, does not affect resistance in vaccinated mice. Neither IgE nor



eosinophils appear to be required in vaccinated mice. Therefore, secretion of Th1 cytokines correlates with the degree of vaccine-induced immunity and Th2-associated antibody responses in multiply vaccinated mice enhance protection.

A potent inducer of IFN- $\gamma$  production is IL-12. This cytokine affects the differentiation of Th cells by stimulating the expansion of Th1 cells while suppressing the differentiation of Th2 cells. In mice vaccinated once with irradiated cercariae, administration of IL-12 enhances the vaccine-induced protection against a challenge infection by about 20%. At the same time, mRNA levels of IFN- $\gamma$  and IL-12 increase, while those of the Th2 cytokines, IL-4 and IL-5, eosinophilia, and titers of IgE are reduced. Although the responses of the Th2 subset prevail in mice multiply vaccinated with irradiated cercariae, exogenous IL-12 is capable of further augmenting the degree of protection, even achieving complete protection in some individuals. In such multiply vaccinated mice, IL-12 appears to enhance the production of parasite-specific antibodies, particularly those isotypes that are Th1-associated. Studies on IL-12 knockout (IL-12KO) mice vaccinated with irradiated cercariae confirm the fundamental role this cytokine plays in generating protective immune responses. Vaccinated IL-12KO mice produce cytokines and antibody isotypes that correspond to the Th2 phenotype and, possibly as a result, develop a significantly greater worm burden from a challenge infection than do their wild-type counterparts. Inflammatory foci in the lung of vaccinated IL-12KO mice have a looser appearance and contain more eosinophils than do those in wild-type mice and, as a result, may be less efficient in blocking the migration of challenging schistosomes. In IL-12KO mice, recombinant IL-12 permanently restores the ability to generate protective Th1 responses. If this cytokine is administered during the first week after vaccination, such knockout mice produce levels of IFN- $\gamma$ , develop inflammatory foci around challenge larvae, and achieve levels of protection comparable to those of wild-type mice. Thus, IL-12 serves an important role in inducing protective Th1 responses in mice vaccinated with irradiated cercariae. On the other hand, vaccinated IL-10-deficient mice generating an intermediate Th1/Th2 response develop higher levels of protection than do wild-type mice, indicating that IL-10 may downregulate the protective immune response in vaccinated mice.

The importance of Th1 responses is further evidenced by studies on the delayed type hypersensitivity (DTH) (type IV). Vaccinated mice exhibit a profound DTH reaction to soluble schistosomal antigens *in vivo*, starting 10 days after exposure to irradiated cercariae and peaking one week later. Significantly decreased DTH reactivity coincides with reduced levels of resistance in athymic mice, P/N mice, or in mice

depleted of CD4<sup>+</sup> or IL-2-receptor bearing cells. On the other hand, mice deficient in mast cells or IgE production develop levels of resistance comparable to that of nondeficient controls. The immediate hypersensitivity (type I) response observed in mice of the P/N and C57 strains does not differ. Delayed but not immediate hypersensitivity appears to be relevant to the immunity induced by irradiated cercariae.

Inflammatory foci in the skin and lungs of vaccinated mice participate in the development of protection. Upon challenge infection of multiply vaccinated mice, ICAM-1 mediates an early accumulation of mononuclear cells in the skin and local production of nitric oxide. Similarly, large numbers of Th cells infiltrate the lungs after vaccination. Virtually all express high levels of the CD44 molecule, identifying them as effector/memory cells. Because binding of CD44 to its ligand, which is present in the lung, promotes cell aggregation and cytokine release, it may serve to initiate and maintain inflammatory responses. Upon challenge, the cellular composition of these foci is characteristic of a DTH response. The cells are found in tightly compact aggregates. Whereas in vaccinated IL-10-deficient mice tight inflammatory foci develop, in vaccinated IL-12KO or IFN-gamma-receptor-KO mice, cell aggregates are much larger and looser, concurrent with a reduction in immunity. In addition, IFN- $\gamma$  affects the expression of inducible nitric-oxide synthase, which is associated with inflammatory foci developing around challenge schistomula in the lungs of vaccinated mice. Thus, challenge parasites appear to be trapped in compact pulmonary inflammatory foci of vaccinated mice.

### Candidate Vaccine Antigens

The antigens that are recognized by the humoral compartment of mice vaccinated by irradiated cercariae also induce lymphocyte proliferation in these mice (Figs. 2, 3). The response to this array of antigens, consisting of Sm23, GST, TPI, cathepsin B, Sm32, HSP70, and paramyosin, has been further characterized by quantifying levels of antigen-specific isotypes as well as their lymphostimulatory capacities in different groups of vaccinated mice. Experimental groups of mice achieve various degrees of resistance due to their genetic background, the number of exposures to irradiated cercariae, and the irradiation dose with which the immunizing cercariae had been attenuated. Vaccinated C57 mice develop a higher degree of protection than do CBA mice which can be further enhanced by multiple exposures to irradiated cercariae. Those mice that are vaccinated with 15-kRad irradiated cercariae are better protected against challenge infection than those vaccinated with 50-kRad irradiated cercariae. GST is recognized by the humoral and the cellular immune compartment of all groups of vaccinated mice.

Protective sera, passively transferring resistance, contain particularly high titers of IgM antibodies to GST. These antibodies bind predominantly to →[carbohydrate](#) epitopes of this antigen. GST stimulates proliferation of Th2 cells in both C57 and CBA mice, whereas proliferation of Th1 cells is restricted to vaccinated CBA mice. Antibodies specific for the integral membrane protein Sm23 are present in all vaccine sera tested. The highest levels of protection in mice multiply vaccinated with 15-kRad irradiated cercariae coincides with the highest levels of Sm23-specific antibodies. Highly protective sera contain large quantities of IgG<sub>2b</sub> antibodies binding to Sm23. In contrast, the humoral and cellular responses to recombinant TPI are restricted to once-vaccinated mice in this vaccine model. Thus, protective vaccine sera derived from mice immunized with irradiated cercariae appear not to contain TPI-specific antibodies. The digestive enzymes, Sm32 and cathepsin B, are recognized by mice vaccinated with 15-kRad, but not 50-kRad irradiated cercariae. Only worms that are able to survive to the hemoglobin-digesting stage seem to induce antibody production to these developmentally regulated antigens. The humoral and cellular recognition of Sm32 is strain-specific, i.e., limited to vaccinated CBA mice. In contrast, HSP70 is predominantly recognized by vaccinated C57 mice. Strong responses of both immune compartments coincide with the highest level of resistance in this strain. In highly protected mice, the response to HSP70 appears to shift from a mixed Th1/Th2 cell population to an exclusive Th2 cell population upon multiple vaccinations. The highest levels of anti-paramyosin antibodies correlate with the lowest degree of protection in vaccinated CBA mice. Although vaccinated C57 mice fail to produce paramyosin-specific antibodies, a distinct cellular response to paramyosin is associated with a high degree of immunity in these mice. Factors such as the irradiation dose used to attenuate the immunizing cercariae, the genetic background of the host, and the number of vaccinations have distinct effects on the recognition of individual antigens in this vaccine model.

### Conclusions

The results of extensive studies on the irradiated cercariae vaccine model demonstrate the importance of analyzing diverse aspects of the immune responses that are induced by attenuated parasites. They allow us to begin to understand the complex mechanisms that are involved in generating vaccine-induced protection against plathelminths. Conditions for immunization, such as irradiation dose, number of cercariae, route, site, and schedule of application, have been compared and optimized. Further, the migratory pattern and attrition site of immunizing and of challenge parasites have been outlined. The compartments of the host's

immune system that participate in the induction of protective immunity have been elucidated. This has initiated an analysis of where, when, and how the immune compartments interact. Subsequently, antigens were identified that stimulate humoral as well as cellular immune responses of vaccinated mice. As a result, the complex kinetics of multifaceted immune response to irradiated cercariae are being increasingly understood and may facilitate the development of a vaccine against schistosomes. It will likely consist of a cocktail of antigens in order to address the heterogeneous responsiveness to particular antigens among a majority of individuals to be protected. It may need to be administered in a way that mirrors the efficient mode of →[antigen presentation](#) by moderately irradiated cercariae.

### Planning of Control

Intestinal and urinary schistosomiasis may cause gross pathology and shorten the human host's life expectancy. Worm load is recognized as a major determinant of the severity of the disease. For a long time, the measures available for the control of schistosomiasis were water management, especially in connection with water impoundments and irrigation schemes, rather inefficient use of molluscicides, safe excreta disposal, →[health education](#), and less than satisfactory treatment. The introduction of oxamniquine has rendered infections with *S. mansoni* treatable, and that of praziquantel has radically improved the treatment of all forms of schistosomiasis. Both drugs are well tolerated and simple to use.

Molluscicides still pose problems: copper salts, though cheap, are not sufficiently effective, while niclosamide, though highly effective, is expensive and associated with strong nontarget effects on the aquatic fauna. Much can be achieved with appropriate water management and other forms of →[environmental management](#).

→[Biological methods](#) of snail control, e.g., snail pathogens and the replacement of host species by nonsusceptible snail species, are being explored but their nontarget effects need to be assessed very carefully before a wider use may be contemplated. The provision of safe water supplies is an important factor in reducing the transmission of schistosomiasis.

Currently the primary objective of schistosomiasis control is the reduction or elimination of morbidity. Appropriate operational approaches for the attainment of this objective are available. However, control programs offer a reasonable prospect of success only if they have sufficient and well-qualified man power, and organizational/managerial structures capable of ensuring correct planning, smooth implementation, and continuous evaluation of operations and results. A key

factor for success is local and national commitment to such a program, expressed in adequate financial resources to maintain it without external assistance. The strategy of schistosomiasis control consists, essentially, of 3 phases:

1. A planning period devoted to the collection and analysis of epidemiological baseline data, the determination of feasible control approaches, the preparation of a master plan of action, the allocation of resources, and training.
2. An intervention period during which intensive operations are conducted, aimed at reducing as rapidly as possible the reservoir of infection and curbing transmission. Treatment will be instrumental during this phase which is usually shorter than the first.
3. A maintenance phase during which the gains of the second phase are to be consolidated and safeguarded and, if possible, a further reduction of disease prevalence and intensity of infection are achieved. Apart from the environmental management activities, this phase will be less demanding in resources than phase 2, and most of the diagnostic and therapeutic maintenance effort will be the responsibility of the general health-care services which undertake the bulk of surveillance and monitoring.

### Targets for Intervention

Infection results from the active transdermal invasion of the free-swimming cercariae. These originate from the waterborne miracidium which emerges from the egg and develops further in a suitable aquatic snail host. Targets of intervention (Fig. 4) are the infected human host, the snail →[intermediate host](#) and the infection cycle. Suitable approaches to control consist of the detection and treatment of cases, the safe disposal of excreta, the use of safe water for drinking, washing, bathing and swimming, and snail control through environmental management.

### Therapy

→[Trematodocidal Drugs](#).

---

## Schistosomulum

As the free-swimming freshwater →[cercariae](#) of →[Schistosoma](#) penetrate the host's skin they lose their tails and become schistosomules (→[Schistosomiasis, Animals](#), →[Schistosomiasis, Man](#)).

---

## Schizocystis

→[Gregarines](#).

---

## Schizodemes

→[Amoebiasis](#).

---

## Schizogony

### Name

Greek: *schizis* = division, *gone* = generation, production.

In addition to →[sporogony](#), there is another asexual phase in the life cycle of →[Coccidia](#) giving rise to generations of schizonts (syn. →[meronts](#)) and merozoites. Some of the latter initiate →[gamogony](#) leading to →[syngamy](#). The →[zygote](#) initiates an asexual reproduction leading to the production of numerous infectious sporozoites. In →[microsporidia](#) schizomerogony also occurs.

---

## Schizont

Asexual stage in →[coccidia](#) that gives rise to motile merozoites that enter other cells. Schizonts (Greek: *schizein* = dividing) are thus also called →[meronts](#) (Greek: *meros* = portion).

---

## Schizotrypanum

Subgenus of the genus *Trypanosoma* with the type species →[T. cruzi](#). The trypomastigotes of this subgenus are always C-shaped, have a large kinetoplast, and they reproduce intracellularly via amastigotes.

## Schüffner, Wilhelm (1867–1949)

German physician (Fig. 1), known for the discovery of the peculiar clefts in *Plasmodium vivax*-infected red blood cells. In 1923 he became director of the Tropical Institute of Amsterdam.



**Schüffner, Wilhelm (1867–1949).** Figure 1 Professor Dr. Schüffner in the Bernhard Nocht institute.

## Schüffner's Dots

The coloured dots described by →Schüffner in *Plasmodium vivax* are fine caveolae (= invaginations) at the surface of the infected reticulocytes (which become filled with the stain). →Maurer's clefts, however, are enlargements of the parasitophorous vacuole inside *P. falciparum*- and *P. malariae*-infected red blood cells.

## Sclerotization

→Quinone-Tanning. This is the conversion of soft proteinaceous material to hard and resistant covers.

This process is found in specimens of many phyla of the living organisms.

## Scolex

Head of →cestodes. It is attached to the wall of the host's gut by suckers and/or hooks (→Platyhelminthes/ Figs. 15, 19A).

## Scorpions

→Amandibulata.

## Scrapie

Brain disease of sheep due to infections with →prions that introduce spongious degenerations. These prions may become transmitted orally by ingestion of contaminated brain or by ingestion of fly larvae and pupae which have eaten infected brain.

## Screw Flies

→Skin Diseases, Animals.

## Screw Fly Disease

Myiasis due to infection with →*Callitroga* (syn. *Cochliomyia*) or *Chrysomya* spp. (→Bot Flies, →Myiasis, Animals, →Myiasis, Man).

## Scrub Itch

→Mites, →Neotrombicula.

## Scrub Typhus

→Tsutsugamushi Fever.

## Scutum

Dorsal shield of sclerotized →cuticle in ixodid or “hard” →ticks. The scutum is present in all stages and occupies about one-third of the anterior dorsal surface of females, nymphs, and larvae, and the entire dorsal surface in males (→Ticks/Figs. 4–6A). In female and immature ixodid ticks, the remaining, extensible dorsal surface is called the →alloscutum.

## SEA

Soluble Egg Antigen.

## Secernentea

### Synonym

→Phasmodia.

### Classification

Class of →Nematodes.

### General Information

→Phasmids are present posterior to the anus; →hypodermis uni- to multinucleate; →cuticle with 2–4 layers; males have only a single →testis and are commonly endowed with caudal →alae (known as copulatory bursa); somatic setae or papillae absent on females; →amphids usually open to exterior through pores located dorsolaterally on lateral lips or anterior extremity; cephalic sensory organs are porelike, found on lips (16 in 2 circles with 6 inner and 10 outer ones).

## Secnidazole

→Antidiarrhoeal and Antitrichomoniasis Drugs.

## Second Endoplasmic Reticulum of Apicomplexa

This structure abbreviated as →SERA is found adjacent to the surface of penetrated →Plasmodium stages. It is involved in an alternative secretory pathway and is formed by the fusion of normal ER plus the membranes of →rhoptries and →micronemes.

## Secondary Antibody

### Synonym

Conjugate, Anti-Immunoglobulin antibodies.

### General Information

In indirect serological methods, which are common for →serodiagnosis of parasitic infections, the antigen-specific antibody is detected by use of a secondary antibody. The secondary antibody (anti-immunoglobulin antibody) is available as species, class, subclass, or domain-specific. It can be used as a general reagent for screening of all antibodies or as a selective reagent to identify one type of antibody class or molecule. Different degrees of cross-reactions occur at all levels between subclasses, classes, and species and may decrease the specificity of an assay. A reduction of cross-reactions is possible by use of cross-absorbed preparations. The conjugate provided by suppliers should be specific for the stated isotype. Labeling of the secondary antibody is mainly by enzymes (horseradish peroxidase, alkaline phosphatase), fluorochromes (fluorescein, rhodamine), or biotin. The choice of label depends on the technique used, the available detection system and the field of application.

### Characteristics

Fluorescein-labeling is unstable and does not allow a repeated reading or long-term storage of the preparations. The conjugated enzyme and its substrate are chosen for sensitivity and convenience. In general, alkaline phosphatase is simpler to use but horseradish peroxidase is probably more sensitive.

## Secondary Cyst Wall

→Tissue-Cyst.

## Secretion

The process of emitting a substance from a cell (→[Exocytosis](#)) by mechanisms similar to those for the internalization of materials (→[Endocytosis](#)). →[Platyhelminthes/Integument](#), →[Ticks/Intestine and Food Uptake](#), →[Insects/Intestine and Food Uptake](#).

## Secretory Proteins

In asexual apicomplexan motile stages (e.g., merozoites, sporozoites, →[tachyzoites](#), →[bradyzoites](#)) various apical organelles secrete proteins (→[Dense Bodies](#), →[Dense Granule Protein](#), →[Rhoptries](#), →[Micronemes](#)), which are discharged, and reach the surface of the stages (→[Apicomplexa/Host Cell Invasion](#)).

## Secretome

This system transports parasite proteins to the →[Maurer's clefts](#) (MC) – resembling Golgi-lamella – in *Plasmodium*-infected red blood cells via 2 ways:

1. Vesicles are secreted from the lumen of the parasitophorous vacuole, which join the MC.
2. Proteins are translocated across the vacuolar membrane into host cell cytosol and become associated with the cytoplasmic face of the MC.

Both processes are steered by a host-targeting signal (HT) and finally lead to transport of parasite protein into the host cell.

## Seed Ticks

Trivial name for the small larval →[ticks](#).

## SEIR Model

→[Mathematical Models of Vector-Borne Diseases](#).

## Selamectin

### Chemical Class

Macrocyclic lactone (16-membered macrocyclic lactone, avermectins).

### Mode of Action

Glutamate-gated chloride channel modulator. →[Ectoparasitocides – Antagonists and Modulators of Chloride Channels](#), →[Nematocidal Drugs](#).

## Self-Fecundation

Occurs in large →[tapeworms](#) (e.g., →[Taenia solium](#)), which are mostly single inside the host's intestine. In the anterior →[proglottids](#) the sperms become mature, while in the mid- and posterior portion of the worms the →[oocytes](#) mature.

## Self-Infection

Humans carrying, e.g., an adult →[Taenia solium](#) tapeworm may infect themselves by the worm eggs and then may develop →[neurocysticercosis](#) (→[Autoinfection](#)).

## Selfish Gene Theory

→[Acanthocephala](#).

## Self-Medication

→[Behavior](#).

## SEM

Scanning Electron Microscope.

## Semduramycin

Ionophorous polyether, →Coccidiocidal Drugs.

## Semicarbazone

→Ectoparasitocidal Drugs.

## Semihibernation

Some overwintering female →mosquitoes (→Culicidae) interrupt their rest and suck blood, but do not produce eggs.

## Sensillum

→Pentastomida.

## Septata Species

→Microsporidia.

## Sequestration

Some parasites retire from regions with active immune attacks (e.g., →Malaria parasites do it by adhesion at walls of inner blood vessels or cysticerci of →tapeworms stay in the brain).

## Sequestrin

→Knobs.

## sERA

→Second endoplasmic reticulum.

## SERA

Serine-repeated antigen of →Plasmodium merozoites.

## Sergentomyia

Genus of the mosquito family Phlebotomidae.

## Serodiagnosis

→Proteins, →Serology.

## Serology

### Synonyms

→Serodiagnosis, →antibody detection, →immunodiagnosis.

### General Information

Serology in general, which describes changes in the immunological potency of body fluids after infection with a specific pathogen under diagnostic aspects, has gained increasing importance over the last 20 years for microbiology. Serology of parasitic infections, in particular, gained much from the *in vitro* cultivation of parasites and the production of monoclonal antibodies. Both techniques together improved the knowledge of parasitologists on stage-specific antigens and antibodies and their relevance for immunodiagnosis. A variety of potential →immunoassays were developed to measure the change in kinetics and concentration of

parasite-specific antibodies. The technical developments favoured the ELISA-system, as it needs only minor quantities of reagents and it can equally be used for antigen and antibody detection. The application of highly specialized test systems showed clearly that serological values are never absolute but a function of the type of antigens presented and antibody classes detected. Whereas IFAT antibodies are predominately directed against the surface-membrane-associated parasite antigens, →ELISA antibodies are usually directed against soluble antigens of a complex mixture or already predefined soluble antigens. Traditional serology was primarily used to demonstrate a specific antibody response in symptomatic individuals. Today, epidemiological studies can provide fast knowledge on the distribution and host specificity of parasites as demonstrated for *Neospora (Hammondia)*. Standardization and quality control of test systems is now regarded as an essential requirement. There is evidence that many difficulties in antigen production and standardization may be solved with the exciting advances in molecular biology and biotechnology. Specific detection systems for the quantification of parasitic antigens in body fluids, which allow a non-invasive diagnosis at low costs, are currently favoured, and may reduce the need for indirect diagnosis. Also, the introduction of the polymerase chain reaction (PCR) as diagnostic tool has dramatically lowered the level for direct parasite detection, so far determined by microscopic examination only.

The development in serodiagnostic methods, however, which are easy and cheap to use in countries with a population at high risk in contracting parasitic infections, has been neglected.

The value of serology for clinical diagnosis depends on the interaction of the specific parasite and the host (Table 1). Parasites not only stimulate the humoral immune response as part of the immunological defence mechanisms but are also capable of evading the immune response to exposed epitopes. Some parasitic infections are associated with the production of non-specific serum antibodies (IgM in trypanosomiasis and →malaria, IgG in malaria and leishmaniasis) or the production of autoantibodies (Chagas' disease, malaria, onchocercosis). Each serological assay has advantages or disadvantages in regard to sensitivity, specificity, or →cost-effectiveness. The combination of at least 2 different test systems will increase the diagnostic reliability.

### Clinical Relevance

Conventional parasitological diagnosis relies upon the visualizing of the parasites or their products of reproduction in body fluids, excreta, or tissue. Because of their often long and complicated life cycles, parasites may be undetectable during the prepatent

period. Thereafter, they may occur intermittently, in low grade or be frequently absent from body fluids (*Trypanosoma* spp., microfilariae), from excreta (→*Ascaris*, →*Strongyloides*, *Schistosoma* spp., *Fasciola* spp., →hookworms), or hidden within/between host cells or tissue (*Leishmania* spp., *T. cruzi*, *Toxocara* spp., *Trichinella* spp.).

While serology is an important diagnostic method in many situations, in other situations it is not helpful (Table 1). A basic finding is that parasites which are either free-living throughout their whole life cycle within the gut (*Entameba dispar*, →*Lambli* *intestinalis*, *Cryptosporidium parvum*, *Cyclospora*, *Enterobius*, →*Trichuris*, *Taenia* spp.) or remain restricted to the skin (*L. tropica*, ectoparasites), epithel (*Acanthameba*), or mucosal surface (*Trichomonas* spp.), do not induce a strong humoral immune response. Antibody detection is either negative or at a low level or the seroprevalence rate exceeds the number of parasite carriers. Here, serology is not helpful for the clinical diagnosis.

The acute phase with severe clinical symptoms precedes the antibody formation after infection with *Plasmodium* spp., *Babesia* spp., *Theileria* spp., *Sarcocystis* spp., and *Trichinella* spp. Parasitaemic individuals have a delay in raising their antibody response. Here, diagnosis of acute infection relies primarily upon parasite detection and/or clinical parameters. The finding of significant antibody titers in asymptomatic, untreated individuals indicates a carrier state since parasitaemia drops below the detectable level long before antibodies disappear.

Serology is of main advantage for the diagnosis of parasitic infections which are characterized either by larval migration through host tissues (→*Toxocara* spp., *Ascaris* spp., *Strongyloides*, *Schistosoma* spp., *Fasciola* spp., filariae), by →encystation (→*Toxoplasma gondii*, →*Sarcocystis* spp., *Trichinella* spp., →*Echinococcus* spp., *Cysticercus* spp.), or inter-/intracellular residence (*Leishmania* spp., *Entameba histolytica*, *Trypanosoma cruzi*, *Neospora* spp.) in the host tissues during →chronic infection. Here, diagnosis is based on serological techniques and is virtually the only practicable way of screening for infection.

The humoral immune response to parasitic infections involves almost all antibody classes and subclasses. Most →helminth infections are chronic and have an extended subclinical phase. When clinical symptoms occur the IgG response is predominant. Screening for infection with total Ig- or IgG-conjugates (enzyme or FITC labelled) is efficient in most cases. The reactivity of the IgG4 subclass, which is elevated in chronic helminth infections, is highly specific and enables a species-specific diagnosis for many parasites by ELISA.

Detection of specific IgM antibodies is essential for an early diagnosis of toxoplasmosis and may improve the early diagnosis of →sleeping sickness and Chagas'



**Serology. Table 1** The serology of various parasites in the treatment of disease. Antibody detection is either by ELISA, IIFAT, IHAT, or other test systems. The common strategy is to choose a test system of high sensitivity for primary antibody screening. Positive test results, dependent upon the level of cross-reactivity with other parasites and the geographical origin of the patient, have to be confirmed by either more specific assays (recombinant antigens, WB) or parasite detection

Disease	Parasite	Prepatent period	Serology
<b>Amoebiasis</b>	<i>Entamoeba histolytica</i>	Days to weeks	Is of main value for detection of amoebic liver abscess with an approx. sensitivity of 100% when tested a few days after onset of disease; positive serology is also indicative of an invasion of the gut by the parasite; background reaction is possible in endemic areas; antibodies may persist after therapy
<b>Babesiosis</b>	<i>Babesia</i>	1–3 weeks	<b>Is not for acute infection!</b>
	<i>B. ovis/divergens</i>		Is useful, however, when parasitaemia is at a low level or transient and for epidemiological studies
	<i>B. microti</i>		
	<i>B. canis</i>		
<i>B. equi/caballi</i>			
<b>Chagas's disease</b>	<i>Trypanosoma cruzi</i>	2–4 weeks	Is not reliable for screening during acute infection; is of great value for screening during chronic infection and for blood transfusion screening
<b>Cysticercosis</b>	<i>Taenia solium</i>	60–70 days	Is a valuable tool for the diagnosis of neurocysticercosis in symptomatic/asymptomatic cyst carriers; a positive result has to be confirmed by a species-specific test system; negative serology occurs in approx. 30% of individuals with low cyst burden
<b>Echinococcosis</b>		Months to years	Is of great value for the differential diagnosis in cyst carriers; seropositivity may be low in patients with cystic echinococcosis (70–95%) but is normally high in patients with alveolar echinococcosis (95–100%); positive results in a genus-specific screening test are confirmed with an <i>E.-multilocularis</i> -specific ELISA; serology is of limited value in monitoring the course of disease after specific therapy or post operatively
Cystic	<i>Echinococcus granulosus</i>		
Alveolar	<i>Echinococcus multilocularis</i>		
Fascioliasis	<i>Fasciola hepatica</i>	2–4 months	Positive test results in symptomatic patients indicate infection; eggs may be undetectable or excreted in low quantities; first antibodies appear 4–8 weeks after infection and return to negative values 3–6 months after successful therapy
<b>Filariasis</b>			Is of value for a first screening for infection; specific antibodies can be expected a few weeks after infection; most test systems available have high sensitivity and low specificity; positive results in exposed/symptomatic individuals must be confirmed by parasite detection; negative serology practically excludes infection
Onchocerciasis	<i>Onchocerca volvulus</i>	12–20 months	
Lymphatic Filariasis	<i>Wuchereria bancrofti</i>	3–7 months	
	<i>Brugia malayi</i>		
	<i>B. timori</i>		
Loiasis	<i>Loa loa</i> <i>Mansonella</i> spec.	6–12 months	
<b>Leishmaniasis</b>		Days to months	Is not of practical value for diagnosis of CL as low antibody titers occur only in a proportion of patients; in ML, antibody response is more consistent; high antibody levels are common in patients with generalized infection and clinical symptoms; antibody detection may be positive in asymptomatic individuals; treatment can be monitored by detection of antibodies which decrease slowly after therapy
Visceral (VL)	<i>Leishmania infantum</i> , <i>L. donovani</i> , <i>L. chagasi</i>		
Mucosal (ML)	<i>L. braziliensis</i> complex		
Cutaneous (CL)	<i>L. tropica</i> , <i>L. major</i> , <i>L. aethiopica</i> , <i>L. mexicana</i> ,		

**Serology. Table 1** The serology of various parasites in the treatment of disease. Antibody detection is either by ELISA, IIFAT, IHAT, or other test systems. The common strategy is to choose a test system of high sensitivity for primary antibody screening. Positive test results, dependent upon the level of cross-reactivity with other parasites and the geographical origin of the patient, have to be confirmed by either more specific assays (recombinant antigens, WB) or parasite detection (Continued)

Disease	Parasite	Prepatent period	Serology
	<i>L. braziliensis</i>		
<b>Malaria</b>	<i>Plasmodium</i>	8–10 days	<b>Is not for acute infection!</b>
	<i>P. falciparum</i> , <i>P. vivax</i> , <i>P. ovale</i> , <i>P. malariae</i>		Is mainly for patients with few parasites, retrospective confirmation of infection, and epidemiological surveys; antibodies persist for approx. 6 months after eradication of the parasite; species-specific diagnosis is normally not possible
<b>Schistosomiasis</b>			Is of great value during prepatent infection and in patients with a low egg load or neurological schistosomiasis; diagnosis is normally not species-specific; the prolonged and slow decrease of specific antibodies after treatment does not allow a post-therapeutical monitoring by serology
Intestinal and/or	<i>Schistosoma</i> , <i>S. mansoni</i> , <i>S. japonicum</i> , <i>S. haematobium</i>	5–7 weeks	
Urinary	<i>S. haematobium</i>	10–12 weeks	
<b>Strongyloidiasis</b>	<i>Strongyloides stercoralis</i>	17–28 days	Most test systems show considerable cross-reaction with other nematodes; IIFAT with filarial antigen is possible but not reliable for screening
<b>Trypanosomiasis African</b>	<i>Trypanosoma brucei</i>	3–21 days	Is not reliable during early infection but antibody concentration increases with prolonged infection; serodiagnosis of <i>T. b. gambiense</i> – infection is based on the detection of variant surface proteins, serodiagnosis of <i>T. b. rhodesiense</i> – infection of the invariant surface antigens; CATT, which is widely used under field conditions is not reliable for the detection of East African sleeping sickness
West African	<i>T. b. gambiense</i>		
East African	<i>T. b. rhodesiense</i>		
<b>Toxocariasis</b>	<i>Toxocara canis</i> <i>T. cati</i>	–	Is virtually the only possibility of detecting an infection; the rate of seropositivity in a population varies depending on the test system used (2–30%)
<b>Trichinellosis</b>	<i>Trichinella spiralis</i>	5–28 days	IgM and IgG antibodies are undetectable or very low during acute infection when clinical symptoms occur; a diagnostic antibody level is reached 3–6 weeks after infection; in chronically infected individuals low level antibodies may persist for more than 20 years

disease. However, IgM persistence at low level during chronic *Toxoplasma*-infection raises many questions. After helminth infection, IgM antibodies may be constantly found.

Only few of the species-specific antibody detection systems (ELISA, WB) described in literature are available in routine practice. Cross-reaction between genus (helminths) and species (helminths, →protozoa) is therefore a common phenomenon in the laboratory practice of today. This is of major importance for individuals living in or coming from regions where cross-reacting parasites are co-endemic (*Leishmania* spp. and →*Trypanosoma cruzi*, *Babesia* spp. and →*Plasmodium*, *Echinococcus* spp. and →*Cysticercus*, filariae and other tissue →nematodes, *Schistosoma* spp.).

Serodiagnosis is currently most advanced for toxoplasmosis. There exists much knowledge on the diagnostic use of antibody classes during acute and congenital infection, standardization and quality control. Major advances were achieved in the serodiagnosis of →cestode infections. A routine serological differentiation between cystic and alveolar →echinococcosis is possible by use of recombinant antigens. Human →cysticercosis is specifically diagnosed by use of the WB. Although many propositions were published to improve the serodiagnosis in schistosomiasis by antibody detection to circulating antigens (CAA, CCA) more emphasis is put on the development of antigen detection in serum and urine of infected patients. This is also true for infection with →*Wuchereria bancrofti*. ELISAs with E/S antigens have been shown to be

specific and sensitive for antibody detection to *Toxocara* and *Trichinella*.

The IIFAT, once described as the most sensitive and specific assay for detection of infection with *Babesia* spp. in animals is now supplemented by specific and fast-to-perform ELISAs.

The serodiagnosis for tropical protozoal infections (amoebiasis, leishmaniasis, trypanosomiasis, malaria) has much profited from technical developments. User-friendly ELISAs are available for mass surveys, such as blood transfusion screening on malaria and Chagas' disease. Not only cross-reactions between *Trypanosoma cruzi*, *T. rangeli*, and *Leishmania* spp. were overcome by using recombinant antigens but an increase in sensitivity for →cutaneous leishmaniasis was also achieved, and prediction for active disease in →visceral leishmaniasis and →amoebiasis seems possible.

The interpretation of positive serological test results may be complicated by high background levels of seropositivity in areas endemic for a specific parasite. In patients with severe immunosuppression, serology is not a reliable diagnostic tool.

## Serotonin

→Amino Acids, →Nervous System of Platyhelminthes.

## SERP

Serine-rich protein.

## Sessilida

Ciliates of the genera →*Epistylis*, →*Apiosoma*, →*Ambiphrya*, which are firmly attached to the surface of skin and gills of fish, while Mobilida (e.g., →*Trichodina* sp.) may move from one place to others.

## Seta

Bristle-like protrusion at the tip of →nematodes.

## Setaria

→Nervous System Diseases, Horses.

## Severe Combined Immune Deficiency (SCID)

These artificially immunodeficient mice are models to study vaccines in →amoebiasis, →babesiosis, etc.

## Sex Chromosomes

→Sex Determination.

## Sex Determination

In protozoans direct evidence of sexual stages is limited to those species with known →gametes (e.g., →gregarines, →coccidia, →Hypermastigida), but remain scarce in other classes, although in some groups nowadays significant signs of sexuality are noted (e.g., in trypanosomes, gametes). Even in species that form gametes sex determination remains unclear because typical →sex chromosomes are not present or not seen (since →chromosomes do not become condensed). In metazoan parasites, however, there is significant genetic sex determination due to the formation and activity of sex chromosomes (heterosomes) in addition to autosomes. The most common system among animals is the XX/XY pattern. Except for a few groups (e.g., Sauropsida) in most animals the 2 X →chromosomes were found in females (leading to homogametism), while in the male sex the XY situation occurs producing X or Y gametes (heterogametism). Therefore, it is not surprising that in most parasites this XX/XY system occurs predominantly. However, in some parasitic genera (as well as in other animals) the Y chromosome is lacking (apparently lost during evolution). Then the males have one chromosome less than females and are thus characterized by a XO situation. This is for example the case in some →nematodes (*Trichiuris trichiura*, →*Strongyloides papillosus*), while closely related species (*S. ratti*, *T. ovis*)

belong to the XY type. In →ticks the events are even more complicated than in other groups. There is the XX/XO system (most Meta- and →Prostriata, except e.g., *Ixodes holocyclus*) as well as the XX/XY arrangement (all argasid ticks) and the occurrence of multiple sex chromosomes with apparently 2 different X chromosomes (e.g., →*Amblyomma* spp.). A similar occurrence of multiple sex chromosomes is described in →*Ascaris lumbricoides* and *A. suum*, where females possess  $2 \times 19$  autosomes plus 2 sets of  $X_1, X_2, X_3, X_4, X_5$ , ( $= 2n = 48$  chromosomes); while males have only one set of those  $X_1-X_5$  chromosomes ( $= 2n = 43$  chromosomes). In general X and Y chromosomes are different in shape and organization. However, in schistosomes the sex chromosomes of males and females are relatively similar. Thus they were described as ZZ in males and ZW in females. While Z is the largest chromosome of the 16 in →*Schistosoma* spp., W belongs to the smallest ones in this genus. With respect to the formation of the gametes female schistosomes belong to the group of heterogametic animals.

## Sex Ratio Distortion

→Behavior.

## Sex Steroid Hormones

### General Information

In addition to sex-specific effects, sex steroid hormones also influence a variety of other functions like metabolism and immune response. It is therefore not astonishing that these hormones are also involved in parasite–host interactions and there is abundant evidence for gender-specific parasitic infection rates. But so far it is difficult to elucidate the underlying mechanisms for these interactions because of opposite effects in nearly related species (Table 1). Immunomodulatory effects alone are certainly not sufficient to explain all effects of the host's sex steroid hormones on parasites since e.g., growth and →fecundity are also affected. Whereas the effects of host hormones on parasites have often been investigated there is much less information available on the influence of the parasite on the host's sex steroid hormones.

The structure of some steroid hormones are shown in Fig. 1. Lipophilic C18, C19, and C21 steroid hormones are synthesized *de novo* predominantly from cholesterol or cholesteryl ester and to a lesser extent from

→acetyl-CoA mainly in the gonads, but also in the cortex of the adrenal organ, and in the brain. The molecular weights of common steroid hormones are 277 (17β-estradiol), 288 (→testosterone), 314 (progesterone), and 330 (dehydroepiandrosterone).

### Physiological Function

During pregnancy there are pronounced changes in sex steroid hormone levels influencing immunity. Usually susceptibility to many infections including those by protozoan and helminthic parasites is increased as compared to non-pregnant females. For example, there is a higher infection rate with →malaria parasites in pregnant females. Parasitaemia increases from the first to the second trimester. Primigravid females and their fetuses are at highest risk from malaria infection. Multigravid mothers show lower degrees of parasitaemia.

### Pathology

One well-documented example of manipulation of the host's sex steroid hormone concentrations by a parasite is the effect of →*Taenia crassiceps* on male mice. Infection with cysticerci reduces testosterone levels in the male to only 10% of the control and simultaneously increases estradiol concentrations to 200 times their normal values. Infected female mice also show an

**Sex Steroid Hormones. Table 1** Sex differences in reaction to parasitic infections

Taxon	Higher susceptibility in hosts	
	Males	Females
<b>Protozoa</b>		
<i>Giardia lamblia</i>	+	
<i>Leishmania donovani</i>		+
<i>Leishmania major</i>	+	
<i>Leishmania tropica</i>		+
<i>Plasmodium chabaudi</i>	+	
<i>Toxoplasma gondii</i>		+
<i>Trichomonas vaginalis</i>		+
<i>Trypanosoma brucei</i>	+	
<i>Trypanosoma cruzi</i>	+	
<b>Cestoda</b>		
<i>Taenia crassiceps</i>		+
<b>Trematoda</b>		
<i>Schistosoma mansoni</i> in mice		+
<i>Schistosoma mansoni</i> in men	+	
<b>Nematoda</b>		
<i>Heterakis spumosa</i>	+	
<i>Nippostrongylus</i> sp.	+	
<i>N. brasiliensis</i>	+	
<i>Strongyloides ratti</i>	+	

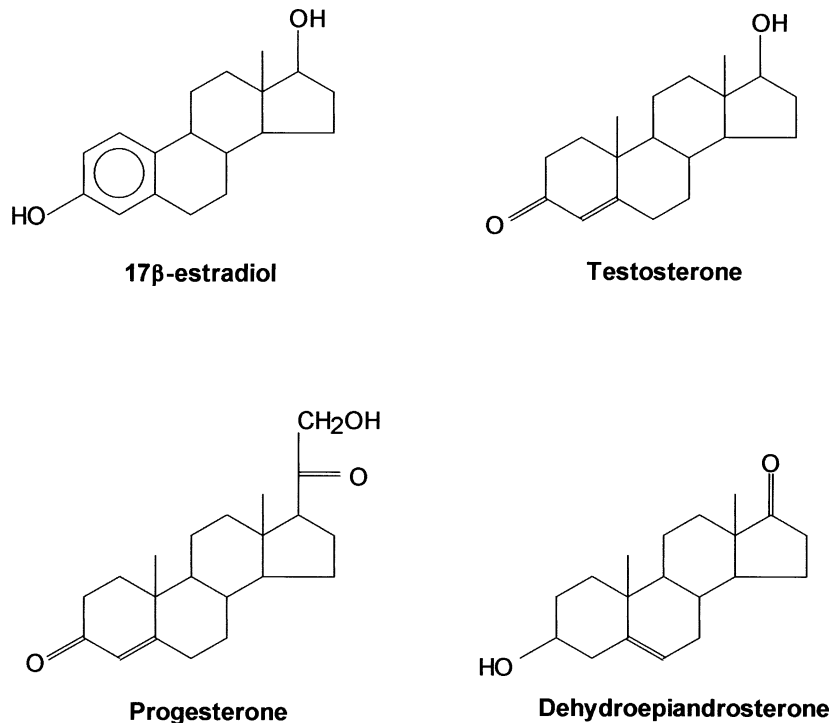

**Sex Steroid Hormones. Figure 1** Sex steroid hormones: Representative examples of female (17β-estradiol and progesterone) and male (testosterone and dehydroepiandrosterone) steroid →hormones.

increase in estrogen blood levels and in uterus weight. This →feminization by the parasite leads to a complete loss of sexual response of male mice towards females after 13 weeks of infection.

### Implications

Dehydroepiandrosterone (DHEA) or its sulfate are potent agents protecting mice, rats, and Syrian golden hamsters from infection with the coccidian parasite →*Cryptosporidium parvum*, which leads to severe diarrhoeal diseases in animals and humans. Since it also protects mice from lethal infections with viruses and bacteria, there must be a general upregulation of the immune system by exogenous DHEA. In addition to this more general application of DHEA, there is also a specific one in *Schistosoma mansoni*-infected mice. In this case female mice are more susceptible to the infection than males. If during early infection DHEA is given, there is a partial protection against infection.

## Sexual Dimorphism

Males and females of a species being morphologically clearly distinguishable.

## Sexual Reversal

→Behavior.

## Sexual Transmitted Diseases (STD)

STD includes besides viral and bacterial also parasitological infections, e.g., →trichomoniasis.

## Sheath

A cover that surrounds either microfilariae of filarial →nematodes (representing the stretched →eggshell) (→Filariidae, →Microfilariae) or that is found around the larvae 3 of →hookworms (consisting of the →cuticle of the preceding larval stage).

## Siberian Tick Typhus

→ Tick Typhus.

## Sickle Cell Anaemia

Blood disease that is fatal in humans being homozygous carriers of the defect gene. On the other hand individuals being heterozygous for the gene responsible for sickle cell haemoglobin (HbS), in which a substitution of valine for glutamic acid occurs in the beta-chain of the molecule, are strongly (90%) protected against severe → *Malaria tropica* (due to → *Plasmodium falciparum*). This effect is based on the fact that *P. falciparum* may not develop into mature schizonts after having entered the red blood cell due to the low oxygen tension and leakage of potassium from host cells during sequestration in capillaries, thus considerably reducing the pathologic effects, e.g., in the brain.

## Siebold, Philipp Franz von (1796–1866)

German physician and early specialist of tropical diseases. In the service of the Netherlands, he introduced European medicine in Japan.

## Signet-Ring Stage

Due to a large food vacuole and the peripherally situated nucleus young spherical → trophozoites (merozoites) of → *Plasmodium* spp. inside of red blood cells look like a signet ring.

## Siloius

Genus of tabanid flies.

## Simondsia

Genus of a nematode family in pigs. Intermediate hosts are beetles and cockroaches.

## Simuliidae

From Latin: *simulare* = to make similar. → Blackflies, → Diptera.

## Simuliidosis

Disease due to bites of simuliids, see Table 1.

## Simulium

### Name

Latin: *simulare* = betraying, cheating.

### Classification

Genus of the dipteran mosquito family Simuliidae.

### Life Cycle

The species of the genus *Simulium* contain rather small (2–6 mm) specimens, which look dark and thus are called “blackflies” (Fig. 1). Since their thorax segments are dorsally protruded, they also got the name “buffalo flies.” There are nearly 1,800 species described in 19 genera, 4 of which have zoonotic importance (*Simulium*, *Prosimulium*, *Austrosimulium*, *Cnephia*). *Simulium*, *Odagmia*, *Boophthora*, and *Wilhelmia* have importance for humans, too. The stages of the life cycle, which occurs in quickly running rivers, is shown in Fig. 2 (page 1309). Only the females suck blood and thus may transmit pathogens (e.g., → *Onchocerca*). The females live for 3 months, while eggs and larvae overwinter (in Europe). The symptoms of simuliotoxicosis (due to injection of saliva during bites) are necrosis, oedema, severe itching until death. The adult simuliids may fly up to 10 km per day, but mostly do not enter stables. They bite at daylight and are feared by cattle,

**Simuliidosis. Table 1** Simuliids and control measurements

Parasite	Host	Vector for	Symptoms	Country	Therapy		
					Products	Application	Compounds
<i>Simulium</i> spp. (blackflies)	All animals, <b>Man</b>	<i>Onchocerca volvulus</i> (human filariasis)	Edema, allergic reactions (simulio-toxicosis)	Worldwide	1% Vapona insecticide (Durvet)	Spray	Diclorvos
<i>Simulium reptans</i>	Ruminants, Horse, Pig		Edema, allergic reactions (simulio-toxicosis)	Central-Northern Germany, Austria, foothills of the Alps			
<i>Odagmia ornata</i>	Ruminants, Horse, Pig	<i>Onchocerca gutturosa</i>		Worldwide			
<i>Wilhelmia equina</i>	Ruminants, Horse, Pig			Switzerland, Germany			
<i>Boophthora erythrocephala</i>	Ruminants, Horse, Pig			Germany, Switzerland, Poland, Czechoslovakia, Italy, France			

**Simulium. Figure 1** LM of an adult stage.

if the bloodsuckers attack en masse (Fig. 3, page 1309).  
 →Diptera, →Insects/Fig. 9D, →Filaridae, →Leucocytozoon simondi.

## Simulium damnosum

→Blackflies, →Insects/Fig. 9D.

## Siphonaptera

### Name

Greek: *siphon* = tube, *a* = non, *pteron* = wing.

### Synonym

→Fleas, →Aphaniptera.

## Siphonapteridosis

Disease due to →flea bites, Table 1 (page 1310–1313).

## SIV

Simian Immunodeficiency Virus, →HIV.

## Skin Diseases, Animals

### General Information

Parasitic diseases of the skin are of major economic importance. Discomfort and pruritis interfere with the

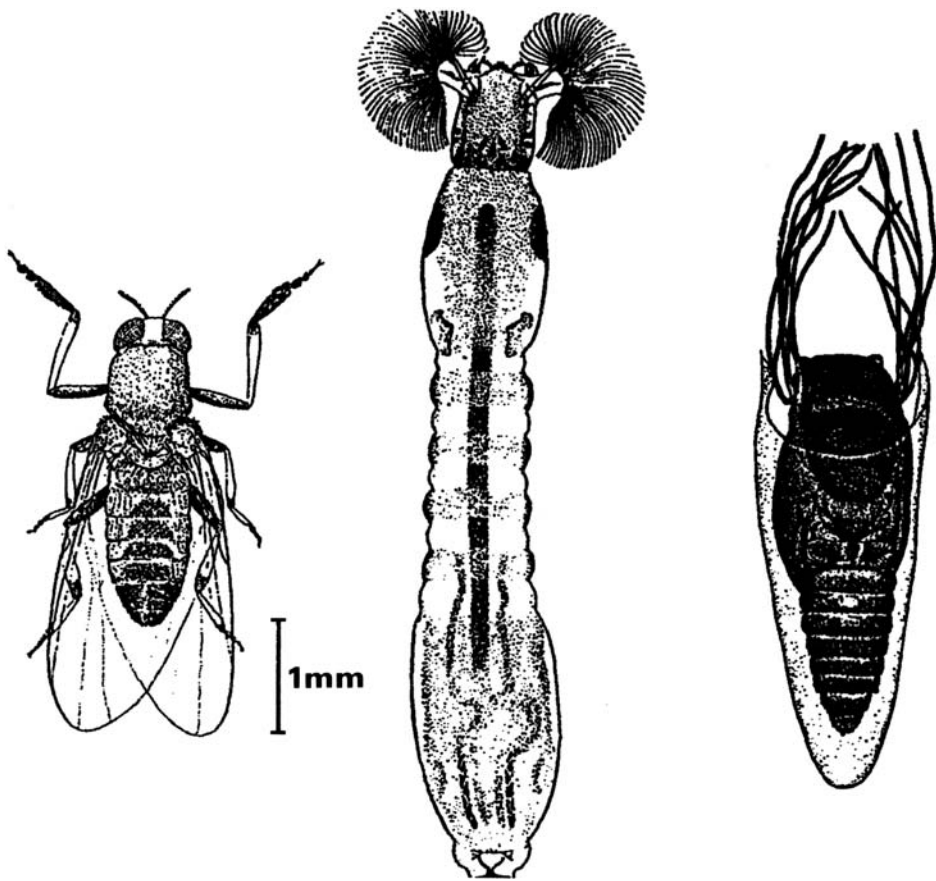

**Simulium.** Figure 2 DR of stages (adult, larva, pupa, from left) in the life cycle of simuliids.

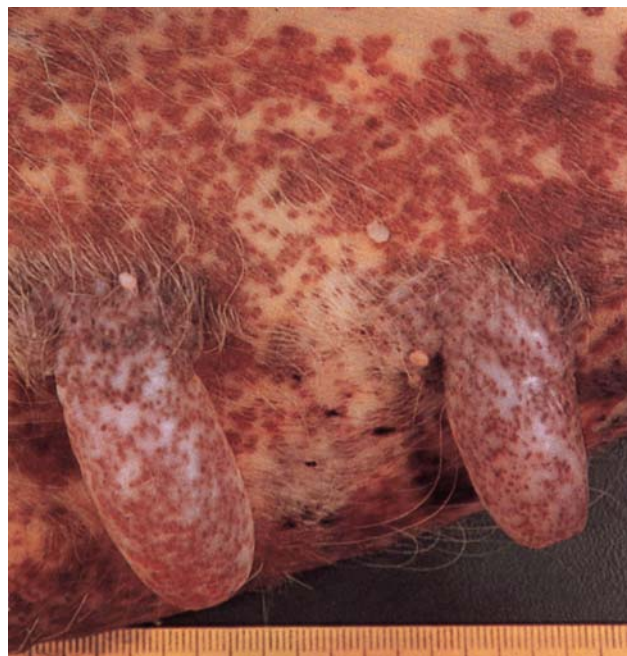

**Simulium.** Figure 3 Udder of a cow with hemorrhages many bites of simuliids.



Siphonapteridosis. Table 1 Fleas and control measurements

Parasite	Host	Vector for	Symptoms	Country	Therapy		
					Products	Application	Compounds
<i>Ctenocephalides canis</i> (Dog flea)	Dog, Cat (fleas in general not very host-specific)	<i>Dipylidium caninum</i> , <i>Dipetalonema reconditum</i> , Bartonellosis (Cat scratch fever)	Blood loss, local skin reaction, strong itching, flea allergic dermatitis	Worldwide	Advantage (Bayer)	Spot on collar	Imidacloprid
					Performer Flea and Tick Collar (Performer)		Naled
					Adams Flea and Tick Dip (Pfizer)	Dip	Chlorpyrifos
					Duocide Flea and Tick Collar (Allerderm/Virbac)	Collar	Chlorpyrifos
					Cyfflee (Boehringer Ingelheim)	Oral	Cythioate
					Escort (Schering-Plough)	Collar	Diazinon
					Tiguvon (Bayer)	Spot on Shampoo	Fenthion
					Mycodex Pet Shampoo, Carbaryl (Pfizer)		Carbaryl
					Cap Star (Novartis)	Oral	Nitenpyram
					Frontline Top Spot (Merial)	Spot on	Fipronil
					Kiltix (Bayer)	Collar	Flumethrin + Propoxur
					Zodiac Duo-OpTM (Exil)	Spray	Pyrethrin + Piperonylbutoxid + N-octyl bicycloheptene dicarboximide + S-Methoprene
					DefendJust-For-Dogs Insecticide (Schering Plough)	Spray	Pyrethrin + Permethrin + Piperonylbutoxid + N-octyl bicycloheptene dicarboximide
Exspot (Schering Plough)	Spot on	Permethrin					

<i>Ctenocephalides felis</i> (Cat flea)	Dog, Cat (fleas general not very host-specific)	<i>Dipylidium caninum</i> , <i>Dipetalonema reconditum</i> , Bartonellosis (Cat scratch fever)	Blood loss, local skin reaction, strong itching, flea allergic dermatitis	Worldwide	<p>Program Tablets (Novartis)</p> <p>Ovitrol Flea Egg-Control Collar (Vet Kem)</p> <p>Prac-tic (Novartis)</p> <p>Advantix (Bayer)</p> <p>Promeris (Fort Dodge)</p> <p>Advocate/Advantage Multi (Bayer)</p> <p>Mycodex Fast Act IGR Flea and Tick Spray (Pfizer)</p> <p>Vapona (Pfizer)</p> <p>Bolfo</p> <p>Flohenschutzband (Bayer)</p> <p>Faszin (Albrecht)</p> <p>Fleegard (Bayer)</p> <p>Advantage (Bayer)</p> <p>Revolution (Pfizer)</p> <p>Stronghold (Pfizer)</p> <p>Performer Flea and Tick Collar (Performer)</p> <p>Adams Flea and Tick Dip (Pfizer)</p> <p>Duocide Flea and Tick Collar (Allerderm/Virbac)</p> <p>Cyflee (Boehringer Ingelheim)</p> <p>Escort (Schering-Plough)</p>	<p>Oral</p> <p>Collar</p> <p>Spot on</p> <p>Spot on</p> <p>Spot on</p> <p>Spot on</p> <p>Spray</p> <p>Collar</p> <p>Collar</p> <p>Collar</p> <p>Spot on</p> <p>Spot on</p> <p>Spot on</p> <p>Spot on</p> <p>Collar</p> <p>Dip</p> <p>Collar</p> <p>Oral</p> <p>Collar</p>	<p>Lufenuron</p> <p>Methoprene</p> <p>Pyriprole</p> <p>Imidacloprid + Permethrin</p> <p>Metaflumizone</p> <p>Imidacloprid + Moxidectin</p> <p>Pyriproxyfen (+Pyrethrins)</p> <p>Diclorvos (DDVP)</p> <p>Propoxur</p> <p>Diazinon (Dimpylate)</p> <p>Pyriproxyfen</p> <p>Imidacloprid</p> <p>Selamectin</p> <p>Selamectin</p> <p>Naled</p> <p>Chlorpyrifos</p> <p>Chlorpyrifos</p> <p>Cythoate</p> <p>Diazinon</p>
---	---	--	---	-----------	---	---	---

**Siphonapteridosis. Table 1** Fleas and control measurements (Continued)

Parasite	Host	Vector for	Symptoms	Country	Therapy		
					Products	Application	Compounds
					Tiguvon (Bayer)	Spot on	Fenthion
					Mycodex Pet Shampoo, Carbaryl (Pfizer)	Shampoo	Carbaryl
					Cap Star (Novartis)	Oral	Nitenpyram
					Frontline Top Spot (Merial)	Spot on	Fipronil
					Kiltix (Bayer)	Collar	Flumethrin + Propoxur
					Zodiac Duo-Op™ (Exil)	Spray	Pyrethrin + Piperonylbutoxid + N-octyl bicycloheptene dicarboximide + S-Methoprene
					Prac-tic (Novartis)	Spot on	Pyriprole
					Advantix (Bayer)	Spot on	Imidacloprid + Permethrin
					Promeris (Fort Dodge)	Spot on	Metaflumizone
					Advocate/Advantage Multi (Bayer)	Spot on	Imidacloprid + Moxidectin
					Defend Just-For-Dogs Insecticide (Schering Plough)	Spray	Pyrethrin + Permethrin + Piperonylbutoxid + N-octyl bicycloheptene dicarboximide
					Exspot (Schering Plough)	Spot on	Permethrin



normal rest and feeding of the animal, and the loss of protective function of the skin facilitates bacterial infection. In addition, the commercial value of the hides is often reduced. Some ectoparasites, such as bloodsucking flies and some species of →ticks are of great economic importance because of the diseases they transmit. However, the skin lesions produced by these parasites are of relatively minor significance. Finally, parasitic infections of the skin and the sometimes ugly lesions they cause affect the general appearance of the animal, and upset the owner. It is intended to deal only with those parasites which are of importance owing to the damage they cause to the skin (Table 1). Most of these are arthropods. However, some →protozoa and helminths may occasionally be responsible for localized skin lesions and these will be referred to briefly.

### Protozoa

Cutaneous lesions occur in several systemic protozoal infections, including →besnoitiosis in cattle and horses, →dourine (*Trypanosoma equiperdum*) in horses and leishmaniasis in the dog.

Cattle – and rarely horses – serve as intermediate hosts of →*Besnoitia besnoiti*. In cattle, the parasite mainly infects cells of the connective tissue and produces characteristic cysts with a very thick wall. Clinical besnoitiosis in cattle is characterized by 2 sequential stages: an acute febrile stage and a chronic seborrheic stage. Persistent high fever is the first clinical sign. During the febrile stage cattle may develop a photophobia, anasarca, →diarrhoea, and swelling of the lymph nodes. This is followed by a progressive thickening and wrinkling of the skin and the development of a marked →alopecia. During the seborrheic stages denuded parts are covered by a thick scurfy layer. In chronic cases the skin remains alopecic, lichenified, and scaly. The cysts may be visible macroscopically in the scleral conjunctiva or nasal mucosa as small, round, white foci. Death may occur in severe cases.

→*Trypanosoma equiperdum* causes typical oedematous swelling of the external genitalia and ventral abdomen in horses. Raised urticarial plaques, 4–5 cm in diameter, called silver dollar plaques, may also appear, especially on the flanks.

The cutaneous lesions of leishmaniasis commonly observed in dogs include a dry exfoliative dermatitis, ulcerations, a periorbital alopecia, diffuse alopecia, and onychogryphosis.

### Helminths

The skin is the natural site of entry for a number of parasites that have their final habitat in the gastrointestinal tract or elsewhere, e.g., the →nematodes

→*Strongyloides*, →*Ancylostoma*, →*Bunostomum*, and *Gnathostoma*, and the trematode →*Schistosoma*. The passage of these parasites rarely causes cutaneous lesions in animals, except for *Ancylostoma*. Hookworm dermatitis begins with the appearance of red papules on those parts of the body which are often in contact with the ground; later these areas become uniformly erythematous, and then thickened and alopecic. Pruritis is mild but evident, especially during initial larval penetration. Repeated hookworm penetration of the foot in dogs may result in secondary bacterial invasion producing gross enlargement of the feet and paronychia. As a result of the paronychia the claws may become deformed.

The →helminth infestations that remain more or less localized to the dermis are the filariid parasites most commonly seen in cattle, sheep and horses (→*Onchocercosis, Animals*, →*Stephanofilariosis*, →*Elaeophoriosis*, *Elaeophorosis*, →*Parafilariosis*, *Parafilariosis*, →*Habronemiasis*, *Habronemosis*). Some filariid worms have been reported to occasionally cause cutaneous lesions, e.g., *Dirofilaria* (→*Dirofilariosis, Man*), →*Brugia*, →*Dipetalonema*.

### Arthropods

#### Mite Infestation

Several →mites infest animals and cause significant dermatological diseases. The lesions are the result of mechanical damage to the skin and probably also of →hypersensitivity reactions to toxic secretions (→*Acariosis, Animals*).

#### Tick Infestation

Ticks, like the other mites, are important arachnid parasites of both large and small animals. They play a major role as vectors of a large number of diseases. Ticks also harm their hosts more directly by causing local injury at the site of attachment. Ticks suck blood and heavy infestations may cause →anaemia. Sites of tick bites attract flies and may become the site of development of →myiasis.

#### Lice Infestation

Several species of →lice infest large and small animals. Domestic animals may suffer from infestations with both biting (→*Mallophaga*) and sucking (→*Anoplura*) lice. Lice are extremely host-specific. Infection is a seasonal problem and the signs associated with pediculosis are extremely variable. Most lesions result from skin irritation and →pruritus. They include alopecia alone, papulocrustous dermatitis, and damage to wool or hide caused by rubbing or biting. Sucking lice may induce anaemia. Constant irritation during lice infestations causes a loss of weight and a decrease in milk production.

Skin Diseases, Animals. Table 1 Parasites affecting the skin and subcutaneous tissue. (according to Vercruyse and De Bont)

Parasite	Clinical aspects													Localization					
	1	2	3	4	5	6	7	8	9	10	11	12	13	1	2	3	4	5	
<b>CATTLE</b>																			
<b>Protozoa</b>																			
<i>Besnoitia besnoiti</i>			+			+				+		+	+	+					
<b>Helminths</b>																			
L <sub>3</sub> - <i>Bunostomum</i> and <i>Strongyloides</i> , <i>Schistosoma</i> spp.	+				+												+	+	
<i>Onchocerca</i> spp.			+																+
<i>Parafilaria bovicola</i>			+					+					+						+
<i>Stephanofilaria</i> spp.	(+)	+	+					+	+		+		+				+	+	
<b>Arthropoda</b>																			
<b>Mites</b>																			
<i>Chorioptes bovis</i>	+			+					+		+						+	+	+
<i>Demodex bovis</i>			+			+								(+)	+				
<i>Psoroptes bovis</i>	+	+		+				+	+	+		+	+	(+)			+	+	
<i>Sarcoptes scabiei</i>	+	+						+	+	+	+	+	+	(+)	+				
<b>Lice</b>																			
<i>Damalinea bovis</i> , <i>Haematopinus eurysternus</i> , <i>Linognathus vituli</i>	+					+			+			+		+	+				+
<b>Diptera</b>																			
<i>Hypoderma bovis</i> , <i>H. lineatum</i>			+						+									+	+
<i>Chrysomya bezziana</i> , <i>Callitroga hominivorax</i>	+							+	+					+	+				+
<b>SHEEP and GOATS</b>																			
<b>Helminths</b>																			
L <sub>3</sub> - <i>Strongyloides</i> , <i>Bunostomum</i> , <i>Gaigeria pachicelis</i>	+				+												+	+	
<i>Elaeophora schneideri</i>	+				+			+	+	+	+			+		+	+		
<b>Arthropods</b>																			
<i>Chorioptes ovis</i>	+							+									+		
<i>Psoroptes ovis</i>	+	+	+					+	+		+		+					+	
<i>Psoroptes cuniculi</i> (G)	+							+											
<i>Psorergates ovis</i>	+							+	+				+					+	
<i>Sarcoptes scabiei</i>	+	+															+		
<i>Demodex ovis</i>			+					+									+	+	
<i>Damalinea</i> spp., <i>Linognathus ovillus</i>	+														+				
<i>Melophagus ovinus</i>	+													+	+				
<i>Blowfly strike</i> ( <i>Lucilia</i> spp., <i>Calliphora</i> spp., <i>Phormia</i> spp.)	+							+	+	+				+		+	+	+	
<b>HORSE</b>																			
<b>Helminths</b>																			
<i>Habronema</i> spp.	+							+	+								+	+	
<i>Onchocerca</i> spp.	+				+	+	+				+	+					+	+	+
<i>Parafilaria multipapillosa</i>			+					+											
<b>Arthropods</b>																			
<i>Chorioptes equi</i>	+							+	+			+					+		
<i>Psoroptes equi</i>	+	+			+			+	+		+	+	+						+
<i>Sarcoptes scabiei</i>	+	+						+	+	+	+	+	+	+	+				
<i>Werneckiella equi</i> ,	+							+	+	+		+		(+)					+
<i>Haematopinus asini</i>	+																		
<i>Culicoides</i> spp.	+					+	+	+		+	+	+				+	+	+	
<b>PIG</b>																			
<b>Arthropods</b>																			
<i>Demodex phylloides</i>																	+	+	

**Skin Diseases, Animals. Table 1** Parasites affecting the skin and subcutaneous tissue. (according to Vercruyse and De Bont) (Continued)

Parasite	Clinical aspects													Localization				
	1	2	3	4	5	6	7	8	9	10	11	12	13	1	2	3	4	5
<i>Sarcoptes scabiei</i>	+	+				+	+		+				+	+	+			+
<i>Haematopinus suis</i>	+						+							+				
<b>CARNIVORES</b>																		
<b>Protozoa</b>																		
<i>Leishmania</i> spp.	+					+	+					+	+	+				
<b>Helminths</b>																		
<i>Dirofilaria immitis</i>	+	+						+					+		+	+	+	
L <sub>3</sub> - <i>Ancylostoma</i> spp.	+	+			+									+		+	+	
<b>Arthropods</b>																		
<i>Demodex canis</i>	+					+				+	+	+	+	+	+			
<i>Notoedres cati</i>		+					+							+			+	
<i>Sarcoptes scabiei</i>	+	+					+	+							+			
<i>Otodectes cynotis</i>	+						+								+			
<i>Cheyletiella yasguri/blakei</i>	+	+		+		+	+					+					+	+
<i>Trichodectes canis</i> , <i>Felicola subrostratus</i>	+					+								+				
<i>Ctenocephalides canis</i> , <i>C. felis</i>	+	+			+								+	+				
Blow- and flesh flies, <i>Cordylobia</i>	+	+						+						+				

**Clinical aspects:** 1, Pruritus; 2, Papule; 3, Nodule; 4, Vesicle; 5, Erythema; 6, Scale; 7, Crust; 8, Ulcer; 9, Excoriation; 10, Lechification; 11, Abnormal pigmentation; 12, Alopecia; 13, Systemic signs;

**Localization:** 1, Generalized/not specific; 2, Head, neck; 3, Limbs; 4, Thorax, ventral abdomen; 5, Back, hindquarters

### Flea Infestation

→Fleas are the most common ectoparasites of dogs and cats. The clinical manifestations are highly variable. Some animals remain asymptomatic carriers, others develop a flea-bite dermatitis which is a reaction to irritant substances in the flea's saliva. The infection may also cause a mild papulocrustous dermatitis with a mild pruritus. An acute flea-bite allergic dermatitis may develop in dogs, causing intense pruritus and erythema. Secondary lesions which result from self-excoriation include breaking of hair and local alopecia, and occasional areas of acute dermatitis. Fleas may also induce anaemia in heavily infested animals (see Table 1).

### Flying and Biting Insect (Diptera) Infestation

Flying and biting insects are ubiquitous pests for domestic animals. Not only do they cause a loss of productivity by continuously annoying the animals, they may also cause diseases. Direct or indirect pathological effects of these flies include the deposition of larvae on or into the skin (myiasis), the local irritation (→Dermatitis), the injection of antigens inducing hypersensitivity reactions, the blood-feeding activities leading to anaemia; and the inoculation of pathogenic organisms.

The most important flies are those species whose larvae are highly destructive, facultative or obligate parasites. Infestation with such larvae is called myiasis. Warbles, caused by →*Hypoderma bovis* and →*H. lineatus* occur chiefly in cattle. They form on the back of the animal multiple →nodules with breathing pores which may be painful upon palpation. Affected animals may manifest signs referable to the migration path of the individual grub prior to the development of nodules. Economic losses are due to gadding, milk and meat loss, and depreciation of the carcass and hide. Destruction of →*Hypoderma* larvae in the infected host may cause severe clinical reactions, which are sometimes fatal. These toxic manifestations appear in the form of local and systemic effects which include, in the instance of *H. bovis*, inflammatory lesions in the spinal canal accompanied by stiffens, and ataxia, paraplegia, and collapse. *H. lineatum* larvae cause inflammation in the oesophageal wall, dysphagia, drooling of saliva, and bloating. Shocklike cardiorespiratory signs may accompany any of these conditions. The exact nature of these adverse signs is not known but it seems possible that, in the living host, adverse reactions to dying larvae may comprise both direct (toxemic) and indirect (→Anaphylactic Shock) components.

Myiasis caused by screwworms has been a cause of great financial loss in the livestock industry. There are 2 important species of “screw-flies”: → *Callitroga* (*Cochliomyia*) *hominivorax* and → *Chrysomya bezziana*. These flies are obligatory parasites which may infect all domestic animals, and which only lay eggs on fresh wounds. The infection causes intermittent irritation and pyrexia. A cavernous lesion is formed, characterized by progressive liquefactive → necrosis and haemorrhage that oozes a foul-smelling liquid. A gross fibrous involution follows the larval exodus. Significant haematological and biochemical changes include an initial neutrophilia, anaemia, and decreased total serum protein with a progressive rise in serum globulins. A significant loss in body weight occurs in infested animals.

Cutaneous infestation by blowfly maggots causes heavy mortality in sheep and significant losses in wool production in many countries. A large number of species belonging to the genera *Lucilia*, *Calliphora*, *Phormia*, and *Chrysomya* are capable of causing the disease. Moisture and warmth are essential for the hatching of eggs and the development of the larvae. The breech is by far the most common site involved because of soiling and excoriation by the soft faeces and the urine of the animal. The affected sheep are restless, do not feed, tend to bite or lick at the “struck” area. Examination shows a patch of discoloured, greyish-brown, moist wool with an evil odour. In very early cases the maggots may be found in the wool attached to the skin, while in the latter stages the maggots burrow into the tissues causing an inflamed wound which produces a foul-smelling liquid. There may be fever, and death may follow.

The larvae of the Tumbu-fly *Cordylobia anthropophaga* penetrate the skin of dogs, cats, and humans in sub-Saharan Africa and produce painful boil-like swellings.

The housefly (*Musca domestica*), → stable fly (*Stomoxys calcitrans*), face fly (*M. autumnalis*) and the → hornfly (*Haematobia irritans*) are responsible for considerable annoyance of animals. Wheals, crusts, and cutaneous papules and nodules have mainly been associated with the biting flies → *Stomoxys* and *Haematobia* and several tabanid species.

Mosquitos (family Culicidae) considerably annoy man and animals if present in large numbers. Individuals may respond more or less sensitive to mosquito bites by local swelling at the site of mosquito bite. Certain species of mosquitos are important vectors of pathogens (e.g., heartworm, blue tongue disease, malaria).

→ *Culicoides* spp. are small midges which inflict extremely painful bites. In horses they are associated with → hypersensitivity reactions leading to a pruritic dermatitis (referred to as sweet → itch or summer dermatitis). Pruritus is most intense along the base of

the mane and tail and on the withers. However, the condition can also involve other parts of the body. Lesions consist of self-inflicting hair loss, excoriations with crusting and scaling, and – after a period of incessant rubbing – striking hyperkeratosis and thickening of the skin.

The saliva of blackflies (family Simuliidae) contains a toxin (simuliotoxin) that induces anaphylactic-responses when injected into the site of biting. The response can be localized or develop into a generalized acute anaphylactic shock syndrome with rapid death. Oedematous swelling of the throat may lead to suffocation. Due to their breeding habits blackflies usually occur in the vicinity of oxygen-rich bodies of flowing water and occur in large numbers mainly in spring.

### Treatment

→ Arthropodicidal Drugs, → Ectoparasitocidal Drugs.

---

## Skin-Snips

Method of diagnosis in onchocercosis (→ Filariidae).

---

## Skrjabinagia

Genus of nematodes introducing an ostertagiosis in cattle. → Alimentary System Diseases, Ruminants.

---

## Skrjabinema

Genus of the nematode family Oxyurida. For example *S. ovis* is found worldwide in the colon of goats and sheep (male 4 mm, female 8 mm).

### Prepatent Period

30–45 days. The 60 × 30 μm-sized eggs already contain the infectious larva 3.

### Symptoms of Disease

Itching along the anal groove.

### Therapy

→ Nematocidal Drugs.



## Sleeping Sickness

### Synonym

→African Trypanosomiasis.

### Pathology

The African →trypanosomes are parasites of humans and domestic animals causing the disease African trypanosomiasis Trypanosomiasis, Animals, →Trypanosomiasis, Man) or sleeping sickness. *T. brucei gambiense* infection occurs in Central and West Africa and is slowly progressive, and generalized. Initially the trypanosomes are present extracellularly in the subcutaneous tissue at the site of the bite of the →tsetse fly and give rise to a papular and later ulcerating lesion, often called a →chancre, which persists for about 2 weeks. In the second stage trypanosomes enter the bloodstream and multiply there. In the third stage there is fever and lymphoid →hyperplasia leading to enlargement of the spleen and especially of the cervical lymph nodes, which contain trypanosomes useful for diagnosis by puncture and smear. The fourth stage is central nervous invasion associated with intermittent fever. Trypanosomes in the neuropil and the cerebrospinal fluid produce diffuse →meningoencephalitis with lymphocytes, plasma cells, and histiocytes infiltrating mainly the gray matter, the Virchow-Robin perivascular spaces, and the vessel walls. Notable are the plasma cells with multiple eosinophilic proteinaceous globules, or morula cells, found in the meninges. Trypanosomes are not easily found but can be cultured from the spinal fluid. Neuronal loss and demyelination are not prominent, but the cortical microglial and astrocytic gliosis is impressive, especially in the superficial cortex. This →inflammatory reaction extends to the spinal ganglia and cranial and spinal nerve roots. These central nervous system lesions are accompanied by headache, apathy, wasting of musculature, emaciation, tremors, inability to walk, and eventually to somnolence, paralysis, coma, and death, usually after a course of 1–3 years. Often the disease is complicated by other infections such as →malaria, →schistosomiasis, animals, →schistosomiasis, man, →hookworm disease, or →pneumonia. Hematologically there is anemia and granulocytopenia, sometimes with lymphocytosis and hyperglobulinemia, especially of IgM.

### Immune Responses

These kinetoplastid →protozoa live only extracellular and have evolved remarkable →immune evasion mechanisms. Since *T. brucei* infects laboratory rodents readily, the mouse model has been used for almost all

immunological studies. Different inbred strains of mice exhibit different resistance to *T. brucei*, but all eventually succumb to the parasite. As in other experimental parasitic diseases resistance is under polygenic control, but the exact nature of the genes involved is not known. The initial host response toward *T. brucei* is characterized by the early release of inflammatory mediators associated with a type 1 immune response. It has been shown that this inflammatory response is dependent on activation of the innate immune system mediated by the TLR-adaptor molecule MyD88. MyD88-deficient macrophages are nonresponsive toward the variant-specific surface glycoprotein (VSG). Infection of MyD88-deficient mice with *T. brucei* resulted in elevated levels of parasitemia. Analysis of several TLR-deficient mice revealed a partial requirement for TLR9 in the generation of an efficient Th1 response. These results implicate the mammalian TLR family and MyD88 signaling in the innate immune recognition of *T. brucei*.

### B Cells, Antibodies, and Antigenic Variation

The metacyclic and bloodstream forms of *T. brucei* are uniformly coated with the →variant surface glycoprotein (VSG). This GPI-anchored protein has a highly polymorphic N-terminus forming the exposed domain. Up to 1,000 different VSG genes distributed throughout the genome are present in the genome of the parasite. At any one time, only a single VSG gene is actively transcribed at a telomeric expression site. The switching from one VSG variant to another by translocation events or telomeric *in situ* activation occurs in a spontaneous manner at a surprisingly high rate of  $10^{-4}$  to  $10^{-5}$  per →cell division. →Antigenic variation leads to the characteristic fluctuating parasitemia, as successive VSG variants elicit an antibody response and are then destroyed. The primary antibody response is a T cell-independent IgM response, but T cell-dependent IgG responses against normally buried nonvariant VSG epitopes can be also initiated after phagocytosis of trypanosomes.

### Immunosuppression

Immunosuppression, which occurs both in infected animals and humans, has been extensively studied in the mouse model of trypanosomiasis. Lymph node enlargement and splenomegaly are accompanied by massive accumulation of B cells and null cells. The massive polyclonal B cell activation manifests in elevated IgM levels and autoantibody production. The alterations in the cellularity and architecture of the lymphoid system are accompanied by a dramatic suppression of T and B cell responses to antigens and mitogens. These effects are mediated by intermediate cells, in particular suppressor macrophages. The transfer of as few as 40,000 peritoneal or splenic macrophages from trypanosome-infected donor mice were

capable of causing a 50% suppression of recipient mitogen responses. The suppressor macrophages display an activated phenotype and especially 2 secreted products of these cells, PGE2 and NO, have been shown to mediate suppressive effects. Both, inhibitors of iNOS (L-NMMA and L-NAME) and cyclooxygenases (indomethacin) led to a partial abrogation of suppressor macrophage activity, and when used in combination there was a complete restoration of proliferative responses in splenocyte cultures from *T. brucei*-infected mice. The role of NO during murine trypanosomiasis has also been studied *in vivo*. Treatment of infected mice with L-NMMA resulted in a restoration of mitogen-driven T cell proliferation in the spleen and surprisingly also in a significant reduction of the first parasitemic peak. In contrast to other parasites, NO does not significantly affect trypanosome proliferation. While *T. brucei* is killed by NO *in vitro*, the presence of red blood cells, as in the natural habitat of the parasite, the bloodstream, abolishes this effect completely. This is a result of hemoglobin acting as high affinity sink for →Nitric Oxide (NO).

While the suppressor macrophage products PGE2 and NO are clearly damaging to the host, TNF has a more ambiguous role. TNF has been originally identified as the cachexia-inducing factor in chronic trypanosomiasis. However, treatment of primed mice with anti-TNF antibodies reduced the duration of survival, and subsequent studies showed a direct trypanolytic activity of TNF.

### T Cells

Given the central role of activated macrophages in African trypanosomiasis, IFN- $\gamma$  which has been found to be significantly upregulated in infected humans and mice most likely plays a central role. Recent studies have shown 3 independent cellular sources of IFN- $\gamma$  in experimental trypanosomiasis. First, VSG-specific MHC class II restricted CD4<sup>+</sup> Th1 cells have been identified. A second source is a CD8<sup>+</sup> T cell population which is directly activated by a 42–45 kDa trypanosomal protein designated trypanosome-derived lymphocyte triggering factor (TLTF). A third source for IFN- $\gamma$  early after *T. brucei* infection (e.g., days 2–4 of infection) are NK cells, as revealed by (1) a significant T-cell-independent production of IFN- $\gamma$  in infected nude mice and (2) the reduction of IFN- $\gamma$  production after depleting NK cells with anti-asialo-GM antibodies. A contribution of NK cells to the pathogenesis in murine trypanosomiasis is further suggested by the finding that NK cell-deficient beige mice showed prolonged survival time after *T. brucei* infection. Most interestingly and in addition to its role in the generation of activated suppressor macrophages IFN- $\gamma$  appears to have also a direct stimulatory effect on the growth of the parasite. The proliferative response of *T. brucei*

to IFN- $\gamma$  has been demonstrated in axenic cultures. In line with the parasite growth-promoting activity of IFN- $\gamma$  parasitemia in IFN- $\gamma$ -deficient mice were consistently lower than in Wild-type mice. In contrast, IFN- $\gamma$  receptor  $-/-$  mice displayed a more rapid parasitemia and shorter survival time, ascribed to higher levels of free plasma IFN- $\gamma$  in these mice. Thus, IFN- $\gamma$  represents another host cytokine in addition to epidermal growth factor described earlier which is able to directly influence the growth of *T. brucei*.

In addition to IFN- $\gamma$  there appear to be factor(s) produced by the parasite acting as costimulators for macrophage activation. This activity was named trypanosomal macrophage-activating factor (TMAF) and although there is currently no information on the molecular nature of TMAF it appears to be distinct from VSGs of *T. brucei*. However, since TMAF was able to induce both PGE2 and NO synthesis by host macrophages, it may represent a virulence factor of the parasite contributing to the immunosuppression observed in trypanosomiasis.

**Main clinical symptoms:** Fever, local →edema, possibly polyadenitis, neural complications, death.

**Incubation period:** local oedema: 1–21 days, fever: 3 weeks; cerebral disorders: 3 months in *T. b. rhodesiense*, 9–12 months in *T. b. gambiense*.

**Prepatent period:** 1–3 weeks.

**Patent period:** Years in chronic cases.

**Diagnosis:** Microscopic determination of blood stages →serologic methods.

**Prophylaxis:** Avoid bite of →tsetse flies in endemic regions.

**Therapy:** Treatment see →Trypanocidal Drugs, Animals, →Trypanocidal Drugs, Man.

---

## Slender Forms

Stages of the *Trypanosoma brucei*-group, which divide in the host's blood, while the stumpy forms are prepared for a life in the vector. →Polymorphism.

---

## Slowing-Down Phenomenon

Several parasites (e.g., →*Echinococcus* cysts, →*Riberoia* →trematodes) lead to deformities in their intermediate hosts and thus decrease the hosts' ability to flee from a predator (= final host).

## S-Methoprene

### Chemical Class

Juvenile hormone agonist (juvenile hormone analogue).

### Mode of Action

Insect growth regulator (IGR, juvenile hormone mimics). → [Ectoparasitocides – Inhibitors of Arthropod Development](#).

## Sm-Genes

Schistosomal (*S. mansoni*) gene products sm 1, sm 14, sm 23, sm 26, sm 28, sm 62 (similar ones exist in *S. japonicum*) are candidates used for the development of vaccines. → [Vaccination](#).

## Snipe Flies

Common name for the fly family Rhagionidae with the genera *Atherix* (South and North America), *Austroleptis* and *Spaniopsis* (in Australia) (→ [Spaniopsis/Fig. 1](#)), and *Symphoromyia* (in Europe, Asia, and North America). They land noiselessly on human skin, bite very painfully, and often occur en masse.

## Snoring Disease

Disease due to infection of cattle with the trematode *Schistosoma nasale* (→ [Respiratory System Diseases, Ruminants](#)).

## Snow Flake Opacities

Symptom of → [onchocercosis](#) in the eye (occurs due to dead microfilariae).

## Soboleviacanthus

Genus of tapeworms of birds. *S. gracilis* (syn. *Hymenolepis gracilis*) is found in European chicken, *S. columbae* in doves.

## Sodium stibogluconate

→ [Leishmaniacidal Drugs](#).

## Soil Amoeba

→ [Amoebae](#).

## Soil-Transmitted Helminths (STH)

About 4.2 billion humans live at risk of being infected by → [hookworms](#), → [ascarids](#), and/or whipworms (→ [Trichurids](#)) in practically all countries of the tropics due to larvae or eggs in human faeces. Regular mass treatments (2 per year) with → [nematocidal drugs](#) would reduce the risk.

## Soil-Transmitted Nematodes

Nematodes, the eggs of which are found on soil (e.g., → [Ascaris](#), → [Trichuris](#)).

## Solenocytes

Terminal cells of the nephridial organs of platyhelminths (= protonephridia, flame cells, cyrtocytes). This cell type forms a bundle of flagella, which stretch into the fluid deviating channel (→ [Cyrtocyte](#)).

## Solenopotes

Genus of →lice of cattle (e.g., *S. capillatus* = little blue cattle louse) (1.7 mm), parasitizes head, neck, especially in winter and early spring (Fig. 1).

## Soluble Egg Antigen (SEA)

The granulomatous inflammation around eggs, e.g., in liver (→Schistosomiasis, Man) is based on stimulatory effects of egg molecules (with a size of 38–42 and 64–68 kDa, respectively). Similar crude extracts of the eggs are called SEA, which are used for studies of immune reactions.

## Sowda

→Onchocerciasis, →Man

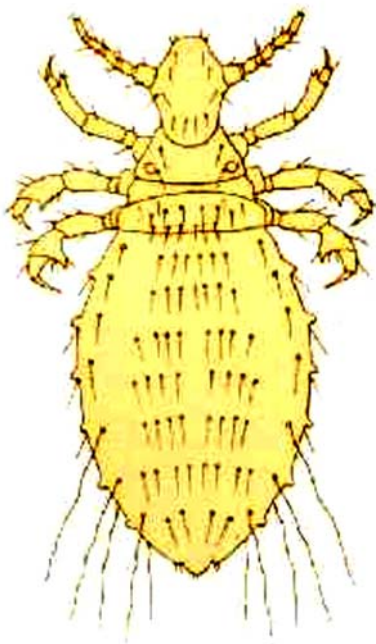

**Solenopotes.** Figure 1 Adult cattle louse.

## Spaniopsis

Genus of Rhagionidae (English: snipe flies), which are found in Australia and bite painfully (Fig. 1).

## Sparganosis, Man

Sparganosis is an infection with a larval tapeworm, usually *Spirometra* of dogs and cats (see also →Pseudophyllidea). Humans become infected by drinking water containing infected copepods, eating infected amphibians, or reptiles, the intermediate hosts. The spargana give rise to small, sometimes migratory, →nodules or abscesses containing the elongated, segmented wormlike structures without →scolex, sucker, or cyst (→Pathology/ Fig. 18B). The larvae in the →abscess are surrounded by an intense mixed →inflammatory reaction, often containing large numbers of eosinophils and →Charcot-Leyden crystals. The →nodule is delimited by granulation tissue. Rarely, the spargana proliferate in humans, giving rise to tracts or to space-occupying cysts in the brain, surrounded by inflammation variable in size and shape over time, that can be observed by tomography and magnetic resonance imaging.

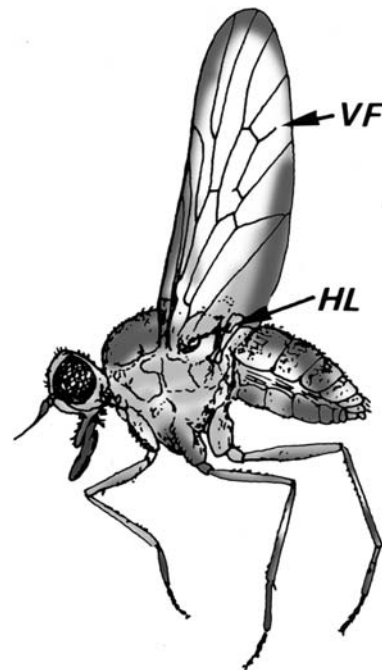

**Spaniopsis.** Figure 1 DR of an adult *Spaniopsis*. HL, hindwing (= haltere); VF, anterior wing.

## Therapy

→[Cestodocidal Drugs](#).

---

## Sparganum

Common name for the second larva = plerocercoid, e.g., of the tapeworm →[Diphyllobothrium latum](#), →[Eucestoda](#).

---

## Speciation

The speciation of parasites follow the general rules of speciation: if 2 populations of the same species are isolated from each other, they can diverge genetically because of different selective pressures or simply by genetic drift if the populations are of small size. Isolation is always necessary to prevent gene flows.

The isolation may be achieved by a physical barrier (mountain range, sea, etc.) which causes →[allopatric speciation](#). This process is certainly the more common.

When a parasite–host system is fragmented in 2 or more parts, for instance by geologic events, does the host populations diverge faster than the parasite, or the parasite faster than the host, or do they diverge synchronously? There are no satisfactory answers to these questions. One can only suppose that, in the majority of cases, the parasites diverge (and finally speciate) faster than the hosts, because, during the time the populations are separated, the number of generations of the parasite is greater than that of the host, giving the parasite population more opportunities for natural selection to intervene. If the hypothesis is true, it could explain why some hosts harbour what are called “species-flocks”: if a host species has been fragmented then re-united and if the parasites have diverged to a greater degree than the host, then the different populations of the host will merge into a single population whereas the parasites will have become reproductively isolated.

In recent years, increased attention has been paid to sympatric speciation, i.e., speciation occurring without geographical separation. Sympatric speciation is not accepted by all ecologists but it has gained acceptance in recent years. It can be achieved in various ways in parasites.

One way is →[alloxenic speciation](#). The exploitation of several host species by a single parasite species may provoke sympatric speciation if the larval stages produced in a particular host species tend to “return”

to individuals of this same species. The reason for this can be a →[polymorphism](#) of habitat preference, which means that some individual parasites differ genetically by “preferences” for different species hosts. Also, different behaviours of host species may determine the isolation of parasite sub-populations which later evolve into species.

Another way is →[synxenic speciation](#), which occurs not only in a same geographical area but also in a same host species. Does synxenic speciation actually exist? Although there is no formal demonstration of its existence, one may suppose that it may happen if there is a polymorphism of habitat preference in the parasite initial population for different parts of the host organism. “Parasites account for a large part of known species diversity and are considered to have a high potential for sympatric speciation” (McCoy). The process is the same as in alloxenic speciation except that the scale is different: organ of the host instead of host species. Let us suppose for instance that in a population of an intestinal parasite, some individuals have genes which make them prefer the duodenum and others have genes which make them inhabit the jejunum; if it is the case, the individuals which exhibit one type of preference will mate only with individuals exhibiting the same preference; and so on at each generation. This is a powerful isolating mechanism. The 2 “sub-populations” can later diverge genetically and ultimately become different species.

---

## Species

Group of similar individuals among which reproduction is possible and leading to further sexual reproduction in further generations.

---

## Specificity

There is no living being which lives everywhere. In this sense, all animal or vegetal species are specific to certain →[environmental conditions](#). In the world of parasites, being specific means being capable of exploiting a limited range of host species (the term “specific” can be also used to define the exploitation of certain organs or parts of organs, but this acceptance is less common).

Usually, a parasite species which infects a single species of host is called “oioxenic,” a parasite which infects a range of closely related host species is called

“stenoxenic,” and a parasite which may develop in or on unrelated host species is called “euryxenic.” A general rule of parasitism is that specificity is narrow, with certain exceptions.

Human schistosomes, in their adult stages, provide examples for these different types of specificity.

→ *Schistosoma haematobium*, the agent of urinary schistosomiasis in Africa, is considered as strictly specific to humans, even if it has been occasionally reported in the case of baboons. This strict specificity makes *S. haematobium* a parasite that is difficult to keep in the laboratory, although at least some strains can be adapted to a few species of laboratory rodents, for instance *Meriones unguiculatus*.

→ *S. mansoni*, the agent of intestinal schistosomiasis in Africa and South America, is common in humans and, in certain foci, also parasitizes various species of rodents. For unknown reasons, this is especially true in the Caribbean and South America. In certain foci of the island of Guadeloupe for instance, the black rat, *Rattus rattus*, plays a major role in the maintenance of the parasite.

→ *S. japonicum*, the agent of intestinal schistosomiasis in Asia, parasitizes nearly all mammals having sufficient contacts with water bodies. More than 40 species of mammals have been reported as hosts in continental China only. It must be stressed, however, that specificity varies in different foci. For instance, Taiwanese strains parasitize various mammals but apparently not humans, Philippine strains parasitize rodents, whereas this is rare in continental China.

The fact that, within a single genus (→ *Schistosoma* in the above example), specificity varies widely, means that specificity is an adaptive character and has been selected for. However, the way a host spectrum is selected during the course of evolution as well as the nature of selective pressures remain largely misunderstood. It is remarkable that, at the first stage of their development, in their molluscan host, the 3 species of *Schistosoma* mentioned above seem to be equally strictly host-specific: *S. haematobium* develops only in pulmonates of the genus *Bulinus* (with a local exception in North Africa and Spain), *S. mansoni* in pulmonates of the genus *Biomphalaria*, *S. japonicum* in prosobranchs of the genus *Oncomelania*.

Host specificity has important implications for the geographical distribution of parasites. This is particularly obvious in the case of schistosomes: during the 16th and 17th centuries, tens of thousands of black people were forced to leave Africa and transported into the New World. Most of them were infected by one or the other of the 2 main species of african schistosomes *S. mansoni* and *S. haematobium*. However, only *S. mansoni* became established into the New World (Caribbean and South America) because snails

of the genus *Biomphalaria* were present. On the other hand, *S. haematobium* never became established in America because of the absence of representatives of the genus *Bulinus*.

Certain groups, such as monogeneans (platyhelminths parasitic on gills or skin of fish, more rarely endoparasitic in amphibians and turtles) are extremely specific (most species parasitize only one host species). The improvement of chemical analysis (allozymes, DNA sequences) has often shown that species which were reported from a variety of hosts were in fact complexes of closely related but strictly separated species. Cestoda are another group characterized nearly always by a narrow specificity. Other groups, such as digeneans (see the case of *Schistosoma* above) and nematoda, comprise both oioxenic, stenoxenic, and euryxenic species. The case of parasites with complex life cycles is specially intriguing, because the host spectrum can be extremely different at different steps of the cycle. In digeneans for instance, specificity is narrow towards the first host (mollusc), but variable at the other steps of the cycle.

An intriguing question concerning parasite specificity is: why have certain parasites a narrow specificity and others a wide one? As a matter of fact, the question is not particular to parasites: why are certain plants restricted to precise environmental conditions, whereas others are ubiquitous, why does the koala eat only eucalyptus leaves and the pig nearly anything? The question is thus: why are there specialists and generalists in life? In terms of natural selection, the answer is that it is sometimes advantageous to be a specialist and sometimes to be a generalist. But this answer is unsatisfying. At a first glimpse, it seems that it should be always better for a parasite to be relatively unspecific, but this is to forget that there is a cost involved in generalism (investment in → *evasion mechanisms* adapted to different immune systems, increased competition with other parasites, etc.).

Availability of computers and the development of methods of “comparative analysis” have permitted the investigation of ecological factors that determine specificity. For instance, after investigating into the confounding effect of the sampling effort (study intensity), Poulin showed that there is a positive relationship between the number of potential hosts (i.e., phylogenetically related hosts) and specificity. Although a phylogenetic conservatism in an ecological character such as specificity has been demonstrated, detailed explanation of differences in specificity is not presently available.

## Related Entry

→ *Richness, Parasitic.*

## Spermatheca

A sac for sperm storage (surrounded by a chitin capsule), e.g., in the female reproductive tract of insects ([→Insects/Reproduction](#) [→Pulex irritans](#)).

## Spermatogenesis

[→Acanthocephala](#), [→Nematodes](#), [→Platyhelminthes](#), [→Gametes](#).

## Spermatophore

Small packet of sperm, produced by some animals having internal fertilization, e.g., [→ticks](#) ([→Ticks/Reproduction](#)).

## Spermatozoa

Male sexual [→gametes](#) of metazoans that are produced during a peculiar spermiogenesis. They are motile (by help of a flagellum or pseudopodium) and thus able to reach the female gamete (the oocyte), [→Platyhelminthes](#), [→Nematodes](#), [→Insects](#), [→Ticks](#).

## SPf 66

Polymerized chimera peptide ([→Malaria/Vaccination](#)).

## Sphaerospora

[→Myxozoa](#).

## Sphirion

Genus of parasitic crustaceans reaching a size of 6 cm being anchored inside the muscles of freshwater fish.

## Spicules

### Name

Latin: *spiculum* = thorn.

The spicules are characteristic copulatory structures of male nematodes ([→Nematodes/Figs. 12, →13](#)). In most nematodes there are 2 spicules, which often differ in length and shape, but in some species only a single spiculum (Latin = peak, arrow) is found ([→Nematodes/Fig. 13](#)). The spicules are needle-shaped and consist of thick cuticular material which surrounds a cytoplasmatic core with nerve processes. The nerve endings are covered by cuticular material. In many species the spicule wall is bent to form a hollow needle with an opening at its base and tip. The spicules are formed in a dorsal sac of the [→cloaca](#) called the spicular pouch. The spicules can be moved back and forth by accessory muscles and during copulation they are inserted into the female vulva. A thickening of the dorsal wall of the spicular pouch, the [→gubernaculum](#), stabilizes the protruded spicule. Additional copulatory structures are found in some groups ([→Nematodes/Reproductive Organs](#)).

## Spiders

[→Amandibulata](#); Chelicerata.

## Spilopsyllus cuniculi

From Greek: *spilos* = spot, *psyllos* = flea. [→Flea](#) of rabbits, rodents, hare ([Fig. 1](#)).

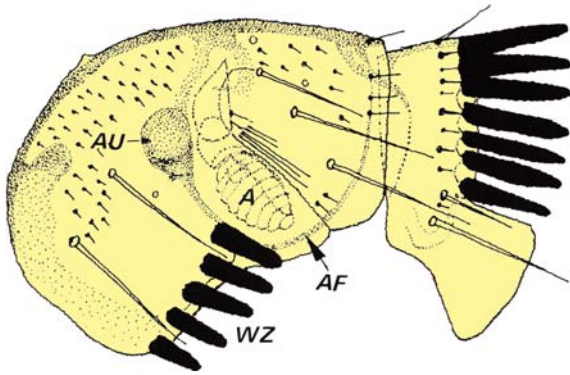

**Spilopsyllus cuniculi.** Figure 1 Head and first thorax segment of the rabbit flea. *A*, antenna; *AF*, antenna groove; *AU*, eye; *WZ*, head ctenides.

## Spines

The tegumental surface of several trematodes is provided with proteinaceous scales, which in light microscopy look like spines (→*Fasciola*, →*Paragonimus*, →*Heterophyes*). These spines apparently are used as holdfast system besides the 2 suckers.

## Spinosad

### Chemical Class

Macrocyclic lactone (12-membered macrocyclic lactone, spinosyns).

### Mode of Action

Nicotinic acetylcholine receptor agonist. →[Ectoparasiticides – Agonists and Antagonists of Cholinergic Transmission](#).

## Spinose Ear Tick

→*Otobius megnini*, the bite of which may introduce severe secondary bacterial ear canal infections in cattle (→[Tick Bites: Effects in Animals](#)).

## Spiracles

→[Acarina](#).

## Spiramycin

Drug used in →[toxoplasmosis and cryptosporidiosis](#).

## Spirocerca lupi

### Name

Greek: *speira* = winding, *kerkos* = tail.

### Classification

Species of the nematode superfamily Spiruoidea.

### Life Cycle

The reddish worms (female 8 cm, male 5 cm) live in the submucosa of the esophagus of carnivores leading to nodules about 5–6 months after infection. The eggs ( $35 \times 19 \mu\text{m}$ , [Fig. 1](#), page 1326) contain the L<sub>1</sub>. After ingestion by beetles the L<sub>3</sub> is developed there being infectious to final hosts, if they swallow the intermediate hosts. Another species (*S. arctica*) is found in North and East Europe.

**Disease:** Vomiting, anaemia, loss of weight. →[Alimentary System Diseases, Carnivores](#).

**Therapy:** →[Nematocidal Drugs](#).

## Spirometra erinacei europaei

### Name

Greek: *speira* = winding, *metra* = uterus.

### Life Cycle

This worm (40 cm long) lives in the small intestine of carnivores in Europe, Asia, Australia. First intermediate hosts are rodents, amphibia, second intermediate hosts are rodents, pigs, monkeys.



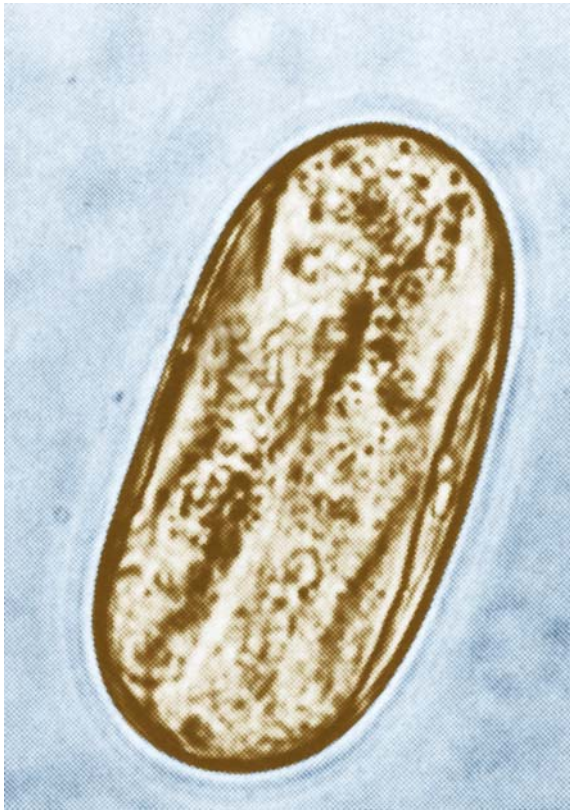

**Spirocerca lupi.** Figure 1 LM of an egg containing the larva.

**Prepatent period**

2–3 weeks. In humans the plerocercoids = spargana may be found in various organs. → [Eucestoda](#).

---

**Spirometra mansonoides**

Tapeworm of dogs, cats in North and South America. → [Cestodes](#).

---

**Spironucleus**

**Name**

Latin: *spira* = winding, nucleus.

Genus of flagellates of birds and of fish. *S. meleagridis* is synonym to → [Hexamita meleagridis](#) (6–12 μm, 6 anterior, 2 posterior flagella), *Spironucleus* spp. from

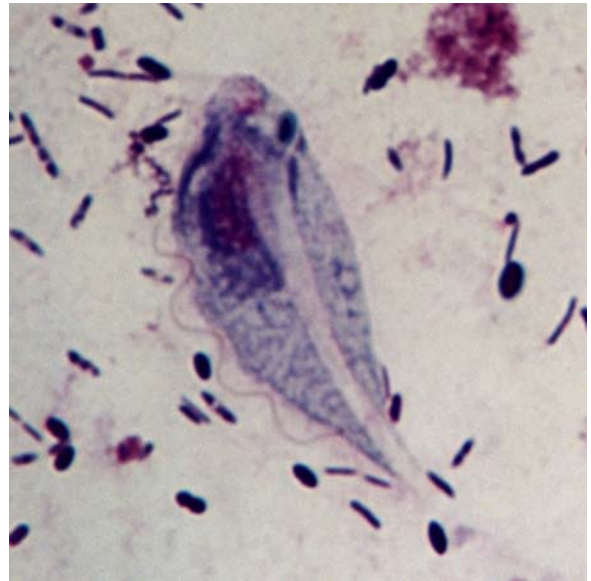

**Spironucleus.** Figure 1 LM of a trophozoite, Giemsa-stained.

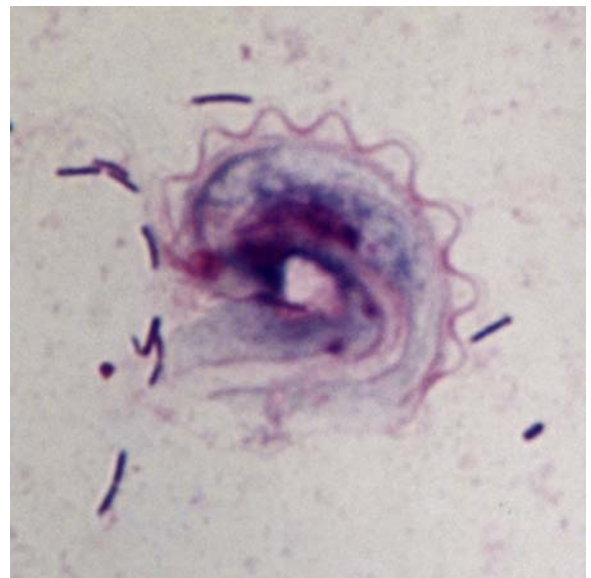

**Spironucleus.** Figure 2 Giemsa-stained trophozoite transforming into a cyst-stage.

the intestine of fish show the same morphology (Figs. 1, 2), they parasitize in the intestine and may lead to important losses in ornamental fish cultivation. Transmission occurs via cysts with a size of 4–5 × 6–7 μm. → [Diplomonadida](#).

**Therapy of Fish**

Flagellol of Alpha-Biocare, Düsseldorf.

## Spirorchis Species

→[Digenea](#), which lay fully embryonated eggs.

## Spirotrichonympha

Hypermastigid flagellates from intestines of insects.  
→[Chromosomes](#), →[Barbulanympha](#).

## Spirotrichosoma

→[Chromosomes](#).

## Spiruoid Type X Larva

Larva of a spiruoid larva which causes syndromes of →[larva migrans externa](#) (in skin) and larva migrans interna in the ileum and in the eye of humans in Asia. These type X larvae measure 6–8 × 0.1 mm and possess 2 tubercles at the tail and 2 pseudolabia at the head. Symptoms occur 2–9 days after eating raw squid.

## Spiruoidea: Gongylonematidae

Superfamily of →[nematodes](#). Especially members of the family →[Gongylonematidae](#) may infect humans, e.g., the “gullet worm” of domestic animals may occur in the esophagus and/or stomach and becomes embedded in the mucosa. Infections occur (also in humans) by eating the intermediate hosts (beetles).

## Splendidofilaria fallisensis

Species (syn. *Ornithofilaria*) of filariid nematodes in the subcutis of ducks in North America.

## Splendore-Hoepli-Reaction

→[Pathology](#), →[Onchocerciasis](#), [Man](#).

## Splenomegaly

Symptom of disease due to infections with →[African trypanosomiasis](#), →[babesiosis](#), →[malaria](#) in children, →[visceral leishmaniasis](#).

## Spliced Leader

The spliced leader (SL) is a small nucleotide sequence (mini-exon) that is required for protein-coding gene expression. The SL is encoded as part of a donor RNA gene (SL RNA) and transferred to pre-mRNA during *trans*-splicing to generate the mature 5' ends of mRNAs (→[Trans-Splicing/Fig. 1](#)). SL addition is unique to kinetoplastids, euglenoids, →[nematodes](#), and flatworms. In kinetoplastids, it serves to resolve polycistronic into monocistronic transcripts and may have the same function in helminths. SL RNA in *Trypanosoma brucei* is 140 nucleotides long and is encoded by about 200 genes organized in tandem repeats of 1.35 kb. SL sequences have similar structures in different organisms and resemble small nuclear RNAs (snRNAs) but vary in length among different species. In kinetoplastids, every nuclear-derived mRNA carries a 39–41 SL nucleotide sequence at its 5'-terminus, while helminth SLs are 22 and 36 nucleotides long, respectively.

## Spontaneous Healing

→[Leishmanization](#), →[Leishmania](#).

## Spores

From Greek: *spora* = seed. →[Amblyospora](#), →[Microsporidia](#), →[Coccidia](#), →[Myxozoa](#), →[Ascetospora](#), →[Haplosporidia](#).

## Sporoblast

Stage prior to formation of sporocysts in →*Coccidia* or →*Spores* in →*Microsporidia*.

## Sporocyst

Most common meanings are:

- Cyst inside oocysts of →*Coccidia* containing the infectious stages = sporozoites (→*Gregarines*).
- Developmental stage of digenean life cycle (→*Digenea/Life Cycle*) inside the first →*intermediate host* snail. These sporocysts produce depending on the species – daughter sporocysts, →*rediae*, or →*cercariae*. The latter leave the snail and may become infectious to a second intermediate host (e.g., in the case of →*Clonorchis*), to the final host (e.g., →*Schistosoma*), or are attached at plants to become →*metacercariae* (e.g., →*Fasciola hepatica*, →*Fasciolopsis buski*).

## Sporogonic Cell

→*Myxosoma cerebralis*.

## Sporogony

Asexual reproduction of →*Coccidia*, →*gregarines* and →*Microsporidia*. The →*zygote* – the only diploid stage in the life cycle of →*Apicomplexa* – produces infectious sporozoites by means of meiosis followed by numerous divisions.

## Sporokinete

In the piroplasm genus →*Babesia* and some adeleidean →*Coccidia* (e.g., *Karyolysus*) the motile →*zygote* (= →*kinete*) grows up to a spherical stage (= sporont), which divides into several motile stages identical in appearance to the zygotic kinete. These new kinetes are now called sporokinetes.

## Sporophorous Vacuole

→*Amblyospora*, →*Microsporidia*.

## Sporoplasm

→*Nosema apis*, →*Coccidia*.

## Sporozoa

### Synonym

→*Apicomplexa*, a subgroup of →*Alveolata*.

## Sporozoite

Motile banana-shaped stage within sporocysts of →*Coccidia*. Their fine structure is practically identical to that of →*merozoites*. In addition to the organelles of merozoites they possess 1 or 2 (depending on the species) large →*reserve granules* (= →*refractile bodies*, crystalloid bodies). Having reached a new host the sporozoites enter host cells and start reproduction by →*schizogony*.

## Sporozoite's Liver Invasion

Malarial sporozoites that enter the liver parenchyma of their hosts have to pass through a cascade of events: binding to extracellular matrix proteoglycans, passage through Kupffer cells, transmigration through several hepatocytes until the final cell is invaded. The sporozoite thus exploits the properties of the liver to evade the immune system.

## Sporulation

The asexual formation of sporocysts and sporozoites inside oocysts of →*Coccidia* is called sporulation with

respect to the process and its timing. It is synonymous to [→sporogony](#) which reflects the phase inside the life cycle.

## Spotted Fever

Diseases due to infection with tick-transmitted rickettsiae; *R. rickettsii*: [→Rocky Mountain spotted fever](#) (RMSF); *R. conori*: fièvre boutonneuse; *R. sibirica*: North-Asian spotted fever. [→Ricketts](#).

### Therapy

Tetracyclines.

## SPOV

Sporophorus vesicle, [→microspora](#).

## Spraguea lophii

Species of [→microsporidia of fish](#).

## Spring Rise Phenomenon

Increased excretion of egg in spring by trichostrongylid [→nematodes](#) ([→Hypobiosis](#), [→Trichostrongylidae](#)).

## SREHP

Serine-rich [→Entamoeba histolytica](#) protein; its excretion leads to abscesses, e.g., in liver ([→Amoebiasis](#)).

## SSP

Surface protein of *Plasmodium* sporozoites.

## S,S,S-tributyl phosphorotrithioate (DEF, TBPT)

### Chemical Class

Synergist.

### Mode of Action

Detoxifying esterase inhibitor.

## SSU

Small subunit.

## SSUrRNA

Small subunit ribosomal RNA.

## St. Louis Encephalitis

Disease in the Americas due to [→Flaviviridae](#) transmitted by [→Culex](#) [→mosquitoes](#).

## Stable Fly

*Stomoxys calcitrans* ([→Diptera](#)).

## Stage Conversion

This phenomenon, that a parasite converts from one life cycle stage to another (e.g., from tachyzoite to bradyzoite or invertebrates in *Toxoplasma*), is steered by a change in gene expression.

## STARP

Sporozoite-threonine- and asparagine-rich protein of *Plasmodium* sporozoites.

## Stegomyia

Genus of mosquitoes. Recently the species *Aedes aegypti* was changed to *Stegomyia aegypti*.

## Steinernema

Genus of entomopathogenic →[Nematodes](#), which contain symbiotically living enterobacteriaceae of the genus *Xenorhabdus*. Inveniles of the worm enter the insects and often kill them during development just after having produced progeny as adults. Fitness of the worms is apparently dependent on their bacteria.

## Stellantchasmus

Genus of the trematode family Heterophyiidae.

## Stenopterys hirundinis

→[Hippoboscidae](#).

## Stenocrotaphus

→[Lice](#).

## Stenoxeny

From Greek: *stenos* = narrow, *xenos* = guest, foreigner. Species of this kind have a high host specificity.

## Stephanofilariosis

Several species of *Stephanofilaria* (→[Filaridae](#)) cause cutaneous lesions similar to those of →[onchocercosis](#) in cattle, but on different parts of the body. The adult worms live in cystic diverticula at the base of the hair follicles. The lesions develop over several years. Initially they appear as small papules which coalesce to form a larger lesion covered with crusts. Eventually the skin becomes thickened, there is loss of hair, hyperkeratosis, an ulcerating core, and haemorrhage. The lesions are mildly pruritic. After healing, the affected areas remain as hairless lichenified plaques.

### Therapy

→[Nematocidal Drugs, Animals](#).

## Stephanurus dentatus

This worm is commonly found in cysts in the kidneys of pigs (or rarely in cattle and donkeys) in tropical and subtropical regions. The infections occur by skin penetration of the L<sub>3</sub> or by its oral uptake within the paratenic host (earthworms). →[Nematodes](#).

### Diseases

→[Nervous System Diseases, Swine](#), →[Urinary System Diseases, Animals](#).

## Stercoraria

From Latin: *stercoralis* = living in faeces; group of fecally transmitted →[Trypanosoma](#).

## Sterile Male Technique

Method to eliminate an insect species from a biotope by setting free of males, which had been artificially sterilized by gamma-rays, röntgen-x-rays, or chemical methods.

## Sterilization

→ [Parasitic Sterilization](#).

## Sternostoma tracheaculum

Species of → [mites](#) that parasitize in the respiratory tract of canarian finches and other birds ([Fig. 1](#)) being sized  $0.7 \times 0.4$  mm. The eggs already contain larvae, which reach maturity via 2 nymphs.

## STEVOR

Variant antigen (→ [Malaria/Vaccination](#)).

## Stichocotyle nephropis

→ [Aspidogastrea](#).

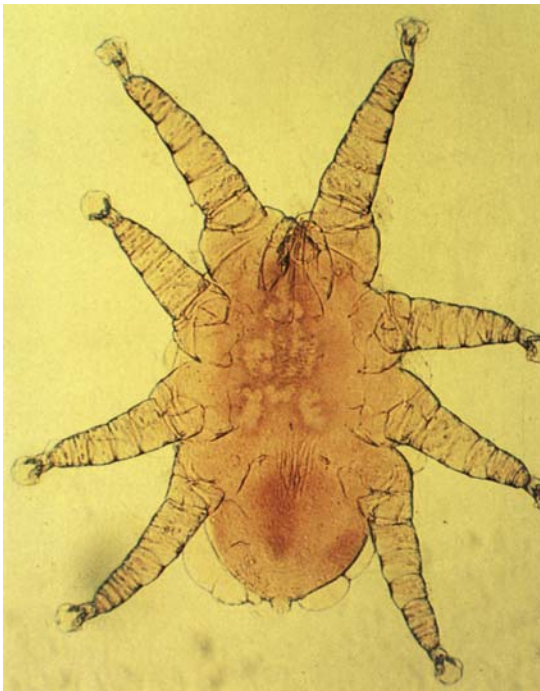

## Stichocytes

Characteristic cells (syn. stichosomes) of the oesophagus of trichinellid worms (→ [Nematodes/Fig. 17](#)).

## Stichorchis subtriquetrus

Digenetic trematode of beavers; in this species the miracidium already contains a redia.

## Stichosome

→ [Nematodes](#), → [Trichinella spiralis](#).

## Stieda Body

The sporocysts in Eimerian oocysts have an opening for exit of the sporozoites which is closed by the Stieda body. It is digested when the sporocysts are set free in the small intestine of the hosts.

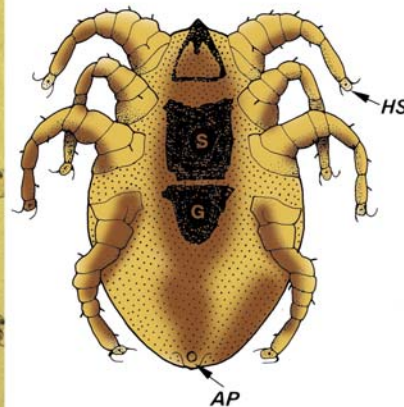

**Sternostoma tracheaculum.** **Figure 1** Male (a) and female (b) mite. *AP*, anal plate; *G*, genital plate; *HS*, attachment system (including 2 claws); *S*, sternal plate (= breast plate).

## Stieda, Christian Hermann Ludwig (1837–1918)

German physician and biologist, co-worker of →Leuckart. His name is honoured by the Stieda-body, which represents the bottleneck of the Eimerian sporocysts.

## Stigmata

→Argasidae.

## Stilesia

Species of the genus *Stilesia* are found in the intestine of ruminants and belong to the group of Anoplocephalidae (e.g., →*Moniezia*). *S. globipunctata* reaches a length of 60 cm, the terminal proglottids (Fig. 1) are 2–5 mm wide and contain 2 →paruterine organs with many eggs, 0.25 µm in diameter. Intermediate hosts are oribatid mites. →Eucestoda, →Anoplocephalidae.

## Stinking Gland

Gland of bedbug being situated at both hind coxae of adult bedbugs storing its oily excretions in 2 reservoirs.

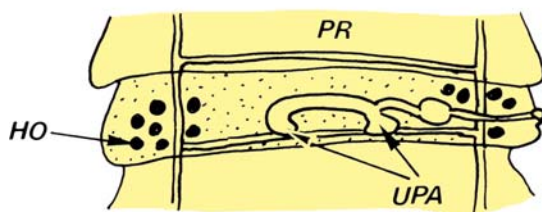

**Stilesia. Figure 1** DR of the shape of midbody and terminal proglottids (right). HO, testis; PA, paruterine organ with eggs; PR, proglottis; TP, terminal proglottis; UPA, uterus with anlage of paruterine organ.

The product is used as social recognition among the bugs.

## Stirofos

→Organophosphate, →Ectoparasitocidal Drugs.

## Stokes, Adrian († 1927)

English microbiologist and specialist for spirochaetes/leptospire, which were at first claimed to be the agents of the yellow fever. During his investigations of the suggested vectors (tiger mosquitoes of the genus *Aedes*) he died from the yellow fever. He proved that the leptospire are not the initiators of yellow fever, but that the *Aedes* must contain the, at this time unknown, final agent.

## Stomach Worms

→Nematodes of the genus →*Habronema* parasitizing horses; the adults live in the stomach, the larvae in skin, lung, or eyes.

## Stomatodaeum

Ectodermal portion of mouth, →Arthropoda, →Insects.

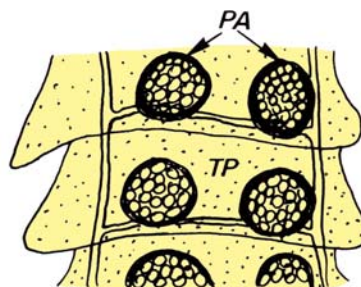

## Stomoxys

### Name

Greek: *stomoxys* = with pointed mouth.

### Classification

Genus of the fly family Muscidae, subfamily Stomoxynae = biting flies.

### Life Cycle

The worldwide occurring species *S. calcitrans* (= stable fly) reaches a size of up to 7 mm and is found mainly in stables (Fig. 1). After bloodsucking the females deposit 60–100 eggs per batch (800 in total) onto the faeces of cattle, horses, or degenerating plants. Within 3–7 weeks the new generation develops. Females feed 2 times per day (often double their own weight) and thus introduce a considerable blood loss, if they occur in masses. The larvae and pupae overwinter at protected places in the stables or close by. → [Diptera](#), → [Insects/Fig. 9C](#).



**Stomoxys. Figure 1** LM of an adult *Stomoxys calcitrans*.



## Storage Elements

→ [Reserve Granules](#).

## Strahlenkörper

German term (English: ray bodies) created by Robert Koch to determine the theilerian and babesian stages in the intestine of ticks. In 1975 Schein and Mehlhorn proved that they are the gamonts and gametes of the → [Theileria](#) and → [Babesia spp.](#)

## Strategies

→ [Disease Control, Strategies](#).

## Stratification of Disease

Method of integrated control of some parasitic diseases such as malaria, leishmaniasis, trypanosomiasis, onchocerciasis, filariasis, schistosomiasis by planning and execution of stepwise coordinated consecutive measurements.

## Streptocara

Genus of the nematode family Acuariidae.

## Streptomyces avermectinius

Fungus, out of which the avermectines had been isolated in the year 1975 (by Professor Omura, → [Kitasato University](#), Japan), starting a furious career in → [nematocidal drugs](#).

## Streptopharagus

Genus of the nematode family Spirocercidae.

## Streptothricosis

Bovine streptothricosis is associated with the tick species *Amblyomma variegatum*. It is an acute or chronic, local or progressive, and sometimes fatal, exudative dermatitis of cattle and other domestic and wild hosts caused by the bacterium *Dermatophilus congolensis*. It is characterized by a serious exudate which dries to mat the hair into paintbrush-like tufts, or to form crusts and thick scabs. It is widespread in tropical areas of vector distribution, where its appearance is mainly seasonal, occurring more during the rainy season.

### Therapy

→ [Antibiotica](#).

## Strigeida

Order of the class Trematoda including the families Diplostomidae, Gymnophallidae, Schistosomatidae.

## String Test

Diagnostic method to collect jejunal fluid (by expressing a swallowed string) in order to examine this fluid for stages of → [Giardia](#), → [Cryptosporidium](#), → [Strongyloides](#).

## Striped Layer

Surface cover of → [Acanthella](#) larvae (→ [Acanthocephala/Integument](#)).

## Strobila

Members of the →Eucestoda (e.g., →*Echinococcus* species) show a characteristic body differentiation into →scolex, →neck, and strobila consisting of a few (e.g., *Echinococcus*) up to 4,000 →proglottids (e.g., →*Diphyllobothrium*).

## Strobilocercus

Syn. *Cysticercus fasciolaris*, which is the larva of the cat tapeworm *Taenia taeniaeformis* (→Cestodes). These larvae appear with a 3–20 cm long segmented proglottis-like band emerging from a terminal bladder. This cysticercus occurs in the liver of the intermediate hosts: rodents.

## Strongyloides

### Name

Greek: *strongylos* = rounded, *eides* = *oides* = similar.

### Classification

Genus of →Nematodes.

### Important Species

Table 1.

**Strongyloides. Table 1** Important species of the genus *Strongyloides*

Species	Length of adult worms (mm)		Size of eggs (or larvae) (µm)	Final host/Habitat	Intermediate host	Prepatent period in final host (weeks)
	f	m				
<i>Strongyloides papillosus</i>	<sup>a</sup> 4–6	–	40–60 × 32–40	<sup>a</sup> Ruminants/Intestine	–	1.5
	<sup>b</sup> 0.7–1.1	0.6	30	<sup>b</sup> Free-living		
<i>S. stercoralis</i>	<sup>a</sup> 2	–	40 × 30	<sup>a</sup> Dogs, <b>humans</b> /Intestine	–	2.5–4
	<sup>b</sup> 0.8–1.0	0.7	30	<sup>b</sup> Free-living		
<i>S. ransomi</i>	<sup>a</sup> 3–5	–	40×30	<sup>a</sup> Pigs/Intestine	–	1
	<sup>b</sup> 1	0.7	30	<sup>b</sup> Free-living		

<sup>a</sup> parthenogenic female (parasitic)

<sup>b</sup> free-living female

## Life Cycle

Fig. 1 (page 1336).

## Disease

→Alimentary System Diseases, Ruminants, →Respiratory System Diseases, Animals, →Strongyloidiasis, Man.

## Strongyloides papillosus

### Morphology

Egg Fig. 1 (page 1337). →Nematodes.

### Life Cycle

→Strongyloides/Fig. 1.

### Disease

→Strongyloidosis, Animals.

## Strongyloides ransomi

→Strongyloidosis, Animals.

## Strongyloides stercoralis

→Strongyloidosis, Animals/Fig. 1, →Strongyloidiasis, Man.

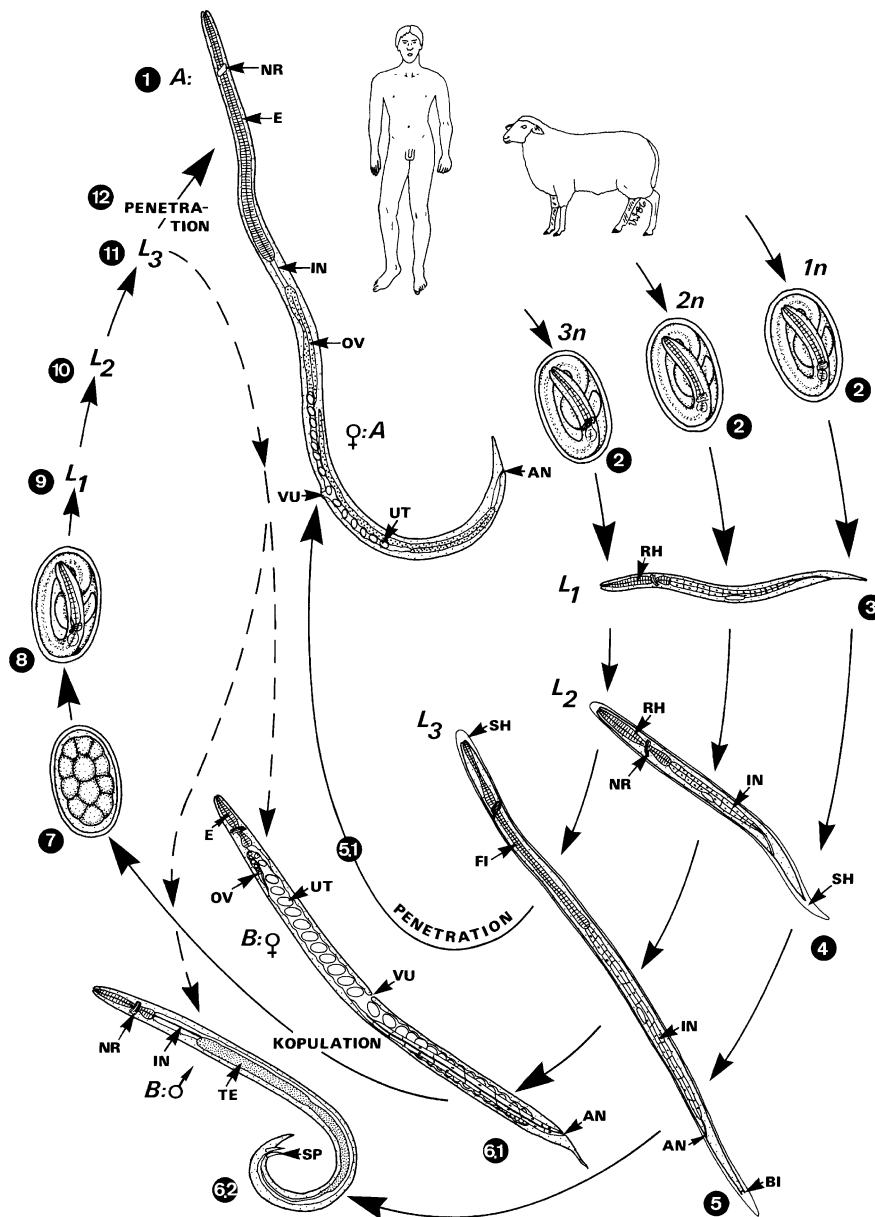

**Strongyloides.** Figure 1 Life cycles (tentative) of *Strongyloides* spp. (e.g., → *S. stercoralis* of man, → *S. papillosus* of ruminants). **A** Parthenogenetic female-homogonic generation. **B** Free-living heterogonic generation. 1–4 Parthenogenetic females live embedded in the mucosa of the small intestine and produce eggs with different numbers of chromosomal sets ( $n$ ). Larvae may escape from eggshells inside the intestine and then be passed with feces. 3–5.1 The 3 $n$  type egg develops directly via L<sub>1</sub>–L<sub>3</sub> into the homogonic female (1). This may occur inside the host's intestine (→ Autoinfection) or via free L<sub>3</sub> on soil (5.1). 3–6.1 The 2 $n$  type eggs produce the heterogonic free-living males (6.1). 3–6.2 The 1 $n$  eggs give rise to the free-living males (6.2). 7–12 The progeny of the free-living generation develops via (nonfeeding) L<sub>3</sub> into parthenogenetic females upon entering the vertebrate host. Some L<sub>3</sub>, however, may give rise to another free-living generation (apparently endowed with a different chromosomal pattern). After penetration into the vertebrate host the L<sub>3</sub> are carried passively through the bloodstream to the heart and lung, and after a → molt accidentally break out into the alveolar space. From there, they wander up the respiratory tract to the pharynx and are swallowed. In the intestine the L<sub>4</sub> undergoes a final molt and becomes mature, starting (according to some authors) a protandric reproduction. This includes the initial development of a male gonad, followed by the female gonad, and self-fertilization; thus a true parasitic male does not appear. AN, anus; BI, bifurcated posterior pole; E, esophagus; FI, →filariform esophagus; IN, intestine; L, larval stages; N, number of chromosomal sets; NR, nerve ring; OV, ovary; RH, →rhabditiform esophagus; SH, sheath (→cuticle of preceding larval stage); SP, spicula; TE, →testis; UT, uterus with eggs.



**Strongyloides papillosus.** Figure 1 LM of an egg from faeces of cattle.

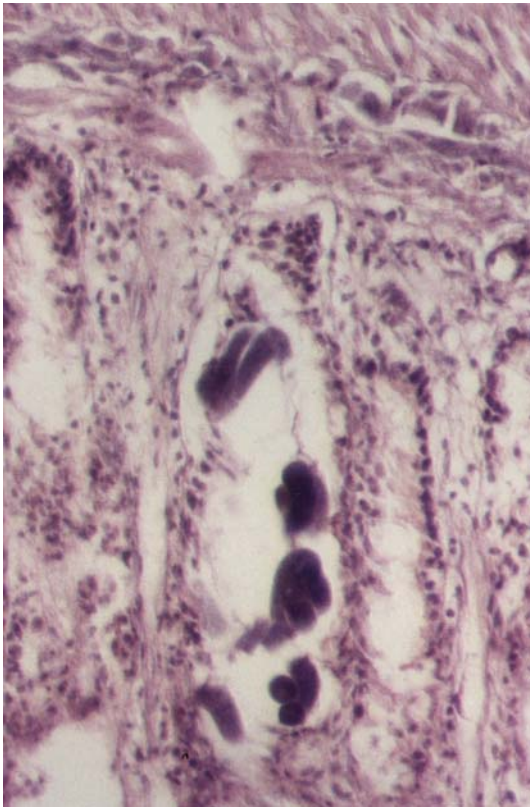

**Strongyloides stercoralis.** Figure 1 LM of freshly hatched larvae in the intestine.

## Strongyloidiasis, Man

Strongyloidiasis is produced by [→Strongyloides stercoralis](#), a parasite of humans, dogs, and cats, and occasionally other species, normally from other hosts. Larvae penetrate the skin and give rise to dermatitis at the site of entry. They then migrate either through the lung, where they may cause allergic [→pneumonia](#), or by other pathways to the intestine where they become adults. The females most commonly reach adulthood in the duodenum and upper jejunum and enter the mucosa, to lay eggs. Mucosal inflammation, and later atrophy, leading to [→malabsorption](#) and emaciation, are the consequence of heavy infections. The larvae, which are soon released from the thin-walled eggs, are shed in the stool. However, some reenter the mucosa or the perianal skin maintaining a [→chronic infection](#) which is characterized by fleeting urticarial rashes on the abdomen, buttocks, thighs, and often perianally. In immunosuppressed hosts this autoinfection can lead to a marked increase in tissue invasion by larvae and of adult females in the gut ([→Pathology/Fig. 2F](#)), which may contribute to a fatal outcome.

**Main clinical symptoms:** Bronchitis, bronchopneumonia, [→diarrhoea](#), loss of weight, [→eosinophilia](#), [→anaemia](#), death.

**Incubation period:** Skin: 12–18 hours, lung: 1 week, intestine: 2 weeks.

**Prepatent period:** 14–21 days.

**Patent period:** 40 years (due to repeated autoinfections).

**Diagnosis:** Microscopic determination of larvae in faeces or duodenal fluid, [→Serology](#).

**Prophylaxis:** Use solid shoes in endemic regions and avoid human faeces.

**Therapy:** Treatment see [→Nematocidal Drugs, Man](#).

## Strongyloidosis, Animals

### Pathology

#### Ruminants

[→Strongyloides papillosus](#) occurs in cattle, sheep, and goats. This nematode lives in tunnels within the epithelium of the villi of the anterior part of the small intestine. Severe infections cause villous atrophy, with a loss of plasma proteins and a reduced activity of several enzymes (alkaline phosphatase, lactase, saccharase and maltase). Clinical outbreaks principally affect

young suckling animals. Signs include →**anorexia**, loss of weight, →**diarrhoea** (rarely haemorrhagic), →**dehydration**, slight to moderate →**anaemia**. Severe infections may be fatal. Studies in Japan demonstrated that *S. papillosus* could cause sudden death in calves.

### Horses

The only species in the small intestine of horses is *Strongyloides westeri* (→**Alimentary System Diseases, Ruminants**). Clinical outbreaks principally affect young suckling foals. Signs include anorexia, loss of weight, coughing, diarrhoea (rarely haemorrhagic), dehydration, slight to moderate anaemia. Severe infections may be fatal.

### Carnivores

→*Strongyloides stercoralis* occurs in dogs. Though not common, infection in young animals may have severe consequences. There is enteritis with erosion of the mucosa of the small intestine, and haemorrhages. Bloody diarrhoea occurs in heavy infections. Dehydration develops rapidly, and death may occur.

### Swine

Strongyloidosis caused by →*Strongyloides ransomi* occurs in swine. Clinical outbreaks principally affect piglets. Signs include anorexia, loss of weight, diarrhoea (rarely haemorrhagic), dehydration, slight to moderate anaemia. Severe infections may be fatal.

### Therapy

→**Nematocidal Drugs, Animals**.

## Strongylus vulgaris

### Name

Greek: *strongylos* = rounded.

### Classification

Species of the nematode family Strongylidae.

### Life Cycle

The species of the genus *Strongylus* (*S. vulgaris*, *S. equinus*, *S. edentatus*, *S. asini*) are 1–5 cm long, yellowish-brown roundworms with a buccal capsule (Figs. 1, 2). They are found worldwide in the caeca and colon of equids. The **prepatent periods** are long (6.5–11 months), since the larva 3 starts a parental wandering (and rest) after being taken up with the food.

### Diseases

→**Cardiovascular System Diseases, Animals**, →**Nervous System Diseases, Horses**.

## Stumpy Form

Trypomastigote stages of the *T. brucei*-group prepared to settle in the intestinal tract of the vector after its blood meal.

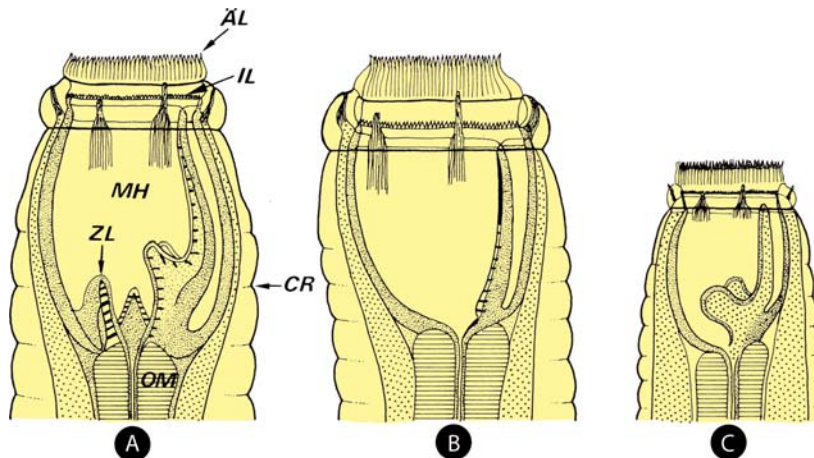

**Strongylus vulgaris. Figure 1** DR of anterior ends (from left: *Strongylus equinus*, *S. edentatus*, *S. vulgaris*). *AL*, outer crown of lamellae; *CR*, cuticular annulus; *IL*, inner crown of lamellae; *MH*, buccal cavity; *OM*, muscles of oesophagus; *ZL*, toothlike structures.



*Strongylus vulgaris*. Figure 2 LM of an egg.

## Stylocephalus longicollis

→ Gregarines.

## Stylostome

Channel-like structure which is formed by → *Neotrombicula* → mites during sucking at the host's surface.

## Subpellicular Microtubules

Components of the → pellicle of many → Protozoa where the single outer membrane (e.g., trypanosomes) or the membranous complexes (→ Apicomplexa, → Ciliophora) have → microtubules (~25 nm in diameter) underneath them (→ Pellicle/Figs. 2–4). In coccidians the number of microtubules is species-specific (e.g., *Toxoplasma* has 22) and they are anchored at the apical → polar ring (→ Coccidia/Host Cell Invasion/Motility).

## Substrate Level Phosphorylation

→ Energy Metabolism.

## Subunit Vaccines

→ Vaccination Against Nematodes.

## Succinea

Genus of snails, intermediate host of the small lungworms of cattle.

## Succinyl CoA Synthetase

→ Energy Metabolism.

## Sucker

Organ of attachment; → Digenea, → Cestodes, → Leeches.

## Suifilaria suis

Species of the nematode family Filariidae parasitizing in pigs.

## Sulfadiazine

Sulfonamid drug to treat → toxoplasmosis, → babesiosis.

## Sulfadimethoxine

Drug to treat →[toxoplasmosis](#).

## Sulfadimidine and Other Sulfonamides

→[Drugs](#) to treat →[toxoplasmosis](#), →[coccidiosis](#), →[malaria](#).

## Sulfadoxine

→[Coccidiocidal Drugs](#).

## Sulfamethoxazole

→[Pneumocystosis](#).

## Sulfaquinoxaline

→[Coccidiocidal Drugs](#).

## Sulfonamides

→[Coccidiocidal Drugs](#).

## Summer Bleeding

Symptom of disease due to infections with →[Parafilaria](#) spp., which form skin nodules. These nodules break off due to UV-light leading to skin bleeding. The microfilariae are then found in the wound and become transmitted by →[Haematobia](#) flies.

## Summer Influenza

Disease (flu) due to the Tahyna virus which is (occasionally) transmitted during bites of blood-sucking →[mosquitoes](#) in the European summer.

## Summer Ostertagiosis

Infection due to →[Ostertagia](#), see also →[Nematodes](#).

## Sunken Epithelium

The inner →[cell membrane](#) of the syncytical →[tegument](#) of →[Platyhelminthes](#) is connected to finger-like protrusions of parenchymal cells (→[Platyhelminthes/Figs. 11, →19](#)), the cell body (cyton) of which is situated below the circular and longitudinal muscle bundles. These connections, which pass the basal lamina, led in earlier light microscopic studies to descriptions such as “sunken epithelium” for the body wall of platyhelminths (→[Platyhelminthes/Integument](#)).

## Superinfection

Occurrence of a second infection besides an existing primary one.

## Suprapopulation

This term describes all individuals (including all developmental stages) in all hosts in a given ecosystem.

## Suramin

→[Trypanocidal Drugs](#), →[Trypanosomiasis](#), African.

## Surface Coat

### Synonym

→Glycocalyx (→Apicomplexa/Surface Coat).

### General Information

Surface coats are present both in protozoan and in helminthic endoparasites. In general, the plasma membrane of cells is strikingly asymmetric, its outer and inner layers are clearly delineated and the polypeptides on each surface are distinct. Glycolipids, glycoproteins, and glycosphingolipids are present only on the external surface. The peripheral layer is rich in →carbohydrate and is called the glycocalyx, or surface coat. The thickness of this layer varies with the species and with the developmental stage of the organism (Fig. 1, →Pellicle/Fig. 3A). Not only is the surface coat composed of glycoproteins and glycolipids, but various glycoproteins and proteoglycans (acid mucopolysaccharides) may also be adsorbed to it (for more details see →Apicomplexa/Surface Coat). The surface coat may be a rather delicate coating, a mass of delicate filaments, or a thick mat, and it comprises 10% of the cell protein. Whatever its structure, the surface coat has several functions in the life of the organism: (1) it acts as a mechanical or chemical barrier; (2) it

plays a role in recognition and adhesion to other cells; (3) it contains enzymes that act on substances in the environment; and (4) it contains molecules that can act as antigens and thus plays an important role in the initiation of immunological processes. The surface coat may change its composition as the parasite develops from stage to stage.

What has been originally described as a surface coat on parasitic →Protozoa has further been shown to be the electron microscopic image of surface glycoproteins or glycolipids sharing a common original feature: all the molecules are anchored in the plasma membrane by a →glycosylphosphatidylinositol (GPI) moiety. This type of anchor had been discovered in trypanosomes, before being found in many eucaryotic cells, where it often coexists with transmembrane proteins. In parasitic protozoa, the GPI anchor is by far the most important type of plasmalemmal protein.

The surface coat that fulfills its tasks in defending the cell against environmental influences while covering “normal” and parasitic cells is thought to be the ancestor of all cuticular systems of the whole animal and plant world. Apparently during evolution, the glycocalyx, while situated between body- and/or cell protrusions (e.g., →microvilli, protuberances), became fortified by enclosing fibers of →collagen, →chitin, Cellulose, and/or calcium carbonate components, etc. Thus, the original protection system received a second

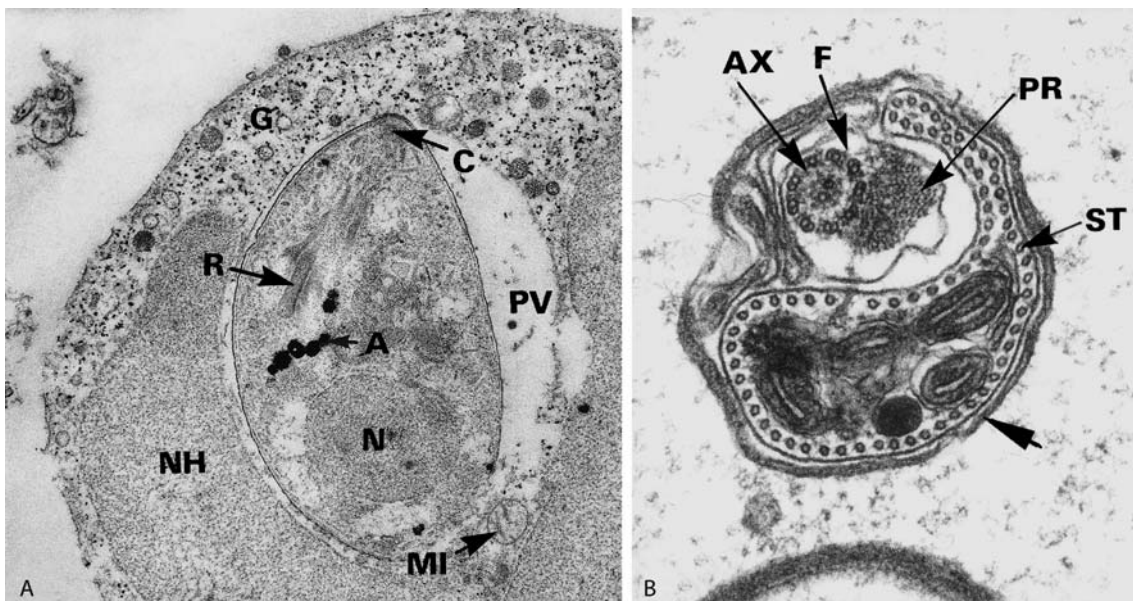

**Surface Coat. Figure 1** TEMs of the surface coat. **A** →*Toxoplasma gondii*; the →zoite within a host cell vacuole (PV) shows a slight positive Thiéry reaction along its surface (arrow). Note the presence of →amylopectin (A) granules in the parasite and of →glycogen (G) in the host cell. C, →conoid; MI, mitochondrion; N, nucleus; NH, nucleus of the host cell; R, →rhoptry (× 7,000). **B** →*Trypanosoma vivax*; cross-section through a trypomastigote stage showing the discharge of a thick surface coat (arrow). AX, →axoneme; F, →flagellum; PR, →paraxial rod; ST, →subpellicular microtubule (× 25,000).



function, i.e., the preservation of the body shape as a system belonging to the exoskeleton. However, the uptake of nutrients through this increasing outer surface remained possible by using a variety of mechanisms and carrier systems. Thus, for example, schistosomes are able to take in huge amounts of glucose through their surface membranes and [→nematodes](#) may become hidden by several drugs due to their cuticular uptake, too ([→Platyhelminthes/Integument](#), [→Nematodes/Surface Coat](#), [→Acanthocephala/Surface Coat](#)).

### Antigenic Variation

Many parasitic Protozoa, in particular the blood stages of the [→trypanosomes](#), have developed the ability to change their surface coat by [→antigenic variation](#) (Fig. 2). This may be achieved by selective activation of different genes at different times. Organisms of the *Trypanosoma brucei* group have up to 1,000 genes that may be activated during the production of variant surface glycoproteins (VSGs). This selective activation results in changes in the [→variable antigen types](#) (VATs) displayed and hinders the host defense against these blood-inhabiting flagellates. Blood stages

of [→Plasmodium](#) and piroplasmian species may also display variant antigen types, but there are fewer variants than those displayed by trypanosomes. The action of these genes results in antigenic variation and the production of immunologically different strains of Protozoa; this explains why most antiprotozoal vaccines provide only limited protection, restricted to certain localities. The development of potent vaccines against protozoan parasites depends on the discovery of species-specific antigens with invariant epitopes that are accessible to the immune system during the parasite's life (Fig. 2). In addition, they must be essential to the parasite's survival, possibly playing an important role in cell recognition, adhesion, [→immune evasion](#), metabolism, and/or cell invasion. Whether such antigens exist in significant amounts, in various developmental stages of many parasitic stages, remains to be determined.

Inside their evertbrate vector the parasitic stages develop a surface coat, too. Thus the trypanosomatids shed their VSG-coat when they reach their vector's intestine and replace it by a coat called [→Procyclin](#) or [→PARP](#) ([→Procyclic Acidic Repetitive Protein](#)) which consists of 400-500 aminoacids linked (like the VSGs)

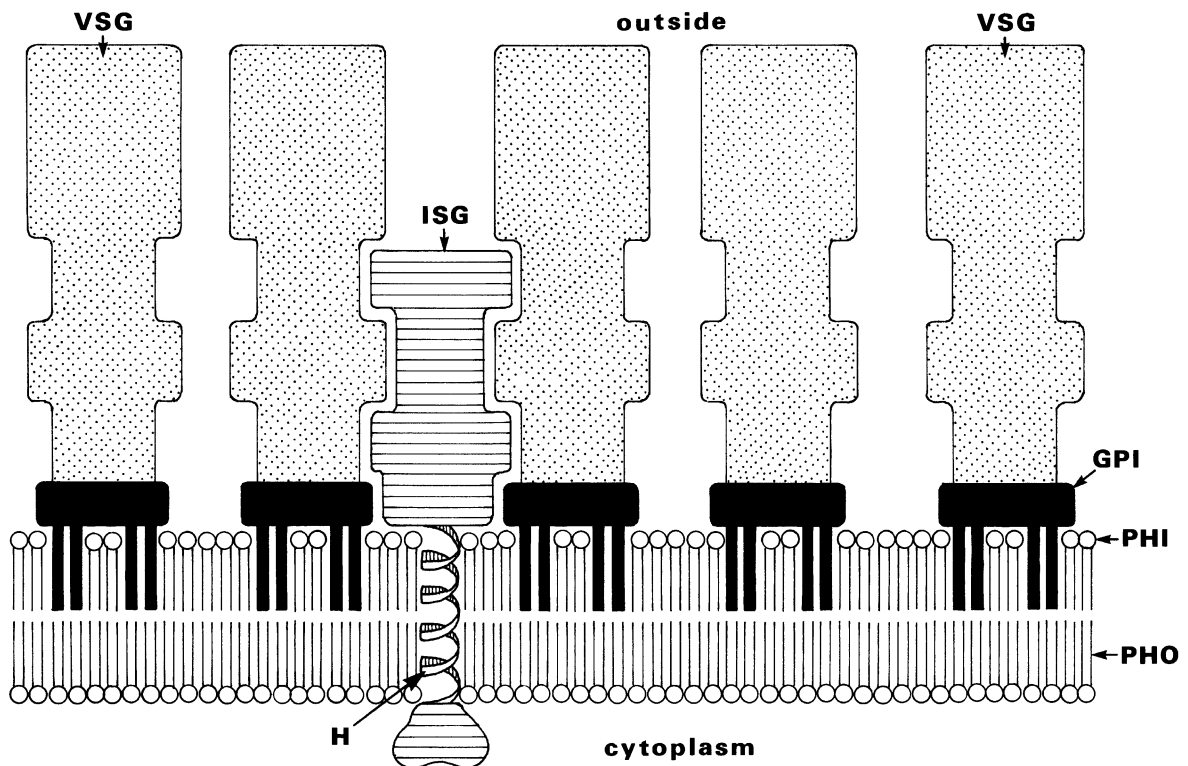

**Surface Coat. Figure 2** Diagrammatic representation of a cell, the surface of which is covered by a surface coat consisting of variant surface glycoproteins ([→VSG](#)) and a few (ratio 1:100) invariant surface proteins (ISG). Both are differently anchored in the membrane. The transmembranous proteins, glycolipids, and sphingolipids, etc. are not drawn. *GPI*, glycosulphatidylinositol-anchor; *H*,  $\alpha$ -helical anchor; *ISG*, invariant surface glycoprotein; *PHI*, hydrophilic region of the [→cell membrane](#); *PHO*, hydrophobic region of the cell membrane; *VSG*, variant (dimeric) surface protein.

to the parasite's cell membrane by a GPI-anchor (→[Glycosylphosphatidylinositols](#)). However, this PARP-coat, which is regulated by the activity of 8 genes shows apparently no variation and is not preserved in bloodstream forms. As was recently shown, both PARP- and VSG-genes become transcribed by RNA-polymerase I, which normally only transcribes the ribosomal RNAs and which does not add a cap to the 5'-end of the RNA. This peculiar occurrence – probably made possible because of *trans*-splicing – is perhaps expression of the rather early divergence of the trypanosomatids from the eukaryotic lineage.

---

## Surra

*Trypanosoma evansi* (syn. *T. equinum*) has a wide range of hosts and is pathogenic to most domestic animals (→[Trypanosomiasis, Animals](#)). Camels, horses, dogs, and Asian elephants are highly susceptible. The infection in horses (called surra) and dogs is severe and probably uniformly fatal in the absence of adequate treatment. Cattle are mildly affected and act as reservoir.

### Therapy

→[Trypanocidal Drugs, Animals](#).

---

## Surra-Syndrome

Disease of ruminants due to an infection with *Trypanosoma brucei evansi*, named in honour of its discoverer (G. H. Evans), who described the parasite in 1880 in India. The name comes from Hindi language: *surra* = foul, degenerating.

---

## Survival Strategies, Protozoa

Intracellular protozoans have developed different strategies to survive attacks of the host defense systems. Examples are:

1. *Leishmania* spp. invade by receptor-mediated phagocytosis, are placed inside phagolysosomes, become protected inside by lipophosphoglycan.
2. *Trypanosoma cruzi* tissue stages enter actively their host cells, lay immediately in the cytoplasm, and are

protected there by a protein (C 9 cross-reactive protein, TcTox trans-sialidase).

3. *Toxoplasma gondii* tachyzoites enter actively, are situated in a fusion-resistant parasitophorous vacuole and are protected there by the excreted proteins of micronemes, rhoptries, and dense granules.

---

## Swarmer

Infectious stage of some ciliates →[Ichthyophthirius multifiliis](#) and →[Cryptocaryon irritans](#); they are formed inside cysts at the bottom of their habitat (e.g., pond, lake).

---

## Swarming

Males of several →[mosquitoes](#) form swarms in the evening twilight and this attracts females in order to mate.

---

## Sweating Sickness

This is an acute toxicosis of cattle, sheep, goats, pigs due to injection of immunogenic toxins in the saliva of the tick *Hyalomma truncatum* in South Africa and India.

### Symptoms

Name-giving sweating, lacrimation, salivation, acute dermatitis, stomatitis, and secondary infections. →[Tick Bites: Effects in Animals](#).

---

## Sweet Itch

Disease (also named: summer wounds) in horses due to bites of midges (→[Ceratopogonidae](#)). In horses these *Culicoides*-spp. bite along the margin of the eyes, at the belly and feet. Their aggressive saliva introduces pain and intensive allergic reactions in the skin.

## Swimmer's Itch

Dermatitis due to penetrating →[cercariae](#) of →[Schistosoma](#) and related species, →[cercarial dermatitis](#).

## Swollen-Belly-Syndrome

Symptom/syndrome in children due to infection with →[Strongyloides fuelleborni](#) (protein-losing-enteropathy, respiratory distress, diarrhea); in dogs →[Toxocara canis](#) Toxocariasis (→[Toxocara](#)/Fig. 1).

## Symbionts

→[Lice](#), →[Filariidae](#), →[Glossina](#), →[Wolbachia](#).

## Symbionts in Tsetse Flies

There are 2 members of the enterobacterian type found in the gut. The obligate mutualist *Wigglesworthia* and the facultative secondary (= S =) symbiont *Sodalis*. A third type is the parasite microbe *Wolbachia pipientis* which is related to the  $\lambda$ -proteobacteria. The gut microbes are transmitted to the progeny of the flies via the mother's "milk glands", while the *Wolbachia*-stages are included into the eggs.

## Symbiosis

### Name

From Greek: *symbiosis* = living together.

This term describes the cohabitation of 2 different types of organisms, both benefiting from this way of living. For example, see the occurrence of →[Wolbachia](#)-bacteria in insects or filariid worms.

## Sympatry

From Greek: *sym, syn* = together; Latin: *patria* = homeland. Occurrence of 2 species within the same geographic zone or the same habitat.

## Symphoromyia

Genus of →[snipe flies](#).

## Synanthropic Cycle

Life cycle of parasites involving humans at essential positions.

## Synapomorphy

A shared derived character state. →[Phylogeny](#).

## Synapses

→[Nervous System of Platyhelminthes](#).

## Synaptonemal Complex

Attachment zone of pairing →[chromosomes](#); this region appears in electron microscopy as a bandlike, 100 nm broad, striated zone, see →[Cestodes/Reproduction](#), →[Platyhelminthes](#).

## Synchronicity

Phenomenon found in all human malarial parasites, that after a short phase of adaptation the growing of schizonts, the formation of merozoites, and the resulting rupture of the red blood cells occur at the same time in all infected red blood cells. It has been suggested the paroxysms of fever sharpen the level of synchronicity. Furthermore the host's circadian rhythm is also a determining factor. Altogether synchronicity represents an adaptation of the parasites to optimize the transmission by night-biting mosquitoes (→*Anopheles* spp.).

## Syncytium

Mass of →cytoplasm containing many nuclei enclosed in a single continuous plasma membrane (→Plasmalemma, →Tegument, →Platyhelminthes/Integument).

## Synergists

### Important Compound

Piperonylbutoxide (PBO), n-octyl bicycloheptene dicarboximide (MGK 264).

### General Information

Synergists usually enhance the efficacy of an →arthropodicidal drug without displaying toxic effects by themselves. In most cases synergists are thought to act by inhibiting metabolism of a given drug and in this context can be used at least, sometimes to prolong the activity of a compound in resistant parasite strains. PBO, one of the most frequently used synergists, inhibits cytochrome P-450 microsomal monooxygenases, and is used together with DEET (→Repellents) and pyrethrins (→Arthropodicidal Drugs/Pyrethroids and DDT) to control →lice and biting →midges on companion animals.

## Syngamus trachea

### Name

Greek: *syn* = together, *gamein* = copulating (since the worms are mostly found in constant copula).

## Classification

Species of the nematode family Syngamidae; worms live in the trachea (Fig. 1, page 1346).

## Life Cycle

The adult worms (female 5–20 mm, male 2–8 mm) are found attached by their large buccal capsules at the wall of the trachea. They suck blood and thus appear reddish. The eggs are excreted with the host's faeces. The larva 3 develops within 2–4 weeks (often still within the eggshell). Paratenic hosts are earthworms. When orally taken up the L<sub>3</sub> wanders from the intestine via lung into the trachea, where the mature adults finally copulate. →Nematodes.

## Prepatency

3 weeks, lifespan 3–7 months.

## Therapy

→Nematocidal Drugs.

## Syngamy

Sexual process in which differently determined →Gametes fuse completely, whether they include large (iso- or →anisogametes) or only small (→Microgametes) amounts of cytoplasmic material. Syngamy always starts with the fusion of the limiting membranes (→Gametes/Figs. 4, 5), thus leading to a unicellular diplokaryon. Although karyogamy may be more or less delayed, depending on the species, no further fertilization can occur along the surface of such →zygote, whether a fertilization membrane (as in some eimerian species) is formed or not.

## Synganglion

→Ticks/Nervous System.

## Synxenic Speciation

→Speciation.

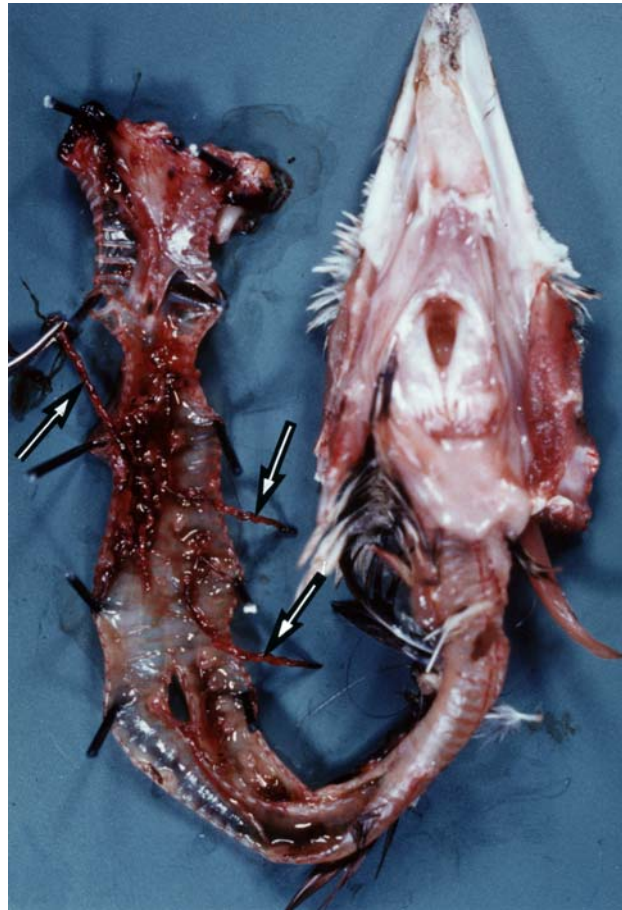

**Syngamus trachea.** Figure 1 Adults in the trachea of a bird.

## Syphacia

Genus of the nematode family Oxyuridae. *Syphacia* spp. (*S. muris*, *S. obvelata*) and *Aspiculuris* spp. occur in the caeca and colon of rats, mice, and hamsters. Males are 1.5  $\mu\text{m}$ , females up to 4.5 mm long. The eggs of *S. obvelata* are crescent-shaped ( $150 \times 50 \mu\text{m}$ ) and contain only a morula (*S. muris* contains a larva), Fig. 1 (page 1347).

### Prepatent Period

9 days.

### Therapy

→[Nematocidal Drugs](#).

## Syringophilus

The mite *S. bipectinatus* (Fig. 1) lives inside the bases of feathers of birds and leads to their loss. →[Mites](#).

## Systematics

### General Information

For centuries, scientists have tried to detect, identify, describe, compare and analyze organisms and their amazing diversity. This endeavour is known as systematics, which can be defined as “the scientific study of the kinds and diversity of organisms and of any

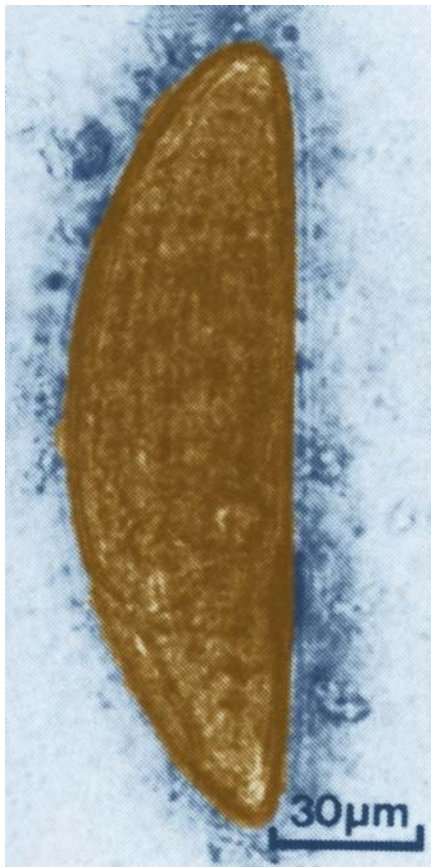

**Syphacia.** Figure 1 LM of eggs of *Syphacia obvelata*.

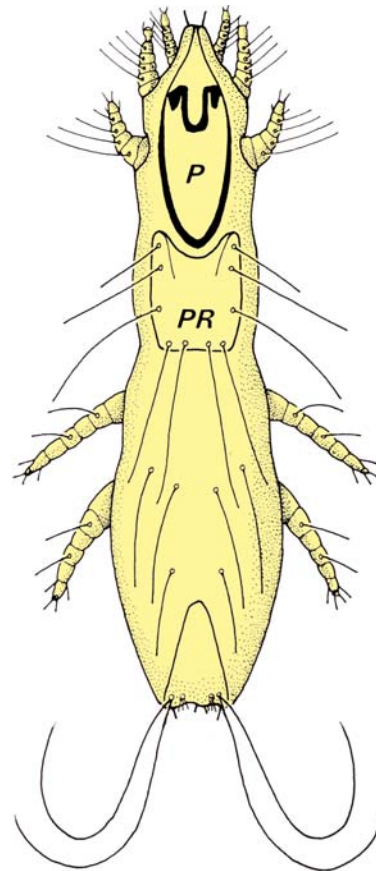

**Syringophilus.** Figure 1 DR of a female mite. *P*, propodosoma; *PR*, shield of propodosoma.

or all of the relationships among them". Thus the final goal of systematic research is to detect and to identify species, to describe and to name them according to well-accepted rules and to place them into a hierarchical system which should consider the history of evolution, i.e., the phylogenetic relationships of species. Hillis and Moritz preferred to use systematics in the broad sense of the term, that is to elucidate both interspecific as well as intraspecific diversity, to study the variation within populations and the factors which causes population diversity, leading finally to the development of new species. Therefore systematic research is concerned with →population genetics, →phylogeny, →speciation and cospeciation (host-parasite interaction), taxonomy and nomenclature (→Classification).

Up to the sixties of this century, organisms have been primarily identified and named on the basis of their morphology, biochemistry, ecology, epidemiology and behaviour, i.e., phenotypic markers. Phylogenies have been constructed using morphological, biochemical and behavioural characteristics. The classification of parasites is no exception. Individual parasites have been detected and identified on the basis of their

morphology, the host-parasite interaction (i.e., host-specificity, number of hosts within the life cycle, pathogenetic effects on the host), their epidemiology, their behaviour and their geographical distribution. But many parasites have developed complicated Life cycles, including more than one host, and this is compounded by striking morphological differences at different stages in their development. Other parasites have evolved along long lines revealing striking morphological similarities although they are not closely related species. Parasitic →protozoa or →nematodes have little to offer in terms of morphological characteristics although the invention of the electron microscope provided new insights into the morphology of these organisms. Some of the parasites are very host-specific whereas closely related species are capable of infecting a variety of different hosts. Therefore the use of phenotypic characteristics for taxonomic purposes can be troublesome and of limited use as far as parasites are concerned, because the adoption of a parasitic lifestyle is often accompanied by dramatic alterations which make it difficult to identify these organisms, to distinguish between species, and it might finally blur the taxonomic

position. However, the unambiguous identification and characterization of parasites is not only relevant for taxonomic purposes but also of special importance for diagnosis, treatment and →disease control. A knowledge of phylogenetic relationships between parasites is fundamental for understanding parasitism in general and the results of these analyses may inspire new approaches in diagnosis, vaccine development and treatment of important parasites in humans and animals. Detailed data on population diversity are relevant for the identification of cryptic species and may explain differences in virulence or drug resistance.

### Phylogenetic Systematics

Only the very early attempts to compare and to describe organisms were independent from evolutionary aspects, but, as Mayr pointed out, since Darwin and Haeckel, the classification of species considers phylogenetic relationships as well. The last thirty years are characterized by numerous attempts to construct phylogenetic trees (→Phylogeny/Phylogenetic Trees) on the bases of reliable and repeatable methods. The most widely accepted method derived from the cladistic approach invented by Hennig (→Phylogeny). The increasing interest in cladistics (used in the broad sense of the term) gave rise to more sophisticated analytical methods, and the process of evaluating and analyzing the data resulted in different and sometimes conflicting classifications. This is especially true for unicellular eukaryotes (12, 13, 18, 19, 20, 53, 55, 63, 64, 113), which reveal an amazing diversity, exceeding by far that of multicellular eukaryotes. Andrews and Chilton criticized the fact that the term systematics is used nowadays in a very restricted manner, i.e., that many authors equate systematics with phylogenetics. It may be, that phylogenetic studies seem to dominate the research in systematics. However, Vickerman pointed out that, for example, the hitherto utilitarian systematics of unicellular eukaryotes may be replaced in the near future by a more natural system based on evolutionary relationships, resulting from the impact of new phylogenetics based on genetic information. Additionally, the careful interpretation of phylogenetic analyses provides valuable information on →population genetics and their parameters.

### Molecular Systematics

The molecular approach in systematics utilizes the genetic information of organisms which is stored in genomes (including that of organelles) at the level of →chromosomes, gene sequences, and their secondary products, proteins. Molecular data offer some advantages, which can be successfully used for different purposes. Gene sequences (e.g., ribosomal RNA genes) are comparable although the species to be compared are

disparate (e.g., helminths, humans, and bacteria). The rationale is that some homologous genes are present in all major lineages of organisms. Consequently molecular data can be used across a wide taxonomic range. Genes or parts of the genomes evolve at different rates, therefore molecular data may either elucidate microevolutionary events within populations, including the process of →speciation, or reveal the evolution of major lineages of species in the course of millions of years. Finally some genes evolve at constant rates allowing us to estimate the time of divergence using molecular clocks. The last 20 or 30 years have seen the invention of new molecular methods and vast improvements of sophisticated frameworks for analyzing the data. Additionally, Hillis and Moritz pointed out that systematic research, especially phylogenetics (→Phylogeny), and research in →population genetics are now linked. Cooperation between these 2 disciplines is essential for understanding evolution.

The value of genetic information for systematic research is generally accepted and different methods, combined with mathematical frameworks, have been developed to analyze population genetics, phylogeny, cospeciation, and to identify and characterize organisms. Page and Holmes complained about the tendency, with the invention of new methods, to consider the well-established and valuable ones as old-fashioned and unsuitable; this is clearly not acceptable. The combination of different approaches, using different methods and different characteristics, is necessary to address all aspects of systematic research. The final goal must be to use every possible source of information which is available to understand the diversity and evolution of organisms.

---

## Syzygy

The term describes still motile stages consisting of 2 gamonts of →gregarines or adeleideans (→*Karyolysus lacertae*) that are attached to each other; later (en-sheathed or not) they start formation of →gametes. The whole process is also called →gamontogamy.

---

## Szidat's Hypothesis

The more evolutionarily specialized the host group, the more specialized are the parasites. Thus the degree of specialization of the parasites may serve as a clue to the phylogenetic position of the host.

## Tabanidosis

Disease due to infestation with tabanids, (Table 1, page 1350).

## Tabanids

From Latin: *tabanus* = biting fly (Fig. 1, page 1350).  
Group of biting →Diptera/Fig. 1.

## Tabanus

From Latin: *tabanus* = biting fly; large bloodsuckers with cutting mouthparts (→Pool Feeders).→Diptera, →Insects/Fig. 9.

## TAC

→Tripartite Attachment Complex.

## Tachyzoite–Bradyzoite Interconversion

The 2 developmental (asexual stages) of →*Toxoplasma* inside intermediate hosts change their activity if several conditions are given:

1. Tachyzoite →bradyzoite
  - high pH
  - low pH
  - heat shock
  - mitochondrial inhibition

- presence of nitric oxids

2. Bradyzoite →tachyzoite

- lack of nitric oxids
- lack of IFN  $\gamma$
- lack of TNF  $\alpha$
- lack of T cells
- lack of IL-12

## Tachyzoites

### Name

Greek: *tachys* = quick.

Motile stages, which divide rapidly by →endodyogeny, of tissue-forming coccidians (e.g., →*Toxoplasma*). They are formed in →parasitophorous vacuoles within macrophages and other cells.

## Taenia

### Name

Greek: *tainia* = belt, band.

### Classification

Genus of →Eucestoda.

### Important Species

Table 1 (page 1351).

### Life Cycle

Fig. 1 (page 1352).

### Morphology

Fig. 3 (page 1354), →Eucestoda, →Platyhelminthes.

### Development

Fig. 2 (page 1353), →Eucestoda.



**Tabanidosis. Table 1** Tabanids and control measurements

Parasite	Host	Vector for	Symptoms	Country	Therapy		
					Products	Application	Compounds
<i>Tabanus</i> spp. (Horse flies)	Ruminants, Horse	Bact. infections (e.g., Leptospirosis, Listeriosis)	Females suck blood; irritation, allergic reactions, economic loss	Worldwide	Many	Pour on	Pyrethroids
<i>Tabanus bromius</i>	Ruminants			Central Europe			
<i>Tabanus spodopterus</i>	Ruminants						
<i>Tabanus atratus</i>	Ruminants						
<i>Tabanus sudeticus</i>	Horse						
<i>Hybomitra ciurea</i>	Ruminants						
<i>Chrysops caecutiens</i> (Deer flies)	Ruminants, Horse						
<i>Chrysops relictus</i> (Deer flies)	Ruminants						
<i>Haematopota pluvialis</i> (Rain biter)	Ruminants, Horse				Bayofly Pour on (Bayer)	Pour on	Cyfluthrin
<i>Haematopota italica</i>	Horse						
Tropic tabanids	Horse	<i>Trypanosoma brucei evansi</i> ("Surra"); <i>Trypanosoma brucei equinum</i> ("Mal de	Females suck blood, bothering	Tropic areas			

**Tabanids. Figure 1** Adult *Haematopota pluvialis* (common rain biter) on human skin.**Diseases**

→ Taeniasis, Animals, → Taeniasis, Man, → Cysticercosis,  
→ Neurocysticercosis.

**Taenia crassiceps**

→ Behavior.

**Taenia multiceps**

→ Coenurosis, Animals.

**Taenia saginata**

From Latin: *taenia* = band, *saginata* = fed, thick. Large human tapeworm (Figs. 1–3, page 1354, 1355).

**Taenia.** Table 1 Important species of the genus *Taenia*

Species	Length of adult worm (m)	Egg size ( $\mu\text{m}$ )	Final host	Prepatent period	Intermediate host (i.h.)/Habitat	Stage inside intermediate host (i.h.)
<i>Taenia solium</i>	2–7	35–40	<b>Humans</b>	5–12	Pigs, humans/Many tissues	Cysticercus; <i>C. cellulosae</i>
<i>T. saginata</i>	6–15	35–40	<b>Humans</b>	10–12	Cattle/Many organs	Cysticercus; <i>C. bovis</i> ( <i>C. intermis</i> )
<i>T. asiatica</i>	5–7	35–40	<b>Humans</b>	8–18	Pigs, cattle, goat	Cysticercus
<i>T. (= Hydatigera) taeniaeformis</i>	0.6	35	Cats	7	Rats, mice/Various organs	Strobilocercus; <i>Cysticercus fasciolaris</i>
<i>T. hydatigena</i>	1	20	Dogs	11–12	Ruminants/Omentum	Cysticercus; <i>C. tenuicollis</i>
<i>T. ovis</i>	1	30	Dogs, foxes	6–7	Sheep/Muscles	Cysticercus; <i>C. ovis</i>
<i>T. pisiformis</i>	0.5–2	35	Dogs, cats	6	Rodents/Omentum	Cysticercus; <i>C. pisiformis</i>
<i>T. (= Multiceps) multiceps</i>	0.4–1	33	Dogs, foxes	6	Sheep, humans/Brain	Coenurus; <i>C. cerebralis</i>
<i>T. serialis</i>	0.2–0.7	35	Dogs, foxes	1–2	Lagomorpha/Connective tissues	Coenurus

## Taenia solium

### Name

From Latin: *taenia* = band, Arabian: *sosl* = chain.

Smaller human tapeworm (Figs. 1, 2, page 1355).  
 →Eucestoda, →Taeniasis, Animals, →Taeniasis, Man.

## Taenia taeniaeformis

→Cestodes.

## Taeniasis, Animals

Figs. 1, 2 (page 1356) →Alimentary System Diseases, Animals, →Taenia, →Platyhelminthes.

## Taeniasis, Man

Taeniasis with *T. saginata* and *T. solium* →tapeworms (→Taenia) in the small intestinal lumen is largely asymptomatic. Microscopic lesions have not been described, except for slight →eosinophilia. However,

after ingestion of *T. solium* eggs humans can act as intermediate hosts. The larval cysts develop in almost any tissue and can cause serious damage especially when they involve special areas of the brain (→Cysticercosis).

**Main clinical symptoms:** Loss of weight, →abdominal pain, →anal pruritus.

**Incubation period:** 8 weeks.

**Prepatent period:** 8–18 weeks.

**Patent period:** 25 years in man.

**Diagnosis:** Occurrence of typical white →proglottids in feces (Fig. 1, 1356).

**Prophylaxis:** Avoid eating raw meat.

**Therapy:** Treatment with praziquantel, see →Cestocidal Drugs.

### Related entry

→Taenia.

## Taeniidae

→Eucestoda.

## Taeniorhynchus

Genus of family Culicidae, now synonym to →Mansonia.

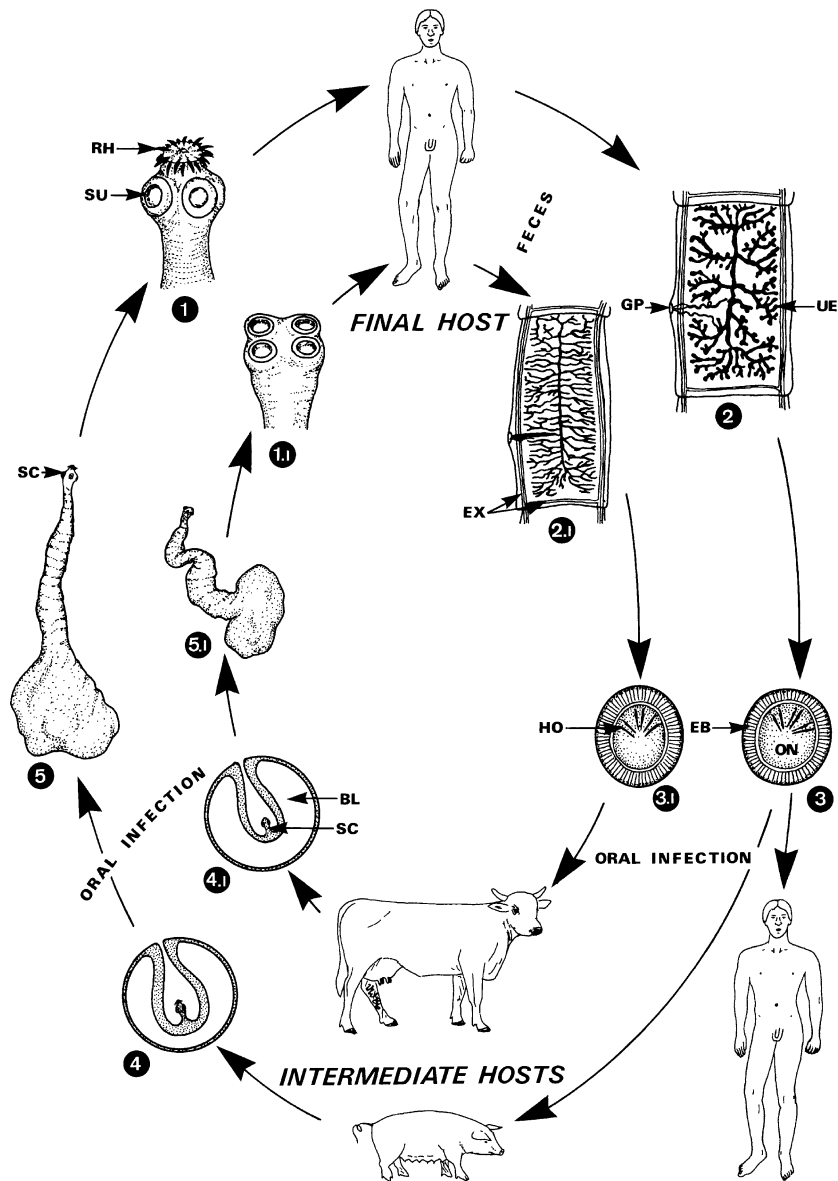

**Taenia.** Figure 1 Life cycles of *Taenia solium* (1–5) and *T. saginata* (1.1–5.1). 1–2.1 Adult worms live exclusively in the intestine of man and reach a length of 4–6 m (*T. solium*) or 6–10 m (*T. saginata*) often with about 2,000 proglottids. The scolex of *T. solium* is endowed with an armed rostellum (1). The terminal proglottids (10–20 × 5–7 mm) are characterized by a typically branched uterus filled with up to 100,000 eggs. On each day 6–7 of these proglottids detach and may either pass out with the feces or actively migrate out of the anus. 3, 3.1 As an excreted proglottid begins to dry up, a rupture occurs along the midventral and terminal regions, and allows eggs to escape. The spherical eggs (40–45 μm; indistinguishable between species) originally have a hyaline outer membrane (Eggshell) which is usually lost by the time the eggs are voided with the feces. Thus, the eggs are bordered by a thick, striated embryophore surrounding the oncosphere (ON). 4, 4.1 When eaten by the intermediate host, the oncosphere hatches in the duodenum, penetrates the mucosa, enters a venule, and is carried throughout the body. A bladder worm (Cysticercus) of about 7–9 × 5 mm is formed, reaching infectivity in about 2 months (*C. cellulosae* in *T. solium*; *C. bovis*, *C. inermis* in *T. saginata*). When humans ingest eggs of *T. solium* or a terminal proglottid is destroyed inside the intestine, cysticerci may also readily develop in many organs including brain and eyes. These infections lead to severe disfunctions depending on the parasitized organ (Cysticercosis). 5 A person becomes infected when a bladderworm is eaten along with raw or insufficiently cooked meat. The evaginating scolex becomes attached to the mucosa of the small intestine and matures in about 5–10 weeks. BL, bladder of cysticercus; EB, embryophore; EX, excretory vessels; GP, genital pore; HO, hooks of oncosphaera; ON, oncosphaera; RH, rostellar hooks; SC, scolex; SU, sucker; UE, uterus filled with eggs.

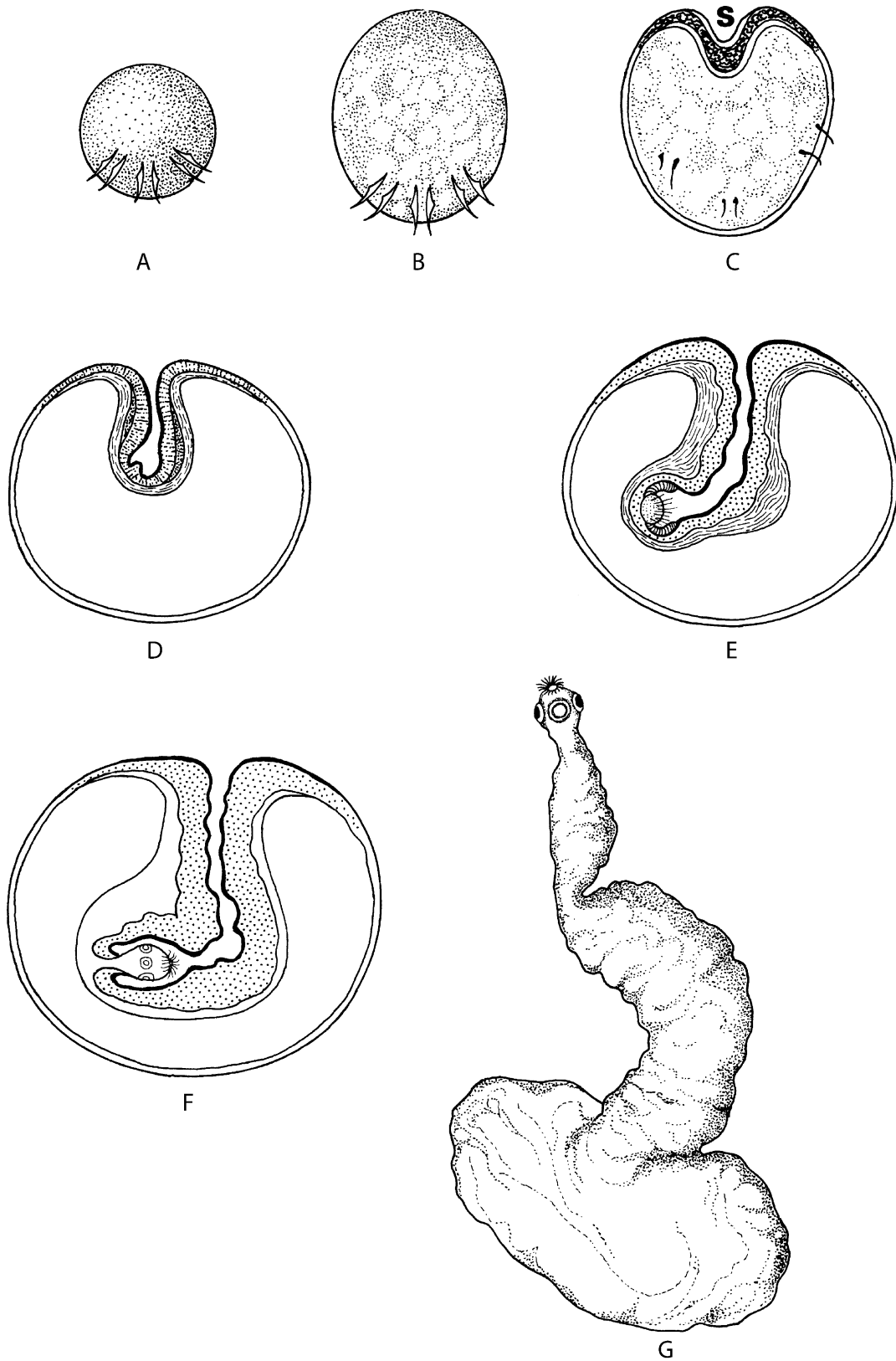

**Taenia.** Figure 2 DR of the development of a young *Taenia solium* worm (G) starting from an oncosphere (A, B) via different stages of cysticercus (C–F). S, scolex anlage.

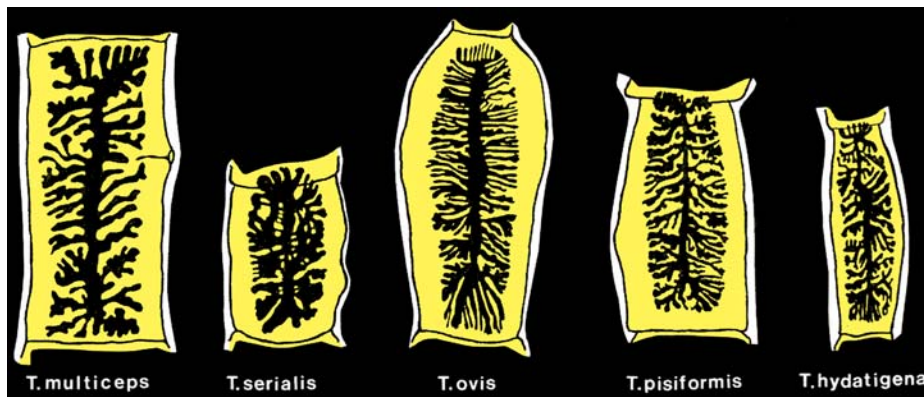

**Taenia.** Figure 3 DR of the excreted proglottids of different tapeworms of carnivores showing the differently branched uteri.

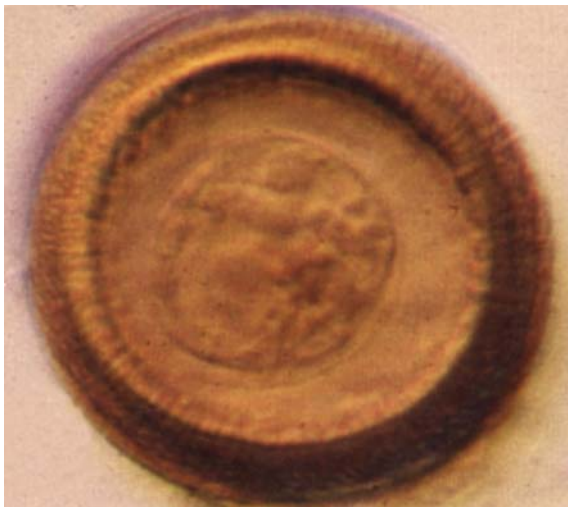

**Taenia saginata.** Figure 1 Egg of *Taenia saginata*.



**Taenia saginata.** Figure 2 Scolex of *Taenia saginata* without hooks.

## Tapeworms

### Synonym

→ Cestodes.

## Targets for Intervention

→ Disease Control, Targets.

## Tapir Nose

Common South American name for → cutaneous leishmaniasis.

## Tarsonemus

### Name

Greek: *tarsos* = basis of the foot, *nemo* = filament, hair.

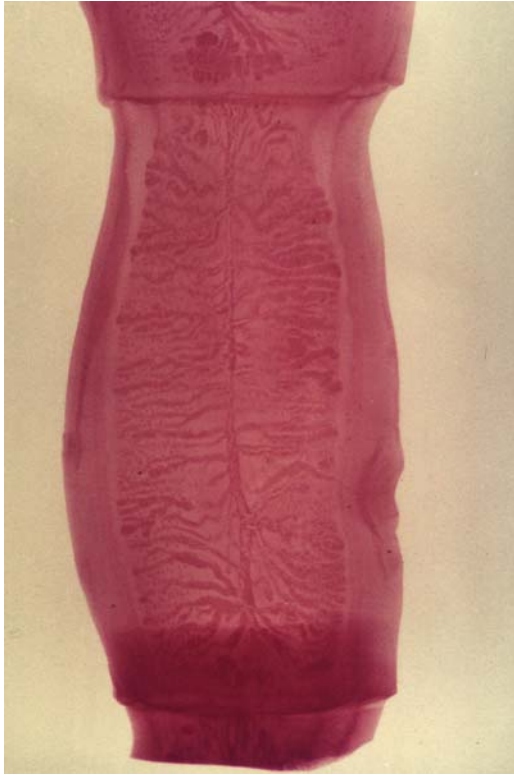

**Taenia saginata.** Figure 3 Typical *Taenia* proglottids.

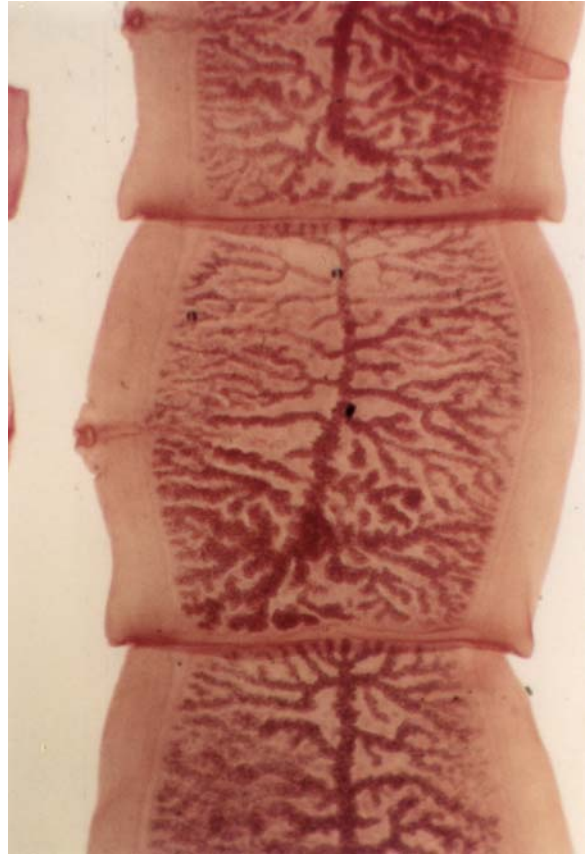

**Taenia solium.** Figure 2 Terminal proglottids of *Taenia solium*.



**Taenia solium.** Figure 1 Scolex (with typical hooks) of *Taenia solium*.

Genus (syn. → *Acarapis*) of the mite family Tarsonemidae, which have long hair at their feet (e.g., → *Acarapis woodi* of the honey bee).

---

## Tau-Fluvalinate

### Chemical Class

Pyrethroid (type II,  $\alpha$ -CN-pyrethroids).

### Mode of Action

Open state voltage-gated sodium channel blocker.  
→ Ectoparasitocides – Blockers / Modulators of Voltage-Gated Sodium Channels.

---

## Tautonymia

### Name

Greek: *tauto* = identical, *onoma* = name.

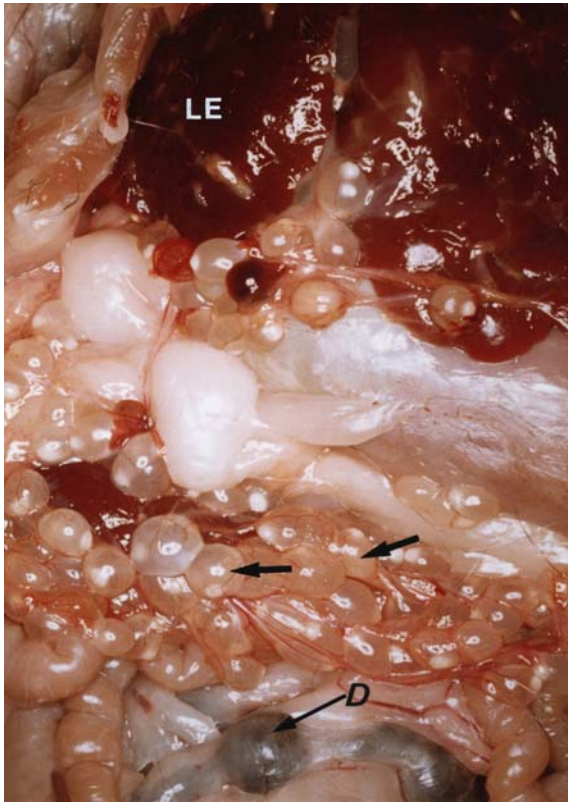

**Taeniasis, Animals. Figure 1** Cysticerci of *Taenia pisiformis* at the omentum of hare (arrows). *D*, intestine, *LE*, liver.



**Taeniasis, Man. Figure 1** Typical singly excreted proglottis of *Taenia*-worms.



**Taeniasis, Animals. Figure 2** Cysticerci of *Taenia hydatigena* in the liver of sheep.

In the Zoological nomenclature it is possible that genus and species names are identical (e.g., the rat acanthocephalan *Moniliformis moniliformis*), while this is forbidden in Botanical nomenclature.

---

## Taxis

### Name

Greek: *taxis* = order.

Taxis describes a type of movement in the direction of, or as a reaction to, a stimulus (positive taxis) or away from such a stimulus (negative taxis), e.g., phototaxis, thigmotaxis, chemotaxis.

---

## Taxon

### Name

Greek: *taxon* (pl. *taxa*) = category.

Taxa are ranks, which are given to different groups of related organs due to their characteristics in order to establish a hierarchical →[classification](#).

## TBE

### Synonym

→[Tick-Borne Encephalitis](#).

## TBF

Thick blood film, →[malaria diagnosis](#).

## TCA-Cycle

Tricarboxylic acid cycle, which is fed by substrates being oxidated in the mitochondrial chain metabolism. Electrons deriving from this cycle are imported into an electron transport chain at the inner mitochondrial membrane. Thus the development of cristate mitochondria is in most cases correlated with an active TCA cycle and the active mitochondrial respiration. →[Energy Metabolism](#).

## T-Cells

→[Immune Responses](#).

## Teclozan

→[Antidiarrhoeal and Antitrichomoniasis Drugs](#).

## Tegument

### Synonym

→[Neodermis](#) (= new skin).

The syncytial cytoplasmic type of →[body cover](#) in which giant nuclei or nuclear fragments may occur. It covers the surface of larval →[platyhelminthes](#) (→[Monogenea](#), →[Digenea](#), →[Cestodes](#) and →[Metazoa](#)) and →[acanthocephala](#), but the tegument of adult parasitic platyhelminths lacks nuclei (→[Platyhelminthes/Integument](#)).

## Tegumental Disks

The →[tegument](#) of →[tapeworms](#) is tightly filled with numerous electron-dense-appearing platelets which are apparently composed of proteins. They are also present in other groups of →[Platyhelminthes](#), but in lower numbers.

## Teladorsagia

### Name

Greek: *telos* = end, finish, Latin: *dorsalis* = belonging to the backside.

### General Information

Genus of the nematode family Trichostrongylidae. *T. circumcineta* and *T. trifucata* are mainly placed in the genus →[Ostertagia](#). They reach as females a length of 12 mm, and 9 mm as males.

## Telamon

→[Nematodes](#).

## Telogonic Ovaries

In most →[nematodes](#) the ovaries are of the telogonic type where the oogonia are formed in the very tip of the ovary and descend the tube, undergoing the various stages of oogenesis (→[Nematodes/Reproductive Organs](#)).

### Related Entry

→[Hologonic Ovaries](#).

## Telogonic Testes

The →[testis](#) of parasitic →[nematodes](#) belonging to the Secernentae is of the telogonic type, one in which the terminal portion of the testis contains the spermatogonia (→[Nematodes/Reproductive Organs](#)).



## Telonymphe

Last stage of scabies-mites, that leaves the skin-channel to copulate on the skin surface. → [Sarcoptes](#).

## TEM

Transmission electron microscopy.

## Temephos

### Chemical Class

Organophosphorous compounds (monothiophosphate).

### Mode of Action

Acetylcholine esterase inhibitor. → [Ectoparasitocides – Agonists and Antagonists of Cholinergic Transmission](#).

## Tenacity

### Name

Latin: *tenacitas* = withstanding.

Resistance of an agent of disease (or a stage of which) against environmental influences, e.g., rate of survival of worm eggs or protozoan cysts when exposed to heat, cold, or dryness.

## Tendons

→ [Insects](#).

## Tenonitrozole

→ [Antidiarrhoeal and Antitrichomoniasis Drugs](#).

## Terminal Cell

### Synonyms

→ [Cyrtoocyte](#); → [Flame Cell](#).

### General Information

The basic component of the protonephritic excretory organs of Platyhelminthes (→ [Platyhelminthes/Excretory System](#)) is the terminal cell which is embedded in the → [parenchyma](#) of the worms. At the basal side, this cell is equipped with typical → [cilia](#) (→ [Platyhelminthes/Fig. 24A](#)), the number of which varies between systematic groups and with the size of the developmental stage. These cilia are attached to each other and are surrounded by a circle of finger-like projections of the terminal cell which run along the inner side of the basal lamina (→ [Platyhelminthes/Fig. 24](#)), which, however, are often missing. The canal cells form a similar ring of protrusions on the outer side of the basement membrane; they stand in the gaps between the inner projections and thus lead to a lattice-like appearance. Ultrafiltration occurs at the basal lamina via the lattice gaps.

The pattern of arrangement and the number of terminal cells is characteristic and may be used for diagnosing species in digeneans, for which flame-cell formula have been established. Adult → [Dicrocoelium dendriticum](#) worms, for example, have 24 of such cyrtocytes (flame cells) symmetrically arranged in consecutive sets of 2, and are thus described by the formula  $2(2 + 2 + 2 + 2 + 2 + 2) = 24$ .

### Fine Structure

→ [Platyhelminthes/Fig. 24, 25](#).

## Ternidens deminutus

### Classification

Species of the nematode family Chabertiidae (superfamily Strongyloidea).

### General Information

This species (female 9–17 mm, male 6–13 mm) is found in monkeys and humans in East Africa, South Africa, Central Africa, and also in Asia. It parasitizes the terminal region of the intestine, where the L<sub>3</sub> enters

the mucosa and the L<sub>4</sub> induces nodules. The eggs (80 × 50 μm) look like those of →hookworms, thus *T. deminutus* is also called “false hookworm.” Outside the body the L<sub>1</sub> hatches from the egg within 2–3 days and the infectious filariform L<sub>3</sub> is developed (via rhabditiform L<sub>2</sub>) within 8–10 days. Infections occur by oral uptake of the L<sub>3</sub> with contaminated food.

### Disease

Due to lesions in the stomach wall the most important sign is anaemia, which may occur in heavily infected hosts.

### Therapy

→Nematocidal Drugs.

## Terranova sp.

From Latin: *terra* = earth, *nova* = new. Genus of anisakid worms. →Anisakis/Fig. 1.

## Territorial Behavior

→Behavior.

## Testis

Male sex organ; →Platyhelminthes, →nematodes, →Acanthocephala, →Pentastomida, →Arthropoda.

## Testosterone

→Behavior.

## Tetrachlorvinphos (CVMP)

### Chemical Class

Organophosphorous compounds (organophosphate).

### Mode of Action

Acetylcholine esterase inhibitor. →Ectoparasitocides – Agonists and Antagonists of Cholinergic Transmission, →Ectoparasitocidal Drugs.

## Tetracycline

An antibiotal drug, that is often administered in addition to parasitocidal drugs.

## Tetrahydropyrimidines

→Malariacidal Drugs.

## Tetrameres fissipina

### Synonym

*Tropisurus fissipinus*.

This 6 mm long stomach worm lives in the digestive stomach of duck, chicken, turkey, and dove. Intermediate hosts are: small crustaceans, beetles; the eggs measure 60 × 30 μm.

## Tetramethrin

### Chemical Class

Pyrethroid (type I).

**Mode of Action**

Open state voltage-gated sodium channel blocker.  
 →Ectoparasiticides – Blockers / Modulators of Voltage-Gated Sodium Channels, →Ectoparasitocidal Drugs.

**Tetramitus**

Genus of free-living amoeba related to the genera  
 →*Naegleria*, →*Vahlkampfia*.

**Tetrastigmata**

→Acarina.

**Tetrathyridium**

Larva of →tapeworms of the family Mesocestoidae  
 (→*Mesocestoides*, →*Eucestoda*), Fig. 1.

**Tetratrichomonas gallinarum**

Species of →*Trichomonadina* of chicken, which has a pearlike shape, is 8–18 µm long and possesses 4 anterior free flagella and a fifth lateral (recurrent) one. The trophozoites are found in the caeca. Related species are: *T. anatis*, *T. anseris*, *T. canistomae*. It is not yet clear, whether cysts occur, that would facilitate transmission.

**Tetratrichomonas ovis**

→*Trichomonadida*.



**Tetrathyridium.** Figure 1 LM of the so-called tetrathyridium larva (which may divide) of the tapeworm →*Mesocestoides* in a mouse.

**Texas Fever**

→*Babesiosis*, Animals.

**TGF**

Transforming growth factor, which is active in mammalian angiogenesis (also in organ growth due to parasitic infections, e.g., schistosomiasis).

## Th

T helper cell.

## Thalidomide

→ [Antimicrosporidial Drugs](#); see treatment of opportunistic agents of diseases.

## Thalassemia

Type of genetically derived human blood diseases ( $\alpha$ ,  $\beta$ -types); the patients with a  $\alpha$ -thalassemia, however, profit from a retarded growth of *Plasmodium*

*falciparum* schizonts in red blood cells and thus suffer at a lower degree.

## Theiler, Arnold (1867–1936)

German-Swiss protozoologist, who described in South Africa several tick-transmitted piroplasmosis and virosis and was honoured by the genus name → *Theileria*.

## Theileria

### Classification

Genus of → [Piroplasm](#)s, Table 1.

### General Information

The tick-borne → [Protozoa](#) of the genus *Theileria* elicit severe, often fatal diseases in ruminants and cause huge

**Theileria. Table 1** Important species of *Theileria*

Species	Vector	Vertebrate	Disease	Geographic distribution
<i>Theileria parva parva</i>	<i>Rhipicephalus appendiculatus</i> , <i>R. spp.</i>	Cattle, <i>Syncerus caffer</i>	East Coast fever	Africa
<i>T. parva lawrencei</i>	<i>Rhipicephalus appendiculatus</i> , <i>R. spp.</i>	Cattle, <i>Syncerus caffer</i>	Corridor disease	Africa
<i>T. annulata</i>	<i>Hyalomma</i> spp.	Cattle, domestic water buffalo	Mediterranean or tropical theileriosis	Africa, Asia, Southern Europe
<i>T. mutans</i>	<i>Amblyomma</i> spp.	Cattle, <i>Syncerus caffer</i>	Benign African theileriosis I	Africa
<i>T. velifera</i>	<i>Amblyomma</i> spp.	Cattle, <i>Syncerus caffer</i>	–	Africa
<i>T. taurotragi</i> (syn. <i>Cytauxzoon</i> )	<i>R. appendiculatus</i> , <i>R. spp.</i>	Cattle, <i>Taurotragus oryx</i>	Benign African theileriosis II	Africa
<i>T. sergenti</i> (syn. <i>T. orientalis</i> )	<i>Haemaphysalis</i> spp.	Cattle, buffalo	Oriental theileriosis	Asia, Europe, Australia, North Africa
<i>T. orientalis</i>	<i>Haemaphysalis longicornis</i>	Cattle	Asian theileriosis	Japan, South and East Asia
<i>T. hirci</i>	<i>Hyalomma</i> spp.	Sheep, goats	Malignant ovine and caprine theileriosis	Southern Europe, Asia, Africa
<i>T. ovis</i>	<i>Rhipicephalus</i> spp., <i>Hyalomma</i> spp.	Sheep	–	Africa, Europe
<i>T. separata</i>	<i>Rhipicephalus evertsi</i> , <i>R. spp.</i>	Sheep	–	Africa
<i>T. equi</i> <sup>a</sup>	<i>Dermacentor</i> spp., <i>Hyalomma</i> spp., <i>Rhipicephalus</i> spp.	Horses, mules, donkeys	Horse theileriosis	Southern Europe Africa, Asia, America

<sup>a</sup> Formerly called *Babesia equi*

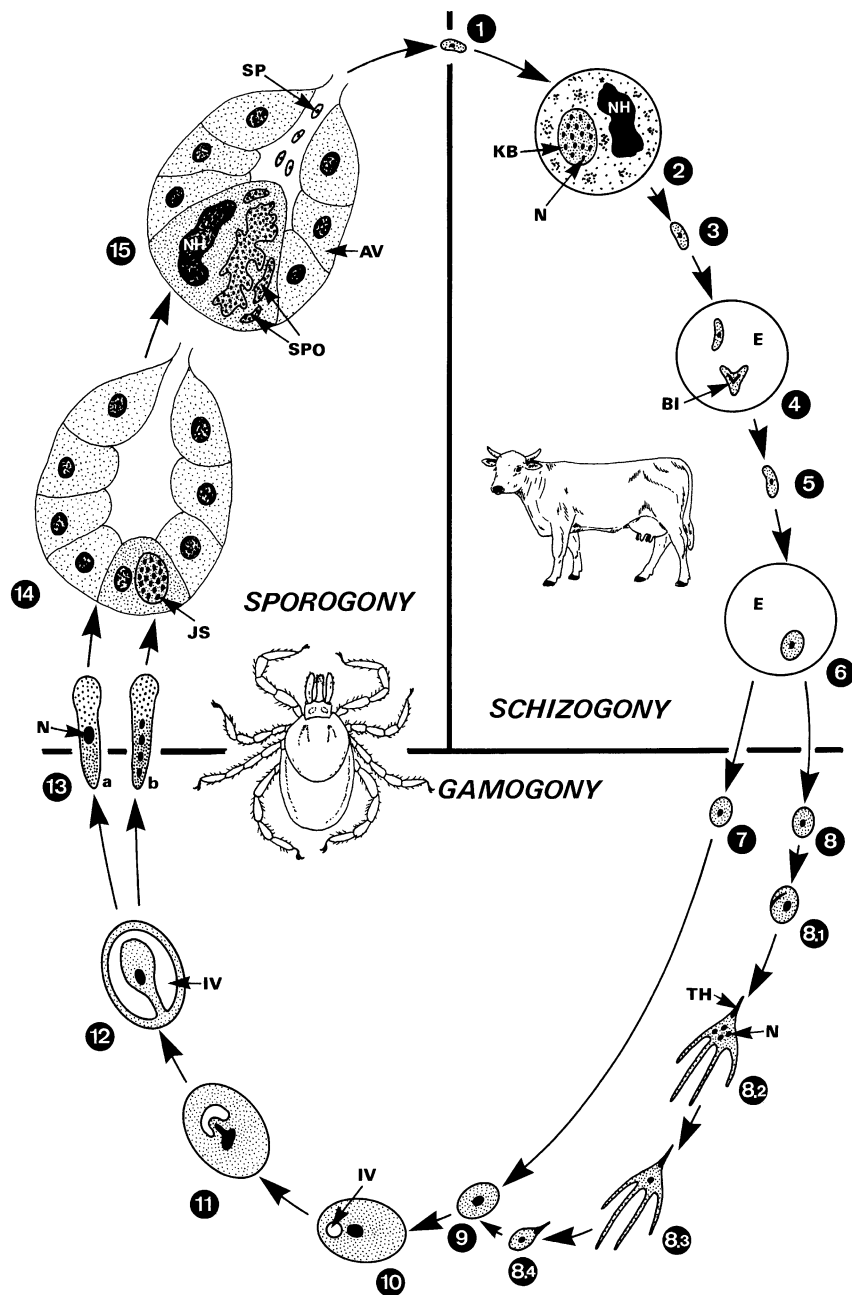

**Theileria. Figure 1** Life cycle of *Theileria* spp. (for hosts see Table 1). 1 Sporozoites are injected during blood meal of ixodid →ticks (Fig. 1). 2 →Schizont (→Koch's Body) inside the →cytoplasm of newly dividing lymphocyte, eventually forming merozoites. 3 Free motile merozoites enter erythrocytes. 4 →Binary fission inside erythrocyte (at a low rate). 5 A few free merozoites enter other erythrocytes. 6 Formation of spherical or ovoid stages (i.e. gamonts). 7, 8 Gamonts free in blood masses inside tick gut. 8.1–8.4 Formation of 4-nucleate →microgamonts (8.2) which give rise by fission to uninucleate →microgametes (8.3–8.4). The latter fuse with the macrogamete (9). 9 →Macrogamete. 10 →Zygote. 11–13 Formation of motile →kinete from ovoid immobile zygote inside intestinal cells of the tick. Note that the developing kinete protrudes into an enlarging vacuole (IV) within the zygote. In *T. parva* kinetes (13) division of the nucleus may start before they leave the intestinal cells. 14 After moult of the ixodid tick and attachment to a new host, kinetes enter the cytoplasm of cells of salivary glands, and give rise to young sporonts which grow and initiate repeated nuclear divisions. 15 Parasitism leads to considerable enlargement of the host cell and its nucleus. Inside the giant host cell the sporont forms thousands of sporozoites. The latter become transmitted during the next blood meal. AV, alveolar cell of salivary glands; BI, →binary fission; E, erythrocyte; IV, inner vacuole; KB, →Koch's body (= schizont); N, nucleus; NH, nucleus of host cell; SP, →sporozoite; SPO, sporont; TH, thornlike structure; YS, young sporont.

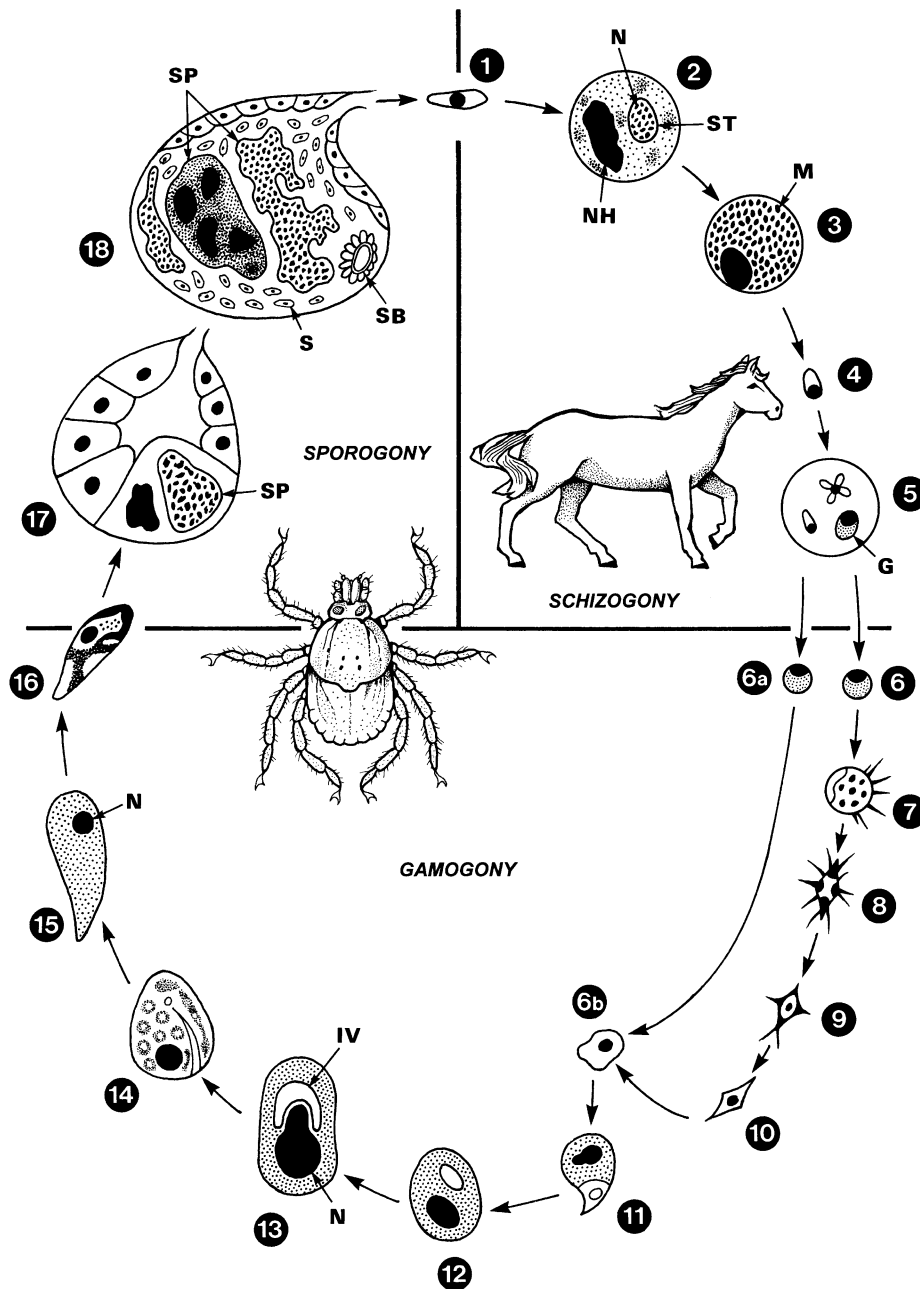

**Theileria. Figure 2** DR of the life cycle of *T. equi* (syn. *Babesia equi*). 1 Sporozoite injected with tick (→ nymph, adult female) saliva. 2 Young schizont in a lymphocyte (macrochizont, Koch's body). 3 Late schizont in a lymphocyte during the formation of merozoites (microschizont). 4 Free →merozoite. 5 Reproduction inside erythrocytes – note the occurrence of Maltese crosslike dividing stages and the presence of spherical stages (gamonts). 6 After engorgement of ticks the ovoid/spherical gamonts undergo further development within the blood masses inside the intestine (mostly inside host cells). 7–10 By divisions, some raylike microgametes (10) are produced by microgamonts (7, 8). 11 Fusion (→ Syngamy) of → gametes. 12–16 Inside the zygote (12) a slender, motile, club-shaped → kinete is developed, which leaves the intestinal cells and enters via haemolymph the → salivary gland cells of the ticks after their moult (larva → nymph or nymph → adult female) and their attachment to another host. 17 Penetrated kinetes grow up inside the salivary gland cells and give rise to multinucleated sporonts. 18 The multinucleated sporonts are divided into numerous small sporoblasts (SB) which form sporozoites by a budding process at their periphery; during the next sucking period the sporozoites are injected (with the saliva) to the new host. G, →gamont; IV, inner vacuole; M, microschizont; N, nucleus; NH, nucleus of the host cell; S, sporozoite; SB, →sporoblast; SP, sporonts.

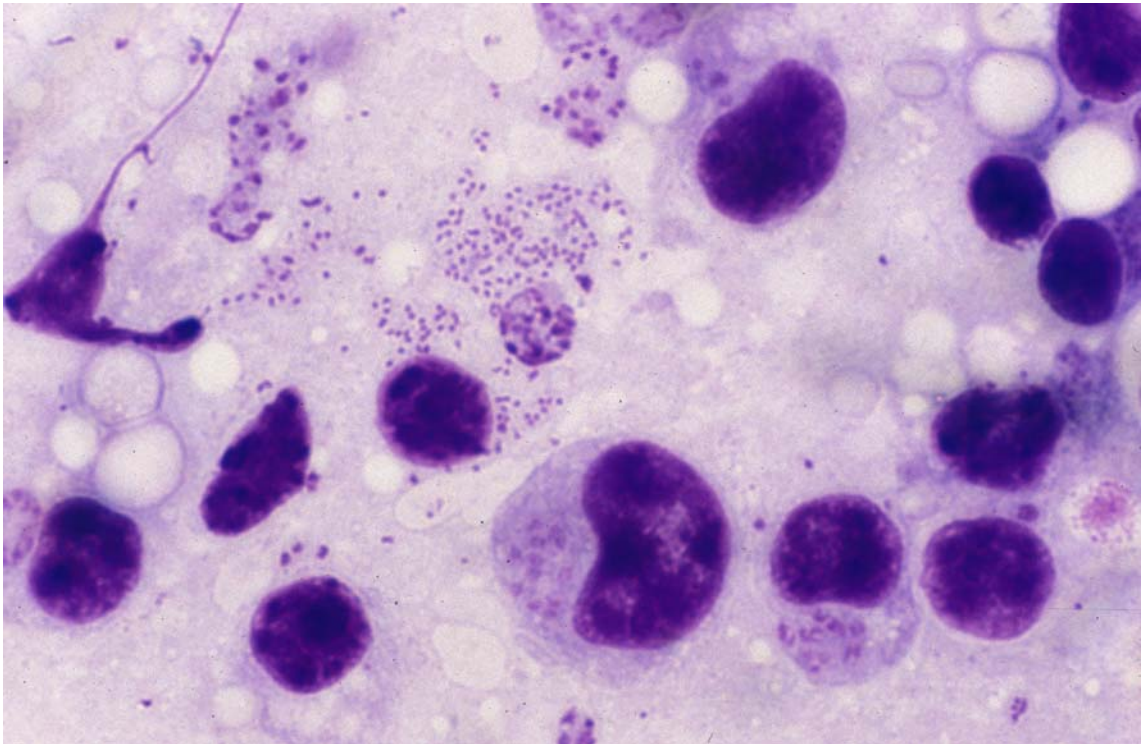

**Theileria. Figure 3** LM of merozoite forming schizonts of *Theileria* in cattle lymphocytes (= Koch's bodies).

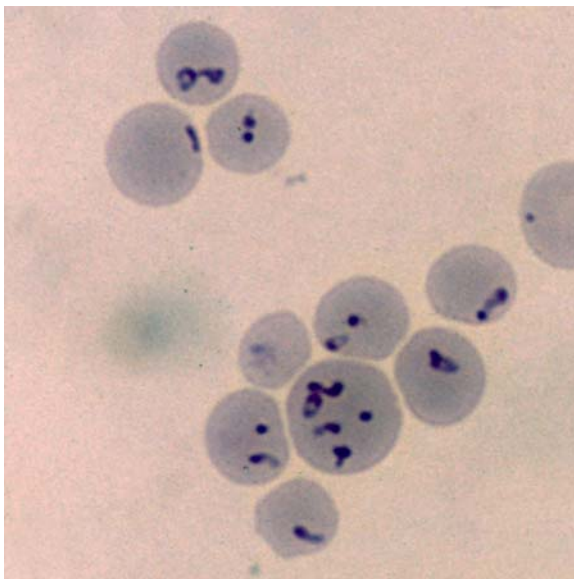

**Theileria. Figure 4** LM of *Theileria parva* in red blood cells.

economic losses to the cattle industry, primarily in East and southern Africa. In the horse, *Babesia equi*, which has now been redescribed as *Theileria equi*, is also a major pathogen.

**Important Species**

Table 1, Figs. 3–6.

**Life Cycle**

Figs. 1, 2.

**Diseases**

→Theileriosis, →East Coast Fever, →Mediterranean Coast Fever.

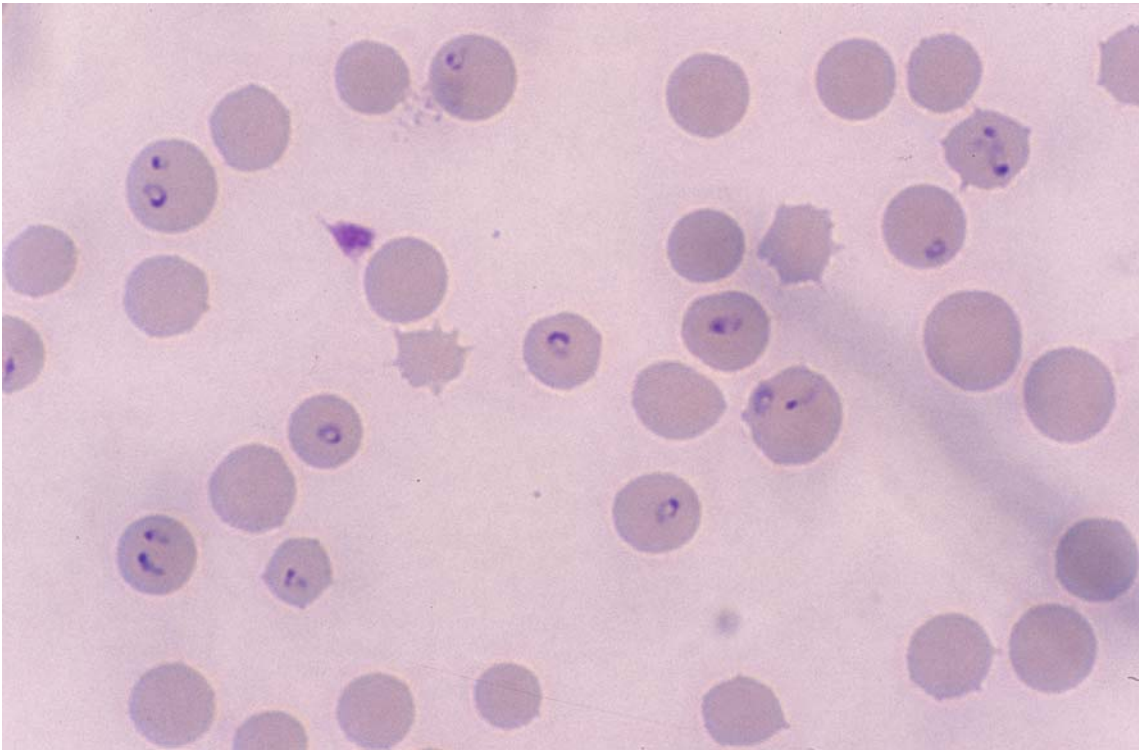

**Theileria.** Figure 5 LM of Giemsa-stained *Theileria annulata* in red blood cells.

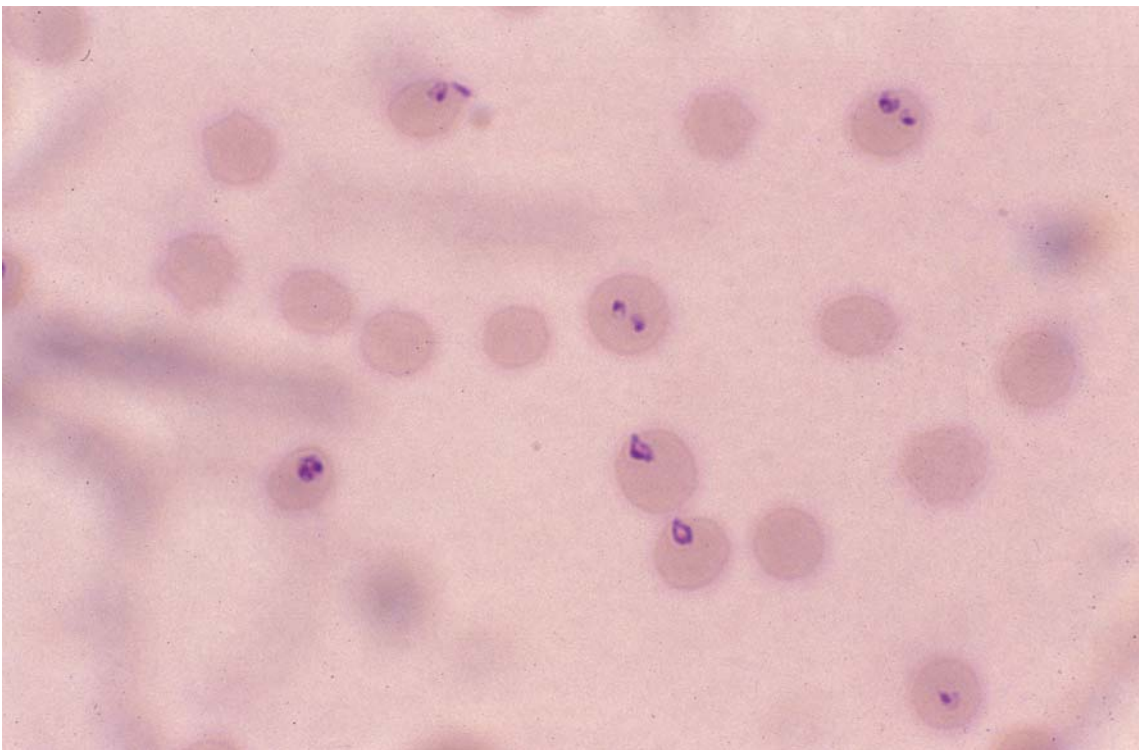

**Theileria.** Figure 6 LM of *Theileria equi* (formerly *Babesia equi*).



## Theileriacidal Drugs

For overview see [Table 1](#) (page 1367 et sqq.).

### Epizootiology

The [→piroplasms](#) are tick-transmitted blood cell parasites of vertebrates occurring in lymphocytes, erythrocytes, and other blood system cells ([→Theileria](#)). The occurrence of vectors ([→Ticks](#)) determines the geographical distribution of *Theileria* spp. in tropical and subtropical areas.

*T. p. parva* causing [→East Coast fever](#) (ECF) is enzootic in South, East, and Central Africa and may be lethal for *Bos taurus*, *B. indicus*, and *Bubalus bubalis* (water buffalo) as well as for imported cattle. *T. p. lawrencei* causing [→corridor disease](#) occurs primarily in African buffalo (*Syncerus caffer*) and is endemic in East and Central Africa and Angola as well. It may produce a mild disease in buffalo but a fatal one in cattle and water buffalo. *T. annulata* causing tropical [→theileriosis](#) occurs in the northern subtropical and Mediterranean regions from Morocco through the Middle East, southern region of Russia, and neighboring countries to the Indian subcontinent and China. It may be lethal to cattle but may produce only mild disease in buffalo. *T. orientalis* (syn. *T. sergenti*) has a low to moderate pathogenicity, and its distribution coincides over large areas of Asia with that of *T. annulata*. *T. mutans* regarded as mildly pathogenic or nonpathogenic may be severely pathogenic in cattle under various stress situations; this species is ubiquitous. *T. hirci* and *T. ovis* may be common in sheep and goats. *T. hirci* occurs in Asia, Africa, and South Europe and may cause a severe disease (50–100% mortality), mainly in newly introduced animals. Its morphology is similar to that of *T. annulata*. *T. ovis* has a low pathogenicity and is morphologically indistinguishable from *T. hirci*. However, *T. ovis* is more widely distributed than *T. hirci* and occurs in Africa, Europe, parts of the former USSR, India, and West Asia.

### Strategic Control Programs

Strategic control programs used in enzootic areas with [→theileriosis](#) in livestock are similar to that applied in babesiasis ([→Babesiocidal Drugs](#)). They rely on measures, such as premunization (live, attenuated vaccines, or “infection-treatment”), tick control (regular acaricide dipping, other application techniques), quarantine (especially with regard to importation of cattle from *Theileria*-free areas into enzootic regions where tick vectors exist), [→chemoprophylaxis](#), and finally chemotherapy.

To prevent cattle from areas and farms contaminated with infected ticks stock-proof fencing is essential.

Therefore, the farm area must be cleaned of infected ticks before susceptible animals are brought in, and at least weekly dipping (in case of *Rhipicephalus appendiculatus* at least 2 treatments per week) should be carried out to control *T. p. parva* infections. Enzootic stability as a means of controlling theileriosis (as partially practiced in controlling babesiasis) may be achieved by natural challenge in indigenous cattle and thus development of some degree of resistance against theileriosis. Stock recently introduced into infested areas and coming from regions free of *Theileria* spp. or areas with different strains of *Theileria* spp. may need, however, a year longer for partial immunity to be developed by application of various vaccination schemes. Tetracyclines ([Table 1](#)) are mainly used in chemoimmunization programs (infection-treatment methods). They may suppress or eliminate infections in areas where cattle have already developed a certain degree of protective immunity against *T. p. parva* and *T. annulata*. Tetracyclines administered simultaneously with infected ticks or vaccines can modify the course of the infection so that proliferation of parasites is limited and allow the development of protective immunity. As a result of infection-treatment methods mild clinical symptoms may occur while immunity is built up in the host. Another successful method of immunization against ECF seems to be the infection of cattle with live sporozoites (derived from standardized stabilates of *Rhipicephalus appendiculatus* followed by the administration of a long-acting oxytetracycline (cf. [Table 1](#)). Although treated animals showed a solid resistance to homologous challenge, they were not protected against a challenge with parasites unrelated to those initiating the primary reaction. To overcome this very specific immune responses, so called “cocktail” vaccines derived from different strains have been prepared and used in large-scale field trials of immunization against cattle theileriosis. A satisfactory [→schizont](#) vaccine against *T. annulata* does not require simultaneous drug treatment, and so saves costs.

### Economic Importance and Pathogenesis

There are several *Theileria* spp. with different pathogenic features ([→Theileriosis](#)). Parasites of economic importance in cattle are *T. p. parva* and *T. p. lawrencei*, which cause East Coast fever (ECF) and corridor disease, respectively, as well as *T. annulata*, which produces tropical theileriosis. Commercial dairy herds and high-performance beef cattle on pastures must be protected against these *Theileria* spp. since their pathogenicity is generally high. Thus, mortality in fully susceptible cattle infected with *T. p. parva* may reach 90–100% although fatal cases in all are lower in endemic areas, and zebu cattle commonly show a high level of [→natural resistance](#). Fatal infections caused by *T. annulata* in cattle may vary considerably (10–90%).

**Theileriacidal Drugs. Table 1** Antitheilerial drugs for use in cattle

<b>CHEMICAL GROUP</b> nonproprietary name (single dose mg/kg body weight = b.w.)	<b>*BRAND NAMES</b> (manufacturer, companies, distributors), WT (in days = d) before slaughter, other information	<b>COMMENTS</b> on efficacy, pharmacokinetics, metabolism, mode of action, toxicity, and other information
Theileriosis, caused by <i>Theileria</i> spp. is a cattle disease transmitted by various ticks (e.g., brown ear tick <i>Rhipicephalus appendiculatus</i> transmitted <i>T. parva</i> causing East Cost fever = ECF and Corridor disease); ECF is widespread in several countries in eastern, central, and southern Africa; efficacy of chemotherapy depends on early and fast diagnosis; treatment should be given in the early stages of clinical disease; after the onset of respiratory symptoms none of the chemotherapeutic agents is effective any more; recovered animals can remain carriers of the parasite; the disease results in inevitable costs for cattle keepers, either by losses in productivity (mortality, morbidity) or by expenditures for disease and/or vector control [for details cf. D'Haese L. et al. (1999) Trop Med and Int Health 4: 49–57]		
<b>TETRACYCLINES</b> (first practical use of chlortetracycline 1953)		
<b>oxytetracycline</b> (OTC) hydrochloride or dehydrate (= base) (11-20 i.m. cattle, calves) <i>approved indications:</i> bacteria, <i>Mycoplasma</i> , chlamydia, and rickettsiae, <i>Anaplasma</i> spp.	*Terramycin LA (Pfizer, USA, Australia, EC, elsewhere), injectable solution for cattle, calves, WT: USA 15d; Australia WT: 42d (OTC base in 2-pyrrolidone); EC/ Germany WT: 21d	Theileriosis is a severe disease of cattle in Africa; the disease has severe depressant effects on immune system; therefore, any vaccination should be delayed until animals have recovered; in experimental studies Neitz (Onderstepoort, University Pretoria,
SA) had demonstrated in 1953 that chlortetracycline HCl (CTC) was able to prevent clinical signs of <i>theileriosis</i> (ECF) in cattle when treatment was started 1 day prior to or simultaneously with <i>Theileria parva</i> ( <i>T. parva parva</i> ) challenge (oral dose regimen: 1.5 mg/kg b.w. daily for 28 days); effective plasma drug levels during incubation period are necessary to arrest schizogony of <i>Theileria</i> in lymphoid cells and reduce parasitemia (merozoites in erythrocytes); OTC may be used in preventive chemoimmunization programs aimed at supporting the development of a premunition type immunity in cattle herds against <i>Theileria</i> challenges in endemic areas; an immunization procedure used for ECF may be Radley's "Infection and Treatment method" whereby a titrated (attenuated) sporozoite stabilate of infected ticks is injected simultaneously with a 20 mg/kg b.w. dose of long-acting tetracyclines; selection of the immunizing stock(s) of <i>T. parva</i> should ensure that cattle are immunized against subsequent field challenges with all <i>T. parva</i> stocks in the area; so treated animals usually remain carriers of the parasite since long-acting formulations of OTC suppress but do not eliminate all organism at the schizont stage; OTC base in pyrrolidone (*Terramycin LA) is designed to give long duration effective plasma drug concentrations, e.g., a single injection supplies 3–5 days "therapeutic" cover and can be repeated if necessary; OTC appears to be concentrated in the liver and is excreted in the bile; it is found in the urine and feces in high concentrations in a biological active form; <i>anaplasmosis</i> is a hemotropic disease of cattle (transmitted by ticks) and may hamper development of livestock industry; tetracyclines such as CTC and OTC are equally effective, and low numbers of <i>Anaplasma</i> in carriers can be eliminated by the 2 tetracyclines; vaccination with attenuated <i>Anaplasma</i> vaccines and chemotherapy with tetracyclines or a combination of the 2 are aimed at controlling the disease in tropical and subtropical areas; premunition type immunity may also exist in <i>Anaplasma</i> infected cattle (cf. <i>Theileria</i> ↑); carrier state of low numbers of the organism may serve to propagate the spread of organisms; it allows long-lasting buildup of premunition-immunity that may prevent heavy outbreaks of the disease in cattle herds.		
<b>HYDROXYNAPHTHOQUINONES</b>		
<b>menoctone</b> is a hydroxy alkylated naphthoquinone (experimental studies mid/end 1970s, Wellcome Research Laboratories); it has not been developed as a commercial product because its synthesis was too expensive; it controlled theileriosis in cattle caused by <i>T. parva</i> at a single i.m. or i.v. dose of 10 mg/kg b.w. up to 4 days after the disease became apparent; the oral route of menoctone had only a slight and transient beneficial effect; the drug caused degeneration of schizonts in lymphoid cells, and merozoites in red cells (piroplasms) were destroyed; intramuscular injection of the drug produced severe but transient pain; menoctone was replaced by <b>parvaquone</b> (= PVQ, BW 993, introduced in Kenya 1985, it has been commercialized as *Clexon and then as *Parvexon); it was selected as the most cost-effective compound from a series of naphthoquinones; its antitheilerial activity is inferior to that of menoctone; there is no apparent discomfort after deep i.m. injection; occasionally, localized "painless" edematous swelling occurred; PVQ is sufficiently active against <i>T. parva</i> and <i>T. annulata</i> infections in the field if used in the early stage of infection (macroschizonts detectable, fever starts); PVQ is liable to eliminate stabilate infection of <i>T. parva</i> when the sporozoite stabilate and the drug is injected simultaneously; *Clexon/*Parvexon therefore is unsuitable for use in a single-treatment infection-and-treatment system of immunization; <b>recommended dose regimen:</b> single dose of 20 mg PVQ/kg b.w. i.m. for cattle infected with <i>T. annulata</i> , and 10 mg PVQ/kg b.w. i.m. twice (48 h interval) for cattle infected with <i>T. parva</i> , <i>T. parva lawrencei</i> (Corridor disease) and <i>T. mutans</i> (benign African theileriosis).		

**Theileriacidal Drugs. Table 1** Antitheilerial drugs for use in cattle (Continued)

CHEMICAL GROUP nonproprietary name (single dose mg/kg body weight = b.w.)	*BRAND NAMES (manufacturer, companies, distributors), WT (in days = d) before slaughter, other information	COMMENTS on efficacy, pharmacokinetics, metabolism, mode of action, toxicity, and other information
<b>buparvaquone</b> (BW 720 C) (BPQ) (2.5, i.m. cattle single dose: in severe cases a further treatment with BPQ, at same dose rate of 1 ml/20 kg b.w. = 2.5 mg/kg b.w. may be given within 48–72 h of initial injection)	*Butalex (various manufacturers and suppliers, e.g., ICI Pakistan: (rights from Schering Plough), Coopers AH UK, solution for i.m. injection (50 mg BPQ/ml), WT: 42?; BPQ + primaquine phosphate: APVMA limited use permit 5538: exp. infected calves with <i>T. buffeli?</i> , Australia)	Synthesis of BPQ is much more expensive than that of PVQ; it is an analogue of PVQ with long persistence in plasma following i.m. injection (half-life at least 7 days) and low acute toxicity in rats (<8000 mg/kg per os); there is a high <i>in vitro</i> activity against <i>T. parva</i> (Muguga strain: 0.0003 mg BPQ/L); high <i>in vitro</i> activity and plasma persistence may both be
<p>related to the tertiary-butyl moiety (at 4-position of cyclohexyl ring) in the BPQ molecule, which results in far slower drug metabolism compared to that of PVQ (hydroxy group at 4-position of cyclohexyl ring: plasma half-life approx. 2 days); retard elimination of BPQ by metabolic alteration (biotransformation) appears to be responsible for increased <i>in vivo</i> efficacy of the drug against <i>Theileria</i>; BPQ proved <i>in vitro</i> 20 times more active against <i>T. parva</i> than PVQ; it has been reported that *Butalex (2.5 mg BPQ/ kg b.w.) injected at the same time as infection with <i>T. parva</i> suppressed but did not eliminate the organism at the schizont stage, and no piroplasms (merozoites in red cells) were detected in any of the 10 treated calves (all untreated controls died of theileriosis); recovered animals can remain carriers of the parasite and it is suspected that this occurs more frequently after PVQ treatment than when BPQ was used; BPQ has been tested against <i>T. annulata</i> infection in several countries (e.g., India, countries of former Soviet Union, Egypt) and was found to be highly active against this organism; it improved productivity of cattle carrying subclinical theilerial infections; little is known about <b>mode of action</b> of BPQ; studies indicated an effect on “energy metabolism”, as demonstrated in coccidia; in electron microscopical studies, <i>T. parva</i> schizonts in cultured lymphoid cells showed progressive vacuolation of cytoplasm as principal alteration; BPQ (as an ubiquinone analogue) appears to block electron transport at the ubiquinone level in <i>Plasmodium</i>; mechanism of selective toxicity might be due to difference between parasite and mammalian ubiquinone moiety; <b>approved indications</b>: for treatment of theileriosis [ECF caused by <i>T. p. parva</i>, Corridor disease: <i>T. p. lawrencei</i>, and tropical theileriosis: <i>T. annulata</i> and <i>T. orientalis</i> (syn. <i>T. sergenti</i>)]; BPQ is active against both schizont and piroplasms stages of <i>Theileria</i> and should be used in incubation period of the disease, or at the latest when first clinical signs are apparent; <b>limitations</b>: *Butalex must not be given by intravenous or subcutaneous injection; regular injection into muscles of the neck may occasionally cause localized, painless, edematous swelling; repeat treatment in cases of severe theileriosis (relapse), or when relapses occur as a result of subsequent infections with antigenically unrelated species or strains of <i>Theileria</i> (animals will develop homologous immunity only); any vaccination should be delayed until animal has recovered from theileriosis (the disease suppresses immune system).</p>		
<b>QUINAZOLINONES</b>		
<p><b>halofuginone lactate</b> (= HAL), introduced 1986 in Kenya, first available as *Lerioxine, and then *Terit (former Hoechst Roussel Vet., oral tablets, aqueous solution); HAL is no longer approved for use against theileriosis caused by pathogen <i>Theileria</i> spp. in cattle; *Terit has been discontinued possibly because of little commercial return for minor uses in a major species; HAL (1.2 mg/kg b.w. per os and repeated after 48 h) manifested a potent effect on schizonts of natural <i>T. parva</i> infections in cattle between 5 and 11 days post treatment; disappearance of piroplasms (erythrocytic stages) took long, ranging from 1 week to 1 month following treatment; recommended treatment during acute clinical disease induced by <i>T. parva</i> isolates in cattle rapidly reduced fever and parasitosis but parasite recrudescences and mortality occurred in about 50% of treated animals within 15 months after treatment; because HAL showed only moderate action on erythrocytic forms recovered animals usually remained carriers of the parasite; a potent activity of HAL was seen when treatment of <i>T. annulata</i> and <i>T. parva</i> infected cattle was started with first clinical signs (body temperature above 40°C) and macroschizonts were detectable by lymph node biopsies; it was less active when administered during incubation period; recovered animals were then carriers; in a field trial in Kenya, 293 cattle suffering from ECF were treated at a dose of 1.2 mg/kg b.w. per os and treatment was repeated after 48 h: 236 (80.5%) animals recovered and 49 (16.7%) died; there were no differences in recovery rates between uncomplicated cases with concurrent anaplasmosis or babesiosis; younger animals had a poorer recovery rate than adults and early treatments were more successful than those administered late; it was concluded that with early detection and treatment, coupled with efficient tick control HAL is effective in treatment of clinical ECF under field conditions; <b>tolerability</b> of HAL at recommended dose regimen is good but safety margin is narrow; 3 mg/kg may cause subnormal temperature,</p>		

**Theileriacidal Drugs. Table 1** Antitheilerial drugs for use in cattle (Continued)

CHEMICAL GROUP nonproprietary name (single dose mg/kg body weight = b.w.)	*BRAND NAMES (manufacturer, companies, distributors), WT (in days = d) before slaughter, other information	COMMENTS on efficacy, pharmacokinetics, metabolism, mode of action, toxicity, and other information
profuse diarrhea, cachexia, and purulent eye discharge; cattle preslaughter withdrawal periods for milk/edible tissues were 8/24 days.		
HAL is now commercialized as *Halocur: <b>approved indication</b> in EC: for prevention of diarrhea caused by <i>Cryptosporidium parvum</i> in newborn calves on farms with a history of cryptosporidiosis and reduction of diarrhea due to diagnosed <i>Cryptosporidium parvum</i> . *Halocur has been demonstrated to reduce oocyst excretion; <b>drug/dose form</b> : pale yellow solution for oral administration containing 0.5 mg HAL/mL in aqueous excipient for oral use in calves <b>after feeding</b> ; WT: calves, meat and offal 13d; <b>dose regimen</b> : 0.08–0.13 mg HAL/kg b.w. once a day for 7 consecutive days (calves 35–45 kg b.w.: 8 mL *Halocur and calves 45–60 kg b.w.: 12mL *Halocur once a day for 7 consecutive days); <b>toxicity</b> may occur at 2 times the recommended dose; animals should therefore receive accurate dose; adverse effects following overdose may be diarrhea, visible blood in feces, decline in milk consumption, dehydration, apathy and prostration; HAL proved also active against acute <i>sarcosporidiosis</i> in goats ( <i>Sarcocystis capracanis</i> ) and sheep ( <i>S. ovis</i> , syn. <i>S. tenella</i> ) at 0.67 mg/kg daily for 2 days (for data concerning anticoccidial activity of halofuginone bromide cf. →Coccidiocidal Drugs/Table 1).		

Data of drug products (approved labels) listed in this table refer to information from literature, manufacturer, supplier, and websites such as the European Medicines Agency (EMA), Committee for Veterinary Medicinal Products (CVMP), the US Food and Drug Administration (FDA), Center for Veterinary Medicine (CVM), the Australian Pesticides and Veterinary Medicines Authority (APVMA) and associated Infopost (search for products), VETIDATA, Leipzig, Germany, and Clini Pharm, Clini Tox (CPT), Zurich, Switzerland and others. Data given in this table have no claim to full information.

Under natural conditions the interaction between host and parasite depends on host susceptibility, age, and variations in virulence of *Theileria* spp. strains, and intensity of challenge, i.e., the number of parasites transmitted by total number of ticks. The course of infection may therefore vary from peracute, acute, or subacute, to chronic, although the acute form is the usual one in susceptible animals (calves are more resistant to infection). Clinical signs in the acute and subacute forms are high to irregular intermittent fever, markedly swollen (enlarged) lymph nodes (→Hyperplasia), edema, →diarrhoea, dyspnea, anemia, leukopenia (below 1,000 cells/mm<sup>3</sup> is fatal in most cases), and general weakness. The pathogenesis and clinical symptoms are associated with the multiplication of parasites within transformed lymphoblastoid cells. Damaging effects on lymphoid tissues follows repeated →schizogony synchronized with division of host cells. The lymphodestructive processes are characteristic for infections with *T. p. parva*, *T. annulata*, and *T. hirci*, while *T. orientalis* (syn. *T. sergenti*) and *T. mutans* infections are associated with invasion and destruction of erythrocytes resulting in anemia. Animals that recover from lymphoproliferative theileriosis have usually eliminated macroschizont stages and are solidly resistant to homologous challenge; however, challenge with heterologous parasites may lead to a partial or complete breakdown of immunity.

### Drugs Acting on Theileriasis and Theileriosis

For a long time the search for an active drug was hampered by the lack of a suitable laboratory model of the infection. Chlortetracycline was shown to be the only drug, which exhibited prophylactic activity on *T. p. parva* infections. Today, long-acting oxytetracyclines are used which may arrest development of parasites in lymphocytes and thus reduce the rate of invasion of the cells (Table 1). To exhibit a reliable action tetracyclines must be given simultaneously with the initial *Theileria* spp. infection. As a result they curtail clinical symptoms in susceptible cattle types and consolidate immunity to virulent *Theileria* spp. strains; tetracyclines cannot be used for curative treatment and are ineffective once clinical signs become evident.

A high level of antitheilerial activity of **menoctone** [2-hydroxy-3-(8-cyclohexyloctyl)-1,4-naphthoquinone] was demonstrated by several investigators in *T. parva*-infected bovine lymphoid cell cultures. Subsequent tests in cattle artificially infected with *T. p. parva* confirmed the activity of menoctone against East Coast fever (ECF), even in cases with already established infection. Prior to the discovery of the antitheilerial effect hydroxy-naphthoquinones had been shown to be active against →coccidia and →malaria parasites; recently, **atovaquone** (→Malaria Drugs/Tables 1, 2) has also been proved to exhibit a high antiplasmodial activity. Menoctone was

then replaced by the closely related analogue **parvaquone**, which has a lower activity but is better tolerated by cattle than menoctone. The most active antitheilerial compound in the hydroxynaphthoquinone series is **buparvaquone**; it has been shown to be distinctly more active than parvaquone (Table 1). Like the quinazolinone derivative **halofuginone lactate** (no longer available for this indication; anticoccidial effect of the bromide salt cf. →Coccidiocidal Drugs/Table 1) both drugs are effective in treating the early stages of *T. p. parva* and *T. annulata* infections. Once established neither halofuginone nor parvaquone or buparvaquone can sterilize *Theileria* spp. infections. Prophylactic administration of hydroxynaphthoquinones obviously prevents infection completely and thus development of any serological/immunological response. Treated cattle were fully susceptible to a later *T. p. parva* challenge. The use of halofuginone lactate in the treatment of ECF in Tanzania had certain limitations. Field studies revealed that losses from theileriosis could be prevented only following diagnosis of early cases of the disease in several herds by repeated oral administration of 1.2 mg/kg b.w. Cattle suffering from the early stages of ECF recovered completely after this dosage regimen whereas 2 out of 6 cattle treated in the late stages died. **Imidocarb** dipropionate (→Babesiocidal Drugs/Table 1) and **primaquine** diphosphate (antimalarial, cf. →Malariaicidal Drugs/Tables 1, 2) have been shown to be effective in reducing *T. orientalis* (syn. *T. sergenti*) parasitemiae in cattle at doses of 1.2 mg/kg b.w. (×1) and 1 mg/kg b.w. (×2), respectively.

*B. equi* has been renamed as *Theileria equi*. Infections are more refractory to therapy, and some cases may be cleared with imidocarb. Thus recommended doses of drugs must be enhanced to obtain elimination of carrier infections. However, marked increase of dose level and repeated injection often lead to undesirable acute side effects and occasionally to mortality. Obviously there are different susceptibilities among *B. (T.) equi* strains to drugs. Antitheilerial compounds parvaquone and buparvaquone (Table 1) have also been shown to have some efficacy against parasitemia of initial *B. (T.) equi* infection indicating an action chiefly directed against schizontal stages. Halofuginone lactate can also be used to treat *cryptosporidiosis* of calves (EC approved indication) and was used experimentally to treat *sarcosporidiosis* of goats and sheep (cf. Table 1).

## Theileriasis

### Synonym

→Theileriosis. →Tick Bites: Effects in Animals.

## Theileriosis

### Synonym

→Theileriasis.

### General Information

→*Theileria* species are tick-borne protozoan parasites which cause infections of ruminants characterized by successive developmental stages in leukocytes and erythrocytes. In contrast to other apicomplexan protozoans such as →*Plasmodium* and →*Babesia* which cause disease by destruction or sequestration of erythrocytes, pathology produced by →*Theileria* is attributable mainly to the intraleukocyte stage. The severe, often fatal diseases in ruminants cause huge economic losses to the cattle industry, primarily in East and Southern Africa. In the horse, *Babesia equi* which has now been redescribed as *Theileria equi*, is also a major pathogen.

In cattle, the most important species in East and Southern Africa is *T. parva*. Two types are generally recognized: *T. parva parva* which causes →East Coast Fever and *T. parva lawrencei* which causes →corridor disease. *T. annulata* causes theileriosis in North Africa, the near Middle East, Southern Europe, and Central Asia (e.g., →Mediterranean Coast Fever). *T. mutans* has a very wide distribution and is generally benign, except in some parts of East Africa where it is reported to cause severe disease. *T. lestoquardi (T. hirci)* and *T. ovis* are parasites of sheep in North Africa, Southern Europe, and Asia.

### Pathology

When introduced into a non-endemic region, **East Coast Fever** normally kills 90% or more of the susceptible cattle population. In endemic areas the severity of the disease is greatly reduced, particularly in calves which develop only subclinical infections when exposed to moderate tick challenge. Susceptible animals introduced into enzootic areas rarely survive the infection. The disease is characterized by high fever, lymphadenopathy, severe pulmonary oedema, and wasting. The fever follows a severe panleukopenia and remains high until recovery or death, which commonly occur after a course of 5–25 days. Oedema of the eyelids and lacrimation are often present. Dyspnoea and a soft moist cough usually occur in terminal stages, sometimes with a voluminous frothy nasal discharge. At necropsy, the most obvious finding is often a severe pulmonary oedema. Lymph nodes are enlarged, oedematous, and may contain haemorrhages. Multifocal lymphoid →hyperplasia may be visible as white spots within the renal cortex. Infection with *T. parva lawrencei* induces clinical signs and

pathological changes very similar to those of →East Coast Fever. The differentiation between the 2 diseases is mainly based on epidemiological grounds: →Corridor Disease is transmitted to cattle by →ticks of the African buffalo and occurs only in areas within the distribution of *Syncoerus caffer*. The clinical signs of Tropical Theileriosis are very similar to those of East Coast Fever, except maybe that in the former disease →anaemia becomes more severe and icterus may be present. Leukocytopenia does not usually develop in tropical theileriosis. However, the geographical ranges of *T. annulata* and *T. parva parva* do not overlap except, perhaps, in some parts of East Africa. The pathogenesis of *T. mutans* is entirely associated with the proliferation of the intraerythrocytic →piroplasm. The disease is normally mild in character, but cases of anaemia, icterus, and haemoglobinuria, have been reported from East Africa. *T. lestoquardi* (*T. hirci*) is pathogenic in sheep and goats, clinical signs resemble those of East Coast Fever in cattle.

The horse parasite *T. equi* has recently been redescribed. It is highly pathogenic and induces the following clinical signs: high fever, listlessness, lacrimation, oedema of the eyelids, severe anaemia, →haemoglobinuria, and icterus. Pathological findings include emaciation, anaemia, and icterus, hepatomegaly and splenomegaly, lymphadenopathy, oedema of the lungs, ascites, hydrothorax, and hydropericardium.

### Immune Responses

In the following section we will focus on *T. parva*.

Development from →sporozoite to →schizont inside leukocytes induces activation and proliferation of the host cell. This process results in rapid clonal expansion of parasitized cells and thus allows the parasite to remain intracellularly. As a consequence, immunological control of established infections is largely T-cell mediated. Studies *in vitro* have demonstrated that *T. parva* can infect  $\alpha\beta$  T cells (both CD4<sup>+</sup> and CD8<sup>+</sup>),  $\gamma\delta$  T cells, and B cells with similar frequencies. However, *in vivo* the vast majority of infected cells are CD4<sup>+</sup> and CD8<sup>+</sup> T cells and infection of unfractionated blood mononuclear cells usually gives rise to  $\alpha\beta$  T-cell lines. Infected cells constantly express high levels of class I and II MHC molecules.

The reservoir host of *T. parva*, the African buffalo, does not develop disease despite the fact that its cells are equally susceptible to infection and transformation by the parasite *in vitro*. Since in contrast experimental infection of susceptible cattle results in an acute fatal disease in the majority of animals, most studies on the immunity to *Theileria* spp. have been performed in an “infection and treatment model.” In this model, the treatment with a slow-release formulation of oxytetracycline at the time of infection allows animals to recover from infection.

### B Cells and Antibodies

Studies with immune sera and mAbs have failed to demonstrate expression of *Theileria* antigens on the surface of parasitized lymphoblasts. Because of the apparent absence of such antigens on the cell surface and the intracellular localization throughout this stage of development it is not surprising that passive transfer of immune serum to susceptible animals failed to give any protection. However, sporozoite-specific antibodies capable of neutralizing infectivity *in vitro* have been detected in cattle in endemic areas. The major specificity recognized by these sera appeared to be a 67 kDa protein (p67) which has been cloned and used as recombinant immunogen in vaccination studies. Although all immunized animals generated strong antibody responses with similar titres, isotype patterns, avidity, and epitope specificity, only 70% of the cattle were protected against challenge infections. Thus it is not clear yet whether protection induced by p67 immunization relates to antibody function.

### T Cells

Immunization of cattle by infection and treatment elicits a strong MHC-I restricted specific response of CD8<sup>+</sup> cytotoxic T cells (CTL), whereas parasite-specific CTL are not detected at any stage of the primary infection with *T. parva*. In immune animals the frequency of detectable CTL precursors is relatively constant (1:2,000–1:12,000) at 5–6 weeks p.i. but reaches levels as high as 1:30 in efferent lymph to 1:600 in PBMC following challenge with sporozoites. The strain specificity of CTL responses varied between animals immunized with the same parasites but only a restricted, immunodominant subset of epitopes appeared to be recognized. Furthermore, in many MHC-heterozygous animals a single class I molecule determined the epitopes that were recognized by CTL. The molecular and cellular events leading to immunodominance are not understood but are likely to involve variation in the concentrations of antigenic peptides bound to the presenting MHC molecules and the composition of the T-cell receptor repertoire. Cell transfer experiments utilizing identical twin calves produced by embryo splitting have shown, that CD8<sup>+</sup> T cells mediate protection. Whether they exert their effect solely by killing parasitized cells or by cytokine-mediated mechanisms has not been investigated in detail. There is some evidence that TNF as well as other cytokines may inhibit early *Theileria* development inside lymphocytes, but none of the cytokines tested so far inhibited established infections. In addition, a wide range of cytokines, such as IL-2 and IL-10, appears to be expressed by *T. parva*-infected cells themselves.

Although the majority of studies have focused on the role of CD8<sup>+</sup> T cells, there is no doubt that parasite-specific CD4<sup>+</sup> T cells are generated following

immunization with *T. parva*. Some cloned CD4<sup>+</sup> T cells have been shown to produce IFN- $\gamma$  indicating that they are Th1-like. However, the functional role of CD4<sup>+</sup> T cells in *T. parva* infection, for example, as helper cells for the establishment of a CD8<sup>+</sup> T-cell response or as anti-parasitic effector cells, has not been analyzed.

During primary infection of cattle with *T. parva* the lymph node draining the site of infection undergoes a dramatic threefold to fourfold increase in size 7–9 days after infection. Proliferation of mainly CD8<sup>+</sup> T cells is induced which contain a large subset of CD2<sup>-</sup> T cells. The latter cells may be derived from a rare pre-existing population and are polyclonal in origin as shown by analysis of their TCR repertoire. Analyses of the stimulatory requirements and function of these CD2<sup>-</sup>CD8<sup>+</sup> T cells have been hampered by the inability to culture them *in vitro*. Since only a minor part of the lymphoblastic cells in the lymph nodes is parasitized, the question has been raised, whether or not the T-cell response in naive animals contributes to the pathogenesis of the disease by potentiating the growth of parasitized cells. Since parasitized cell lines express cytokine receptors such as CD25 (IL-2 receptor, p55) and their growth could be enhanced by cytokines like IL-2, IL-1, and IL-10 *in vitro*, it is likely that the induction of an early cytokine expression in the infected host could help parasitized cells to multiply. Transfer studies with lymphocytes infected *in vitro* with *T. parva* sporozoites clearly demonstrated that the cell type infected influences the pathogenicity of the parasite. While infected CD4<sup>+</sup> or CD8<sup>+</sup> T cells induced severe, potentially lethal infections, infected B cells produced only mild self-limiting disease. The factors that determine the difference in the pathogenic potential of parasitized B and T cells have not been identified so far.

### Vaccination

A number of attempts to produce commercially available products have not yet been successful. *T. annulata* can be grown in culture using lymphocytes or fibroblasts as host cells. If this cultivation is done over a longer period of time, the virulence of the parasite is attenuated. In Israel, vaccination of cattle against *T. annulata* was introduced using attenuated cultured schizonts which are distributed in frozen form. The use was generalized in wide scale in North Africa and Asia and provides very effective control.

The search for attenuated vaccines against *T. parva* has not yet reached the same stage. However, in spite of the high costs, vaccine using live parasites has been used. The strategy of such a vaccine is based on the injection of live schizonts followed by treatment of the animal with tetracycline. More recently an attenuated *T. parva* isolate Boleni, has been used with success

without concurrent tetracycline therapy. The main hindrance is that suitable infective parasite materials, i.e., sporozoites, can only be obtained from the salivary glands of the ticks. Sporozoites have been successfully used to obtain protection in cattle by injecting them frequently together with tetracycline. In vaccination trials, cattle immunized against *T. parva* with this technique developed immunity against the homologous sporozoites as well as those of *T. parva lawrencei* and a number of other *T. parva* strains, indicating that there is a common protective antigenic determinant on the sporozoites used for vaccination. Doherty and Nussenzweig mentioned in 1985 that a number of monoclonal antibodies do not distinguish between sporozoites of the various *T. parva* strains.

A 67 kDa protein on the surface of the sporozoite of *T. parva* was identified as target antigen. Corresponding recombinant molecules have been used in vaccination experiments but producing partial protection. An equivalent recombinant protein SPAG-1 from *T. annulata* was also used, also producing partial protection. Intensive efforts have been focused on the identification of schizont-specific components for incorporation in a second-generation multi-component product, but these efforts remain so far inconclusive. Attenuated vaccine lines of *T. annulata* and *T. parva* are at the present time the only practical solutions for theileriosis control. Thus the molecular biology studies on the mechanisms of parasite virulence remain a priority in the hope of achieving a rational attenuated parasite line for vaccination.

### Therapy

→[Theileriacidal Drugs](#).

---

## Thelazia

### Classification

Genus of →[Nematodes](#).

### General Information

The genus *Thelazia* comprises nematode worms, commonly named →[eyeworms](#), which infect mostly the eyes and associated tissues of many domestic and wild animals ([Table 1](#)). However, they are also found in the nose and pharynx. Transmission occurs via non-biting dipterans that lick ocular secretions at the conjunctiva of animals. However, **human cases** (e.g., *T. californiensis* of dogs, cats, deer in North America) are also common in poor socio-economic regions in

**Thelazia.** Table 1 Some *Thelazia* species, hosts, vectors, and their geographic distribution

Species	Hosts parasitized	Vectors	Geographic distribution
<i>Thelazia californiensis</i>	Canids, felids, domestic and wild ruminants, <b>humans</b>	<i>Fannia benjamini</i> , <i>F. canicularis</i>	North America
<i>T. gulosa</i>	Domestic and wild ruminants	<i>Musca amica</i> , <i>M. autumnalis</i> , <i>M. domestica</i>	Europe, Asia, North America, Australia
<i>T. lacrymalis</i>	Equids, domestic and wild ruminants	<i>M. autumnalis</i> , <i>M. osiris</i>	Europe, North and South America
<i>T. leesei</i>	Camels	<i>M. lucidula</i>	Ex-USSR, India
<i>T. rhodesi</i>	Domestic and wild ruminants, horses	<i>M. autumnalis</i> , <i>M. domestica</i> , <i>M. larvipara</i>	Europe, Asia, Africa, North and South America
<i>T. skrjabini</i>	Domestic and wild ruminants	<i>M. amica</i> , <i>M. autumnalis</i> , <i>M. hervei</i> , <i>M. osiris</i>	Europe, Asia, North America, Australia

many Asian countries (e.g., *T. callipaeda* from rats, dogs, rabbits).

### Morphology

The adult worms grow up to 18 mm as females of *T. lacrymalis* (males 11 mm) (in horses, cattle, dogs in Europe, South Africa, South America) and of *T. rhodesii* (in cattle, horses, worldwide). The females release microfilariae (L<sub>1</sub>), which are taken up by feeding flies. Within the vector's intestine the development proceeds, until the infectious L<sub>3</sub>-stage is reached (within 9–12 days). During next feeding the L<sub>3</sub> emerge from the labellum of infected flies, start feeding on the lacrymal secretions of the new hosts and develop into the adult stage within 3–4 weeks. The adults live for 2–3 months. Morphological characteristics are the roughly striped cuticle, the absence of lips, a short oesophagus, and the differently sized spicula of males (Figs. 1–4, page 1374–1375). Some species are viviparous (see above), others excrete larva-containing eggs.

### Symptoms of Disease

Inflammation of eyes, keratitis, blindness.

### Therapy

→ **Nematocidal Drugs**, mechanical extracting of the worm from the conjunctival sac.

## Thelohanellus nikolskii

Species of → **Myxozoa**.

## Thelohania

→ **Microsporidia**.

## Theobaldia

Former genus name for → **Culiseta**-mosquitoes.

## Therapeutic Targets (TT)

A drug of choice is best, if it has a fixed target, which steers such an important mechanism in the physiology of a parasite, that it cannot survive or reproduce without it. For example, in *Plasmodium falciparum* there are several TT dependent on the attacked system:

1. **Targets in apicoplast:** fatty acid synthesis, isoprenoid synthesis; **new drugs:** triclosan, fosidomycin.
2. **Targets in cytosol:** glycolysis, pyrimidine synthesis, folate pathways; **existing drugs:** antifolates, atovaquone.
3. **Targets in food vacuole:** heme detoxification; **drugs:** chloroquine, aminoquinolines; **new targets:** falcipains, plasmepsins; **drugs:** protease inhibitors.
4. **Targets in mitochondrion:** respiratory chain; **drug:** atovaquone.



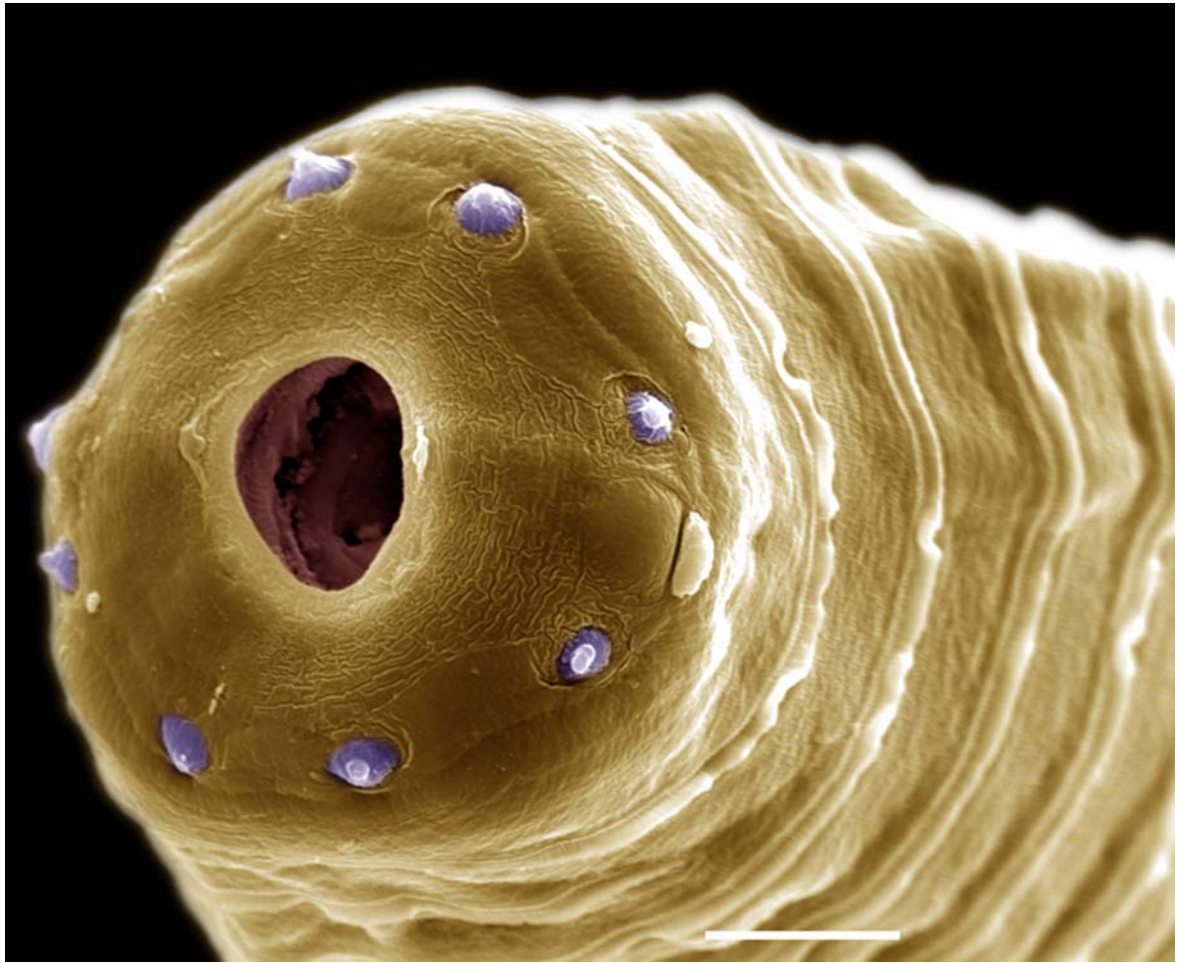

**Thelazia. Figure 1** SEM of adult female *Thelazia rhodesi* worm (mouth); bar = 0.1 mm; (courtesy Dr. Naem, Iran).

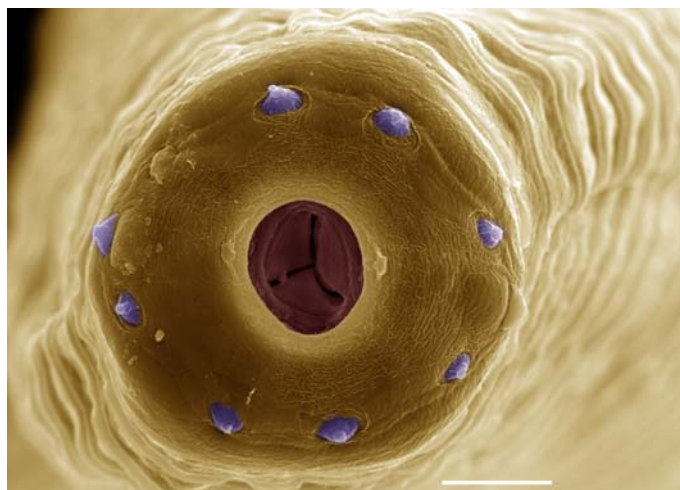

**Thelazia. Figure 2** SEM of adult male *Thelazia rhodesi* worm (mouth); bar = 0.2 mm.

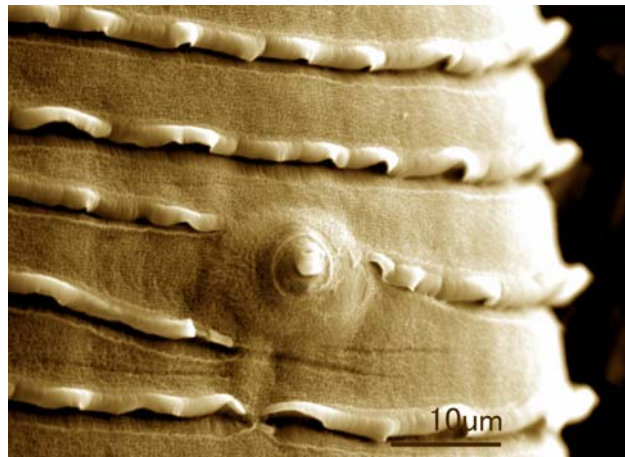

**Thelazia.** Figure 3 SEM of cuticular sensory papillae of *Thelazia skrjabini*.



**Thelazia.** Figure 4 Coiled posterior pole of a *Thelazia gulosa* male, showing the 2 different spicula; bar = 0.1 mm. (Courtesy of Dr. S. Naem, Urmia, Iran).

## Therapy

See chapters on Disease Control, Control, and  
[→Chemotherapy](#), [→Drugs](#), [→Biological Control](#).

## Theronts

Swarmer stage of [→Ichthyophthirius](#).

## Thiabendazole

→Nematocidal Drugs.

## Thiara

Genus of snails that act as intermediate hosts in →*Paragonimus* transmission.

## Thigmotaxis

Movement after touching or instabilisation.

## Thiolproteinases

Thiolproteinases are widely spread in the animal kingdom. In parasites at least 3 groups had been defined acting similarly like cathepsin L of humans:

- →**Cruzipain** (syn. cruzain) is described in *Trypanosoma cruzi* and possesses a very long C-terminus consisting of 149 amino acids. It steers the metacyclogenesis (i.e., the change from amastigote stages into →**trypomastigotes** and inverse).
- →**Falcipain** (syn. trophozoite cysteine proteinase = TCP) is found in →*Plasmodium falciparum* and plays its role during the separation of the hem –

component from the globin during digestion within the intraerythrocytic food →**vacuoles**.

- Sm 219. This thiolproteinase was found in →**tachyzoites** and →**bradyzoites** of →*Toxoplasma gondii* and →*Sarcocystis* spp. In the first case it is found in the →**rhoptries**, while in *Sarcocystis* (where 219 aminoacids are noted) it is localized in the →**dense bodies** and becomes thus excreted into the rising →**parasitophorous vacuole**

## Thiols

Low-molecular-weight thiol compounds and their associated enzymatic recycling systems are responsible for the protection of cells against oxidative stress and the maintenance of an optimal intracellular redox state. In most eukaryotes, including helminths, glutathione (GSH, L-γ-glutamyl-L-cysteinylglycine) in conjunction with various enzymes, including GSH reductase, GSH peroxidase, catalase and superoxide dismutase, fulfils these important functions. Although the majority of parasites appears capable of GSH biosynthesis, many of them lack an effective enzymatic equipment to protect themselves against reactive oxygen metabolites. Catalase and GSH peroxidase are often missing, but with the exception of anaerobic protozoa most parasites contain superoxide dismutase for removal of peroxides (Fig. 1). In common with various prokaryotes, anaerobic protozoa lack GSH and its recycling enzymes, together with other defending antioxidants, such as catalase and peroxidases (Fig. 1). Instead, these parasites use cysteine as the major GSH substitute together with a disulphide reductase as the thiol recycling enzyme. In this system,

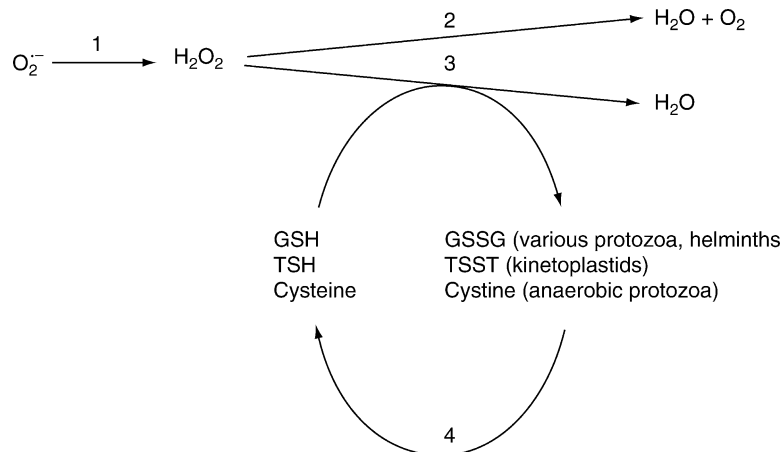

**Thiols. Figure 1** Mechanisms of detoxification and the associated role of thiol compounds in protozoa and helminths. 1, Superoxide dismutase; 2, catalase; 3, thiol dependent peroxidases; 4, thiol reductases. GSH and GSSG, reduced and oxidized forms of glutathione; TSH and TSST, reduced and oxidized forms of trypanothione.

thioredoxin (Trx) appears to function as an intermediate electron carrier between the enzyme and the thiol. Thioredoxin is a ubiquitous, low-molecular-mass polypeptide that is re-oxidized in an NADPH-dependent reaction by thioredoxin reductase (TrxR). The Trx-TrxR system plays an important role in parasites as an alternative to the GSH-dependent enzymatic system for the elimination of reactive oxygen species. An exceptional thiol metabolism is observed in kinetoplastids. These protozoans produce GSH, but the major portion of this thiol is conjugated with spermidine to form the cyclic peptide, trypanothione. Trypanothione (N<sup>1</sup>,N<sup>8</sup>-bis (glutathionyl)spermidine) is a novel thiol compound that is used in trypanosomatids to regulate the intracellular redox environment and detoxify free radicals and other toxic compounds. The protective thiol is synthesized from spermidine and glutathione by the consecutive action of 2 distinct enzymes, glutathionylspermidine synthetase and trypanothione synthetase. Trypanothione is maintained in its reduced form by the action of trypanothione reductase. Other recently identified components of the trypanothione-dependent metabolism are tryparedoxin and tryparedoxin peroxidase. These proteins are, together with trypanothione and trypanothione reductase, constituents of a complex peroxidase system that kinetoplastids have evolved to detoxify hydroperoxides.

## Thominx Species

Genus of the nematode family Capillariidae (hair-worms) of birds.

## Threadworm Disease

### Synonym

→ *Strongyloides stercoralis* (→ *Strongyloides*).

## Thrombocytopenia

Reduction of thrombocytes in infections with *Babesia* spp. or in malaria.

## Thrombosis

→ *Pathology*, → *Malaria*.

## Thrombospondine-Related Anonymous Protein

→ *Malaria*, → *TRAP*, → *Vaccination*.

## Thrombospondin-Related Adhesion Protein (TRAP)

One of the circumsporozoite proteins (CSP), that are involved in the movements of *Plasmodium* sporozoites.

## Thynascaris

### Synonym

Genus name for → *Contracaecum* spp. parasitizing fish (Ascaroidea-group).

## Thysaniezia

### Name

Greek: *thysanos* = ruptured ends.

### General Information

Genus of anoplocephalid cestodes. *T. giardi* is found in cattle in Europe, Asia, Africa, and America, reaches a length of about 2 m, and its terminal proglottids are characterized by a uterus with several paruterine organs containing 25 µm eggs (Fig. 1).

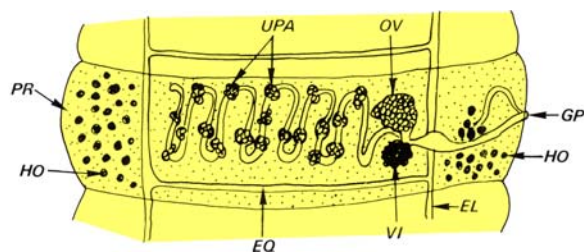

**Thysaniezia.** Figure 1 DR of a proglottis of *Thysaniezia*. EL, longitudinal excretory channel; EQ, cross excretory channel; GP, genital porus; HO, testis; OV, ovary; PR, proglottis; UPA, anlagen of the paruterine organs; VI, vitellarium.

## Thysanosoma actinoides

Tapeworm of ruminants, which is found in the small intestine and in the ductus pancreaticus. This species has 2 sets of genitalia in each proglottis.

## Tiabendazol

Other spelling for thiabendazole, →[Nematocidal Drugs](#).

## Tiacc-arana

Leishmaniasis due to *L. peruviana*. Other common names are uta, llaga.

## Tiamulin

→[Coccidiocidal Drugs](#).

## Tick Bites: Effects in Animals

### General Information

→[Ticks](#) play a major role in the human economy by causing significant losses in animal production through their own direct effects, as well as by transmitting diseases to domestic stock. In temperate and tropical countries, ticks surpass all other arthropods in the number and variety of diseases they transmit to animals. Disease agents transmitted to animals by ticks include viruses, rickettsiae, bacteria, →[fungi](#), and protozoans. In a few cases, helminths have also been found in ticks. A summary of the most important pathogens transmitted by ticks to animals is shown in [Table 1](#). Direct effects of ticks are manifested as mechanical injury, anemia, paralysis, and →[toxicosis](#). These may be extended by secondary infections with bacteria, fungi, or myiasis.

### Lesions

In most cases the bite of a tick is not felt at first, but it can be painful in →[Amblyomma](#) spp., which have very long mouthparts. Even if ticks are removed by grooming, persistent lesions can remain.

Mechanical injury to the host is initiated by the penetration of the mouthparts into the skin, during which the →[chelicerae](#) serve to cut into the epidermis, causing some damage to capillaries and tissues. The recurved denticles of the →[hypostome](#) serve to anchor the tick within the lesion. The depth to which inserted mouthparts enter the host's skin depends on the morphology and feeding habits of the tick species. Those with long mouthparts, such as members of the genera *Amblyomma* and →[Hyalomma](#), penetrate much deeper than ticks with short mouthparts, such as members of the genera →[Boophilus](#), *Dermacentor*, →[Haemaphysalis](#), and →[Rhipicephalus](#), which are superficial feeders. Female *A. americanum* ticks insert their mouthparts well into the lower reticular area of the dermis to the layer of adipose tissue. *Hyalomma asiaticum* penetrate to a similar depth in sheep.

The extent of tissue damage caused by tick feeding is not always clearly differentiated from host reactive tissue damage. The involvement of host reactions leading to tissue damage may be dependent upon recruitment and degranulation of mast cells, resulting in the release of heparin and →[histamine](#) (or 5-hydroxytryptamine in bovines) from the granules, leading to →[inflammatory responses](#) characterized by dermal cell infiltrates which form the lesion. The type of cell which infiltrates is dependent upon the tick/host system involved and can be predominantly neutrophil or mononuclear. The cell populations can change after multiple infestations. At the feeding site of *Hyalomma a. anatolicum* on rabbits, the extent of →[collagen](#) destruction is parallel to the degree of neutrophil infiltration. Mated females *A. americanum* caused a more substantial inflammatory response than unmated females, which produced, on average, smaller cavities and lesions over the same duration of attachment. Lesions from unmated females were the same size after 24 hours as those from mated females after 48 hours.

In fast-feeding argasid ticks, the leukocyte response is less marked than in the slow-feeding ixodid species. After primary feeding by *Ornithodoros parkeri* and *O. tartakovskyi*, basophils were found to accumulate after as little as 24 hours in guinea pig skin. There was also a marked blood basophilic response, with weak →[eosinophilia](#).

The extent of local injuries can be influenced by the tick species and the site. There is a higher frequency of severe udder damage in cattle infested by *Amblyomma hebraeum* than in those infested by *A. variegatum*. Larvae and nymphs of →[Otobius megnini](#), the →[spinose ear tick](#), cause marked irritation in the ear canal, with secondary bacterial infections extending inward, sometimes resulting in serious complications.

Theoretical estimates of blood loss and ensuing damage due to ticks do not always apply to the field situation. In many cases the severity of effects is likely

**Tick Bites: Effects in Animals. Table 1** Tick-borne bacteria, rickettsiae, and protozoans in domestic animals

Tick vector	Pathogen	Host	Disease
<i>Argas reflexus</i>	<i>Borrelia anserina</i>	Poultry	Avian spirochaetosis
	<i>Aegyptianella pullorum</i>	Poultry	
<i>Amblyomma</i> spp.	<i>Cowdria ruminantium</i>	Ruminants	Heartwater
	<i>Theileria mutans</i>	Ruminants	Benign theileriosis
	<i>Theileria velifera</i>	Bovines	
<i>Amblyomma variegatum</i>	<i>Dermatophilus congolensis</i>		Streptotrichosis
	<i>Ehrlichia bovis</i>	Bovines	Ehrlichiosis
<i>Boophilus</i> spp.	<i>Anaplasma marginale</i>	Bovines	Anaplasmosis
	<i>Anaplasma centrale</i>	Bovines	Anaplasmosis
	<i>Babesia bigemina</i>	Bovines	Texas fever
	<i>Babesia bovis</i>	Bovines	Babesiosis
	<i>Borrelia theileri</i>	Bovines	Borreliosis
<i>Dermacentor andersoni</i>	<i>Anaplasma marginale</i>	Bovines	Anaplasmosis
<i>Haemaphysalis leachi</i>	<i>Babesia canis</i>	Dogs	Babesiosis
	<i>Ehrlichia canis</i>	Dogs	Ehrlichiosis
	<i>Babesia felis</i>	Felines	Babesiosis
<i>Haemaphysalis longicornis</i>	<i>Theileria orientalis</i>	Bovines	Theileriosis
<i>Haemaphysalis punctata</i>	<i>Babesia major</i>	Bovines	Babesiosis
<i>Hyalomma anatolicum</i> , <i>Hyalomma</i> spp.	<i>Theileria annulata</i>	Bovines	Mediterranean Coast Fever
<i>Hyalomma</i> spp.	<i>Trypanosoma theileri</i>	Bovines	
<i>Ixodes persulcatus</i>	<i>Babesia divergens</i>	Bovines	Babesiosis
<i>Ixodes ricinus</i>	<i>Babesia divergens</i>	Bovines	Babesiosis
	<i>Ehrlichia phagocytophila</i>	Sheep	Tickborne Fever
	<i>Staphylococcus aureus</i>	Sheep	Tick pyemia
	<i>Borrelia burgdorferi</i>	Many	Lyme-Disease
<i>Rhipicephalus appendiculatus</i>	<i>Theileria parva parva</i>	Bovines	East Coast Fever
	<i>Theileria parva lawrencei</i>	Bovines	Corridor Disease
	<i>Theileria taurotragi</i>	Elands	Theileriosis
<i>Rhipicephalus bursa</i>	<i>Theileria ovis</i>	Sheep	Theileriosis
<i>Rhipicephalus evertsi</i>	<i>Theileria ovis</i>	Sheep	Theileriosis
<i>Rhipicephalus pulchrellus</i>	<i>Theileria taurotragi</i>	Elands	Theileriosis
<i>Rhipicephalus sanguineus</i>	<i>Babesia canis</i>	Dogs	Babesiosis
	<i>Ehrlichia/Anaplasma canis</i>	Dogs	Ehrlichiosis/USA
	<i>Haemobartonella canis</i>	Dogs	Bartonellosis

to be enhanced by toxic salivary excretions. Acute and even fatal anemia can occur in heavy infestations. *Argas persicus* can completely exsanguinate chickens, particularly young ones, within short periods.

## Paralysis

→Paralysis caused by ticks is reversible when the causative ticks are removed, but it is sometimes difficult to clearly separate paralysis from toxicosis. Paralysis is usually associated more with female ticks and can be produced by a single tick. In Australia, paralysis is produced by *Ixodes holocyclus*, particularly in dogs, but sometimes also in other animals. In South Africa, Karoo tick paralysis is caused by *I. rubicundus*, mainly in sheep, as well as in other domestic stock. Also

in South Africa, *Rhipicephalus evertsi evertsi* and *R. e. mimeticus* cause spring lamb paralysis while →*Argas* ticks in the subgenus *Persicargas* cause paralysis in poultry. Other important paralysis-producing species are *Dermacentor andersoni*, the Rock Mountain wood tick, which affects sheep and cattle, and *D. variabilis*, the American dog tick, which paralyzes dogs. A number of other species in several genera have also been incriminated. The distribution of paralysis due to a certain species of tick does not necessarily coincide with the total area of distribution of the species, and pathogenicity may also change within this area.

A paralysis-inducing toxin has been isolated in *I. holocyclus* and used as an immunizing agent. *Rhipicephalus evertsi* females are only able to produce toxin while they are within a specific weight range,

which is of short duration when they are mated but prolonged in the absence of mating; thus there is increased risk of paralysis when females feed in the absence of males. This explains the higher frequency of some forms of paralysis in the field than in the laboratory, where in the past females have usually been provided with adequate numbers of males.

### Toxicosis

Tick toxicosis is also associated with tick bite. A well-known African form is [→sweating sickness](#), a disease of cattle, with profuse serum exudation onto the skin. It is caused by the bite of *Hyalomma truncatum*, a species of tick common throughout sub-sahelian Africa. Reactions to argasid ticks are more frequently caused by juvenile instars. *Ornithodoros savignyi* toxicosis can cause losses among cattle and *O. lahorensis* among sheep. The toxic component of oral secretions of *O. savignyi* was found to have a molecular weight of 15 kDa.

A variety of different pathogens can use lesions caused by ticks to infect animals. The bite of *Ixodes ricinus* is associated with tick pyemia, a disease of 2- to 6-week-old lambs in the UK caused by *Staphylococcus aureus*. A similar, usually fatal condition, caused by the same bacteria, has been found in rabbits infested with *R. appendiculatus*. It is thought to be related to immunosuppressive components of tick saliva.

### Clinical Relevance

Clinical signs due to ticks are found in birds, reptiles, and mammals. There are reports of large tick burdens on some wild animals but the effects of ticks on individual animals are best known from domestic stock. Threshold values for production loss in domestic animals, i.e., changes in average daily weight gains, differ depending on tick species and hosts. For instance, weight gain was shown to be affected by 15 *Amblyomma americanum* females per calf, but far larger numbers of ticks are considered acceptable under other challenge situations.

Nevertheless, systematic tick control nearly always results in improved weight gain and yield in domestic stock. On the other hand, it has also been shown that under extensive husbandry conditions in dry African rangelands, cattle may make better weight gains in the absence of acaricide treatment, despite tick challenge.

Enormous tick challenge can be encountered in some parts of the world. The classic report of heavy infestation was by Theiler, who in 3 days removed half the *Boophilus decoloratus* ticks from a horse which had died of acute anemia and found them to weigh about 7 kg. In addition to blood loss and anemia, host animals are also affected by tick salivary excretion into the host, which may amount to at least the equivalent in weight of the engorged ticks. However, it must be

accepted that most reports of massive harmful infestations with ticks involve either naive animals which have had no opportunity to acquire resistance, notoriously tick-susceptible species/breeds, e.g., Friesian (Holstein) cattle, or animals stressed by other causes.

### Transmitted Pathogens

Many tick-borne diseases ([Table 1](#)) are characterized by a high degree of endemic stability, i.e., in areas with well-established populations of host animals, disease is experienced by most individuals, without more than passing clinical signs, and there is a high degree of immunity or premunity. Stability can be disturbed by the introduction of susceptible, nonadapted hosts, after which serious outbreaks can occur in the new animals, inducing altered epidemiological conditions.

Virus diseases transmitted by ticks have been described from a large number of different hosts and are associated with a large number of different species of ticks (e.g., [→African Swine Fever](#), [→Nairobi Sheep Disease](#)). The presence of viruses in ticks in an area is not always associated with disease. In addition, ticks transmit protozoans ([→Babesia](#), [→Theileria](#)), rickettsiae, and bacteria which cause severe diseases ([→Heartwater](#), [→Streptothricosis](#)).

### Related Entries

[→Tick Bites: Effects in Humans](#), [→Protozoan Infections](#), [→Ticks as Vectors](#), [→Virosis](#).

---

## Tick Bites: Effects in Humans

### General Information

[→Ticks](#) are a hazard to human health through direct effects as well as through the transmission of viral, rickettsial, bacterial, fungal, and protozoan diseases ([→Ticks/Important Species](#)). Their capacity as vectors for the transmission of human diseases is surpassed only by that of [→mosquitoes](#). A summary of some major diseases transmitted by ticks is shown in [Table 1](#). Direct effects of tick activity include mechanical lesions, haemorrhages ([Figs. 1, 2](#)), and paralysis.

### Lesions

Some lesions are complicated by the mouthparts of ticks breaking off during manual detachment. This is rare in many tick species, but can occur in up to 50% of *Ixodes* spp. female detachments. This can be followed by the formation of abscesses at the tick feeding site. The bite may not be known to the patient, particularly in cases where the tick is found on the scalp. This is a preferred site of *Rhipicephalus sanguineus*, a tick

**Tick Bites: Effects in Humans. Table 1** Some important tick-borne viruses, bacteria, rickettsiae, and protozoans in humans

Tick	Pathogens	Diseases
<i>Ornithodoros</i> spp.	<i>Borrelia duttoni</i>	Relapsing fever
<i>Dermacentor</i> spp. and other ixodid species	<i>Rickettsia rickettsii</i>	Rocky Mountain spotted fever
	<i>Francisella tularensis</i>	Tularemia
<i>Ixodes dammini</i>	<i>Borrelia burgdorferi</i>	Lyme disease
	<i>Babesia microti</i>	Babesiosis
<i>Ixodes holocyclus</i>	<i>Rickettsia australis</i>	Queensland tick typhus
<i>Ixodes ricinus</i>	<i>Babesia microti</i>	Babesiosis
	<i>Babesia divergens</i>	Babesiosis
	<i>Borrelia burgdorferi</i>	Lyme disease
	Toga-/Flavi-virus	Meningoencephalitis
<i>Rhipicephalus sanguineus</i>	<i>Rickettsia conori</i>	Boutonneuse fever
Several ixodid species	<i>Rickettsia sibirica</i>	Siberian tick typhus
<i>Amblyomma</i> spp.	<i>Francisella tularensis</i>	Tularemia



**Tick Bites: Effects in Humans. Figure 1** Attached *Ixodes* female introducing Rosacea at the biting place.

species which has spread rapidly during the recent past, attaching to children in temperate European countries. Some human cases of ear infestation with larval and nymphal spinose ear ticks, →*Otobius megnini*, have also been reported.

Tick bites from ixodid ticks are sometimes biopsied because they give rise to a persistent →ulcer with a necrotic base. In the center of the lesion, up to 2–3 mm into the dermis, one can sometimes find remnants of the chitinous mouthparts (→Hypostome) of a tick which was removed incompletely several months earlier. These irregular brownish fragments elicit an intense

→hypersensitivity reaction and are embedded in necrotic connective tissue surrounded by fibrosis and an intense lymphohistiocytic reaction including eosinophils and basophils. The epithelium peripheral to the lesion undergoes acanthosis, hyperkeratosis, and focal parakeratosis.

The attachment of ticks is usually not felt, but may result in persistent irritation long after the tick has been removed. Larval ticks, also called →pepper ticks or →seed ticks, cause a small lesion which may lead to a relatively large inflammatory area remaining for several weeks. Large numbers of larvae are picked up when the offspring of a female tick crowd together on





**Tick Bites: Effects in Humans. Figure 2** Tâche bleue (French) = remnant skin lesion due to a preceding tick bite.

the vegetation. They will frequently attach on the ankles just above the socks and can cause intense and persistent itching.

### Paralysis

Tick [paralysis](#) in man has been associated with *Dermacentor andersoni* and *D. variabilis* in North America, *Ixodes hexagonus* in Britain, and *I. holocyclus* in Australia, among others. Female ticks are usually involved. It is caused by a toxin and can lead to complete locomotory paralysis and death through respiratory paralysis.

Paralysis due to ticks is characterized by an acute ascending flaccid motor paralysis which can be fatal if the causative tick is not removed. In North America tick paralysis, the first symptoms usually appear 4–6 days after exposure. The cause of paralysis may not always be determined correctly, since the tick may be hidden by hair, which can lead to incorrect diagnosis. It is manifest at first as difficulty in walking, followed by inability to walk, limb numbness, and complete locomotory paralysis within 24 hours, difficulties in speech, respiratory paralysis, and death. Removal of the culprit tick results in rapid and complete recovery. In cases of extensive paralysis, recovery may be delayed for 1–6 weeks. Paralysis caused by *Ixodes holocyclus* in Australia does not usually peak until about 48 hours after the tick involved has been removed. Accompanying symptoms are [vomiting](#) and acute illness.

### Transmitted Pathogens

Ticks are more important as transmitters of disease ([Table 1](#), [Ticks/Important Species](#)) than through their

own direct effects. It is wise to regard all live ticks collected in the field for laboratory maintenance as potential sources of infection and they should always be handled with extreme caution. There are, unfortunately, too many instances where neglect of this principle has resulted in loss of life or severe illness. The association of many tick species with migrating birds can allow a rapid movement of virus-infected ticks into new areas. It should be kept in mind that tick tissues or excretory products may contain infective agents which can be transmitted through contact or aspiration alone. It may be necessary to investigate ticks for the presence of unwanted virus infections before general handling can take place. Even apparently very closely related tick species may differ completely in their capacity to transmit pathogens. It can therefore be of great importance to identify tick species correctly.

Many tick-transmitted pathogens are likely to be carried by natural wild hosts (Reservoir), to which they are well adapted and in which they therefore cause no or only mild symptoms. At the same time, they can pose a serious threat to human beings or domestic stock, which may be severely affected and respond pathologically to infection. On the other hand, viruses have also been detected in ticks in areas where no disease is reported.

The [arboviruses](#) associated with ticks and human disease belong to the [Togaviridae](#), [Flaviviridae](#) ([Flavivirus](#), group B), to the [Reoviridae](#), *Orbivirus*, and several ungrouped viruses.

Tick-transmitted rickettsiae usually do not persist for long in the peripheral circulation and the ticks themselves therefore serve as the main reservoir of disease. The best known is [Rocky Mountain spotted fever](#) caused by *Rickettsia rickettsii*, which is found from Canada to South America and is associated with various ixodid ticks (*D. andersoni* and *D. variabilis* in North America) which can transmit the pathogen transovarially to the next generation. [Tick typhus](#) is caused by other rickettsiae (e.g., *Rickettsia sibirica*). [Boutonneuse fever](#) is caused by *R. conori*, which is widespread in Africa, the mediterranean region, and parts of Southeast Asia. Queensland [tick typhus](#) is caused by *R. australis* and is found in coastal Queensland, where *Ixodes holocyclus* appears to be the main vector. The transmission of *R. prowazeki*, the agent of *epidemic typhus*, by ticks has not been confirmed, although at one time they were thought to be vectors ([Lice/Feeding Behavior and Transmission of Disease](#)).

Ticks are also known or suspected of harboring a number of bacterial infections of man. [Relapsing fever](#) is caused by spirochaetes ([Borrelia](#) spp.) and is transmitted by [Ornithodoros](#) tick species. [Tularemia](#), caused by *Francisella tularensis*, is found in North America, reaching as far south as Venezuela, and

is also found in parts of Asia and Europe. It is transmitted by *Dermacentor andersoni* (in the USA) and other tick species such as *Rhipicephalus sanguineus*. →Lyme disease is caused by →*Borrelia burgdorferi*, a spirochaete-like bacterium transmitted by the ticks *Ixodes dammini*, *I. pacificus*, and *I. ricinus*.

Finally, ticks are vectors of many protozoan infections in man (e.g., →Babesiosis, Man).

**Therapy**

Treatment and control see →Acarizides.

**Tick Fever**

→Babesia.

**Tick Genus Diagnosis**

The anterior end of ixodid ticks can be used as criterion for diagnosis (Fig. 1).

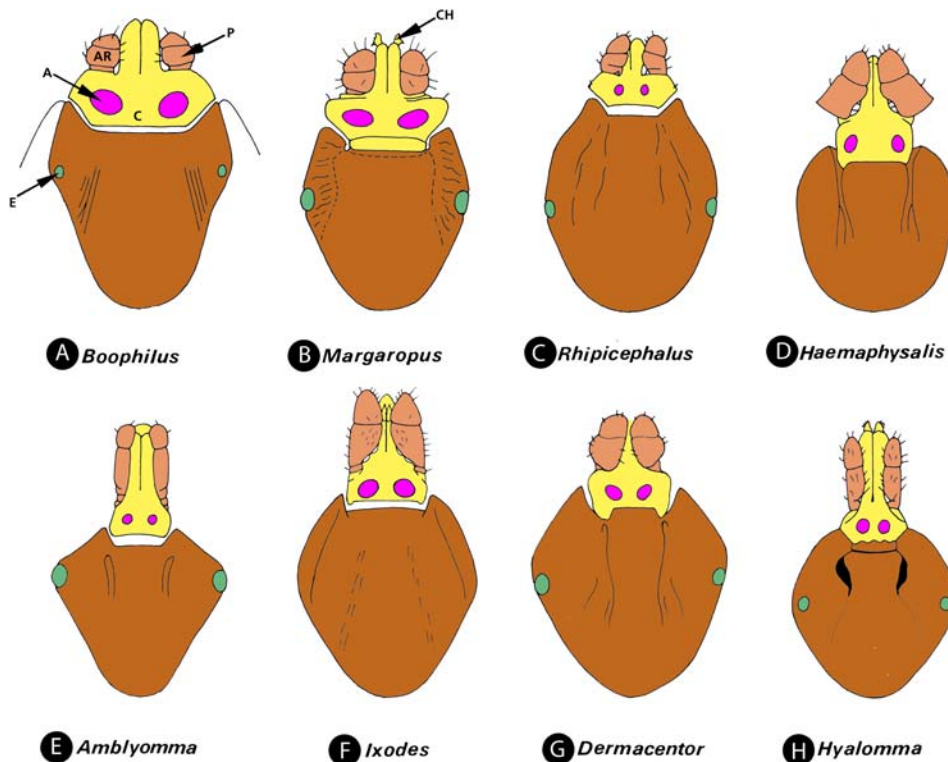

**Tick Genus Diagnosis. Figure 1** DR of the 8 important species of hard ticks. A, area porosa; AR, article (= segment) of pedipalp; C, basis of capitulum; CH, chelicera; E, eye; P, pedipalp.

**Tick Typhus**

Tick typhus is caused by different rickettsiae. *Rickettsia sibirica* causes Siberian tick typhus which is transmitted transstadially and transovarially by →ticks of the genera *Dermacentor* and →*Haemaphysalis* as well as *Rhipicephalus sanguineus* and *Hyalomma asiaticum*. Ticks can serve as long-lived reservoirs of disease. Other arthropods may also play a role. Queensland tick typhus is caused by *Rickettsia australis* and is found in coastal Queensland, where *Ixodes holocyclus* appears to be the main vector.

**Related Entries**

→Rocky Mountain Spotted Fever, →Boutonneuse Fever.

**Tick Worry**

Unspecific toxicosis induced in European cattle species (if imported in tropical regions) by the saliva of the

one-host tick *Boophilus*. The symptoms are large skin lesions, disturbances of metabolism, loss of weight, and even death. → [Ticks](#)

## Tick-Borne Encephalitis

### Synonym

TBE.

### General Information

Tick-borne encephalitis is caused by the TBE virus (→ [Flavivirus](#), group B) which is also called hyps virus. It is a disease clinically similar to → [Russian spring-summer encephalitis](#). A frequent route of infection is oral, by drinking the milk of infected domestic animals. The main vector is *Ixodes ricinus*, a tick found throughout Europe, including Turkey, and the Atlas region of North Africa. The TBE virus has a tendency to spread westwards throughout the area of vector distribution. In Austria it is a serious menace and it has more recently widely occurred in West Germany, where mortalities were initially high. *I. ricinus* is also associated with → [louping ill](#).

### Therapy

→ [Vaccination](#).

## Ticks

### Synonym

→ [Metastigmata](#).

### Classification

Suborder of → [Acarina](#).

### General Information

The monoecious ticks may reach up to 2 cm in length and are vectors of important pathogens (viruses, bacteria, rickettsiae, anaplasms, → [protozoa](#), and helminths; [Table 2](#)), since they feed on the blood of their hosts. Unlike → [vessel feeders](#) (→ [Mosquitoes](#)), tick mouthparts bring about more or less deep hollows in the host's skin, which become filled by blood of ruptured blood vessels ([Fig. 1](#)). Thus, the ticks are → [pool feeders](#) engorging (in some species for minutes,

in others for up to days) large amounts of blood (several times their body weights). During feeding salivary secretions prevent blood coagulation. In some species (e.g., *Ixodes* spp., *Dermacentor* spp.) these injected substances are toxic and cause paralysis (tick paralysis), which may lead to death in man and animals. In general, all stages of the tick's life cycle (larvae with 6 legs, nymphs and adults with 8 legs) suck blood. The life cycle of ticks is characterized by periods of starvation which can be of long duration, and by relatively short periods involved with the uptake of enormous concentrated blood meals. The life cycle of an ixodid tick can often have a total duration of 6 years and host attachment may constitute less than 2% of this time. Starvation periods of more than 3 years are common, and starvation can be particularly extended in some argasid tick species which have been known to survive for up to about 14 years. This ability is very important and has to be considered when dealing with the acute transmission and epidemiology of certain pathogens.

### System

The ticks are subdivided into 3 families, namely the → [Argasidae](#) and the → [Ixodidae](#), to which most ticks belong, and the Nuttalliellidae, which is a monotypic family characterized by features mainly intermediate to those of the 2 major tick families. The 2 major families, the "soft" Argasidae and the "hard" Ixodidae, can be differentiated according to the following biological and behavioral criteria ([Table 1](#)).

The more common genera of argasid ticks are *Antricola* (4 species), → [Argas](#) (140 species), *Otobius* (2 species), and → [Ornithodoros](#) (90 species). Ixodid ticks are further divided into 2 groups, the → [Prostriata](#) and the → [Metastrata](#). Prostriata contains only the genus → [Ixodes](#) which has about 250 species worldwide, while all other ixodid genera are classified as Metastrata. A distinctive difference between these 2 groups of ticks is the location of an anal groove anterior to the anus in Prostriata, and posterior to the anus in Metastrata. The more important metastratid genera are → [Amblyomma](#) (100 species), *Aponomma* (26 species), *Anocentor* (monotypic), → [Boophilus](#) (5 species), *Dermacentor* (31 species), → [Haemaphysalis](#) (150 species), → [Hyalomma](#) (21 species), → [Rhipicephalus](#) (63 species), and *Margaropus* (3 species) ([Table 2](#)).

### Important Species

[Table 2](#).

### Life Cycle

→ [Argas/Life Cycle](#), → [Ixodes Species/Life Cycle](#).

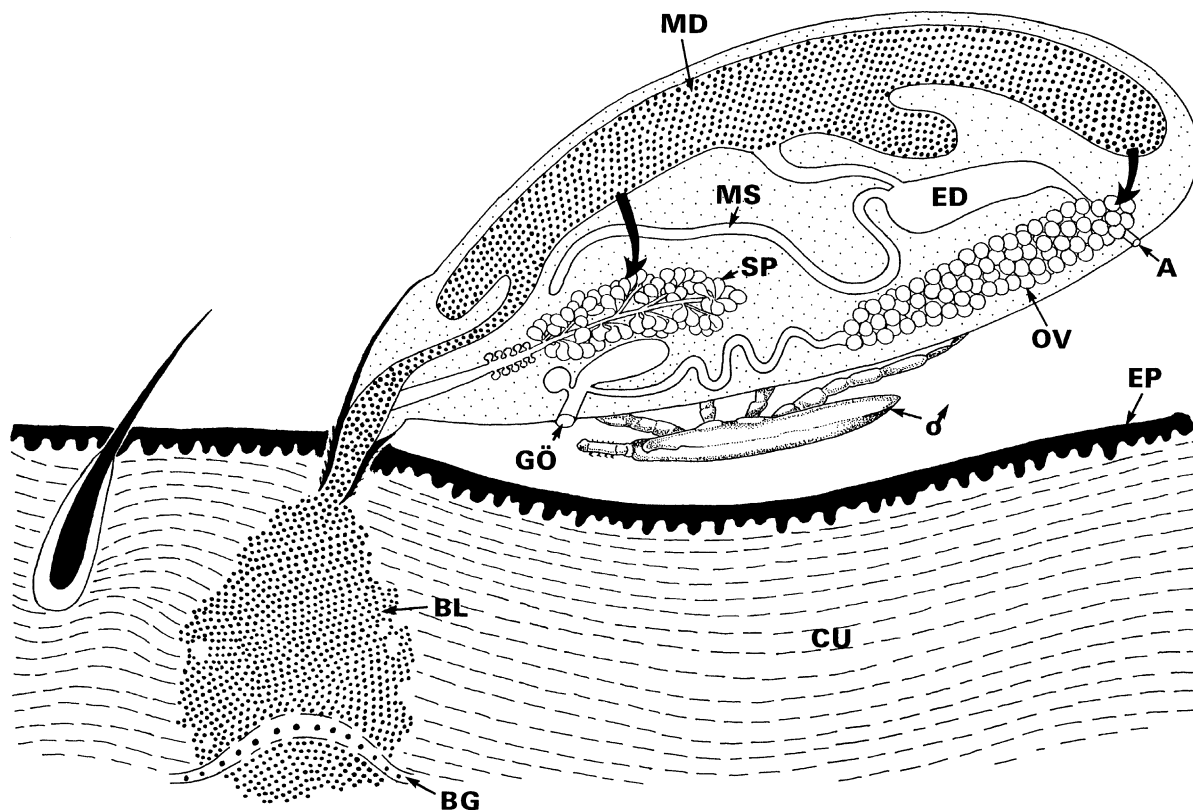

**Ticks. Figure 1** DR of a feeding female ixodid tick. The arrows indicate pathways of wandering agents of diseases. Note that the tick engorges blood cells and lymph present within interstitial spaces of the tissues. *A*, anus; *BL*, interstitial blood cells; *BG*, blood vessel; *CU*, cutis; *ED*, hind gut; *EP*, epidermis; *GÖ*, genital opening; *MD*, midgut filled with blood cells; *MS*, Malpighian tubules, excretory system; *OV*, ovary; *SP*, salivary glands.

**Ticks. Table 1** Differences between the two main families of ticks

Ixodidae	Argasidae
1. Cuticle is relatively hard.	1. Cuticle is smooth and leathery.
2. Scutum is present in all developmental stages covering the whole dorsal region of adult males, but only the small propodosomal zone of larvae, nymphs, and adult females ( <i>Ixodes</i> ).	2. Scutum absent in all stages ( <i>Argas</i> ).
3. Capitulum anterior and always visible from dorsal view.	3. Capitulum either subterminal or protruding from anterior margin of body in larval stages.
4. Spiracles of tracheal systems are located behind fourth coxae.	4. Spiracles between third coxae.
5. Mostly one pair of eyes, if present, situated dorsally on sides of scutum. The eyes consist of a single cuticular lens (no eyes in <i>Ixodes</i> , <i>Haemaphysalis</i> ).	5. Eyes are usually absent (if present, on supracoxal folds).
6. Larvae, nymphs, and adults suck only once for several days.	6. Nymphs and adults suck several times (in general for minutes), whereas larvae engorge for some days.
7. Only one nymphal stage occurs in life cycle.	7. Mostly 2 nymphal stages occur; in some species up to 8 are encountered.
8. Males die after copulation which proceeds during the feeding act of females. Females die having laid the eggs on the soil (3,000 eggs in <i>Ixodes</i> , 6,000 in <i>Dermacentor</i> , 15,000 in <i>Amblyomma</i> ).	8. Several copulation acts; several hundred eggs are laid on soil after each of the following feedings and copulation.
9. Live mostly out of doors and only seldom in human dwellings; during life span species may attach consecutively to 1–3 hosts (species-specific; Table 2).	9. Live in farm houses, stables, nests of animals, etc., and attack their hosts during sleep.

**Ticks. Table 2** Some common tick species

Family/Species	Length (mm) of unfed adults <sup>a</sup>	Hosts during development	Main hosts <sup>b</sup>	Disease (pathogen) <sup>c</sup>	Type of bite-transmitted pathogens <sup>c</sup>
<b>Argasidae</b>					
<i>Ornithodoros moubata</i>	m 8 f 10	Many	<b>Humans</b>	Relapsing fever ( <i>Borrelia duttoni</i> )	S
<i>Argas persicus</i>	f 5.5–11 m 5.5–8	Many	Chickens	Fowl spirochaetosis	S
<i>A. reflexus</i>	5–8	Many	Pigeons	( <i>Borrelia anserina</i> )	S
<i>Otobius megnini</i>	Fed nymphs 7–10	Many	Dogs, ruminants, horses, pigs, <b>humans</b>	Secondary bacterial infections	–
<b>Ixodidae</b>					
<i>Ixodes ricinus</i>	f 2.8–3.4 (7–8) m 2.8–4	3	Dogs, cats, cattle, <b>humans</b>	Borreliosis Spring-summer encephalitis, Redwater ( <i>Babesia divergens</i> , <i>B. microti</i> ) <sup>d</sup>	B V P
<i>I. dammini</i> <sup>c</sup>		3	Deer, cattle, <b>humans</b>	Borreliosis, Encephalitis, Babesiosis	B V P
<i>I. pacificus</i>		3			
<i>I. scapularis</i>		3			
<i>Dermacentor marginatus</i>	5 (16)	3	Many mammals	Tularemia ( <i>Francisella tularensis</i> ), Rocky Mountain spotted fever ( <i>Rickettsia rickettsii</i> )	B R
<i>D. reticulatus</i>	5 (10)	3	Many mammals	Anaplasmosis Piroplasmosis ( <i>Babesia canis</i> , <i>Theileria equi</i> )	A P
<i>D. andersoni</i>	5	3	Many mammals, <b>humans</b>	Anaplasmosis Piroplasmosis ( <i>Babesia canis</i> , <i>Theileria equi</i> )	A P
<i>Boophilus annulatus</i>	f 2–2.5 (6–8) m 2	1	Cattle	Texas fever ( <i>Babesia bigemina</i> ), bovine piroplasmosis ( <i>B. bovis</i> )	P
<i>B. microplus</i>	f 2–2.5 (6–8) m 3	1	Cattle, equines	Q fever (= <i>Coxiella burnetii</i> = <i>R. burnetii</i> ), Anaplasmosis ( <i>A. marginale</i> )	R A
<i>Amblyomma</i> spp. <i>A. variegatum</i> <i>A. hebraeum</i>	f 6–7 (–20) m 5–6	3	Many mammals, <b>humans</b>	Tularemia ( <i>Francisella tularensis</i> ), Rocky Mountain spotted fever ( <i>Rickettsia rickettsii</i> ) Theileriosis	B R P
<i>Hyalomma</i> spp. <i>H. anatolicum</i> <i>H. marginatum</i>	4–6 (10–14)	2–3	Ruminants	Mediterranean Coast fever ( <i>Theileria annulata</i> )	P
<i>Rhipicephalus appendiculatus</i>	f 2–4 (8–10) m 4–5	3	Cattle, goats, equines, dogs	East Coast fever ( <i>Theileria parva</i> )	P
<i>R. bursa</i>	4 (9–11)	2	Cattle, goats, equines, dogs	Piroplasmosis ( <i>Babesia ovis</i> , <i>B. canis</i> , <i>Theileria ovis</i> )	P
<i>R. evertsi</i>	4 (9–11)	2	Many mammals	East Coast fever ( <i>Theileria parva</i> ) Biliary fever ( <i>Theileria equi</i> ) Q fever ( <i>R. conori</i> ) Spirochaetosis ( <i>Borrelia theileri</i> )	P P R S

**Ticks. Table 2** Some common tick species (Continued)

Family/Species	Length (mm) of unfed adults <sup>a</sup>	Hosts during development	Main hosts <sup>b</sup>	Disease (pathogen) <sup>c</sup>	Type of bite-transmitted pathogens <sup>c</sup>
<i>R. sanguineus</i>	f 2–3 (6–7) m 2	3	Dogs, <b>humans</b>	Boutonneuse fever ( <i>Rickettsia conori</i> ) Piroplasmosis	P
<i>Haemaphysalis punctata</i>	f 2.8–3.5 (8–9) m 2.5–3.1	3	Ruminants, <b>humans</b>	Meningoencephalitis, Piroplasmosis, Anaplasmosis	V P A
<i>H. leachi leachi</i>	f 2.8–3.5 (8–9) m 2.5–3.1	3	Carnivores, small rodents	Canine piroplasmosis Tick bite fever ( <i>Rickettsia conori</i> ), Q fever ( <i>R. burneti</i> )	P R

m = male, f = female

<sup>a</sup> Size of fed ticks in brackets

<sup>b</sup> Hosts were selected according to important diseases; other hosts are possible

<sup>c</sup> These pathogens do not occur in all hosts and may also be transmitted by other tick species

<sup>d</sup> For piroplasmosis compare *Coccidia*/Table 7, *Plasmodium*/Table 1

<sup>e</sup> Some authors claim that *I. dammini* is *I. scapularis*. A, *Anaplasma*; B, Bacteria; P, Protozoa; R, *Rickettsia*; S, Spirochaeta; V, Virus

## Reproduction

In ticks the sexes are separate but →sexual dimorphism is less visible in the Argasidae than in the Ixodidae. In hard ticks, males and females have marked differences in the shape of the →scutum, and females possess →porose areas (with the exception of *Ixodes kopsteini*) which are not present in males. In the genus *Ixodes*, there is generally further dimorphism in the shape of the gnathosomal appendages. Superficially, soft tick males and females are distinguishable by the shape of the sexual aperture alone. There are principal differences in the reproduction of the 2 main tick families.

## Reproduction and Feeding

Reproduction in ticks is closely associated with feeding. This is of parasitological significance, since many pathogens of veterinary and medicinal importance are transmitted transovarially to the progeny of female ticks which have taken up the pathogens with their blood meal. Because many tick species can lay very large numbers of eggs, this mode of transmission can become a most efficient means of multiplying the pathogens (viruses, bacteria, rickettsia, or protozoans). Reproduction in ticks is therefore not only of direct interest for the maintenance of tick populations, but also assumes a serious economic significance in relation to tick-transmitted diseases.

In argasid females, feeding and →oviposition are cyclical activities which can be repeated several times (up to 7 or more times). Mating can also be repeated in association with each female feeding. Mating can take place before or after feeding. Mated females digest the blood meal and oviposit, after which they are ready to repeat the process. Virgin argasid females, on the other

hand, interrupt vitellogenesis until mating takes place, even if this does not occur for a long time. Unmated, engorged female *Ornithodoros moubata* can starve for up to 200 days before mating triggers off the completion of vitellogenesis and oviposition.

Autogenic development, i.e., the production of the next generation without the female feeding, has been reported in a number of argasid tick species. Facultative →autogeny is usually exhibited during the first gonotrophic cycle when mated females lay eggs from which larvae hatch in the prolonged absence of a host, particularly in the case of ticks parasitizing seasonally migrant hosts. In the laboratory, autogeny can be induced in appropriate species under favorable conditions of temperature and humidity. Facultative autogeny has been observed in several species of *Ornithodoros* and →Argas. The larvae of *Ornithodoros moubata* emerge from the egg and then remain quiescent until completing the →molt to the →nymph. In *Ornithodoros savignyi* some individuals complete the transformation from larvae to nymphs within the egg and emerge as nymphs. Obligatory autogeny is shown by 2 argasid genera with prolonged parasitic behavior, *Otobius* and *Antricola*. *Antricola* spp. females lack fully functional mouthparts. →*Otobius megnini* has one parasitic larval and 2 parasitic nymphal instars which inhabit and do not leave the ungulate host's ear canals between blood meals, until the second nymphs leave the host and molt to the adult stages. Male and female adults both have vestigial mouthparts and do not take a blood meal. Mating takes place off the host and the female lays up to 1,500 eggs in small batches over a period of several months. Obligatory autogeny is similar in *Antricola* spp., where larvae and nymphs parasitize cave-dwelling →bats, and females do not feed.

In ixodid ticks, larvae, nymphs, and females all take a single complete meal after which they molt to the next →*instar*, except when the female lays a single batch of eggs and then dies.

Thus, feeding and oviposition are each single events in the lifetime of a female. Autogeny has not been reported in ixodid ticks. Mating is only possible up to the completion of feeding, and is usually not possible prior to feeding. In most Ixodid spp. mating takes place on the host only after attachment, but there are exceptions in the genus *Ixodes*, where in some species mating can take place prior to attachment to the host. In several species of *Ixodes* the male is as yet unknown, because mating apparently takes place off the host. The males appear either not to feed, or to feed parasitically on engorged females. Male *Ixodes holocyclus* and *I. moreli* have been shown to engage in homoparasitism, during which they feed on the hemolymph of partially or fully engorged females of the same species which appear to be unaffected. This may be an obligate form of male feeding in these and other ixodid species. Nymphs and males of *Argas* spp. and *Ornithodoros* spp. can also feed on the hemolymph and/or midgut contents of engorged individuals of their own species.

In contrast to oogenesis, a large part of gametogenesis is not closely correlated with adult feeding. After the initial development, formation is discontinuous pending adulthood and the transfer of germinal cells to the female genital system. Argasid ticks (*Argas*, *Antricola*, *Ornithodoros*, and *Otobius*) undergo →*spermatogenesis* prior to feeding as adults.

### Reproductive Organs

The female genital systems of ixodid and argasid ticks are basically similar, consisting of a single ovary with paired oviducts which fuse to become an unpaired common oviduct or uterus (*Argas vespertilionis*, possessing a paired ovary, is an exception). The uterus opens into the vagina which is divided into cervical and vestibular regions (Fig. 2). The ovary of the tick is a hollow, tubular, thin-walled organ with a horseshoe-shaped cross section due to a fold or longitudinal groove along the dorsal or anterodorsal surface. The unpaired ovary forms a garland-like continuous loop through most of the length of the unfed female, beginning anteriorly at the level of the central nerve mass or genital aperture, and extending posteriorly near the sides of the tick to curve forward in front of the rectal sac. At the height of egg production it is the most prominent organ in the female ixodid tick. It is made up of thin layers of epithelial cells with interspersed germinal cells and a basement lamina or tunica propria which forms the external, hemocoelic surface of the organ. Germinal cells are least developed in the longitudinal groove where oögonia and early oocyte stages are found. Outside the groove, the →*oocytes* are

generally more advanced and give the ovary a granular appearance (Fig. 3). When the tick starts feeding, oocytes covered by the basement lamina protrude into the hemocoel. The ovary then has a characteristic grapelike surface structure. In members of the Argasidae the posterior part of the ovary is studded with oocytes while the anterior part is smooth, whereas in members of the Ixodidae ova develop along the whole length of the organ.

At both ends the ovary tapers and passes into long, coiled oviducts running in an anterior direction. The oviducts are elastic tubes capable of peristaltic movements which serve to transport eggs toward the uterus and vagina. The oviduct is capable of stretching in order to accommodate eggs. In argasid ticks, the distal oviduct forms a distinct ampulla, but this is less pronounced in ixodid ticks. Distally, the oviducts fuse into a single common oviduct or uterus; this is a large bilobed triangular sac in argasid ticks, smaller in the Prostriata, and inconspicuous in the Metastricata, where a separate →*receptaculum seminis* takes over the function of storing the spermatophores and spermatids. In argasid ticks these are stored in the uterus. The uterus is connected by a short tube to the cervical region of the vagina. This is short in argasids, but is an enlarged saclike structure in prostriates, where it functions as a receptaculum seminis.

The receptaculum seminis of metastriates is above the uterus and opens directly into the cervical vagina which is the proximal portion of the vagina as opposed to the distal, vestibular portion of the vagina. In argasid ticks the cervical vagina is short. It is ensheathed with a thick layer of circular muscles. In all ticks the vestibular vagina connects the cervical vagina to the genital aperture, and is capable of prolapsing actively during oviposition when it plays a significant role as an ovipositing tube. Tubular accessory sexual glands are present in all ticks. They have openings between the 2 regions of the vagina and are presumed to coat eggs with secretory products as they pass prior to expulsion. The lobular accessory sexual gland, which is only found in ixodid ticks, is formed in the vestibular vagina from the hypodermis during feeding. Its secretion partially waterproofs eggs during their passage through the vagina.

→*Géné's organ* is common to all female ticks. It is found just above where the capitulum is joined to the →*idiosoma*, in the camerostomal fold of ixodid ticks, the camerostomal depression of argasid ticks, or anterodorsally ventrad of the pseudoscutum in nuttalliellids. During oviposition, Géné's organ emerges through an aperture to give each egg a waxy surface, as a final waterproofing. The porose areas of female ixodid ticks (Fig. 6), whose function was not known for a long time, appear to act in conjunction with Géné's organ by producing inhibitors of the autoxidation of the unsaturated egg wax lipids.

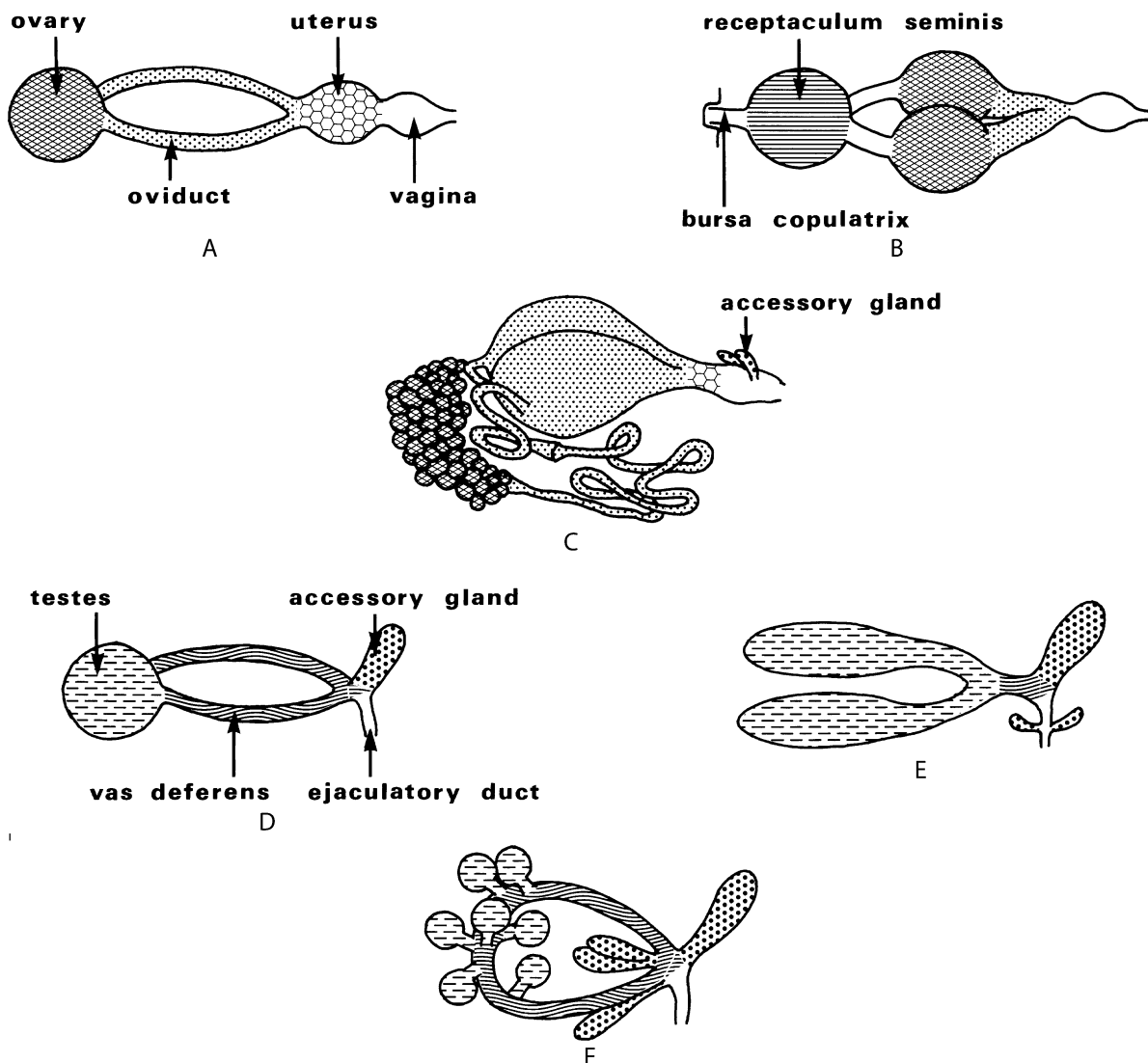

**Ticks. Figure 2** DR of acarine reproductive systems. **A–C** Females, **D–F** Males. **A** Generalized system Gamasida and Actinedida; **B** Acaridida, →Acaridae; **C** Ixodida, Argasidae; **D** Gamasida, Parasitidae; **E** Gamasida, Uropodidae; **F** Actinedida, Erythraeidae.

The morphology of the female reproductive organs of the single species in the family Nuttalliellidae, *Nuttalliella namaqua*, is basically intermediate between corresponding argasid and ixodid organs. The transverse position of the ovary, bilobed uterus, and vaginal divisions into cervical and vestibular parts are as in argasids; however, the connecting tube joining the uterus and cervical vagina and the valve between the vaginal divisions are ixodid in character. On the other hand, Gén e’s organ has a structure unique to this family.

The **male** reproductive system consists of paired tubular testes which extend from the level of the central nerve mass or genital aperture to about the level of the posterior margin of coxa IV (Fig. 2). Apically, the testes

extend to become a pair of vasa efferentia which fuse to form a common vas deferens and ejaculatory duct.

Posteriorly, the testes may be fused (as in the Argasidae), broadly joined (as in many prostriate ticks), or connected only by a thin filament (as in the metastriate ticks). The testes in adults are covered by a thin connective tissue membrane similar to the tunica propria of the ovary. There are muscle fibers under the membrane. The wall of the →testis; consists of epithelial, interstitial, and germinal cells. The germinal cells are arranged radially around the small lumen of the testis, forming cysts. The lumen of the testis is continuous with the lumen of the vas deferens. The appearance of the testes varies with the tick species and its nutritional and reproductive state. In particular, there



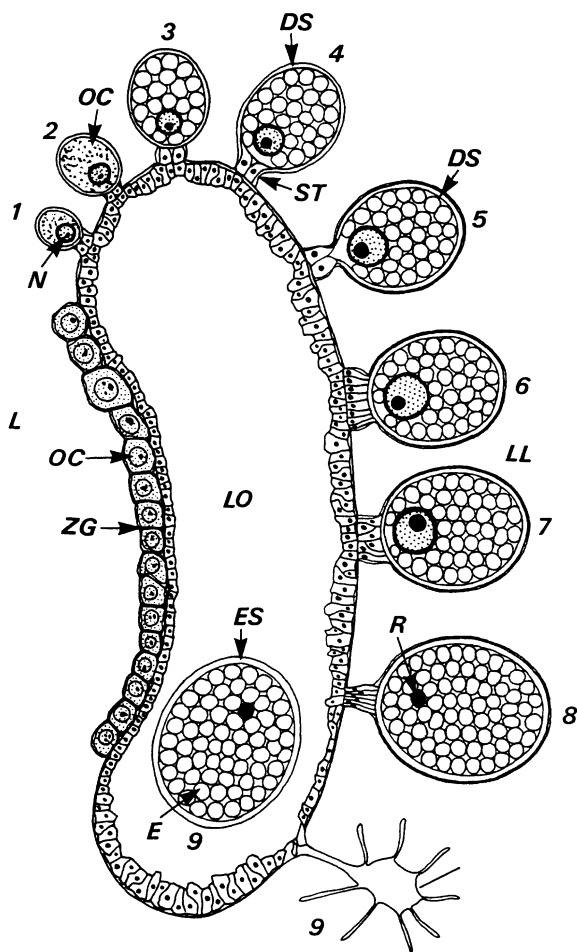

**Ticks. Figure 3** Cross section through the ovarian tube of an ixodid tick showing eggs in 9 different stages of development. At place 9 the mature fertilized egg is released into the lumen to become set free. Note that the →eggshell is thin in stages 1–4; until then fertilization and infection with parasites/virus/bacteria may occur. *DS*, development of eggshell; *E*, egg; *ES*, eggshell; *LL*, lumen of body cavity; *LO*, lumen of ovarian tube; *N*, nucleus; *OC*, oocyte; *R*, nucleus after karyogamy; *ST*, funiculus; *ZG*, young oocyte in a groove. (after Sonenshine)

are marked changes in the testes of ixodid males when they commence feeding.

The vasa efferentia are extensions at the end of the testes which fuse to become the common vas deferens whose connection to the external genital aperture is called the ejaculatory duct, a name sometimes also given to the common vas deferens as a whole.

Close to the fusion between the vasa deferentia, the accessory gland complex opens into the common vas deferens (Fig. 2). This is a large, multilobed gland system which varies in appearance between tick species. The accessory gland secretes mucoproteins, mucopolysaccharides, and other compounds. The glands are involved

in producing materials for →spermatophore formation as well as for spermatid →capacitation.

### Spermatogenesis and Fertilization

The testes in ticks are fully developed at the end of nymphal molting. In contrast to insects, male germinal cell maturation occurs gradually from the posterior end to the anterior end of the testes. In *Hyalomma asiaticum* nymphs, primary spermatogonia areas occupy the anterior end of the testes and secondary spermatogonia areas the posterior end. Primary spermatogonia undergo mitotic divisions to produce several generations of secondary spermatogonia, the last generation becoming primary spermatocytes during nymphal blood feeding. In *H. asiaticum*, as in most other metastriate ixodid ticks, further development only occurs when the adult males begin feeding. Autogenous spermatid production in unfed males has been reported in 2 metastriate ticks, *Aponomma hydrosauri* and *A. concolor*. A third species *Amblyomma triguttatum* transfers elongated spermatids to females without a prior blood meal.

The timing of meiosis and spermiogenesis in the argasid and prostriate ticks is similar to that in most insects, occurring maximally during the final nymphal stage and the young adult period, i.e., prior to feeding as adults. Males of many prostriate ticks (genus *Ixodes*) do not feed at all. The same occurs in those species of argasid ticks which have vestigial mouthparts in the adult (*Otobius* spp.). A blood meal accelerates the germinal development.

Thus the male adult blood meal is the foremost stimulus for development of the primary spermatocyte stage in most metastriates. Other, earlier stimuli are active in the males of prostriate and argasid ticks. As a result of the stimuli which are effective, the spermatocyte undergoes a major growth stage, followed by 2 meiotic divisions to secondary spermatocytes. Newly formed spermatids are rounded and are found in the testes. Further development takes place as they move to the vasa deferentia and then to the common vas deferens, by which time they have an elongated form. Here they are stored until transfer to the female takes place through mating. Development is arrested at this point. Then the male transfers a spermatophore to the female. This is not preformed, but is produced during mating. The formation is a rapid process, requiring less than one minute to complete, and it occurs outside the male genital aperture. The spermatophore consists of 2 vessels, i.e., an outer (→Ectospermatophore) and an inner (→Endospermatophore) container between which the elongated spermatids are to be found.

When both sexes are prepared for copulation, the male tick positions himself with his venter in juxtaposition to the female venter, and inserts certain parts of the capitulum (varying between species) into the female sexual aperture. After this initial stimulation,

which lasts some minutes, the spermatophore is formed and transferred to the female sexual aperture. Through evagination of the spermatophore only the endospermatophore is inserted into the female genital tract during copulation; the spermatids are contained only in the endospermatophore, while the ectospermatophore remains outside and soon drops off. The spermatophore is easily visible at the genital aperture of freshly mated *Amblyomma variegatum* females which are then no longer receptive for further stimuli from male ticks, which are themselves not attracted to these females. Mating triggers off an immediate feeding response in the females, regardless of the presence or absence of males. In this state female *A. variegatum* can then be induced to feed in an *in vitro* system.

In argasid ticks, endospermatophores and immature (uncapacitated) spermatids are stored in the uterus, while in ixodids they are transferred to and stored in other regions of the female genital tract: in the Prostriata this is the enlarged cervical vagina and in the Metastricata it is a separate receptaculum seminis which opens posterodorsally into the cervical vagina. The last stage of spermiogenesis, capacitation, then takes place within the female genital tract. The fully mature, or capacitated, →spermatozoa are clavate or paddle-shaped at the anterior end, tapering into long posterior portions. Argasid sperm are longer than those of ixodids. The spermatozoon is 150–1,000 µm long which is twice the length of uncapacitated spermatids. This is extremely large by comparison with the spermatozoa of other animals.

### Oogenesis

The surface of the tick ovary has a characteristic granular appearance which is caused by the partial protrusion into the hemocoel of the oocytes (Fig. 3). The oogonia and oocytes are less developed in the longitudinal groove along the ovary. As the female begins feeding, the oocytes protrude more into the hemocoel, above the surface of the ovary. They gradually project further until they are totally above the surface of the ovary, to which they remain attached by a thin stalk, the funicle, which is composed of elongated epithelial cells. Covering the oocytes and the ovary and separating them from the hemolymph is a basement lamina, which carries some muscle fibers on the outside. Balashov has divided the early, previtellogenic development into a phase of “small growth” followed by a phase of “large growth” with cytoplasmic growth, which is characterized by intense development of cytoplasmic organelles almost entirely lacking during the first phase. During cytoplasmic growth the surface area of the oocyte cellular membrane is greatly enlarged by the production of numerous →microvilli below the basement lamina in preparation for further maturation of the egg. Vitellogenesis, the production of

→yolk as a nutrient for the developing larvae, is usually initiated by engorgement and mating, except in cases of autogeny or →parthenogenesis as discussed above. The final product of vitellogenesis is represented by 2 kinds of yolk, protein and lipid. Lipid yolk is produced during the previtellogenic period but protein yolk is a characteristic of vitellogenesis, appearing as the membrane-limited granules shown in *Omithodorus moubata* to be composed of hemoglycolipoproteins which are immunologically identical to female hemolymph proteins. The yolk appears to have 2 different sources, intracellular from autosynthesis in the oocyte, and extracellular from synthesis in extraovarian tissues of precursors which are internalized by the developing oocytes. Protein yolk vesicles fuse to form large homogeneous yolk granules with a diameter of up to 80 µm in the egg of *O. moubata*, which itself has a diameter of 1,200 µm.

The source of the vitelline membrane has not been ascertained, but appears to be the oocyte. Eggshell synthesis begins during vitellogenesis when plaques of material appear between the microvilli of the →cell membrane in the extracellular space under the basement lamina. As development advances, the microvilli become fewer and retract, while the eggshell plaques coalesce to form a complete vitelline envelope. From a certain point onwards, the vitelline membrane and the basement lamina appear to act as a barrier to the entry of pathogens which take the transovarian route of transmission. This has been shown for *Babesia major* kinetes in *Haemaphysalis punctata*, *B. bigemina* in *Boophilus decoloratus*, and in rickettsia. Although 28°C is a favorable temperature for the rapid development of *B. bigemina* kinetes in *Boophilus decoloratus*, only very few appear to be able to enter the oocytes which become impenetrable sooner at this temperature; at 24°C fewer kinetes are found in the hemolymph since a greater number are able to enter the oocytes before they become impenetrable (Fig. 3).

The success of →transovarial transmission of parasites appears to be dependent on close synchronization with the development of the tick vector, and may be a reason for the more efficient transmission by some vectors. For example, *Boophilus microplus* appears to be a less efficient vector for *Babesia bigemina*, but a good vector for *B. bovis*.

The oocytes in the ovary of a tick do not develop synchronously, but can be found at different developmental stages at any time. As a result, vitellogenesis and oviposition are prolonged over several days or weeks in ixodid ticks.

Ovulation in ticks usually takes place within 1–2 weeks after the fertilized female has engorged. Following ovulation, peristaltic movements of the genital tract transport the eggs into the uterus where they can accumulate. The actual site of →syngamy, i.e.,

the penetration of the oocyte by the sperm, has not been determined, and it may take place in the ovary or in the oviducts. During its passage the oocyte increases greatly in size, and the originally soft, extensible eggshell hardens progressively.

### Oviposition

Generally, argasid females lay fewer eggs than ixodid females. *Argas persicus* can lay a total of 874 eggs in as many as 7 batches, with a blood meal and mating preceding each batch. *Ornithodoros coriaceus* can lay over 2,000 eggs during a productive life of about 3 years.

Before oviposition can begin, the fully engorged females usually become positively geotropic and negatively phototactic, seeking sheltered places with a suitable microclimate. The female then becomes immobile. The preoviposition period of engorged female ticks lasts from 1–2 days up to several weeks depending on species and temperature. In *Boophilus microplus* this period is 2–4 days in the Australian summer and 5–9 days in winter, with a range of 2–12 days. On the periphery of the main area of distribution, in Southeast Queensland, oviposition is postponed indefinitely. Oviposition may be so far extended that many females die before ovipositing. The duration of oviposition is also dependent on the species of tick and the environmental temperatures, and can last from a few days up to several weeks.

Oviposition entails the individual treatment of each egg as it is laid. In ixodid ticks this requires a reorientation of the genital aperture to face the capitulum at an angle and to shorten the passage of eggs. In argasid ticks this does not take place, but otherwise oviposition is similar in both tick families. The next step is to bring the Gén e's organ close to the sexual aperture. Gén e's organ, the egg-waxing organ, is located in the camerostomal fold of ixodid ticks or the camerostomal depression of argasid ticks, dorsally behind or above the capitulum where it is joined to the idiosoma. It is an eversible 2- or 4-lobed sac with 2 anterolateral horns on each side. When eggs are about to be extruded from the vestibular vagina, the →hypostome is depressed ventrally to such a degree that it rests against the venter of the tick, while the palpi diverge. As Gén e's organ becomes fully everted, the vestibular vagina prolapses, forming an ovipositing tube through which the individual eggs are passed; they then pass between the horns of the Gén e's organ. While the vagina retracts, the oocyte is thoroughly coated with waxy waterproofing secretions. In ixodid ticks, each oocyte is simultaneously exposed to a secretion from the porose areas during the period in which the Gén e's organ covers this area of the capitulum. This additional secretion appears to inhibit the autoxidation of unsaturated egg-wax lipids. In argasid ticks waterproofing of the eggs is begun in the vestibular

vagina. The eggs of argasid ticks are usually not sticky, while ixodid eggs adhere to the surfaces they rest upon. This can be upon the female tick's dorsum.

The ovipositing female of many ixodid species changes color, becoming yellowish or pale brown due to the masses of developing oocytes on the one hand, and the grossly distended Malpighian tubules on the other hand. Most of the metabolic waste is not eliminated by the female, and may be responsible, together with →dehydration, for the death of the female ixodid tick soon after completion of oviposition.

The eggs of ixodid ticks are toxic to experimental animals, as are ovipositing female ticks. On the other hand, fully engorged female *Amblyomma variegatum* (which can have an engorged weight of up to 6 g) are consumed by herdsman in parts of East and Central Africa, either raw or after roasting, and are considered a delicacy.

### Pheromones

Contact between sexes and behavioral patterns leading up to copulation appear to be strongly influenced by →pheromones. In ticks which mate off the host (i.e., argasid and some prostriate ticks) assembly pheromones, which are the least specific of the tick pheromones, appear to be responsible for bringing together males and females. These pheromones are also attractive to immature instars, e.g., in *Argas persicus*. The relationships between individuals of *A. walkerae* in the biotope are mainly induced by pheromones. Replete females determine the location of settlement, thereby sending the primary pheromonal stimulus attracting first males and then preimaginal stages to aggregate. Guanine excretions have a lesser pheromone effect. The assembly pheromone in guanine is less volatile than that emitted by the tick itself. In *Ornithodoros porcinus porcinus*, the guanine itself has been identified as an assembly pheromone which not only attracts conspecific ticks but is also attractive for larvae of *Amblyomma cohaerens* and adult *Rhipicephalus appendiculatus*.

A second type of pheromones, the →aggregation-attachment pheromones, have been demonstrated in the →metastriate genus *Amblyomma*, where they are produced by males during the course of feeding. They are more specific than assembly pheromones and attract conspecific unmated females, unfed males, and nymphs. Hungry unmated females are reluctant to attach in the absence of this powerful stimulus. It is possible to induce mating in *A. variegatum* by removing males from the host after several days of feeding and placing them together with unfed females. Mating responses are immediate, culminating in copulation within a few minutes, after which the female is no longer receptive for males, but will commence feeding, frequently in the complete absence of a male. In this

species, the primary stimulus leading to contact appears to be the male aggregation-attachment pheromone, followed by a response from the female (which may be recognized visually, or possibly chemically, by the male), whereupon the excited male agitates its striped legs, grasps the female, corrects her position if necessary, and then proceeds to insert his mouthparts into the genital opening and transfer the spermatophore.

The aggregation-attachment pheromones have been identified, the active substances being *o*-nitrophenol, methyl-salicylate, and pelargonic acid. Pheromones are usually obtained for study by washing intact ticks in suitable solvents or by extraction from tick homogenates. They can also be collected from living ticks in small stainless-steel chambers when the effluent air is passed through solvents. The site of pheromone production

in ticks has therefore remained difficult to determine. In a field trial synthetic pheromones were only partially successful in attracting ticks to an artificial target.

### Integument

Ixodid or hard ticks are characterized by a dorsal shield or scutum of sclerotized →cuticle in all stages which occupies about one-third of the anterior dorsal surface of females, nymphs, and larvae, and the entire dorsal surface of males (Figs. 4–6). In female and immature ixodid ticks, the remaining, extensible dorsal surface is called the →alloscutum. Argasid ticks are also called soft ticks, since they lack a scutum or dorsal shield in the adult stages and are covered by a leathery →integument (Fig. 6).

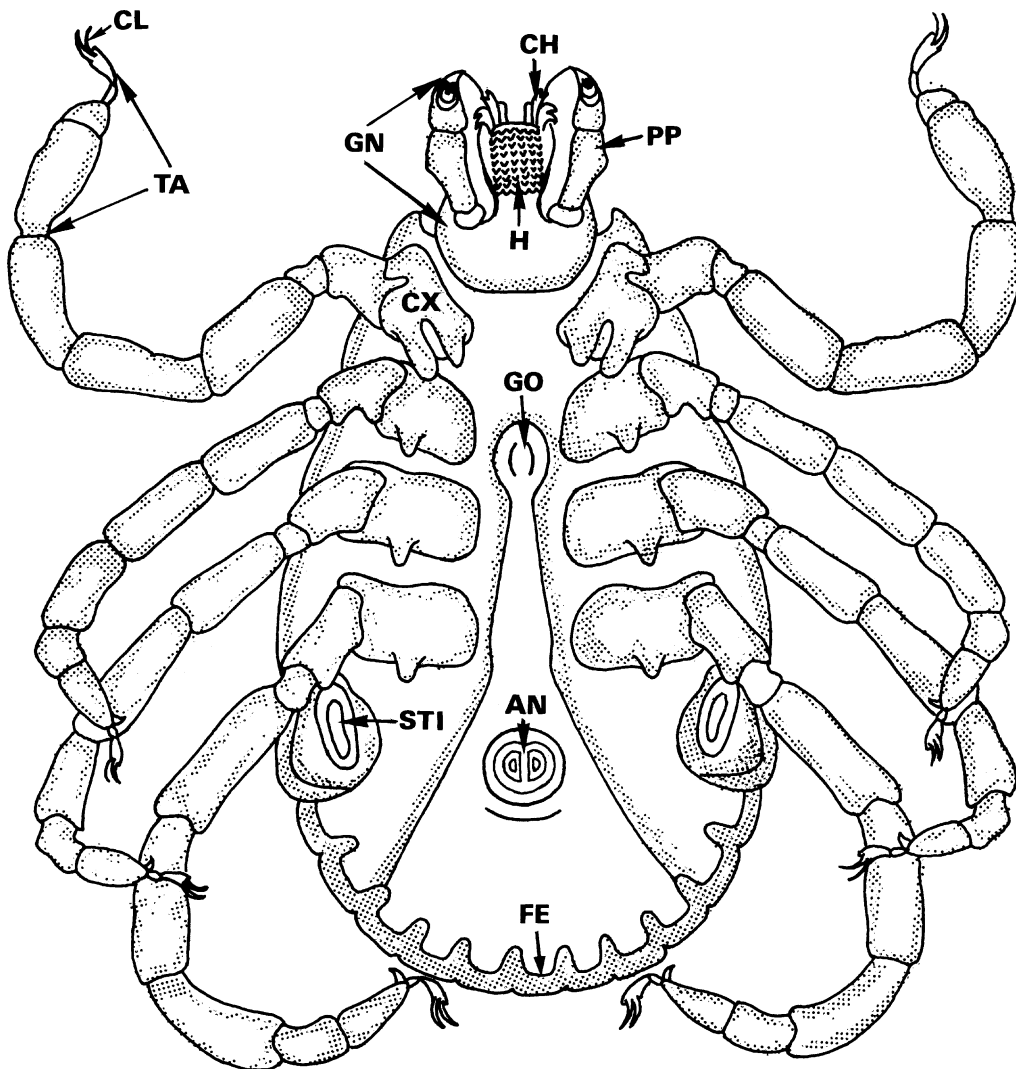

**Ticks. Figure 4** DR of an ixodid tick (e.g., *Dermacentor* sp.) from its ventral side. AN, anus; CH, chelicera; CL, claw; CS, sheath of chelicera; CX, coxa; E, esophagus; EM, pulvillus; FE, festoon; GN, gnathosoma (capitulum); GO, genital opening; H, hypostome; PP, pedipalpus; SA, salivary duct; SC, scutum; STI, stigma; TA, tarsus.

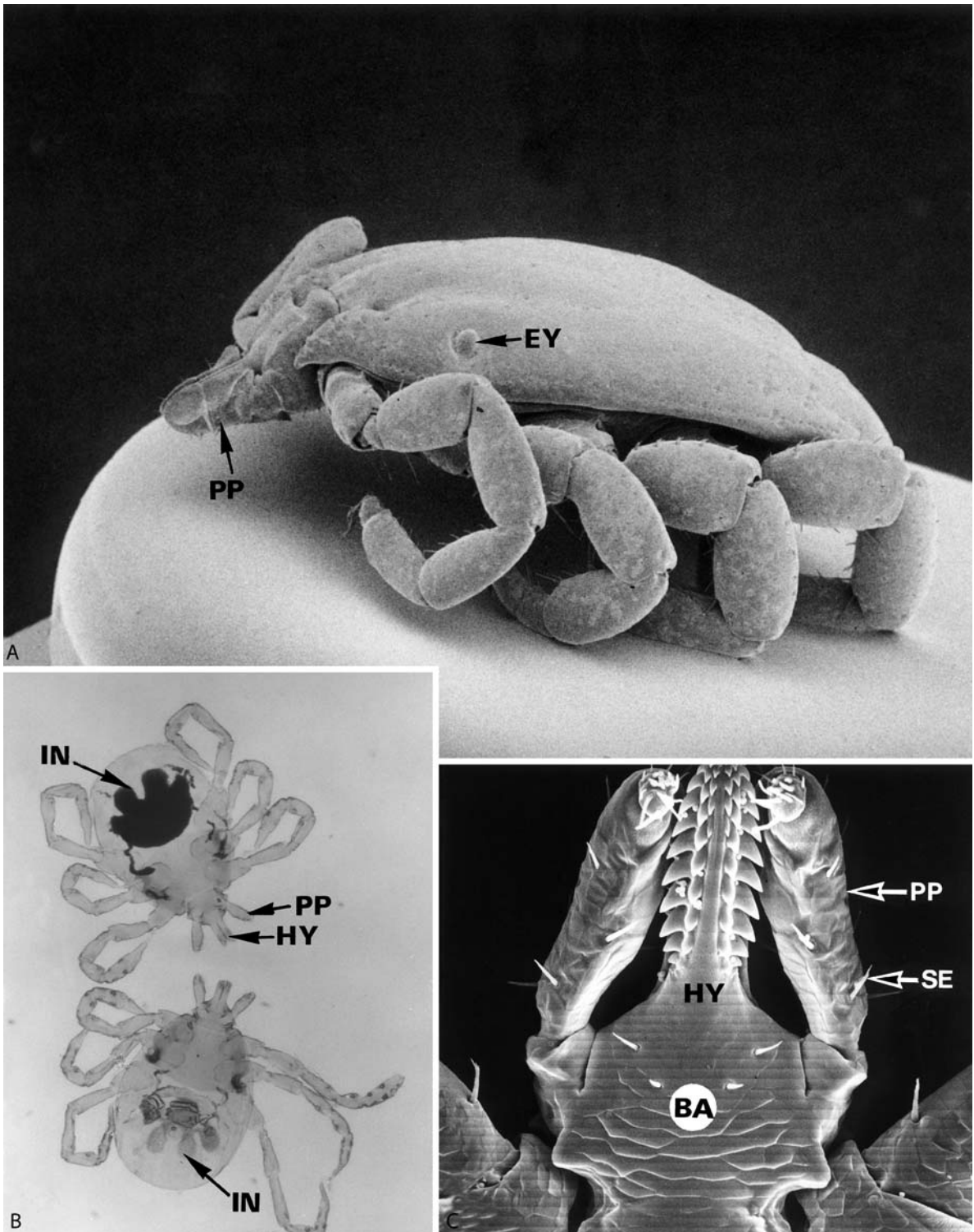

**Ticks. Figure 5 A–C** External morphology of ixodid ticks in LM (B) and SEMs (A, C). **A** *Dermacentor* sp. lateral view ( $\times 22$ ); **B** *Hyalomma* sp. larvae ventral ( $\times 40$ ); **C** *Ixodes ricinus* mouthparts, ventral ( $\times 80$ ). *BA*,  $\rightarrow$ basis capituli; *EY*, eye (ocellus); *HY*, hypostome; *IN*, intestine; *PP*,  $\rightarrow$ pedipalps; *SE*, setae.

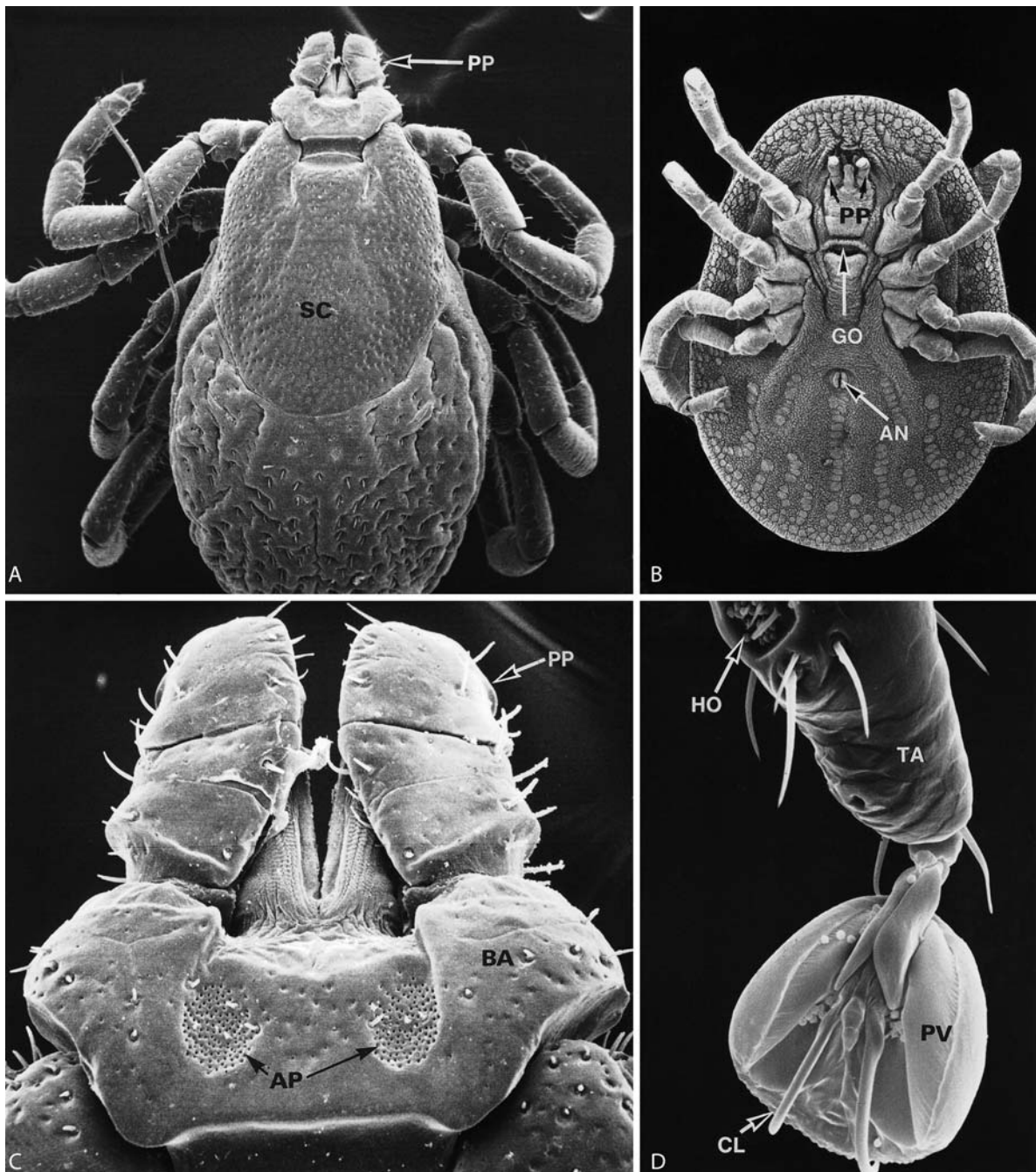

**Ticks. Figure 6 A–D** External morphology of ixodid (A, C, D) and argasid ticks (B) (SEMs). **A, C** Female *Rhipicephalus sanguineus*, dorsal view (A  $\times 20$ , C  $\times 75$ ). **B** Ventral view of an adult *Argas* sp.; note that the mouthparts do not reach the body anterior line ( $\times 10$ ). **D** *Ixodes ricinus*, tarsus of the first leg ( $\times 75$ ). AN, anus; AP, area porosae; BA, basis capituli; CL, claws; GO, genital opening; HO, [→Haller's organ](#); PP, pedipalps; PV, pulvillus; SC, scutum; TA, tarsus.

In addition to exoskeletal functions of support and protection, the integument of ticks, particularly of ixodid ticks, is required to grow and expand in order to accommodate the large and concentrated blood meal. In ixodid ticks, the differences in size between larvae, nymphs, and adults are not as great as the differences

between the flat, unfed instar and that same instar fully engorged. Larval, nymphal, and female ticks of some species of ixodid ticks can increase in weight up to about 200-fold during feeding. As an example, *Rhipicephalus appendiculatus* larvae, nymphs, and females can each increase their weight about 100-fold. During the blood

meal the idiosoma of these stages is distended to give the typical enormously swollen appearance of the engorged tick. An additional important function of the integument of ticks is the regulation of water balance since it is highly impermeable to water.

The cuticle constitutes a limitation of the shape and maximum size of each tick stage. Further growth is only possible through molting of the preimaginal instars, i.e., by shedding the cuticle and replacing it with the larger form of the next stage.

As in other arthropods, the integument of ticks consists primarily of the cuticle and a single epidermal cell layer which secretes the cuticle. The cuticle is similar to that of insects (Figs. 7, 8, →Insects), but differences exist, particularly in the alloscutum of female ixodid ticks. The cuticle is a heterogeneous, noncellular layer which forms an external covering but also extends into the fore- and hindguts and lines the ducts of dermal glands and the tracheal system. The degree of sclerotization of the cuticle varies from hard sclerotized plates to soft, extensible membranes. Ixodid ticks have relatively large areas of sclerotized cuticle, while in argasid ticks sclerotization is limited to fairly small areas.

The cuticle is composed of 2 primary layers, a thin outer epicuticle and the thicker inner procuticle. The epicuticle has considerable flexibility but is nonextensible in ixodid ticks. Stretching during feeding is possible through the unfolding of deep folds in nonsclerotized areas of the idiosoma of the ixodid tick.

The epicuticle is nonchitinous and consists of wax, →cuticulin, and polyphenol layers. Argasid ticks also have a further outermost protective layer, the cement, a general arthropod characteristic which is absent in ixodid ticks. The cement is produced by dermal gland secretion. The wax layer confers impermeability on the cuticle. In ixodid ticks this is the outermost layer. Beneath it, the polyphenol layer is composed of minute droplets rich in polyphenols which penetrate into the underlying cuticulin layer. A thin protein or lipoprotein membrane carries large numbers of →micropores connected to pore canals which themselves originate in the epidermal cell layer and pass through the procuticle, anastomosing terminally before reaching the cuticulin. In *I. ricinus* it has been estimated that more than 1.4 million pore canals can be found per square millimeter (Fig. 7). Dermal glands become active soon after feeding begins, remain so until molting is complete, and are thought to participate in cuticular transformation.

The procuticle is composed mainly of →chitin bound to protein and can show differing degrees of sclerotization. When the outer part of the procuticle is completely sclerotized, it is called exocuticle, and the nonsclerotized portions are then called endocuticle. The mesocuticle is defined as a partly sclerotized layer of the procuticle. Both the endo- and the mesocuticle, which form the alloscutum cuticle, are extensible and enable the accommodation of the large blood meal in larval, nymphal, and female ixodid ticks, through

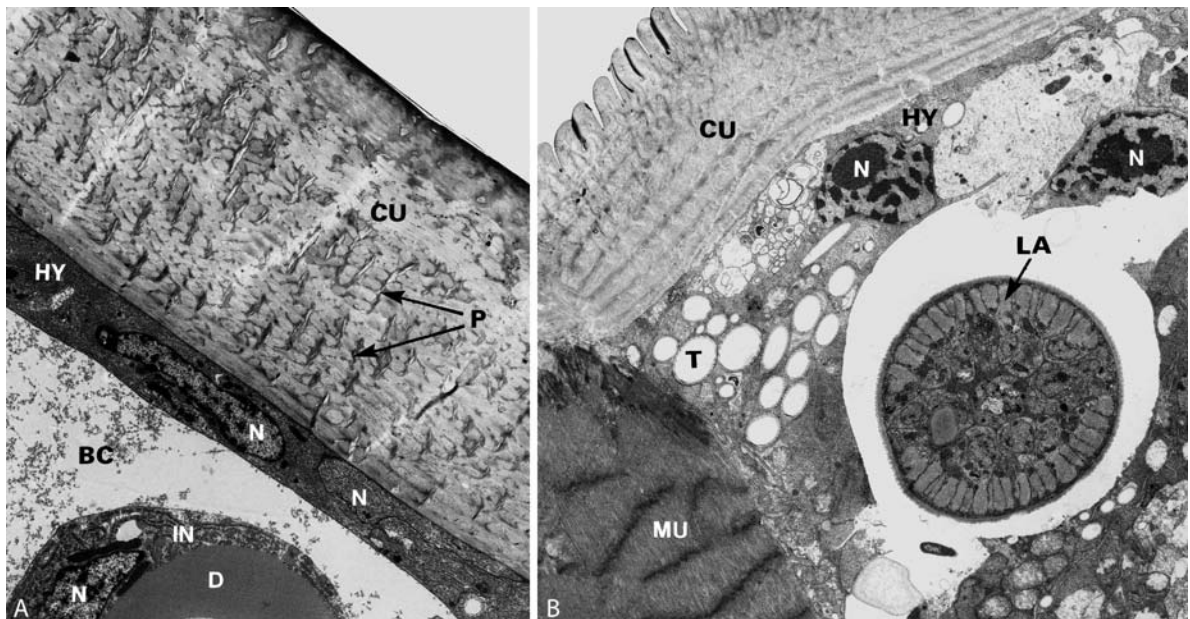

**Ticks. Figure 7 A, B** TEMs of the cuticle of acarids. **A** Ixodid tick (*Ixodes ricinus*) ( $\times 2,000$ ). **B** Mite (*Bdellonyssus* sp.), which contains a second stage larva (in cross section) of the rodent filarial worm *Litomosoides carinii* ( $\times 1,700$ ). *BC*, body cavity; *CU*, cuticle; *D*, digested blood; *HY*, hypodermis; *IN*, intestinal branch; *LA*, nematode larva; *MU*, muscle strand; *N*, nucleus; *P*, pore channels; *T*, tracheole.

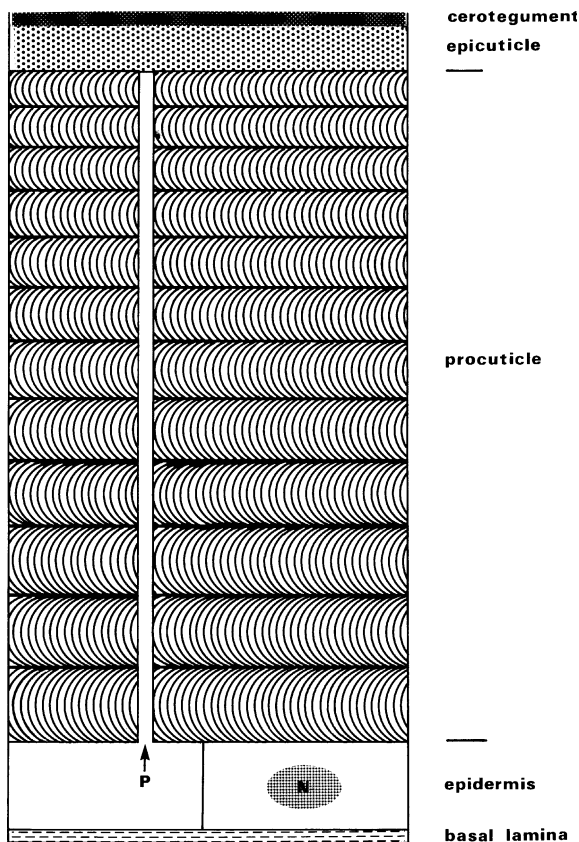

**Ticks. Figure 8** DR of the acarine cuticle. *N*, nucleus; *P*, pore channel.

their capacity for expansion and stretching. The increase in the volume of the tick is particularly rapid during the final feeding period and is achieved by considerable stretching of the alloscutum. This is made possible during the initial feeding period through preparatory growth of the cuticle, enabling the phase of rapid feeding. During the first phase of feeding, growth of the cuticle dominates over expansion, while at the end of feeding, when ingestion reaches a peak, idiosomal distension occurs as a result of cuticular extension.

During the growth period, procuticle with a complex lamellate structure is deposited. At the same time, epidermal cells enlarge 3–4 times, with rapid development of organelles involved in synthesis. In argasid tick larvae, which feed for several days, there is also cuticle thickening during the growth phase. During the final phase of ixodid female feeding, the cuticle of the alloscutum stretches and is reduced to about half the thickness reached at the end of the growth phase.

During molting (**→Ecdysis**), a phase of cuticle separation (**→Apolysis**) is followed by formation of new cuticle and shedding of the previous cuticle. Separation results from lysis of the procuticular lamellae closest to the epidermis. In the new cuticle epicuticle is formed first and then procuticle.

Hemocyte participation in the molting process is peculiar to ticks. During the premolting period, apolysis and the early stages of new cuticle formation, numerous hemocytes lie under the epidermal cell layer, sometimes penetrating into the epidermis.

### Musculature

Ticks are typically acarine in having hexapod larvae and octapod nymphs and adults. The legs are jointed and divided into 7 segments (coxa, trochanter, femur, genu, tibia, tarsus, and pretarsus). The terminal pretarsus consists of a basal stalk, paired claws, and a membranous pulvillus (**Figs. 4, 6**). The pulvillus is absent in argasid ticks. Each true segment is flexed by an individual flexor muscle, while coxal protractor and retractor muscles provide backward and forward leg movement. Leg extension is brought about by hydrostatic pressure. All legs are ambulatory, but the first pair of legs also **→aids** in sensory **→orientation**.

Powerful muscle groups are also present in the alloscutum of female, nymphal, and larval ixodid ticks, through which the tick is able to redistribute the centre of gravity and regain an upright position when it falls into an upside-down position. The dorsoventral muscles are arranged roughly in longitudinal rows. The point of insertion is characterized only by shallow furrows or grooves.

The major organ systems and the **→chelicerae** are equipped with muscles, most of which only play a role during the short periods of host-orientated activity and the following digestive and/or ovipositing periods.

The structure of muscle attachment in ticks must make allowance for the periods of molting from one stage to the next, particularly when the muscle is attached to the cuticle. By means of the electron microscope, muscle attachment has been shown to be through a structure characteristic of other arthropods. **→Tendons**, or tonofibrillae, by which the muscles are attached, consist of 2 sets of tonofibrillae which are not continuous from the muscle to the epidermal cells of the cuticle. One set of tonofibrillae is anchored to the internal faces of muscle cells, while the second set is attached to the epidermal cells. The intercellular spaces between tonofibrillae are filled with a cement-like substance. The anchorage at both the proximal muscle cells and distally the epidermal cells is through structures known as **→hemidesmosomes**, which are adhesions between the basal lamina through the plasma membrane to the **→cytoskeleton**. Similar arrangements are found in **→mites** (**Fig. 7B**, **→Mites/Fig. 1**).

### Alimentary System

The entrance to the alimentary canal, the tubular buccal canal, is formed dorsally by the chelicerae and ventrally by the hypostome (**Figs. 4, 9**). These 2 parts of the



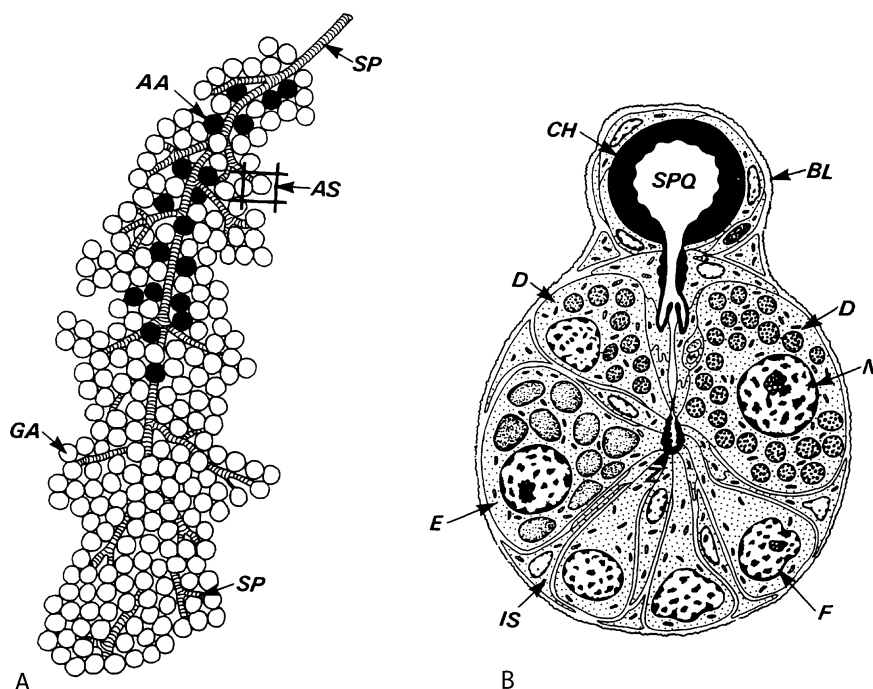

**Ticks. Figure 9** DR of the salivary gland of an ixodid female tick. **A** Overview on one branch of the salivary glands. Agranular (AA, black) and granular (GR) →acini are grouped grapelike around the twisting salivary duct (SP). AS, portion being magnified in B. **B** Cross section of an acinus of type III including granular cells of type D, E, F with different contents. After release of the secretory granules, the cell becomes replaced by interstitial cells. AA, agranular acinus; BL, basal lamina; CH, chitin; D, E, F, salivary gland cell types; GA, granular acinus; IS, interstitial cell; N, nucleus; SP, salivary duct; SPQ, cross section of SP; Z, central lumen of the acinus. (after Sonenshine).

gnathosoma form the anchorage of the tick to the host skin during feeding. The chelicerae are paired, sheathed, rigid, sclerotized tubes with 2 segments (other acarians have 3 segments) ending in cutting digits with recurved teeth with which the tick penetrates the host skin (Figs. 9, 10). The unpaired hypostome is an extended, toothed anterior process of the basis capituli with retrograde denticles on the ventral surface. In ixodid ticks with the exception of some *Ixodes* spp., the feeding channel is further sealed during host attachment by attachment cement, a →salivary gland product which solidifies almost immediately, making the tick alimentary canal continuous with the lesion in the host skin. The cement seals off and firmly embeds the mouthparts (Food Uptake and Digestion). If some tick species are removed manually from the host, the cement often remains attached to the mouthparts.

The buccal canal is a common duct for the intake of host tissues and for the outflow of saliva. It passes into the pharynx, a powerful suction organ with several sets of constrictor and dilator muscles, which, in conjunction with the pharyngeal valve, moves host tissues into the esophagus. The esophagus, a narrow tube adjoining the pharynx, passes through the

→synganglion or “brain” (as in other acarians) before leading to the midgut or →ventriculus. This consists of a large central chamber from which several pairs of blind-ending diverticula or ceca lead off, providing additional surface area on which digestive processes can take place. Some are branched or form numerous loops. The midgut fills most of the body cavity of the tick. It is well equipped with muscle fibers situated externally and arranged both longitudinally and transversely, and is capable of peristaltic and other movements. When the leg of a tick is cut off, as in investigations for hemolymph stages of →*Babesia* spp. or →*Theileria* spp., the hemolymph is frequently mixed with gut contents because ceca protruding into the leg are also damaged.

The midgut has a fairly uniform structure throughout, the wall consisting of a single epithelial cell layer resting on a thin basal lamina, with muscle fibers on the hemocoelic side. According to Balashov and Sonenshine, 3 types of cells are present in the epithelium: reserve or stem (undifferentiated) cells, secretory cells, and digestive cells. Agdebe and Kemp described intermediate digestive cells (digestive cell series) and 2 different secretory cells in *Boophilus microplus*. There are indications that each cell can differentiate successively to serve both secretory and digestive

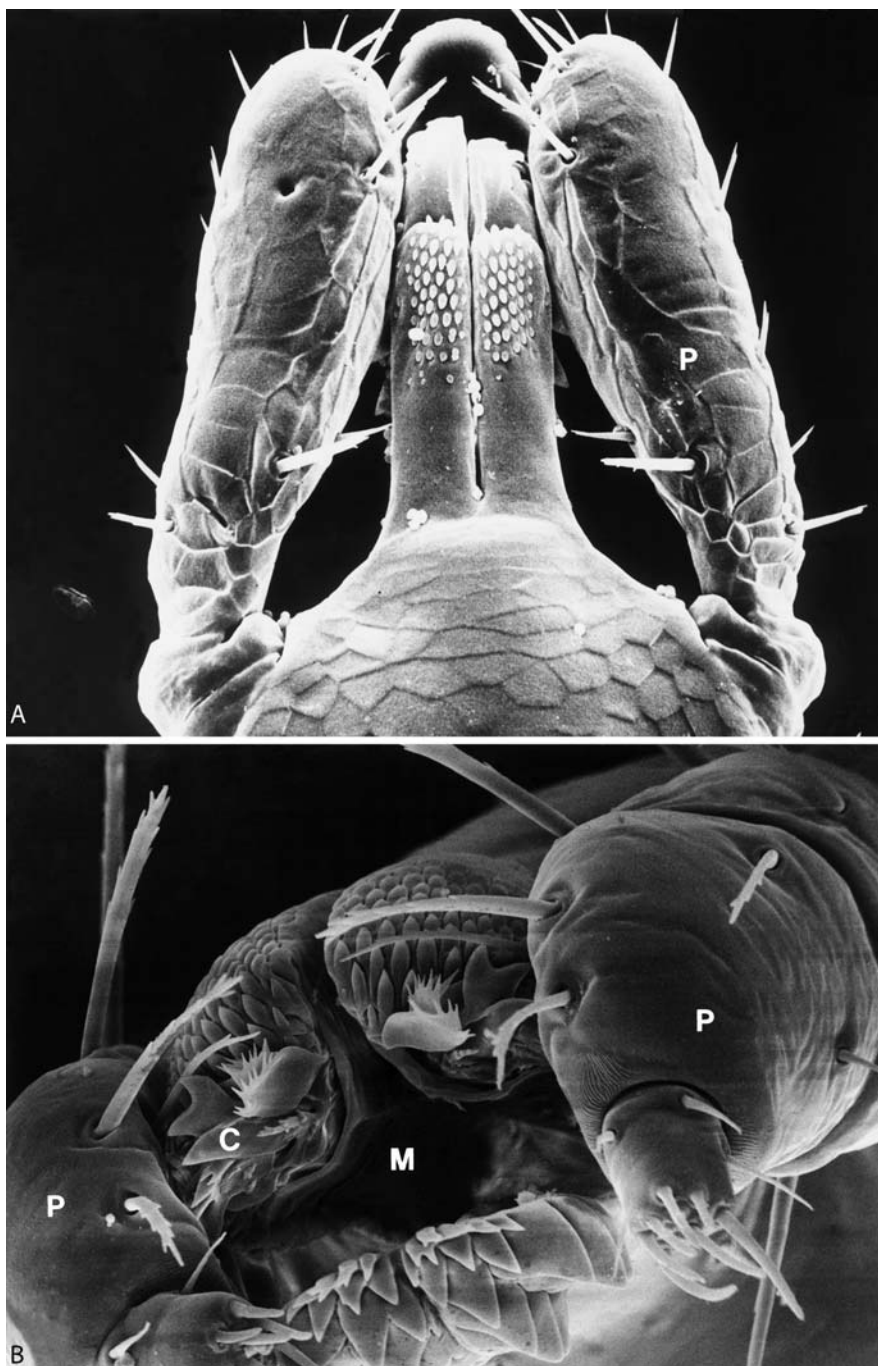

**Ticks. Figure 10** SEMs of mouthparts of ixodid ticks. **A** view from the dorsal side in a larva of *Ixodes ricinus*.  $\times 150$ . **B** View into the mouth (M) of *Amblyomma variegatum*. Note the teeth at the hypo- and epistome.  $\times 400$ . C, chelicera; M, mouth; P, pedipalps.

functions, particularly in argasid ticks. In ixodid ticks it appears more likely that each cell differentiates irreversibly to take either a secretory or a digestive role. The apical or luminal surface of epithelial cells is covered with microvilli, while the distal plasma membrane is folded until the time when the tick begins

ingesting blood. Because of projecting epithelial cells, the midgut lumen is small.

A short intestine (sometimes called the small intestine) joins the midgut to the rectal sac. It is a tube narrowing towards the rectal sac which it enters anteroventrally. In the rectal sac, the fecal discharge

accumulates, together with the products of the Malpighian tubules, to be expelled through the anus.

In ixodid ticks the salivary gland plays a major role during feeding, and it is also of importance for the development of a variety of pathogens, many of which conclude their development there before being transmitted to the host. The role of the salivary gland in argasid ticks is different, the excretion of fluid into the host during feeding being minimal. In ixodid ticks salivary excretion into the host animal body is responsible, to a large extent, for preventing the excess dilution of the tick body fluids by eliminating the major part of the blood meal's liquid content ([Food Uptake and Digestion](#)). It has been the subject of extensive studies, both by light and electron microscopy.

The salivary gland is a paired organ with a similar appearance in both sexes ([Fig. 9](#)). It consists of grapelike clusters of acini extending from the level of the peritremes along the sides to the gnathosoma, where the paired main ducts open into the salivarium, which opens dorsally into the buccal canal.

In argasid ticks 2 types of acini are present, while in ixodid ticks there are 3 in females and 4 in males of some species. Type I acini are agranular and are confined to the anterior region of the gland, where they open directly into the main or secondary ducts ([Fig. 9](#)). In *Hyalomma asiaticum*, type I acini contain several nuclei, one of which is considerably larger than the others. In *R. appendiculatus* 4 types of cells are found. The peripheral cells show densely compact foldings of their plasma membranes to and from the basal lamina, forming a basal labyrinth, and interdigitate with the peripheral plasma membranes of the central cell with its large nucleus. A ring-shaped constrictor cell surrounds the acinar duct which is also formed by the →neck cell. The structure is thought to be responsible for secreting hygroscopic salts required for the active uptake of atmospheric moisture by nonparasitic stages. The acinus type I shows little change during feeding. Type II acini in argasids show 2 or 3 cell types in different species. In ixodid ticks, the granular types II–IV acini show marked changes during feeding. Up to 10 different granular cell types are found. The granules are sometimes complex in structure. Type II acini increase in size and secretory activity during feeding, and can dominate in late feeding. As in type III and IV acini, cells are arranged in radial segment fashion around the lumen which leads to the duct, passing a valve (argasids do not have a valve). There is no clearly proven association between structure and function of cells in granular acini, some of which pass through a rapid sequence of synthesis, secretion, and hypertrophy. This sequence is asynchronous between cells. The type IV acinus of *R. appendiculatus* males continues development after the first mating and may reach its maximum size several days after the female has

dropped. All acini types include a variety of secretory cells, the products of which fulfill different tasks such as lytic, anesthetic, anticoagulant functions.

## Food Uptake and Digestion

### Feeding Habits

All ticks are obligate ectoparasites of mammals, reptiles, or birds. Depending on their host relationships, ixodid ticks can be referred to as one-, two-, or three-host ticks, while most argasid ticks can be referred to as multihost ticks. These feeding habits are of ecological interest as well as of significance in disease transmission and control of ticks. The larvae, nymphs, and adults of one-host ticks all feed and molt on the same host. Ticks of the genus *Boophilus* are such examples where larvae attach to bovines and engorged females drop off the host 3–4 weeks later. Except for the engorged female, all stages are very small. The genus *Margaropus* also includes one-host ticks. Acaricide resistance in ticks is particularly prevalent among one-host ticks (*Boophilus*) where selection pressure is directed against all stages and heritably resistant mutant individuals have a greater chance of survival and of becoming the progenitors of resistant populations. In the two-host ticks larvae feed and molt without leaving the host, the replete nymph dropping and molting on the ground. The adults then seek a second host to complete development. *R. evertsi*, with 2 subspecies, is a 2-host tick found throughout sub-Saharan Africa. Some species of *Hyalomma* are also 2-host ticks and among them are ticks which can use 2 or 3 hosts in different generations. The majority of hard ticks require 3 hosts to complete development, each stage becoming replete on a host and then dropping to the ground to molt. Larvae, nymphs, and adults each seek a different host, the engorged female dropping from the third host to lay eggs on the ground. Seasonal and regional variations in the prevailing microclimate conditions of 3-host ticks can result in life cycle spans of 2 or 3 years in *Dermacentor andersoni*, or even up to 6 years in *I. ricinus*, in cool climates.

In 2- and 3-host ticks the different stages may prefer completely different host species. In many 3-host ticks larvae and nymphs prefer small rodents and lagomorphs as hosts while adults attack larger mammals. In some cases the larvae and nymphs of a species are unable to survive on the host species of the adults.

The argasid ticks have different feeding habits from hard ticks, with usually much shorter feeding periods and up to 7 nymphal feedings (*Ornithodoros coriaceus*) as well as up to 7 meals in the adult stage (*Argas persicus*), with a different host each time. Ticks with these feeding habits can be termed multihost ticks. *Otobius* spp. are exceptions, showing a modified one-host pattern of feeding.

Ticks show a varying degree of host specificity. This varies from the very wide range in ticks such as *Ixodes ricinus* (mammals, birds, reptiles) to preferences for smaller groups such as in the *Haemaphysalis leachi* group which prefers carnivores, and finally to very high specificity, sometimes involving a single host such as is found with *R. simpsoni* on the cane rat. On the host, many tick species choose more or less specific sites, usually for strategic rather than other purposes. In East Africa, ticks with long mouthparts and very painful bites (*Amblyomma* spp.) prefer the perianal and inguinal regions where the host cannot reach them and where they are safer from predating birds of the genus →*Buphagus* (→*Oxpeckers*). Specific sites in adult ticks are also likely to improve the chances of finding a mating partner.

Ticks are reluctant to feed on an unusual host. If they do feed, they take up smaller quantities and concentrate the components to a lesser degree. Out of 5 mated rhinoceros tick (*Amblyomma rhinocerotis*) females engorged on a bovine, only 3 laid eggs, of which only one batch hatched. The resultant larvae refused a variety of laboratory hosts.

In ticks, reproduction and feeding are often closely related. However, there are many cases of larval and adult ticks not requiring a blood meal for further development (**Reproduction and Feeding**). In many prostriate species the male does not feed.

As a rule, the period of feeding is short in argasids and long in ixodids. In most species of *Argas* and *Ornithodoros* adults and nymphs do not require more than 15–60 minutes to engorge, the range being approximately 2 minutes to 2 hours. Larvae of argasid ticks require longer feeding times than the corresponding nymphs and adults. *Argas persicus* and *A. reflexus* larvae require 5–10 days and *A. boueti* 16–25 days. During engorgement soft ticks ingest quantities of blood corresponding to 3 or 4 times their original body weight. In hard ticks this quantity can be 50–200 times the weight of the unfed female. They remain attached to the host and engorge in 5–12 days, unless they do not mate, in which case they may remain for several weeks. Larvae and nymphs of *R. appendiculatus* increase their body weight to the same degree as the female, i.e., about 100 times. Male ixodid ticks feed for 3–5 days, during which time their weight more or less doubles and after which they will ingest further blood only if the nutrients are exhausted while they are searching for or waiting for a female. They may remain on the host, sometimes seeking a fresh host, for several weeks or months.

### Attachment

The attachment of ticks to the host is interesting both from the point of view of the physiological adaptations to this role and from its significance for the health of the host which is of extreme economic importance, the cost

of tick and tick-borne disease control being measured in thousands of millions of dollars per year.

The initial lesion is formed by the cutting digits of the chelicerae which in some species may be aided by lytic components of saliva. The hypostome enters the wound and becomes embedded by the recurved teeth which are mainly found on the ventral surface (**Fig. 1**).

In most ixodid ticks, insertion is accompanied by a flow of attachment cement which enters the wound and bathes the hypostome and chelicerae, apparently hardening almost instantaneously, and which results in a formation characteristic of the tick species or genus involved. The cement casting usually consists of a core wedged into the skin lesion and a spread cone encasing the hypostome and chelicerae which provides a seal on the skin of the host. The cement appears to be basically proteinaceous, and, interestingly, contains several immunogenic proteins also found in salivary gland extracts. The physical nature of the cement prevents these proteins from having antigenic activity. When ticks are forcibly removed cement is still often found on the mouthparts. Argasidae and some prostriate ticks do not form cement.

While the mechanical action of host penetration is confined to minor damage to adjacent tissues, tick salivary components are responsible for a wide range of tissue changes and local or systemic host reactions. It is not always possible to distinguish direct salivary activities from immune or pathological reactions of the host. The saliva has been shown to have a variety of pharmacological effects. The anticoagulant activity was shown as early as 1898–1899 in *I. ricinus* by Sabbatini and has since been found in other ixodid tick species. In argasid ticks, the excretion of fluid into the host during feeding is minimal. The anticoagulant of *R. appendiculatus* has been isolated and purified from the salivary glands of adults. It is a protein with a relative molecular weight of approximately 65,000 that inhibits blood clotting factor Xa and is mainly produced during the period of rapid engorgement from day 4 to day 7 of feeding and is not immunogenic. Small quantities are effective anticoagulants for large volumes of blood at 10°C and at room temperature, but at 37°C the anticoagulant activity is removed in less than 1 hour possibly due to metabolizing activities of bovine or rabbit blood. This may be an indication that the anticoagulant is only active directly at the tick bite site and is possibly a precaution to prevent continuing activities within the tick itself. Tick salivary gland extracts also have effects on vasodilation, vascular permeability, and cytolytic activities.

In both ixodid and argasid ticks the elimination of excess water and ions is a vital function during the uptake of the more or less exclusively fluid nutrients (**Excretory System**). Two different strategies are involved in extracting these from the hemolymph.

In argasid ticks coxal fluid secretion starts near the end of or immediately after engorgement. In ixodid ticks the salivary glands remove the excess fluid from the hemolymph while the tick is still attached to the host, thereby concentrating the blood meal immediately and allowing a larger volume of blood to be taken up. When this process has been completed it is a major endeavor of all ticks to prevent any further loss of fluid until the next blood meal.

Some tick species do not form clearly distinguishable hemorrhagic feeding pools at the tick bite site, although there is a distinct area of affected tissue surrounding the tick mouthparts. The fast-feeding argasid adults cause a hemorrhagic pool to develop soon after attachment. The cavity formed beneath the mouthparts of some ixodid ticks may to some extent be a result of host reactions and may not be essential to tick feeding.

Whole blood forms an essential part of the tick diet. Ixodid ticks can also successfully ingest other tissues practically devoid of red blood cells. *Amblyomma variegatum* nymphs feeding in an *in vitro* system achieved 24% higher engorged weights when they fed on heparinized whole blood than when they fed on defibrinated blood from the same bovine donor.

Feeding stimuli are better known from argasid ticks than from ixodids due to the possibility of *in vitro* feeding which is less successful in ixodids. *Argas* spp. and *Ornithodoros* spp. respond to reduced →glutathione, nucleotides, and amino acids, but in most cases only if at least 1 mg glucose/ml is also present in the medium. There appear to be separate chemoreceptors on the mouthparts, one specific for glutathione and nucleotides and the other for amino acids.

In ixodid ticks the addition of ATP or glutathione to the medium enhanced the attachment process of ticks partially fed *in vitro*. Recently, carbon dioxide which is known to be an attractant for ticks (Host Finding) and to have a strong effect on the water balance has also been shown to be a phagostimulant for *R. appendiculatus* and *Amblyomma variegatum*. Using a 5% CO<sub>2</sub> atmosphere, the larvae and nymphs of *A. variegatum* can be induced to fully engorge in an *in vitro* system in the total absence of a host animal, achieving engorged weights comparable to those achieved on mammalian hosts and with a high molting rate. *R. appendiculatus* larvae, nymphs, and females can be fed in an artificial system when the CO<sub>2</sub> concentration is 7%. In this system female *A. variegatum* feed more successfully if ATP is added to the whole blood medium upon which they feed.

### Digestion

Host tissues, mainly in fluid form, are sucked in by a pharyngeal pump mechanism and pass through the esophagus into the midgut where digestion takes place.

In ticks this is a slow intracellular process, in contrast to hematophagous insects where protein digestion basically takes place in the lumen of the intestine. As blood enters the midgut it passes into the large central chamber, from where it is further distributed into the diverticulae by peristaltic movement.

During the first phase of feeding in ixodid ticks, the growth phase, the tick ingests only small quantities of blood, while organs undergo growth and development. This period lasts for about 4–6 days in most species, with almost no blood uptake during the first 12–24 hours of preparatory feeding behavior. During the growth phase blood is taken up by phago- and →pinocytosis into the type I digestive cells which are predominant at this time; this is followed by a rapid breakdown of their components. The mobilized nutrients are used to build the cuticle for the enormous expansion during the following phase, as well as for the preparation of intense metabolism during and after feeding. During the second or expansion phase the major part of the blood meal is ingested by the tick within a period of usually not more than 1–2 days. At this stage the main component appears to be whole blood, while in the earlier stage a large proportion of inflammatory cellular components is contained in the ingested tissues. As the first large part of hemolyzed blood enters the midgut, type II digestive cells become abundant. These cells take up hemoglobin and other proteins by pinocytosis. No signs of phagocytosis have been observed in this cell type. During the expansion phase the idiosoma of larval, nymphal, and female ixodids shows the characteristic enormous distension which is due to cuticular extension.

Whereas feeding and digestion in ixodid ticks are not separated but merge, digestion in argasid ticks starts after the tick has dropped off its host. During the first phase the blood meal is concentrated in the gut lumen with little digestion, while hemolysis of red blood cells begins. This is followed by a second phase of intensive intracellular digestion by the digestive cells. The third phase is characterized by a slow rate of digestion and low metabolic activity of the starving tick while it is waiting for its next blood meal which, in extreme cases, can be delayed for many years.

Hemolysis, i.e., the rupturing of the red blood cell membranes and the release of hemoglobin, has been investigated in →*Ornithodoros savignyi* and has been shown to take place gradually as the red blood cell membranes became increasingly fragile. In this tick species, hemolysis was more rapid in males than in females. In ixodid ticks hemolysis appears to be a more abrupt process, taking place soon after ingestion of blood and leaving no trace of cell membranes in the midgut blood mass. The saliva of *R. appendiculatus* females fed for 4 days was found not to have any hemolytic effect.

## Excretory System

The engorged weight of an ixodid tick can correspond to 50–200 times the unfed weight, while there is less weight increase in feeding argasid ticks. The blood is concentrated 2–3 times during uptake and the volume of the blood in the engorged tick may be only 20% of the total volume of blood imbibed. Some ticks, particularly members of the genus *Dermacentor*, excrete large amounts of undigested blood through the anus during feeding, i.e., while they are still on the host animal.

In all ticks, the task of removing excess hyposmotic fluid rapidly during or immediately following the blood meal is vital for osmoregulation and is a major excretory effort. In the 2 main tick families, fluid excretion is achieved by 2 entirely different mechanisms.

Argasid ticks remove fluid during the final period of engorgement and/or after they have left the host. They can be observed to exude large volumes of a clear fluid from a pore on the first coxal joint. The fluid is secreted from the coxal organ, a tubular osmoregulatory apparatus ending distally in a filtration membrane. This is assumed to form an ultrafiltrate of hemolymph, which itself receives fluids and ions from the midgut while the blood meal is being concentrated. Further regulation of the fluid balance is carried out in the coxal tubule which leads the final excretory product to the coxal orifice by which it leaves the tick; this mechanism is suited to the fast feeding habits of most argasid ticks which remain attached for a few minutes to 2 hours. Argasid ticks appear to inject negligible saliva into the host.

In ixodid ticks, which usually feed for several days or even weeks, removal of hyposmotic fluids is

achieved by means of the salivary glands. The salivary gland is a paired acinar organ with a complex of various cells, of which a major portion is granular. Of the 3 acinus types found in female ixodid ticks, type I and type III acini have been suggested as sites of water secretion (Fig. 9A). There is more evidence available that cells in type III acini are mainly responsible. These cells undergo striking morphological changes during the course of feeding, including the appearance of a cell type designated the “water cell.” Type II and III acini play a significant role as the sites of proliferation of the infective stages of *Theileria* spp. and *Babesia* spp. which are transmitted with the saliva. This may be a further indication of the major excretory function of these 2 types of acini.

None of the cells found in the acini have been conclusively attributed with specific functions related to the known activities of the salivary gland or the saliva. These include the production of attachment cement and various pharmacologically active components, some of which are shown in Table 3.

In ixodid ticks, the final phase of feeding involves in particular a rapid concentration of blood nutrients, during which the hemolymph is loaded with the resulting excess fluid; this excess is then removed by the salivary gland and injected into the host. Feeding is a rhythmic succession of salivation and →food uptake. Interfering with salivary gland function or control and hence osmoregulation, such as by applying organophosphate acaricides, results in an inability to remove excess fluid, leading to a disruptive increase in hemolymph volume. During feeding, some ixodid tick species excrete large amounts of undigested or partially digested blood. Particularly profuse excretion occurs in

**Ticks. Table 3** Biologically active molecules of *Rhipicephalus appendiculatus* tick salivary gland extracts and saliva

	Inf. TSGE	Uninf. TSGE	Inf. Saliva	Uninf. Saliva	Gut
Smooth muscle contractor	–	–	–	–	–
Histaminase	–	–	+	+	ND
Bradykininase	++	++	–	–	–
Carboxypeptidase A	++	++	–	–	–
Carboxypeptidase B	++	++	–	–	–
Leucine aminopeptidase	+++	+++	–	–	+++
Monoarginine amino peptidase	++	++	–	–	++
Diarginine amino peptidase	++	++	–	–	++
BTEE esterase	++	++	–	–	+
Esterase (BAEE)	+	+	–	–	+
Amidase (Bz-Ile-Glu-Gly-Arg-PNA)	++	++	ND	ND	+
Chymotrypsin inhibitor	+++	+++	++	++	++
Plasmin inhibitor	++	++	ND	ND	+
Blood coagulation inhibitor	+++	+++	+	+	+

Activity: –, nil; +, slightly; ++, moderate; +++, considerable; ND, not determined; inf., *Theileria* sp. infected; uninf., uninfected; TSGE, tick salivary gland extract

the genus *Dermacentor* where fecal water loss can be up to 25% of the total elimination of water. In other species fecal loss may be negligible, but the volume of saliva injected into the host can be as great as or greater than the total volume of the engorged larva, nymph, or female.

As in other arachnids, ticks conclude nitrogen metabolism with the production of guanine rather than uric acid. In ticks, nitrogenous excretion is largely separate from ion and water regulation. The guanine content of excreta is very high and it is eliminated in almost solid form, thus preserving water reserves in the starving tick. Excretion takes place in the Malpighian tubules, a pair of blind-ending slender tubules which form several loops in the body cavity and open into the rectal sac where there may be mixing of Malpighian excreta with feces before elimination of both forms through the anus. In engorged female ixodid ticks, the Malpighian tubules are grossly distended and visible through the integument as wide yellowish lines which increasingly fill the body cavity, since the tick eliminates only a very limited amount of metabolic waste before dying. Ticks kept at constant temperatures under laboratory conditions appear to defecate less frequently, but in greater quantity at a time, than ticks exposed to natural diurnal temperature rhythms. This may be a factor contributing to the longer survival of many ticks kept under natural temperature regimes.

### Nervous System

In ticks there is a very close association between the nervous and the circulatory systems. This is demonstrated by the enclosure of the entire central nervous system within a perineural sinus of the circulatory system; this receives a dorsal aortic vessel and gives rise to vessels enclosing the major nerve trunks.

No part of the central nervous system is located within the gnathosoma of the tick, which therefore does not correspond to the head in the generalized arthropod. The brain is located centrally at the level of the second coxa. Ticks can be killed quickly by crushing this region with a hard object (ticks are very resilient: a practical method of destruction is with hot water). The central idiosomal position of the central nervous system makes it poorly accessible for direct investigations.

The tick central nervous system is more condensed than in other  $\rightarrow$ *Chelicerata*. It is a synganglion, formed by the fusion of the brain ganglia and the abdominal nerve cord into a single mass. The nerve trunks arising from the ganglia are formed by axons of both receptor and motor cells. As in other acari, the synganglion is divided into 2 parts by the esophagus. Cranially, the esophagus lies beneath the synganglion, then crosses obliquely through the synganglion in a ventrodorsal direction to lie dorsally on the posterior portion before

joining the midgut. The cranial, pre-esophageal part of the synganglion consists of the protocerebrum, the optic lobes, the cheliceral and pedipalpal ganglia, and the stomodeal pons or bridge.

All ticks examined have been found to possess well-developed photoreceptors, even the “eyeless” ticks (*Aponomma*, *Ixodes*, *Haemaphysalis*). They also have optic nerves and optic ganglia in the brain. A set of paired nerves extends from the optic lobes, a second set of paired nerves serves the chelicerae, and a third innervates the pedipalps. The unpaired stomodeal or pharyngeal nerve innervates the pharynx.

The postesophageal part of the synganglion gives rise to 4 pairs of pedal ganglia serving the 4 pairs of legs in the adult tick. Fine “sympathetic” nerves connect all 4 pedal nerve trunks laterally on each side of the synganglion. Several pairs of opisthosomal nerves innervate the viscera. The ventral lobes of the pedal ganglia of leg 1 contain discrete areas of highly differentiated neuropile which are thought to receive olfactory fibers from pedal nerve 1, and have been called olfactory lobes.

Associative centers are represented by several bilaterally symmetrical glomerular structures. Antero-dorsal, posterodorsal, and ventral glomeruli in the pre-esophageal part are connected by nerve fiber trunks. A complex of nerve fibers and trunks in the postesophageal part of the synganglion forms a 5-level commissure-connective system.

The synganglion and all peripheral nerves are covered by a connective tissue sheath, the neurilemma, below which there is a relatively thin layer of glial cells, the perineurium. Beneath these layers, subperineural glial cells are located on both sides of a cortex layer of nerve cell bodies surrounding the central fibrous neuropile, which constitutes the greater part of the synganglion mass.

There is some direct and indirect (effects of acaricidal activity) evidence that acetylcholine and  $\rightarrow$ *catecholamines* (dopamine, noradrenaline, norepinephrine) play a role as  $\rightarrow$ *neurotransmitters* in ticks. However, the role of these substances, which are known to act as neurotransmitters in other animal groups, must remain speculative until further evidence has been provided.

### Host Finding

The various tick species show very different types of host-finding and feeding behavior patterns. For example, they may find their hosts by active hunting or by ambushing behavior, they may use one host for their whole life cycle, or depend on the acquisition of 2 or more hosts, they may be specialized on a specific host type or show little specificity for particular animal groups. In one-host ticks host-seeking takes place once

during the whole life cycle. The risks involved are thus reduced in comparison with 2-, 3-, or multiple-host ticks where there are correspondingly more critical periods for each individual. Ticks which can complete their whole life cycle within one limited environment (e.g., nest, burrow, cave) may nonetheless be exposed to long periods of starvation during migration and other seasonal or irregular absences of the host. This risk is reflected in the ability of starving soft ticks to survive for periods of up to 14 years. Judging by the large number of offspring and the long periods of starvation to which ticks can be exposed, the chances of finding a new host appear to be fairly poor.

Host-finding of most ticks can be divided into phases such as →[habitat selection](#), host recognition at a distance, change over to the host, enduring contact with the host, and exploration (selection of a feeding site), and the sequence of behavior patterns related to the feeding process such as piercing (insertion of the mouthparts), attachment of the mouthparts, secretion of salivary gland contents, ingestion, detachment of the mouthparts, and leaving the host.

### Microhabitat Selection

Following hatching or molting and a period of quiescence, →[host finding](#) is aided by orientation responses, which in ixodid ticks lead to a favorable distribution on the vegetation or other sites. In argasid ticks, orientation may depend on the presence of suitable hosts and may be more marked at night, as in the case of *Argas persicus* or *A. reflexus* in which the adults and nymphs feed on roosting avian hosts, remaining hidden during the day.

Much of the behavior of ticks seems to be dedicated to selecting optimal resting sites. Host-finding behavior is often only displayed when the environmental and physiological conditions support their survival. During host seeking, ticks normally select microhabitats with good opportunities to encounter a host. Many species ascend vegetation to heights favorable for contacts with the particular hosts. Also, the time of day has an effect on the microhabitat selection. For example, the larvae of the cattle tick *Boophilus microplus* ascend vegetation in the early morning and again in the evening. The microhabitat selection is achieved by responses to environmental cues such as gravity, light, and humidity.

### Host-Finding Strategies

Ticks respond to hosts at a distance with various behavior patterns, depending on their host-finding strategy: Many ticks, in particular certain *Hyalomma*, *Amblyomma*, *Ornithodoros*, and *Dermacentor* spp., seek their hosts by hunting, they move actively in the direction in which the host is seen or sensed. Due to their limited mobility, more abundant among ticks is the ambushing strategy, in which the parasites await the

hosts in their selected microhabitats in the vegetation. They respond to host cues with questing behavior, i.e., an erect posture, in which the first pair of legs is waved in the direction of the host stimuli. The larvae of *Boophilus* spp., and probably the larvae of most ixodid ticks, show marked ambushing behavior. The larvae of *B. microplus* ascend the vegetation early in the morning and again in the evening to a height favorable for attaching to cattle passing close by. In other species, similar ambushes are prepared at heights appropriate to the preferred host species.

### Host Recognition

The approach of a suitable host is heralded by several stimuli such as volatile host emanations, vibrations, visual cues, radiant heat, and touch. These cues are taken up by sense organs concentrated at the anterior end of the tick which indicate proximity of the host. There may be no response from quiescent ticks. Sense organs suspected to be involved in the host location and feeding behavior of ixodid ticks have so far been located at 4 main sites: on the tarsi of the first pair of legs, on the mouthparts, and on the scutum. They include olfactory, gustatory, mechano-, photo- and thermoreceptors, and probably humidity receptors. The dorsal surface of the tarsi on leg I of ticks has a unique set of sensory structures which include Haller's organ complex housing some of the tick's olfactory chemoreceptors. Other sensory organs on the tarsi are gustatory, mechano-, and thermoreceptors. The involvement of Haller's organ in host perception is evident from the "questing" posture of an alert tick, which lifts its first pair of legs and waves them while taking up a position favorable for dropping or crawling onto the host. In this function, the legs and the olfactory receptors correspond to the antennae of insects.

Volatile host emanations are the most important cues in tick host finding. Most tick species are attracted by sources of carbon dioxide which can function as an "artificial host" and be used to demonstrate how active a tick is in finding a host. Activity ranges between hunting and ambushing behavior. Hunters are attracted to the carbon dioxide-emitting source and can be trapped with this gas, and ambushers respond sensitively with questing behavior. *Amblyomma americanum* is actively attracted by a carbon dioxide source from a distance of 21 m and carbon dioxide appears to also act as a phagostimulant. The more specific a tick species is in its choice of host, the more likely it is to require additional highly specific chemical stimuli to alert and attract it to the host. However, little is known on how different host specificities are encoded in the odors. The characteristics of tick olfactory sensilla suggest that they use very different compounds of the odors for host identification. This may be concluded in particular from data on the sensilla of tarsus I (including those of



Haller's organ) of *A. variegatum*. Gas chromatography-coupled electrophysiology recordings using different vertebrate odors allowed the identification of specific receptors for lactone (2 receptor types), methylsalicylate, carbon dioxide (2 types), sulfide (2 types), benzaldehyde, 2-hydroxybenzaldehyde, aliphatic aldehydes, 2,6-dichlorophenol, nitrophenol, pentanoic acid, 2-methylpropanoic acid, butanoic acid, →ammonia (2 types), and 3-pentanone.

Also, the behavior responses of ticks indicate that they may react to different components of host odor and that they may discriminate the odors of different host types. For example, the larvae of the bovine-specific *B. microplus* responded sensitively with questing behavior to skin surface odors of cattle, but only weakly or not at all to those of humans, pig, mouse, and deer, whereas the larvae of the generalist *I. ricinus* responded similarly to the different odors. Blends of synthetic odor compounds stimulated questing in both species. The stimulating activity of a blend of 37 compounds was achieved by a combination of only 7 of the compounds which as single substances were without effect (benzoic acid, 2-ethylhexanoic acid, hexanoic acid, 2-nitrophenol, 1-octen-3-ol, pentanoic acid, and pyruvate). Under these conditions *B. microplus* achieved its specificity for bovine odors by responding more to the bovine-specific compounds 1-octen-3-ol and 2-nitrophenol, whereas *I. ricinus* reacted to each of the 7 compounds with similar intensity. Obviously, the response of ticks to odor is stimulated by a combination of different compounds, rather than by particular individual compounds, and also specific hosts may be recognized via the interplay of different odor compounds.

A special attraction to hosts occurs in certain species of *Amblyomma*. Females are attracted to the ungulate hosts by attraction/aggregation attachment pheromones which are emitted by feeding males on the hosts. The major chemical components in the pheromone are ortho-nitrophenol, methyl salicylate, and pelargonic acid.

The ocelli of some tick species are sufficiently developed to play a significant role not only in perception of light and darkness, but also in perception of the host itself. Paired ocelli are found at the edge of the scutum at about the level of the second pair of legs. In argasid ticks they are smaller and found in folds at the sides of the idiosoma. In *Omithodoros savignyi* there are 2 pairs of ocelli. Even "eyeless" ixodid ticks (of the genera *Aponomma*, *Haemaphysalis*, *Ixodes*) have been found to have well-developed photoreceptors and optic ganglia in the brain. In ticks with ocelli there is a lens, a hemispherical, transparent, flat or convex cuticular thickening, underneath which a small group of photoreceptors or optic cells are situated. An optic nerve extending from this location leads to the

optical center of the synganglion. This has been studied in *A. americanum* and in *Hyalomma asiaticum*. Vision in some species of *Hyalomma* and *O. savignyi* is thought to enable these ticks to actively pursue their hosts over long distances.

Also, vibrations which stimulate host-finding responses in many ticks may signal some host specificity. Sounds in the range of 3,000–8,000 Hz, as produced by swallows, stimulate hunting in *O. concanensis*, and airborne vibrations in the range of 80–800 Hz, as elicited by grazing cattle, activate *B. microplus* larvae.

Radiant heat as another host cue may be effective over certain distances and offers directional information. Hunting species are attracted to heat sources and ambushers respond to heat with questing behavior.

### Change Over to the Host

Alert ticks cling to any moving substrate touching them. Particular host cues do not seem to be necessary for the change over to a host. However, on the host's surface gustatory and olfactory cues seem to decide whether the parasites will remain on the host, and they guide the parasites to particular feeding sites. Some species prefer feeding sites where they are out of reach of the attacks by the grooming behavior of the hosts. Little is known on how the feeding sites are found. On artificial substrates ticks orientate towards certain host skin extracts, but the chemical nature of the directing cues still has to be analyzed.

### Feeding Site Selection

Once on the host animal, many tick species will not probe until they have arrived at the preferred feeding site and are out of reach of grooming by the host. On the few occasions that male ticks climb onto unsuitable hosts, they may probe immediately. Female ticks appear to avoid or reject inappropriate hosts more than males, but may engorge in exceptional cases. The carnivore tick *Haemaphysalis leachi* may engorge on bovines and lay viable eggs under conditions where dogs and cattle are kept in close contact.

In certain *Amblyomma* spp. an aggregation of the parasites at specific feeding sites is supported by the male-emitted attraction/aggregation attachment pheromones which attract conspecific males, females, and nymphae. In the majority of the hard ticks studied so far, feeding females produce an attractant sex pheromone containing 2,6-dichlorophenol which attracts males to the feeding site.

### Drop-Off

The drop-off periodicity and its correlation with the distribution and habits of possible hosts for the next feeding are particularly important for ectoparasites of host animals that do not exhibit nesting behavior. In

some tick species, it has been observed that drop-off times are regulated by a circadian rhythm related to the daily light cycle. There may also be a host-induced rhythm. Darkness plays the principal role in setting the phase of the rhythm. This may be combined with changes in temperature, such as those during movement from the shade of trees to light or vice versa, or from the stable to sunshine. In some ixodid ticks, such as *Boophilus* spp. females or *A. variegatum* nymphs, the sudden exposure of bovine hosts to increased light can trigger a rapid drop-off of engorged ticks. Such an effect is likely to cause the next tick stage to be found close to host-resting places. In tick species where the next stage has different host preferences, more complicated strategies may arise to ensure the availability of the next host candidates. After dropping off, the engorged larvae of some ixodid tick species tend to move downward, whereas in other species there may be a tendency toward upward movement. These movements may reflect the nesting or nonnesting habits of the resultant nymphal tick's preferred next host.

### Artificial Feeding Methods

Much information on the host-recognition phases of the ticks on the host's surface comes from studies dealing with the development of artificial feeding methods. The feeding sequence consists of behavior patterns such as piercing the skin with the cheliceral digits, anchoring with the hypostome-chelicerae complex to the attachment site (possibly with cement material), salivary gland secretion, uptake of host body fluids, withdrawal of the mouthparts, and leaving the host. Important cues for successful feeding on artificial membranes are unknown chemical compounds of skin extracts, heat, humidity, carbon dioxide, and mechanical properties of the membranes. Reduced glutathione, nucleotides, and amino acids seem to function as phagostimulants. Feeding systems *in vitro* now provide the means to investigate tick – pathogen relationships without the complication of feeding ticks on acutely infected hosts.

### Chromosomes

As in many other arthropod taxa, several groups of tick species are not sufficiently defined for a reliable differentiation and classification of species and subspecies. The scanning electron microscope has provided a tool to support morphological differentiation, but few investigations have included a biological background to validate the authenticity of species based on minor morphological differences and/or on host preferences. This is not required where the morphology is unique, and is nearly impossible in the ectoparasites of rare and elusive host animals.

Cross-breeding trials have been used to substantiate the results of morphological investigations. Thus *Argas persicus*, *A. arboreum* and *A. walkerae* have been confirmed as separate species. The males of 2 ixodid species, *Rhipicephalus appendiculatus* and *R. pulchellus*, can induce females of the other species to complete feeding although mating does not take place. In this way, some *R. appendiculatus* females can produce viable eggs and larvae, which can normally only take place after being triggered by conspecific mating. There is no parthenogenetic development in *R. pulchellus*. The phylogenetic relationship appears to be close enough for common pheromones to be present even though appropriate behavioral patterns are lacking. Intersubspecific hybrid formation between *R. evertsi evertsi* and *R. e. mimeticus* has confirmed the separation at subspecies level rather than at species level. When *Boophilus annulatus* and *B. microplus* are mated, sterile hybrid males and fertile hybrid females are produced. The female hybrids produce sterile males when back-crossed with males of the male parent species. Theoretically, sterile hybrid *Boophilus* ticks could be used to eradicate low-level *Boophilus* populations.

Studies on the cytogenetics of tick species may eventually provide a useful means of investigating phylogenetic relationships and may also provide a taxonomic tool for studying living tick specimens. The →chromosomes of several tick species have been described. Most species are diploid. The diploid chromosome number in ticks ranges from 12 to 36, the whole range being present in the genus *Omithodoros*, where *O. guernei* has 12 and *O. alactagalis* has 34. Both species of *Otobius* (*O. megnini* and *O. lagophilus*) possess 20 chromosomes. In *Argas* most investigated species have 26 chromosomes (with 24 autosomes plus two →sex chromosomes), exceptions being *A. vespertilionis* (20) and *A. brumpti*, with 24.

In the ixodid bisexual species which have been studied, there is a range of 17–28 chromosomes. The most common number of chromosomes and sex-determining mechanism found in metastriate ticks is 20 + XX in females and 20 + X in males. This combination is found in 11 species of *Rhipicephalus*, 12 species of *Hyalomma*, 3 species of *Boophilus*, and in some species of *Amblyomma*. The range in *Amblyomma* is from 19 to 22, in *Aponomma* from 17 to 21, in *Dermacentor* from 20 to 22, and in the bisexual species of *Haemaphysalis* from 19 to 22. In the parthenogenetic races of *Haemaphysalis longicornis* there is a triploid chromosome set with 30–35 chromosomes. The prostriate genus *Ixodes* has a chromosome range of 23–28, with 23 in *I. holocyclus*, 24 in *I. cornuatus* and *I. tasmani*, and 28 in others.

The male usually has one chromosome less than the female, except in *Ixodes*. With 6 exceptions, all

members of the Metastriata have XO:XX male: female sex chromosome systems. Four species possess an XY:XX system, as do the Prostriata with the exception of *I. holocyclus*, which has XO:XX. All argasid species described have XY:XX chromosome systems. Two *Amblyomma* species have multiple sex chromosomes, with 2 different X-chromosomes in males and females. Chromosome polyploidy is suspected in some ixodid species, too. In general parthenogenesis is rare in ticks. If it does occur, it is accomplished by thelotoky; in such cases all the progeny are female and polyploidy is frequently associated with this type of reproduction. An obligate parthenogenetic tick is *Amblyomma rohindatum*, in *Haemaphysalis longicornis* this phenomenon occurs more often than in *Dermacentor variabilis*. The morphology of the chromosomes is species-specific. An X-chromosome is invariably longer than the autosomes (often 3–4 times as long) and represents the isobranchial type (= metacentric), while the Y-chromosome is usually heterobranchial (= submetacentric). The autosomes are mostly acrocentric.

---

## Ticks as Vectors

→Tick Bites: Effects in Animals.

---

## Ticks as Vectors of Agents of Diseases, Man

### Introduction

Human populations are becoming increasingly vulnerable to infection by tick-borne pathogens (→Arboviruses, →Babesia, →Theileria, →Bacteria). These infections are more intense and diverse now than they appeared to be during the mid-1900s. Our recent experience with →Lyme disease, human babesiosis, and human →ehrlichiosis illustrates this pattern of emergent tick-borne infection. This trend is driven by a proliferation of vector →ticks in many parts of the world and widespread human encroachment into forested sites. The purpose of this review, therefore, is to identify the environmental determinants of tick-borne disease. In particular, we shall review concepts concerning the diverse modes of perpetuation of tick-borne agents and identify conditions leading toward human infection. Although Lyme disease will be emphasized, this review will include other tick-borne pathogens that share similar ecological features.

### Biology of Ticks

→Ticks are arthropods, as are insects, but are classified with the →mites and →spiders. They may readily be distinguished from insects by their characteristic flat, unsegmented bodies, absence of antennae and 4 pairs of legs in the nymphal and adult stages. All ticks share various structural features employed for finding and feeding on vertebrate hosts. Their mouthparts include retractable →chelicerae that penetrate the vertebrate skin and a multispined →hypostome that affixes the feeding tick to its host. Olfactory setae, located on the anterior ends of their legs, serve to detect the presence of such animals. Hooklike structures at the ends of their legs enable ticks to attain contact with passing hosts. These features facilitate the parasitic mode of life.

The 2 major taxa of ticks, the →Argasidae (soft ticks) and the →Ixodidae (hard ticks), differ radically in structure, life history, and pathogen associations. The →cuticle encasing the bodies of soft ticks is leathery while that of hard ticks is rigid. It becomes elastic, however, as a hard tick fills with blood. Soft ticks are endemic to arid regions and are closely associated with the nests or burrows of birds or rodents. Such ticks feed frequently during each trophic stage and become attached to their hosts only briefly, generally for no more than an hour. Each of these feeding episodes provides a tick-borne pathogen with another opportunity to infect susceptible hosts. Hard ticks, in contrast, feed for several days or more and do so only 3 times during their entire lifespan: once during each of the 3 trophic stages. Although pathogens of hard ticks have fewer transmission opportunities than do soft ticks, they maintain a diverse array of viral, bacterial, protozoan, and metazoan pathogens. Soft ticks in contrast, transmit only →relapsing fever spirochetes, a complex of pathogens that is restricted to a few particularly arid sites. The following discussion, therefore, will focus exclusively on hard ticks and their associated pathogens.

Ticks require vertebrate blood to grow and to reproduce. Molting follows each feeding episode by a subadult tick. The life cycle culminates after adult ticks feed and the female deposits a batch of eggs. Ticks ingest enormous quantities of blood, hundreds of times their prior weight. A complex series of physiological events within the vertebrate host and vector tick facilitates this feeding process. The mouthparts of the tick penetrate the skin and secrete a cement-like substance that affixes it to the host. During blood feeding, antihemostatic and anti-inflammatory components of the saliva are secreted into the host to prevent platelet activation and suppress the immune response of the host. The tick ingests a mixture of blood and tissue fluids from the skin of its host in a manner that is poorly understood. The exoskeleton then becomes plastic and unfolds, accordion-like, to accommodate the final

phase of blood feeding. Vast quantities of blood are ingested during the final 24 hours of feeding. The bloated tick then withdraws its feeding apparatus and proceeds to digest its meal of blood. Replete ticks either →molt to the next developmental stage, if subadult, or, if adult, produce a clutch of eggs. Death follows →oviposition.

Ticks may survive for months or even years between feeding episodes. They remain motionless in a dormant state until →environmental conditions permit them to resume activity. Day-length and temperature serve as seasonal cues to initiate or suppress questing activity. During their questing season, ticks generally ambush their hosts. They leave their sheltered habitats, ascend on vegetation to a height commensurate with the body-form of their host, and wait for any passing object. Those ticks that hunt more aggressively may actively pursue their hosts. Such ticks will move great distances in response to carbon dioxide and other host-related stimuli to locate suitable hosts.

### Perpetuation of Infection

Virtually all tick-borne microbes that cause human disease are zoonotic, in that they perpetuate mainly as parasites of certain nonhuman reservoirs. Each human infection, therefore, constitutes a diversion that reduces the force of transmission. Ticks that narrowly focus their feeding on a particular reservoir population most effectively amplify the natural cycle of transmission of the pathogen. Vector ticks that feed most frequently on people would seem to contribute least to the enzootic cycle of transmission because their host-range is broad. Infections tend to perpetuate most readily in those ticks that seem innocuous because they rarely come in contact with “dead-end” human hosts. This paradox, that is common to all →zoonoses, is resolved in sites where species diversity is limited. In such sites, vectors that fail to discriminate between hosts may sustain enzootic transmission while allowing for episodes of human infection to occur.

### Contribution of Vector Ticks

The intensity of transmission of a tick-borne pathogen is determined, in part, by a series of vector-related physiological and ecological variables. The salient properties of the tick population include (1) competence, (2) abundance, (3) site-fidelity, (4) longevity, (5) seasonality, and (6) narrowness of host range. The term “→Vector Capacity,” which is based on a comprehensive synthesis of these 6 entomological properties, describes the number of new infections derived from each originally infected reservoir animal per unit of time. The relative contribution of each of

these variables to the force of transmission of a tick-borne pathogen remains poorly defined. These variables will be discussed, in turn, in the discussion that follows.

Vector competence describes the physiological suitability of a particular kind of arthropod as host for a microbe. This parameter is measured in the laboratory and estimates the proportion of ticks that acquire, maintain, and transmit a pathogen between vertebrate hosts. Vector ticks, therefore, must be able to ingest sufficient infectious organisms for the pathogen to become established, must maintain infection transtadially through the relevant molt and must deliver a sufficiently large inoculum to infect a particular vertebrate host. In addition to this horizontal mode of transmission, certain pathogens are maintained vertically, by inherited infection. The various babesial infections of cattle, for example, illustrate this pattern of transmission by inheritance, while the rodent babesias rely exclusively on horizontal passage between the larval and →nymphal stages of development. Although Lyme disease spirochetes (→*Borrelia burgdorferi*) mainly perpetuate in a similarly horizontal cycle, occasional episodes of inherited infection seem to occur. Transmission by cofeeding, i.e., direct passage of a pathogen from the mouthparts of an infected tick to those of a noninfected tick, has been demonstrated in laboratory experiments but not in the field. These cycles defy generality.

Vector abundance constitutes an important variable in the force of microbial transmission. When vector ticks are sparsely distributed, individual reservoir hosts may not sustain the requisite number of vector contacts; only a few reservoir animals would acquire and subsequently pass-on the pathogen. They might only rarely acquire infection or acquire infection so late in the transmission season that they would infect few ticks. Intensity of transmission correlates directly with vector density relative to the density of reservoir hosts.

Because the environmental requirements of ticks tend to be highly specific, their distribution is discontinuous. Vector ticks, therefore, must be sessile enough to preclude dispersal from their point of origin. Although ticks generally remain close to their point of origin, some may migrate several hundred meters in response to such host-associated stimuli as carbon dioxide. Those that attach to vagile hosts, such as birds, may readily be carried away from a permissive habitat and be lost to the transmission cycle. In this manner, tick-borne infections simulate the classical Russian concept of the “nidality of disease.”

The proportion of the tick population that survives long enough to become infectious also influences the force of transmission. Incidence of infection in the reservoir population, therefore, depends directly on interstadial survival of the vector tick. Indeed, the vast

majority of ticks that feed as larvae fail to feed once again as nymphs. In northeastern USA, for example, 3.5 times as many larval as nymphal deer ticks (*Ixodes dammini*) attach to white-footed mice (*Peromyscus leucopus*). Almost a third of these ticks appear to survive to feed again. In addition to longevity, however, this estimate of survival assumes that each relevant developmental stage of the tick responds similarly to the array of available hosts. Transstadial survival has not been estimated directly, and the magnitude of its contribution to the force of transmission remains unknown.

The seasonality of feeding activity of the vector tick relative to the density of the reservoir population may also affect transmission. In the case of the American vector of the agent of Lyme disease, seasonality is highly punctuated. The nymphal stage of the tick feeds, each season, before the younger larval stage. This inverted pattern of feeding serves to intensify transmission of pathogens because the reservoir population receives its infectious inocula before the larval recipient stage of the tick commences feeding. Because European wood ticks (*Ixodes ricinus*) lack such a precisely punctuated developmental cycle, the cycle in Europe seems less efficient than in eastern North America. The requirement for precision would be exacerbated in the event that reservoir hosts remain infectious only for a brief period of time. The pathogen must then become available to the vector population precisely when the appropriate stage of the vector quests for hosts. Seasonal events may profoundly affect transmission.

Narrowness of host range of the vector tick powerfully affects transmission because hard ticks feed only 3 times per generation. At least 2 of these feeding episodes must be directed toward the population of reservoir animals that enables vectors to successfully acquire and ultimately transmit the pathogen. For example, only larval and nymphal stages of the deer tick feed on rodent reservoirs, while adults parasitize larger noncompetent hosts such as deer. Diversion of either of the subadult stages to noncompetent hosts, therefore, negates transmission for the other feeding episode.

### Contribution of Reservoir Hosts

Although vector ticks may acquire infection from an array of hosts existing in nature, only one generally serves as the main reservoir of the pathogen. "Reservoir capacity" expresses the relative number of infected ticks derived from each host species. An effective reservoir host must be (1) competent for the pathogen, (2) sufficiently abundant, (3) parasitized by numerous vector ticks, (4) parasitized by at least 2 developmental stages of the vector tick, and (5) continuously resident

in the enzootic site. These biological properties, together, define the capacity of reservoir populations to perpetuate tick-borne pathogens.

Reservoir competence is a measure of the physiological ability of a vertebrate host to exchange a pathogen with vector ticks, and generally is analyzed experimentally in the laboratory. A competent reservoir must readily acquire infection, sustain its development, and ultimately present the pathogen to the vector. This parameter should be measured over a span of time that corresponds to that of the seasonal activity of the vector tick. For the Lyme disease agent in North America, for example, reservoir hosts must become and remain infectious over the 2 month interval spanning the maximum feeding activity of nymphal and larval deer ticks. The white-footed mouse fulfills this criterion because it attains infectivity within 2 weeks of infection and remains infectious for life. A competent reservoir, therefore, must remain infectious long enough to pass infection to the relevant stage of the tick.

Reservoir hosts should be sufficiently abundant in nature that vector ticks are likely to encounter them before encountering other less suitable but tick-attractive hosts. Although the force of transmission initially increases with reservoir density, greater host density might dilute the vector population such that individual hosts that become infected are unlikely to encounter and infect noninfected ticks. The presence of tick-attractive but pathogen-incompetent hosts would divert vector ticks, a relationship known as "zooprophylaxis." Transmission, therefore, tends to be most intense in ecological island sites where host diversity is restricted and particular reservoir hosts predominate.

A complex set of ecological and physiological properties of reservoir and vector populations determines the frequency of vector-host contact. Effective reservoirs, of course, must occupy the same habitats as do vector ticks. Ticks position themselves on the vegetation at an appropriate height above the ground, thereby ensuring a degree of host specificity. The stature of particular hosts influences the probability of encountering a tick in nature. In addition, reservoir hosts must forage at a time of day when ticks actively seek hosts. Ticks quest most effectively at night and during the morning and evening hours when the atmosphere is sufficiently humid. Once a questing tick attains host-contact, it must successfully feed without invoking an inflammatory response. Poorly adapted hosts develop an inflammatory response against tick bites after repeated exposure. Such resistant animals feed fewer ticks due to the direct effects of host immunity and irritation induced by tick bites which increases host grooming. The physiological and ecological variables that regulate host-tick contact remain poorly understood.

Reservoir hosts must have sufficient contact with pathogen-acquiring and infecting stages of the tick to perpetuate the pathogen. Entomological inoculation rate (EIR) describes the frequency of vector ticks delivering infection to the reservoir population. This variable depends on the frequency with which pathogen-infective stages of the tick feed on a particular reservoir population and the prevalence of infection in these ticks. To complete transmission, reservoir hosts must be abundantly parasitized by the pathogen-receptive stage of the tick. Reservoir inoculation rate (RIR) describes the number of infections generated in the vector population per unit of time. Together, these variables describe the ability of particular kinds of hosts to receive (EIR) and deliver (RIR) infection to and from the vector population.

Reservoir hosts should remain within the enzootic site throughout the transmission season. Mobile hosts such as birds tend to be ineffective reservoirs because they may readily disperse the pathogen to an inappropriate site that lies outside of the focus of transmission. Although migratory hosts may fail to maintain infection locally, they may passively transport ticks into new permissive sites. In this manner, excessively mobile hosts may reduce the force of transmission of a pathogen locally while accelerating the expansion of its range.

### Risk of Infection

The potential for tick-borne pathogens to infect human hosts depends on the questing density of infected ticks and the behavior of human hosts. Herein, we explore the conditions that may favor human infection.

The density of ticks largely correlates with that of their main vertebrate host(s). Definitive hosts, in particular, powerfully affect tick abundance because they comprise the main food source for the reproductive stage of the tick. Successful feeding of the adult stage of the tick results in huge increments of increase: thousands of larvae may result. In contrast, feeding success by subadult ticks merely promotes development. Adult deer ticks, for example, feed mainly on deer and proliferate solely where deer are abundant. This relationship was tested experimentally by depriving deer ticks of access to their cervid hosts. Deer inhabiting an island site were virtually eliminated, which resulted in a diminished tick population. The density of larvae per mouse declined fivefold during the year following the intervention, and that of nymphs somewhat more slowly, extending over several years. This relationship, however, appears to be nonlinear because incremental decreases in deer density may fail to reduce tick densities. Modest reductions in deer abundance may simply cause more ticks to feed on

each remaining host. The quantitative relationships between tick and host density have not been defined precisely.

Seasonality in the questing density of ticks may profoundly affect the shape of the epidemic curve representing any pathogens that they transmit. In North America, human Lyme disease infections tend to occur most frequently during July because fewer people engage in risk-promoting activities during May and June, when deer tick densities are greatest. Nymphal densities decline greatly by July and are virtually nonexistent in August. Fewer human infections occur during the fall and winter months, although adult ticks, which quest at that time of year, are far more frequently infected than are nymphal ticks. Few people, however, are exposed and those that enter forested sites then are fully clothed. Then too, adult ticks are more readily discovered before they can feed long enough for transmission to occur. Risk of human infection is modified by a complex interaction of the stage-specific activity of vector ticks and human behavior.

Pathogen-infected vector ticks may be more abundant in certain sites than in others and infection far more prevalent than in the case of insect-borne disease. The Lyme disease spirochete, for example, infects 20–40% of deer tick nymphs and 40–70% of adults in northeastern and northcentral USA but rarely infects ticks south of Maryland. Likewise, human infections cluster in space and time mainly in the upper Midwest and Northeast, but also in several sites in California. Elsewhere, the scattered distribution of human cases suggests that infected ticks may be imported, perhaps carried by south-migrating birds. Enzootic transmission implies that both vector and pathogen populations propagate locally. Larval ticks, for example, would outnumber nymphs where transmission is stable; a preponderance of nymphs would imply that the vector population is sustained by importation from some remote enzootic site. In a stable zoonotic focus, the RIR (prevalence of infection in the reservoir and feeding density of vector ticks on those hosts) would be consistent with the EIR (stage-specific density of infected ticks). Stable transmission requires long-term constancy in the incidence of infection in both vector and reservoir populations.

Outbreaks of tick-borne disease may emerge when people encroach upon previously silent transmission foci. In this manner, focused contacts between reservoir hosts and vector ticks may be altered and redirected toward human hosts. The first outbreak of [Rocky Mountain spotted fever](#) erupted, for example, when pioneers cleared land in the Bitterroot Valley of Montana. The result was devastating, nearly preventing this fertile region from developing. [Tick-borne encephalitis](#), likewise, became intensely prevalent when

forestry workers and trappers relocated into undisturbed tracts of Siberian forest. Human disruption of enzootic cycles serves to produce sporadic outbreaks of tick-borne disease.

Environmental change may promote epidemics of tick-borne disease when particular hosts and ticks become extraordinary abundant. Reforestation of previously cultivated land in eastern USA has permitted deer to proliferate, often in close proximity to residential communities. Lyme disease emerged as a significant health problem when deer and their associated tick ectoparasites increased in abundance and expanded in distribution. The first outbreak of →Crimean-Congo hemorrhagic fever occurred when population densities of hares and *Hyalomma marginatum* vectors exploded after hunting was prohibited and fields were abandoned. Massive outbreaks of human infection followed the resulting proliferation of these apparent reservoir hosts. Any disruption in the balance of vertebrate hosts may support an overabundance of vector ticks.

### Example of Lyme Borreliosis

While *Borrelia burgdorferi* is the sole causative agent of human Lyme disease in North America, the etiologic agents in Europe and Asia are more diverse. They include the “genospecies” designated as *B. burgdorferi*, *B. afzelii*, and *B. garinii*. These spirochetal agents of human disease are transmitted by members of the *Ixodes ricinus* complex, including *I. dammini* in eastern North America, *I. pacificus* in western North America, *I. ricinus* in Europe, *I. persulcatus* in eastern Europe and Asia. People become infected mainly via the bites of nymphal ticks, although some infections may be derived from the adult stage of the tick. In certain communities, Lyme disease transmission may be particularly intense. Lyme disease spirochetes may infect as many as 40% of nymphal ticks and virtually all of the rodents. Human seroprevalence may approach 25%, and 5% of residents may become infected each year. Currently, Lyme disease accounts for more than 90% of all reports of vector-borne disease in the USA.

In northeastern USA, the Lyme disease spirochete perpetuates in a cycle involving vector deer ticks (*I. dammini*) and white-footed mouse reservoir hosts (*Peromyscus leucopus*). White-tailed deer (*Odocoileus virginianus*) are not directly involved in the transmission cycle, but play a vital role in maintaining tick densities because they serve as the preferred hosts of the adult stage of the vector tick. Although various other vertebrate hosts may inhabit zoonotic sites and come in contact with vector ticks, white-footed mice provide the main source of spirochetal infection to the nymphal stage of the vector tick. These mice serve as effective

reservoirs because they are locally abundant in zoonotic sites, are the main hosts for the larval and nymphal stages of the vector, are frequently infected in nature, and readily infect vector ticks. Estimates of reservoir capacity suggest that one white-footed mouse infects as many ticks as do 12 chipmunks or 221 meadow voles. Some kinds of passerine birds may also transmit infection to the vector population. The greater mobility of avian hosts diminishes their contribution to local transmission but →aids in dispersing vector ticks and Lyme disease spirochetes to new sites.

The apparent diversity of vector ticks, spirochete variants, and the vertebrate reservoir fauna of western USA renders the →epizootiology of these microbes more complex than in the Northeast. Although *I. pacificus* serves as the principle vector to people in this region, relatively few harbor Lyme disease spirochetes. The diversity and abundance of noncompetent hosts in western USA appear to contribute to low infection rates in *I. pacificus*. *I. neotomae*, in contrast, narrowly focuses its feeding on wood rats and kangaroo rats and may effectively maintain Lyme disease spirochetes in an enzootic cycle involving these hosts. Lyme disease spirochetes may perpetuate in this *I. neotomae*-wood rat cycle and occasionally infect the *I. pacificus* population. It is not clear, however, whether wood rats and kangaroo rats represent the main source of spirochetal infection within the *I. pacificus* population.

The force of transmission of the agent of Lyme disease in western Europe tends to be weaker than in northeastern North America. European *I. ricinus* ticks transmit these microbes less efficiently than do their North American counterpart, *I. dammini*, because each trophic stage feeds most frequently on different kinds of hosts. Larvae tend to parasitize rodents, and nymphs to feed on medium-sized mammals, birds, and lizards. Adults feed mainly on deer or sheep. So few of these rodents are parasitized by nymphs that the EIR may be limited. Nevertheless, certain kinds of rodents harbor sufficient infectious nymphs to ensure perpetuation of the pathogen. Edible door mice (*Glis glis*) and black-striped mice (*Apodemus agarius*) serve as particularly efficient reservoirs because they are frequently infested by both the infectious and pathogen-acquiring stages of the wood tick. Norway rats (*Rattus norvegicus*), too, may support transmission of the Lyme disease agent in particular urban sites. Because shrews and voles are far more abundant than mice in Sweden, these small mammals may perpetuate the life cycle in certain Scandinavian sites. The relative importance of each kind of vertebrate host as a reservoir of infection differs according to local conditions.

In eastern Asia, Lyme disease spirochetes appear to circulate in a cycle involving the taiga tick (*I. persulcatus*) and rodents of the genera *Clethrionomys*

and *Apodemus*. To date, solely *B. garinii* and *B. afzelii* have been isolated from tick vectors and rodent hosts inhabiting these regions. The bank vole (*Clethrionomys glareolus*) predominates in western Russia, whereas *C. rufocanus*, *C. rutilus*, and *Apodemus peninsulae* dominate further to the east. Although numerous →*Borrelia* isolates have been derived from these hosts, their relative contribution to infecting the tick population by →*xenodiagnosis* remains uncertain.

### Co-infecting Pathogens

Although public attention has focused on Lyme disease, *Ixodes* ticks may transmit numerous other agents of human disease. Human babesiosis, a malaria-like illness, is caused by the protozoan parasites *Babesia microti* in North America and *B. divergens* in Europe. Signs of this illness become evident mainly among elderly or immunocompromised subjects and may be fatal if not treated promptly. Viruses of the tick-borne encephalitis complex induce a potentially fatal form of →*encephalitis* endemic to Europe and Asia. More recently, a new member of this viral complex was discovered in North America; transmission was attributed to deer ticks. Finally, 2 closely-related pathogens (*Ehrlichia phagocytophila* and *E. equi* in eastern and western North America, respectively) were recently implicated as agents of human disease. These rickettsial pathogens infect leukocytes, and human cases may also terminate fatally. The diverse array of pathogens transmitted by *Ixodes* ticks, thereby, severely burdens human health.

In northeastern USA, the agents of Lyme disease, human babesiosis, and human granulocytic ehrlichiosis perpetuate mainly in a cycle involving white-footed mice. Vector ticks, thereby, tend to acquire more than one of these microbes from reservoir rodents. This implies that individual human hosts tend to be vulnerable to coinfection. Serological surveys indicate that 10–60% of Lyme disease patients had been coinfecting by *B. microti*. Interestingly, these pathogens tend to synergize in human hosts such that the resulting illness is more severe than would be anticipated as the sum of symptoms produced by each pathogen. More symptoms are experienced, and the duration of illness is prolonged. The particularly severe manifestations of *Ixodes*-borne disease that occur in certain enzootic sites may reflect a peculiar combination of coinfecting pathogens.

### Antivector Interventions

Once established, local transmission cycles of tick-borne zoonoses tend to persist in the face of public health interventions. Various interventions, however,

have been devised, and few of them appear promising. The following discussion describes selected strategies designed to reduce the public health burden presented by vector ticks.

Individual residents of enzootic sites may practice preventive measures that effectively reduce their risk of infection by tick-borne pathogens. They should: (1) avoid tick-infested habitats whenever feasible; (2) wear light-colored trousers with cuffs that are tucked into their socks; (3) apply tick-repellent containing DEET to exposed parts of their skin and permethrin to their clothing; (4) periodically examine the surface of their clothing and skin and remove any ticks that have attached using fine tipped forceps. Prompt removal of attached ticks generally aborts transmission because transmission of many of these infections tends to require extended periods of host attachment. The arboviral agents may constitute an exception. Although the efficacy of these measures has not systematically been evaluated, they appear to provide an important degree of protection against tick-borne disease.

Depriving ticks of access to their main vertebrate hosts may effectively reduce the density of ticks. This intervention strategy, however, is practical solely in sites that such hosts would not rapidly reinvade. Deer inhabiting a study site on Great Island, MA were virtually eliminated, which resulted in decreased abundance of deer ticks. Host reduction proved to be effective largely because the relative isolation of the site restricted the movements of deer. Similar efforts on the mainland proved to be impractical and excessively costly. Thousands of small rodents, for example, were destroyed in Montana in order to suppress the density of American wood ticks (*Dermacentor andersoni*), the vectors of the agent of Rocky Mountain spotted fever. Any gains were transient, however, because wood ticks from nearby undisturbed sites rapidly reinvaded the intervention site. Antitick measures based on the removal of their vertebrate hosts require that the site be isolated in order to limit immigration from adjacent sites.

Although broad-scale applications of acaricides may destroy numerous ticks, environmental damage tends to result. Acaricidal applications focused around residential sites may alleviate the immediate tick burden. Residual pesticides such as carbaryl, chlorpyrifos, and diazinon temporarily render such sites virtually tick-free. Less toxic materials, containing pyrethroids, may also reduce tick density. These products, however, lack long-term residual activity and require at least monthly application to maintain satisfactory freedom from ticks. Regardless of the kind of acaricidal compound that is applied, pesticide resistance should always be anticipated. Intensive and extensive applications of killing chemicals can only be



temporary. Loss of acaricide susceptibility renders acaricidal interventions inherently unsustainable.

Innovative strategies have been developed for delivering acaricides directly to the hosts of vector ticks. Various self-medicating devices for destroying ticks on deer or other ungulates are in various stages of development and evaluation. In general, such devices deliver acaricide from a dispenser that the animal contacts when feeding on a bait contained within. Another host-targeted strategy distributes grain impregnated with systemic acaricides, such as ivermectin. When deer are the targets of such interventions, they must be habituated to the bait-station, and this requires delivery of large quantities of grain, frequently a maize-molasses mixture. This has the undesirable side effect of promoting the density of various rodents as well as the targeted deer, themselves. A cotton-baited acaricidal formulation has been implemented to target rodent hosts such as the white-footed mouse in eastern North America. This method is designed to reduce the force of transmission of *Ixodes*-borne pathogens by eliminating those ticks that feed on the rodent reservoirs. Host-targeted acaricidal formulations are attractive because they limit any environmental damage that might be induced by these biologically active chemicals.

Ticks are vulnerable to destruction by various parasitic or predatory organisms. Although certain *Dermacentor* and [→Amblyomma](#) ticks secrete a pheromone that deters attack by ants, *Ixodes* lack such protection against predation. To the extent that fire ants are important predators of these ticks, their presence might benefit public health. A chalcid wasp (*Hunterella hookeri*) frequently parasitizes larval *Ixodes* ticks in northeastern North America and Europe and destroys them in their nymphal stage. Although these wasps infect as many as a third of the nymphal deer ticks in eastern North America where Lyme disease is enzootic, none infect spirochete- or *B. microti*-infected ticks. Efforts to use these wasps to reduce risk of Lyme disease, therefore, would fail. Certainly, tick densities seem unaffected in the face of this natural burden. The applicability of bio-control efforts against vector ticks remains speculative.

The density of vector ticks may be reduced by removing understory vegetation and leaf litter, either mechanically, chemically, or by fire. Where few buildings are present, the undergrowth or ground cover that shelters ticks is most readily destroyed by burning. In a Massachusetts site, burning and mowing reduced deer tick densities by as much as 80%. Similar efforts in Tennessee greatly reduced the density of Lone Star ticks. Safety considerations, however, limit the wide-scale application of this measure. Limited areas such as along a road, may be mowed, and this would seem to protect people from contact with ticks. The efficacy of this measure, however, remains ill-defined. Routine

herbicide applications are poorly tolerated by many people and may excessively harm the environment. While vegetation management provides effective protection against ticks, it must be reapplied on a yearly basis.

---

## Tilbroquinol

→[Malariacidal Drugs](#).

---

## Tinidazole

→[Antidiarrhoeal and Antitrichomoniasis Drugs](#), →[Giardia](#).

---

## Tiphia popillivora

Parasitic wasp, →[Polyembryony](#), →[Biological Control](#).

---

## Tissue Anoxia

→[Pathology](#).

---

## Tissue Cyst

The species of the protozoan genera →[Toxoplasma](#), →[Sarcocystis](#), →[Globidium](#), →[Hammondia](#), →[Cystoisospora](#), →[Frenkelia](#), →[Besnoitia](#), →[Caryospora](#) and the nematode →[Trichinella spiralis](#) form intracellularly situated cysts within different tissues of their hosts. While the *T. spiralis* larva is always situated directly in the →[cytoplasm](#) of its host cell (muscle fiber), the protozoan cysts are always surrounded by a →[primary cyst wall](#), which derives from the original membrane of the →[parasitophorous vacuole](#) (Figs. 1–4, page 1415–1418). In some cases the parasitized host cell (e.g., →[Besnoitia](#) species, →[Globidium](#) species, →[Sarcocystis ovifelis](#)) is covered (along its outer surface) by host cell material. This layer is called →[secondary cyst wall](#). In trichines such a secondary cyst

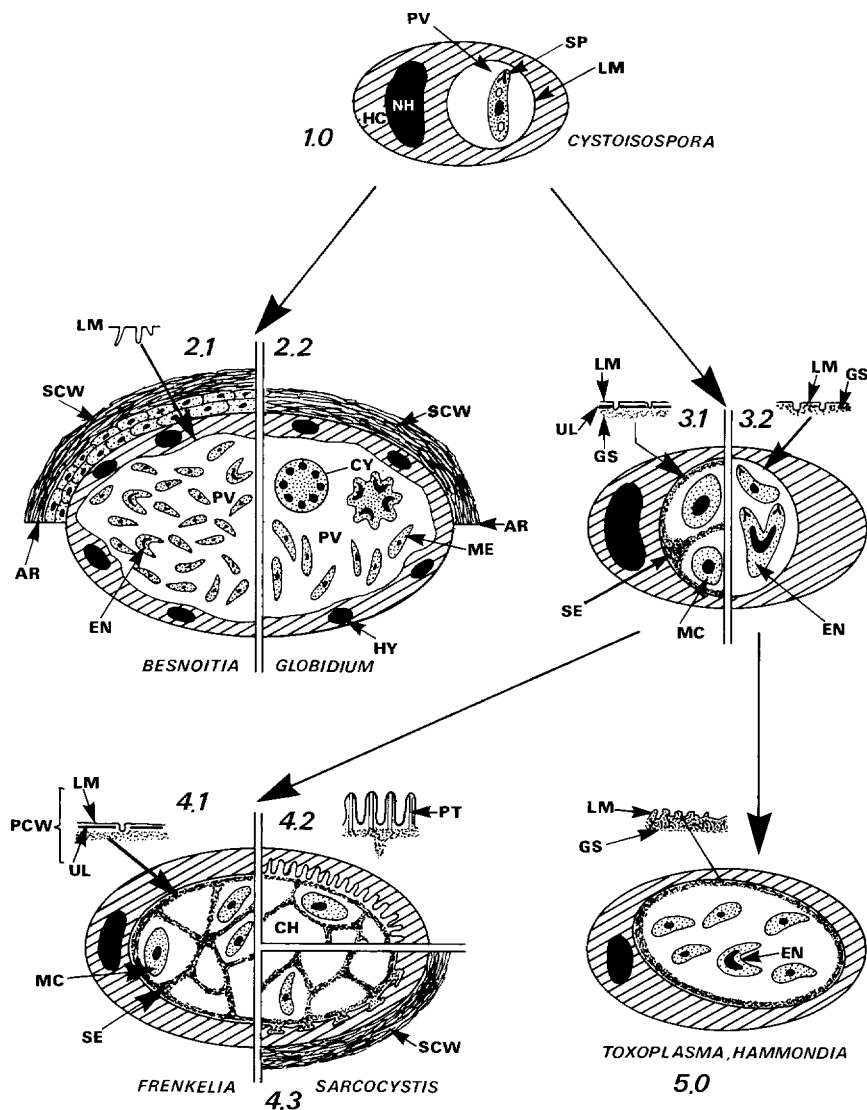

**Tissue Cyst. Figure 1** DR of cysts in different cyst-forming  $\rightarrow$ coccidia. 1 The simplest cyst formation. A parasite  $\rightarrow$ (sporozoite) is included into a  $\rightarrow$ parasitophorous vacuole (PV) which is bounded by a single  $\rightarrow$ cell membrane (LM). This is representative of the monozoic cysts of *Cystoisospora felis*, *C. rivolta*, and *C. ohioensis* in transport (i. e., *paratenic*) hosts (such as mice). 2 In  $\rightarrow$ *Besnoitia* spp. (2.1) and  $\rightarrow$ *Globidium* spp. (2.2) cysts the original parasitophorous vacuole (PV) is enlarged and is filled by numerous parasites reproducing by  $\rightarrow$ endodyogeny (2.1) or  $\rightarrow$ schizogony (2.2). Even in old cysts the PV is bounded by a single unthickened cell membrane (LM). A secondary cyst wall (SCW) consisting of fibrillar material is always present; the host cell nuclei generally undergo hypertrophy and  $\rightarrow$ hyperplasia. 3 Young cysts of  $\rightarrow$ *Frenkelia* spp. and  $\rightarrow$ *Sarcocystis* spp. (3.1), and *Toxoplasma* spp. and *Hammondia* spp. (3.2) show the indicated features. In cysts of *Frenkelia* spp. and *Sarcocystis* spp. (3.1) spherical  $\rightarrow$ merocytes (MC) are present (in chamberlike spaces) and divide by endodyogeny, whereas in  $\rightarrow$ *Toxoplasma gondii* and *Hammondia* spp. the slender parasites divide by endodyogeny. 4 Mature tissue cysts of *Frenkelia* and *Sarcocystis* are characterized by typical septa (SE) formed by the ground substance (GS). In *Frenkelia* spp. and some *Sarcocystis* spp. (4.1) the  $\rightarrow$ primary cyst wall (PCW) never forms long protrusions, whereas in other *Sarcocystis* spp. typical protrusions occur (4.2; 4.3). With cysts of *S. ovifelis*, a secondary cyst wall (ECU) surrounds the parasitized muscle fiber (4.3). 5 The primary cyst wall of mature *T. gondii* and *Hammondia* spp. cysts remains smooth; the cysts are tightly filled with cyst merozoites (bradyzoites). Typical septa as well as merocytes never occur. AR, Artificially interrupted SCW; CH, chamber-like space filled with parasites; CY  $\rightarrow$ cytome; EN, endodyogeny; GS, ground substance; HC, host cell; HY, hypertrophic host cell nuclei; LM, limiting single membrane of PV; MC, merocyte; ME,  $\rightarrow$ merozoite; N, nucleus; NH, nucleus of host cell; PCW, primary cyst wall; PT, protrusion of PCW; PK, parasitophorous vacuole; SCW, secondary cyst wall; SE, septum formed by GS; SP, sporozoite; UL, underlying dense material. (From Mehlhorn and Frenkel 1980)

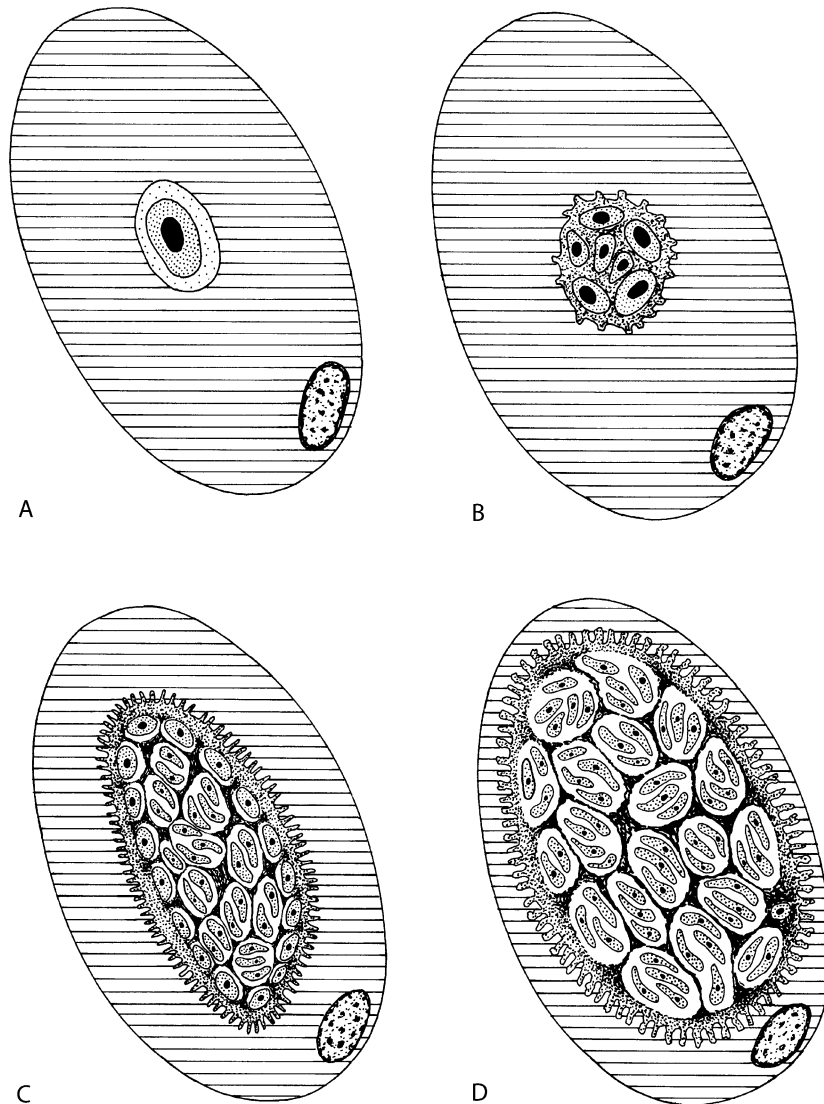

**Tissue Cyst. Figure 2** DR of the development of a tissue cyst of *Sarcocystis bovihominis* (cycle man-cattle) in the muscle fiber of a calve in four steps (A–D). The just penetrated parasite lies in a parasitophorous vacuole (A), the surface of which is transformed to the primary cyst wall with long protrusions. Inside the cyst the parasites divide by endodyogony within chamber-like hollows of the ground substance.

wall may also be formed by defense cells of the host and may later introduce the calcification of the muscle fiber containing the worm larva. The stages inside the protozoan tissue-cysts are called →bradyzoites (due to their slow division rate). They survive for years at a reduced metabolism and remain infectious (→*Toxoplasma gondii*).

## TMAF

Trypanosomal macrophage activating factor.

## TLTF

Trypanosome-derived lymphocyte triggering factor.

## TMN

Tubular membranous network.

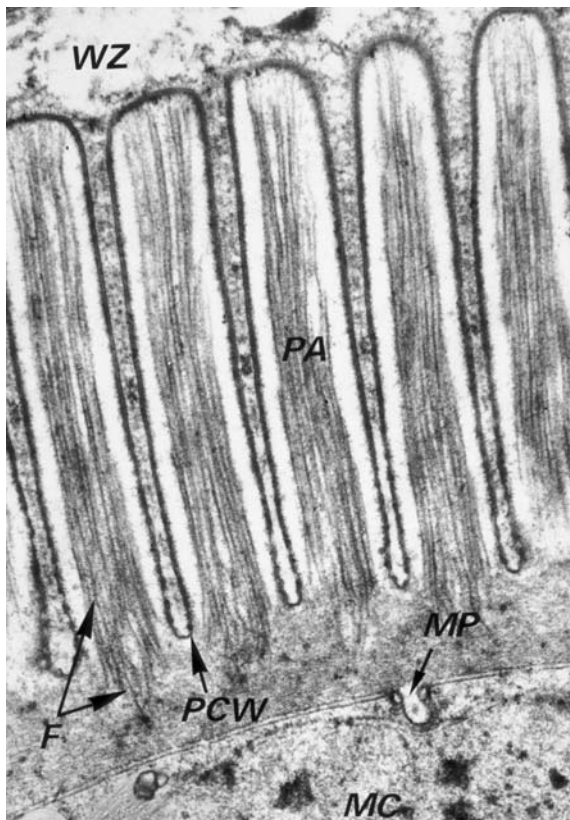

**Tissue Cyst.** Figure 3 LM of a thick-walled sarcocyst of *S. ovicanis* (due to protruding foldings of the primary cyst wall); note the presence of parasites-containing chambers inside. *F*, filaments; *MC*, cyst merozoite; *MP*, micropore of the parasitic stage (cyst merozoite); *PA*, palisade-like protrusion of the tissue cyst; *PCW*, primary cyst wall; *WZ*, host cell.

## TNF

→Tumor Necrosis Factor.

## Togaviridae

### Classification

Family of viruses containing the genus Alphavirus which are transmitted by arthropods (→Arboviruses).

### General Information

Positive-sense single-stranded →RNA viruses (spherical, with envelope); about 30 species.

## Important Species

Table 1 (page 1419).

## Toltrazuril

→Coccidiocidal drugs, also efficacious against several other parasites of ornamental fish.

## Tomit

Other name for →theront of →*Ichthyophthirius*.

## Top Ten of Human Parasites

According to WHO (<http://www.who.int>) →*Ascaris*, →hookworms, →malaria agents, →*Trichuris*, →amoebae, filarial worms, schistosomes, *Giardia*, trypanosomes, and →*Leishmania* are the 10 most important agents in human diseases, together causing more death than anything else apart from HIV/AIDS and tuberculosis (<http://www.jama.com>). Some other worms (e.g., →*Enterobius vermicularis*) are as numerous but not as pathogenic. One in 10 humans on this earth suffers from one or more of these major tropical diseases.

## Tosylchloramide

Drug used in medical bath for fish.

## Toxaphene

### Chemical Class

Organohalogenide.

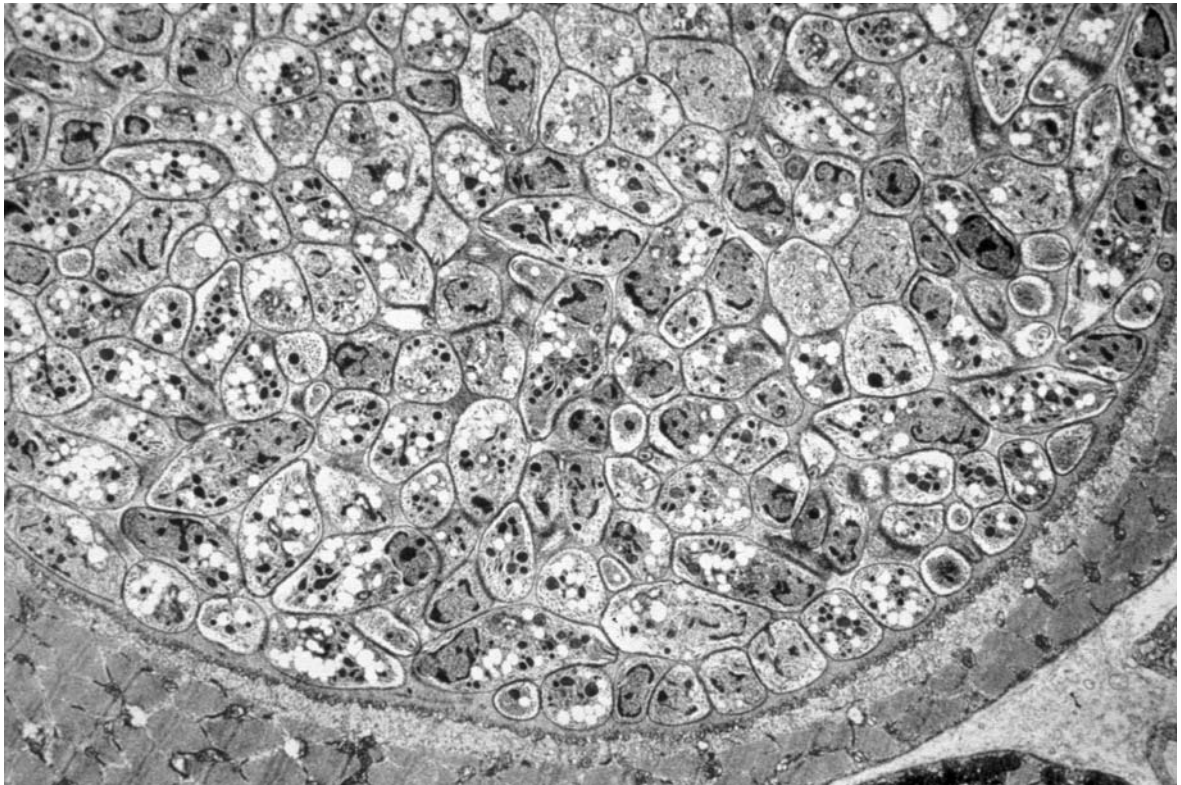

**Tissue Cyst. Figure 4** LM of a thin-walled cyst of *Hammondia hammondi*. The primary cyst wall is smooth and has no protrusions; there is not subdivision inside.

### Mode of Action

GABA-gated chloride channel antagonist. → [Ectoparasiticides – Antagonists and Modulators of Chloride Channels](#).

## Toxascaris leonina

### Name

Greek: *toxon* = crescent-shaped, *ascaris* = intestinal worm, *leon* = lion.

*T. leonina* occurs with a low host specificity in many canids and felids, reaches as females, 10 cm or males, 7 cm and is characterized by very long and small cervical wings ([Fig. 1](#), page 1420). The development is direct without a wandering phase inside the host after oral uptake of larva-containing eggs.

## Toxicosis

→ [Tick Bites: Effects in Animals](#), → [Tick Bites: Effects in Humans](#).

## Toxocara

### Name

Greek: *toxon* = halfmoon-/crescent-shaped, *kara* = head, protrusion.

### Classification

Genus of ascarid → [nematodes of carnivores](#).

### Important Species

[Table 1](#) (page 1420), [Figs. 2–5](#) (pages 1422, 1423).

### Life Cycle

[Fig. 1](#) (page 1421).

### Disease

→ [Toxocariasis, Man](#), → [Toxocarosis, Animals](#), → [Visceral Larva Migrans, Man](#).

**Togaviridae. Table 1** Arboviruses X. Positive sense, single-stranded RNA viruses: Family Togaviridae, genus *Alphavirus*

Serocomplex (no. of known members)	Species (selected)	Arthropod host	(Main) vertebrate hosts	Distribution	Disease in man	Disease in animals
Barmah Forest (2)	Barmah Forest	Culicidae ( <i>Culex</i> , <i>Aedes</i> )	Marsupials	Australia	Fever, arthritis	
	Eastern Equine Encephalitis	Culicidae ( <i>Culiseta</i> , <i>Aedes</i> , <i>Coquillettia</i> )	Birds	North America, South America	Eastern Equine Encephalitis	Encephalitis in horses, birds
Middelburg (1)	Middelburg	Culicidae ( <i>Aedes</i> )	Cattle, horse	Africa		
Ndumu (1)	Ndumu	Culicidae ( <i>Mansonia</i> , <i>Aedes</i> )	Cattle (?)	Africa		Abortion in cattle (?)
Semliki Forest (8)	Semliki Forest	Culicidae ( <i>Aedes</i> , <i>Culex</i> , <i>Anopheles</i> )	Birds, monkeys (?), man (?)	Africa	Fever, encephalitis	
	Chikungunya	Culicidae ( <i>Aedes</i> , <i>Mansonia</i> )	<b>Man</b>	Africa, Asia	Chikungunya Fever	
	O'nyong nyong	Culicidae ( <i>Anopheles</i> )	<b>Man</b>	Africa	O'nyong nyong Fever	
	Getah	Culicidae ( <i>Aedes</i> , <i>Culex</i> , <i>Anopheles</i> )	Horse, pig (?)	Asia, Australia		Encephalitis in horses
	Ross River	Culicidae ( <i>Aedes</i> , <i>Culex</i> , <i>Mansonia</i> )	Marsupials	Australia, South Pacific	Epidemic Polyarthritis (fever, arthritis)	
	Mayaro	Culicidae ( <i>Haemagogus</i> , <i>Aedes</i> )	Monkeys, <b>man</b> (?), birds (?)	Brazil, Trinidad, French Guyana, Bolivia, Peru, Colombia, Panama	Fever	
Venezuelan Equine Encephalitis (8)	Venezuelan Equine Encephalitis	Culicidae ( <i>Culex</i> , <i>Anopheles</i> , <i>Aedes</i> , <i>Psorophora</i> )	Rodents	North America, Central America, South America	Venezuelan Equine Encephalitis	Encephalitis in horses
	Everglades	Culicidae ( <i>Culex</i> , <i>Aedes</i> , <i>Anopheles</i> )	Marsupials	USA (Florida)	Fever, encephalitis	
	Mucambo	Culicidae ( <i>Culex</i> , <i>Aedes</i> , <i>Mansonia</i> , <i>Haemagogus</i> , <i>Wyeomyia</i> , <i>Sabethes</i> )	Rodents	Brazil, Trinidad, Surinam, French Guyana, Peru	Fever	
	Tonate	Culicidae ( <i>Culex</i> , <i>Anopheles</i> , <i>Mansonia</i> , <i>Coquillettia</i> , <i>Wyeomyia</i> )	Rodents	Brazil, French Guyana, Surinam	Fever, encephalitis	
	Pixuna	Culicidae ( <i>Anopheles</i> )	Rodents	Brazil	Fever	
	Rio Negro	Culicidae ( <i>Culex</i> )	Rodents	Argentina	Fever	
Western Equine Encephalitis (9)	Western Equine Encephalitis	Culicidae ( <i>Culex</i> , <i>Aedes</i> , <i>Anopheles</i> , <i>Psorophora</i> , <i>Culiseta</i> )	Birds	North America, South America	Western Equine Encephalitis	Encephalitis in horses, birds
	Sindbis	Culicidae ( <i>Culex</i> , <i>Aedes</i> , <i>Anopheles</i> )	Birds	Europe, Africa, Asia, Australia	Sindbis Fever, (fever, arthritis)	
	Ockelbo	Culicidae ( <i>Culex</i> , <i>Culiseta</i> , <i>Aedes</i> )	Birds	Sweden, Finland, Russia	Ockelbo Disease, Karelian Fever, Pogosta Disease (fever, arthritis)	



**Toxascaris leonina.** Figure 1 SEM of the anterior end with cervical wing longer than those of *T. canis*.

inside the infectious larva 3. After oral uptake this larva wanders via liver, heart, lung, and trachea finally again into the small intestine, where maturity is reached 27–35 days after infection. Females may infect their puppies inside the uterus or via milk. In case humans swallow infectious eggs, a →larva migrans interna-syndrom may occur. Infected puppies may suffer from swollen belly when heavily infected (Fig. 1, page 1424).

### Diseases

→Alimentary System Diseases, Carnivores, →Nervous System Diseases, Swine.

## Toxocara cati

### Synonym

*T. mystax*.

This is the ascarid worm of cats (females, 10 cm; males, 6 cm). Its cervical wings are rather wide and striped (→*Toxocara*/Fig. 4). The development includes a wandering phase as in *T. canis*. Larvae may also induce in humans the symptoms of →larva migrans interna.

## Toxocara canis

This ascarid worm of dogs occurs worldwide, reaches as adults a size of 10–12 cm as male or 12–18 cm as female, and is characterized by apical cervical wings (→*Toxocara*/Fig. 4). The adult worms are found in the small intestine, where the females excrete the 75–90 μm eggs (→*Toxocara*/Fig. 5), which develop within 2 weeks

## Toxocariasis, Man

### Synonym

→Visceral Larva Migrans (VLM). See →*Toxocara*.

### Therapy

→Nematocidal Drugs, Man.

**Toxocara.** Table 1 Important species of the genus *Toxocara*

Species	Length of adult worms (μm)		Size of eggs (or larvae) (μm)	Final host/Habitat	Intermediate host	Prepatent period in final host (weeks)
	f	m				
<i>Toxocara canis</i>	120–180	100–120	90 × 75	Dogs/Small intestine	Mice	4
<i>T. cati</i> / <i>T. mystax</i>	100	60	75 × 70	Cats/Small intestine	Mice	8
<i>T. vitulorum</i>	210–270	150–250	69–93 × 62–77	Cattle/Small intestine	–	3

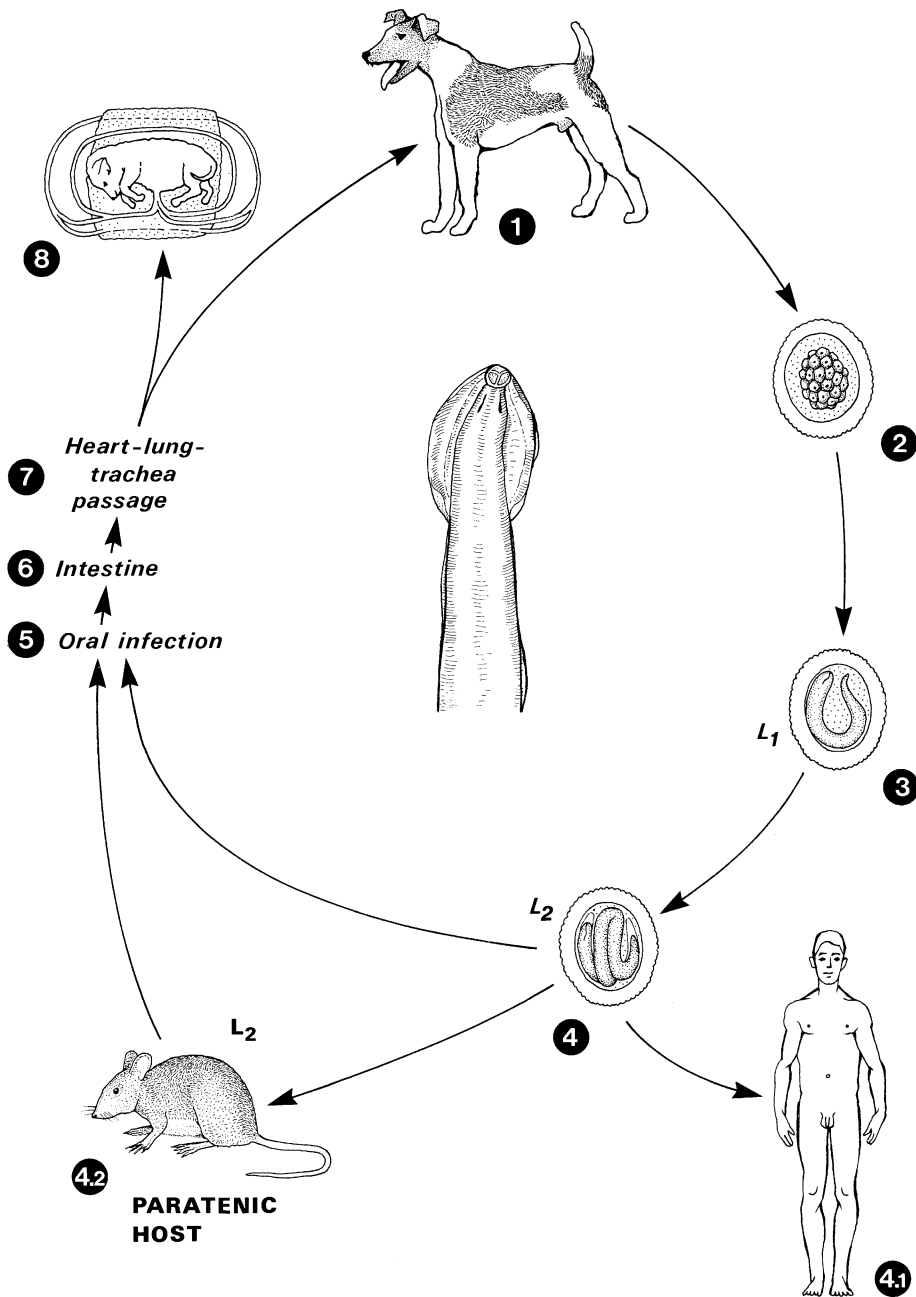

**Toxocara. Figure 1** Life cycle of *Toxocara canis* (*T. cati* is similar except for 8). 1, 2 Adults (*→Nematodes/*Table 1), which are characterized by species-specific lips and by typical cervical *→alae* (center), live in the small intestine of their hosts, producing large numbers of eggs which are passed unembryonated (2) with the host's feces. The eggs are characterized by a relatively thick shell which is provided with a mammilated surface. 3, 4 The first and second larval stages are formed within the *→eggshell* under favorable conditions. 4.1, 4.2 If humans, inadequate hosts (4.2), or even immune dogs swallow such eggs, the L<sub>2</sub> hatch from the eggs in the intestine, penetrate through the intestinal wall, and migrate through the body (*larva migrans visceralis*), but there is no further development. Such larvae may become included in *→granulomes* and remain infective to final hosts (5) for a long time. 5–8 When nonimmune final hosts swallow the eggs (4), the L<sub>2</sub> hatches from the egg inside the intestine, penetrates the intestinal wall, and is transported via the bloodstream to the liver and lung, where it molts to L<sub>3</sub> and L<sub>4</sub>. The L<sub>4</sub> finally reaches, via the trachea, the intestine and matures. If the host is provided with a low immunity, the larvae do not complete the lung migration, but wander through the body and remain "dormant" for a long period. During pregnancy the dormant larvae are activated (8) by host hormones, reenter the circulatory system, are carried to the placenta, and penetrate into the fetus, which thus becomes prenatally infected. Infections from the mother's milk are also common.





**Toxocara.** Figure 2 Adult *Toxocara canis*-worms in the intestine of a dog.

## Toxocarosis, Animals

→[Toxocara](#), →[Alimentary System Diseases, Animals](#).

## Toxonemes

Former name for the →[micronemes](#) (→[Coccidia](#)) of →[Toxoplasma gondii](#).

## Toxoplasma gondii

### Name

Greek: *toxon* = halfmoon-shaped, *plasma* = formed structure, describes the 6–7  $\mu\text{m}$  long tachyzoites.

### Classification

Species of →[Coccidia](#).



**Toxocara.** Figure 3 LM of a bundle of adult worms (*Toxocara canis*).

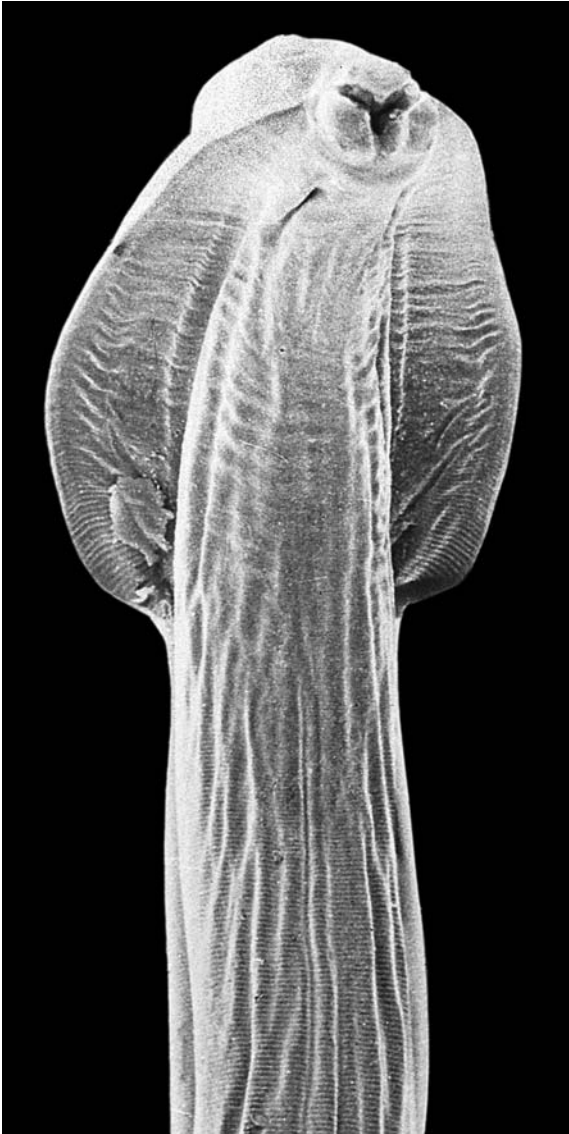

**Toxocara. Figure 4** SEM of the anterior end with short cervical wings (= alae), *T. canis*.

### Life Cycle

→ [Fig. 1](#) (page 1425).

### Morphology

→ [Tachyzoites](#) ([Fig. 2](#), page 1426), → [Tissue-Cyst](#) ([Fig. 3](#), page 1426), → [Oocyst](#) ([Figs. 4, 5](#), pages 1426, 1427), → [Apicomplexa](#).

### Disease

→ [Toxoplasmosis, Animals](#), → [Toxoplasmosis, Man](#).



**Toxocara. Figure 5** Egg of *Toxocara canis* containing a larva.

## Toxoplasmosis, Animals

→ [Nervous System Diseases, Carnivores](#), → [Nervous System Diseases, Ruminants](#), → [Nervous System Diseases, Swine](#).

## Toxoplasmosis, Man

### Pathology

Ignored for a long time, human toxoplasmosis was universally recognized as a genuine toxoplasmic disease only 50 years ago while the *Toxoplasma* parasite was first identified at the beginning of the century. Not being highly virulent, → [Toxoplasma gondii](#) is indeed a typical parasite which is found worldwide and often at very high prevalence. About half of the human population are asymptomatic carriers. The rapid multiplication of the invading → [tachyzoite](#) stage, leads



**Toxocara canis.** Figure 1 Swollen belly of an infected young dog. (courtesy of the late Professor Stoye)

to a mild to subclinical phase. Recovery is associated with parasite sequestration into →cysts containing →bradyzoites located particularly within skeletal and heart muscle and in the central nervous system and remaining latent for life.

Infection originates from infected house cats (the definitive = final host) excreting oocysts in their feces or from undercooked meat with bradyzoites in tissue-cysts. Indeed, *T. gondii* infection is also widespread in farm animals in particular, goat, sheep, and pigs and causes large financial losses in Australia, New Zealand, and England (→Toxoplasmosis, Animals).

In man *T. gondii* disseminates from the site of entry via the bloodstream and the lymphatics to involve many tissues. The sites and character of lesions depend on the vascular supply of the tissue and the regenerative ability of the host cells. →Tachyzoites proliferate approximately until immunity develops, at which time more slowly multiplying bradyzoites develop in tissue-cysts. These cysts are common in the brain, skeletal and heart muscle, and sometimes the retina. The cysts persist for months or years, in a biological sense waiting to be eaten by a cat; hence a chronic latent infection persists, and we have an infection immunity rather than a sterile immunity. The intact cysts are not chemotactic

(→Pathology/Fig. 5A,B). However, leaking or ruptured cyst; elicit →necrosis and an →inflammatory reaction, interpreted as manifestations of →hypersensitivity. The inflammatory reaction is mixed, involving neutrophils, lymphocytes, and macrophages, followed by fibrosis, and in the brain gliosis.

Two stages are distinguished in tissues: →tachyzoites and →bradyzoites. The tachyzoites multiply rapidly, destroying the cells they parasitize, giving rise to diffuse lesions, as in connective tissue or lungs, or to focal lesions, as in the liver and brain (→Pathology/Fig. 10). Tachyzoites destroying cells during acute toxoplasmosis lead to interstitial →pneumonia, hepatitis, →encephalitis, and myocarditis. A maculopapular rash may develop from small foci of *T. gondii* multiplying in the dermis. Many tissues may be only microscopically involved, and clinical symptoms do not draw attention to all of them. Lymphocytes and macrophages are the main inflammatory cells, with an admixture and neutrophils. When blood vessels are involved in the brain infarcts may result.

As already mentioned, individuals develop a non-sterilizing immunity with indefinitely latent infection when infected postnatally. This immunity is congenitally transferred to the fetus if acquired before pregnancy.

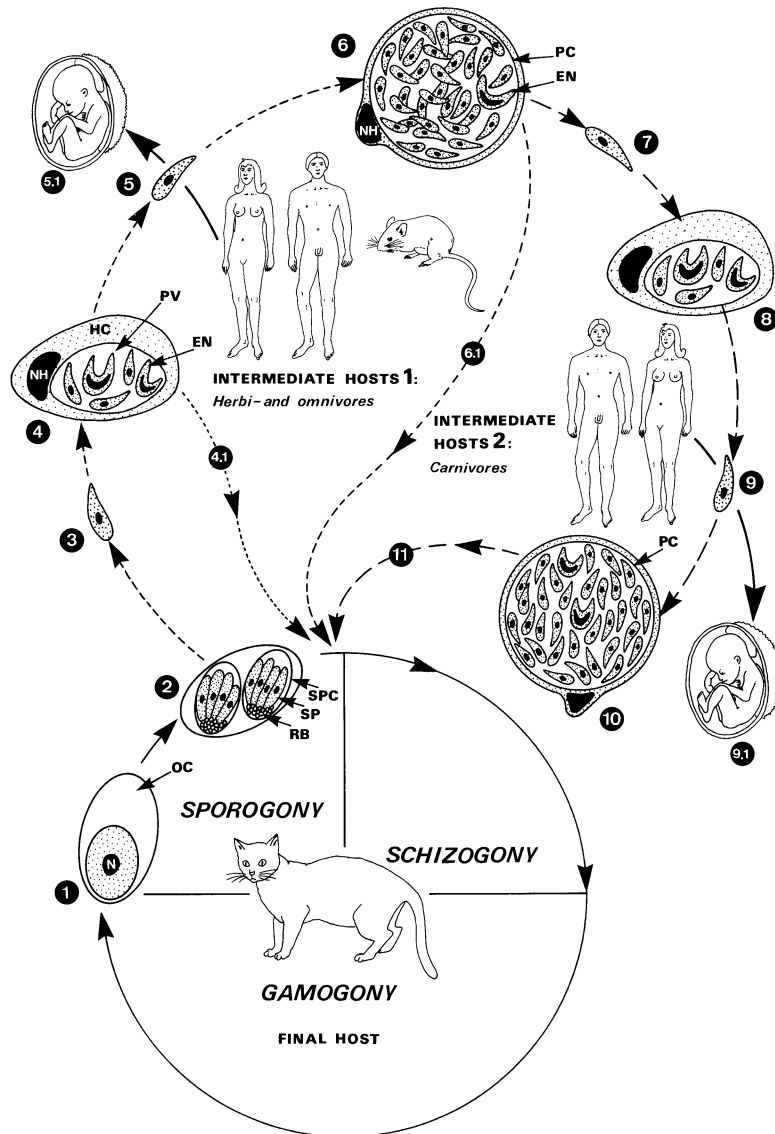

**Toxoplasma gondii.** Figure 1 Life cycle and transmission pathways of *Toxoplasma gondii*. The typical coccidian life cycle proceeds in the intestinal epithelium of felids (final host) which are infected by oral uptake of sporulated oocysts (2), ingestion of “pseudocysts” (4.1; 8) or tissue-cysts (6.1; 11) with meat of various intermediate hosts (of 2 types). 1 Unsporulated oocysts are excreted with feces. 2 → Sporulation (i.e., formation of sporocysts and sporozoites) occurs outside the final host. These stages may become spread by transport hosts such as flies and cockroaches. 3 After ingestion of oocysts by intermediate hosts of type 1, the sporozoites are set free inside its intestine and penetrate numerous types of extraintestinal cells (i.e., cells of the RES). 4 Inside the host cell the parasites reproduce by a typical → binary fission (→ Endodyogeny) leading to “pseudocysts” which are filled with merozoites (i.e., → Tachyzoites). 4.1 After ingestion of such → pseudocysts, cats may become infected. 5 Free → merozoite (tachyzoite) in blood or lymph fluid after bursting of a pseudocyst. 5.1 When the first infection is in pregnant women (or animals), these merozoites may pass into the placenta and infect the fetus, leading to severe damage. 6 Formation of → tissue-cyst, mainly inside brain and muscle cells. After several endodyogenies these cysts (waiting stages) contain numerous cyst merozoites (→ Bradyzoites, → Cystozoites) which are infectious for cats (6.1). 7–10 When carnivorous animals or man (intermediate hosts of type 2) ingest such tissue-cysts with raw or insufficiently cooked meat, reproduction (see 3–6) via → pseudocysts is repeated, leading to the same tissue-cysts (10) as in intermediate hosts of type 1. Diaplacental transmission (9.1) may also occur (see 5.1), leading to congenital toxoplasmosis. 11 Cats may also become infected by ingestion of → Tissue-cysts from type 2 intermediate hosts. Then they pass oocysts after 3–5 days, whereas this prepatent period is longer after inoculation of pseudocysts (9–11 days) or oocysts (21–24 days). EN, division by → endodyogeny; HC, host cell; N, nucleus; NH, nucleus of host cell; OC, → oocyst; PC, → primary cyst wall; PV, → parasitophorous vacuole; RB, residual body; SP, → sporozoite; SPC, → sporocyst (for related species see → Coccidia/Table 5).

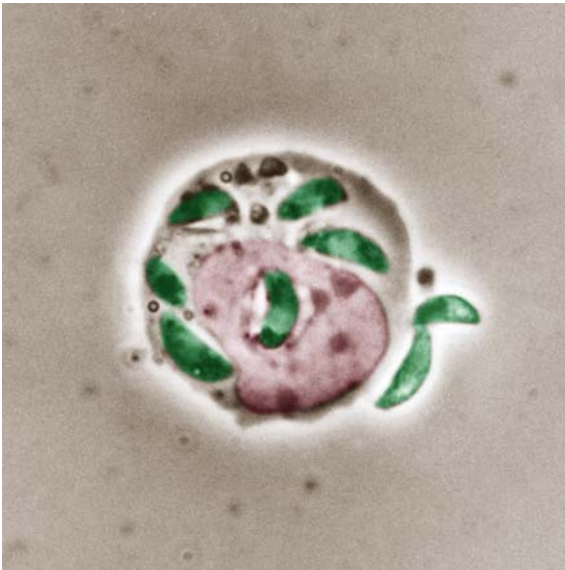

**Toxoplasma gondii.** Figure 2 LM of tachyzoites of *T. gondii* (they develop by endodyogeny in macrophages).



**Toxoplasma gondii.** Figure 4 LM of an unsporulated oocyst.

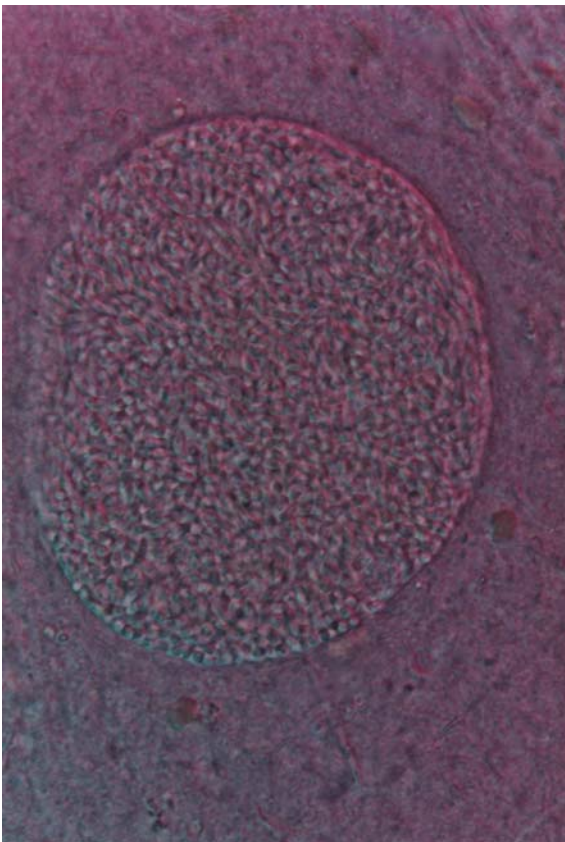

**Toxoplasma gondii.** Figure 3 LM of a tissue-cyst (filled with bradyzoites).

However, at the occasion of an intercurrent infection or modification of the host immunocompetence, slight such as pregnancy or more profound such as malignancies, organ transplants, or the acquired immune deficiency syndrome ( $\rightarrow$  **AIDS**), mid-syndrome to severe life-threatening pathologies can be observed. Notably, when a primary infection is contracted by pregnant women, congenital infection can lead to  $\rightarrow$  **abortion** or neurological sequels and ocular disorders in the fetus. While fetal death and abortion have been attributed to rapidly dividing tachyzoites, the CNS lesions and chorioretinitis in congenital infection or transplant or AIDS patients are caused directly by the cysts containing **bradyzoites** or by reactivation of this so-called dormant stage. The emergence of toxoplasmosis as a major opportunistic infection in AIDS leading to toxoplasmic encephalitis, in up to 48% of the AIDS patients in areas where  $\rightarrow$  *T. gondii* is highly prevalent, has considerably stimulated interest in the past decade. Numerous scientists from all the fields of the biology have taken up the challenge and have begun to study various aspects of the host-parasite relationship. They have particularly concentrated their efforts on the understanding of the immune response against the parasite in order to develop vaccines and new immunotherapeutic approaches able to prevent (1) primary infection during pregnancy that eventually results in congenital infection in the fetus or abortion (i.e., immunity against the tachyzoite stage) (2) reactivated toxoplasmosis in immunocompromised patients (i.e., immunity against the cyst stage).

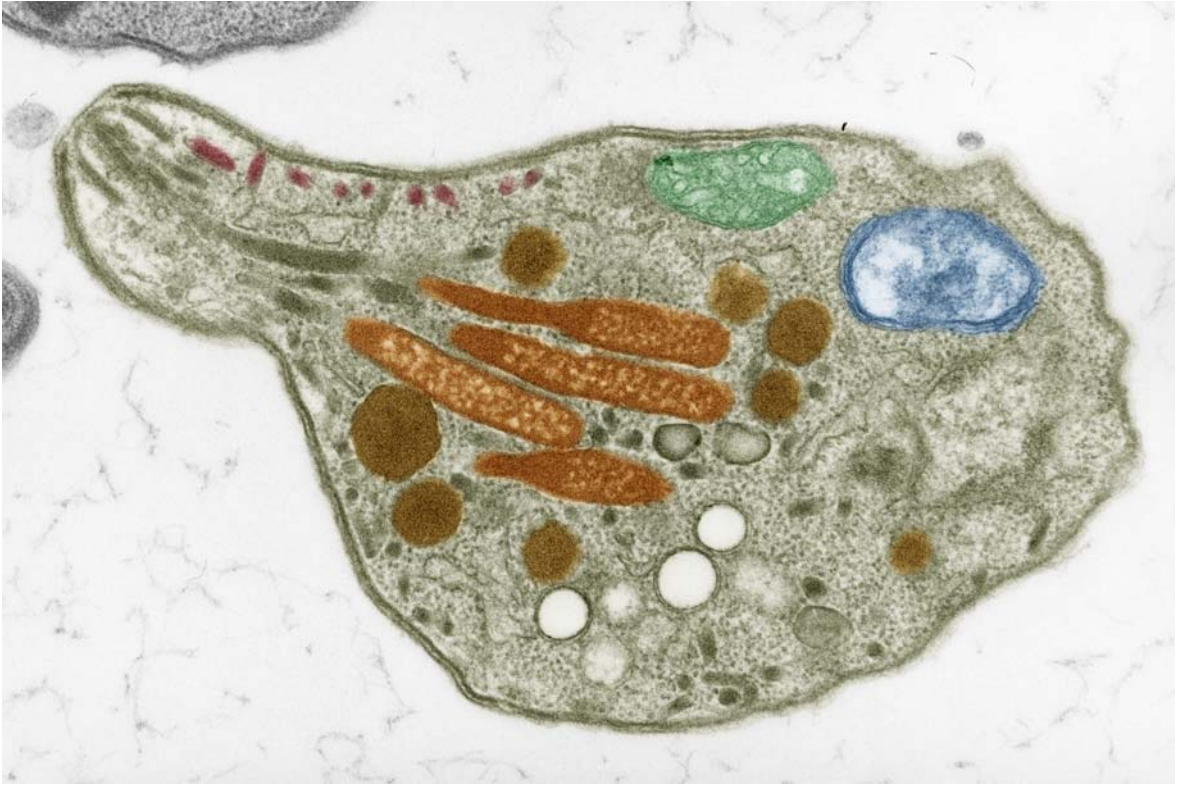

**Toxoplasma gondii.** Figure 5 TEM of the anterior pole of a moving tachyzoite.

### Lymphoreticular Hyperplasia

Lymphoreticular →hyperplasia with prominent histiocytes is often present in the posterior cervical lymph nodes following febrile acute, or asymptomatic toxoplasmosis (→Pathology/Fig. 11). This is not associated with tachyzoites or with cell or tissue necrosis; even bradyzoites in cysts are rare. Serologic tests indicate high antibody titers, and so the lymphoreticular →hyperplasia is interpreted as an immune reaction. The diagnosis can be suspected histologically and confirmed serologically, or vice versa.

### Placental Toxoplasmosis

Placental toxoplasmosis occurs in 20–40% of primary infections acquired during pregnancy, with microscopic but no gross lesions. This leads to toxoplasmosis in the fetus which most often is asymptomatic, but which in 10–20% of infected babies is accompanied by clinical manifestation. Initially the lesions are generalized with hepatitis, splenomegaly, pneumonia, rash, anemia, extramedullary hematopoiesis, and failure to gain weight. As partial immunity is developed extraneural lesions subside. →Sabin's tetrad, →hydrocephalus, retinochoroiditis, intracerebral calcification, and psychomotor retardation characterizes persistent central nervous system infection.

### Hydrocephalus

The pathogenesis of hydrocephalus in fetal and neonatal toxoplasmosis is unique. *T. gondii* tachyzoites reaching the central nervous system via the bloodstream give rise to microglial →nodules throughout the brain (→Pathology/Figs. 5, 6). In addition, the tachyzoites are disseminated through the ventricular system, resulting in widespread infection and necrosis of ependyma and subjacent tissues. This leads to obstruction in the narrow aqueduct of Sylvius (→Pathology/Fig. 12A). As a consequence metabolic products of *T. gondii* and liquefied necrotic brain material accumulate in the lateral and third ventricles. *T. gondii* antigen in the ventricles diffuses through ependymal ulcers and interacts with antibody in the periventricular blood vessels (→Pathology/Fig. 12B). These become surrounded with inflammatory cells as they approach the ventricles, further inwards the vessels leak protein and they become thrombosed close to the ventricles, leading to infarction necrosis. This *in vivo* antigen–antibody reaction and the zone of necrosis surrounding the lateral and third ventricles and the aqueduct are pathognomonic of congenital toxoplasmosis. Because the fourth ventricle fluid is drained through the open foramina of Luschka and Magendri; ependymal ulcers are not accompanied by this reaction.

Calcifications, often visible radiologically, develop in the areas of periventricular and aqueductal necrosis, and focally in areas of →[vasculitis](#) throughout the infant's brain.

### Retinochoroiditis

Retinochoroiditis (→[Eye Parasites](#)), found in infected babies, also occurs in children, adolescents, and adults. It rarely results from acute infection, but usually develops during →[chronic infection](#), after *T. gondii* cysts persisting in the retina, disintegrate. Most of the retinal lesions are believed to have followed infection acquired *in utero*. The rupture of a cyst results in destruction of the bradyzoites if immunity is intact (→[Pathology/Fig. 13C](#)); if not, proliferation of tachyzoites results. After either event, retinochoroiditis develops. The release of *T. gondii* antigen is inflammatory in the presence of hypersensitivity, the usual state during chronic infection, and reflected by a positive skin test. In the absence of an effective cellular immunity multiplication of tachyzoite results in destruction of retinal cells and inflammation. Because of the concentration of function in the retina, cyst rupture will often be symptomatic, whereas similarly sized lesions would not be noted in muscle or even the brain. Retinal lesions from recrudescence multiplication of tachyzoites are a dangerous complication of immunosuppression from corticosteroid or tumor chemotherapy, or with AIDS, and if untreated may lead to →[blindness](#).

### Cerebral Toxoplasmosis

Cerebral toxoplasmosis is seen in immunosuppressed adults such as those treated for Hodgkin's disease, other lymphomas or carcinomas, in corticosteroid-treated patients after organ transplantation, and in patients with AIDS. Encephalitis usually results during chronic infection probably after an accidental cyst rupture. Normally the bradyzoites would be destroyed with a glial scar remaining (→[Pathology/Fig. 5A,B](#)). However, because of the immunosuppression, the released bradyzoites have time to develop into tachyzoites and to multiply, wandering from cell to cell and producing an ever-expanding focus of necrosis accompanied by little inflammation (→[Pathology/Fig. 10A,B](#)). One or numerous focal lesions have been found in the brains of immunosuppressed patients. They can be identified by computerized tomography and magnetic resonance imaging where they resemble abscesses, although microscopically they are focal necrosis without granulocytes or pus, the hallmark of an →[abscess](#).

### Immune Responses

Interaction between *T. gondii* and the functional immune system does not result in parasite elimination,

but rather in a reduced parasite load and changes in morphology and surface antigen expression. The adapted parasites persist as bradyzoites in cysts located in different tissues for the remaining life span of the host. Acquired immunosuppression leads to reactivation of the parasite resulting in life-threatening toxoplasmic encephalitis. The sexual part of the life cycle of *Toxoplasma* takes place in the intestine of the definitive host, the cat. Despite the sexual life cycle in cats, only 3 major clonal lineages have been identified with little of the recombination one would expect if these animals fed on prey infected with different *T. gondii* strains. Thus, under normal conditions, the protective immune response against *T. gondii* is effective and long-lasting, thereby preventing infection of animals with multiple strains of *T. gondii*.

### Intracellular Survival and Host Cell Activation

*T. gondii* is able to replicate in nearly all nucleated cells of mammals. The intracellular fate of the parasite depends on the type and activation state of the host cell. Depending on the ability to restrict replication of intracellular toxoplasma, all cell types analyzed so far can be arranged into 3 groups. Group A consists of cells that are able to restrict the growth of *Toxoplasma* without prior activation, e.g., human monocytes. Group B, to which the majority of cell types belong, includes cells that restrict the growth of the parasite only after activation with cytokines, e.g., IFN- $\gamma$ . Microglia cells and macrophages of mice as well as human fibroblasts belong to this group. Cells of group C, such as murine astrocytes and fibroblasts or human EBV-transformed B cells, are unable to restrict the growth of *T. gondii*, even after activation with IFN- $\gamma$ . Cells of group C might thus function as safe harbor and transport vehicle for the spread of the parasite throughout the body. However, depending on the species of the host, the precise nature and frequency of these C-type cells differ, possibly influencing the susceptibility of the mammal species to *T. gondii* infection.

For example, human astrocytes and fibroblasts were found to restrict toxoplasma growth after activation with cytokines, while these cell types from mice support growth of the parasite even after IFN- $\gamma$  activation. Thus the more severe illness in mice as compared to humans may in part be a consequence of the high frequency of these type C cells in rodents.

Among the cytokines able to induce antitoxoplasma effector mechanisms IFN- $\gamma$  appears to be the most potent. TNF was found to enhance the activation by IFN- $\gamma$  in a synergistic manner *in vitro* and induces protection of mice *in vivo*. Likewise, IFN- $\beta$  and IL-1 were described to stimulate toxoplasmacidal effects in human cells *in vitro* and induced protection in mice infected with *T. gondii*. The protective effects of cytokines such as IL-2, IL-7, and IL-12 in experimental

infections of mice are most likely indirect, caused by an enhanced production of IFN- $\gamma$ . At least 3 different antiparasitic effector mechanisms induced by IFN- $\gamma$  have been defined: (1) production of toxic oxygen radicals, (2) production of  $\rightarrow$ nitric oxide, and (3) degradation of L-tryptophan.

The role of the oxidative burst in control of toxoplasma growth is still a matter of debate, since many conflicting results have been published. Free radical scavengers such as catalase and superoxide dismutase have been shown to inhibit toxoplasmatosis in human and murine macrophages. Although some investigators reported that toxoplasma infection induces oxidative burst, others have been unable to detect even traces of oxidative burst products in comparable cells. Moreover, *Toxoplasma* tachyzoites are at least in part resistant against the damaging effects of toxic oxygen radicals since they possess reactive radical scavengers. The pathway by which toxoplasma enters a cell determines the fate of the parasite. While antibody-coated toxoplasma were rapidly killed in human granulocytes by strong superoxide anion production, parasites without antibodies on their surface were able to replicate and induce only a minor oxidative burst. Thus, toxic oxygen radicals may be operative under certain circumstances, while other mechanisms of defense are definitively also able to inhibit *T. gondii*, even in oxidatively incompetent cells of patients with chronic granulomatous disease.

Nitrogen intermediates such as  $\rightarrow$ nitric oxide (NO) contribute to antimicrobial activity of rodent macrophages. The inducible form of NO synthase (iNOS) is induced by IFN- $\gamma$  and there is no doubt that NO production is the key defense mechanism against *Toxoplasma* (as well as other intracellular pathogens) in murine macrophages and other rodent non professional APCs. In addition, human astrocytes stimulated with IL-1 and IFN- $\gamma$  are also able to inhibit toxoplasma growth by producing NO. However, as shown by experiments with iNOS inhibitors, NO does not contribute to the defense of human monocyte-derived macrophages against *Toxoplasma*. In addition an IL-12-mediated mechanism of protection independent of iNOS has been recently described in IRF-1-deficient mice infected with *T. gondii*. Although macrophages isolated from iNOS-deficient mice (iNOS  $-/-$ ) displayed defective microbicidal activity against the *Toxoplasma in vitro*, iNOS-deficient mice survived acute infection and controlled parasite growth at the site of infection. By 3–4 weeks p.i., however, iNOS-deficient mice did succumb to *T. gondii* and enhanced parasite expansion and pathology were evident in the CNS. This suggests that the protective effects of NO might be tissue and / or infection phase-specific.

In many different human cell types IFN- $\gamma$  induces the indolamine 2,3-dioxygenase (IDO), an enzyme capable of degrading tryptophan. Since tryptophan is an

essential amino acid for *T. gondii*, the depletion of this amino acid results in parasite growth inhibition. This has been confirmed by several different experimental findings, e.g., (1) the fact that tryptophan supplementation partly antagonized antiparasitic effects induced by IFN- $\gamma$  in human cells (2) the absence of antiparasitic effector mechanisms in a mutant cell line lacking the IDO gene, and (3) the capability of tryptophan auxotroph, to replicate in human IFN- $\gamma$  treated fibroblasts. The induction of IDO appears to be inhibited by NO in rodent cells, since the addition of iNOS inhibitors resulted in detectable IDO activity in stimulated murine macrophages.

The existence of further defense mechanisms in addition to oxidative burst, NO production and tryptophan degradation is suggested by experiments in which the inhibition of all 3 pathways in human endothelial cells did not abolish the IFN- $\gamma$ -induced antiparasitic effect.

### Innate Immunity

Mice deficient in the gene for MyD88, an adaptor molecule essential for most TLR as well as IL-1 and IL-18 signaling, were shown to have defective IL-12 responses during parasite infection and, in the case of *T. gondii*, were acutely susceptible to the pathogen. In a subsequent elegant study Yarovinsky et al. identified a profilin-like protein from *T. gondii* that generates a potent IL-12 response in murine dendritic cells (DCs). *T. gondii* profilin activates DCs through TLR11 and is the first chemically defined ligand for this TLR. Moreover, TLR11 is required *in vivo* for parasite-induced IL-12 production and optimal resistance to infection. In addition glycosylphosphatidylinositol (GPI) protein anchors are highly abundant in the membranes of *T. gondii* tachyzoites and can serve as ligands for innate recognition through TLR2 as well as TLR4 agonists. TLR2-deficient mice display enhanced susceptibility when challenged with high infective doses of *T. gondii*. A role for TLR2 is also suggested by the requirement for this receptor in the *T. gondii*-induced production of the neutrophil-attracting chemokine CCL2 both *in vitro* and *in vivo*. The latter observation is relevant because of the known involvement of neutrophils in the innate response to the parasite. An increased percentage of neutrophils has been detected in the blood of mice infected with *T. gondii* by gavage and depletion of neutrophils by specific antibodies resulted in increased disease-severity and death during acute toxoplasmosis. Another cell type possibly contributing to the very early innate defense against *T. gondii* are platelets. It was observed that tachyzoites of *T. gondii* induced activation of human platelets and that platelet-derived growth factor inhibited intracellular growth of the parasite.



In experimental infection of mice, one of the first events occurring after infection with *T. gondii* is the activation of NK cells. However, in contrast to human IL-2-activated NK cells, murine NK cells are unable to lyse *T. gondii*-infected target cells. Instead, IFN- $\gamma$  produced by mouse NK cells appears to be of importance for early resistance against *T. gondii*. Although T cell-deficient SCID mice eventually succumb to infection, IFN- $\gamma$  produced by NK cells leads to control of the parasite soon after infection. In addition, administration of IL-12 to SCID mice known to stimulate NK cells resulted in a remarkable delay in time till death, while treatment with anti-IL-12 resulted in early  $\rightarrow$ lethality following infection. Antigen preparations of *T. gondii* can activate NK cells *in vivo* and *in vitro*, presumably via stimulation of the secretion of monokines such as IL-1, IL-12, and TNF by macrophages or as shown recently for IL-12, by dendritic cells. In addition to these NK-stimulatory cytokines, cell-cell contact involving CD28 on NK cells and CD80 or CD86 on macrophages is able to amplify the IL-12-driven IFN- $\gamma$  production of NK cells. Only in the absence of a functional NK compartment as seen in mice deficient for the common  $\gamma$ -chain of cytokine receptors, are CD4<sup>+</sup> cells able to confer early IFN- $\gamma$ -dependent resistance.

The fall of NK cell activity shortly after the initial peak of activation appears to be mediated by IL-10 and TGF- $\beta$ . Following infection with *T. gondii*, the expression of both of these cytokines is upregulated and treatment of SCID mice with neutralizing antibodies against IL-10 or TGF- $\beta$  delays the time period till death.

### B Cells and Antibodies

An important immune reaction of mammalian hosts is the production of IgM and IgG antibodies directed against *T. gondii*, which eventually activate complement by the classical pathway, resulting in efficient killing of extracellular parasites. In contrast, activation of complement by the alternative pathway, does not result in destruction of *T. gondii*. A protective role of IgA is suggested by the finding that secretory IgA obtained from toxoplasma-infected cats reduced the parasite's cell penetrating activity. The humoral immune response is mainly involved in the acute phase of *T. gondii* infection, possibly hampering hematogenous spread of extracellular tachyzoites.

### T Cells

In addition to NK cells, T cells driven by a recently described superantigen of *T. gondii* play an important role after infection with the parasite. This manifests as expansion of CD8<sup>+</sup> V $\alpha$ 5<sup>+</sup> cells producing IFN- $\gamma$  soon after infection followed by nonresponsiveness of this

population during chronic infection. Surprisingly and for reasons unclear at the moment, mice expressing the highest levels of V $\alpha$ 5<sup>+</sup> cells display also the highest mortality level. IL-12 and IFN- $\beta$  expressed during the early response play a decisive role in the development of Th1 cells, which in turn produce IL-2 thereby driving the expansion of CD8<sup>+</sup> cells. Adoptive transfer and *in vivo* depletion experiments in various mouse strains confirmed the paramount importance of CD8<sup>+</sup> T cells in controlling the acute infection as well as in preventing toxoplasmic encephalitis. CD8<sup>+</sup> cells mediate their protective effects through 3 different mechanisms: (1) production of IFN- $\gamma$  important for the activation of macrophages, (2) MHC class I restricted cytotoxicity for *Toxoplasma*-infected cells, and (3) direct tachyzoite cytolytic activity. Perforin-mediated cytotoxicity by T and NK cells, however, plays a limited role in host resistance to *T. gondii*, since *T. gondii*-vaccinated perforin-deficient mice were completely resistant to a challenge infection and only in the chronic stage of toxoplasmosis was there a three- to fourfold enhancement of brain cyst numbers in the mice lacking perforin.

The role of CD4<sup>+</sup> T cells during *T. gondii* infection remains controversial. On the one hand depletion of CD4<sup>+</sup> cells *in vivo* exacerbated the course of the disease, increased parasite burden and promoted recrudescence of latent infection. On the other hand, CD4<sup>+</sup> cell depletion reduced brain inflammation and Th1 cells were associated with the development of necrotic lesions in the ilea of susceptible mice. In contrast, the coproduction of Th2 cytokines together with IFN- $\gamma$  by CD8<sup>+</sup> cells in the gut-associated lymphoid tissue ( $\rightarrow$ GALT) may be essential to limit the pathological inflammatory response.

Given the decisive role of T cell for the immune defense against *T. gondii*, it is important to mention, that infection of murine macrophages with the parasite results in downregulation of MHC class II molecules and inability to upregulate class I molecules. The interference with  $\rightarrow$ antigen presentation may be an  $\rightarrow$ evasion strategy of *T. gondii* to facilitate intracellular survival.

In addition to the activation of T cells expressing  $\alpha\beta$  TCRs, an activation of  $\gamma\delta$ <sup>+</sup> T cells has been described in humans as well as in mice. These cells were found to play a role in the induction of hsp 65 expression of macrophages and were mainly involved in the early defense against *T. gondii* in the gut by mechanisms which await clarification.

### Toxoplasma Immunity in the Brain

In the course of toxoplasmosis the central nervous system is almost always involved. The limited access of cells of the immune system to the brain may, in part,

explain the persistence of the cyst stage in the brain which is responsible for the neurological symptoms in congenital toxoplasmosis and reactivation *Toxoplasma*-encephalitis in immunocompromised individuals.

The unique immune status of the brain is a consequence of a number of factors. Resting T cells, antibodies, and cytokines are unable to cross the blood-brain barrier, and a primary immune response does not usually occur. In addition, glial cells are known to be able to suppress T cell responses. Since furthermore the CNS lacks a proper lymphatic system and only low levels of endogenous MHC class I and II molecules are expressed, it may be easy for *T. gondii* to evade the full consequences of the host immune system at this site.

Although *Toxoplasma*-encephalitis is one of the most common manifestations of clinical toxoplasmosis there clearly is evidence for antiparasitic effector mechanisms operative in the brain. The essential role of T cells is illustrated by the fact that there is no toxoplasmic encephalitis in immunocompetent individuals, while the disease occurring in AIDS patients is almost invariably associated with very low CD4<sup>+</sup> T-cell counts (<100/mm<sup>3</sup>) with a corresponding reduction in CD8<sup>+</sup> T cells. In addition to the impaired T-cell function in AIDS patients, macrophages infected with HIV have a reduced ability to kill *T. gondii*. Furthermore, a direct link between replication of *T. gondii* and HIV is suggested by the fact that *T. gondii* infection of HIV-1-transgenic mice stimulated proviral transcription in macrophages. Thus, infection with *T. gondii* might increase the viral replication, thereby hastening the loss of T cells and allowing *Toxoplasma*-encephalitis to develop.

In murine *Toxoplasma*-encephalitis adult immunocompetent mice were found to develop cellular infiltrates composed of CD4<sup>+</sup> and CD8<sup>+</sup> T cells and macrophages surrounding *Toxoplasma* cysts and tachyzoites. Cell transfer experiments showed that especially CD4<sup>+</sup> T cells are able to confer protection against cyst reactivation in the brains of infected SCID mice. In addition, it was found by cell depletion experiments that CD8<sup>+</sup> T cells participate in the control of cyst numbers.

Analysis of cytokine production in the brains of *T. gondii*-infected mice indicated that the outcome of the encephalitis is dependent on the differential production of Th1 or Th2 cytokines. IFN- $\gamma$  appears to be the most important protective cytokine since (1) administration of rIFN- $\gamma$  to chronically infected mice reduced disease severity which (2) was enhanced in mice treated with neutralizing antibodies against this cytokine and (3) IFN- $\gamma$  receptor-deficient mice with a resistant genetic 129 background rapidly died following infection. Studies showing that administration of the NO inhibitor aminoguanidine resulted in increased

severity of *Toxoplasma*-encephalitis strongly suggest that NO synthesis is an important mechanism of IFN- $\gamma$ -induced protection. TNF is another cytokine which appears to be centrally involved in the control of *Toxoplasma*-encephalitis since treatment with TNF-neutralizing antibodies or the disruption of the TNF receptor p55 gene resulted in increased disease severity. In line with these findings, the enhanced *T. gondii*-resistance of male mice compared to females is associated with more rapid production of IL-12, IFN- $\gamma$  and TNF.

The role of other cytokines is less clear. IL-6 neutralization using antibodies in mice with established encephalitis led to reduced brain inflammation and decreased parasite burden, while IL-6-deficient mice were found to be more susceptible than their immunocompetent counterparts. The function of the Th<sub>2</sub> cytokines IL-4 and IL-10 is also uncertain. Elevated levels of expression of both these cytokines have been detected in brains of mice with *Toxoplasma*-encephalitis. While studies with mice deficient in IL-4 or IL-10 demonstrated an enhanced disease susceptibility others reported that IL-4 deficient mice were resistant to *Toxoplasma*-encephalitis. The differences between these studies may be related to the different strains of parasites and genetic backgrounds of the mice.

### Immune Pathogenesis

*T. gondii* infection during both the acute and the chronic phases of disease is controlled by a delicate balance between different inflammatory and regulatory cytokines. As described above, the production of IL-12, IFN- $\gamma$  and TNF is a prerequisite for protective immunity, but on the other hand their overproduction can also be deleterious to the host. For example, mouse strains producing the highest levels of IFN- $\gamma$  also have the highest mortality rates. In addition, administration of rTNF results in earlier mortality in immunocompetent and SCID mice. In addition, mice lacking IL-10, a counterregulator of cell-mediated immunity, are more susceptible to toxoplasmosis.

### Vaccination

*T. gondii* is one of the most successful parasites able to infect virtually all nucleated cells from a broad host-range including birds, farm animals, wild animals, and humans. Moreover this parasite is easy to grow, is haploid in most stages, and can easily be manipulated by transfection strategies. Although there is no evidence of sophisticated mechanisms such as [antigenic variation](#), the parasite has developed a strategy to infect the host cells allowing to escape to the immune system and/or trigger different immune effectors. It has been

shown that the parasitophorous vacuole formed upon penetration of tachyzoites into macrophages, or fibroblasts is fusion-incompetent. This would allow the parasite to avoid direct cellular destruction by macrophage machinery. Nevertheless, like a number of other intracellular pathogens, such as *Leishmania*, macrophages activated by cytokines, notably those derived from activated T cells, acquire the capacity to kill or inhibit the development of intracellular pathogens. *In vitro* studies as well as experiments in *Toxoplasma*-infected mice whose cytokine genes or cytokine receptor genes have been inactivated have shown that IFN- $\gamma$  and TNF- $\alpha$  are the most cytokines implicated. The general consensus is that *T. gondii* induces TNF- $\alpha$  and IL-12 production by macrophages. This induces IFN- $\gamma$  release by NK cells that synergize with TNF- $\alpha$  for the parasite killing by a combination of oxygen-dependent and independent mechanisms. Intracellular macrophage killing cannot be sufficient to account for the immune control of the infection since *Toxoplasma* (in contrast with *Leishmania* parasites) is able to develop in practically every nucleated cell. Although the role of T cells in anti-*Toxoplasma* immunity has been recognized for a long time, it is only recently that important progress has been made in understanding the control mechanisms involved, particularly the role of CD8<sup>+</sup> T cells. CD8<sup>+</sup> would have not only a direct tachyzoite cytolytic activity but also would prevent high cyst burden and *Toxoplasma*-encephalitis through IFN- $\gamma$  secretion. Although cell-mediated immunity is the major component, antibodies also have been protective in models. While antibodies do not seem to play an essential role in maintaining a steady-state equilibrium between the parasite and the host during the chronic phase of the infection, they could participate in the protection during the primary infection in vaccinated animals.

A vaccine comprising live attenuated tachyzoites (the infecting stage) is already successfully used in sheep to prevent abortion, but such vaccine is inappropriate in humans. Therefore an important research area is the identification of molecules involved in the invasion process by the tachyzoite of the parasite in its host cell. It is a difficult issue because the parasite has evolved a complex family of redundant receptors able to match to virtually all nucleated cells within an enormous number of animals from birds to humans. The new advances of the reverse genetics have made it possible to clarify the respective roles of the tachyzoite surface antigens in the invasion process and therefore has pointed out some of these antigens as interesting targets for vaccine development. Among the 5 originally described surface antigens 3 have been extensively studied: SAG1 (P30), SAG2 (P22), and SAG3 (P43). SAG1 and SAG3 correspond to homologous proteins with 24%

of amino-acid identity and conserved cysteines leading to similar secondary and tertiary structures. SAG2 shows no apparent similarities with SAG1 and SAG3, other than that these 3 tachyzoites are anchored in the membrane by glycosyl-phosphatidyl inositol (GPI) moieties. Polymorphism analysis of these antigens has shown that in contrast to what is observed for *Plasmodium* merozoite antigens (MSP1 and MSP2 for instance), the number of alleles is extremely limited which is encouraging for vaccine development. For instance, the analysis of the SAG1 locus (encoding the P30 surface antigen) has shown the existence of only 3 alleles, 2 of them (CEP and ME49) encoding for identical proteins and 2 alleles have been described for SAG2. Vaccination experiments using one or the other of these 2 antigens, SAG1 and SAG2, as recombinant antigens or synthetic peptide have given drastically different results, reducing or increasing the mice or rats mortality, depending on the adjuvant. Indeed recent knowledge on immune responses against *T. gondii* have readily established that induction of CD8<sup>+</sup> T cells and Th1 cells is pivotal for the induction of a successful control of *T. gondii* infection. Adjuvant inducing a Th1 response such as immunostimulatory complexes (ISCOMs) induce generally protecting immunity whereas adjuvant promoting Th2 responses such as Aluminium hydroxide (the only adjuvant licenced for use in humans) exacerbate the disease in rodent models. Recombinant cytokines such as IL-12, that is determinant for Th1 differentiation, could provide the adjuvant activity for new generation vaccine as proven by successful experiment for *Leishmania* vaccination. However the surproduction of pro-inflammatory cytokines, such as IFN- $\gamma$  and TNF- $\alpha$ , may increase morbidity or/and mortality. Indeed, recent elegant experiments have found a correlation between the susceptibility of inbred mouse strains to *Toxoplasma* encephalopathy (TE) and the structure of the gene to TNF $\alpha$ . Thus, differences in TNF $\alpha$  expression could be one of the factors implicated in the TE susceptibility.

In contrast to SAG3 which is expressed on tachy- and bradyzoites surface, SAG1 and SAG2 are abundant tachyzoite specific antigens, highly immunogenic. Mutant parasites lacking either SAG1 or SAG3 clearly show an impaired invasion, suggesting a role in the attachment of the parasite to the host cell. SAG2 would rather play a role in the reorientation of the tachyzoite during the invasion process as indicated by blocking experiments with mAbs against SAG2. Invasion and establishment in the parasitophorous vacuole is a key event for the survival of this parasite. The GRA proteins, discharged from the dense granule play a major role in the modification of the parasitophorous vacuole, and may also be relevant as vaccine component. Immunization of mice with GRA2 induces the increase

of the survival of mice from 10–75%. Recent advance in the *Toxoplasma* genome project has yielded over 10,000 expressed sequence tags (ESTs) from *Toxoplasma gondii*. Sequencing of ESTs has already led to the discovery of 4 new SRS genes (SAG1 Related Sequences), increasing the →SAG family to 8 members. As SRS antigens are less abundant antigens they were missed by classical biochemical techniques. This illustrated the fantastic potential advance coming from the postgenome period in the discovery of new vaccine candidates. Due to the stage specificity of *Toxoplasma* antigens as well as the differential immunological control of the tachy- and bradyzoite stages, an efficient vaccine preventing fetal damages and abortion as well as reducing cysts formation has to contain multistage antigens. Thus future vaccine research has not only to target antigens from different stages but also to induce the appropriate immune responses. Further progress in the dissection of protective defense mechanisms in experimental models as well as naturally infected individuals will help for vaccine design.

Once established in host cells and disseminated, *T. gondii* differentiates from tachyzoites to the persistent encysted bradyzoite stages. Knowledge about factors which lead to bradyzoite, or oocyst formation is still very poor and almost nothing is known about the genes which are involved in this transition. Concerning cysts wall composition, Sims et al. have recently reported the presence of *Toxoplasma* antigens, but the interaction between these antigens and the host immune system has not yet been investigated. The understanding of the mechanisms by which this stage becomes reactivated in immunocompromised host, is a major challenge for researchers, in order to develop strategies preventing this transition. Decreasing levels of IFN- $\gamma$  observed in AIDS patients would play a role via the decrease of expression of indoleamine 2,3-dioxygenase (IDO) and inducible NO synthase (iNOS), which are important for the stabilization of the cyst stage. New approaches in molecular genetics, cellular microbiology, and immunology will clarify the complex interrelationship between the different forms (tachyzoites, bradyzoites, and oocysts) as well as the suitable balance in the induction of immune mechanisms, knowledge essential for vaccine development.

Lastly, recent experiments have highlighted the possibility of expressing *P. falciparum* antigens in *T. gondii* opening the possibility of using *T. gondii* as carrier for vaccination.

**Main clinical symptoms:** In immunoincompetent people mostly symptomless, but in acute infection the following are common: →lymphadenitis, iridozyklitis, chorioretinitis, myocarditis, meningoencephalitis-mye-litis; see →Connatal Toxoplasmosis.

**Incubation period:** Hours to 2 days.

**Prepatent period:** 1 day to weeks (strain-dependent).

**Patent period:** Years.

**Diagnosis:** Serodiagnostic tests, →Serology.

**Prophylaxis:** Avoid eating raw meat and having contact with cats that feed on mice.

**Therapy:** see →Treatment of Opportunistic Agents, →Coccidiocidal Drugs.

---

## Toxorhynchites brevipalpis

→Diptera, mosquito species, that does not suck blood.

---

## Traberkrankheit

German common name for a disease of small ruminants due to an infection with the agents of scrapie disease (→Prions). Scrapie initiates (like the worm-derived →turning disease or →whirling disease) uncontrolled movements due to disintegration of the brain.

---

## Tracheoles

Chitin-fortified hollow tubes, which start at the surface of insects/acarids (at stigmata) and are used as channels for O<sub>2</sub> supply leading to the single cell.

---

## Tracheophilus sisowi

Cosmopolitan digenean trematode (6–11.5 mm × 3 mm), that parasitizes in the pharynx, nasal region, and bronchioles of house and wild birds. Intermediate hosts are snails (*Lymnaea*, *Planorbis*, *Planorbarius*).

---

## Trachipleistophora hominis

→Microsporidia.

## Trachoma

About 540 million humans in 55 countries (primarily in Africa, Asia, but also in regions of the Americas and Australia) are endangered to become infected by the fly-transmitted bacterium *Chlamydia trachomatis*. The disease may lead via severe symptoms (e.g., conjunctivitis, trichiasis) to blindness, which, however, is preventable by the use of proper means of control (e.g., use of Azithromycin), →[eye parasites](#).

- active penetration into the skin,
- body contact between 2 hosts,
- air-borne inhalation.

## Transamination

→[Amino Acids](#).

## Transformation

Bite-transmitted parasites (e.g., *Plasmodium*, *Trypanosoma*, *Leishmania*) must adapt to the environment inside of the vector and after transformation again in a similar process, to the vertebrate host (to achieve the metacyclic stage that is able to survive), →[Phlebotomus](#), →[Leishmania](#).

## Transforming Growth Factors (TGF)

Factors ( $\beta$ -type) that lead to stage conversion in many parasites (African trypanosomiasis, cryptosporidiasis, *Plasmodium* spp., etc.).

## Transmission

Parasites may become transmitted to their hosts by

- fecally contaminated food or drinking water,
- raw or undercooked meat of fish or animals,
- milk,
- body fluids (including mothermilk),
- bite of ectoparasites,

## Transmission Models

→[Mathematical Models of Vector-Borne Diseases](#).

## Transovarial Transmission

Some agents of diseases enter the eggs of insects or ticks and thus become transmitted to the next generation. For example, →[Babesia](#), viruses (meningitis), etc., →[Borrelia burgdorferi](#).

## Trans-Sialidase

→[Glycosylphosphatidylinositols](#).

## Transsialidase Transmission

Trypanosomes are unable to synthesize the monosaccharide sialic acid and thus incorporate it from the host. In order to do so, e.g., *T. cruzi* expresses a transsialidase that catalyzes the transfer of sialic acid from host glycoconjugates to mucin-like molecules on the parasites' membrane.

## Trans-Splicing

*Trans*-splicing is a mechanism of nuclear pre-mRNA maturation that occurs in several branches of eukaryotes, including kinetoplastids, euglenoids, →[nematodes](#), →[flatworms](#), and primitive chordates, but does not exist in vertebrates. *Trans*-splicing appears to reflect an ancestral form of RNA processing that is used to donate a leader sequence (→[Spliced Leader](#), SL) from the 5' end

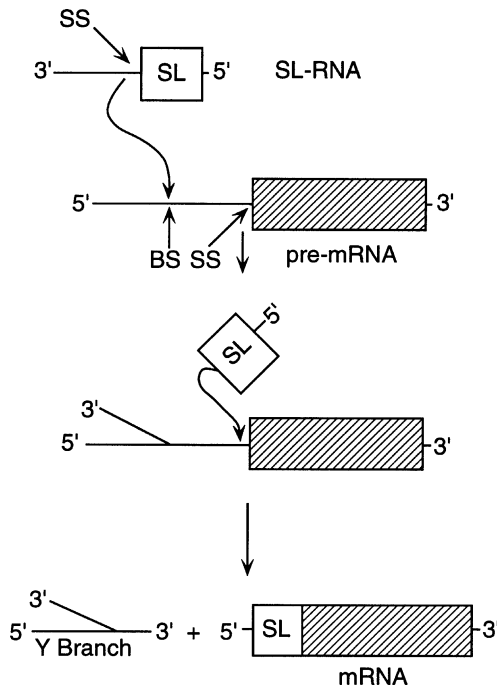

**Trans-Splicing. Figure 1** Schematic illustration of the proposed reactions involved in the *trans*-splicing of kinetoplastids, trematodes, and nematodes. *BS*, branching site; *SL*, spliced leader; *SS*, splice sites.

of a small mRNA (SL RNA) to pre-mRNAs to form the 5' end of the mature mRNAs (Fig. 1). The fundamental mechanism of *trans*-splicing parallels that of *cis*-splicing which is used for intron removal in eukaryotes. One major difference between the two events is that *trans*-splicing is an intermolecular mechanism that involves the joining of exons from two separately transcribed RNAs, while *cis*-splicing is an intramolecular mechanism in which intervening sequences in eukaryotic pre-mRNAs are removed. Both splicing processes take place in one of the most complex macromolecular machines known as the spliceosome. In trypanosomatids, all pre-mRNAs receive the SL, whereas in helminths only a part of the pre-mRNAs is processed by *trans*-splicing. *Trans*-splicing has several distinct biological functions. A unique role in kinetoplastids is that it provides a 5' cap structure for mRNAs transcribed by RNA polymerase I, and in the same organisms, flatworms, and nematodes, it serves to resolve polycistronic RNA polymerase II transcripts into capped, monocistronic mRNAs.

## Transstadial Transmission

Transmission of sporozoites via saliva in *Theileria*, after their formation in the salivary glands of ticks.

## TRAP

Thrombospondin-related adhesive protein, that covers together with the *→CSP* protein the surface of *Plasmodium* sporozoites and thus may be used as candidate for vaccination.

## Traps

Insects have to be caught in order to determine their parasitic load. The attraction of traps is initiated by light (UV, black light), or by chemicals, or by pheromones.

## Traveller's Disease

Disease due to infections with *→Cyclospora cayentensis*; the leading symptom is diarrhea, which may also occur in infections with *→Blastocystis*, *→Giardia*, *→microsporidia*, *→Entamoeba*.

## Travellers Information

JAMA: <http://www.jama.com>.

## Treatment

See chapters on Disease Control and Control.

## Treatment of Opportunistic Agents

### Drugs Acting on [*P. carinii*] Pneumonia (PCP) in Humans

*Pneumocystis carinii*, a unicellular eukaryote (a fungus), develops extracellularly in the alveoli of lungs of animals (e.g., rat) and humans (a particular species *P. jiroveci* (a new name) that does not infect other host

species) thereby undergoing encystment during one phase of its life cycle (→*Pneumocystis carinii*). The **clinical symptoms** of acute pneumonitis in immunosuppressed children and adults, both, with and without HIV infection are dyspnoea, tachypnoea, cough, and fever. In immunocompetent hosts the infection is latent without any clinical signs and widely distributed in a variety of domestic and wild animals. Direct or close contact to carriers, and airborne transmission seems to be the common route of infection in humans. The incidence rate is high and may exceed 80% in children. An effective **therapy** of infection with chemotherapeutic drugs (cf. [Table 1](#)) is dependent on early diagnosis. Treatment of choice for PCP and extrapulmonary *Pneumocystis* infections in →[AIDS](#) patients is oral (PO) or intravenous (IV) administration of trimethoprim plus sulfamethoxazole (Bactrim and others). The dosage is 15 mg/kg b.w./day (based on trimethoprim component) given in 3 or 4 doses × 14–21 days. In PCP accompanied by severe hypoxia, oral prednisone at the start of treatment has decreased incidence of respiratory deterioration and may improve tolerance for high-dose trimethoprim +sulfamethoxazole. However, the corticosteroid may reactivate herpes simplex infections or other opportunistic infections like candidiasis. Alternative treatment (for regimens cf. [Table 1](#)) may be used for patients with mild to moderate or even severe PCP who have failed or have shown intolerance to the standard treatment (trimethoprim +sulfamethoxazole). For cases of moderate to severe PCP, alternative drugs may be pentamidine (IV) or atovaquone (PO) or dapsone (sulfone with antileprosy activity) given concurrently with trimethoprim. All these drugs appear to be less active but better tolerated than trimethoprim plus sulfamethoxazole. This seems to be true also for the antimalarial atovaquone. Simultaneous use of clindamycin (IV or PO) with oral primaquine (→[Malariaicidal Drugs](#)) has been successful in patients with mild to moderate PCP. For primary and secondary →[chemoprophylaxis](#) of PCP, standard treatment is oral trimethoprim plus sulfamethoxazole (cf. [Table 1](#)). For alternative treatment, dapsone may be used alone, or concurrently with pyrimethamine plus folinic acid. Aerosolised pentamidine (e.g., NebuPent, 300 mg inhaled monthly via a Respigard II nebuliser) is well tolerated but less effective than trimethoprim plus sulfamethoxazole and, in patients with < 100 CD4 cells, less active than dapsone. Chemoprophylaxis against PCP is also needed in patients with AIDS-related complex diseases or those with bone marrow or solid organ transplants. In absence of prophylaxis most of heart-lung, and lung allograft recipients will probably develop PCP. Supporting treatment as elevation of arterial oxygen pressure, support of lung function, or

corticosteroid therapy along with specific causal agents against PCP will reduce the frequency of mortality in immunocompromised patients, particularly in those suffering from AIDS.

### Drugs Acting on Cryptosporidiosis

Species of the genus *Cryptosporidium* are coccidian parasites that infect epithelial cells (extracytoplasmic) of the intestinal and respiratory tract of vertebrates (see also →[Cryptosporidium](#) for life cycle and →[Coccidiocidal Drugs](#)). Although immunocompetent hosts show no or only mild clinical signs after *C. parvum* infections immunosuppressed hosts may suffer from life-threatening watery →[diarrhoea](#) caused by enteritis of the small intestine. Infections are due to infective oocysts (=sporocysts) passed in feces of carriers in the environment. Transmission may occur by food/feed or water supplies containing sporulated oocysts, or by droplet infections. Outbreaks of the disease are mainly seen in **young animals** or **neonates** (calves, lambs, piglets, foals and zoo, pet or laboratory animals). The disease in livestock is associated with intensive husbandry, seasonal breeding, and mixed grazing practices (feed, water and holding facilities contaminated with →[oocyst](#)). Clinical signs are weakness, dullness, rough coat, weight loss and mortality. In **humans** the severity of infection depends on immunocompetence of the patient. Immunosuppressed humans suffering from AIDS can show intractable diarrhea causing →[dehydration](#), weakness, considerable weight loss and even mortality.

No consistently effective therapy or chemoprophylaxis is available for either cryptosporidiosis or **microsporidiosis** (cf. [Table 1](#)). Only a few drugs show some activity against *C. parvum* infections and are approved for the use in animals and humans for this indication (e.g., halofuginone lactate cf. →[Theileriicidal Drugs](#)). Many approaches to anticryptosporidial efficacy of commercial drugs have failed in improving symptoms in ruminants suffering from *C. parvum* infections. Several anticoccidials, like sulfonamides, lasalocid sodium, halofuginone lactate, decoquinatate or paromomycin (available as additives in-feed, cf. →[Coccidiocidal Drugs](#), or other dosage forms for oral or parenteral administration) have been found to be insufficiently effective in controlling or even eradicating *C. parvum* infection in calves and kids. They may exhibit positive clinical short-term effects such as improvement of watery diarrhea and reduction of oocyst output in feces. Monoclonal antibodies raised against *C. parvum* may reduce clinical signs in *C. parvum* infected laboratory animals. Therefore, drug treatment should be associated with **strict measures of** →[hygiene](#) (which should also

**Treatment of Opportunistic Agents. Table 1** Drugs acting on opportunistic infections among HIV-exposed or infected humans

<b>DISEASE</b> <b>non-proprietary name</b> (chemical group) <b>Brand name</b> other information	<b>Adult dosage/*pediatric dosage</b> (mg/kg b.w., or total dose/individual, oral route), miscellaneous comments
<b>PNEUMOCYSTOSIS</b> ( <i>Pneumocystis pneumonia</i> = PCP) is an acute, usually a bilateral and diffuse pneumonitis caused by pulmonary infection of <i>P. carinii</i> ; this unicellular eukaryote that usually develops extracellularly in the lungs of rats undergoes encystment in one phase of its life cycle; its biological characteristics resemble those of both fungi and the protozoans; <i>Pneumocystis</i> organisms are quite different on the basis of DNA analysis in different mammals and widely distributed in nature; in immunocompetent hosts, the infections are latent and asymptomatic; <i>P. jiroveci</i> is an important pathogen causing opportunistic pneumonia in immunosuppressed humans; PCP remains the most common AIDS-indicator disease among HIV-infected children (>60% of AIDS patients in the USA and Europe were estimated to develop PCP); extrapulmonary infected lesions (all tissues) are more common in AIDS patients than in other immunocompromised persons; prevention of PCP and its treatment is entirely dependent on current chemotherapeutic drugs, which all may produce severe side effects; early diagnosis is essential for effective treatment consisting of both specific chemotherapy and supporting therapy; chemoprophylaxis against PCP is necessary for individuals suffering from conditions such as AIDS, aids related complex (ARC), acute lymphoblastic leukaemia, and those having received solid organ transplants or bone marrow transplantation; aerosolised pentamidine (AP) given by inhalation is extensively used for PCP prophylaxis in children >6-year old and adults producing moderate to severe cough as adverse effect; undesirable side effects may require termination of AP but this may also be true for all other treatment regimens used to prevent PCP; in PCP, accompanied by moderate or severe hypoxia, adding prednisone (corticosteroid) at the start of treatment has decreased the incidence of respiratory deterioration and death; corticosteroids may also improve tolerance for high-dose trimethoprim-sulfamethoxazole; oral candidiasis and reactivation of herpes simplex infections can occur; at present no protective vaccine against PCP is available.	
<b>trimethoprim (TMP)/sulfamethoxazole (SMX)</b> (diaminopyrimidine/sulfonamide) Bactrim, Eusaprim, and others (drug of choice) <b>recommended therapy,</b> after acute pneumonitis has resolved patient can be administered oral treatment	TMP 15 mg/kg/d, SMX 75 mg/kg/d (i.v. or p.o. = per os) in 3 or 4 doses $\times$ 14–21d; *same as adult dose; adverse effects may be folate deficiency, neutropenia, thrombocytopenia, agranulocytosis, rash, fever, headache, depression, jaundice, diarrhoea (rare) and others; is the treatment of choice for PCP and extrapulmonary <i>P. carinii</i> infections; episodes of toxicity may require discontinuation of the drug; subsequent desensitisation may lead to renewed drug tolerance
<b>Pentamidine</b> isetionate (aromatic diamidine) Pentam, others ( <i>alternative therapy</i> ) it is recommended for patients intolerant of TMP/SMX or who demonstrate clinical treatment failure after 5–7 days of TMX/SMX therapy	3–4 mg/kg i.v. (over 60–90 min.) qd $\times$ 14–21d; *same as adult dose; side effects may be sharp fall in blood pressure after rapid i.v. injection (orthostatic hypotension); it can induce pancreatitis (hypoglycemia and hyperglycemia), reversible renal dysfunction, abortion, peripheral neuritis (rare), cardiac arrhythmias; drug is contraindicated in diabetes
<b>trimetrexate plus folinic acid</b> (diaminopyrimidine) Neutrexin, others ( <i>alternative therapy</i> ) has been used as initial therapy in severe PCP in adults; data are limited for children	45 mg/m <sup>2</sup> i.v. qd $\times$ 21d plus folinic acid 20 mg/m <sup>2</sup> p.o. or i.v. q6h $\times$ 21d; antifolate drug approved for treatment of moderate to severe PCP; is not as effective as TMP/SMX; folinic acid (e.g. Leucovorin) prevents bone marrow suppression; (Neutrexin is licensed in the USA and elsewhere)
<b>trimethoprim plus dapsone</b> (diaminopyrimidine/sulfone) ( <i>alternative therapy</i> ) pediatric dose of TMP is the same as adult dose; among children aged < 13 years a dapsone dose of 2 mg/kg/d is required to achieve therapeutic levels	5 mg/kg TMP p.o. tid $\times$ 21d plus dapsone 100 mg per os qd $\times$ 21d; antileprosy sulfone dapsone given concurrently with trimethoprim can be used in treatment of mild to moderate PCP; adverse effects may be nausea, rash and methaemoglobinemia and haemolytic anaemia in patients with G-6-PD deficiency; (drugs are not licensed for this dosage regimen in the USA but considered investigational for this condition by the FDA)
<b>atovaquone (ATQ)</b> (hydroxynaphthoquinone) Mepron, others (suspension) ( <i>alternative therapy</i> )	750 mg bid p.o. $\times$ 21d; can be used for treatment of mild to moderate PCP; it is less effective than TMP/SMX but better tolerated; most side effects may be nausea, skin



**Treatment of Opportunistic Agents. Table 1** Drugs acting on opportunistic infections among HIV-exposed or infected humans (Continued)

DISEASE non-proprietary name (chemical group) Brand name other information	Adult dosage/*pediatric dosage (mg/kg b.w., or total dose/individual, oral route), miscellaneous comments
pediatric dose: 1–3 mos; 30 mg/kg/d; 4–24 mos: 45 mg/kg/d > 24 mos: 30 mg/d ATQ concentration is increased/decreased with coadministration of fluconazole and prednisone/ acyclovir, opiates, cephalosporins rifampin and benzodiazepines	rashes and diarrhea after first week of therapy (licensed in the USA and Europe)
<b>primaquine</b> phosphate (PMQ) (8-aminoquinoline) plus <b>clindamycin</b> (CDM) (7-chloro-lincomycin) (alternative therapy) Cleocin, and others dose information (data) for children is limited and based on use of these drugs for treatment of other infections, e.g. bacterial ones: 10 mg/kg q6h CDM, or malaria: 0.3 mg/kg q6h PMQ; adverse reactions include skin rashes, nausea, and diarrhea	30 mg base p.o. qd × 21d plus clindamycin 600 mg i.v q6h × 21d, or 300–450 mg p.o. q6h × 21d; concurrent use of i.v. or oral clindamycin with oral primaquine can be used in patients with mild to moderate PCP; <i>primaquine</i> can frequently cause haemolytic anaemia, especially in patients whose red cells are deficient in glucose-6-phosphate dehydrogenase, this deficiency is most common in African, Asian and Mediterranean peoples; patients should be screened for G-6- PD deficiency before treatment, it should not be used during pregnancy; (not licensed in the USA but considered investigational for this condition by the FDA)
<b>PRIMARY AND SECONDARY PROPHYLAXIS:</b> in HIV-infected patients, <i>Pneumocystis</i> pneumonia can be prevented by oral TMP/SMX or other alternative drugs; chemoprophylaxis in patients with HIV can be discontinued after CD4 count increases to > 200 × 10 <sup>6</sup> /L for > 3 mos.	
<b>trimethoprim</b> /sulfamethoxazole (TMP/SMX) (diaminopyrimidine/sulfonamide) Bactrim, and others (drug of choice) an alternative TMP/SMX regimen is one DS tab 3×/week; weekly therapy with <i>sulfadoxine</i> 500 mg/ <i>pyrimethamine</i> 25 mg/folinic acid 25 mg was effective PCP prophylaxis in liver transplant patients	1 tablet (single or double strength/=DS) p.o. qd daily; *TMP 150 mg/m <sup>2</sup> , SMX 750 mg/m <sup>2</sup> in 2 doses p.o. on 3 three consecutive days per week; oral TMP/SMX prophylaxis can prevent PCP in most HIV-infected patients; adverse reactions are frequent, particularly nausea, rash and fever; reduction of dosage may reduce toxic episodes or patients have to discontinue the drug and take an alternative drug
<b>dapsone</b> (sulfone) (not licensed in the USA but considered investigational for this condition by the FDA) (alternative drug)	50 mg p.o. bid or 100 mg p.o. qd; *2 mg/kg (max. 100 mg) p.o. qd or 4 mg/kg (max. 200 mg) each week; frequent rash, GI irritation, anorexia, infectious mononucleosis-like syndrome, occasionally methaemoglobinemia, haemolytic anaemia (G-6-PD deficiency), nephrotic syndrome, liver damage and others, rare optic atrophy, agranulocytosis
<b>dapsone</b> (sulfone) plus <b>pyrimethamine</b> (PYR) (diaminopyrimidine) plus folinic acid (alternative drugs)	50 mg p.o. qd or 200 mg each week plus pyrimethamine 50 mg or 75 mg p.o. each week plus 25 mg folinic acid with each dose of PYR; PYR occasionally causes blood dyscrasias, folic acid deficiency, rare rash, and vomiting
<b>atovaquone</b> (hydroxynaphthoquinone) Mepro, others (alternative drug) for interaction with other drugs cf. atovaquone↑	750 mg bid; frequent rash, nausea, occasionally diarrhoea; (licensed in the USA and elsewhere); antimalarial drug in combination with proguanil (Malarone, GSK, cf. → <a href="#">Malaria</a> cidal Drugs)
<b>pentamidine</b> aerosol (diaminopyrimidine) Nebupent, others (alternative drug) pediatric dose via Respirgard II nebulizer: 1–3 mos: 30 mg/ kg/d; 4–24 mos: 45 mg/kg/d; >24 mos: 30 mg/kg/d	300 mg inhaled monthly via Respirgard II nebuliser; *≥5 year-old: same as adult dose; (not licensed in the USA but considered investigational for this condition by the FDA, licensed in Europe)
<b>CRYPTOSPORIDIOSIS</b> though <i>Cryptosporidium parvum</i> is a coccidian parasite and should be affected by anticoccidial drugs (cf. → <a href="#">Coccidiocidal Drugs/</a> Table 1), it turns out that this monoxenous coccidian parasite proves considerably refractory to any known chemotherapeutic drug; only a very few chemotherapeutic agents seem to have moderate clinical effects on life-threatening diarrhea in immunocompromised persons (AIDS patients) and in young animals (cf. text: Drugs Acting on Cryptosporidiosis); management of cryptosporidiosis has to include fluid therapy, and nutritional support; the use of antimotility agents should be used with caution among young children.	

**Treatment of Opportunistic Agents. Table 1** Drugs acting on opportunistic infections among HIV-exposed or infected humans (Continued)

<b>DISEASE</b> <b>non-proprietary name</b> (chemical group) <b>Brand name</b> other information	<b>Adult dosage/*pediatric dosage</b> (mg/kg b.w., or total dose/individual, oral route), miscellaneous comments
<b>nitazoxanide (NZX)</b> <i>non-HIV infected patients:</i> NZX is approved for treatment of diarrhea caused by <i>Cryptosporidium</i> and <i>Giardia lamblia</i> , and is available in a tablet and liquid formulation; NTZ therapy reduces duration of both diarrhea and oocyst shedding; no substantial adverse reactions are reported	400 mg NZX qd x 3d; *1-3 years: 100 mg NZX bid x 3d; 4-11 years: 200 mg NZX bid x 3d; in <i>HIV infected patients</i> , NZX has not consistently been shown to be superior to placebo [Amadi B et al (2002) Lancet 360: 1375]; a small randomized, double-blind trial in symptomatic HIV patients who were not receiving highly active anti-retroviral therapy (HAART) found <i>paromomycin</i> (25-35 mg/kg/d p.o. in 2-4 divided doses, maximum dose: 500mg 4x daily) similar to placebo; <i>azithromycin</i> (10 mg/kg/d on d1 and 5mg/kg/d on days 2-10) was successful in rapidly resolving enteric symptoms in 3 of 4 HIV infected children with cryptosporidiosis ( <i>C. parvum</i> ); oral hyperimmune bovine colostrums and oral immune globulin have variable benefits among immunocompromised patients with cryptosporidiosis; immune reconstitution resulting from HAART frequently results in clearance of <i>Cryptosporidium</i> and Microsporidia ↓ infections; therefore, effective HAART is the recommended treatment for these infections, including supportive care with hydration, correction of electrolyte abnormalities, and nutritional supplementation
<b>TOXOPLASMOSIS</b> The definitive host of <i>Toxoplasma gondii</i> is the cat, which passes infective oocysts in its feces; there is no satisfactory treatment, which eliminates completely oocyst shedding in cats; a combination of antimalarial drug <i>pyrimethamine</i> (PYR) and sulfadiazine is effective against tachyzoites, but not so bradyzoites; <i>clindamycin</i> affects murine toxoplasmosis, and like PYR will reduce but not eliminate oocyst output in cats; infection of humans may be postnatally acquired or congenital; the majority of acquired infections are asymptomatic and widespread among humans though prevalence varies locally (about 500 million humans have antibodies to <i>T. gondii</i> , and in most countries about 60% of adults are seropositive); in immunosuppressed patients, including AIDS patients rupture of 'dormant' tissue cysts may lead to transformation of bradyzoites into tachyzoites and new multiplication; thus HIV infected patients often develop CNS (central-nervous-system) toxoplasmosis characterised by a focal encephalitis; human chemotherapy and chemoprophylaxis rely on drugs that affect tachyzoites rather than bradyzoites 'encapsulated' in the tissue cyst; <i>atovaquone</i> appears to be the most cytotoxic among drugs tested in the mouse model; in <i>ocular toxoplasmosis</i> with macular involvement, <i>corticosteroids</i> should also be used for an anti-inflammatory effect on the eyes; the antifolate PYR given with <i>sulfadiazine</i> is the treatment of choice for CNS toxoplasmosis; folinic acid is given concurrently to attenuate bone marrow suppression caused by PYR; length of treatment is determined by clinical response to therapy and can last for weeks; <b>feline toxoplasmosis</b> may be treated with clindamycin (12.5–25 mg/kg b.w. p.o. or i.m. q12h × 2 weeks) or sulfadiazine (30 mg/kg b.w.) plus PYR (0.25–0.5 mg/kg b.w.) p.o. q12h x 2 weeks) or sulfadiazine (30 mg/kg b.w.) plus PYR (0.25–0.5 mg/kg b.w.) p.o. q12h × 2 wks plus folinic acid (5 mg/d).	
<b>pyrimethamine (PYR)</b> (diaminopyrimidine) plus <b>sulfadiazine</b> (sulfonamide) Daraprim, others (standard treatment, drugs of choice)	PYR: 25–100 mg/kg/d × 3–4 weeks plus sulfadiazine 1–1.5 grams qid × 3–4 weeks plus folinic acid 10 mg with each dose of PYR; *PYR: 2 mg/kg/d × 3d, then 1 mg/kg/d (max. 25 mg/d) × 4 weeks plus sulfadiazine 100–200 mg/kg/d × 3–4 wks plus folinic acid 10 mg with each dose of PYR; congenitally infected newborns should be treated with PYR every 2 or 3 days and sulfonamide daily for about 1 year
<b>atovaquone</b> (hydroxynaphthoquinone) plus <b>pyrimethamine</b> (alternative regimen in sulfa-intolerant patients)	atovaquone (1.5 g p.o. bid with meals or p.c.) plus PYR and folinic acid appears to be an effective alternative in sulfa-intolerant patients
<b>pyrimethamine</b> plus <b>clindamycin</b> alternative treatment	50–100 mg/d × 3–4 wks plus clindamycin 450–600 mg per os or 600–120 mg i.v. qid plus folinic acid, 10 mg, with each dose of PYR
<b>spiramycin</b> (therapeutic use during first trimester of pregnancy) Rovamycine, others (alternative drug)	3–4 grams/d; after the first trimester, if there is no documented transmission to fetus, spiramycin can be continued until term; if it is determined that transmission has occurred <i>in utero</i> , therapy with PYR and sulfadiazine should be started; congenitally infected newborns should be treated with PYR every 2 or 3 days and a sulfonamide daily for about 1 year

**Treatment of Opportunistic Agents. Table 1** Drugs acting on opportunistic infections among HIV-exposed or infected humans (Continued)

DISEASE non-proprietary name (chemical group) Brand name other information	Adult dosage/*pediatric dosage (mg/kg b.w., or total dose/individual, oral route), miscellaneous comments
<b>ALTERNATIVE REGIMENS TO TREAT CNS TOXOPLASMOSIS:</b> In HIV-infected patients with cerebral toxoplasmosis, some clinicians have used PYR 50–100 mg/d after a loading dose of 200 mg with a sulfonamide and, when sulfonamide sensitivity developed, have given <i>clindamycin</i> (PYR 1.8–2.4 g/d in divided doses) instead of the sulfonamide; clindamycin with plus PYR (see above) has been proved an effective alternative for treatment of cerebral toxoplasmosis; also <i>atovaquone</i> plus PYR has been effective and well tolerated in insulfa-patients.	
<b>CHRONIC SUPPRESSION OF TOXOPLASMOSIS:</b> PYR and sulfadiazine or PYR and clindamycin are the most commonly used regimens for chronic suppression of toxoplasmosis; daily PYR and sulfadiazine appears to be more effective than a twice-weekly regimen.	
<b>pyrimethamine (PYR) plus sulfadiazine</b> standard treatment	PYR 25–50 mg per os daily plus sulfadiazine 500 mg-1g p.o. q6h plus folinic acid, 10 mg, with each dose of PYR
<b>pyrimethamine (PYR) plus clindamycin</b> alternative treatment	PYR 50 mg per os daily plus clindamycin 300 mg p.o. qid plus folinic acid, 10mg, with each dose of PYR
<b>PRIMARY PROPHYLAXIS OF TOXOPLASMOSIS:</b> in HIV patients: with $< 100 \times 10^6/L$ CD4 cells, either trimethoprim-sulfamethoxazole, PYR plus dapsone or atovaquone with or without PYR and folinic acid can be used; primary and secondary prophylaxis may be discontinued when CD4 count increases to $> 200 \times 10^6/L$ for $> 3$ mos; doses of trimethoprim-sulfamethoxazole used to prevent <i>Pneumocystis pneumonia</i> (PCP, see above) may also prevent first episodes of toxoplasmosis; daily dapsone and weekly pyrimethamine or both twice weekly may also prevent first episodes of toxoplasmosis	
<b>MICROSPORIDIOSIS</b> current information indicates that immunocompromised patients (as in HIV infected individuals) are at the greatest risk of developing microsporidial disease patterns such as ocular infections involving conjunctival, corneal epithelium and even corneal stroma (keratoconjunctivitis) or enteric infections associated with enteritis, colangitis and diarrhoea; there may also be multiorgan infection or systemic dissemination of microsporidians, including the liver, lungs and kidneys; treatment of microsporidial infections is problematic because of the intracellular habitat of the parasite stages and the resistant nature of the spores (for more information see → <a href="#">Microsporidiosis</a> )	
<b>OCULAR INFECTIONS</b> due to <i>Encephalitozoon hellem</i> , <i>Encephalitozoon cuniculi</i> , <i>Vittaforma corneae</i> ( <i>Nosema corneum</i> )	
<b>albendazole</b> (benzimidazole carbamate) licensed for treatment of various helminthes animals (cf. Nematocidal Drugs, Animals Benzimidazole Compounds) and humans (cf. → <a href="#">Nematocidal Drugs, Man/Table 1</a> ) Albenza, others (drug of choice)	400 mg bid (not licensed in the USA but considered investigational for this condition by the FDA, licensed in Europe and elsewhere); ocular lesions due to <i>E. hellem</i> in HIV infected patients have also responded to <i>fumagillin</i> eyedrops prepared from Fumidil-B, a commercial product, used to control a microsporidial disease of honey bees; for lesions due to <i>V. corneae</i> , topical therapy is generally not effective and keratoplasty may be required
<b>INTESTINAL INFECTIONS</b> due to <i>Encephalitozoon bienersi</i> , and <i>Encephalitozoon (Septata) intestinalis</i>	
<b>albendazole</b> (drug of choice)	400 mg bid octreotide (a somatostatin analogue, Sanostatin) has provided symptomatic relief in some patients with large volume diarrhoea; oral fumagillin has been effective in treating <i>E. bienersi</i> but has been associated with thrombocytopenia
<b>DISSEMINATED INFECTIONS</b> due to <i>Encephalitozoon hellem</i> , <i>Encephalitozoon cuniculi</i> , <i>Encephalitozoon intestinalis</i> , and <i>Pleistophora</i> sp.	
<b>albendazole</b> (drug of choice)	400 mg bid; there is no established treatment for <i>Pleistophora</i>

**Abbreviations:** the letter d stands for day (days); qd = daily (quaque die); qh = each hour; bid = twice daily; tid = three times per day; qid = four times per day (quarter in die); p.c. (post cibum) = after meals

**Dosages** listed in the table refer to information from manufacturer or literature, preferably from The Medical Letter (1998 and 2004) 'Drugs for parasitic Infections'

Data given in this table have no claim to full information

include the farm personnel) and sanitation, such as disinfection (ammonium hydroxide) and thorough cleaning in contaminated farms. During the calving period, calving cows must be separated from other animals and newborn calves too. Oral and parenteral rehydration therapy is essential in animals with severe diarrhea to maintain the fluid balance. Also management in AIDS patients has principally included fluid therapy, use of antidiarrheal agents and nutritional support. For treatment of microsporidiosis, **albendazole** decreases diarrhea (sometimes eradication of the organism) caused by *Encephalitozoon intestinalis*. **Nitazoxanide** has been used for treatment of *E. bienersi* infection among HIV-infected adults (for Fumagillin treatment cf. [Table 1](#)).

### Drugs Acting on Toxoplasmosis

The cyst-forming coccidian parasite →*Toxoplasma gondii* is widespread in human beings and many warm-blooded animals, and cats including wild Felidae, are the only definitive hosts excreting *T. gondii* oocysts in their feces. The domestic cat appears to be the major source of contamination with oocyst since a cat can excrete millions of oocyst surviving for long periods under ordinary →[environmental conditions](#) (e.g., in moist soil). Despite the fact that cats are frequently infected clinical signs are rare. Feline toxoplasmosis can be treated with clindamycin or sulfadiazine plus antifolates (cf. [Table 1](#)).

**Ovine toxoplasmosis** may be associated with →[abortion](#) in ewes and perinatal mortality in lambs. Toxovax (Internet), commercially available in Europe and New Zealand, is a live vaccine containing *T. gondii* →[tachyzoites](#) of the S 48 “incomplete” strain. The vaccine is used for the control of ovine toxoplasmosis and reduces fetal losses in sheep in endemic areas (withdrawal time: 6 weeks).

**Human toxoplasmosis** is most often the result of ingestion of tissue cysts in raw or undercooked meat from pigs, sheep and rabbits (less prevalent in cattle). Exposure to heat (70°C) and cold (−15°C) can kill parasites in meat. Good hygiene and sanitation can help to control infection; hands of people preparing raw meat and all materials (cutting boards, knives, etc.) coming in contact with uncooked meat should be washed with soap and water, and rinsed thereafter thoroughly with tap water. To avoid oral infection with oocysts shed by cats gloves should be worn while gardening, and vegetables should be washed thoroughly before eating because of possible contamination with cat feces. Pet cats should be fed only cooked food. **Pregnant women**, in particular, should not eat raw or uncooked meat and avoid contact with cats and soil because of risk of a congenital infection. The infected fetus may develop full tetrad of signs, i.e., retinochoroiditis, →[hydrocephalus](#), convulsions and intracerebral calcification. In the USA the overall risk for maternal-fetal transmission in women

without HIV infection who acquire *primary Toxoplasma* infection during pregnancy is 29%; the risk of primary congenital infection sharply increases during the last few weeks of pregnancy (up to 81%). Infection of the fetus in early gestation usually results in more severe involvement.

Patients with AIDS often develop central nervous system (CNS) toxoplasmosis (focal encephalitis). **Currently used drugs** and dosages for treating the disease in individuals are shown in [Table 1](#). In AIDS patients, ‘dormant’ developmental stages of *T. gondii* (tissue cysts containing →[bradyzoites](#)) are reactivated thereby altering the latent infection to an acute one. The drug of choice for treating CNS toxoplasmic →[encephalitis](#) is oral pyrimethamine (e.g. Daraprim GSK) plus sulfadiazine, usually given for 3 to 5 weeks depending on clinical response, plus folinic acid (for dosage regimen cf. [Table 1](#)). Concurrently given drugs may cause severe adverse reactions in approx. 40% of the so treated patients, though folinic acid may reduce bone marrow suppression caused by pyrimethamine. *Alternative regimens* can be used in patients with failure to pyrimethamine plus sulfadiazine treatment or intolerance to these drugs. On the other hand these regimens may be used for treatment of mild to moderate cerebral toxoplasmosis as oral pyrimethamine given concurrently with clindamycin or other atovaquone (ATQ) plus pyrimethamine (PYR) and folinic acid, or ATQ with sulfadiazine (SFD) alone, or ATQ as a single agent in patients intolerant to both PYR and SFD, or trimethoprim plus sulfamethoxazole alone: all these alternative regimens have been used in adults only and have not been studied among children. Experimental drugs with good activity against *T. gondii* in mice are diclazuril and toltrazuril (→[Coccidiocidal Drugs](#)). Although the action of diclazuril on tachyzoites can be enhanced by combination with pyrimethamine this drug mixture is not able to prevent →[tissue cyst](#) formation in surviving mice.

---

## Trematocidal Drugs

### Synonym

→[Trematodocidal Drugs](#).

---

## Trematode Infections

→[Platyhelminthic Infections, Man](#), →[Pathology](#).

## Trematodes

### Name

Greek: *trema* = hollow (means the sucker), *todein* = porting.

The term Trematodes comprising digeneans and monogeneans is thought by some authors to be an artificial grouping since all morphological evidence, especially at the ultrastructural level, suggests that the →*Monogenea* are more closely related to the Cestoda than to the →*Digenea* and →*Aspidogastrea* (→*Platyhelminthes/System*).

## Trematodocidal Drugs

**Overview:** see [Tables 1, 2](#).

### Current Status of Structurally Different Flukicides

Some of the medications are no longer available, but will be considered for historical understanding of drug evolution and use. The anthelmintic activity of carbon tetrachloride and hexachloroethane was discovered between 1921 and 1926. Despite their high toxicity and variable efficacy, these halogenated hydrocarbons had been used for many years in the chemotherapy of various trematode diseases, primarily against *Fasciola* infections in cattle. Later, hexachloroparaxylene (*Hetol* former Hoechst), and the carbon acid piperazine derivative 1-β,β,β-tris-(p-chloro-phenyl)-propionyl-4-methyl-piperazine hydrochloride (*Hetolin*, former Hoechst) showed better tolerability and enhanced efficacy against adult liver flukes such as *F. hepatica* and *Dicrocoelium dendriticum*, and paramphistomes (rumen flukes) in cattle and sheep. Current flukicides for use in cattle and sheep come from various chemical groups: **Halogenated phenols and bisphenols**, e.g., hexachlorophene (used since the late 1950s but now discontinued in most countries), *bithionol* (with a sulfur bridge between the 2 phenol rings), which is used to a limited extent against *F. hepatica* and intestinal fluke infections of humans (cf. [Table 2](#)), and the corresponding structural variants *bithionol sulfoxide* and *bithionolate sodium*. They were predominantly used as antimicrobials with activity against bacteria and fungi. *Niclofolan* (syn. menichlopholan, having 2 phenol rings linked directly via a carbon bond) is highly active against mature *F. hepatica* but has been discontinued in many countries. In the late 1960s, the monophenolic *nitroxynil* (syn. nitroxinil, having an electron-withdrawing nitro

group and a cyano group in ortho- and para-position) was developed in the UK as an injectable formulation. In Australia, the drug is currently approved for the control and treatment of liver fluke, barber's pole worm (*Haemonchus contortus*) and nodule worm (*Oesophagostomum*) infections in cattle and sheep (cf. [Table 1](#)). *Bromofenofos* (or bromophenophos, an organophosphate structurally similar to a masked bisphenol derivative, former Acedist Merial) and the monophenolic resorcylianilide *resorantel* (former Terenol Hoechst) are no longer available in EC, USA, Australia, and elsewhere. In cattle and sheep, the 2 drugs proved highly effective against mature *F. hepatica* and young and adult stages of *Paramphistomum* spp. (intestinal flukes), respectively. **Halogenated salicylanilides** that may be regarded as close analogues of the bisphenols with a carboxamide group connecting the 2 aromatic rings as in case of *bromsalans* (cf. [Table 1](#)) were discovered in 1963. Inexpensive bromsalans, which consist of a certain mixture of 3,4', 5-tribromosalicylanilide (tribromsalan, the active principle), and 4', 5-dibromosalicylanilide (dibromsalan, a germicide), may still be used in many countries against mature and immature *Fasciola hepatica* infections in sheep (simultaneous use of benzimidazole with *bromsalans* can cause severe adverse effects and even mortality in cattle); further structural modifications in this group led to a number of modified salicylanilides like *brotianide*, *bromoxanide*, and *clioxanide*; they have been discontinued in most countries (not considered in [Table 1](#)). Other salicylanilides such as *oxyclozanide* and *closantel* (cf. [Table 1](#)) are still in use; *rafoxanide* that has been used in Australia and Europe for a long time is no longer approved in Australia (USA and elsewhere), it is approved in the EC but not commercially available in Germany and elsewhere. Oxyclozanide is only available as combination with levamisole, and closantel may be combined with other nematocidal anthelmintics such as oxfendazole or abamectin; these combinations are commercially available in Australia and elsewhere. Closantel also provides a sustained control of susceptible Barber's pole worm (*Haemonchus contortus*) infections in sheep. **Bisanilino compounds** initially synthesized as mono- and bisanilino structures in the late 1960s, had caused serious toxic side effects (visual disorders and blindness) in ruminants. Only *diamfenetide* (cf. [Table 1](#)), introduced much later in the early 1970s in form of the bisacetylated prodrug, exhibits an excellent activity against immature *F. hepatica* and is tolerated well in sheep. Its rapid deacetylation in the liver leads to the active metabolite whose effectiveness decreases as the flukes grow old (the drug is no longer approved in the USA, Australia, Germany, and elsewhere). **Benzimidazoles** generally affect mature stages of *F. hepatica*; in the USA, *albendazole* (cf. [Table 1](#)) is approved as a flukicide, and in Australia it is commercially available as

**Trematodocidal Drugs. Table 1** Drugs used against trematode infections of domestic animals

<b>CHEMICAL GROUP</b> International nonproprietary name (INN) (single oral dose, mg/kg body weight = b.w.), other information	<b>*DRUG PRODUCT</b> dose form (formulation), withdrawal time (WT) days (d) before slaughter, manufacturer, supplier, other information	<b>CHARACTERISTICS:</b> miscellaneous comments on pharmacokinetics, metabolism, mode of action, toxicity, and limitations
<b>MONOPHENOLIC DERIVATIVES</b>		
<b>nitroxylin (NXN)</b> (syn. <i>nitroxinil</i> : EC) (8.5–10.2 s.c. sheep, cattle) (cattle: *1.5mL/50kg b.w., sheep: *0.25mL/10kg b.w.) <b>limitation:</b> contraindicated for use in lactating animals	<b>*Trodax</b> (Fort Dodge, Merial, Australia), (340 g NXN/ L as eglumine salt), liquid for subcutaneous injection (usually as water-soluble N-ethylglucamine salt), WT: sheep, cattle 28 d (not approved in the USA, evaluated by EMEA, EC: no drug products available in Germany, elsewhere)	developed in the UK as an injectable fasciolicide in the late 1960s; it is effective against <i>Fasciola hepatica</i> and <i>F. gigantica</i> infections but not the rumen fluke ( <i>Paramphistomum</i> ) in cattle and sheep; it has some activity against GI nematodes such as <i>Haemonchus contortus</i> and <i>Parafilaria bovicola</i> ; there is a reasonably good activity against <i>F. hepatica</i> (activity: 50–90%:
flukes aged 6–8 weeks is erratic, 90–99%: flukes aged 10–14 weeks); it exhibits good activity against <i>F. gigantica</i> but not so against paramphistomes; <b>approved indications</b> in Australia: sheep and cattle: liver fluke; sheep: plus barber's pole worm; cattle: plus barber's pole worm, hookworms, and nodule worm); NXN is also administered to game birds (pheasant, red legged partridge poults) in drinking water for the treatment syngamiasis caused by <i>Syngamus trachea</i> and/or <i>Cyathostoma bronchialis</i> (evaluated by EMEA, EC); at recommended dose, its antitrepatodal effect against immature flukes is slightly inferior to that of rafoxanide (↓); <b>mode of action:</b> it is of similar structure to the herbicides ioxynil and bromoxynil; like them it is an uncoupler of oxidative phosphorylation (27–35 μM = 93–121 μg/mL in rat liver mitochondria); its mode of action is attributed to this effect; it also affects adversely fluke spermatogenesis (reduced fertile eggs of surviving flukes); <b>pharmacokinetics and metabolism:</b> peak plasma concentration (in rats) ~67 μg/mL 5 hours after dosing with 10 mg/kg b.w.; terminal half-life in plasma was ~22 hours; excretion was predominantly via the urine and consisted of a mixture of metabolites together with some unchanged NXN; in cattle, sheep and rabbits, the drug was highly bound (97–98%) to plasma protein, and in all species residues in plasma were higher than those in tissues and consisted almost entirely of NXN; in cattle and sheep it is extensively metabolized, and unmetabolized NXN was the major component of the residues in muscle and fat; chemical structure of some of the metabolites (e.g., 4-cyano-2-nitrophenol) suggested that they would have toxicological properties similar to those of NXN; <b>tolerability:</b> it is well tolerated in cattle and sheep at the recommended dose level; doses of 20 mg/kg b.w. may cause minimal side effects such as hyperthermia and hyperpnoea associated with uncoupling of oxidative phosphorylation; doses of 40 mg/kg b.w. and above may cause death of target species; administration of *Trodax may cause some yellow staining of fleece in sheep, and local reactions at injection site		
<b>SALICYLANILIDES</b>		
<b>bromsalans</b> (various mixtures of <i>tribromsalan</i> and <i>dibromsalan</i> ) (30–50 sheep)	drug products may be available in some countries; (no longer approved in the USA and Australia?, not approved in EC, elsewhere)	for treatment of mature and immature liver fluke ( <i>Fasciola hepatica</i> ) infections; drug mixtures show good but somewhat erratic activity (40–98%) against mature <i>F. hepatica</i>
aged 12 weeks and above; efficacy against juvenile flukes (6-10-week-old) is good (90–99%); maximum tolerated dose in sheep is approx. 90mg/kg b.w. (safety index ~3); in cattle, bromsalans are not compatible with benzimidazole carbamates (BZs) (cf. →Nematocidal Drugs, Animals/Table 1 →BZs, such as fenbendazole, oxfendazole albendazole); <b>contraindication:</b> do not administer BZs in cattle within 7 days of a <i>bromsalans</i> flukicide: simultaneous use of BZs with <i>bromsalans</i> causes severe (fatal) adverse effects in cattle		
<b>oxyclozanide/ levamisole HCl</b> (OCZ /LEV ) (150 g OCZ//64 g LEV/L) (5mL/45 kg b.w. cattle) (1mL/10 kg b.w. sheep)	<b>*Coopers Nilzan LV</b> (Schering Plough Australia), oral liquid (drench), WT: cattle 14 d, milk 0d, sheep 14 d (see limitations: milk)	OCZ was introduced for its fasciolidal activity in 1966; it is active against adult liver fluke infections and in some countries combined with LEV hydrochloride (HCl) to offer broad-spectrum anthelmintic treatment; OCZ
is highly active against mature <i>Fasciola hepatica</i> (efficacy 90–99% against flukes aged 10–14 weeks); repeated doses (3 × 15mg/kg) show some activity against immature flukes; drug has been primarily used in treating acute fascioliasis; it has a moderate effect against the rumen fluke ( <i>Paramphistomum</i> : immature stages: cattle ~60%, sheep 80–92%, and mature		

**Trematodocidal Drugs. Table 1** Drugs used against trematode infections of domestic animals (Continued)

CHEMICAL GROUP International nonproprietary name (INN) (single oral dose, mg/kg body weight = b.w.), other information	*DRUG PRODUCT dose form (formulation), withdrawal time (WT) days (d) before slaughter, manufacturer, supplier, other information	CHARACTERISTICS: miscellaneous comments on pharmacokinetics, metabolism, mode of action, toxicity, and limitations
<p>stages: cattle, sheep 70–90%); OCZ (at 15 mg/kg) has been found partially effective against immature and mature <i>Fascioloides magna</i> in cattle; however, this effect is considered unsatisfactory since a single migrating fluke can kill the host; it exhibits efficacy against the fluke <i>Notocotylus attenuatus</i> in ducks (at 15 mg/kg b.w., well-tolerated oral liquid, or 30 mg/kg in feed.); maximum tolerated dose of OCZ in sheep is 60 mg/kg b.w. (safety index ~4); <i>mode of action</i>: like other salicylanilides and substituted phenols it is an uncoupler of oxidative phosphorylation; following absorption in the gut it is excreted as an active glucuronide metabolite into bile (terminal half-life 6.5 days); it has been used at therapeutic doses in debilitated and pregnant animals without side effects; OCZ/LEV include efficacy against roundworms, including lungworms, and BZs resistant <i>Haemonchus contortus</i> particularly in sheep (details cf. →Nematocidal Drugs, Animals/Table 1 →levamisole); it should also assist in removal of tapeworm segments in sheep and lambs; <i>limitations</i>: do not use *Nilzan LV in sheep, which are producing or may in future produce milk or milk products for human consumption; do not administer to dogs or horses</p>		
<p><b>rafoxanide</b> (RFX) (7.5–15 mg/kg b.w. per os cattle, sheep) like <i>oxyclozanide</i>, RFX is a salicylanilide; [current status in EC (EMA): establishment of MRLs was requested for nonlactating cattle and sheep: RFX is included in Annex I Council Regulation (EEC) No. 2377/90, currently no drug products on the German market, not approved in USA, Australia, and elsewhere] RFX was developed in 1969 and subsequently has had commercial use for fascioliasis in various countries (Australia, SA, UK, Europe, Brazil); it proved highly active against mature <i>Fasciola hepatica</i>, and <i>F. gigantica</i> (efficacy ~100% against flukes aged 12–14 weeks, 85–97% against flukes aged 6–8 weeks, and 50–85% against flukes aged 4 weeks); the drug has been used for strategic treatment and chemoprophylaxis (long-lasting effect due to binding of RFX to plasma proteins) to reduce pasture contamination; at 10 and 15 mg/kg b.w., it proves 100% effective against immature and mature <i>Fascioloides magna</i> and juvenile paramphistomes in sheep; it is also active against GI nematodes (<i>Haemonchus</i>, <i>Bunostomum</i>, <i>Gaigeria</i>, and <i>Oesophagostomum</i>) and the sheep nasal bot fly (<i>Oestrus ovis</i>); at recommended dose, the drug is well tolerated in sheep and cattle of all ages; <i>mode of action</i> is uncoupling of oxidative phosphorylation of flukes, including reduced ATP levels, decreased glycogen content, and accumulation of succinate; in sheep, drug is extensively bound (&gt;99%) to plasma proteins and has a long terminal half-life (~17 days), maximum tolerated dose (sheep) is ~45mg/kg b.w. per os; RFX is contraindicated in lactating animals and may have an extreme long withdrawal times (several months) in cattle and sheep</p>		
<p><b>closantel</b> (CST) (7.5 sheep, 10 cattle) <i>approved</i> <i>indications</i>: for the sustained control of <i>H. contortus</i> and control of liver fluke (and nasal bots in sheep and lambs) <i>limitations</i>: do not use in animals which are producing or may in future produce milk or milk products for human consumption</p>	<p>*Closamax Closantel (Pharmtech Australia, elsewhere), others, oral liquid for sheep and lambs (37.5 g CST/1L: 1mL/5 kg b.w. = 7.5mg/kg bw), WT: sheep, lambs 28 d; *Flukiver (Janssen-Cilag Germany, elsewhere), oral liquid (54.375 mg CST Na/ 1mL: 1mL/5 kg b.w. = 10.87 mg/ kg b.w.) WT: cattle 28 d, sheep 42 d</p>	<p>introduced principally as a flukicide for sheep and cattle in the 1970s; its efficacy in either host is &gt;95% for 8-week-old and adult <i>Fasciola hepatica</i> (efficacy 70–80% against 6-week-old stages migrating in the liver); at 15 mg/kg b.w. CST is active (~95–98%) against 8-week-old <i>Fascioloides magna</i> in sheep; it is inactive against the rumen flukes (paramphistomes); at</p>
<p>recommended dose, it shows also activity against strains of Barber's pole worm (<i>Haemonchus contortus</i>) of sheep resistant to ivermectin, BZs, levamisole, morantel, and rafoxanide; however, there are strains of <i>H. contortus</i>, which have developed resistance to CST; it has been used in horses to prevent or reduce <i>Strongylus vulgaris</i> infections and infestations with bots (<i>Gasterophilus</i> spp.) and nasal bot <i>Oestrus ovis</i> in sheep; it is also active against adult stages of <i>Ancylostoma caninum</i>; <i>mode of action</i>: flukicidal action of CST has been linked to its capacity for uncoupling electron-transport-associated phosphorylation and possibly the site-1 phosphorylation of ADP associated with reduction of fumarate to succinate; <i>pharmacokinetic and metabolism</i>: like rafoxanide, CST is extensively bound (&gt;99%) to plasma proteins (mainly albumin) and has a long terminal half-life (~15days); metabolic studies in cattle have shown that CST was poorly metabolized in the majority of tissues, except liver; it represented at least 70% of total residues in fat, 80% in kidneys, and 100% in muscle: on the other hand it represented only 10% in liver; kinetic studies using radiolabeled elements have shown that the radioactivity concentration ratio between plasma and tissues did not vary with time for the bovine nor for the ovine species; prolonged residuals may prevent <i>Haemonchus</i> and <i>Fasciola</i> infections up to 60 days post treatment; CST is primarily excreted via feces (80%; urine &lt;05%); <i>tolerability</i>: the drug is well tolerated in sheep and cattle (also in reproduction studies in rams, ewes, and bulls); safety margin in sheep and cattle is ~4; overdosing (&gt;4 times the therapeutic dose) may cause ataxia, weakness, inappetence, and visual disorders (and blindness); there is no antidote</p>		

**Trematodocidal Drugs. Table 1** Drugs used against trematode infections of domestic animals (Continued)

CHEMICAL GROUP International nonproprietary name (INN) (single oral dose, mg/kg body weight = b.w.), other information	*DRUG PRODUCT dose form (formulation), withdrawal time (WT) days (d) before slaughter, manufacturer, supplier, other information	CHARACTERISTICS: miscellaneous comments on pharmacokinetics, metabolism, mode of action, toxicity, and limitations
*1 closantel (CST)/ <b>oxfendazole</b> (OFZ) (7.5/4.52 sheep) *2 closantel (CST)/ <b>abamectin</b> (ABA) (10/0.2 sheep) *2 <b>limitations</b> : do not use in lambs under 6 (six) weeks of age; do not use in lambs under 10 kg b.w. ( <b>closantel/albendazole</b> cf. albendazole ↓)	1*Cloisicomb (Virbac BASF Australia, elsewhere) others, oral liquid (drench) with sustained action (37.5 g CST/L// 22.6g OFZ/L: 1mL/5 kg b.w.), WT: sheep 28 d 2*Genesis XTRA (Ancare Australia, elsewhere), oral liquid (drench) with sustained action (50 g CST/ L// 1gABA/ L: 1mL/ 5 kg b.w.), WT: sheep 49 d	1* for control of susceptible mature and immature GI nematodes and tapeworms ( <i>Moniezia</i> spp.), lungworms ( <i>Dictyocaulus filaria</i> ), liver fluke ( <i>Fasciola hepatica</i> ) including 4-week- old immature stages, all stages of nasal bots ( <i>Oestrus ovis</i> ), and sustained control of susceptible Barber's pole worm ( <i>Haemonchus contortus</i> ) in sheep; can be used at recommended
dose in sheep of all ages including pregnant ewes; 2* for control and treatment of roundworms, nasal bot, itch mite ( <i>Psorergates ovis</i> ), and mature and late immature liver fluke in sheep with sustained activity against resistant strains of Barber's pole worm in sheep (including strains resistant to macrocyclic lactones); <b>limitations</b> : do not use in ewes, which are producing or may in the future produce milk or milk products for human consumption		
<b>BISANILINO COMPOUNDS</b> or <b>PHENOXYALKANES</b> : <b>diamfenetide</b> (former *Coriban Wellcome) syn. acemidophene, former USSR (100 mg/kg per os sheep, goats) no longer approved in the USA, Australia, Germany (EC), and elsewhere; chemically a bisacetamide or bisacetanilide (or may be regarded as masked aromatic diamidine) that is enzymatically converted in liver cells of sheep (deacetylation by deacylases) to the bisanilino compound; this amine metabolite is highly effective (91–100%) against early immature <i>Fasciola hepatica</i> aged 1 day to 9 weeks; thus very juvenile flukes passing through the liver parenchyma become rapidly killed by high local concentrations of the bisanilino compound; older and mature flukes located in bile ducts may survive because of obviously quick catabolism of the very toxic bisanilino compound, and concentrations of the active metabolite till reaching mature flukes are too low to kill them; thus there is a gradually lower activity (70–50%) with aging of the fluke; the drug was very useful for treating acute fascioliasis and in prophylactic control programs against liver fluke disease in sheep (e.g., repeated treatment, interval 6–8-weeks: 2 × in spring and 2 × in autumn, or combined with a flukicide acting against flukes aged 6–14 weeks); at 200 mg/kg it proved active (85–93%) against adult stages of the small liver fluke ( <i>Dicrocoelium dendriticum</i> ) in sheep; following oral administration, the drug was absorbed into blood and distributed via circulation throughout the body (peak concentration in liver and gallbladder was reached 3 days post dosing, and then drug levels declined to negligible values within 7 days); diamfenetide was well tolerated at recommended dose (no teratogenic in pregnant ewes, or adverse effects on fertility in ewes or rams, maximum tolerated dose in sheep: 400 mg/kg b.w.; 1600 mg/kg b.w. caused low incidence of mortality)		
<b>BENZIMIDAZOLES</b> (BZs) among the BZs (cf. → <b>Nematocidal Drugs, Animals</b> ), only albendazole (ABZ ↓) and triclabendazole (TCBZ ↓) have therapeutic activity against adult stages of <i>Fasciola hepatica</i> and <i>F. magna</i> in cattle and sheep; <b>fenbendazole</b> (FBZ) is not as effective as ABZ and TCBZ against the liver fluke (not approved indication, and others following) but apparently has good activity against <i>Dicrocoelium dendriticum</i> in sheep at 150 mg/kg × 1, or 20 mg/kg/d × 5d, and some activity (~70% after 7.5mg/kg bw in feed for 6d) against adult and migrating (immature) stages of rumen flukes ( <i>Paramphistomum</i> ) of cattle, and against <i>F. gigantica</i> infection (~90%: 5 mg/kg b.w. × 1) in sheep; in experimental studies, FBZ has been shown to cure infections with the blood fluke <i>Heterobilharzia americana</i> (40 mg/kg b.w. daily for 10 d) in dogs, and infections with pancreatic fluke <i>Eurytrema procyonis</i> (30 mg/kg b.w. daily for 6 d) in cats; at enhanced dose levels (15 mg/kg b.w.), <b>oxfendazole</b> shows also good activity (~95%) against adult stages of <i>F. hepatica</i> in sheep and cattle; also other BZs proved to be active (~90%) against adult <i>D. dendriticum</i> , e.g., albendazole (7.5–15 mg/kg × 2: weekly interval), cambendazole (25 mg/kg × 1), thiabendazole (200 mg/kg × 1), or mebendazole (20 mg/kg × 1); proved uneconomically and were illegal at enhanced doses (15–20 mg/kg b.w.), <b>netobimin</b> (prodrug of ABZ/ABZ sulfoxide) affects adult stages of flukes such as <i>D. dendriticum</i> (90–98% efficacy) and <i>F. hepatica</i> (~90% efficacy); however, most of these doses proved uneconomically; <b>contraindication</b> : do not administer BZs within 7 d of a bromsalans flukicide because of severe adverse reactions which result after coadministration of these drugs and which may be fatal in cattle		



**Trematocidal Drugs. Table 1** Drugs used against trematode infections of domestic animals (Continued)

CHEMICAL GROUP International nonproprietary name (INN) (single oral dose, mg/kg body weight = b.w.), other information	*DRUG PRODUCT dose form (formulation), withdrawal time (WT) days (d) before slaughter, manufacturer, supplier, other information	CHARACTERISTICS: miscellaneous comments on pharmacokinetics, metabolism, mode of action, toxicity, and limitations
<b>triclabendazole</b> (TCBZ) (12 cattle) (10 sheep, goats) 2*Fasinex 120 (Novartis AH Australia) others, oral liquid for cattle and sheep (120 g TCBZ/L: cattle 5 mL/50 kg b.w., sheep 1 mL/12 kg b.w.), WT: sheep, cattle 28 d, 3*Fasinex 10% (Novartis AH Germany, elsewhere), oral liquid for cattle and sheep (10 g TCBZ/100mL: cattle 6 mL/ 50 kg b.w., sheep 1mL/10 kg b.w.), WT: sheep, cattle 50 d	1*Fasinex 100 (Novartis AH Australia), oral paste (100 g TCBZ/L: cattle 6mL/ 50 kg b.w., sheep 1mL/10 kg bw), WT: sheep, cattle 21 d, 1*, 2*, 3* <b>indications:</b> for treatment of susceptible early immature, immature and mature liver fluke in sheep, cattle, and goats of all ages, including pregnant animals 1*, 2*, 3* <b>limitations:</b> do not use in lactating animals where milk or milk products may be used for human consumption	a thiobenzimidazole derivative introduced in 1983 as a flukicide for use in cattle and sheep in Europe, Australia, SA, USA (no longer approved), and elsewhere; it has been investigated as a fasciolicide in <i>humans</i> showing promising results in treating human fascioliasis, it appears to be a safe and effective drug; it is now used as drug of choice for the treatment of <i>F. hepatica</i> infections in humans (cf. Table 2↓); in <i>veterinary medicine</i> , use of TCBZ is limited to <i>liver fluke</i> infection in cattle, sheep, and goats and some other fluke
infections of horses and wild animals (e.g., deer); it is principally active against adult flukes, and immature stages of <i>F. hepatica</i> in sheep are affected (98–100% efficacy) by gradually elevating the dosage of the drug (2.5 mg/kg b.w. 12-week-old flukes, 5 mg/kg b.w. 10-week-old flukes, 10 mg/kg 6–8-week-old flukes, 12.5 mg/kg 1–4-week-old flukes, and 15 mg/kg 1-day-old flukes); thus doses of 10 mg/kg for sheep and 12 mg/kg for cattle are recommended in either acute, subacute, or chronic fascioliasis; typically, an oral dose of 10 or 12 mg/kg b.w. is administered to sheep and cattle, respectively, at 8–10-week intervals during the fluke season, or at 5–6 week intervals in acute or subacute cases; TCBZ proved effective against <i>F. hepatica</i> infections in horses (12 mg/kg), <i>F. gigantica</i> in cattle (12 mg/kg), and <i>Fascioloides magna</i> in deer (10 mg/kg) and sheep (20 mg/kg); <b>pharmacokinetics and metabolism:</b> following oral or intraruminal administration TCBZ is rapidly metabolized to its sulfoxide and sulfone (maximum plasma concentrations 12–38 h after dosing); metabolites are bound to albumin and persist in plasma for up to 7 d; excretion is chiefly via bile (~50%) and then feces; EMEA/CVMP/320386/2005-FINAL →TCBZ: in a radiometric study in cattle, urine and feces elimination accounted for 2.2% and 76% of the 12 mg/kg b.w. dose, respectively, equaling a total 7 d elimination of 81.49% of the administered dose; absorption (urine content and unrecovered dose) accounted for 21% of the administered dose; pharmacokinetic studies in rats, rabbits, dogs, sheep, cattle, goats, and humans indicated qualitative similarities in metabolism with sulfone, sulfoxide, ketone, and the 4-hydroxyderivatives of TCBZ identified in plasma and feces; the only metabolite identified in urine was 2-benzimidazolone; in the rat the predominant identifiable metabolites in feces were the sulfoxide and 4-hydroxy-derivatives; in sheep and goats, TCBZ and 4-hydroxyderivatives were the major components; plasma kinetics studies of sulfoxide and sulfone derivatives in various species after oral dosing showed the sulfoxide to predominate in rabbits, sheep, and humans, and the sulfone in the horse, dog, and cattle; pharmacokinetics in most species appear to be linear, although there is evidence of a deviation from linearity in the rabbit, possibly due to coprophagy; plasma Tmax for the sulfoxide was around 6–12 h in most species, 22 h in cattle, at oral doses of 10–12 mg TCBZ/kg b.w.; plasma Tmax for sulfone was around 12–30 h in most species and 72 h in cattle; <b>tolerability:</b> TCBZ is a safe and well-tolerated drug at recommended dose (safety index >10), and can be simultaneously used with other nematocidal drugs (cf. fixed-dose <b>combinations</b> ↓: TCBZ has no effect on nematodes, including <i>Haemonchus contortus</i> ); maximum tolerated dose in sheep is 200 mg/kg (has not yet been reported in cattle, or goat); on the Australian market there are a variety of drug products from various suppliers that contain TCBZ and a nematocidal drug (examples see below)		
*1 <b>triclabendazole</b> (TCBZ)/ <b>oxfendazole</b> (OFZ) (12/4.53 cattle)	1*Flukazole Combination (Virbac BASF Australia); oral liquid for cattle (120 g TCBZ/L// 45.3 g OFZ/L: 1mL/10 kg bw), WT: cattle 21 d	1*: for control of BZ-sensitive mature and immature roundworms, lungworms, tapeworms, and early immature, immature, and mature liver fluke in cattle; <b>limitations:</b> do not use in cows which are producing milk or milk products for human consumption; do not administer within 7 d of a bromsalans flukicide

**Trematodocidal Drugs. Table 1** Drugs used against trematode infections of domestic animals (Continued)

<b>CHEMICAL GROUP</b> <b>International nonproprietary name (INN)</b> (single oral dose, mg/kg body weight = b.w.), other information	<b>*DRUG PRODUCT</b> dose form (formulation), withdrawal time (WT) days (d) before slaughter, manufacturer, supplier, other information	<b>CHARACTERISTICS:</b> miscellaneous comments on pharmacokinetics, metabolism, mode of action, toxicity, and limitations
triclabendazole (TCBZ)/ <b>ivermectin</b> (IVER) *2 (12/0.2 cattle) *3 (24/1.5 topically cattle) (240g TCBZ/L// 15g IVER/L: 1mL/10kg bw)	2*Fasimec Cattle Oral (Novartis AH Australia) others, oral liquid for cattle (120 g TCBZ/L// 2 g IVER/ L: 5 mL/50 kg b.w.), WT: 21 d 3* Coopers Sovereign Pour-ON (Schering-Plough Australia) topical liquid for cattle; WT: cattle 28 d	2*: for treatment of TCBZ-sensitive early immature, immature, and mature liver fluke in cattle; for treatment and control of IVER sensitive strains of roundworms and lungworm, and sucking lice of cattle; not to be used for animals producing milk for human consumption or processing 3*: for treatment and control of IVER-sensitive GI roundworms, lungworm, and adult liver fluke of cattle; do not use on dairy cows except replacement heifers; do not use on dairy replacement heifers within 70 d (10 weeks) of calving
*4 <b>triclabendazole</b> (TCBZ)/ <b>abamectin</b> (ABA) (30/0.5 topically cattle)	4*Fasimec Cattle Pour-On (Novartis AH Australia) others, topical liquid for cattle (300 mg TCBZ/mL// 5 mg ABA/ mL: 1mL/10 kg bw), WT: cattle 49 d	4*: for treatment and control of roundworms, liver fluke (all 3 stages), and external parasites of beef cattle; do not use in dairy animals producing or which will in the future be producing milk for human consumption; this product is contraindicated for use in calves under 50 kg b.w.
*5 <b>triclabendazole</b> (TCBZ)/ <b>moxidectin</b> (MOX) (10/0.2 sheep)	5*Cydectin Plus Fluke (Fort Dodge Australia) oral liquid for sheep (50 mg TCBZ/ mL// 1mg MOX/mL: 1mL/ 5 kg b.w.), WT: sheep 21 d	5*: for treatment and control of MOX sensitive GI parasites (incl. BZ and/or levamisole resistant strains), lungworm, TCBZ sensitive strains of liver fluke, and itchmite ( <i>Psorergates ovis</i> ) of sheep; do not use in female sheep producing or may in the future produce milk or milk products for human consumption; not recommended for use in goats as safety/efficacy has not been evaluated
<b>albendazole</b> (ABZ) ABZ sulfoxide (7.5–10 cattle) (4–7.5 sheep, lambs, goats)	for detailed information on drug products (incl. other ABZ-combinations), their indications and limitations cf. → <a href="#">Nematocidal Drugs, Animals/Table 1</a>	<b>approved indications:</b> for removal and control of the following internal parasites of cattle and sheep: adult liver flukes ( <i>Fasciola hepatica</i> ; also reduces the output of viable worm and fluke eggs), BZ-sensitive mature and immature gastrointestinal roundworms
(including inhibited type II <i>Ostertagia</i> larvae), lungworms, tapeworms; <b>contraindication:</b> do not administer BZs within 7 d of a <i>bromsalans</i> flukicide because of severe adverse reactions, which result after coadministration of these drugs and which may be fatal in cattle; <b>experimental studies:</b> therapeutic activity of ABZ against adult stages of <i>F. hepatica</i> (75–100%) and <i>Fascioloides magna</i> (60–99%) at a single dose of 10 mg/kg b.w. in cattle and 7.5 mg/kg b.w. in sheep is unique among BZs; at latter doses, activity for immature (3–4-week-old stages) <i>Fasciola</i> in cattle is weak (20–25%) but increased (to 75%) at higher dosages (50 mg ABZ/kg b.w.); greatest activity against liver fluke infection in sheep has been obtained by using the drug prophylactically (3 mg ABZ/kg b.w. d for 35 d); ABZ is also effective for adult <i>D. dendriticum</i> (7.5–15 mg/kg × 2: weekly interval)		
albendazole (ABZ)/ <b>closantel</b> (as sodium salt) (CST) (3.8/7.5 sheep)	*Coopers Closal for sheep (Schering-Plough Australia), others, oral liquid (19 gABZ/ L// 37.5 g CST/L: sheep 1ml/5 kg b.w.), WT: 28 d	ABZ has been combined with closantel to increase anthelmintic spectrum and efficacy against <i>F. hepatica</i> and <i>Haemonchus contortus</i> ; <b>approved</b>

**Trematodocidal Drugs. Table 1** Drugs used against trematode infections of domestic animals (Continued)

CHEMICAL GROUP International nonproprietary name (INN) (single oral dose, mg/kg body weight = b.w.), other information	*DRUG PRODUCT dose form (formulation), withdrawal time (WT) days (d) before slaughter, manufacturer, supplier, other information	CHARACTERISTICS: miscellaneous comments on pharmacokinetics, metabolism, mode of action, toxicity, and limitations
<b>indications and limitations:</b> for the control of *Closal susceptible mature and immature GI-roundworms, lungworms ( <i>Dictyocaulus filaria</i> ), tapeworms ( <i>Moniezia</i> spp.), nasal bots ( <i>Oestrus ovis</i> ), liver fluke, and to reduce the output of viable worm and fluke eggs; for the sustained control of Barber's pole worms ( <i>H. contortus</i> ) in sheep; do not use in lactating ewes where milk or milk products may be used for human consumption		
albendazole (ABZ)/ <b>closantel</b> (CST)/ <b>levamisole</b> HCl (LEV)/ <b>abamectin</b> (ABA) (5/ 7.5/ 8/ 0.2 sheep)	*Q-Drench for sheep (Jurox Australia, elsewhere), oral liquid (drench) (25 g ABZ/ L// 37.5 g CST/L// 40 g LEV/ L// 1 g ABA/L: sheep 1ml/ 5 kg b.w.), WT: sheep 28 d	<b>approved indications and limitations:</b> for the treatment and control in sheep of susceptible GI-roundworms (including strains with single or dual resistance to macrocyclic lactones, BZs, LEV or CST) and strains of Barber's pole worm
<i>(Haemonchus contortus)</i> with emerging resistance to CST; it is also effective against lungworm ( <i>Dictyocaulus filaria</i> ), tapeworms ( <i>Moniezia</i> spp.), mature and late immature liver fluke ( <i>F. hepatica</i> ), nasal bot ( <i>Oestrus ovis</i> ), and itch mite ( <i>Psorergates ovis</i> ); do not use in female sheep, which are producing or may in the future produce milk or milk products for human consumption; do not use in lambs under 6 weeks of age or 10 kg b.w.		
<b>PYRAZINOISOQUINOLINES</b>		
<b>praziquantel</b> (PZQ): for detailed information on drug products (incl. PZQ-combinations), their indications and limitations cf. → <a href="#">Cestodocidal Drugs</a> , and <a href="#">Table 2</a> ; primarily active against various cestodes and schistosomes; it also affects <i>D. dendriticum</i> in sheep but efficacy proved erratic (no dose-activity relationship: 98% efficacy at 20 mg/kg, 76% at 40 mg/kg, and 98% at 50 mg/kg; total elimination of flukes was not achieved); infections of dogs with <i>Paragonimus</i> spp. (lung flukes) has been successfully treated with 25 mg/kg b.w. on each of 3 consecutive days; the intestinal fluke <i>Fasciolopsis buski</i> of swine and pancreatic fluke, <i>Eurytrema pancreaticum</i> of sheep, both become eliminated by a single oral dose of 30 and 60 mg/kg b.w., respectively; the skin fluke <i>Gyrodactylus aculeatus</i> of fish can be removed effectively by placing the fish in a water bath for 3 h containing a concentration of 10 mg PZQ/L; it is highly effective against various intestinal flukes in humans ( <i>Heterophyes</i> spp., <i>Metagonimus yokogawai</i> and other zoonotic flukes cf. <a href="#">Table 2</a> ) and various intestinal flukes of (domestic) animals, including those of fish and reptiles [PZQ-drug products in Australia → *Aquatopia Australia Fluke Eliminator, tablets (100 mgPZQ/Tb: 1 tb/20 L) for fish tank medication: 5 mg PZQ/L controls flukes and tapeworms in ornamental fresh and saltwater aquarium fishes (prohibited for fish intended for human consumption), or *Reptile Science Repti Worm (Universal Manufacturing & Labs, Australia): the combination (50 g fenbendazole/L// 5 g PZQ/L: 0.4 mL/kg b.w. per os) controls all important GI-nematodes, lungworms, trematodes (flukes), and cestodes (tapeworms)]		
<b>HALOGENATED BENZENESULFONAMIDES</b>		
In EC, USA, Australia, and elsewhere, clorsulon (CSL) is used for the control of adult liver flukes ( <i>Fasciola hepatica</i> and <i>F. gigantica</i> ) in cattle only; currently, no drug product containing CSL (incl. clorsulon/ivermectin combination) is commercially available in Germany and elsewhere; however, the clorsulon/ivermectin combination (*Ivomec Plus Biokema SA) is approved for use in beef and dairy cattle in Switzerland (product limitations are similar to those specified by FDA in USA, and a withdrawal time for milk has not been established); neither drug product is approved for use in sheep in EC, USA, Australia and elsewhere; CSL is formulated either as a suspension for oral use (recommended dose: 7 mg/kg b.w. as drench) or an injectable liquid for the subcutaneous route (recommended dose: 2 mg/kg b.w.); the drug combination CSL/ivermectin is frequently used because of its additional effects against important pathogenic nematodes and arthropods		
*1 <b>clorsulon</b> (CSL) (7 cattle, beef, cattle, dairy, not breeding age) *2 clorsulon (CSL)/ <b>ivermectin</b> (IVER) (2/0.2 subcutaneously, cattle, beef, excluding veal calves, cattle, dairy, not breeding age) 4*Ivomec Plus Injection for cattle (Merial; Australia), liquid (solution) for injection (100 mg CSL/mL// 10 mg IVER/mL: 1 mL/50 kg b.w.), WT: cattle 28 d, milk 0 d	1*Curatrem Drench for Cattle (Merial; USA, elsewhere); oral liquid (suspension: 85 mg CSL /mL), WT: cattle 8 d 2*Ivomec F Injection or Ivomec Plus Injection for cattle (Merial; USA), aqueous solution for injection (100 mg CSL/mL// 10 mg IVER/mL: 1 mL/50 kg b.w.), WT: cattle 49 d 3*Virbac Virbamax Plus (Virbac BASF Australia) liquid for injection for cattle (100 g CSL/L// 10 g IVER/L:	extensive chemical modification of halogenated sulfanilamide derivatives showing fasciolicidal activity led to the discovery of clorsulon (=MK-401) with 100% activity against adult <i>F. hepatica</i> (14–16-week-old stages) in both cattle and sheep at recommended dose; higher dosages are needed to attain satisfactory effects (in %) against younger flukes (15 mg/kg: 91–99% 8–6-week-old stages, and 30mg/kg: 99–100% 3-week-old stages, and 85%

**Trematodocidal Drugs. Table 1** Drugs used against trematode infections of domestic animals (Continued)

<b>CHEMICAL GROUP</b> International nonproprietary name (INN) (single oral dose, mg/kg body weight = b.w.), other information	<b>*DRUG PRODUCT</b> dose form (formulation), withdrawal time (WT) days (d) before slaughter, manufacturer, supplier, other information	<b>CHARACTERISTICS:</b> miscellaneous comments on pharmacokinetics, metabolism, mode of action, toxicity, and limitations
	1mL/ 50 kg bw), WT: 28 d, milk 0	2-week-old stages); there is also
<p>reasonable efficacy against other fluke species (<i>F. gigantica</i> in cattle: 7 mg/kg/d for 5 d: 100% against adult stages, 92% →immature stages; <i>Fascioloides magna</i> in cattle, sheep 21 mg/kg x1 per os: &gt;92% →8-week-old immature stages, 72% →16-week-old stages); <b>1*approved indications and limitations:</b> for the treatment of immature and adult liver fluke (<i>Fasciola hepatica</i>) infestations in cattle; using dose syringe, deposit drench over back of tongue, because a withdrawal time in milk has not been established, do not use in female dairy cattle of breeding age; <b>2* approved indications:</b> for the treatment and control of GI nematodes, adults and fourth-stage larvae: (<i>Haemonchus placei</i>, <i>Ostertagia ostertagi</i> (including inhibited larvae), <i>O. lyrata</i>, <i>Trichostrongylus axei</i>, <i>T. colubriformis</i>, <i>Cooperia oncophora</i>, <i>C. punctata</i>, <i>C. pectinata</i>, <i>Oesophagostomum radiatum</i>, <i>Nematodirus helvetianus</i> (adults only), <i>N. spathiger</i> (adults only), <i>Bunostomum phlebotomum</i>); lungworms, adults and fourth-stage larvae (<i>Dictyocaulus viviparus</i>); liver flukes (<i>Fasciola hepatica</i>, adults only); grubs (parasitic stages) (<i>Hypoderma bovis</i>, <i>H. lineatum</i>); lice (<i>Linognathus vituli</i>, <i>Haematopinus eurysternus</i>, <i>Solenopotes capillatus</i>); mites (<i>Psoroptes ovis</i> syn. <i>P. communis</i> var. <i>bovis</i>), <i>Sarcoptes scabiei</i> var. <i>bovis</i>; it is also used to control infections of <i>D. viviparus</i> for 28 days and <i>O. ostertagi</i> for 21 days after treatment, and <i>H. placei</i>, <i>T. axei</i>, <i>C. punctata</i>, <i>C. oncophora</i>, and <i>O. radiatum</i> for 14 days after treatment; <b>limitations:</b> for subcutaneous use only; not for intravenous or intramuscular use; because a withdrawal time in milk has not been established, do not use in female dairy cattle of breeding age; do not use in other animal species because severe adverse reactions, including fatalities in dogs, may result; a withdrawal period has not been established for this product in preruminating calves; do not use in calves to be processed for veal; <b>3*/4*approved indications and limitations:</b> for treatment and control of IVER and CSL sensitive strains of internal and external parasites of beef and dairy cattle, including adult liver flukes; does not provide full control of <i>Chorioptes bovis</i> mite and <i>Bovicola (Damalinia) bovis</i> biting louse; product should not be used intravenously or intramuscularly; products should be injected only under the skin; if possible inject high on the neck behind the ear; <b>mode of action:</b> CSL (given per os in dose levels from 0.25–15.8 mg/kg b.w. to rats experimentally infected by flukes) is well absorbed by flukes; it inhibits enzymes involved in glycolytic pathway (primary source of energy in flukes); it is a competitive inhibitor of 8-phosphoglycerate kinase and phosphor-glyceromutase and blocks oxidation of glucose to acetate and propionate; CSL also depresses ATP levels in fluke; as a carbonic anhydrase inhibitor it causes significant increases in urinary pH, urinary volume, and urinary sodium concentrations at all doses (0.2, 2 and 20 mg/kg b.w./day) in a 54-week repeated dose rat toxicity study; benzenesulfonamide derivatives have the potential to decrease renal tubular resorptions of sodium in order to decrease excretion of hydrogen ions; thus, excretion of sodium, potassium carbonate, and water are increased (effects are reported to be short-lived); <b>pharmacokinetics:</b> in cattle, after intraruminal administration of <sup>14</sup>C-CSL (10 mg/kg b.w.) maximum plasma levels (close to 3,000 µg/L) were observed about 24 h after dosing (elimination of total radioactivity from plasma was biphasic); mean plasma level was 14 µg/L at 21 d after dosing; after s.c. administration of 2 or 3 mg/kg b.w., maximum plasma levels (1,290 and 2,500 µg/L) were attained 6 h after injection; at 7 d, plasma levels were close to limit of detection (10µg/L); after single intraruminal administration of 6.6mg <sup>35</sup>S-CSL/kg b.w. or 15mg <sup>14</sup>C-CSL/kg b.w., about 90% of the administered dose was excreted within 7d, the major fraction being excreted in feces (~70%) and a minor fraction (~30%) in urine; <b>metabolism:</b> studies in steers with labeled <sup>14</sup>C-CSL (10 mg/kg b.w.) revealed 2 major metabolites: acetaldehyde derivative (2.9%) and butyric acid derivative (6.2%), several other compounds were isolated (10 compounds were less polar and 3 more polar entities: no account &gt;5% of total residue or radioactivity; in kidney, major component recovered was unchanged drug); <b>tolerability:</b> CSL is characterized by low toxicity: studies have demonstrated a wide margin of safety in male fertility and female reproductive performance studies in rodents, rabbits, dogs, and cattle; in 2 carcinogenicity studies carried out in mice (44, 120, and 306 mg CSL/kg b.w., daily for 2 years) CSL proved not carcinogenic; uninfected sheep tolerated a single oral dose of 200 or 400 mg/kg b.w., and cattle 175 mg/kg b.w. (i.e., 25 times label dosage per os) without adverse reactions (normal weight gain and feed consumption, no clinical signs or histopathologic findings); CSL alone or in combination with IVER are well tolerated by cattle apart from swelling at s.c. injection sites; CSL is considered safe in breeding and pregnant animals provided normal care is taken in handling, CSL is compatible with other anthelmintics</p>		

Data of drug products (approved labels) listed in this table refer to information from literature, manufacturer, supplier, and websites such as the European Medicines Agency (EMA), Committee for Veterinary Medicinal Products (CVMP), the US Food and Drug Administration (FDA), Center for Veterinary Medicine (CVM), the Australian Pesticides and Veterinary Medicines Authority (APVMA), and associated Infopest (search for products), VETIDATA, Leipzig, Germany, and Clini Pharm, Clini Tox (CPT), Zurich, Switzerland. Data given in this table have no claim to full information

**Trematodocidal Drugs. Table 2** Drugs used against trematode infections of humans

DISEASE Stage(s) of interest (location of stages), other information	International nonproprietary name oral dosage: adult/pediatric (d = days), additional information (*Brand name)	Characteristics of compound, miscellaneous comments
<b>BLOOD FLUKES</b>		
<p>SCHISTOSOMIASIS (snail-mediated helminthiasis): <b>statistics</b> about 200 million people are affected with schistosomiasis (120 million: symptomatic, with 20 million having severe clinical disease) worldwide, of whom ~85% live on the African continent and ~600 million people are at risk [global case fatality rate (infected persons/year) → <i>Schistosoma mansoni</i>: 1–7%, → <i>S. haematobium</i>: 2% and → <i>S. japonicum</i> 5%; global disease burden in 2002 (DALYs): 1,760,000]; infection is caused by cercariae penetrating human skin during contact with freshwater; prevention on an individual level requires that people should avoid any contact with infested freshwater, or that all individuals defecate and urinate in sanitary facilities; at the community level the following control measures should be considered: public health education, sanitation, eradication of snail vector, and chemotherapy; the aim of the chemotherapy is to suppress egg production, which is responsible for pathological damages; early attempts to control the disease (1930–1985) were based on the use of <i>synthetic molluscicides</i> for snail control and drugs such as <i>antimony-based agents</i> and <i>niridazole</i> (Ambilhar) whose efficacy and tolerability was unsatisfactory (reduction in prevalence from 60–30% at too high cost); since 1975, <i>oxamniquine</i> was used in control programs in Brazil, but in recent years Brazil has switched to using <i>praziquantel</i> (a pyrazinoisoquinoline) as first line drug; over the last 15 years mainly drug treatment programs have reduced serious morbidity caused by schistosomiasis (e.g., bladder cancer in Egypt has declined significantly, as has serious <i>S. mansoni</i>-induced morbidity in Brazil, and <i>S. japonicum</i> morbidity in China); the global distribution of schistosomiasis has changed in recent years; it has been eradicated from Japan and the Lesser Antilles islands; transmission has been interrupted in Tunisia; and transmission is very low in Morocco, Saudi Arabia, Venezuela, and Puerto Rico; <b>current control</b> of schistosomiasis mainly relies on the use of <i>praziquantel</i> (PZQ), the only readily commercially available drug; the original PZQ (*Biltricide) was marketed by Bayer; there are now about 20 pharmaceutical companies formulating PZQ into 600 mg tablets from technical materials produced in South Korea and China; the price/tablet is around US\$ 0.07–0.10; in Egypt a suspension (containing 1800 mg PZQ/15 mL) is commercially available (price: \$0.90); it was formulated to overcome the bitter taste of the large 600 mg PZQ tablet: treatment in children led to vomiting or reluctance to swallow the tablets; average cost of treatment/child including delivery through a school-based system (schistosome and soil-transmitted helminth infections) is less than \$0.50; PZQ is safe and effective and to date there is little evidence of development of significant resistance; children are particularly vulnerable to schistosomiasis, and infected school-age children are often physically and intellectually compromised by concurrent anemia, attention defects, learning disabilities, and dropout rates; the WHO has generated a strategy whereby most adults and children infected or at risk of developing morbidity will receive PZQ treatment they need [for detailed information cf. → <a href="http://www.who.int/wormcontrol">http://www.who.int/wormcontrol</a> and Fenwick A et al. (2003), Trends Parasitol 19: 509, or Hagan P. et al. (2004), Trends Parasitol 20: 92]; PZQ has been used extensively and successfully in national control programs in China, the Philippines, Egypt, and Brazil, and treatment programs with PZQ are now expanding in several countries of Africa for more widespread control of schistosomiasis; the market for PZQ was expected to rise substantially towards 40 million tablets a year by the end of 2005 if price can be maintained and resistance is avoided; <b>resistance to PZQ</b>: it may be possible to induce resistance in the laboratory using drug pressure, and thereby prevent or delay emergence of resistance; thus chemotherapy should be targeted only to high-risk groups such as women, fishermen, and school-age children thereby monitoring drug efficacy in operational programs in order to detect first signs of resistance development; to date, no other PZQ-resistant isolates has been identified (in 1992, in Egypt several individuals did not sufficiently respond to PZQ; in 1997, in Senegal patients with extremely high egg counts before treatment showed a certain tolerance to PZQ treatment at regular dose); however, all infected individuals responded to treatment with 2 or 3 doses of PZQ; <b>alternative drugs</b>: other drugs, which were used prior to the discovery of PZQ, such as <i>oxamniquine</i> (a tetrahydroquinoline active against <i>S. mansoni</i>) or <i>metrifonate</i> (active against <i>S. haematobium</i>; cf. trichlorfon → <a href="#">Nematocidal Drugs Animals/Table 3</a>) are no longer available commercially; consequently, there is a lack of altering drugs in control programs, a classical strategy of avoiding development of drug resistance; several “alternatives” to PZQ are currently discussed and under investigation: (1) development of PZQ analogues but rational approach to new derivatives is hampered by a lack of knowledge as to mechanism of PZQ’s action <i>in vivo</i> – 37 years after its discovery in 1970, (2) the use of malariacidal <i>artemisinin</i> derivatives (e.g., <i>artemether</i>, a methoxy derivative of artemisinin or sesquiterpene lactol, has a good safety profile and is already in use as an antimalarial, cf. (→ <a href="#">Malariaicidal Drugs</a>); earlier studies in golden hamsters demonstrated that artemether interferes with maturation thereby killing larval stages of <i>S. japonicum</i> and <i>S. mansoni</i>; results of another study demonstrated that artemether (1 × 300 mg/kg orally) given at least once every 4 weeks had a preventive effect against <i>S. haematobium</i>, thus providing a basis for testing its ‘prophylactic’ effect in a human population in a highly endemic area; clinical trials in China, Africa and elsewhere corroborate a protective effect of artemether against infections with juvenile stages of <i>S. japonicum</i>, <i>S. mansoni</i>, and <i>S. haematobium</i>; (3) a combination of PZQ and artemether is under evaluation in China, Egypt, the Philippines, and other countries; feasibility of this novel control strategy based on experimental trials using animals challenged with <i>S. mansoni</i> and <i>S. japonicum</i> and clinical trials [Utzinger J. et al. (2003)</p>		

**Trematodocidal Drugs. Table 2** Drugs used against trematode infections of humans (Continued)

DISEASE Stage(s) of interest (location of stages), other information	International nonproprietary name oral dosage: adult/pediatric (d = days), additional information (*Brand name)	Characteristics of compound, miscellaneous comments
		<p>Antimicrob Agents Chemother 47: 1487], and (4) Mirazid (tablets containing 300 mg purified <i>Commiphora</i> extract from the stem of the plant <i>Commiphora molmol</i> or myrrh): when Mirazid was marketed in Egypt, the WHO had been informed; its effect on human schistosomiasis is controversially discussed; it has been reported that myrrh exhibits antischistosomal activity (worm pairs become separated and female worms are shifted to the liver, where they are destroyed); in 1995, raw material was independently tested at laboratories in Brazil and the USA, and <i>in vitro</i> no antischistosomal activity was found; Mirazid's label claims "amelioration of all symptoms within one week" but original claims published might be difficult to reproduce; <b>enantiomers of PZQ</b>: PZQ is currently marketed as a chiral molecule, i.e., standard preparations are composed of equal proportions of the active, levo (-) and the inactive, dextro (+) optical isomers; the activity of the (-) enantiomer has been established in experiments performed both <i>in vivo</i> and <i>in vitro</i>; thus, the production of PZQ as a single active form would halve the therapeutic dose and possibly minimize adverse effects of the drug; however, methods (selective synthesis, or industrial chromatography) that could achieve production of levo-PZQ would drastically increase cost and might be an uneconomic exercise; <b>characteristics of PZQ</b>: usually well tolerated; mechanism of action is complex and is apparent in damage of the worm's tegument membrane; exposure of such damaged integument to the host's immune system induces inflammatory reactions, which lead to worm's death; cure rate is equal to or greater than 85%; in persons not cured, the egg burden is markedly decreased; <b>contraindications</b>: documented hypersensitivity and ocular cysticercosis; destruction of parasite within the eyes can cause irreparable lesions; therefore, ocular cysticercosis must not be treated with PZQ (cf. →Cestodocidal Drugs); <b>interactions</b>: <i>hydantoins</i> may reduce serum praziquantel concentrations, possibly leading to treatment failures; <b>pregnancy</b>: usually safe but benefits must outweigh the risks; <b>precautions</b>: caution while driving or performing other tasks requiring alertness on the day of and following treatment; minimal increases in liver enzymes reported; when schistosomiasis or fluke infection is associated with cerebral cysticercosis, patient should be hospitalized for duration of treatment; <b>characteristics of oxamniquine</b> (e.g., *Vansil Pfizer, drug is no longer available commercially in the USA and elsewhere): mechanism of action is complex: the <i>tetrahydroquinoline</i> is metabolized into an ester by schistosomes which may damage tegument surface of male schistosome worms so that the immune system is able to kill the worm; drug has action on reproductive processes thereby inhibiting female worms from producing eggs; drug is only effective against <i>S. mansoni</i> (cure rates: 70–90%); <b>contraindications</b>: documented hypersensitivity and pregnancy (unsafe); <b>interactions</b>: none reported but food may delay absorption; <b>precautions</b>: use caution and closely monitor in patients with history of seizures because they may experience epileptiform convulsions; EEG abnormalities may develop in patients with normal pretreatment recordings</p>
<p><i>Schistosoma mansoni</i> <b>adults</b> (venous system of intestine), <b>eggs</b> (embryonated, large, oval, with lateral spine, pass into feces; the latter must be deposited in fresh water so that miracidia can hatch and reach appropriate snails), endemic in Africa, Middle East, and parts of South America; intestine and liver are primarily affected; eggs (soluble antigens in tissues) induce severe inflammatory reactions related to intensity of infection and so host response; damage caused in acute phase is followed by irreversible fibrosis of liver and adjacent tissues</p>	<p><i>drug of choice</i>: <b>praziquantel</b> (PZQ) (e.g., *Biltricide Bayer, others) (40 mg/kg/d in 2 doses × 1 d: adult/pediatric) <i>alternative</i>: <b>oxamniquine</b> (15 mg/kg once, pediatric 20mg/kg/d in 2 doses × 1d adult/pediatric: in East Africa, the dose should be increased to 30 mg/kg, and in Egypt and South Africa to 30 mg/kg/d × 2d; some experts recommended 40–60mg/kg over 2–3d in all Africa [Shekhar KC (1991) Drugs 42: 379]</p>	<p>PZQ is (was) a major therapeutic breakthrough in control of schistosomiasis (cure rates 85%–100%); side effects are common and mild: headache, diarrhea, rash, fever; single dose treatment results in a very high cure rate; <i>levo</i>-PZQ (150 mg/kg b.w.) administered to mice infected with <i>S. mansoni</i> caused damage to the tegument of adults including severe swelling, vacuolization, fusion of the tegumental ridges, and loss or shortening of the spines on the tubercles, collapse, and peeling (<i>dextro</i> PZQ proved inactive) <i>oxamniquine</i> (*Vansil Pfizer) (regional differences in efficacy,</p>
		<p>cure rates 70–90%) has been used in areas in which PZQ is less effective; it has no useful efficacy against <i>S. haematobium</i> and <i>S. japonicum</i>; side effects are common but mild; in rare cases convulsions (history of epilepsy), and minor increase of transaminase activities; its use is contraindicated in pregnancy, and safety has not been established in young children</p>
<p><i>S. japonicum</i> <b>adults</b> (mesenteric venules), <b>eggs</b> (embryonated, large but smaller than those of <i>S. haematobium</i>, globular, lack a spine, pass into feces; eggs must be deposited in fresh water so that miracidia can hatch and reach appropriate snails) endemic in the</p>	<p><i>drug of choice</i>: <b>praziquantel</b> (PZQ) (60mg/kg in 3 doses × 1d: adult/pediatric); <b>artemether</b> (*Artenam Arencio) [field trials (&gt;4500 individuals) conducted in China among high-risk groups have shown that artemether is a promising drug against schistosomula at oral</p>	<p>cure rates of PZQ may be 80–92%; generally a single dose of PZQ has the same efficacy as several smaller doses given at intervals of several hours but frequency of side effects is greater with a large single PZQ dose; tissue damages induced by <i>S. japonicum</i> is more severe than those caused by <i>S. mansoni</i></p>

**Trematocidal Drugs. Table 2** Drugs used against trematode infections of humans (Continued)

DISEASE Stage(s) of interest (location of stages), other information	International nonproprietary name oral dosage: adult/pediatric (d = days), additional information (*Brand name)	Characteristics of compound, miscellaneous comments
Far East, SE Asia, Philippines; acute systemic reactions (Katayama fever); chronic stage of disease with hepatomegaly caused by portal fibrosis, and splenomegaly; liver is the organ most affected (fatal fibrosis)	doses of 6 mg/kg b.w./d given in 15-day-intervals × 4]	(for diagnostic problems cf. <i>S. mekongi</i> ↓); over the last 25 years, researchers from China [cf. Xiao SH (2005) Acta Trop 96: 153] successfully developed <i>artemether</i> and <i>artesunate</i> (Guilin No.1 Factory China),
2 derivatives from the antimalarial artemisinin, as promising drugs against <i>S. japonicum</i> ; laboratory investigations showed that the artemisinins display their highest activity against the juvenile stages of the parasite; thus <i>artemether</i> (3 × 15 mg/kg per os given on d7/d14/d21 after infection) exhibited 93–98% efficacy against schistosomula (juvenile flukes) in rabbits and dogs infected with cercariae of <i>S. japonicum</i> ; these findings were consistently confirmed in randomized controlled trials in humans; repeated oral administration of artemether or artesunate was safe and efficacious in the prevention of patent <i>S. japonicum</i> infections; <i>Schistosoma</i> species are sensitive to artemether medication for slightly different lengths of time: <i>S. japonicum</i> is susceptible up to 21 days of age, while <i>S. mansoni</i> responds to the drug for up to 42 days of age, and <i>S. haematobium</i> , due to the longer time it takes to develop into adults, has an even longer period of sensitivity; in areas that are endemic for both malaria and schistosomiasis, the use of artemether is precluded because of the possibility that its regular use might contribute to the development of resistance of the malaria parasite; on the other hand, the drug could safely be recommended for use in schistosomiasis in areas where there is no regular malaria transmission (e.g., in China, southern Brazil, countries north of the Sahara, parts of the Middle East); of particular interest are those areas where human schistosomiasis has been very much reduced, but final eradication has proved difficult (e.g., in Saudi Arabia, Morocco), where artemether could contribute to breaking its transmission; it could also play an important role in the control of schistosomiasis in Egypt		
<i>S. mekongi</i> <b>adults</b> (mesenteric venules), <b>eggs</b> (resemble closely <i>S. japonicum</i> eggs) pass into feces; “minor” species in Southeast Asia	<i>drug of choice:</i> <b>praziquantel</b> (PZQ) (60 mg/kg in 3 doses × 1 d: adult/pediatric)	endemic along Mekong river, including Laos, Cambodia, Thailand) <b>diagnostic problems:</b> fecal debris adheres to shell of <i>S. japonicum</i> and <i>S. mekongi</i> eggs; thus eggs may be overlooked in fecal preparations (spine is inapparent and difficult to see)
<i>S. intercalatum</i> <b>adults</b> (mesenteric venules), <b>eggs</b> (resemble closely <i>S. haematobium</i> eggs but are larger) pass into feces	<i>drug of choice:</i> <b>praziquantel</b> (PZQ) (60 mg/kg in 3 doses × 1 d: adult/pediatric)	<i>S. intercalatum</i> (a “minor” species of man in West and Central Africa) <i>S. bovis</i> , <i>S. matthei</i> or <i>S. nasalis</i> are primarily parasites in other mammals (e.g., equines, ruminants), and may infrequently infect humans
<i>S. haematobium</i> <b>adults</b> (venous plexus of urinary tract mainly bladder), <b>eggs</b> (embryonated, large oval, with terminal spine pass into urine; latter must be deposited in fresh water so that miracidia can hatch and reach appropriate snails); endemic in 54 countries of Africa and the eastern Mediterranean	<i>drug of choice:</i> <b>praziquantel</b> (PZQ) (e.g., *Biltricide Bayer, others) (40 mg/kg/d in 2 doses × 1 d: adult/pediatric), considered safe in children over 4 years of age who tolerate it better than do adults (contraindications: ocular cysticercosis cf. general information on schistosomiasis↑)	single dose treatment results in a cure rate equal to or greater than 85%; in persons not cured, the egg burden is markedly decreased; side effects caused by PZQ are common but mild such as nausea, abdominal discomfort, dizziness, headache, and diarrhea; rash, pruritus, urticaria, fever; myalgia and eosinophilia are noted occasionally and are related to parasite burden
(inflammatory reactions); high doses of PZQ do increase abortion rates in rats, so drug probably is best avoided during first trimesters of human pregnancy; relatively inexpensive <i>metrifonate</i> (syn trichlorfon, e.g., *Neguvon Bayer cf. → <a href="#">Nematocidal Drugs, Animals</a> ), an organophosphate (5–10 mg/kg b.w. × 3 at 2 week intervals) may be still used concurrently with <i>oxamniquine</i> (*Vansil Pfizer, contraindicated in pregnancy) for the treatment of mixed infections with <i>S. haematobium</i> and <i>S. mansoni</i> ; the drug has no useful effects against other schistosome species; <i>niridazole</i> (earlier *Ambilhar: 25 mg/kg b.w., maximum 1.5 g/d, for 7 d), a 5-nitrothiazole, is no longer in use because of serious adverse effects it had caused in patients with CNS and/or hepatic disorders exaggerating typical symptoms like confusion, hallucinations, convulsions, and metabolic imbalance; it was used also in <i>Dracunculus medinensis</i> (Guinea worm) infections (cf. → <a href="#">Nematocidal Drugs, Man</a> ); <i>disease pattern</i> of <i>S. haematobium</i> infection primarily involves the lower genitourinary tract; urinary bilharziasis is characterized by hematuria, obstruction of ureters, and hydronephrosis; in chronic infections, accumulation of eggs around the bladder and		

**Trematodocidal Drugs. Table 2** Drugs used against trematode infections of humans (Continued)

DISEASE Stage(s) of interest (location of stages), other information	International nonproprietary name oral dosage: adult/pediatric (d = days), additional information (*Brand name)	Characteristics of compound, miscellaneous comments
<p>ureters results in severe inflammation of bladder and adjacent tissues (organs), which may involve the kidneys (pyelonephritis); the extent of granuloma formation (around eggs) and following fibrosis of affected tissues generally correlate with the intensity of infection; in untreated patients, the bladder epithelium can transform into squamous cell carcinoma occurring usually 10–20 years after the initial infection; in addition, immune complexes that contain egg antigens may deposit in the glomeruli, leading to glomerulonephritis and amyloidosis</p>		
<p><b>INTESTINAL FLUKES</b> (more than 50 hermaphroditic species exist) infections are acquired by consumption of littoral vegetation, raw or undercooked fish, or mollusks contaminated/infected with encysted cercariae (metacercariae); only a few species cause infection in humans, and the most common human intestinal trematode is <i>Fasciolopsis buski</i> (~15–20 million infected people in areas of the Far East, cercariae encyst on aquatic plants); metacercariae of <i>Echinostoma ilocanum</i> encyst in freshwater mollusks (primarily snails or clams), and metacercariae of <i>Heterophyes heterophyes</i> (~10 million infected people, uncommon but widely distributed) and those of <i>Metagonimus yokogawai</i> (most common heterophyid fluke in areas of the Far East and Mediterranean basin) encyst under the scales or in the skin of various brackish or freshwater fish; common symptoms caused by these small digeneans armed with spines, such as heterophyids are dependent on worm burden present; in heavy infections with thousands of worms occlusion of common bile duct and small intestine can occur and then individuals develop a nonspecific diarrhea and experience abdominal pain similar to that due to peptic ulcer; eosinophilia is a common feature; rarely, the small heterophyids (<i>H. heterophyes</i>: 1–1.8 mm in length and 0.3–0.7 mm in width) and their eggs tend to form clots (emboli) traveling via the circulation to aberrant sites of the body causing fatal pathological alterations (cf. Trematode Infections of humans ↓); the primary control measure against infections with intestinal flukes (transmission of eggs to intermediate hosts) is prevention of contamination of water supplies with fecal material; reservoir hosts like fish-eating mammals may also play a role in the maintenance of intestinal trematodes in the environment</p>		
<p><i>Nanophyetus salmincola</i> <b>adults</b> (small or large intestine), <b>eggs</b> (unembryonated, indistinct operculum, much smaller than those of <i>P. westermani</i>) pass into feces; it occurs in eastern Siberia, Northwestern of USA</p>	<p>drug of choice: <b>praziquantel</b> (PZQ) (e.g., *Biltricide Bayer, others) (60mg/kg in 3 doses × 1d: adult/pediatric)</p>	<p>fluke infects various fish-eating mammals (dog, cat, fox otter mink, lynx, and some piscivorous birds, including man) cercariae emerge from snail, come in contact with fish (family Salmonidae) and encyst under scales; man becomes infected by ingestion of raw or undercooked fish or via contaminated</p>
<p>utensils, hands and surfaces used first to prepare fish or vegetables for cooking or other foods taken raw; the fluke penetrates deeply into the mucosa of the duodenum or attaches to the mucosa of other parts of the small and large intestine thereby causing superficial or hemorrhagic enteritis; adult <i>N. salmincola</i> may harbor rickettsial organisms causing an often fatal disease in dogs or other Canidae (so-called “salmon poisoning,” and “Elokomin fluke fever” may cause high morbidity); <i>N. salmincola</i> and lung flukes (<i>Paragonimus</i> spp.↓) belong to the same family (Troglotremitidae)</p>		
<p><b>HETEROPHYIASIS</b></p>		
<p><i>Heterophyes heterophyes</i> <b>adults</b> (attached to wall of small intestine), <b>eggs</b> (small, embryonated inconspicuous operculum, egg resembles that of <i>C. sinensis</i>) pass into feces</p>	<p>drug of choice: <b>praziquantel</b> (PZQ) (75 mg/kg in 3 doses × 1d: adult/pediatric)</p>	<p>small intestinal fluke, which is uncommon but widely distributed (Middle East, Turkey, eastern and southeastern Asia); it occurs in dog, cat, fox, and man; many species of fish (brackish or freshwater fish ) act as second intermediate host; only heavily infected individuals may show nonspecific diarrhea, abdominal pain, and eosinophilia</p>
<p><b>METAGONIMIASIS</b></p>		
<p><i>Metagonimus yokogawai</i> <b>adults</b> (attached to wall of small intestine), <b>eggs</b> (embryonated, small, egg resembles that of <i>C. sinensis</i> and <i>Heterophyes</i> but it has an obvious operculum)</p>	<p>drug of choice: <b>praziquantel</b> (PZQ) (75 mg/kg in 3 doses × 1d: adult/pediatric)</p>	<p>small intestinal fluke; most common heterophyid fluke in the Far East (also found in Mediterranean basin); it may occur in dog, cat, pig, and man; several species of freshwater fish act as second intermediate host; only heavily infected individuals may develop nonspecific diarrhea and vague abdominal complaints</p>



**Trematocidal Drugs. Table 2** Drugs used against trematode infections of humans (Continued)

DISEASE Stage(s) of interest (location of stages), other information	International nonproprietary name oral dosage: adult/pediatric (d = days), additional information (*Brand name)	Characteristics of compound, miscellaneous comments
<b>ECHINOSTOMATIASIS</b>		
<i>Echinostoma ilocanum</i> <i>E. lindoense</i> , <i>E. hortense</i> <b>adults</b> (attached to wall of <i>small intestine</i> ), <b>eggs</b> (usually large, oval, unembryonated)	<i>drug of choice:</i> <b>praziquantel (PZQ)</b> (e.g., *Biltricide Bayer, others) (75 mg/kg in 3 doses × 1d: adult/pediatric)	are primarily parasites of birds and rodents; <i>E. ilocanum</i> may be common in humans (Korea, Philippines, Indonesia) whereas <i>E. hortense</i> is principally a parasite of rodents; same snail or neighboring snails (some
echinostomatids: fish, clams, and tadpoles) also serve as second intermediate host; mild infections are asymptomatic but heavy infection can be accompanied with diarrhea, and intestinal colic (similar to fasciolopsiasis)		
<b>GASTRODISCIASIS</b>		
<i>Gastrodiscoides hominis</i> <b>adults</b> (attached to wall of <i>colon and cecum</i> ), <b>eggs</b> (unembryonated, large, ovoid, egg resembles closely to that of <i>F. hepatica</i> or <i>F. buski</i> )	<i>drug of choice:</i> <b>praziquantel (PZQ)</b> (75 mg/kg in 3 doses × 1d: adult/pediatric)	occurs in India southeast Asia and parts of the former USSR; pigs (natural host), monkeys and man, field rats serve as hosts; incorrect egg diagnosis may occur; man acquired infection by eating uncooked aquatic plants; only a massive infection may produce mucous diarrhea
<b>FASCIOLOPSIASIS</b>		
<i>Fasciolopsis buski</i> <b>adults</b> (~7.5 cm long, 2 cm wide, attached to wall of <i>small intestine</i> ), <b>eggs</b> (unembryonated, large, broadly ellipsoidal, operculum indistinct; egg resembles closely to that of <i>F. hepatica</i> )	<i>drug of choice:</i> <b>praziquantel (PZQ)</b> (75 mg/kg in 3 doses × 1d: adult/pediatric)	large intestinal fluke that occurs in Far East (India, China, Taiwan, Thailand, Indonesia, and other parts of Asia); fresh water snails serve as intermediated hosts; mature cercariae emerge from snail, attach to aquatic plants (water
caltrop, water bamboo, water chestnut, lotus on the roots, and other aquatic vegetables) and encyst to become metacercariae; man becomes infected by ingestion of uncooked vegetation contaminated with metacercariae; in severe infections (thousands of worms), flukes may also attach to the ileum or colon; intestinal flukes cause inflammation, ulceration, and mucous secretion at the site of attachment; symptoms may be eosinophilia, diarrhea, and edema, severe infections may also cause intestinal obstruction or malabsorption leading to hypoalbuminemia, ascites, and obstruction of common bile duct; pigs are an important reservoir host		
<b>LIVER FLUKES</b>		
infections are acquired from consumption of raw or undercooked fish or crustaceans infected with encysted metacercariae, or from ingestion of raw or undercooked plants contaminated with metacercariae; <i>Fasciola</i> infections are rare but globally widespread: a total of ~2,600 cases of human <i>F. hepatica</i> has been reported in the UK, France, Spain; Portugal, Tadjikistan, Egypt, Peru, Cuba between 1970–1990, and some cases of human <i>F. gigantica</i> infection has been reported in Africa, Asia, Hawaii, former USSR, Vietnam, and Iraq		
FASCIOLIASIS is a major public health problem in several areas of the world, including the highlands of Bolivia, Ecuador and Peru, the Nile Delta in Egypt, and Central Vietnam; it is estimated that at least 2.4 million people are infected (more than 180 million at risk of infection: Report of WHO informal meeting on use of triclabendazole on fascioliasis control, Geneva 2006)		
<i>Fasciola hepatica</i> , <i>F. gigantica</i> <b>adults</b> (2.5–5 cm long, 0.6–1.4 cm wide, <i>F. gigantica</i> up to 7.5 cm long: both flukes live in bile ducts, liver tissue, and aberrant sites, e.g., lung and/or subcutaneous tissue), <b>eggs</b> [unembryonated, large, broadly ellipsoidal, operculum indistinct; shape of egg (both species) resembles closely to that of <i>F. buski</i> and pass into feces] cosmopolitan distribution, closely related flukes of herbivores and other mammals, rarely man; if no eggs are found (aberrant sites) serological tests	<i>drug of choice:</i> <b>triclabendazole</b> (a benzimidazoles) (TCBZ) (*Egaten, Novartis) (10 mg/kg once or twice: adult/pediatric) [Richter J et al. (2002) Curr Treat Option Infect Dis 4: 313] (cf. characteristics of TCBZ in animals <a href="#">Table 1</a> ↑) <i>alternative: bithionol</i> (a bisphenols) (*Bitin, Tanabe, Japan) (30–50 mg/kg on alternate days × 10–15 doses: adult/pediatric) (praziquantel proved ineffective against <i>Fasciola</i> ) TCBZ: there may be availability problems or it is	aquatic snails ( <i>Lymnaea</i> spp.) serve as intermediate hosts; infection is acquired by ingestions of encysted cercariae (metacercariae) attached to wet grass and herbs (e.g., watercress); adults of <i>Fasciola hepatica</i> (global distribution, most common in sheep and cattle, wild ruminants, but also dog, cat, swine, horse, kangaroo, man) and <i>F. gigantica</i> (throughout Asia, Middle East, Africa, the Americas, and Hawaii, most common in cattle) borrow tunnels through the liver parenchyma and feed on hepatocytes and blood; they produce

**Trematodocidal Drugs. Table 2** Drugs used against trematode infections of humans (Continued)

DISEASE Stage(s) of interest (location of stages), other information	International nonproprietary name oral dosage: adult/pediatric (d = days), additional information (*Brand name)	Characteristics of compound, miscellaneous comments
(e.g., ELISA) may be positive during acute phase of infections; recent experimental results with artemisinin derivatives are encouraging	available only from the manufacturer, e.g. in the USA and elsewhere	inflammation reactions leading to fibrosis of adjacent tissues in chronic infections; symptoms in humans are malaise, intermittent fever, pruritus, eosinophilia, abdominal pain,
jaundice, enlarged liver, anemia, aberrant adults (e.g., subcutaneous tissue) may be removed surgically most common adverse reactions of TCBZ in patients with acute/chronic disease are biliary colic, nausea, anorexia, vomiting, pruritus, jaundice (for details cf. <a href="http://www.who.int/neglected_disease/preventive_chemotherapy/WHO_CDS_NTD_PCT_2007.1.pdf">http://www.who.int/neglected_disease/preventive_chemotherapy/WHO_CDS_NTD_PCT_2007.1.pdf</a> )		
<b>SMALL LIVER FLUKES</b> (adult worms are flattened and spatulate (1–2.5cm long, 3–5mm wide) most food-borne trematodes are zoonotic (parasites of nonhuman animals), which “accidentally” infect humans; there are several species, e.g., <i>Dicrocoelium</i> , <i>Opisthorchis</i> , or <i>Clonorchis</i> , which infect livestock and mammalian wildlife and have been reported to be endemic in several countries [total number of human liver fluke infections is estimated ~30 million worldwide: <i>Clonorchis</i> ~19 million (e.g., India, China, Taiwan, Korea, Southeast Asia: Vietnam, Laos, Cambodia, other countries), <i>O. viverrini</i> ~9 million (Thailand, Laos), and <i>O. felineus</i> ~1.5 million, (Russian Federation, Eastern Europe)]; eggs of these genera are very similar in shape (and color) and are difficult to differentiate and may be sometimes confused with heterophyid eggs but generally are somewhat larger and may have a seated operculum; obligate intermediate hosts are snails and other invertebrates (e.g., <i>Dicrocoelium</i> : nonaquatic snails and ants); biology, pathogenesis, and clinical disease caused by <i>Opisthorchis</i> and <i>Clonorchis</i> are largely identical		
<i>Dicrocoelium dendriticum</i> <b>adults</b> (fine branches of bile ducts, gallbladder), <b>eggs</b> (embryonated, ovoid, small, indistinct operculum, brown shell) pass into feces; is cosmopolitan in herbivores, rabbit, pig, dog, deer)	<i>praziquantel</i> , or <i>albendazole</i> (may be effective at dose regimens recommended for other small liver flukes, cf. <i>Clonorchis sinensis</i> and <i>O. viverrini</i> )	infections in man are rare but globally widespread, cf. <i>F. hepatica</i> ↑), not as pathogen as <i>F. hepatica</i> ; intermediate (IM) hosts are land snails (first IM) and ants (second IM); infection is acquired by ingestions of ants; in advanced cases extensive cirrhosis of liver, clinical signs may be anemia, edema, and emaciation
<b>CLONORCHIASIS</b>		
<i>Clonorchis sinensis</i> (Chinese or oriental liver fluke) <b>adults</b> (bile ducts, some-times pancreatic duct and duodenum) <b>eggs</b> (embryonated, ovoid, small, seated operculum) pass into feces occur in Japan, Korea, Vietnam and China	<i>drug of choice:</i> <b>praziquantel</b> (PZQ) (75 mg/kg in 3 doses × 1d: adult/pediatric) or <b>albendazole</b> (*Albenza or *Eskazole GlaxoSmithKline) (10 mg/kg × 7 d: adult/pediatric)	fish-eating mammals (e.g., weasel, mink, dog, cat, pig, rats) serve as reservoir hosts; adult worms may live in host for up to 25 years; cercariae emerge from snail, come in contact with fish and encyst under scales; man becomes infected by ingestion of raw or
undercooked <i>freshwater fish</i> (Cyprinidae: ~100 species of cyprinoid fish serve as second intermediate host of <i>Clonorchis</i> or <i>Opisthorchis</i> ); such fish is prepared in many different ways depending on cultural, nutritional, and medicinal habits (e.g., marinating raw fish in various sauces and dipping in rice porridge or kongee, or beliefs that consumption of alcohol will kill the parasites); transmission can also occur via contaminated utensils, hands, and surfaces used first to prepare fish or vegetables for cooking or other foods taken raw, or by imported <i>pickled fish</i> containing viable metacercariae, which may lead to human infections in countries where <i>Clonorchis</i> and <i>Opisthorchis</i> do not occur; only heavy infections are clinically significant caused by obstructive liver disease and inflammatory gallbladder pathology (stones: hepatolithiasis); symptoms may be diarrhea, abdominal pain, icterus; ascites resulting from cirrhosis of liver; in severe chronic infection <i>cholangiocarcinoma</i> of the liver may develop; <i>C. sinensis</i> infection was judged a <i>probable carcinogen</i> [International Agency for Research on Cancer (Lyon 1994) schistosomes, liver flukes, and <i>Helicobacter pylori</i> . IARC Monographs on the evaluation of carcinogenic risks to humans, 61: 121–175]		
<b>OPISTHORCHIASIS</b>		
<i>O. viverrini</i> infection was classified as a <i>human carcinogen</i> (IARC 1994, for literature cf. <i>Clonorchis sinensis</i> ↑)		
<i>Opisthorchis felineus</i> ( <i>syn.</i> <i>O. tenuicollis</i> ); <i>O. viverrini</i> , (southeast Asian liver fluke) <i>Metorchis conjunctus</i> (North American liver fluke); <b>adults</b> (gall bladder, bile ducts of liver), <b>eggs</b> (embryonated, small, seated (or small: <i>Metorchis</i> ) operculum, difficult	<i>drug of choice:</i> <b>praziquantel</b> (PZQ) (e.g., *Biltricide Bayer, others) (75 mg/kg in 3 doses × 1 d: adult/pediatric) <i>mebendazole</i> (has been reported to be effective)	<i>distribution and reservoir hosts</i> of closely related liver flukes: <i>O. felineus</i> (Russian Federation, Eastern Europe; cats, civets, dogs, pigs, rats, other mammals, and <b>man</b> ), <i>O. viverrini</i> (northern Thailand, and Laos; dog, cat, fox, pig, endemic in man), <i>M. conjunctus</i> (areas of northern America;

**Trematodocidal Drugs. Table 2** Drugs used against trematode infections of humans (Continued)

DISEASE Stage(s) of interest (location of stages), other information	International nonproprietary name oral dosage: adult/pediatric (d = days), additional information (*Brand name)	Characteristics of compound, miscellaneous comments
to distinguish from those of <i>C. sinensis</i> ) pass into feces		dog, cat fox, mink, raccoon, other wildlife, man); <i>M. albidus</i> (Europe,
former parts of the USSR, and North America, cyprinid fish serve as second intermediate hosts; dog, cat, fox, mink, raccoon, other wildlife, man); humans become infected by ingestion of raw or undercooked cyprinoid freshwater fish (details concerning transmission of <i>Opisthorchis</i> and <i>Metorchis</i> infection to man including pathogenesis, pathologic alterations, and clinical signs cf. <i>Clonorchis sinensis</i> ↑; disease pattern of small liver flukes is very so similar that separate description is unnecessary)		
<b>LUNG FLUKES:</b> some 16 species of the <i>Paragonimus</i> genus cause human paragonimiasis, the most common cause being the “Oriental lung fluke,” <i>Paragonimus westermani</i> ; genera <i>Nanophyetus salmincola</i> (cf. intestinal fluke↑) and <i>Paragonimus</i> belong to the same family (Troglorematidae); infections are often due to cultural-specific habits of minorities and aboriginal people, i.e., consumption of raw or undercooked freshwater crustaceans (crabs, crayfish) infected with metacercariae		
<b>PARAGONIMIASIS</b>		
Asia: <i>Paragonimus westermani</i> <i>P. heterotremus</i> , <i>P. skrjabini</i> Africa: <i>P. uterobilateralis</i> , <i>P. africanus</i> Canada: <i>P. kelliottii</i> Peru, Ecuador: <i>P. mexicanus</i> <b>adults/**larvae</b> (forming cysts, capsules in lung parenchyma; <b>**aberrant sites:</b> brain, spinal cord, peritoneum, liver, spleen, kidneys, testes/ovary, muscles, intestinal wall, mesenteric lymph nodes, s.c. tissue) <b>eggs</b> (unembryonated, prominent operculum, different sizes: <i>P. westermani</i> much larger than others, dark shell) pass up from lung into sputum (eggs: either dislodged by coughing or swallowed and pass into feces); eggs can be confused with smaller cestode eggs of <i>Diphyllobothrium latum</i>	<i>drug of choice:</i> <b>praziquantel (PZQ)</b> (e.g., *Biltricide Bayer, others) (75 mg/kg in 3 doses × 2 d: adult/pediatric); PZQ is better tolerated than bithionol; PZQ is contraindicated in ocular disease alternative: <b>bithionol</b> (*Bitin Tanabe, Japan) (30–50 mg/kg on alternate days × 10–15 doses: adult/pediatric) (*availability problems) <b>Surgical:</b> excision of extra-pulmonary lesions, shunt in case of hydrocephalus	human lung flukes may infect an estimated 21 million people worldwide (~10 million in China: Asiatic species), <i>Paragonimus</i> infections being endemic in central China, Philippines, Thailand, Korea, Laos, and found in Taiwan, Japan, Malaysia, Indonesia, and India; other species cause infections in Asia and the Pacific, Africa, Canada, Central and South America (scattered reports); lung flukes are common in <i>crustacean-eating</i> wild carnivores (e.g., otter, fox, mink, mongoose, dog, cat, wildcat, raccoon, tiger, leopard, panther, wolf, and omnivores like bush rat, rat, pig, monkeys, and other mammals including man; <i>transmission:</i> humans acquired infection by ingestion of raw undercooked <i>crabs</i> or <i>crayfish</i> (second intermediate hosts containing encysted
cercariae or metacercariae in the viscera, muscles or gills) in form of uncooked paste and other prepared crab food (e.g., strips of raw crab meat soaked in rice wine: “drunken crab” in China, raw crab/crayfish plus alcohol in the Philippines, seasoned raw crab “Gye muchim” in Korea, raw prawn “ama ebi”, sushi crab, and others in Japan); <i>symptoms:</i> slight infection is asymptomatic; during acute phase (invasion and migration of immature stages may last several weeks): urticaria, diarrhea, abdominal pain followed by fever, sweats, chest pain, cough, dyspnea, and malaise; <i>pulmonary symptoms</i> (~6 months postinfection) resemble a chronic bronchitis or <i>tuberculosis</i> (dry cough, dyspnea, chest pain, production of tenacious and rusty or golden sputum); <i>pathogenesis:</i> soluble antigens and metabolic products of worms/eggs may cause inflammatory reactions in lungs as fibrotic lesions, hyperplasia of bronchioles, bronchiectasis, and interstitial/bronchopneumonia, and rarely pneumothorax (communicating capsules may cause bacterial superinfection leading to lung abscesses, pleural effusion, or empyema, especially in untreated cases); in chronic infection clubbing of fingers and toes may occur; migrating worms or eggs lodge in other organs (cf. left column: aberrant sites ↑) may cause cysts, abscesses, or granulomas; <i>cerebral infection</i> (<1% of patients, more common in children) resembles cysticercosis, and epilepsy being a frequent manifestation; brain lesions produce seizures, facial palsy, hemiplegia, and paraplegia; ocular disease can impair visual acuity because of optic atrophy, papilledema, and hemianopsia (loss of vision in one half of one or both eyes’ visual field); <i>diagnostic tests:</i> serology: ELISA; immunoblot, intradermal, others; <i>imaging:</i> CXR (= chest x-ray), CT/MRI (= magnetic resonance imaging) or ultrasound scans, or lumbar puncture, pleural aspiration, and lung biopsy		

Dosages listed in the table refer to information from manufacturer, literature, websites (WHO), and Medical Letter (2004) *Drugs for parasitic infections*’ Volume 46 (issue 1198): e1–e12. New Rochelle New York. Additional information on trematodocidal drugs used in veterinary medicine (drug products, manufacturers and suppliers, biological characteristics and adverse effects of drugs) cf. “Trematodocidal Drugs”↑ (general consideration: text and Table 1)

Data given in this Table have no claim to full information

combinations containing closantel and other nematocidal drugs. The excellent flukicide *luxabendazole* (former Hoechst) is no longer available on the Australian market (not considered in Table 1). The chlorinated methylthio-benzimidazole derivative *triclabendazole* has an excellent efficacy against adult stages of *F. hepatica* in cattle and sheep (Table 1); it is also the drug of choice for the treatment of *F. hepatica* infections in humans (cf. Table 2). **Benzene sulfonamides** to be subjected to extensive modification in a series of halogenated sulfanilamide derivatives led to *clorsulon* (cf. Table 1) in the late 1970. It is approved in the USA and elsewhere for the oral and parenteral treatment of immature and adult liver fluke infestations in cattle removing all adult stages of *F. hepatica* at recommended doses. The drug is safe for use in breeding and pregnant animals; it is frequently used as combination with *ivermectin* exhibiting high efficacy against important pathogenic nematodes and arthropods.

*Side effects, limitations and drug resistance:* In general, side effects due to flukicides are negligible (occasionally loosening of feces); only some older halogenated hydrocarbons may rarely show erratic toxicity including mortality. At recommended dose, the majority of therapeutic indices of current flukicides seem to be safe for ruminants (e.g., halogenated phenols: 1–4, diamfenetide: 3–5, salicylanilides: 4–6, clorsulon: 5, triclabendazole: 20–40). *Limitations* of flukicide products (cf. Table 1) specified for meat and milk producing cattle and sheep are due to the wide range of preslaughter withdrawal (withholding) periods depending on their pharmacokinetic properties (terminal half-life and resulting residues in edible tissues after treatment). Thus some salicylanilides as closantel and rafoxanide showing additional activity against *H. contortus* are bound extensively to plasma proteins (mainly to albumin) resulting in long terminal half-lives in sheep and cattle. *Drug resistance* in *F. hepatica* to various flukicides (rafoxanide, closantel, and triclabendazole) has been identified in endemic areas of Australian sheep farms and other countries with extensive grassland husbandry in the early 1990s and has become an increasing problem. The long and regular use of salicylanilides, particularly rafoxanide, and closantel but also the benzimidazoles triclabendazole and albendazole support the selection of drug-tolerant field strains of this fluke. Several drug combinations, actually used in Australia and elsewhere may slow down the development of further spreading of drug-tolerant *F. hepatica*. The application of such drug combinations may be indicated if one partner of the combination has developed reduced efficacy and the counterpart is still fully active against *F. hepatica* field strains.

**Pyrazinoisoquinolines** first synthesized and modified for their pharmacological activities had their major breakthrough with the discovery of the cestodocidal

activity of *praziquantel* (PZQ) in the early 1970s (cf. →Cestodocidal Drugs). Early reports on the efficacy of PZQ against various schistosome species in mice, hamsters, and nonhuman primates were soon followed by reports of high efficacy in man in 1979. In time, it turned out that PZQ was highly active against all pathogenic trematodes with the exception of *F. hepatica*. The absence of morphological PZQ effects in *Fasciola* may be attributable to the thickness of the tegument (up to 22  $\mu\text{m}$ , versus 1–3  $\mu\text{m}$  in *Schistosoma*) and the high content of fortifying fibrils. Also, the molecular mode of action of these 2 trematodes may be significantly different. PZQ removes adult stages of *D. dendriticum* (erratic effect) and the pancreatic fluke *Eurytrema pancreaticum* in sheep, adults of *Paragonimus* sp. in dogs and *Fasciolopsis buski* in swine; it also kills the skin fluke *Gyrodactylus aculeatus* of fish and other piscivorous parasites such as intestinal flukes and cestodes (cf. Table 1). PZQ affects the adult stages of zoonotic and nonzoonotic *Schistosoma* spp. in cattle thereby producing large numbers of killed worm pairs and thus portal obstruction with more serious consequences than the disease itself. It is the current drug of choice for the treatment of human schistosomiasis (cf. Table 2) caused by bloodflukes such as *S. mansoni*, *S. haematobium*, or *S. japonicum*, and other human trematode infections due to small liver flukes (*Clonorchis*, *Opisthorchis*), lung flukes (*Paragonimus* spp.), and intestinal flukes (*Fasciolopsis buski*, *Heterophyes*, *Metagonimus*, *Echinostoma*, *Gastrodiscoides*, and others). The drug is remarkably safe; it is well tolerated with few, minor side effects and is suitable for mass treatment because of single dose regimen. *Resistance to PZQ:* The question has been posed whether resistance or tolerance to PZQ in schistosomes is a fact or artifact. Drug tolerance has been developed in strains selected in the laboratory. There was also evidence of drug tolerance to PZQ in a few endemic human populations; PZQ tolerant strains of *S. mansoni* proved fully susceptible to oxamniquine. To date, there is no evidence of development of clinically relevant resistance and the danger of drug resistance is considered to be lower for schistosomes than for soil-transmitted helminths [Doenhoff M et al. (2002) Trans R Soc Trop Med Hyg 96: 465]. *Oxamniquine* (a **tetrahydroquinoline**, cf. Table 2) is an alternative to PZQ for the treatment of schistosomiasis caused by *S. mansoni*. Since 1975, it has been used in a sustained control program in Brazil but in recent years Brazil has switched to using PZQ as the drug of choice. *S. haematobium* and *S. japonicum* are virtually unaffected by therapeutic doses; it is well tolerated and there is a low incidence of mild side effects. *Metrifonate* (syn. trichlorfon, an **organophosphate**) is converted nonenzymatically at physiological pH to dichlorvos and a potent cholinesterase inhibitor; it is effective clinically only against

infections with *S. haematobium*. Because of its low cost and ready acceptance metrifonate can be used as an alternative to PZQ for treatment of urinary schistosomiasis (usual dose is 7.5–10 mg/kg b. w. per os  $\times$ 3 at intervals of 2 weeks). Unfortunately, oxamniquine and metrifonate are no longer available commercially. **Artemisinin derivatives**, which are primarily used against malaria (cf.  $\rightarrow$ Malariacidal Drugs), also exhibit antischistosomal activity. In the mid-1990s, clinical trials were carried out in China, demonstrating that artemether fully protect against *S. japonicum* infections. Chemoprophylactic treatment with artemether was started prior to contact with water containing *Schistosoma* infected snails and then continued at intervals of 2 weeks. The feasibility of this novel control strategy has been demonstrated in further clinical trials including also *S. mansoni* and *S. haematobium* in China, Egypt, the Philippines, and other countries (for more information cf. Table 2 and text below).

### TREMATODE INFECTIONS OF ANIMALS (Economic importance, occurrence, disease patterns, epizootiology, and control measures)

The life histories of all genera and species belonging to the subclass Digenea are indirect, i.e., trematodes require 1, 2 or more intermediate hosts to complete their life cycle in the definitive host; obligatory intermediate hosts are snails. The main flukes parasitic in domestic animals and humans belong to the subclass Digenea of the class Trematoda (phylum  $\rightarrow$ Platyhelminthes).

**LIVER FLUKES:** The most common and pathogenic liver flukes in cattle, sheep, and goats are *F. hepatica* (common liver fluke), and *F. gigantica*. In humans, fascioliasis (mainly caused by *F. hepatica*) is focal in distribution and sporadic while in ruminants the infection is principally endemic and of greatest economic importance. *F. hepatica* is widespread and about 250 million sheep and 350 million cattle are at fascioliasis risk worldwide [Hillyer GV, AptW (1997) Parasitol Today 13: 87]. In Australia and New Zealand, up to 40 million sheep and 6 million cattle graze pastures where liver fluke is endemic. Graziers spend approximately \$10 million a year on fluke drenches alone; lost production (including liver condemnation) costs a further \$50–80 million a year (1999 estimate). Deaths account for only a part of this loss. Other significant losses in sheep include reduced production and quality of wool, reduced lambing percentages, poor growth rate of lambs, and increased costs for replacement stock. In cattle, losses include reduced production and quality of milk, lower growth rates, and lower feed conversion rates in fattening cattle (<http://www.dpi.nsw.gov.au/> website primefact 446, 2007). Thus in many countries about a quarter of the sheep and cattle population are exposed to the infection causing severe economic loss

in domestic livestock. Annual losses to the world's agricultural community due to liver fluke infestation are estimated to be in excess of \$2 billion. **Pathogenesis and clinical disease:** The liver fluke can develop to sexual maturity in sheep, cattle, horses, pigs, goats, alpacas. Other hosts include kangaroos, wombats, and rabbits, which may maintain the contamination of pastures as reservoirs. During the migration phase of parasites through the abdominal cavity and liver parenchyma (causing acute/ subacute fasciolosis), burrowing young flukes may produce serious, acute inflammatory tissue reactions resulting in extensive tissue damage and severe anemia (blood loss by mechanical trauma). The outcome may be "Black disease" of sheep and cattle, an acute and fatal liver disease associated with liver failure and death in 8–10 weeks. Chronic fasciolosis occurs when young flukes reach the bile ducts in the liver where they mature to adults. It is the most common form of liver fluke infection in sheep, goats, and cattle, particularly in more resistant hosts such as horses and pigs. The fluke ingests blood, which causes severe anemia and chronic inflammation and enlargement of the bile ducts. The clinical signs develop slowly (increasingly anemic, lowered appetite, pale mucous membranes of mouth and eyes, edema under the jaw – so-called 'bottle jaw'). Cattle have a natural resistance and under normal conditions the clinical disease is only likely in young cattle. Chronically infected cattle can spontaneously recover, and previously infected animals can partially resist reinfection. Thus cattle seem to be more resistant to fascioliasis than are sheep, possibly because of chronic fibrotic changes in the liver that form a certain mechanical barrier against reinfection. In sheep, there is no evidence of any acquired resistance to *F. hepatica* and *F. gigantica*. Acute and chronic fasciolosis can occur at any age. *Fascioloides magna*, a common trematode of deer in North America and brought in several European countries and South Africa, may cause severe disease and death in cattle, sheep, and goats by continuous tissue migration. Thus, a single migrating fluke can eventually cause the death of the host. The situation concerning *Dicrocoelium* is not clear either. In China, *D. chinensis* has been described as different from *D. dendriticum* and *D. hospes*. Young *D. dendriticum*, *D. hospes*, and *D. chinensis* (estimated prevalence of *D. chinensis* in South Korea 30–100% in sheep, and 35% in cattle) migrate directly from the small intestine via the common bile duct into the biliary system; they do not cause mechanical tissue damage to liver parenchyma. These small liver flukes produce *chronic tissue reactions* in the liver parenchyma as fibrosis of the Glisson's capsule (consisting of small bile ducts, portal veins, and hepatic artery), leading to biliary cirrhosis. Heavy infections may result in loss of weight and emaciation.

**Epizootiology and control measures of fasciolosis:** The chronically infected sheep and cattle play an

important part in contaminating pastures with million of embryonated *F. hepatica* eggs (an animal may produce 1–2 million eggs per day). Other domestic animals and wild animals may serve as reservoir hosts for *F. hepatica* and *F. gigantica*. Fasciolosis in ruminants (e.g., cattle, buffaloes, sheep, and goats) is found throughout the Americas, southeastern USA, Africa, Europe, and Asia (South Western Asia, and India, Central East Asia, and Southeast Asia). The disease occurs mainly in late autumn and winter. Due to the great biotic potential of *F. hepatica* and their intermediate host snails, only a continuous and coordinated strategic application of all available measures can provide economic control of the disease. Thus control of fasciolosis should be on a preventive rather than a curative basis and should include epizootiological parameters such as fluke development in the intermediate host and weather patterns.

*Preventive measures* may involve (1) strategic use of flukicides to reduce the number of flukes in the host and fluke eggs on pasture; (2) intermediate host snail control (management of fluke-prone areas to reduce exposure to infection, i.e., regular clearing of vegetation from drainage channels may reduce silting and blockages that normally support snail-contaminated herbage), and (3) disease control by farm management (snail-infested pastures occupy only a small part of the animals' grazing area; fencing off these contaminated areas is a most economic and efficient method of controlling fasciolosis; grazing management, i.e., grazing between the potentially fluke-infected areas and the fluke-free areas, or pasture rotation depending on suitable grazing properties of paddocks (e.g., more resistant cattle could be grazed on the known fluke-prone areas and are less likely to be affected and would require less treatments). Effective flukicides play an important role in the control of fasciolosis. An efficient strategic control program relying on a minimum number of treatments per year and aimed at long-term elimination of pasture contamination requires drug products that are effective against both mature and early immature flukes. More frequent treatments are necessary with drugs that are only effective against advanced mature fluke aged 12–16 weeks or older. Using anthelmintics the first of these strategies is the use of anthelmintics, based on the epidemiology of the disease. This makes it possible to determine the time of the year when the maximum effect can be achieved with the fewest possible treatments. The correct time for anthelmintic treatment depends mainly on climatic conditions and weather data. A *geographic information system* (GIS) forecast model based on moisture and thermal regime has been developed to assess the risk of *F. hepatica* infections in endemic areas [Yilma JM, Malone JB (1998) *Vet Parasitol* 78: 103]. GIS can be used to complement conventional ecological monitoring and modeling techniques; it permits database

management of standard maps, aerial photographs, satellite images, climate zones, and ground survey maps. Careful definition of factors affecting dynamics of fasciolosis on a geographic basis may be useful for researchers when making decisions on resource allocation and setting priorities. This makes it possible to determine the time of the year when the maximum effect can be achieved with the fewest possible treatments. Treatments are essential when clinical disease is apparent, even though it may be too late to prevent economic losses. Thus strategic treatments at epizootiological appropriate times (in late summer to avoid outbreaks of disease, and in late winter plus early spring to reduce contamination of pastures with eggs before grazing commences) are designed to minimize subsequent snail infection in the autumn and spring [Boray JC (1993) *Agfact* AO.9.57, NSW Agriculture, Orange, NSW: 10]. Annual programs of control for fluke may be 3 *triclabendazole* (TCBZ) treatments combined with other broad-spectrum anthelmintics. Using TCBZ more frequently (such as every 3 months from September) reduces fluke disease to a negligible level. However, more frequent drenching may lead to development of drug resistance. TCBZ resistance in liver fluke has been reported. The development of resistance may be delayed by alternating use of TCBZ with a closantel/ oxfendazole combination or other drug combinations (cf. [Table 1](#)). Adult beef cattle (more resistant to fluke) require fewer treatments than sheep to control fasciolosis. The recommended treatments (in Australia/New Zealand) are in August/September to eliminate fluke before spring, when the conditions become favorable for fluke eggs and host snails. This is an essential treatment for all cattle (incl. young heifers and dry cows). It is advisable to treat cattle and sheep at the same time, especially if sheep and cattle are grazing on the same pasture; an additional treatment for all young cattle should be performed in April/May to eliminate any fluke picked up during summer. Some of the available anthelmintics (cf. [Table 1](#)) are not effective against immature fluke and so are not recommended in acute fluke outbreaks. Also, they are less efficient for the strategic control of fasciolosis. The best prevention and control can be achieved with TCBZ, which affects early immature and adult fluke in particular; treatment a month before calving, and immediately after drying off will additionally improve performance in cattle.

*Closantel* (CST) is effective against *Haemonchus* as well as liver fluke; however, in certain areas there may be widespread resistance of *Haemonchus* against this drug. CST is effective against young mature fluke aged about 6–8 weeks, but has reduced effect on early immature fluke populations. This lower efficacy against early immature fluke is more evident where CST resistance in immature *F. hepatica* has emerged. The closantel/ oxfendazole combination has good

synergistic efficacy against susceptible fluke aged 4 weeks and can be successfully used against TCBZ-resistant fluke. CST, or the above combination (both approved for use in sheep in Australia and elsewhere), may be suitable for the late winter/early spring treatment. Successful prevention and control of the disease have been achieved with *diamfenetide* (~100% efficacy against 1-day-old to 9-week-old flukes, cf. Table 1) and *rafoxanide* (efficacy ~86–100% against 6-week-old stages to adult flukes, cf. Table 1); however, these drugs are no longer available commercially in various countries. *Albendazole*, *clorsulon* and *bromsalans* affecting only adult stages of *F. hepatica* do not play a role in strategic control programs. This is also true for older drugs such as *bithionol*, *hexachlorophene*, *bromofenofos*, and *niclofolan* (not considered in Table 1), which may still be used in some countries and are no longer approved as flukicides in Australia, USA, EC, and elsewhere. Only at doses approaching toxic levels, these drugs affect immature flukes aged 8–10 weeks. Also, drug combinations such as *oxyclozanide* / *levamisole*, and *clorsulon* / *ivermectin* (approved for use in lactating cows, cf. Table 1) are used against adult fluke aged 12–14 weeks or older including gastrointestinal nematodes and lung-worms; if the property is heavily contaminated, treatment in lactating cows should be performed monthly during summer and autumn.

*Vaccines* may offer a more effective and acceptable alternative to drugs because they are regarded as safe, environmentally friendly, and leave no chemical residues in the food chain. Until now, there is no commercially available vaccine against liver fluke. The main market opportunity for a vaccine (~US\$ 182 million) is in those countries with intensive cattle and sheep farming industries (Australia, Argentina, Brazil, Europe, New Zealand, and the USA). A novel recombinant protease (University College Dublin Ireland owns Intellectual Property) has demonstrated effective protection against liver fluke in cattle and sheep. Current work is focused on developing a formulation and administration regime, which will induce maximal protection using the most commercially viable adjuvant. Another available strategy for controlling liver fluke infection in livestock is *intermediate host snail control*. The snails (e.g., *Lymnaea* spp.) produce eggs throughout the year and there is a marked increase in reproduction from spring to late autumn. Each snail may produce 3,000 eggs a month and one generation of snails from egg to egg takes only about one month under optimum conditions. *Lymnaea* survives in dry mud for at least one year, moves with and against the water current for long distances, and tolerates low temperatures. Metacercariae encysted on grass blades; in the presence of sufficient moisture they will remain

alive for many weeks, depending on the temperature (survive longer at below 20°C, higher temperatures and desiccation will destroy them in a short time). Fluke survive for many years in the liver of infected sheep; the adult fluke produces between 20,000 and 50,000 eggs a day, and over a long period. In cattle, the egg production declines as the animal develops a natural resistance to chronic infections. The epizootiology of the disease is influenced by the grazing habits of animals. Cattle often graze in the wet marshy areas favored by the fluke snail, so the eggs are deposited in a suitable environment. If food is available elsewhere, sheep and goats prefer to graze away from marshy pastures. Long wet seasons are usually associated with a higher infection rate but sheep are more likely to ingest large numbers of cysts during dry periods after a wet season, when the animals are forced to graze in swampy areas, resulting in heavy infection. It is unlikely that *chemical control* or *biological means* (living antagonists or predators of snails like ducks and frogs ingesting snails in endemic areas) will eradicate the snail population, because it reproduces readily. Rapid repopulation from adjoining areas can occur. Chemical control by the use of highly active and for the environment toxic molluscicides (e.g., niclosamide ethanolamine salt, former Bayluscid, N-tritylmorpholine, former Frescon, and sodium pentachlorophenate or copper sulfate) is now obsolete. These agents not only kill snails but also other invertebrates and fish. Therefore, the use of molluscicides has been severely restricted in most countries (no registered products for snail control in the USA, Australia, EC, and elsewhere). Current strategic control of fluke infections in cattle and sheep relies on drug treatment and farm management (↑) including improved drainage and regular clearing of vegetation from drainage channels. In low-lying areas, adequate drainage would prevent accumulation of water (snails multiply for extended periods in wet, low-lying areas). Draining marshy pastures and building dams may reduce snail habitats and increase grazing areas.

There are no efficient control measures for preventing *Dicrocoelium* infections in sheep and cattle. Intermediate hosts (snails, ants) of *Dicrocoelium* spp. are known to be widespread in arid areas and have high reproductive rates. However, intermediate host snail/ant control is impracticable though ant populations might be reduced by destroying nests in certain districts. But Formicidae are protected animals and control of ants is basically prohibited. Further, none of the antitrematodal drugs available is effective enough to remove all adult *Dicrocoelium* and obtain permanent improvement of liver function and regeneration of liver parenchyma. Nevertheless, common strategic drug treatments in early spring, summer, and autumn may help to reduce

production loss in sheep and cattle. *Benzimidazoles* show some activity against *Dicrocoelium* infection at relatively high (not approved and uneconomic) dosages given orally (e.g., albendazole: 7.5–15 mg/kg × 2: weekly interval; fenbendazole: 20 mg/kg for 5 days; febantel: 50 mg/kg for 2 days).

**INTESTINAL FLUKES:** Global infections due to amphistomes (e.g., family Paramphistomatidae) in cattle and sheep are of minor economic (veterinary) importance. Thus, the pathogenicity of these flukes is lower than that caused by the hepatic trematodes and intestinal nematodes. There are 3 groups of amphistomes living in gastrointestinal tract of animals: (1) *Paramphistomum* spp. (13 species, and several other genera) inhabiting the duodenum as larvae and invading the rumen at a later developmental stage (major pathogenic effect caused by juvenile stages in duodenum); (2) *Gigantocotyle* spp. and *Eurytrema* (belonging to Dicrocoeliidae) inhabiting the duodenum and bile ducts; and (3) *Gastrodiscus*, and *Homalogaster* living in the lower alimentary tract (considered to be of minor importance). Young paramphistomes are deeply embedded into the mucosa of the small intestine causing mechanical damage of the epithelial cells by their large posterior (ventral) sucker. Adult *Paramphistomum* living in the forestomachs of ruminants may produce only slight clinical signs. During the migration phase in the duodenal wall and abomasum wall the young rumen flukes are highly pathogenic to young, naive (previously uninfected) sheep and cattle, and large numbers of larval stages can cause clinical signs, such as loss of appetite (anorexia), diarrhea (dehydration), anemia (loss of protein), retarded growth, and even mortality. As a rule, susceptible calves, and lambs should not be grazed together with adult animals, as these are chronically infected in most cases. If an outbreak of disease occurs all animals should be treated and removed immediately from pasture. *Gigantocotyle explanatum* (a common paramphistome in cattle in India) may cause pathological damage similar to those caused by *F. hepatica* or *F. gigantica*. There are many other genera and species of intestinal trematodes in ruminants, equines (e.g., *Gastrodiscus aegyptiacus*), and pigs (e.g., *Fasciolopsis buski* and *Gastrodiscus aegyptiacus*). In dogs, there are also a large number of intestinal flukes, such as heterophyids, echinostomes, and diplostomes, which show little host specificity and can also infect humans (cf. Table 2). Adult stages of these genera are nearly without pathological findings and, in general, do not cause clinical disease. Intestinal flukes also frequently occur in birds and rodents, which may form reservoirs for infections in humans and livestock. Because there is little host specificity intestinal trematodes are often found in unusual hosts. *Farm management techniques and control measures* in the treatment of rumen fluke

infections (paramphistomiasis) in cattle, sheep, and goats are similar to those used in integrated control for fascioliasis. Paramphistomes respond to flukicides used for the control of fascioliasis in ruminants; some anticestodal agents (→ **Cestodocidal Drugs**) such as bithionol, resorantel, and niclosamide affect them too. However, compounds may exhibit different chemotherapeutic activities in cattle or sheep, or their actions on juvenile flukes in the intestinal and abomasal walls, and adult flukes in the rumen may differ as well. For instance, *bithionol* exhibits better efficacy against juvenile than adult flukes whereas *oxyclozanide* or resorantel are effective against both immature and mature stages.

**BLOOD FLUKES:** The worms live in the vascular system of vertebrates. Distribution patterns of human and animal blood fluke infections (*Schistosoma* spp. causing schistosomiasis in humans cf. Table 2) are mainly restricted to the tropical and subtropical areas. Two genera of animal schistosomes of importance belong to the genera *Schistosoma* and *Orientobilharzia*. Within *Schistosoma* there are species of zoonotic importance, which infect also man, such as *S. japonicum* (described from cattle, buffaloes, goats, and pigs), *S. mattheei* (found in cattle and buffaloes) and *S. curassoni* (found in cattle, goats, and sheep). The nonzoonotic species also have limited host specificity and include *S. bovis* (cattle, sheep, and goats), *S. indicum* (cattle, goats, and sheep), *S. spindale* (cattle and goats), *S. nasalis* (cattle, buffaloes, and goats) and *S. incognitum* (pigs). *Orientobilharzia turkestanicum* was described as occurring in cattle and sheep. Schistosomiasis in ruminants is known to occur often focally in endemic areas because of aggregated distribution of the intermediate snail hosts and the restricted stock movement from one farm to another. Thus individuals from the same herd are likely to be exposed to similar ranges of cercarial challenge. The per-oral route of infection may be of importance in cattle, particularly when animals drink infrequently and swallow large volumes of water. In China, *S. japonicum* infections are known to be an important zoonosis; millions of cattle may be infected and develop a natural acquired immunity to this schistosome infection. Generally the pathogenicity of blood fluke infections in grazing animals is considered to be low, only occasionally causing serious problems (particularly in cattle) in Africa, the Middle East, and Asia, e.g., India and China (for further information on geographical distribution and prevalence of common trematode infections cf. FAO Corporate Document Repository <http://www.fao.org/DOCREP/>). In most parts of endemic regions chemotherapy (e.g., with PZQ = praziquantel) appears not to be a suitable mean for controlling schistosomiasis in domestic livestock (cf. current status of flukicides: PZQ ↑) though it is the current method of choice in the control of human schistosomiasis (Table 2).



## TREMATODE INFECTIONS OF HUMANS (Prevalence, disease patterns, and control measures)

**BLOOD FLUKES (SCHISTOSOMIASIS):** *Clinical manifestations, pathogenesis, and pathology:* Exposure to infection can begin shortly after birth and maximum risk of exposure may occur in children aged 10–14 years. The lower prevalence in adults possibly is due to partial immunity and decreased exposure to water containing cercariae. Symptoms of the disease correlate with developmental stages of the blood flukes: (1) Cercariae emerged from aquatic snails penetrate the skin and produce an allergic dermatitis (pruritic papular rash) at site of entry; nonhuman avian schistosomes cause similar symptoms. (2) The tailless cercariae (schistosomula) migrate into the lungs via the venous circulation. From there schistosomula are carried through the left heart into the systemic circulation, finally reaching the portal system (in case of *Schistosoma mansoni*, *S. japonicum* infections) or the umbilical plexus (*S. haematobium*). Cardiopulmonary schistosomiasis is associated with larval pneumonitis causing cough, mild wheezing, low-grade fever, and eosinophilia. (3) Adult worms rarely are pathogenic. In the venous blood, male and female worms mate, and the female lays eggs. Prepatent period, (time between penetration by cercariae and first appearance of eggs in feces or \*urine) is ~35 days for *S. mansoni*, *S. japonicum* (others) and ~70 days for \**S. haematobium*, respectively. The female worm may live for approximately 3–8 years and lays eggs throughout her life span. In heavy infection, symptoms are similar to those seen with schistosomula (cough, fever, and eosinophilia).

*Acute manifestations:* Clinical symptoms reflect host responses to toxic or antigenic substances derived from the parasites and eggs. Eggs cause so-called Katayama fever (termed after the District in Hiroshima Prefecture) and schistosomiasis. High fever, lethargy, and myalgia (less common are cough, headache, anorexia, and rash) may suddenly start after termination of prepatent period and is observed most commonly with *S. japonicum* but also has been reported with *S. mansoni*. These symptoms can mimic any acute viral, bacterial, or malarial illness. An anamnesis that includes freshwater exposure in an endemic area may confirm an infection with schistosomes. Katayama syndrome may be due to host's response against egg antigens released in serum and forming immune complexes. It is obviously not associated with granulomatous inflammation around schistosome eggs; *Granuloma formation* (aggregations of mononuclear phagocytes, neutrophils, particular eosinophils, lymphocytes, plasma cells, fibroblasts, and giant cells) has been considered to be the result of delayed-type hypersensitivity reactions mediated through T helper cells (Th1 and Th2 cells, phenotype

CD4+) mediated immune response to soluble egg antigens. Thus, schistosomiasis is principally due to immunological reactions of the host to *Schistosoma* eggs trapped in tissues that results in clinical disease. Symptoms and signs depend on the number and location of eggs trapped in the tissues. Initially, the inflammatory reaction is readily reversible. In the latter stages of the disease, the pathology is associated with collagen deposition and fibrosis, resulting in organ damage that may be only partially reversible.

*Chronic manifestations:* Most patients are asymptomatic or mildly symptomatic. Only a small proportion of the endemic population harbors a heavy worm burden that later leads to clinical complications. Typically, onset may be insidious and depends on the species of schistosome, the duration, and severity of infestation. The immune response to eggs of *S. mansoni*, *S. mekongi*, *S. intercalatum*, and *S. japonicum* causes intestinal tract and liver disease (abdominal pain, diarrhea, dysentery, dyspepsia, flatulence, pain in the left hypochondrium due to the enlargement of the spleen). In the later stages of hepatic schistosomiasis, abdominal distention, lower limb edema, hematemesis, and melena (dark stools containing blood) can occur. The most common complication of gastrointestinal schistosomiasis is periportal fibrosis leading to portal hypertension and gastrointestinal hemorrhage and then to hepatosplenomegaly, pedal edema, pallor, distended abdominal veins, and ascites. Symptoms of liver failure are rare unless other infectious, toxic, or malignant causes of hepatitis are present leading via chronic hepatitis to cirrhosis. Thus, people coinfecting with either hepatitis B or C and *S. mansoni* have been shown to have rapid progression of liver disease. An important complication occurring in about 5% of patients with hepato-splenic *S. mansoni* is schistosomal cor pulmonale and anemia (palpitations, generalized pain, easy fatigability, weakness, and dyspnea on exertion, hemoptysis = spitting of blood-stained sputum). *S. japonicum* may cause cerebral schistosomiasis in 2–4% of patients (seizures; headache; and myelo-radiculopathy with lower limb and back pain, bladder dysfunction, paresthesia, and lower limb weakness); in a few cases CNS involvement may also occur with other species. Spinal disease usually presents as transverse myelitis and primarily is due to *S. mansoni* infection. *S. haematobium* causes urinary tract disease (dysuria, urinary frequency, and terminal hematuria) and only rarely intestinal or liver disease. There may be renal failure due to obstructive uropathy, pyelonephritis, or bladder carcinoma (latter may occur 10–20 years after initial infection); immune complexes and worm antigens may deposit in the glomeruli causing glomerulonephritis and amyloidosis. Female genital schistosomiasis (FGS) is characterized by lesions in the lower genital tract (cervix, vagina); the history

includes postcoital bleeding, genital ulceration, irregular menstruation, and pelvic pain. FGS has been identified as a major social and medical problem that may facilitate the spread of some sexually transmitted diseases such as HIV and human papilloma virus (HPV).

*Burden of schistosomiasis:* Morbidity caused by schistosomiasis and *soil-transmitted helminth infections* (cf. →Nematocidal Drugs, Man) remain major public health concerns in many tropical and subtropical regions of the world, particularly in the poorest developing countries; cost-effective solutions are both available and deliverable. Recent World Health Organization (WHO) reports estimate that 500–600 million people in 74 tropical and subtropical countries are at risk for schistosomiasis. Gastrointestinal disease due to *S. mansoni* occurs in 52 countries, including Caribbean countries (Saint Lucia, Antigua, Montserrat, Martinique, Guadeloupe, Dominican Republic, Puerto Rico), eastern Mediterranean countries, South American countries (Brazil, Venezuela, Surinam), and most countries in Africa. Urinary tract disease produced by *S. haematobium* affects 54 countries in Africa and the eastern Mediterranean. Other *Schistosoma* spp. that can cause gastrointestinal diseases include *S. intercalatum*, *S. mekongi*, and *S. japonicum*; latter species is endemic in the western Pacific region (e.g., Philippines, China, Indonesia, and Thailand), *S. mekongi* infection occurs in the Mekong River area of Southeast Asia (Cambodia, Laos, and Thailand) and *S. intercalatum* is found in several countries within the rain forests of central Africa. Over 200 million people in these countries are infected with schistosomes and of these about 10% having a severe clinical disease. Persons at risk include those who live or travel in areas where schistosomiasis occurs and who come into contact with fresh water where the appropriate type of snail intermediate host is present.

*Control measures and drug treatment programs:* According to the WHO, the global distribution of schistosomiasis has changed in recent years. It has been eradicated from Japan and the Lesser Antilles islands; transmission has been stopped in Tunisia and is very low in Morocco, Saudi Arabia, Venezuela, and Puerto Rico. The morbidity caused by disease has been controlled in Egypt, China, and the Philippines mainly by widespread use of praziquantel (PZQ) and oxamniquine and PZQ in Brazil. In 2001, the WHO has developed a strategy aimed at control of morbidity due to schistosomiasis and intestinal worms in sub-Saharan Africa [World Health Organ Tech Rep. Ser (2002) 912: i-vi, 1-57]. The goal of World Health Assembly resolution is to attain a minimum target of regular administration of chemotherapy to >75% of all school-age children at risk of morbidity by 2010. Thus,

school-age children should be treated on a regular basis during their childhood, thereby improving their health and nutritional status and protecting them from liver fibrosis and bladder complications, which would otherwise occur later in life. PZQ treatment should be also offered to pregnant women (benefits of treatment greatly outweighing theoretical drug toxicity) and to adults infected or at risk of developing morbidity by the disease. Similarities in the population at risk and in the tools required to combat the problems have prompted moves toward a combined approach to the control of schistosomiasis (and soil-transmitted helminthiasis caused by nematodes). Such an approach relies largely on epidemiological surveillance, health education (in endemic areas, people should avoid contact with fresh water; need for providing a safe water supply, the role of snails as intermediate host for blood flukes), improvements in hygiene and sanitation (improving water sanitation and avoiding schistosome-contaminated urine or stool), and in the first place, regular treatment of high-risk groups, particularly school-age children. The cost of recommended anthelmintic drugs has now fallen to a level at which it should no longer deter Member States from making treatment widely available in endemic areas. Thus PZQ and oxamniquine (no longer commercially available in the USA) are used commonly, but PZQ is the treatment of choice for all species of schistosomiasis (dose regimen, cf. Table 2). Clinical studies demonstrated that artemether (derivative of dihydroartemisinin) which is used as antimalarial drug, is also active against all 3 major schistosome parasites (mainly schistosomula). In addition, clinical studies have shown that artemether is a suitable prophylactic agent if given once every 2–4 weeks; also trials that included a combination of artemether and praziquantel demonstrated beneficial effects (for more information on current status of control programs, PZQ delivery strategies, price of PZQ, and alternative drugs cf. Table 2). To date, no prophylactic acting or vaccine is available. However, clinical trials involving human volunteers are underway to develop an effective vaccine against schistosomiasis.

**LIVER FLUKES:** Human infections with the cosmopolitan liver flukes *Fasciola hepatica* and *Dicrocoelium dendriticum* may occur by chance in endemic areas depending on eating habits of people (cf. Table 2). When a person eats contaminated plants (e.g., by eating watercress from naturally contaminated creeks), the metacercariae leave their cysts, pass through the wall of the intestine, and enter the liver, where they cause inflammation and destroy tissue. Following prepatent period (10–15 weeks), the adult flukes move to the bile ducts and produce eggs. *Acute fascioliasis* is characterized by abdominal pain with headache, loss of appetite, anemia, and vomiting. Some patients may develop

hives, muscle pains, and jaundice (yellow-color to the skin and whites of the eyes). *Chronic forms* of the disease may produce complications, including blockage of the bile ducts or the migration of adult flukes to other sites of the body. Drug of choice for treating fasciolosis is *triclabendazole* (a benzimidazole), an alternative may be bithionol (cf. [Table 2](#)); PZQ proved ineffective against *Fasciola* (for reason cf. Current status of flukicides†). Human infections with *Opisthorchis* spp. and *Clonorchis* are widespread, affecting about 30 million people in China, Korea, Japan, Southeast Asia, and India. The life cycle of these liver flukes is similar to that of *F. hepatica* except that the metacercariae are found under the scales of freshwater fish rather than on plants. Dogs, cats, and other mammals that eat raw fish may serve as reservoir hosts. Man becomes infected by consumption of raw or improperly cooked cyprinoid fish chiefly coming from contaminated aquacultures. The symptoms of the diseases resemble those of fascioliasis and include both acute and chronic forms. The acute syndrome may be difficult to diagnose (absence of typical eggs in feces during prepatent period); patients with the chronic form of the disease may show low-grade fever, diarrhea, inappetence, fatigue, and an enlarged liver that feels sore when the abdomen is pressed. Safe and effective oral drugs are available for the treatment of both opisthorchiasis and clonorchiasis. PZQ is the drug of choice for treating all species of *Opisthorchis* and *Clonorchis sinensis* (cf. [Table 2](#)). Effective snail control in order to interrupt transmission of cercariae to fish is impracticable; it is also unlikely that chemical control (use of toxic molluscicides is obsolete and prohibited in most countries) or biological means will eradicate the snail population, because of its rapid repopulation from adjoining areas. Ammonium sulfate added to egg-contaminated feces may kill the eggs and so interrupt life cycle of parasites in freshwater snails.

*Carcinogenic risks due to liver and blood flukes:* In 1994 the International Agency for Research on Cancer (IARC) decided to include in its monograph series on carcinogenic risks to man, schistosomes and liver flukes [International Agency for Research on Cancer (Lyon 1994) schistosomes, liver flukes and *Helicobacter pylori*. IARC Monographs on the evaluation of carcinogenic risks to humans, 61: 121–175]. The evidence here comes from epidemiological studies (helpful animal cancer model are not available). *Opisthorchis viverrini* and *S. haematobium* are classified as carcinogenic (category 1, main cancer cholangiocarcinoma and bladder cancer, respectively). *Clonorchis sinensis* and *S. japonicum* are classified as probably or possibly carcinogenic (category 2A/2B, main cancers cholangiocarcinoma and gastrointestinal cancer, respectively). *O. felineus* and *S. mansoni* are nonclassifiable because of insufficient human evidence (category 3).

**LUNG FLUKE INFECTION:** *Paragonimus westermani* and some other 16 species of the *Paragonimus* genus cause paragonimiasis in man (~21 million infected people worldwide). Infections are often due to cultural-specific habits of minorities in certain areas of Southeast Asia, West Africa, and the Americas. Numerous reservoir hosts (various crustacean-eating wild carnivores and omnivores) makes control of *Paragonimus* nearly impossible; boiling the freshwater crabs or crayfish (second intermediate host; all organs of the crab/crayfish can harbor metacercariae) for several minutes until the meat has turned opaque will kill metacercariae. Slight infection may be asymptomatic in humans. The disease is insidious (first nonspecific cough that becomes chronic and produces blood-tinged sputum followed by pleural pain and dyspnea). Primary manifestation can be complicated by recurrent pneumonitis, lung abscess, and pleural effusion. Lesions in brain can lead to seizures and resemble those seen in cysticercosis (cf. →[Cestodocidal Drugs](#)). Chronically infected patients may show clubbing of fingers and toes. PZQ is the drug of choice for the treatment and control of *Paragonimus* infections (dose regimen cf. [Table 2](#)).

**INTESTINAL FLUKES:** They are widely distributed throughout the Far East and Southeast Asia, the Indian subcontinent, West Africa, and Mediterranean countries (*Heterophyes heterophyes* can be found especially in the Nile delta region of Egypt). Although intestinal flukes are of minor medical importance they may cause morbidity, which is only observed in patients with heavy worm burdens who suffering from severe cachexia and prostration. There are numerous species living attached to the epithelium of the small and large intestine. *Fasciolopsis buski* (giant intestinal fluke, ~15–20 million infected people) occurring in areas of the Far East is transmitted by metacercariae attached to various aquatic plants (water chestnut, lotus on the roots, water bamboo, and other aquatic vegetation). Young flukes attach to the duodenal and jejunal mucosa and become mature in approximately 3 months. In severe infections, they may attach also to the ileum or colon. The adult worm produces traumatic, toxic, and obstructive damage to the intestinal mucosa. At the site of attachment, deep inflammatory ulcerations may be seen. Large numbers of this fluke provoke excess mucous discharge and can obstruct the lumen. Metabolites released from adult stages in the lumen and then absorbed may cause intoxication and sensitization. Malabsorption can lead to hypoalbuminemia, protein-losing enteropathy, and impaired vitamin B<sub>12</sub> absorption. *Echinostoma ilocanum* (12 species) is the most common species of this genus occurring in man; metacercariae are transmitted by eating raw or undercooked freshwater mollusks (snails or clams). Adult worms attach to the mucosa of small intestine and produce inflammation, superficial ulcers, and local necrosis of the mucosa. Small numbers of this

fluke are asymptomatic but large ones produce diarrhea, flatulence, and intestinal colic. *H. heterophyes* (10 species, ~10 million infected people, uncommon but widely distributed) and *Metagonimus yokogawai* (most common heterophyid fluke in areas of the Far East and Mediterranean basin) encyst under the scales or in the skin of various fish species. Following ingestion of infected raw or undercooked fish, the small flukes (closely related species measuring 1–2.5 mm in length and 0.4–0.75 mm in width) attach to and also invade the mucosa of the jejunum and ileum thereby causing inflammation, shallow ulcers, and superficial necrosis of the mucosa. Symptoms include vague abdominal complaints, dyspepsia, mucous diarrhea, and intestinal colic. Flukes eventually become encapsulated, or they form sometimes clots (emboli) together with their eggs entering blood vessels and may lodge in the brain producing symptoms similar to cerebral hemorrhage, or worm/egg clots enter the mesenteric lymphatics and travel to the heart causing myocarditis and chronic congestive heart failure; death may occasionally occur by an embolic infarct if clots obstruct important arteries in the brain or heart. Other intestinal flukes that rarely cause intestinal infection in man are *Gastrodiscoides hominis* occurring in India, Southeast Asia, and parts of the former USSR (transmitted by eating uncooked aquatic plants; adult worms attach to wall of colon and cecum), *Nanophyetus salmincola* occurring in eastern Siberia and Northwestern USA (transmitted by eating raw infected fish, adults attach to small and/or large intestine), or lecitodendriids (occurring in a wide variety of insectivores vertebrates, e.g., bats) such as *Phaneropterus bonnei* and *Prosthodendrium molenkampi*, minute flukes that may infect people in Southeast Asia (Thailand and Indonesia) presumably by feeding upon infected larval or adult insects in regions where these are local delicacies, or by accidentally ingesting insect larvae with aquatic vegetables or water. PZQ is the drug of choice for the treatment and control of all intestinal fluke infections (dose regimens, Table 2).

## Trench Fever

Disease with 3–8 repeated fever phases (all 5 days = therefore also called 5-days fever) due to infection with *Bartonella quintana*-bacteria. These bacteria being previously members of the genus →*Rochalimea* are transmitted by →lice.

### Therapy

Tetracyclines.

## Trepomonas

→Diplomonadida.

## Triactinomyxon ignotum

Stage of →*Myxosoma cerebralis*.

## Triacylglycerol

→Acanthocephala.

## Triaeophorus

→Eucestoda.

## Triatoma infestans

→*Blastocrithidia triatomae*, →Bugs, →*Trypanosoma cruzi*.

## Triatominae

→Bugs.

## Triazines

→Coccidiocidal Drugs.

## Tricarboxylic Acid Cycle

### Synonym

TCA Cycle, →Krebs Cycle, Citric Acid Cycle

### Definition

→Energy Metabolism.

## Trichinella spiralis

### Name

Greek: *thrix*, *trichos* = fine hair, *ella* = small; Latin: *spiralis* = enrolled.

### Classification

Species of →Nematodes.

### General Information

Originally it was claimed that there is only one worldwide occurring species (→*T. spiralis*). However, up to now 13 genotypes have been described, which were considered to belong to 8 defined species. The size of the adults is tiny (males, 1–1.8 mm; females, 1.4–3.7 mm), their oesophagus is lined with the typical stichocyte-cells. The males have small leaflike appendices for copulation, but do not possess spicula. Based on alloenzymes and DNA-analysis the following species were described:

1. **Worldwide:** *Trichinella spiralis* (life cycle synanthropic in pig, rat, horse, camel, dog, fox, bear, **humans**; muscle cysts with capsule),
2. **Arctic:** *T. nativa* (cycle sylvatic; muscle cyst with capsule; highly resistant to freezing),
3. **Moderate climates:** *T. britovi* (cycle sylvatic, muscle cysts with capsule),
4. **Africa:** *T. nelsoni* (cycle sylvatic, muscle cyst with capsule),
5. **USA, Asia:** *T. pseudospiralis* (cycle sylvatic, muscle cyst without capsule),
6. **Europe, North America:** *T. murreli* (cycle sylvatic, muscle cyst with capsule),
7. **Papua-New Guinea:** *T. papuae* (cycle sylvatic, muscle cyst without capsule),
8. **Zimbabwe:** *T. zimbabwensis* (in crocodiles, without capsule).

### Life Cycle

Fig. 1 (page 1467).

### Morphology

→Nematodes, Figs. 2–5 (pages 1468, 1469).

### Diseases

→Cardiovascular System Diseases, Animals, →Trichinosis, →Trichinelliasis, Man.

## Trichinelliasis, Man

### Synonym

Trichinellosis, →Trichinosis.

### Pathology

Infection with →*Trichinella spiralis* and several subspecies is acquired by ingestion of undercooked meat from pig, bear, walrus, and certain other omnivorous species (→Pathology/Figs. 18C,D-20). Encysted larvae in muscle are set free during digestion, and enter the intestinal epithelial cells where they become mature in the first week, generally giving rise to →diarrhoea and severe eosinophilic inflammation especially in reinfections. The worms mate and produce larvae which invade the intestinal wall and enter the bloodstream. After some migration, they enter skeletal muscle in the second and third week of infection. With heavy infection myositis, oedema, and high fever with →eosinophilia. make their appearance in the second week when larvae invade the muscle fibres in which they encapsulate (→*Trichinella*, →Pathology/Fig. 18C). Blood eosinophilic is pronounced 3–5 weeks after infection. Myocarditis and →encephalitis may result from transitory worm migration. While the larvae grow intracellularly, the muscle fibres form an inner capsule and an outer capsule, the endomysium, which becomes hyalinized. The coiled larvae may persist for many years. Calcium may be deposited in the capsule and muscle and eventually the larvae dies (→Pathology/Fig. 18D). Eosinophilic inflammatory foci caused by occasional degenerating larvae are found in muscles.

### Immune Responses

Within 10–15 days *Trichinella* are completely removed from the intestine of infected rats or mice. The worm loss is associated with profound inflammatory changes such as infiltration of the mucosa with mast cells, villus atrophy and crypt →hyperplasia, net secretion and accumulation of fluid in the gut lumen, and increased peristalsis. These changes in the environment appear to make the intestine inhospitable to the worm, so that it is no longer able to maintain its preferred position

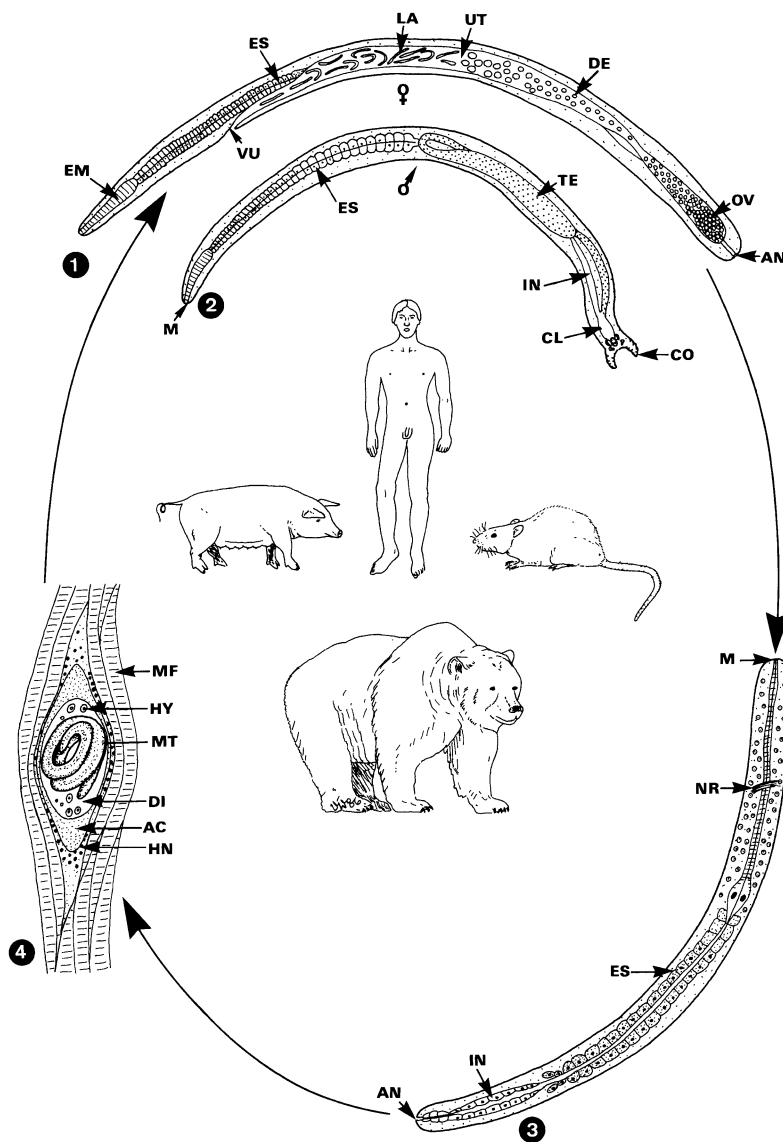

**Trichinella spiralis.** Figure 1 Life cycle of *Trichinella spiralis*. 1–2 The adults (male 1.5 mm × 40 μm, female 3–4 mm × 60 μm) live for 6 weeks (at the maximum) in the small intestines (being anchored in the mucous layer) of many carnivorous and omnivorous animals including man. Beginning from the 5th day after infection the females release (over a period of 4–16 weeks) in total about 2000 larvae (→viviparous) which hatch from their eggshells while still inside the single uterus (UT). The hatched larvae (LA) measure about 100 × 8 μm and are characterized by rounded poles and an extremely long esophagus (ES); they eventually enter the wall of the intestine and are carried away by the hepatic portal system through the liver, heart and lung, and thus are distributed by the arterial system throughout the body of the same host (which thus is the final and →intermediate host). 4 When larvae reach skeletal muscles, they penetrate individual fibers and begin to grow, reaching up to 1 mm in length (without →molt); up to seven larvae have been seen within a single fiber which is altered due to the parasitism. At first, the region around the worm becomes amorphous (due to disappearance of sarcomeres) and finally a broad dense outer, but still intracellular, zone is produced, apparently by deposition of primarily metabolic material (AC) leading to some sort of a capsule. Outside this capsule thickening may be brought about by infiltration of leukocytes and calcification (beginning about 10 months after infection). Such encysted worms are infectious for many years; transmission occurs again when such larvae are ingested by another omni- or carnivorous host. In the intestine excystation proceeds; however, the number and location of the following molts are still a matter of controversy. AC, anlage of a capsule (at the inner periphery of an infected muscle fiber); AN, anus; CL, →cloaca; CO, copulatory appendages; DE, development of fertilized eggs; DI, disintegrated →cytoplasm of the host muscle fiber; EM, esophagus (muscular region); ES, esophagus (stichosomal region); HN, host cell nucleus (unchanged); HY, hypertrophied host cell nucleus; IN, intestine; LA, larvae; M, mouth; MF, muscle fiber (uninfected); MT, muscle trichine; NR, neural ring; OV, ovary with eggs; TE, →testis; UT, uterus; VU, vulva.



**Trichinella spiralis.** Figure 2 LM of an adult female and a couple (arrow).

in the small intestine. The inflammatory changes are dependent upon the local activation of CD4<sup>+</sup> Th2 cells that develop in the lamina propria and draining mesenteric lymph nodes. These cells do not mediate worm expulsion by themselves, but instead promote the differentiation and activation of mast cells. Several experimental findings support this scenario: (1) Nude mice and mast-cell-deficient mice allow prolonged *Trichinella* persistence and restoration of mast-cell responses restores the ability to expel worms, (2) worm loss correlates with the release of mucosal mast cell-specific proteases, and (3) blocking mast-cell development with antibodies against c-kit (stem cell factor receptor) prevents worm expulsion. Th2 cytokines such as IL-3, IL-4, and IL-9 participate in the development of a protective mastocytosis. The accompanying infiltration of the mucosa with eosinophils could be blocked by treatment of mice with anti-IL-5 antibodies. The finding that this treatment did not stop worm expulsion suggests, that if eosinophils do have a role it is not essential.

Unexpectedly, it has been recently shown that IL-4 is not only required for worm expulsion but also involved

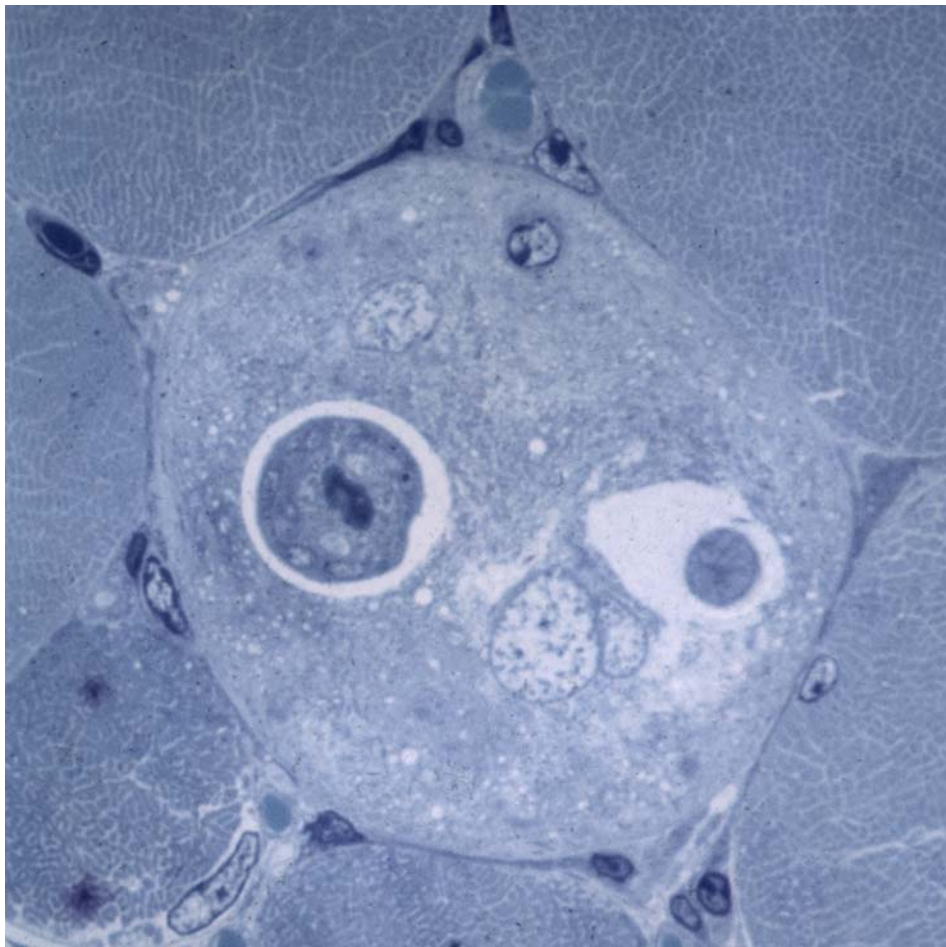

**Trichinella spiralis.** Figure 3 LM of a semithin section with a twice cross-sectioned larva in muscle cell.



**Trichinella spiralis.** Figure 4 LM of an unfixed coiled larvae 1 (note the rounded ends).

in the development of enteropathy. Moreover, abrogation of severe pathology in TNF-receptor-deficient mice did not prevent parasite expulsion. These findings suggests (1) a novel interplay between IL-4 and TNF and (2) that IL-4-mediated protection operates by mechanisms other than merely the gross degradation of the parasite's environment as a consequence of immune enteropathy.

The role of antibodies in worm expulsion is questionable. Passive transfer experiments suggest that IgA and IgG antibodies may interfere with worm growth and reproduction, but do not directly cause worm loss during primary infections. Experience of a primary infection with *Trichinella* however leads to a dramatically faster expulsion of worms following a secondary infection. This is associated with a number of electrophysiological changes in the epithelial cells of the mucosa which are induced by IgE- and IgG bound to mucosal mast cells leading to an anaphylactic reaction mediated via 5-hydroxytryptamine.

**Main clinical symptoms:** →Abdominal pain, diarrhoea, →vomiting, →oedema, fever for days to weeks, muscle pain, eosinophilia.

**Incubation period:** 1–28 days.

**Prepatent period:** 5 days.

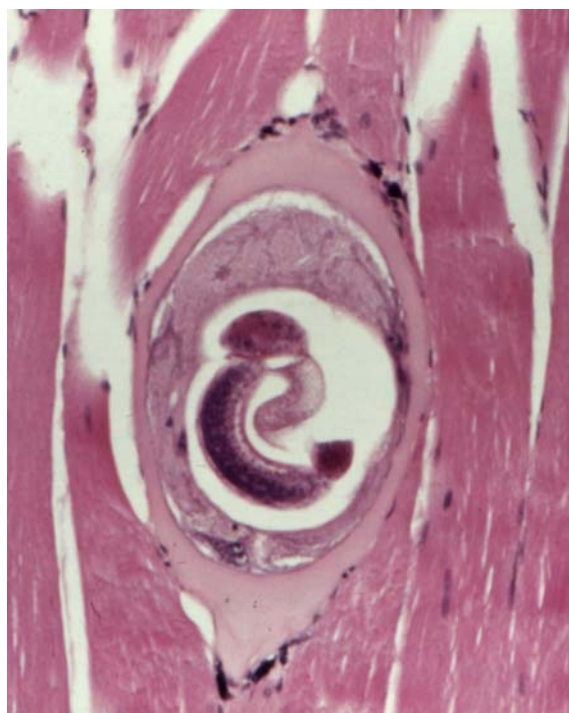

**Trichinella spiralis.** Figure 5 LM of a section through a paraffin-embedded muscle fiber with a cross-sectioned larva. Note that the host cell is dedifferentiated close to the larva and the number and size of host cell nuclei has increased.

**Patent period:** 20 years.

**Diagnosis:** Serodiagnostic methods, microscopic determination of larvae in muscle biopsies (→*Trichinella spiralis*/Fig.5), →Serology.

**Prophylaxis:** Avoid eating raw meat.

**Therapy:** Treatment see →Nematocidal Drugs, Man.

---

## Trichinosis

→*Trichinella spiralis*, →Trichinelliasis, Man.

---

## Trichlorfon (Metrifonat)

### Chemical Class

Organophosphorous compounds (organophosphonate).





**Trichodectes canis.** Figure 1 LM of an adult stage. Note that the head is broader than the breast.

### Mode of Action

Acetylcholine esterase inhibitor. →Ectoparasiticides – Agonists and Antagonists of Cholinergic Transmission.

---

## Trichobilharzia

Genus of schistosomes (subfamily Bilharziellinae) of waterbirds in Europe and Asia. The females of *T. szidati* reach a length of 3 mm. Their cercariae, which develop inside *Lymnaea*-snails, may also enter human skin and introduce cercarial dermatitis.

---

## Trichobilharzia ocellata

→Digenea/Fig. 11.

---

## Trichobilharzia Species

One of several schistosomes of birds leading to dermatitis in humans (→Digenea/Table 1).

## Trichobothria

Type of tactile sensory organ in →mites that is solid internally, in contrast to other tactile setae (→Mites/Nervous System).

## Trichodectes canis

### Name

Greek: *trichos* = fine hair, *dektes* = biting.

Mallophagan louse (2 mm long) of dogs (Fig. 1, page 1470), which introduces itching, inflammations, loss of hair. Both males and females may be vector of the tapeworm →*Dipylidium caninum*.

## Trichodina

### Name

Greek: *trix*, *trichos* = fine hair, *dinos* = unregular.

### Classification

Genus of the subphylum →Ciliophora (belonging to the protozoan phylum Alveolata)-classis: Oligohymenophorea, order: Mobilida.

### Morphology

Species of the genera *Trichodina* (Ø 60 µm), *Trichodinella* (Ø 40–50 µm), *Tripartiella* (Ø 40 µm), etc., live as ectoparasites on the skin and/or gills of many fresh and saltwater fish, but also on hydrozoan or anthozoan polyps (e.g., *T. pediculus* = louse of polyps). The trophozoites look like a depressed cylinder and show bunches and rows of cilia at both sides. At the ventral side they develop species-specific circles of hooks, which are used as holdfast organs to become attached at the surface of their hosts, where they move in slight rotations (Figs. 1–3, pages 1471, 1472). At high infection rates (in mass productions of fish or on fish with other diseases) the symptoms of trichodinosis may become severe. →Flagella.

### Therapy

Protazol of Alpha-Biocard, Düsseldorf.



**Trichodina. Figure 1** LM of the ventral anchor-apparatus of the trophozoite.

## Trichomitus rotundus

This species is found in the caecum of pigs, infection probably due to trophozoites in food and drinking water. Other species are found in reptiles and amphibia.

## Trichomonadida

Order of →Mastigophora.

### General Information

Apart from the genera *Histomonas* (one free flagellum) and *Dientamoeba* (no flagellum), the trichomonadids listed in Table 1 (page 1473) are provided at their apical pole with 4, 5, or 6 free →flagella and an additional →recurrent flagellum (Figs. 1, 2, pages 1474, 1475) which runs along a surface wave giving rise to the aspect of an →undulating membrane (Fig. 1, RF). Further characteristics of →trichomonads are the →axostyle, →pelta, →costa, and parabasal bodies, which serve as →cytoskeleton (Figs. 1, 2).

The trichomonads, which are anaerobic, have →microbodies called →hydrogenosomes. They are limited by two closely attached membranes surrounding a granular matrix (Fig. 1C, E). The enzyme system of these bodies differs from that of →mitochondria, as they metabolize pyruvate from →glycolysis into acetate, CO<sub>2</sub>, and H<sub>2</sub>. (In ciliates, similar hydrogenosomes with

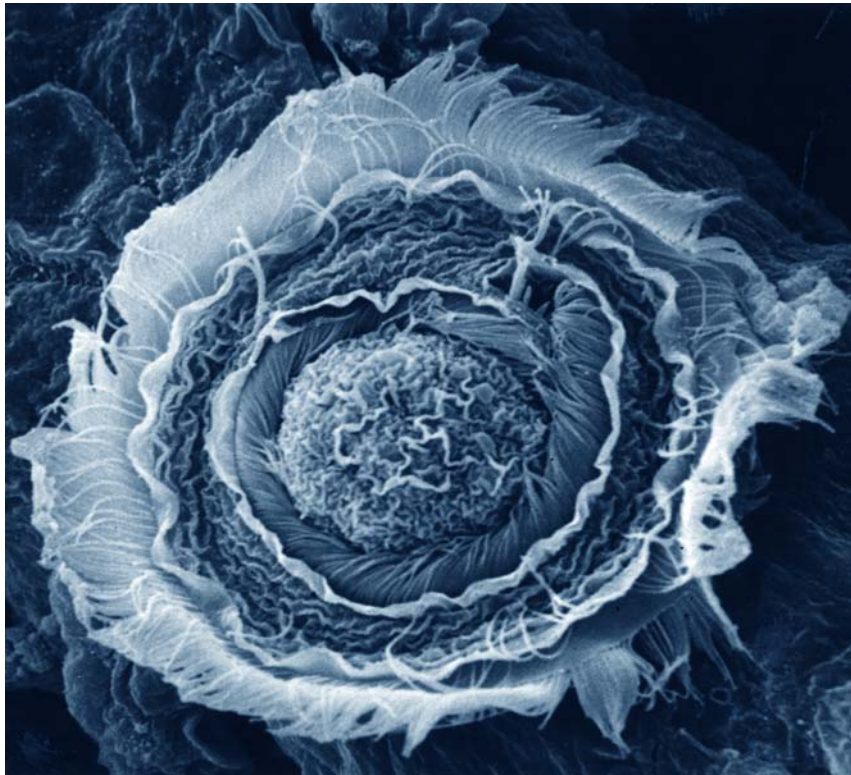

**Trichodina.** Figure 2 SEM of the ventral ciliary bundles.

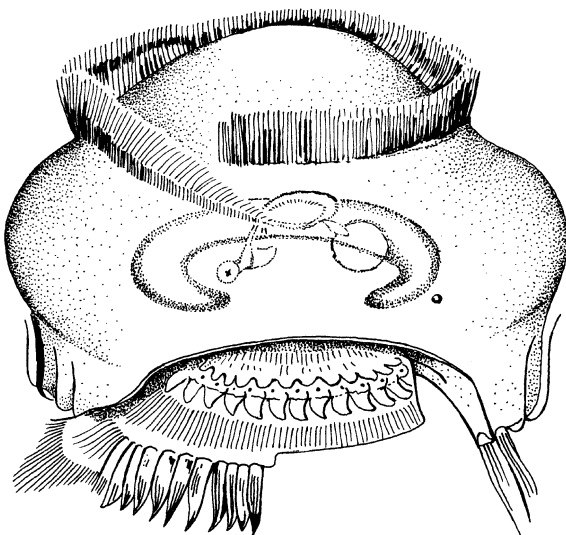

**Trichodina.** Figure 3 DR of a mature stage.

double membranes are present, in addition to regular mitochondria, Figs. 1, 2, pages 1474, 1475).

The cytostomeless trichomonadids feed by phagocytosis on the fluids of their hosts, on leukocytes, or on bacteria. Reproduction occurs by a special form of longitudinal [→binary fission](#) ([→Cell Division](#)), leading to

large numbers of [→trophozoites](#) in a short time; cysts never occur, so transmission is always based on direct contact between the final sites of parasitism (e.g., copulatory organs, mouth, or fresh intestinal contents).

Among the trichomonads there are nonpathogenic, facultatively pathogenic, and regularly pathogenic species closely related to each other. [→Histomonas meleagridis](#), [→Trichomonas vaginalis](#), and [→Tritrichomonas foetus](#) cause diseases of considerable importance ([Table 1](#)).

### Important Species

[Table 1.](#)

---

## Trichomonads

[→Amino Acids.](#)

---

## Trichomonas

[→Chromosomes.](#)

**Trichomonadida. Table 1** Important species of the Monocercomonadina and Trichomonadina

Family/Species	Size (µm)	Hosts	Habitat	Pathogenicity
<b>Monocercomonadina</b>				
<i>Monocercus ruminantium</i>	12–14	Ruminants	Rumen	–
<i>M. cuniculi</i>	5–14	Rabbits	Cecum	–
<i>Histomonas meleagridis</i>	8–20	Chickens, turkeys, ducks, geese	Cecum, liver, other organs	+
<i>Dientamoeba fragilis</i> <sup>a</sup>	6–12	<b>Humans</b>	Cecum, colon	?
<b>Trichomonadina</b>				
<i>Trichomonas vaginalis</i>	10–30	<b>Humans</b>	Urogenital system	–
<i>T. tenax</i> (syn. <i>T. buccalis</i> )	6–10	<b>Humans</b>	Mouth	+/-
<i>T. hominis</i>	5–20	<b>Humans</b>	Intestine	–
<i>T. gallinae</i>	7–20	Chickens, pigeons	Upper digestive tract, liver	+
<i>Tetratrichomonas ovis</i>	6–9	Sheep	Rumen, cecum	–
<i>Tritrichomonas foetus</i>	10–18	Cattle	Urogenital system	+
<i>T. suis</i>	8–16	Pigs	Intestine	–
<i>T. equi</i>	8–10	Horses	Cecum, colon	+
<i>Pentatrichomonas hominis</i>	8–20	<b>Humans</b>	Small intestine	–
<i>P. gallinarum</i>	5–8	Chickens, turkeys, pigeons	Cecum	+

<sup>a</sup> Systematic position remains doubtful

## Trichomonas vaginalis

→Trichomonadida/Figs. 1, 2, →Trichomoniasis, Man/ Fig. 1.

## Trichomoniasis, Man

→*Trichomonas vaginalis* is a flagellate, 10–30 µm in size, a pale-staining nucleus, 4 free →flagella, and an →undulating membrane (→Trichomonadida). It lives in the vagina and prostate gland. It is best recognized supravivally by its motility or in a smear. Trichomoniasis gives rise to acute and chronic vaginitis accompanied by a neutrophil exudate and a change in bacterial flora. Infection is chronic, but if cured by chemotherapy reinfections can occur giving rise to renewed symptoms. Immunity in the vagina appears to be poor. Cervical dysplasia is occasionally observed but appears to be the result of concomitant infection with one of the papilloma viruses. Males may have infection in the prostate gland which is usually asymptomatic but is accompanied by acute and chronic inflammation. *T. tenax* from the mouth and *T. hominis* from the gut are regarded as commensals.

**Main clinical symptoms:** Occurrence of whitish mucus (fluor), feeling of burning in vaginal and urethral regions.

**Incubation period:** 4–24 days.

**Prepatent period:** 4–20 days.

**Patent period:** Months – years.

**Diagnosis:** Microscopic detection of →trophozoites in mucus samples.

**Prophylaxis:** Avoid unprotected sexual intercourse.

**Therapy:** Treatment see →Antidiarrhoeal and Antitrichomoniasis Drugs.

## Trichosomoides crassicauda

Species of nematodes (females, 10–19 mm; males, 1–3 mm), the specimens of which live in groups in the urinary bladder, ureter, kidney of hare, rabbits, and rodents. Eggs have small polar plugs. The larvae enter the stomach wall and penetrate into the blood vessels.

## Trichostrongyliasis

→Trichostrongylidae, →Trichostrongylosis, Animals.

## Trichostrongylidae

### Classification

Family of →Nematodes.

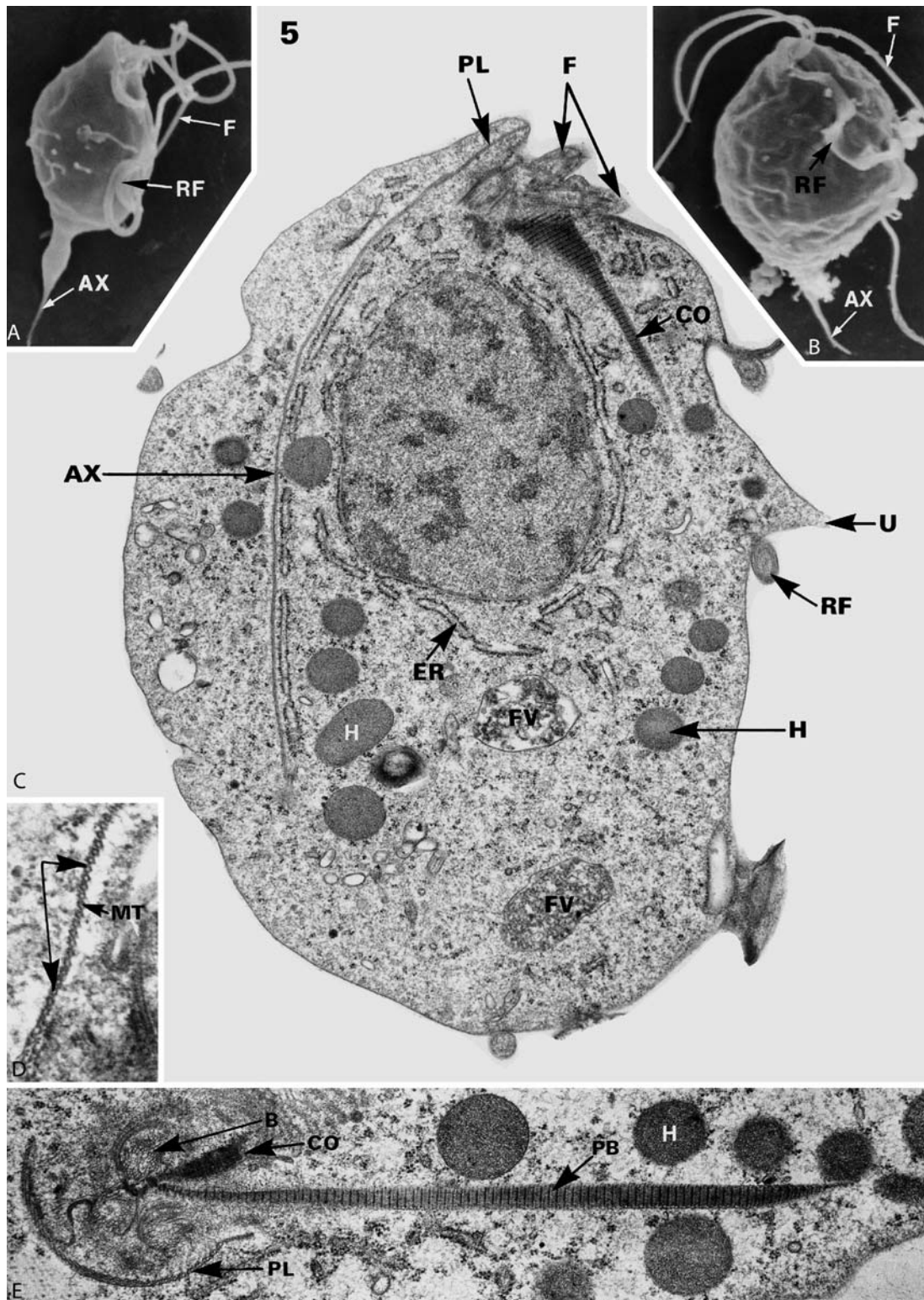

**Trichomonadida. Figure 1 A–E** SEMS (A, B) and TEMS (C–E) of *Trichomonas vaginalis* (B–E) and *Tritrichomonas foetus* (A). Note that in *T. foetus* the recurrent flagellum runs until the posterior pole (compare Fig. 2). The axostyle (AX) and pelta (PL) consist of single rows of microtubules (A, B  $\times 3,000$ , C  $\times 6,000$ , D  $\times 34,000$ , E  $\times 33,000$ ). AX, axostyle; B, basal body of F; CO, costa; ER, endoplasmic reticulum; F, free flagellum; FV, food vacuole; H, hydrogenosome; MT,  $\rightarrow$  microtubules; PB, parabasal body (filament); PL, pelta; RF, recurrent flagellum; U, undulating membrane (formed by surface).

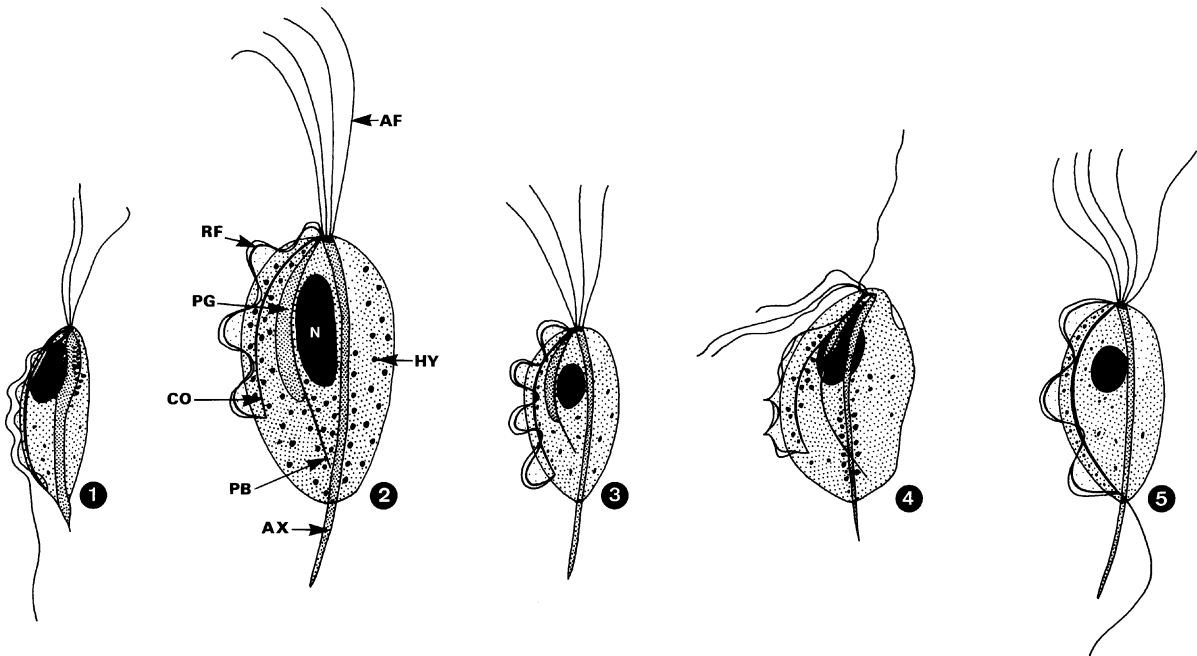

**Trichomonadida.** **Figure 2** Some variously flagellated trichomonads of man and animals; transmission proceeds directly by sexual intercourse or close body contact, respectively; cysts do not occur. Note that besides the free anterior flagella (*AF*) there is always a characteristic recurrent flagellum (*RF*); it often runs along a surface folding and thus appears with some sort of “undulating membrane”. 1 *Trichomonas foetus* from genital organs of cattle (10–20  $\mu\text{m}$  long). 2 *Trichomonas vaginalis* from reproductive tracts of men and women (10–30  $\mu\text{m}$  long). 3 *T. tenax* (5–16  $\mu\text{m}$  long) from human mouth. 4 *T. gallinae* (5–20  $\mu\text{m}$  long) from mouth, pharynx, and crop of many birds. 5  $\rightarrow$  *Pentatrichomonas hominis* (8–20  $\mu\text{m}$  long) from human intestine. *AF*, anterior free-flagellum; *AX*, axostyle; *CO*, costa; *HY*, hydrogenosome; *N*, nucleus; *PB*, paragonal body; *PG*, paragonal body and  $\rightarrow$  Golgi apparatus (seen together); *RF*, recurrent flagellum (for other species see Table 1, page 1473).

### Life Cycle

Fig. 1 (page 1476).

### Diseases

$\rightarrow$  Cooperiosis,  $\rightarrow$  Nematodirosis,  $\rightarrow$  Trichostrongylosis, Animals,  $\rightarrow$  Trichostrongyliasis.

## Trichostrongylosis, Animals

### Stomach

$\rightarrow$  *Trichostrongylus axei* worms occur in the stomach of horses and rarely in pigs. These  $\rightarrow$  nematodes are rarely pathogens on their own, most infections are chronic and mild. However, *T. axei* induces typical lesions in horses. The condition has been described as a *gastritis chronica hyperplastica et erosiva circumscripta* for the main lesion is a pad- or cushion-like thickening in the glandular part of the stomach.

### Abomasum

$\rightarrow$  *T. axei* lives in the abomasum of cattle, sheep, and goats. In ruminants, *T. axei* infections are usually part of a mixed abomasal helminthosis and its effects cannot be dissociated from those of other worm species. The worm is rarely a pathogen on its own, as most infections are mild. Animals experimentally infected with large numbers of *T. axei* show a decrease of blood albumin, haemoconcentration, and a rise in serum pepsinogen. The clinical signs include  $\rightarrow$  diarrhoea,  $\rightarrow$  anorexia, progressive emaciation, Listlessness, and weakness.

### Small Intestine

Some members of the genus  $\rightarrow$  *Trichostrongylus* parasitize the anterior part of the small intestine of ruminants, and are particularly important in sheep. The most common species in sheep and goats are *T. colubriformis* (also found in cattle), *T. vitrinus* and *T. rugatus*. *T. vitrinus* appears to be more pathogenic than the other 2 species. They all cause a similar syndrome which may range in intensity from a subclinical but significant loss of production to overt disease. Trichostrongylosis is characterized by anorexia, soft faeces, intermittent or continued diarrhoea,  $\rightarrow$  weight loss, listlessness, and

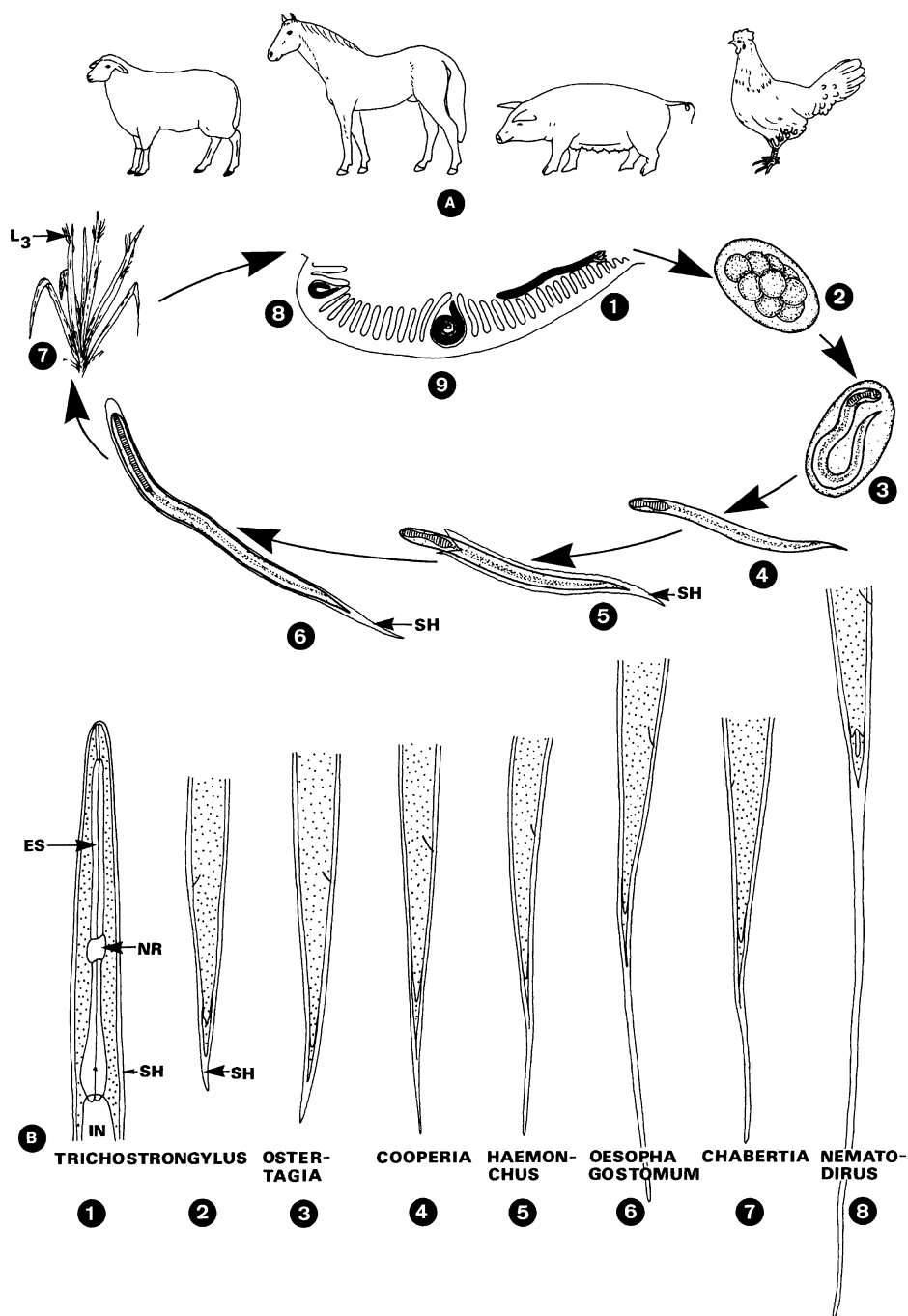

**Trichostrongylidae. Figure 1** A Life cycle of trichostrongylid →nematodes of different hosts. 1 Adults (→Nematodes/ Table 1) live attached to the villi of abomasum or small intestine (species-specific) and feed on blood (e.g., *Haemonchus*). 2 Smooth-walled eggs are passed unembryonated in host's feces. 3 Larvae are developed under favorable conditions inside the eggs. 4-7 Except for →*Nematodirus*, the L<sub>1</sub> hatches from the egg and feeds on detritus. After 2 molts the L<sub>3</sub> stage is achieved, which is infective to final hosts. The third-stage larvae, still wearing the loosely fitting second-stage →cuticle (= sheath), climb to the top of plants (7) and may even hibernate outside a host. 8-9 If final hosts swallow the L<sub>3</sub> with forage, the exsheathment takes place in the stomach. The larvae of some species may burrow into the mucosa and →molt there twice; larvae of other species molt when attached to the villi. In some species (e.g., →*Ostertagia*) the fourth-stage larvae may hibernate inside the mucosa for 3-5 months; this phenomenon is described as →hypobiosis. In spring these L<sub>4</sub> complete their development and become mature after another molt. The increased excretion of eggs is known as →spring rise phenomenon. B The anterior (1) and posterior (2-8) regions of infective larvae (L<sub>3</sub>) of different genera parasitizing sheep, according to several authors. ES, esophagus; L<sub>3</sub>, third-stage larva; NR, nerve ring; SH, sheath (cuticle of the preceding larval stage).

osteoporosis in growing lambs. Severely affected animals become dehydrated and some may die. Changes in blood constituents include a light →[anaemia](#), hypophosphataemia with normocalcaemia, and a characteristic →[hypoalbuminaemia](#). A reduction in thyroxine concentrations and an increase in circulating levels of alkaline phosphatase of intestinal origin has been reported in chronic cases.

Although considerable progress has been achieved in our understanding of the physiopathology of *Trichostrongylus* parasites, it is still difficult to explain the signs of trichostrongylosis. Practically all stages of the parasite live in tunnels beneath the epithelial cells of the intestine, causing mucosal and villous atrophy or flattening. Sparse stunted →[microvilli](#), epithelial →[hyperplasia](#) are also present, with infiltration of lymphocytes and neutrophils in the damaged area. This atrophy leads to a reduction of the effective glandular mass and of the levels of brush-border enzymes (notably dipeptidase, alkaline phosphatase, and maltase). In addition, there is evidence that the parasite alters the levels of gut hormones (e.g., secretin and cholecystokinin) and induces a progressive inhibition of abomasal, duodenal, and cranial jejunal motility, which reduces the passage of digests. Potential causes of diarrhoea, when it occurs, may be an alteration in ruminal and abomasal functions, increased plasma loss into the intestine, or other effects of the worm on water, Na<sup>+</sup> and osmotic loading of the small intestine. The decrease in productivity does not appear to be related to →[malabsorption](#), since net absorption of nutrient over the length of the small intestine is not severely affected. It is rather, caused by the combination of loss of appetite, enteric losses of protein, and increased protein metabolism in the intestinal tissue, which all together cause a movement of amino acid nitrogen from the muscle, and possibly the skin, to the liver and intestines. This decreases the possibility for growth, and production of milk and wool. The reduction in feed intake is the main factor limiting the availability of energy for maintenance and/or growth. Another reason for the less efficient use of metabolic energy is the marked increase in synthetic rates of blood proteins and proteins in the gastrointestinal tissue, to compensate for the losses of plasma protein into the alimentary tract and for the increased sloughing of epithelial cells. The reduced mineralisation of bones leading to osteoporosis in growing lambs may be attributable to reduced intestinal absorption of calcium and phosphorus.

### Related Entry

→[Alimentary System Diseases, Ruminants](#).

### Therapy

→[Nematocidal Drugs, Animals](#).

## Trichostrongylus

### Name

Greek: *thrix*, *trichos* = fine hair, *strongylos* = rounded.

### Classification

Genus of →[nematodes](#).

### General Information

*Trichostrongylus* spp. occur in ruminants and horses (e.g., *T. axei*, *T. vitrinus*, *T. colubriformis*), rabbits (*T. retortaeformis*), and birds (*T. tenuis*). They are tiny worms (often not reaching 1 cm in length). Together with the members of the genera →[Haemonchus](#), →[Teladorsagia](#), →[Cooperia](#), →[Nematodirus](#), →[Ostertagia](#) they are placed in the nematode family Trichostrongylidae. Their individual number is often very large, because the infections occur on the meadow, while uptaking larva-contaminated plants (page 1476).

### Disease

→[Alimentary System Diseases, Cattle](#).

## Trichostrongylus axei

→[Trichostrongylosis, Animals](#).

## Trichrome Stain

→[Microsporidiosis](#).

## Trichuriasis, Animals

→[Trichuris](#) spp., the whipworms, inhabit the caecum and occasionally the colon of ruminants. The most important species are *T. discolor* and *T. globulosa* in cattle, *T. suis* in pigs, and *T. ovis* and *T. skrjabini* in



sheep and goats. → *Trichuris* is highly prevalent in all parts of the world but rarely causes clinical signs. Heavy infections associated with severe and often haemorrhagic typhlitis or typhlocolitis has been rarely reported in cattle. Clinical manifestations include → *anorexia*, dysentery, → *Conjugation*, → *weight loss*, and terminal → *anaemia*. In severe cases the faeces may be markedly haemorrhagic or even all blood. The lesions are caused by the adult worms boring tunnels into the mucosa of the large intestine. Penetration of the mucosa by the parasites produce → *nodules* in the intestinal wall. There is little evidence that *Trichuris* spp. of ruminants ingest measurable quantities of blood. The signs of the disease appear to be primarily related to a reduction of the absorption capacity of the colon, an effusion of protein into the lumen, and a loss of blood through haemorrhages.

### Therapy

→ *Nematocidal Drugs, Animals*.

---

## Trichuriasis, Man

### Pathology

Trichuriasis is an infection with a small lumen-dwelling → *whipworm* → *Trichuris trichiura*, of worldwide distribution. The thin anterior end of the worm is embedded in the epithelium of the colon from which it ingests intercellular fluids. Depending on the degree of infection, the degree of inflammation produced may be severe, with a mixed → *inflammatory reaction* and with bloody mucus, containing eosinophils and → *Charcot-Leyden crystals* (→ *Pathology/Fig. 3*). Rectal prolapse from tenesmus has been described in heavily infected children. Although it does not actively suck blood, the daily blood loss was calculated as 0.005 ml per worm, supporting its role in causing anemia in iron-deficient children together with malnutrition.

### Immune Responses

→ *Nematode Infections, Man/Immune Responses*.

**Main clinical symptoms:** Red-diarrhoea, → *anaemia*, colitis, → *eosinophilia*.

**Incubation period:** 2–3 months.

**Prepatent period:** 3 months.

**Patent period:** 15–18 months.

**Diagnosis:** Microscopic determination of eggs in faecal samples (→ *Trichuris/Fig.4*).

**Prophylaxis:** Avoid eating uncooked vegetables and contact with human faeces.

**Therapy:** Treatment see → *Nematocidal Drugs, Man*.

---

## Trichuris

### Synonym

→ *Whipworm*.

### Name

Greek: *thrix* = fine hair, *ura* = tail.

### Classification

Genus of → *Nematodes*.

### Important Species

Table 1 (page 1479).

### Morphology

Figs. 1–5 (pages 1479–1483).

### Life Cycle

Fig. 1.

### Disease

→ *Trichuriasis, Animals*, → *Trichuriasis, Man*.

---

## Trichuris myocastoris

Parasite of beaver. → *Nematodes*.

---

## Trichuris trichiura

→ *Trichuriasis, Man*.

---

## Trichuris vulpis

This worldwide occurring species in dogs and foxes reaches a length of 7.5 cm in both sexes in the caeca and colon of their hosts. Since the worms suck blood, oedema of the intestinal wall and bloody stools may occur in heavy infections, as well as anaemia, and loss of weight.

**Trichuris.** Table 1 Important species of the genus *Trichuris*

Species	Length of adult worms (mm)		Size of eggs (or larvae) ( $\mu\text{m}$ )	Final host/Habitat	Intermediate host	Prepatent period in final host (weeks)
	f	m				
<i>Trichuris trichiura</i>	50–60	50	50	Humans/Colon	–	4–12
<i>T. ovis</i>	35–70	50	70–80 $\times$ 30–42	Ruminants/Cecum	–	12
<i>T. vulpis</i>	75	75	80 $\times$ 35	Dogs, cats/Colon	–	11–15
<i>T. suis</i>	55	45	65 $\times$ 30	Pigs/Colon	–	6–7
<i>T. muris</i>	45	35	70 $\times$ 35	Rodents/Colon	–	8

f = female, m = male

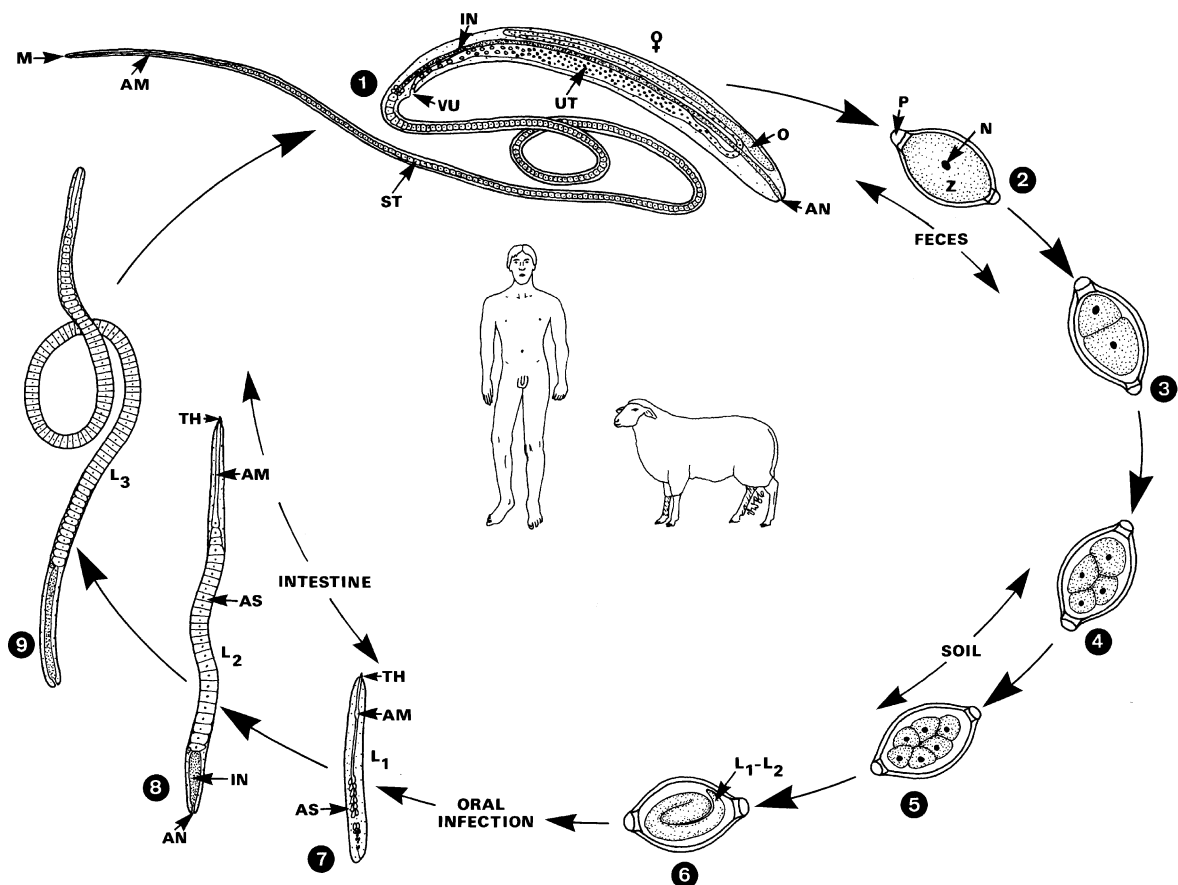

**Trichuris.** Figure 1 Life cycle of whipworms (e.g., *Trichuris trichiura*, *T. ovis*) as examples of a direct development. 1–2 The adult male and female worms (4–8 cm long) are anchored with their slender anterior ends inside the mucosal layer of the cecum, colon, and/or rectum of their hosts. After fertilization the females produce numerous (3,000–7,000 daily) eggs (each with 2  $\rightarrow$  polar plugs) which measure about 70–90  $\times$  30–40  $\mu\text{m}$  and are passed unembryonated in the feces of their hosts (2). 3–9 On the soil the  $\rightarrow$  zygote slowly develops into the first-stage larva (7) which remains inside the egg for this embryonation; at least 3 weeks (up to 4 months) are needed (dependent on the temperature). Finally (still inside the egg), the second larval stage (8) is formed and reaches infectivity. (Some authors, however, consider eggs containing the first-stage larvae as already infectious.) When eggs including infectious larvae (8) are swallowed with contaminated food, the second larval stage escapes from the egg within 60 minutes (in the duodenum). Via 3 following molts the typical adult worm is finally formed, reaching maturity in about 5–9 weeks ( $\rightarrow$  Prepatent Period), it may parasitize for 1–4 years ( $\rightarrow$  Patent Period). AM, anterior part of esophagus; AN, anus; AS, anlage of stichosome (cells surrounding the esophagus); IN, intestine;  $L_{1-3}$ , larval stages; M, mouth; N, nucleus; O, ovary (single); P, polar plug of  $\rightarrow$  eggshell; ST, slender anterior region of the body (filled with the stichosomal part of the esophagus); TH, thorn; UT, uterus (single); VU, vulva; Z, zygote.

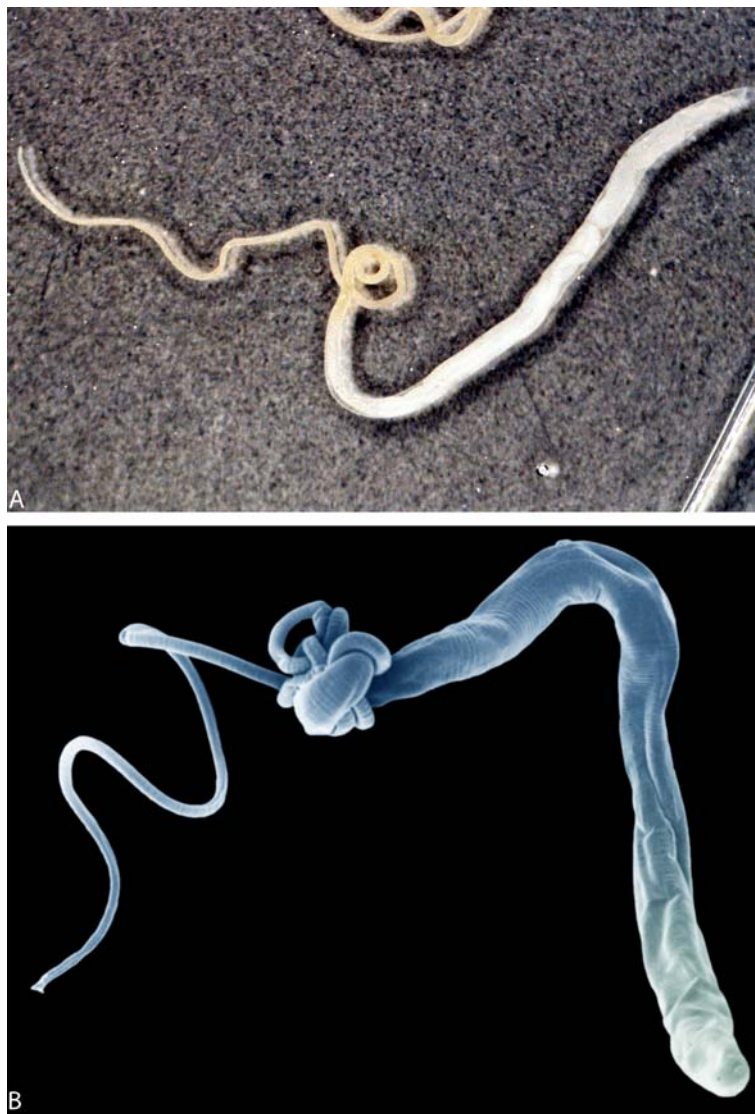

**Trichuris.** Figure 2 A–B A LM of an adult female of *Trichuris trichiura*. B SEM of an adult worm.

---

## Trickle Infections

Application of low doses (given continuously at short intervals) of parasites to produce a persistent parasitic load in a given laboratory host. For examples, it is proven that → *Nippostrongylus brasiliensis* given in this way produces large and persistent infections in rats and the normal spontaneous cure response does not occur. Trickle infections may establish worms even in immune hosts.

---

## Triclabendazole

→ Nematocidal Drugs.

---

## Triflumuron

**Chemical Class**  
Benzoylphenyl urea.

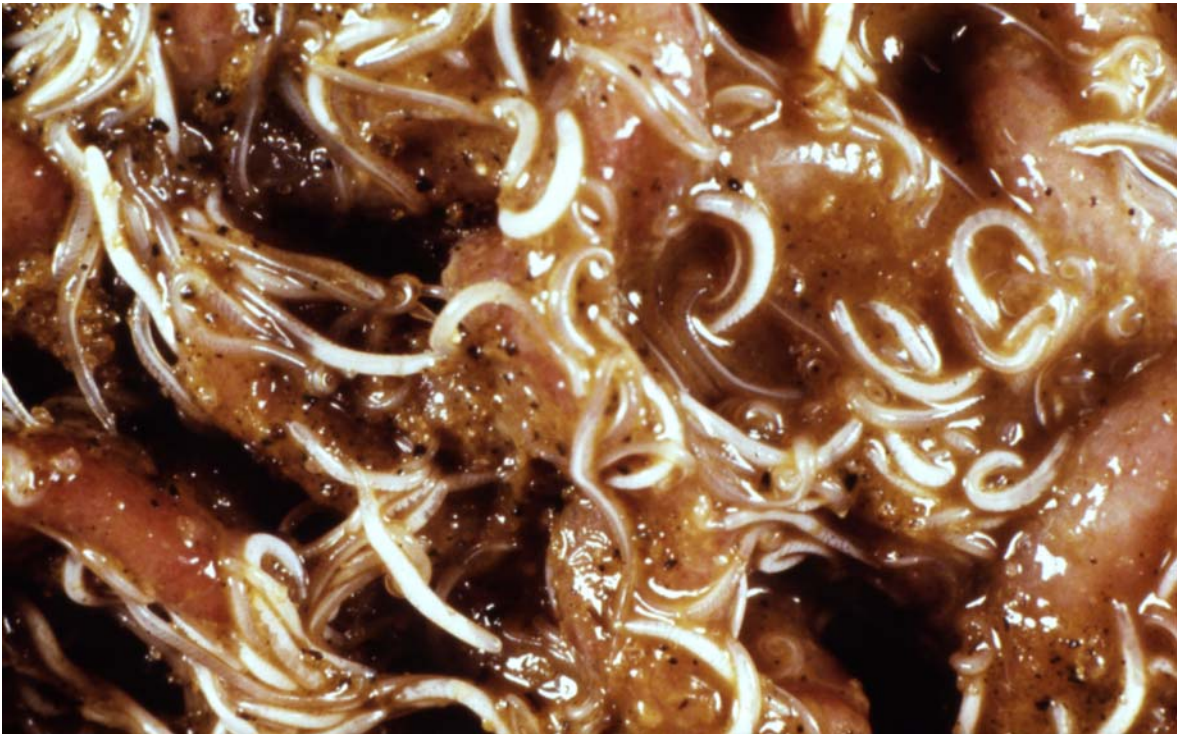

**Trichuris.** Figure 3 *Trichuris ovis* worms in the colon of a sheep.

### Mode of Action

Insect growth regulator (IGR, chitin synthesis inhibitor).  
 → [Ectoparasiticides – Inhibitors of Arthropod Development](#).

### Trimethoprim

→ [Pneumocystis](#), → [Treatment of Opportunistic Agents](#).

### Trimitis

Genus of intestinal flagellates of fish.

### Trinotum anserinum

Species of → [Mallophaga](#) of birds, vector of onchocercid worms.

### Triodontophorus

Genus of small strongylids of horses.

### Triodontophorus serratus

Strongylid → [nematode](#) of horses.

### Tripartite Attachment Complex (TAC)

Filament system that connects the DNA of the kinetoplast (KD) of → [trypanosomes](#) and the flagellar basal body ([Fig. 1](#), page 1484). This complex comprises unilateral filaments (F), differentiated mitochondrial membranes (M), and exclusion zone filaments (E). Both the TAC and the flagellar-system become reduplicated prior to cell division of the trypanosomal stages.



**Trichuris.** Figure 4 *Trichuris trichiura* egg found in fresh human faeces.

---

## Triphenylphosphate (TPP)

### Chemical Class

Synergist.

### Mode of Action

Detoxifying esterase inhibitor.

---

## Tritonymph

The last of the three →[nymphal stages](#) found in some members of the Actinedida and Acaridida (= Astigmata).

By contrast, in most members of the Gamasida only proto- and deutonymphs occur.

The tritonymph is usually an active stage, but may be a →[pharate stage](#) in some members of the Actinedida (→[Mites/Ontogeny](#)).

---

## Tritrichomonas foetus

Trichomonad species of cattle ([Fig. 1](#), page 1484).  
→[Trichomonadida](#).

---

## Tritrichomonas suis

Agent of pig trichomoniasis, probably identical with *T. foetus*. →[Trichomonadida](#).

---

## Trixacarus caviae

Sarcoptic mange mite of guinea pigs.

---

## Trochophora

Ciliated larva of many water inhabiting annelids (not present in →[leeches](#)).

---

## Trogocytosis

From Greek: *trogein* = to nibble. Way of feeding of →[Naegleria fowleri](#)-amoebae.

---

## Trombicula akamushi

→[Mites](#).



**Trichuris.** Figure 5 *Trichuris suis* egg with the 2 typical polar plugs and the already formed larva.

## Trombiculidae

→Acarina.

## Trombiculidiasis

→Mange, Animals/Trombiculidiasis, →*Neotrombicula autumnalis*.

## Trophozoites

Feeding stages →Amoebae, →*Balantidium coli*, →*Blastocystis hominis*, →*Ichthyophthirius multifiliis*, →*Plasmodium*.

## Tropical Elephantiasis

Symptoms (=enormous swellings of legs, arms, breasts, or scrotum) due to infections with filarial worms, →*Wuchereria* or *Brugia*, →Lymphatic Filariasis.

## Tropical Parasitic Diseases of Man, Geographical Distribution

This group of diseases includes conditions the natural occurrence of which is largely limited to the tropics and the subtropics. This may be either due to the specific temperature requirements for the survival or development of parasite forms in the free environment or in the poikilothermal vector or intermediate host, or due to the

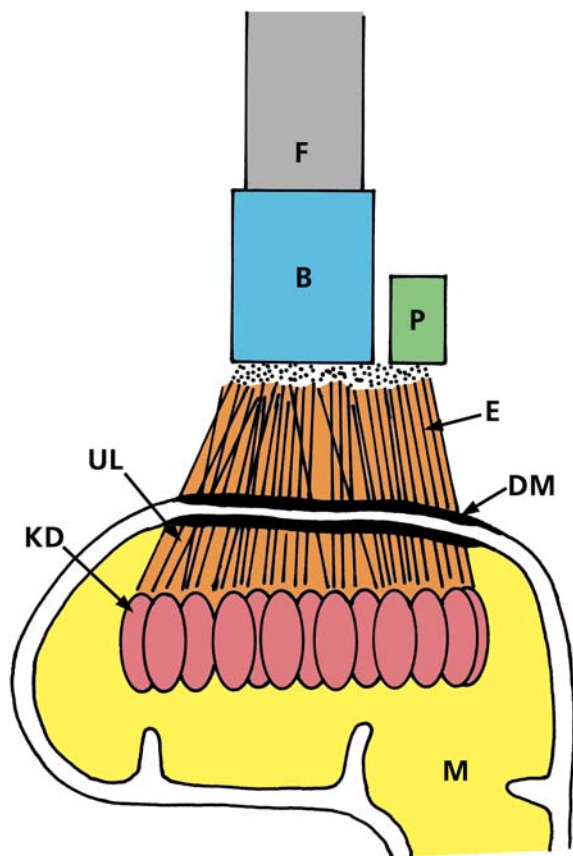

**Tripartite Attachment Complex (TAC).** Figure 1 DR of the filament system connecting the kinetoplast DNA and the basal body. (from Trends in Parasitology 2005, redrawn, coloured) *B*, basal body; *DM*, differentiated mitochondrial membrane; *E*, exclusion zone filaments; *F*, flagellum; *KD*, kinetoplast DNA; *M*, mitochondrion; *P*, parabasal body; *UL*, unilateral filaments.

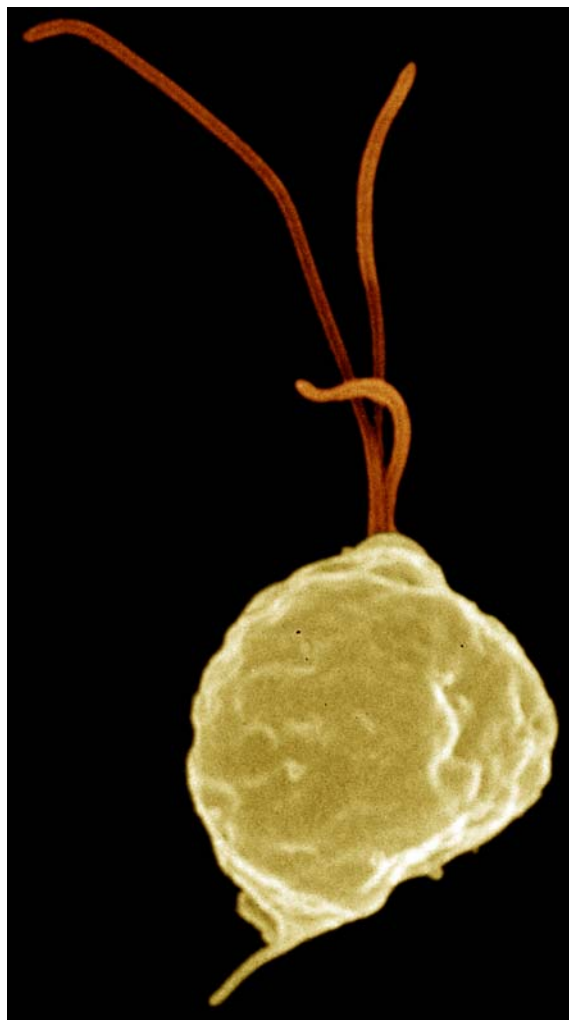

***Triticomonas foetus*.** Figure 1 SEM of a trophozoite from cattle.

specific geographical distribution of the vector or intermediate host, again a feature that is dependent on environmental factors. This applies, inter alia, to African trypanosomiasis, falciparum malaria and ovale malaria.

However, the category includes also borderline cases such as diseases occurring mainly in the tropics and the subtropics, and at much lower frequency in temperate climates as well, e.g., opisthorchiasis, vivax malaria and malaria quartana. There are also diseases occasionally occurring outside the usual geographical distribution, e.g., sporadic cases of ovale malaria in southeastern Asia. While the clinical picture resembles that of *Plasmodium ovale* infections contracted in Africa, the morphology of the parasites shows characteristics of simian malaria parasites of the *P. ovale* group, pointing to a zoo-anthropotic origin analogous to the occasional

human infections with *P. knowlesi* or *P. cynomolgi cynomolgi* observed in southeastern Asia.

Table 1 lists the major tropical diseases of man and excludes the cosmopolitan opportunistic parasitic infections in immunocompromised individuals such as patients with HIV infections. It should be noted, however, that also some tropical parasitoses show atypical pathology in such patients, especially marked in those trypanosomatid infections where amastigotes are responsible for the clinical-pathological lesions, i.e., visceral leishmaniasis and American trypanosomiasis. Moreover, *Leishmania* species usually responsible for cutaneous or mucocutaneous leishmaniasis, may cause visceral leishmaniasis (kala-azar) in patients with HIV infections, a phenomenon particularly marked in Sahelian Africa.

**Tropical Parasitic Diseases of Man, Geographical Distribution. Table 1** Geographical distribution of major tropical parasitic diseases

Disease	Causative parasite	Vector/alternate host	Geographical distribution
African trypanosomiasis	<i>Tryp. brucei gambiense</i>	<i>Glossina palpalis</i> group	Tropical west and central Africa
	<i>Tryp. brucei rhodesiense</i>	<i>Glossina morsitans</i> group	Tropical east and central Africa
American trypanosomiasis	<i>Trypanosoma cruzi</i>	Reduviid bugs	Americas south of the USA
Clonorchiasis	<i>Clonorchis sinensis</i>	<i>Bithynia</i> →cyprinid fish	Eastern and southeastern Asia
Dracunculiasis	<i>Dracunculus medinensis</i>	<i>Cyclops</i>	Sub Saharan Africa north of 5°S
Leishmaniasis, cutaneous	<i>Leishmania tropica</i> group	<i>Phlebotomus</i> spp.	Central and southern Asia, north and Sahelian Africa,
		<i>Lutzomyia</i> spp.	America south of the USA
Leishmaniasis, mucocutaneous	<i>Leishmania braziliensis</i> and <i>Leishmania mexicana</i> groups	<i>Lutzomyia</i> spp.	South America
Leishmaniasis, visceral (kala-azar)	<i>Leishmania donovani</i> group	<i>Phlebotomus</i> spp.	Southern Asia, semi-arid zones in Africa
		<i>Lutzomyia</i> spp.	America south of USA
Loiasis	<i>Loa loa</i>	<i>Chrysops</i> spp.	Tropical west and central Africa
Lymphatic filariasis	<i>Wuchereria bancrofti</i>	Culicine mosquitoes	Tropical Africa, SE Asia, Central and Southern America
	<i>Brugia malayi</i>	<i>Mansonia</i> spp.	SE Asia and Pacific islands
Malaria	<i>Plasmodium falciparum</i>	<i>Anopheles</i> spp.	Tropical Africa, Asia, America
	<i>Plasmodium malariae</i>	<i>Anopheles</i> spp.	Tropical Africa, Asia, America
	<i>Plasmodium vivax</i>	<i>Anopheles</i> spp.	North and East Africa, Asia, America south of the USA
	<i>Plasmodium ovale</i>	<i>Anopheles</i> spp.	Tropical Africa
Onchocerciasis	<i>Onchocerca volvulus</i>	<i>Simulium damnosum</i>	Tropical Africa, Yemen, S. America
Opisthorchiasis	<i>Opisthorchis felinus</i> , <i>O. viverrini</i>	<i>Bithynia</i> →cyprinid fish	SE and central Asia, eastern Europe
Paragonimiasis	<i>Paragonimus westermanni</i> , <i>P. kellyi</i> , <i>P. africanus</i>	<i>Melania</i> →crabs	Southeastern Asia, West and central Africa
Schistosomiasis, Asian, intestinal	<i>Schistosoma japonicum</i>	<i>Oncomelania</i> spp.	Eastern and SE Asia
	<i>Schistosoma mekongi</i>	<i>Tricula aperta</i>	Central Mekong area
Schistosomiasis, intestinal	<i>Schistosoma mansoni</i>	<i>Biomphalaria</i> spp.	Africa, Arab Penins., S. America
	<i>Schistosoma intercalatum</i>	<i>Bulinus</i> spp.	Tropical Africa, S. America
Schistosomiasis, urinary	<i>Schistosoma haematobium</i>	<i>Bulinus</i> spp.	Africa and southwestern Asia

## Tropical Parasitic Diseases of Man, Impact on Health

The major tropical parasitic diseases differ widely in the degree of impact on human life, ranging between nearly 100% fatality in the absence of treatment, such as in African trypanosomiasis, and a generally non-fatal course such as in lymphatic filariasis (see Table 1). In all cases the infections will have a detrimental

impact on health as expressed in the →DALY index, reflecting the “disability adjusted life years”, i.e., the number of healthy years of life lost due to premature death and disability. Estimates for DALY are available for several of the most important tropical parasitic diseases, but not for others, especially those not yet covered by internationally supported control efforts.

Difficulties are also experienced in the determination of the number of deaths associated with particular parasitic infections, especially if they occur in areas with poor coverage by health services or if the



**Tropical Parasitic Diseases of Man, Impact on Health. Table 1** Major tropical diseases of man, impact

Disease	Annual number of symptomatic cases or new infections	Annual number of deaths	Number of chronic cases million	DALY*
African trypanosomiasis	150,000	50,000	–	1,598,000
American trypanosomiasis (Chagas Disease)	500,000	13,000	16–18	667,000
Clonorchiasis	>1,000,000	?	>10	N.D.
Dracunculiasis	75,000	–	–	N.D.
Leishmaniasis	1,500,000	59,000	~12	2,357,000
Loiasis	~1,000,000	?	~13	N.D.
Lymphatic filariasis	10,000,000	–	120	5,777,000
Malaria	300–500 million	1.5–3.0 million	400	45,000,000
Onchocerciasis	~2,000,000	–	50	987,000
Opisthorchiasis	~5,000,000	?	50	N.D.
Paragonimiasis	~2,000,000	?	20	N.D.
Schistosomiasis	~10,000,000	60,000	100	1,760,000

DALY = Disability adjusted life years (number of healthy years of life lost due to premature death and disability)

N.D. and ? = no data available

infections give rise to fatal secondary pathological conditions such as cholangiocarcinoma. In the latter case the secondary condition is usually registered as the cause of death and not the truly causative infection with *Clonorchis* or *Opisthorchis*.

Some of the diseases have recently shown a remarkable change in morbidity and fatality, such as visceral leishmaniasis in association with HIV infections. The advent of HIV has radically changed the understanding of the epidemiology of leishmanial infections by indicating that oligosymptomatic carrier status largely outweighs the number of clinically manifest infections.

Other diseases, hitherto subject to rather successful attempts at their elimination, e.g., dracunculiasis, show lately unexpected persistence, having brought the control effort to a grinding halt in the last strongholds of their existence in tropical Africa. Disruptions by armed conflicts are obviously the major reason for the stalemate since the large majority of the recent dracunculiasis cases had occurred in areas affected by war or civil strife.

## Trypanocidal Drugs, Animals

Table 1 (pages 1487–1489).

### Disease Patterns of African Trypanosomiasis

→ **African trypanosomiasis** caused by tsetse-borne heteroxenous trypanosomes (*T. vivax vivax*, *T. congolense congolense*, and *T. brucei brucei*) is known as

→ **Nagana**. Formerly the term was restricted to infections caused by *T. b. brucei*. Today, the term “trypanosomiasis” is also used as a collective word for all animal trypanosomiasis. The severity of disease may depend on several factors, such as trypanosome species, strain variants, infection dose (low or high tsetse risk), and species of host. Infections can vary from acute (*T. c. simiae* infections in pigs, *T. b. evansi* infections in camels) to usually mild or almost inapparent (*T. b. brucei* infections in cattle). In typical cases, African trypanosomiasis is a wasting disease with clinical signs like anemia, leucopenia, thrombocytopenia, plasma biochemical changes and lesions in some tissues and organs. The disease produces slowly progressive loss of condition accompanied by increasing weakness and extreme emaciation, leading eventually to collapse and death. *T. v. vivax* causes the most important form of trypanosomiasis in cattle in West Africa and elsewhere. The infection may be asymptomatic, subacute, peracute or chronic. Hemorrhagic *T. vivax* outbreaks have been reported from farmers in Kenya and Uganda with considerable deaths of cattle. Symptoms were anemia, bleeding through the skin and ears (prior to death), petechial hemorrhages on the tongue, and enlarged spleen (for more information on hemorrhagic *T. vivax* see: [Use of Drugs in the Field to Control Cattle Trypanosomiasis](#)). *T. c. congolense* produces the most severe form of animal trypanosomiasis in East and Central Africa. Serious disease and death may occur in cattle, horses, and dogs. *T. b. evansi* also occurs in a dyskinetoplasmic form in Central and South America (synonyms include *T. equinum* and *T. venezuelense*) where it is regarded as a separate species. *T. brucei equiperdum* produces a venereal disease (= → **Dourine**) in equids (horses and

**Trypanocidal Drugs, Animals. Table 1** Drugs used against trypanosome infections of domestic animals

CHEMICAL GROUP, nonproprietary name (approx. dose, mg/kg body weight, parenteral route) other information	*Brand name (manufacturer, company); other information; °first practical (commercial) use of drug	Characteristics (chemotherapeutic effects, adverse effects, miscellaneous comments)
<b>TRIVALENT ANTIMONY COMPLEXES</b>		
<b>potassium antimony tartrate</b> (tartar emetic) (1–1.5 g i.v., repeatedly, 5% aqueous solution) (3–6 g/100 kg i.m. or s.c. repeated doses required at weekly intervals) °1908	<b>Therapeutic use</b> antimosan, stibophen (sodium salt of antimosan)	the only satisfactory and cheap compound available prior to discovery of phenanthridine derivatives; it was useful for over 40 years in treating <i>T. c. congolense</i> and <i>T. v. vivax</i> infections in cattle and <i>T. b. evansi</i> infections in camels; extravascular
injection causes severe necrosis; narrow chemotherapeutic index (about 6% mortality in routine treatment); antimosan and stibophen were found to be effective against <i>T. c. congolense</i> and <i>T. v. vivax</i> but less against <i>T. b. brucei</i> ; it had been replaced by better tolerated drug products		
<b>SULFATED NAPHTHYLAMINES</b>		
<b>suramin</b> (standard dose: camel, 10, slowly i.v., horse, three doses in 1 week; dog, dose may be repeated for several days) °1920	<b>Therapeutic use</b> *Germanin, *Bayer 205, *Naganium and others (Bayer) suramin does not cross blood-brain barrier and is not active against secondary CNS stages of subgenus <i>Trypanozoon</i>	developed by Bayer in Germany during the 1914–1918 war (Bayer 205); first report on <i>T. evansi</i> activity in 1925; shows high efficacy against trypanosomes of subgenus <i>Trypanozoon</i> ( <i>T. b. brucei</i> , <i>T. b. evansi</i> , <i>T. equiperdum</i> ) and <i>onchocerciasis</i> in man
(→ <a href="#">Nematocidal Drugs</a> , Man); drug of choice for <i>T. b. evansi</i> infections (surra) in camels and horses; it may be toxic in equines (slow i.v. injection) causing edema of sexual organs, lips, eyelids or painful hoofs; i.m. or s.c. administration can cause severe necrosis at injection site (beware paravenous injection); subdosing (less than 1 g/100 kg b.w.) may lead to suramin-resistant strains, which are usually sensitive to quinapyramine dimethylsulfate; drug is embryotoxic in mice and bound to almost 100% to plasma proteins and slowly eliminated via kidneys; plasma t50% is about 32 h, which may be problematic in animals intended for human consumption		
< <b>suramin</b> (anhydrous) - <i>quinapyramine</i> sulfate complex>	<b>Prophylactic use</b> °1966 → pig; °1971 → horse	strongly anionic suramin is able to form a sparingly soluble salt complex with cationic groups of other known trypanocidal drugs; as a result toxicity
is reduced and prophylactic effect considerably prolonged; “depot effect” of suramin/ quinapyramine against <i>T. b. evansi</i> infection in horses may last up to 6 months; it can be used prophylactically against <i>T. c. simiae</i> infections in pigs; trypanosomes resistant to the complex can be treated with isometamidium; mode of action is energy metabolism and hydrogen transport; it blocks NADH oxidation by inhibition of $\alpha$ -glycerophosphate dehydrogenase and oxidase		
<b>AMINOQUINALDINES</b>		
<b>quinapyramine</b> dimethosulfate (ruminants, pig, dog, 5, s.c.; equines, camel 3–5, s.c.; dose should be divided, and given at 6 h intervals because animals are more sensitive to drug than bovines °1949	<b>Therapeutic use</b> *Trypacide sulphate (Merial) *Antrycide (Alkaline Chemical Corp., India; Bella Trading Khartoum, Sudan) *Noroquine (Norbrook) *Quintrycide (Gharda) (usually used as a 10 % aqueous solution)	is highly active against <i>T. c. congolense</i> , <i>T. v. vivax</i> , <i>T. b. brucei</i> , and <i>T. b. evansi</i> and reaches therapeutic levels quickly; drug can cause local and systemic reactions (salivation, shaking, trembling, diarrhoea, collapse) in cattle, horse, dogs, and pigs within minutes of treatment; effects resemble those of
curare; stress (heat, fatigue, fear, etc.) should be avoided before and after treatment; unexpected acute toxicity and rapid development of drug-resistant strains of <i>T. c. congolense</i> have limited its operational area in treating trypanosomiasis in cattle; however, drug seems to be safe and efficient for treating surra ( <i>T. b. evansi</i> ) in camels and horses as well as <i>T. b. evansi</i> infections in pigs; quinapyramine-resistant strains are usually controlled by isometamidium; quinapyramine is active against suramin-resistant strains ( <i>T. b. evansi</i> , <i>T. b. brucei</i> )		
<b>quinapyramine</b> dimethosulfate (water soluble) + chloride (insoluble in water) (3:2, w/w) (7.4, s.c.) °1950 <b>quinapyramine</b> chloride (unstable thick suspension, must be	<b>Prophylactic (Therapeutic) use</b> *Trypacide Prosalt (Merial) *Antrycide Prosalt (Alkaline Chemical Corp., India; Bella Trading Khartoum, Sudan) * Noroquine Prosal (Norbrook)	salt mixture has the same spectrum of activity as the dimethosulfate; s.c. injection of the mixture results in formation of a depot from which drug is slowly released; it can also become enclosed in a fibrous capsule or abscess

**Trypanocidal Drugs, Animals. Table 1** Drugs used against trypanosome infections of domestic animals (Continued)

CHEMICAL GROUP, nonproprietary name (approx. dose, mg/kg body weight, parenteral route) other information	*Brand name (manufacturer, company); other information; °first practical (commercial) use of drug	Characteristics (chemotherapeutic effects, adverse effects, miscellaneous comments)
shaken during use) (pig, s.c., behind the ear) °1961	* Quintrycide Prosalt (Gharda) (usually used as a 16,7 % aqueous solution)	resulting in loss of efficacy (observed chiefly in horses); protective activity may last about 2–3 months depending
on severity of tsetse fly challenge; unexpected acute toxicity (see dimethosulfate), and signs of a delayed toxicity can infrequently occur about 14 days after treatment; signs are loss of condition, weakness, collapse, and death as a result of severe kidney and liver damage; drug is selectively localized in these organs; <b>quinapyramine chloride</b> is not commercially available (special order necessary); it has been used prophylactically in pigs; <i>T. c. simiae</i> infections in growing pigs can be protected by the chloride, given 50 mg/kg at 3-month intervals; pigs and cattle are remarkably tolerant to the drug; its “depot” effect is due to an “egg-like” deposit from which drug is slowly released giving protection for 3 months in low tsetse fly challenge; target of action of quinapyramine is protein synthesis; it seems to act by displaying Mg ions and polyamines from cytoplasmic ribosomes; there is a similar type of kinetoplast DNA condensation as in diminazene, and an extensive loss of ribosomes		
PHENANTHRIDINE DERIVATIVES (PHENANTHRIDINIUM COMPOUNDS)		
<b>homidium</b> bromide (soluble in warm water) (1; cattle, deeply i.m.; small ruminants, pigs, horse, i.v.) °1952	<b>Therapeutic use</b> * Ethidium (Laprovect) (2.5% aqueous solution)	both salts have a somewhat higher selective effect on <i>T. v. vivax</i> infections in cattle than they have against <i>T. c. congolense</i> ; <i>T. b. brucei</i> is less susceptible; homidium can be used for treating <i>T. v. vivax</i> and <i>T. c. congolense</i> infections in horses and dogs; its limited protective activity in cattle depends on severity of challenge and may last
<b>homidium</b> chloride (soluble in cold water) (1; cattle, deeply i.m.; small ruminants, pigs, horse, i.v.) °1955	* <b>Novidium</b> (2.5 % aqueous solution); is as active as the bromide) (Merial) homidium does not cross bloodbrain barrier and is not active against secondary CNS stages of <i>T. b. brucei</i>	3–5 weeks; mass treatment with homidium resulted in appearance of resistant <i>T. c. congolense</i> strains in East and West Africa; homidium-resistant trypanosomes can be controlled by diminazene or isometamidium (enhanced doses); homidium is generally well tolerated at recommended dose and also at higher dose levels (no systemic toxicity); drug may be irritant at site of injection; deep i.m. injection effectively reduces local irritations; severe reactions may occur in horses after i.m. injection whereas i.v. injection seems to be well tolerated (paraveneous injection can lead to severe damage of jugular vein); homidium may be used for prophylactic treatment of slaughter cattle if tsetse fly challenge is moderate and cattle are trekked over not too long distances; it interferes with nucleic acid synthesis by intercalative DNA binding; interaction with DNA depends on length and nature of linking chain causing unwinding and extension; drug binds well to kinetoplast DNA
older drugs of this series are <b>phenidium</b> chloride and <b>dimidium</b> bromide (precursor of homidium), which cause a high incidence of delayed toxicity (marked liver damage) and severe local reaction at injection site; they were replaced by better tolerated homidium		
AROMATIC DIAMIDINES		
<b>diminazene</b> aceturate (3.5, cattle, sheep, horses, i.m.) °1955 in case of resistant trypanosomes dose can be raised up to 8 mg/kg b.w. but total single dose should not exceed 4g per animal diminazene does not cross blood-brain barrier and is not active against secondary CNS stages of <i>T. b. evansi</i> and <i>T. b. brucei</i>	<b>Therapeutic use</b> °* Berenil (Intervet) * Ganaseg and others (7% aqueous solution) 1g of granules contains 445 mg diminazene aceturate and 555mg phenyldimethyl pyrazolone (*Antipyrin, an analgesic acting as solvent mediator); withdrawal time before slaughter: 21 days	is highly effective against <i>Babesia</i> spp. (→ <i>Babesiocidal Drugs/</i> Table 1), <i>T. c. congolense</i> , and <i>T. v. vivax</i> , but less active against <i>T. b. brucei</i> and <i>T. b. evansi</i> infections (5–10 mg/kg); drug shows no activity against <i>T. c. simiae</i> ; it seems to have a wide therapeutic index in cattle: subcutaneous doses up to 21 mg/kg were reported to be tolerated in cattle without serious side effects; as ‘sanative’ drug it is used alternately with isometamidium, which
does not cause mutual cross-resistance; its relative ‘rapid’ excretion was believed to reduce risk of parasites becoming resistant (see Pharmacokinetics of Trypanocides and Chemical Residues in Edible Tissues and Milk); trypanosomes resistant to other drugs (except quinapyramine) are commonly susceptible to diminazene; routine and mass treatment may lead to development of diminazene-resistant <i>T. v. vivax</i> and <i>T. c. congolense</i> strains; as a rule, diminazene-resistant strains are		

**Trypanocidal Drugs, Animals. Table 1** Drugs used against trypanosome infections of domestic animals (Continued)

CHEMICAL GROUP, nonproprietary name (approx. dose, mg/kg body weight, parenteral route) other information	*Brand name (manufacturer, company); other information; <sup>c</sup> first practical (commercial) use of drug	Characteristics (chemotherapeutic effects, adverse effects, miscellaneous comments)
susceptible to isometamidium; local reactions can occur in cattle (slight swelling after s.c. injection) and in horses (skin may slough off after s.c. injection, abscess formation after i.m. injection); severe systemic reactions may be evident in equines after higher than recommended doses; camels seem to be most sensitive to diminazene; treating <i>T. b. evansi</i> infections, severe toxic reactions and death can occur at 3.5 and 7 mg/kg, respectively; unexpected side effects (hypotensive, hypoglycemic, and neurotoxic effects: tremor, nystagmus, ataxia, convulsions, vomiting) have been observed in dogs at the recommended dose; for that reason diminazene should only be used in dogs and camels by or under the immediate supervision of the veterinarian; besides its trypanocidal and babesiacidal action, Beremil may exert some anti-inflammatory (antihistaminic) effect; diminazene and pentamidine (→ <a href="#">Trypanocidal Drugs</a> , Man, see Pharmacokinetics of Trypanocides and Chemical Residues in Edible Tissues and Milk and → <a href="#">Chemotherapy/Withdrawal Time of Drugs in Target Animals</a> ); diminazene interferes with nucleic acid synthesis; and bind to DNA <i>in vitro</i> (particularly well to kinetoplast DNA) by a non-intercalative mechanism; drug blocks DNA and RNA synthesis (see Search for New Drugs)		
<b>isometamidium</b> chloride (0.25–0.5, cattle, sheep goats deeply i.m.) (1, dog, buffalo) <sup>c</sup> 1958, launched in 1961	<b>Therapeutic use</b> *Samorin (Merial) * Trypamidium (Merial) (1% aqueous solution) *Veridium (CEVA, Sanofi Santé Nutrition Animal France) isometamidium does not cross blood- brain barrier and is not active against secondary CNS stages of <i>T. b. evansi</i>	metamidium was itself a mixture of two isomers; subsequently the much more soluble, red, highly active isomer was isolated for field trials and named isometamidium; it is a synthetic hybrid like <i>pyrithidium</i> (discontinued) consisting of diazotized p-aminobenzamidine moiety of diminazene molecule linked into 7-position with homidium chloride;
drug is highly active against <i>T. v. vivax</i> infections in ruminants and horses as well as against <i>T. c. congolense</i> infections in ruminants, horses, and dogs; it is less active against <i>T. b. brucei</i> and <i>T. b. evansi</i> infections in horses, ruminants, camels, and dogs; location of the latter <i>Trypanosoma</i> spp. in tissues and body cavities makes them less susceptible to drug action, and treatment with suramin or quinapyramin is therefore suggested; trypanosomes resistant to the drug are usually susceptible to diminazene; acceptable daily intake (ADI, cf. → <a href="#">Chemotherapy/Withdrawal Time of Drugs in Target Animals</a> ) of isometamidium for humans is 6 mg (total intake); maximum residue limit (MRCL) suggested for meat, fat, and milk is 0.1 mg/kg, for liver 0.5 mg/kg, and kidney 1mg/kg resulting in a withdrawal time of at least 30 days (excluded injection site) for recommended dose		
<b>isometamidium</b> chloride (0.5–1, deeply i.m., cattle; s.c. injection in dewlap of cattle may avoid muscle necrosis) (0.5, i.v. 1% glucose solution over 30 min horses and camels)	<b>Prophylactic use</b> *brand names see under therapeutic use	isometamidium provides extended protection at higher doses, 2–4 months depending on tsetse fly challenge; medium tsetse fly challenge may require 0.5 mg/kg, heavy challenge 1 mg/kg every 2 months; recommended dose is
usually well tolerated by cattle; however, i.m. injection can cause severe local reactions like extensive fibrosis at injection site (muscle of neck); i.v. injection in horses and camels may avoid local reaction but may cause systemic toxicity (salivation, tachycardia, profuse diarrhoea, hindleg weakness, collapse due to histamine release); drug can reversibly block neuromuscular transmission and stimulation in cholinergic receptors; extensive accumulation of drug occurs in liver and kidney		
<b>MELAMINOPHENYL ARSENICALS</b>		
<b>melarsamine</b> HCl <sup>c</sup> 1989	<b>Therapeutic use</b> *Cymelarsen (Merial)	effective against trypanosomes of the <i>T. brucei</i> group ( <i>T. b. evansi</i> , <i>T. equiperdum</i> in camels, buffalo,
goats and pigs); it was found to be effective against diminazene-resistant <i>T. b. brucei</i> , and <i>T. b. evansi</i> , it is at least 2-2,5 times more effective than Mel W; it is suggested that trivalent cationic arsenicals interact with trypanothion to form the stable adduct Mel T; arsenical agents may be frequently associated with serious side effects (e.g., agent induced encephalopathy)		

Doses listed in this table refer to information from manufacturer and literature or websites on the subject

Data given in this table have no claim to full information.

donkeys) in Northwest Africa, Ethiopia, Central and South America, the Middle East, and Asiatic Russia. The disease is usually transmitted by coitus, and infrequently by biting flies or infective discharge. Apart from the typical salivarian or stercorarian pathway of infection any trypanosome can also be transmitted mechanically (e.g., artificially by “syringe passage”) without undergoing cyclical development in a vector as *T. vivax* infections of ruminant livestock in South and Central America. Noncyclical transmission can be done in nature by bloodsucking insects, such as →*Tabanus* spp. and →*Stomoxys* spp. flies (→*Diptera*). In South America →*Vampire Bats* should also be a vector transmitting *T. brucei evansi* infections in horses. The disease is known as →*Murrina* (Panama) or →*Derrengadera* (Venezuela).

### Economic Loss in Livestock

Economic loss due to cattle trypanosomiasis is difficult to assess, but the fact that livestock in Africa are treated with more than 30 million doses of trypanocidal drugs each year may give some indication of the importance of this problem. The impact of disease extends over approximately 9 million km<sup>2</sup> of Africa between the southern border of the Sahara in the north and the Limpopo in the south (sub-Saharan Africa), and threatens more than 50–70 million animals in 37 African countries. Partly a result of this disastrous situation is that Africa produces about 70 times less animal protein per unit area than Europe.

### Dissemination of Trypanosomes in the Body of Host and its Influence on Drug Action

There are two groups of tsetse-transmitted organisms, which can be distinguished: (1) the hematic group, including *T. c. congolense* and *T. v. vivax* and confined to the blood and lymphatic systems and (2) the humoral group, including *T. b. brucei*, *T. b. rhodesiense*, and *T. b. gambiense* (→*Trypanocidal Drugs, Man/Drugs Acting on African Trypanosomiasis (Sleeping Sickness) of Humans*). In addition to occurring in plasma, species of the humoral group are also present in body cavity fluids and intercellular tissue. Parasites of this group are parasitic only in the terminal stages of the infection, and the chief pathological changes caused by these trypanosomes are extensive inflammatory, necrotic, and degenerative reactions (tissue damage), probably associated with release of kinins and fibrinogen degradation products. In contrast, parasites of the hematic group produce mainly a severe anemia, which determines the severity of disease. Although the anemias produced by *T. v. vivax* and *T. c. congolense* are equally serious, the mechanism of pathogenicity may be different for each species. *T. c. congolense* can also develop outside the circulatory system. Thus, the

different distributions of the trypanosomes in the body of host result in varying susceptibilities to trypanocides depending on their pharmacodynamics (mechanisms of drug action) and pharmacokinetics (disposition and fate of drugs in the body). Relapse of infection, i.e., return of patent parasitemia after its apparent cessation by drug administration, may occur in chronic *T. b. brucei* infections (→*Trypanocidal Drugs, Man/Drugs Acting on African Trypanosomiasis (Sleeping Sickness) of Humans: late stage of trypanosomiasis = →sleeping sickness of man*). The relapse due to the appearance of trypanosome populations from privileged sites, such as the cerebrospinal fluid and/or intercellular tissue spaces (parasites from the latter site may also be the cause of relapse in *T. c. congolense* infections). Commonly used drugs, such as **diminazene**, **isometamidium** and **homidium** do not have the ability to cross the blood-brain barrier or produce constant trypanocidal concentrations in body cavity fluids and intercellular tissues that kill trypanosomes. Relapse in chronic *T. b. brucei* infections is evident when chemotherapy was started too late. This is of considerable interest because drug sensitivity changes as the infection progresses. Complete cure is usually achieved when drugs are given in the early stage of infection. In late-stage *T. b. brucei* infections with CNS involvement treatment with non-arsenic drugs gives rise to an apparent cure since parasites disappear from the circulation but, after a period of weeks, they reestablish themselves in the circulation. The natural immunity of humans to the cattle pathogen *T. b. brucei*, but not to the morphological indistinguishable human pathogens *T. b. rhodesiense* and *T. b. gambiense*, is probably a result of the selective killing of this species by normal human serum containing trypanolytic factors. Unlike in animal trypanosomiasis, the most prominent symptoms of sleeping sickness may result from the marked damage to the CNS in late-stage *T. b. gambiense* (and *T. b. rhodesiense*) infections. **Melarsoprol** and related arsenicals e.g., melarsamine (Table 1), (known for their high systemic toxicity (→*Trypanocidal Drugs, Man/Drugs Acting on African Trypanosomiasis (Sleeping Sickness) of Humans*), are able to cross the blood-brain barrier. A long-term model of African trypanosomiasis in mice producing meningo-encephalitis astrocytosis and neurological disorders can be used to understand the pathogenesis of human African trypanosomiasis from initial infection to advanced stages and to evaluate drug efficacy in the late stage of disease. Trypanocides may also be suitable tools in diagnosis of chronic (subpatent) *T. c. congolense* infections in cattle. For this purpose drugs are applied intravenously before and in combination with the indirect fluorescent antibody test. Rapid flushing of cryptic trypanosomes from the microcirculation may lead to increase of jugular parasite concentrations within 6–10 min of the administration of

diminazene, pentamidine, or homidium chloride. However, diamidines given by the intravenous route are liable to give rise to hypotension and other severe, alarming reactions, some of which are due to →[histamine](#) release.

### Current Control Measures

Measures currently used to control trypanosomiasis are diagnosis and treatment, →[chemoprophylaxis](#), tsetse fly control or eradication of →[tsetse flies](#), and the utilization of so-called trypanotolerant breeds. However, this most challenging task in Africa is complicated and hampered by several specific factors. The number of tsetse flies (and thus the occurrence of disease) fluctuates greatly over periods of several years and makes assessment of the actual risk to which livestock are exposed difficult. In addition, control of trypanosomiasis is hindered considerably by the fact that African trypanosomes are able to establish →[chronic infections](#) in their mammalian hosts because of their highly developed system of →[antigenic variation](#). Individual members of the parasite population change the composition of their →[surface coat](#) so that variations in the composition of these variant surface glycoproteins (VSGs) allow the parasite to escape the host's immune system. Thus fluctuating parasitemias produced by *T. brucei* are associated not only with the phenomena of variable antigen type (→[VAT](#)) but certainly also the potential for regulation of trypanosome growth by environmental factors such as epidermal growth factor (EGF), transferrin and low-density lipoprotein. This makes effective →[immunoprophylaxis](#) unlikely.

In areas with low tsetse fly density the method of choice for controlling African trypanosomiasis seems to be the eradication of the vector. For the time being the spraying of →[insecticides](#) dominates in tsetse fly eradication. In regions with very low levels of infestation, e.g., by riverine →[tsetse](#) species (*Glossina palpalis* group, e.g., *G. palpalis*, *G. fuscipes*), trypanosomiasis can be controlled by surveillance and treatment only. Nevertheless, flies of the savanna (and thicket) group (*G. morsitans* group, e.g., *G. morsitans*, *G. pallidipes*, *G. austeni*) may give rise to severe trypanosomiasis in susceptible stock even if their numbers are low. In these areas commercial cattle ranching may be possible under chemoprophylactic protection. However, tsetse fly density and thus contact between cattle and vector must be reduced by additional spraying of insecticides with residual effects (e.g., synthetic pyrethroids) and by setting up impregnated traps and screens. In areas with medium tsetse fly density the further exploration and logical exploitation of trypanotolerant cattle, including crossbreeding trials with European breeds to increase milk and meat productivity of indigenous trypanotolerant cattle, may offer a realistic alternative

to not yet available vaccination. At least in areas with high tsetse fly density even trypanotolerant animals may not survive unless they are treated prophylactically against trypanosomiasis. The control of the disease in fully susceptible stock even under chemoprophylaxis seems to be impossible in regions heavily infected with tsetse.

Tsetse flies can detect odors by means of receptors on their antennae. Experience with insect →[pheromones](#) was used to identify the chemical components of the ox odor, which might attract tsetse flies and led to the discovery of 1-octen-3-ol. It proved highly attractive to flies of the savanna (*G. pallidipes* and *G. m. morsitans*). Thus live bait (e.g., cattle treated with insecticides: spot-on, pour-on), fly traps, and screens impregnated with “essence of ox” and pyrethroid insecticides (e.g., deltamethrin, or cyfluthrin), and sophisticated ground spraying technology may markedly reduce tsetse infestation in limited areas of riverine woodland or transitional forest-savanna zones. Traps baited with acetone and 1-octen-3-ol have been used in Zimbabwe, Zambia and Malawi to detect the presence and distribution of tsetse flies. It has been shown that **isometamidium** is capable of eliminating the insect vector form of *T. v. vivax*. This experimental finding may be of potential significance in the control of trypanosomiasis in the field, particularly in the operation of the sterile insect technique (e.g., in Nigeria).

Effects of infections on vector survival are of interest for the evolution of parasite-vector interactions since trypanosome transmission depends strongly on vector survival and the frequency of genetic factors controlling vector susceptibility depending on the fitness of infected vectors. In several species of tsetse flies, males from natural populations, and from laboratory-bred colonies, are more likely to develop mature trypanosome infections than females.

Today, there is neither a breakthrough in →[biological control](#) of tsetse flies nor are there promising solutions for a vaccine against African trypanosomes.

### Trypanotolerance of Indigenous African Breeds

The term “trypanotolerance” means reduced susceptibility to trypanosomiasis and denotes an inherited biological property allowing animals to live, breed, grow and survive in a naturally infected environment without exhibiting clinical signs of trypanosomiasis after harboring pathogenic trypanosomes.

In regions where eradication of the vector is not possible with present methods, genetic improvement of trypanotolerant breeds should be attempted. Attention has recently focused on genetic resistance and various selection programs are being discussed to select trypanotolerant animals. Such programs could involve

selection of trypanotolerant animals under natural challenge or selection of marker traits (e.g., aspects of the immune response). Selection could also act on polymorphic loci that may affect trypanotolerance, and may be closely linked to genes acting upon tolerance via marker loci. Trypanotolerance is found not only in cattle (all dwarf semiachondroplastic West and Central African types) but also in sheep, goats, and in some rare pony types, such as the Kotokoli of the Ivory Coast. The N'Dama (Hamitic Longhorn of the *Bos taurus* type as well as those breeds of the West African Shorthorn) is a West African breed (e.g., Gambian cattle) noted for its small size and its trypanotolerance. This humpless breed responds very well to improved management and can attain levels of productivity comparable to that of many African beef breeds of the *Bos indicus* type, such as the West African Zebu, the Orma Boran, the Ankole, or the Afrikander. In addition the N'Dama can maintain reasonable production levels under conditions of poor management, climate, nutrition and high tsetse fly densities. Trypanotolerant breeds of Zebus, sheep and goats may also exist in East Africa. Field studies on two types of large East African Zebu (*Bos indicus*) Boran cattle on a beef ranch in Kenya have demonstrated that a boran type bred by the Orma tribe had a superior response to tsetse fly challenge compared to an improved Boran when introduced to a new locality. Superior resistance to tsetse fly challenge was evident by lower trypanosome infection rate, and when this was untreated, by lower anemia and decreased mortality.

### Drug Interactions Associated with Induction of Immunity

Following the successful feeding of tsetse flies infected with *T. c. congolense*, cattle develop local reactions of delayed onset (commonly called a →chancre) that persist for several days. The proliferation of the parasite in the hosts skin prior to its passage into the bloodstream via draining lymphatics plays an important role in the induction of immunity, as it is only after regression of the chancre that cattle are immune to tsetse-transmitted homologous challenge. Attempts to induce skin reactions by intradermal injection of bloodstream forms of *T. c. congolense* have failed. Thus, the induction of immunity to trypanosomes may be adversely affected if trypanocidal drugs are given prior to regression of the chancre. In an area of medium tsetse fly challenge it was found that the degree of immunity was greatest in cattle in which infections were established and clinical disease could develop before treatment. Conversely, no immunity developed in cattle treated immediately trypanosomes were seen in the peripheral blood and prior to any evident clinical signs. Induction of immunity to *T. c. congolense* in rabbits by infection and treatment with **homidium chloride** may also be

adversely affected if animals are infected concurrently with antigenically different stocks of trypanosomes. There was no marked cellular proliferation in the skin at the sites of secondary infection bites following feeding of a single *G. morsitans*; a chancre failed to develop. Possibly the impaired response was due to drug action preventing trypanosomes from developing extravascularly.

On the other hand, the apparent duration of drug protection has been thought to be influenced by protective immunity, which may develop as a result of interactions between insect vector, host, trypanosome population, and drug. These interactive effects may lead to “non-sterile immunity” or “tolerance” in cattle following drug administration and trypanosome challenge. The role of immune responses has been investigated in **isometamidium** treated Boran cattle under single or repeated challenge with *T. c. congolense* infected tsetse flies. Six months after treatment two-thirds of the cattle were resistant to challenge, irrespective of whether animals had received single or multiple challenge. The animals had no detectable skin reactions at the site of deposition of metacyclic trypanosomes and produced no trypanosome-specific antibodies, indicating that drug residues effectively inhibited trypanosome multiplication in the skin and thus subsequent parasitemia. It was concluded that immunological priming of the host had not occurred, and that the protection achieved was not related to the development of immune responses by the host enhancing the length and potency of protection afforded by isometamidium. These findings indicate that development of immunity is not necessary for successful maintenance of cattle in tsetse fly areas provided close control of drug regimes is maintained. The results may also indicate that it is essential to allow multiplication of parasites prior to drug treatment to induce immunity in the host.

Induction of non-specific host defense (e.g., macrophage functional activity) by immunomodulators was demonstrated in 1979 by Murray et al. *Bacillus Calmette-Guérin* (BCG) and *Corynebacterium parvum* were found to enhance the immune response to *T. c. congolense* infections in susceptible A/J mice and more resistant C57B1/6J mice, both showing reduced parasitemias and increased survival times. This effect could not be transferred from treated to untreated mice of the identical strain by spleen cells or serum. It is not yet clear by which mechanisms immunomodulators influence the course of infection. The development of effective, immunostimulants may provide attractive, complementary tools for combating trypanosomiasis and should be considered as an additional approach to the complex undertaking of a screening program for new trypanocidal drugs and breeding programs for trypanotolerant livestock.

## Search for New Drugs

For animal trypanosomiasis no new drugs of any kind have appeared in the field since the introduction of isometamidium in 1961. Nevertheless, aromatic diamidines continue to provide new compounds of high intrinsic activity. Among these, several compounds are highly active on *T. c. congolense* and *T. v. vivax*, while others show a high activity on trypanosomes of the subgenus *Trypanozoon*. Unfortunately, resistance to one trypanocidal diamidine appears to confer resistance to all diamidines, and diminazene-resistant trypanosomes have been shown to be resistant to **DAPI** (4',6-diamidino-2-phenyl-indole) and other **diamidines** synthesized by Dann and his colleagues. Aromatic diamidines (e.g., pentamidine, diminazene) not only inhibit the growth of protozoans but also of bacteria, →fungi and tumor cells, generally at concentrations below those found to be active on the host. DAPI forms fluorescent complexes with double-stranded DNA and is now used for the fluorescent staining of prokaryotic and eukaryotic cells. The drug seems to interact with A-T-rich regions of DNA and thereby to suppress the DNA-directed RNA and DNA polymerases. Several trypanocides (quinapyramine, pentamidine, diminazene aceturate, and isometamidium) and a babesiacidal drug (imidocarb) have been investigated in an activated DNA-directed →DNA synthesis assay system catalyzed by *T. b. brucei* DNA polymerases, murine thymus DNA polymerase alpha, and Rauscher murine leukemia virus reverse transcriptase. From the results obtained it was suggested that trypanosomal DNA polymerases are not the selective target of drugs as they showed a similar dose dependent inhibition to other DNA polymerases of eukaryotic cells. Stimulation of reverse transcriptase activity was observed in the presence of quinapyramine and imidocarb but this could be negated by the presence of spermine in the reaction mixture. As part of studies on N-oxidative biotransformation of amidines, potential metabolites of pentamidine have been synthesized. Although several **amidoximes** of pentamidine and diminazene proved highly active against various African trypanosomes in mice, their potency was inferior to that of the parent compounds. Several compounds of a series of **aryl bis-benzimidazoles** have shown excellent activity against diminazene-resistant *T. c. congolense*, *T. v. vivax*, and *T. b. evansi* strains. Unfortunately this series caused delayed toxicity in calves, including serious liver and kidney damage.

Several antitumor antibiotics have revealed unsuspected high activity against trypanosomes *in vitro*, particularly DNA and RNA synthesis inhibitors such as 5-chloro-puromycin. **Daunorubicin**, an anthracycline antibiotic intercalating with DNA, which is one of the most potent trypanocidal agents *in vitro*, has proved totally inactive against *T. b. rhodesiense* in infected

mice. Limitations of efficacy and problems with toxicity impose severe limitations on the usefulness of antitumor drugs as potential leads to new trypanocides in humans and animals. The antifungal nucleoside antibiotic **sinefungin**, which strongly inhibits S-adenosyl-methionine dependent transmethylation reactions, has a marked effect on African trypanosomes in mice when administered intraperitoneally. Goats infected with *T. c. congolense* and treated with intramuscular doses of 10 or 20 mg/kg b.w. showed relapse of infection; higher doses (up to 50 mg/kg b.w.) were toxic and caused death. Among a series of novel **purine derivatives** (phosphonylmethoxyalkylpurines and →pyrimidines) with antiviral activity against a broad spectrum of DNA viruses some of them showed potential activity *in vivo* against *T. b. brucei* at dosages that were below those toxic for mice. **Ketoconazole** and related **azole derivatives** with high activity against *T. cruzi* infections in mice have proved ineffective against *T. b. brucei* in mice. Among a series of **phthalanilides** and related compounds, **BW 458 C** was the most effective in curing short-term and long-term *T. b. brucei* infections in mice. Cure rates greater than 90% were achieved with the drug at 10 or 25 mg/kg body weight. None of several compounds of a series of **suramin analogues** was more active than suramin against →macrofilariae of *Dipetalonema viteae* and various →*Trypanosoma* spp. Inhibition of lipid metabolism in the trypanosomes may be central to the therapeutic effects of the garlic extract containing **diallyl-disulfide** (DAD). DAD is known to have a lipid-regulatory effect and a sulfur-rich compound that readily undergoes ionic interaction with SH being a vital component of coenzyme A. The latter is required in growing cells for the provision of activated acetate molecules, which are then channelled into →lipid synthesis and other vital cellular processes.

**Salicylhydroxamic acid** (SHAM), a substituted aromatic hydroxamic acid, inhibits aerobic energy production (L-glycerol-3-phosphate oxidase system) in trypomastigote stages; it can clear temporarily bloodstream infections of *T. b. brucei* in rats if administered concomitantly with →glycerol. In practice, only one far from ideal drug, **melarsoprol** (Mel B) is available to treat late-stage sleeping sickness. Calcium (Ca) has a synergistic effect on this trypanocide and has been shown to be more critical in its action than SHAM +glycerol. These data may be important in the clinical management of sleeping sickness. If total Ca is reduced in a patient it is possible that supportive therapy to restore Ca concentrations could improve the therapy, especially in late-stage Gambian infections.

The reason that potent chelators are trypanocidal but not toxic to mice may relate to acute competition for Fe between the host's Fe-binding proteins like transferrins and ferritin and the parasite's Fe requirement. Several



chelators such as caffeic acid, cuproine, and other commercially available chelators, which had shown heme sparing or inhibition of growth of *→Crithidia fasciculata* *in vitro* were active against *T. b. rhodesiense* in mice after high doses only. Divalent cation chelators such as ethylenediamine tetraacetate (EDTA) or the calcium-specific chelator ethyleneglycol tetraacetate (EGTA) can abolish the synergistic action of heparinized rat blood with SHAM +glycerol. Transferrin may also function as a drug carrier in African trypanosomes in such a manner that complexes of transferrin with isometamidium (Samorin) are targeted directly with high specificity into the lysosome system of *T. c. congolense*.

DL- $\alpha$ - difluoromethylornithine (DMFO = **eflornithine**) is a selective and irreversible inhibitor of *→ornithine* decarboxylase and a key enzyme in polyamine biosynthesis in *T. b. brucei*. The substituted amino acid was shown to have activity against CNS *T. b. brucei* infections in rodents and is the only “new” drug to be developed for the treatment of sleeping sickness in humans. It has proved to be an effective treatment for late stage infections of *T. b. gambiense* in humans [*→Trypanocidal Drugs, Man/Drugs Acting on African Trypanosomiasis (Sleeping Sickness) of Humans*].

There are various areas considered as leads in research relevant to the development of potential new agents for African trypanosomiasis and targets for chemotherapeutic attacks such as, glycolytic enzymes (non-oxidative branch of pentose phosphate pathway = PPP), antigenic variation, and trypanothione metabolism in trypanosomes. Oxidative branch of PPP might be an alternative lead for new drugs. It maintains a pool of NADPH (reduced form of nicotinamide adenine dinucleotide phosphate required for synthesis of fatty acids via phosphogluconate pathway) that serves to protect against oxidant stress and which generates *→carbohydrate* intermediates used in nucleotide and other biosynthetic pathways. Thus 6-phosphogluconate dehydrogenase (6PGDH) in *T. b. brucei* may be a potential target for chemotherapy because in other eukaryotic organisms the deletion of the gene encoding 6PGDH is lethal. The gene encoding *T. b. brucei* 6PGDH has been cloned, and the enzyme purified and crystallized. Suramin inhibits 6PGDH, and trivalent aromatic arsenoxides inactivate the enzyme with marked potency. Considerable attention has been devoted also to topoisomerases of kinetoplastid organisms. This group of enzymes could be another valuable drug target for new trypanocides. Topoisomerases, which mediate topological changes in DNA, are essential for nucleic acid biosynthesis and for cell survival. Topoisomerase II activity has been purified from *Leishmania donovani*, *T. cruzi* (*→Trypanocidal Drugs, Man*) and *T. equiperdum*, and topoisomerase II genes have been cloned also from *T. b. brucei* and *T. cruzi*.

Studies with purified topoisomerases indicate that the enzymes from kinetoplastids generally exhibit the expected inhibitor sensitivities. Thus activity is reduced by intercalators acting by deforming the DNA substrate, minor groove binders (compounds that bind in the minor groove of the DNA helix) and compounds that compete for binding at the enzyme’s ATP site (e.g., novobiocin, coumermycin). Agents that specifically inhibit type II enzymes by trapping the enzyme on its DNA substrate, forming a “cleavable complex”, are the fluoroquinolones and etoposide. Thus, antibacterial fluoroquinolones were shown to exhibit marked activity *in vivo* against *Leishmania donovani*. Some classical trypanocides such as DNA-binding agents (diminazene and pentamidine: minor groove binders) and intercalators (e.g., ethidium bromide) are well known for their ability to generate dyskinoplastic trypanosomes, which retain mitochondrial membranes but lack detectable kDNA. Selective inhibition of mitochondrial topoisomerase II may be an explanation for the propensity of these drugs to induce dyskinoplastic cells. Because kDNA is not essential for the survival of bloodstream form of African trypanosomes, nuclear rather than mitochondrial topoisomerases should be the preferred target for drug search. Differences in parasite and mammalian topoisomerases may provide the basis for selective toxicity of new trypanocidal compounds. On the other hand, kinetoplasts can be an obligatory target for antitrypanosomal drug action if these organelles are important for successful subsequent cycling into the insect vectors. There must be some mechanism to assure that an organism does not replicate the nucleus and divide until or unless it has replicated its *→kinetoplast*. Drug targeting of kinetoplasts, then, could interfere with cell replication by preempting this regulatory mechanism. Thus identification of regulatory mechanism generating dyskinetoplastic resistance in trypanosomes could possibly provide a basis for new therapeutic approaches. Also molecular biological investigations, as well as inducible gene expression systems (e.g., the tetracycline-responsive repressor of *Escherichia coli*, TetR) in trypanosomes, could suggest potential targets for chemotherapy and pathogenicity.

### Drug Combinations with Synergic Effects

For cattle treatment only a few drugs have been developed, and these are involved in resistance problems today. Under such conditions (such as in cancer chemotherapy) exploration of combinations might be an alternative strategy. Therefore, the possibilities of trypanocidal synergic effects of known drugs have been extensively examined *in vitro* and *in vivo* using monomorphic laboratory strains of *T. b. rhodesiense*. Only suramin +tryparsamide, suramin +puromycin, suramin +diminazene, and 9-deazainosine +DL- $\alpha$ -difluoromethylornithine (cf. also [Search for New Drugs](#))

have been shown statistically significant synergy. Another example of a successful combination therapy is the suppression of chronic *T. b. brucei* infections in mice (CNS involvement) by diminazene diaceturate or suramin, each combined with a substituted 5-nitroimidazole (e.g., fexinidazole or MK 436). None of these drugs administered singly caused 100% permanent cure. Only fexinidazole (Hoe 239) was able to cure a high percentage of the mice when given repeatedly at relatively high dose levels of 250 mg/kg. In several experimental studies fexinidazole has also been found to exhibit a strong effect against *T. cruzi*, *T. vaginalis* and *E. histolytica in vivo*.

### Chemoprophylaxis of Cattle Trypanosomiasis

Although there are different ways of combating cattle trypanosomiasis, each of the control methods in use at present has serious limitations. Because of the major economic importance of trypanosomiasis in cattle the great majority of control measures have been aimed primarily at the protection of these animals by the use of suitable trypanocidal drugs. In the absence of a suitable vaccine, chemotherapy and chemoprophylaxis are the most important tactics, which are available as part of any strategy of trypanosomiasis control. They are still considered to be the most effective measures for trypanosomiasis control.

Drugs used for the treatment and →prophylaxis of animal trypanosomiasis center on a small number (Table 1). They can be characterized on the basis of their ionization at blood pH as cationic or anionic drugs. Cationic drugs are quaternary ammonium trypanocides (quinapyramine, homidium, isometamidium), and aromatic diamidines (diminazene and pentamidine). The only anionic drug currently in use is presented by suramin. It is a sulfated naphthylamine derivative that readily binds to plasma proteins; it is still widely used in the treatment of equine trypanosomiasis.

The risk of infection to which cattle are exposed is closely related to the density and the species of tsetse fly present. The incidence of tsetse flies thus chiefly determines the frequency of treatment, which is in most regions regulated by the government. The nomadic habits of the major cattle-owning peoples have given rise to the widespread use of trypanocidal drugs and, in general, treatment of individual animals is not practiced. Several authors pointed out that rationale for treating cattle trypanosomiasis is entirely different from that for treating sleeping sickness, for the following reasons. (1) Trypanosomes are very much more common, so that any animal, which becomes infected by tsetse flies, is liable to be infected. Therefore treatment of individuals (or even herds) has no general sanitary significance. (2) Drugs are often given prophylactically to cattle on their way to slaughter in

Africa. Cattle are usually moved over long distances to provide meat in urban areas, and prophylactic drugs are administered so that animals can pass through the “fly belt”. Prophylactic treatment is particularly afflicted with problems concerning variations in the length of protection resulting from varying field situations and the rate of drug elimination from the body (preslaughter withdrawal time). The duration of chemoprophylaxis thus not only depends on the degree of tsetse fly challenge but also on the timing of treatment in relation to occurrence of infection. Insufficient drug protection may result if infection by tsetse flies occurs too early in the trek, and cattle may then succumb to infection before reaching their destination.

The period of effectiveness of prophylactic drugs thus varies with →environmental conditions, the tsetse fly challenge and activity of the treated animal as well as actual concentration of the active drug (there is the risk of producing a too long-lasting subcurative concentration in blood and tissues). Thus, the period of protection may be considerably reduced particularly during strenuous activity, especially when trade cattle pass through a fly belt in the course of their journey.

### Drug Complexes with Enhanced Prophylactic Activity

The prophylactic action of drugs has been prolonged by preparing complexes of **suramin** (anionic drug) with cationic/basic drugs, thereby reducing systemic toxicity of the drugs. Although a **homidium-suramin complex** gave extended protection (6–12 months), it caused unacceptably severe reactions at injection sites. A **quinapyramin-suramin complex** proved active at a single dose of 50 mg/kg body weight in protecting adult pigs and piglets for at least 6 and 3 months, respectively. However such long acting drugs often cause rapid development of drug resistant trypanosomes. Encapsulation of drugs, either in polymers or in artificial phospholipid membranes (liposomes) has been known for a long time. Preparing a complex of isometamidium with the well-defined polyanion dextran, thereby reducing its toxicity, could enhance the duration of protection produced by the drug. Entrapping homidium bromide in bovine carrier erythrocytes has caused slow release of the drug. However, the various shortcomings of such preparations, like drug quality problems (standardization), marked drug residues (possibly posing a human health hazard) and severe reactions at sites of injection, have hindered the further preclinical development of such preparations. Recently, more promising results were obtained using different types of subcutaneously implanted slow release devices (SRD) containing polycaprolactone/homidium bromide SRD or more readily biodegradable poly (D, L-lactide) or poly (D, L-lactide-co-glycolide)

SRD containing either isometamidium chloride or homidium bromide for intramuscular administration. As a result local toxicity was minimized and prophylactic effects in comparison with the parent compounds were markedly prolonged. When breakthrough isolates derived from SRD-treated animals (rabbits) were compared with the original *T. congolense* strain, such isolates showed some loss of sensitivity to homidium only.

### Drug Tolerance in the Field and Assays to Assess Intrinsic Trypanocidal Activity

The conditions under which 'man made drug tolerance' develops in the field are derived basically from under-dosing due to incorrect estimation of body weight; this is difficult to avoid when mass treatment is involved. A high incidence of trypanosomiasis in conjunction with the irregular use of prophylactic and therapeutic drugs also favors the emergence of drug-resistant trypanosomes. Thus, drug-resistant parasites may emerge in any situation where prophylaxis and therapy are inadequate for the degree of tsetse fly challenge. This may be the case particularly in regions of high tsetse fly challenge. The misuse of drugs leads consequently first to "individual" resistance and then to "area" resistance. Generally, prophylactic drugs induce resistance more rapidly in trypanosomes than do "therapeutic" drugs. The latter drugs reach trypanocidal plasma levels relatively quickly and may be more rapidly metabolized and excreted from organisms than "prophylactic" drugs. In areas with a high incidence of tsetse flies, subcurative drug levels may already exist towards the end of the protection period, and this is the case particularly after using drugs for prophylaxis. Treatment must therefore be repeated to restore trypanocidal plasma concentrations.

The phenomenon of "natural (intrinsic) drug tolerance," i.e., variation in drug sensitivity that is not dependent on previous exposure to the drug concerned, has been demonstrated in *T. v. vivax* and *T. c. congolense*. Thus, West African *T. v. vivax* strains seem to be more susceptible to homidium than are East African *T. c. congolense* strains. By contrast, *T. c. congolense* strains appear to be more susceptible to diminazene than are *T. v. vivax* strains. It is likely that the initial appearance of homidium-resistant *T. c. congolense* strains and diminazene-resistant *T. v. vivax* strains can be connected directly with the varying intrinsic sensitivity of these species of a given drug. Some of this variation in drug sensitivity may also be the result of persistent cross-resistance induced by quinapyramine, which was extensively used for therapeutic and chemoprophylactic treatment before homidium became the drug of choice. Differences in drug sensitivity of stocks of the subgenus *Trypanozoon* have also been

reported. In an *in vivo* assay designed to minimize the influence of host-parasite interactions using X-irradiated trypanosomes, it was demonstrated that isoenzymically defined West African *T. b. brucei* stocks were not as sensitive to pentamidine and diminazene as typical East African stocks. This test sought to measure the intrinsic sensitivity of a trypanosome population by reducing the influence of extrinsic determinants of drug sensitivity, in particular trypanosome "penetration" of tissues inaccessible to drugs and host antibody-mediated relapses of parasitemia.

Problems involved in using inappropriate *in vivo* models for testing drug sensitivity may be overcome by culturing trypanosomes *in vitro*, allowing precise detection of intrinsic sensitivity of all stages in the life cycle of trypanosomes. The use of simple *in vitro* assays using feeder layer-free *in vitro* systems may help to obtain rapid information on the susceptibility of isolated trypanosome strains to the drug concerned. However, based upon the ability of these assays to predict potential drug efficacy *in vivo*, not all fresh isolates or clones of trypanosomes can be grown in feeder layer free systems. Thus, a combined mammalian feeder layer-trypanosome culture system may make it possible to determine different effects of a compound on host cells (general toxicity) versus parasites (selective toxicity). Calcium antagonists of several chemical classes including verapamil, cyproheptidine, desipramine and chlorpromazine, alone and in combination with various trypanocidal drugs (suramin, diminazene and others), were unable to reverse resistance in *T. evansi* to any of the trypanocides tested *in vitro*. These results are in contrast with those occurring in *T. cruzi*, *Plasmodium*, *Leishmania* and cancer cells, in which calcium antagonists have successfully reversed resistance.

### Use of Drugs in the Field to Control Cattle Trypanosomiasis

Current limitations on drug efficacy are due to the occurrence of trypanosomes showing multiple drug tolerance to several drugs with close chemical relationship. This has been true also for a *T. v. vivax* strains first reported from Kenya in 1985. Thus a "cocktail" of 11 *T. v. vivax* isolates has proved resistant to all drugs on the market, e.g., to isometamidium chloride (2 mg/kg b.w.), diminazene aceturate (3.5 mg/kg b.w.), homidium chloride (2 mg/kg b.w.), and quinapyramine sulfate (5 mg/kg b.w.). This finding appears to have implications of considerable importance to East African cattle producers. The ability of *T. v. vivax* to cause a hemorrhagic syndrome has also been discussed. Hemorrhages apparently do not occur in all cases and not in all stages of the disease. This

form of trypanosomiasis can be acute or peracute and is responsible for severe losses in unprotected stock.

The main problem in chemotherapy and chemoprophylaxis is to control the widespread cross-resistance in trypanosomes to the few drugs on the market (Table 1). Resistance to a drug, which has developed as a result of previous exposure of trypanosomes to a different drug of the same series or to a drug of an unrelated series can only be effectively controlled by using drugs that do not induce resistance to each other. If this is the case, then they can be used alternately when resistance to either drug appears in the field. In the early 1960s significant knowledge of cross-resistance patterns was obtained from studies of large numbers of cattle maintained under controlled field condition in East Africa. Insufficient response of trypanosomes to certain prophylactic and curative drugs at recommended doses led to the strategic use of "sanative" pairs of drugs in the field. Such drug pairs include homidium/diminzene and isometamidium/diminzene, which show no cross-resistance although quinapyramine-resistant trypanosomes confer resistance to each of these drugs. Moderate side-resistance may also be present between homidium, and isometamidium, which belong to the same chemical class of phenanthridines. Increased doses of isometamidium (1–2 mg/kg b.w.) may, however, control resistance to homidium.

In curative field programs homidium may be used until evidence of resistance appears. It should then be replaced by diminzene, which generally controls infections in cattle reinfected with homidium-resistant parasites. Homidium may be used again after a year or so. Isometamidium and diminzene may be used alternately in prophylactic field programs. However, the appearance of drug-tolerant strains is believed to be inevitable in these programs, particularly in high-risk areas where isometamidium chloride is used at the standard dose of 1 mg/kg b.w. every 3 months. This dose may protect cattle against trypanosomiasis for 6–12 weeks if tsetse fly challenge is not too high. Higher dose levels can cause local reactions, a problem, which is common to all prophylactic drugs currently used (for comments see Table 1).

Control of the disease has been maintained when quarterly prophylactic injections with isometamidium were supplemented by block treatment with diminzene at regular intervals, i.e., every 6 months, 1 month prior to routine treatment with isometamidium. "Sanative" diminzene will not control the situation if the challenge becomes too high as a result of increasing rates of reinfection with resistant trypanosomes. *T. v. vivax* and *T. c. congolense* strains, which survive isometamidium doses of 1 mg/kg b.w. and are cross-resistant to homidium can be controlled, however, by

repeated administration of diminzene acetate at a dose of 7 mg/kg b.w.

Field observations on the **stability of drug-resistance** in trypanosomes undergoing cyclical transmission are contradictory. Some observations suggest that drug resistance is stable and transmissible, while other investigators have assumed that drug-resistance in a trypanosome population is transient in the absence of drug pressure and infected cattle. In a series of experiments drug tolerance to curative doses of trypanocides was shown to be of stable nature, while *T. v. vivax* and *T. c. congolense* were transmitted through tsetse and cattle. However, it was assumed, that in the field competition between resistant and sensitive parasites in the trypanosome population might lead to an advantage for sensitive forms resulting in a gradual disappearance of drug-resistant parasites.

### Pharmacokinetics of Trypanocides and Chemical Residues in Edible Tissues and Milk

There has been increasing public health concern about the consumption of trypanocidal drug residues in foods. A survey conducted recently in central Kenya has shown significant quantities of trypanocides in cattle meat from various slaughterhouses. Previously, the phenanthridines (Table 1) **isometamidium** (for MRLs see Table 1) and quinapyramine have been believed generally to maintain trypanocidal blood concentrations for longer periods than diminzene. This led to the assumption that storage in and release from deep compartment are due to a process different from that occurring with diminzene. Thus, diminzene has been found to have only a limited prophylactic effect, and patent parasitemia has often been detected 2 weeks after treatment. This indicates that diminzene may be rapidly removed from bloodstream if given as the readily water-soluble acetate. In contrast, the virtually water-insoluble diminzene dihydrochloride (or embonate) yielded in rats a fairly long protection period of 56–70 days at subcutaneous doses of  $1 \times 16.5$  and  $1 \times 33$  mg/kg b.w. against a high challenge of *T. b. rhodesiense* and *T. b. gambiense*. It was also demonstrated that diminzene diacetate was "rapidly" removed from the plasma in mice whereas its tissue concentration remained relatively high for several weeks. In rhesus monkey (*Macaca mulatta*) the elimination of diminzene acetate (single intramuscular dose of 20 mg/kg b.w.) occurred in two phases with half-lives of 2.1–2.7 hours and 15.5–23.3 hours; the protection period against a high challenge of *T. b. rhodesiense* was 21 days. Similar biphasic elimination of the drug was observed in rabbits after intramuscular injection of 3.5 mg/kg b.w. Seven days after treatment 40–50% of the dose had been excreted

in the urine and 8–20% in the feces; the highest diminazene residues were found in the liver and corresponded to 35–50% of the dose given.

Pharmacokinetic studies in cattle provided further evidence for the validity of a two-compartment model in the case of diminazene; there were a biphasic profile and two phases of distribution. Pharmacokinetic properties of **diminazene diacetate** [bisphenyl- $U^{14}C$ ] (3.5 mg/kg b.w. i.m.) were investigated in healthy calves. Levels of radioactivity were determined in the blood, plasma, urine, feces, and edible tissues. There was a rapid onset of absorption, which led to high blood, and plasma levels (4.6 nEq/ml). The decrease in concentration followed a biphasic process with half-lives of 2 and 188 h; 20 days after administration 72.2% and 10.3% of the dose had been excreted in the urine and feces, respectively. The main product in urine was unchanged diminazene. Radioactivity could be detected in blood and plasma for up to 20 days after administration. Distribution studies revealed low concentrations in edible tissues, particularly in skeletal muscle and fat. From these results it was concluded that diminazene is not as rapidly and entirely metabolized (or biotransformed) in the body as suggested previously. Following the results a preslaughter withdrawal time of 21 days for all edible tissues (also liver) was recommended for cattle. A similar long preslaughter withdrawal period (14–20 days) was estimated for sheep after a single intramuscular dose of diminazene 3.5 mg/kg. Drug concentrations were determined in plasma and equilibrium dialysis and high-performance liquid chromatography. As expected, dairy goats that had received two successive intramuscular doses of diminazene acetate 2 and 3.5 mg/kg b.w. showed somewhat different pharmacokinetics from those that received a single injection. The estimated preslaughter withdrawal period was between 28 and 35 days. Dairy cows repeatedly infected with different strains of *T. congolense* and treated with different dose of radiolabelled diminazene acetate have been investigated for dependence of drug residue levels in milk. Results of this study indicate that the degree of parasitemia (anemia) affects the distribution, disposition, and elimination of diminazene. At 3.5 mg/kg b.w. 0.4% of the dose was excreted in milk after 21 days, while 0.54% of the 7 mg/kg b.w. dose was excreted during the same time. On the basis of data of half-lives for the second phase (elimination phase) milk from treated animals should not be consumed for at least 3 weeks posttreatment. In rabbits treated with a single intramuscular dose of [ $^{14}C$ ] **homidium** bromide 1 or 10 mg/kg b.w. blood and tissue levels reached a maximum within 1 h then fell rapidly. After 4 days 80%–90% of the radioactivity injected had been excreted, 33% in the urine and 66% in the feces. In

view of the rapid rate of drug excretion it was assumed that the time and level of infection relative to the time of drug administration might markedly affect the protective action of ethidium. Some doubt must therefore remain about the value of this drug for the prophylactic treatment of slaughter cattle as recommended previously.

### Changes in the Field of Animal Trypanosomiasis over the Past 40 Years

Based on a review of the literature with special reference to control of animal trypanosomiasis in Africa, the conclusion was that each of the control methods in use has serious limitations. This appears to be true also for the present situation. Today and in the past, the effectiveness of chemoprophylaxis and chemotherapy has been reduced markedly by the widespread development of drug resistance. The enormous cost involved in research on and development of new drugs, which industry has to consider, have meant that very little research on potential trypanocides has been done. Thus, 30 years ago some pharmaceutical companies were still involved in research on the chemotherapy of trypanosomiasis, despite the financial considerations of the relatively small market and uncertain financial returns. Economic and ecological constraints on trypanosomiasis control are still evident, and the high cost involved in a continuing program of eradication of tsetse flies, or even of isolated tsetse-belts, is often beyond the reach of individual countries. Furthermore, tsetse fly clearance remains an unreliable control measure when continued surveillance is not guaranteed, and tsetse fly eradication will not necessarily result in the eradication of trypanosomiasis since *T. v. vivax* and *T. b. evansi* can cause infections without cyclical transmission and can be spread mechanically by biting dipterans. On the other hand, attempts to eradicate tsetse flies by chemical control, e.g., by massive aerial insecticide spraying, are always associated with considerable adverse effects on environment.

Biological and genetic control methods are still at an early stage of development (as 30 years ago) and control of trypanosomiasis by immunological tools will only be achievable on a long-term basis. It seems likely that research into the response of trypanotolerant cattle will be of special value although host-parasite relationships and thus, trypanotolerance are still poorly understood. All these limitations would be less important if the present control measures were used in an integrated control program; the importance of international cooperation in combating trypanosomiasis should be stressed. However, the problems encountered in the organization of control programs

differ greatly according to whether the method of control is directed against the parasite or the vector tsetse fly. Campaigns directed against the vector are much more a matter of straightforward organization, logistics, and cost (e.g., considerations of the economic return from development after tsetse fly eradication) than are those which involve the attack of infections of the vertebrate host using curative or prophylactic drugs. Perhaps the most valuable use of trypanocidal drugs is in the development of cattle rearing and production in areas where tsetse fly eradication cannot be achieved in the near future. In such areas, conditions can gradually be created under which operations against tsetse flies may be undertaken. Thus, attention must be drawn to one of the chief remaining constraints on the improvement and multiplication of trypanotolerant livestock, i.e., the relatively low reproductive performances of certain cattle breeds under traditional management systems.

## Trypanocidal Drugs, Man

Table 1 (pages 1500, 1501).

### Drugs Acting on African Trypanosomiasis (Sleeping Sickness) of Humans

In humans, *Trypanosoma brucei gambiense* and *T. b. rhodesiense* cause →African trypanosomiasis (→Sleeping Sickness); the disease is transmitted by the bite of infected →tsetse flies (→*Glossina* spp.). These two subspecies are morphologically indistinguishable but differ in their pathogenicity and thus disease pattern. In animals, *T. b. brucei* and other →*Trypanosoma* spp. cause the disease →'nagana' (→Trypanocidal Drugs, Animals). *T. b. gambiense* infection is widespread in West and Central Africa whereas *T. b. rhodesiense* is restricted to the East and East Central areas with some overlaps between both species. In 37 countries of sub-Saharan Africa, 22 of which are among the least developed countries in the world, more than 55 million people are at risk of African trypanosomiasis.

Differences in host specificity are due to a non-immune killing factor (trypanosome lytic factor = TLF) in human serum causing lysis of *T. b. brucei* *in vitro* and *in vivo*. African sleeping sickness trypanosomes are resistant to this factor which is long known and may support chemotherapy. In the bloodstream of infected humans the trypanosomes grow and multiply extracellularly as long slender (LS) forms. After several divisions they transform into first intermediate (I) forms and then nondividing short stumpy (SS) forms, which are infective for tsetse. The latter possess a functional

mitochondrion. **Eflornithine** (DMFO, cf. →Trypanocidal Drugs, Animals/Table 1), interfere with the division process of LS forms and reduce hemolymphatic →trypomastigotes and those in the central nervous system (CNS) (for more information see below and Table 1).

West African trypanosomiasis produced by *T. b. gambiense* is chronic in nature lasting up to 4 years. In the absence of chemotherapy, patients with Gambian infection become progressively more wasted and comatose. Involvement of (CNS) disorders, damage of the heart, and other organs generate the classical picture of sleeping sickness. Disease caused by *T. b. rhodesiense* is more acute and may last rarely longer than 9 months. Without treatment, death often occurs from toxic manifestations before CNS changes are evident. Because Rhodesian form is a zoonotic disease (reservoir animals) treatment of infected humans has less effect on incidence of infection in humans. In contrast, control of Gambian form and hence treatment of infected individuals relies mainly on surveillance of human population and direct field diagnosis by mobile teams. In general, cure rates are higher when infected individuals are treated in the early phase of the disease.

Only four drugs are available which may be used for the treatment of African trypanosomiasis (→Trypanocidal Drugs, Animals/Search for New Drugs). **Suramin** and **pentamidine**, which were discovered in the first two or three decades of last century, are still used for clearing blood and the hemolymphatic system from trypanosomes in the early phase of the disease. The trivalent arsenical **melarsoprol** (Mel B) and eflornithine, which cross the blood-brain barrier, are used for the treatment of later CNS stages of the infection. Melarsoprol is derived from melarsen and its phenylarsenoxide with the melaminyl moiety in the *p*-position. It requires parenteral administration as other standard trypanocides. It may be extremely effective but highly toxic in all advanced CNS cases and need hospitalization and considerable care in its use (→Trypanocidal Drugs, Animals). Melarsoprol exhibits a rapid lethal effect on trypanosomes in the CNS causing the so-called Herxheimer-Jarisch type of reactive encephalopathy in up to 10% of the treated patients with a mortality rate of 3-10%. Recent data on clinical pharmacokinetics led to an alternative regimen of melarsoprol, which could reduce its toxicity. The only "new" drug developed for the treatment of sleeping sickness is **eflornithine** (DL- $\alpha$ -difluoromethylornithine = DMFO, Ornidyl, cf. →Trypanocidal Drugs, Animals/Search for New Drugs). In *T. b. brucei* →polyamines are synthesized from →ornithine, and DMFO is a highly inhibitor of ornithine decarboxylase (ODC), which catalyzes the decarboxylation of ornithine to yield putrescine and then spermidine. Polyamines play an important role in →cell division

**Trypanocidal Drugs, Man. Table 1** Drugs used against trypanosome infection of humans

AFRICAN TRYPANOSOMIASIS (SLEEPING SICKNESS)				
epidemic/endemic in a belt across central Africa south of the Sahara Desert and transmitted by the bite of infected tsetse flies ( <i>Glossina</i> spp.); in tsetse, trypomastigotes transform into epimastigotes, which divide during a complicated migration in the fly and then transform into metacyclic trypomastigotes infective for humans and reservoir animals ( <i>T. b. rhodesiense</i> ); <b>chemotherapy</b> in patients with CNS involvement (sleeping sickness) is generally problematic because of many undesired side effects caused by arsenical drugs such as melarsoprol; corticosteroids have been used to prevent reactive arsenical encephalopathy (encephalopathic syndrome), which can be fatal (3–10%); an increase of resistance to the drug has been observed in several foci particularly in central Africa (~20% of patients with <i>T. b. gambiense</i> fail to respond to melarsoprol); the type of treatment depends on the stage of the disease; drugs used in the hemolymphatic or first stage of the disease are less toxic, easier to administer and more effective than arsenicals; drugs that can cross the blood–brain barrier to reach the parasite (second stage treatment) are quite toxic and complicated to administer; <b>four drugs</b> are registered for the treatment of sleeping sickness and provided free charge to endemic countries through a WHO private partnership with Sanofi-Aventis, Specia (pentamidine: also Fujisawa, melarsoprol and eflornithine) and Bayer AG (suramin); for treatment of <i>T. b. gambiense</i> , pentamidine and suramin have equal efficacy but pentamidine is better tolerated				
PARASITE; DISEASE distribution	Stages affected (location comments)	Chemical class other information	Nonproprietary name adult/*pediatric dosage, routes	Toxic effects other information
<i>T. brucei gambiense</i> <b>hemolymphatic (first) stage</b> (West and central Africa, probably only human reservoir)	<b>trypomastigote</b> Gambian disease (chronic with low parasitemias; incubation time: months to years)	<b>aromatic diamidines</b> (does not pass bloodbrain barrier); pentamidine (Pentam, others) was discovered in 1949	<b>pentamidine</b> isethionate drug of choice regimen for adults and children: 4 mg/kg/d i.m. × 10d <i>alternative: suramin:</i> adult/*pediatric dosages: cf. <i>T. brucei rhodesiense</i> ↓	contraindication: diabetes; drug can induce pancreatitis, hypo- or hyper-glycemia, sharp fall in blood pressure after i.v. injection; renal dysfunction is reversible; abortion and peripheral neuritis (rare)
<i>T. brucei rhodesiense</i> <b>hemolymphatic (first) stage</b> (East Africa, zoonotic infection, reservoir hosts: antelope, hartebeest, cattle, lion, hyena and others)	<b>trypomastigote</b> Rhodesian form (acute with high parasitemias; incubation time: days to weeks)	<b>sulfated naphthylamines</b> (anionic urea compound) does not pass blood-brain barrier; high protein binding activity; suramin (Germanin, others) was discovered in 1921	<b>suramin</b> (drug of choice) regimen for adults children: *20 mg/kg on days 1, 3, 7, 14 and 21; 100–200 mg (test dose) i.v., then 1 g i.v. on days 1, 3, 7, 14 and 21	side effects may be shock, loss of consciousness (rare), urticaria, colic, heavy proteinuria, severe toxic (degenerative) effects on kidney (withdrawal of drug!), peripheral neuropathy as paresthesia, hypoesthesia, agranulocytosis and hemolytic anemia (rare)
<i>T. brucei gambiense</i> <b>Late disease with CNS involvement</b> (West and central Africa, probably only human reservoir)	<b>trypomastigote</b> Gambian disease (chronic with low parasitemias; incubation time: months to years; parasites cross blood- brain barrier and may be found in cerebrospinal fluid causing severe inflammation reactions)	<b>melaminophenyl arsenicals</b> (trivalent cationic compound) melarsoprol (Mel-B) was discovered in 1949 (it pass blood-brain barrier) <b>substituted amino acid:</b> eflornithine was registered in 1990; it is only effective against <i>T. brucei gambiense</i> ; the regimen is strict and difficult to apply	<b>melarsoprol</b> regimen for adults and children: 2.2 mg/kg/d i. v. × 10d; pre-treatment with <i>suramin</i> in debilitated patients; in frail patients increase the dose progressively (initial dose is as little as 18 mg) <b>eflornithine</b> regimen for adults and children: 400 mg/kg/d i.v. in 4 doses × 14d; it is an alternative to Mel-B treatment	most serious side effect of <b>melarsoprol</b> is reactive encephalopathy (cf. text of table ↑, hospital supervision is necessary), other adverse effects may be: fever, joint pain, renal damage, myocarditis, peripheral neuropathy, gastrointestinal disturbance, hypersensitivity or hypertension; <b>eflornithine</b> is less toxic than Mel-B and highly effective against <i>T. brucei gambiense</i> ; side effects see ↓

**Trypanocidal Drugs, Man. Table 1** Drugs used against trypanosome infection of humans (Continued)

PARASITE; DISEASE distribution	Stages affected (location comments)	Chemical class other information	Nonproprietary name adult/*pediatric dosage, routes	Toxic effects other information
<i>T. brucei rhodesiense</i> <b>Late disease with CNS involvement</b> (East Africa, zoonotic infection, reservoir hosts: antelope, hartebeest, cattle, lion, hyena and others)	<b>trypomastigote</b> Rhodesian form (acute with high parasitemias; incubation time: days to weeks; parasites cross blood-brain barrier and may be found in cerebrospinal fluid causing severe inflammation reactions)	<b>melaminophenyl arsenicals</b> (trivalent cationic compound) for other information see text ↑	<b>melarsoprol</b> regimen for adults and children: 2-3.6 mg/kg/d i.v. × 3; after 7d 3.6 mg/kg/d i.v. × 3d; repeat again after 7d; in frail patients: begin with 18 mg and increase the dose progressively; <i>suramin</i> pre-treatment in debilitated patients	<b>eflornithine</b> is not effective against <i>T. brucei rhodesiense</i> infections; in patients with Gambian disease it may cause frequent anemia and leukopenia, occasionally thrombocytopenia, seizure, diarrhea, hair loss (rare)
<b>AMERICAN TRYPANOSOMIASIS (CHAGAS' DISEASE):</b> zoonosis with an extensive mammalian reservoir (armadillos and opossums, some domestic animals and humans) is endemic in Central and South America, being found only in the American Hemisphere. <i>T. cruzi</i> may be transmitted to humans in two ways, either by blood-sucking infected reduviid, or directly by transfusion of infected blood (iatrogenic transmission); the vector bugs infest poor housing and thatched roofs; acute phase of disease is seen in children with and without acute clinical manifestations (all patients must be treated with a trypanocidal drug); lesions of chronic phase irreversibly affects internal organs such as heart, esophagus, colon and peripheral nervous system (treatment is indicated in recent chronic infection of children); chronic cases with established pathology appear to be unable to benefit from long-term treatment (~60–90 days: hospitalization or careful monitoring may be needed); <i>T. rangeli</i> differs from <i>T. cruzi</i> by longer and better developed undulating membrane, and small subterminal kinetoplast; <i>T. rangeli</i> (appears to be non-pathogenic to man; only (T) forms in blood of humans, resemble <i>T. cruzi</i>				
<i>Trypanosoma cruzi</i> <b>PRECAUTIONS</b> neither benznidazole nor nifurtimox should be given to pregnant women; in patients with illnesses associated with Chagas disease potential risk of severe adverse effects should be considered carefully dividing (A) forms produce pseudocysts; daughter (A) transform back to (T); these enter blood and may then reinvade various muscular tissue	<b>trypomastigotes</b> (=T), <b>amastigotes</b> (=A) (T) in blood and (A) in: cardiac muscle, smooth muscle of gut, skeletal muscle	<b>2-nitroimidazoles</b> (drug of choice in Brazil because of fewer drug-tolerant strains than elsewhere), mode of action may be interactions of its metabolites with DNA	<b>benznidazole</b> Rochagan (Roche Brazil) (drug of choice, 5–7 mg/kg/d in 2 divided doses orally × 30–90d * ≤12years: 10 mg/kg/d orally in 2 doses × 30–90d	side effects common: immediate and frequent hypersensitivity reactions (rashes in 30% of treated patients), bone marrow suppression, psychic and GI disturbances, peripheral polyneuritis, leucopenia, agranulocytosis (rare); side effects can lead to interruption of treatment
		<b>nitrofurans derivatives</b> (no longer readily available) addition of $\gamma$ -interferon for 20 days may shortened acute phase of disease (RE McCabe et al., J Infect Dis 163: 912, 1991) mode of action may be production of free oxygen radicals enhancing oxidative stress on (T) + (A)	<b>nifurtimox</b> Lampit (Bayer) (alternative drug, 8–10 mg/kg/d orally in 3–4 doses × 90–120d * 1–10 years: 15–20 mg/kg/d orally in 4 doses × 90d * 11–16 years: 12.5–15 mg/kg/d orally in 4 divided doses × 90d)	side effects common (50 %): gastrointestinal complaints as anorexia, nausea, vomiting; vertigo insomnia, headache, peripheral neuritis, myalgia, arthralgia; neurological reactions: excitability; rare: convulsion, rashes, pulmonary infiltrates and pleural effusion; side effects can lead to interruption of treatment

Abbreviations: d = days; mg/kg = mg/kg body weight; i.m. = intramuscularly; i.v. = intravenously

Dosages and other information refer to data from The Medical Letter, Drugs for Parasitic Infections, 46 (1189), August 16, 2004, literature, and WHO websites (publications/medicines, and others)

Data cited in the table have no claim to full information



and differentiation of eukariotic cells. Depletion of putrescine (and thus spermidine) leads to inhibition of the transformation of the LS form to the SS form and therefore to inhibition of trypanosome growth. When administered in drinking water, DMFO selectively blocks multiplication of the parasites and eliminates the infection. It was shown to have activity against CNS *T. b. brucei* infections in rodents, and has proved to be an effective treatment for late stage infections of *T. b. gambiense* in humans, even in arsenical-refractory CNS patients. Although eflornithine is highly active against Gambian trypanosomiasis its use may be limited (available via WHO). Clinical trials with the drug have been performed and are going on to evaluate its trypanocidal efficacy and systemic toxicity in patients with Gambian sleeping sickness. Dosage regimen, which had successfully been used, was 400 mg/kg/day intravenously in 4 divided doses for 14 days, followed by oral treatment with 300 mg/kg/day for 3–4 weeks. The drug may have some “minor” drawbacks such as variable activity against *T. b. rhodesiense* infections and the need for high parenteral doses in late cases which makes treatment management questionably. A combination of DMFO and suramin has been on trial for the treatment of CNS involved Rhodesian infections.

The current regimen for the treatment of early *T. b. rhodesiense* and *T. b. gambiense* infections is **suramin** or pentamidine. In late stage Rhodesian infections, patients are treated first with suramin to clear the blood and lymph from parasites and then with multiple injections of **melarsoprol**. **Pentamidine** isethionate is the drug of choice for the treatment of early (primary) *T. b. gambiense* infection. It may also be used in late (secondary) stage patients with CNS involvement to eliminate hemolymphatic trypanosomes prior to administration of melarsoprol (for route and dosage cf. see [Table 1](#)). In addition, it had been used in prevention and control projects (FAO/WHO initiative initiated in 1993, or PAAT = program against African trypanosomiasis) in epidemic/endemic regions of Angola, Cameroon, Central African Republic, Congo, Gabon, Equatorial Guinea, Uganda, Sudan, Chad and Zaire.

Retrospective long-term study with the diamidine, **diminazene** aceturate (Berenil, Intervet), by follow-up of 99 human patients with early-stage disease of sleeping sickness showed that there was satisfactory efficacy after the parenteral route, and side effects were no more serious than those produced by suramin. However, the drug exhibits reduced activity after oral administration because its extensive hydrolysis in stomach results in two metabolites: one is 4-amidino-phenyl-diazonium chloride, which exerts distinct trypanocidal activity, the other is 4-aminobenzamidine dihydrochloride, which proves ineffective against *T. b. brucei*.

## Drug Acting on American Trypanosomiasis (Chagas Disease) of Humans

*Trypanosoma cruzi* is the causative agent of →Chagas' disease (→American Trypanosomiasis) and occurs only in the Western Hemisphere from the Central American countries in the North to the Andean countries and Southern Cone countries in the South. Uruguay was certified free of vectorial and transfusional transmission of Chagas disease in 1997 (WHO, CTD homepage January 1999). The disease affects 16–18 million people and some 100 million, i.e., about 25% of the population of Latin America is at risk of acquiring Chagas disease. Rural migration to urban areas changed the traditional epidemiological pattern of Chagas disease; it became an urban disease, as unscreened blood transfusion created a second way of transmission. *T. cruzi* is primarily an intracellular parasite (amastigote stages) occurring as →pseudocysts in cardiac and smooth muscle cells, glial cells of the brain, and mononuclear phagocytes. However, immediately after the infection of the host by the reduviid bug (various species *Rhodnius*, *Triatoma*, *Panstrongylus*) first trypomastigote stages circulate in the bloodstream. During this early phase of infection, which may last up to 60 days, trypomastigote forms can be detected by direct examination of peripheral blood (by wet smear or after staining) along with the detection of IgM anti-*T. cruzi* antibodies. All patients suffering from acute Chagas disease must be treated since cure rate (checked by parasitological and serological assays) in the acute phase of infection may be 50–60% only. Positive serological reactions in children 6 months after birth are indicative of congenital transmission and →xenodiagnosis or hemoculture may corroborate the serological finding; specific treatment should be started immediately. Treatment is indicated in recent →chronic infections, especially in all children with positive serological reactions whose infection occurred a few years (<10) ago. Patients (selected cases) with the indeterminate form, slight cardiac form and digestive form may be treated as well. To assure the free passage of the chemotherapeutic drug and its absorption, symptomatic treatment of dysphagia is recommended in cases with megaesophagus. However, it is not clear whether etiological intervention will stop the progression of the disease in chronic patients. Operational problems should be envisaged in the majority of chronic infections because long-term treatment demands thorough and proper follow-up of adverse effects caused by chemotherapy. Reactivation of Chagas disease may occur in immunosuppressed patients (e.g., HIV infection, →AIDS related infections, or any organ transplantation) but clinical manifestations usually differ from those of the acute phase. For this reason, adequate monitoring of a potential *T. cruzi* infection should be done. In cases where parasitological reactivation is

evident, chemotherapy should be envisaged though the risk of severe side effects may increase, or →[chemo-prophylaxis](#) has been suggested for these patients.

Current treatment is based on the nitrofurans, **nifurtimox** (no longer readily available), and the 2-nitroimidazole, **benznidazole**. Both drugs are administered orally for prolonged time (dosage and side effects cf. [Table 1](#)). Successful treatment requires either hospitalization or careful monitoring of the patient. There may be marked variation in the drug response of different *T. cruzi* strains. Therefore, in the acute phase of infection, cure rates with both drugs are not total and vary regionally. There is limited or no action of both drugs on the chronic phase of the disease. However chemotherapy is essential in immunocompromised patients showing meningo-encephalitis.

**Allopurinol** (structural analogue of hypoxanthine), a drug used to decrease the excessive amounts of uric acid in the blood caused by gout and other metabolic disorders, may be a low cost, non-toxic alternative for treatment of *T. cruzi* infection. However, results from clinical trials indicate some doubt of its efficacy. The drug is taken up by the →[purine salvage](#) pathway and prevents formation of ATP and also interferes with nucleic acid synthesis (→[Leishmania](#) spp. cf. →[Leishmaniacidal Drugs/Table 1](#)).

Sterol biosynthesis inhibitors such as the antifungal azoles, **ketoconazole** and **itraconazole** and the more recently investigated D0870, the *R* (+) enantiomer of ICI 195,735 continue to be potential chemotherapeutic agents against Chaga's disease, especially at the chronic stage. However, previous studies in humans have failed to corroborate the action of ketoconazole on *T. cruzi* reported from animal models (for information on chemotherapy including regimen and adverse effects of current drugs see [Table 1](#)).

For the control of vector-transmitted infection through triatomid →[bugs](#) (popular names: "vinchuca," "barbeiro," "chipo," and others) the objective is to interrupt transmission of *T. cruzi* by insecticide spraying, insecticidal paints, fumigant canisters, housing improvement and →[health education](#) in rural and suburban areas. The basic strategy includes house spraying with modern pyrethroids followed by long-term, community-based surveillance designed to report any "residual" infestation that then can be selectively treated. For the control of blood-transmitted infections the goal is to screen all blood donors from endemic countries for *T. cruzi* antibodies (including HIV and hepatitis B). **Gentian violet** (Aksuris, Oxiuran, Viocid) toxic and mutagenic to mammals is still used as a disinfectant against *T. cruzi* in blood samples of potential infected donors. In blood banks of urban areas, transmission of *T. cruzi* by blood transfusion remains a major problem.

---

## Trypanoplasma

### Name

Greek: *trypanon* = piercing structure, *plasma* = formed structure.

### Classification

Genus of →[Kinetoplastida](#).

### Life Cycle

[Fig. 1](#) (page 1504).

### Disease

→[Trypanoplasmosis of Fish](#).

---

## Trypanoplasmosis of Fish

This disease occurs due to infections with host-specific parasites (e.g., *Trypanoplasma borelli* of the red-feather – white fish, *T. cyprini* of carps, *T. salmositica* of salmon). Some species were formerly placed in the genus *Cryptobia*, the species of which are now restricted to snails (e.g., *Helix pomatia*). The biflagellated blood stages may be slender ([Fig. 1](#), page 1505) reaching a length of 15 µm or appear polymorphous-stumpy with diameters of up to 20 µm ([Fig. 2](#), page 1505). They are transmitted by leeches, e.g., →[Piscicola](#) spp. **Symptoms of disease:** apathy, non-feeding, loss of weight, and often death (especially in juvenile fish); often the eyes of infected fish are sunken in the eye hollows.

### Therapy

Medical bath for ornamental fish with Flagellol of Alpha-Biocare, Düsseldorf.

---

## Trypanorhyncha

Within the class Cestoda, besides the Cyclophyllidea, most other orders are fish parasites. Many primitive cestodes such as the Diphyllidea and Tetrphyllidea are marine group of tapeworms and are common parasites in the spiral valve of elasmobranchs. Of these, the order

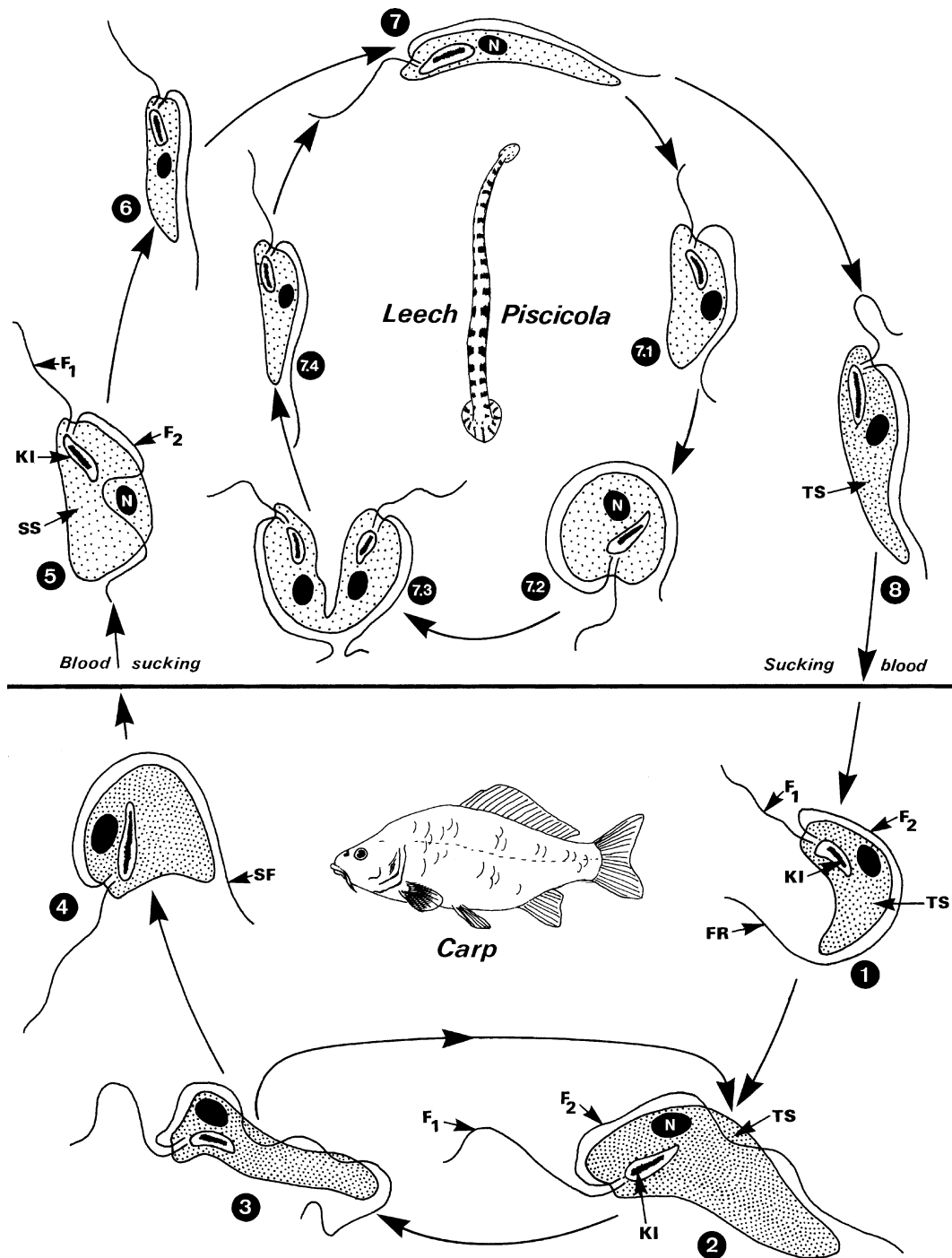

**Trypanoplasma.** Figure 1 Life cycle of *Trypanoplasma* sp. in fish (carp) and vector leech (*Piscicola geometra*). 1 Transformed metacyclic stages with a long free end of the recurrent flagellum ( $F_2$ ) and a thick surface coat (TH) occur in the blood after inoculation by the leech. 2–4 During binary fission stumpy forms finally appear, whose recurrent flagellum (SF) has a short end. These forms (4) are mainly found in the bloodstream when fish are kept in cold water, and may infect leeches during a blood meal. 5–7 Developmental stages inside the pharynx, esophagus, and upper intestine of the vector have a reduced surface coat (SS). The slender forms (7, 8) are attached to the intestinal wall. The stumpy forms (7.1–7.4) are seen free inside the blood masses and may recolonize the intestine after each sucking phase. 8 Metacyclic stages with a thicker surface coat (TS) are found in the anterior parts of the intestine and are injected into fish during blood meal of the vector.  $F_1$ , free flagellum;  $F_2$ , recurrent flagellum; FR, long free end of recurrent flagellum; KI, kinetoplast; N, nucleus; SJ, short free end of recurrent flagellum; SS, slight surface coat; TS, thick surface coat.

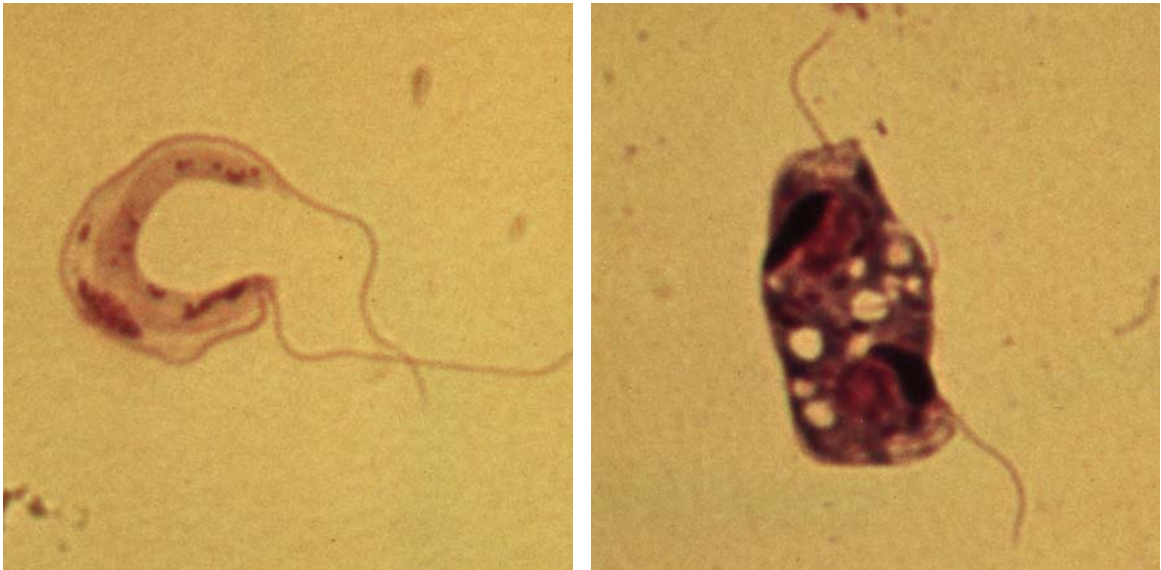

**Trypanoplasmosis of Fish. Figures 1, 2** Giemsa-stained blood smears showing 2 typical biflagellated stages (one is in division, Fig. 2).

Trypanorhyncha Diesing, 1863 is among the most species-rich. More than 260 valid species have been described, and new species are added every year. They infest the stomach and intestine of sharks and rays (Elasmobranchii) as final hosts. Therefore, they have a cosmopolitan distribution and, in accordance to the species-richness of their final hosts, they belong to the most abundant fish parasites in tropical waters. The larval stages live in various organs of teleost fish and also in marine invertebrates, such as crustaceans, cephalopods, and bivalves. Some larvae have been recorded even from sea turtles, sea snakes, and also from the living fossil *Latimeria chalumnae*.

Trypanorhynchs have complex, indirect life cycles and can be found in all tropic levels of the marine food web. Two main groups of trypanorhynchs can be identified. The mainly ray parasitic eutetrarhynchoids develop non-operculated eggs (oncosphere) with an enclosed embryo that is freed from the eggshell when eaten by a copepod first intermediate host. It develops into the proceroid in the first and into a plerocercus inside invertebrates as second intermediate hosts. For example, *Prochristianella hispida* lives in the spiral valve of dasyatid stingrays, such as *Dasyatis sayi*, in the Gulf of Mexico, with the number of parasites increasing with the host fish size. Experimental first intermediate hosts were the harpacticoid copepod *Tigriopus californicus* and *Mesochra* sp., and infective plerocerci were identified in the mud shrimp *Callinectes islagrande*.

The mainly shark parasitic lacistorhynchoids develop operculated eggs that release a free-swimming coracidium following the eggs' release into seawater. A relatively undifferentiated proceroid develops in

copepods as first intermediate hosts. Second intermediate hosts are teleosts. A low level of host specificity in many species enables them to successfully infest a wide range of different host species worldwide. Experimental infestation of the leopard shark *Triakis semifasciata* was successful with *Lacistorhynchus dollfusi* from the US Californian coast. The eggs released free-swimming coracidia 5 days following the eggs' release into seawater. They are infective for the harpacticoid copepod *Tigriopus californicus*. The proceroid within the haemocoel of the copepod is infective to small teleosts, such as the mosquito fish *Gambusia affinis*. In the body cavity or muscle of its teleost host, the plerocercus is protected within a blastocyst and develops the same scolex morphology as typical for the adult worm. A similar life cycle pattern, however, involving different hosts from the various marine habitats, is assumed especially for those trypanorhynchs that live in mainly pelagic or oceanic environments (Figs. 1, 2, page 1506).

Main distinguishing feature of trypanorhynch cestodes is the characteristic scolex with 2 or 4 bothria and a tentacular apparatus for attachment (Fig. 1). Four evaginable tentacles are connected to tentacle sheaths and bulbs that function hydrostatically. They are adorned with numerous hooks that are arranged in highly complex patterns (Fig. 2) and are adapted to the typical attachment site inside the final host. Both, adults and plerocerci have the same armature pattern along the tentacles, enabling exact identification. Reaching an individual body length from millimeter to meter, the whitish colour, high abundance, and ability to infest the musculature of many commercially

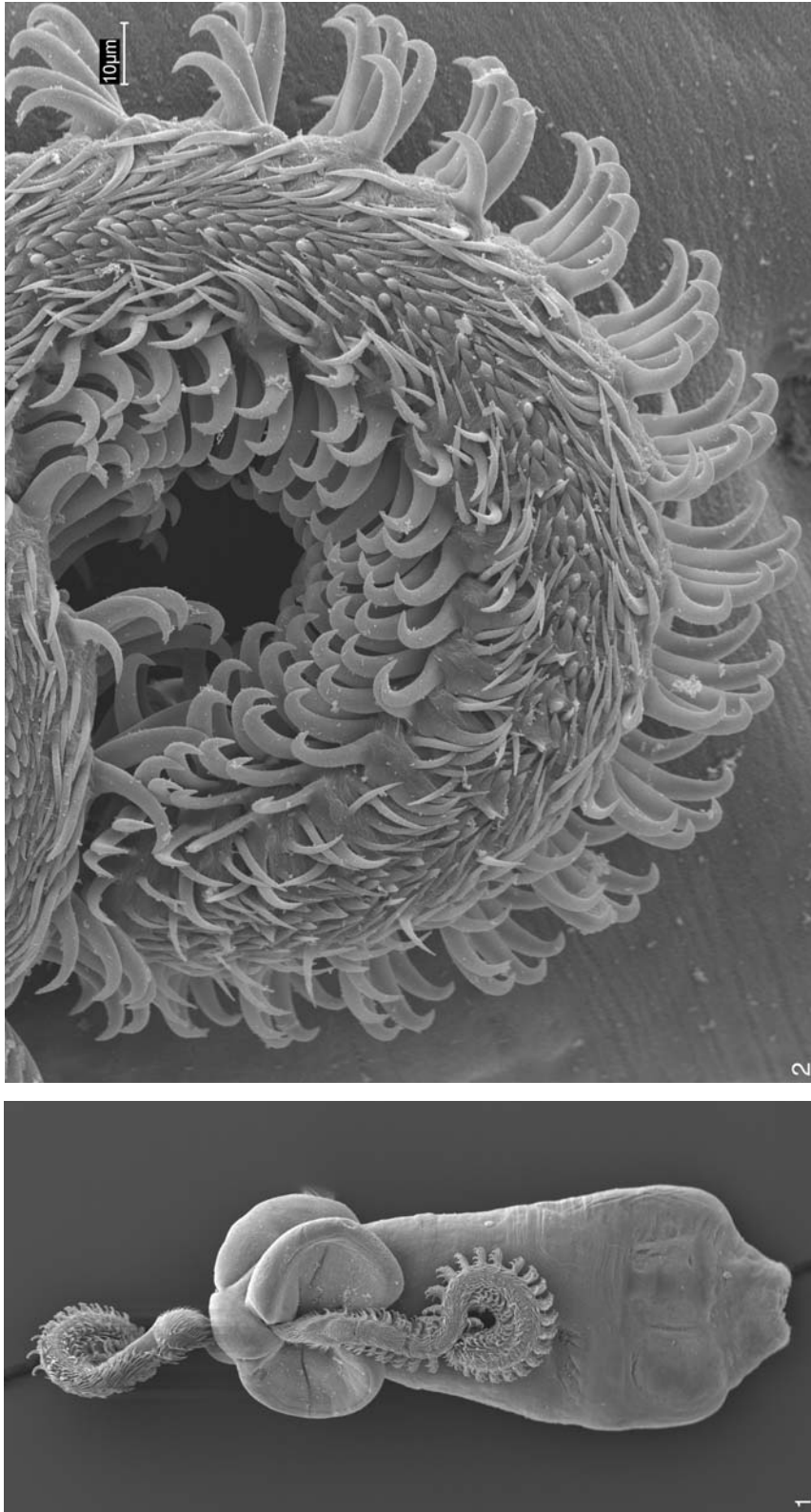

**Trypanorhyncha. Figures 1, 2** The lacistorhynchoid trypanorhynch cestode *Grilloitiella exile* from the tiger shark (*Galeocerdo cuvier*) and the gills of the narrow-barred Spanish mackerel (*Scomberomorus commerson*) as its intermediate host. Scolex (Fig. 1) with 2 bothria and armed tentacles (worm length = 0.8 mm). Tentacular armature (Fig. 2) of *Grilloitiella exile*. Note the heteromorphous hooks that are arranged in a complex pattern. (Photos courtesy of Professor. H. W. Palm, University Düsseldorf).

important fish species make these cestodes an important group for fisheries and the fish processing industry.

## Important Species

Table 1.

## Life Cycle

Figs. 1, 2 (pages 1508, 1509).

## Distribution

Figs. 3, 4 (page 1510).

## Morphology

Figs. 9–13 (pages 1513–1516).

## Fine Structure

Figs. 5–8 (pages 1511–1513).

# Trypanosoma

## Name

Greek: *trypanon* = piercing structure, *soma* = body.

## Classification

Genus of → *Trypanosomatidae*.

**Trypanosoma. Table 1** Important *Trypanosoma* spp. parasitizing humans and domestic animals

Species	Size (µm)	Vertebrate hosts	Disease	Vector	Mode of transmission	Geographic distribution
<b>Salivaria</b>						
<i>Trypanosoma brucei brucei</i>	25–42 <sup>a</sup>	Horses, pigs, cattle, rodents	Nagana	<i>Glossina</i> spp.	Bite	Tropical Africa
<i>T. brucei gambiense</i>	16–31 <sup>a</sup>	<b>Humans</b> , monkeys, dogs, pigs, antelopes, etc.	Sleeping sickness	<i>Glossina</i> spp.	Bite	West Africa
<i>T. brucei rhodesiense</i>	20–30 <sup>a</sup>	<b>Humans</b> , wild game, pigs	Sleeping sickness	<i>Glossina</i> spp.	Bite	East Africa
<i>T. congolense</i>	9–18	Cattle, domestic animals	Bovine trypanosomiasis	<i>Glossina</i> spp.	Bite	Congo, Zululand
<i>T. simiae</i>	12–24	Sheep, goat, pigs, monkeys	Virulent trypanosomiasis	<i>Glossina</i> spp.	Bite	East Africa
<i>T. vivax</i>	20–27	Ruminants, horses	Souma	<i>Glossina</i> spp.	Bite	Tropical Africa
<i>T. evansi</i>	18–34	Ruminants, horses, dogs	Surra	<i>Tabanus</i> spp., <i>Stomoxys</i> spp.	Mechanically during bite	India, Africa, Siberia, Australia, South and Central America
<i>T. equinum</i>	20–30	Horses, cattle, water pigs	Mal de Caderas	<i>Tabanus</i> spp.	Mechanically during bite	South and Central America
<i>T. equiperdum</i>	18–29	Horses	Dourine	–	Mechanically during copulation	Mediterranean countries, India, America
<b>Stercoraria</b>						
<i>T. cruzi</i>	16–20	<b>Humans</b> , domestic and wild animals	Chagas' disease	Reduviid bugs ( <i>Triatoma</i> , <i>Rhodnius</i> )	Contamination by bug feces	South America
<i>T. rangeli</i> <sup>b</sup>	25–32	<b>Humans</b> , rats	Nonpathogenic	Reduviid bugs	Bite, feces?	South America
<i>T. theileri</i>	25–120	Cattle	Nonpathogenic	Tabanids	Feces	Worldwide
<i>T. melophagium</i>	25–70	Sheep	Nonpathogenic	Sheep ked (louse fly)	Feces	Worldwide
<i>T. lewisi</i>	24–35	Rats	Nonpathogenic	Rat flea	Feces	Worldwide

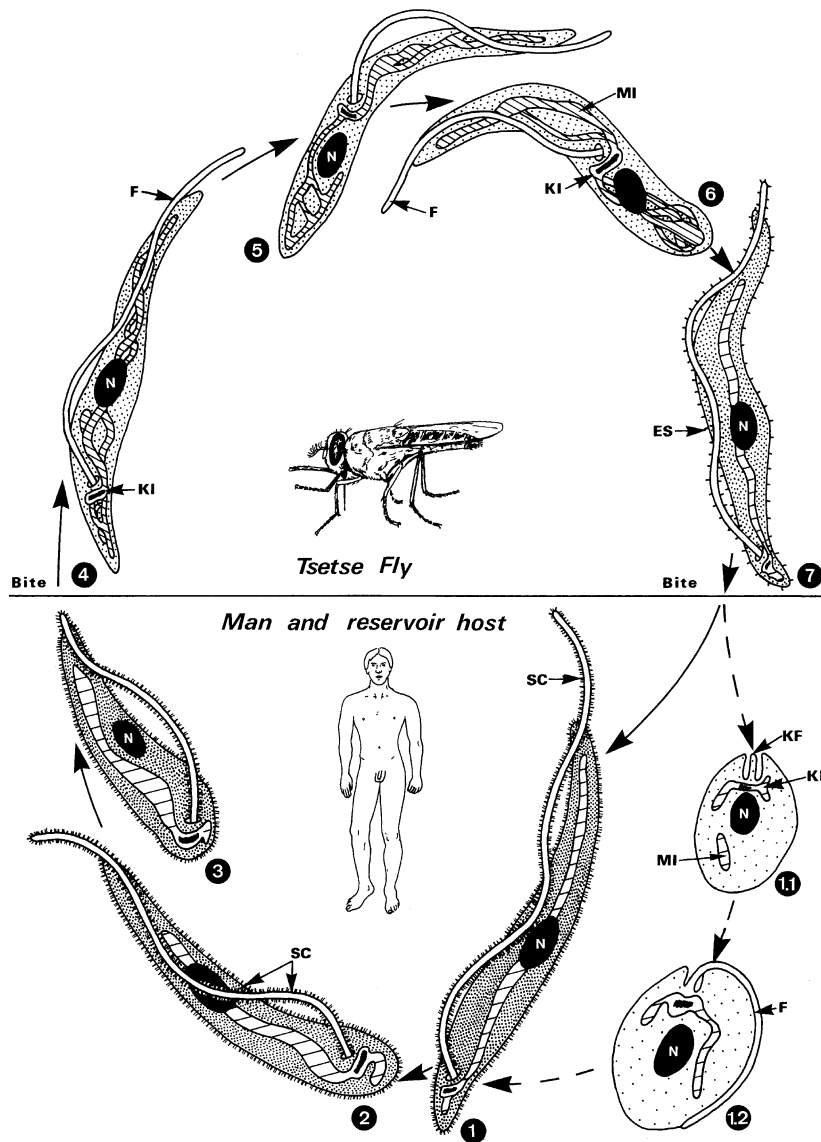

**Trypanosoma.** Figure 1 Life cycles of *Trypanosoma brucei gambiense* and *T. b. rhodesiense*, causatives of the →sleeping sickness diseases in West and East Africa (Fig. 3). 1 Slender trypomastigote bloodstream forms (they also penetrate into the cerebrospinal fluid). These stages are characterized by a mitochondrion with sparse, short, tubular cristae. The slender forms lack a functional →Krebs cycle and cytochrome chain. 1.1 According to several authors, →amastigotes (i.e., →micromastigotes) are seen 48 hours later inside the cells of chorioidea. 1.2 Transformation of amastigotes into sphaeromastigote forms (→surface coat not investigated), which give rise to slender blood forms. 2 Intermediate →trypomastigotes which reproduce by intensive →binary fission; cristae of mitochondrion lengthen. 3 Stumpy trypomastigote forms have a partially functional Krebs cycle but still lack →cytochromes. When these stages are ingested by the tsetse fly (→Glossina spp.), they may develop inside this vector. According to results of Jenni (Basel), bloodstream forms are diploid, and sexual processes with mating and DNA recombination occur inside the vector. 4 Trypomastigotes (without surface coat) in the crop of the tsetse fly. A waiting phase of at least 1 hour is needed. 5 Transformation to epimastigote (= procyclic) forms in the cardia and midgut of the tsetse fly; these stages develop a smooth surface coat and divide for about 12 days. 6 Epimastigote forms have a mitochondrion with numerous platelike cristae, acting with an active Krebs cycle and the cytochrome chain. Reproduction occurs by constant binary fission. These stages leave the intestine and enter the salivary glands. 7 Metacyclic trypomastigote from the salivary glands, which develops a blood-stage surface coat (DS) and has a mitochondrion with closely packed tubular cristae. This stage is infectious for man and →reservoir hosts when injected during the next blood meal of the vector. The whole development in the vector lasts 25–50 days and each tsetse fly remains infected for life (= 2–3 months). The minimum infective dose for man is about 300 flagellates. DS, developing blood-stage surface coat; F, flagellum; KI, →kinetoplast; MI, mitochondrion; N, nucleus; SC, surface coat; SF, short flagellum of amastigotes (for further species see Table 1, page 1507).

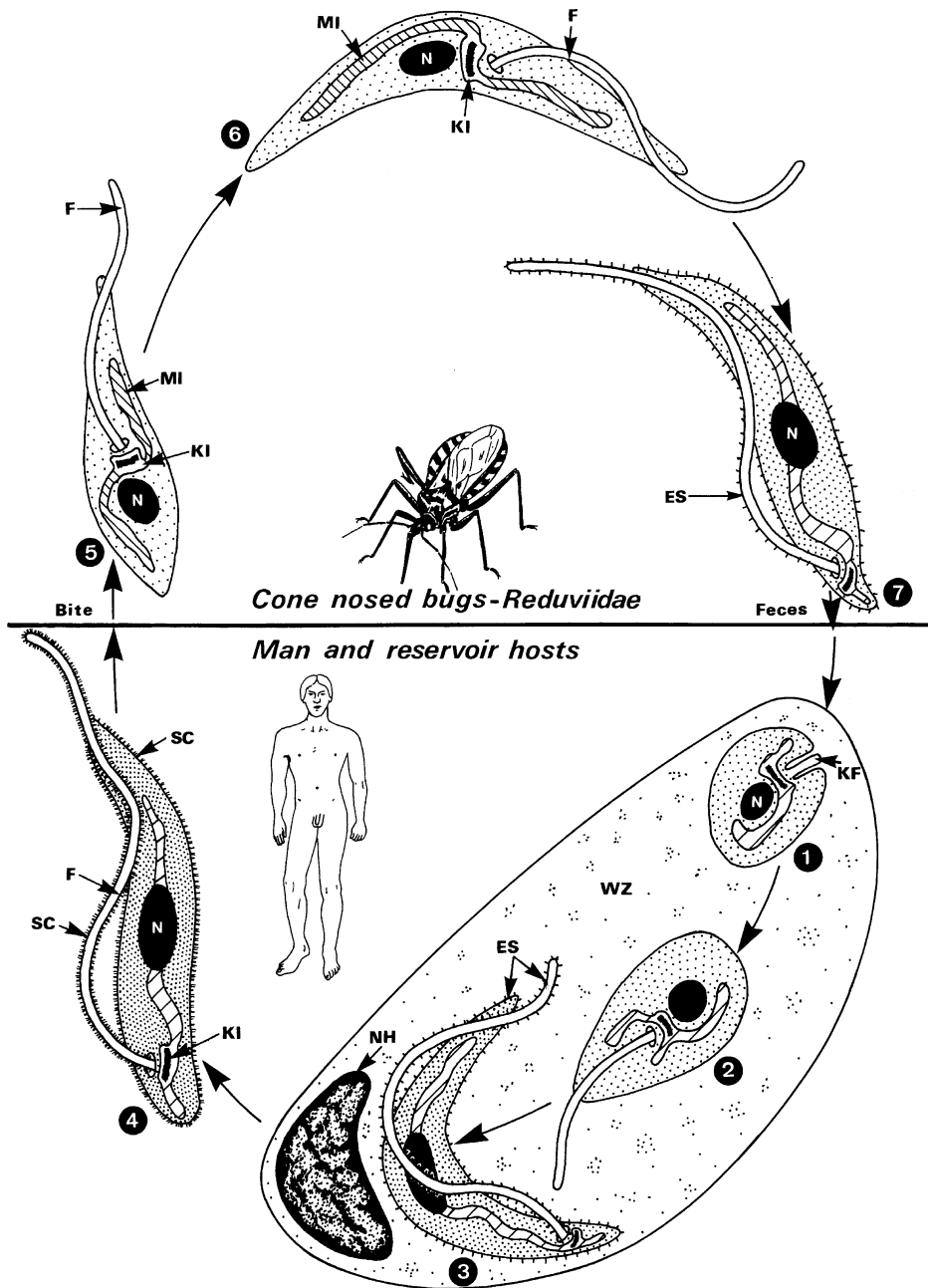

**Trypanosoma. Figure 2** Life cycle of *Trypanosoma cruzi*, cause of Chagas' disease in South America (Fig. 4). 1 Amastigotes = micromastigotes reproduce by binary fission inside the →cytoplasm of different host cell types (RES, heart muscle, nerve, spleen, liver, etc.). Host cells appear as "pseudocysts" when they are completely filled with parasites. 2, 3 Transformation to trypomastigotes (3) via →epimastigotes (2) and development of a surface coat (DS) occurs inside the cell. 4 Trypomastigotes inside the bloodstream after disruption of the host cell. These stages enter other host cells or are ingested by cone-nosed →bugs during the blood meal. 5 Transformation to epimastigotes inside the midgut of reduviid bugs (*Rhodnius* spp.; *Triatoma* spp., etc.) after blood meal. These stages are attached to the intestinal wall and reproduce by binary divisions, thus being accumulated in high numbers. 6 Epimastigotes in the hindgut of bugs; they were transformed to metacyclic stages with a specific surface coat. 7 Metacyclic (= infectious) stage (trypomastigote) inside the rectum of bugs. These stages are set free in fecal droplets during blood meal on their hosts. They enter the skin after the blood meal through a bite channel, scratched skin, or via mucous membranes. Inside the mammalian host they penetrate into various cells. DS, developing surface coat; F, flagellum; HC, host cell; KI, kinetoplast; MI, mitochondrion; N, nucleus; NH, nucleus of the host cell; SC, surface coat; SF, short flagellum.



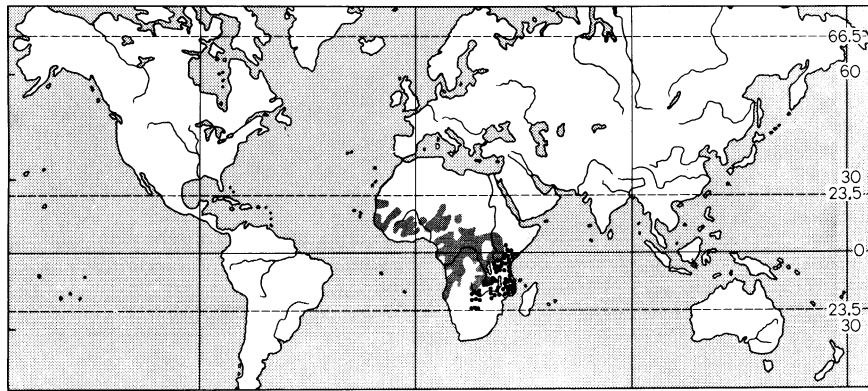

**Trypanosoma. Figure 3** Distribution map of African trypanosomes; grey = *T. b. gambiense*, dotted = *T. b. rhodesiense*.

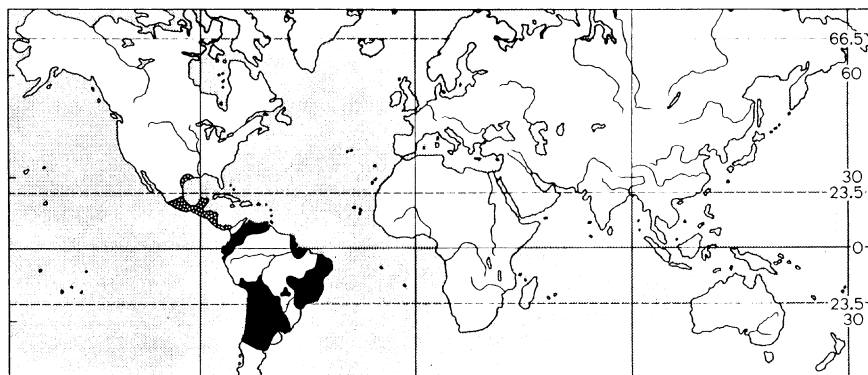

**Trypanosoma. Figure 4** Distribution map of *Trypanosoma cruzi* in South (black) and Middle America (dotted).

### Surface Coat

African trypanosomes at the blood stage in the vertebrate host (trypomastigotes) are covered with a major protein species that is removed and replaced periodically as a result of [→antigenic variation](#). This variation is the parasites' major way of escaping the immune response of the host. All these variant surface glycoproteins are linked to the plasma membrane through a glycosyl phosphatidyl inositol lipid anchor that is susceptible to the lipase GPIPLC. The procyclic insect stage of the same parasites is covered with another GPI-anchored protein named [→procyclin](#), the [→GPI anchor](#) of which differs from that of the [→VSG](#) by acylation of the inositol ring that renders it insensitive to GPIPLC.

Minor surface proteins related to [→VSG](#) present on trypomastigotes seem to be involved in interacting with host molecules.

On the surface of *Trypanosoma cruzi*, another class of GPI-anchored proteins closely related to higher eukaryote mucins has been described. These highly *O*-glycosylated structures are acceptors of sialic acids

for the surface transsialidase, and are involved in [→host cell invasion](#) in the trypomastigote stage. These mucins are encoded by several hundreds of genes with hypervariable regions that are differentially expressed among developmental stages, leading to stage-specific mucins on the surface of these parasites.

### Host Cell Invasion

*T. cruzi* has a broad host-range and can infect in vitro a variety of different cell types from a number of species. Trypomastigotes invade both phagocytic cells and cells incapable of phagocytosis. Amastigotes have also been shown to be able to invade both types of cells. It is not yet known whether 1 or 2 mechanisms of internalization occur, i.e., phagocytosis and active invasion. Early works have suggested that phagocytosis (or induced phagocytosis) was the mechanism of internalization ([→Apicomplexa/Fig. 8](#)). More recent studies have shown that the process is an induced internalization in a lysosomal compartment induced by the parasites after recruitment of the host cell [→lysosomes](#) in the area of

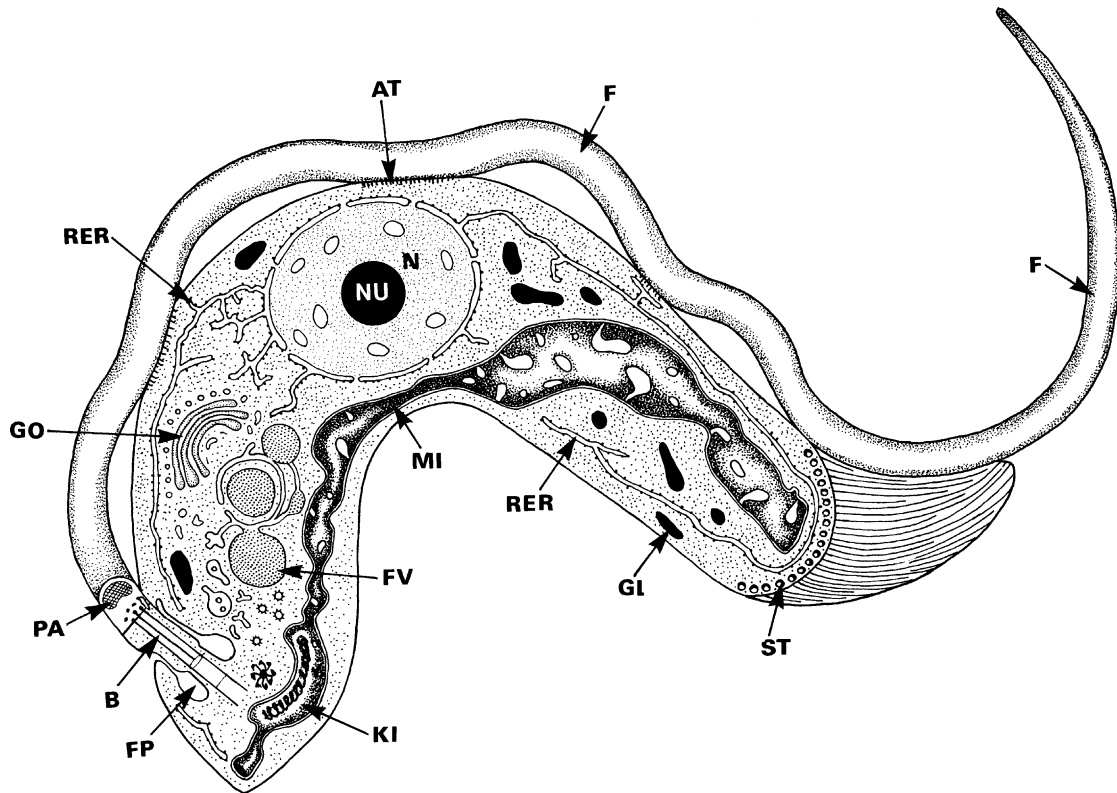

**Trypanosoma. Figure 5** DR of a longitudinal section through a trypomastigote of *Trypanosoma* sp. AT, attaching zone of the flagellum; B, basal body; F, flagellum; FP, →flagellar pocket (with cytostomal activity); FV, food vacuole; GL, →glycosomes; GO, →Golgi apparatus; KI, kinetoplast (containing DNA filaments); MI, mitochondrion; N, nucleus; NU, →nucleolus; PA, →paraxial rod; RER, rough →endoplasmic reticulum; ST, →subpellicular microtubules.

initial cell contact by the parasite. Lysosomes are actually induced to fuse with the plasma membrane of the cell at the site of contact and this leads to internalization. Parasite-induced signalization is involved, inducing calcium transients in the host cell responsible for lysosome →exocytosis; this signal is dependent on a parasite cytoplasmic serine protease (prolyl oligopeptidase).

Intracellular trypanosomes are located in a membrane bound →parasitophorous vacuole immediately after invasion, but they are rapidly found in the host cell cytoplasm, which suggests that they are able to leave the vacuolar compartment where they are first found. They develop in the cytoplasm of the host cell (→Apicomplexa/Fig. 8). This escape phenomenon is due to the rise in vacuolar pH due to the lysosomal nature of the vacuole which activates the parasite surface transsialidase that degrades the sialyl moieties of the vacuolar membrane proteins (essentially the lysosomal glycoprotein LGP), allowing a parasite pore-forming protein (Tctox) to access the phospholipids of the membrane and to degrade the vacuole membrane itself. As a result the parasite is eventually

found in the host cell cytoplasm where it will undergo its development.

### Diseases

*Trypanosoma cruzi*: →Chagas' Disease, Man in South America, →Cardiovascular System Diseases, Animals.

*Trypanosoma brucei*-group: →Sleeping Sickness in humans in West and East Africa; →Nagana in animals.

## Trypanosoma Genome

Genome sequences showed that in the haploid stage *T. brucei* has a genome size of 25 megabases and about 9,068 genes. *T. cruzi* is provided with a genome of 55 Mb and 12,000 genes, while *Leishmania major* has 33 Mb, but only 8,311 genes.

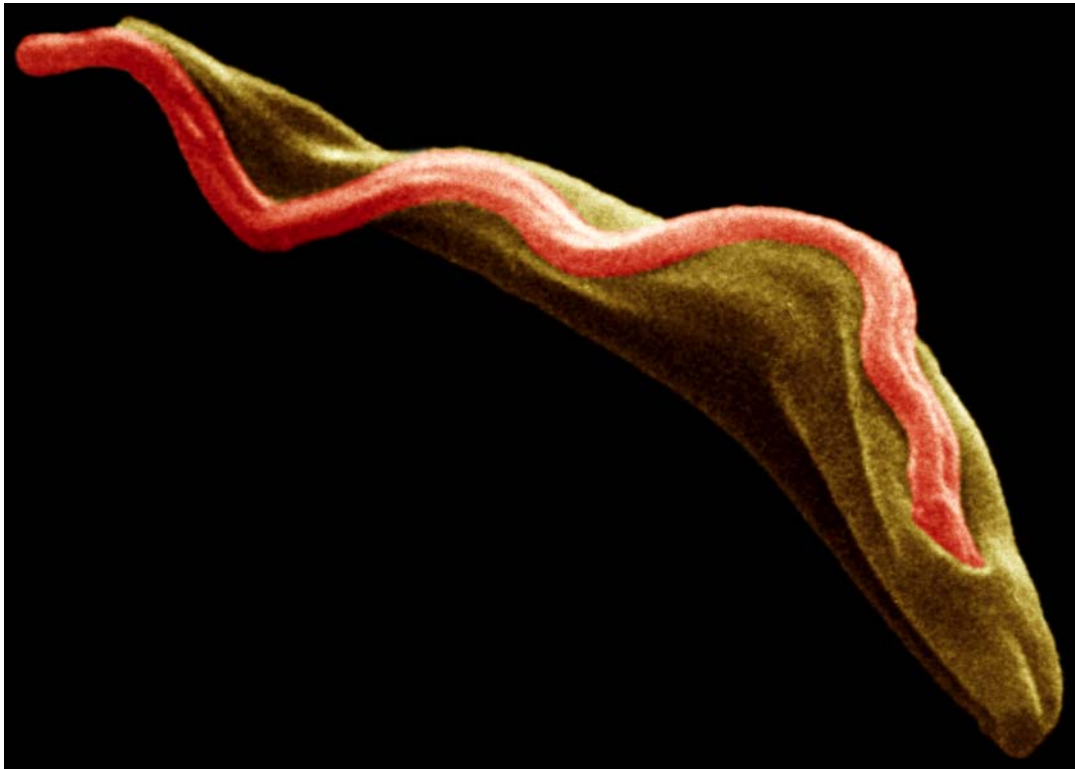

**Trypanosoma. Figure 6** SEM of a trypomastigote stage.



**Trypanosoma. Figure 7** SEM of an epimastigote stage.



**Trypanosoma. Figure 8** TEM of an amastigote stage inside a muscle cell; note that the flagellum is hidden in a pocket.



**Trypanosoma. Figure 9** LM of Giemsa-stained blood stages of *Trypanosoma brucei gambiense*.

## Trypanosoma-Derived Lymphocyte Triggering Factor (TLTF)

Excretions of trypanosomes that attract host cells.

## Trypanosomatidae

### Classification

Family of →[Kinetoplastida](#).

### Important Genera

[Table 1](#) (pages 1507, 1516).

## Trypanosomiasis, Animals

### Synonym

Trypanosomosis.

### General Information

Trypanosomosis is a cardiovascular system disease (→[Cardiovascular System Diseases, Animals](#)) which results from infection with protozoan parasites of the genus →[Trypanosoma](#). With the exception of *T. equiperdum*, the cause of →[dourine](#), they are all transmitted by haematophagous arthropods, such as →[kissing, bugs](#) for *T. cruzi* (the cause of →[Chagas' disease](#) in South America), biting flies for *T. evansi* (the cause of →[Surra](#) in Asia, central America, and North Africa), or blood-sucking flies of the genus →[Glossina](#), for *T. congolense*, *T. vivax*, and *T. brucei* (the cause of →[Nagana](#) in Africa).

### Therapy

→[Trypanocidal Drugs, Animals](#).

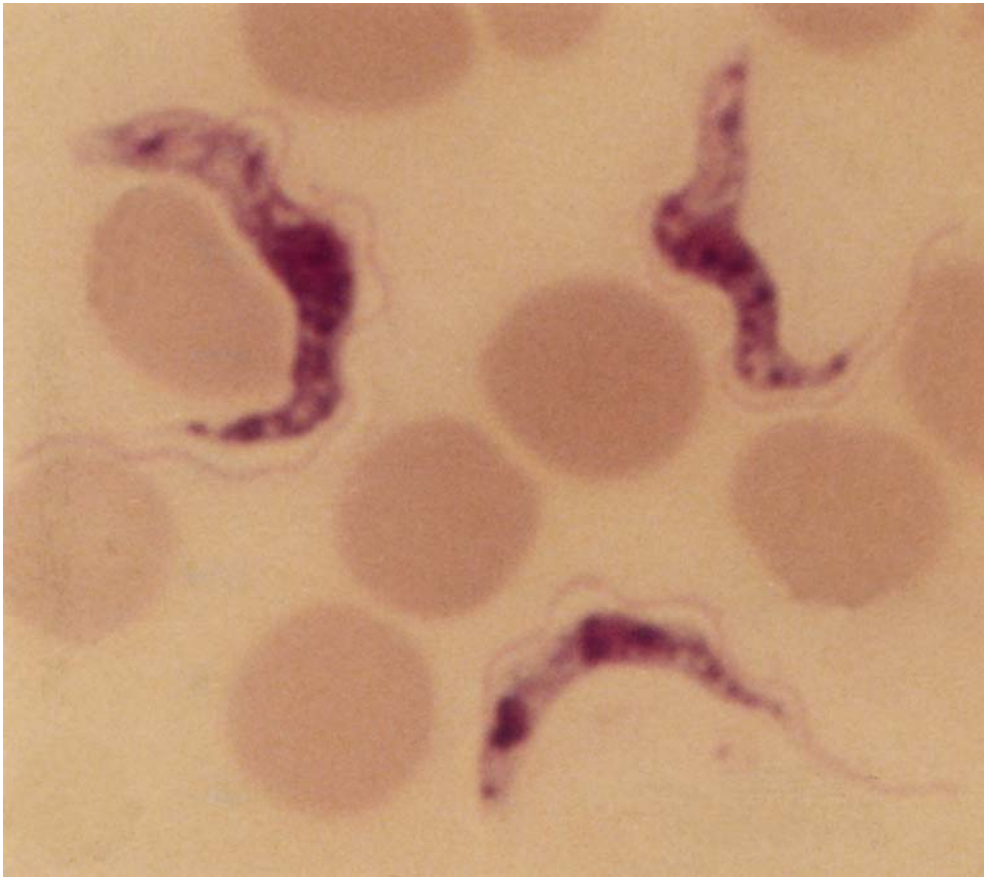

**Trypanosoma.** Figure 10 LM of Giemsa-stained blood stages of *Trypanosoma brucei rhodesiense*.

## Trypanosomiasis, Man

The following →trypanosomes commonly have been found in humans: *T. brucei gambiense* and *T. b. rhodesiense* (→Sleeping Sickness), *T. cruzi* (→Chagas' Disease, Man), and *T. rangeli*. The first 3 produce disease; the last gives rise to asymptomatic infection in Latin America and must be distinguished from the less frequent, but pathogenic *T. cruzi*.

Since *Trypanosoma cruzi*, restricted to America, is a mainly intracellular protozoan parasite, while the African trypanosomes (*T. brucei* sp.) live extracellularly, the immune defense mechanisms against these parasites as well as the mechanisms of pathogenesis are distinct (→Chagas' Disease, Man/Immune Responses, →Sleeping Sickness/Immune Responses).

### Therapy

→Trypanocidal Drugs, Man.

## Trypanosomiasis, Rhodesian

→*Trypanosoma brucei rhodesiense* infection occurs in East and Central Africa. It is characterized by a rapidly progressive clinical course and often leads to death within months, in the third stage of the disease, without pronounced central nervous system involvement. The early course of the disease, →chancres and parasitemia, is similar to the Gambian disease. Fever and lymph node enlargement are especially prominent, often with myocarditis, weakness, →weight loss, preceding death. Myocarditis is characterized by the presence of lymphocytes and plasma cells, and is accompanied by trypanosomes in myocardial cells and by pericardial effusion.

### Therapy

→Trypanocidal Drugs, Man.



**Trypanosoma.** Figure 11 LM of Giemsa-stained blood stages of *Trypanosoma cruzi* (= C-shaped).

## Trypanothione

Gluthathione (GSH) is replaced by trypanothione (TT), a glutathione dimere, that is reduced by trypanothione reductase.

## Trypanozoon

Subgenus of the genus *Trypanosoma* including the typical species *T. brucei brucei*, *T. b. gambiense*, *T. b. rhodesiense*, *T. equiperdum*, *T. evansi*.

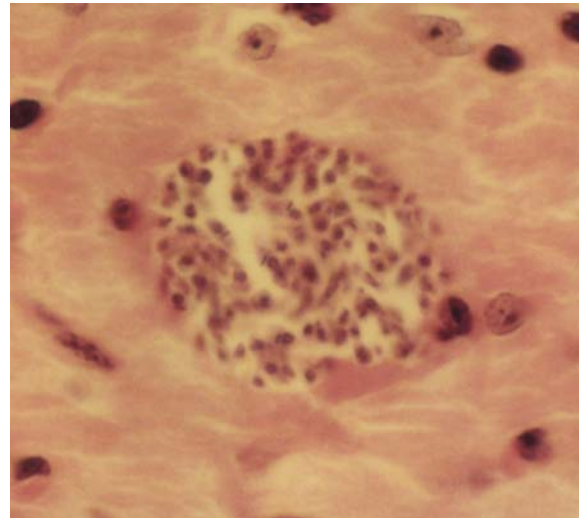

**Trypanosoma.** Figure 12 Pseudocyst of *Trypanosoma cruzi* in a muscle cell (HE-stained section).

## Trypomastigotes

Developmental stage of →[Trypanosomatidae](#) (→[Trypanosoma](#)/Fig. 5) living mostly free in the blood of vertebrate hosts. The flagellum arises from a significant →[flagellar pocket](#) that is situated at the rounded end of the parasite, while the flagellum becomes free at the pointed end (→[Flagella](#)).

## Tsetse Flies

### Name

African: *tse-tse* = biting fly, naming: flight noise.

### Classification

Family of →[Insects](#), Genus →[Glossina](#).

### Synonym

→[Glossinidae](#).

### General Information

Fossil Glossinidae are about 30 million years old. About 23 species belong to this family of the →[Diptera](#), of which males and females feed exclusively on blood. Only a few species are vectors of human →[sleeping sickness](#), but all are potential vectors of animal trypanosomiasis.



**Trypanosoma.** Figure 13 LM of a Giemsa-stained blood smear of *Trypanosoma theileri*, an apathogenic species of cattle (25–120  $\mu\text{m}$  ! long) being transmitted mechanically by tabanids.

**Trypanosomatidae. Table 1** Important genera of the Trypanosomatidae and the different developmental stages seen in their hosts.

Genus	Stages exclusively in invertebrates	Stages in two hosts		Stages in two hosts	
		invertebrate	plant	invertebrate	vertebrate
<i>Phytomonas</i>	–	Pro-, amastigotes <sup>a</sup>	Promastigotes	–	–
<i>Herpetomonas</i>	A-, pro-, epi-, opisthomastigotes	–	–	–	–
<i>Leishmania</i>	–	–	–	Promastigotes	Amastigotes
<i>Leptomonas</i>	A-, promastigotes	–	–	–	–
<i>Crithidia</i>	A-, pro-, epi-, choanomastigotes	–	–	–	–
<i>Blastocrithidia</i>	Pro-, epi-, sphaeromastigotes	–	–	–	–
<i>Trypanosoma brucei</i> group	–	–	–	Epi-, trypomastigotes	A-, trypomastigotes
<i>Trypanosoma cruzi</i>	–	–	–	Epi-, trypomastigotes	A-, trypomastigotes

<sup>a</sup> Amastigotes have a light microscopically invisible short flagellum; thus they may preferably be called micromastigotes



**Tsetse Flies. Figure 1** Fly on human skin.

Tsetse flies possess large, widely spaced eyes, forward-projected mouthparts and wings which cover in rest the whole abdomen horizontally, like closed blades of a pair of scissors. Tsetse flies are holometabolous insects, females giving birth to full-grown larvae which rapidly pupate in the soil.

### Distribution

Tsetse flies occur nearly exclusively in an area of about 11 million square km in the tropical rain forest and the savannah woodland. The population density is generally low.

### Morphology

Tsetse flies are 6–14 mm long (Figs. 1, 2, →*glossina*/Figs. 1–3), excluding the →*proboscis*. The broad head bears 3 ocelli and 2 large compound eyes which are widely spaced in both sexes. The pair of short antennae has 3 segments and each an arista with its characteristically branched hairs. Hygro-, thermo-, chemo-, and mechanoreceptors are concentrated on the antennae. The mouthparts consist of 3 unpaired components, the piercing labium, the labrum enclosing the food channel, and the hypopharynx with the salivary channel. All are sheathed by 2 modified maxillary

palps. On the back, the thorax ends in a caudal, triangular scutellum. The 8 abdominal segments can distend greatly after feeding. Males and females can only be distinguished by the genital organs, males possessing a button-like hypopygium under the dorsal end of the body which covers the clasper. The white larvae are elongated, without eyes and legs, at the posterior end possessing a pair of black polypneustic lobes. Like in →*Muscidae*, the pupae develop in the tanned skin of this final third larval →*instar*, and the adults emerge from the →*puparium* by means of the →*ptilinum*, a region on front of the head which can be ejected and retracted and hardens later.

### Genetics

Genetics of different populations of species are investigated to identify loci for different enzymes and those responsible for refractoriness to the trypanosomes in order to combat →*African trypanosomiasis* by the release of genetically modified vectors.

### Reproduction

Breeding of tsetse flies in the laboratory is possible, but labour-intensive, either by feeding them on living hosts or *in vitro* through membranes.





**Tsetse Flies. Figure 2** Magnification of the mouthparts prior to injection into skin.

In nature, males search for the females near the hosts. Both have fed at least 2 times before mating. Contact sex-recognition →pheromones in the →cuticle help to avoid interspecific pairing. During copulation a →spermatophore is produced and filled with sperms. Usually females mate only once. They have 2 ovaries and each of them 2 ovarioles in which eggs develop sequentially. About 9 days after emergence of the female, the ovulation and fertilization of the first egg occurs; about 9–10 days later the second and so on. After ovulation, a relict body remains in the ovariole, thereby allowing determination of the number of depositions of larvae at least for the first 4 ones. Females live several months – at 25°C about 80–100 days – and can survive long periods of starvation. During this period each female can deposit only about 10 full-grown larvae.

### Biochemical/Molecular Data

Biochemical techniques, e.g., enzyme electrophoresis and gas chromatography of cuticular hydrocarbons, and DNA probes have been successfully used to distinguish between morphologically similar species or at least to classify them into one of the

3 groups of →*Glossina*. Other biochemical/molecular-biological investigations focus on changes in the reproductive cycle, the endosymbionts and the rickettsia-like organisms. PCR is mainly used to identify infected tsetse flies.

### Life Cycle

Also in tsetse flies the duration of the respective developmental phase is temperature-dependent. The following data are based on a development at 25°C, unless otherwise stated. Eggs are not deposited, but after an embryonic development of about 4 days, the first instar larva hatches within the uterus. It is nourished by “milk” glands, a pair of modified accessory glands. The first instar is held in position within the uterus by a sticky material, the second one by uterine →ridges and the third one by the wall of the uterus. The duration of these three instars is 1, 1.5, and 2.5 days, respectively. The first two instars respire through posterior →spiracles, but the third instar develops posterior polypneustic lobes. The mature larva is about 5 mm long and weighs about 35 mg, heavier than the female. The deposited larva excretes the waste products and burrows into the soil and within an hour after larviposition it pupates. At a mean temperature of 30°C the puparial development needs 20 days, at 20°C additional 27 days. About one hour after emergence the adult fly, termed “teneral” fly, is capable of flight, but needs about 10 days to complete the development of cuticle and flight muscles. Bacterial →symbionts, which are restricted to special organs (→*Mycetomes*) near the gut and are transmitted transovarially or by the milk to the progeny, are necessary for adult reproduction (→*Glossina*/Fig. 1).

### Transmission

Tsetse flies can fly at speeds of up to 25 km per hour, but they usually fly more slowly and only for short periods of time, e.g., up to 50 minutes. Usually tsetse flies rest more than 23 hours per day in trees to avoid desiccation. Dispersal distances of 100–200 m per week are covered, but under optimal conditions 2 km per day can be covered. Tsetse flies do not need carbohydrates as fuel for flight but can use the amino acid →proline derived from the blood meal.

### Feeding Behavior and Transmission of Disease

The diurnal tsetse flies are induced by breath and urine components of the host to fly upwind. Near the host they orientate visually, responding more strongly to moving than stationary hosts. Colours are discriminated, blue being particularly attractive. The different species prefer different regions of the body of the host

for bloodsucking. The bites of tsetse flies usually result in a minimal skin reaction. The mouth parts of tsetse flies enter a capillary directly or suck from a little open pool of blood. Ingested blood (40–80 mg or more) is first pumped into the midgut and if this is distended maximally, then into the crop. At the beginning of the midgut, the →peritrophic membranes are made to enclose the blood. In the anterior region of the midgut, the blood meal is concentrated, not digested. This takes place in the middle region, and absorption in the posterior region of the midgut. Within 2 days nearly all of the blood is digested.

Tsetse flies transmit human and animal trypanosomiasis. The causative agents for sleeping sickness (→Sleeping Sickness) are *Trypanosoma brucei gambiense* and *T. b. rhodesiense*. *T. b. brucei*, *T. congolense*, and *T. vivax* attack cattle and *T. simiae* pigs.

### Interaction of Vector and Parasite

When the tsetse flies suck blood, the further development of the trypanosomes depends on the species of →*Trypanosoma*. *T. vivax* only colonizes the proboscis, *T. congolense* and *T. simiae* the midgut and the proboscis, whereas *T. b. gambiense*, *T. b. rhodesiense*, and *T. b. brucei* develop different stages in different regions of the intestine. This seems to occur only in ‘teneral’ tsetse flies taking the first blood meal, whereas old flies are refractory, perhaps due to the action of rickettsia-like organisms or stronger peritrophic membranes. After ingestion, the stumpy blood →trypomastigotes transform in the midgut to procyclic trypomastigotes, also changing the →surface coat. After colonization of the ectoperitrophic region and penetration of the anterior peritrophic membranes, they migrate to the foregut and colonize the salivary glands presumably via the salivary duct. Penetration of the wall of the gut and migration in the hemolymph to the glands have also been postulated. In the glands, they transform to →epimastigotes which possess no surface coat and attach to the →microvilli of the glands. This stage transforms to metacyclic trypomastigotes which finally make a new surface coat.

Effects of the parasites have been reported by different investigators, while others did not observe such effects, perhaps due to the choice of strains of flagellate and vector. In susceptible systems, the parasites interfere with the blood ingestion, perhaps by an attachment to mechanoreceptors in the proboscis which register the speed of the ingested blood. In addition, carpets of flagellates in this region should also affect the blood flow, and damage to the →salivary gland the recognition of blood vessels. Thereby, infected flies probe more often and need more time for a blood meal. Minor effects are the development of more bacteria in the intestinal tract of infected

flies and reduction of intestinal microvilli. The longevity of infected adults seems to be unaffected or only slightly reduced, but insecticide resistance is clearly reduced.

### Prophylaxis

Since the flies are active outdoors during the day, no →prophylaxis is possible.

### Control

Originally, clearance of the vegetation around the villages reduced the number of bites by tsetse flies. However, this is labour-intensive and has to be repeated. All tsetse flies can be killed using →insecticides: aerial application is complicated by the low population density of the fly; ground application techniques reduce the side effects on other animals. Trapping seems to offer the best protection. Traps made of blue cloth, baited with ox urine, impregnated with insecticides, and located around the villages strongly reduce the number of attacks. The effect could be increased by screens. The sterile-male technique has also been used successfully, but on a long term, most areas cannot be protected from reinvasion.

### Bait Methods for Control

Tsetse host-finding behavior can be used as a specific method of controlling these parasites with low environmental impact. Numerous traps and targets have been developed which kill attracted tsetse flies with insecticides. The highly effective devices that are presently in use attract the flies visually by their form and color and chemically by host odor components such as acetone, butanone, 1-octen-3-ol, 4-methylphenol, 3-methylphenol, and 3-*n*-propylphenol. Further research on host finding of the lesser studied *Glossina* spp. and on other attractive components of host odour may improve the effectivity of the traps (→Insecticides).

### Host Finding

In tsetse flies, in contrast to →mosquitoes, both sexes obligatorily feed on blood, so there is no interference between host-finding behavior and sugar feeding. However, the physiological state of the flies, such as circadian rhythm of activity and excitability, age, sexual activity, and nutritional state, as well as →environmental conditions, may modify the host-finding behavior. Host-finding is best known in *G. morsitans* and *G. pallidipes*, 2 species which behave relatively similarly. However, other species show very different host-finding strategies, and even populations of the same species may differ in their behavior. Host signals have an influence on the fly’s activation, on the oriented flight towards the host, on alighting, probing and on ingestion of food.

### Activation

The great mass of a tsetse population is normally at rest and it has been suggested that most tsetse flies spend only 10–30 minutes in active flight daily. Resting or flying (ranging) tsetse flies are activated by visual, olfactory, or mechanical host cues. The effectiveness of the activating visual stimuli depends on size, shape, pattern, contrast with the background, color, and movement. Carbon dioxide, acetone, acetic acid, 2-hexanone, and certain phenolic compounds have been identified as activating chemicals, and they may be involved in the effect of cattle odors. However, 1-octen-3-ol, a component of cattle breath which attracts tsetse flies, has no activating effect.

### Oriented Flight

In their flight toward the host over longer distances (up to more than 90 m) the tsetse flies use chemical cues. They follow the airstream downward of the host by an odor-regulated upwind anemotaxis. As stimulating compounds of cattle odors, carbon dioxide, 1-octen-3-ol, acetone, and several ketones and aldehydes have been identified and certain phenolic compounds of cattle urine (e.g., 4-methylphenol, 3-methylphenol, and 3-*n*-propylphenol) were attractive as well. However, host odors are more attractive as their isolated compounds. They in fact contain unknown additional attractants which eventually might be effective only in combination, not as single chemicals.

At close range the chemically attracted tsetse flies orient to the host using visual cues. The visual characteristics which maximally attract tsetse flies have mainly been studied using traps, which may also include attractive components related to behavioral patterns other than →host finding, e.g., to search for resting sites or refuges. The attractiveness of visual bait depends on its shape, size, movement, contrast versus background, color, and pattern. Surprisingly, some of the factors which increase the attractivity of visual bait have only little in common with characteristics of the hosts. For example, biconical bait attracts much more tsetse flies than do animal-shaped traps. The most attractive color is royal blue with a high reflectivity at 650 nm (mid blue) and low ultraviolet reflectivity, characteristics which are very unusual in nature. Generally, the attractiveness of a surface is increased by blue and red reflectivity, and diminished by ultraviolet and green-yellow reflectivity. Uniformly colored bait attracts more tsetse flies than that with stripes and complex patterns, probably because they have a higher contrast to the background patterns. It was speculated that this may be linked to the evolution of the stripe pattern of zebras, on which tsetse seldom feed.

Tsetse flies can be activated and attracted by visual stimuli alone. They then move to an area just

downwind of the bait. This may enable the flies to distinguish a possible host from nonanimal materials by odor. This behavior may also be involved in mate finding, as it can produce a localized swarm downwind of the bait. Warm body radiation and moist convection currents, which strongly attract mosquitoes, seem to have no influence in tsetse host identification.

### Alighting and Probing

The tendency of tsetse flies to land on bait is intensified by movements of the bait, by increased size, by chemical cues such as carbon dioxide, and by unknown components of cattle odor and sebum, but not by the attractants 1-octen-3-ol and phenolic compounds. The flies in addition prefer to land on dark surfaces or on surfaces with strong reflectivity in the ultraviolet wavelengths. That ultraviolet increases the number of landing flies, but inhibits their attraction, might have a simple explanation: ultraviolet reflectivity is typical of sky light, and the increased landing rate of the flies might be the result of accidental collisions with “transparent” surfaces, rather than the result of normal alighting responses. Probing is stimulated by a temperature gradient and odors, whereas engorging seems to depend on the adenine nucleotides ATP, ADP, and AMP, as well as on salts in the diet.

---

## Tsutsugamushi Fever

→Mite-transmitted disease in humans (→*Orientia*).

---

## T-System

→Platyhelminthes/Musculature.

---

## Tuberculosis

This worldwide emerging bacterial disease (the agent of which was discovered by *R. Koch*) increases the severeness of many parasitic infections.

---

## Tubovesicular Network (TVN)

This term describes an outgrowth of the parasitophorus vacuole in *Plasmodium*-infected red-blood cells being involved in transport processes.

## Tubulin

The →microtubules of parasites (and other cells) are composed of  $\alpha$  and  $\beta$  subunits, which are becoming targets for drug development (e.g., dinitroanilines bind to both subunits with a different sensitivity).

## Tularemia

Tularemia, caused by the bacterium *Francisella tularensis*, has a reservoir in lagomorphs and some rodents from which it can be transmitted through direct contact, such as when rabbits are skinned, or via the bite of →ticks and tabanids. Mortality is low. Antibiotics such as streptomycin can be used for treatment. *D. andersoni* (in the USA), and other tick species such as *Rhipicephalus sanguineus* can transmit the pathogen. It is found in North America, reaching as far south as Venezuela, and is also found in parts of Asia and Europe.

## Tumbu-Fly Disease

Myiasis due to the larvae of the fly *Cordylobia anthropophaga* (→Myiasis, Man).

## Tumor Necrosis Factor (TNF)

TNF is produced by macrophages and has a synergistic effect with nitric oxide (NO), that produces highly toxic peroxynitrite and hydroxyl radicales. TNF- $\beta$  is one of the most important cytokines in context to immunity against infectious diseases.

## Tunga penetrans

### Name

Indian: *tung* = penetrating organism.

### Synonyms

→Jigger, →Sand Flea (→Fleas), *Sarcopsylla penetrans*, *Dermatophilus* sp., *Rhynchoprion* sp.

## Classification

Species of →fleas, →Aphaniptera, family Tungidae.

## General Information

This flea species is found in dry regions of the tropics in South and Central America, Africa and Australia. It is not host-specific and attacks many warm-blooded hosts such as canids, cats, cattle, rats and other rodents, as well as humans and pigs. The unfed males and females (Figs. 1, 2, page 1522, 1523) are only 0.8–1 mm in length. They are thus one of the smallest species out of the 3,000 species known worldwide. By help of their swordlike mouthparts (Fig. 2) the females penetrate head forward (→Echidnophaga) into the host's epidermis and start growing for about 3–4 weeks, while drinking blood. Especially the region of the second and third abdominal segments becomes enormously enlarged (Figs. 4, 5, page 1524, 1525), so that the whole flea finally reaches diameters of up to 1 cm: The males (Fig. 3, page 1524) copulate with penetrated females several times, and only after each copulation they suck blood. On day 6 after penetration and after a copulation the females start to eject the large ovoid, about 600  $\mu$ m sized eggs, which fall to the ground. Larval development in the eggs takes about 3–4 days. The 2 larval stages grew up via one molt within 5–11 days and then start pupation, which takes 4–7 days. It was recently shown by comparing *T. penetrans* fleas from different hosts, that there might be 2 different groups, since those of humans, pigs, and dogs differ in some morphological and molecular biological features from those of cats and rats. Another species of humans is *T. trimamillata*, while 8 other *Tunga* spp. live rather host-specific on other animals. In contrast to the former believe, that *Tunga* fleas were imported around 1900 with a ship full of sand to Africa, molecular biological data of African *Tunga* point to a separation nearly 250,000 years ago.

## Life Cycle

Fig. 1 (page 1522).

## Disease

→Tungiasis.

## Tungiasis

Tungiasis is an infection of the epidermis, usually the foot, with sand →fleas (→*Tunga penetrans*), usually acquired by walking barefoot on moist sand or soil in the tropics (Figs. 1–3, page 1525, 1526). The parasitic stage is a mated female flea which attaches to the skin

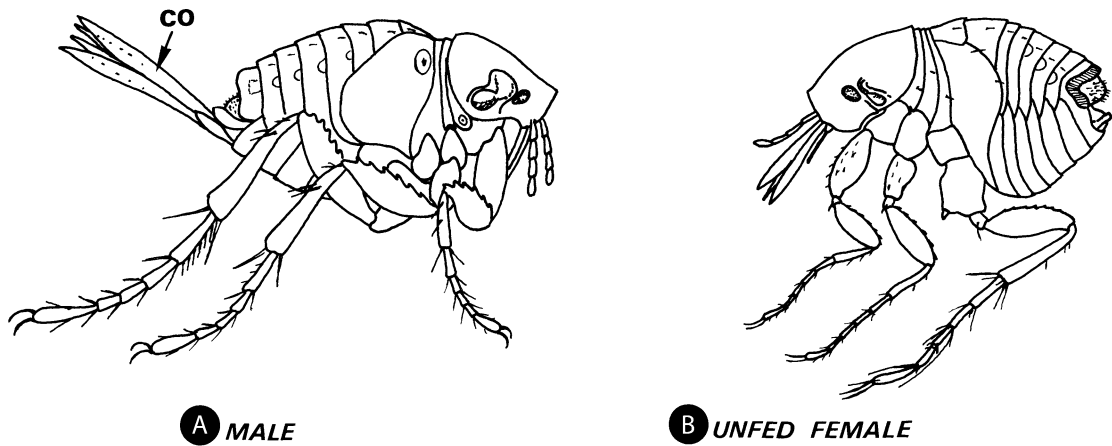

### TUNGA PENETRANS

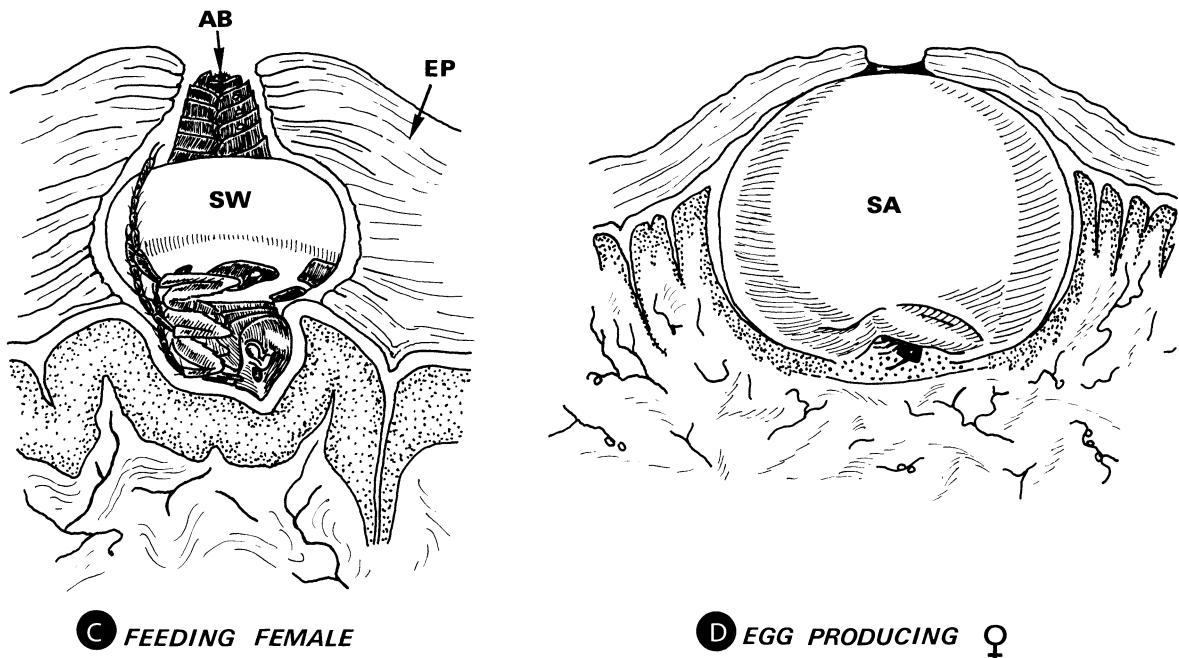

**Tunga penetrans.** Figure 1 A–D Life cycle stages of the jigger or →sand flea *Tunga penetrans* which parasitizes man and animals in tropical and subtropical regions. **A** Male (temporarily bloodsucking). **B** Unfed female (1 mm long). **C** Inseminated females enter the skin (of feet) and feed head down. **D** Fully grown, pea-sized female starts producing eggs (in total about 200) which fall to the ground. Having laid her eggs the female dies. The infested tissues may become ulcerated and infected with other pathogens. The eggs hatch and release a larva which follows the typical cycle of →fleas in about 3 weeks. *AB*, abdomen; *CO*, copulatory organ; *EP*, epidermis of host skin; *SA*, swollen abdomen; *SW*, swelling abdomen.

and feeds on blood, enlarging in size up to about 1 cm in diameter when eggs develop. The flea becomes surrounded by keratin except for the head, which extends into the papillary dermis. The whole tumor is surrounded by chronic →inflammatory reaction including eosinophils. The flea sucks blood and has a

digestive tract which ends superficially where the keratin layer is incomplete. Large numbers of eggs develop in the flea and are discharged to the outside. The flea dies when it has discharged all of its eggs, its body collapses, and an intraepithelial →abscess develops which eventually drains and heals. The flea



**Tunga penetrans.** Figure 2 LM of the head of a female with its strong, swordlike sawing mouthparts.

larvae live in the soil. After pupation, mating occurs, the male flea dies after copulation, the place of which is not yet fully understood, and the female flea attaches to the foot of any of a number of hosts and burrows into the keratinaceous layer.

### Therapy

→Control of Insects, →Insecticides, →Arthropodicidal Drugs, →Ectoparasitocidal Drugs, see also →Siphonapteridosis.

## Tungidosis

### Synonym

→Tungiasis.

## Turning Disease

The larval stage (*Coenurus cerebralis*) of the canid tapeworm →*Multiceps (Taenia) multiceps* may reach in the brain of small ruminants (e.g., sheep) a diameter of several centimeters. This may lead to a specific loss of control in movements. The sheep walk stiff, make uncontrolled turning movements, show torticollis, bruxism, trembling, and may suddenly die. The motility disturbances look like those of →Traberkrankheit. →Coenurosis, Animals, →Coenurosis, Man.

## Tylodelphys clavata

Trematode species (family Diplostomidae) parasitic on the eye lenses of fish (gobies) in the Baltic Sea and Black Sea. *T. excavata* inhabits as adult stage the intestine of stork (*Ciconia ciconia*), the intermediate hosts are the snail *Coretus corneus* (first) and frogs (second), where the metacercariae are formed.

## Typhloceras poppei

Flea species of rodents (Fig. 1, page 1526).

## Typhus exanthematicus

### Synonyms

Louse-borne Typhus, Spotted Typhus.

Human disease due to infection with →*Rickettsia prowazekii* transmitted via feces of →lice.

## Tyrode, Maurice Vejux (1878–1930)

French pharmacologist, famous for his buffer, that is still used in many culture systems and is similar to the salt contents of the blood serum.



**Tunga penetrans.** Figure 3 SEM of an adult male and a female.



**Tunga penetrans.** Figure 4 LM of an enlarged female (the 2nd and 3rd segments of abdomen are swollen) taken out of the skin.

---

## Tyroglyphus

Genus of mites of the family Tyroglyphidae with feed grain dust; they may induce allergic reactions in man and birds or may transmit bacteria (*Salmonella*) in bird stables.

---

## Tyrollichus casei

### Name

Greek: *tyros* = cheese, *lichen* = covering.

### Synonym

*Tyrophagus casei*.



**Tunga penetrans. Figure 5** SEM of a hypertrophying female, lateral aspect. (Courtesy of Dr. Nagy, Düsseldorf.)



**Tungiasis. Figure 1** Foot of a child with penetrated females.



**Tungiasis. Figure 2** Hand with several *Tunga* fleas.





**Tungiasis.** Figure 3 Foot of a rat with 3 penetrated females.

### Morphology

Mite species, which reaches as adults a length of 0.5–0.7 mm. Specimens appear ovoid, whitish with reddish legs (Fig. 1, page 1527). They live on/in different cheese, but also on other organic material, if it is not too dry. This species is also cultured and added to some commercial cheese types.

### Disease

Some people show allergic reactions upon contact with such mites (so-called para – or pseudomange). Others suffer from abdominal pain, and diarrhoea, if they eat such mite – cheese.

---

## Tyrophagus putrescentiae

Mite that feed *Aspergillum* fungi or grains; skin contacts or inhalation may lead in humans to itching and other allergic reactions.

---

## Tyvelose

Sugar (with a strong antigenic activity) excreted by intracellular stages of → *Trichinella spiralis*. It becomes connected with worm proteins. Both – the sugar and the proteins – modulate the gene expression of the parasitized muscle fibers, since the latter become dedifferentiated (= they loose many fibrils) within 7–8 days p.i. The Tyvelose is a 3,6-dideoxy-D-arabinohexose, which covers finally the muscle larvae,



**Typhloceras poppei.** Figure 1 Light microscopical lateral view of a female flea from rodents.

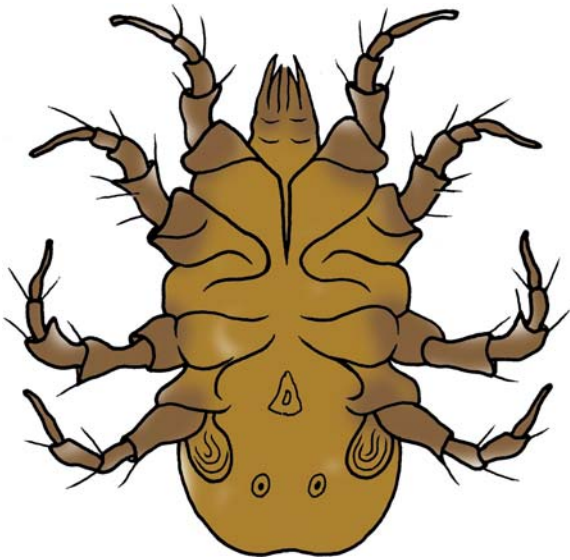

**Tyrollichus casei.** Figure 1 DR of the ventral side of an adult male.

which induce the fusion of up to intestinal cells of the next host in order to form a syncytium.

---

### Tyzzer, Edward Ernest

American scientist, discoverer (1912) of the genus →*Cryptosporidium*.

---

### Tyzzeria

Genus of →*Coccidia* of ducks. The oocysts contain 8 sporozoites, but no sporocyst.



## Ubiquinone

→ [Quinones](#).

## Uitpeuloog

Infection with → [Gedoeelstia](#) larvae (→ [Diptera](#)) leading to thrombo- and endophlebitis in animals, as well as to the bulging eye disease of cattle (→ [Cardiovascular System Diseases, Animals](#)).

## Ulcer

Clinical and pathological symptom of infections with skin parasites (→ [Skin Diseases, Animals](#), → [Ectoparasite](#)).

## Ulcera de Bauru

Symptoms due to infections with *Leishmania braziliensis*.

## Ulcerating Lesions

→ [Pathology](#), → [Skin Diseases, Animals](#).

## Ultrasound

This method is now sensitive enough for a significant diagnosis of alveolar echinococcosis, anisakiasis, ascariasis, echinococcosis, fascioliasis, lymphatic filariasis, paragonimiasis, and schistosomiasis.

## Uncinaria

### Name

Latin: *uncinatus* = hooklike.

### Classification

Genus of the nematode family Ancylostomatidae.

### General Information

Specimens of *U. stenocephala* (Figs. 1–5) are found worldwide in zones with moderate climate and live in the small intestine of canids (occasionally also in felids, rarely in pigs). The adults (female, 4–16 mm; male, 3–11 mm) suck blood by means of their buccal capsules, which is provided with 2 bladelike cutters (Fig. 1). The **prepatent period** is 14–17 days, the typical hookworm eggs are ovoidal and reach a size of 70–90 μm × 35–60 μm. The infections of the final hosts occur by oral uptake of the free-living, sheathed larva 3 (there is no skin penetration). Two days after uptake the larvae hatch from the sheath in the stomach or in the duodenum and reach maturity after 2 moults already in 14–18 d.p.i. The **patency** lasts 4–6 months. Some of the larvae 3 are able to survive in paratenic hosts (rodents). By feeding such infected hosts the canids/felids may also become infected. In contrast to other hookworms a prenatal or lactogenic transmission of worm larvae to the puppies does not occur.

### Disease

Heavy infections introduce retarded growth, loss of weight, slimy diarrhoea as well as hypoproteinaemia.

### Diagnosis

Microscopical finding of the ovoidal eggs showing 4–16 blastomeres in fresh faeces.

### Therapy

→ [Nematocidal Drugs](#).



**Uncinaria.** Figures 1, 2 LM (above) and SEM of the anterior pole of adult worms.

**Uncinaria.** Figures 3, 4 LM (above) and SEM of the posterior end of a male.

## Undifferentiated Cell

They occur in →[Platyhelminthes](#) and are able to develop into all other specialized cells. In →[hydatids](#) and in the alveolar cysts of the →[Echinococcus](#) spp. they

divide constantly, thus giving rise to the growth of the →[brood capsules](#) and the formation of the infectious protoscolices. They are still omnipotent.



**Uncinaria.** Figure 5 LM of the posterior end of a female.

## Undulating Membrane

In the →trichomonads and in the trypomastigote stages of →trypanosomes, a flagellum may be connected to the cell surface by →desmosomes (→Trypanosoma/ Fig. 5). The →recurrent flagellum is attached in this manner so that when it pulls the plasma membrane (→Plasmalemma) away from the body, the undulating membrane is created (→Trichomonadida/Fig. 1C).

## Unguitractor

Thornlike structure at the last tarsal segment of →Cimex bugs.

## UNICEF

United Nations' (International) Children's (Emergency) Fund.

## Unilocular Cysts

→Echinococcus granulosus, →Hydatids.

## Unthriftness

Clinical symptom in animals due to parasitic infections (→Alimentary System Diseases, →Clinical Pathology, Animals).

## Urea

→Amino Acids.

## Urinary System Diseases, Animals

Parasitic infections of the urinary system are not of major importance in domestic animals. Clinical signs are generally absent, or not seen, and the presence of the parasites is often only detected incidentally through the observation of sporocysts, eggs, or fragmented worms in the urinary sediment. Only few species of nematodes (*Capillaria plica*, *C. feliscati*, *Diectophyma renale*, *Stephanurus dentatus*) and protozoa (*Klosiella equi*, *Eimeria truncata*) inhabit the urinary system of domestic animals. (Table 1). In addition, migrating nematode larvae (e.g., *Toxocara canis* in dogs) or *Schistosoma mattheei* in cattle, may occasionally invade the urinary system and lead to the formation of small granulomas around the larvae or eggs. Protozoa such as *Babesia* and *Leishmania* may induce excessive immunocomplex formation thus causing glomerulonephritis. →Haemoglobinuria (or →"red water"), a clinical sign which may be caused by →*Babesia* multiplying in erythrocytes, is not associated with the presence of parasites in the urinary system.

**Urinary System Diseases, Animals. Table 1** Parasites affecting the urinary system of domestic animals (according to Vercruyse and De Bont)

Parasite	Host	Location	Clinical presentation	Principal lesions
<b>Protozoa</b>				
<i>Klossiella equi</i>	Horse	Kidney	None	Interstitial nephritis
<i>Eimeria truncata</i>	Goose	Kidney	Diarrhoea, weakness, ataxia	Tubulonecrosis, interstitial nephrosis
<b>Trematoda</b>				
<i>Schistosoma</i> spp.	Ruminants	Kidney, bladder	Haematuria	Granuloma formation around eggs
<b>Nematoda</b>				
<i>Capillaria feliscati</i>	Cat	Bladder, sometimes the pelvis of the kidneys	Mostly asymptomatic, in heavy infections haematuria, dysuria, and pollakiuria	Light inflammation of bladder mucosa
<i>C. plica</i>	Dog, fox, wolf			
<i>Dioctophyme renale</i>	Dog, mink, cat, fish-eating mammals, rarely horse, pig, man	Free in abdomen, kidney	Asymptomatic when one kidney is involved, otherwise uremia may occur	Kidney parenchyma (usually right) is destroyed, often only the capsule being left
<i>Stephanurus dentatus</i>	Pig	Perirenal fat and adjacent tissues	No typical signs, weight loss	Adults: cysts, filled with greenish pus

*K. equi* is found in the convoluted tubules of the kidney in the horse and its relatives. These sporozoan parasites cause a destruction of renal epithelial cells, and histopathological examination of the kidneys may reveal an interstitial nephritis in some animals. However, the infection produces no clinical manifestation of disease. *Eimeria truncata* develops in epithelial cells of renal tubuli in geese. The kidney appears swollen showing many white or yellow foci. Young geese are highly susceptible and may die due to tubulonecrosis and interstitial nephrosis.

The trichurid nematodes *Capillaria plica* and *C. feliscati* live in the urinary bladder and occasionally the ureters and renal pelvis of dogs and cats, respectively. They are about 3–6 cm long and produce little or no pathogenic effect, probably because of the superficial attachment of the worms to the epithelium of the urinary bladder. However, the parasites may occasionally invade the mucosa and cause an [inflammatory reaction](#), leading to haematuria, dysuria, and pollakiuria.

The giant [kidney worm](#) *Dioctophyme renale* occurs in the kidneys and peritoneal cavity of the mink and dog and other fish-eating mammals, but has also occasionally been found in the pig, cattle, horse, and man. In the dog, adult worms have primarily been found in the peritoneal cavity, which suggests that it is not a natural definitive host of the parasite. *D. renale* is the largest known nematode. Female worms may reach up to 100 cm in length and the pathogenesis of the infection is related to the considerable space that the parasite takes inside the renal pelvis. The enlargement

of the cavity occurs at the expense of the [parenchyma](#), to such an extent that the kidney may eventually be reduced to an empty capsule. Partial obstruction of the ureter may also take place, leading to hydronephrosis. The severity of clinical disturbance and outcome of the infection depend on the ability of the host to maintain a normal renal function. In dogs, the right kidney is more frequently invaded than the left. Such unilateral infection generally leads to a compensatory hypertrophy of the opposite kidney, and does not cause clinical disturbance. When both kidneys are parasitized the animal may die of uraemia without sufficient time for extensive pathologic changes to develop in the kidneys. Although the presence of adult worms in the abdominal cavity has occasionally been associated with ascites and haemorrhages, it does not usually cause clinical signs.

→ *Stephanurus dentatus*, the kidney worm of swine, is generally found in the perirenal fat and adjacent tissues. About 2–4 cm in length, these worms form cystic cavities that communicate with the renal pelvis and allow the eggs to be passed in the urine. Most of the pathogenesis of this tropical and subtropical parasite is related to its larval stages. They are particularly aggressive in the liver where their migration causes severe inflammatory reactions and eventually results in extensive portal fibrosis. The adult parasite encysted near the ureters is not markedly pathogenic, although thickening of the ureters and cystitis have occasionally been reported. Aberrant migration of *S. dentatus* to other abdominal or thoracic organs where it causes local

purulent tissue reaction, appears to be a common feature. As in many helminthosis of the pig, the major clinical sign in most infections is a failure to gain weight.

The urinary form of schistosomiasis in domestic animals appears to occur only in cattle heavily infected with *Schistosoma mattheei*, a parasite of the mesenteric and hepatic portal veins of ruminants in southern Africa. The lesions in the urinary bladder may range from scattered individual granulomas with petechia to widespread polypoid and granular patches. Urinary manifestations such as haematuria are rare and seen only in super infected animals.

### Therapy

See entries of the different species.

---

## Uroid

Terminal region of some protozoa, e.g., amoebae, where excretion is done by inner vacuoles with the outer cell membrane (→[Exocytosis](#)).

---

## Urosporidium Species

Species of the protozoan phylum →[Ascetospora](#).

---

## Urticaria

Skin reaction to previous bites of many bloodsucking insects and →[mites](#).

---

## Uta

Disease due to neotropical cutaneous leishmaniasis (NCC), which was first described as “Peruvian uta” by Villar in 1859, but the symptoms of which had been already shown on pottery from Peru and Ecuador in the years 900–400 BC.





## Vaccination

Long before the parasites and the causes of parasitic diseases were known, it was observed that if an individual recovered from a disease, rather than succumbing to it, he rarely developed the same illness again. It must have been these types of observations that led people in Asia some hundreds of years ago to deliberately infect infants on the backside with infective material from →*Leishmania* lesions (→*Leishmanization*), thus inducing an immunity that protected immunized individuals from reinfections with disfiguring lesions (→*Immune Responses*). After **Edward Jenner** in **1796** succeeded in immunizing a young boy with material from cowpox blisters against a challenge infection with smallpox, the first attenuated live vaccine (after “vacca,” the Latin word for cow) was born. Up to now the vast majority of successful vaccines against virus, bacteria or parasites are attenuated live vaccines based on the principle that avirulent organisms can confer protection against virulent, disease-causing pathogens (→*Vaccination Against Nematodes*, →*Vaccination Against Protozoa*, →*Vaccination Against Platyhelminthes*, →*Amoebiasis*, →*Chagas' Disease, Animals*, →*Chagas' Disease, Man*, →*Trypanosomiasis, Animals*, →*Trypanosomiasis, Man*, →*Leishmaniasis, Animals*, →*Leishmaniasis, Man*, →*Malaria*, →*Toxoplasmosis, Animals*, →*Toxoplasmosis, Man*).

## Vaccination Against Nematodes

Vaccine research always has to compete with the development of anthelmintics. Whereas the latter increasingly cover a broad range of endo- and even ectoparasites, vaccines are efficient against only one parasite species. However, with increasing resistance of parasites against anthelmintics and ecological awareness about drug residues, vaccines become more and more important.

### Irradiation Attenuated Live Vaccines

The first and undoubtedly most successful anti-nematode vaccine to date is the irradiation attenuated live vaccine against the bovine lungworm, →*Dictyocaulus viviparus*. Following the observation that cattle who survived natural infections with →*D. viviparus* larvae obviously developed a degree of immunity that protected them from clinical disease after a natural challenge, first immunization trials were carried out in the mid-1950s. It was soon found out that crude preparations of somatic antigens from adult worms or larvae did not stimulate sufficient active immunity to prevent the disease. It was then assumed that the stimulation of protective immunity might depend on substances which were only elaborated by living worms. After intensive search for methods to weaken the infective larvae without killing them, X-ray irradiation proved to be the method of choice. Whereas irradiation below 200 Gy did not produce a sufficient degree of alteration of the larvae, 600 Gy considerably damaged the larvae which failed to stimulate a protective immunity. Eventually best results under both experimental and field conditions were obtained by two oral administrations of 1,000 infective, 400 Gy attenuated third-stage larvae, each, 4 weeks apart. This vaccine was launched on the market in 1958 and has been commercially available ever since (Dictol<sup>®</sup>, Bovilis<sup>®</sup>, Intervet).

Vaccination with irradiated lungworm larvae does not confer a sterile immunity. During subsequent challenge infections animals are protected against clinical disease and worm burdens are reduced by 95–98%, but low numbers of worms may reach maturity and produce new larvae. Immunity from vaccination protects for up to 12 months (similar to a single natural infection), i.e., for the following grazing season. If no natural infections booster the immunity, animals are susceptible to disease again thereafter. Therefore, vaccination is recommended for endemic *D. viviparus* areas, where natural boosts can be expected and lifelong protection may be achieved.

Although calves may be vaccinated already from 2 weeks after birth the vaccine usually is administered to susceptible calves in early spring. The second immunization has to be given at least 2–3 weeks before turnout to pasture. Within 2 weeks after the last vaccination no anthelmintic treatment should be given.

As freezing kills the larvae and higher temperatures reduce their life span, the vaccine must be stored between 2°C and 8°C. Under these conditions the shelf life is 3 months.

The mechanism of X-ray attenuation is unknown. It has been speculated that irradiation induces abnormalities in protein structure producing highly immunogenic molecules, which in their normal configuration are only weak immunogens. However, they still have to be common enough to native antigens to stimulate an immune response that is able to interact with antigens from normal organisms. Besides modified antigen conformation additional modes of action have been discussed, such as prolonged exposure of particular antigens, induction of specific cytokines and dynamics of cell-mediated responses.

The →mode of action of the irradiated *D. viviparus* live vaccine and the relevant antigens have not been identified yet. Efforts have been made to identify protective antigens on a molecular level and will be described under “→Recombinant vaccines.”

The successful vaccination of cattle against *D. viviparus* inspired the initiation of a similar programme and the production of a commercial vaccine against *D. filaria* in sheep in India in 1971 and Iraq shortly thereafter. Infective, third-stage larvae are irradiated with 500 Gy. As with bovine lungworms, irradiated larvae confer high levels of immunity when given orally to young lambs in two doses of 1,000 and 2,000 larvae, 4 weeks apart. Without reinfection protection lasts between 12 and 24 months and varies between sheep breeds. The efficacy of the vaccine has been demonstrated under experimental and field conditions. Within the first ten years about 360,000 sheep in endemic areas had been successfully vaccinated, however the demand is much higher and by far exceeds the production capacity of the vaccine producers. The vaccine is also used for the immunization of goats. Irradiated larvae have to be maintained at 4°C and have a shelf life of only 2 weeks.

After irradiation proved to be a successful method to attenuate infective →helminth larvae for live vaccines a number of immunization experiments with all kinds of →nematodes were carried out. A second, although only temporarily available commercial vaccine was developed against the canine hookworm, →*Ancylostoma caninum* and released in the USA in 1973. After washing and →sterilization of eggs collected from faeces, larvae were cultured in sterile medium, harvested by filtration and irradiated (400 Gy). Due to sterile culture conditions, a shelf life of 6 months was achieved at 10–15°C. The vaccine conferred a high degree of protection but no sterile immunity allowing single worms to become adult and produce eggs. Therefore, the veterinarians preferred the simultaneously introduced modern anthelmintics, which immediately eliminated

eggs from faeces. This together with increasing production costs eventually led to the withdrawal of the vaccine in 1975. Trials with 5-fluorouracil or UV attenuated hookworm larvae also showed a considerable degree of protection but remained at an experimental stage.

Immunization experiments with attenuated infective larvae under both experimental and field conditions have been performed with a large number of nematodes (Table 1). Most of them never reached beyond an experimental stage and did not lead to a commercial vaccine. Problems arose with vaccination of young animals. Juvenile animals often are not yet immunocompetent at the time of vaccination or still have maternal antibodies that kill and eliminate vaccine larvae before they can stimulate immunity.

### Subunit Vaccines

A major advantage of live vaccines is that during invasion, tissue penetration and development a whole range of antigens is presented and generally a solid protective humoral and cellular immune response is stimulated. However, a major disadvantage is always that shelf life is short and insufficient attenuation may lead to pathogenic effects and the spread of the parasite. Compared to attenuated live vaccines, →subunit vaccines contain only a small number of defined antigens but are safe in that no viable parasites are administered and development and reproduction cannot occur.

One of the nematodes, where major research efforts have been undertaken is →*Haemonchus contortus*, a sheep nematode that causes major economical losses in sheep breeding countries. Strategies for vaccine development against →haemonchosis basically take two different approaches: (1) identification of “natural antigens” (or conventional antigens), that are presented to the host’s immune system during natural or experimental infections and (2) search for “hidden antigens” (sometimes also called concealed, covert or novel antigens), that are extracted from internal parts of the parasite, mostly the gastrointestinal tract, and that are not “seen” by the host during the course of infection.

Natural antigens usually comprise excretory/secretory (ES) or surface antigens and in *Haemonchus* are mostly derived from the early infective larval stage (L3). In early immunization experiments whole L3 extracts and ES antigens gave no significant protection, whereas a high molecular weight (>30,000) fraction from both antigen preparations reduced wormburdens after challenge by 59%. Immunization with a purified metabolite of exsheathed *in vitro* cultured L3 considerably reduced the egg production but not the number of worms. A new approach for the identification of natural protective antigens was reviewed by Newton. It is based on the observation that →B-cells are rapidly recruited to the site of infection with a pathogen and to the local

**Vaccination Against Nematodes. Table 1** Studies on the protective potential of irradiated vaccines against nematodes (according to Schnieder)

NEMATODE	HOST	ATTENUATION
<b>Ascaridida:</b>		
<i>Ascaridia galli</i>	chicken	gamma
<i>Ascaris suum</i>	pig	UV
<i>Toxocara canis</i>	mouse	X-ray, UV
<b>Enoplida:</b>		
<i>Capillaria obsignata</i>	chicken	X-ray
<i>Trichinella spiralis</i>	<i>in vitro</i> , mouse	X-ray, UV
<b>Rhabditida:</b>		
<i>Strongyloides avium</i>	chicken	X-ray
<i>Strongyloides papillosus</i>	sheep	UV
<i>Strongyloides ratti</i>	rat	gamma
<b>Spirurida:</b>		
<i>Brugia malayi</i>	gerbil	gamma
<i>Brugia pahangi</i>	cat	gamma
<i>Dirofilaria immitis</i>	dog	X-ray
<i>Litomosoides carinii</i>	rat	X-ray, gamma
<i>Onchocerca volvulus</i>	chimpanzee	X-ray
<b>Strongylida:</b>		
<i>Amidostomum anseris</i>	goose	X-ray
<i>Ancylostoma caninum</i>	dog	X-ray, UV
<i>Ancylostoma ceylanicum</i>	hamster	UV
<i>Bunostomum trigonocephalum</i>	sheep	X-ray
<i>Cooperia oncophora</i>	cattle	X-ray
<i>Cooperia punctata</i>	cattle	X-ray
<i>Dictyocaulus filaria</i>	sheep	X-ray
<i>Dictyocaulus viviparus</i>	cattle	X-ray
<i>Gaigeria pachyscelis</i>	sheep	gamma
<i>Haemonchus contortus</i>	sheep	X-ray
<i>Heligmosomoides polygyrus</i>	mouse	X-ray
<i>Metastrongylus apri</i>	guinea pig	X-ray
<i>Nippostrongylus brasiliensis</i>	rat	X-ray
<i>Oesophagostomum columbianum</i>	sheep	gamma
<i>Ostertagia circumcincta</i>	sheep	UV
<i>Ostertagia ostertagi</i>	cattle	X-ray
<i>Stephanurus dentatus</i>	pig	UV
<i>Strongylus vulgaris</i>	horse	gamma
<i>Syngamus trachea</i>	chicken, pheasant	X-ray, gamma
<i>Trichostrongylus colubriformis</i>	gerbil, guinea pig, sheep	gamma
<i>Trichostrongylus tenuis</i>	grouse	X-ray
<i>Trichostrongylus vitrinus</i>	guinea pig	gamma

draining lymph node before they migrate into the target tissue and differentiate into antibody-secreting cells (ASC). It was therefore assumed that antibodies secreted by parasite activated B-cells are likely to recognize antigens important in rejection of the parasite by the host. Compared to serum antibodies, ASCs from immune animals, harvested during stimulation by the parasite from the lymph node draining the site of

infection, recognized a much more limited and different group of antigens. ASCs isolated from sheep 5 days after a challenge infection with large doses of →*H. contortus* specifically recognized L3/L4 antigens at approximately 44–48 kDa and a broad band at 70–83 kDa. These antigens did not react with ASCs from older infections (without challenge) whereas serum from both groups showed complex patterns of

antigens, emphasizing the advantage of using ASCs compared to serum. The 70–83 kDa band proved to be a glycosylated L3 surface antigen. Immunization trials with this purified antigen showed a significant reduction in total faecal egg counts (FEC) in vaccinates of 54% and 50% in adult worm numbers. Although natural antigens described above conferred only about 50% protection, efficacy could possibly be enhanced with optimal →antigen presentation and different adjuvants.

A number of ES antigens from adult worms and L3 with protease activity have been described and some have been evaluated for their protective potential. Three apical gut surface proteins of adult *H. contortus*, p46, p52 and p100, were able to induce protective immunity to challenge infection in goats. All three proteins are encoded by a single gene, GA1, and initially expressed in adult parasites as a polyprotein, p100GA1. p46GA1 and p52GA1 are related proteins with 47% sequence identity. GA1 proteins occur in the abomasal mucus of infected lambs, suggesting that they are ES antigens and possibly presented to the host immune system during infection.

In other experiments partly purified low molecular weight antigens obtained by gel filtration of whole worm homogenates or total adult ES antigens were tested for their ability to induce protective immunity against *H. contortus*. Except for one animal low molecular weight fraction vaccinates showed a highly significant reduction of adult worms of 97.6% and FEC reduction of 99.9%. Vaccination with ES antigens conferred a lower protection of 63.7% (adult worms) and 32.2% (FEC). Further analysis of the ES fraction of adult worms revealed two immunogenic low molecular weight proteins of 15 and 24 kDa, the first not glycosylated the latter containing some glycosylation. Sheep immunized with either fraction showed more than 70% reduction in worm burdens and FEC, respectively. Corresponding recombinant proteins were isolated from a *H. contortus* L5 cDNA library and expressed in *E. coli*. As mRNA encoding both ES products occurred only in the parasitic stages, expression appears to be developmentally regulated. Both recombinant antigens were recognized by sera from *H. contortus* hyperimmunized sheep, suggesting that antigenic determinants were also present on the recombinant proteins. Protein extracts enriched for cysteine protease activity (thiol Sepharose-binding fraction = TSBP) confer substantial protection against challenge infection. Fractionation of these proteins showed that protection is associated with the protease components of the protein. Vaccination with recombinant cysteine proteases did not reduce faecal egg counts and showed a moderate (38%), but significant reduction in worm burdens.

Whereas immunity against natural antigens is boosted by natural infections, immunity against hidden

antigens is not. The hidden antigen strategy has been simultaneously developed for the cattle tick →*Boophilus microplus* and for the nematode *H. contortus*, both haematophagous parasites. The immunization of an animal against “Achilles’ heels” of the parasite such as surface proteins from the gastrointestinal tract or metabolic or detoxifying enzymes will result in the production of specific circulating antibodies. After ingestion of these antibodies by the parasite they bind to the corresponding antigen and disrupt its structure or function. Although this strategy is most effective in blood feeders the ingestion of immunoglobulins has also been described for non-blood feeding nematodes such as →*Ostertagia* and →*Dictyocaulus*. The first hidden antigen described for *H. contortus* was a polymeric helical structure, associated with the surface of the intestinal epithelium, called contortin. Although immunization trials showed protection levels of >90% purification proved to be difficult. With the discovery of H11 contortin was not further developed. H 11 (or H110D) is a heavily glycosylated 110 kDa integral membrane protein of intestinal →microvilli of adult *H. contortus*. DNA and amino acid sequence analysis showed a high identity to mammalian microsomal aminopeptidases. Their function is the cleavage of dipeptide products of digestion to amino acids for transport across the plasma membrane. Therefore the efficacy of the vaccine is most likely based on the inhibition of enzyme activity and subsequent starvation of the worms for essential amino acids. Numerous immunization trials with different breeds of sheep showed that, unlike irradiated vaccines, H11 is effective in very young lambs already and average protection levels exceed 90% in terms of FEC reduction and 75% reduction in worm burdens. The higher effect on egg production is at least partly caused by the fact that the vaccine affects female worms to a greater extent than males. Additionally, surviving female worms are smaller than those from control animals and presumably produce fewer eggs. As the parasites have to suck blood before protective antibodies can be effective, PCV values fall after challenge, but less marked than in controls and animals do not show clinical signs of haemonchosis. Although the native H11 is highly protective and recombinant clones have been produced, there are no reports to date about successful immunization trials with the recombinants. It may be assumed that *in vitro* expression of the heavily glycosylated protein in both prokaryotic and eukaryotic cells does not correctly produce the immunogenic epitopes. Aminopeptidases are functional proteins not only present in *Haemonchus*. Homologues have been described in *Ostertagia* spp. and will most likely be present in numerous nematodes.

During the first steps for the extraction of H11 two additional proteins are co-purified, H45 od also termed P1 and a *H. contortus*-galactose binding glycoprotein

(H-gal-GP). P1 is a protein complex that comprises 3 protein bands on SDS-PAGE of about 53, 49 and 45 kDa. P1 is also localized at the surface of intestinal epithelium cells and has aspartyl proteinase activity. It is assumed that it contributes to the digestion of blood meals and may therefore be a promising vaccine candidate. Immunization trials showed only about 30% reduction of adult worms and about 70% egg counts. H-gal-GP is a complex of intestinal surface proteins that appear on non-reducing SDS gels as two main bands at 230 and 170 kDa and two faint bands at 47 and 50 kDa. It is not known whether one of these bands or the complex as a whole confers protection. Immunization with the whole protein complex showed an average FEC reduction of about 90% and again a lower efficacy against adult worms with approximately 60% reduction after challenge. Antibodies raised against the corresponding recombinant antigen bound to the luminal surface of the gut in adult *H. contortus*, but to date no data about protective potential of the recombinant antigen are available. The examples show that gut associated proteins of *H. contortus* proved to be a rich source for vaccine candidates and will be further evaluated.

Although non-blood feeding nematodes do also take up host IgG, to date only natural antigens have been examined for their protective potential in other trichostrongylid nematodes. A complex ES antigen preparation (molecular weight > 10,000) of adult *Cooperia punctata* showed various degrees of protection ranging from 16% to >80% reduction of worm counts in calves. Immunization trials with ES antigens from exsheathed *Trichostrongylus colubriformis* L3 in guinea pigs showed worm reductions between 0% and 74%. Among different protective components an immunodominant glycoprotein of 94 kDa was identified.

In *Ostertagia circumcincta* a 31 kDa glycoprotein (GP31) was identified in secretory organelles within the cells of the oesophageal glands of L3. After *in vitro* cultivation GP31 was shown to be one of the major components of the ES complex. The purified GP31 had no detectable proteolytic activity in protein degradation assays, but homologues were found in *T. colubriformis* and *H. contortus* L3. Immunization of lambs conferred insignificant reduction in total worm counts and FEC. In immunized animals humoral and cellular immune responses could be detected.

Tropomyosin is a protein of muscle cells of vertebrates but can be found in different isoforms in non-muscle cells such as fibroblasts as well. A 41 kDa tropomyosin has been identified from a detergent-soluble fraction of *T. colubriformis* L3. Immunization of guinea pigs with the 41 kDa antigen induced 43–51% protection in terms of reduced worm burden after challenge infection. The same antigen was isolated from *Acanthocheilonema viteae* and conferred significant protection (up to 65 % reduced adult worms,

up to 95% reduced circulating microfilariae) in jirds. Recombinant tropomyosin cDNA clones from *Onchocerca volvulus* have been used to vaccinate BALB/c mice against challenge infection with *O. lienalis*. Significant reductions (48–62%) in the recovery of microfilariae from the skin were achieved. Recombinant tropomyosin clones have also been prepared from *T. colubriformis* and *H. contortus*; however, protectivity data have not yet been published.

→Paramyosin, a filamental protein, is a substantial part of →myosin filaments in muscle cells of many nematodes. It blocks the actomyosin binding in the contracted muscle cell to make possible a persistent contraction without energy consumption. Paramyosin has been identified as a protective antigen and a major vaccine candidate in schistosomes but also in different nematode species. In filariid nematodes such as *O. volvulus*, →*Dirofilaria immitis* and →*Brugia malayi* paramyosin clones have been identified. Immunization of mice with a native 97 kDa paramyosin homologue of *B. malayi* reduced microfilaraemia by 40–60% after *i.v.* challenge with live *B. malayi* microfilariae. Vaccination of jirds with a recombinant *B. malayi* paramyosin fused with maltose-binding protein (BM5-MBP) stimulated protection against challenge infection. Adult worm recoveries (43%) and female worm length (10%) were significant, blood →microfilaria counts slightly reduced compared to MBP vaccinated controls.

The early success and the introduction of a commercial live vaccine against *D. viviparus* in cattle seemed to paralyze the research on lungworm immunity and the search for alternative vaccine candidates for the following years. Because vaccination trials with cattle are expensive, most studies on protective antigens were done in a guinea pig model. However, it is well known that the immune response is different from cattle and antigens such as lyophilized worms that proved to be protective in guinea pigs may have no efficacy in cattle. McKeand and colleagues immunized guinea pigs with either somatic extracts of adult lungworms, somatic extracts of L3 or ES products from adults. Only the adult ES fraction conferred more than 80% protection.

Acetylcholinesterases (AChE) are found mainly in adult stages of many free-living and parasitic nematode species. Secreted AChE are assumed to have an anti-coagulant role and affect glycogenesis. Most importantly, however, they seem to have an immune modulatory effect and reduce inflammation in the vicinity of the parasites. The reason why some benzimidazole resistant nematode strains contain elevated amounts of AChE is still unknown. As in many other nematodes AChE activity was also identified in somatic extracts and ES products of adult *D. viviparus*, the latter containing over 200 times more AChE activity than the first. In Western blots AChE was only recognized by serum from naturally or experimentally infected calves and not by

serum from irradiated larvae vaccinated animals, suggesting that AChE is secreted only by adult worms. Guinea pigs immunized with the AChE enriched fraction of ES antigens of adult worms showed significant lower worm burdens after challenge. The AChE was successfully cloned but immunization trials with the recombinant antigen in cattle were not successful. A secretory AChE from *T. colubriformis* had already been used to vaccinate against mixed infections of *T. colubriformis*, *H. contortus* and *C. oncophora* with average worm count reductions of 31% and up to 58% in individual cases.

In preliminary vaccination trials recombinant methyl transferases showed a substantial degree of protective potential reducing worm burdens and larval counts by more than 50% while stimulating a strong IgG response.

Vaccination with an ES polyprotein allergen in *O. ostertagi* was able to reduce faecal egg counts by 60%. Adult worms in the vaccinated animals were significantly shorter. Adult worm ES cysteine protease enriched proteins used in vaccination trials were also able to reduce egg counts by 60%. Neither of these proteins was successful as recombinant antigen.

Because of its zoonotic importance and lacking prophylactic strategies a vaccine against *Trichinella spiralis* would be a great advantage. A preparation of whole newborn *T. spiralis* larvae killed by freezing and thawing induced a high level of protection against challenge. Muscle larval counts were reduced by 78% compared to 40% after immunization with ES antigens from muscle larvae. In a comparative study freeze-thaw/sonicated preparations of newborn larvae, adult worms, muscle larvae and a mixture of all three were used to immunize pigs. Eight weeks after challenge infection muscle larval counts were reduced by 82–93% (newborn larvae), 66% (muscle larvae) and 98% (mixture of all fractions). ES antigen preparations from *T. spiralis* and *T. britovi* conferred significant protection in a mouse model, showing that *T. britovi* was more immunogenic with greater host-protective immunity. A 40-mer synthetic peptide was produced from a 43 kDa immunodominant glycoprotein secreted by *T. spiralis* larvae. Immunization of mice with the 40–80 peptide fraction induced an accelerated expulsion of adult worms from the gut. As this is mainly induced by T-cell-mediated inflammatory events in the intestine, the 40–80 peptide was assumed to induce a protective T-cell response. This was the first time a synthetic peptide was shown to confer protective immunity in an intestinal nematode.

Successful DNA vaccination trials against *T. spiralis* suggest that this may be a promising way of immunization.

### Recombinant Subunit Vaccines

The production of purified native antigens of defined quality for a commercial vaccine would be too expensive. Promising subunit vaccine candidates must be produced as recombinant antigens. Although recombinant subunit vaccines hold great promise, they do present some potential limitations. Recombinant subunit vaccines generally seem to be less immunogenic than their conventional counterparts because they are composed of a single antigen. In contrast, conventional vaccines contain a mixture of antigens that may aid in conferring an immunity to infectious agents that is more solid than could be provided by a monovalent vaccine.

Vaccination with recombinant subunit proteins or synthetic peptides is often hampered by a weak immune response due to inappropriate presentation of the antigen to the host's immune system or the loss of critical immunogenic epitopes during *in vitro* expression. Additionally protein immunization very often stimulates a B-cell response only where a T-cell response is necessary for protective immunity. Such problems may be circumvented by DNA vaccines (also called DNA-based immunization, genetic immunization, naked DNA vaccines, etc.) which has recently emerged as an attractive alternative to conventional vaccines. Numerous studies have already shown that immunization of experimental animals with plasmid DNA encoding antigens from a wide spectrum of parasites leads to protective humoral and cell-mediated immunity. cDNAs encoding protective protein epitopes can be cloned into plasmid vectors containing strong mammalian promoters for high expression. Purified plasmid DNA containing the protective parasite antigen is administered to the host via intramuscular or subcutaneous or intracutaneous injection or needle free application by carbon dioxide pressure (Biojector<sup>®</sup>, Bioject Inc.) or with particle bombardment (Gene gun<sup>®</sup>, Powderject Inc.). The DNA is incorporated by professional antigen presenting cells and tissue cells and expressed in enough quantity to induce a potent and specific protective immune response. Expression of the protein antigens of interest directly in host cells can provide appropriate tertiary structure for the induction of conformationally specific antibodies, and also facilitates the induction of cellular immunity. Because the vaccine does not contain genetic elements responsible for replication or infectivity, the vaccine itself is safe and cannot cause the disease. DNA vaccine technology has been successfully used to protect against many different viral, bacterial, mycoplasmal, protozoal and worm infections. Except for successful trials with a cestode (*Taenia ovis*) and *trematodes* (*Schistosoma* species) preliminary DNA vaccination trials against

nematode infections have been conducted to date with →*A. caninum*. A paramyosin homologue was used to intramuscularly immunize mice and dogs against challenge infection. Preliminary results showed a consistent B- and T-cell stimulation and reduced wormcounts.

As mentioned before, one of the disadvantages of using single clones as vaccine candidates is often the narrow immunogenic spectrum that may lead to an inappropriate immune response compared to conventional vaccines. The current approach to include a large number of cDNAs encoding putative protective antigens without knowing beforehand the protective epitopes is called 'expression library immunization' and comprises the vaccination with several thousand different cDNAs at the same time. DNA vaccine technology is only beginning to exploit its possibilities in parasite vaccine development and as its advantages in terms of production costs, storage conditions, safety and efficacy compared to other vaccines are convincing, it can be expected that the number of vaccination trials against nematodes will increase and possibly will soon lead to the development of a commercial product.

## Vaccination Against Platyhelminthes

### General Information

#### Requirements of Vaccines Against Multicellular Organisms

The development of vaccines against multicellular parasites, such as platyhelminths, poses particular requirements. Although many vaccines have been developed and marketed to protect against viruses and bacteria, vaccines against parasitic →protozoa and →metazoa are limited to a few that are available solely for animal use. None has yet successfully been developed which eliminates or eases the burden that multicellular parasites inflict on people. Not only have platyhelminths a far more complex genetic composition than do viruses and bacteria, they also pass through an often complex sequence of developmental stages that home in to specific sites within their host's body. Thus, the target of an antiplatyhelminth vaccine constantly changes and moves. In →coevolution with their hosts, these parasites have acquired sophisticated mechanisms of →immune evasion. As a result, little or no protective immunity develops even in hosts that are frequently reinfected or superinfected. A vaccine against a platyhelminth ought to target a mixture of diverse antigens.

### Advantages of Immunotherapy over Chemotherapy

Although chemotherapy successfully reduces worm burden resulting from the most common platyhelminth infections, a vaccine would offer added benefits. Whereas a drug removes worms after they have accumulated in the host's body, a vaccine prophylactically limits or even prevents the worm burden. Drug therapy fails to prevent reinfection and necessitates frequent re-treatment; its antiparasitic effect, however, is almost immediate, often acting within hours or days. Immunity resulting from vaccination develops slowly, requiring several months, but continues to protect the host for years, particularly when frequently boosted by exposure to the parasite. Drug resistance of platyhelminths is a common outcome of overuse or inadequate administration of a drug. No such genetic adaptation to vaccine-induced immunity has yet been demonstrated for any pathogen. To combine the immediate but short-term effect of chemotherapy with the slowly generated but long-lasting effect of →immunoprophylaxis seems the most desirable strategy.

### Reduction of Morbidity Versus Sterilizing Immunity

In contrast to parasitic protozoa, platyhelminths, such as schistosomes, fasciolids, and taeniid →cestodes, do not divide within their definitive hosts. The worm burden is accumulative and chronic. It differs sharply from the sudden acute attack by rapidly dividing protozoan parasites. Vaccines against parasitic protozoa, such as →*Plasmodium* spp., must produce a sterilizing immunity. Because the →morbidity resulting from platyhelminths derives largely from the intensity of infection, even a partially effective vaccine may benefit the host by reducing pathology. To evaluate the protective potential of an experimental vaccine against platyhelminths, the worm burden resulting from a challenge of vaccinated animals is compared with that of challenged nonvaccinated animals. The degree of pathology can also be compared. Immunoprophylaxis would not only limit morbidity, it may also reduce transmission. If the →fecundity of the challenge worms is affected by the vaccine, egg production is reduced, subsequently affecting the transmission of the parasite. A vaccine directed against platyhelminths may be effective in reducing morbidity and limiting transmission, even if it fails to eliminate all worms.

### Concomitant Immunity and Acquired Resistance

Infections with platyhelminths rarely induce →acquired immunity. A particular form of immunity has been described as concomitant immunity. Here, a persisting primary infection confers resistance of the host against a



secondary infection with the same pathogen. In the murine model of schistosomiasis, however, it has become evident that the presumed concomitant immunity is an artifact. Pathology induced by →granuloma formation affects the portal vasculature and impedes the establishment of schistosomes that arrive with a secondary infection. Platyhelminths have evolved successful mechanisms of immune evasion. Schistosomes, for example, adsorb host molecules on their surface to disguise themselves against the host's immune system. Evidence of acquired immunity against human schistosomiasis remains inconclusive. Although prevalence and intensity of infection decreases with age, children before puberty are completely unprotected.

## Parasite Antigens as Vaccine Candidates

### Antigen Groups

**Fatty acid-binding protein (FABP)**, a protein of 12–14 kDa, has been described for various platyhelminths, including →*Schistosoma*, *Fasciola*, and →*Echinococcus*. Similar to its mammalian counterpart, it is involved in intracellular transport of fatty acids. By electron microscopy, it is detected in lipid droplets in the subtegumental area of male schistosomes and in vitelline droplets of the →vitelline glands of female schistosomes. Vaccination of cattle with purified FABP achieves 55% protection against →*Fasciola hepatica* and 30% protection against →*F. gigantica* (Table 1). It reduces the worm burden resulting from a *F. hepatica* challenge in vaccinated mice by more than 80%. In FABP-vaccinated outbred mice challenged with *Schistosoma mansoni*, up to 67% reduction in worm burden may be achieved; in similarly treated rabbits, protection reaches 90%. Mice and rats vaccinated with either recombinant FABP or DNA vaccine develop 32–39% resistance against a challenge with *S. japonicum*, whereas in sheep, vaccination with recombinant FABP reduces the worm burden of a *S. japonicum* challenge infection by 59%.

**Sm23** and **Sj23**, the integral membrane protein of 23kDa of *S. mansoni* and →*S. japonicum*, respectively, is present on the surface of all stages of schistosomes in the mammalian host. It is expressed also by the lung stage which presents a favorable target for a vaccine. Mice vaccinated with its recombinant form or with Sm23 as a multiple antigenic peptide (MAP) achieve 40–60% protection against a challenge with *S. mansoni* (Table 1). Sm23 administered as plasmid DNA to mice results in a 44% reduction of worm burden. A similar degree of protection results from vaccination of mice, sheep, or water buffalo with recombinant Sj23 or with plasmid DNA. Interestingly, Sm23 and Sj23 are members of a superfamily of membrane proteins of unknown function expressed by hemopoietic and/or malignant cells of mammals.

**Glutathione-S-transferase (GST)** is an ubiquitous enzyme that initiates detoxification of xenobiotics or endogenous toxic compounds. Several isoenzymes between 23 and 28 kDa are found in schistosomes and fasciolids. It is localized in the →parenchyma and the →tegument of schistosomula and adult schistosomes as well as of juvenile and adult *F. hepatica*. As much as 70% reduction in worm burden can be achieved over an extended period in vaccinated sheep and cattle challenged with *F. hepatica* (Table 1). Protection against a challenge with *S. mansoni* by vaccination with native or recombinant GST reaches levels of 30–60% in experimental rodents and of 40% in nonhuman primate models. In addition, it reduces the fecundity of female schistosomes as well as egg viability. As a result, GST may also reduce morbidity and affect transmission efficiency. SmGST28 of *S. mansoni* has been tested extensively and in diverse vaccine formulations. SjGST26 of *S. japonicum* and SbGST28 of *S. bovis* are similarly promising vaccine candidates and have been tested in recombinant form or as plasmid DNA in a variety of hosts. Preclinical trials in people using recombinant ShGST28 of *S. haematobium* have been initiated to evaluate safety. Although no protection data are yet available for mice vaccinated with purified plasmid DNA encoding SmGST28, studies on this DNA vaccine indicate that it effectively stimulates antigen-specific humoral and cell-mediated immune responses.

**Triosephosphate isomerase (TPI)** is an ubiquitous glycolytic enzyme of 28 kDa that has been detected in all stages of schistosomes. It appears to be localized on the surface of →cercariae and young schistosomula. Monoclonal antibodies specific for TPI confer protection in the murine model and initiated research on this vaccine candidate. Vaccination with synthetic peptides of TPI in the form of MAPs reduces the worm burden of a challenge infection with *S. mansoni* in mice by 30–60% (Table 1). In pigs vaccinated with a TPI plasmid DNA vaccine, worm burden is reduced by 48% upon challenge infection with *S. japonicum*. In addition, the egg output is halved, reducing the transmission efficiency of this zoonosis.

**Cathepsin L** includes two proteolytic enzymes of 27 (CatL1) and 29 (CatL2) kDa that are secreted in the gastrodermis of *F. hepatica* to aid digestion of ingested liver and blood tissue. Regurgitating worms release these enzymes into the host's blood stream. Both cathepsins may also have extracorporeal functions. CatL1 is able to cleave immunoglobulins and may, thus, prevent antibody-mediated attachment of effector cells. CatL2 cleaves fibrinogen furthering clot formation on the parasite's surface. Vaccination of cattle with atL1 reduces the worm burden of a challenge infection with *F. hepatica* by about 50% (Table 1). A combination of CatL2 and hemoprotein (see below) achieves more than

**Vaccination Against Platyhelminthes. Table 1** Candidate vaccine antigens that reduce worm burden resulting from various platyhelminth infections

Vaccine candidate	Molecular mass (kDa)	Form of antigen	Kind of platyhelminth	Kind of host	% Reduction in worm burden
Fatty acid-binding protein	12	Native	<i>Fasciola hepatica</i>	Mice	80–100
				Cattle	55
	12	Native	<i>Fasciola gigantica</i>	Cattle	30
	14	Recombinant	<i>Schistosoma mansoni</i>	Mice	67
				Rabbits	89
	14	Recombinant DNA	<i>Schistosoma japonicum</i>	Mice	39
				Mice	34
			Rats	32	
			Sheep	59	
Sm23	23	MAP	<i>Schistosoma mansoni</i>	Mice	60
		DNA		Mice	44
Sj23	23	Recombinant	<i>Schistosoma japonicum</i>	Sheep	59
		DNA		Mice	38
				Sheep	42
				Water buffalo	38
Glutathione-S-transferase	23–26	Native	<i>Fasciola hepatica</i>	Cattle	50–70
				Sheep	57
	28	Native/recombinant	<i>Schistosoma mansoni</i>	Mice	30–60
				Rats	40–60
				Baboons	38
	28	Recombinant	<i>Schistosoma bovis</i>	Goats	48
	26	DNA	<i>Schistosoma japonicum</i>	Water buffalo	39
	26	Recombinant		Pigs	25–28
Cattle				30	
			Sheep	30–60	
Triosephosphate isomerase	28	MAP	<i>Schistosoma mansoni</i>	Mice	30–60
		DNA	<i>Schistosoma japonicum</i>	Pigs	48
Cathepsin L	27–29	Native	<i>Fasciola hepatica</i>	Cattle	40–70
Oncosphere antigen 45W	45	Recombinant	<i>Taenia ovis</i>	Sheep	94–100
Calpain	80	Recombinant	<i>Schistosoma mansoni</i>	Mice	29–39
		DNA		Mice	39
	80	Recombinant	<i>Schistosoma japonicum</i>	Mice	41
Oncosphere antigen EG95	95	Recombinant	<i>Echinococcus granulosus</i>	Sheep	96
Oncosphere antigen EM95	95	Recombinant	<i>Echinococcus multilocularis</i>	Mice	83
Paramyosin	97	Native/recombinant	<i>Schistosoma mansoni</i>	Mice	30
		Native/recombinant	<i>Schistosoma japonicum</i>	Mice	60–80
		Native		Sheep	48
	98	DNA	<i>Taenia solium</i> / <i>T. crassiceps</i>	Mice	48
Hemoprotein	>200	Native	<i>Fasciola hepatica</i>	Cattle	43

70% protection against *F. hepatica* in cattle. In addition, the egg output of *F. hepatica* in vaccinated sheep and cattle is reduced by up to 70% and surviving eggs are less viable than those generated in nonvaccinated hosts. In schistosomes, **cathepsin B** and **hemoglobinase** with a molecular mass of 31 and 32 kDa, respectively, are secreted in a similar fashion by those stages of schistosomes that digest blood. Although the protective capacity of these digestive enzymes has not been studied in animals challenged by blood →flukes, related enzymes appear to protect hosts against →liver flukes.

The cestode-specific **45W antigen** has been isolated from oncospheres of *Taenia ovis*. Its recombinant form induces 94% protection in sheep (Table 1). 45W is the first vaccine against a platyhelminth that is registered for commercial use. However, the amount of 45W expressed by different parasite isolates varies, possibly affecting their susceptibility to anti-45W immune responses. Studies on the oncosphere antigens EG95 of *Echinococcus granulosus* and EM95 of *E. multilocularis* demonstrate similarly high degrees of protection. Oncosphere antigens of taeniid cestodes are promising candidates for the vaccination of intermediate hosts, thereby limiting the transmission of these →tapeworms to their definitive hosts.

The large subunit of **calpain** of 80 kDa, a calcium-dependent neutral cysteine protease, appears to be secreted by migrating cercariae and schistosomula. Vaccination of mice with recombinant calpain or with a calpain DNA plasmid results in 30–40% protection in mice against challenge infection with either *S. mansoni* or *S. japonicum*. Fecundity of the adult worms in vaccinated mice is also impaired.

→**Paramyosin**, known to be involved in the catch mechanism of mollusks, is a major component of the thick filament of invertebrate muscles. This 97 kDa protein is expressed by all stages of schistosomes, localized in membrane-bound elongate bodies of the tegument. Paramyosin does not appear to be a surface protein that is easily accessible by the immune system. However, metacestodes of →*Taenia solium* and adult schistosomes secrete this protein, as it is detected in culture supernatants. Electron microscopy studies also suggest that schistosomula release paramyosin from their postacetabular glands, while shedding the highly immunogenic →glycocalyx of their previous stage. Paramyosin of these platyhelminths inhibits the classical complement cascade by binding to the collagen-like region of C1. As a result, it may modulate the host's immune system. Native and recombinant paramyosin confer protection against challenge infection; at least 30% reduction of worm burden has been measured in paramyosin-vaccinated mice after challenge with *S. mansoni* and as much as 80% protection has been achieved against *S. japonicum* (Table 1). Intramuscular injection of a plasmid construct containing a fragment

of *T. solium* paramyosin confers 48% protection in mice challenged with *T. crassiceps*.

Although the **hemoglobin-like protein** found in *Fasciola* has a similar adsorption spectrum to that of hemoglobins, its sequence bears no resemblance to this ubiquitous protein. The function of hemoprotein with a molecular mass exceeding 200 kDa is unknown but may involve oxygen transport or storage. Cattle vaccinated with hemoprotein and challenged by *F. hepatica* harbor a worm burden that is reduced by about 40% (Table 1). A combination of hemoprotein and cathepsin L achieves up to 70% protection with an additional 98% decrease in egg production. Thus, a combined vaccine including hemoprotein may offer the added benefit of limiting parasite transmission.

### Parasite-Specific Antigens and Ubiquitous Proteins

The platyhelminth antigens that are currently under investigation as vaccine candidates can be divided into those that are specific to the parasite and those that are similar to host proteins. Parasite proteins of genetically conserved nature bear the risk of stimulating autoimmune responses in the host. Of the vaccine candidates that resemble host proteins, such as GST, TPI, Sm23, cathepsin, and FABP, none has yet been shown to elicit autoimmune responses of the host. Not surprisingly, the epitopes that stimulate protective immune responses are located in the nonconserved, parasite-specific regions of these proteins. If selected epitopes, e.g., in the form of synthetic peptides, are used for vaccination rather than the entire protein, the genetic variability of the host may affect the effectiveness of the vaccine in different host individuals. Parasite-specific proteins such as the hemoprotein of *Fasciola* and the 45W oncosphere protein of →*Taenia* constitute unique targets. Their functions remain unidentified, but may relate to the unique requirements of these parasites in their host organisms. Paramyosin, a protein common to invertebrates, may have a different function in platyhelminths, as its location in the parasite suggests. To circumvent the genetic variability of the host organism, a cocktail of a variety of vaccine antigens or of selected epitopes seems most appropriate.

### Homologous and Cross-Protective Antigens

Particular vaccine candidates have been identified for several different platyhelminths. GST is a protective antigen in fascioliasis as well as in schistosomiasis, its immunoreactive epitopes, however, differ. Variances in B- and T-cell repertoires of the respective definitive hosts may have led to this distinct immunoreactivity. Within the genus of *Schistosoma*, cross-protection by vaccination with GST may be feasible. Paramyosin secreted by schistosomes and taeniid cestodes may share a similar immunomodulating function for both groups of worms.

Some of these homologous antigens even cross-protect their hosts against diverse worms. A particular protein fraction of *F. hepatica* not only protects mice and cattle against the worms that served as source for the antigen preparation, it also reduces the worm burden of mice challenged by schistosomes. This cross-protective protein fraction of liver flukes contains an FABP that is homologous to its counterpart in blood flukes. Similarly, vaccination with the recombinant FABP of *S. mansoni* reduces the worm burden of mice challenged by cercariae by 67% and completely abrogates the establishment of *F. hepatica* → [metacercariae](#) in the same animal model. Thus, one antigen may potentially protect against two kinds of worms.

### Vaccination Methods

An array of different vaccination methods has been evaluated for potential antiplatyhelminth vaccines. Exposing hosts to **irradiated larvae** consistently generates high degrees of protection. In schistosomiasis, the worm burden of challenge infection in mice vaccinated with irradiated cercariae is reduced by an unsurpassed 90% compared to nonvaccinated mice. Because it is not practical to vaccinate people or animals with such short-lived attenuated larvae, this approach is considered as a model system to identify vaccine candidates and understand the requirements for optimal vaccination routes (→ [Schistosomiasis, Man/Vaccination](#)). **Native antigens** purified from the parasites are usually obtained in such small quantities that they are not sufficient for more than the early phase of the development of a vaccine. Commonly, vaccine candidates are produced as **recombinant proteins**. Large quantities can easily be generated. Different expression systems are available and the optimal system has to be determined for each vaccine candidate. Recombinant proteins expressed in bacteria however often lack glycosylation sites that are characteristic for the native protein and may, thus, stimulate altered immune responses. Alternatively synthetic peptides that contain protective epitopes may be presented as MAPs. This structure consisting of multiple peptides combined with a branching lysine core is large enough to eliminate the requirement of a carrier. Recently, vaccination with MAPs of TPI and Sm23 in mice challenged with *S. mansoni* produced promising results. The most recent development in vaccinology is the application of **DNA vaccines**. Instead of vaccinating with a protein, its coding DNA is injected into the organism that is to be immunized. The cell machinery of the vaccinated organism subsequently transcribes and expresses the antigen. Compared to protein vaccines, the advantages of DNA vaccines lie in fast and economic production and relative stability for storage. This technology permits multiantigen vaccines. In addition, the protective

capacity of heterologous prime–boost vaccinations may be evaluated by priming with a DNA vaccine and boosting with its recombinant protein. Co-injection with particular cytokine-encoding plasmids helps driving the vaccine-related immune response toward protective Th subsets. Such plasmids function as genetic adjuvant, conventional adjuvants are not required.

To increase the immunogenicity of an antigen, various adjuvants are available. Freund's adjuvant, an oil emulsion of heat-killed *Mycobacterium tuberculosis*, saponins, and various other formulations have commonly been used in experimental animal models. Because of possibly severe local and systemic reactions, they are considered unsafe for use in people and their use in animals is now restricted. Solely aluminum hydroxides and aluminum phosphate are registered for use in people. The efficacy of self-replicating live vaccine vehicles is currently being tested; nonvirulent strains of *Salmonella typhimurium*, *Escherichia coli*, Bacillus Calmette Guérin (BCG), or vaccinia virus are transformed with gene fragments encoding the antigen in question. Other antigen vehicles in form of liposomes and proteosomes are similarly under development. Immune-stimulating complexes (iscoms) are cage-like structures consisting of the saponin Quil A, cholesterol, phospholipids, and antigen. Lastly, coadministration of interleukin-12 (IL-12) augments vaccine-induced immune responses to various pathogens. Besides determining the suitable antigen or cocktail of antigens, it is important to determine the optimal carrier for presenting it to the host's immune system.

## Vaccination Against Protozoa

### General Information

Parasite-induced diseases, both in animals and in man, represent a considerable medical and economical burden in many countries. Despite the availability of a number of effective drugs for treatment of the most important diseases, a pressing need for development of successful vaccines remains and is in fact increasing. The reasons for this are multifold. One of the most important is the increasing problem of resistance of vectors and parasites to both successfully used and newly developed drugs. This is typified, for example, by human → [malaria](#). In animals the main problem is in factory farming, where the presence of parasitic diseases over a long, seasonal time, requires high amounts of antiparasitic drugs, resulting in the associated problems of drug residues in milk, milk derived products and meat. In addition, such → [chemoprophylaxis](#) and

chemotherapy is often difficult to apply over a long period of time.

Many parasites possess sophisticated →immune evasion mechanisms making it, at present, difficult to conceive the development of efficient vaccines. However, the rapid development of immunology and genetic manipulations of cells will perhaps change these perspectives in the near future. Already commercially available vaccines against parasites as well as the state of development of other vaccines which might become applicable for animals or humans in the near future are described in detail under the headwords of the respective diseases.

### Immunological Aspects

In general parasites induce a strong humoral and cellular →immune response but this does not ensure that the host becomes protected against the disease and also against reinfection. Parasites indeed have developed mechanisms not only to evade immune responses of the host but also to facilitate their survival in the immunocompetent host and their transmission. Therefore, immune responses in most cases do not impair parasites' development and sometimes even favour their development but in contrast often become harmful to the host. Pernicious effect can originate from an excess of activation of the immune system to an exhaustion of the immune system that becomes unable to construct the convenient protective response; also an unbalanced production of cellular and/or humoral effectors can originate that results in immunopathology.

Various evasion/subversion mechanisms have been described among parasitic →protozoa to escape the host immunity. Some of them are very sophisticated such as →antigenic variation, well studied in African trypanosomes and more recently in →*Plasmodium* spp. Antigenic variation depends on polygenic families whose members code for membrane proteins at the surface of the parasite (or the infected cells) and are continuously exchanged. Therefore the immune system is constantly confronted with new parasite surface molecules. Intracellular protozoa like →*Leishmania*, *Toxoplasma* and *T. cruzi* have elaborate strategies to escape destruction by lysosome effectors: avoiding fusion of the →parasitophorous vacuole with →lysosomes by introduction of parasite proteins in the membrane vacuole like *Toxoplasma*, digesting the parasitophorous vacuolar membrane and invading the cytosolic compartment like *T. cruzi* surface structures which resist complement and hydrolytic lysosome enzymes like *Leishmania*. Invasive →*Entamoeba histolytica* secrete proteases that degrade antibodies and some protozoans inactivate antibodies producing sophisticated papain-like proteases that split the Fab2 fragments in the phenomenon described as fabulation.

Among the various processes elaborated by parasites to escape host immunity, are the production of parasite products able to interfere with the regulation of the immune response: for instance the production of mitogens and or superantigens inducing polyclonal B and/or T lymphocyte activation well described in trypanosomiasis and in toxoplasmosis. In →malaria the polyclonal T- and B-cell activation seems rather to be the result of a flood of soluble and insoluble antigens released during the schizonte rupture. The presence in numerous surface antigens of degenerate repeats of amino acids sequences but quite immunogenic is another sophisticated method elaborated by *Plasmodium* to escape immunity. These more or less degenerated repeats are dominant B-cell epitopes, inducing a strong antibody response with large and diffuse affinity avoiding clonal selection and maturation of B cell clones secreting high affinity specific antibodies. Another strategy to avoid the induction of an efficient immune response is the generation of high levels of antigenic polymorphisms. When concurrent presentation to the immune system of different allelic forms occurs, antigenic competition as well as altered peptide ligand antagonism prevent induction of an efficient memory response. This is another →evasion strategy utilized by malaria parasites. Another possibility is the production of a dominant antigen subverting the immune system. This is the case of the LACK antigen (*Leishmania* homologous for activated C kinase) which induces an early secretion of IL-4 by a particular T-cell population, thus creating a microenvironment propitious for the development of a Th2 T-cell response which prevents the development of a healing Th1 response. Some parasites produce macrophage and/or T lymphocyte activators that interfere with the cytokine cascade of the immune response, by an excess production of inflammatory cytokines (TNF, IFN- $\gamma$ ), creating a "cytokine chock" involved in different pathogenic mechanisms like in malaria.

### Accomplishments

In the early 1980s, with the development of new technologies in biological sciences, in particular recombinant DNA technology and monoclonal antibodies, it became possible to identify individual antigens that were the target of immune (humoral or/and cellular) responses. It became equally possible to identify, clone, and sequence the corresponding genes and to produce recombinant or synthetic antigens in considerable amounts to study them as possible vaccine candidates against various pathogenic parasites. The field of anti parasite vaccine then attracted a large number of new participants, particularly many brilliant and competent molecular biologists with, however, poor knowledge of parasitology and immunology. Their first contribution

was to discover an additional problem for vaccine construction, represented by the extreme variability and plasticity of the parasite genome, concerning sequences coding for potential vaccine targets. At the end of the century, 20 years after the beginning of this golden age, we still do not have any effective subunit anti-parasite vaccine. However, the efforts and investments made by the new generation of “vaccinologists” associated with progress in the understanding of immune mechanisms, has considerably increased our knowledge on the molecular structure of parasites, on the genetic variability, as well as on the immune responses (protective and escape mechanisms) they develop. This will certainly open new alternative pathways for the development of anti-parasite vaccines. In the present mature status of knowledge in these areas it is reasonable to wait for the birth of recombinant and synthetic vaccines with sufficient effects to be introduced in public health practices for control of parasite infections at the beginning of the new century. In the following, some important progress that has been made in the area since the 1st edition of this book justifying this optimistic view will be summarized.

### Progress in Understanding Protective Responses

The efficiency of antibodies in protection against parasites has been shown to depend not only on their inhibition/neutralization activity as observed in virus infections but also on their capacity to interact with immunocompetent cells such as, natural killer cells, monocytes/macrophages, or granulocytes to induce →ADCC (antibody-dependent cellular cytotoxicity), ADCI (antibody-dependents cellular inhibition), opsonization/phagocytosis, etc. The desired antibody response for such protective mechanisms is, therefore isotype-specific and depend on cellular effectors. New knowledge arises from the role of cytokines, like the role of IL-12 and inflammatory cytokines such as IL-18 and IFN- $\gamma$  in regulation of the Th1/Th2 pathways of T-helper lymphocytes and in the production of specific cytotoxic CD8 T lymphocytes. Immunologists are accumulating new information on the role of IFN- $\gamma$ , IL-4, IL13, and IL-10 in the regulation of the immunoglobulin switch in humans.

### Progress in Genetics

Considerable progress has been registered in the last decades on protozoan genome structure, particularly in *Leishmania*, →*Trypanosoma*, *Toxoplasma*, and *Plasmodium* parasites. On the one hand various Genome sequencing programs have now been developed, in particular by US and UK institutions with the support of TDR/WHO and private Foundations. In relation to parasites responsible for human diseases, data banks are organized like the TDR/IMMAL Malaria DNA sequence database open to access by Internet

(<http://www.monash.edu.au/informatics/malaria/who.html>) and the *Leishmania/Trypanosoma cruzi* database. On the other hand, genetic studies of some parasitic protozoa are in progress, due to the success in transfection with navette vectors which are able to grow in *E. coli* and/or yeast as well as in protozoa. These vectors have been used for promoting gene disruption, gene mapping, gene complementation, and gene replacement by homologous recombination. These genetic manipulations allow characterization of target proteins by their function and progress in the understanding of parasite virulence mechanisms as well as new rationale for the construction of attenuated parasites that will replace the empirical ones used so far.

### Progress in the Preparation of Antigen Carriers and Adjuvants

Until recently the only allowed adjuvant used in human vaccines was alum (antigens are adsorbed on aluminum hydroxide) which has poor effects. New adjuvants have been investigated and used in human volunteers and in animal trials. ISCOMS (immunostimulating complexes) are large spherical multilamellar structures of the Quil A adjuvant (complex lipid) associated to different immunogens. Other adjuvants in development are DETOX (cell wall skeleton of *Mycobacterium phlei* associated to lipid A and squalen), MPL (lysosome monophosphoril lipid A), mf59 9 (oil-water emulsion), QS-21 (saponin-based adjuvant), and detoxified toxin of *Pseudomonas aeruginosa*, tetanus, and diphteria toxoid. Enhancement of immune responses has also been achieved using cytokines as adjuvants, in particular IL-1 and IL-12, which act by enhancing →antigen presentation and/or processing via MHC pathways. In addition to adjuvants, synthetic peptides usually require carrier molecules containing “universal T cell epitopes” able to induce Th cells in a genetically diverse population. Tetanus and diphteria toxoids have been currently used as carriers but provoked some undesirable side effects such as hypersensitive reaction. More recently, synthetic carriers have been constructed such as MAPS (multiple antigen presentation) composed of 4, 8, or 16 peptide-antigen branched on a lysine core.

### DNA Vaccines

Finally, an important biotechnological development represented by DNA vaccines has been intensively studied recently and seems promising. This approach has been successfully used in the immunization of experimental animals against a range of infectious and parasitic diseases as well as several tumor model diseases. The technique involves insertion of the gene encoding the antigen of choice into a bacterial plasmid and intramuscular or subcutaneous injection into the host. This leads to the constant production at a low level of the antigen inducing long-lived humoral and

cellular immune responses. Among the numerous advantages of this revolutionary approach over the conventional vaccines is the induction of antigen-specific protective cytotoxic →T-cells as well as humoral immunity. The antigenic specificity of the Cytotoxic T cell response depends in this case on antigens presentation via class II MHC molecules. These advances and the emerging voluminous literature on this subject announce a wide use of this approach for animal vaccines development. At the same time, intense experimental vaccination of non-human primates and current trials with human volunteers indicate that DNA vaccines will certainly constitute the third generation of vaccines. Experiments to clarify and develop safety aspects for human use of DNA vaccine are, however, still not available for a generalized use in human trials.

### Examples for Vaccination

→Amoebiasis, →Babesiosis, Animals, →Chagas' Disease, Animals, →Chagas' Disease, Man, →Coccidiosis, Animals, →Leishmaniasis, Man, →Malaria, →Theileriosis, →Toxoplasmosis, Man, →Trypanosomiasis, Animals, →Trypanosomiasis, Man.

## Vaccines

### Name

Latin: *vacca* = cow.

Product to protect against infectious diseases. The number of anti-parasitic vaccines is rather limited (Table 1).

→Arboviruses, →Vaccination Against Protozoa, →Vaccination Against Platyhelminthes, →Vaccination Against Nematodes.

**Vaccines. Table 1** Anti-parasitic vaccines commercially produced

Parasite	Host	Type of vaccine
<i>Eimeria</i> spp.	Poultry	Non-attenuated
<i>Eimeria</i> spp.	Poultry	Attenuated for precocity
<i>Eimeria maxima</i>	Poultry	Subunit vaccine of gametocyte antigen
<i>Toxoplasma gondii</i>	Sheep	Attenuated for truncated life cycle
<i>Neospora caninum</i>	Cattle	Killed tachyzoites
<i>Babesia canis</i>	Dog	Antigens from <i>in vitro</i> culture supernatants
<i>Babesia bovis</i> and <i>Babesia bigemina</i>	Cattle	Attenuated by repeated passage through splenectomized calves
<i>Theileria parva</i>	Cattle	Non-attenuated wild-type parasites
<i>Theileria annulata</i>	Cattle	Attenuated by <i>in vitro</i> culture
<i>Giardia duodenalis</i>	Dogs	Disrupted axenically cultured whole trophozoites
<i>Taenia ovis</i>	Sheep	Recombinant antigen
<i>Dictyocaulus viviparus</i>	Cattle	Irradiated L <sub>3</sub> larvae
<i>Boophilus microplus</i>	Cattle	Recombinant tick gut antigen

## Vacuoles

→Reserve Granules, Food Vacuole (→Pellicle), →Parasitophorus Vacuole.

## Vahlkampfia

→Amoebae.

## Validation of Approaches

→Disease Control, Planning.

## Vampire Bats

### General Information

In South and Middle America unique →bats occur that lick blood after having scratched the skin of sleeping animals and humans with the help of their sharp incisive and long, stylet-like canini which appear vampire-like. The silent night flights of bats, their occurrence in large numbers, the shape of their teeth, and their blood-feeding activity have surely impressed human minds fearing human vampires and introduced these unique vampire bats as chubacabras into Mexican folkloristic songs. There exist recent species of such

vampire bats (*span.* chubracabras), while 3 others became extinct, prehistorically.

- →*Desmodus rotundus* is the most common species; it reaches a body length of about 9 cm, a diameter of the wings of 40 cm and a body weight of about 50 g (thus belonging to the medium-sized bats). The skin hairs of these mammals appear grey to brown, while the breast is light brown (Fig.1).
- →*Diphylla ecaudata* varies in body length between 7.5 and 9.3 cm, has small rounded ears and the hairs are dark brown at the backside, while light brown at the ventral side. The eyes are rather large.
- →*Diaemus youngi* reaches a body length of 8.5 cm and is characterized by dark brown wings with white rims and tips.
- Three other species – *Desmodus archaeodaptes* (Florida), *D. stocki* (Mexico, USA), and *D. draculae* (Venezuela, Brazil) – died out in prehistoric times. The latter bat was named according to Bram Stokers' novel character Count Dracula.

### Feeding Behavior and Transmission of Disease

- Vampire bats are active within the night and spend daytime hidden in buildings, under bridges, and in stony caverns – mostly in colonies of 30–300 animals. At night vampire bats look for prey. They fly around close to the ground and touchdown close to a possible blood spender. Then they crawl lightly onto the skin of the sleeping animals from where they may start with a start jump. In general, horses and cattle are bitten in the ears, between the eyes,

along the flanks, or in the sexual organs. In pigs they attack nose, ears, and the ventral body, while in man they prefer fingers, nose, ears, lips, and the lateral sides of the →neck. Children and young animals are mainly attacked apparently due to their soft skin. Having reached a favorable site on the host, the vampire bat licks a 10–15 mm<sup>2</sup> space of the skin and excretes saliva. Then the bat cuts off a small piece of the skin and/or scratches a wound of 1–3 mm in diameter. This process is painless and in general the hosts do not notice it. The blood, which is kept fluid by excreted coagulant components of the saliva, is taken up by licking. Depending on the speed of blood flow the feeding takes 8–60 minutes (~medium 25 minutes). Such bats may take up to 40 ml blood, which corresponds to 100% of their own body weight. The feeding is repeated each night and a portion of the blood is given to their own and other progeny. During the feeding process several pathogens may become transmitted:

- viruses of →rabies (transmission among animals and to man),
- viruses of hepatitis B (transmission among humans),
- trypanosomes (transmission among animals) leading to diseases such as →Mal de Caderas in horses or →Surra in many animals hosts.

Rabies is the most prominent problem, since more than 100,000 farm animals die each year in the USA and Mexico and many humans are affected, too. Furthermore the mechanical transmission of hepatitis B viruses is highly dangerous for people staying outside overnight in the bat biotopes.



**Vampire Bats. Figure 1** Teeth of a Vampire bat.

## Vampire Fish

### Synonym

→Candiru fish.

### General Information

In the Amazonas river and its tributaries so-called Candiru fish are found which live as vampires. They reach a length of about 1 cm and possess 2 hooklike teeth within their mouth →*Vandellia cirrhosa*/Fig.1.

### Feeding

By cutting the surface of fish, birds, and mammals (including man) their head may enter the skin and start sucking considerable amounts of blood. During drinking/bathing/working on the host in the water small fish stages (~3 mm in length) may enter the urinary bladder, nose, mouth, anus, or vagina of humans and



animals. After a few days severe inflammatory reactions occurred, leading (in many cases) to sepsis.

### Therapy

The exclusive therapy is the mechanical removal of the stages and the treatment of the infections by antibiotics.

## Vampirolepis

→Hymenolepidae.

## Vandellia cirrhosa

Species of the fish family Trichomyteridae (comprising over 40 genera with 180 species of small catfish). They are often nearly transparent (Fig. 1) and due to their small size of 5 cm at the maximum they are often called pencil catfish. *V. cirrhosa* and some related species enter occasionally (in the Amazonas region) the urethra, vagina, or anus of bathing or fishing humans. Due to this activity and its bloodsucking at inner walls of the human or animal organs it is named vampire fish, candiru, or carnero by the local population. Host attraction is probably due to ammonia or urea around these persons. Surgical removal is needed.

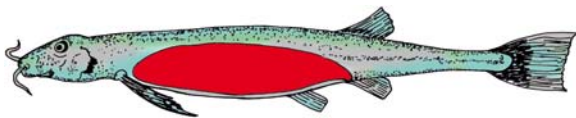

**Vandellia cirrhosa.** Figure 1 DR of a *Vandellia cirrhosa*, also named candiru, the intestine of which is filled with blood.

## Variable Antigen Types

→VAT, →Trypanosoma, →Surface Coat.

## Variant Surface Glycoprotein (VSG)

### Synonym

→VSG.

→Surface Coat/Antigenic Variation, →Glycosylphosphatidylinositols, →Trypanosoma.

## Varroa jacobsoni (syn. V. destructor)

A →mite parasitizing on honey bees (Figs. 1, 2); the adult females lay their eggs in the honeycombs. The proto- and deutonymphs of the mite suck hemolymph at the bee larvae, which thus become weak and finally die.

## Varroatosis

Disease due to infection of honey bees with the mite →*Varroa jacobsoni* which sucks at larvae and workers. Symptoms: Occurrence of small, degenerated workers, the number of which becomes constantly reduced.

### Therapy

Treatment with Amitraz (Miticur), Coumafos (Perizin, Ceteafix) or similar compounds.

## Vasculitis

→Cardiovascular System Diseases, Animals.

## VAT

### Synonym

Variable Antigen Type. →Surface Coat.

## Vector

A transmitter of pathogens and parasites (→Leeches, →Vampire Bats, →Insects, →Ticks, →Mites); transmission mostly occurs during bloodsucking or contamination of food with cyst stages from feces of infected hosts.

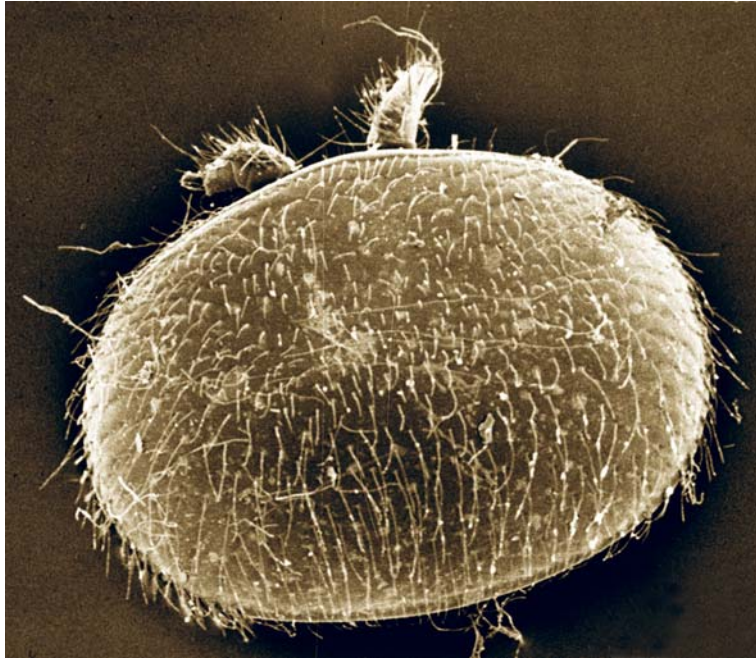

**Varroa jacobsoni.** Figure 1 REM of *Varroa jacobsoni* from dorsal.

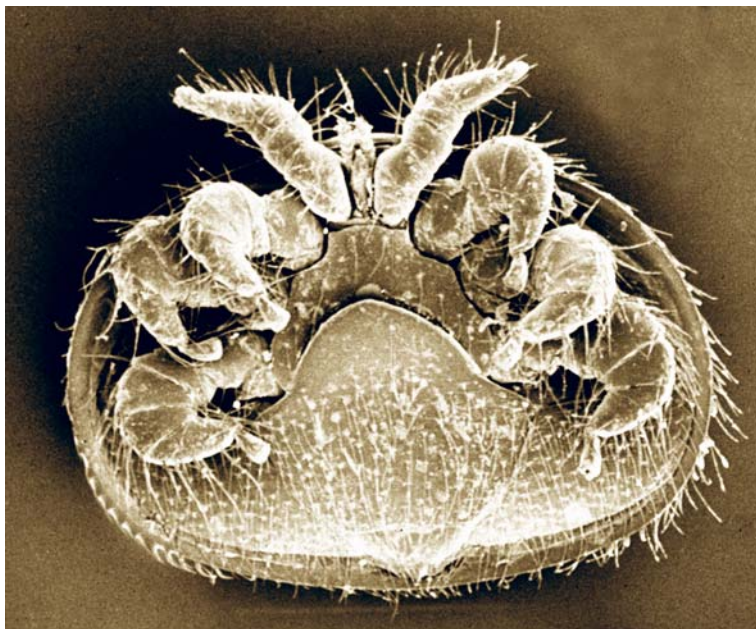

**Varroa jacobsoni.** Figure 2 REM of *Varroa jacobsoni* from ventral.

## Vector Capacity

The number of transmissions and the degree of efficacy of a vector-based transmission depends on different factors: host preference, biting or feeding rates/day, gonotrophic cycle, population densities of hosts and vectors, vector longevity, and climatic factors.

## Vector Competence

This describes the ability of a vector to become infected with a pathogen, to infect (eventually) its progeny by transovarial transmission, and to transmit the eventually reproduced or adapted pathogens to a suitable host. The vector competence is increased at higher temperatures.

## Vector Control

→Disease Control, Methods, →Insecticides.

## Velvet Disease

Fish disease due to infection with the protozoon *Oodinium ocellatum*.

## Ventral Disc

1. Structure (fortified by short protein fibrils) in →*Giardia* trophozoites, which allows them to attach at the surface of intestinal cells.
2. Holdfast system in →*Aspidobothrea*.

## Ventriculus

→Insects.

## Vermes

From Latin: *vermes* = worms, see →Helminth, →Helminthic Infections, Pathologic Reactions.

## Verruga peruana

Cutaneous disease due to infection with *Bartonella bacilliformis*-bacteria transmitted by →sand flies (*Lutzomyia colombiana*, *L. verrucarum*). The characteristic papulae appear on the skin of extremities and face several months after survival of the initial →Oroya fever.

### Therapy

Tetracyclines, Macrolids.

## Vertical Transmission

→Transovarial Transmission, →*Babesia*, →Arboviruses, →Ticks, →Insects.

## Vesicles, Endocytotic

→Endocytosis.

## Vesicular Layer

→*Acanthocephala*.

## Vesiculation

Clinical and pathological symptoms of infections with skin parasites (→Skin Diseases, Animals, →Ectoparasite).

## Vessel Feeders

→ [Insects](#) (e.g. mosquitoes).

## Viannia

Synonym of the genus name of → [Leishmania](#), e.g., *V. panamensis* causing local cutaneous leishmaniasis.

## Villous Atrophy

Symptom of disease (degeneration of intestinal villi) due to infections with → [Cryptosporidium](#).

## Virchow, Rudolf Ludwig (1821–1902)

German physician and politician, one of the scientific “popes” of his time, famous for his works on *Trichinella* and tapeworms, thus introducing the obligatory meat control. His conclusion – Latin: *omnis cellula ex cellula* – finished the scientific discussion on the origin of animals.

## Virosis

→ [Arboviruses](#), → [Bunyaviridae](#), → [Dipteraviridae](#).

## Virulence

Although various definitions of virulence were given by different authors, ecologists generally agree that “virulence” is the loss of fitness (reproductive success) of a host due to a parasite (which may be a bacteria, a protozoan, or a metazoan as well as a “virus”).

### Evolutionary Aspects

For a long time, it has been believed that, during the course of evolution, virulence evolved necessarily from

high to low degree, from war to pacific coexistence. It was then supposed that a well-adapted parasite could only be moderately pathogenic, because it would want its host to survive. For instance, during the 19th century, Van Beneden supposed that “the parasite practices the precept: not to kill the fowl in order to get the eggs.” However, several authors have demonstrated that the question is more complex. Ewald summarizes the question as follows: “natural selection does not necessarily favor peaceful coexistence.” As early as 1941, Ball had stated: “a parasite may choose the course of manifest destiny and find aggressiveness more attractive and more valuable than an existence of peace.”

What can be expected is that there exists an optimal pathogenicity, which is a compromise between the benefits and costs of virulence. The optimal pathogenicity is the point at which, as Ebert and Herre point out, “a decrease or increase in virulence is associated with a loss of fitness” (Fig. 1).

Optimal pathogenicity is at the crossroads of two selective processes (called arms races) the “encounter arms race” and the “compatibility arms race.” For various reasons, optimal pathogenicity is not always selected. A maladaptation, which implies that the fitness of the parasite could be improved but is not, may subsist, for instance when the parasite exploits several host species.

Probably the most important point is that the equilibrium between the parasite and its host is fragile. The selective processes which lead to this equilibrium

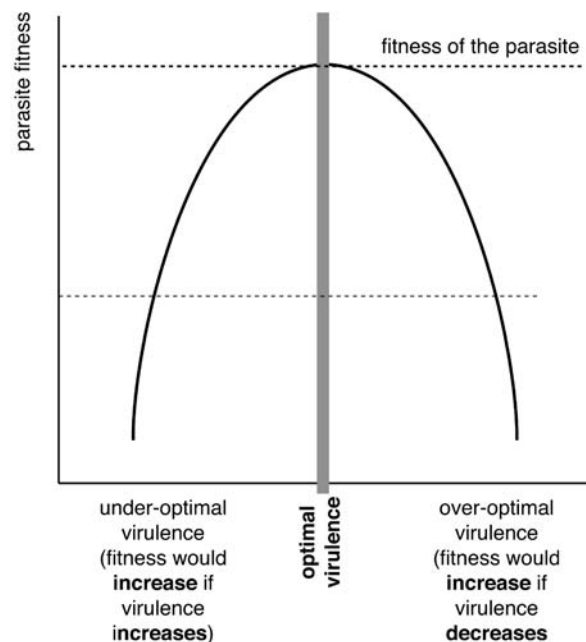

**Virulence. Figure 1** Optimal virulence: when virulence is under- or over-optimal, selective pressures cause it to increase or decrease, respectively.

are meaningful only in definite [→environmental conditions](#). If these conditions are modified, the change often favors the parasite more than the host, because the generation time is shorter and the genetic variation is greater on the side of the parasite, which gives it more opportunities for adaptation. As a rule, parasites (especially microparasites) adapt more rapidly to environmental changes than to their hosts. This accounts for the outbursts of certain human parasites during the course of history and at the present time. The development of medicine has reversed the process: the present-day achievements in drugs and vaccines give increasing advantages to the host, at least to a certain extent.

### Benefits and costs

Because the host is both the habitat and the resource base of the parasite, there is a limit in virulence that the parasite should not transgress: beyond this limit (known as optimal virulence, see above), the fitness of the parasite is reduced because the benefit of virulence (exploiting the host so that it can produce its own offspring) is outweighed by the price paid (weakening or killing the host in such a way that the transmission rate decreases or is interrupted). It is only in particular cases that there is virtually no cost of virulence, for instance when the death of the host is necessary for transmission, as in certain life cycles in which a parasite is transmitted from a prey to a predator. In this type of cycle, it is in the interests of the parasite to be highly virulent, in order to weaken its host so that it can be easily captured by a predator ([→Favorisation](#)). “Useless virulence” also exists, i.e., a pathogenic effect which has only disadvantages for both the host and the parasite; useless virulence is normally reduced by natural selection.

### Related Entries

[→Coevolution](#), [→Human Parasitic Diseases: Origins](#).

---

## Visceral Larva Migrans, Man

### Synonym

VLM, Toxocariasis.

### Pathology

[→Toxocara canis](#) (from dogs) and other larval parasites such as *Baylisascaris procyonis* (from racoons) or [→T. cati](#) (from cats) can cause the visceral [→larva migrans](#) syndrome (VLM) of humans. Since they cannot complete their development in man they are usually not found as adults in the intestine. Instead

the larvae undergo a prolonged migration through various tissues of the human host ([→Pathology/Fig. 28C](#)) with less tropism towards the lung than in the normal host. Most of the nonspecific symptoms of VLM like fever, cough, and [→abdominal pain](#) or signs such as hepatosplenomegaly, lymphadenopathy, [→granuloma](#) formation, and [→eosinophilia](#) can be attributed to the migrating larvae and the [→host response](#) to them.

The larvae ultimately die in various organs, and each one gives rise to a granuloma, with inflammation containing lymphocyte and eosinophils. Blood eosinophilia is common. Heavy infection such as in children with a craving for pica, the eating of dirt, may lead to myocarditis, [→encephalitis](#), and granulomas in liver ([→Pathology/Fig. 28](#)) and lung, together with diffuse inflammation, and is sometimes fatal. Even in light infections, if a larva enters the eye the intense allergic inflammation may give rise to retinal [→necrosis](#) with formation of granulomas and retinochoroiditis, vitritis, and iridocyclitis. The eye may become blind or be enucleated to exclude a malignant neoplasm, retinoblastoma.

### Immune Responses

When laboratory mice are infected with *T. canis* eggs, the larvae disseminate throughout the body and become encapsulated within eosinophil-rich granulomas. A significant peripheral eosinophilia which peaks around day 14 p.i. persists for months thereafter. Both the formation of granulomas and the eosinophilia as well as the IgE and IgG1 antibody responses observed in experimental toxocariasis are largely CD4<sup>+</sup> T cell-dependent. Granulomatous reactions which can be found in the musculature, the liver, the kidneys and the heart, begin as accumulations of eosinophils around the worms, and within a week or 2 these cells are replaced by lymphocytes and macrophages. As late as 6 months p.i. the granulomas have contracted in size and the macrophages have become epitheloid, which is suggestive of a response to the secretion of soluble antigens by viable larvae.

The CD4<sup>+</sup> T cell response against [→Toxocara](#) in mice is dominated by Th2 cells. In mice treated with antibodies against IL-5 the pulmonary infiltrates were devoid of eosinophils, while treatment with anti-IFN- $\gamma$  had no effects on the extent or cellular compositions of the pulmonary infiltrates. In line with this, human T-cell clones with specificity for *T. canis* consistently produced the Th2 cytokines IL-4 and IL-5 in response to *Toxocara* antigens. However, other cells than CD4<sup>+</sup> T cells might contribute to the production of IL-5. In T-cell-deficient mice the first wave of eosinophilia, occurring at day 11 p.i. could still be detected, while only the second wave around day 21, was absent.

Interestingly, it has been reported recently that a population of double negative ( $CD4^- CD8^-$ ) cells can also produce IL-5.

The functional role of eosinophils, one of the most striking features of tissue-invasive worm parasites, is still a matter of debate. Several studies suggest that eosinophils with their low affinity receptors for IgE (CD23) are highly efficient antiparasitic killer cells. The mechanism of killing is presumed to involve the attachment of the eosinophil via CD23 to the worm which had been opsonized or coated with parasite-specific IgE. The eosinophils then degranulate and exocytose their toxic proteins onto the parasite's surface. However, some findings also suggest that eosinophils may not directly kill *T. canis*. First, in contrast to human eosinophils no CD23 has been detected on the surface of mouse eosinophils. Second, although eosinophils could attach to *T. canis* larvae *in vitro*, the larval surface was shed and the worms were not affected by this interaction. Furthermore, *in vivo* the *T. canis* larvae obviously survive in the paratenic hosts despite a strong infiltration of eosinophils surrounding them in the tissues.

The question as to whether or not a →paratenic host can develop resistance to *T. canis* infection was analyzed in the mouse model in 1960. There was an only partial resistance induced by a primary infection which resulted in approximately 20% fewer worms recovered from multiply infected mice than from mice infected only once. More interestingly, the worms comprising the subsequent infective doses tended to accumulate in eosinophil-rich granulomatous reactions in the liver, a phenomenon which has been termed "liver trapping." It appeared to be antigen-specific as mice immunized with secreted products of *Toxocara* did →trap larvae, while mice immunized with the soluble egg antigens derived from *S. mansoni* failed to do so. Anti-IL-5 treatment depleting eosinophils or passive transfer of immune sera from primed mice did not influence the liver trapping. In contrast, the trapping phenomenon was clearly T-cell-dependent because nude mice failed to trap larvae upon a second exposure. Since depletion of  $CD4^+$  T cells did not completely abrogate liver trapping this host response most likely is a multifaceted reaction.

### Therapy

→Nematocidal Drugs, Man.

## Visceral Leishmaniasis

→Leishmania.

## Vitamin A

→Acanthocephala.

## Vitamine B<sub>2</sub>

Riboflavin (Vitamine B<sub>2</sub>) deficiency confers a degree of protection against malaria infection, while a supplementation of vitamin A (200.000 IU every 3 months) significantly reduces the number of clinical episodes in malaria.

## Vitellarium

A single or double set of relatively large glands producing cells that excrete substances for →eggshell formation, when packed together in the →ootype with a fertilized oocyte (→Platyhelminthes/Reproductive Organs).

## Vitelline Glands

→Vitellarium.

## Vitex agnus castus

Plant of the regions around the Mediterranean Sea, the seeds of which had been used for centuries as pepper. Extracts of this plant have good repellency activity against ticks and other arthropods.

## Vittaforma corneae

→Microsporidia.

---

## Viviparous

Producing living young instead of eggs from within the maternal body (→[Trichinella spiralis](#), →[Sarcophaga](#)).

---

## Vomiting

Clinical symptom in animals due to parasitic infections (→[Alimentary System Diseases](#), →[Clinical Pathology, Animals](#)).

---

## VL

→[Visceral Leishmaniasis](#).

---

## VSG

### Synonym

→[Variant Surface Glycoprotein](#). →[Glycosylphosphatidylinositols](#), →[Surface Coat/Antigenic Variation](#).

---

## VLM

Visceral larva migrans (e.g., *Toxocara canis*).

---

## VSG Coat

→[Surface Coat](#).





---

## Waddycephalus

Genus of →pentastomids in Ophidia (snakes).

---

## Wall-Forming Bodies

Parasites that produce walled cysts, such as *Pneumocystis*, *Blastocystis*, →amoebae, *Giardia*, most coccidians, *Balantidium*, →Myxozoa, and →Microspora, develop wall-forming bodies of various types (→Cyst Wall). In amoebae, diplomonadids, Microspora, and Myxozoa, the contents of the wall-forming bodies fuse outside the →cell membrane after being excreted by →exocytosis. This fused material forms an external cyst wall. In macrogametes of coccidians, however, the wall-forming bodies fuse in the region immediately below the cell membrane, thus producing an internal cyst wall (Fig. 1).

One or two different types of wall-forming body may occur in →coccidia of the various genera. For example, in →*Eimeria* and →*Isospora* the macrogametes have 2 types of wall-forming bodies: (1) electron-dense bodies that give rise to the outer layer of the →oocyst wall; and (2) spongelike bodies that fuse to produce the inner layer of the oocyst wall (Fig. 1). The entire oocyst wall is produced inside the cell membrane. The oocysts of →*Sarcocystis* and the sporocysts of all coccidia are bound by a smooth wall that is formed by the fusion of a single type of electron-dense wall-forming body (→Cyst Wall/Fig. 2).

---

## Warble Fly

→*Hypoderma bovis*.

---

## Warthin-Starry Silver Impregnation

→Microsporidiosis.

---

## Waterborne Infections

Infections due to parasitic stages within water, e.g.,

- (1) by oral uptake of cysts or eggs: →*Cryptosporidium*, →*Giardia*, →Worm eggs,
- (2) by skin penetration of worm larvae: →*Schistosoma cercariae*,
- (3) by entering nose: →*Naegleria-amoebae*, leeches,
- (4) by entering body openings: →Vampire fish.

---

## Watsonius watsonius

### Synonym

*Watsonius watsoni*.

### Classification

Species of the trematode superfamily Paramphistomoidae (→Digenea).

### General Information

This trematode worm species, which is found focally in Europe, Africa, and Asia in the intestine of humans has a pear-shaped body, reaches a length of 8–10 mm, a width of 4–5 mm, and a thickness of 4 mm. The eggs are in size and shape similar to those of →*Fasciola*. The infection of humans occurs by oral uptake of metacercariae being attached at water plants.

### Disease

Intensive diarrhoea, abdominal pain in cases of heavy infections.

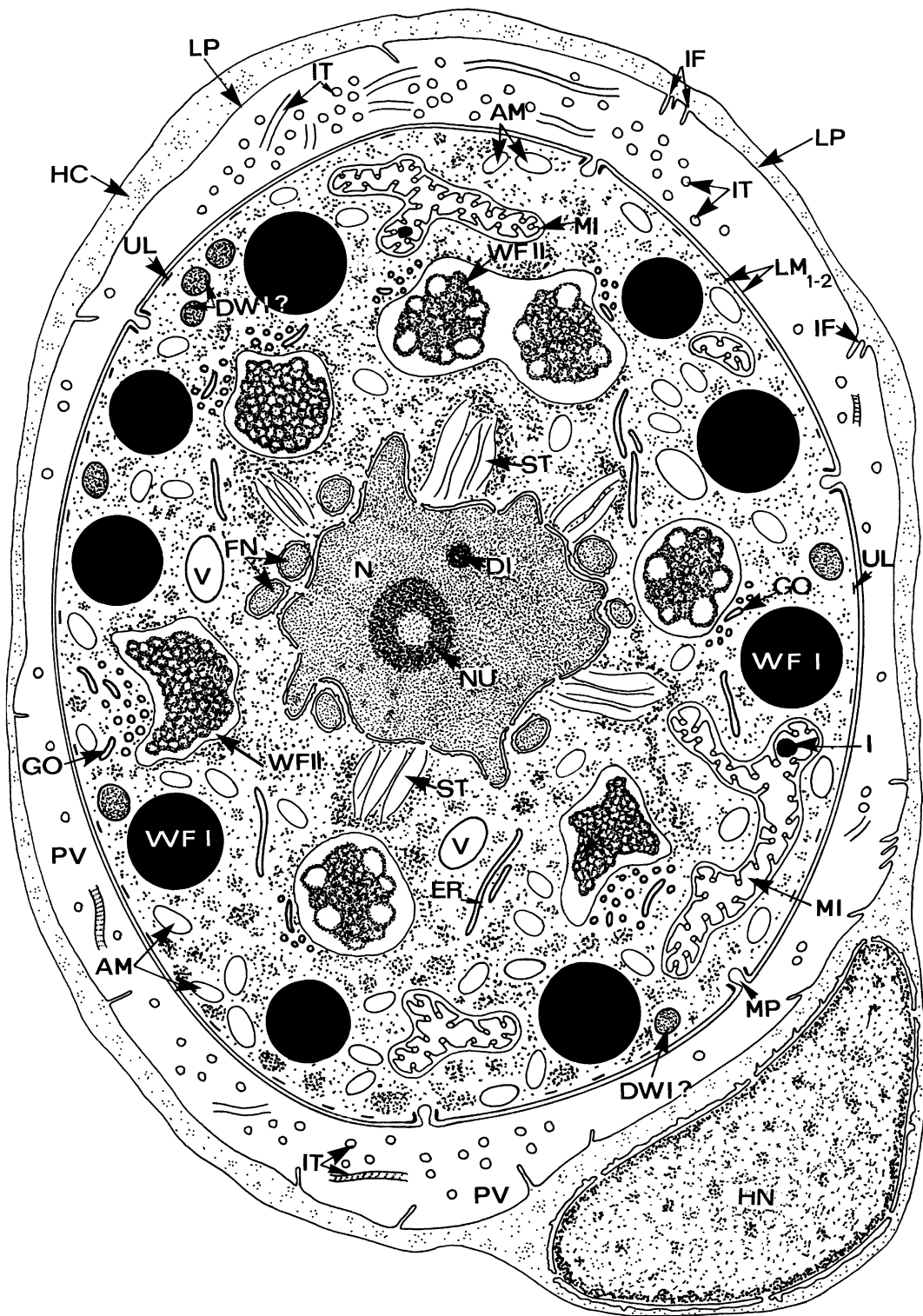

**Wall-Forming Bodies.** Figure 1 DR of a mature eimerian →macrogamete (limited by 2 membranes, other species have only 1). AM, →amylopectin; DI, dense inclusion; DWI, developing wall-forming body of type 1; ER, endoplasmic reticulum; FN, finger-like protrusion of the active nucleus; GO, →Golgi apparatus; HC, host cell; HN, host cell nucleus; I, inclusion in →mitochondria; IF, intravacuolar folds; IT, intravacuolar tubules; LM, limiting membranes of the macrogamete; LP, limiting membrane of PV; MI, mitochondrion; MP, micropore; N, nucleus; NU, →nucleolus; PV, →parasitophorous vacuole; ST, structures surrounding the active nucleus; UL, underlying material; V, vacuole; WF I, II, wall-forming bodies of types I and II.

**Therapy**

→[Trematocidal Drugs](#).

**WB**

Western blot.

**WDDV**

→[Weighted Degree Day Value](#).

**Websites**

Genome Projects, Discussion Groups.

**Weight Loss**

Clinical symptom in animals due to parasitic infections (→[Alimentary System Diseases](#), →[Clinical Pathology, Animals](#)).

**Weighted Degree Day Value**

Mode of measurement of the chances for overwintering/surviving of an agent of disease in a vector. Day maximum temperatures over 18°C get 6 points, temperatures of 13–17°C 1–5 points. The points obtained within one month are added and finally divided through the number of days of the month. The survival of an agent such as the bluetongue virus in a certain region is limited by the temperature. This virus can only persist in its hosts, if temperatures below 13°C occur at less than 40 days in a year at the habitat. Even short periods of freezing will not influence this rule.

**Wenyonella**

Genus of →[Coccidia](#) in ducks. The oocysts contain 4 sporozoites in each of the 4 sporocysts, e.g., *W. anatis*.

**Werneckiella**

Genus of →[Mallophaga](#) of horses and other equids (e.g., *Werneckiella equi equi*, *W. equi asini*, [Fig. 1](#)). Both species may lead to itching and loss of hair.

**Therapy**

→[Acaricidal Drugs](#).

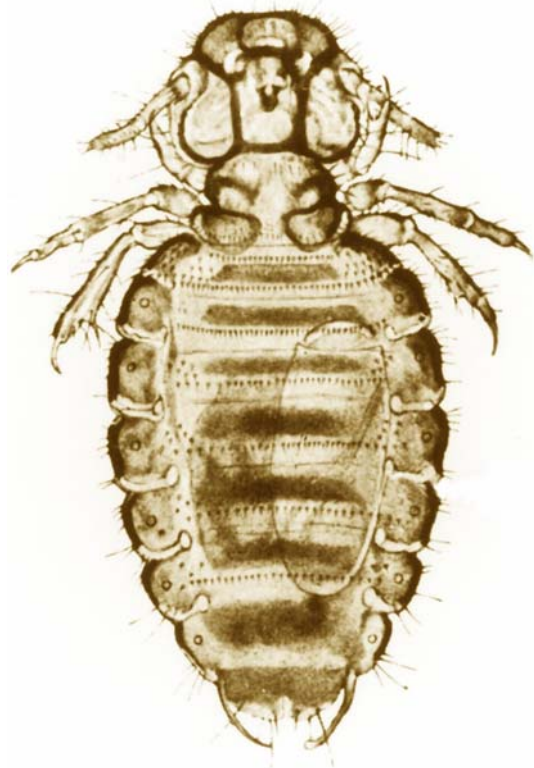

**Werneckiella.** **Figure 1** DR of a female mite from dorsal.

---

## West Nile Fever

Virus disease transmitted by →*Culicidae* (→*Togaviridae*), recently spreading all over USA.

---

## Whipworm

→*Trichuris*, →*Trichuris trichiura*.

---

## Whipworm Disease

### Synonym

→*Trichuriasis*, →*Alimentary System Diseases*.

---

## Whirling Disease

Uncontrolled movements of small ruminants when their brain is infected with the *Coenurus*-larva of the tapeworm *T. multiceps*. →*Turning Disease*.

---

## White Dot Disease

→*Ichthyophthirius multifiliis*.

---

## WHO

- Leishmaniasis home page: <http://www.who.ch/programmes/ctd/diseases/leis/leishmain.htm>
- Statistics hyperlink: <http://www.who.int>

---

## Wigglesworthia

Symbiotic bacterium in gut cells of →*Glossina*.

---

## Willaertia

Genus of free-living amoebae, which were found in ulci/carcinomas in stomach of dogs.

---

## Winter Ostertagiosis

→*Ostertagia*.

---

## Wohlfartia

Fig. 1, →*Diptera*.

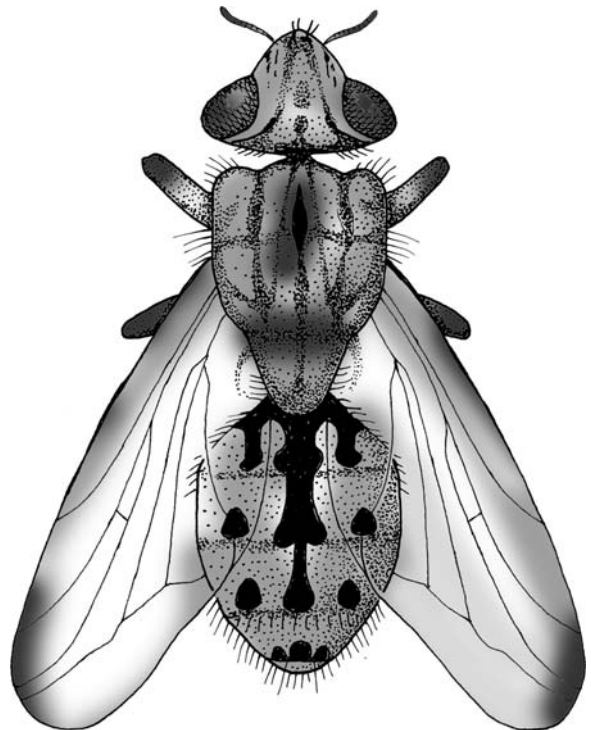

**Wohlfartia.** Figure 1 DR of an adult fly.

## Wolbachia Species

The *Wolbachia*-bacteria are Proteobacteria (alpha-subdivision) and are closely related to the *Rickettsia* spp. They are obligate intracellular bacteria that are transmitted from female hosts to their eggs. Up to now a total of 8 subgroups (A–H) is described using molecular data (cell cycle protein FTSZ/ftsZ; SSU rRNA). Groups A, B have been found only in arthropods, groups C, D only in filarial nematodes and rarely in insects (lice), while group G occurs in spiders and group H only in the Pacific dampwood termites.

The genus *Wolbachia* represents a group of bacteria that are able (among benefits) to introduce different phenotypic effects on their evertbrate hosts. Their efficacy ranges from initiating the popcorn disease of fruit flies to a possible beneficial effect of group D in filarial worm (→*Filariidae*), and from introducing →parthenogenesis in wasps to →feminization of genetically determined males in crustaceans. Today, studies are being carried out in order to eliminate or disturb the symbiotic effect of *Wolbachia* in filariae. To date these bacteria are described in →*Acanthocheilonea viteae*, →*Brugia malayi*, *B. pahangi*, *Dipetalonema setariosum*, →*Dirofilaria immitis*, *D. repens*, *Litomosoides sigmodontis*, →*Loa loa*, *Mansonella ozzardi*, 10 species of →*Onchocerca* including *O. volvulus* and in →*Wuchereria bancrofti*. In all cases they were determined in all developmental stages of the filariid life cycle (being especially abundant in adults). *Wolbachia* stages, however, are restricted to the hypodermis and the reproductive tissues (e.g., in the ovary of →*Glossina*), and are thus being included in the eggs. They are situated within a vacuole of their host cell and reproduce therein.

## Wolhynic Fever

Disease in humans due to infection with *Rickettsia quintana* transmitted by body →lice.

## Worm Eggs

Worm eggs have a shell (cover), that protects the inside developing larva from heat, dryness, attacks of bacteria, etc. The shape and size of eggs are often very specific, thus these characteristics are used for species diagnosis (Figs. 1–4, pages 1562–1565).

## Wucherer, Otto (1820-1873)

German physician; after studies in London, he worked in Lissabon and emigrated in 1847 to Bahia (now Salvador). There he discovered in August 1866 the hookworm disease and also (in human urine) the microfilariae of the worm, which is now described by his name (→*Wuchereria*). After a short return to Germany he died in 1873 in Brazil (in absolute poverty).

## Wuchereria

Genus of →*Filariidae*. Fig. 1 (page 1566).

## Wuchereria bancrofti

Species of →nematodes, →*Filariidae*, induces the →lymphatic filariasis. →*Wuchereria*/Fig. 1 (page 1566).

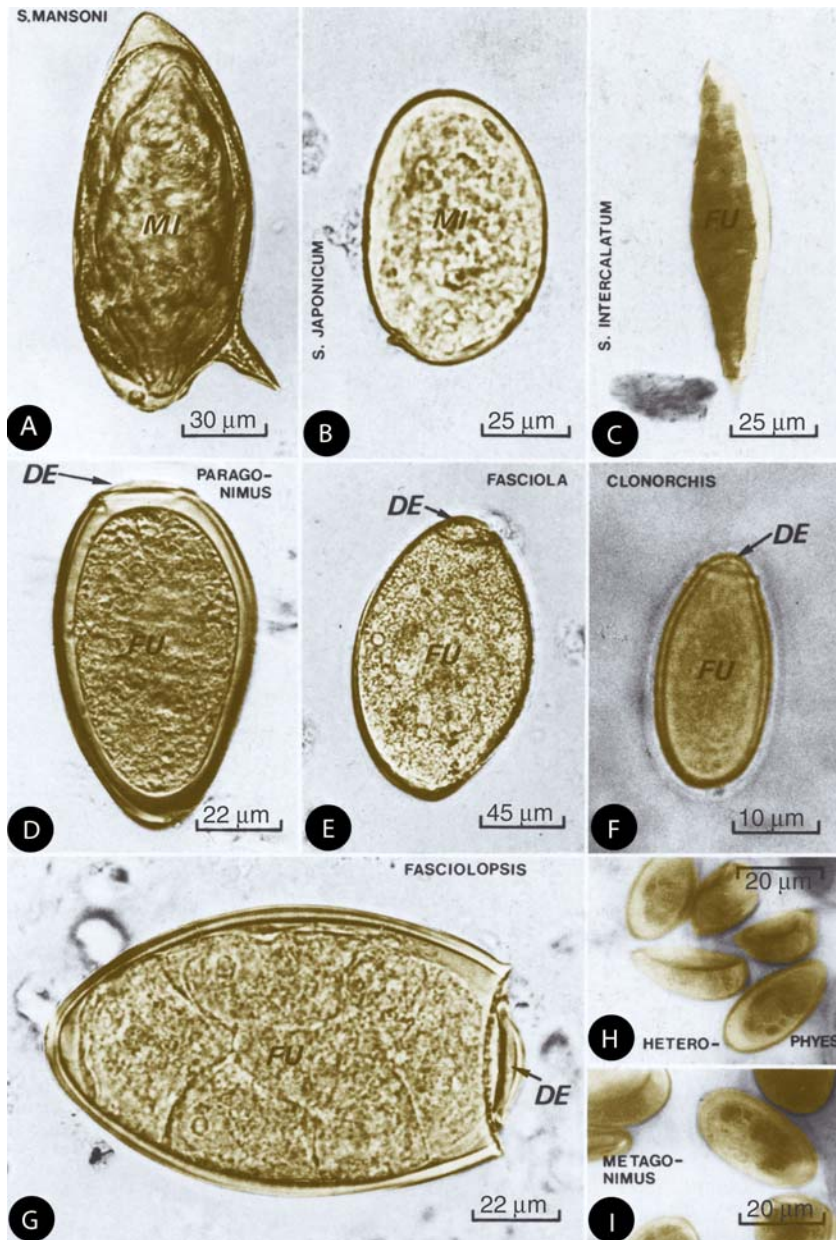

**Worm Eggs. Figure 1** LM of eggs of trematodes. *MI*, miracidium; *FU*, egg in cleavage; *DE*, cover = operculum; *S*, Schistosoma.

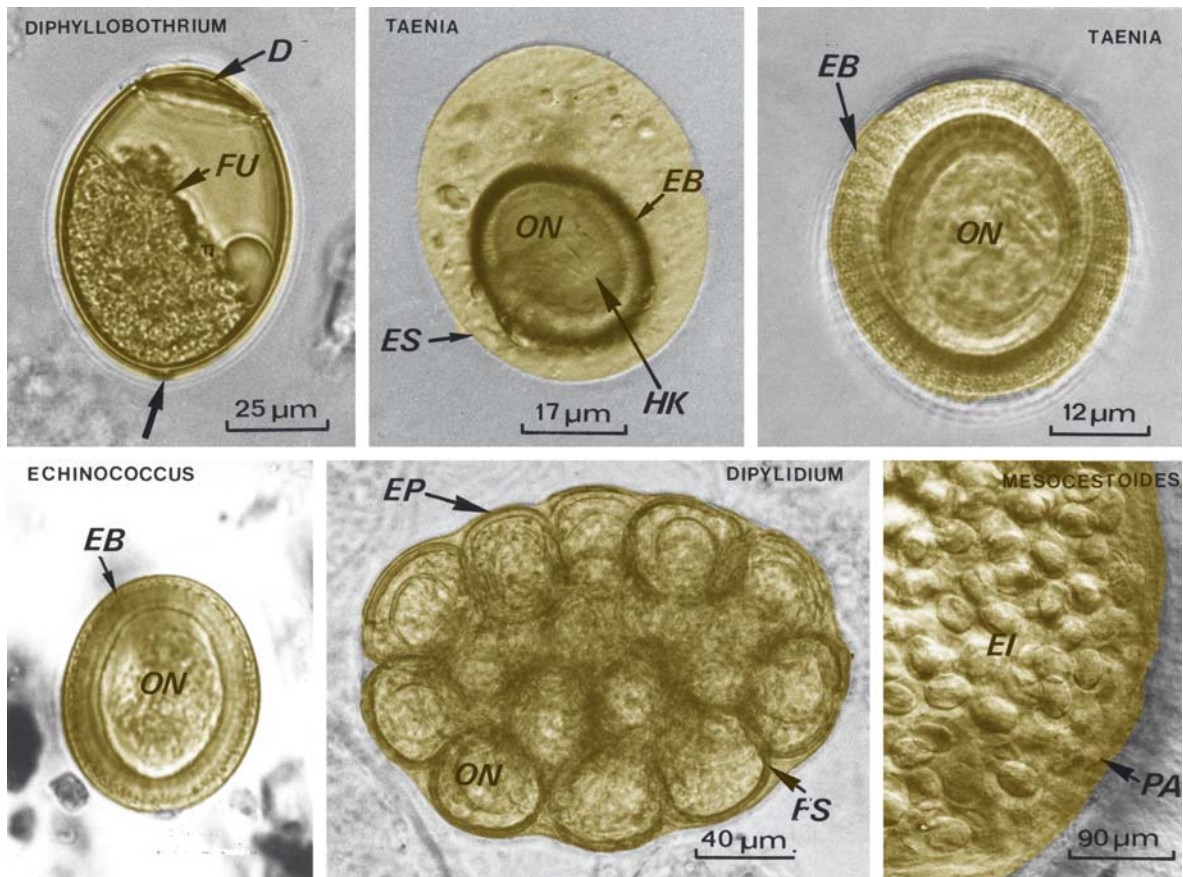

**Worm Eggs. Figure 2** LM of eggs of cestodes; arrow points to a terminal protrusion. *D*, operculum, cover; *FU*, egg in cleavage; *ES*, egg shell; *ON*, oncosphaera; *EB*, embryophore; *HK*, hooks; *EP*, cover of egg package; *FS*, cover of egg; *EI*, worm eggs; *PA*, paruterine organ.

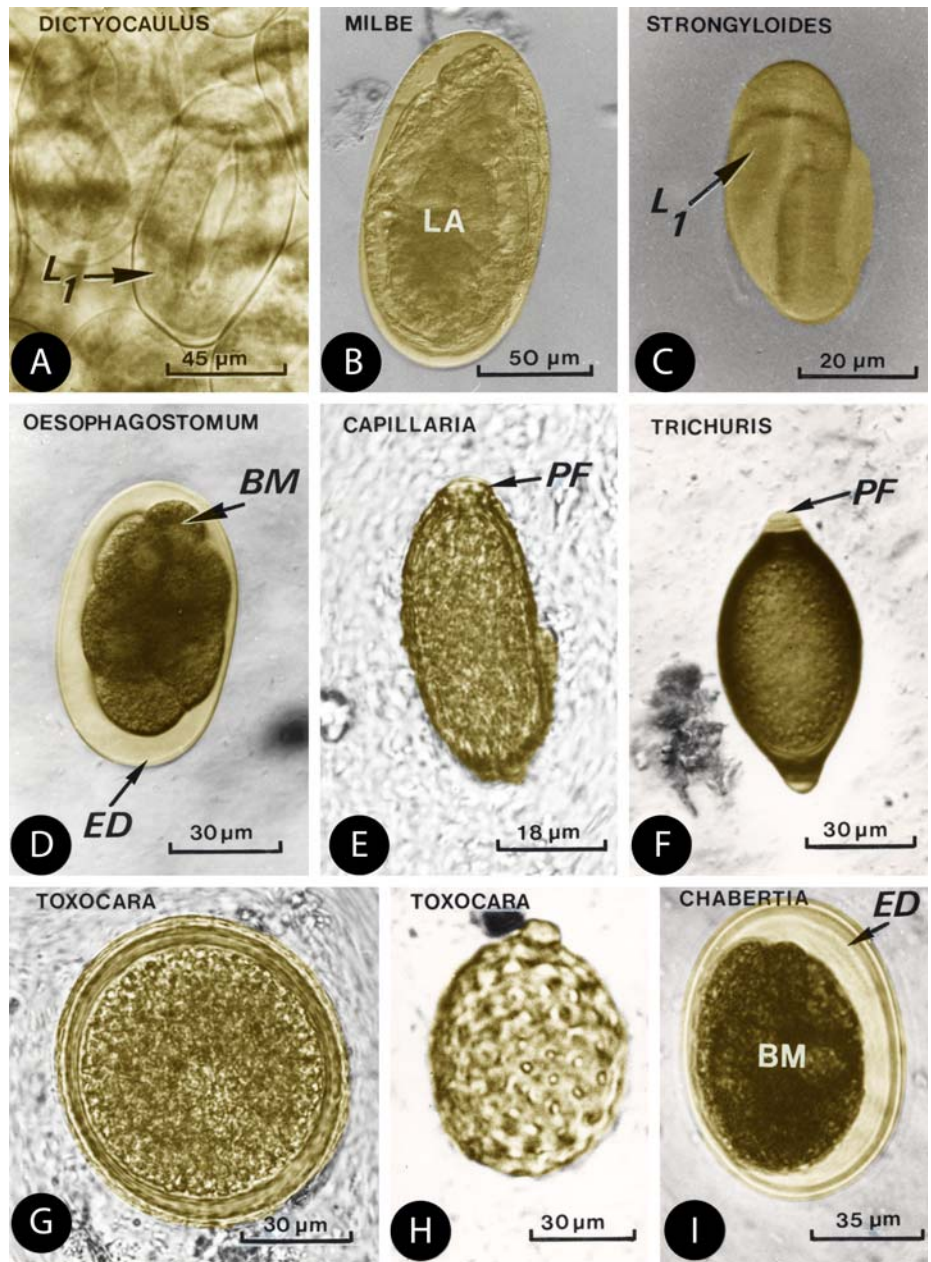

**Worm Eggs.** Figure 3 LM of nematode eggs. *L*<sub>1</sub>, larva 1; *LA*, larva; *BM*, blastomere; *ED*, egg cover; *PF*, polar plug; *MILBE*, mite.



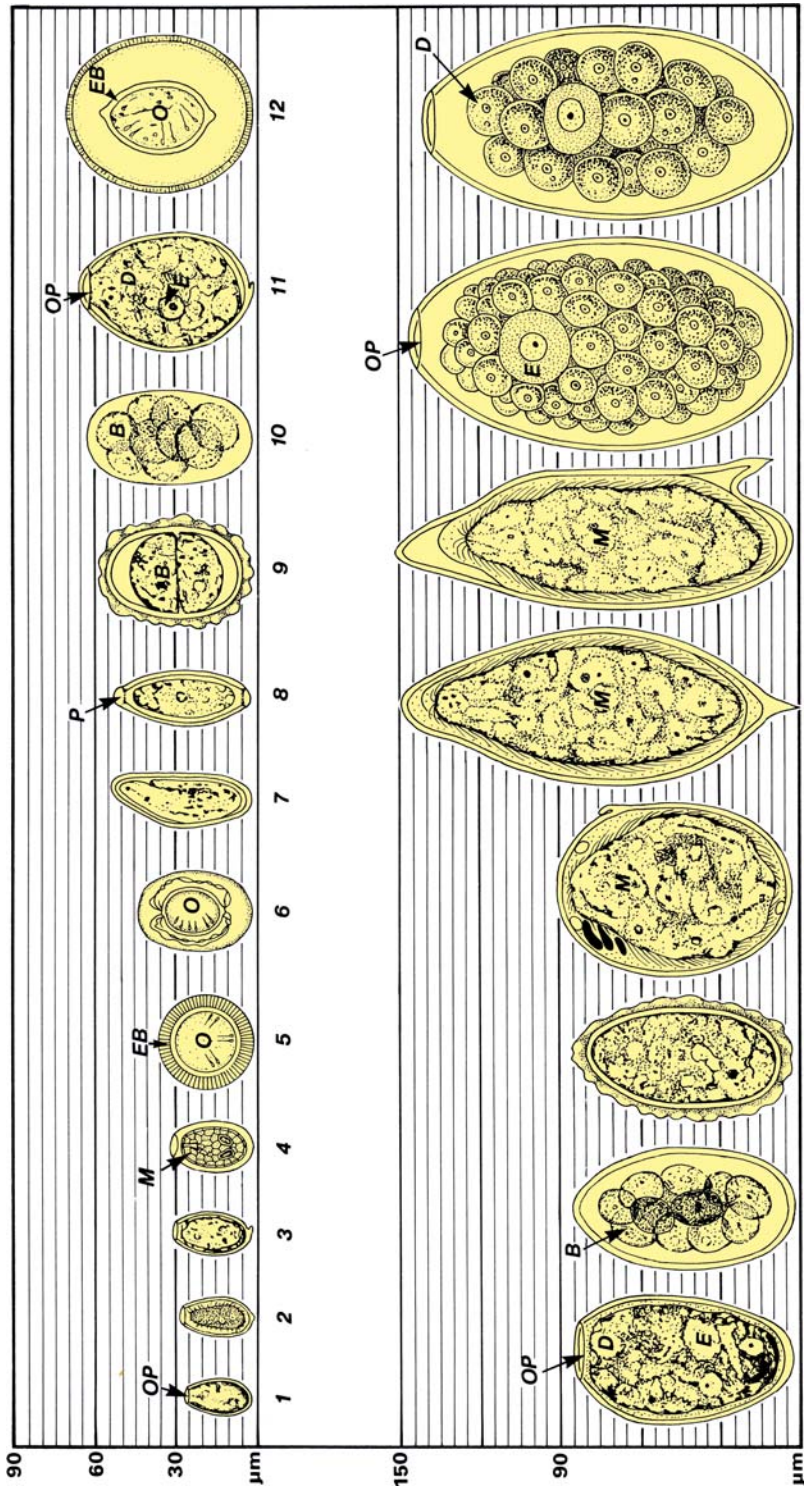

**Worm Eggs. Figure 4** DR of worm eggs in size comparison. B, blastomeres; D, vitellarial cells; E, egg (ovum), EB, embryophore; M, miracidium; O, oncosphaera; OP, operculum; P, polar plug. 1 *Metagonimus yokogawai*, 2 *Heterophyes heterophyes*, 3 *Clonorchis sinensis*, 4 *Dicrocoelium dendriticum*, 5 *Taenia*-species, 6 *Vampirolepis nana*, 7 *Enterobius vermicularis*, 8 *Trichuris trichiura*, 9 *Ascaris lumbricoides* (fertilized), 10 *Ancylostoma duodenale* and *Necator americanus*, 11 *Diphyllobothrium latum*, 12 *Hymenolepis microstoma*, 13 *Paragonimus westermani*, 14 *Trichostrongylus* sp., 15 *Ascaris lumbricoides* (unfertilized), 16 *Schistosoma japonicum*, 17 *Schistosoma haematobium*, 18 *Schistosoma mansoni*, 19 *Echinostoma* sp., 20 *Fasciola hepatica*.

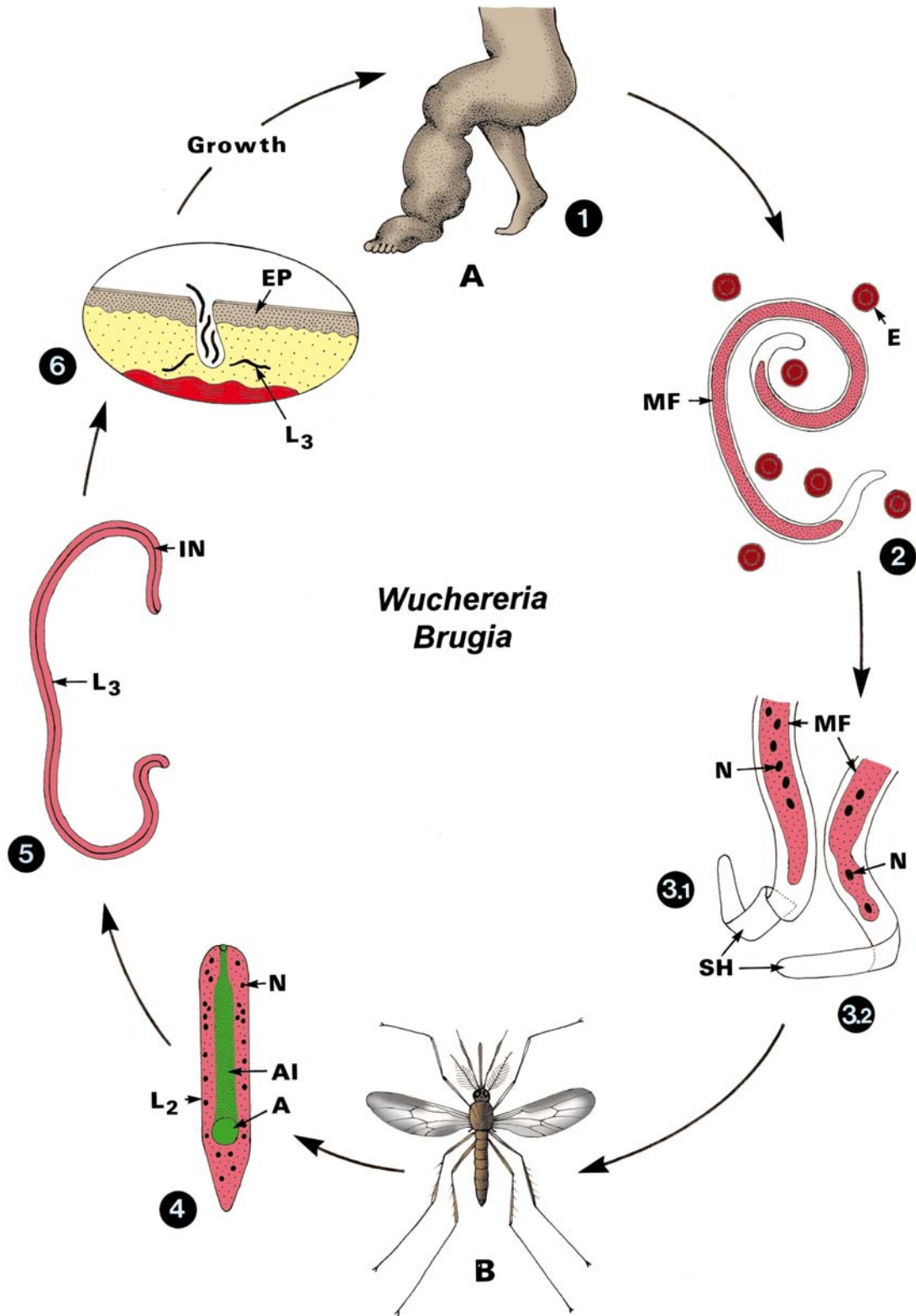

**Wuchereria. Figure 1** DR of life cycle. **A** Human with lymphatic swellings (tropical filariasis). **B** Vector: female mosquitoes. 1, Symptom of disease; 2, Sheathed microfilaria and red blood cells; 3, Anterior (left) and posterior end of microfilaria; 4, Larva 2 (in mosquito); 5, Larva 3 (infectious); 6 Skin penetration. A, anus; AI, anlage of intestine; E, erythrocyte; EP, epidermis; IN, intestine; MF, microfilariae; N, nucleus; SH, sheath.



## Xenocommunity

→ [Communities](#).

## Xenodiagnosis

Parasite-free triatomid → [bugs](#) were attached to patients with suspected → [Chagas' disease](#). Three weeks after bloodsucking the bug's intestine was checked microscopically for motile → [epimastigotes](#) of → [Trypanosoma cruzi](#).

## Xenom

Region with many developmental stages of → [Microsporidia](#) inside a host that has been surrounded by thick layers of connective tissues.

## Xenopsylla cheopis

### Name

Greek: *xenos* = foreign, *psylla* = flea, *cheops* = Egyptian pharaoh.

### General Information

Tropical rat flea (described by → [Rothschildt](#)), vector of the agent of the plague (*Yersinia pestis*). This flea, which has no ctenidia at the head or notum, reaches a length of 1.5–2 mm and is now found worldwide ([Fig. 1](#)). Other *Xenopsylla* spp. are: *X. braziliensis* (African rat flea, first described in Brazil, but important in Africa, India), *X. asiatica* (syn. *X. astia*) in Sri Lanka. Development see → [Fleas](#).

## Xerophil

Species adapted to dryness (e.g., phlebotomes, → [sand tamarin](#)).

## Xerophthalmy

Drying of eye as symptom of lack of → [vitamin A](#).

## Xiphidiocercariae

→ [Cercariae](#) with apical bore stylet. → [Digenea](#), → [Prosthogonimus macrorchis](#).

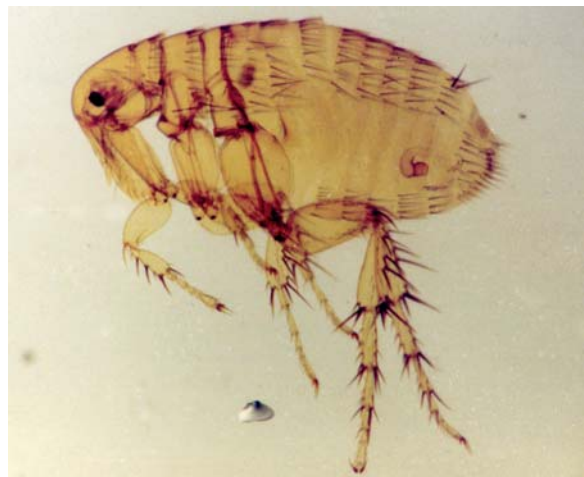

**Xenopsylla cheopis.** [Figure 1](#) LM of an adult female of *Xenopsylla cheopis*.

---

## Yawn

Clinical symptom in horses due to infection with →*Gasterophilus* larvae.

---

## Yeast Extract

0.1% are added to tissue cultures as source of amino acids.

---

## Yellow Body

Symptom of disease in carps due to infection with the myxosporidean species →*Hoferellus cyprinii*.

---

## Yellow Dot

German: *gelber Knopf*, symptom seen in the pharynx of doves due to infections with *Trichomonas gallinae*.

---

## Yellow Fever

Virus disease transmitted either from person to person by bite of →mosquitoes, or from primate to human by contact (→*Aedes*, →Arboviruses, Gorgas, →Insects/ Fig. 8B, →Noguchi, →Reed).

---

## Yersinia pestis

### Synonym

*Bacterium pestis* or *Pasteurella pestis*.

Agent of →plague being transmitted by tropical rat fleas (→*Xenopsylla cheopis*, →Fleas, →Insects/ Fig. 7); Yersin, →Kitasato.

---

## Yolk

Reserve material inside eggs or special cells being added to growing larvae. The so-called yolk cells of →*Digenea* (being formed inside of the →vitellarium) give rise to the →eggshell.

## Zelleriella intermedia

→Opalinata, →Chromosomes.

## Ziehl-Neelsen Staining

Method of demonstrating *Cryptosporidium* oocysts in fecal smears (Figs. 1, 2).

## Zoëa

Larva of higher →Crustacea, characterized by 2 large compound eyes and many paired extremities (→Isopoda).

## Zoite

Stage within →Tissue-cysts of →Coccidia, may become motile (→Bradyzoites, →Tachyzoites).

## Zooanthroponoses

### Synonym

→Anthropozoonoses.

## Zooanthroposis

→Anthropozoonoses.

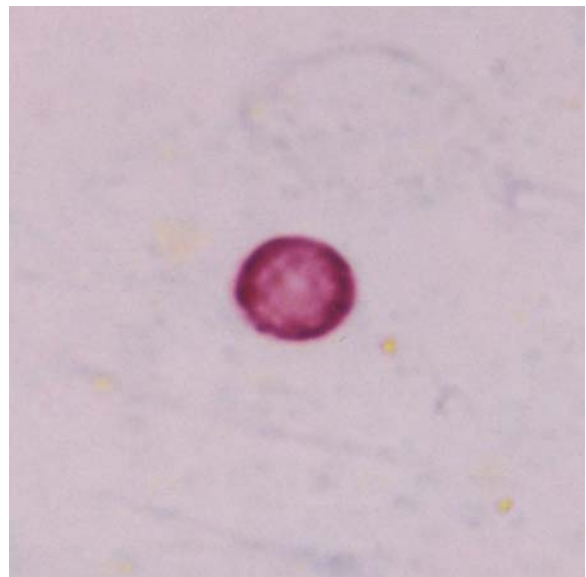
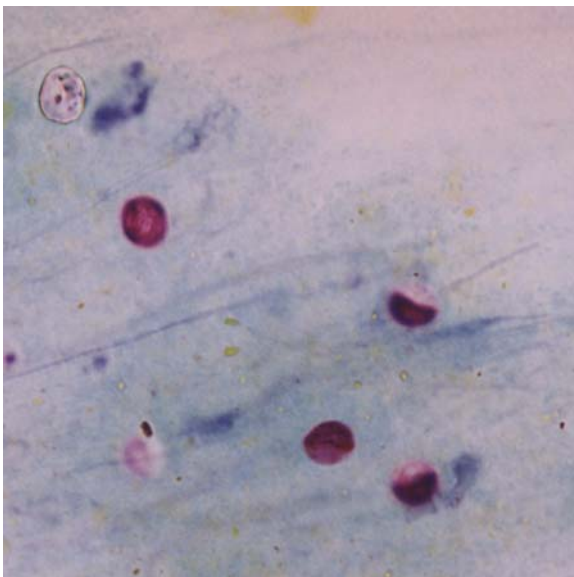

**Ziehl-Neelsen Staining. Figures 1, 2** Cryptosporidial oocysts stained according to this method appear reddish; in the figure at the left side some cysts are colored in different intensities.

## Zoonoses

Diseases due to agents being transmitted between animals and man (→[Anthropozoonoses](#)). However, there are many diseases affecting only animals. The major representatives of such parasitic “animalosis” are listed in [Table 1](#).

See also →[Anthropozoonoses](#), →[Opportunistic Agents](#).

## Zoophagic

→[Mosquitoes](#) that exclusively bite animals.

## Zygote

Fusion product of →[gametes](#), →[Syngamy](#).

**Zoonoses. Table 1** Economically important parasites which are usually restricted to animals other than man. (According to Wernsdorfer)

Parasite species	Principal hosts	Infective stage	Mode of infection	Other obligatory hosts	Disease
<b>Protozoa</b>					
<i>Trypanosoma equiperdum</i>	Equines	Trypanosome	Sexual transmission	None	Dourine
<i>Trypanosoma evansi</i>	Various domestic animals	Metacyclic trypanosome	Bite of horseflies	<i>Tabanus</i> spp.	Surra
<i>Trypanosoma brucei</i>	Bovines, equines, camels, porcines, canines	Metacyclic trypanosome	Bite of <i>Glossina</i>	<i>Glossina</i> spp.	Nagana
<i>Trypanosoma congolense</i>	Bovines and other domestic mammals	Metacyclic trypanosome	Bite of <i>Glossina</i>	<i>Glossina</i> spp.	Bovine trypanosomiasis
<i>Trichomonas gallinae</i>	Avians	Trophozoite	Ingestion	None	Avian trichomoniasis
<i>Tritrichomonas foetus</i>	Cattle	Trophozoite	Sexual transmission	None	<i>Tritrichomonas</i> abortion
<i>Histomonas meleagridis</i>	Avians	Ameboid and flagellate forms	Ingestion	None	Blackhead enterohepatitis
<i>Nosema bombycis</i>	Silkworms	Spore, transovarian and regular forms)	Ingestion, transovarial	None	Pébrine disease of silkworm
<i>Nosema apis</i>	Bees	Spore	Ingestion	None	<i>Nosema</i> disease of bees
<i>Glugea hertwigi</i>	} Various freshwater and marine fish	Spore	Ingestion	None	Microsporidiosis of fish
<i>Glugea mulleri</i>					
<i>Babesia caballi</i>	} Equines	Sporozoite	Tick bite	Various ticks ( <i>Dermacentor</i> , <i>Hyalomma</i> , <i>Rhipicephalus</i> spp.)	Equine piroplasmiasis
<i>Babesia equi</i> (syn. <i>Theileria</i> )					
<i>Eimeria tenella</i>	} Domestic poultry	Oocyst	Ingestion	None	Avian eimeriosis (coccidiosis)
<i>Eimeria averculina</i>					
<i>Eimeria bovis</i>	} Bovines	Oocyst	Ingestion	None	Bovine eimeriosis (coccidiosis)
<i>Eimeria zürnii</i>					
<i>Theileria parva</i>	Cattle	Sporozoite	Tick bite	Ticks ( <i>Rhipicephalus</i> spp.)	East Coast Fever
<b>Trematodes</b>					
<i>Fasciola</i>	Equines, bovines	Metacercaria	Ingestion	Aquatic snails	Fascioliasis gigantea

**Zoonoses. Table 1** Economically important parasites which are usually restricted to animals other than man. (According to Wernsdorfer) (Continued)

Parasite species	Principal hosts	Infective stage	Mode of infection	Other obligatory hosts	Disease
<i>gigantica</i>					
<i>Fascioloides magna</i>	Equines, bovines, sheep	Metacercaria	Ingestion	Aquatic snails ( <i>Galba</i> , <i>Pseudosuccinea</i> , <i>Fossaria</i> spp.)	Fascioloidiasis
<b>Nematodes</b>					
<i>Ascaris suis</i>	Porcines	Egg containing 2nd-stage larva	Ingestion	None	Porcine ascariasis
<i>Parascaris equorum</i>	Equines	Egg containing 2nd-stage larva	Ingestion	None	Equine parascariasis
<i>Trichuris discolor</i>	Cattle	Embryonated egg	Ingestion	None	Bovine trichuriasis
<i>Trichuris suis</i>	Pigs	Embryonated egg	Ingestion	None	Porcine trichuriasis
<b>Nematodes</b>					
<i>Trichuris ovis</i>	Cattle, sheep	Embryonated egg	Ingestion	None	Trichuriasis of cattle and sheep
<i>Ancylostoma caninum</i>	Canines, felines	Strongyliform larva	Transdermal penetration	None	Canine and feline ancylostomiasis
<i>Uncinaria stenocephala</i>					
<i>Strongyloides papillosus</i>	Sheep	Filariform larva	Transdermal penetration	None	Strongyloidosis of sheep
<i>Strongyloides ransomi</i>	Pigs	Filariform larva	Transdermal penetration	None	Strongyloidosis of pigs
<i>Dictyocaulus arnfieldi</i>	Equines	3rd-stage larva	Ingestion	None	Equine lungworm disease
<i>Trichostrongylus axei</i>	Cattle, sheep, horses	3rd-stage larva	Ingestion	None	Stomach worm disease
<i>Haemonchus contortus</i>	Sheep, other ruminants	3rd-stage larva	Ingestion	None	“Twisted” stomach worm disease
<i>Metastrongylus apri</i>	Mainly porcines	3rd-stage larva	Ingestion with earthworm	Earthworms ( <i>Lumbricus</i> , <i>Eisenia</i> spp., etc.)	Swine lungworm disease
<i>Strongylus equines</i>	Equines	Strongyliform larva	Ingestion	None	<i>Strongylus</i> - disease of equines
<i>Prostrostrongylus rutescens</i>	Sheep, goats	3rd-stage larva	Ingestion with infected snail	Aquatic snails (mainly <i>Helicella</i> spp.)	Red lungworm disease
<i>Dirofilaria immitis</i>	Canines, felines	3rd-stage larva	Mosquito bite	<i>Culex</i> , <i>Aedes</i> , <i>Anopheles</i> spp.	Heartworm disease of dogs and cats

## Zygotokinete

More correct term for the → ookinete of → *Plasmodium* spp.

## Zymodemes

Genomic patterns of different strains of a parasite, e.g., → *Entamoeba histolytica*, → Amoebiasis.