

SHIP KNOWLEDGE

A MODERN ENCYCLOPEDIA

K. VAN DOKKUM

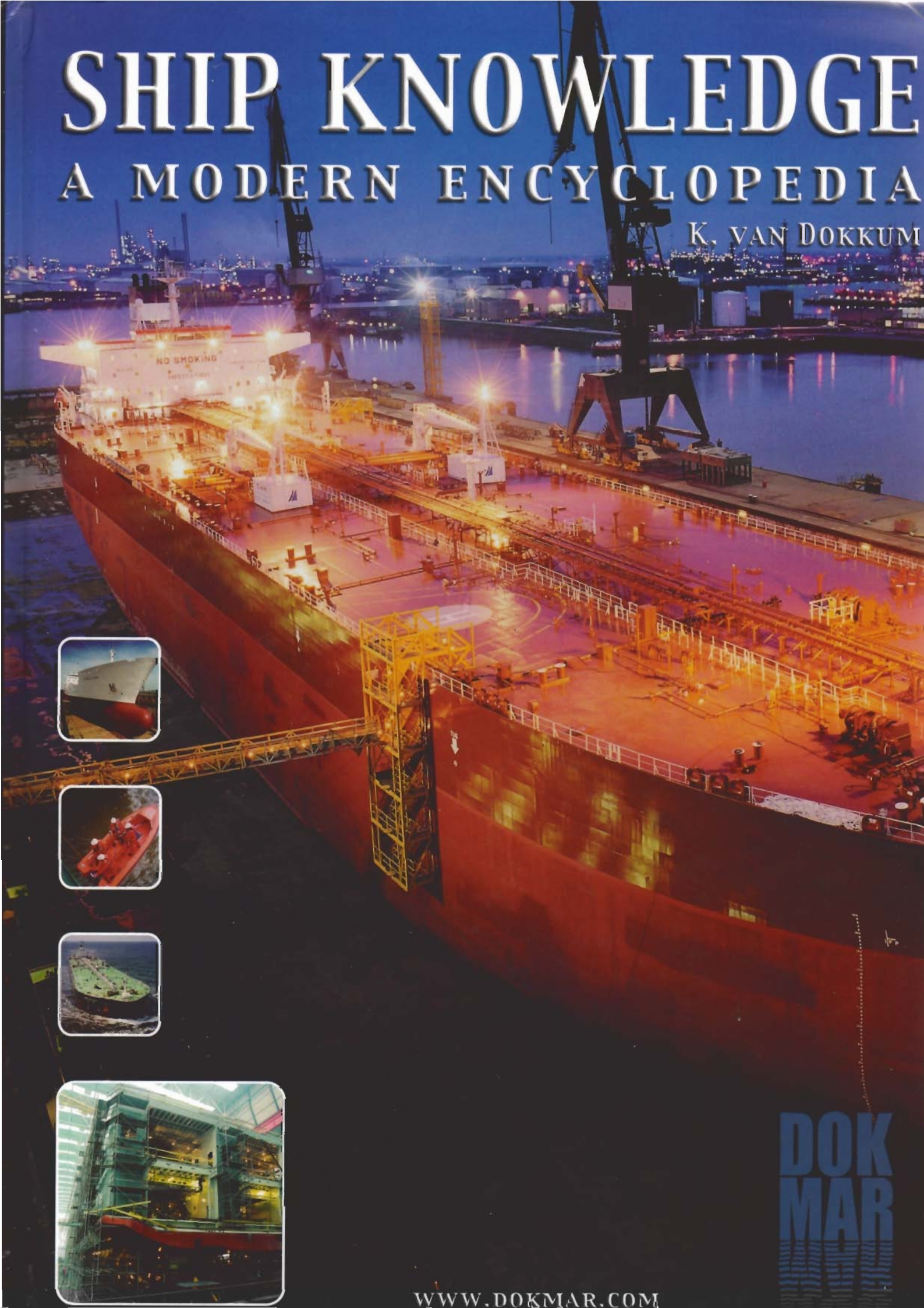

**DOK
MAR**

WWW.DOKMAR.COM

Author:
Klaas van Dokkum

Lay-out:
Unbound, IJmuiden, The Netherlands
<http://www.unbound.nl/>

Printed by:
Giethoorn Ten Brink bv, Meppel, The
Netherlands

Published by:
DOKMAR,
P.O.Box 360
1600 AJ Enkhuzen, The Netherlands.

© Copyright 2003, DOKMAR,
Enkhuzen, The Netherlands
ISBN 90-806330-2-X

All rights reserved. No part of this publication may be reproduced, stored in a retrieval system or transmitted in any form or by any means, including electronic, mechanical, by photo-copy, through recording or otherwise, without prior written permission of the publisher.

Great care has been taken with the investigation of prior copyright. In case of omission the rightful claimant is requested to inform the publishers.

Acknowledgements

Thanks are due to the following persons:

Mr J.H. ten Katen who was the first to alert me to some shortcomings in the Dutch edition and who contributed to their rectification. He supplemented and corrected several subjects. He also assisted with and advised on problems arising when working on a book with such a large scope as this one.

Mr Jan Groen and Mr Erwin van den Berg who not only checked the contents but also the linguistic aspects of the English edition. They corrected and supplemented many items in the book. Their expert advice proved invaluable.

The following persons, authorities each in their field, supplied the following chapters:

Chapter 3 part 4	"Offshore Industry"	by Jan Groen, Naval Architect
Chapter 4	"The building of a sea-ship"	by Arie Stuurman, Naval Architect
Chapter 11	"Engine room"	by Hans ten Katen, Naval Architect
Chapter 13	"Electrical Installations"	by René Borstlap, Naval Architect
Chapter 16 part 4	"Rules and regulations"	by Herbert Koelman, Naval Architect
part 1-2	"Stability"	by Hans ten Katen, Naval Architect

Translation:

Carmen Koenen-Loos, Noordbroek - The Netherlands

Michel Wijnold, Appingedam - The Netherlands

Castigation:

Erwin van den Berg, Delft, Naval Architect

Mike Cooke-Yarborough, Naval Architect, UK

Jan Groen, Koudum, Naval Architect

John Hutchins, Shipping and Transport College, Rotterdam - The Netherlands

Bob Ireland, Liverpool, UK

Hans ten Katen, Rotterdam, Naval Architect

Mimi Kuyper- Heeres, Terschelling

Chapter 3	part 3.16 J.A. Bloemberg Lt. RNLN, part 4, IHC Gusto Engineering BV
Chapter 9	part 1.1 to 4.2 incl., Liebherr Maritime Benelux BV
Chapter 10	part 1.1 to 2.2 incl., Ship's Equipment Centre, part 2.3 to 3.1 incl., Lankhorst Touwfabrieken BV,, part 3.4 to 3.5 incl., Hendrik Veder
Chapter 11	Kees Kuiken, Target-Global Energy Training
Chapter 12	Wärtsilä Propulsion Netherlands BV and Promac BV
Chapter 14	part 2 to 6.4 incl., Jotun Paints and Sigma Coatings
Chapter 15	part 1.1 to 2.11 incl., Ajax Fire Protection Systems BV, part 3.1 to 6 incl., De Wolf Products

For kindly allowing me free use of their pictures and drawings:

Van der Giessen de Noord, Krimpen a/d IJssel - The Netherlands

Nopa Oy, Helsinki - Finland

Keppel-Verolme (Photography Voets & van Leeuwen), Rozenburg - The Netherlands

Seatrade, Groningen - The Netherlands

Vuyk Engineering Centre, Groningen - The Netherlands

Jotun Paints, Spijkenisse - The Netherlands

Advice:

Hans Beukema, Delfzijl

Martijn van Engeland, Naval Architect TU-Delft

Aart Jan Martijn, Yerseke

Jacob Pinkster, M.Sc. FRINA, Naval Architect, TU-Delft

Ubbo van Sijtsema, Hoogezand

Jelle Visser, Berechja College, Urk

And of course my wife Joke for all her support and advice while I was working on this book.

Preface

Following the successful introduction of "Scheepskennis", a Dutch-language book on ship's knowledge, very soon requests were made for an English version. These resulted in the publication of the English-language book on ships and shipping matters with the title "Ship's Knowledge". In preparing this book any shortcomings of the former publication were remedied and quite some fresh (relevant) subjects were added. A new layout was also decided upon.

In a very clear and yet detailed way the various subjects pertaining to modern shipbuilding and seamanship as well as to present-day shipping modes and the offshore industry are dealt with in this book. An attempt is made to give as complete an overview of ships, pertinent auxiliaries, systems, rules and regulations as possible. The book provides a rich source of maritime information meant for all persons with an interest in shipping. Especially for basic studies it is eminently suitable for maritime students and newcomers in the fleet. For those employed in shipbuilding, shipping and related fields the work is an efficient work of reference and a convenient manual. Realizing this book could not have been accomplished without the help and loyal support from the shipping trade and industry themselves. Besides pertinent documentation they also supplied expert knowledge and commentary regarding contents and textual issues, for which I stand in great debt to them.

The author aims at forging a strong link between the contents of the book and the preferences and views of its readers and any reactions, recommendations, criticism on their behalf is highly welcome. On the website www.dokmar.com free downloads of questions pertaining to each chapter as well as a glossary of technical terms will be available. Translations of the glossary into more languages will be available presently.



Table of contents

SHIPWISE	PAGE 8	1	
THE SHAPE OF A SHIP	PAGE 22	2	
SHIP'S TYPES	PAGE 44	3	
THE BUILDING OF A SHIP	PAGE 68	4	
FORCES ON A SHIP	PAGE 82	5	
LAWS AND REGULATIONS	PAGE 104	6	
CONSTRUCTION OF THE VARIOUS SECTIONS	PAGE 126	7	
CLOSING ARRANGEMENTS	PAGE 160	8	
LOADING GEAR	PAGE 174	9	
ANCHOR AND MOORING GEAR	PAGE 196	10	
ENGINE ROOM	PAGE 216	11	
PROPULSION AND STEERING GEAR	PAGE 244	12	
ELECTRICAL INSTALLATIONS	PAGE 266	13	
MAINTENANCE AND DOCKING	PAGE 280	14	
SAFETY	PAGE 302	15	
STABILITY	PAGE 322	16	

Questions: www.dokmar.com

CHAPTER 1

Shipwise



EDWIN VANDERMARK



1. Introduction
2. Multi-purpose ship
"Capricorn"
3. Open container ship
"Nedlloyd Europa"
4. Car & Passenger Ferry
"Pride of Hull"
5. Chemical tanker and a
product tanker
6. Anchor Handling Tug
Supplier (AHTS)
7. Fishing vessel (Eurocutter)
"Z575"

1 Introduction

This chapter shows some 3-dimensional views of ships. All visible parts and spaces are numbered and named.

This is meant as an introduction to different types of ships and can be used as a reference for the following chapters. It can also be used as an indication of the size of a compartment compared to the whole ship.

2 Multi-purpose ship "Capricorn"

1. Rudder
2. Propeller
3. Main engine with gearbox and shaft generator
4. CO₂ bottles in CO₂ room
5. Man overboard boat (MOB)
6. Free fall lifeboat
7. Crane for MOB, lifeboat, liferaft and provisions.
8. Funnel with all exhaust pipes
9. Rear mast with navigation lights
10. Cross trees with radarscanners
11. Topdeck with magnetic compass and search light
12. Accommodation
13. Hatch cradle
14. Heavy fuel oil tank
15. Bulk cargo
16. Vertical bulkhead or pontoon
17. Heavy cargo, steel coils
18. Project cargo
19. Horizontal decks or hatchcovers
20. General cargo, rolls of paper
21. Shear strake
22. Hold fan
23. Fixed bulkhead
24. Container pedestal
25. Tanktop, max. load 15 t/m²
26. Containers, 5 rows, 3 bays
27. Vertical bulkhead or pontoon
28. Hatch coaming
29. Wing tank (ballast)
30. Bulk cargo
31. Gangway
32. Stacked hatches
33. Top light, range light
34. Breakwater
35. Anchor winch
36. Collision bulkhead
37. Deeptank
38. Bow thruster in nozzle
39. Forepeak tank in bulbous stem
40. Port side
41. Starboard side

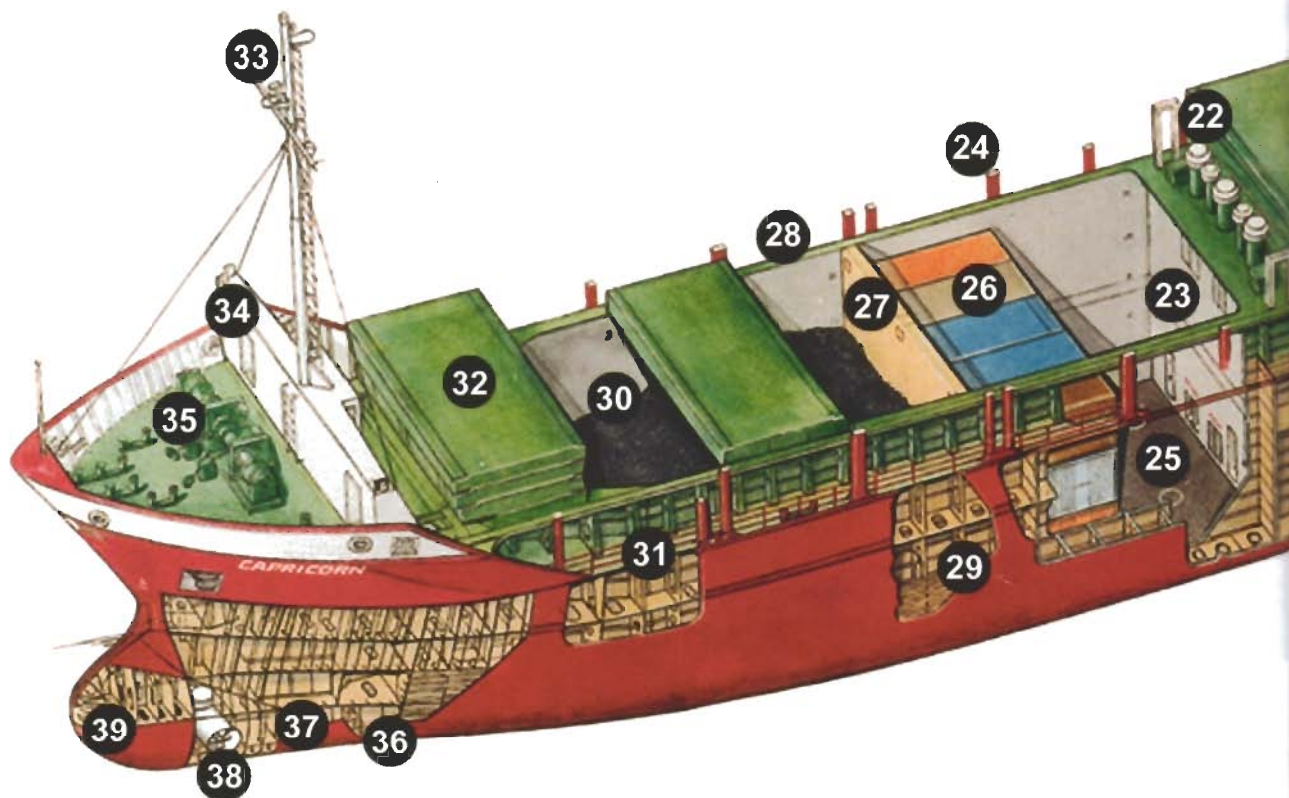

Principal Dimensions

Length o.a.	118.55 m
Length b.p.p.	111.85 m
Breadth moulded	15.20 m
Depth to maindeck	8.45 m
Design Draught	6.30 m
Corresponding deadweight (excl. grain bulkheads/tweendeck)	6600 tons

Capacities

Containers (14 ton homogeneous, v.c.g. 45%) in accordance with ISO standard at mean draught of appr. 6.30 mtr.

in hold	174 TEU
on hatches	96 TEU

Containers

in hold	174 TEU
on hatches	242 TEU

Tonnage Regulation (London 1969)	4900 GT
Grain capacity (excl. bulkheads)	328500 cbft

Speed

At a draught of 6.30 m service speed will be 14 knots, at a shaft power of 3321 kW.
(main engine = 3840 kW / 150 kW for PTO / 90% MCR)

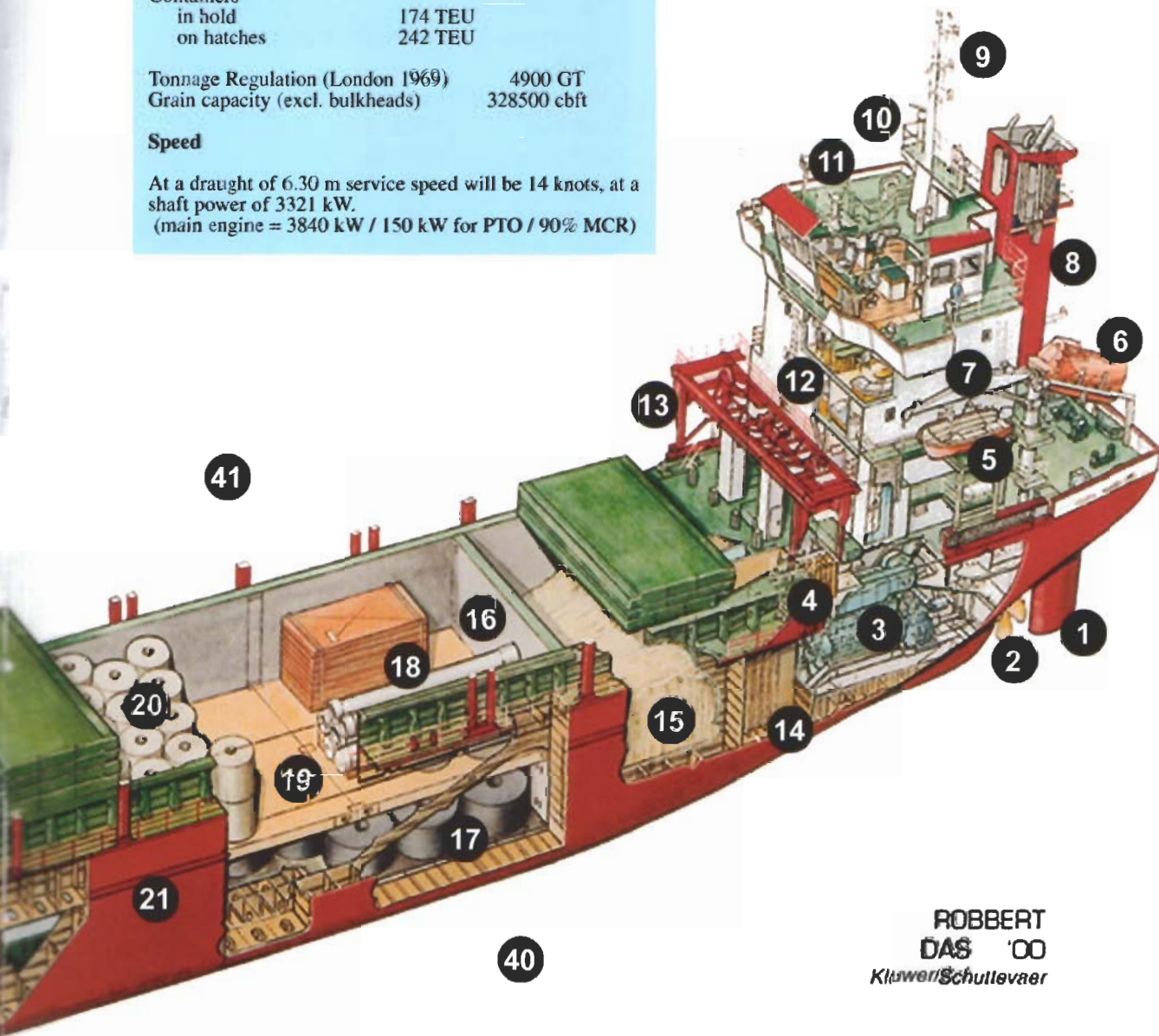

ROBERT
DAS '00
Kluwer/Schuttenvaer

3 Open container ship "Nedlloyd Europa"

1. Rudder
2. Propeller
3. Stem
4. Container with a length of 40 feet (FEU) on a 40' stack
5. Container with a length of 20 feet (TEU) on a 20' stack
6. Accommodation ladder
7. Pilot or bunker door
8. Container guide rail
9. Row no 11
10. Row no 04
11. Tier no 08
12. Wing tank (water ballast)
13. Service gallery
14. Fixed stack
15. Movable stack
16. Bay no 15
17. Bay no 06
18. Tier no 86
19. Cells, hold 1 and 2, for containers with dangerous goods (explosives)
20. Container support
21. Breakwater
22. Bulbous bow

Principal Dimensions

IMO no	8915691
Name	Nedlloyd Europa
Gross Tonnage	48508
Net Tonnage	19254
Deadwt Tonnage	50620
Year when Built	1991
Engine	41615 hp Sulzer
Ship Builder	Mitsubishi H.I.Nagasaki Japan
Speed	23.5 knots
Yard Number	1184
Dimensions	266.30-32.24-23.25
Depth	12.50
Vessel Type	Container Ship
Call Sign	PGDF
Containers	3604 teu
Flag	Neth.
In Service	1997

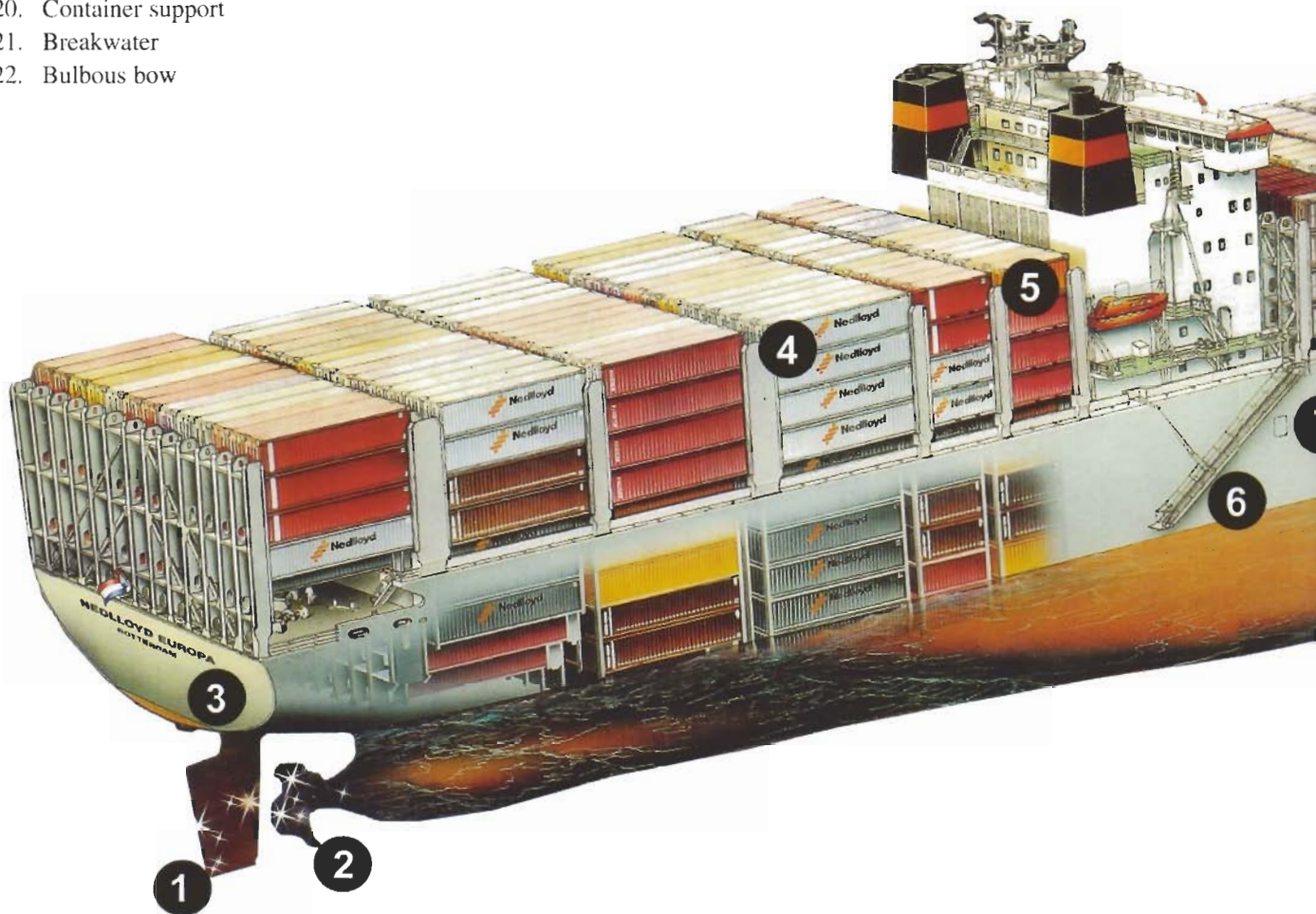

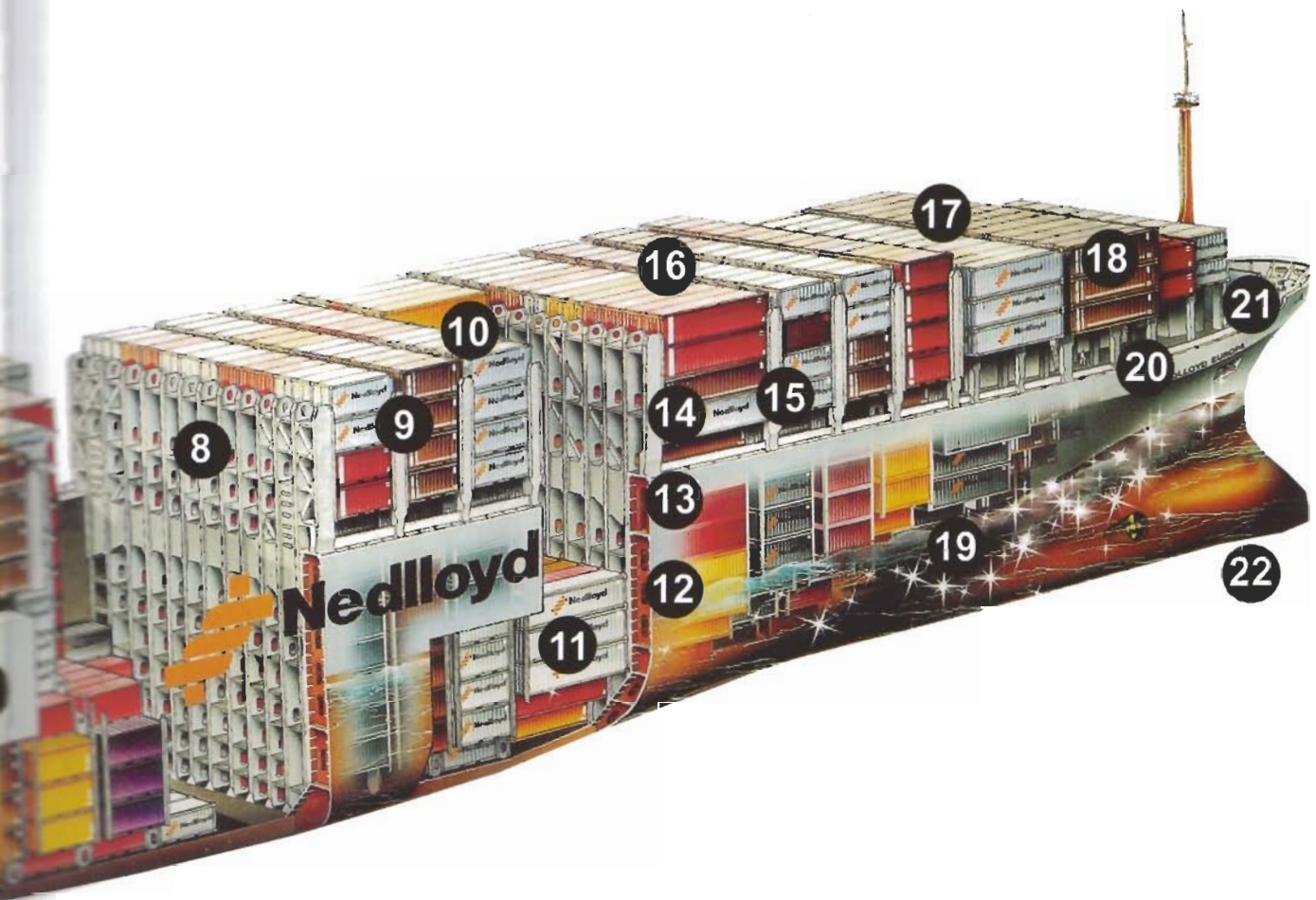

4 Car & Passenger Ferry "Pride of Hull"

1. Becker rudder
2. Controllable pitch propeller
3. Sterntube
4. Ballast tank
5. Aft engine room with gearbox
6. Seawater inlet chest
7. Forward engine room with 1 of the 4 main engines
8. Stern ramp
9. Mooring gear
10. CO₂ - battery space
11. Harbour control room for loading officer
12. Maindeck for trailers and double stacked containers
13. Gangway
14. Outside decks
15. Lifeboat hanging in davits
16. Deck 11
17. Funnel
18. Exhaust pipes
19. Panorama lounge
20. Officer and crew mess
21. Passenger cabins
22. Fast-rescue boat
23. Driver accommodation
24. Upper trailer deck
25. Ramp to lower hold
26. Stabilizer, retractable
27. Shops and restaurants
28. Helicopter deck
29. Entertainment spaces and bars
30. Fan room
31. Heeling tank
32. Void
33. Ro-ro cargo
34. Web frame
35. Car deck
36. Marine evacuation system
37. Cinema
38. Satellite dome for internet
39. Satellite dome for communication (Inmarsat)
40. Radar mast
41. Officer cabins
42. Wheelhouse
43. Car deck fan room
44. Forecastle
45. Anchor
46. Bulbous bow
47. Bow thrusters

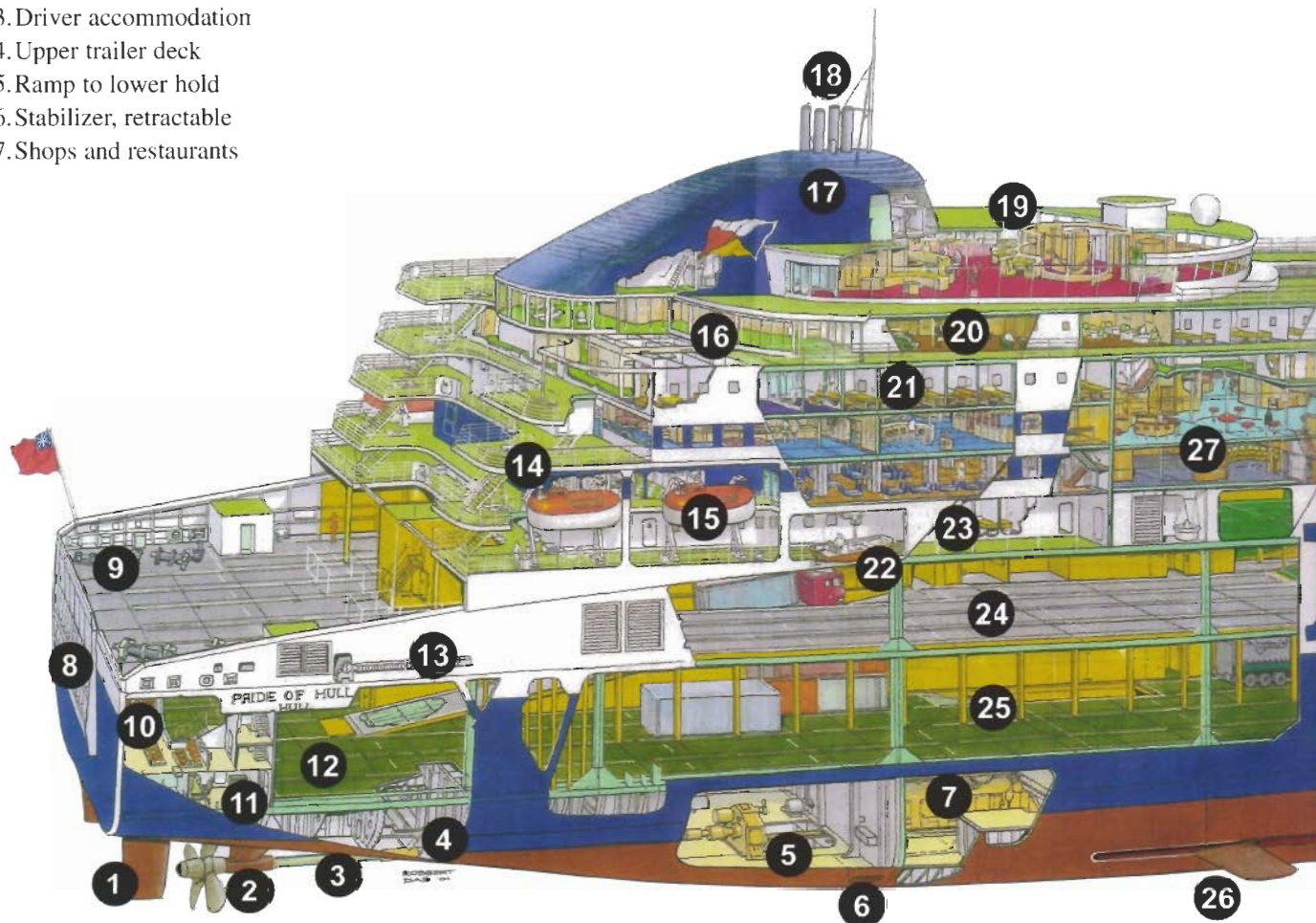

Principal Dimensions:

Delivered: Nov. 2001

Contract Price: 128 million USD

Classification:
Lloyd's Register +100A1,
Roll-on Roll-off Cargo and
Passenger Ship
+LMC, UMS, SLM.

Dimensions:

Length o.a. 215.10 m
Length b.p. 203.70 m
Beam mld. 31.50 m
Draught design 6.05 m
Depth to maindeck 9.40 m

Tonnage:

GT 59,925
NT 26,868
tDW design 8,800
tDW scantling 10,350

Passengers:

Total capacity 1360
- cabins 546

Car / Trailer Deck:

Cars 1380
Lane 3355 m.

Crew: 141

Access:

Stern ramp (1 x w)
12.5x18 m

Machinery:

Main engines (4):
Output, Kw each 9450
Output, BHP ttl 51394
Rpm 500

Aux engines (2):
kW each 4050
Rpm 720

Propellers (2):

Diameter 4.9 m
Rpm 720

Bowthrusters (2):

kW each 2000

Speed / Consumption:

Trial speed 23.8 knots
Service speed 22.0 knots
Fuel consump. 130.8t./24hr
Fuel quality 380 cSt

Tank Capacities:

Heavy fuel oil 1000 m³
Lub oil 50 m³
Fresh water 400 m³
Ballast water 3500 m³



Sistership "Pride of Rotterdam" in Venice

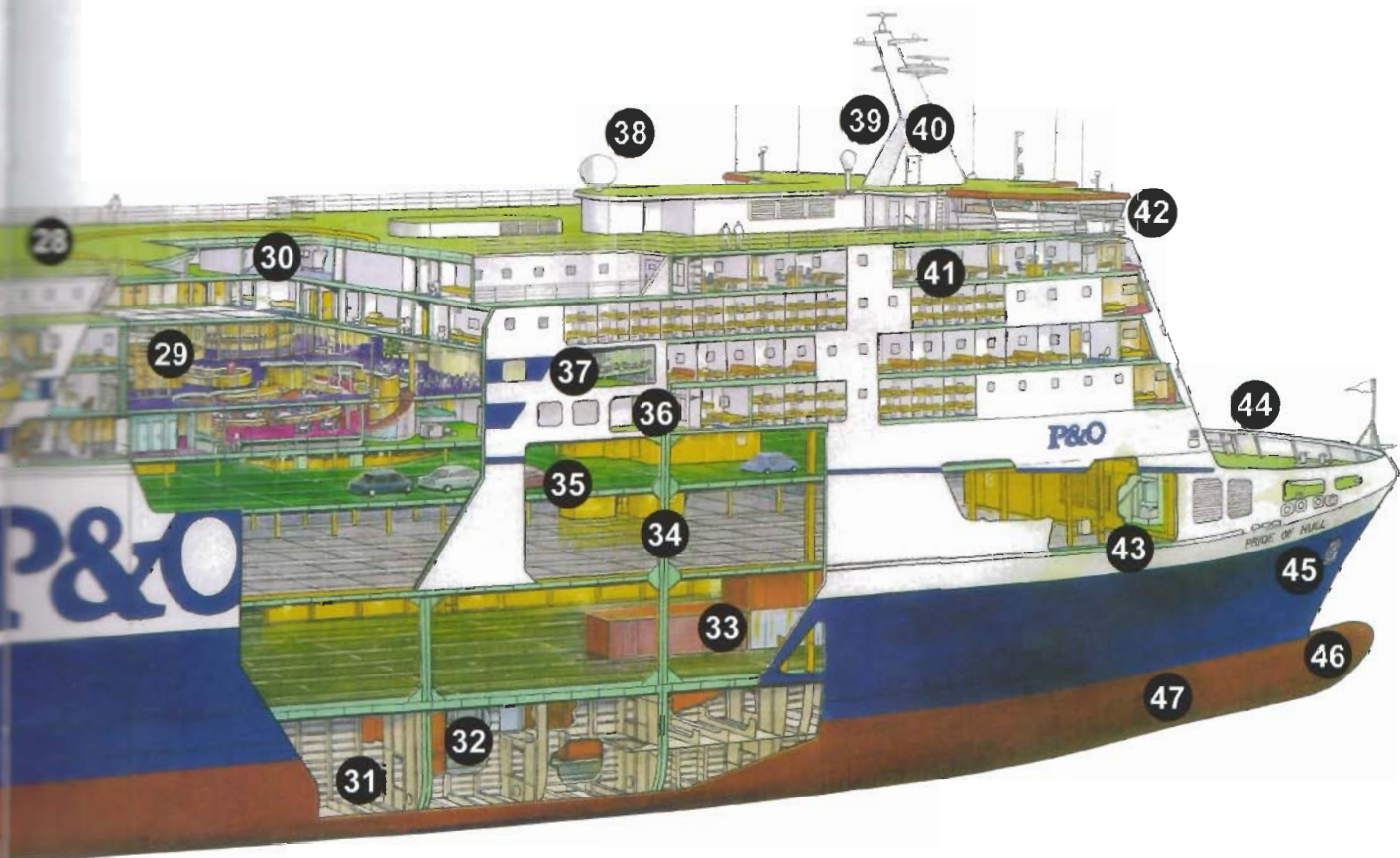

ROBBERT DAS '02

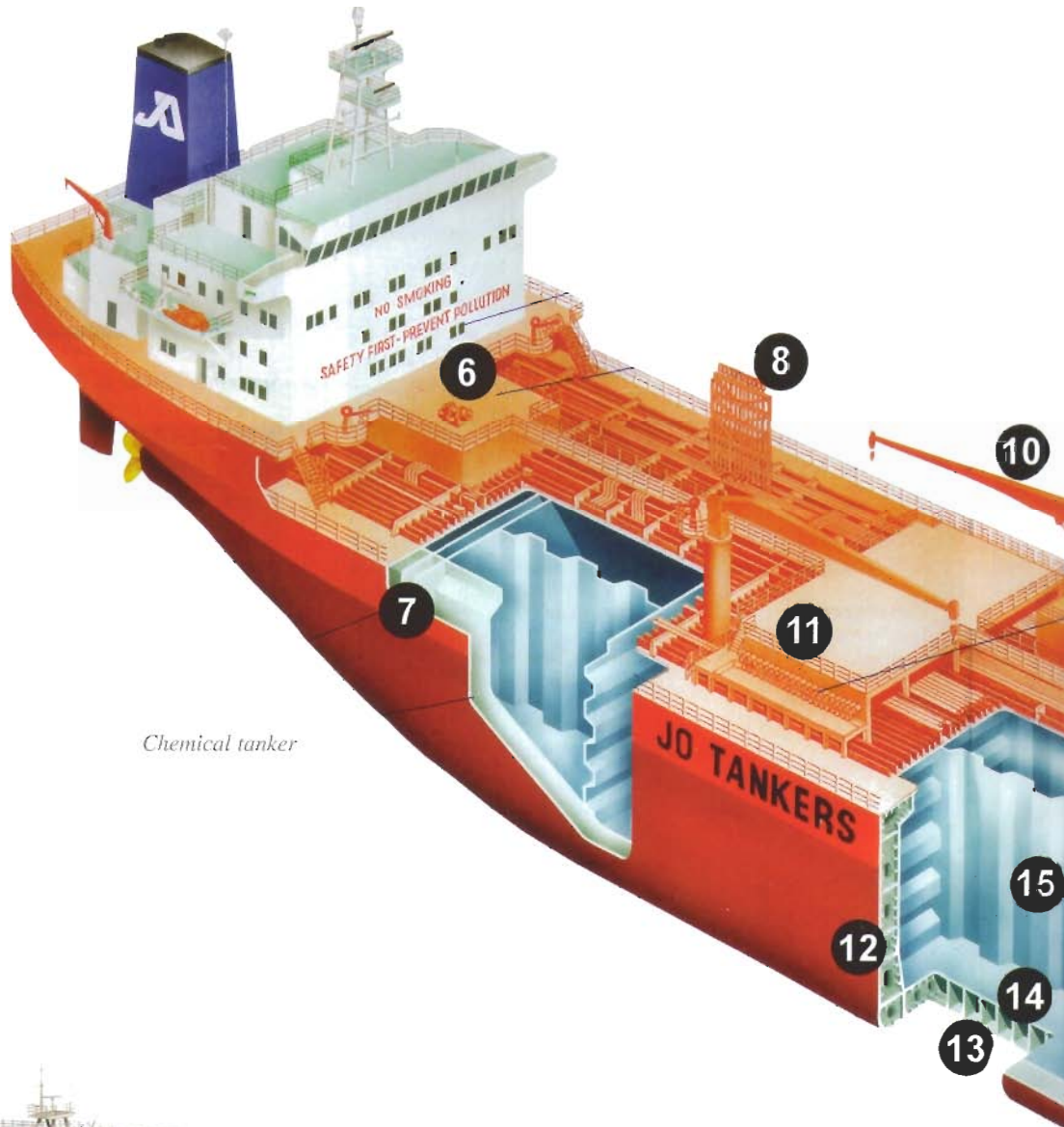

Chemical tanker

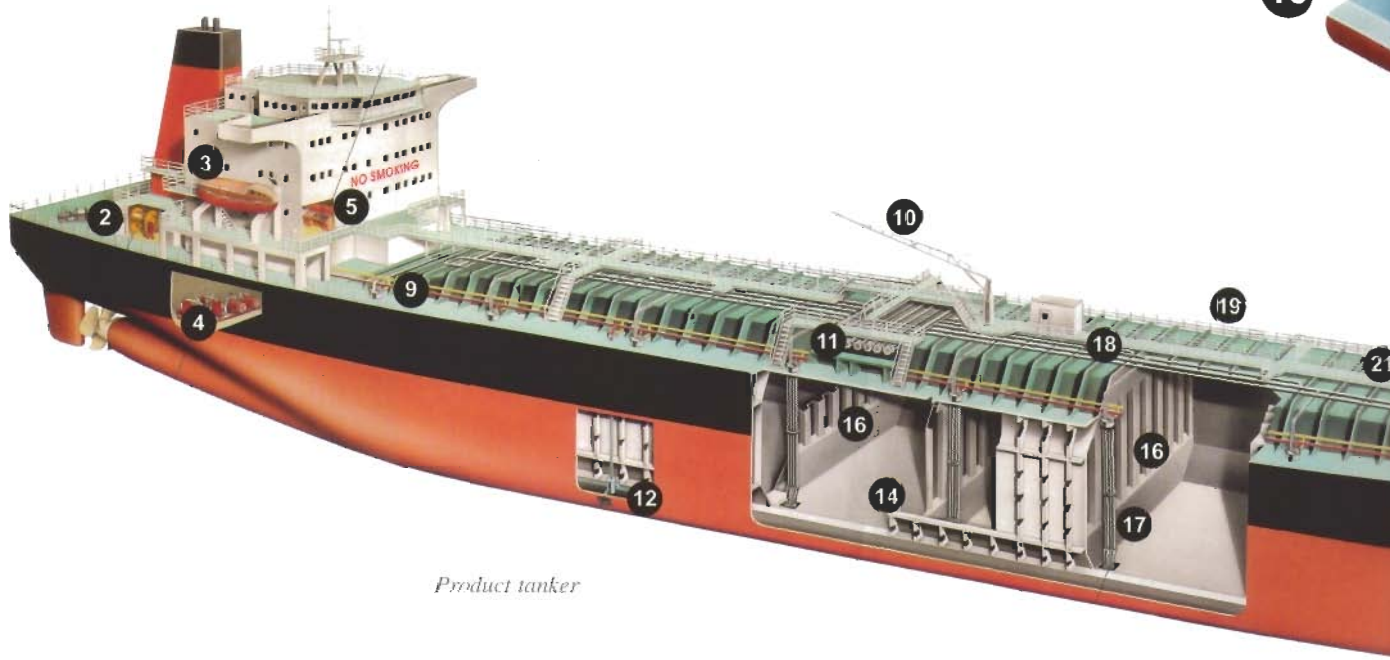

Product tanker

5 Chemical tanker and a product tanker

- | | |
|--|--|
| 1. Balanced rudder with conventional propeller | 13. Double bottom tank |
| 2. Auxiliary unit | 14. Tanktop |
| 3. Lifeboat in gravity davits | 15. Longitudinal vertically corrugated bulkhead |
| 4. Hydraulic prime mover | 16. Transverse horizontally corrugated bulkhead |
| 5. Cargo control room | 17. Cargo pump |
| 6. Tank heating / tankwash room | 18. Catwalk |
| 7. Cofferdam, empty space between two tanks | 19. Railing |
| 8. Vent pipes with pressure-vacuum valves | 20. Deck longitudinals |
| 9. Hydraulic high pressure oil-and return lines for anchor and mooring gear. | 21. Deck transverses |
| 10. Hose crane | 22. Cargo heater |
| 11. Manifold | 23. Forecastle deck with anchor-and mooring gear |
| 12. Wing tank in double hull | 24. Bow thruster |
| | 25. Bulbous bow |

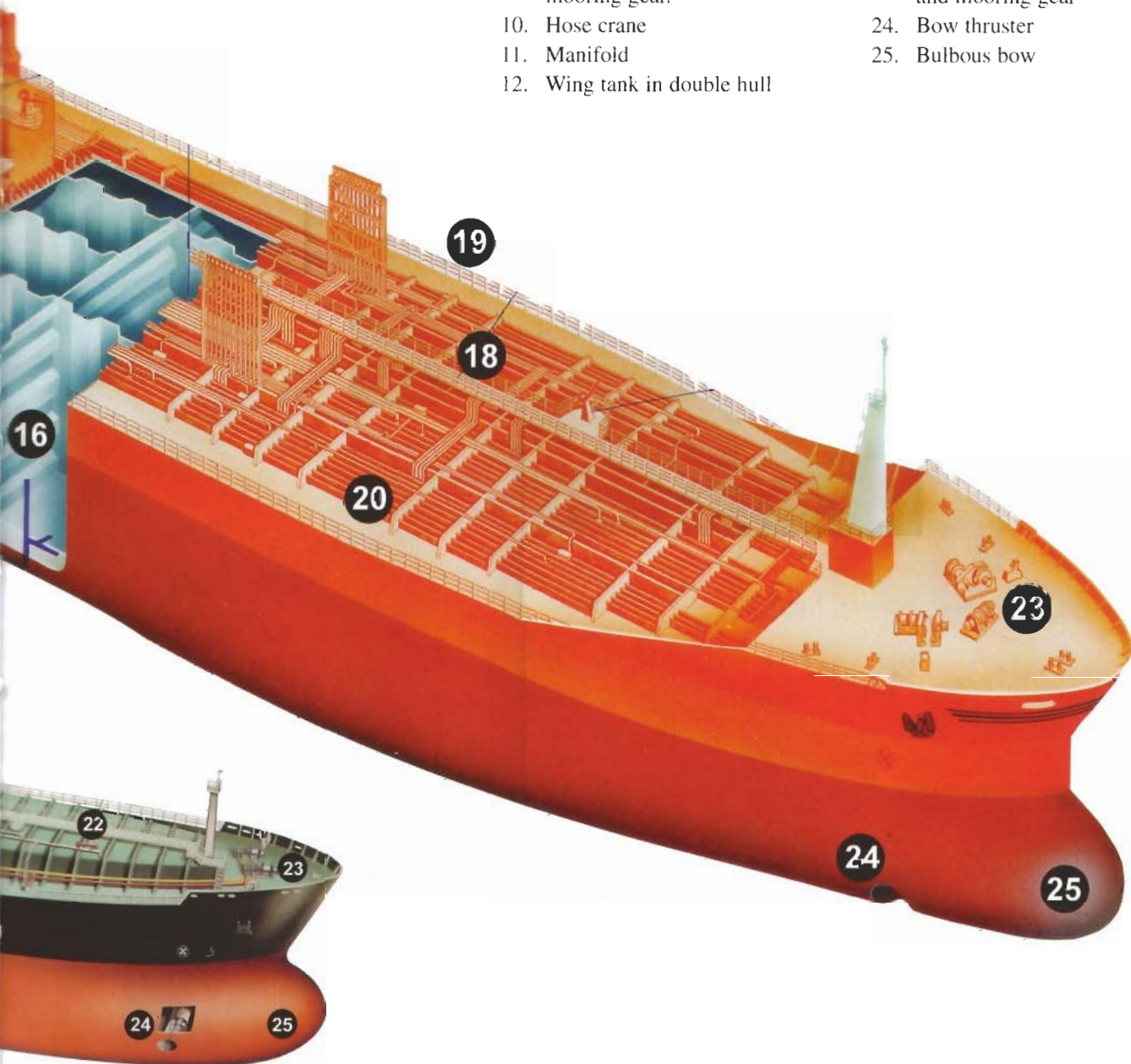

6. Anchor Handling Tug Supplier (AHTS)

1. Stern roll for anchor handling
2. Stoppers for anchor handling
3. Steering engine
4. Starboard ducted propeller
5. Stern tube
6. Transverse thruster
7. Cofferdam
8. Tanks for dry bulk cargo e.g. cement
9. Mud tanks
10. Propeller shaft
11. (Reduction) Gear box
12. Main engine
13. Fire pump
14. Life rafts
15. MOB-boat with crane
16. Storage reel for steel wires for anchor handling
17. Anchor handling winch
18. Bridge with controls for deck gear and ship's steering
19. Fire fighting monitor
20. Radar antennas
21. Antenna for communication system / satellite antenna
22. Watertight bulkhead
23. Anchor windlass, below deck
24. Azimuth thruster
25. Bow thruster

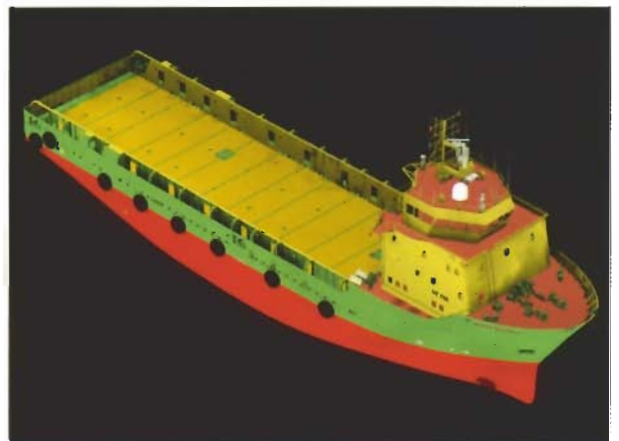
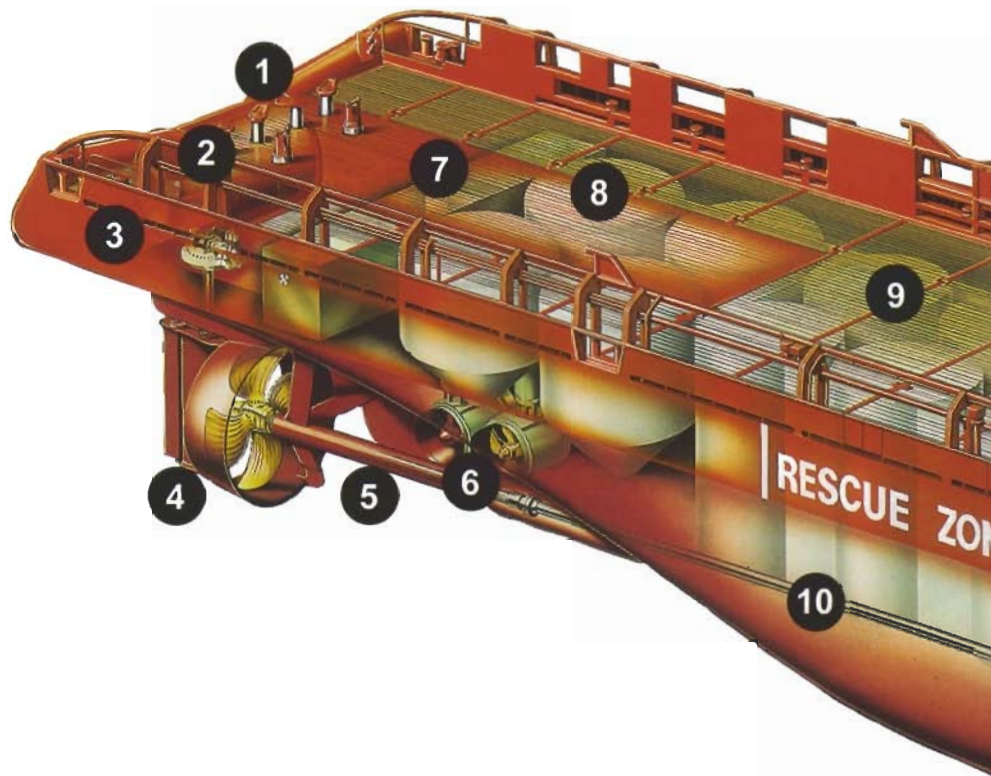

Two 3D images of a platform supply vessel.
Ship Knowledge, a modern encyclopedia

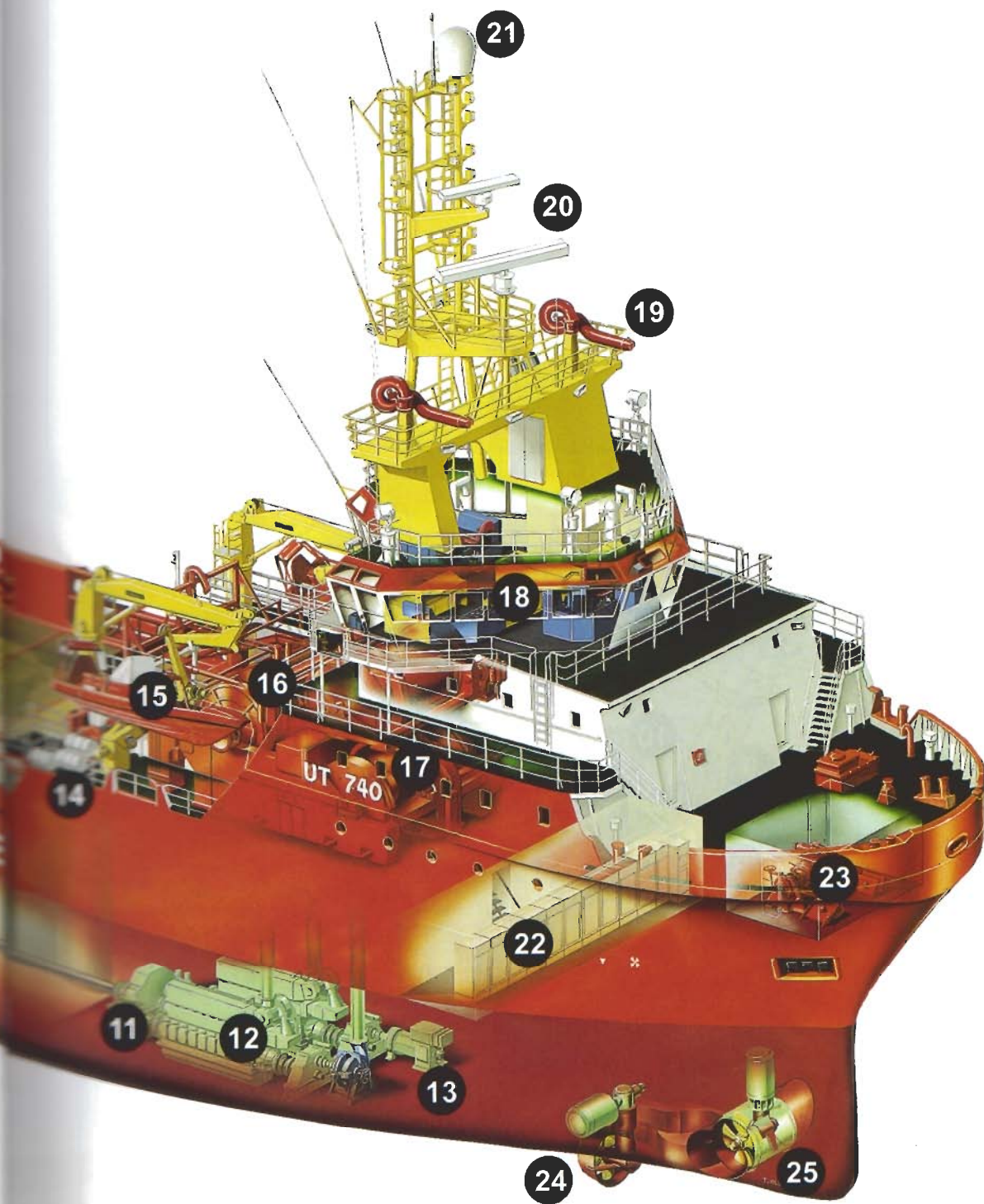

7 Fishing vessel (Eurocutter) "Z575"

1. Rudder
2. Jet nozzle
3. Propeller
4. Engine room
5. Engine room bulkhead
6. Main engine
7. Fuel tanks, two wing tanks and a center tank
8. Starboard bracket pole, used when fishing is done with nets and otter boards. The derrick will not be used in that case
9. Mast aft
10. Revolving drum for nets
11. Funnel
12. Messroom, dayroom
13. Bridge with navigational equipment and control panels for main engine, drum for nets and fish winch
14. Cabin for four
15. Railing
16. Capping
17. Scupper hole
18. Wooden workdeck
19. Hatch on fish tank
20. Drop chute
21. Fish tank, with an insulation layer of about 20 cm all around
22. Bilge keel
23. Shear strake
24. Double bottom
25. Bow thruster installation
26. Name of the ship and fishery (registration) number
27. Fish winch
28. Conveyor belt and fish cleaning table
29. Guide pulleys for fish line
30. Forecastle deck
31. Fish wire blocks
32. Fish wire
33. Fish derrick
34. Mast
35. Radar antenna on mast

Principal Dimension:

Dimensions:

Length:	23.99 m
Breadth:	6.20 m
Depth:	2.70 m

Gross Tonnage: 102 GT

Delivered: 2000

Main Engine: 300 hp

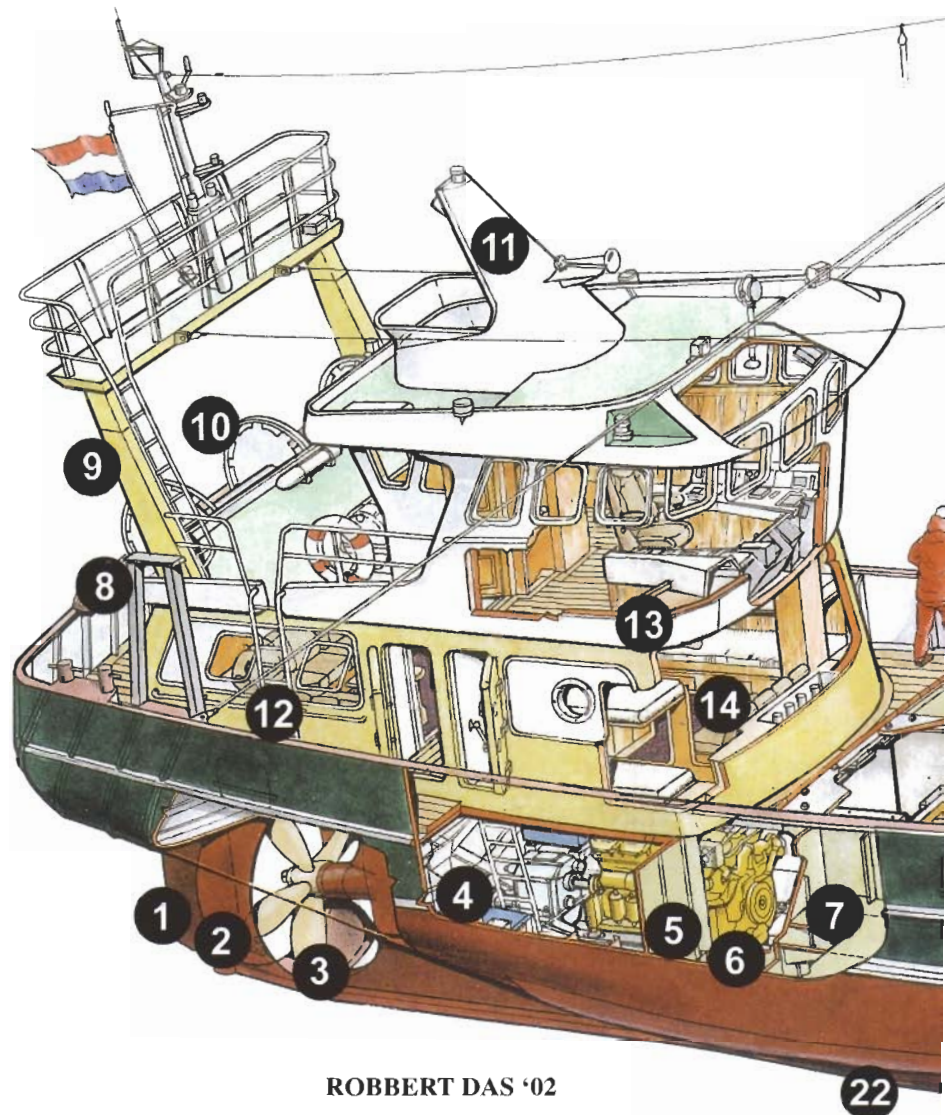

ROBBERT DAS '02

22



A comparable type of the fishing vessel in service



A picture of the fishing vessel Z 575 on her sea trials.

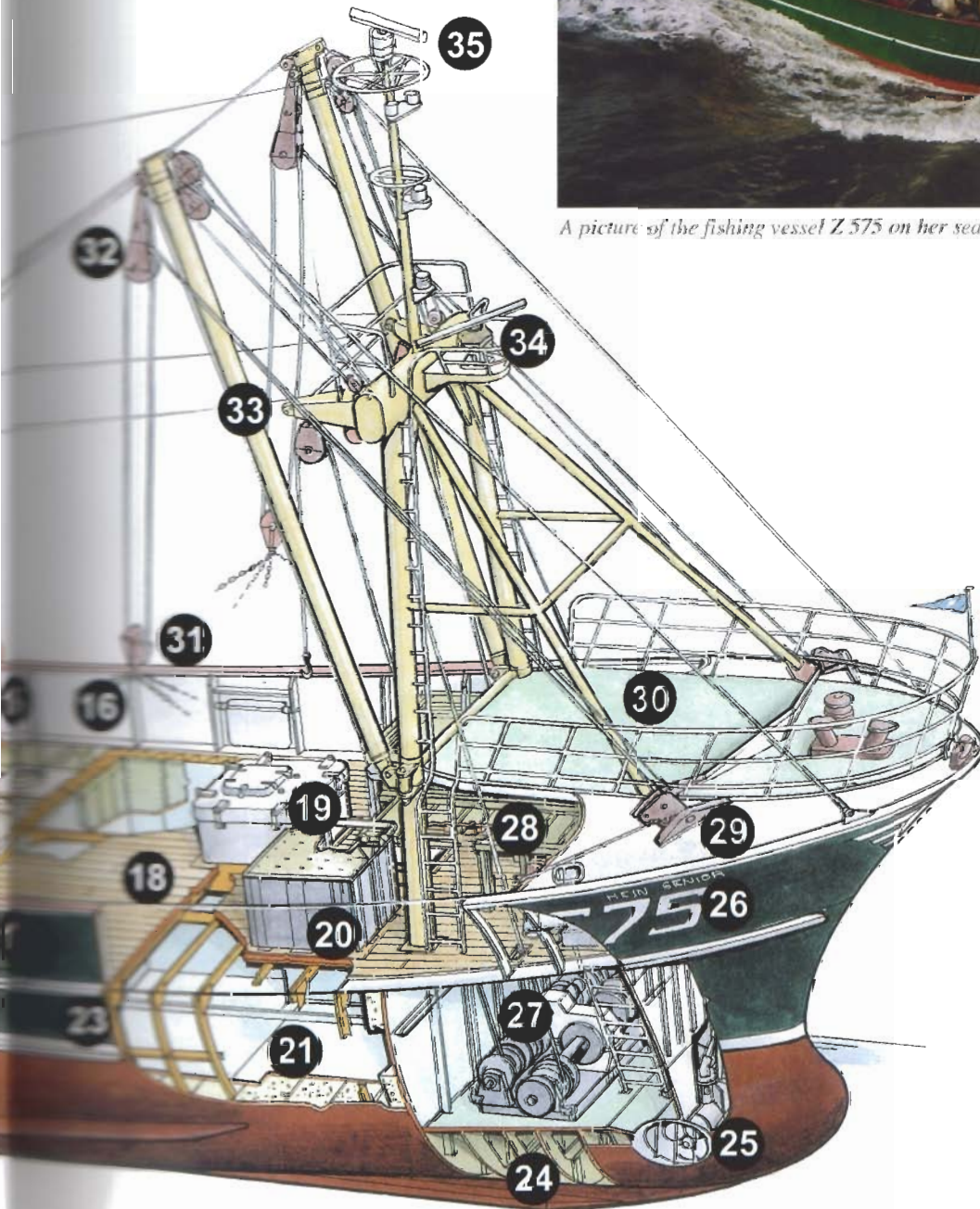

CHAPTER 2

The shape of a ship



1 Principal dimensions

- 1.1 General
- 1.2 Dimensions
- 1.3 Proportions
- 1.4 Volumes and weights

2 Form coefficients

- 2.1 Waterplane-coefficient
- 2.2 Midship section coefficient
- 2.3 Block coefficient
- 2.4 Prismatic coefficient

3 Lines plan

4 Drawings

- 4.1 General arrangement plan
- 4.2 Midship section
- 4.3 Shell expansion
- 4.4 Other plans

5 Important data on various ships

- 5.1 General cargo ship
- 5.2 Refrigerated vessel
- 5.3 Coastal trade liner
- 5.4 Ferry
- 5.5 Bitumen tanker
- 5.6 Chemical tanker



SHIP KNOWLEDGE

A MODERN ENCYCLOPEDIA

SHIPWISE

PAGE 8 **1**

THE SHAPE OF A SHIP

PAGE 22 **2**

SHIP'S TYPES

PAGE 44 **3**

THE BUILDING OF A SHIP

PAGE 68 **4**

FORCES ON A SHIP

PAGE 82 **5**

LAWS AND REGULATIONS

PAGE 104 **6**

CONSTRUCTION OF THE VARIOUS SECTIONS

PAGE 126 **7**

CLOSING ARRANGEMENTS

PAGE 160 **8**

LOADING GEAR

PAGE 174 **9**

ANCHOR AND MOORING GEAR

PAGE 196 **10**

ENGINE ROOM

PAGE 216 **11**

PROPULSION AND STEERING GEAR

PAGE 244 **12**

ELECTRICAL INSTALLATIONS

PAGE 266 **13**

MAINTENANCE AND DOCKING

PAGE 280 **14**

SAFETY

PAGE 302 **15**

STABILITY

PAGE 322 **16**

CHAPTER 2 QUESTIONS
VISIT
WWW.DOKMAR.COM

1. Principal Dimensions

1.1 General

Measurement Treaty

All aspects concerning the measurements of seagoing vessels are arranged in the certificate of registry act of 1982. Part of the certificate of registry act is the International treaty on the measurement of ships, as set up by the IMO-conference in 1969. The treaty applies to seagoing vessels with a minimum length of 24 metres and came into force in July 1994.

Perpendicular

Line perpendicular to another line or plane (for instance the water line). On a ship there are:

Fore Perpendicular (FPP, or FP)

This line crosses the intersection of the water line and the front of the stem.

Aft Perpendicular (APP, or AP)

This line usually aligns with the centerline of the rudder stock (the imaginary line around which the rudder rotates).

Load Line

The water line of a ship lying in the water. There are different load lines for different situations, such as:

Light water line

The water line of a ship carrying only her regular inventory.

Deep water line

The water line of maximum load draught in seawater.

Water line

The load line at the summer mark as calculated in the design of the ship by the ship builder.

Construction water line (CWL)

The water line used to determine the dimensions of the various components from which the vessel is constructed.

Deck line

Extended line from the topside of the fixed deck covering at the ship's side.

Moulded dimensions

Distance between two points, measured on inside plating (or outside framing).

Base Line

Top of the keel.

Plimsoll Mark

The Plimsoll mark or Freeboard mark consists of a circle with diameter of one foot, which through a horizontal line is drawn with as upper edge the centre of the circle. This level indicates the minimum freeboard in salt water summer conditions. Beside the circle is a number of horizontal lines indicating the minimum freeboard as above. Summer freeboard: S. Other conditions: Tropical: T, Winter: W, Fresh (water): F, Tropical Fresh: TF, and for small ships, less than 100 m: Winter North Atlantic: WNA. All connected by a vertical line. For easy checking of the position of the Mark, above the mark a reference line is drawn: the Deck line. Normally at the level of the weather deck, but in case the weather deck is not the freeboard deck (e.g. Ro-Ro), at the level of that deck. When the distance is impractically large, or the connection deck shellplate is rounded off (tankers, bulkcarriers), the reference line is positioned at a lower level. The Mark and the Deckline are to be marked permanently on port and starboard-side, midlength.

The draught marks, Plimsoll Line and Plimsoll Mark are permanent marks. Usually this means that they are carved into the hull.



Explanation of the picture at the right:

- S = Summer (for water with a density of 1.025 t/m³)
- W = Winter (ditto)
- T = Tropics (ditto)
- WNA = Winter North Atlantic (ditto)
- TF = Tropical Fresh water
- F = Fresh water

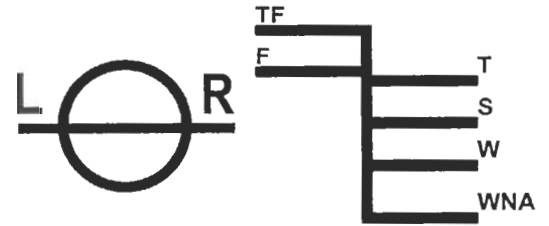

- 1: Plimsoll mark
- 2: Plimsoll line
- 3: Draught marks
- 4: Deckline

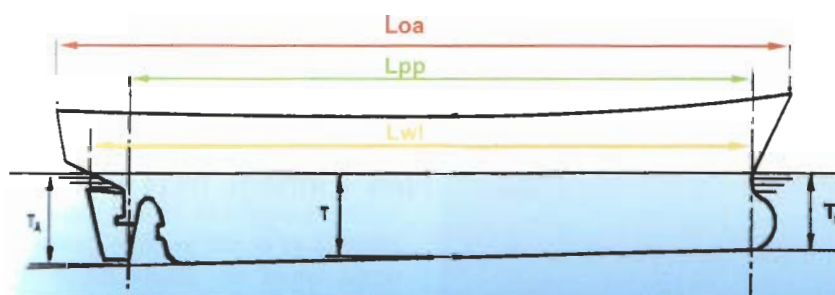
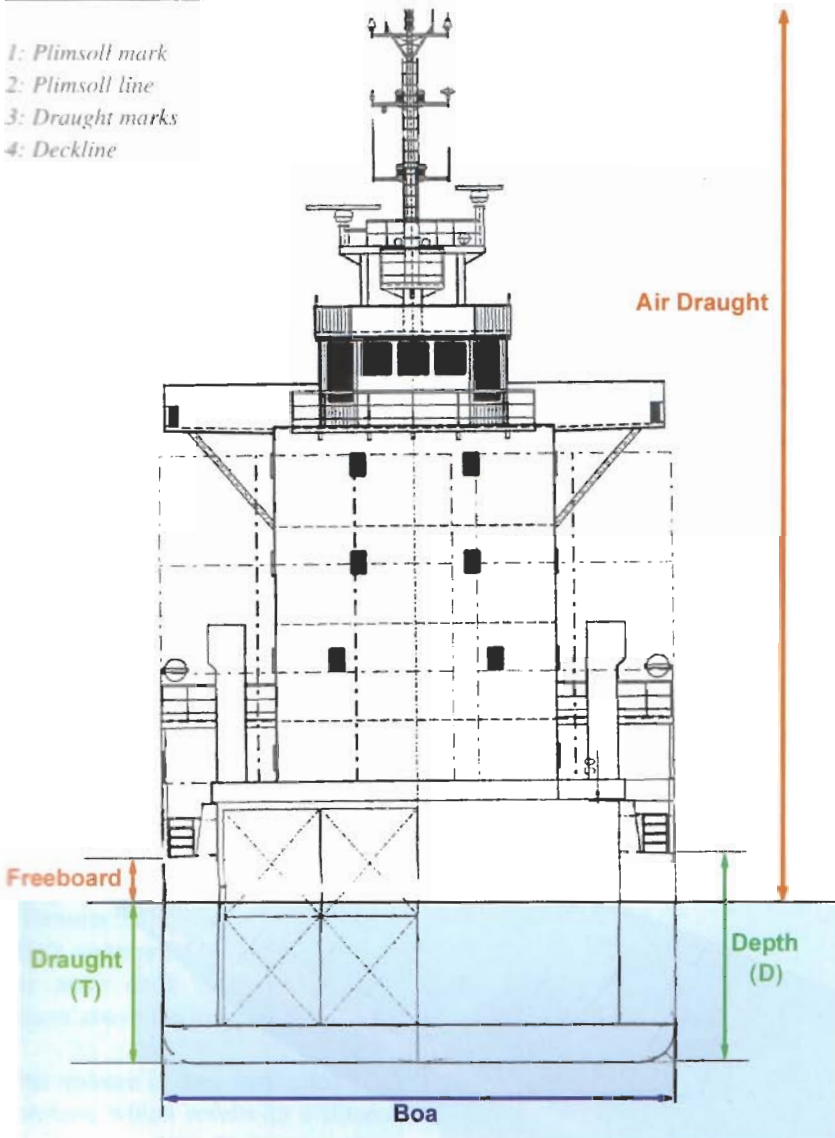

When a ship carries a deck cargo of timber, and certain demands are met, this ship is allowed to have more draught (less freeboard). This is because of the reserve buoyancy caused by the deck cargo. To indicate this, the ship has a special Plimsoll's mark for when it is carrying a deck cargo of timber, the so-called timber mark.

1.2 Dimensions

Length between perpendiculars (Lpp)
Distance between the Fore and the Aft Perpendicular.

Length over all (Loa)
The horizontal distance from stem to stern.

Length on the water line (Lwl)
Horizontal distance between the moulded sides of stem and stern when the ship is on her summer mark.

Breadth (B)
The greatest moulded breadth, measured from side to side outside the frames, but inside the shell plating.

Breadth over all
The maximum breadth of the ship as measured from the outer hull on starboard to the outer hull on port side.

Draught at the stem (T_{fwd})
Vertical distance between the water line and the underside of the keel, as measured on the fore perpendicular.

Draught at the stern (T_{aft})
The vertical distance between the water line and the underside of the keel as measured from the aft perpendicular.

Trim
The difference between the draught at the stem and the draught at the stern.

Down and trimmed by the head.

If the draft is larger at the stem, than at the stern.

Down and trimmed by the stern.

If the draft is larger at the stern, than at the stem.

On an even keel, in proper trim.

The draft of the stern equals the draft of the stem.

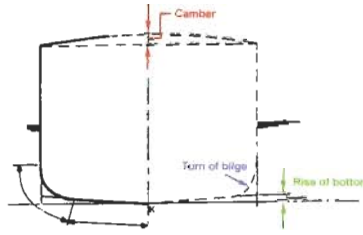

Depth

The vertical distance between the base line and the upper continuous deck. The depth is measured at half Lpp at the side of the ship.

Freeboard

The distance between the water line and the top of the deck at the side (at the deck line). The term summer freeboard means the distance from the top of the S-line of the Plimsoll's mark and the topside of the deck line.

Air draught

The vertical distance between the water line and the highest point of the ship. The air draught is measured from the summer mark. If the ship has less draught one can ballast until it reaches the summer draught and so obtain its minimum air draught.

Sheer

This is the upward rise of a ship's deck from amidships towards the bow and stern. The sheer gives the vessel extra reserve buoyancy at the stem and the stern.

Camber

Gives the athwart-ships curvature of the weather deck. The curvature helps ensure sufficient drainage.

Rise of floor

Unique to some types of vessels like tugboats and fishing boats. This is the upward rise of the lower edges of the floors from the keel towards the bilges.

Turn of bilge

Gives the turn of bilge of the ship.

1.3 Proportions

The ratios of some of the dimensions discussed above can be used to obtain information on resistance, stability and manoeuvrability of the ship. Some widely used relations are:

L/B

The ratio of length and breadth can differ quite dramatically depending on the type of vessel. Common values:

Passenger ships	6-8
Freighters	5-7
Tug boats	3-5

A larger L/B value is favourable for speed, but unfavourable for manoeuvrability.

L/D

The length/depth-ratio. The customary values for L/D varies between 10 and 15. This relation plays a role in the determination of the freeboard and the longitudinal strength.

B/T (T = Draught)

The breadth/draught-ratio, varies between 2.3 and 4.5. A larger breadth in relation to the draught (a larger B/T-value) gives a greater initial stability.

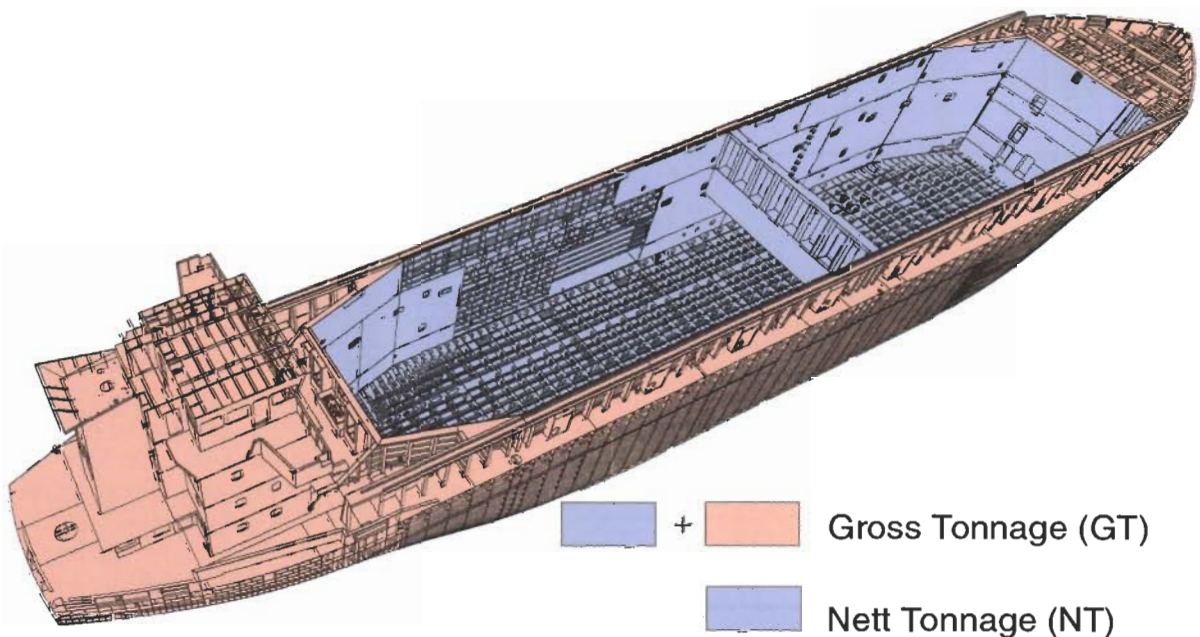

B/D

The breadth / depth-ratio; varies between 1.3 and 2. If this value becomes larger, it will have an unfavourable effect on the stability (because the deck will be flooded when the vessel has an inclination) and on the strength.

1.4 Volumes and weights

General

The dimensions of a ship can be expressed by using terms which describe the characteristics of the ship. Each term has a specific abbreviation. The type of ship determines the term to be used. For instance, the size of a container vessel is expressed in the number of containers it can transport; a roll-on roll-off carrier's size is given by the total deck-area in square metres and a passenger ship in the number of people it can carry. At the IMO-conference in 1969 the new units "Gross Tonnage" and "Net Tonnage" were introduced, to establish a world-wide standard in calculating the size of a ship. In many countries the Gross Tonnage is used to determine port dues and pilotage, or to determine the number of people in the crew.

Register ton

To determine the volume of a space the register ton is used. One register ton equals 100 cft, or 2.83 m³.

Gross Tonnage

The gross tonnage is calculated using a formula that takes into account the ship's volume in cubic metre below the main deck and the enclosed spaces above the main deck.

This volume is then multiplied by a constant, which results in a dimensionless number (this means no values of T or m³ should be placed after the number). All distances used in the calculation are moulded dimensions.

In order to minimize the daily expenses of a ship, the ship owner will keep the GT as low as possible. The way of doing this is by keeping the depth small, so more cargo

(mostly containers) can be placed on deck. It is typical for small container ships to use this strategy. As a consequence of this, dangerous situations can occur because the loss of reserve buoyancy can result in a loss of stability and more "water on deck".

Net Tonnage

The Net Tonnage is also a dimensionless number that describes the volume of the cargo space. The NT can be calculated from the GT by subtracting the volume of space occupied by:

- crew
- navigation equipment
- propulsion equipment
- workshops

The NT may not be less than 30% of the GT.

Displacement (in m³)

The displacement equals the volume of the part of the ship below the water line including the shell plating, propeller and rudder.

Underwater body (in m³)

The underwater body of a ship equals the displacement minus the contribution of the shell, propeller and rudder. Or: the calculated volume of the part of the hull which is submerged in the water, on the outside of the frames without extensions.



An example of a ship with a small depth



Displacement Δ (in t)

The displacement is the weight of the volume of water displaced by the ship. One could also say: the displacement equals the total mass of the ship.

$$\text{Displacement (t)} = \text{water displacement (m}^3\text{)} * \text{density of water (t/m}^3\text{)}$$

Light displacement (in t)

This is the weight of the hull including the regular inventory. The regular inventory includes: anchors, life-saving appliances, lubricating oil, paint, etc.

Dead weight (in t)

This is the weight a ship can load until the maximum allowable submersion is reached. This is a constant, which is unique for every ship.

$$\text{Dead weight (t)} = \text{maximum weight } \Delta(t) - \text{light displacement (t)}$$

$$\text{Dead weight (t)} = \text{maximum weight } \Delta(t) - \text{actual weight } \Delta(t)$$

Cargo, carrying or dead weight capacity (in t)

This is the total weight of cargo a ship can carry. The cargo capacity (in t) is not a fixed number, it depends on the ship's maximum allowable submersion, which will include the capacity (in t) of fuel, provisions and drinking water. For a long voyage there has to be room for extra fuel, which reduces the cargo capacity. If, on the other hand, the ship refuels (bunkers) halfway, the cargo capacity is larger upon departure. The choices for the amount of fuel on board and the location for refuelling depend on many factors, but in the end the master has final responsibility for the choices made.

$$\text{Cargo capacity (t)} = \text{dead weight (t)} - \text{ballast, fuel, provisions (t)}$$



The cargo capacity largely determines the amount of money a ship generates.



Ship discharging bulk cargo

2. Form coefficients

Form coefficients give clues about the characteristics of the vessel's shape from the water line down into the water. This makes it possible to get an impression of the shape of the underwater body of a ship without extensive use of any data. However, the form coefficients do not contain any information on the dimensions of the ship, they are non-dimensional numbers.

2.1 Waterplane-coefficient C_w .

The waterplane-coefficient gives the ratio of the area of the water line A and the rectangular plane spanned by L_{pp} and B_{mld} . A large waterplane-coefficient in combination with a small block-coefficient (or coefficient of fineness) is favourable for the stability in both athwart and fore and aft direction.

$$\text{Waterplane-coefficient (} C_w \text{)} \approx \frac{A_w}{L_{pp} \times B_{mld}}$$

2.2 Midship section coefficient, C_m .

The midship-coefficient gives the ratio of the area of the midship section (A_m) and the area spanned by B_{mld} and T .

$$\text{Midship-coefficient } (C_m) = \frac{A_m}{B_{mld} \times T}$$

2.3 Block coefficient, coefficient of fineness, C_b .

The block coefficient gives the ratio of the volume of the underwater body and the rectangular beam spanned by L_{pp} , B_{mld} and T . A vessel with a small block coefficient is referred to as 'slim'. In general, fast ships have a small block coefficient.

Customary values for the block coefficient of several types of vessels:

Tanker	0.80-0.90
Freighter	0.70-0.80
Container vessel	0.60-0.75
Reefer	0.55-0.70
Frigate	0.50-0.55

$$\text{Block coefficient } (C_b) = \frac{V}{L_{pp} \times B_{mld} \times T}$$

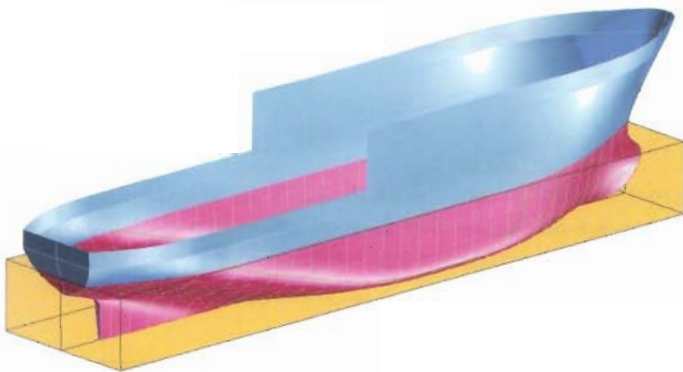

Graphical representation of the block coefficient.



A ship with a small block-coefficient and a large midship section coefficient



A ship with a large block-coefficient and a large midship section and prismatic coefficient.

$$\text{Prismatic coefficient } (C_p) = \frac{V}{L_{pp} \times A_m}$$

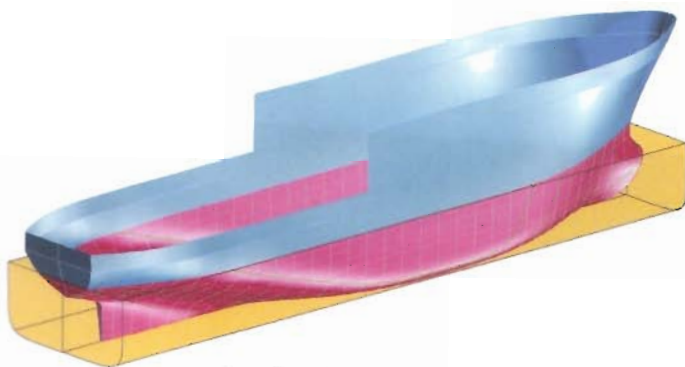

Graphical representation of the prismatic coefficient.

2.4 Prismatic coefficient, C_p .

The prismatic coefficient gives the ratio of the volume of the underwater body and the block formed by the area of the midship section (A_m) and L_{pp} . The C_p is important for the resistance and hence for the necessary power of propulsion (if the C_p decreases, the necessary propulsion power also becomes smaller).

The maximum value of all these coefficients is reached in case of a rectangular beam, and equals 1. The minimal value is theoretically 0.

3. Lines and offsets (Lines plan)

When the principal dimensions, displacement and line-coefficients are known, one has an impressive amount of design information, but not yet a clear image of the exact geometrical shape of the ship. This can be obtained by the use of a lines plan.

The shape of a ship can vary in height, length and breadth of the ship's hull. In order to represent this complex shape on paper, cross-sections of the hull are combined with three sets of parallel planes, each one perpendicular to the others.

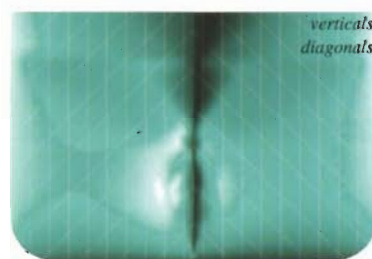
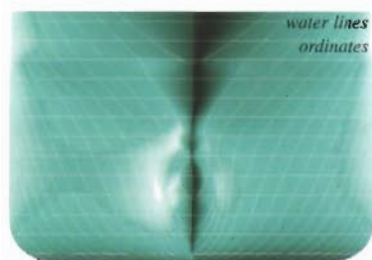
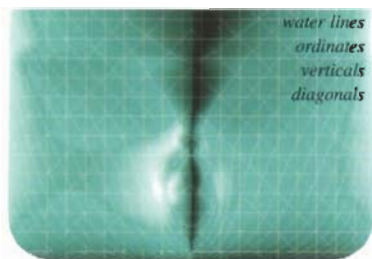

Water lines.

Horizontal cross-sections of the hull are called water lines. One of these is the water line/design draught. This is the water line used in the design of the ship when it is hypothetically loaded. When the water lines are projected and drawn into one particular view, the result is called a water line model.



The waterlines

Ordinates.

Evenly spaced vertical cross-sections in athwart direction are called ordinates. Usually the ship is divided into 20 ordinates, from the centre of the rudder stock (ordinate 0) to the intersection of the water line and the mould-side of the stem (ordinate 20). The boundaries of these distances are numbered 1 to 20, called the ordinate numbers. A projection of all ordinates into one view is called a body plan.



The ordinates

Buttocks

Vertical cross-sections in fore and aft direction are called buttock lines. These cross-sections are parallel to the plane of symmetry of the ship. When the buttocks are projected and drawn into one particular view, the result is called a sheer plan.



Buttock lines

Diagonals

The diagonals are cross-sections of fore and aft planes that intersect with the water lines and verticals at a certain angle. On the longitudinal plan they show up as straight lines. The curvature of the water lines and buttocks are compared to each other and modified until they are consistent. When this procedure is executed, the results can be checked using the diagonals. The most common diagonal is called the bilge diagonal.



The diagonals

Nowadays the lines plans are being made with the aid of computer-programs that have the possibility to transform the shape of the vessel automatically when modifications in the ship's design require this. When the linesplan is ready, the programs may be used to calculate, among other things, the volume and stability of the ship.

As shown in the lines plan below, both the water lines and the buttocks are drawn in one half of the ship. In the body plan, the frames aft of the midships are drawn on the left side and the fore frames are drawn on the right. The linesplan is drawn on the inside of the skin plating.

The lines plans shown here are of vessels that have underwater bodies



that differ quite dramatically. The reader can tell from these plans that a ship will be slimmer with smaller coefficients, when the water lines, ordinates and buttocks are more

closely spaced. For instance, a rectangular forecastle has only one water line, one ordinate and one buttock, the coefficients are 1.

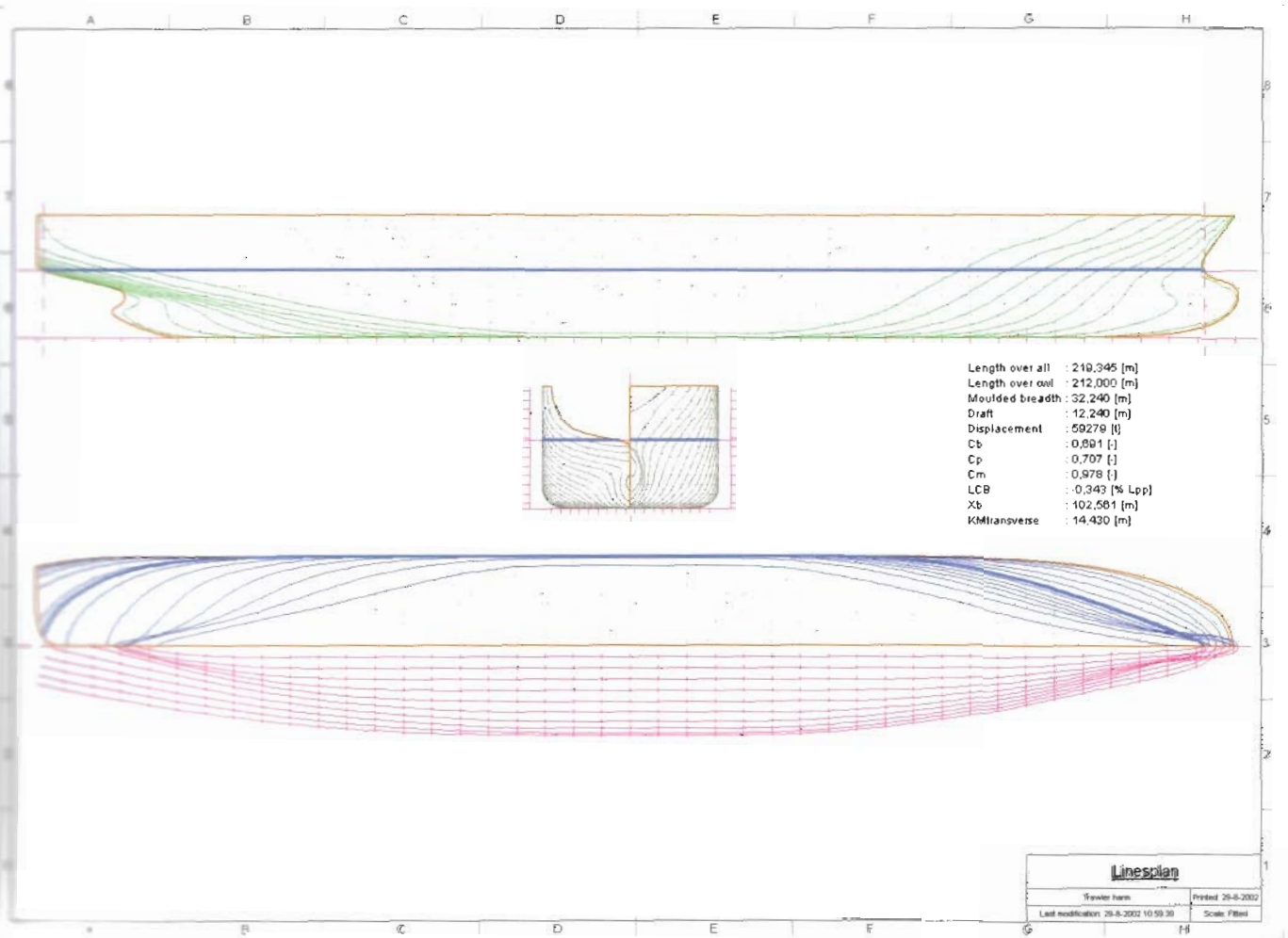

The lines plan of a container vessel with a length over all of 203,5 meters

Tug boat

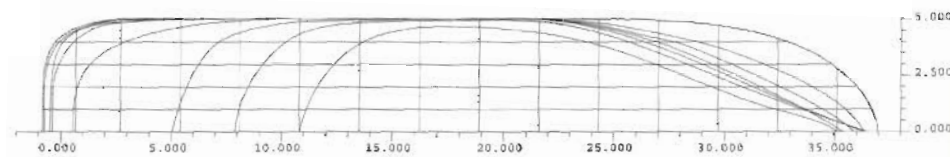
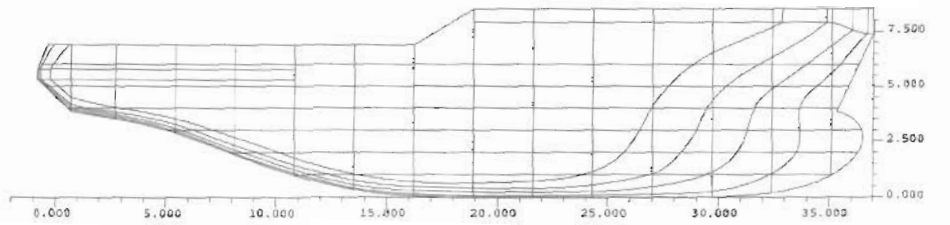
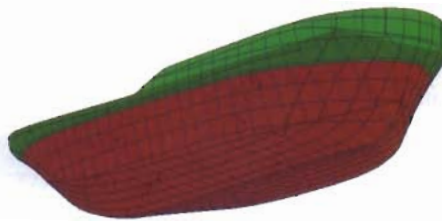
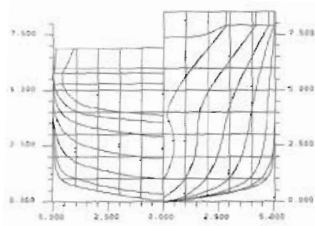

Lpp	= 35.000 m
Cb	= 0.565
Volume	= 896 m ³
Bmld	= 10.080 m
Cm	= 0.908
LCB	= 2.90 %
Tmld	= 4.500 m
Cp	= 0.622
KM	= 5.13 m

Yacht

Lpp	= 23.500 m
Cb	= 0.157

Volume	= 92 m ³
Bmld	= 6.250 m

Cm	= 0.305
LCB	= -3.16 %

Tmld	= 4.000 m
Cp	= 0.515

KM	= 6.06 m
----	----------

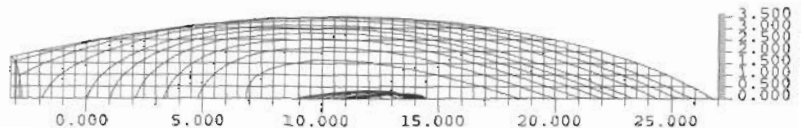
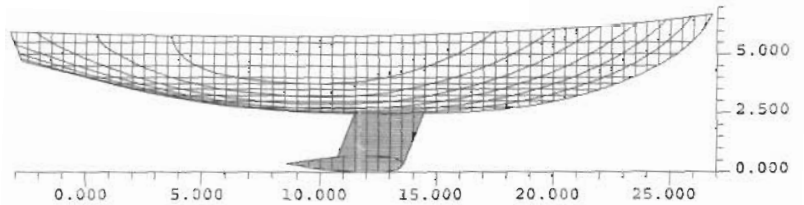
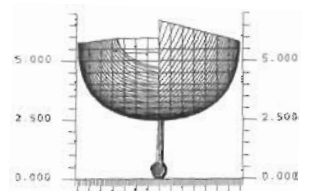

Coast guard ship with a somewhat exceptional underwater-shape.

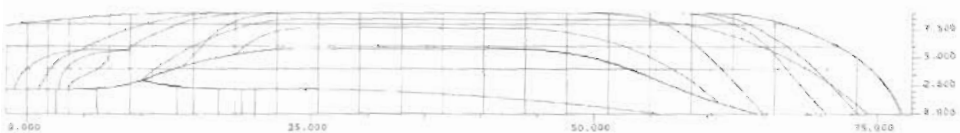
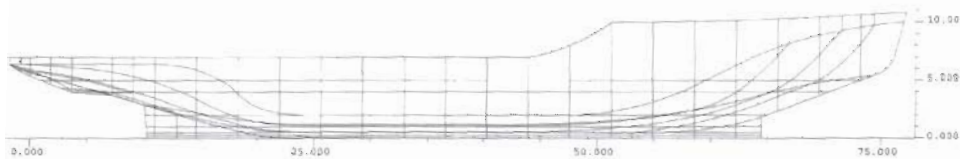
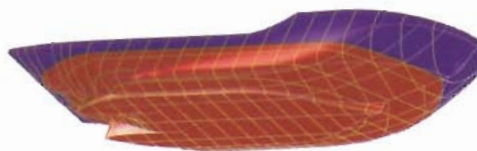
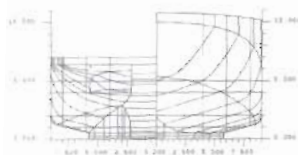

Lpp	= 73.200 m
Cb	= 0.637

Volume	= 4196 m ³
Bmld	= 18.000 m

Cm	= 0.933
LCB	= -0.75 %

Tmld	= 5.000 m
Cp	= 0.683

KM	= 8.67 m
----	----------

Heavy cargo ship, multi-purpose.

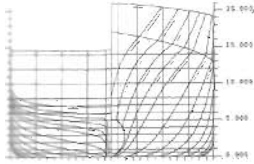

Lpp	= 134.000 m
Cb	= 0.710
Volume	= 18644 m ³
Bmld	= 28.000 m
Cm	= 0.992
LCB	= -2.24 %
Tmld	= 7.000 m
Cp	= 0.715
KM	= 14.46 m

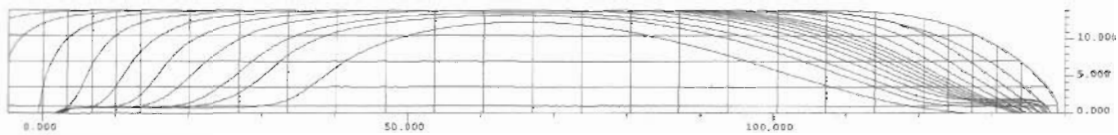

Frigate

Lpp	= 96.000 m
Cb	= 0.452
Volume	= 1620 m ³
Bmld	= 11.500 m
Cm	= 0.752
LCB	= -2.30 %
Tmld	= 3.250 m
Cp	= 0.601
KM	= 6.17 m

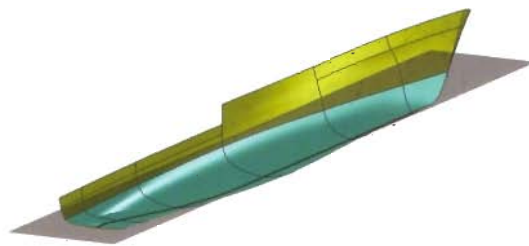
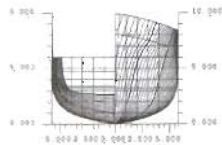

Frigate

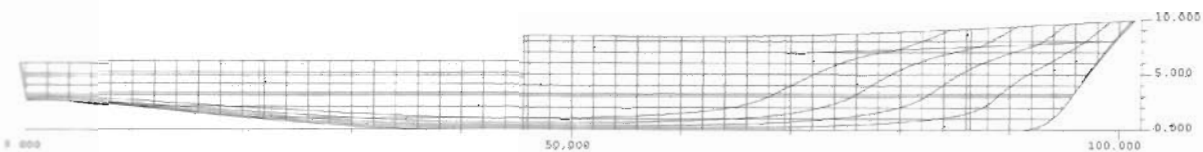
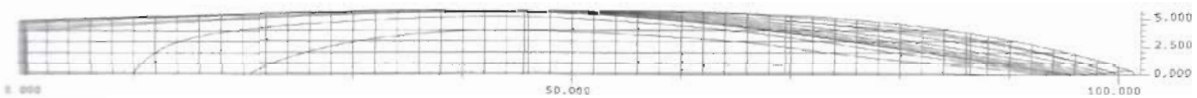

Abbreviations used in the drawings:

Lpp = length between perpendiculars
 Bmld = breadth moulded
 Tmld = draught moulded
 Cb = block coefficient or coefficient of fineness

Cm = midship section coefficient
 Cp = prismatic coefficient
 Volume = volume of the underwater body, as measured on the water lines, to the outside of the frames (m³).

LCB = point of application of the resultant of all upward forces; longitudinal centre of buoyancy (m).
 KM = Height of meta-centre above the keel (m).

4. Drawings

Of the many drawings, only the most important ones are mentioned here. In general, the following demands are made:

The general arrangement plan, safety plan, docking plan and capacity plan have to be submitted to the Shipping Inspectorate for approval.

The general arrangement plan, midship section drawing, shell expansion and construction plan (or sheer plan or working drawing) have to be submitted to the classification bureau for approval.

4.1 General arrangement plan

The general plan roughly depicts the division and arrangement of the ship. The following views are displayed:

- a (SB) side-view of the ship.
- the plan views of the most important decks.
- sometimes cross-sections, or a front and back view are included.

The views and cross-sections mentioned above, display among other things:

- the division into the different compartments (for example: tanks, engine room, holds)
- location of bulkheads.
- location and arrangement of the superstructures.
- parts of the equipment (for example: winches, loading gear, bow thruster, lifeboat).

Next to these, some basic data are included in the drawing like: principal dimensions, volumes of the holds, tonnage, dead weight, engine power, speed and class.

Fig: General arrangement plan of a multi-purpose vessel that carries mainly paper, timber products and containers.

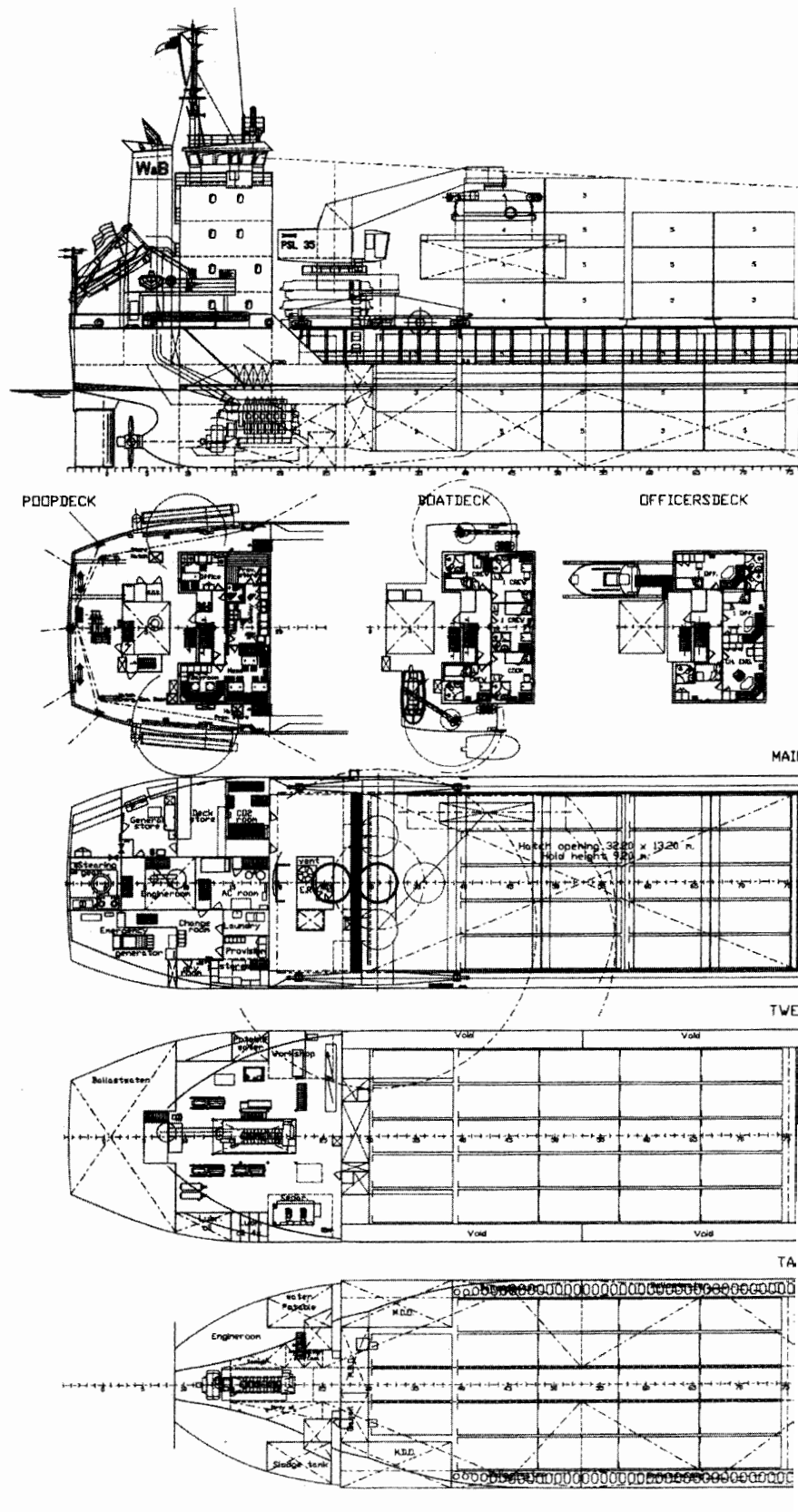

An example of a general arrangement plan

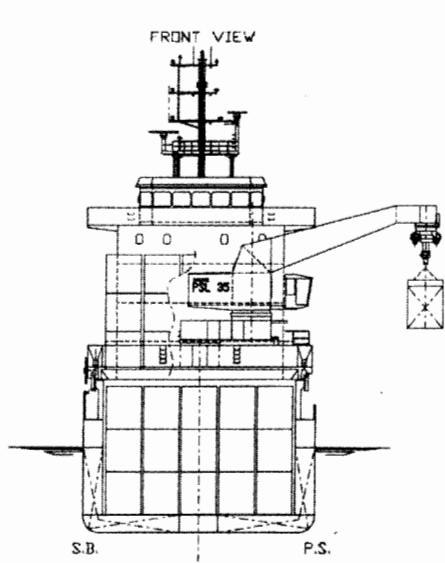
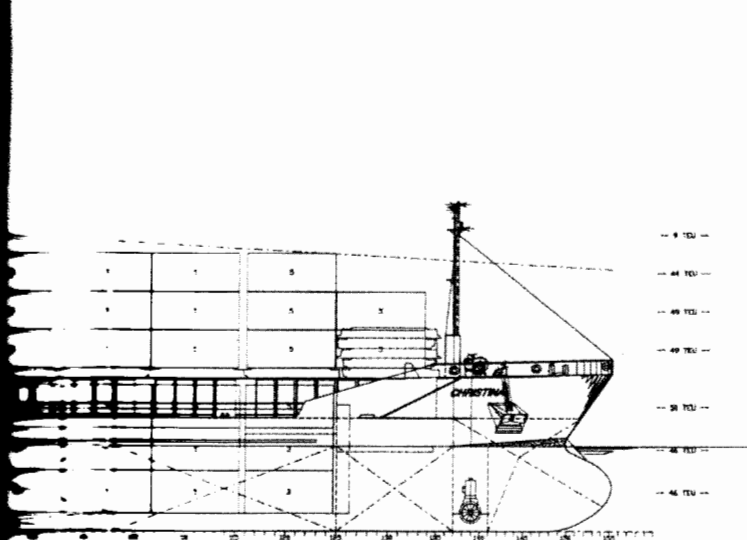

BRIDGEDECK

FORECASTLEDECK

Frame 27

Frame 76

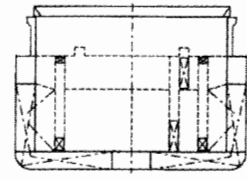
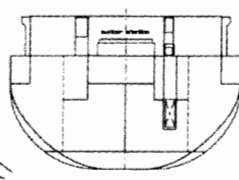
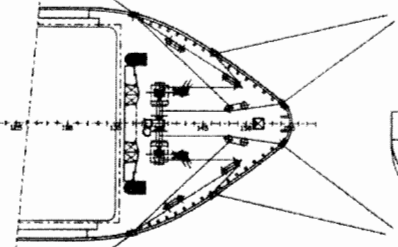
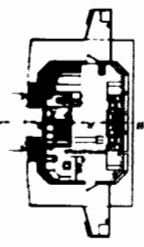

Frame 79

Frame 126

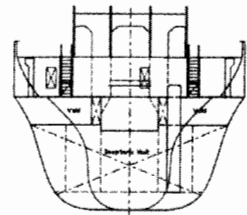
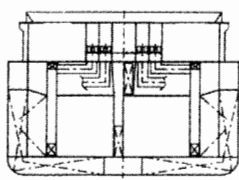
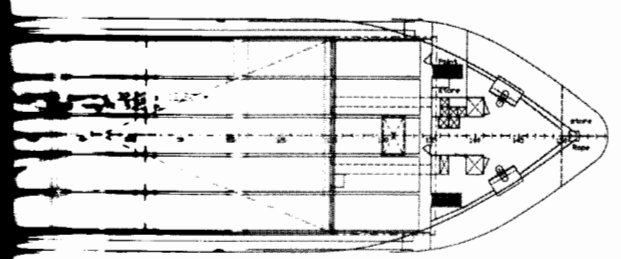

Frame 125

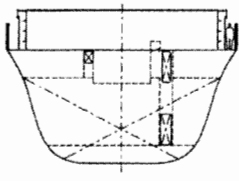

MAIN PARTICULARS

Length over all	108.50 m.
Length between perpendiculars	102.40 m.
Breadth moulded	15.88 m.
Depth	7.70 m.
Draft (summer)	5.892 m.
Deadweight (incl. crane)	5222 T.
Deadweight (incl. crane)	5441 T.
Tonnage	4235 GT
	2100 NT
Capacity:	
H2O	7505 m ³
Ballast water	2588 m ³
Potable water	28 m ³
MDO	318 m ³
Gasoil	37 m ³

ICE class 1A Finnish / Swedish

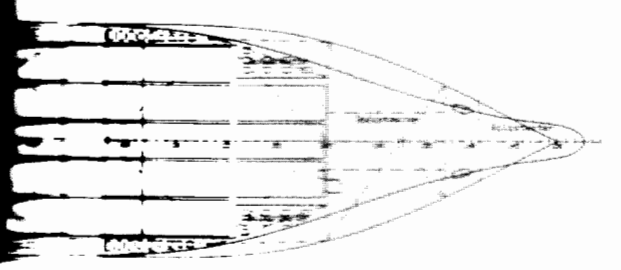
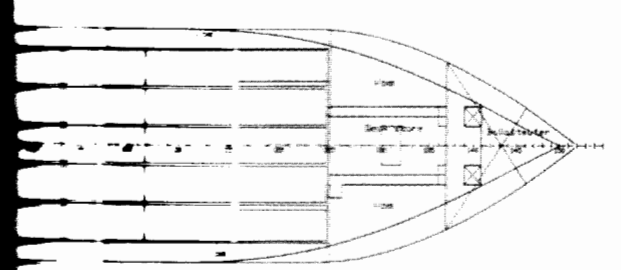



WILJNE & BAREND'S
corporation in registration form in

H C C 5000



ROBBERY PROTECTIVE EQUIPMENT

Niestern Sander b.v.

Postbus 100, 1300 AA Almere, T. 036-477979
Fax 036-477978, Telex 5208 UNISAR NL

CONOSHIP INTERNATIONAL

CONDOSHIP INTERNATIONAL B.V. - P.O. BOX 6029
GRONINGEN - THE NETHERLANDS

HIGH CUBIC CONTAINER 5000

SCALE:	DATE:	YARD NO.:	DRAWING NO.:	SHEET:
1:200	12-01-2000	907	100	
DRAWN BY:		VERSION:		
J.v.Zelderen				

4.2 Midship section

This cross-section shows one or more athwart cross-sections of the ship. In case of a freighter it is always a cross-section of the hold closest to the midship. Some of the data shows includes:

- principal dimensions
- engine power and speed
- data on classification
- equipment numbers
- maximum longitudinal bending moment.

Web Frame

Frame Spacing 700 mm

Web every 2nd Frame

Principal dimensions :

Length o.a	108.5	m
Length b.p.p.	102.4	m
Length rule	101.85	m
Breadth mid.	15.88	m
Depth mid.	7.7	m
Design draught	5.8	m
Scantling draught	5.931	m
Engine output	2880	kw
Max displacement ice	7444	ton
Service speed	14	kts
C.p. propeller		

Classification : Lloyds + 100A1

Strengthening for heavy cargoes

Container cargoes in holds and on upperdeck hatchcovers
ICE Class 1A (Finnish/Swedish ice class Rules 1985)
with the descriptive note in col. 6 of the register book
Pt. Ht. steel

Ballast draught in ice condition

Ballast departure	aft	4.251	m
	fwd	3.107	m
Ballast arrival	aft	4.118	m
	fwd	3.115	m

Tanktop load : 15 t/m²

Stackload containers hold : 20 ft - 75 ton
: 40 ft - 90 ton

Stackload containers on hatches : 20 ft - 30 ton

(line load) : 40 ft - 40 ton

Hatch load : 2 ton/m²

Equipmentnr. : 994

2 Anchors 2295 kg PDQL TW

44 mm Stud Chain U3 495 m

Max. long. bendingmoment : 166000 kN.m
(hogging)

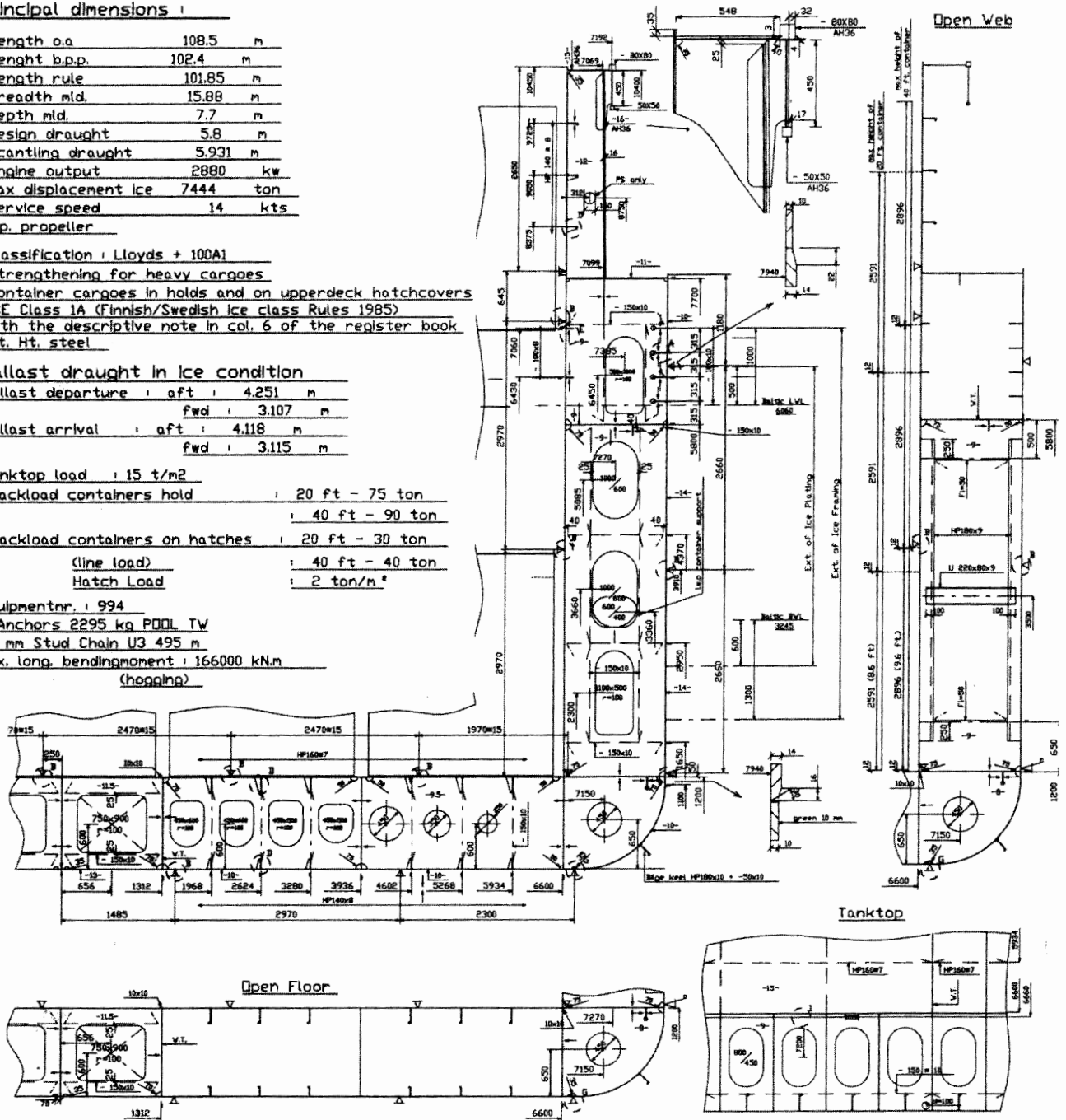

7

Here part of the midship section of the same multi-purpose ship is shown.

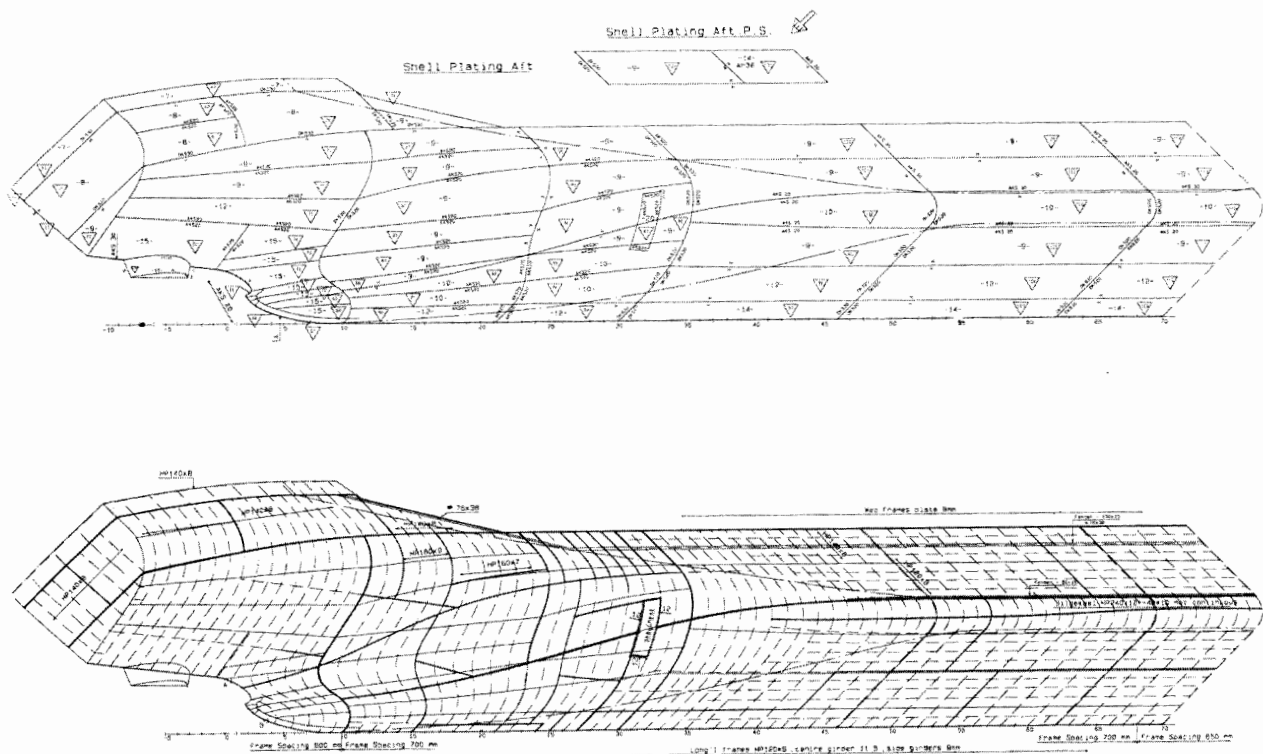

Shell expansion of a container-feeder.

4.3 Shell Expansion

In order to get an idea about the composition of the different plates of the shell plating and their particulars (for example hull openings), a shell expansion is drawn. This drawing can be made in two forms. In one version the true athwart-length of the shell is shown; therefore the length shown in fore and aft direction is not the real length of the shell. This results in what seems a somewhat distorted image of the ship. The other version (shown below) shows a 3D-like view of the ship.

4.4 Other plans

Construction plan

This drawing depicts the fore and aft cross section midships (CL) and the main views of the most important parts. Sometimes the drawing also includes the watertight and other important bulkheads. It indicates

their locations and the dimensions of the structural members (including the plate thickness).

Safety plan

The safety plan is a general arrangement plan on which all the safety devices (for example lifeboats, life rafts, escape routes, fire extinguishers) are shown.

Docking plan

The docking plan is a simplified version of the general plan. It indicates where the ship should be supported by the keel blocks in case of docking. Furthermore the bottom and other tank plugs are shown with the type of liquid with which tanks may be filled.

Capacity plan

This is also a simplified version of the general plan. All tanks and holds are indicated with their volumes and centre of gravity respectively.

Together with the stability and 'light weight' particulars, this forms the basis from which stability calculations can be performed. Normally this drawing goes together with the deadweight scale, which gives information about the relationship between draught and for example displacement in fresh and salt water.

5. Important data on various ships

Ship owners have an interest in promoting their ships as much as possible, especially the types of cargo their ships can transport. Or to put it in another way: how they can earn money. The table on the next page contains data of a number of ships which differ very much in the type of cargo they can carry. The abbreviations and other information are explained, unless they have already been explained in the text.

CLASS	S-TYPE	LLOYD'S + 100 A1 + LMC UMS LA NAVI	(1)
		strengthened for heavy cargoes	(2)
Ice Class Finnish/Swedish		1A	
PRINCIPAL DIMENSIONS			(3)
Length over all		168.14 m	
Breadth moulded		25.20/25.30 m	
Height in hold as SID		14.30 m	
Height in lower hold as TWD		3 height 3.30, 7.00 or 10.25 m	
Height in tween deck as TWD		3 heights 9.90, 6.20 or 2.95 m	
Design draft		10.00 m	
Max summer draft		10.65 m	
GT		abt 16,800	(4)
NT		abt 6,900	
DEADWEIGHT all told	design draft	abt 18,900/18,275 mt (excl/incl TWD)	(5)
	max summer draft	abt 21,150/20,525 mt (excl/incl TWD)	
CAPACITY	grain = bale	hold 0 14,000 cbft 400 m ³	(6)
		hold 1 179,000 cbft 5,050 m ³	
		hold 2/3 662,000 cbft 18,750 m ³	
		total 855,000 cbft 24,200 m³	
		if tween deck installed 63,000 cbft/1,780 m ³ less in holds	
FLOOR SPACE	tank top	total 1,625 (no 0: 50 m ² , no 1: 340 m ² , no 2/3: 1,235 m ²)	(7)
	tween deck	total 1,840 m ² (no 1: 425 m ² , no 2/3: 1,415 m ²)	
	weather deck	total 2,800 m ² (no 0: 50 m ² , no 1: 425 m ² , no 2: 685 m ² , no 3: 650 m ²)	
AIR CHANGE (basis empty holds)		abt 20 x per hour	(8)
CONTAINER INTAKE			(9)
Hold	units	478 TEU	
Deck	units	632 TEU	
Total	units	1,110 TEU	
Max size		height up to 9'6", width up to 2,500 mm	
		limited quantity alternative dimensions such as length 45 ft	
Power available for reefer connect.		up to 800/900 kW	
SIDEPORTS		5 side shifters, each 16t SWL, 500t capacity per hour	(10)
HATCHES	weather deck	no 0: 6.50 x 7.50 min; 1: 25.60 x 17.80/15.20 m	(11)
		no 2: 38.40 x 17.80 m no 3: 25.60 x 20.40 m	
		steel, end folding type	
	tween deck	no 1: 25.60 x 17.80/15.20/10.10 m no 2: 38.40 x 17.80 m	
		under crossbeam: 4.20 x 17.80 m no 3: 25.60 x 20.40 m	
		consisting of 18 steel pontoons;	
		1 of 6.37 x 17.72 m 2 of 6.37 x 10.02 m	
		1 of 6.37 x 15.12 m 5 of 6.37 x 17.72 m	
		2 of 3.17 x 17.72 m 4 of 6.37 x 20.32 m	
		2 of 1.50 x 20.32 m 1 of 4.20 x 17.72 m	
Bulkheads/compartments		removable pontoons up to 14 compartments at TEU interval	
MAXIMUM LOAD			(12)
Weather deck hatch covers		1.75 t/m ² weatherload, 2.00 t/m ² payload	
Tween deck hatch covers		hold 1: 7.5 t/m ² , hold 2: 5.5 t/m ² , hold 3: 5.0 t/m ²	
Tank top		20.0 t/m ²	
DECK CRANES combinable			(13)
Tons/reach		3 of 120 mt SWL/14m and 50 mt SWL/30m	
Position		2 x PS (aft and mid) and 1 x SB (forward)	
MAIN ENGINE		Wärtsilä 16,400 HP/12,060 kW Bowthruster 1,155 HP/850 kW	(14)
Speed	ballast	abt 20.0 knots	
	design draft	abt 19.6 knots	
	max laden	abt 19.2 knots	
Fuel consumption per day		abt 45 mt IFO 380 cSt	
		no MDO at sea, except for maneuvering	
BUNKER CAPACITY			(15)
Intermediate Fuel Oil		1,700 m ³	
Marine Diesel Oil		180 m ³	
BALLAST CAPACITY		7,200 m ³	(16)

5.1 General cargo ship

Explanation on the previous diagram

Lloyd's	=	name of the classification society	(1)
+100A1	=	built according to and under supervision of the Rules of this class.	
+LMC	=	Lloyd's Machinery Class. All machinery has been built in accordance with the specifications of this classification.	
UMS	=	Unmanned Machinery Space. The engineroom does not have to be manned permanently.	
LA	=	Lift Appliance. The cargo gear has been approved as classed.	
NAVI	=	Permission for a single bridge watch control, although SOLAS-rules only permit this in favourable circumstances.	
The vessel has been reinforced to carry heavy cargoes.			(2)
IA	=	Finnish/Swedish Ice-class.	
Height in hold as SID	=	Height in hold as single decker (no tween deck)	(3)
Height in lower deck as TWD	=	Height in lower hold as a tweendecker	
Height in tween deck as TWD	=	Height in the tweendeck as a tweendecker.	(4)
Dead weight all told	=	Dead weight at design draught. Approximately 18900/18275 metric tons (excluding/including tween decks).	(5)
Capacity	=	Grain = bale. Because the hold is box shaped, the total m ³ of bulk cargo equals the total m ³ of general cargo.	(6)
Cbft	=	cubic feet.	
If all the tween decks are installed in the hold, the capacity of the hold decreases by 63000 ft ³ or 1780 m ³ .			
Floor Space	=	Deck area of the tank top, tween deck and weather deck overall and per hold.	(7)
Container intake	=	The number of containers with a length of 20' that can be loaded. Maximum height and breadth.	(8)
			(9)
			(10)
			(11)
Maximum load	=	Minimum strength of the hatches (also according to class) as determined by the loadline convention. The criteria are based on the maximum height of a water column on the hatch, which is 1.8 metres.	(12)
Deck cranes (combinable)	=	The deck cranes can be combined (in twins). All three cranes can lift up to 120 tons if they are extended 14 metres. If they are extended 30 metres, they can lift up to 50 tons. Position of the cranes: 2 on port side, one on starboard (fore).	(13)
Main engine	=	45mt IFO 380cST = 45 tons intermediate fuel oil 380 centistoke (Centistoke is a measurement for the viscosity).	(14)
MDO	=	marine diesel oil	
			(15)



5.2 Refrigerated vessel



Flag:	panama
Call sign:	H.3.E.Y.
Lloyds No: (1)	9167801
Built:	2000
DWT: (2)	12.902 mt

GT/NT:	11.382/6.408
Loa:	155 m
Beam: (3)	24 m
Summer draught:	10,1 m
Holds/Hatches/ Compartments: (4)	4/4/15
Ventilation/Air changes: (5)	Vertical / 90
Different temps: (6)	8/2 per hold
Cranes:	2 x 40 t
Pallet cranes:	2 x 8 t
Container capacity: (7)	294 TEU plus 60 FEU or 207 FEU
Reefer plugs: (8)	185
Speed banana laden: (9)	abt. 21.5 knots
Consumption (reefer plant): (10)	abt. 49 MT IFO 380 RMG 35
Aux: (11)	abt. 6 MT IFO 380 RMG 35
Tank capacity: (12)	1.800 MT IFO 380 RMG 35 150 MT MDO DMA
Additional Features:	Bowthruster

Explanation on the specifications of the "Comoros Stream"

- (1) Lloyd's number is also the IMO-registration number of the ship, even after a change of ownership, this number stays with the vessel.
- (2) Dead weight
- (3) Breadth
- (4) The number of holds, hatches and compartments. Most holds have three tween decks resulting in a hold which is divided into 4 compartments.
- (5) The ventilation is vertical. The entire hold capacity can be replenished 90 times per hour.
- (6) Number of isolated compartments where the temperature can be adjusted separately of the other compartments; two per hold.
- (7) The vessel can transport 294 TEUs + 60 FEUs or 207 FEUs.
- (8) Ship can supply 185 containers with electricity.
- (9) If the vessel is fully laden with bananas, the maximum speed is 21.5 knots.
- (10) The daily fuel consumption (including the refrigerating plant) is approximately 49 tons of Intermediate Fuel Oil 380 (old notation) or Residual Machine G35, the viscosity is 35 cst (at 100° C). G gives the quality of the viscosity.
- (11) The daily fuel consumption of the auxiliaries is 6 tons.
- (12) Capacity of the fuel tanks is 1800 tons RMG and 180 tons DMA (Distillate Marine Fuels, A is gas oil).



Opened hold of the "Comoros Stream"



Hold of a reefer

5.3 Coastal trade liner



Flag:	Dutch
Built:	1998 / 1999
Type:	boxed shape / sid
D.W.T.: (1)	2964 mt
D.W.C.C Summer: (2)	2800 mt
GT / NT:	2056 / 1168
L.O.A.:	88.95 m
B.O.A.:	12.50 m
Draught laden: (3)	04.34 m
Air draught: (4)	09.30 m
Classification: (5)	B.V. 1 3/3 E cargo- ship deepsea - BRG unrestricted waters incl. river Rhine
Trading area:	
Container intake (total):	108 teus
Cubic capacity GR / BA:	151.000 cbft
Movable bulkhead:	2
Tanktop strength:	15 mt/m ²
Hatch strength:	1 mt/m ²

Explanation on the specifications of the "Hansa Bremen"

- (1) Dead weight
- (2) Dead weight Cargo Capacity at Summer draught.
- (3) Maximum draught
- (4) Air draught at summer draught, if the (loaded) vessel is not at summer draught, additional ballast may be used.
- (5) Bureau Veritas, the ship satisfies the rules and requirements of the classification bureau for this type of ship.

Ventilation:	electrical, 6 airchanges p/h
Dimensions of holds (m) length/breadth/depth	
Hold 1:	62,40 x 10,24 x 6,75
Dimensions (m) of hatches	
Hatch 1:	62,40 x 10,24
Tank capacity	
Fuel:	217 cbm
Ballast:	1307 cbm
Fresh water	24 cbm
Engine equipment	
Main engine:	Wartsila 8L20
Output:	1320 bhp
Consumption:	Abt. 10.5 knots on abt. 5.500 litres MGO



5.4 Ferry



Length o.a.:	172.90 m
Length b.p.:	160.58 m
Breadth moulded:	25.70 m
Depth maindeck:	9.40 m
Depth upperdeck:	15.10 m
Design draught:	6.35 m
Total power at MCR: (1)	44,480 kW
Trial speed at design draught:	28 kts
Passenger capacity:	1.600
No of passenger cabins:	160
Dead weight:	4.500 T
Trailer lane length: (2)	1.780 m
Car lane length: (3)	450 m

Explanation on the specifications of the "Blue Star 2"

- (1) Power of the main engine. MCR = Maximum Continuous Rating.
- (2) Maximum total trailer length available.
- (3) Maximum total car length available.

5.5 Bitumen tanker



Present flag:	Dutch
Port of registry:	Rotterdam
Ship type:	LPG (1) Carrier S.P. (2) 9.3 bar -48C 2PG (3)
IMO number:	9031985
Dead weight (summer draft):	3566 tons
Cargo tank volume:	3200 m ³
Main engine:	Deutz SBV 9M 628 1690 kW at 900 r.p.m.
Aux. engines:	Deutz/MWM TBD (4) 234V8 3x331 kW
Type of fuel:	MDO
Total cabins:	10
Required minimum crew:	10

Explanation on the specifications of the “Coral Actinia”

- (1) Liquid Petroleum Gas
- (2) Safety Pressure
- (3) Classification Notation
- (4) Turbo Gasoil



After lengthening Anthony Veder's gas carrier "Coral Actinia" with 24.05 m enough space was provided to install a second cargo tank, increasing cargo capacity with 1000 m³ to 3200 m³.

5.6 Chemical tanker



Imo Type II, Marpol - Annex I & II (1)	
Built:	2000
Dwt m. tons:	6430 mt
GT:	4670
NT:	1679
Speed:	15.5 knots
L.o.a.	118.00 m
Breadth:	17.00 m
Draft:	6.45 m
Cargo cap. 98.5 %:	6871 cbm
Type steel: (2)	duplex stainless steel
Ice class:	1A
Exterior heating of cargo tanks up to 80 °C	
2 sloptanks cap. 206 cbm total (3)	

Explanation on the specifications of the “Dutch Aquamarine”

- (1) Marpol requirements, Annex I: oil products, Annex II: liquid chemicals.
- (2) The tanks are constructed of duplex stainless steel.
- (3) Sloptanks are tanks that collect the tank washing water.

CHAPTER 3

Ship's types



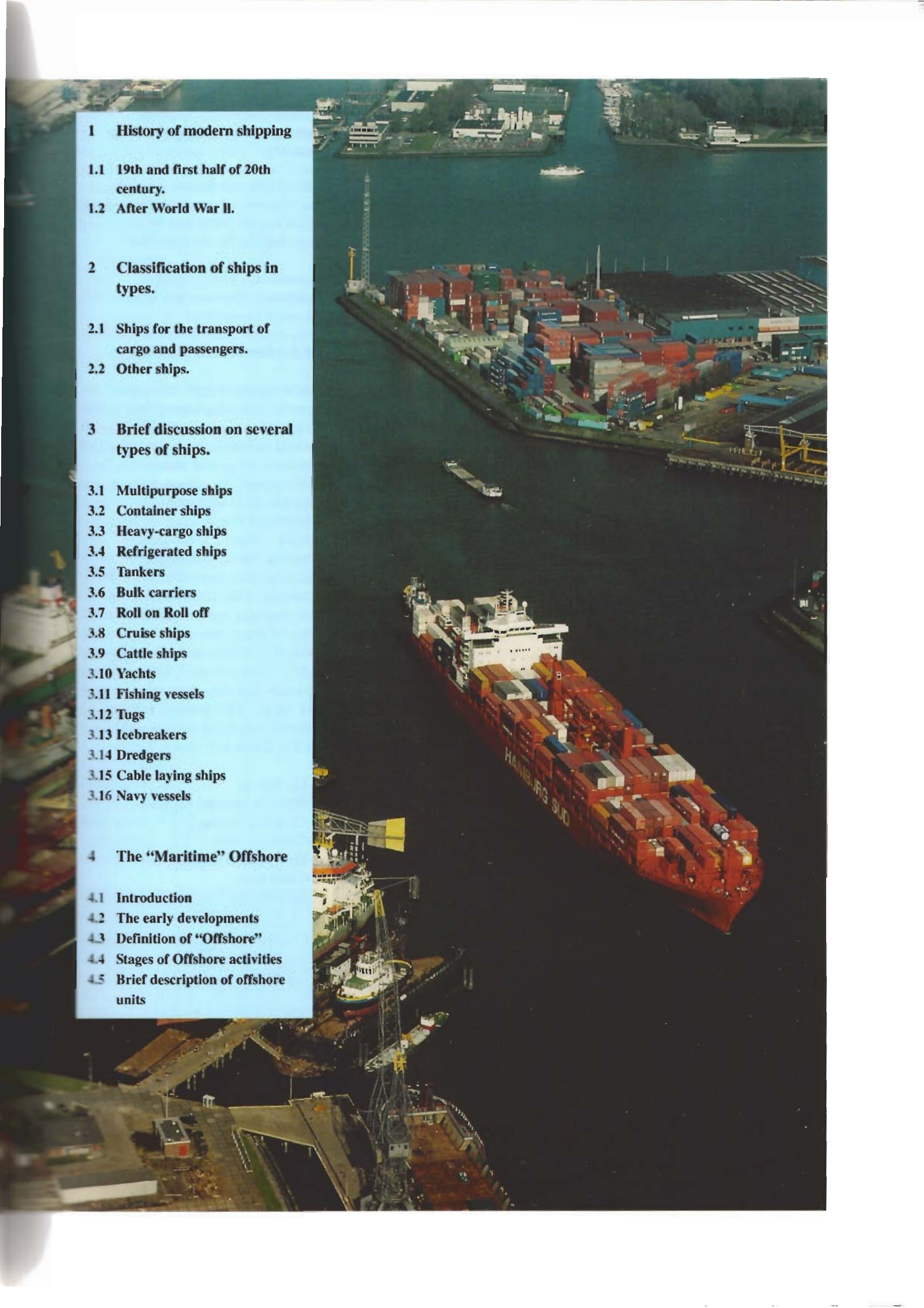

1 History of modern shipping

1.1 19th and first half of 20th century.

1.2 After World War II.

2 Classification of ships in types.

2.1 Ships for the transport of cargo and passengers.

2.2 Other ships.

3 Brief discussion on several types of ships.

3.1 Multipurpose ships

3.2 Container ships

3.3 Heavy-cargo ships

3.4 Refrigerated ships

3.5 Tankers

3.6 Bulk carriers

3.7 Roll on Roll off

3.8 Cruise ships

3.9 Cattle ships

3.10 Yachts

3.11 Fishing vessels

3.12 Tugs

3.13 Icebreakers

3.14 Dredgers

3.15 Cable laying ships

3.16 Navy vessels

4 The "Maritime" Offshore

4.1 Introduction

4.2 The early developments

4.3 Definition of "Offshore"

4.4 Stages of Offshore activities

4.5 Brief description of offshore units

SHIP KNOWLEDGE

A MODERN ENCYCLOPEDIA

SHIPWISE

PAGE 8 **1**

THE SHAPE OF A SHIP

PAGE 22 **2**

SHIP'S TYPES

PAGE 44 **3**

THE BUILDING OF A SHIP

PAGE 68 **4**

FORCES ON A SHIP

PAGE 82 **5**

LAWS AND REGULATIONS

PAGE 104 **6**

CONSTRUCTION OF THE VARIOUS SECTIONS

PAGE 126 **7**

CLOSING ARRANGEMENTS

PAGE 160 **8**

LOADING GEAR

PAGE 174 **9**

ANCHOR AND MOORING GEAR

PAGE 196 **10**

ENGINE ROOM

PAGE 216 **11**

PROPULSION AND STEERING GEAR

PAGE 244 **12**

ELECTRICAL INSTALLATIONS

PAGE 266 **13**

MAINTENANCE AND DOCKING

PAGE 280 **14**

SAFETY

PAGE 302 **15**

STABILITY

PAGE 322 **16**

CHAPTER 3 QUESTIONS

VISIT

WWW.DOKMAR.COM

1. History of modern shipping

1.1 The development of regular service liners during the 19th and the first half of the 20th century.

The period from 1800 until the Second World War saw the rise of the regular service liners. This was the result of the transport of cargo and passengers between Europe and the colonies in the East and the West, and the increasing number of emigrants leaving for North America.



Classic passenger ship

Shipbuilding changed slowly but steadily to facilitate the new demands using new technologies.

The main developments were:

- Wood as main construction material was replaced by iron and later by steel.
- Sailing ships were replaced by steam ships and later by motor ships
- New types of ships like tankers and reefers were developed.
- A gradual improvement in speed, size and safety.

In general, the big and versatile trade vessels of this period were still in use even as late as the 1970s. Transportation of passengers, general cargo, oil, refrigerated cargo, heavy boxed parcels, animals and bulk with one and the same ship was very



The Cottica, an old freighter / passenger ship



Bitumen tanker

common. Even today's "multi purpose" ships do not achieve this level of versatility.

1.2 After World War II.

After some initial hesitation, the period after the Second World War showed a continuous increase in world trade and thus in sea trade. This increase in global commerce, only interrupted by short periods of relapse, lasts even to this day. In the beginning this resulted in more and more ships, subsequently they became faster and bigger. A lot of smaller ships were then taken out of service. The modernization of shipbuilding and navigation led to the loss of many jobs in the sector. After the 1970's more and more universal ships were replaced by specialized vessels that can carry only one type of cargo. This process had already started on a much smaller scale since 1900. These new vessels are:

- Oil tankers
- Bitumen tankers
- Chemical tankers
- Container ships
- Heavy-cargo ships
- Cattle ships
- Reefers



A traditional multi-purpose ship.

Passenger liners have been superseded almost entirely by aeroplanes, because of the large distances involved. However, after 1990 the number of passenger ships that specialize in luxury cruises have increased enormously.

2 Classification of ships in types.

In this overview types of vessels are categorized. It is by no means a complete overview. Some vessels can be placed in more than one category.

2.1 Ships for the transport of cargo and passengers

Bale and unit cargo:

Container vessels
Heavy-cargo vessels
Multipurpose vessels
Cattle ships

Refrigerated cargo:

LPG/LNG carriers
Conventional refrigerated ships
Fishing vessels

Bulk cargo:

Crude carriers
Product tankers
Chemical tankers
Bulk carriers

Roll-on/Roll-off:

RoRo freighters
Car and passenger ferries

Recreation:

Cruise ships
Sailing/motor yachts



A multipurpose support vessel (with heavy crane and A-frame) for the offshore industry.

2.2 Other ships.

Fishing vessels:

Trawlers
Other types of fishing vessels

Vessels providing services for shipping:

Seagoing tugs
Harbour tugs
Icebreakers
Pilot vessels
Coast guard vessels
Research vessels

Salvage:

Tugs
Shear legs
Diving vessels
Barges

Construction and infrastructure:

Dredgers
Cable layers
Shear legs

Navy:

Aircraft carriers
Cruisers
Destroyers
Frigates
Submarines
Mine sweepers

Offshore:

Seismic survey vessels
Drilling rigs / Jack-ups
Drilling ships
Semi-submersible drilling units
Floating (Production) Storage and Offloading vessels
Shuttle tankers
Supply vessels
Construction vessels

3 Brief discussion on several types of ships.

The discussion of the vessels below includes a general description, dimensions and other characteristics. For instance, important features for a container vessel are the maximum number of containers it can carry and the deadweight. For a passenger liner, the deadweight is not important, but the number of passengers is. A tug boat has to possess a high bollard pull, whereas that is not important for a dredger.



A navy supply vessel. Comparable to a cargo ship / tanker



A modern cruise ship



A FPSO tanker

3.1 Multipurpose ships.

Multipurpose means that these vessels can transport many types of cargo. These ships use hatchcovers as bulkheads as well as tweendecks in the hold. These hatchcovers can be placed at varying heights and positions. Usually the headledges and hatch coamings are of the same dimensions as the holds, which makes loading and discharging easier. The holds are sealed with hatches using a variety of systems. Cargo like wood or containers can be carried on top of the hatches. Often the bulwark is heightened to support the containers.

Possible cargo

- containers
- general cargo
- dry bulk cargo like grain
- wood
- cars
- heavy items (project cargo)

Characteristics

- dead weight (t)
- hold capacity (m³, ft³)
- number of containers and their dimensions
- maximum deck load (t/m²)
- maximum wheelload (t)
- lifting capacity of cargo gear

Multipurpose vessels can be subdivided into:

- ships with cargo gear (up to 120 tons lifting capacity per crane)
- ships without cargo gear
- coastal trade liners

A multipurpose vessel can also be equipped with one or more ramps on the side of the ship. Loading and discharging can then commence through these ramps by forklifts. This is faster and less dependent on the weather.

a. Ships with cargo gear.

Multipurpose ships with cargo gear are heavier than comparable vessels without cargo gear. As a result their carrying capacity is less. Some vessels can not pass under a bridge because of the height of the cranes. The advantage of such a ship is that she can work in ports and industrial zones where no cranes are available.



Multi-purpose ship "Schippersgracht" with its own cargo gear and loading ramps

b. Ships without cargo gear.

Ships without cargo gear are dependent on the presence of loading gear in the ports and are therefore limited in their employability.

c. Coastal trade liners

In order to navigate from the sea into the inland waterways, coastal trade liners have a small draught; usually not more than 3.60 metres, a small air draught of approximately 6.5 metres and, compared to other ships of the same size, a large ballast tank capacity. Like inland vessels, coastal trade liners (also called sea-river ships) often have a hydraulically



Multipurpose ship, no cargo gear, with hatch cradle

*Loa - 89.25 m Breadth - 13.40 m
GT - 2780 DWT - 3793 t*

adjustable wheelhouse. When the ship has to pass under a bridge, the wheelhouse can be lowered, the masts must also be able to be lowered.



Coastal trade liner

*Loa - 106 m Breadth - 11.40 m
Depth - 5.6 m Max T - 3.5 m
GT - 2077 DWT - 2580 tons
Max TEUs - 182*

Additional characteristics.

- draught when loaded
- vertical clearance when loaded
- draught when not loaded
- vertical clearance when not loaded.
- ballast tank capacity

3.2 Container ships

Since the 1960s the transport of containers has continued to grow. The specific advantage of the use of containers is that the cargo can be transported directly from customer to customer, and not just from port to port. The transport by water is just a link in the chain of transport.

Container vessels have grown from a capacity of 1500 TEU (1966) to approximately 8000 TEU (2002).

The sizes of containers vary. The ISO-standards distinguish the TEU and the FEU, which may differ in height.

TEU = twenty feet equivalent unit. The nominal length of these containers is:

$$20' = 20 * 0.305 = 6.10 \text{ metres.}$$

The actual length is 1.5' (38mm) shorter, leaving some space between the containers.

FEU = forty feet equivalent unit. The nominal length of these containers is :

$$40' = 40 * 0.305 = 12.20 \text{ metres.}$$

Possible Cargo

- containers

Characteristics

- Maximum amount of TEUs or FEUs
- Amount of TEUs or FEUs below the weather deck along with their heights.
- Number of container tiers.
- Presence of cargo gear
- Open or closed ship.

There are two main types of container vessels:

- a. Big intercontinental container vessels up to 8,400 TEU (1999)
- b. Container feeders, starting at 200 TEU.

a. (Intercontinental) container ships

Container vessels are divided into generations (see the table below). The big container ships can only go to the largest ports because of the ship's size and the transfer capacity of the port.

Large container vessels usually do not have their own loading gear. After 1991 ships without hatches were built, also called cellular vessels. Because there are no hatches it means that water can pour into the holds (tropical rains, seawater). Therefore special provisions have to be made for the bilge pumping systems.

Advantages of cellular vessels:

- more efficient cargo handling, which reduces the lay time and harbour fees.
- guide rails, to keep the containers in position instead of lashings.
- no hatch covers to be carried
- high freeboard and strong construction due to the guide rails

Disadvantages:

- the high freeboard has an adverse effect on the GT measurement of the vessel
- the price is high because of the amount of steel used and the intricate engineering

Analogous to big tankers and bulk carriers, container vessels can also be classified on the basis of the passage that is just suitable.



Nedlloyd America, an open cellular container ship L = 266 metres, B = 32 metres, 3,568 TEU

These designations are:

- Panamax ships. Ships with a width less than 32.25 metres. They have the maximum width with which they can still pass the locks in the Panama Canal.
- Post panamax ships. These ships are too large to pass through the Panama Canal. Since 1988 container vessels with widths exceeding 32.5 metres have been constructed.
- Suezmax ships have a draught of less 19 metres, which allows them to

use the Suez Canal. The Suez Canal is currently being deepened.

b. Container feeders

Container feeders are small or medium-sized ships starting at 200 TEU that specialize in transporting cargo from small ports to large ports and vice versa, or for use in services which are not profitable for the larger container vessels. The feeders may be equipped with cargo gear. Often, multi purpose ships are employed as container feeders.



Container feeder

Generation	period	area of navigation	containers	vessels
1	before 1966	local services near the coast, USA, Australia	Pre-ISO. L * b * h = 35' * 17' * 24'	Predominantly modified ships, with own cargo gear.
2	after 1966	Short international services, USA, Europe, Australia, Japan, etc..	ISO-standard. L= 20' or 40'. B=8'. H= 8' or 8'6"	Container vessels of 700-1500 TEU
3	after 1971	Long international and intercontinental services	High cube containers. H=9' and 9'6".	High speed container vessels bigger than 2000 TEU.
4	after 1984	Around the globe, also China, India and African countries.	Deviations from ISO-standard. E.g. l=45'	Container vessels bigger than 3000 TEU

3.3 Heavy-cargo ships

Heavy-cargo ships can be divided into:

- semi-submersible heavy-lift ships
- conventional heavy-lift ships
- dock-ships (semi-submersible)

Their construction and stability allows them to carry extremely large and heavy objects. The semi-submersible ships can lower their main deck below the waterline in order to lift large floating objects like drilling rigs (float on / float off).



Semi-submersible ship loading a drilling rig.



Semi-submersible ship with the lower hull of a floating production unit (semi-sub).

The conventional vessels are often fitted with loading gear, which does not necessarily mean that the vessels are able to lift heavy objects, but when there is no heavy cargo, the vessels can function as multipurpose vessels.

Possible Cargo

- Heavy or bulky objects
- Complete parts of factories
- Drilling rigs
- Multipurpose / general cargo

Characteristics

- Carrying capacity
- Maximum deck load
- Dimensions of holds and decks
- Lifting capacity per crane and maximum height above deck.



Heavy cargo vessels, also suitable as multipurpose ships

3.4 Refrigerated ships (reefers)

Modern refrigerated ships are carrying cargo more and more in containers instead of on trays. Refrigerated containers have a built in refrigerating system, which can be plugged in to the ship's electricity grid. Air is used to get rid of the excess heat and therefore the ventilation of the containers is very important. Refrigerated containers can also be transported by a regular container vessel.



Refrigerated ship "Santo Lucia", with cargo gear.

When fruit is carried, not just the temperature is being controlled, but also the composition of the air in the containers in order to control the ripening process of the fruit. An increasing number of reefers are taking on general cargo as return

cargo, for instance cars and trucks. Compared to multipurpose vessels, reefers have:

- smaller coamings
- more tweendecks
- loading gear with a limited lifting capacity of about 40 tons.

Possible cargo

- Fruit, vegetables (cooled, chilled)
- Meat, fish (frozen)
- General cargo
- Containers on deck and sometimes in the holds

Characteristics

- Carrying capacity
- Tonnage
- Temperature range
- Cooling and freezing capacity at different temperatures
- Range of atmospheric control in the holds / airchanges per hour
- High sailing speed

3.5 Tankers

- Gas tankers

Gas tankers are ships that are used to carry liquefied gas. In general, there are two kinds of liquefied gases:

- Liquefied Petroleum Gas (LPG)
- Liquefied Natural Gas (LNG)

LPG largely consists of propane and butane with freezing points of -42°C and -0.5°C at atmospheric pressure respectively. LNG is a mixture of methane and ethane. Under normal atmospheric pressure the former has a freezing point of -161°C and the latter freezes at -88°C . Other similar liquefied gases can also be transported by these gas tankers. LPG and similar compounds can be kept liquid at moderate pressures and temperatures, but often higher pressures and lower temperatures are needed to keep the gases in their liquid state. The tanks have to be well insulated because of the following two reasons:

- Heat leaking into the tanks can vaporize part of the liquid. If, as a result of this, the fluid level drops and the free liquid surface increases, this can lead to sloshing of the liquid against the inside of the tank, which will damage the tank wall.



North West Shearwater, LNG-tanker



LPG tanker

- At the low temperatures inside the tank the steel loses its toughness and strength. Therefore it is very important that the liquid does not come into contact with the steel. This is exactly the reason why the tank walls are not strong enough to resist strong sloshing of the liquid.

Gas tankers are often steam turbine ships, the boil-off of the cargo can be used as fuel for the boilers. (boil-off is gas evaporated from the cargo in order to maintain a low temperature)

Possible cargo

- LNG
- LPG
- Similar liquefied gases.

Characteristics

- Tank capacity (m³)
- Minimum allowed tank wall temperature
- Maximum ullage in the tanks
- Time needed for loading and discharging

- Crude oil tankers

Crude oil tankers are used to carry the crude oil from a loading port near an oil field or from the end of a pipeline to a refinery. In general, these vessels are very large. The carrying capacity of these crude oil tankers has risen to as much as 500.000 tons. In contrast to product tankers, crude oil tankers have a limited number of tanks, usually approximately 15 tanks plus two slop tanks.

The large crude oil tankers are subdivided into the following classes:

- Ultra Large Crude Carrier (ULCC) >300,000 dwt
- Very Large Crude Carrier (VLCC) 200,000 - 300,000 dwt
- Suez max (old max Suez draught) ca. 120,000 - 160,000 dwt
- AFRA max, ca. 70,000 - 100,000 dwt

The large draught of the larger tankers restricts the sailing routes and limits the number of ports that can be called for loading or discharge of cargo.



Crude oil tanker.

GRT: 156306 - LOA: 328m

Breadth: 57m - T: 20.20m (max 21.6)

Deadweight (summer): 291,613 tons

Crude oil tankers receive their cargoes through pipes from shore facilities or from a single mooring buoy, via a hose or via a flexible pipeline arm mounted on the jetty. The hose or hoses is/are temporarily connected to transverse pipes on deck, at mid length, the so-called manifold. The oil is pumped on board by shore pumps. From the transverse pipes, the oil goes to droplines, vertically down into the ship, to the

bottom lines. Three or four longitudinal pipelines with branches to each tank. At the end of each branch a valve is installed. The bottom lines are in aft direction connected to the pumps in the pump room, a vertical space between the cargo tanks and the engine room. To discharge cargo, the ship's pumps in the pump room draw the oil from the cargo tanks, and press it upwards to the decklines, from aft to the manifold midships. Via a hose the oil is pumped ashore to the receiving facility where the cargo ends up in a shore tank. Needless to say that numerous valves isolate pumps, tanks, and the separate pipelines from each other. Loading and discharging takes some 24 to 36 hours per operation.

Apart from the cargo pipeline system there are various other cargo related pipeline systems on deck and in the tanks:

- Inert gas system to fill up the empty space created while discharging with inert gas. (a gas with no oxygen) in order to prevent explosions. Oil will not burn as long as the percentage of oxygen stays below 5%. Inert gas is also used to slow down corrosion of ballast tanks when they are not treated with paint. This still occurs on some older tankers. During the loading inert gas is discharged into the atmosphere.
- Tank wash system used to remove deposits from the inside tank wall before repairs, docking or reloading.



Product Tanker Close-up

- A system for the temperature control of sloptanks. Usually crude is not heated during the voyage.
- The ballast system is completely separated from the cargo system.

When a large ship like a crude-oil tanker is damaged by collision or grounding, vast amounts of oil can leak into the ocean. Therefore, regulations now require that such vessels have a double hull.

Possible cargo

- Crude oil

Characteristics

- Carrying capacity (tons)
- Tank volume (m³)
- Discharging speed (m³/h)
- Maximum laden draught (m)

- Product tankers

“Product” refers to the products of refineries and the petrochemical industries instead of crude-oil. Product tankers have a large number of tanks with a total carrying capacity of approximately 50,000 tons. The piping systems on a product tanker are different from the systems in crude oil tankers. Normally every tank has its own filling and discharge line to the manifold and its own cargo pump.

Possible cargo

- Oil products like gasoline, kerosene, naphtha, diesel oil, lubricating oil, bitumen
- Vegetable oil
- Wine
- Drinking water

Characteristics

- Carrying capacity (t)
- Total volume and volume per tank (m³)
- State of tank wall surfaces

3.5 Chemical tankers

There are very strict requirements and regulations for chemical tankers because of the toxicity and flammability of the typical chemical cargo. All cargo tanks are separated from:

- the shell by a ballast tank
- the engine room bulkhead by a cofferdam
- the forepeak bulkhead by a cofferdam.



Product Tanker in Panama Canal

This ensures that in case of leakage from one of the tanks, the crew and environment are not subjected to danger.

To prevent mixing of incompatible cargoes, a cofferdam separates tanks with different contents. A cofferdam is a small empty space fitted with a sounding apparatus, a bilge connection and ventilation.

The size of chemical tankers varies between 2500 and 23,000 GT. The number of tanks in transverse direction varies between 3 for tankers up to 6000 tons and 6 for larger tankers.

Possible cargo

- Acids
- Bases
- Alcohol
- Edible oils
- Chlorinated alkanes
- Amines
- Monomers
- Petrochemical products

Characteristics

- Carrying capacity
- Number of tanks
- Tank coating / Stainless steel



Chemical Tanker

3.6 Bulk carriers

Bulk carriers are ships especially designed to carry loose cargo in bulk. There are three types of bulk carriers:

- Handy size, 30,000 tons dead weight, often with own cargo gear. Cargo: precious ore, sand, scrap, clay, grain and forest products
- Panamax, 80,000 tons dead weight, no cargo gear. Cargo: grain and ore
- Capesize, 160,000 tons dead weight, no cargo gear. Cargo: coal, ore.

Bulk carriers are usually discharged by grabs or by suction pipes. Pouring the cargo through a shooter or via a conveyor belt does the loading. Bulk carriers have large upper and lower ballast tanks to give the empty vessel enough draught and a better behaviour whilst in transit.



Bulkcarrier



An ore carrier being discharged by a lighter.

Ships transporting ore have a special design. Ore is very heavy, (stowage factor is approximately 0.5 m³/t) and thus ships only need small holds to be loaded completely. To prevent a too large stability the holds must not be situated too low or too close to the sides of the ship. Some bulkcarriers can also function as a tanker. This combination carrier is called an Ore Bulk Oil (OBO) carrier.

Possible cargo

- Coal
- Ore
- grain and other agricultural products
- fertiliser
- cement
- light minerals

Characteristics

- Carrying capacity (t)
- Cargo volume (m³)

3.7 Roll on Roll off

- Ro-Ro carriers

To facilitate the transport of mobile cargo, Ro-Ro vessels have continuous decks, spanning the entire length of the ship. As a result of this the vessel loses its stability rapidly if water enters the decks after a collision or a burst side door. In connection with this, the safety regulations for these vessels have been sharpened in the last few years (2003) by the requirement of division doors.

The tweendecks of these ships are often adjustable in height. Loading and discharging proceeds via the

ramps in the side or stern which also function as a driveway. Because the ramps may not be deformed too much, RoRos are equipped with an antiheeling system which automatically distributes water between two opposing ballast tanks. To prevent the cargo from moving in bad weather, the vehicles are fastened using a lashing system. During loading and discharging additional ventilation is required to get rid of the exhaust fumes.



Ro-Ro carrier

- Ro-Ro car and passenger ferries

Almost all ferries transport both passengers and vehicles, whether they are navigating inland waterways or the oceans and seas. The vessels usually shuttle between two ports on a very tight schedule. The passengers drive their own cars on board via a ramp, which is either part of the ship, placed on the quay, or a combination of these two. Ferries have the same type of decks as the Ro-Ro carriers, and therefore they face the same problems when water floods the decks.



Small Ro-Ro freighter with vehicles in the holds and on the main deck

Possible cargo

- Trucks
- passengers
- cars
- trains
- trailers (with containers)

Characteristics

- number of cars or trucks
- lane length
- height between decks
- number of passengers
- carrying capacity

3.8 Cruise ships

Except in some archipelagos areas, as the Philippines and Indonesia, the traditional passenger liners have disappeared. International and inter-continental transport of passengers is now almost completely done by aircraft. The modern cruise ships are used for making luxurious holiday trips to distant countries and ports. On board there is a whole range of facilities for relaxation like swimming pools, cinemas, bars, casinos, theatres etc.

Possible cargo

- passengers

Characteristics

- maximum number of passengers
- number of cabins according to size, luxury and location on the ship.

Without exception, these vessels are equipped with very good air conditioners. Stability fins limit the rolling to 2° ultimately 4°. Even modern cruise ships with sails have no noticeable list when sailing. The number of persons on board can be as high as 4000; the crew is half or two third that number.



Navigating through unknown territories on a luxury ship

3.9 Cattle ships

Cattle ships transport livestock such as sheep from Australia to the Far East, and cows from Northwest Europe to the Mediterranean. The holds are set up as stables. The silos with fodder are located at the main or lower deck. Sheep are often fed automatically, while cows are fed semi-automatically; the feed is mechanically moved from the silo to the deck where it is then distributed to the animals by means of wheelbarrows. A network of conveyor belts and lifts dumps the manure overboard. A proper air conditioning is required: at least 45 air changes per hour are necessary. To achieve a low stability cattle ships are very slender ships. This prevents the animals from breaking their legs when the ship experiences rolling. The slender shape of the fore ship also prevents too much pitching.

Possible cargo

- Livestock like cows, sheep, goats, camels, horses etc.



Cattle Ship

Characteristics

- total deck area (m²)
- stable system
- floor system
- manure system

3.10 Yachts

Yachts can be distinguished as motor yachts and sailing yachts with an auxiliary motor. These vessels are purchased by and used for:

- private individuals for use in leisure time; these yachts have a length of 10 to 20 metres.
- Wealthy persons who use the yacht as their (temporary) domicile, either for leisure or for representative purposes;
- Companies which use the yachts for representative purposes; these yachts have a length of approximately 15 metres or more.
- Private individuals or companies who buy the yacht for races.
- Large yachts used in chartering; the length of these yachts starts at approximately 15 metres.

The building of large luxurious motor and sailing yachts is very similar to the building of commercial ships, but with more emphasis on the finish and appearance.

Large yachts with a length of 25 metres and over are also called Mega-yachts.

Possible cargo

- none or some passengers

Characteristics

- dimensions
- total sail area and nature of the rigging
- motor power
- number of cabins and number of berths
- luxury
- seaworthiness

3.11 Fishing vessels

- Trawlers

Trawlers are fishing vessels which drag their nets through the water. In pelagic fishery, the nets are suspended between the water surface and the seabed. In bottom fishery, the net is dragged over the seabed, which



Seaworthy sailing yacht, length 15 metres



Motor yacht, length 19 metres

requires additional power, especially if the nets are equipped with disturbing chains to churn up the sea floor. The construction and equipment of these fishing vessels strongly depend on the fishing method and the species of fish aimed at. The most important types of trawlers are the cutter and the stern trawler.

Possible cargo

- cooled fish (in crushed ice)
- frozen fish or shell-fish

Characteristics

- engine power
- volume of fish holds
- transport temperature
- freezing capacity
- method of fish processing
- method of refrigerating and freezing
- the fish winch and net drum
- possible fishing methods



Trawler engaged in trawl fishing. Speed whilst fishing is approximately 3 knots, whilst not fishing, the speed can be 12 knots. The length of the nets can be between 60 and 80 metres and the lines can be 300 to 600 metres.



Refrigerated trawler

- Other fishing vessels

Non-trawling vessels can range from a simple craft deploying a net to fishing vessels which can lay out nets which are several kilometres in length, waiting for the fish to swim into the net. Typical examples are: seiners, tuna clippers, crab boats, etc.

Possible cargo

- Frozen fish, or crustaceans
- Cooled fish (in crushed ice)

Characteristics

- nature of the vessel
- fishing methods applied
- engine power
- refrigerating capacity
- volume of fish holds
- methods of processing and storing fish

3.12 Tugs

- Seagoing tugs

A common characteristic of all tugboats is their low aft deck. This guarantees that the towing line has some freedom of movement. The point of application of the force in the towing line must be located close to the midships in such a way that the force has no influence on the manoeuvrability.

The towing winch is of great importance because it has to be able to transfer the total force of the propeller to the towing line.

Seagoing tugs are used for:

- salvage
- towing
- anchor handling in the offshore industry
- environmental service
- ships with engine trouble

Partly completed ships, floating wrecks, docks, drilling rigs and other large floating objects that have to be relocated can be towed by tugboats. Ever since the introduction of semi-submersible heavy lift carriers, long distance towing is used less often as a method of transport. Coastal states often use seagoing tugs to avert an imminent environmental disaster.

- Escort tugs

Escort tugs are used to escort (large) ships along dangerous passages. They have been developed after a number of serious (tanker) accidents in recent years. Escort tugs operate in confined coastal waters and are small sturdy seagoing tugs that can push or pull a large ship away from a danger zone when the own propulsion is not sufficient. Escort tugs need to be



Escort Tug

highly manoeuvrable and therefore often have azimuthing thrusters.

- Harbour tugs

Harbour tugs are used in ports, inland waterways and coastal areas for:

- assisting and towing vessels in and out of ports
- assisting seagoing tugs when these are towing a bulky object
- salvaging, or assisting in salvage in ports or coastal areas.
- fighting fires and environmental disasters.
- Keeping ports free of ice

Characteristics

- Power installed
- bollard pull: this is the towing force at zero velocity
- salvage pump capacity
- fire fighting equipment
- means of fighting pollution



The "Texelbank" is assisting a VLCC



Cargo vessel with icebreaker stem



The same cargo vessel in ice

3.13 Icebreakers

Icebreakers are similar to tugboats; they are often fully equipped for towing and salvaging.

Their main function is to cut a channel through an ice-sheet at sea, in a port, a river or other inland waterways. Obviously these ships have to be able to resist floating ice. The fore ship is especially reinforced and the material used must have a very high impact value. The shell must be free of protrusions because floating ice will rip these off immediately.

There is hardly a paint strong enough to resist the forces involved in icebreaking. For the same reason the



Icebreaker is clearing a passageway for a freighter

wear resistance of the steel in the shell and the propeller is subject to high requirements. Ice is usually broken by sailing the sloping bow on the ice, until the weight of the fore-ship breaks the ice. Some icebreakers have nuclear propulsion.

Characteristics

- engine power
- bollard pull
- shape of the fore-ship, this is important for the method of icebreaking.
- total mass of the ship, this is important for the ability to penetrate the ice.



Trailer hopper suction dredger
 length = 167 meter
 breadth = 31 meter
 carrying capacity = 30000 ton

3.14 Dredgers

- Trailing hopper suction dredger

Trailing hopper suction dredgers are used to maintain or deepen channels and fairways and for construction of artificial islands. These vessels are usually equipped with two adjustable suction pipes, which drag over the bottom to dredge. Dredging pumps in the holds or in the suction pipes pump a mixture of water and material from the sea floor into the holds. Till now (2003) they are able to dredge to a depth of 155 m. The holds are called hoppers. The solid material precipitates in the hopper; the excess water flows overboard. In order to dredge in adverse weather, the suction pipes are suspended from special cranes, which operate with heave compensation. This ensures that the suction nozzles stay in contact with the seabed.

When the vessel is at its (plimsoll) mark, it will navigate to the discharging site. The discharging can be done with pressure, using the dredging pumps and the pressure lines at the bow. When the vessel navigates towards the direct vicinity of the dumping location, the discharging can also be done using the spray nozzle, located on the fore end. This is called rainbowing. In both cases the solid precipitate is mixed with water so that pumps can be used. When the ship reaches the exact dumping location, the cargo is discharged through the bottom flaps. The load is then dumped instantaneously. To facilitate this way of discharging, some small hopper suction dredgers are constructed as



Trailing hopper suction dredger



Rainbowing

two hinged port and starboard halves, which separate when the load is discharged. These vessels are called split rail suction dredgers

Possible cargo

- sand
- gravel
- stratum or clayish soil
- (port) mud

Characteristics

- pump capacity
- depth range
- hold volume (the largest is 13,000 m³)
- carrying capacity



split rail dredger

- Cutter suction dredgers

For tougher types of soils, the kind that cannot be simply sucked up, cutter suction dredgers are used. These vessels rake the seabed with a rotating cutter and are often used in the development of new ports and new waterways. Cutter suction dredgers can be equipped with their own means of propulsion, but this is not always the case. Spud poles are used to temporarily fix the vessels. The dredgers then move in a swinging motion to deepen the bottom. The loosened soils are washed away through a dredging pump and a floating discharge pipeline to the soil destination. The soil can also be pumped into a barge that can



Cutter suction dredger, moving around a spud pole



A cable ship

transport the material over larger distances. Cutter suction dredgers are never equipped with a hopper.

Characteristics

- torque and cutter power
- pump power
- presence of propulsion
- presence of transverse propellers
- length and maximum depth of suction head

3.15 Cable laying ships.

a. Cable laying ships

Cable laying ships are vessels, which can lay one or more cables on the sea floor. If the distance exceeds the length of one cable, multiple cables have to be joined together on board of the ship. These vessels are fully equipped for this task. The ships also have the ability to repair broken cables. Crucial in the cable laying process is that the positions of the cables on the sea floor correspond to their positions on the map. Furthermore, during the joining of the cables, the vessel must be able to keep its position. For these reasons, cable ships are always equipped with multiple adjustable, and often also azimuthing, propellers in com-

ination with DP and DT (dynamic positioning and tracking).

Possible cargo

- new cables
- old cables
- repair equipment

Characteristics

- carrying capacity (t)
- engine power
- details of DP/DT installation



A cable ship

3.16 Navy vessels

- Aircraft carriers

Aircraft carriers are medium-size to large vessels suitable for aircraft and helicopters to land on and take off from.

- CTOL (Conventional Take Off and Landing) Aircraft carriers usually need catapults, driven by steam power to allow the aircraft to take off and an angled deck with brake-cables to recover the landing aircraft.



An aircraft carrier

- STOVL (Short take-off and vertical landing) aircraft carriers are smaller than CTOLs. They use a sort of ski-jump for greater lift during take-off and do not have the auxiliaries that CTOLs have.

- Cruisers

Cruisers mostly have a displacement of more than 10,000 tons and are sufficiently armed to operate on their own. Tasks are surveillance, blocking, protection of convoys and supporting large fleets



Cruiser

- Destroyer

A destroyer is smaller than a cruiser but is also fitted to operate independently. These are multi-functional warships designed to fight submarines and surface vessels and to escort convoys.

-Frigates

Frigates are very versatile warships. They are suitable for air defence, anti-submarine warfare and surface warfare. They have a wide array of sensors, communication devices and large numbers of sonars. There are several different weapon systems on board which are controlled from the command room and can follow and

attack a target fully automatically. Frigates are often equipped with a helicopter landing platform. The ships have a length of about 130 metres and a crew of 150. The vessels are lightweight, highly manoeuvrable ships with a large propulsion power (gas turbines) divided over two engine rooms. At a speed of 30 knots they can come to a complete stop within 1.5 ship-lengths.



Frigate

- Corvettes

Corvettes have a displacement of 700 to 2000 tons and are well armed. They are best equipped to act in regional operations and are seldom used for long-range operations.



Corvette

- Submarines

Submarines are hard to detect and therefore very popular in the navies worldwide.

Types are:

- Ballistic Missile Nuclear Submarine (SSBN), large submarines (120-170 metres) armed with ballistic missiles. These vessels are part of the strategic nuclear deterrence force of the superpowers. They can stay below the surface for months if necessary.



Submarine

- Nuclear-powered Attack Submarine. (SSN) Large submarines between 70 and 150 metres armed with:

- torpedoes, against surface vessels and submarines
- underwater-to-surface missiles (USM) against surface vessels
- cruise missiles against land-based targets

- General purpose Diesel-Electric Submarines (SSK-SSC) Small to medium submarines armed with torpedoes and USMs. The propulsion is provided by propellers getting their power from large batteries (accumulators). In order to recharge the batteries with their diesel generators, SSKs/SSCs have to snorkel (submarine at periscope depth) at regular intervals.

- Fast Attack Craft (FAC)

FACs have a displacement of less than 700 tons, a speed of 25 knots or more and are designed for fast hit-and-run tactics within a range of 100 miles from the coast.

- Offshore Patrol Vessel (OPV)

Ships with a displacement of approx. 700 tons that can patrol the waters of the Exclusive Economic Zone (EEZ) for an extended period of time. Usually an OPV is lightly armed and equipped with a helicopter deck which enhances their patrolling capabilities.

- Mine Counter Measure Vessels (MCMV)

An MCMV is any vessel that is designed to locate and destroy mines.

The main types are:

- Mine hunters (MHS). These vessels are equipped with several types of mine detecting sonars. They usually have a Remotely Operated Vehicle (ROV) for investigation of a sonar

contact and the delivery of a mine destruction charge.

- Fleet minesweeper (MSF). This type of vessel is capable of towing means to sweep anchored as well as bottom mines with acoustic, magnetic or pressure ignition.



Mine hunter

- Amphibious ships.

Vessels designed to deliver an amphibious force to a coastal operation area. Embarked landing craft or helicopters will be used for disembarkation of the force. There are many types of Amphibious ships.

- Landing craft.

Landing craft are smaller than amphibious craft, designed to sail towards a beach and allow vehicles, troops and equipment to leave the ship via a ramp at the bow of the ship. They can not operate in rough conditions and are usually transported to the area of operation in an amphibious ship.

Support vessels.

Ships like:

- **Intelligence collection ships (AGI).** A ship designed to gather information on other ships and coastal installations in other countries.

- **Replenishment Oiler (AOR).** This ship can carry water, stores, fuel and ammunition and can supply these goods at sea.

- **Hydrographic survey ship (AGS).** A vessel used to survey the bottom of the sea to make charts for navigation.

- **Oceanic Research Ship (AGOR).** This vessel gathers information about the physical and biological qualities of the sea.

- **Rescue and Salvage Ship (ARS).** Comparable to a seagoing tug, with the equipment for fire fighting.



Two hydrographic survey ships

4. The "Maritime" Offshore

4.1 Introduction

As our world continues to expand in population and the use of energy consuming applications is ever growing and growing, this makes us more than ever dependent on "energy". As a consequence, nowadays oil and gas are still our most important source of energy.

Within the world of oil and gas, Crude oil is called "Petroleum". Petroleum is a combination of the Greek word PETRA and the Latin word OLEUM, "Petroleum", literally means "ROCK OIL". Crude oil actually comes from rocks (the oil is entrapped within rock formations and the different layers of rocks). Most of the oil and gas is found within the so-called Sandstone and Limestone layers. According to scientists, oil and gas come from the remains of plants and (minuscule) animals that lived and died in the sea, millions of years ago. As time passed, large amounts of sediment covered the organic material. The increasing weight of these overlaying sediments resulted in tremendous pressure and heat on the organic material buried below and transformed this organic material during millions of years into oil and gas. Parallel to this process the surrounding organic material transformed into sedimentary rock e.g. sand- and limestone.

4.2 The early developments

In the early years of 1800 whale oil was used for illumination and lubricating purposes. Around the year 1850 this oil became very scarce and expensive as whales in the USA waters had nearly been hunted to extinction. As a consequence people were anxious to find alternatives.

Around these times an oil well near Titusville, Pennsylvania was found where oil spontaneously came to the surface of the land. It literally leaked out of the rocks which inspired a man named Colonel Drake to recover this "rock oil" and sell it as an inexpensive substitute for whale oil. Proper recovery of the oil by simply collecting from trenches did not work out well. This finally - after some years of trial and error - resulted in 1859 in the early technique of drilling to collect the oil from its point of origin, initially at a depth of 21 metres.

In 1897, this was followed by extensive successful drilling on the beach and extended to approximately 90 metres in the ocean on the coastline of South Carolina, the first steps to offshore activities!

Exactly 50 years later on the 4th of November 1947 the first real offshore oil was found out of sight of land in the Gulf of Mexico, 9 seamiles offshore in a water depth of as little as 6 metres. From then on over the last 50 years progress has been revolutionary. Offshore oil and gas developments are now taking place in over 40 countries, hundreds of kilometres from the shore in ever-increasing waterdepths.

4.3 Definition of "Offshore"

The word "Offshore" in the Oil and Gas Industry refers to industrial activities in open sea, starting from the search (exploration) of oil and gas to production (exploitation) and transporting them to the shore.

The Offshore is part of an industry that actually designs, builds and operates the offshore structures to allow the execution of offshore activities.

4.4 Stages of Offshore activities

The table below briefly highlights the main activities of Offshore and of the vessels / units in use to facilitate the availability of "Oil & Gas".

	Item	Activity	Vessel/unit in operation
a	searching for oil	seismic surveying	seismic survey vessels
b	finding it	exploration	1. Jack-up drilling rigs, see note 1 2. Drilling vessels (ship shape) see note 1 3. Semi-submersible drilling units
c	building the production facilities	construction and installation of the production platform/unit	1. Crane vessels 2. Offshore barges 3. Heavy lift carrier
d	developing the field	drilling and completing the production wells and interconnecting the production wells with the production facility	1. Jack-up drilling rigs 2. Semi-submersible drilling units 3. Pipelaying barges or pipelaying vessels
e	getting the hydrocarbons to the surface and processing at the surface	- production - depressurization and separation in oil, gas and water fractions	1. Fixed platforms 2. Tension leg platforms 3. FPSOs (Floating Production Storage and Offloading Vessel) 4. FSOs (Floating Storage and Offloading Vessel) 5. Production jack-ups or semi-subs 6. Subsea installations 7. Others, see note 2
f	bringing 'the product' to the shore	transportation	1. Shuttle tankers 2. Pipelines, laid at the seabed by pipelaying vessels, see note 3
g	Support	- Supply and services - Maintenance and repair - Watch keeping	1. Suppliers, crewboats, anchor handlers 2. Diving and Multipurpose support vessels 3. Standby and chase vessels

Notes:

1. The type of vessel / unit to be used depends on the water depth.

Due to the limited length of the legs of the jack-up drilling rigs, these rigs are limited in their drilling operations to a maximum of 120 to 150 metres water depth; however in general preferred for use by clients because of their stable work platform. Within and above the operational limitations of the jack-ups the semi-submersible drilling rigs may be used.

Depending on the distance to the shore base and the expected sea state conditions, the ship shaped drilling vessel is a good alternative.

2. The technique to get the hydrocarbons to the surface is rapidly expanding over the last years,

resulting in all kinds of different types of production facilities such as:

- SALM (Self Anchoring Leg Mooring system)
- SALS (Self Anchoring Leg System)
- Spar (A very large spar buoy with production and storage facility)
- SPM (Single Point Mooring System)
- Satellite Platform (Unmanned)

3. The technique of laying pipes on the seabed in extended water depth has drastically improved and as a consequence more and more really "high-tech" pipe-laying units emerge and are successfully operating. To allow the installation of pipelines in open sea the following pipelaying vessels are applied:

- S-lay pipelaying vessels (shallow and deep water)
- J-lay pipelaying vessels (deep water).
- Reel-lay pipelaying vessels (small diameter)

Technical aspects

All technical aspects as for ordinary ships in the designing and engineering process are applicable such as strength, stability, hydrodynamical behaviour, freeboard, safety etc., additionally augmented by the specific technical requirements within the offshore application.

Certification aspects

Based on the applicable specific tasks, Classification Societies and National Authorities have imposed additional Rules, Regulations and Requirements as a basis for certification and safe working conditions. See also chapter 6.

4.5 Brief description of offshore units. *(See table on the left)*

a. Seismic Survey vessel

The purpose of a Seismic Survey vessel is to produce detailed information for oil companies as a basis for actual production drilling.

This information is the result of the evaluated reflected sound waves in the sea floor. To obtain these results sound waves are initiated by the vessel by means of air guns, the reflections are collected by a number of detectors within long cables (so called streamers) towed by the vessel.



Seismic survey vessel in drydock



Seismic survey vessel in operation

b.1 Jack-ups

The Jack-up drilling rig (often shortened to “Jack-up” or “Drilling rig”) is used for exploration drilling in approx. 10 metres to max. 150 metres water depth. The Jack-up barge is a triangular or a rectangularly shaped barge that is towed to the work location. At the location the barge raises its deck alongside the legs with the lower ends of the legs resting on the seabed.

Jack-up barges are mainly used for exploration drilling (usually 3 legged) and as a work barge for construction work (typically 4-legged). Long distance transport of Jack-ups is by towing with a tug (wet tow) or by heavy lift transport ship. (See photo section 3.3 of this chapter)



Jack-up rig in drilling mode, suitable for arctic conditions

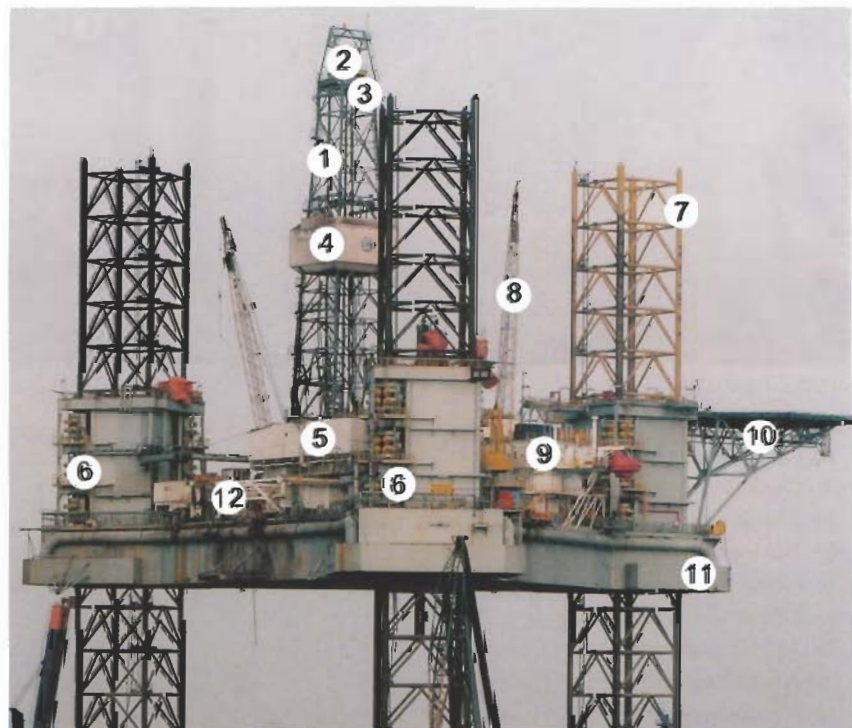

Jack-up rig in jacked up position.

1. Drill floor with windwall
2. Cantilever
3. Drilling derrick
4. Jacking system house
5. Pipe storage house
6. Board crane
7. Supply / stand-by vessel
8. Jack-up legs (rack & pinion system)
9. Accommodation / helideck/ lifeboat stations

1. Drilling derrick
2. A-frame
3. Crown block
4. Monkey board
5. Drill floor
6. Jacking gear & jack houses
7. Leg
8. Deck crane
9. Accommodation
10. Helideck
11. Deck incl. tanks & workspaces
12. Cantilever, supporting the derrick.

b.2 Drilling ship

A ship-shaped drilling ship is used for drilling exploration and production wells in medium to deep water (from 150 to 3000 metres water depth).

A modern drill ship can obtain an average speed of 14 knots in transit with a high drilling equipment storage capacity. The vessel is ideal for drilling consecutive wells in different parts of the world.

To maintain position during drilling operations the ships are either anchored in an anchor pattern or rely on dynamic positioning (DP), depending on the water depth.



Drill ship

1. Drilling derrick
2. Drill floor
3. Riser and pipe storage
4. Supply handling board crane
5. Accommodation / helideck / lifeboat stations

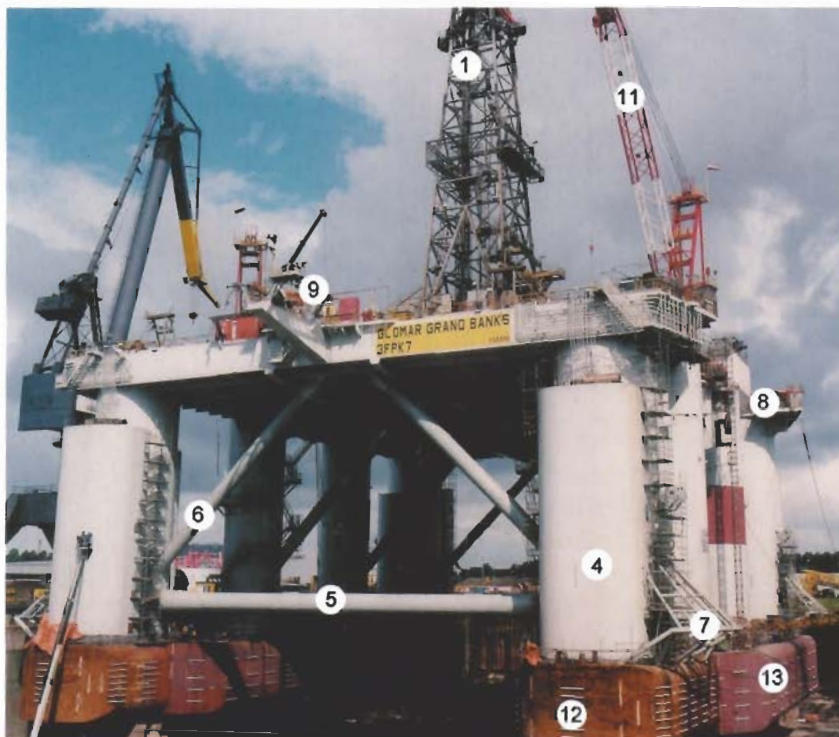

Semi-submersible drilling unit in drydock

b.3 Semi-submersible drilling unit

A semi-submersible drilling unit is used for drilling the exploration and production wells in 150 - 2,500 m water depth.

Anchored units can operate in max. 1500 m water depth. Dynamically positioned vessels can operate independent of water depth (up to around the year 2000 drilling was performed in max. 2,300 m water depth).

An important advantage of the semi-submersible type in comparison with the ship-shaped type drilling vessel is the better motion behaviour of the unit in harsh environments which can give an extended working window

1. Drilling derrick
2. Deck
3. Columns
4. Blisters
5. Cross brace
6. Diagonal brace
7. Anchor racks
8. Anchor winches (on corner edges)
9. Lifeboat station
10. M.O.B. Boat
11. Deck cranes
12. Floater
13. Sponson (additional buoyancy)



semi submersible at operational draught

A dynamically positioned (D.P.) vessel uses its propellers, rudders, tunnel thrusters and/or azimuthing thrusters to stay on position. A control system continuously determines the required thrust vector based on information from a position reference system, like radio or hydro-acoustic beacons or (D) GPS.

c.1 / f.2 Crane vessels

These are semi-submersible barges or vessels, equipped with one or two heavy-duty offshore cranes. The largest crane vessels are the Semi-Submersible Crane Vessels (SSCV). The maximum hoisting capacity is today (2003) 7,000 tonnes per crane. The vessels are used for transportation and installation of large modules (weighing up to 12,000 tonnes) of fixed offshore platforms.

The base of the platform (called jacket) is either launched from a barge or lifted onto the sea-bed by the crane vessel prior to installation of the topside modules. After installation of the jacket it is firmly connected to the seabed by steel piles, that are driven down by large hydraulic hammers suspended from the offshore cranes.

More recently the crane vessels are also used for the removal of offshore platforms when the oil/gas reservoirs are depleted. Some crane vessels also have pipelaying facilities.



Dual purpose semi-submersible crane vessel for heavy lifting/installation and (J-lay) pipe laying

1. J-lay tower
2. 3,000 tonnes crane
3. 4,000 tonnes crane
4. Crane A-frame
5. Jib
6. Storage barge
7. Supply vessel / tugboat
8. Accommodation / helideck / lifeboat stations
9. Pipe storage rack



Crane vessel installing fixed platform

Module:

On top of a jacket, various items are to be fitted and interconnected. These parts are pre-fabricated as far as practicable, and as square as possible, so that, when placed on top of the jacket, and after fixing them permanently to the structure of the jacket, only connections between these items have to be made. These pre-fabricated structures, often box-shaped are called **MODULES**. The weight of each module is limited by the weight the available offshore crane unit can handle.



Fixed production platform

e.1 Fixed Production Platforms.

Fixed Production Platforms are prefabricated onshore, transported on barges to their final production locations at sea and subsequently they are installed and completed to facilitate the actual oil / gas production. The platform can be subdivided into the following main components:

- steel jacket or concrete substructure
- deck
- modules
- drilling derrick
- helideck
- flareboom

Most platforms stand in water depths varying from approx. 20 m to 150 m. The highest jacket ever built was for a water depth of 412 m.



TLP on location connected to the oilwell(s), giving its oil to the temporarily moored shuttle tankers. Water depth 350 metres

e.2 Tension Leg Platform (TLP)

The Tension Leg Platform is used for drilling and production purposes. The unit resembles a semi submersible drilling unit and is attached to the sea floor with tensioned steel cables. The buoyancy of the platform applies tension to the cables. The advantage of the TLP is the economical aspect in comparison with the fixed platforms, specifically for deeper water. In case the production in a particular field goes down, this platform can be re-used in other locations.

1. internal turret (riser connections of flowlines coming from the seabed)
2. flare boom
3. topsides
4. accommodation / helideck / lifeboat stations
5. offloading hose
6. shuttle tanker

e.3 FPSO (Floating Production Storage and Offloading vessel)

An FPSO is a floating unit, which is installed on or in close vicinity of an oil or gas field for receiving, treatment, storage and offloading of oil and/or gas to a shuttle tanker. It is connected directly with the oil/gas reservoir below.



FPSO with shuttle tanker behind

Note: an FSO (Floating Storage and Offloading vessel) has in principle the same function with the exception of the “treatment” (no process installation on board) and is connected to a production facility.

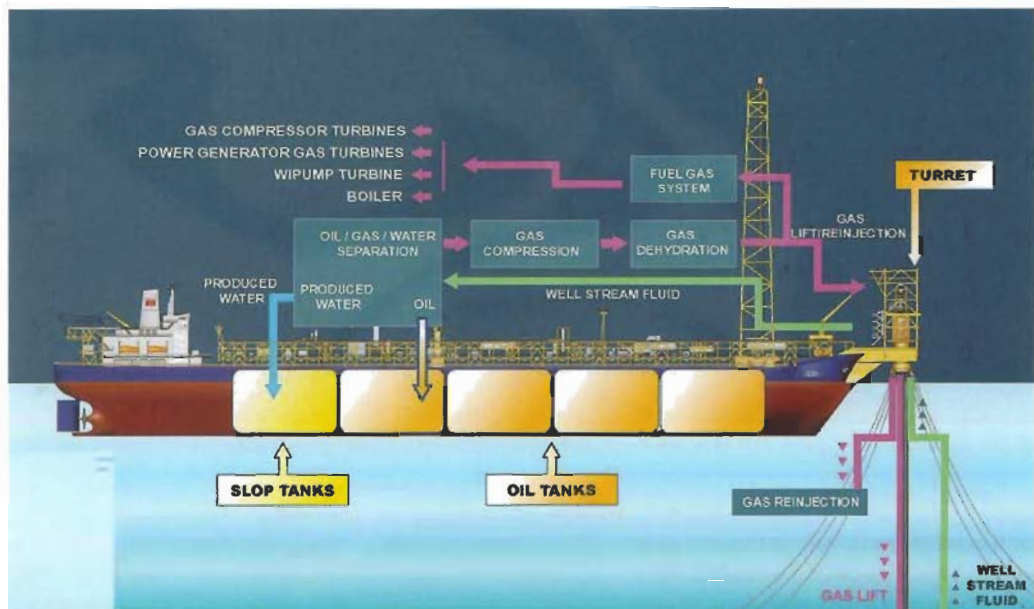

Schematic view of the process and storage on board an FPSO with an external turret

f.1. Shuttle tankers

In the absence of a pipeline from the production facility to the shore terminal a shuttle tanker is needed to take over the oil cargo from the FPSO or FSO on location for transportation to the shore terminal.

Photo of shuttle tanker:

1. Bow loading station incl. temporary mooring arrangement to FPSO
2. Cargo lines
3. Helideck
4. Accommodation
5. Tanks below deck.



Shuttle tanker in dry dock

f.2 Pipelaying barges / semisubs / vessels

For the installation of subsea oil and gas pipelines anchor moored or dynamically positioned flat bottom barges, semi-submersibles or ship-shaped vessels are used. Many of these pipelaying barges have a heavy-duty crane for installation work. Pipes are supplied to the pipelaying vessel by pipe-supply carriers. Cranes on the pipelaying vessel unload the carrier and hoist the joints into temporary pipe-storage racks. On the main deck a complete pipe joining and coating factory is provided. After welding the pipe joints, non-destructive testing (NDT) is executed prior to transporting the joined pipes horizontally over the firing line to the pipe stinger (used in shallow and deep water, max 1600 m). The stinger extends out-board over the stern of the pipelaying barge and functions as an articulated



S-lay pipelaying vessel with crane barge alongside



S-lay pipelaying vessel on DP with pipe supplier alongside



S-lay pipelaying vessel on DP working near a Jack-up platform

outrigger that allows for the lowering of the pipe line onto the seabed. This process is controlled by means of pipe tensioners (varying in capacity from 40 - 250 tons.) For deep water (over 1000 m water depth) installation of subsea pipelines a J-lay tower is used. This J-lay tower is upended and allows welding, coating, NDT and lowering in a vertical manner. The shape of the pipe when lowered onto the seabed resembles a hockey stick (hence the designation J-lay).

g.1a Platform Supply Vessel (PSV)

Used for the supply of fuel, drilling mud, fresh water, (drilling) equipment and pipes to or from offshore platforms or other vessels (e.g. supply of pipes to pipelaying vessels). During supply operations often DP is used to stay on position (joy-stick controlled). Other functions besides supply are fire fighting and towing of floating units. For towing operations PSVs have a high bollard pull. Often a PSV can also perform anchor handling operations, see description of AHTS below. Suppliers are characterised by a superstructure and deckhouse at the foreship and a long flat aft deck. They have no heli-deck and no cranes. The offshore platform or vessel uses its own cranes to lift cargo from the PSV deck. The difference with an AHT is that a PSV has a long aft deck and below-deck storage tanks.

g.1b Crew boat

Used for crew changes in benign waters. In other areas (e.g. North Sea) helicopters are used.



Combined Reel-Lay and J-Lay pipelaying vessel

- 1. J-lay tower / Reeling ramp
- 2. Storage reels for flexibles / rigid reeled pipe line
- 3. Piperack for rigid pipe sections
- 4. Board crane 400 ton capacity
- 5. Accommodation / helideck / lifeboat station



Platform Supply Vessel



Platform Supply Vessel

g.1c Anchor Handling Tug (AHT)

An anchor handling tug is used to set and retrieve anchors of moored offshore units and for towing these units. The AHT often looks similar to a PSV, but has a shorter aft deck and an open stern with a stern roll to be able to pull anchors on the deck. If the anchor handler can also function as a supplier it is called an Anchor Handling Tug Supplier (AHTS).
(see illustration chapter 1, section 9)

g.2a Diving Support Vessel (DSV)

Diving support vessels are used to support divers doing inspection, construction or repair work on subsea structures. To facilitate the diving operations DSVs have diving bell(s) and decompression chambers for the divers. A moonpool is used to lower divers or subsea tools.

Such a subsea tool is the Remotely Operated Vehicle (ROV), a self-propelled underwater robot for inspection or construction and repair work. Usually the ROV is connected by an umbilical to the support vessel.

DSVs are anchor moored or dynamically positioned. When working with divers, very strict requirements to the anchor mooring or DP system apply, as a drift-off of the DSV could bring the divers in danger. Therefore DSVs have to comply with the highest DP standards (DP class 3).

g.2b Multipurpose Support Vessel (MSV)

A multipurpose support vessel is somewhat similar to a diving support vessel, but has no facilities for divers. Without diving operations, the DP requirements are less stringent. MSVs can be used for a large variety of tasks like:

- survey work (e.g. seabed, pipeline, subsea structure);
- (subsea) construction, installation and maintenance or repair work;
- trenching of cables or pipelines;
- installation of flexibles;
- well intervention and workover services.

MSVs typically have a relatively large accommodation, a heli-deck, a flat work-deck aft, (heave-compensated) crane(s) and/or an A-frame aft and moonpool(s) for controlled lowering of ROVs or other equipment. The vessel can be ship-

shaped or of the semi-submersible type. Often an MSV also has facilities for divers and can work as a DSV.

g.3 Standby vessels and chase vessels

Standby vessels stay in the neighbourhood of platforms or offshore operations to perform rescue operations in case of emergencies. Chase vessels are used to chase ships away from platforms, offshore operations or seismic survey vessels and for supply operations. Of course these tasks can be combined in one ship. Often converted fishing vessels are used for this.



Chase Vessel



Multipurpose support vessel

CHAPTER 4

The building of a ship

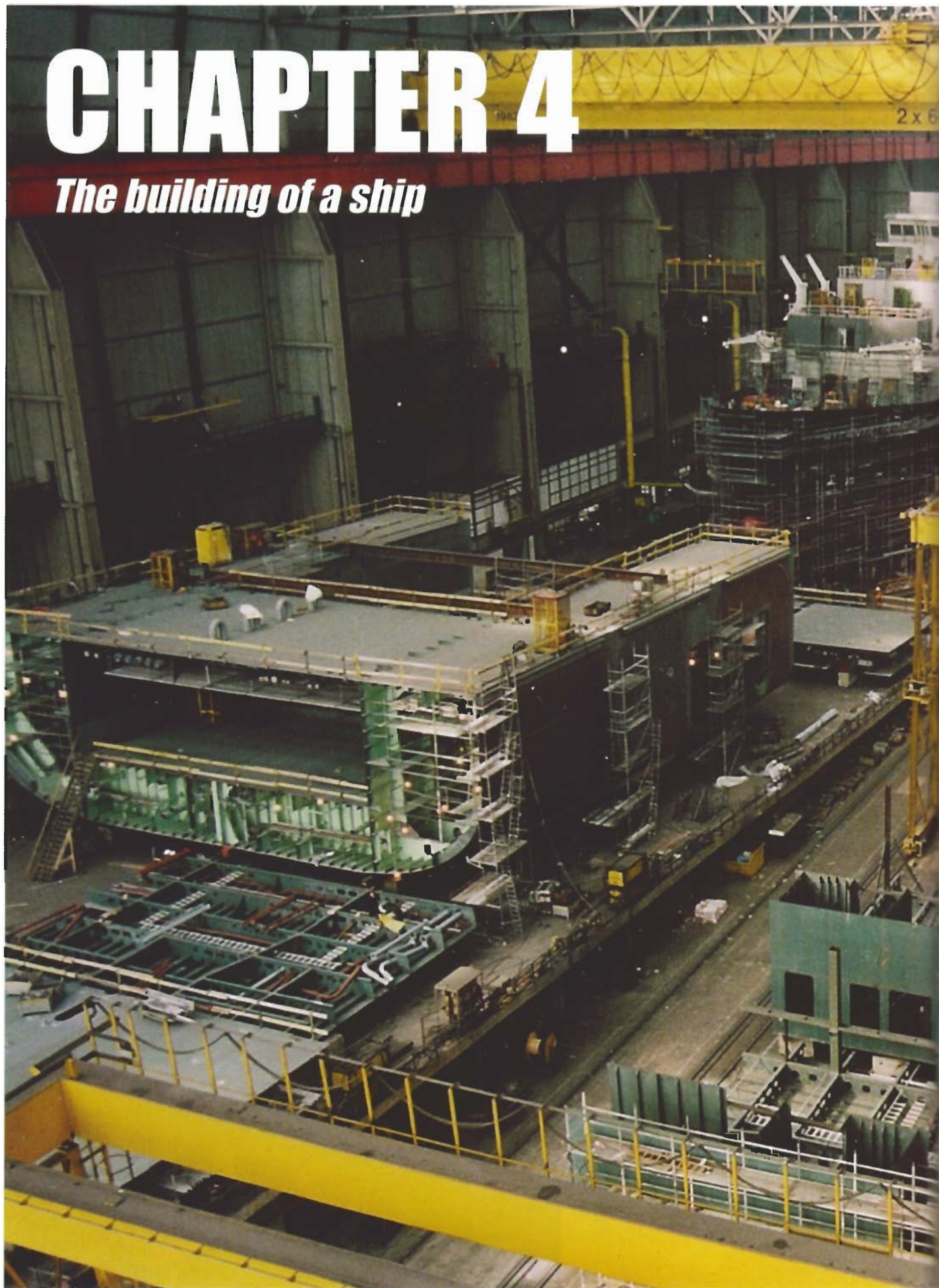

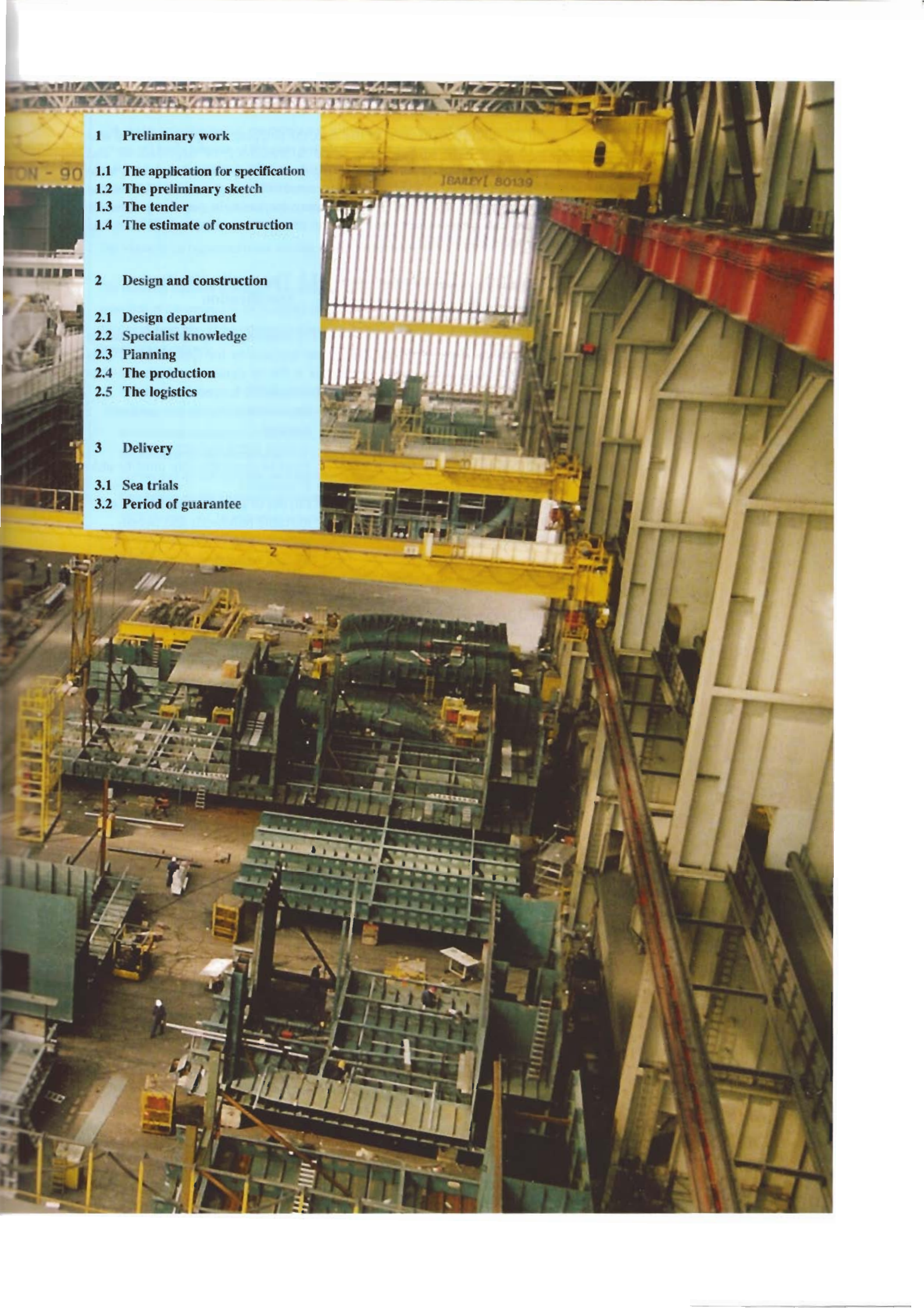
A high-angle photograph of a large industrial shipyard. A prominent yellow crane with the number '80139' is visible. Below it, a large ship hull is under construction, showing a complex network of steel beams and green-painted sections. The background features a large window with vertical bars. The overall scene is one of active industrial construction.

1 Preliminary work

- 1.1 The application for specification
- 1.2 The preliminary sketch
- 1.3 The tender
- 1.4 The estimate of construction

2 Design and construction

- 2.1 Design department
- 2.2 Specialist knowledge
- 2.3 Planning
- 2.4 The production
- 2.5 The logistics

3 Delivery

- 3.1 Sea trials
- 3.2 Period of guarantee

SHIP KNOWLEDGE

A MODERN ENCYCLOPEDIA

SHIPWISE

PAGE 8 1

THE SHAPE OF A SHIP

PAGE 22 2

SHIP'S TYPES

PAGE 44 3

THE BUILDING OF A SHIP

PAGE 68 4

FORCES ON A SHIP

PAGE 82 5

LAWS AND REGULATIONS

PAGE 104 6

CONSTRUCTION OF THE VARIOUS

SECTIONS

PAGE 126 7

CLOSING ARRANGEMENTS

PAGE 160 8

LOADING GEAR

PAGE 174 9

ANCHOR AND MOORING GEAR

PAGE 196 10

ENGINE ROOM

PAGE 216 11

PROPULSION AND STEERING GEAR

PAGE 244 12

ELECTRICAL INSTALLATIONS

PAGE 266 13

MAINTENANCE AND DOCKING

PAGE 280 14

SAFETY

PAGE 302 15

STABILITY

PAGE 322 16

CHAPTER 4 QUESTIONS

VISIT

WWW.DOKMAR.COM

1 Preliminary work

Prior to the actual construction of the ship, the shipping company, financier and future owners have already completed a trajectory of negotiations and considerations. Unlike a car, a cargo ship is not ready for delivery in a wide range of models, but it has to be constructed following the demands of the shipping company. However, it is becoming increasingly popular to classify ships into categories where their designs are then standardised. This makes mass-production possible.

The advantages of a standardised ship are:

- the clients know what they can expect
- the design has already proven itself and, if necessary, it has been improved.
- The price of construction is exactly known
- The almost complete absence of the design-period shortens the delivery period
- Because the costs of designing the ship are spread over multiple ships, the overall costs are lower.

The disadvantages of a standardised ship are:

- the design may not be entirely suitable for the demands of the shipping company
- the involvement of the shipping company is limited to only details

In spite of the disadvantages, shipyards have introduced good and versatile standardised ships in recent years. Some shipping companies are now ordering whole series of these with sometimes only a few modifications to the design. However, each modification will cost extra.



Pontoon hatches used as tween deck in a multi purpose ship

1.1 The application for specification

The shipping company first makes up an application for specification. This is a list of demands which the ship has to fulfil. It specifies:

- the desired carrying capacity and tonnage
- desired speed and top speed
- types of cargo the ship must be able to transport
- Layout of the holds with fixed or movable bulkheads and tween-decks
- System of hatches or an open hold
- Necessity, strength and kind of cargo gear
- Preferred suppliers of the engines, auxiliaries, navigation equipment, cargo gear etc.



Part of the navigation equipment

- Number of crew and passengers to determine the number of cabins
- Luxury and dimensions of the cabins and general accommodation
- Range to determine the size of the fuel tanks and storage compartments
- Limitations to the size of the ship in respect to the routes it will navigate (bridges, locks, waterdepth etc.) and composition of the crew
- Special demands like reinforcement against ice or ramps in the side of the ship

0.0.0 Classification, rules and certificates

The vessel including its hull, machinery and equipment to be built under the special survey of Lloyd's Register of Shipping and to be classed and registered as +100 A1 +LMC, UMS, IWS, PCWBT, SCM, LA, NAV I, Iceclass 1A 'Strengthened for heavy cargoes' Timber deck Cargoes. Container cargoes in hold and on upperdeck', strengthened for regular discharge by grabs.

The vessel to be registered under the flag of the Netherlands.

The following maritime Rules and Regulations, those coming into effect as of the date of execution of the contract to be complied with, including rules and regulations known at the day of execution of the contract, coming into force and being applicable to the vessel before actual delivery:

- Rules and regulation of Classification Society
- International convention for the safety of life at sea, 1992 and latest amendments
- International convention on load lines, 1966
- Regulations for the Measurement of Vessel (London, 1969)
- Convention on the International Regulations for preventing collisions at sea, 1972
- Convention on the International Regulations for preventing pollutions at sea 1973, 1978 (Annex I, IV, V) and latest amendments
- Acts of International Telecommunication and Radio Conference (GMDSS Area III)
- Suez Canal navigation rule
- Panama Canal navigation rule
- USCG rules for foreign flag ship visiting US harbour (+ USDPH)
- Maritime rules of the Netherlands (NSI), including NSI Noise Regulations
- Regulations of Unattended Machinery Space by NSI
- Rule of Australian Waterside Worker's Federation (AWWF), Australian Navigation and Pilot Rule
- Reg-54 of Solas 1981 for the carriage of dangerous goods DHI (Partial application)
- St. Lawrence Seaway and Great Lakes requirements

Yardnumber 671

Date : 20-12-99

One typical page as taken from the "specifications" indicating the applicable Classification and the different National Authorities.

- If freight contracts have already been made, the ultimate completion date
- Required certification and registration

The shipping company then submits this list of demands to several shipyards. The shipyards will then let the shipping companies know if they are interested in the assignment. This will depend on:

- the technical capability of the shipyard
- the amount of material and manpower in the available time
- does the shipyard want to build such a type of ship?
- expected price level
- expected competition

After the exploratory talks the shipping company sets a time period in which the shipyards can submit an offer without engagement. This means that the shipping company does not have to pay for the offer and that the shipyards do not know which one will get the assignment.

Sometimes the shipping company already has a preference for a particular shipyard, and then the offers are used to compare the different prices.

1.2 The preliminary sketch

The offer without engagement is the response of the shipyard to the application for specification. This

offer consists of an estimate of the costs and a preliminary sketch, which, in turn, consists of an outline specification and a general arrangement plan. The outline specification is a brief technical description and the general arrangement plan is a side view of the ship, which depicts the arrangement of all spaces in the vessel. A list of deviations often accompanies the outline specification. This shows how the preliminary sketch differs from the application for specification and gives the reasons for the deviations. On the basis of the offers, a shipping company will continue negotiations with 2 or 3 shipyards.

A preliminary sketch is made in the project department of the shipyard. This requires a lot of calculations, especially if the design is entirely new. The demands on computer programming and personnel are quite heavy and if the shipyard is too small to carry out such an amount of calculating work they will co-operate with other shipyards, or subcontract the work. A computer-programme is used in the following (first in the preliminary sketch and later on in the final design):

- the design of the lines plan and the shape of the superstructures, maximum deckload etc.
- hydrostatic calculations, both for the loaded ship and for all kinds of emergencies like leakage, running aground, docking and how well all of these calculations satisfy the demands laid down by the law. These calculations also give the stability and the longitudinal strength.
- Hydrodynamic calculations, from which the resistance curves are derived. The ship's behaviour at sea and its manoeuvrability at different conditions of loading.
- The necessary size of the propeller(s)
- Checking whether the outline specification satisfies all the legal requirements, see fig.

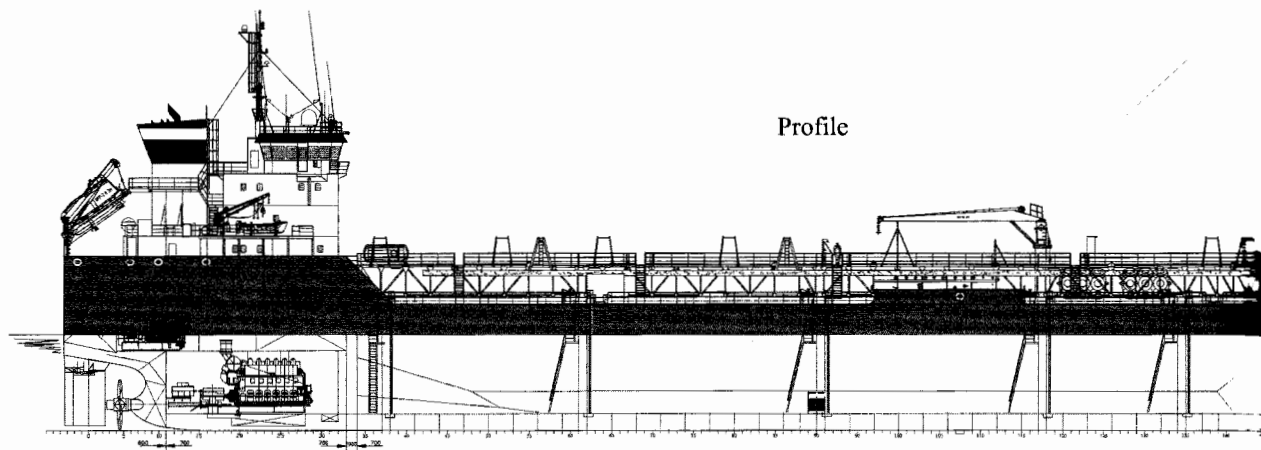

Profile

Poopdeck

Boatdeck

Officersdeck

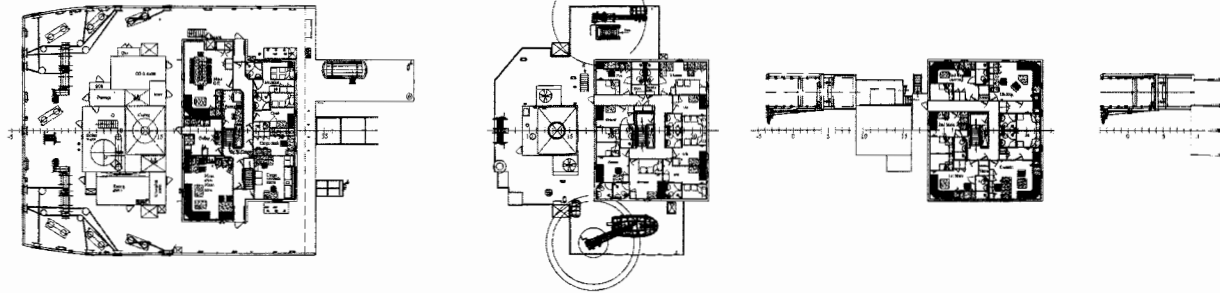

Maindeck

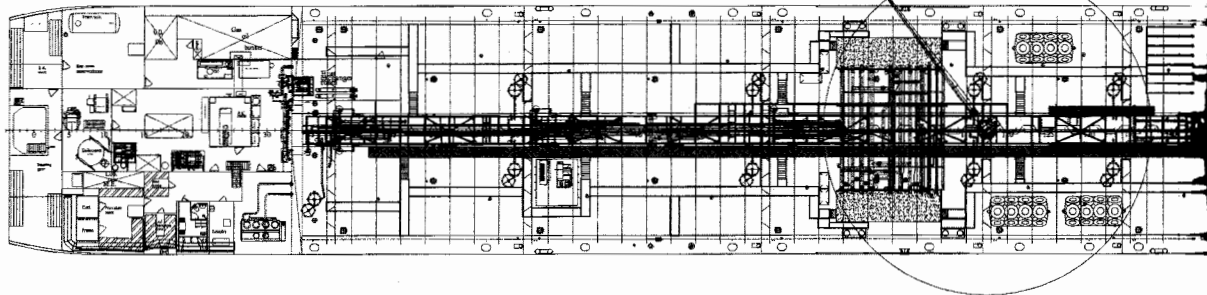

Tweendeck

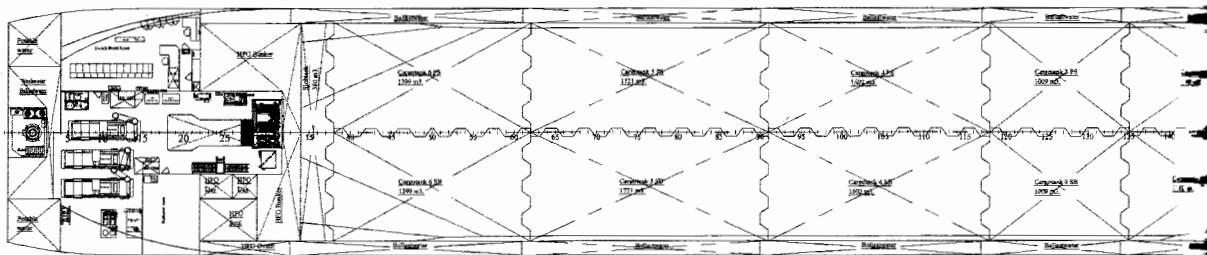

Tanktop

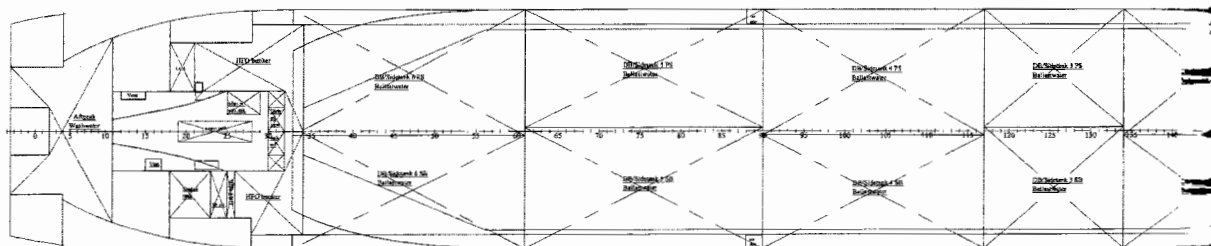

A general arrangement plan for a oil/gas/chemical tanker

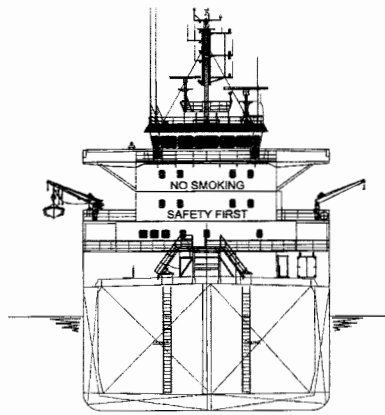
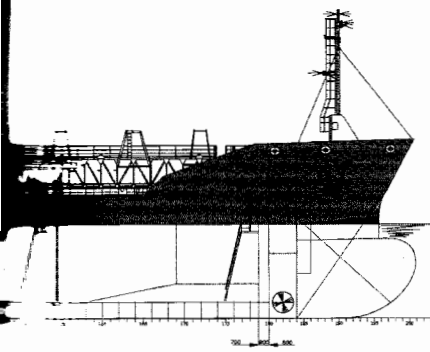

Bridgedeck

Forecastledeck

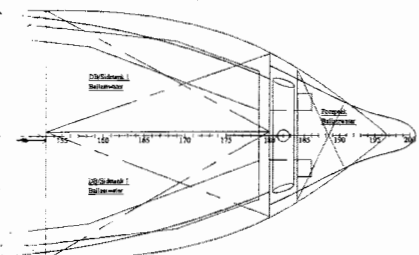
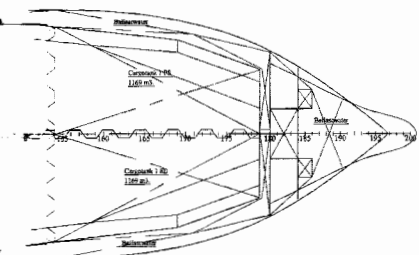
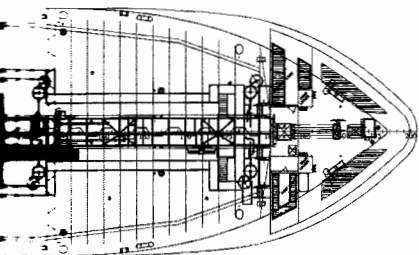
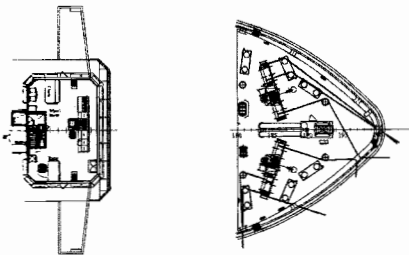

PRINCIPAL PARTICULARS

Length o.a.	139.95 M
Length p.p.	134.70 M
Rule length Bur.Ver.	132.31 M
Breadth moulded	21.00 M
Depth moulded	10.60 M
Draft summer freeboard	CA. 8.06 M
Design Draft	6.90 M
Deadweight (6.90mtr)	appr. 11700 ton
Deadweight (8.06 mtr)	appr. 14800 ton
Draft scantling	8.10 M
Total engine output	5400kW
Service speed	14 Kn
Gross tonnage	approx. 8550 GT

CAPACITIES

Cargotanks 100%	appr. 16000 m3
Slobtank	appr. 380 m3
Washwater / ballast tank	appr. 247 m3
Ballast water	appr. 6014 m3
Potable water	appr. 99 m3
HFO	appr. 725 m3
Gasoil	appr. 114 m3

CLASS: BUREAU VERITAS

- CLASS 1
- + OIL TANKER / CHEMICAL TANKER
- IMO II, Unrestricted Navigation
- (association with a list of defined chemical cargoes, sailing under French flag)
- + AUT-PORT
- + AUT-UMS
- + MACH
- + BOILERS
- + Hull

ESP, SYS-NEQ-1, IG, AVM-APS, MANOVR.

WIJZ.: M	Added venthatch for PPR	26-02-02	AAH
WIJZ.: L	Update crossview	05-02-02	AAH
WIJZ.: K	Ballasttank 1 devided in 2	21-01-02	JvdH
WIJZ.: J	General update	16-01-02	GK
WIJZ.: I	General update	30-11-01	✓
WIJZ.: H	General update aftship	24-10-01	GK
WIJZ.: G	Ventilation channels E.R.	18-07-01	Kostabo
WIJZ.: F	Forecstel deck and gen. update	02/07/01	GD
WIJZ.: E	Manifold crane moved	27/06/01	GD
WIJZ.: D	Corrigated bulkhead fr. 50	25/06/01	GD
WIJZ.: C	General update	25/06/01	GD
WIJZ.: B	deckframes, position bulkheads, pos. domes	22/06/01	GD
WIJZ.: A	MAK humo's	18/05/01	GD

26 Rue de CAMPILLEAU 33520 BRUGES (FRANCE)

Tel: (33)56 16 15 14 / Fax: (33) 56 57 64 74 / Telex: 560828 Petro

GEBEURD	aantal bladen	blad nr.	SCHAAL	200	GETEKEND	31-03-01	GDGE
	1	1	MAATSTAF	mm	GEZIEN		

General Arrangement

A0

Niestern Sander by

MEMBER OF CONSHIP INTERNATIONAL

Postbus 106
9920 AC DELFZIJL
E-mail: Niester@Castel.nl

TELEFOON 0596-617979
FAX 0596-617159

BOUWNUMMER 814

TEKENINGNUMMER 1000

AUTORECHTEN VOORBEHOUDEN
CAD-TREKING, GEDRUKT/MAATWERK WED. NIESTERN SANDER BY

1.3 The tender

After having studied all the offers, the shipping company will make a definitive choice for a particular design. This leads to a preliminary estimate of construction or preliminary building plan, a document that may be as large as 200 pages. The preliminary building plan is then sent to two or three shipyards for an offer. This procedure is called a tender, and participating in it is called "to tender". Sometimes the EU demands an "open tender" in which other shipyards, if they are from the EU, can partake.

It can sometimes take months for the shipyards to calculate an accurate price from the tender, but they still do not receive any money; there are still no obligations. Finally the order will be granted to one of the shipyards. In this choice, not just the price is taken into consideration, but also other factors like the reputation of the shipyard (working within budget and time) and if the shipyard has constructed a vessel for the shipping company before.

1.4 The estimate of construction

After this preparation, often lasting a year, the parties involved sign the final building contract. The building contract establishes all the legal positions and commercial conditions between the shipyard, the shipping company and often also the financier. Now that the building contract has been signed, all the parties have obligations that start with the down payment and end with the delivery on completion and the final payment.

Within the contract there will be a provision to allow for adjustment of the price should any changes be made to the original design at some stage during the building contract. For any alterations or components of which the price is unknown the price will be estimated and included with any other estimates. The payment will be settled at a later date in accordance with the provisions made within the contract. Part of the building contract is the estimate of construction, which

describes the ship in detail and has a fully elaborated general arrangement plan. The shipyard assigns a yard number to the future ship, which is stated on all the drawings and documentation. At this point the clock starts to tick for the time of construction.

2. Design and construction

The building time, as agreed in the contract, comprises the design phase and the building phase. The building time varies between 6 and 24 months. A building group is formed by the shipping company and the shipyard who both appoint people, who are, each person in his or her own field of expertise, responsible for the entire building process until the delivery.

2.1 The design department (engineering)

The design department is often called the drawing office, even though nowadays there is not a single drawing table to be found. The ship is worked out in detail in construction drawings (or sheer plan or working plan) and floor plans. The schemes of all the mechanical, hydraulic, pneumatic, and electrical systems are detailed and the accommodation is drawn in.

Certain essential drawings have to be submitted to the classification society where the ship is to be registered. And even though people from the shipping company are in the building group, some drawings still need approval from the management of the shipping company. Furthermore, the whole of the design has to live up to (legal) demands of the classification bureau, who regularly send their inspectors to the shipyard to assure compliance with initially approved drawings. There are shipyards that have a small design department. They will contract the design out to an independent marine engineering office, or they will co-operate with other shipyards. The working out of all the details to a complete and approved set of drawings takes tens of thousands or even hundreds of thousands of hours. This is costly; as a rule of thumb up to

10% of the total building price is estimated.

In many countries there exists a good co-operation between the various shipyards, and standardisation has led



A cross-section on a screen

to a better match of products and computer-programme. This makes it increasingly easy for shipyards to build parts for each other.

2.2 Specialist knowledge

For certain difficult areas of design, specialist research and engineering firms are approached. These firms will produce work for:

- the optimisation of the shape of the ship
- calculations on noise and vibrations
- the optimisation of the propellers, ducts and rudders

Research on the shape is done both by computer calculations and results of model testing in one of the model tanks. The resistance curves for example are obtained by measuring the required propulsion power at different draughts and speed. In addition to this, research is done on the influence of swell on the speed, the necessary propulsion power, navigability, the rolling and pitching behaviour and manoeuvrability. In the case of very large ships, research is done on the extreme forces and moments of inertia that arise in the ship in case of heavy swell.

The optimisation of the ship's shape is a very laborious task where measuring and calculating go hand in hand.

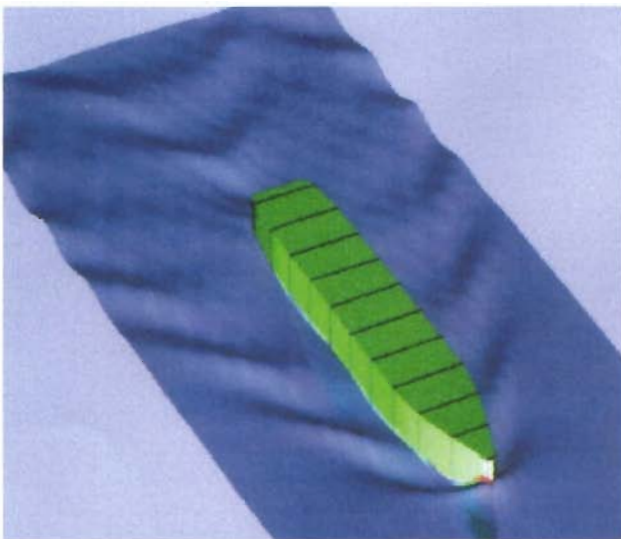

Wave-pattern before optimisation

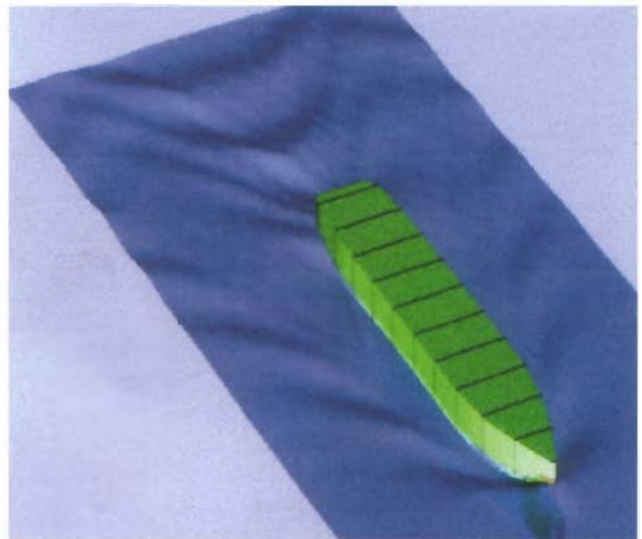

Wave-pattern after optimisation



Cruiseliners during seakeeping and manoeuvring tests at MARIN

In the figure above the wave patterns of a ship at a certain velocity before and after optimisation are depicted. The optimisation procedure has reduced the wave resistance because the ship makes fewer waves after optimisation. The bulb stem has already reduced this resistance because the wave produced by the bulb stem counteracts the bow wave. However, this is only one effect that

is accounted for in the optimisation process, there are many other effects that can further minimize wave resistance.

2.3 Planning

The planning department makes the drawings of the design department ready for production purposes; the right drawings at the right workplace. Furthermore, all the steel parts are given a code.

With the aid of a computer-programme, a draughtsman or draughtswoman nests the steel plates. This means that the steel plates present at the shipyard(s) are chosen in such a way that, after cutting into shape, there is a minimal amount of waste. The computer also controls the cutting torch, a plasma cutter in a water-bath. Because of this the excess heat is drained quickly. As a result minimal distortions will occur and there is a good control of the exact dimensions of the plates. The cutting machine can also engrave the code number of a part into the steel.



A plate cutter

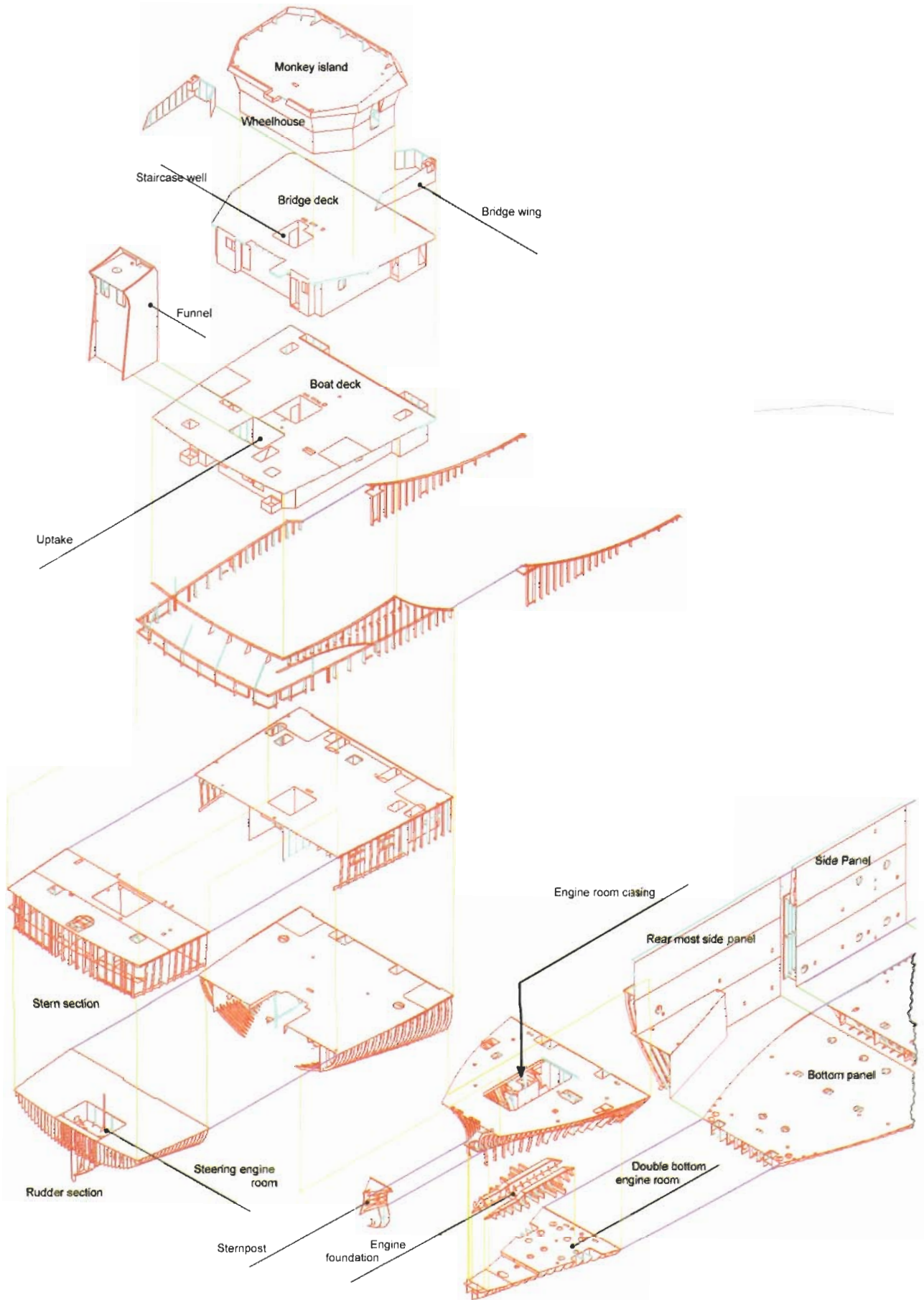

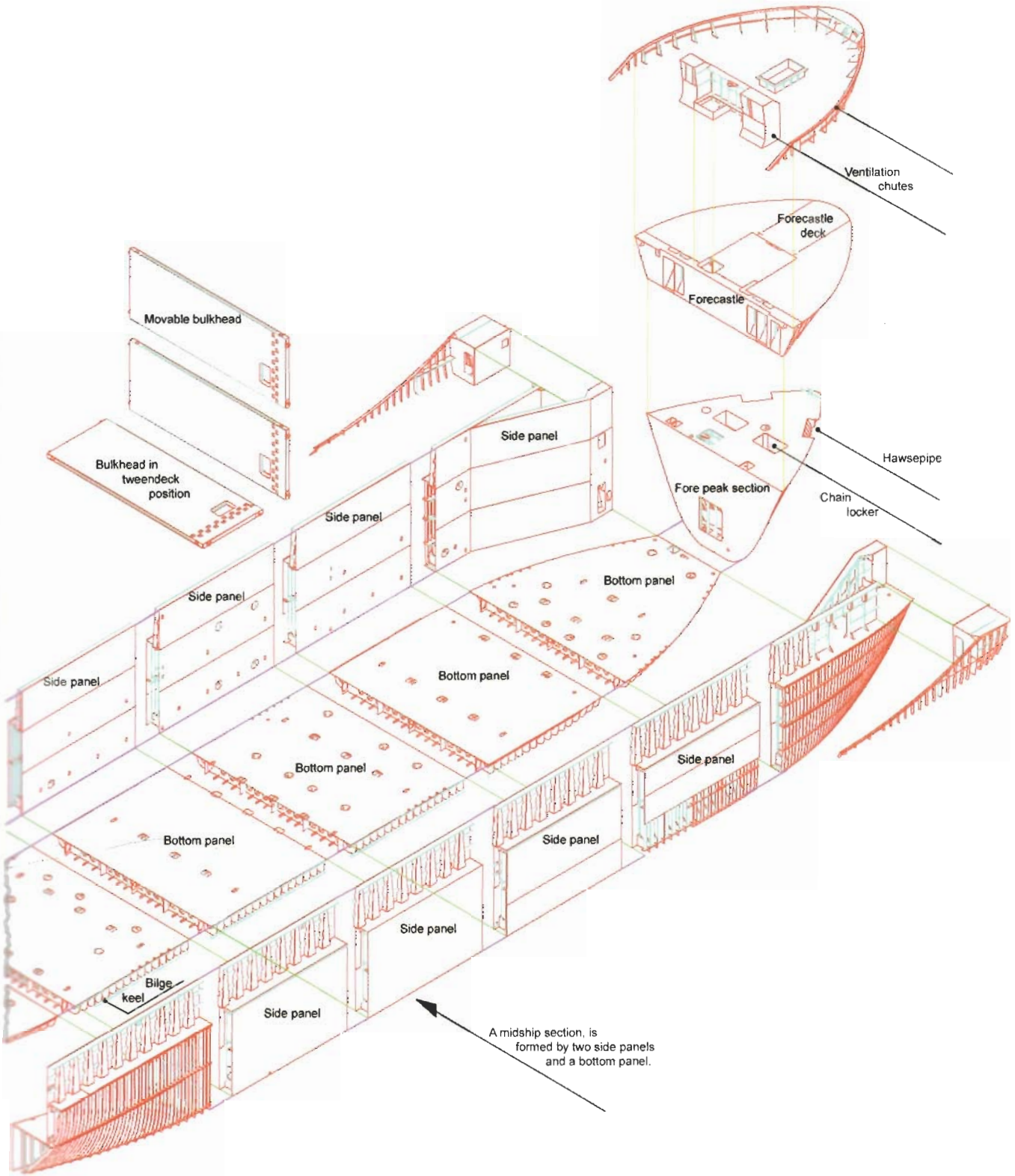

Panels and sections of a ship

2.4 The production

A ship is constructed in various stages, which can sometimes overlap:

- pre-treatment
- building by panel
- building by section
- building of hull and deckhouse
- painting
- launching
- fitting out and subsequently completion
- trials at the shipyard
- sea trial

Automation of the steel construction has led to more efficiency. Furthermore, the designers will design the sections in such a way that as much welding as possible can be done by welding robots. Building by section enables parts of the double bottom, the foreship and the aft ship to be welded whilst lying upside down in the workplace. This way of welding produces a uniform quality of the welds within less production time. Because access to the different sections is much more restricted when they are joined together, the sections are completed as far as possible prior to the joining. This means that piping systems, tanks, filters and other small auxiliaries are all placed in the section before the joining of all the sections.



View in an assembly shop

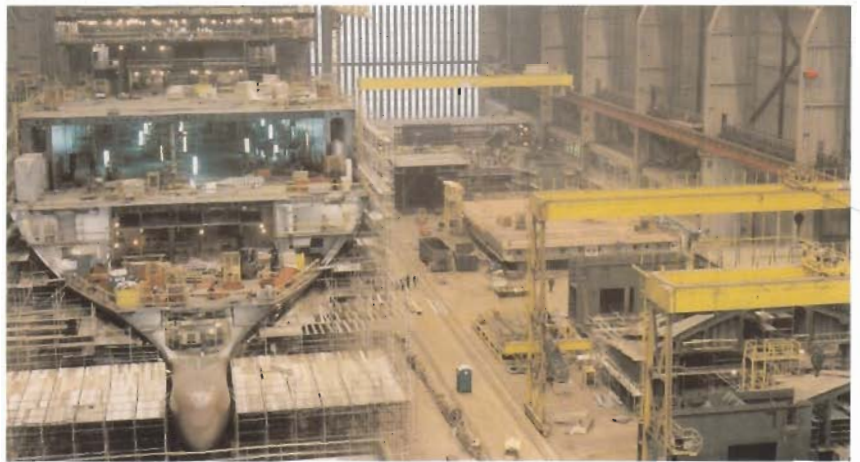

Another view in an assembly shop

The building of a ship used to begin with the placing of the keel followed by the keelplate. The rest of the construction was then connected to

this. Nowadays, laying the keel means that the first bottom segment is placed in the assembly hall. Subsequently, the other sections of the ship are then built to or on this. At this stage, the production is well underway.



The first bottom segment is placed.

Modern shipyards do the actual building in large indoor assembly halls where they use pre-painted steel plates. After welding the plates, the joints are immediately painted.

Several factors determine where the ship will be finished. The finishing is either done in the assembly hall or at the fitting out dock. In some cases the deckhouse can not physically fit into the assembly shop. And if the launching of the vessel is going to be an end-launch, the vessel should have the minimal amount of weight on board. The launching is always an exciting moment because at the moment the ship is launched, there is no way of stopping it.



An end-launch



A side-launch

In end-launches, the ship acquires so much speed that it takes a lot of effort to stop the vessel in the water. In side-launches, the ship can bounce back against the wharf, especially when the water level is high. The ship does not gain much speed, but instead produces very high waves. After the launch, the final touches like masts, hatches, sometimes the engines, funnel, ventilation shafts, cranes etc are added to the ship at the fitting out dock. Finally, the cabins and other spaces are furnished and the inventory is brought on board.

When the ships electrical wiring is ready, it is connected to the shore supply to get a voltage. After this all the engines, generators and auxiliaries are brought on line and the ship can then begin to function independent from the shore. Upon completion of the vessel in the shipyard all the final testing will be conducted at the shipyard with the exception of items which can only be

tested during sea trials in open sea. Final testing at the shipyard is related to electrical systems, engines, generators, pumps, technical equipment, life-saving equipment and a light weight / stability test. Final testing in open sea is mainly related to final testing of machinery under working conditions, fuel consumption, vessel's speed, rudder tests and anchortests.

In principle all these tests will be conducted in the presence of the owner's representative(s), classification surveyor(s) and - if applicable - National Authority representative(s).

Next is the first, technical, sea trial, which can sometimes take up to 2 days. This is the first time that the ship leaves the shore and is completely self-reliant. The ship as a whole and all of its parts are extensively tested and all the results are carefully recorded. The classification society and the Shipping inspectorate are also present to see if all the legal demands are met.

In general, these trials are usually successful, but there are always small imperfections which can be amended during or after the trial. How the ship exactly behaves in open sea will become clear when the ship is in use; however, the speed and fuel consumption of the empty ship can be measured during sea trials.

2.5 The logistics

More and more shipyards advertise shorter delivery periods, and more and more shipping companies stipulate that. In order to facilitate this trend, lots of shipyards contract other shipyards to build parts of the ship. It is also common that the hull of the ship is constructed in cheaper countries and that the hull is fitted out and completed locally. But even without these measures, all the semi-finished parts must be ready for the next phase of construction to commence. Besides, all the purchased parts must be ready in time, but not too early because of the costs for storage and the loss of interest. Keeping the construction process manageable requires that a



The main engine (70 tons) is brought on board



Installation of a complete deckhouse, while the ship is at the fitting out dock.



proper overall planning of the project in terms of technicalities, logistics and finance should be available any time of the day. Such a management system integrates and controls data from the preparation, design, purchase, stocks, production, administration and project management.

3 Delivery

3.1 Sea trials

The Shipping Company and Certifying Authorities will finally accept the ship subject to positive results of sea-trial tests and the issue of the relevant certificates. During this short voyage the protocol of consignment is signed, the shipyard's flag will be exchanged by the flag of the shipping company and the financier pays the last installment. Because there is a 12-month period of guarantee on the ship, the shipping company usually requires a bank guarantee from the shipyard. This is called upon when the shipyard can



Sea trial test of a container ship

not, or refuses to comply with the guarantee. It is normal that in the first month of a ship's life a guarantee engineer from the shipyard is on board.

3.2 Period of guarantee

The guarantee conditions are an integral part of the building contract, because, just like any other product, the ship has a period of guarantee. In general, this period is 12 months after the delivery of the vessel. The shipyard almost always adopts the guarantee conditions and periods of the companies supplying the different ship components. If the ship needs repairing within the period of guarantee, the vessel's location and the urgency of the repair jobs determines who will repair the vessel and where it will be done.

If the ship cannot be repaired at or by the shipyard, for instance, because the ship is in another country, the shipping company is allowed to have the ship be repaired by a third party, but only if the costs of repairing the ship are not more than the price the

shipyard would ask. This condition protects the shipyards against excessive bills if there is a deal between the shipping company and the repair yard.

Repairs of components and equipment are almost exclusively done by local service-dealers, especially when the parts are of a well-known brand. This is always done in consultation with the shipyard or the supplier. The crew is prohibited to do repairs during the period of guarantee unless the repairs are absolutely necessary. If this is the case, the shipyard has to be contacted for consultation first.

Sometimes suppliers have two periods of guarantee for their product. The first period covers some months after delivery from the factory, the second period covers some months after the product is put into operation. The reason for this is, that there sometimes is a long period between the delivery to the shipyard and the moment the component is put into operation.

CHAPTER 5

Forces on a ship



Forces on a ship

1. General

2. Longitudinal strength

2.1 Shearing forces

2.2 Explaining bending moments

2.3 Longitudinal reinforcements

2.4 The loading programme

3. Torsion of the hull

4. Local stress

4.1 Panting stresses

4.2 Pitching loads

4.3 Diagonal loads

4.4 Vibration loads

4.5 Docking loads

5. Ship in waves

6. Stiffening

6.1 Purpose of stiffeners

6.2 Longitudinal framing system and transverse framing system



SHIP KNOWLEDGE

A MODERN ENCYCLOPEDIA

SHIPWISE

PAGE 8

1

THE SHAPE OF A SHIP

PAGE 22

2

SHIP'S TYPES

PAGE 44

3

THE BUILDING OF A SHIP

PAGE 68

4

FORCES ON A SHIP

PAGE 82

5

LAWS AND REGULATIONS

PAGE 104

6

CONSTRUCTION OF THE VARIOUS

SECTIONS

PAGE 126

7

CLOSING ARRANGEMENTS

PAGE 160

8

LOADING GEAR

PAGE 174

9

ANCHOR AND MOORING GEAR

PAGE 196

10

ENGINE ROOM

PAGE 216

11

PROPULSION AND STEERING GEAR

PAGE 244

12

ELECTRICAL INSTALLATIONS

PAGE 266

13

MAINTENANCE AND DOCKING

PAGE 280

14

SAFETY

PAGE 302

15

STABILITY

PAGE 322

16

CHAPTER 5 QUESTIONS

VISIT

WWW.DOKMAR.COM

1 General

There are many forces acting on a ship. How they act is largely determined by the purpose the ship was built for. Forces on a tugboat will be different from the forces acting on a container ship. The types of forces that occur in waves are the same for every ship but the magnitudes and points of action depend on the shape of the ship below the waterline.

The pattern of forces on a ship is very complicated and largely depends on the following parameters:

- the weight of the empty ship
- the weight of the cargo, fuel, ballast, provisions, etc.
- ice
- hydrostatic* pressure on the hull applied by the water
- hydrodynamic* forces resulting from the movement of the ship in the waves
- vibrations caused by engines, propeller, pitching
- incident forces caused by docking, collisions

These and other forces cause the ship to be deflected. When the force stops acting, the ship will regain its original shape. Every ship is different and some have more or less of this flexibility. If, however, the forces exceed a certain limit, the deformation can be permanent.



A ship with heel in an unstable situation.

2 Longitudinal strength

2.1 Shearing forces

When a ship is in calm water, the total upward force will equal the total weight of the ship. Locally this equilibrium will not be realised because the ship is not a rectangular homogeneous object. The local

*Static and dynamic

The concepts static and dynamic are widely used in this and other chapters. Static means that the work done on an object is absorbed immediately. Dynamic means that the work done on an object is absorbed gradually.

Examples of static:

- A swing with a child is slowly pushed forwards from rest. This is a static movement because the force exerted on the swing is absorbed instantaneously.
- A crane on a ship is loading a ship with cargo. As the cargo runner is stiffened, the ship lists slowly. This is a static movement because the ship absorbs the force that lifts the weight instantaneously.

Examples of dynamic

- The same swing is pushed forwards suddenly. The weight of the swing cannot absorb this sudden burst of force and gets out of control. This is a dynamic motion.
- The same crane has lifted the weight several metres. The weight suddenly snaps and falls on the quay. This causes the ship to list violently to the other side. The ship is unable to absorb the sudden change in weight and, as a result, acquires a dynamic motion.

differences between upward pressure and the local weight give rise to shearing forces that lead to longitudinal tensions. The shearing force is the force that wants to shift the (athwart-ship) plane from one part of the ship to another. The submerged part of the ship clearly shows the difference in volume between the midships, the fore- and the aft ship; this is the reason for the difference in

upward pressure. In the drawing on the right a part of the aft ship is depicted along with the shearing force near a bulkhead. The shearing force at the bulkhead is $400-200=200$ tons. The downward force causes a hogging moment of $400t \times 6m$. The upward force causes a sagging moment of $200t \times 3m$. The bending moment at the bulkhead is: $2400tm - 600tm = 1800tm$ hogging.

The longitudinal forces occur because:

- the weights in the ship are not homogeneous in the fore and aft direction
- the upward pressure differs because of the shape of the underwater body

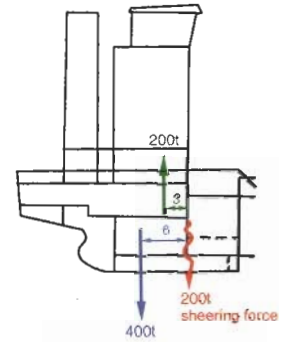

200 tons shearing force at this bulkhead

The submerged part of this ship clearly shows the difference in volume between the midships section and the aft ship. This explains the difference in upward pressure.

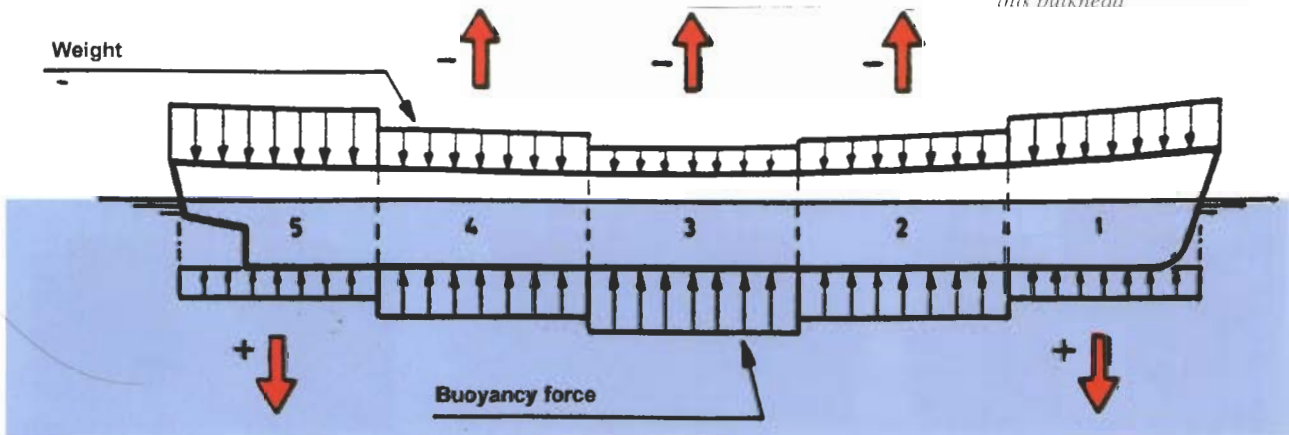

The black vectors represent the upward pressure and the weight of the ship. The red vectors give the resultant per section.

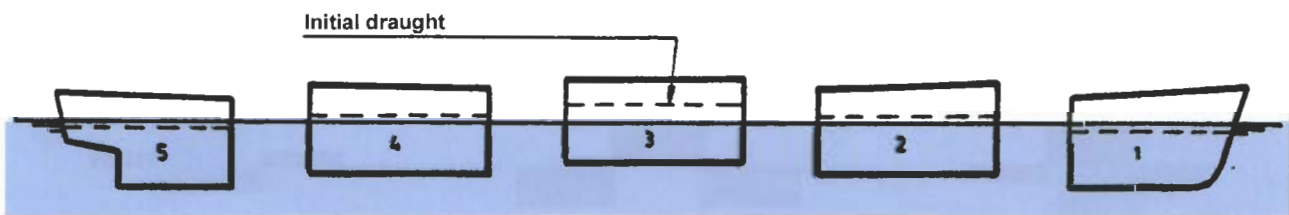

This is how the separate compartments would float. The dashed line gives their actual draught.

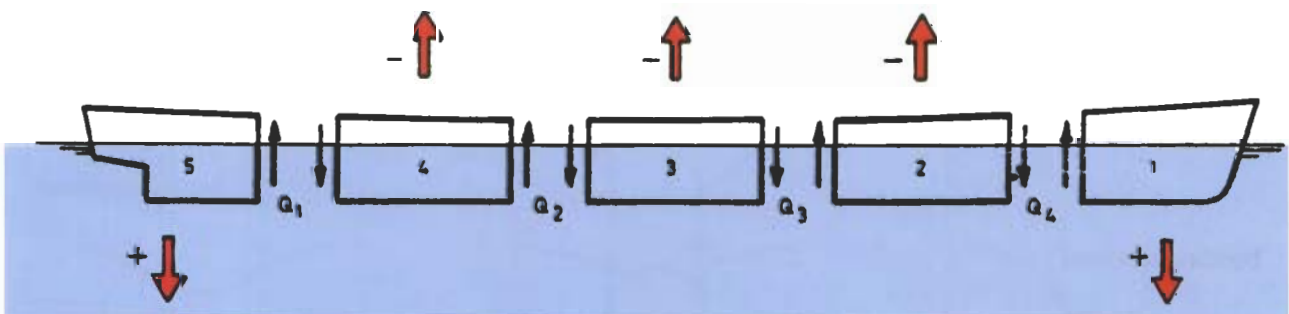

The black vectors give the resultant shearing forces between the different compartments. The red vectors give the resultant per section.



Container feeder in heavy weather. The ship is partially on a wavetop; hogging



The ship is partially in a trough. In this case the foreship will experience a large sagging moment while the aft ship experiences a large hogging moment.

2.2 Explaining bending moments

Below is an explanation of how bending moments and shearing forces are continuously changing. As an example a rectangular vessel is used which is divided into three compartments (A, B and C). In figures 1, 2 and 3 both outer compartments are filled with cargo. In figures 4 and 5 the inner compartment (B) is filled with cargo. In figures 2 and 5 the vessel is on a wavetop and in figures 3 and 6 the vessel is in a trough. The upward pressures keep changing because the wave pattern is also changing. The downward forces however stay the same. The up and downward forces per compartment are depicted as vectors.

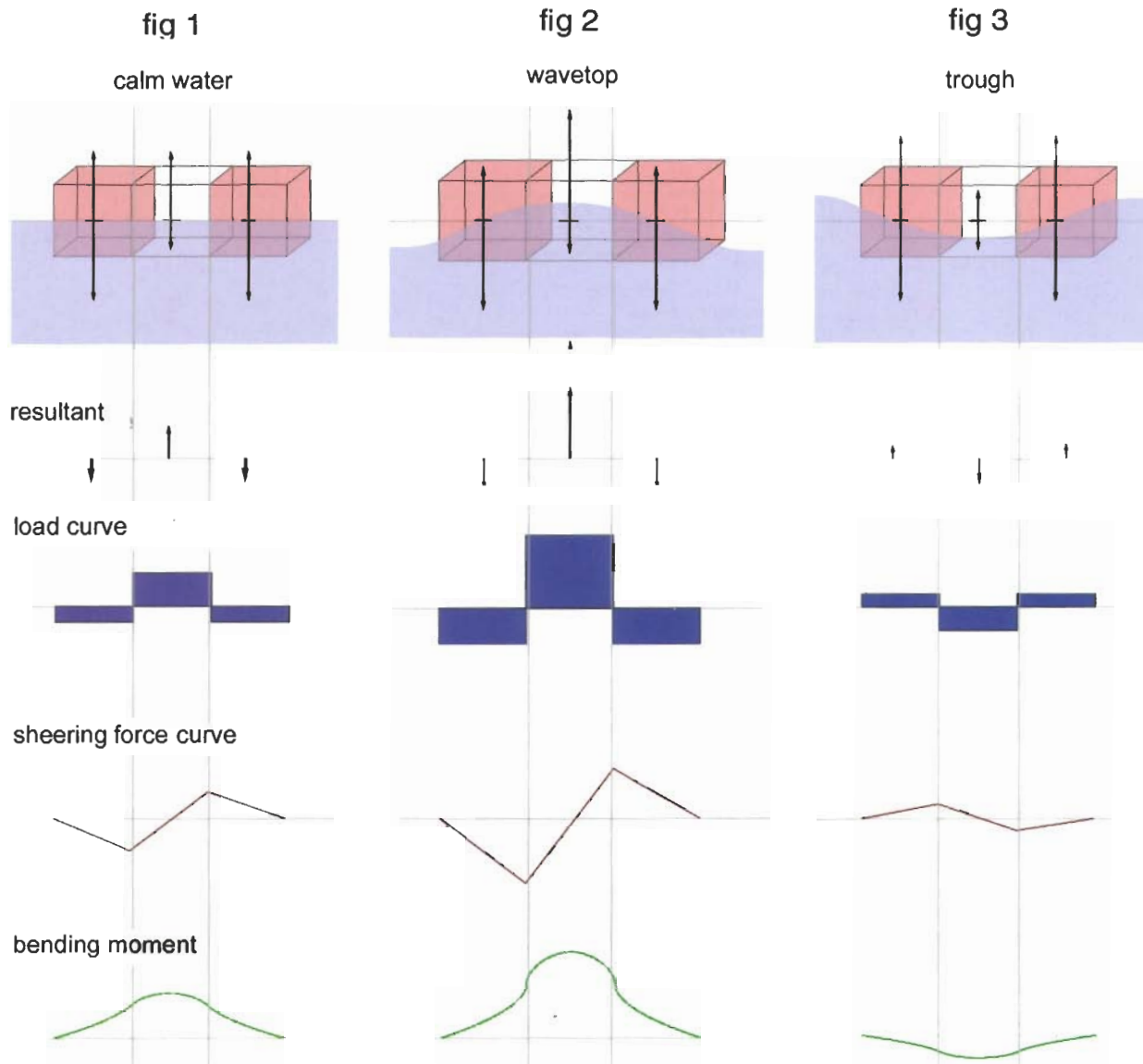

The mean resultant per compartment is given as a vector on the line below.

The **load curve** gives the difference of the up- and downward forces per metre at **each point** on the baseline. The sum of the areas above the baseline and the areas below the baseline should be equal.

The **shearing force** curve gives a sum of the shearing forces on the right part produced by the **left side**, going from **left to right**. If the direction of the force is changing (from upward to downward or vice versa), the shearing force curve will change from rising to falling or vice versa. The shearing force curve has an extreme value at the points where the direction of the force is changing. Converting the load curve to a shear force curve is

called summing. The sum of the areas above the baseline has to equal the sum of the areas below the baseline.

The shearing forces are expressed in tons.

The **bending moment** is determined by summing the shearing forces going from left to right.

The bending moment is expressed in tonmetre (tm). If the shearing force curve changes from rising to falling or vice versa, the bending moment will bend at the bending point from "hollow" to "round" or vice versa. When the shearing force curve crosses the baseline, the bending moment line will change from rising to falling or vice versa. The ship will

take the shape of the bending moment line if this has only one extreme (maximum) value.

The situation in figures 1 and 2 is called a hogging condition and the situation in figures 3, 4, 5 and 6 is called a sagging condition. Around the half height of the vessel there is a "neutral zone". Here there are hardly any tension or compression stresses. However, especially at the ends of the vessel, heavy horizontal shearing stress can occur.

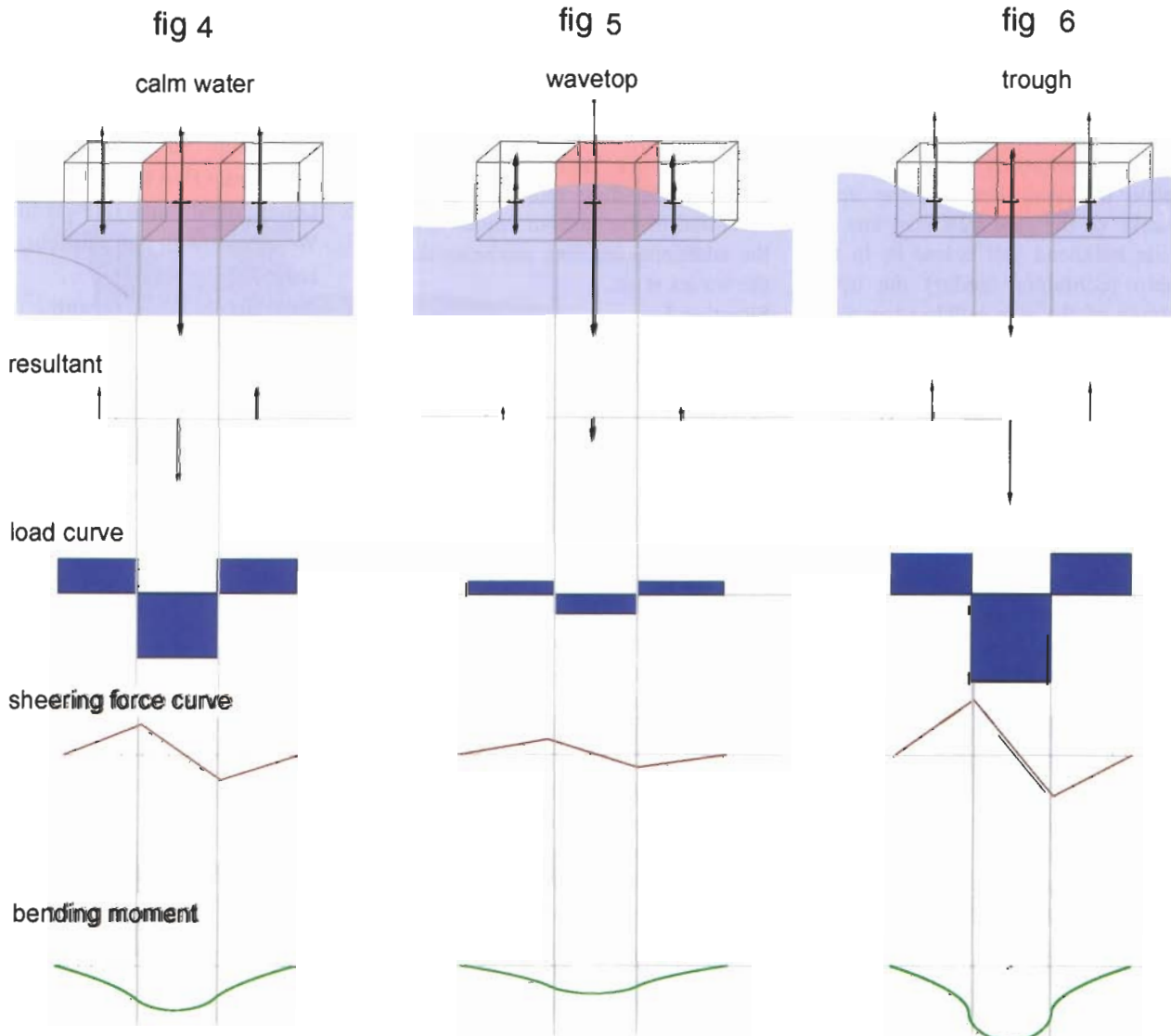

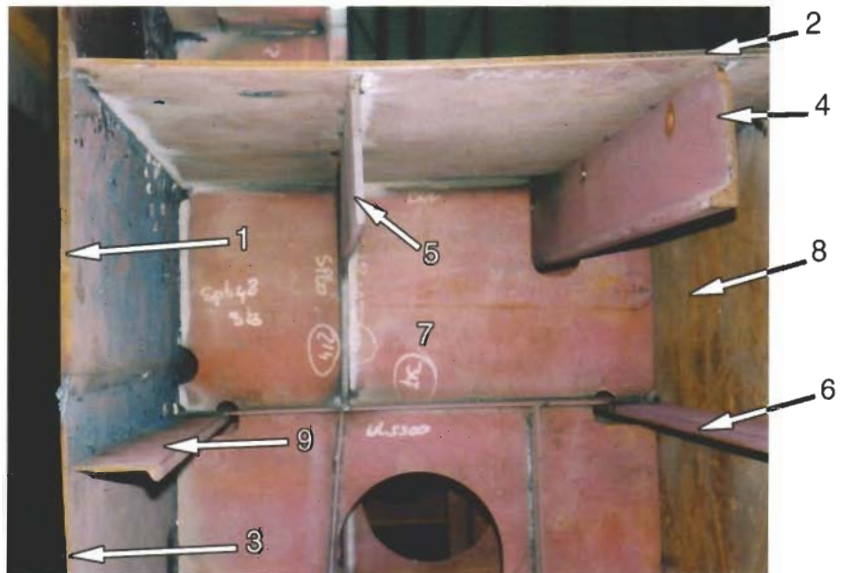
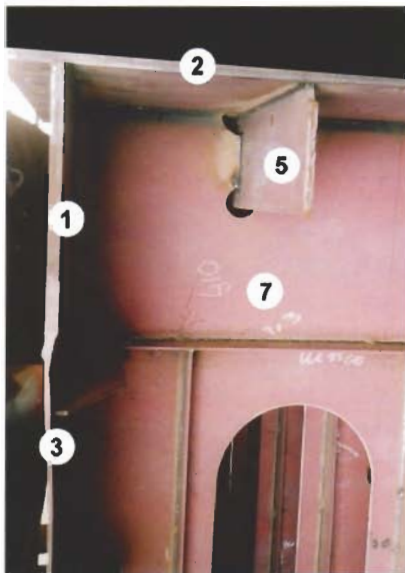

2.3 Longitudinal reinforcements

The preceding shows that the biggest stresses occur in the outer fibres: in the shear strake, bilge strake, upper strake of the side bulkhead and bottom strakes. This is where the thickest plating is applied. The pictures above show a view that clearly emphasizes the difference in plate thickness between the upper strake of the side bulkhead and the side bulkhead just below it. In this ship (container feeder) the upper strake of the side bulkhead is about 2.5 times as thick as the continuous side bulkhead. The place where the plate thickness changes (from 22 mm to 9 mm) is called the taper.

2.4 The loading programme

When the ship's officer has entered the weight of all the items on the ship into the loading programme, the computer can calculate the stability, shearing forces and bending moments. The program compares the present situation with the requirements and regulations of the classification bureau and the proper authorities. The following pages contain a number of examples of loading situations as the computer on board depicts these. The situations have been greatly exaggerated for clarity. Of the total loading programme, only a few (shortened) pages are shown.

Situation 1

Only the holds in the fore and the aft ship are loaded, resulting in a great hogging moment. The graph shows that the bending moment reaches the limit for seagoing condition. Therefore, this is a dangerous situation. During (un)loading in port this bending moment is still allowable. The difference between maximum allowable bending moments at sea level and in the harbour comes from the additional bending moments due to the waves at sea.

Situation 2

The cargo is distributed equally over the whole ship, resulting in modest shear forces and bending moments. Because part of the cargo is placed on the main deck, the initial stability (GM₀) is negative. This means that the centre of gravity (G) is above the metacentre (M) when the ship has no list. When the ship starts listing M will move upwards due to the widening of the waterline till it reaches G. In case of an increasing difference between G and M the ship will eventually capsize.

Situation 3

Only the holds in the midship section are loaded. Because of this the ship experiences a large sagging moment. The maximum bending moment exceeds the acceptable bending moment for seagoing condition at $\frac{1}{2}L$ (frame 108) by 2%. In port this is still permissible. See also the table "strength summary" and the graph of bending moments.

Explanation of the above pictures:

1. Upper strake side bulkhead (22 mm)
2. Main deck or gangway (14 mm)
3. Longitudinal or side bulkhead (9 mm)
4. Deck beam (HP-profile)
5. Deck beam (flat bar)
6. Longitudinal frame (HP-profile)
7. Web frame with plate stiffeners around manhole.
8. Inner side of the shell with stringer.
9. Stringers on the side bulkhead.

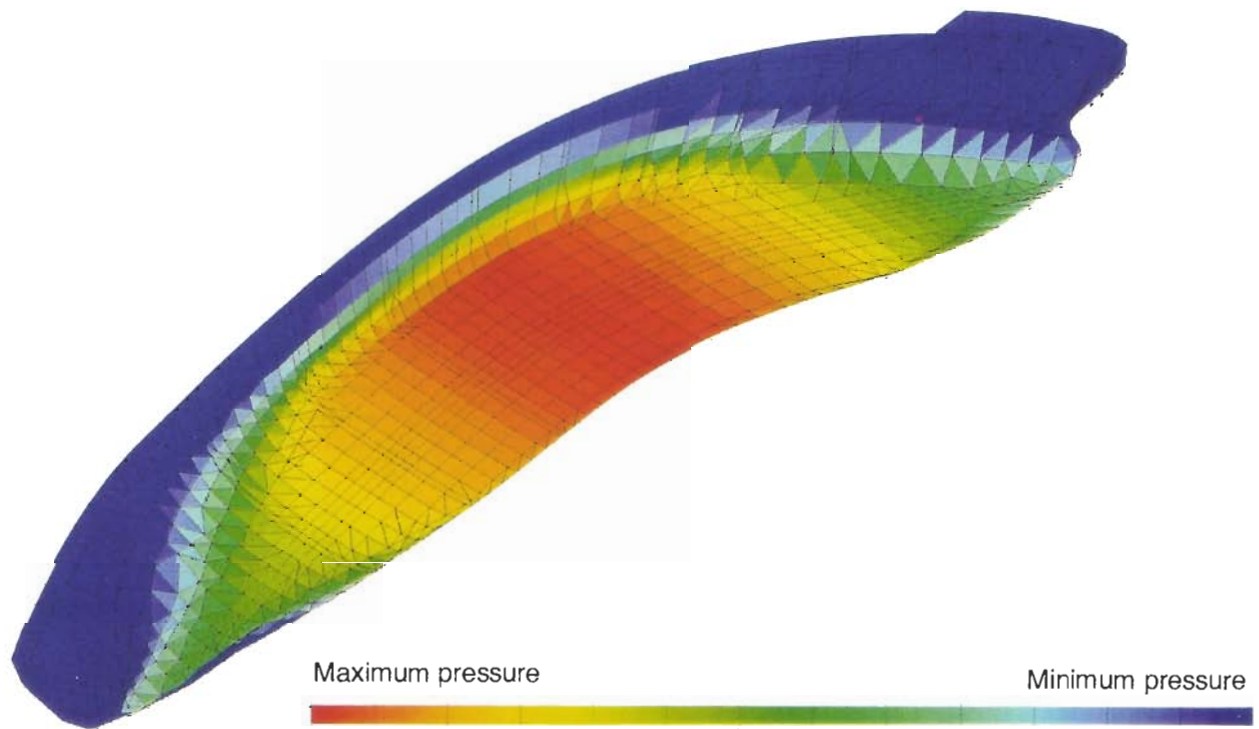

Pressure distribution for a hogging condition

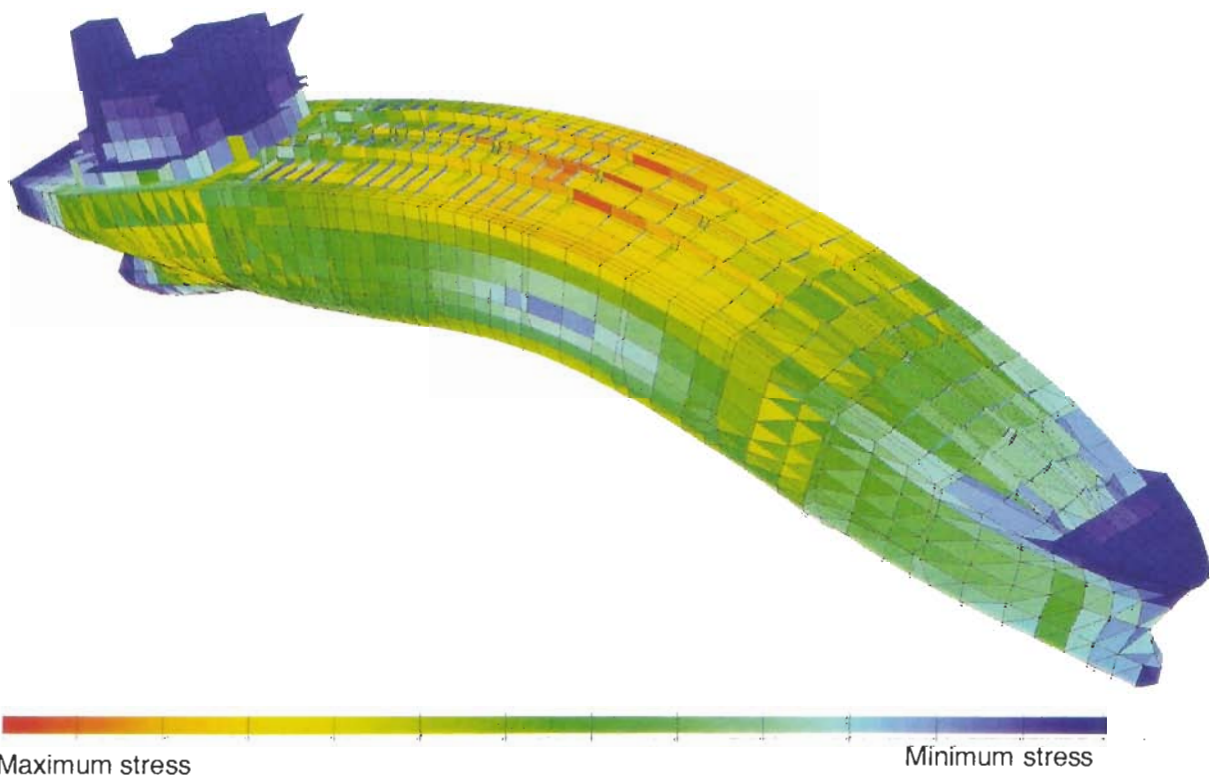

Global stress level (equivalent stress) for a hogging condition

Two computer simulations which show the tension and compressive stresses in a hogging condition.

Situation 1

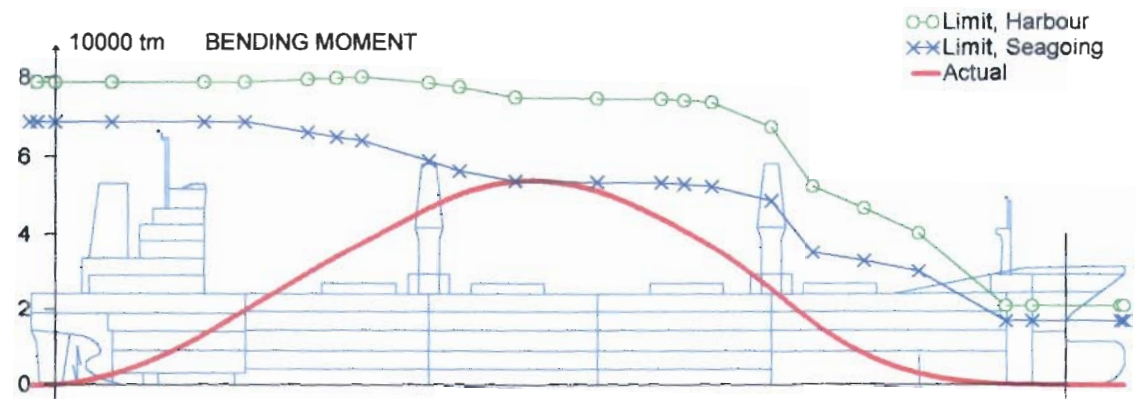
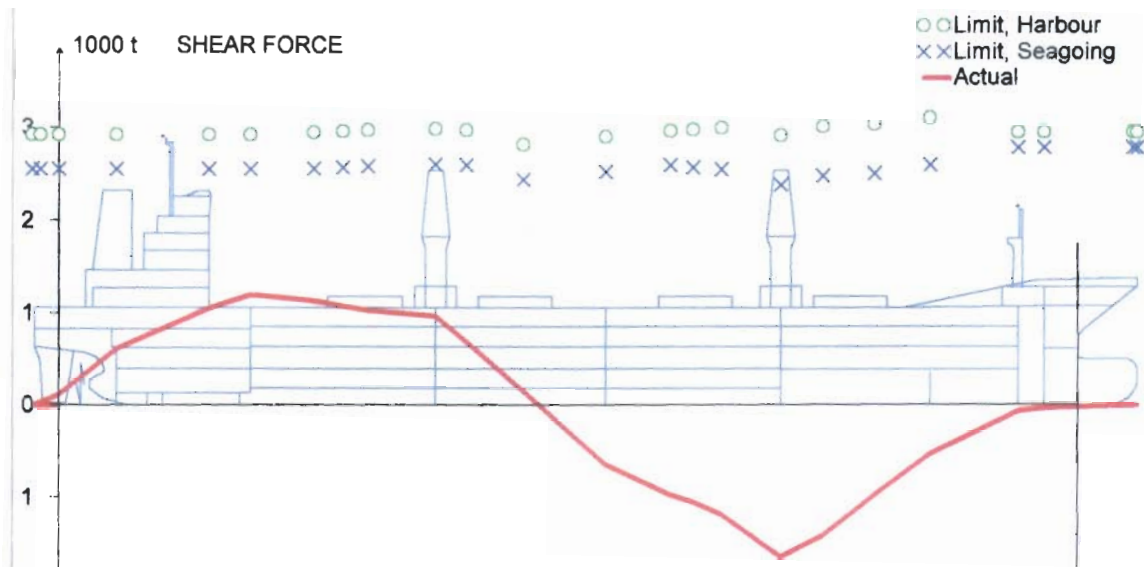
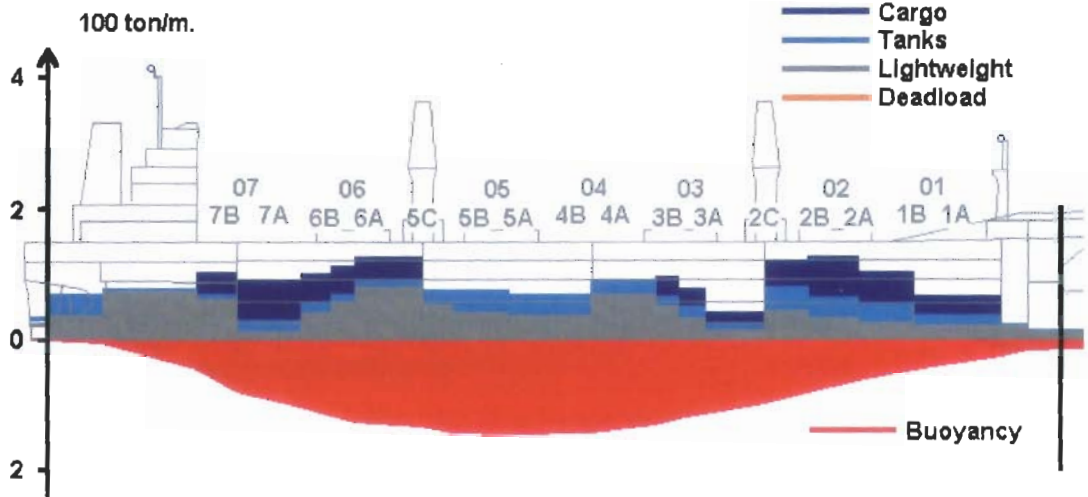
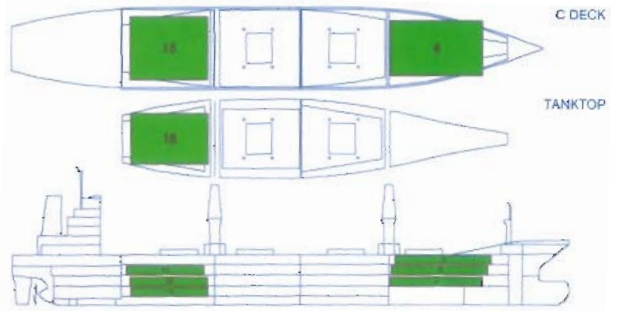
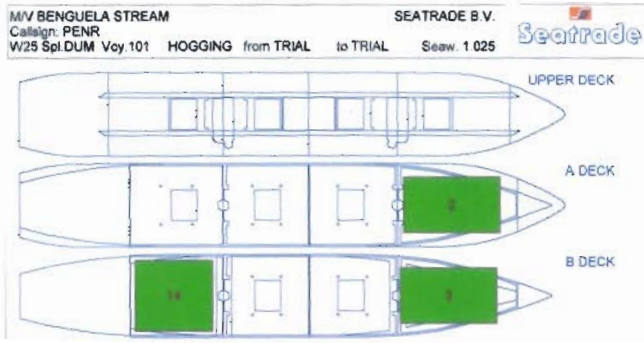

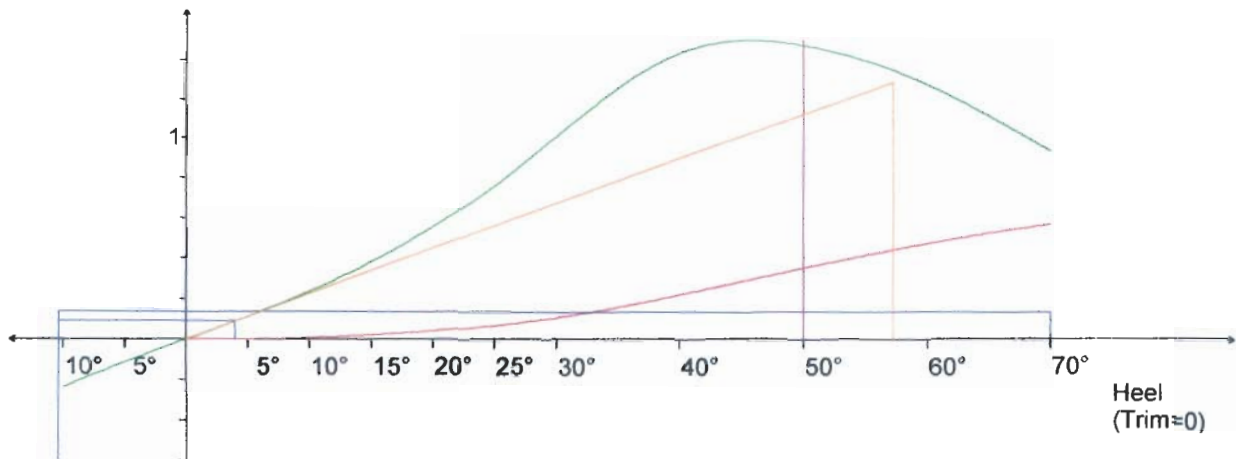

Shear Force and Bending Moment Results:

Distances from Ap. m	Distances from OX m	Wght t	Buoyancy Moment tm	Wght t	Lightweight Moment tm	Wght t	Moment tm	Wght t	Moment tm	Wght t	Moment tm	Wght t	Moment tm	SF t	Strength BM tm
-3.601	72.851	0	0	0	0	0	0	0	0	0	0	0	0	0	0
7.800	61.450	-53	-3403	401	26598	270	17727	0	0	0	0	0	0	617	3012
34.625	34.625	-1912	-86886	1798	97873	507	28087	284	10774	462	19448	1139	29862		
51.200	18.050	-4038	-142256	2914	125683	721	33685	909	27895	462	19448	968	46982		
74.300	-5.050	-7335	-163783	3891	132865	1440	38091	909	27895	462	19448	-633	51319		
90.025	-20.775	-9304	-138955	4788	122453	1739	34379	909	27895	693	15618	-1176	36962		
110.860	-41.610	-11017	-87478	5396	102487	2277	16923	1329	12914	1046	4026	-968	8584		
133.900	-64.650	-11764	-49577	5934	74204	2669	-2502	1826	-11267	1302	-8487	-34	186		
146.501	-77.251	-11910	-39430	6089	63392	2694	-4208	1826	-11267	1302	-8487	0	15		

STRENGTH SUMMARY

Frame no.	From AP	Shear Forces % of perm.				Bending Moment % of perm.			
		t	Seag.	Harb.	41	tm	Seag.	Harb.	25
39	26.000	1199	47	41	19978	29	25		
51	34.625	1139	44	39	29862	45	38		
57	38.800	1976	42	36	34253	53	43		
61	42.010	1037	40	35	37843	59	47		
75	51.200	968	37	32	46982	80	60		
81	55.400	693	27	23	50492	90	65		
92	63.100	163	7	6	53762	100	72		
108	74.300	-633	25	22	51319	96	69		
120	83.100	-962	37	32	44247	93	59		
125	86.200	-1041	40	35	41151	78	56		
130	90.025	-1176	44	38	36962	71	50		
142	96.100	-1639	63	54	25828	53	38		
150	103.850	-1414	52	45	16964	49	32		
160	110.860	-968	36	31	8584	26	18		
171	118.400	-527	19	16	3304	11	8		
188	130.300	-62	2	2	359	2	2		
Maximum :		-1639	63	54	53956	100	72		
Position (m) :		96.10	96.1	98.1	65.49	65.5	65.5		
Bays :		2C	2C	2C	5A-4B	5A-4B	5A-4B		

DEADWEIGHT SUMMARY

	Weight t	LCG m	TCG m	VCG m	S Com. (pos.) m
20' CONTAINERS	0	0	0	0	(0)
40' CONTAINERS	1302	-6.52	-0.22	17.08	(62)
CONTAINERS	1302	-6.52	-0.22	17.08	(62)
BREAKBULK	1826	-6.17	0.09	8.12	(6)
CREW AND STORES	103	3.69	0.00	13.81	0.00
HEAVY FUEL	894	-33.49	-0.00	2.61	0.00
DIESEL OIL	197	36.03	-0.00	6.93	0.00
FRESH WATER	202	65.01	0.02	6.98	0.00
WATER BALLAST	1286	24.7	-0.08	-1.25	0.00
MISCELLANEOUS	91	54.54	0.15	5.92	0.00
DEADWEIGHT	5622	-4.42	-0.06	7.31	0.00
DEADLOAD	0	0	0	0	0.00
LIGHTWEIGHT	8085	19.41	0.00	8.28	0.00
DISPLACEMENT	11910	3.31	-0.03	8.00	0.00
DW RESERVE	11284				

HYDROSTATICS & STABILITY

Draught AP	7.55 m	GM solid	1.37 m	KMT	9.37 m
Draught M.	7.00 m	Correction	0.08 m	LCB	1.94 m
Draught FP	6.45 m	GM fluid	1.29 m	LCF	2.92 m
Trim	1.10 m	GM req.	0.15 m	Immersion	21 t/cm
Air Draught	28.99 m	Heel	-1.1 °SB	TrimMom	138 tm/cm
Propp. Ratio	82 %	Rollp.	15.0 sec.	(Values above for trim=0)	

Situation 2

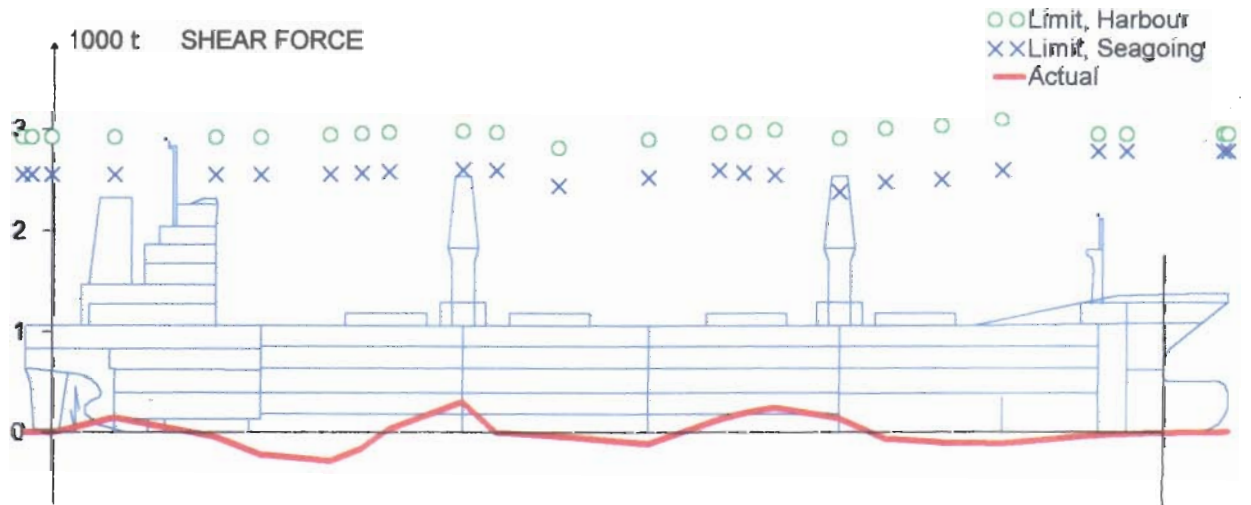
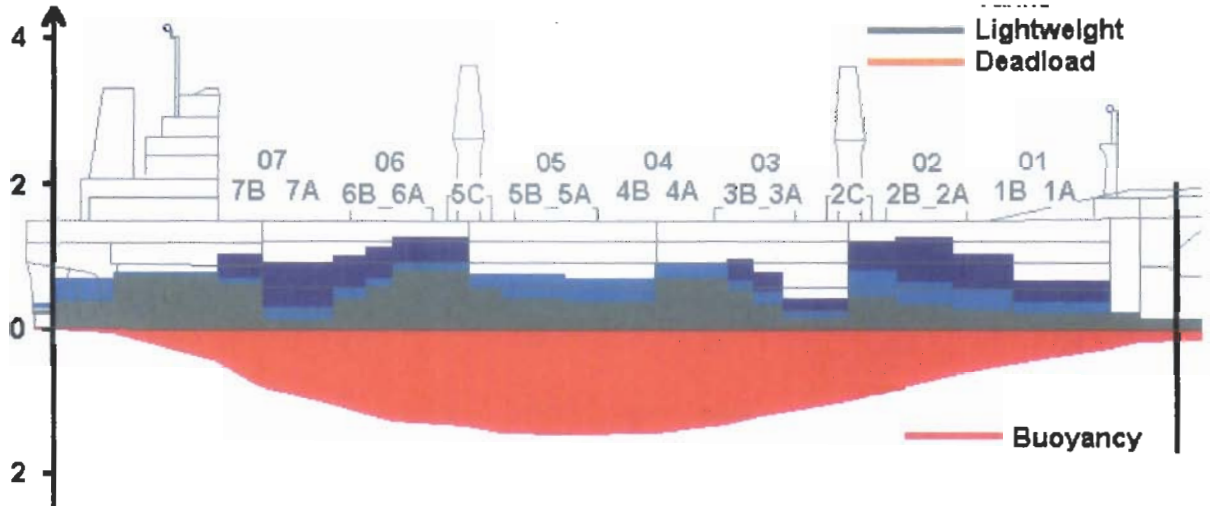
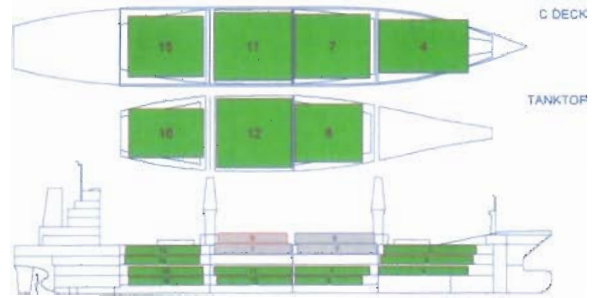
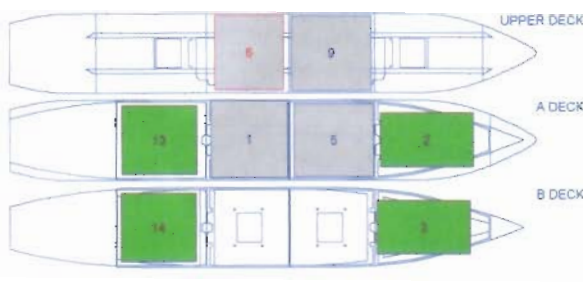

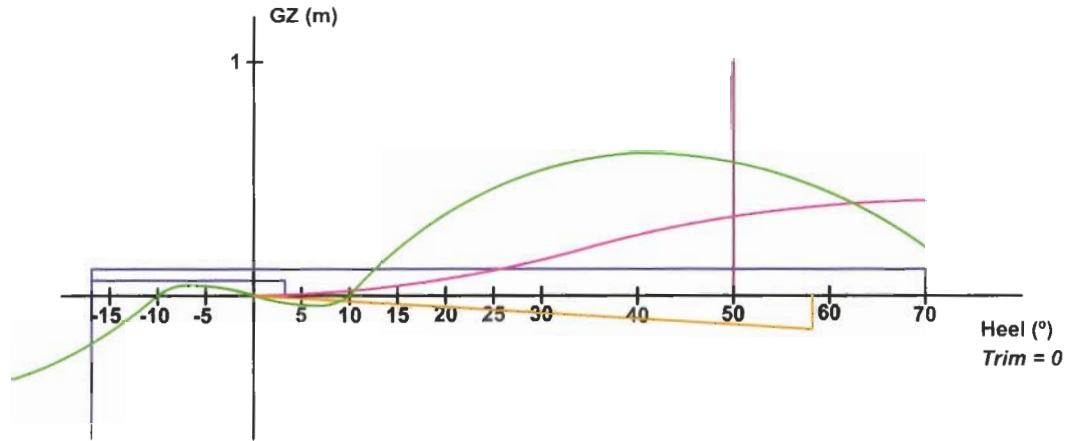

Shear Force and Bending Moment Results

from Ap. m	Distances from OX m	Wght t	Buoyancy Moment tm	Wght t	Lightweight Moment tm	Wght t	Moment tm	Wght t	Moment tm	Wght t	Moment tm	Wght t	Moment tm	SF t	Strength BM tm
-3.601	72.851	0	0	0	0	0	0	0	0	0	0	0	0	0	0
7.800	61.450	-470	-31165	401	26598	220	14265	0	0	0	0	0	0	150	488
34.625	34.625	-3747	-182130	1798	97873	361	20887	842	31981	462	19448	-284	-2098		
51.200	18.050	-6737	-260427	2914	125683	613	27147	2633	81197	882	31066	306	-854		
74.300	-5.050	-10983	-288729	3891	132865	1333	31553	4103	90039	1540	33779	-117	-1081		
90.025	-20.775	-13402	-258328	4788	122453	1631	27841	5197	75390	2037	27744	251	318		
110.860	-41.610	-15406	-198358	5396	102487	1742	25332	5773	60624	2390	16152	-105	1882		
133.900	-64.650	-16197	-158411	5934	74204	1747	25023	5853	56719	2646	3640	-17	91		
146.501	-77.251	-16340	-148428	6089	63392	1752	24681	5853	56719	2646	3640	-0	-27		

STRENGTH SUMMARY

Frame no.	From AP	Shear Forces % of perm.			Bending Moment % of perm.		
		1	Seag.	Harb.	tm	Seag.	Harb.
39	26.000	-216	9	8	707	1	1
51	34.625	-284	12	10	-2098	4	3
57	38.800	-160	7	6	-3060	5	4
61	42.010	32	1	1	-3289	6	4
75	51.200	306	12	10	-854	2	1
81	55.400	-0	0	0	-342	1	0
92	63.100	-39	2	1	-550	1	1
108	74.300	-117	5	4	-1081	3	2
120	83.100	127	5	4	-1087	3	2
125	88.200	195	8	7	-581	1	1
130	90.025	251	10	8	318	1	0
142	98.100	139	6	5	2356	5	3
150	103.850	-63	2	2	2559	7	5
160	110.860	-105	4	3	1882	6	4
171	118.400	-114	4	4	1103	4	3
188	130.300	-33	1	1	181	1	1
Maximum :		306	12	10	-3294	7	5
Position (m) :		51.20	34.6	51.2	41.58	103.8	103.8
Bays :		5C	7A-6B	5C	6B-6A	2C-2B	2C-2B

DEADWEIGHT SUMMARY

	Weight t	LCG m	TCG m	VCG m	S Corr. (pcs.)
20' CONTAINERS	0	0	0	0	(0)
40' CONTAINERS	2646	1.38	-0.23	17.41	(126)
CONTAINERS	2646	1.38	-0.23	17.41	(126)
BREAKBULK	5853	9.69	0.02	10.31	(15)
CREW AND STORES	13	-38.38	0.00	15.90	0.00
HEAVY FUEL	139	24.85	0.00	0.88	0.00
DIESEL OIL	11	-38.27	0.00	0.24	0.00
FRESH WATER	202	65.01	0.02	8.98	0.00
WATER BALLAST	1298	2.47	-0.03	1.25	0.00
MISCELLANEOUS	91	54.54	0.15	5.92	0.00
DEADWEIGHT	10251	8.30	-0.05	10.80	0.00
DEADLOAD	0	0	0	0	0.00
LIGHTWEIGHT	6089	10.41	0.00	8.28	0.00
DISPLACEMENT	16340	9.08	-0.03	9.88	0.00
DW RESERVE	7339				

HYDROSTATICS & STABILITY

Draught AP	11.07	m	GM solid	-0.14	m	KMT	9.72	m
Draught M.	8.64	m	Correction	0.02	m	LCB	2.71	m
Draught FP	6.20	m	GM fluid	-0.16	m	LCF	6.88	m
Trim	4.87	m	GM req.	0.15	m	Immersion	24	t/cm
Air Draught	25.85	m	Heel	10.6	°PS	TrimMom	192	tm/cm
Propp.Ratio	143	%	Rollp.	40.1	sec.	(Values above for trim=0)		

Situation 3

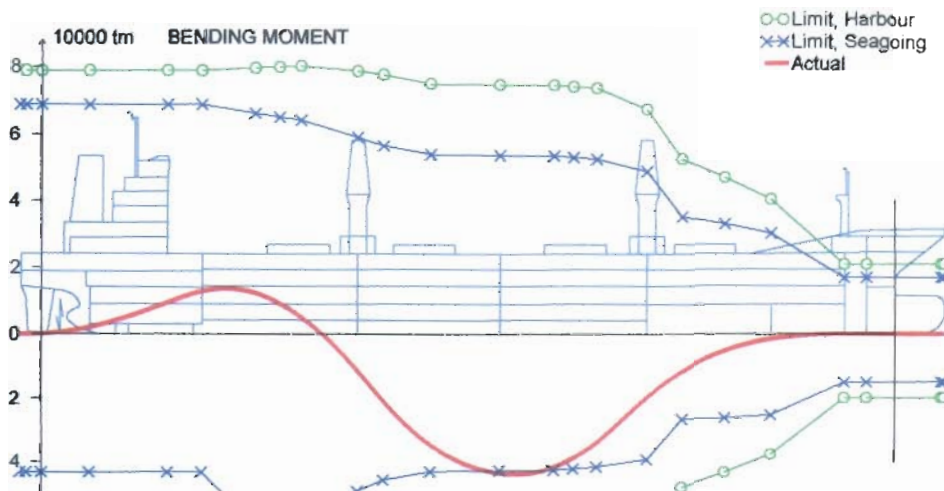
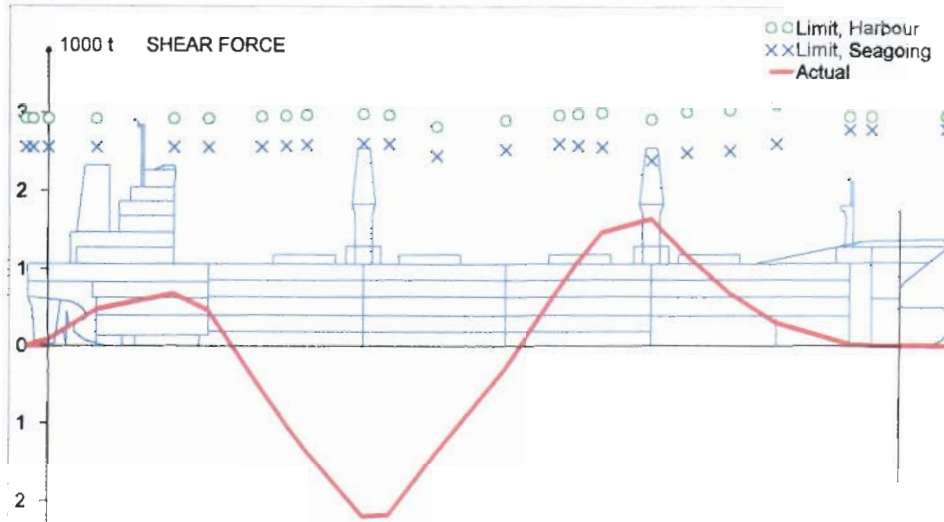
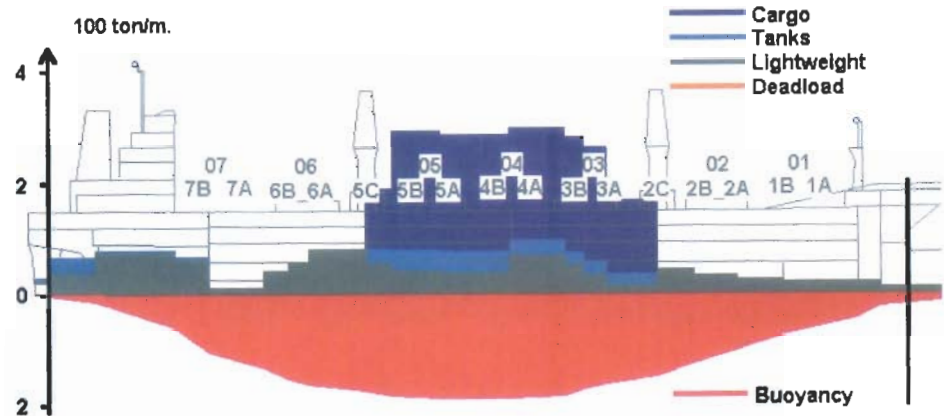
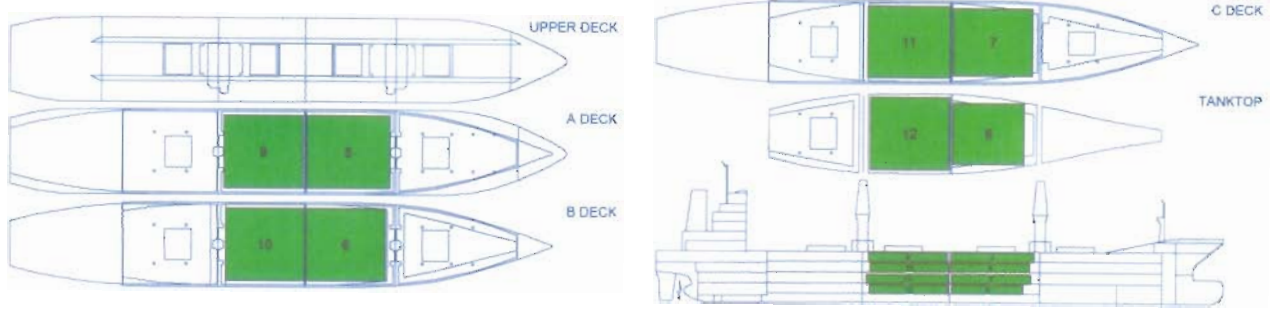

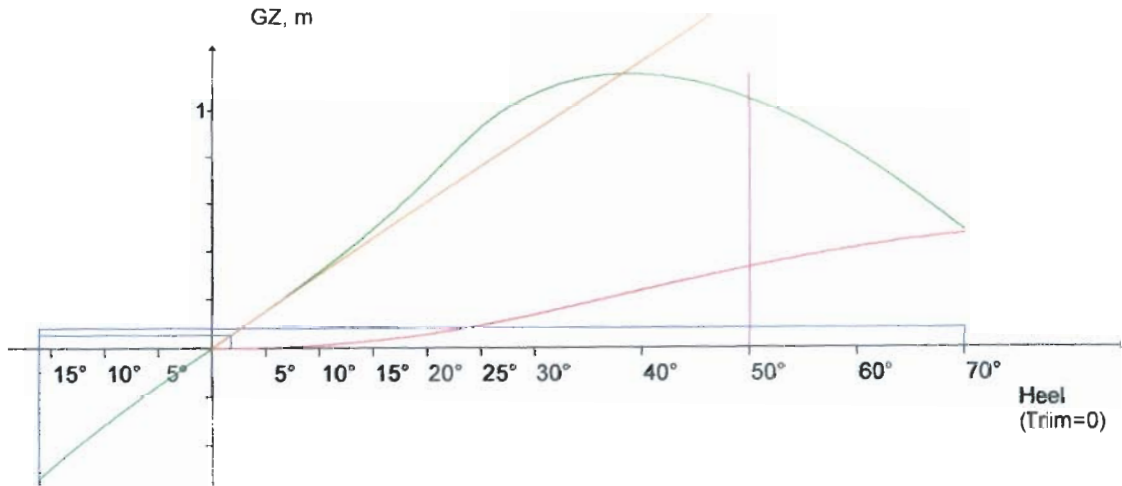

Shear Force and Bending Moment Results

from Ap. m	Distances from OX m	Wght t	Buoyancy Moment tm	Wght t	Lightweight Moment tm	Wght t	Compartments Moment tm	Wght t	BreakBulk Moment tm	Wght t	Bays Moment tm	Strength SF t	Strength BM tm
-3.601	72.851	0	0	0	0	0	0	0	0	0	0	0	0
7.800	61.450	-144	-9411	401	26598	220	14265	0	0	0	0	476	2217
34.625	34.625	-2661	-123187	1798	97873	305	18602	0	0	0	0	-558	12621
74.300	-5.050	-9763	-223138	3891	132865	1125	23786	3800	21874	658	2713	-290	-43362
90.025	-20.775	-12518	-188139	4788	122453	1521	18810	6519	-13967	1155	-3322	1466	-33716
110.850	-41.610	-15155	-108364	5396	102487	1684	15013	7500	-37139	1260	-5704	685	-5188
133.900	-64.650	-16367	-47067	5934	74204	1689	14704	7500	-37139	1260	-5704	15	-5
146.501	-77.251	-16538	-35252	6089	63392	1689	14704	7500	-37139	1260	-5704	-0	-12

STRENGTH SUMMARY

Frame no.	From AP	Shear Forces % of perm. t	Bending Moment % of perm. tm
39	26.000	462	13049
51	34.625	-558	12621
57	38.600	-999	9506
61	42.010	-1351	5494
75	51.200	-2202	-11053
81	55.400	-2183	-20602
92	63.100	-1377	-34330
108	74.300	-290	-43362
120	83.100	745	-41484
125	86.200	1084	-38641
130	90.025	1466	-33716
142	98.100	1641	-19802
150	103.850	1174	-11609
160	110.850	685	-5188
171	118.400	301	-1547
188	130.300	27	-77

Maximum : -2202 86 74 -43634 103 63
 Position (m) : 51.20 51.2 51.2 76.61 76.6 76.6
 Bays : 5C 5C 5C 4B-4A 4B-4A 4B-4A

DEADWEIGHT SUMMARY

	Weight t	LCG m	TCG m	VCG m	S.Corr.(pos) m
20' CONTAINERS	0	0	0	0	(0)
40' CONTAINERS	1260	-4.53	-0.25	17.57	(60)
CONTAINERS	1260	-4.53	-0.25	17.57	(60)
BREAKBULK	7500	-4.86	0.00	7.57	(6)
CREW AND STORES	8	-16.95	0.00	16.61	0.00
HEAVY FUEL	248	-7.46	0.00	3.22	0.01
DIESEL OIL	11	36.27	0.00	0.34	0.00
FRESH WATER	202	65.61	0.02	6.98	0.00
WATER BALLAST	1129	-1.61	-0.03	1.29	0.00
MISCELLANEOUS	91	54.54	0.15	5.92	0.00
DEADWEIGHT	10449	-2.66	-0.03	6.01	0.02
DEADLOAD	0	0	0	0	0.00
LIGHTWEIGHT	8089	10.41	0.00	8.26	0.00
DISPLACEMENT	16537	2.13	-0.02	8.11	0.02
DW RESERVE	6656				

HYDROSTATICS & STABILITY

Draught AP	8.74 m	GM solid	1.76 m	KMT	9.87 m
Draught M.	9.07 m	Correction	0.02 m	LCB	2.99 m
Draught FP	9.41 m	GM fluid	1.74 m	LCF	7.36 m
Trim	-0.66 m	GM req.	0.15 m	Immersion	25 t/cm
Air Draught	27.62 m	Heel	-0.7 *SB	TrimMom	206 tm/cm
Propp.Ratio	103 %	Roll..	12.3 sec.	(Values above for trim=0)	

Heel	GZ	Floodangle, Thf	Deck Subm.	Cb	WindForce	Wind Lever lw1	Cargo WindArea	Total WindArea A	IMO
5°	0.15 m	51.2°	21.0°	0.59	0.051 t/m ²	0.056 m	252 m ²	1610 m ²	Actual
10°	0.31 m								Limit
15°	0.49 m								Min
20°	0.70 m								Min
25°	0.93 m								Min
30°	1.08 m								Min
40°	1.16 m								Min
50°	1.06 m								Min
60°	0.82 m								Min
70°	0.49 m								Min
Container COG	50 %								Min

3 Torsion of the hull

Torsion occurs when there is an asymmetry in the mass-distribution over the horizontal plane. For example, if there is a weight of 100 tons on the starboard side of the fore-ship which is compensated by an equivalent weight on the port side of the aft ship, there will be torsion (or torque). If both weights are 10 metres from the centreline, the torsion will be $100t \times 10m = 1000tm$. In adverse weather, especially when the waves come in at an angle, the torsion can increase as a consequence of the asymmetric distribution of the upward pressure exerted by the water on the submerged part of the hull. Torsion causes a ship to be subject to extra stresses and deformations. This can result in hatches leaking or badly sealing. Especially "open ships", i.e. ships with large deck openings, tend to be torsionally weak and are sensitive to this. A good example are container ships and modern box hold general cargo ships.



Heavily pitching fishing boat.

4 Local stresses

4.1 Panting stresses

These occur mostly in the fore-ship during pitching. The constantly changing water pressure increases the stress in the skin and the frames. Panting stress is not a result of hydrostatic pressure, but more a result of hydrodynamic pressure. To reduce the panting stress effect, panting beams in transverse direction and stringers against the ship's shell are added to the forepeak and aft peak structure.

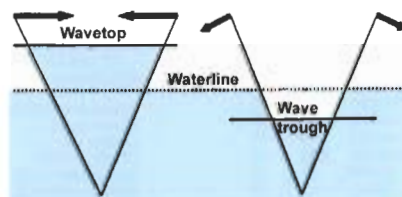

Forces on the foreship if the ship is on a wave top (left) and in a trough(right).



Damage caused by panting strain. Entire forepeak tank torn off. Ship size 100,000 t dead weight.

4.2 Pitching loads

Pitching loads occurs in the flat bottom of the foreship as a result of (heavy) pitching of the ship. The pitching stresses are reduced by increasing the bottom-plating thickness, by the addition of extra side keelsons and closer spacing of the frames and floors on every frame.

4.3 Diagonal loads

These occur when the ship is asymmetrically laden and during rolling of the ship in waves. The effect of the diagonal loads is reduced by the addition of frame brackets, deck beam brackets, cross frames and transverse bulkheads.

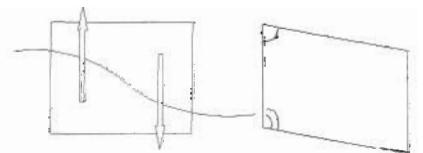

Diagonal loads due to rolling in waves

4.4 Vibration loads

These can be caused by:

- vibrations of the engine
- forces on the aft ship caused by the rotations of the propeller.

4.5 Docking loads

These result from vertical upward forces where the keel blocks are placed and vertical downward forces between the keel blocks and the side blocks.

5 Ship in waves

These figures, made by computer simulation, show exaggeratedly how a small container ship in heavy waves may be distorted.

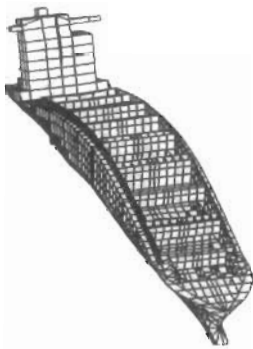

Ship on a wave top, hogging

Waves coming in from starboard at an angle, torsion



Ship in a trough, sagging

Waves coming in from portside at an angle, torsion

6 Stiffening

6.1 Purpose of stiffeners

To prevent the planes (plate fields) of a ship from distorting under influence of the shearing loads, bending moments and local loads, they have to be stiffened. Examples of planes are the shell, decks, bulkheads and tank top. Compared to the dimensions of the ship, the plating is not very thick (about 10 - 20 mm). Once the stiffeners are in place, they also contribute to the reinforcement of the plane by reducing the tensions in it and by preventing local buckling. This enables the stiffened planes to be thinner than the planes, which are not strengthened.

An example of this are the frames on the inside of the skin, most of which are of the type "Holland Profile" (HP). The drawings show the importance of stiffening.

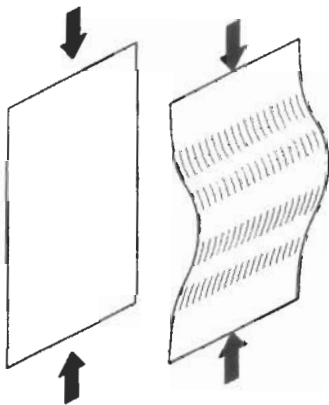

Compressing forces on a plate result in plate buckling.

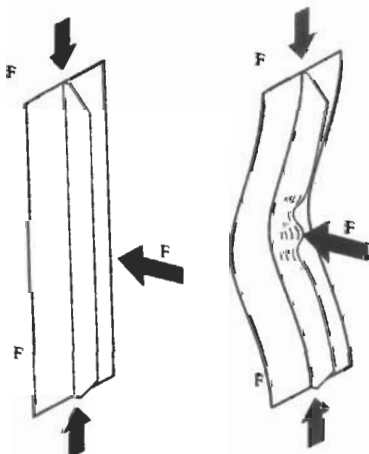

Compression forces on a stiffened plate. Buckling requires extra force.

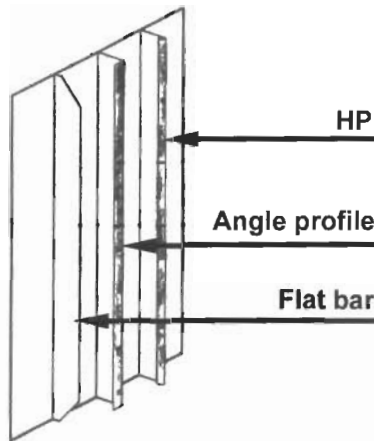

Forces on a plate with an HP-frame or angle bar at the place of bending. The placing of an HP-frame or angle bar instead of a single strip will reduce the risk of bending.

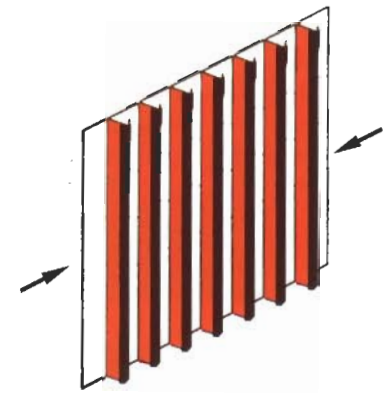

Parallel frames on a plate subjected to bending moment

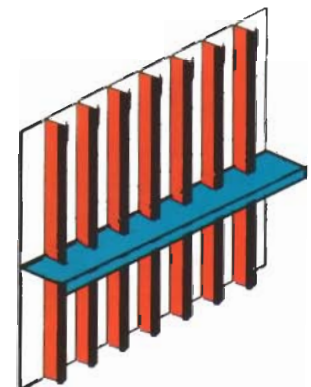

The same situation only now with a stringer placed perpendicular to the frame direction

If all the frames run parallel (in either athwart or fore and aft direction) it is possible that the frames can bend perpendicular to the frame direction. To prevent this, a stiffening is placed perpendicular to the frame direction. Such a stiffening is called a stringer for transverse frames and a webframe for longitudinal frames. Bulkheads are also constructed using this system. In the case of decks, deck beams and deck girders form the stiffening.

Similar stiffenings have different names for different planes.

Planes:	Stiffening:	Support:
shell	(vertical) frames	stringers (horizontal) web frames
bulkheads	horizontal stiffening vertical stiffening	stringers (horizontal) web girders
decks	deck frames	deck girders
flat bottom	bottom frames (fore and aft) bottom frames (transverse)	floors keelsons
tank top	upper frames (fore and aft) upper frames (transverse)	floors keelsons

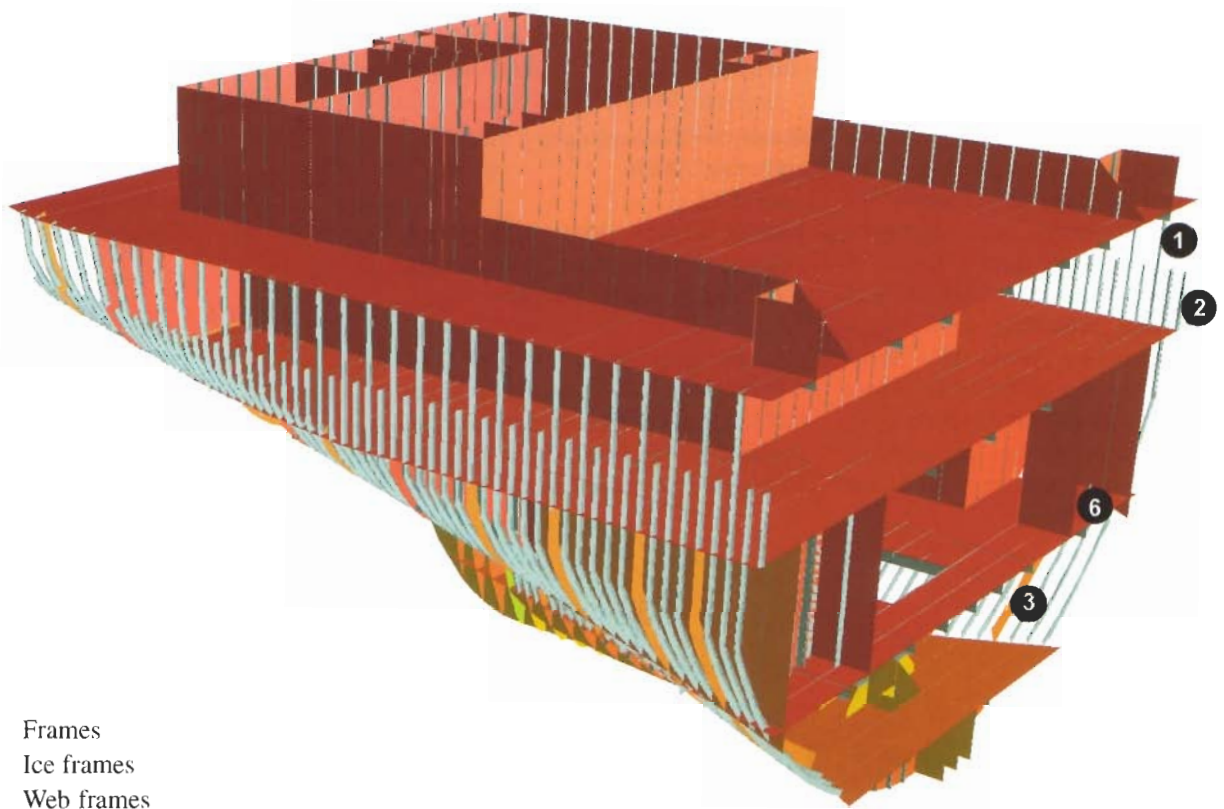

1. Frames
2. Ice frames
3. Web frames
4. Deck frames
5. Deck beams
6. Centre keelson
7. Side keelson

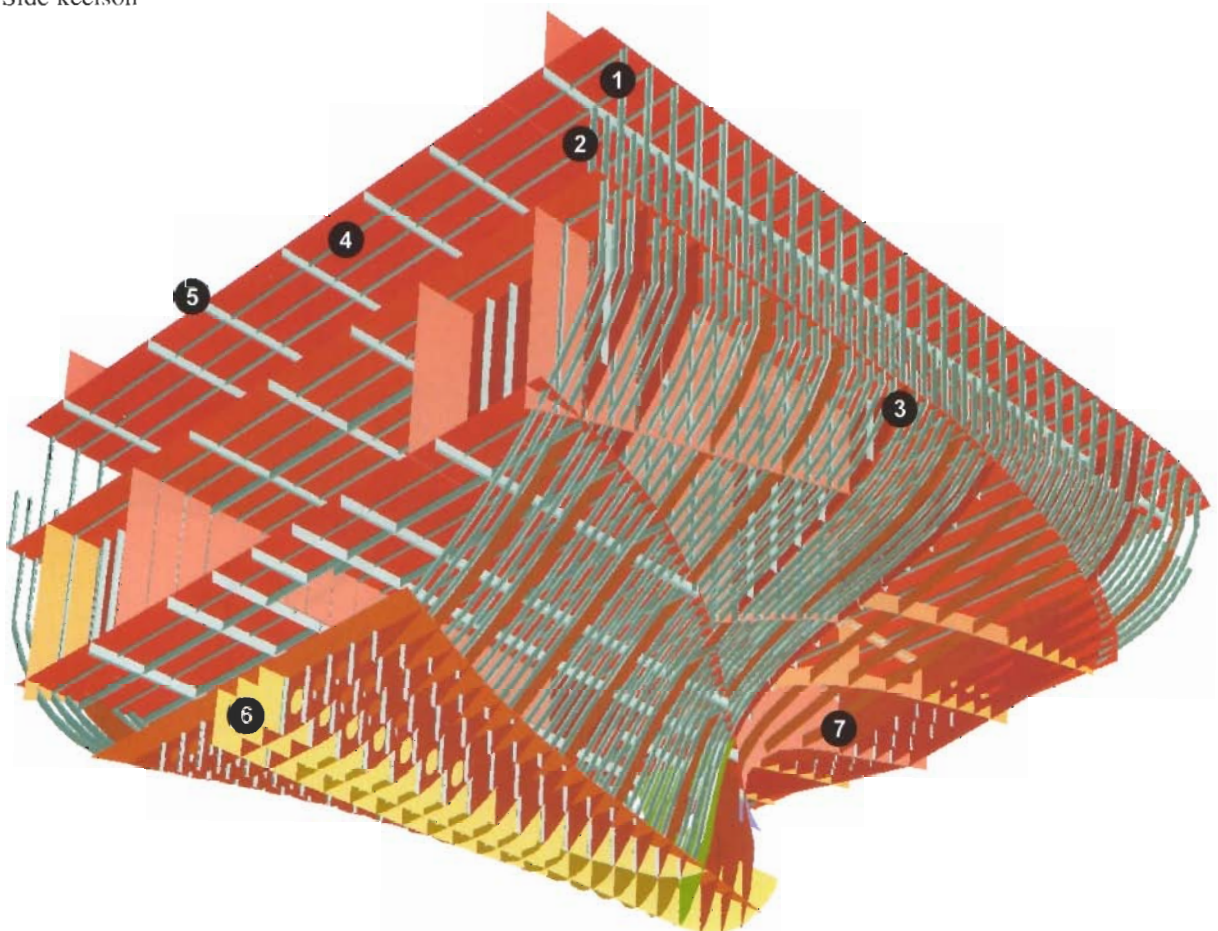

Cross-section of a container ship near the engine room. (transverse frames)

6.2 Longitudinal framing system and transverse framing system.

We have seen in this chapter that longitudinal loads are present on all ships and that they play a larger role if the ship is longer and/or narrower. This is why ships with a length of more than 70 metres are usually constructed according to a longitudinal stiffening system. This means that the frames and the deck beams run in the fore and aft direction. Ship shorter than 70 metres (for example fishing boats and tugboats) are

usually built according to a transverse stiffening system.

Lloyd's Register does not require a calculation for longitudinal strength if the ship is shorter than 65m.

On the next pages we see two different kinds of ships. First a double-hull tanker built with the longitudinal framing system, secondly a tug boat built with transverse frames.

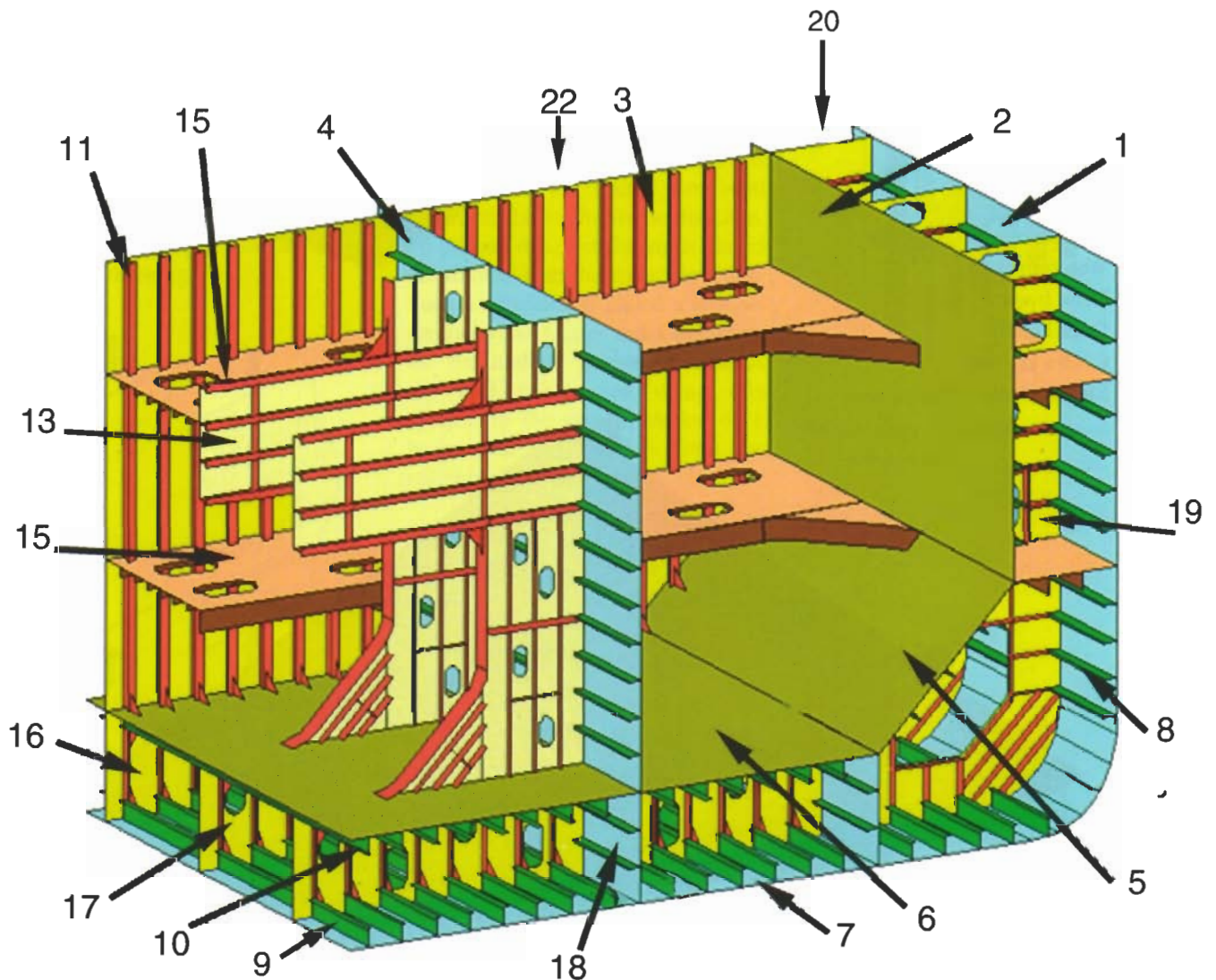

Two drawings of a modern, double-hull tanker built using the longitudinal system

Plating

1. Shell
2. Longitudinal bulkhead (of the inner hull)
3. Transverse bulkhead
4. Longitudinal bulkhead
5. Lower hopper
6. Tanktop
7. Bottom

Stiffenings on the plating

8. Side longitudinals
9. Bottom frame / Longitudinal
10. Inner bottom longitudinal
11. Bulkhead stiffener
12. Stiffener with brackets

Plate-stiffeners

13. Tie beam or cross-tie
14. Stringer
15. Stringer deck
16. Watertight floor
17. Full floor
18. Watertight side keelson
19. Web frame

Holds

20. Wing ballast tank
21. Double bottom
22. Cargo tank

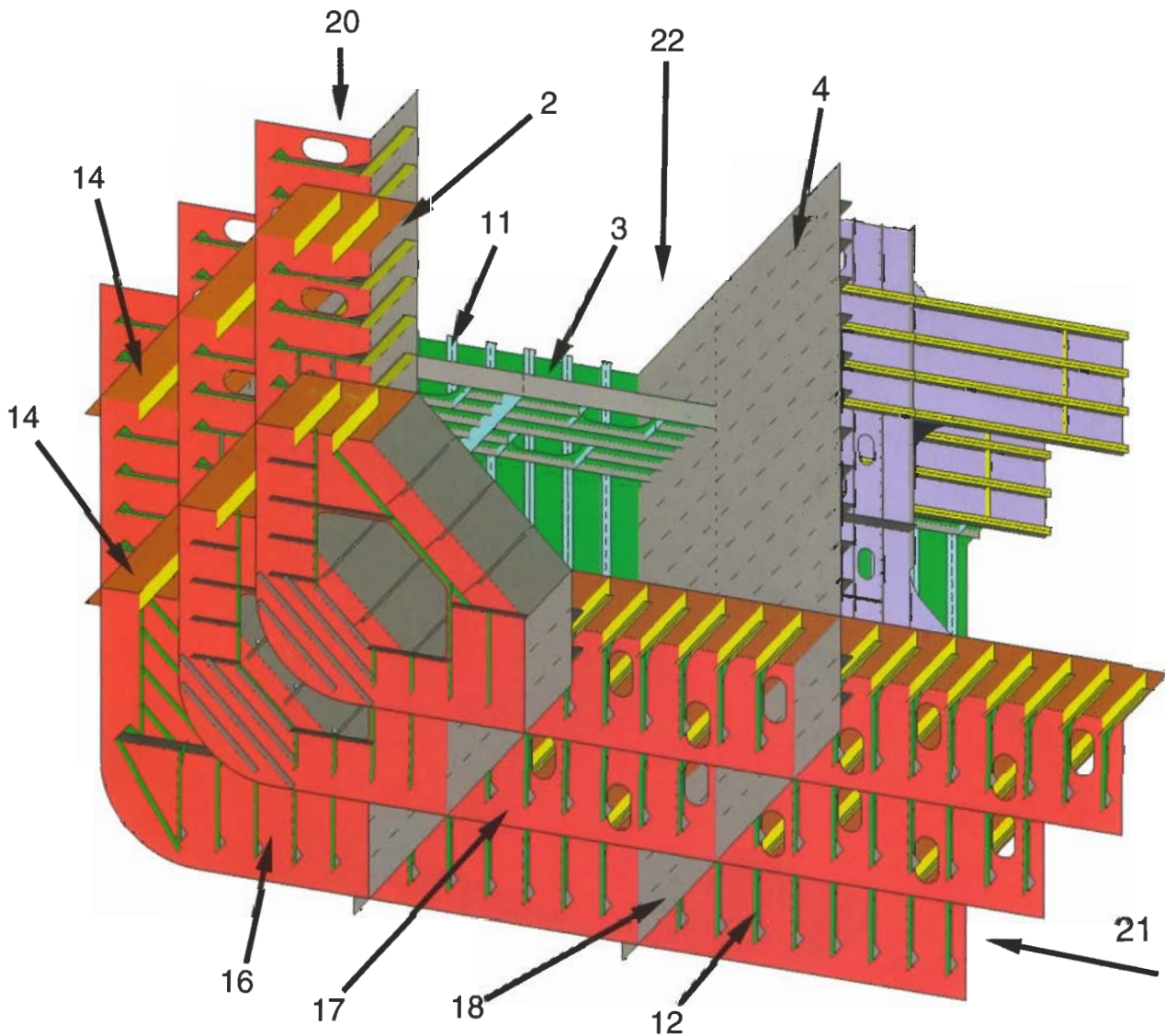

- | | |
|--|---|
| 1 Wheelhouse front windows | 17 Transverse full floor |
| 2 Wheelhouse rear windows | 18 Stringer |
| 3 Portside funnel | 19 Stern fender |
| 4 Starboardside funnel | 20 Sternroller, for anchor handling |
| 5 Mast | 21 Bulwark toprail, gunwale |
| 6 Deckhouse top (location for raft / rescueboat) | 22 Thruster nozzle |
| 7 Foredeck | 23 Poop deck, working deck. |
| 8 Forward bitts | 24 Rubbing bar |
| 9 Forward bulwark with fairlead | 25 Deck beam |
| 10 Location bow fender | 26 Transverse bulkhead |
| 11 Side bollard forward | 27 Location towing winch |
| 12 Bilge keel | 28 Steering-gear room |
| 13 Towing bitt | 29 Side bollard aft |
| 14 Sideshell transverse frame | 30 Longitudinal bulkhead (Tailshaft tunnel) |
| 15 Deck bracket | 31 Bilge plating |
| 16 Bilge bracket | |

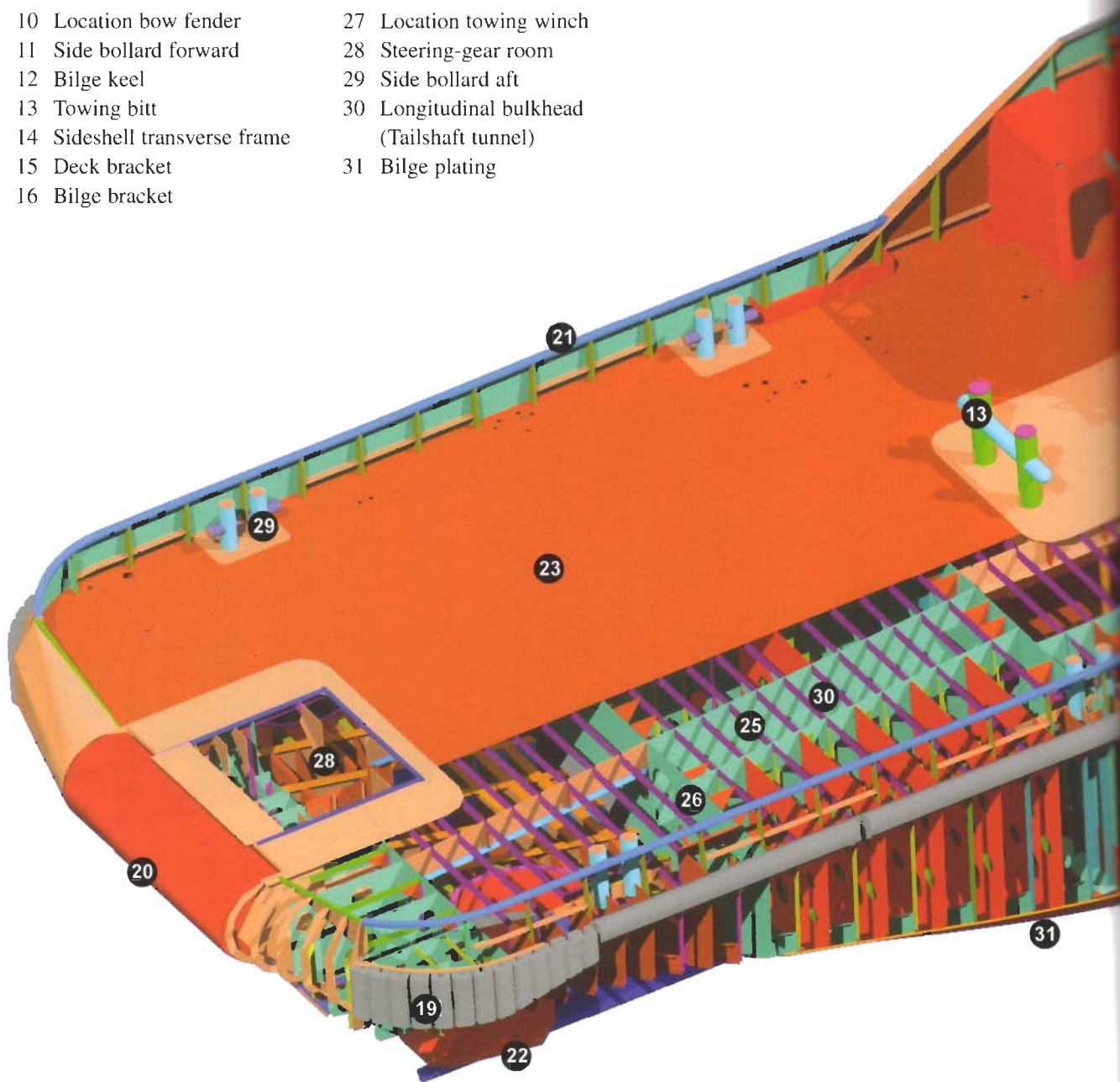

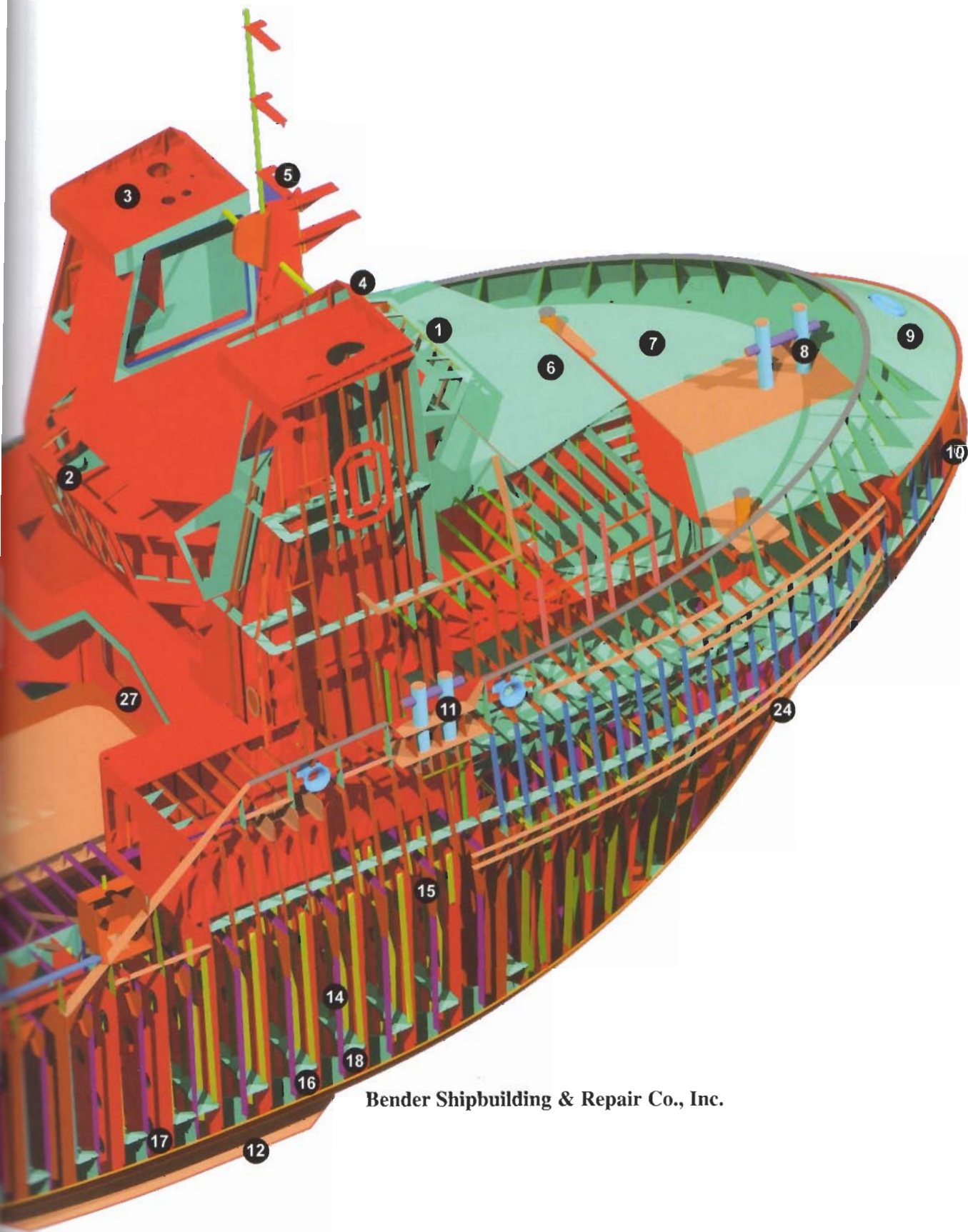

Bender Shipbuilding & Repair Co., Inc.

CHAPTER 6

Laws and regulations





1. IMO

2. Certificates

3. Classification

4. ISM

4.1 Introduction

4.2 Objectives

4.3 How ISM works

4.4 The audits

5. ISO

**6. Marine pollution
(MARPOL)**

6.1 Annex I

6.2 Annex II

6.3 Annex III

6.4 Annex IV

6.5 Annex V

6.6 Annex VI

6.7 Annex VII

7. Documents

SHIP KNOWLEDGE

A MODERN ENCYCLOPEDIA

SHIPWISE

PAGE 8 **1**

THE SHAPE OF A SHIP

PAGE 22 **2**

SHIP'S TYPES

PAGE 44 **3**

THE BUILDING OF A SHIP

PAGE 68 **4**

FORCES ON A SHIP

PAGE 82 **5**

LAWS AND REGULATIONS

PAGE 104 **6**

CONSTRUCTION OF THE VARIOUS SECTIONS

PAGE 126 **7**

CLOSING ARRANGEMENTS

PAGE 160 **8**

LOADING GEAR

PAGE 174 **9**

ANCHOR AND MOORING GEAR

PAGE 196 **10**

ENGINE ROOM

PAGE 216 **11**

PROPULSION AND STEERING GEAR

PAGE 244 **12**

ELECTRICAL INSTALLATIONS

PAGE 266 **13**

MAINTENANCE AND DOCKING

PAGE 280 **14**

SAFETY

PAGE 302 **15**

STABILITY

PAGE 322 **16**

CHAPTER 6 QUESTIONS
VISIT

WWW.DOKMAR.COM

1. IMO

Within the United Nations, maritime affairs are taken care of by the International Maritime Organization, in abbreviation, IMO. The main objective, from the first conference in 1948 up to its entry into force in 1958, is improvement of safety at sea.

Seafaring has, through history, always been one of the most dangerous occupations. Even today that is still true. Many countries had unilateral regulations on safety. As sea trade is of international nature, the rules and regulations had better to be set up internationally, instead of by individual countries, to make them better overall. To improve this subject, in 1948 the basis was laid for IMO.

Safety of ships and navigation was the first issue, but also from the beginning Marine Pollution, particularly from oil carried in tankers, was of great importance.

and conventions have been adopted. After adoption, individual governments must ratify the protocols or conventions. Depending on the number of governments and the tonnage governed by them, a convention comes into force, after a certain time.

Then it followed by the implementation, when the new regulation becomes law under the responsibility of the flagstate. This process sometimes takes years.

As mentioned above, the main Conventions are SOLAS (Safety of Life at Sea) and MARPOL (Marine Pollution). SOLAS goes back as far



Designed, approved and surveyed to withstand the roughest seas.

The governing body is the Assembly, with Committees for the different objectives. Safety is dealt with by the MSC, the Marine Safety Committee.

MEPC, the Marine Environment Protection Committee deals with pollution problems.

The above has resulted in two major issues: SOLAS and MARPOL.

The former deals with the Safety of Life at Sea, SOLAS, and the latter with Marine Pollution, or Marpol.

Through the years many protocols

as 1914, but due to World War I never came into force. A number of safety conventions have been implemented since; the last one SOLAS 1974, with amendments, is now valid.

MARPOL started only in 1954, dealing with oil pollution. Now MARPOL 73/78 with various amendments is valid.

The above Conventions resulted in worldwide recognised certificates which ships have to carry, after being surveyed to ensure that they meet the requirements. A variety of compl-

sory equipment has to be type-approved by Flagstate(s) and/or Classification Society.

2. Certificates

The following certificates are in use:

For SOLAS:

1. Cargo ship Safety Construction Certificate
2. Cargo ship Safety Equipment Certificate
3. Cargo ship Safety Radio Certificate
4. Cargo ship Safety Certificate, combining 1, 2 and 3.

In SOLAS the ship's construction is also regulated, with regards to strength, maximum size of floodable compartments, intact and damage stability.

Rules and regulations and certificates are more stringent for passenger ships than for cargo ships.

The Loadline Certificate, evidence of meeting freeboard requirements, already existed. This was started in the United Kingdom by a member of parliament, Mr Plimsoll, after which certificates have been issued by the Classification Societies since 1876, when the freeboard mark became compulsory.



Survey to verify load lines on side of ship.

For bulk carriers a special certificate has been created in connection with the transport of Solid Bulk Cargoes. These cargoes have been categorized A, B and C, depending on their hazards. For each of these cargoes there are special requirements.

For MARPOL:

The International Oil Pollution Prevention Certificate (IOPP), for oil tankers of 400 GT and above and for other cargo ships above 400 GT, commonly called Annex I. Tankers originally simply pumped their tank washings overboard, causing enormous pollution in the sea and on the beaches. Now this outflow is restricted to max 30 litres per nautical mile, and only when they are not in restricted waters.

As said before, it started with oil pollution. Later other pollutants were also taken into consideration :

Annex II deals with Noxious Liquids and Chemicals.

The relevant regulations are found in the BCH Code, Code for the construction and equipment of ships carrying dangerous chemicals in bulk. This Code classifies ships and cargoes. Cargoes are classified in accordance with their threat to sea life, people etc. Ships are divided in 3 categories, depending on their ability to cope with the hazard of the various cargoes.

Annex III deals with harmful substances in packed form,

Annex IV sewage,

Annex V garbage,

Annex VI air-pollution and

Annex VII ballast water.

3. CLASSIFICATION

Ships are built in accordance with Rules and regulations of a Classification Society. The society approves the relevant drawings, and checks the actual construction. Classification is controlling strength and quality of materials and workmanship in connection with the ship, when built "under Class". The Classification Society issues a



Surveyors check links and shackles of an anchor chain.

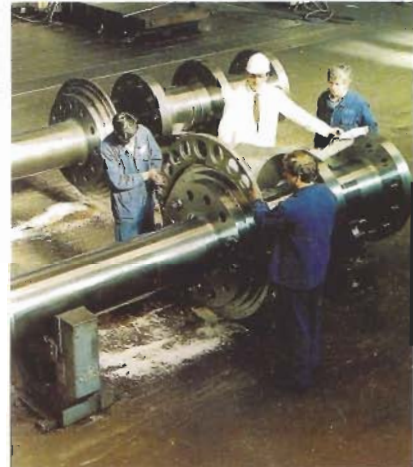

In a manufacturer's workshop a local surveyor reviews the fit-up and alignment of intermediate and thrust shafts.

certificate upon completion of construction: the Certificate of Class, for Hull and Machinery. At the same time a trading certificate is issued with a validity of 5 years which has to be endorsed every year, on completion of the Annual Survey. To carry out the different surveys, the Class Societies each maintain a worldwide network of surveyors, centralized by their main offices.

The main Societies are grouped under IACS, the International Association Of Classification Societies.

The main members are (in alphabetic order):

- American Bureau of Shipping (ABS)
- Bureau Veritas (BV)
- Det Norske Veritas (DNV)
- Germanischer Lloyd (GL)
- Lloyd's Register (LR)
- Nippon Kaiji Kyokai (NKK)

The Certificate of Class is the basis for underwriters to insure a ship.

In general, the Classification Society looks after the technical condition of the ship, and the Flagstate after the people on board, and their behaviour in connection with safety, environment and communication. Many flagstates delegate their tasks to the Classification Society. Therefore, on many ships, apart from the class certificate, the statutory certificates are issued by the Classification Society.

Before any Certificate can be issued, a ship must be registered in a certain country, the Flagstate. This means that the flagstate accepts a ship as carrying their flag and belonging to their 'fleet'. Against a certain fee, and taxation on the earnings, the authorities allow the shipowner to sail under their jurisdiction. The town where the ship has been registered has to be marked on the stern. As proof of the registration the Flagstate



Inspecting a hatch on a life boat for compliance with the latest regulations.

issues the International Tonnage Certificate, or the Classification Society issues this certificate on their behalf. This certificate is worldwide accepted as giving the official details of the ship: main dimensions and contents of the various spaces, in

particular the spaces in connection with cargo: cargo holds, tanks, etc., all in accordance with regulations set out in the Tonnage Convention.

Harbour dues are in most ports based on the gross tonnage, and the certificate is the official paper with the correct figures of tonnage. Producing this certificate involves a lot of calculation of contents of spaces, measuring from drawings or measuring on board.

The Flagstate is also responsible for the Minimum Safe Manning Certificate, stating the minimum number of crew, and the required training for them, who have to be on board when the ship is underway.

Apart from the International Tonnage Certificate, the Suez Canal and the Panama Canal have their own way of establishing 'tonnage' to base their fees on. Therefore, special tonnage certificates are issued for Suez Canal and Panama Canal.

The Classification Societies are, since 1968, associated in IACS. Since 1970 they are consultative to IMO, contributing their expert technical knowledge.

A relatively new issue of IMO is the International Safety Management (ISM). Since July 2002 all ships must have an ISM certificate. In July 2000, passenger ships, tankers and bulk-carriers already needed to have above certificate. This certificate, for both ship and office, is a statement that Owners/Managers and the ship's staff are committing themselves to maintain the vessel as required, and

to fulfil obligations connected with safety and pollution.

Since 1999 all compulsory certificates have been harmonized to a validity of 5 years, in phase with the Classification Special Survey cycle. Before, the Safety Equipment Certificate had a validity of 2 years, the Radio Certificate 1 year, and IOPP Certificate 5 years. This resulted in certificates with different expiration dates, creating the hazard of an expired certificate going unnoticed. The Safety Construction and Loadline Certificates were already in phase with the Classification cycle.

4. ISM-code (International Safety Management)

4.1 Introduction

Most regulations in shipping concern technical aspects of the ship and the required training of the crew. The ISM-code is a list of regulations for the organisation of the ship, so basically it concerns the management-system.

The management-system comprises of:

- the organisation on board the ship
- the organisation on shore; the organisation of the shipping company
- the communication between shore and ship

The importance of good management for safety in general is illustrated by the fact that 80% of all accidents in shipping are the result of human errors.

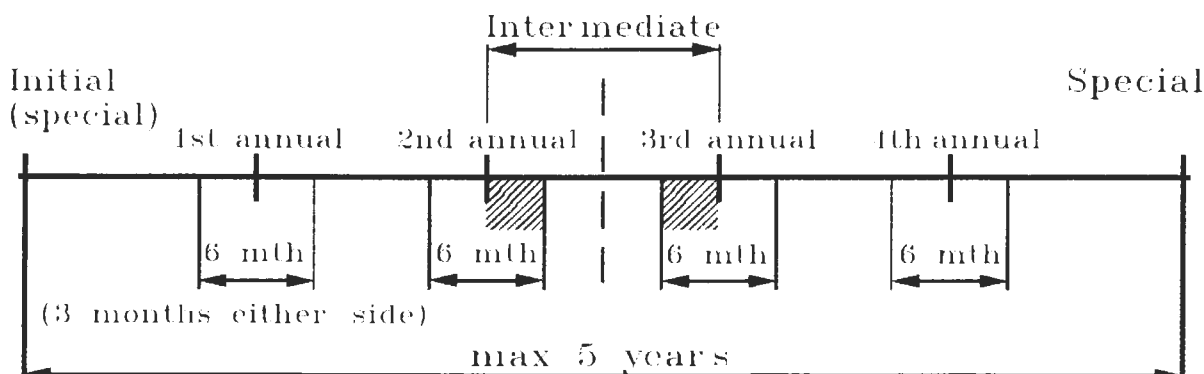

Classification Special Survey Cycle



For Class and ISM, ships have to dry-dock two times in five years

4.2 Objectives

The objectives of the ISM-code are:

- to satisfy all relevant national and international laws like SOLAS, MARPOL, ISM, Class and Labour laws
- creating a permanent awareness of safe behaviour by the personnel on board and ashore
- ensuring a readiness to act effectively in emergencies
- guaranteeing safety at sea
- preventing accidents and damage to environment

The ISM-code is a standard safety of consisting of 13 elements, each describing a business operation that is relevant to safety and environment. The elements can be considered as paragraphs of the ISM-code. They can deal with:

- maintenance (planned maintenance)
- office personnel and crew

4.3 How ISM works

a. The shipping companies

Every shipping company must possess a "Document of Compliance" or "DOC". This document states that the shipping company is seen fit to exploit the ship in accordance with the demands of the ISM-code. One of the demands is that the shipping companies must develop, execute and maintain a safety management system (SMS).

The Flagstate issues the DOC, but only after an official bureau of classification has approved the safety management system. The DOC remains valid for a period of five years, provided that the annual surveys by the bureau of classification yield good results.

b. The ships

The ships can get a safety management certificate (SMC) if the DOC has been issued to the shipping company. The SMC also remains valid for a five year period. During this period there should be an inspection somewhere between the second and third years.

4.4 The audits

The SMS is inspected by means of an audit. An audit is a prescribed survey to check whether the organisations on shore and on the ship are able to successfully execute the regulations and have reached certain goals. Audits can be distinguished into internal audits and external audits. The ISO-organisation (see below) grants one certificate to the entire organisation, contrary to the ISM which has separate certificates for the organisation on and off shore.

a. Internal audits

Internal audits are performed by the shipping company and can comprise matters like:

- the overlap between the way of working on board and the SMS regulations applied

- checking if the measures taken for safety and the environment are in accordance with the SMS
- testing the SMS for efficiency and take measures if necessary

All relevant personnel must be informed of the results of these audits and the measures taken. The management must correct all shortcomings. Internal audits are usually performed annually.

b. External audits

External audits are performed by the bureau of classification under supervision of the Flagstate. If the organisation lives up to the standards set, the shore organisation receives the DOC and the ship the SMC.

5. International organisation for standardisation (ISO), Quality management systems.

ISO has drawn up the ISO 9000 standard. This standard sets demands for matters that an organisation should have or do in such a way that the customer can be confident that the product meets the standards of good quality.

A company will voluntarily use the ISO-standards, possibly under pressure of the free market. The company will draw up a quality management system (QMS) that can be certified by a bureau of classification.

The ISO-9000 standard is a general standard aligned to the ISM-code. This means that every company draws up and executes its own QMS based on the demands.

6. Marine pollutions (MARPOL)

in 1973 IMO adopted the International Convention for the Prevention of Pollution from Ships, (IOPP) modified again in 1978. MEPC, the Marine Environment Protection Committee, does the daily work and has given clarification. The actual regulations to prevent pollution by environment unfriendly substances are given in "Annexes". All the regulations are guided by the size of the ship. Bigger ships must meet more and more stringent requirements.

The following applies to ships. For platforms and other stationary equipment at sea, other regulations apply, also specified under Marpol.

6.1 Annex I

This regulation is against pollution by oil. It concerns the oil generated by the engine room for all ships, and for cargo residue of oiltankers. Engine rooms generate waste oils, mostly mixed with water. This mixture is collected in the engineroom bilge wells, from where it is pumped to a bilge holding tank. When the ship is underway at sea, at least 50 miles from the nearest land, and not in a restricted area, oily mixtures with an oil content of max 15 ppm are allowed to be pumped overboard. To fulfil this requirement, ships have to be provided with a bilge-water separator, combined with an oil content meter with a 15 ppm alarm. When the oilcontent is found to be more than 15 ppm, the alarm sounds and the overboard valve is automatically closed. The dirty water is then pumped to the sludge tank.

Moreover extensive and accurate record is to be carried out of all handling of oils in connection with the engine room. The equipment itself must be type-approved.

Oiltankers have apart from the engine-room generated oils, another problem. When an oil cargo is discharged, there is always residue, and often the tanks must be cleaned to



In port, oil and sludge are to be pumped ashore to a reception facility via the standard discharge connection.



Small bilge pump

prepare them for a next cargo. Washing is done with rotating water jets in the tanks, generating an oily water mixture which is pumped to the so-called slop tank. There it settles into oil and water. The water can be pumped out, under control of the Oil Discharge Monitor which measures the oil content. Again max 15 ppm, underway, 50 miles from shore, not in restricted areas and not more than 30 litres of oil per nautical mile, and the oil pumped overboard maximised to 1/15000 part of the cargo (for new ships 1/30.000). The surplus oil is to be retained in the sloptank. Either to be pumped ashore later, or when the next cargo is suitable, usually only possible with crude, to be mixed with that next cargo.

Crude tankers during discharge wash their tanks with cargo, to prevent the accumulation of sediment. The cargo oil is pumped through the rotating jets with high pressure, and the sediments are kept mixed with the cargo and pumped ashore with the cargo. This is called Crude Oil Washing (COW). A problem connected with high pressure washing and COW is that static electricity is generated. Crude Oil Washing is therefore only allowed at an atmosphere with reduced oxygen, below the level that explosions can occur. COW is compulsory through Marpol legislation, and Inert Gas is a consequence, but legislated via SOLAS.



Bilge pump



Bilge water separator with 15 ppm oil content meter / alarm

Contrary to some years ago, all tankers now need their cargo and ballastwater to be kept in completely separate tanks. These are called Segregated Ballast Tanks (SBT). Before, the tankers had to clean at least two tanks which had been loaded with oil, to a condition that they could be filled with ballast water, sufficiently clean to be pumped out in the loading port. The vessel then left the discharge port with 'dirty ballast' in other tanks which were emptied at sea when the cleaned tanks were available for ballast. At best the dirty ballast tanks had sufficiently settled out (decanted) so that first the water underneath could be pumped out, whereafter the remaining oil could be pumped to the slop tank. The control was by sight only, this type of discharging is no longer allowed. All handling of oils and ballast water has to be accurately administrated and entries are to be kept on board for three years.

The Marpol regulations first started with minimizing oil pollution, and over the years grew more and more stringent with the aim to stop pollution completely. The first compulsory modification was the small-bore discharge line, from pumproom to manifold behind the ship's discharge valve, through which the contents of the cargo pipeline system could be discharged. For a VLCC (Very Large Crude Carrier) 200.000 m³ or more. Also the ballast overboard line had to have its discharge above the ballast waterline, to enable the ship's staff to actually see the outflowing water. When it was growing dark, deballasting had to be stopped.

To enable the discharge of slop tanks ashore, governments are obliged to create reception facilities in the ports for contents of sludge and slop tanks. The minimum SBT capacity of a tanker is regulated to ensure sufficient ballast capacity for safe navigation. That ballast has generally to be carried in sidetanks and double bottom tanks. This, to prevent outflow of oil in case of a grounding or collision. The minimum width and height of these tanks is regulated.

An important document on board, compulsory, is SOPEP, Shipboard Oil Pollution Emergency Procedures, a book which prescribes what to do, and whom to contact in case of oil-pollution. This book must be approved by the flagstate or Classification Society. The pages with the relevant telephone numbers are to be updated regularly.

6.2 Annex II

This Annex regulates the prevention of pollution by Noxious Liquid Substances, in general called 'Chemicals'. The possible cargoes are categorized. Depending on the danger for environment in case of pollution, the regulations are more stringent. The cargoes are categorized as A, B, C and D cargoes. Category A is the most toxic one, and D practically non-toxic to aquatic life. Depending on the type of cargo, the ship's tanks have to meet special requirements, with regard to location, distance from ship's side or bottom and shell, i.e. double hull. Pumping, piping and unloading arrangements are regulated. Slop handling and pre-wash (pre-cleaning after discharge but before leaving port) are prescribed.

To meet the various requirements, the ships are divided into Types I, II and III. A special booklet, issued by IMO, the code for the construction and equipment of ships carrying dangerous chemicals in bulk, the so-called BCH Code, for ships built before 1986, followed by the IBC Code for newer ships. The booklets give a listing of cargoes, defined A, B, C or D, and requirements for the ship in which they are to be transported, in ship type I, II or III. Chemical tankers have double bottoms and double sideskin, to protect them in case of grounding and collision. Stability in intact and damaged condition is an important issue.

Another important requirement for all chemical tankers is the total quantity of residue on board after discharging. Normally, each tank has its own deep-well pump, with its own cargo line to the cargo manifold, where the connection with the shore is made.

All these ships have a double bottom, and the pump is drawing oil in a recess, the well. After normal discharge, back flow of the pump is prevented, and the liquid remaining in the well is pumped out with a special device in order to get the well as dry as possible. Discharge from the device is not via the normal discharge line but via a separate thin pipeline.

As with all other tankers, all cargo handling has to be accurately administrated in the Cargo Record Book. The relevant equipment required for chemicals is described in a specific book: The Procedures and Arrangement Manual.

Each chemical tanker has to be provided with a Certificate of Fitness, with a attached list of cargoes that the ship is fit to carry. This certificate has a validity of five years and runs parallel with the ship's Special Survey cycle. Annual survey of the equipment is mandatory after which the certificate is endorsed.

6.3 Annex III

This Annex regulates the carriage of Packed Harmful substances. The carriage of harmful substances is prohibited, except when in accordance with the provisions in this Annex. Packages have to be labelled with the correct name and durable mark or labelled as a marine pollutant.

The packing must be adequate. There are stowage requirements and quantity limitations. Throwing overboard is only allowed in case the safety of the ship is at risk or in case of saving life at sea. This type of cargo is to be reported (type, quantity, location) to harbour authorities in each port the ship calls at, also when the cargo is not handled.

6.4 Annex IV



Sewage treatment plant

This Annex regulates the Prevention of Pollution by Sewage, applicable to ships of over 200 GT. Discharge of sewage is prohibited, except when the ship has an approved treatment plant and navigates more than 4 miles from the nearest land, or, for untreated sewage, at a minimum of 12 miles from land.

Ships navigating in special areas where the discharge of sewage is not allowed, are to be fitted with holding tanks for the retention of all sewage, its size depending on the ship's normal operating scheme, and there must be adequate connections for discharge into a reception facility. The content of the holding tank can be discharged overboard at least 12 miles from shore, and only at a moderate rate of speed of at least 4 knots.

This annex also concerns the overboard discharge of contents from the ship's hospital. A special certificate is required with a validity of max. 5 years.

6.5 Annex V

This Annex regulates the Prevention of Pollution by Garbage. Garbage means all kinds of victuals, domestic and operational waste, including fresh fish, liable to be disposed of continuously or periodically, except



Garbage

substances defined under other Annexes.

Disposal into the sea of plastics is always prohibited. This includes ropes, fishing nets, and plastic bags. Floating waste like dunnage, lining and packing material is allowed to be disposed of at least 25 miles from the nearest land. Food waste, paper, rags etc. at least 12 miles from shore. When the last is ground into small particles, max. 25 mm, 3 miles is sufficient.

Of garbage a record must be kept, similarly to substances described under other Annexes. Garbage like carton, plastics, etc. can also be disposed of by burning in an incinerator.

On ships intended for long voyages waste from packages, i.e. wood,



Incinerator

carton, plastics, etc. can be disposed of by burning it in an incinerator. This is a simple stove, where the waste is put into the firespace, and where a simple gasoil burner ignites the waste, and if necessary keeps it burning. The ashes may be disposed of in the sea.

6.6 Annex VI

This Annex regulates the air pollution caused by Nitrogen oxides and Sulphur oxides, caused by the combustion of (heavy) fuels, the so-called Noxes and Soxes. These products release with the exhaust gases in the atmosphere, and will eventually come down as aciduous rain. Reducing this pollution can be done by using low-sulphur fuels or de-sulphurizing the fuel.

6.7 Annex VII

This Annex will deal with ballast-water. When a ship sails from one sea area to another in ballast, it takes organisms of the eco-system of the departure or discharge area to the loading area. There are various ideas about how to prevent this type of eco-pollution: emptying and refilling ballast tanks during the voyage or filtering or changing the water by continuous pumping over the top. Directives will come in the near future.

7. Documents

On the following pages some compulsory documents are shown, without which leaving a port is not allowed.

INTERNATIONAL TONNAGE CERTIFICATE (1969)

ISSUED UNDER THE PROVISIONS OF THE
INTERNATIONAL CONVENTION ON TONNAGE MEASUREMENT
OF SHIPS, 1969

UNDER THE AUTHORITY OF THE GOVERNMENT OF THE

REPUBLIC OF PORTUGAL
REGISTO INTERNACIONAL DE NAVIOS DA MADEIRA

for which the Convention came into force on 1st September 1987

by

Germanischer Lloyd

Name of Ship	Official Number or Distinctive Number or Letters	Port of Registry	Date *)
SIDERFLY	CQUT	Madeira	27.08.1984
	IMO No.: 8412405		

*) Date on which the keel was laid or the ship was at a similar stage of construction [Article 2(6)], or date on which the ship underwent alterations or modifications of a major character [Article 3 (2)(b)], as appropriate.

MAIN DIMENSIONS

Length [Article 2 (8)]	Breadth [Regulation 2 (3)]	Moulded Depth amidships to Upper Deck [(Regulation 2 (2))]
95.09 m	14.60 m	6.95 m

The Tonnages of the ship are:

GROSS TONNAGE 2881

NET TONNAGE 1371

This is to certify that the tonnages of this ship have been determined in accordance with the provisions of the International Convention on Tonnage Measurement of Ships, 1969.

Issued at **Hamburg** on 22nd April, 2002



Germanischer Lloyd

Handwritten signature
Franzelius Werner

The undersigned declares that he is duly authorized by the said Government to issue this certificate.



**BUREAU
VERITAS**

INTERNATIONAL REGISTER FOR CLASSIFICATION OF SHIPS,
ESTABLISHED 1828.
*REGISTRO INTERNACIONAL DE CLASIFICACION DE BUQUES,
FUNDADO EN 1828.*

**CERTIFICATE OF CLASSIFICATION
CERTIFICADO DE CLASIFICACION
No RTD0/AST0/2002011105111**

NAME OF SHIP : VERISTAR

Nombre del Buque

Register No : 85L011

Nº de Registro

Owners : MEMBERS

Armado

Flag : PANAMA

Bandera

Port of Registry : PANAMA

Puerto de matrícula

This is to certify that the above named ship has been entered in the Register Book with the classification symbols and notations :

El abajo firmante certifica que este buque ha sido inscrito en el Libro Registro con los simbolos de clasificación y menciones

**I ✕ HULL; ✕ MACH; ✕ AUT-UMS; ✕ SYS-NEQ-1;
Hopper dredger
Unrestricted navigation
Dredging within 15 Miles from shore or within 20
miles from port**

This certificate, issued within the scope of Bureau Veritas Marine Division General Conditions, is valid until :

Este certificado, expedido de acuerdo con las Condiciones Generales de la División Naval de Bureau Veritas es válido hasta el

8 January 2006

At/Expedido en Rotterdam. *on/el* 21 April 2002

By Order of the Secretary

Por Orden del Secretario

K. Docter

This certificate is invalid without the annexes listed. Conditions of use are given on page 2/2. *Este certificado no es válido sin los anexos indicados en la página 2/2. Las condiciones para la utilización se detallan en la página 2/2.*

Any person not a party to the contract pursuant to which this certificate is delivered may not assert a claim against Bureau Veritas for any liability arising out of errors or omissions which may be contained in said certificate, or for errors of judgement, fault or negligence committed by personnel of the Society or its Agents in the establishment or issuance of this certificate, and in connection with any activities which it may provide.

Cargo Ship Safety Construction Certificate

Issued under the provisions of the International Convention for the Safety of Life at Sea, 1974, as modified by the Protocol of 1988 relating thereto,

under the authority of the Government of the Republic of Malta

by Lloyd's Register of Shipping

Particulars of Ship	
Name of ship	"MINERVA ASTRA"
Distinctive number or letters	9 H D W 7
Port of registry	Valletta
Gross tonnage	59,693
Deadweight of ship (metric tons) ¹	105946
IMO number	9230098
Type of ship [*]	Bulk carrier Oil tanker Chemical tanker Gas carrier Cargo ship other than any of the above
Date on which keel was laid ²	01/2001

This is to certify:

1. that the ship has been surveyed in accordance with the requirements of regulation 1/10 of the Convention;
2. that the survey showed that the condition of the structure, machinery and equipment as defined in the above regulation was satisfactory and the ship complied with the relevant requirements of chapters II-1 and II-2 of the Convention (other than those relating to fire safety systems and appliances and fire control plans);
3. that the last two inspections of the outside of the ship's bottom took place on - and -;
4. that an Exemption Certificate has been issued.

This certificate is valid until **04 December 2006** subject to the annual and intermediate surveys and inspections of the outside of the ship's bottom in accordance with regulation 1/10 of the Convention.

Completion date of the survey on which this certificate is based **05 December 2001**

Issued at **Rotterdam**

on **05 December 2001**

C.B.A. van Egmond
 Surveyor to Lloyd's Register of Shipping
 ROTTERDAM

¹ For oil tankers, chemical tankers and gas carriers only.

² Delete as appropriate

³ Date on which keel was laid or ship was at a similar stage of construction or, where applicable, date on which work for a conversion or an alteration or modification of a major character was commenced.

Insert the date of expiry as specified by the Administration in accordance with regulation 1/14(a) of the Convention. The day and the month of this date correspond to the anniversary date as defined in regulation 1/2(n) of the Convention, unless amended in accordance with regulation 1/14(h).

Form 2221 (2002.09)

INTERNATIONAL LOAD LINE CERTIFICATE

Issued under the provisions of the
INTERNATIONAL CONVENTION ON LOAD LINES, 1966,
as modified by the Protocol of 1988 relating thereto
under the authority of the Government of

ANTIGUA AND BARBUDA

by GERMANISCHER LLOYD

Name of Ship	Distinctive Number or Letters	Port of Registry	Length (L) as defined in article 2 (8) (in metres)	IMO Number
MAERSK DUBLIN	V2PW3	St. John's	277.490	9105918

Freeboard assigned as: { *A new ship*
{ *An existing ship*

Type of ship: { ~~Type "A"~~
{ ~~Type "B"~~
{ ~~Type "B" with reduced freeboard~~
{ Type "B" with increased freeboard

Freeboard from deck line

Tropical	3885 mm (T)
Summer	3885 mm (S)
Winter	3885 mm (W)
Winter North Atlantic	--- mm (WNA)

Load Line

Upper edge of line through centre of ring	--- mm above (S)
	--- mm below (S)
	--- mm below (S)

Note: Freeboards and load lines which are not applicable need not be entered on the Certificate.

Allowance for fresh water for all freeboards other than timber 260 mm.

The upper edge of the deck line from which these freeboards are measured is 0 mm above/below the top of the freeboard (2nd) deck at side.

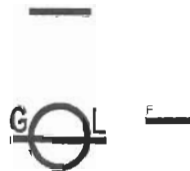

THIS IS TO CERTIFY:

- That the ship has been surveyed in accordance with the requirements of article 14 of the Convention.
- That the survey showed that the freeboards have been assigned and load lines shown above have been marked in accordance with the Convention.

This Certificate is valid until **30th June, 2005** subject to annual surveys in accordance with article 14(1) (c) of the Convention.

Issued at **Hamburg** the **18th** day of **April, 2002**



Germanischer Lloyd *RLA*

Handwritten signature
Franzelus

Handwritten signature
Bremer

Notes

- When a ship departs from a port situated on a river or inland waters, deeper loading shall be permitted corresponding to the weight of fuel and all other materials required for consumption between the point of departure and the sea.
- When a ship is in fresh water of unit density the appropriate load line may be submerged by the amount of the fresh water allowance shown above. Where the density is other than unity, an allowance shall be made proportional to the difference between 1.025 and the actual density.

*Delete as appropriate

Cargo Ship Safety Radio Certificate

This certificate shall be supplemented by a Record of Equipment of Radio Facilities (Form R) No: 9230098/01

Issued under the provisions of the International Convention for the Safety of Life at Sea, 1974, as modified by the Protocol of 1988 relating thereto,

under the authority of the Government of the Republic of Malta

by Lloyd's Register of Shipping

Particulars of Ship	
Name of ship	"MINERVA ASTRA"
Distinctive number or letters	9 H D W 7
Port of registry	Valletta
Gross tonnage	59,693
Sea areas in which ship is certified to operate (regulation IV/2)	A1 + A2 + A3
IMO number	9230098
Date on which keel was laid ¹	01/2001

This is to certify:

1. that the ship has been surveyed in accordance with the requirements of regulation I/9 of the Convention;
2. that the survey showed that:
 - 2.1 the ship complied with the requirements of the Convention as regards radio installations;
 - 2.2 the functioning of the radio installations used in life-saving appliances complied with the requirements of the Convention;
3. that an Exemption Certificate has not been issued.

This certificate is valid until **04 December 2006** subject to the periodical surveys in accordance with regulation I/9 of the Convention.

Completion date of the survey on which this certificate is based **05 December 2001**

Issued at **Rotterdam** on **05 December 2001**



C.B.A. van Egmond
Surveyor to Lloyd's Register of Shipping
ROTTERDAM

¹ Date on which keel was laid or ship was at a similar stage of construction or, where applicable, date on which work for a conversion or an alteration or modification of a major character was commenced.

² Delete as appropriate

³ Insert the date of expiry as specified by the Administration in accordance with regulation I/14(a) of the Convention. The day and month of this date correspond to the anniversary date as defined in regulation I/14(h) of the Convention, unless amended in accordance with regulation I/14(h).

Form 2206 (2002.09)

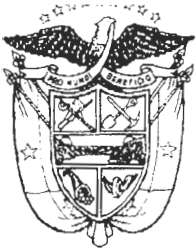

INTERNATIONAL OIL POLLUTION PREVENTION CERTIFICATE

(Note : This Certificate shall be supplemented by a Record of Construction and Equipment)

Certificate No. 2H0-0200M

Issued under the provisions of the
INTERNATIONAL CONVENTION FOR THE PREVENTION OF POLLUTION FROM SHIPS, 1973,
as modified by the Protocol of 1978 relating thereto (hereinafter referred to as "the Convention")
under the authority of the Government of
the Republic of Panama
by Nippon Kaiji Kyokai

Name of Ship	Distinctive Number or Letters	Port of Registry	Gross Tonnage
REEFER IMO 1234567	Panama	7367

Type of ship:

~~Oil tanker*~~

~~Ship other than an oil tanker with cargo tanks coming under Regulation 2(2) of Annex 1 of the Convention*~~

Ship other than any of the above*

THIS IS TO CERTIFY:

- 1 That the ship has been surveyed in accordance with Regulation 4 of Annex 1 of the Convention; and
- 2 That the survey shows that the structure, equipment, systems, fittings, arrangement and material of the ship and the condition thereof are in all respects satisfactory and that the ship complies with the applicable requirements of Annex 1 of the Convention.

This Certificate is valid until 12 October 2004
subject to surveys in accordance with Regulation 4 of Annex 1 of the Convention.

Issued at Tokyo on 15 February 2002

Valid only when the Supplement No. S-2H0-0197M is available for inspection.

The undersigned declares that he is duly authorized by the said Government to issue this certificate.



M. Ochiai
Managing Director
NIPPON KAIJI KYOKAI

*See note(s) on the reverse.
Date of Initial Survey: 13 October 1999*

*Delete as appropriate

IOPP (PNM)

1998. 1



CARGO SHIP SAFETY EQUIPMENT CERTIFICATE

This Certificate shall be supplemented by a Record of Equipment (Form E)
(Form E No. R-9KK-0014SE)

Certificate No. 2NY-0101SE

Issued under the provisions of the
INTERNATIONAL CONVENTION FOR THE SAFETY OF LIFE AT SEA, 1974
as modified by the Protocol of 1978 relating thereto under the authority of the Government of

the Republic of Panama
by **NIPPON KAIJI KYOKAI**

PARTICULARS OF SHIP

Name of Ship	REEFER
Distinctive Number or Letters
Port of Registry	PANAMA
Gross Tonnage	7367
Deadweight of Ship (metric tons) *1	---
Length of Ship(Regulation III/3.10)	127.38 m
IMO Number	IMO 1234567
Type of Ship: *2	Bulk carrier / Oil tanker / Chemical tanker / Gas carrier / Cargo ship other than any of the above
Date on which keel was laid: *3	29 June 1998

THIS IS TO CERTIFY:

- 1 That the ship has been surveyed in accordance with the requirements of Regulation I/8 of the Convention, as modified by the 1978 Protocol.
- 2 That the survey showed that:
 - 2.1 the ship complied with the requirements of the Convention as regards fire safety systems and appliances and fire control plans;
 - 2.2 the life-saving appliances and the equipment of the lifeboats, liferafts and rescue boats were provided in accordance with the requirements of the Convention;
 - 2.3 the ship was provided with a line-throwing appliance and radio installations used in life-saving appliances in accordance with the requirements of the Convention;
 - 2.4 the ship complied with the requirements of the Convention as regards shipborne navigational equipment, means of embarkation for pilots and nautical publications;
 - 2.5 the ship was provided with lights, shapes, means of making sound signals and distress signals, in accordance with the requirements of the Convention and the International Regulations for Preventing Collisions at Sea in force;
 - 2.6 in all other respects the ship complied with the relevant requirements of the Convention.
- 3 That the ship operates in accordance with Regulation III/26.1.1.1 within the limits of the trade area

- 4 That in implementing Regulation I/6 (b) the Government has instituted Mandatory Annual Surveys.
- 5 That an Exemption Certificate has / ~~has not~~ *2 been issued

This certificate is valid until **8 October 2003.**

Issued at **New York** on **28 May 2002.**



Date of Renewal Survey : 9 October 2001

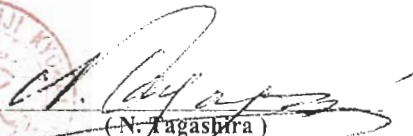

 (N. Tagashira)
 For and on behalf of Managing Director
NIPPON KAIJI KYOKAI

*1 For oil tankers, chemical tankers and gas carriers only.

*2 Delete as appropriate

*3 Date on which keel was laid or ship was at a similar stage of construction or, where applicable, date on which work for a conversion or an alteration or modification of a major character was commenced

Certificate of Class

This certificate is issued to the **CLAUDIA**
LR number **9201798**
Date of build **1 December 1999**
Port of Registry **DELFIJL**
Gross tons **4235**

to confirm that having been surveyed by Lloyd's Register's Surveyors and reported by them to be in compliance with Lloyd's Register's Rules and Regulations for the Classification of Ships, it has been assigned the class

+100A1 Strengthened for Heavy Cargoes, Container Cargoes in Hold and on Upperdeck Hatchcovers, Ice Class 1A (Finnish-Swedish Ice Class Rules 1985) with the descriptive note "FCSA" (plans)
+LMC, UMS with the descriptive note SCM

Date Special Survey Assigned **1 December 1999**

This Certificate is valid until* **30 November 2004**

**Unless extended after completion of a Special Survey (see page 3) or in accordance with Part 1, Chapter 2, Section 3.5.9 of the Rules and Regulations (see page 3) and is subject to surveys as prescribed (see page 2) being satisfactorily completed. (See notes 1 to 4, page 3).*

Issued at **Haren/Groningen**

on **6 June 2000**



A.M. Salomons
Lloyd's Register of Shipping
Haren/Groningen

NOTICE: **1** This certificate is subject to the terms and conditions as shown overleaf.
2 To establish the classification status of this ship, the quarterly computer print-out issued by LR and the Interim Certificates issued on completion of classification surveys should be consulted, in addition to this certificate.

FORM 1717 CERTIFICATE OF CLASS (02/99)

**VERKLARING INZAKE HET VOLDOEN AAN DE BIJZONDERE VOORSCHRIFTEN
VOOR SCHEPEN WELKE GEVAARLIJKE STOFFEN VERVOEREN**
*DOCUMENT OF COMPLIANCE WITH SPECIAL REQUIREMENTS
FOR SHIPS CARRYING DANGEROUS GOODS*

NEDERLAND
THE NETHERLANDS

Het Hoofd van de Scheepvaartinspectie verklaart dat het
The Head of the Shipping Inspection declares that the

"CLAUDIA" P C H E

is gebouwd en uitgerust in overeenstemming met het bepaalde in Artikel 54 van Bijlage IV van het Schepenbesluit 1965, en derhalve geschikt is voor het vervoer van gevaarlijke stoffen zoals aan de ommezijde aangegeven.

is constructed and equipped in accordance with the provisions of Regulation 54 of Chapter II-2 of SOLAS 1974, as amended, and therefore suitable for the carriage of dangerous goods as specified overleaf.

Er bestaan geen bijzondere voorschriften als bedoeld in bovengenoemd Artikel 54 voor het vervoer van gevaarlijke stoffen van klasse 6.2 en 7 en voor het vervoer van alle gevaarlijke stoffen in beperkte hoeveelheden, zoals gedefinieerd in Hoofdstuk 18 van de Algemene inleiding van de International Maritime Dangerous Goods Code.

There are no special requirements as expressed in abovementioned Regulation 54 for the carriage of dangerous goods of Class 6.2 and 7 and for the carriage of dangerous goods in limited quantities, as defined in Section 18 of the General Introduction to the International Maritime Dangerous Goods Code.

Deze verklaring is geldig tot
This document is valid until the 1st of December 2004

Uitgereikt te Rotterdam, de
Issued at Rotterdam, the 9th of February 2000 onder no.
under nr. 492/2000

Namens het Hoofd van de Scheepvaartinspectie,
For the Head of the Shipping Inspection



F.P. Hachmang

International Certificate of Fitness for the Carriage of Dangerous Chemicals in Bulk

Issued under the provisions of the International Code for the Construction and Equipment of Ships Carrying Dangerous Chemicals in Bulk (resolutions MSC. 4(48) and MEPC. 19(22), as amended by resolutions MSC. 16(58) and MEPC. 40(29))

under the authority of the Government of the Kingdom of the Netherlands

by Lloyd's Register of Shipping

Particulars of ship	
Name of ship	"DUTCH AQUAMARINE"
Distinctive number or letters	P C H S
Port of registry	Dordrecht
Gross tonnage	4,671
Ship type* (Code paragraph 2.1.2)	2
IMO number	9191656
Date on which keel was laid or on which the ship was at a similar stage of construction or (in the case of a converted ship) date on which conversion to chemical tanker was commenced.	08/1999

The ship also complies fully with the following amendments to the Code:
MSC 50(66) and MEPC 69(38)

The ship is exempted from compliance with the following provisions of the Code:
N/A

This is to certify:

1. 1.1 that the ship has been surveyed in accordance with the provisions of section 1.5 of the Code;
- 1.2 that the survey showed that the construction and equipment of the ship and the condition thereof are in all respects satisfactory and that the ship complies with the relevant provisions of the Code;
2. that the ship has been provided with a manual, in accordance with the standards for procedures and arrangements as called for by regulations 5, 5A and 8 of Annex II of MARPOL 73/78, and that the arrangements and equipment of the ship prescribed in the manual are in all respects satisfactory and comply with the applicable requirements of the said Standards;
3. that the ship is suitable for the carriage in bulk of the products listed on page(s) 6-16 provided that all the relevant operational provisions of the Code are observed;

PANAMA CANAL



PC/UMS DOCUMENTATION OF TOTAL VOLUME

Name of Ship: AIDA Vita

GL-Reg. No.	:	94690			
Nationality	:	United Kingdom	Length Overall	:	202.85 m
Signal Letters	:	VSTN3	Extreme Breadth	:	35.50 m
Type of Power	:	Engine	ITC(69) Length	:	182.02 m
Type of Vessel	:	Passenger	ITC(69) Breadth	:	28.10 m
IMO-No.	:	9221554	ITC(69) Depth	:	11.55 m
Keel Laid	:	21.11.2000	ITC(69) Gross	:	42289
Year Built	:	2002	ITC(69) Net	:	20877
No. of Passengers	:	1582	Containers above deck**:	:	--

Based upon the rules of measurement for the Panama Canal as specified in 35 Code of Federal Regulations section or the International Tonnage Convention of 1969 this vessel has been measured and assigned the following Total Volume in cubic metres:

149 885.11

Based upon a vessel tonnage of 37540 calculated with the above volume and an above deck container tonnage of --, the PC/UMS Net Tonnage equates to:

37540

Bunker Fuel for Ballast Rate limited to:

9804

B

K4 factor (6 decimals)

0.250459

K5 factor (6 decimals)

not applicable

This Certifies that the above named vessel has been measured in accordance with the Rules for Measurement of Vessels for the Panama Canal, and that the particulars of tonnage contained on this Certificate are correct.

Issued by: Germanischer Lloyd, at: Hamburg, on 22nd April, 2002
 (Authority) (Place) (Date)

Germanischer Lloyd

Franzelius *Werner*

(Signature)

Franzelius

Werner

* **BB (barrels)**. The figure is the sum of the capacities of all fuel oil (light and heavy) and lubricating oil tanks for the vessel's own use. Tanks used for both fuel oil and water ballast are to be included, however, tanks with means for discharging to other vessels or shore installations are not to be included.

** 1 standard container 8' x 8' x 20' = 36.25 m³



Germanischer Lloyd

SUEZ CANAL SPECIAL TONNAGE CERTIFICATE

Name of Ship	Official Number	Signal letters	Port of Registry	Tonnage on International Tonnage Certificate		IMO-No.
				Gross	Net	
AIDAVITA	905689	VSTN3	London	42289	20877	9221554

DETAILS OF TONNAGE FOR THE ABOVE-NAMED SHIP WHEN PASSING THROUGH THE SUEZ CANAL

The space measured for Gross Tonnage in this Ship comprises the following and no others, viz:

- Space under the tonnage deck including part of double bottom available for oil drain tank _____
- Space or spaces between the tonnage deck and the uppermost deck: Lower tween deck _____
Upper tween deck _____

- Closed-in spaces under or in permanent constructions above the uppermost deck, viz.:

Space between uppermost deck and shelterdeck with side openings _____

Forecastle _____

Bridge space 12 001.65 + 13 172.47; 12 870.63 + 7 882.57 _____

Poop _____

Break or breaks _____

Turret _____

	cbm	Trunk	cbm	cbm	cbm	cbm	cbm	cbm
Roundhouses (1st Tier)	10 588.72							
(2nd Tier)								
(3rd Tier)								
(Upper Tiers)	1 426.15	1 533.36	141.61	24.70				
Side screens	101.30	98.31	56.92	34.16				
Hatchways								
Total								

Total of Tonnage of closed-in spaces above the uppermost deck _____

NOTE: for particulars of spaces not included in the Measurement for Gross Tonnage, see page 3

GROSS REGISTER TONNAGE

DEDUCTIONS FROM GROSS TONNAGE (Details on page 2)

NET TONNAGE IF A SAILING SHIP

FURTHER DEDUCTIONS FOR PROPELLING POWER IN THE CASE OF _____ /S (Details on page 4)

Either (1) applicable to ships with fixed bunkers:

- Engine room as measured _____
- Permanent _____ bunkers as measured _____

Total deduction for propelling power _____

NET REGISTER TONNAGE OF _____ /S BY ACTUAL MEASUREMENT

Or (2) Danube Rule:

- Engine room as measured _____
- In a Screw Motor _____ /S + 75 percent of engine room as measured _____
- In a Paddle _____ /S + 50 percent of engine room as measured _____

Total deduction for propelling power _____

NET REGISTER TONNAGE OF Motor _____ /S BY DANUBE RULE

Cubic Metres	Tons of 100 Cubic Feet
68 391.20	24 142.09
45 927.32	
13 714.54	
290.69	
59 932.55	21 156.19
128 323.75	45 298.28
7 527.48	2 657.20
120 796.27	42 641.08
5 331.90	
3 998.93	
9 330.83	3 293.78
111 465.44	39 347.30

THIS IS TO CERTIFY that the British ship above-named has been re-measured, and that the Tonnage ascertained as above is in accordance with the rules adopted by the International Tonnage Commission at Constantinople.

Given under my hand at Hamburg the 22nd day of April, 2002

Germanischer Lloyd
Handwritten signature: Franziskus
Handwritten signature: Werner



DET NORSKE VERITAS

SAFETY MANAGEMENT CERTIFICATE

DNV Ship Id. No.:
00000
DNV Company No.:
000000
Certificate number:
D00000/021202F

Issued under the provisions of the INTERNATIONAL CONVENTION FOR THE SAFETY OF LIFE AT SEA, 1974, as amended

Issued under the authority of the Government of:

Norway

by Det Norske Veritas

Name of ship: "FELICIA"
Distinctive number or letters: XXXX1
Port of Registry: KRAGERØ
Type of Ship*: Other Cargo Ship
Gross Tonnage: 11658
IMO Number: 00000000
Name and address of the Company:
(as per ISM Code sec. 1.1.2) Benkestok Shipping
Rørvikveien 32
3770 Kragerø
Norway

THIS IS TO CERTIFY THAT the safety management system of the ship has been audited and that it complies with the requirements of the International Management Code for the Safe Operation of Ships and for Pollution Prevention (ISM Code), following verification that the Document of Compliance for the Company is applicable to this type of ship.

The Safety Management Certificate is valid until **2007-10-14** ,subject to periodical verification and the validity of the Document of Compliance remaining valid.

Issued at: **Det Norske Veritas, Høvik, Norway**
Date of Issue: **2002-12-02**



Sign.
Name
Head of Section

* Insert the standard IMO ship type.

CHAPTER 7

Construction of the various sections





1 Holds

2 Aft ship

3 Engine room

4 Double bottom and wing tanks

5 Foreship

6 Accommodation

6.1 Introduction

6.2 Safety

6.3 Environment

6.4 Methods of insulation

6.5 Communication

6.6 Maintenance

6.7 Overview of the various spaces

SHIP KNOWLEDGE

A MODERN ENCYCLOPEDIA

SHIPWISE

PAGE 8

1

THE SHAPE OF A SHIP

PAGE 22

2

SHIP'S TYPES

PAGE 44

3

THE BUILDING OF A SHIP

PAGE 68

4

FORCES ON A SHIP

PAGE 82

5

LAWS AND REGULATIONS

PAGE 104

6

CONSTRUCTION OF THE VARIOUS

SECTIONS

PAGE 126

7

CLOSING ARRANGEMENTS

PAGE 160

8

LOADING GEAR

PAGE 174

9

ANCHOR AND MOORING GEAR

PAGE 196

10

ENGINE ROOM

PAGE 216

11

PROPULSION AND STEERING GEAR

PAGE 244

12

ELECTRICAL INSTALLATIONS

PAGE 266

13

MAINTENANCE AND DOCKING

PAGE 280

14

SAFETY

PAGE 302

15

STABILITY

PAGE 322

16

CHAPTER 7 QUESTIONS

VISIT

WWW.DOKMAR.COM

1 Holds

Seemingly the holds are not very interesting. In general they are large empty rectangular spaces without visible stiffenings (frames, floors etc.). Nevertheless, the hold is so important that the entire construction is aimed to enable the moving of the hold and its contents (the cargo). The amount of cargo carried is ultimately the decisive factor for the earning capacity of the ship.



Hold seen in the forward direction (multi-purpose ship)

The bulkheads of the holds are as flat as possible to make them as “user-friendly” as possible. In bulkcarriers the parts of the hold, not under the hatch opening, are made sloped, so that the cargo

slides down towards the area where the grab can take it. Furthermore, these ships have an increased tanktop plate thickness to compensate for the wear caused by grabs.

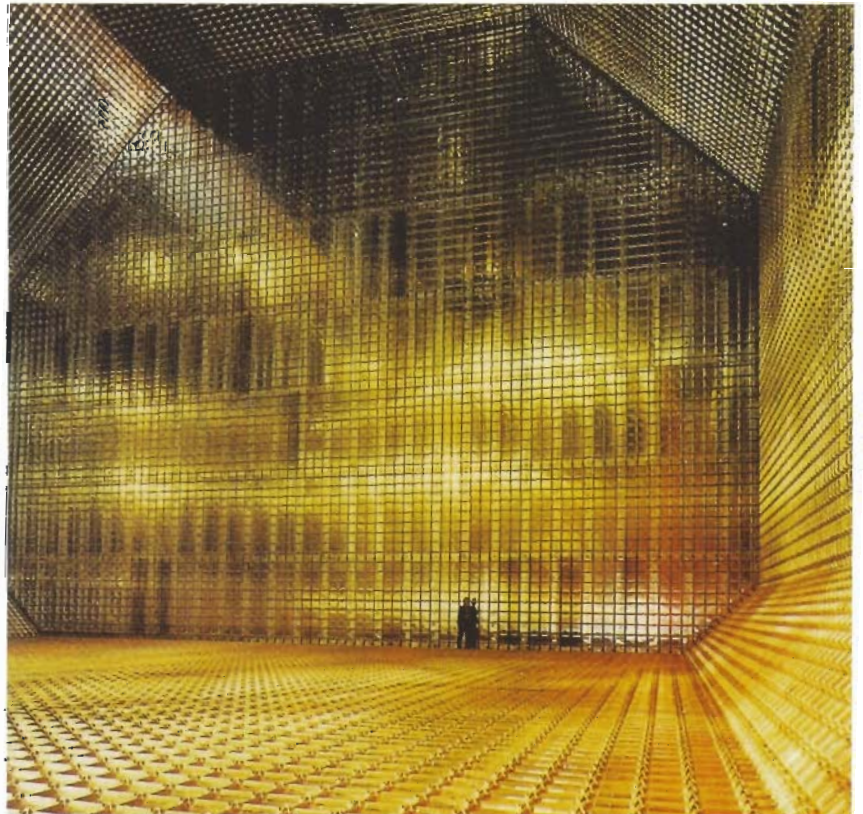

Hold of an LNG Carrier (membrane type)

In multi-purpose ships, the ship owners prefer just one very large hold. The crew can then decide on the basis of the type of cargo how to subdivide the hold. The hold is divided by movable bulkheads positioned either horizontally or vertically. The bulkheads can be attached to the sides of the hold in a very simple manner. Legal safety requirements (intact damage stability) normally require that one or more of these movable bulkheads always be in place. The actual number of cross frames depends on the length of the ship.

Both the sides of the wingtanks and the tanktops have manholes to make inspection of the tanks possible. The sides of the wingtanks also have lashing points for cargo securing. Heavy cargo is often seafastened temporarily by



View of a tank on a chemical tanker.

means of beams and / or brackets welded to strong points in the ship's side and tanktop. This can, of course, only be done with tanks that do not contain oil. The humidity in the holds can be

controlled by ventilation, recirculation and/or the use of driers.

The holds on cellular container-ships are divided into multiple cells, each capable of storing a stack of 20 or 40 containers in fore and aft direction. The spaces (cells) are separated from each other by guide rails. During loading and discharging the containers are guided by the rails in the vertical direction. In addition, the rails also secure the cargo in place.

Most multi-purpose ships are "box shaped". This means that the hold is rectangular and the spaces do not have curves. This is important for the stacking of containers. If the hatches and the holds have a facility to fasten the containers, the holds are then said to be "container fitted".



Another view of the same tank

Explanation of the images at the right:

1. Corrugated bulkhead (transverse)
2. Stringer
3. Main deck
4. Centre line corrugated bulkhead
5. Section of the web frame



Wing tank of a tanker

When ships are designed to carry liquid cargoes in bulk, they are called tankers. The space for cargo is then divided by watertight bulkheads into a large number of separate tanks, each with its own entrance hatch, ladder to descend into the tank, sounding pipe, ventilation pipe, filling and discharge lines, or its own pump, depending on the kind of cargo. Every tank has possibilities for temperature measurement, ullage and/or sounding measurement, often radar level control, temperature measurement, heating possibilities to control the cargo temperature, independent high level alarm (95% full) and overflow alarm (98% full). Also means for tank cleaning with fixed or hand-operated washing machines. The tanks are internally coated with a paint which is resistant to the cargo the ship has been designed for. Or the tanks are constructed of stainless steel. Furthermore, and depending on the size of the ship there are additional spaces in deck for transport of materials, tools, or in case of an accident, for people. The tanks have as little stiffening inside as possible to avoid accumulation of dirt, and to minimise the area to be expensively coated. The stiffening of the bulkheads is in the surrounding ballast tanks. Division-bulkheads between cargo tanks therefore are often corrugated.

The two pictures at the previous page show the insides of a tank on a chemical tanker (GT 3350, dead weight 5070 tons). The transverse bulkhead is a corrugated bulkhead. The hold can be inspected by entering via a (compulsory) hatch and a simple ladder. Perhaps not immediately apparent in the photo, the double bottom is slightly tilted towards the keel-plate, to facilitate the flow of liquids.

The other ship is designed for the transport of packages of timber. The picture shows a ship of which the holds are made to carry the maximum amount of packages of timber with as little lost space as

possible. The hatches are trapezoidal so an extra layer of timber can be loaded. The stiffenings are on top of the hatches.

Some particulars of the hold:

Length:	49.7 m.
Width:	10 m.
Height of the coaming:	2.33 m
Max. depth:	8.85 m
Capacity:	149300 cu.ft. = 4228 m ³



The ship as shown below



The maximum amount of packages of timber with as little lost space as possible

The hold seen looking forward

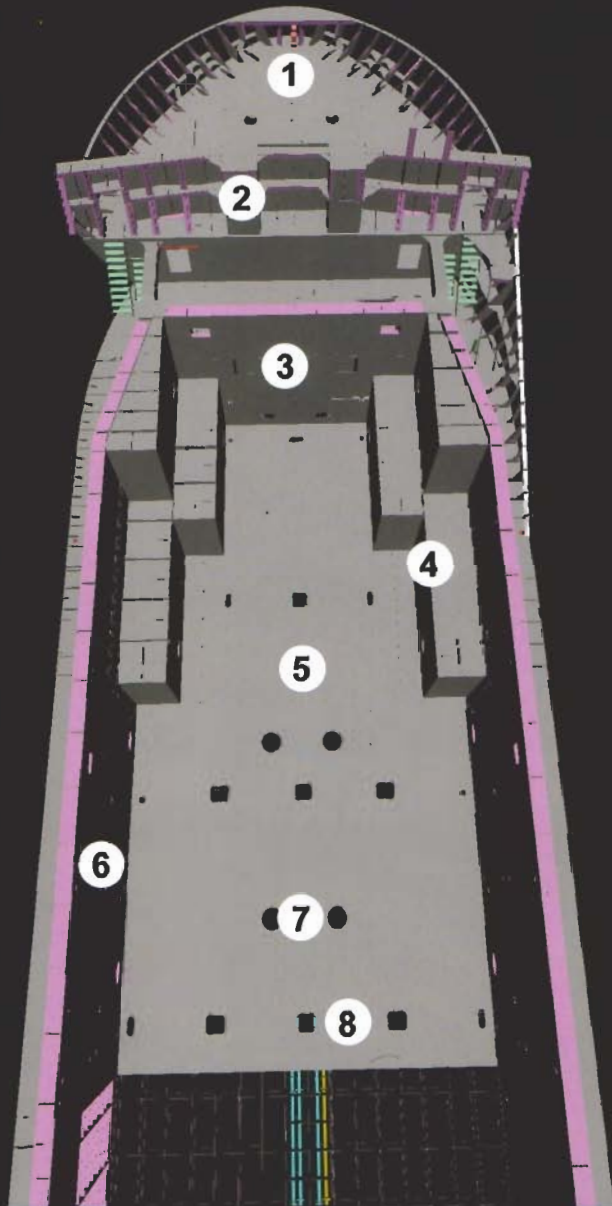

Explanation of the image to the left:

1. Forecastle deck
2. Breakwater on the main deck
3. Bulkhead
4. Ballast tank shaped to make the hold box shaped
5. Tanktop
6. Longitudinal bulkhead between hold and wing tank
7. Manholes, entrances of double bottom
8. Holes for fitting containers

Explanation of the image of the diagram below:

1. Bridge
2. Accommodation
3. Engine-room bulkhead
4. Tanktop
5. Ballast tank shaped to make the hold box shaped
6. Longitudinal bulkhead wing tank
7. (full) Floor (plate)
8. Side keelson
9. Webframe
10. Toprail
11. Coaming
12. Gangway

The hold seen looking aft

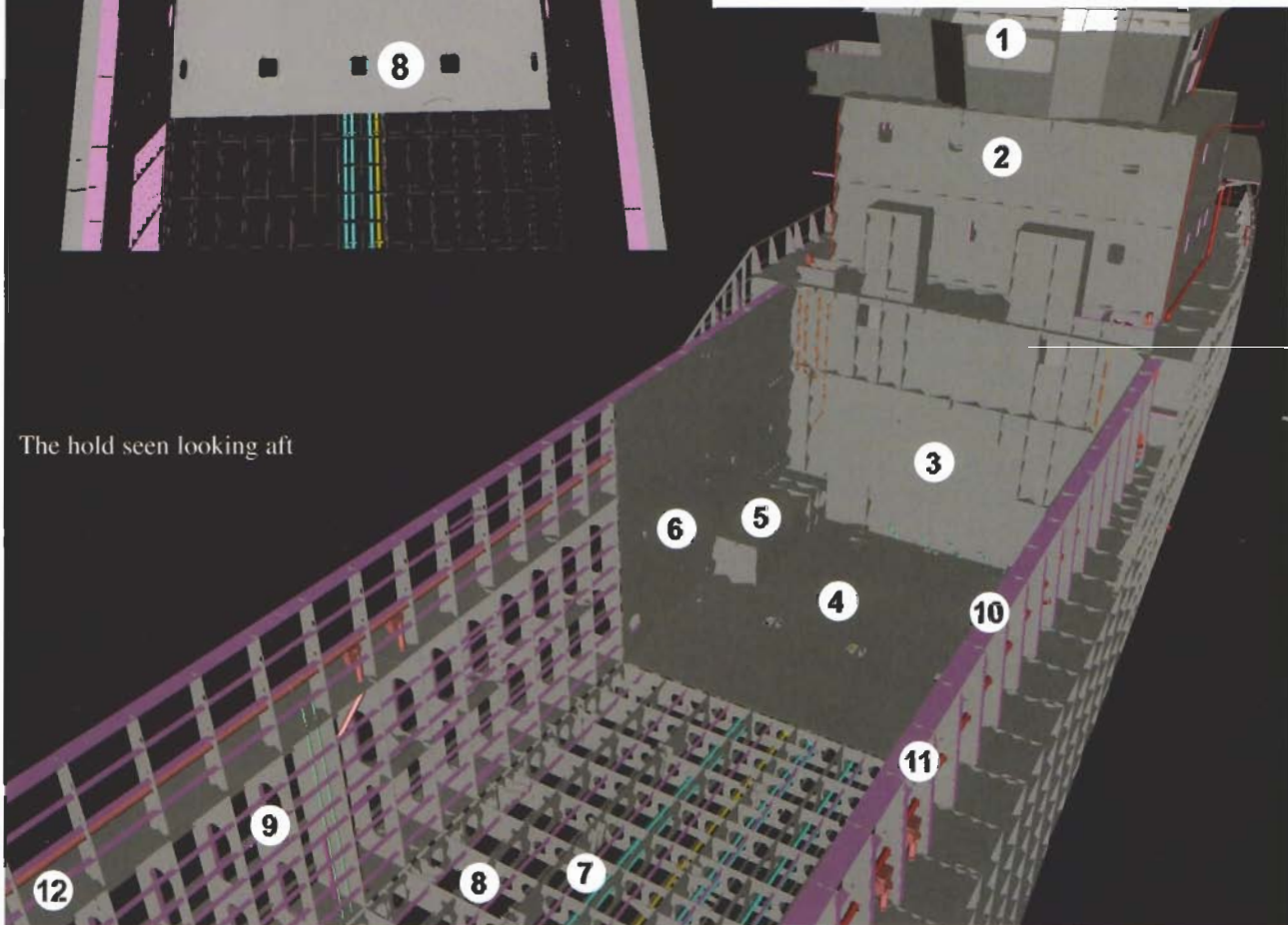

Double hull tanker

These images are of a double hull VLCC tanker, whose main dimensions approximately are:

Deadweight: 300 000 t
 Length over all: 292 m
 maximum breadth: 46 m
 draught: 16 m

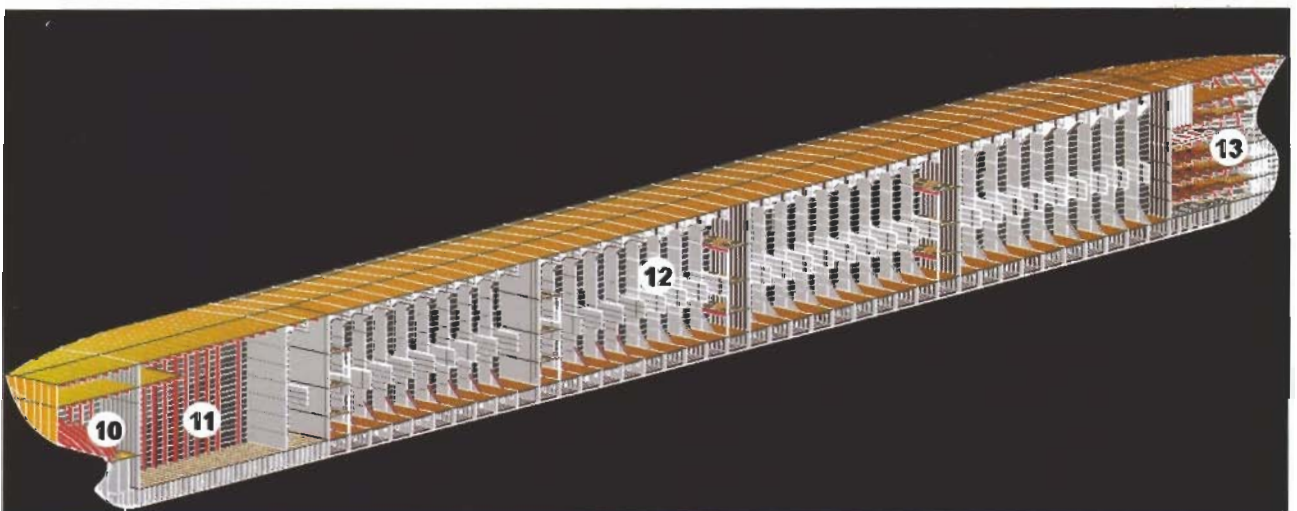
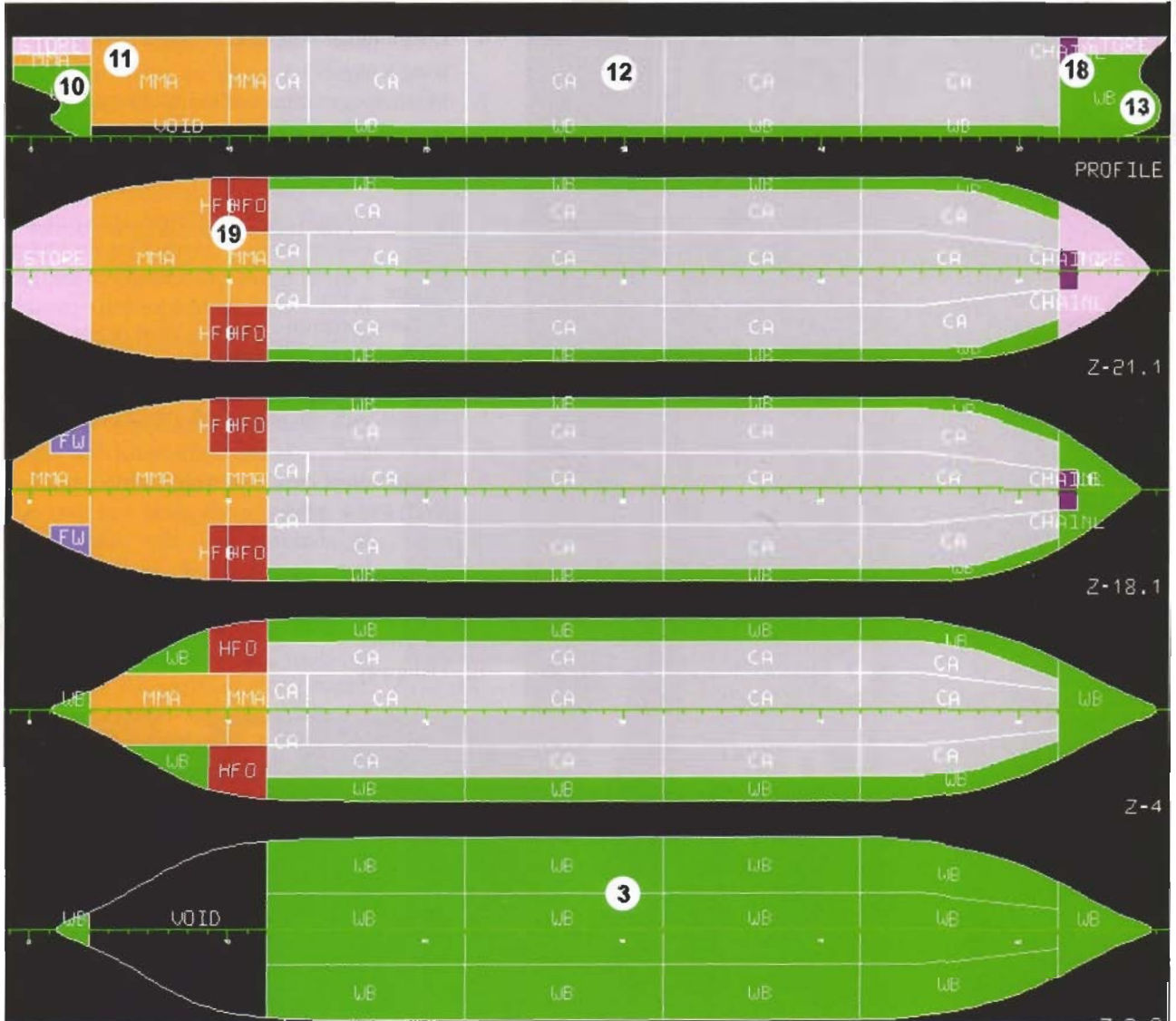

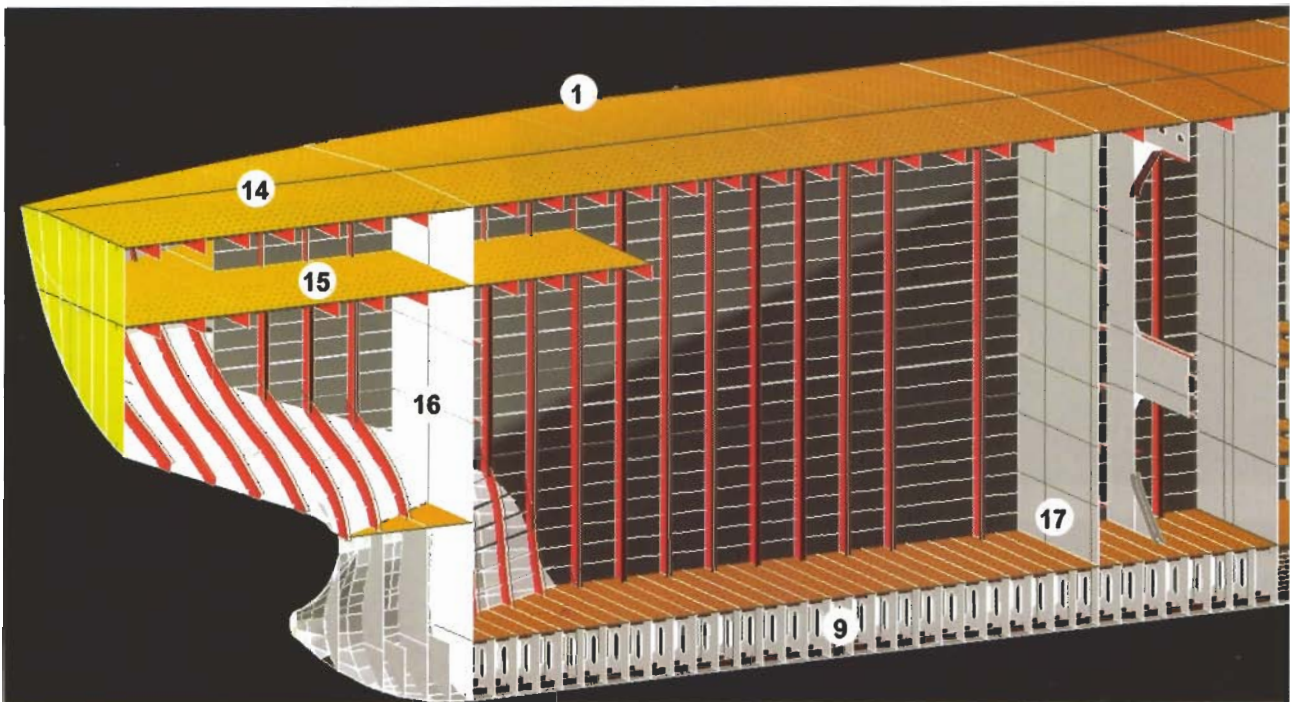
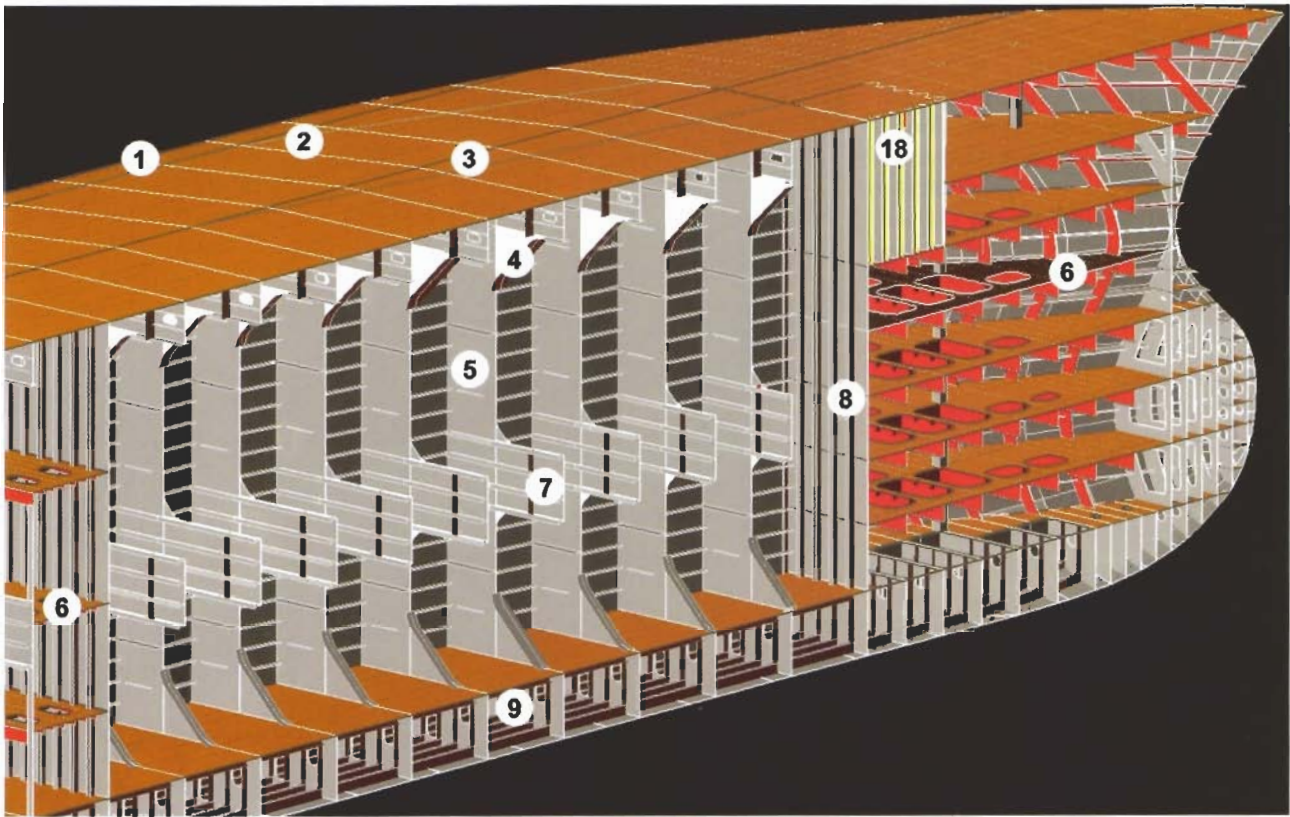

- | | | |
|--------------------------|----------------------------------|--------------------------|
| 1. Outer side shell | 8. Forepeak bulkhead | 15. Tweendeck |
| 2. Inner side shell | 9. Double bottom | 16. Aft peak bulkhead |
| 3. Longitudinal bulkhead | 10. Afterpeak | 17. Engine-room bulkhead |
| 4. Bracket | 11. Machinery space | 18. Chain locker |
| 5. Webframe | 12. Cargo tanks | 19. Fuel bunker |
| 6. Stringer deck | 13. Forepeak tank (waterballast) | |
| 7. Cross-tie | 14. Upper deck | |

2 Aft ship

The most eye-catching spaces aft on most ships are the engine room and the accommodation. Besides there can also be working places, storage facilities and fuel or ballast tanks. The aft peak is the part of the ship that is enclosed by the aft peak bulkhead, the stern and the aft deck. The aft peak is the location through which the main engine shaft runs. For support there are floors in the aft peak.

The stern section is the section above the aft peak. The steering engine room is part of this section. Just below the steering flat is the rudder carrier where the rudderstock is suspended. The rudder stock runs via the rudder trunk (frame no 0) through the aft peak.

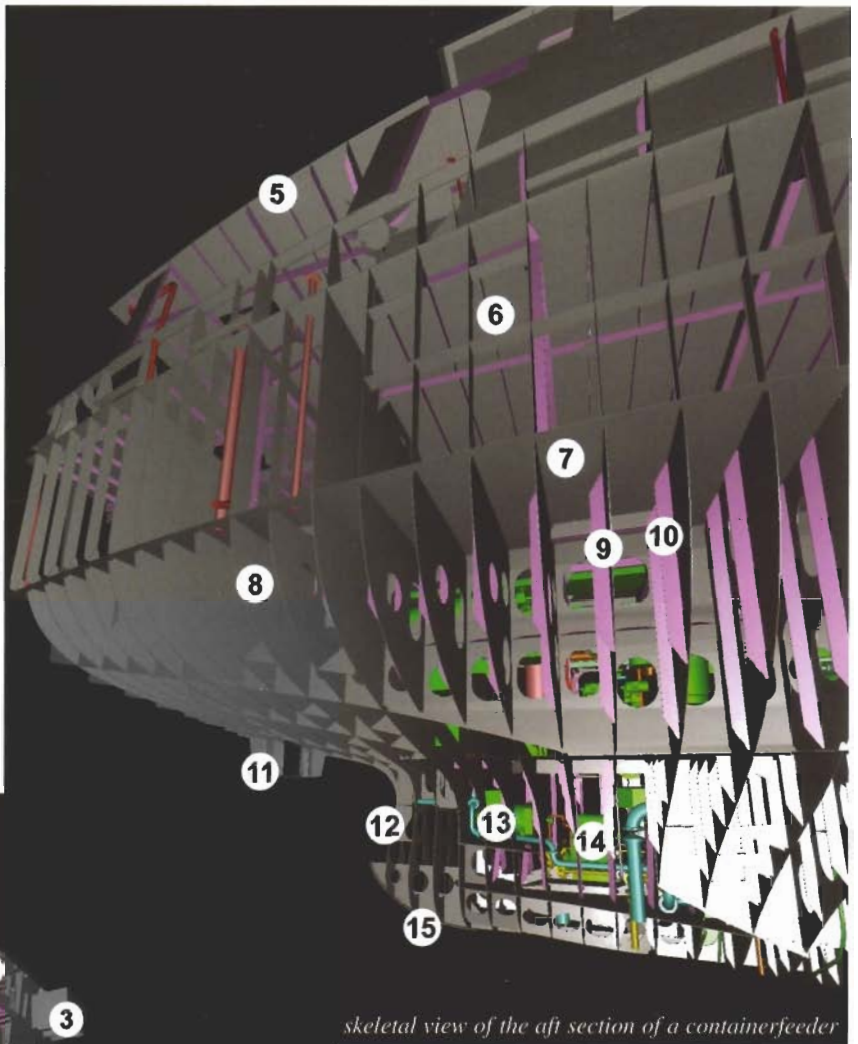

skeletal view of the aft section of a containerfeeder

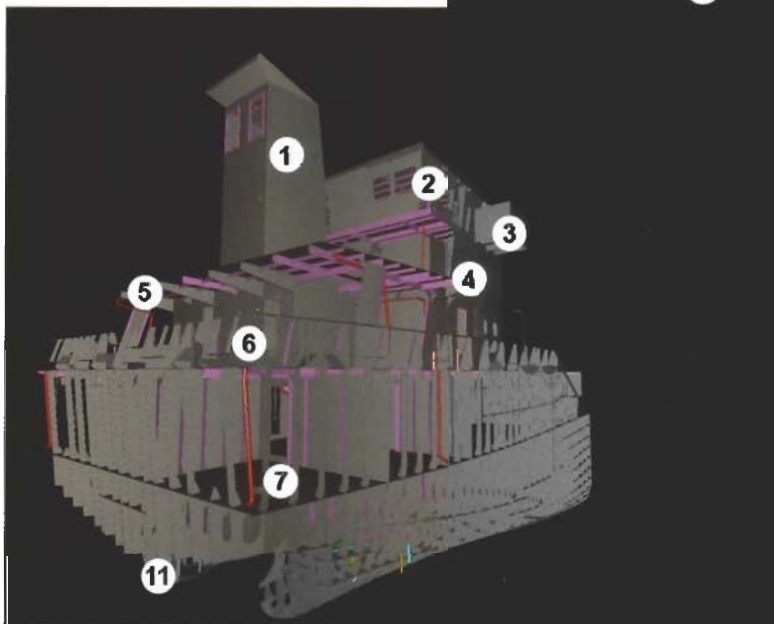

The stern borders the backside of the stern section. This is a plate running the full width of the ship, onto which the name of the ship and the homeport are welded.



Sternpost with shafting

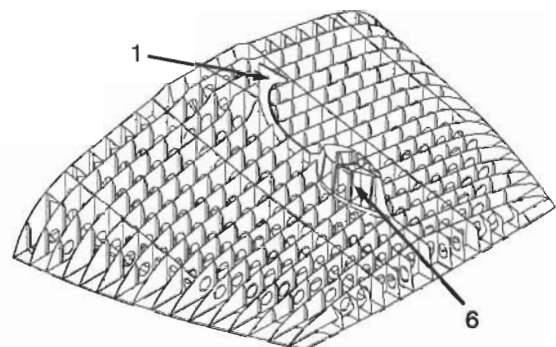

Assembly drawing

- | | |
|------------------|----------------------------|
| 1. Funnel | 5. Boat deck |
| 2. Bridge | 6. Poop deck |
| 3. Bridge wing | 7. Weather deck |
| 4. Accommodation | 8. Floor plate, frame no 3 |

- | | |
|-----------------------------|------------------------|
| 9. Floor plate, frame no 10 | 12. Stern frame |
| 10. Stiffeners | 13. Shaft generator |
| 11. Stern frame | 14. Reduction gear box |

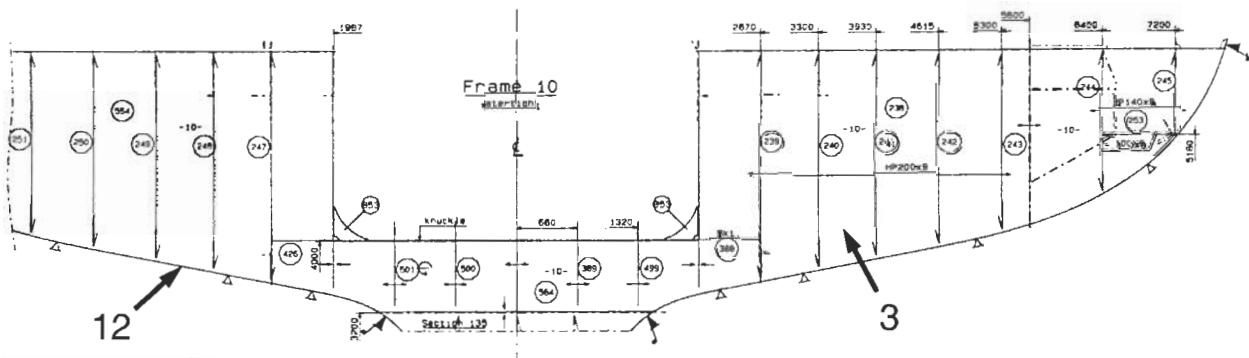

Transverse cross-section at frame 10

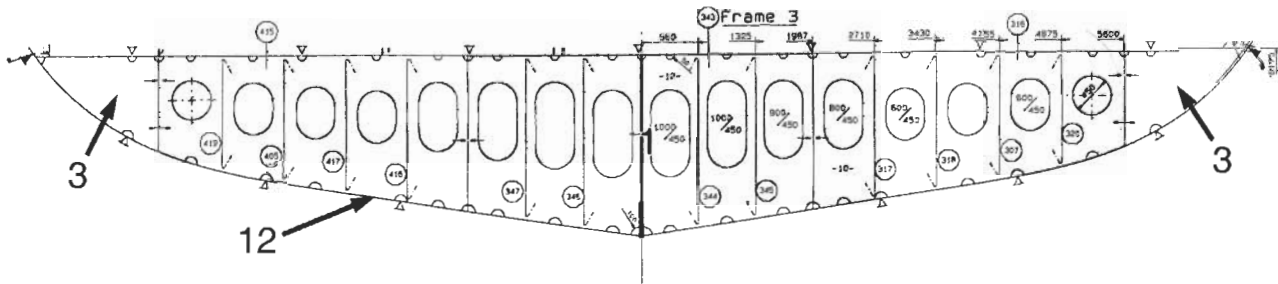

Transverse cross-section at frame 3

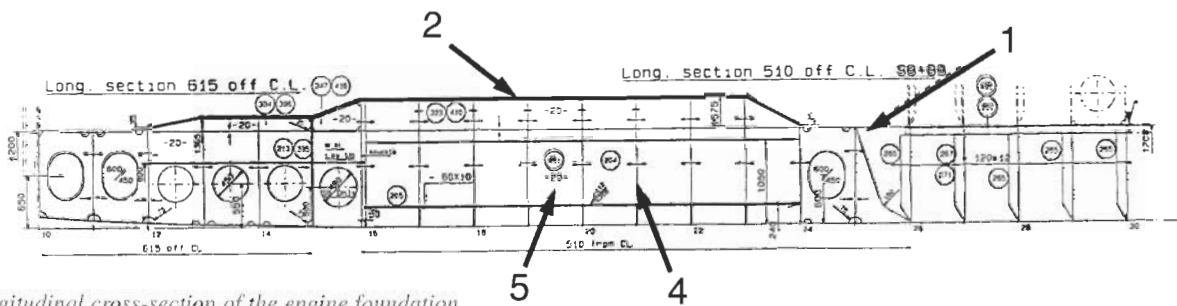

Longitudinal cross-section of the engine foundation

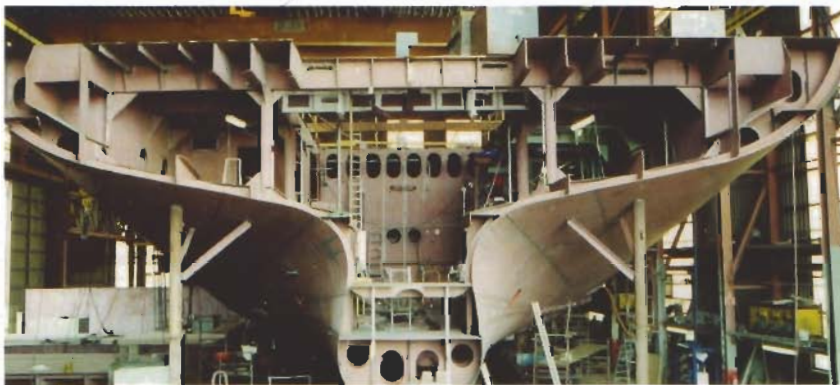

Transverse see-through of the aft ship

Explanation of the above image and of the below images:

1. Tanktop
2. Top plate for engine foundation
3. Brackets under engine foundation
4. Floors
5. Longitudinal girders of the engine foundation

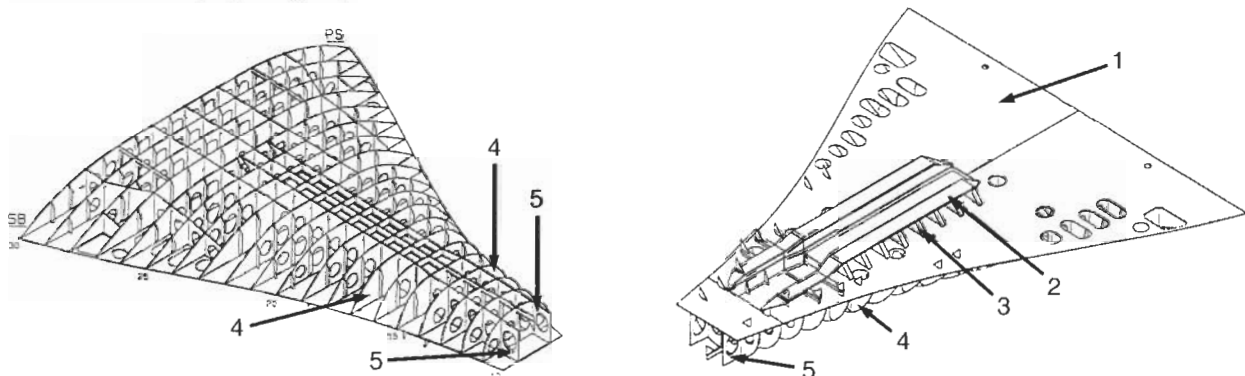

Assembly drawing

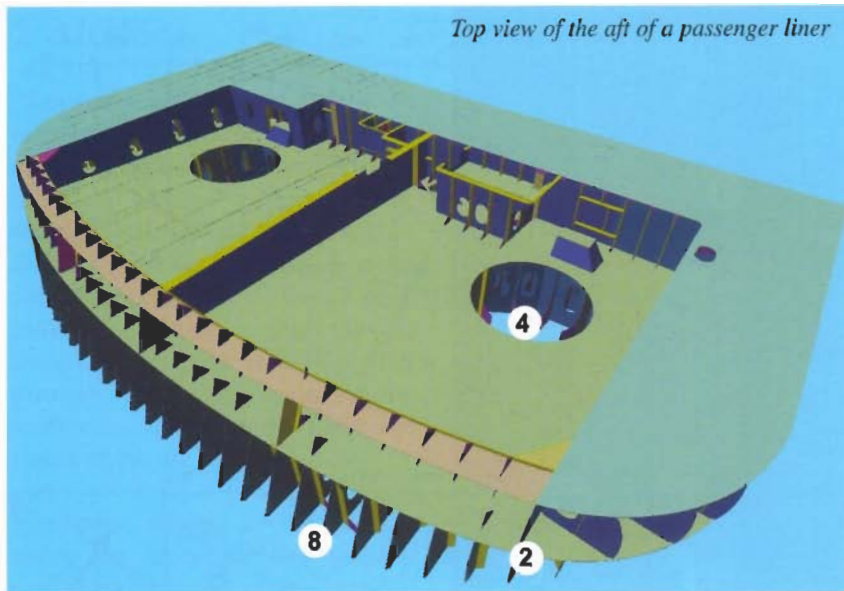

Explanation of the images on this page:

1. Centre keelson
2. Side keelson (watertight)
3. Floors
4. Hole in the deck for the azipod (see also chapter 9)
5. Skeg
6. Floor brackets on the frames
7. Stiffening floor brackets
8. Longitudinal floor brackets
9. Stringer brackets



Attaching the azipod to the ship

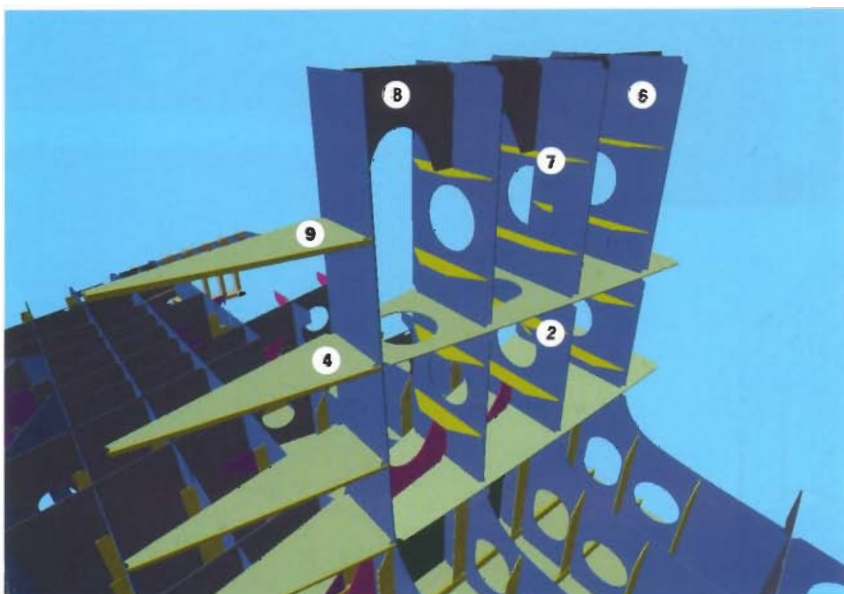
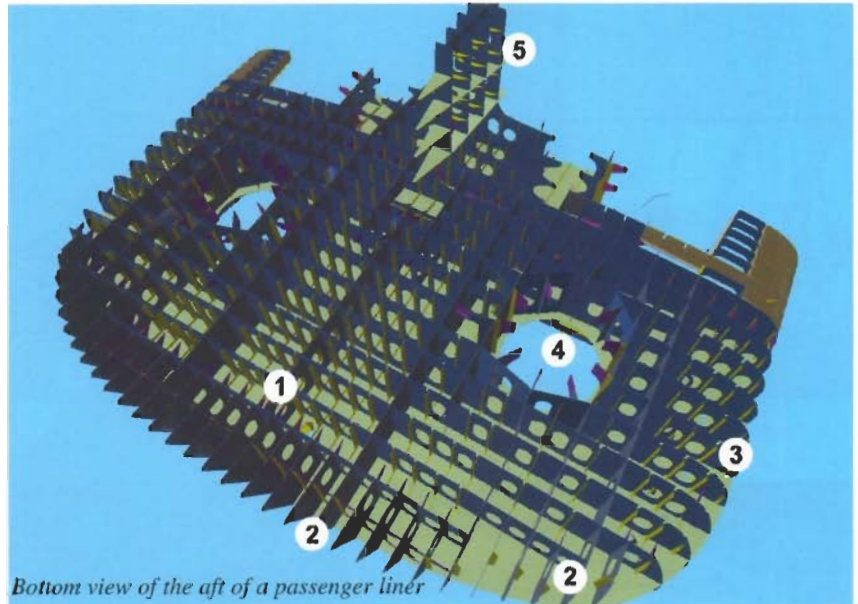

The Skeg.

This is a narrow vertical part of the hull in the aft ship. It is often present in twin propeller ships to enhance the course keeping ability of the ship by enlarging the vertical lateral area, and also to take the load of the aft ship, when the ship is in drydock.

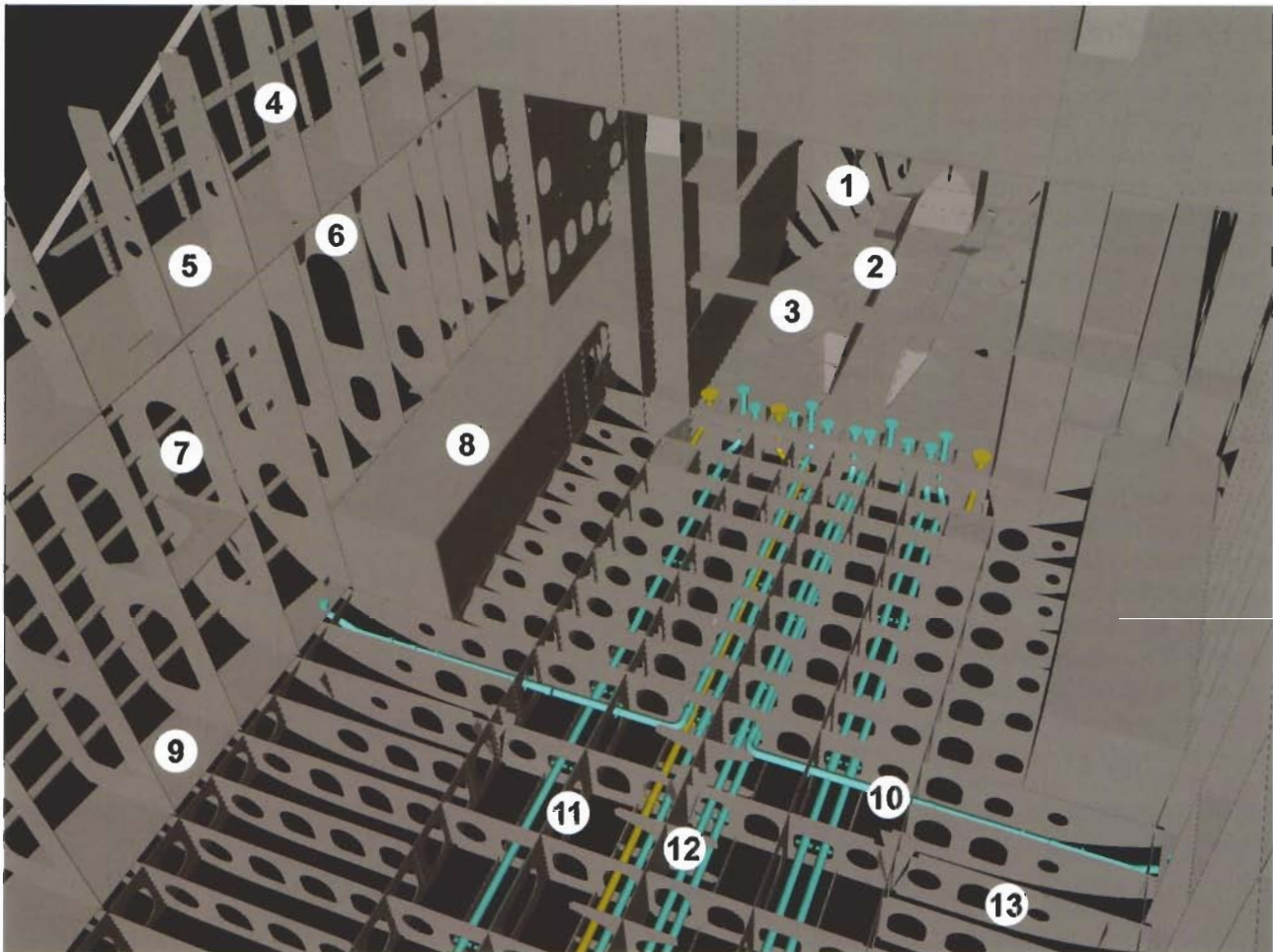

Explanation of the above image:

The same ship (a container feeder), now seen from aft with a glimpse of the engine room. Here you can see ballast lines coming from tanks in the engine room. The frames in the engine room and the double bottom run in the transverse direction and the ones in the wingtanks in the longitudinal direction.

1. Web frame
2. Top plate engine foundation
3. Tanktop
4. Coaming stanchion
5. Upper deck
6. Web frame
7. Longitudinal framing
8. Water or oil tank
9. Bottom wing tank
10. Delivery suction line of the wing tank
11. Side keelson
12. Centre keelson plate
13. (full) Floor (plate)

On the pictures below you see the aft of two Roll-on Roll-off vessels. The open spaces can be closed by ramps (not yet in place). When the ramps are opened, they can be used to load or discharge moving cargo.

1. Freeboard deck
2. Main deck
3. A-frame, space for the clearance of the screw
4. End of shafting
5. Skeg

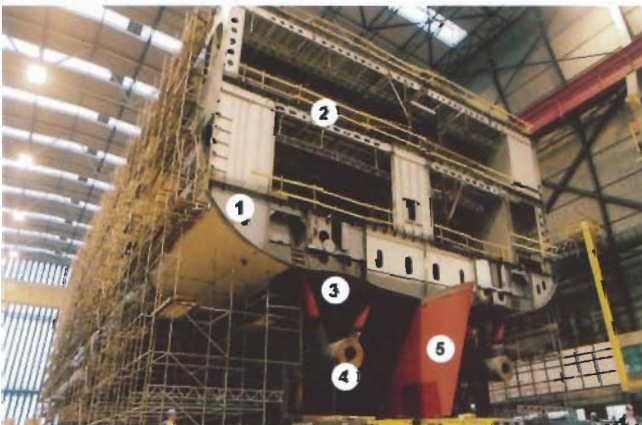

Sternpost with shafting

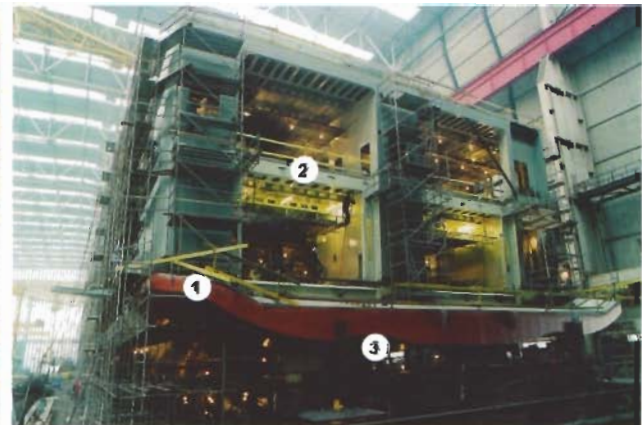

Inside of an aft ship under construction

3 Engine room

The engine room is a compartment that spans the full width of many ships. In tankers and bulkcarriers, however, often there are bunker tanks in the sides so that in those cases, the engine room does not span the complete width of the ship. The back and the front are provided with two watertight bulkheads: the engine-room bulkhead (fore) and, if the engine room is at the after end of the ship, the aft peak bulkhead(aft).

In the vertical direction an open connection is formed by the engine room casing. In the casing there are several catheads (cranes) with either manual or electric tackles for the moving of auxiliaries, tools or parts of the main engine. Motion of larger and smaller masses and the outside water pressure makes the use of web frames in combination with web beams and pillars necessary.

Foundations to support the main and auxiliary engines should also transfer the mass of the engine vibrations and resulting stresses to the ship's structure. The foundation should keep the engines in place when the ship is rolling and/or pitching and highly contributes to maintain a proper alignment with the propeller shaft.

The double bottom below the engine room is sometimes higher than other sections of double bottoms to accommodate the propeller shaft. The exact location of the propeller shaft is determined by the diameter of the propeller. When the double bottom is not higher, the engine foundation will be raised.

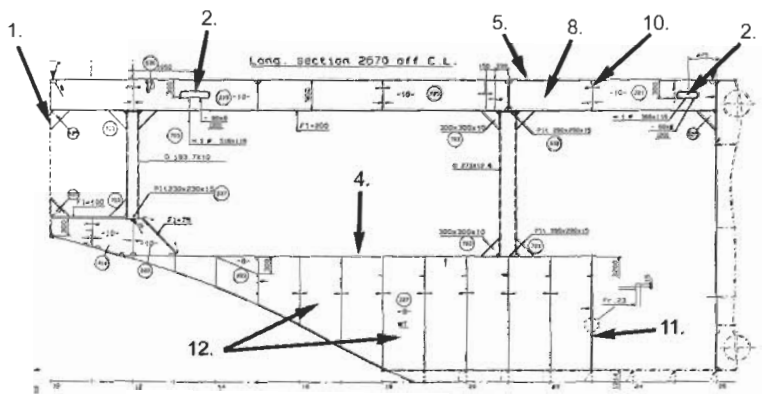
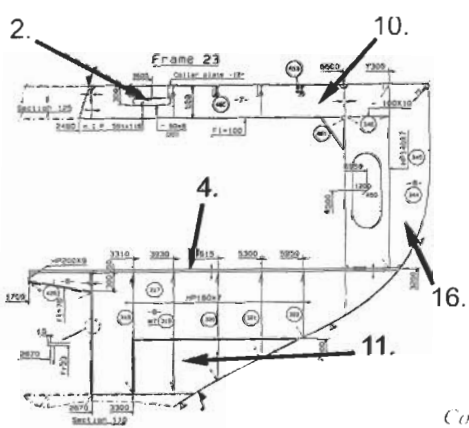
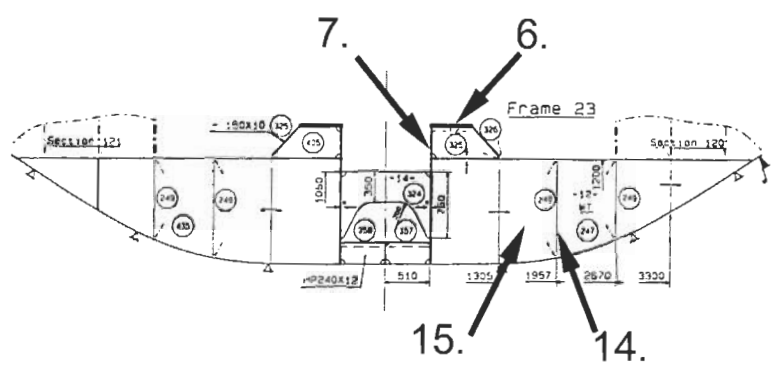
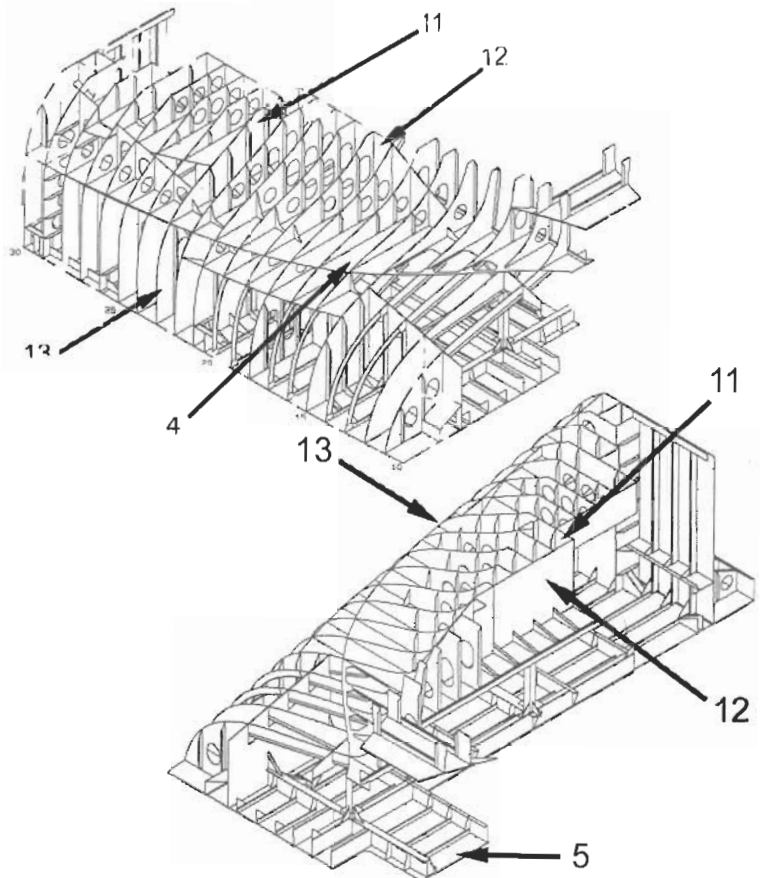
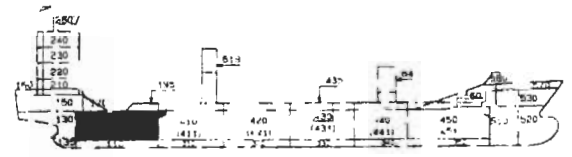

Construction drawings of the engine room of a containerfeeder

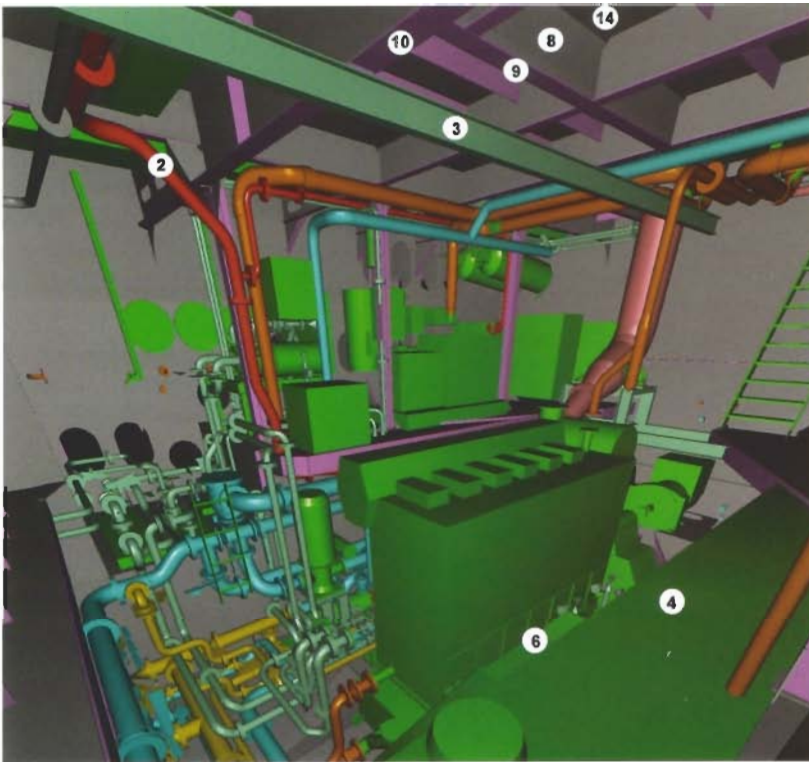

Explanation of the image at the left and of the images of previous page.

1. Aft peak bulkhead
2. Cable guide
3. Hoist beam
4. Tween deck
5. Main deck
6. Top plate for the engine foundation
7. Longitudinal girders for the engine foundation
8. Longitudinal deck girder with facebar
9. Longitudinal deck beam
10. Transverse deck girder
11. Watertight bulkhead (wing tank)
12. Watertight centre line bulkhead (wing tank)
13. Frame 23 (web frame)
14. Side keelson
15. Floor
16. Web frame

Peek in the engine room of a container feeder

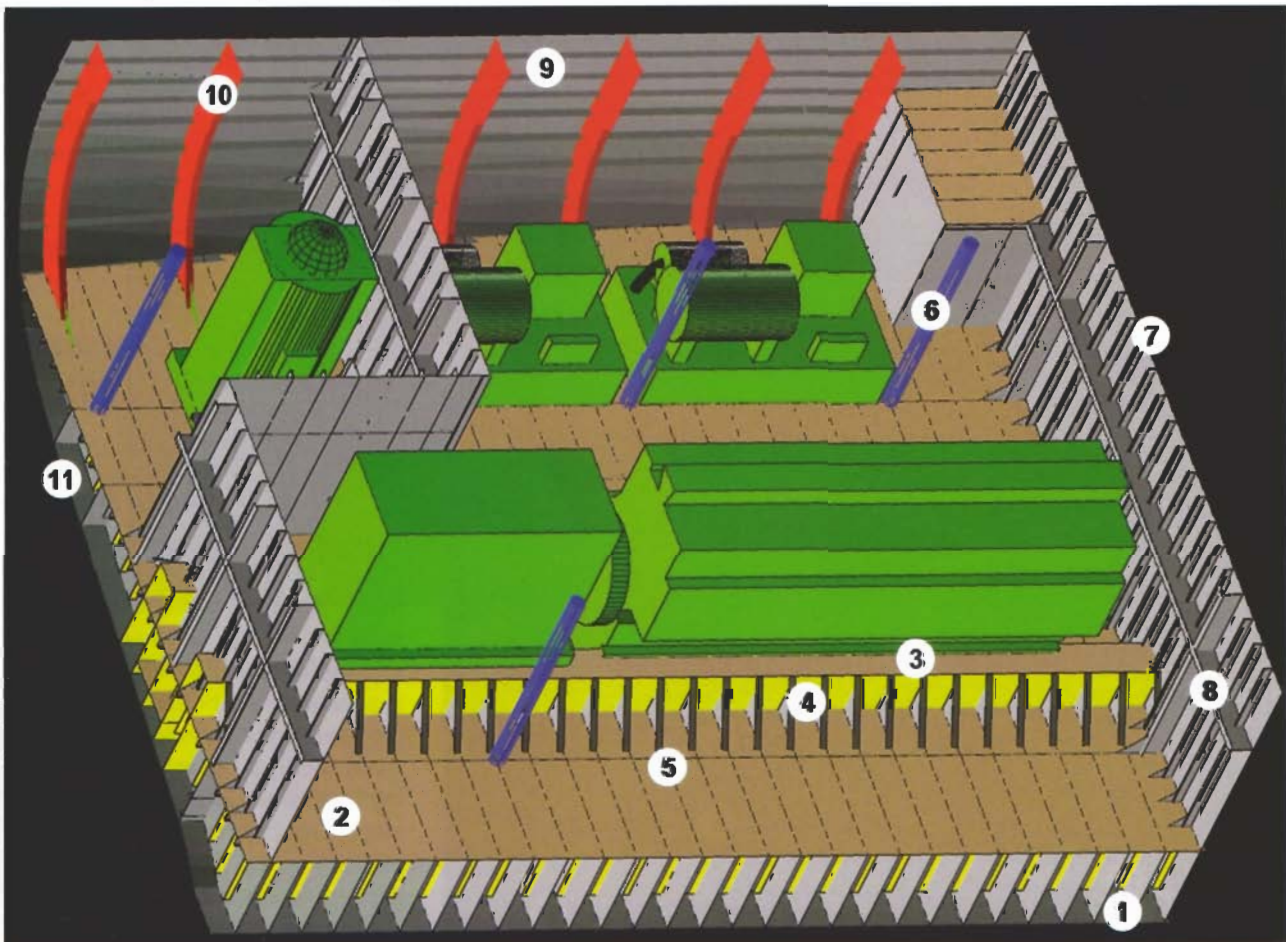

Explanation of the above image.

- | | | |
|---|--|---|
| <ol style="list-style-type: none"> 1. Floors 2. Tanktop | <ol style="list-style-type: none"> 3. Crown plate of the engine foundation 4. Longitudinal girder 5. Brackets with flange 6. Pillars | <ol style="list-style-type: none"> 7. Bulkhead stiffeners 8. Stringer 9. Side longitudinals 10. Web frames 11. Side keelsons |
|---|--|---|

4 Double bottom and wing tanks

The double bottom and the wing tanks are highlighted in the same paragraph as they have the same function. The wing tanks are located at the sides of the ship on top of the double bottom. Usually the two wing tanks are separated in the sense that no fluid can flow between them. Sometimes, however, the two tanks are joined in a U-shaped or L-shaped fashion.

The functions of the double bottom and the wing tanks are:

- To increase the transverse, and the longitudinal strength of the ship.

- Additional safety when the bottom is damaged or in case of a collision (intact stability).
 - To store seawater (ballast water) so that the propeller is below the water surface even when the ship has no cargo in the holds. This is also advantageous for the stability of the vessel.
 - To store fuel
 - To influence the list and the trim.
 - To compensate for uneven loading
- If the ship is equipped with a heeling pump, the pumping of ballast water from one wing tank to the other will automatically minimise the list. This is mainly used by heavy-cargo ships and container ships during loading and discharging.

Both the wing tanks and the double bottom are, in fact, watertight compartments. In the double bottom, the separation of the two sides is accomplished by the centre keelson or the side keelson in the fore and aft direction and with a watertight floor in the transverse direction. An oil tank and a drinking water tank must be separated by an empty space, a so called cofferdam. The wing tanks are separated by watertight web frames. The frames in the double bottom and the wing tanks usually run in the fore and aft direction. When a ship has a length of approximately 60 meters or less, for instance a tugboat or fishing vessel, the frames run in the transverse direction. Sometimes a combination of the two systems is used. The double bottom is covered by the tanktop, and thereby separated from the hold. Several piping systems run through the double bottom, such as piping for bilge or ballast water systems. Container ships need reinforcements in the double bottom to support the corners of the containers.

Floor plates in the double bottom can be divided into:

- full floors, which can be reduced in weight by manholes (also for access)
- floors made of profiles
- water- or oil-tight floors.

Vents and openings are installed for the filling and emptying of the tanks. Every double bottom tank must be fitted with a sounding pipe and a vent pipe. The double bottom is accessible by bolted manholes in the tanktop; every tank has to be fitted with at least one of these. Fuel tanks not in the vicinity of the engine room must have the ability of heating the fuel stored in them depending on the type of oil. This is necessary in colder climates because the low temperature decreases the viscosity of the oil, which can make it impossible to pump the oil to the engine room, and always necessary when heavy fuel is used.

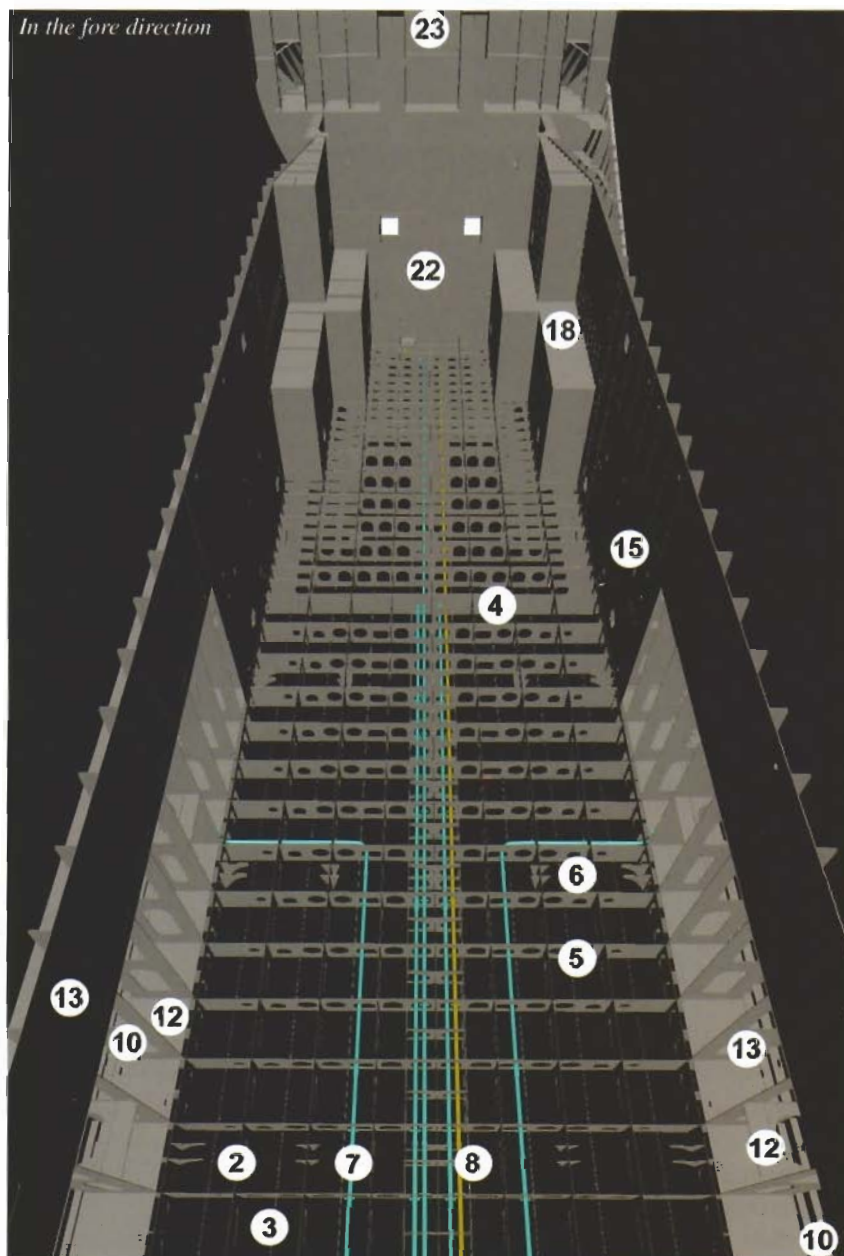

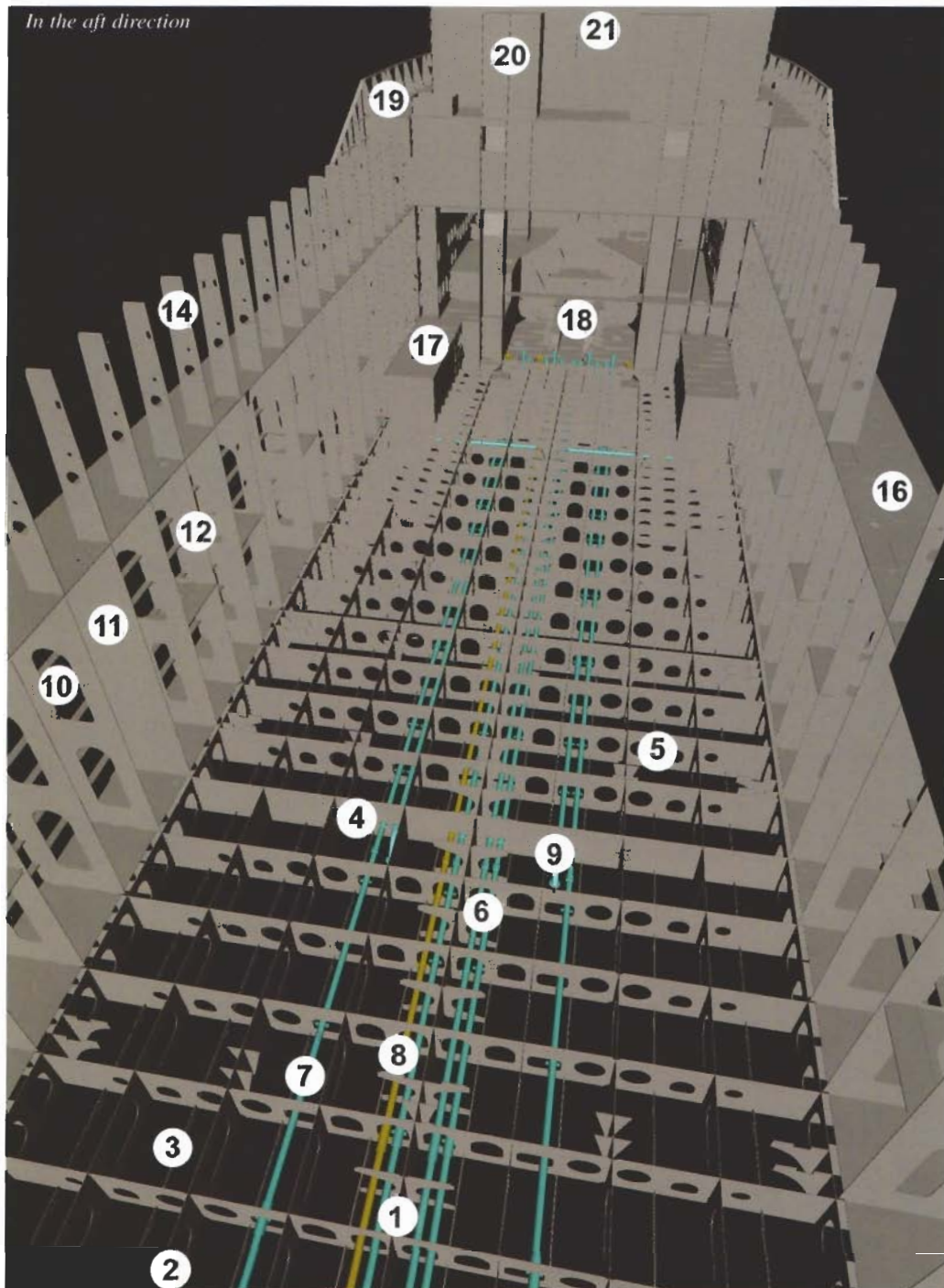

Two images of hold no 2 of a container feeder

Image at the left page:

view to the fore

Image at the right page:

view to the aft

- | | |
|--|---|
| <ol style="list-style-type: none"> 1. Centre keelson 2. Side keelson 3. Bottom frame 4. Water- or oil-tight floor (plate) 5. Full floor (plate) 6. Centre keelson bracket (dock bracket) 7. Ballast line 8. Bilge line | <ol style="list-style-type: none"> 9. End ballast line, with suction 10. Longitudinal frame 11. Water- or oil-tight bulkheads 12. Web frame 13. Hatch coaming 14. Coaming stanchion 15. Side bulkhead wing tank 16. Gangway 17. Ballast or fuel tank 18. Top plate of engine seat 19. Poopdeck 20. Ventilation of the hold 21. Accommodation front panel 22. Collision bulkhead 23. Breakwater |
|--|---|

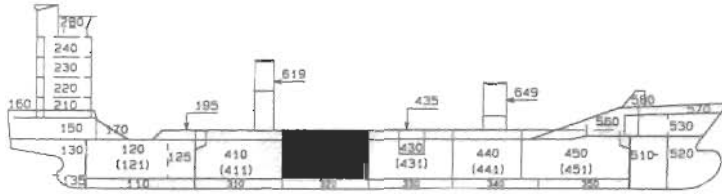

Location of the section in the ship

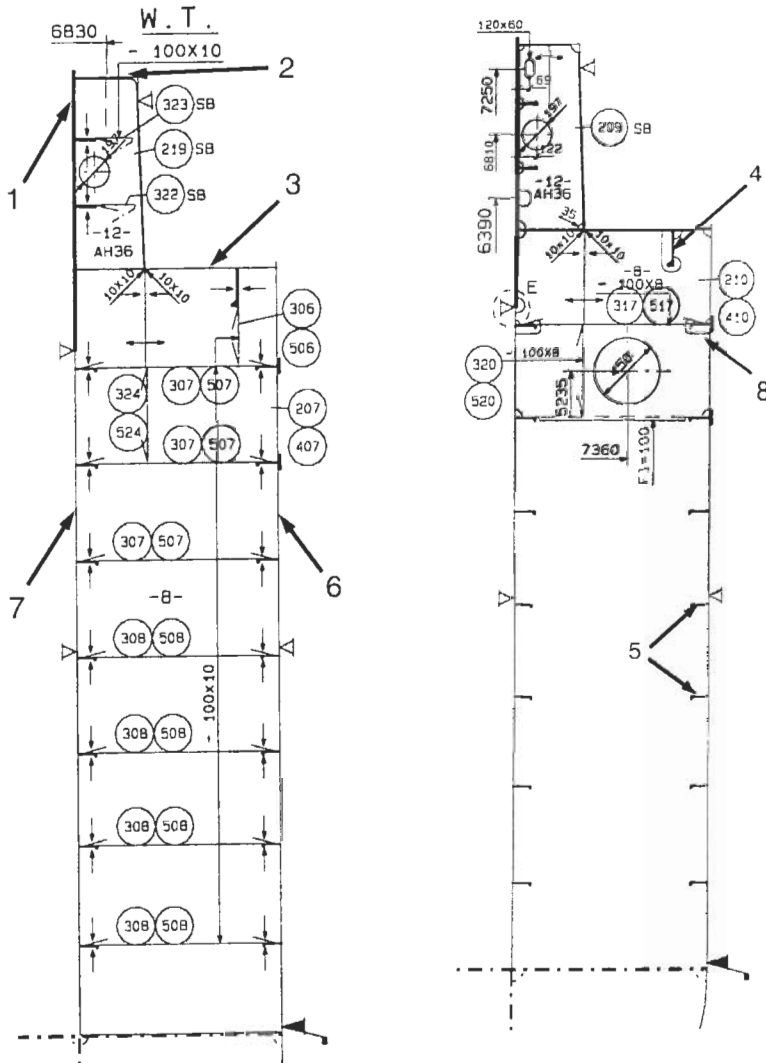

Explanation of the drawings on this page:

1. Hatch coaming plate
2. Toprail
3. Gangway
4. Deck beam
5. Longitudinal frame
6. Shell plating
7. Longitudinal bulkhead, tank side
8. Scallop

Section 1800. (2450, 3050, 3675) a.b.

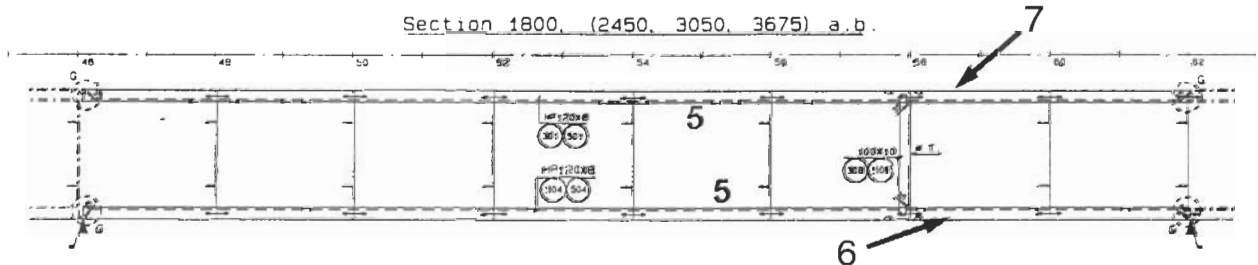

Section 4925 above base

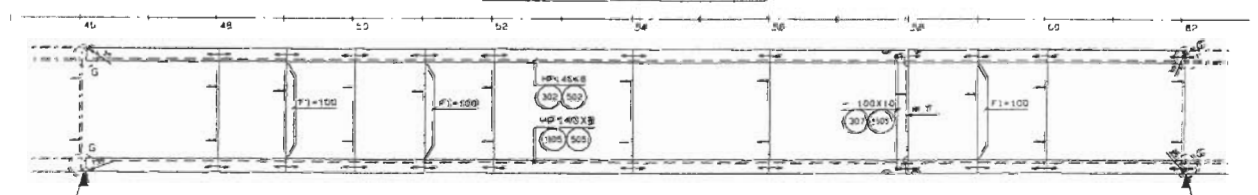

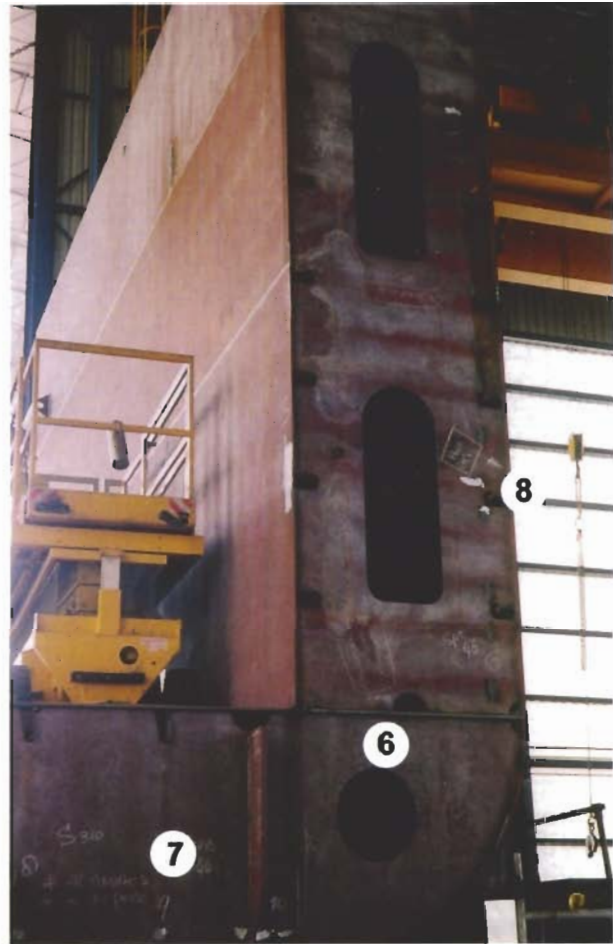

Explanation of both images on top:

1. Main deck, gangway
2. Deck longitudinal beam supporting the tip of the coaming strut
3. Tween deck
4. Web frame
5. Longitudinal frame
6. Bilge bracket
7. Full floor
8. Scallop

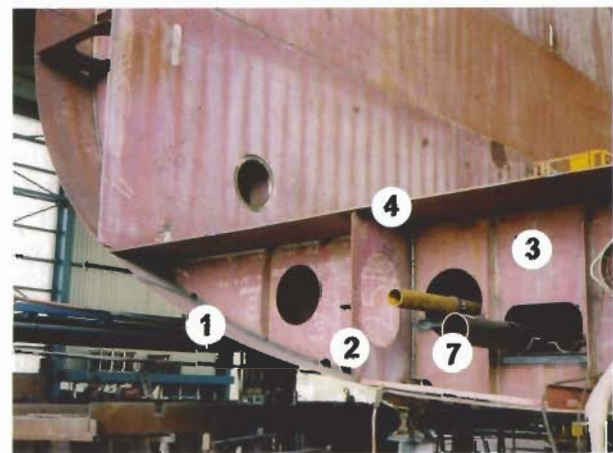

Explanation of both images at the bottom right:

1. Bottom
2. Side keelson
3. Full floor
4. Tanktop
5. Vents
6. Heating coils
7. Synthetic pipe for ballast tank

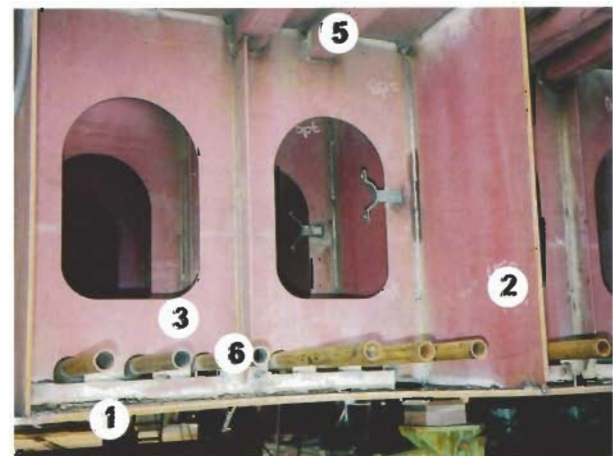

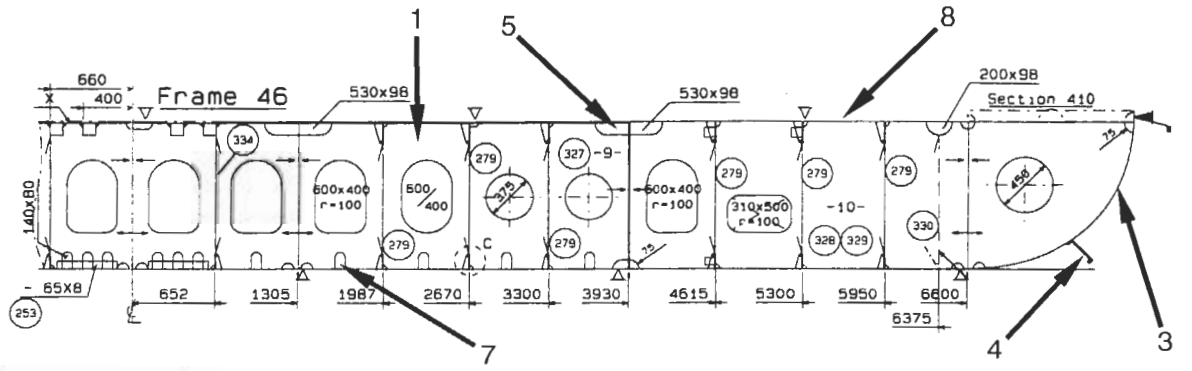
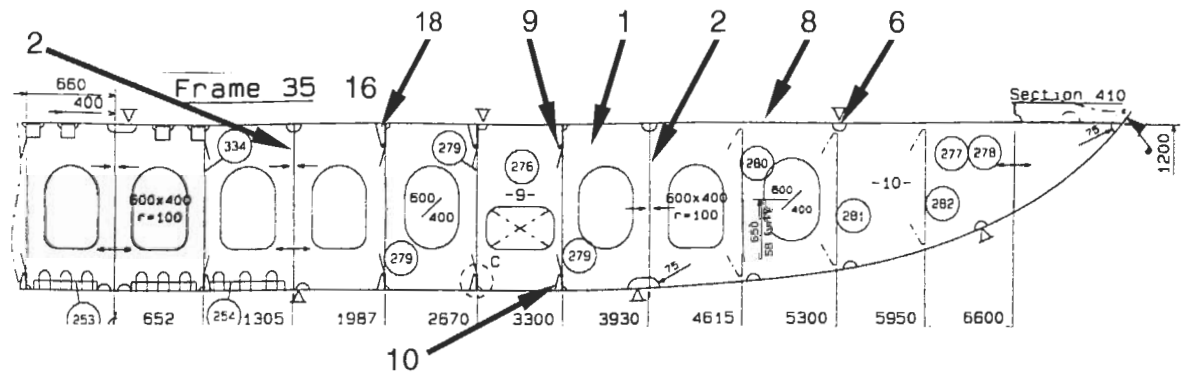
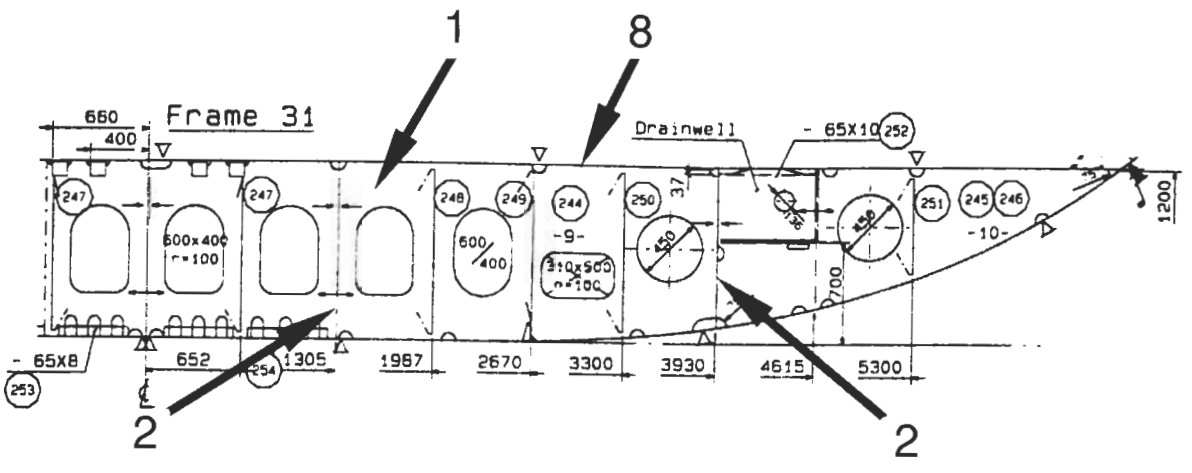
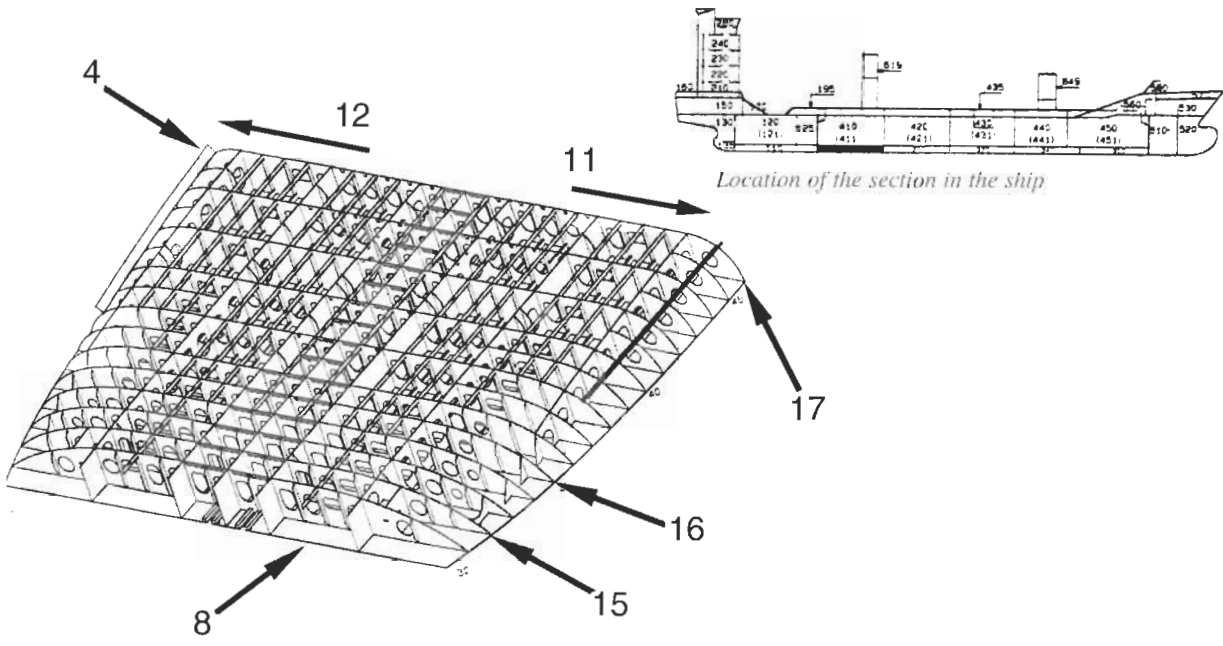

Tansverse cross-section

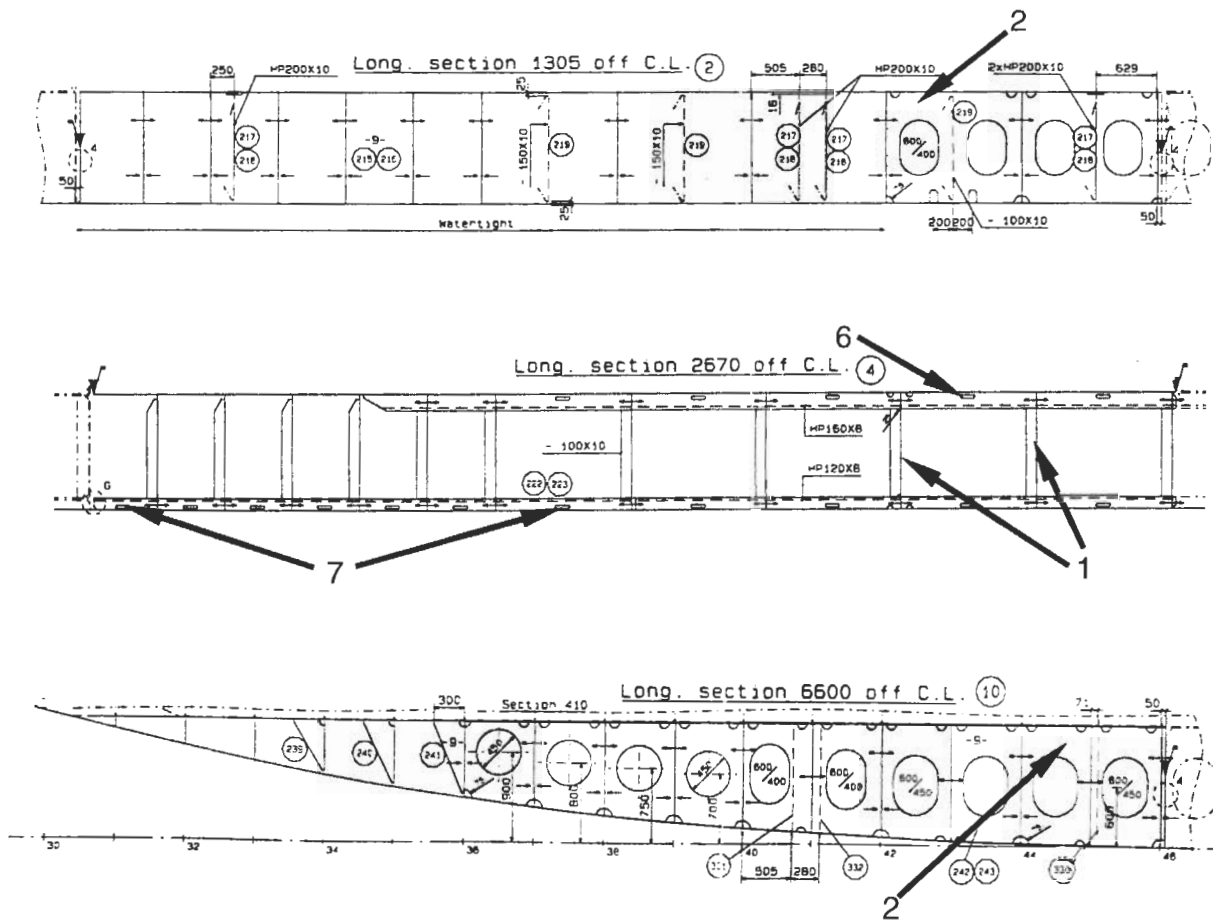

Longitudinal cross-section

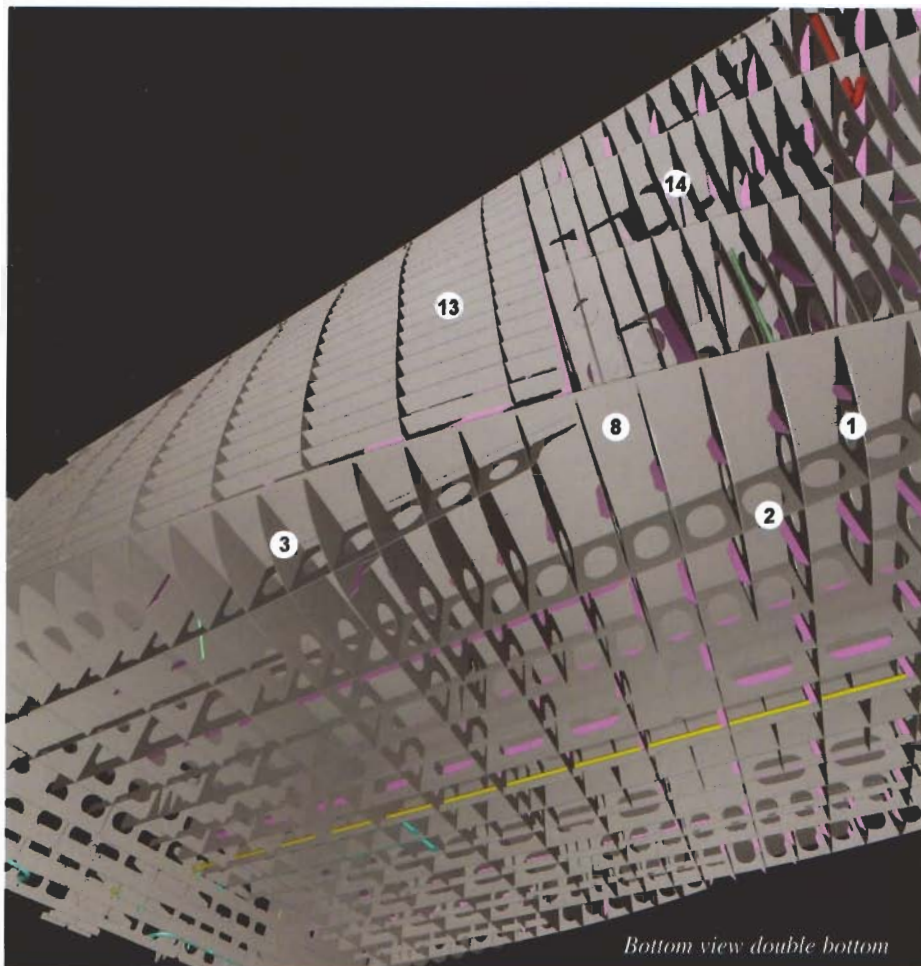

Bottom view double bottom

Explanation of the images on these two pages:

1. Full floor
2. Side keelson
3. Bilge strake
4. Bilge keel
5. Recess container pot
6. Vents
7. Drain holes
8. Tanktop
9. Tanktop stiffening
10. Bottom frame
11. Portside
12. Starboard side
13. Longitudinal frame system
14. Transverse frame system
15. Floor on frame 31
16. Floor on frame 35
17. Floor on frame 46
18. Scallops

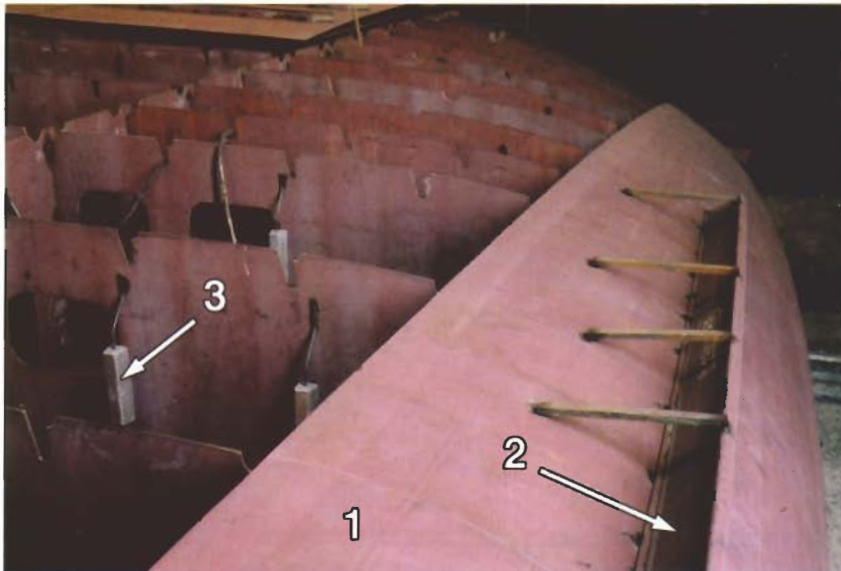

Explanation of the image at the left:

1. Bilge plate
2. Bilge keel
3. Aluminium anodes in the ballast tank

Bottom view of the double bottom

Explanation of the images at the bottom:

1. Bilge plate
2. Side keelson
3. Full floor
4. Tanktop
5. Vent channels
6. Upper frame
7. Container support
8. Bottom frame



Double bottom of a container feeder

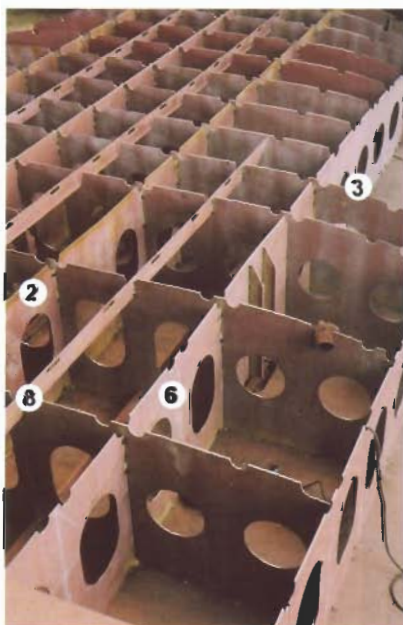

View of the down side of the double bottom. In the middle you can see the HFO-tank with heating coils.

Explanation of these three images:

1. Draught mark
2. Plimsoll mark
3. Hatch
4. Railing
5. Container strut
6. Bilge strake, approximately 10 mm thick
7. Ground bar
8. Bilge keel, approximately 220 x 15 mm (for this particular ship) The bilge keel is welded onto a strip. When damaged, the bilge keel should break off, with the strip remaining attached to the shell. Without backing strip, a fracture in the bilge keel could continue into the bilge strake, and that is dangerous!

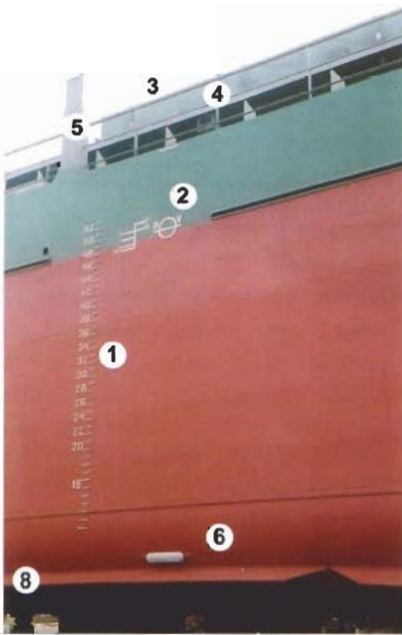

Side view

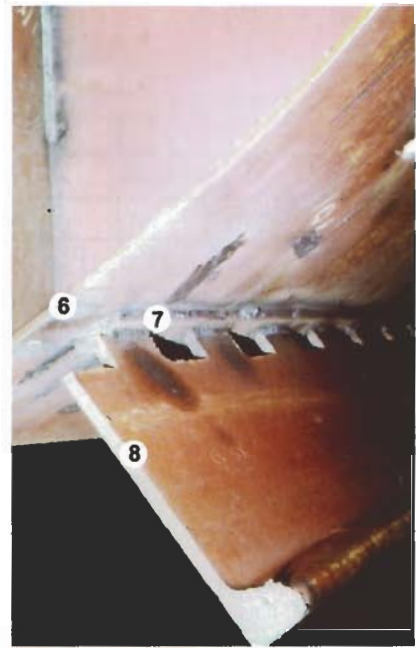

Bilge keel

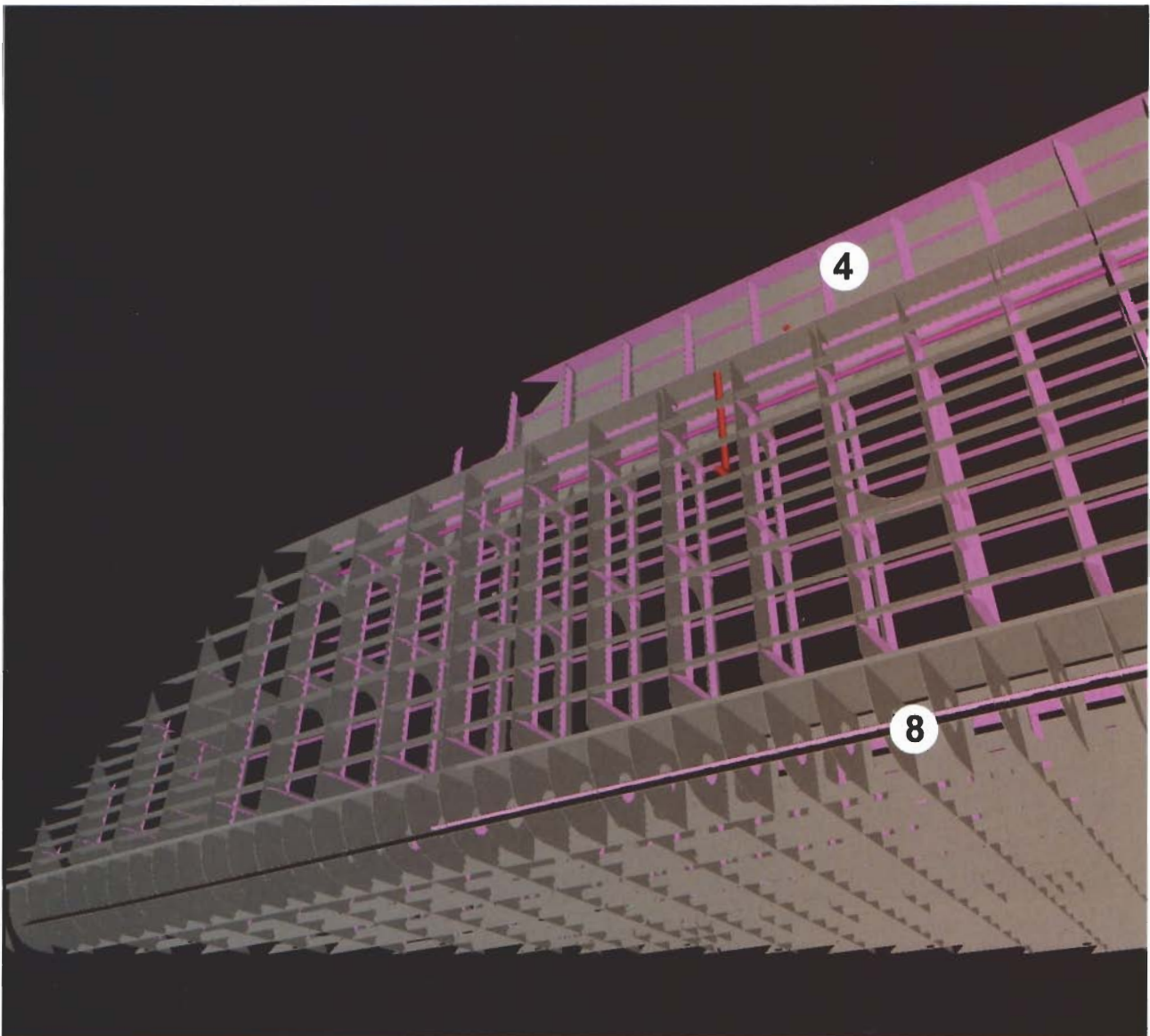

Crosssection of the midship



Location of the section in the ship

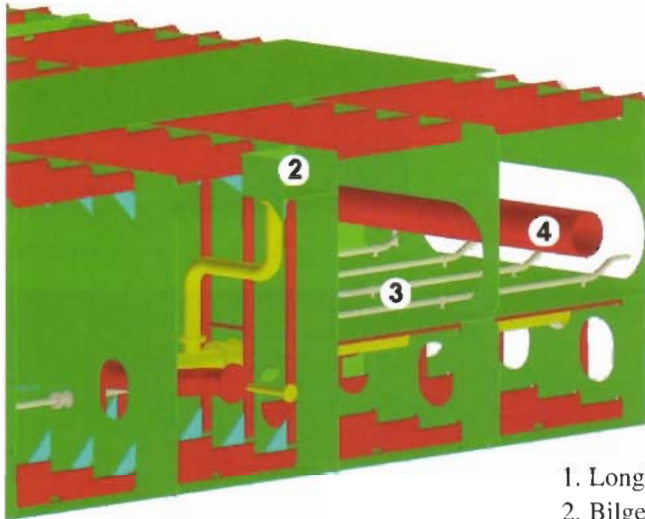

1. Longitudinal bulkhead
2. Bilge well
3. Heating coils
4. Bilge line
5. Cross-over line

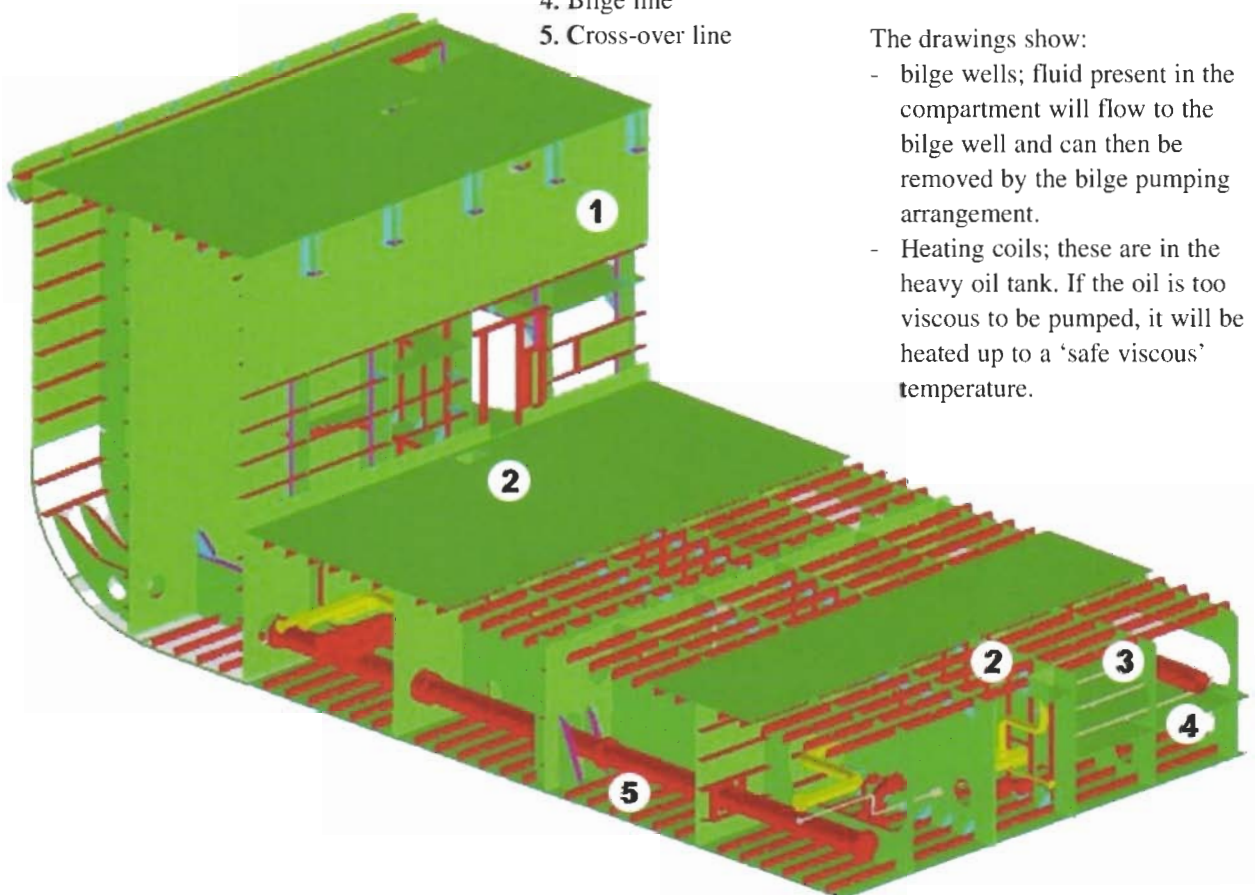

This 3D-images shows an open wing tank and a double bottom of a RoRo-passenger ferry.

The cross-over line is visible as an open line between the portside tank and the starboard tank. A cross-over in this case is designed to be used in the event of a collision. Water entering one space will flow to the tank on the other side. This will moderate the list. The system can result in reduced damage stability requirements. The majority of ferries and passenger liners have such a crossover system.

The drawings show:

- bilge wells; fluid present in the compartment will flow to the bilge well and can then be removed by the bilge pumping arrangement.
- Heating coils; these are in the heavy oil tank. If the oil is too viscous to be pumped, it will be heated up to a 'safe viscous' temperature.

5 Foreship

The foreship is the part of the ship between the stem and the collision or forepeak bulkhead, and the adjacent section.

The space in front of the collision bulkhead is the forepeak. The forepeak tank is the lowest space in the forepeak and can be divided into a lower and an upper forepeak tank. The forepeak tank is usually used as a ballast tank. If the ship is not loaded, this is often filled with water to reduce the trim at the stern. Often there is a wash bulkhead in the peak tanks. This improves the rolling behaviour of the ship, by delaying movement of the ballastwater when the tanks are not completely filled. Just behind the forepeak there can be another tank that extends from starboard to port and from the bottom to the deck: the deep tank. In the top of the forepeak, right below the capstan or anchor winch there are chain lockers for the storage of the anchor chains. Above the weather deck on the foreship is the forecastle, a deck erection that extends to the forecastle bulkhead. This bulkhead is not necessarily on the same frame as the forepeak bulkhead. On the forecastle is the windlass and other mooring equipment. Also the foremast.

The forecastle can be divided into:

- The bosun's store: storage for ropes, tools for work on the deck and cargo handling.
- Storage for cargo handling equipment like twistlocks, slings and airbags. These items are usually stored in racks made for this purpose. If necessary, these racks can be lifted up by the ship's crane or the crane of the hatch cradle.

Explanation of the above image:

1. Hatch coaming
2. Breakwater
3. Bulwark grey with bulwark stanchions (purple)
4. Transition from transverse system to longitudinal system. For constructional purposes the transverse system



The fore part is being attached to the ship



The fore-ship is subject to extra large forces and stress that are caused by:

- a The pitching of the ship (pitching stresses).
- b The foreship moving in and out of the water (panting stresses).
- c Maintaining speed in heavy weather
- d Ice

Strengthening for ice	Where	For
Closer frames (300 mm)	VP	a.b.c.
Extra (heightened) floors	DB +VP	a
Extra sister keelsons	DB	a
Heavier frames and/or web frames	VP	a.b.
Horizontal stringers on shell	VP + deep tank and wingtanks	a.b.
Thicker shell plating	At certain draught	c.
Panting beams	VP	b.

To compensate for these forces, the fore needs additional reinforcements that sometimes partly extend to the back of the ship. The bulb stem is added to reduce the wave resistance. The bowwave causes a resistance that has a negative influence on the speed of the ship. The additional bulb creates a wave which extensively equalises the bowwave and thus positively influencing the ship's speed. (this only in the loaded condition)

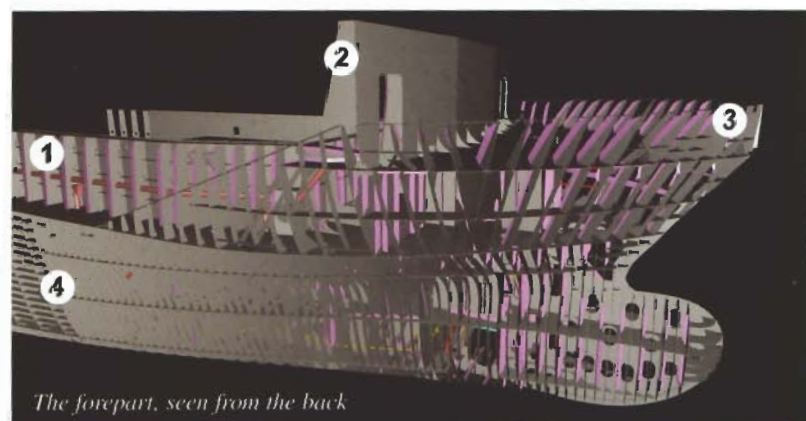

The forepart, seen from the back

is easier than the longitudinal system in the forepart. There is no need for longitudinal framing as the longitudinal stress in this area is minimal. Transverse strength is stronger than longitudinal strength. This transverse strengthening is desired to withstand the forces caused by panting and pitching.

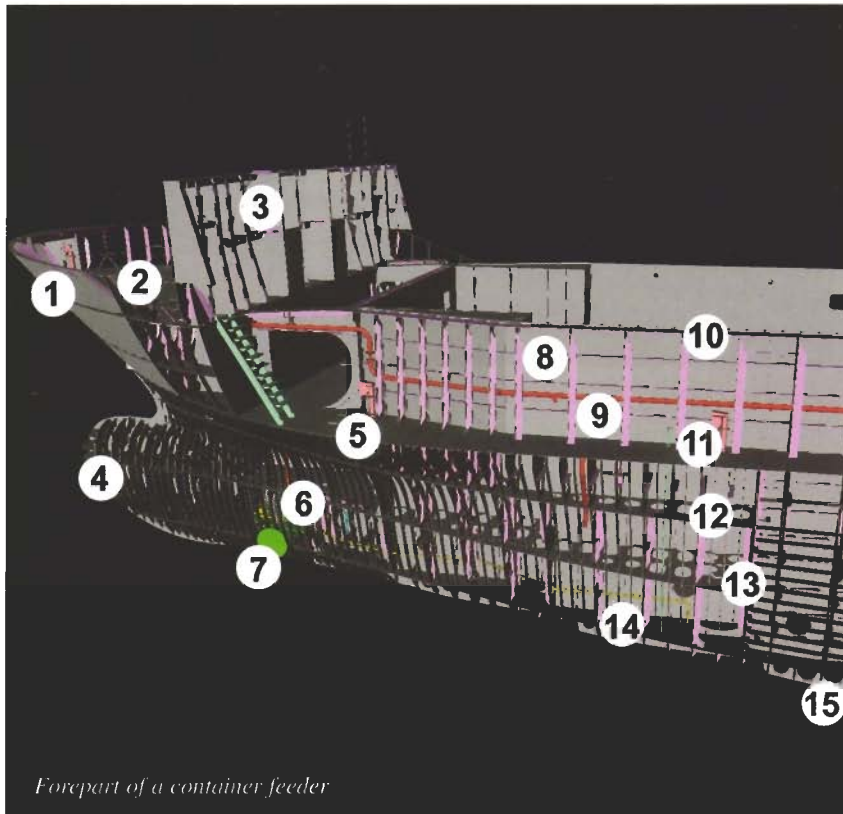

Forepart of a container feeder

The bulbous bow is in fact a piece of protruding bow that breaks up the bow wave before it manages to reach the ship. The bulb stem also has a favourable effect on the wave system around the ship. The ideal situation is one where the ship cuts through the waves, whilst generating no waves by itself. For every wave that is created by the ship is lost energy; compare a tugboat with a “sharp” yacht.

The bulb is most effective at a certain draught (loaded ship). It could very well be that in the case of an unloaded ship, the bulb actually produces more resistance (see also chapter Propulsion).

Explanation of the above image:

1. Bow
2. Forecastle deck
3. Wave breaker
4. Bulbous bow
5. Gangway
6. Stringer deck
7. Bow thruster room
8. Bulwark with stanchions
9. Fire extinguishing line
10. Top rail
11. Vent of the wing tank
12. Stringer
13. Transition of transverse to longitudinal system
14. Tank top
15. Side keelson

Explanation of the right hand image:

1. Side keelson
2. Centre keelson
3. Tanktop
4. Stringer deck
5. Web frame
6. Floor brackets
7. Manhole
8. Bulb
9. Bow thruster tunnel

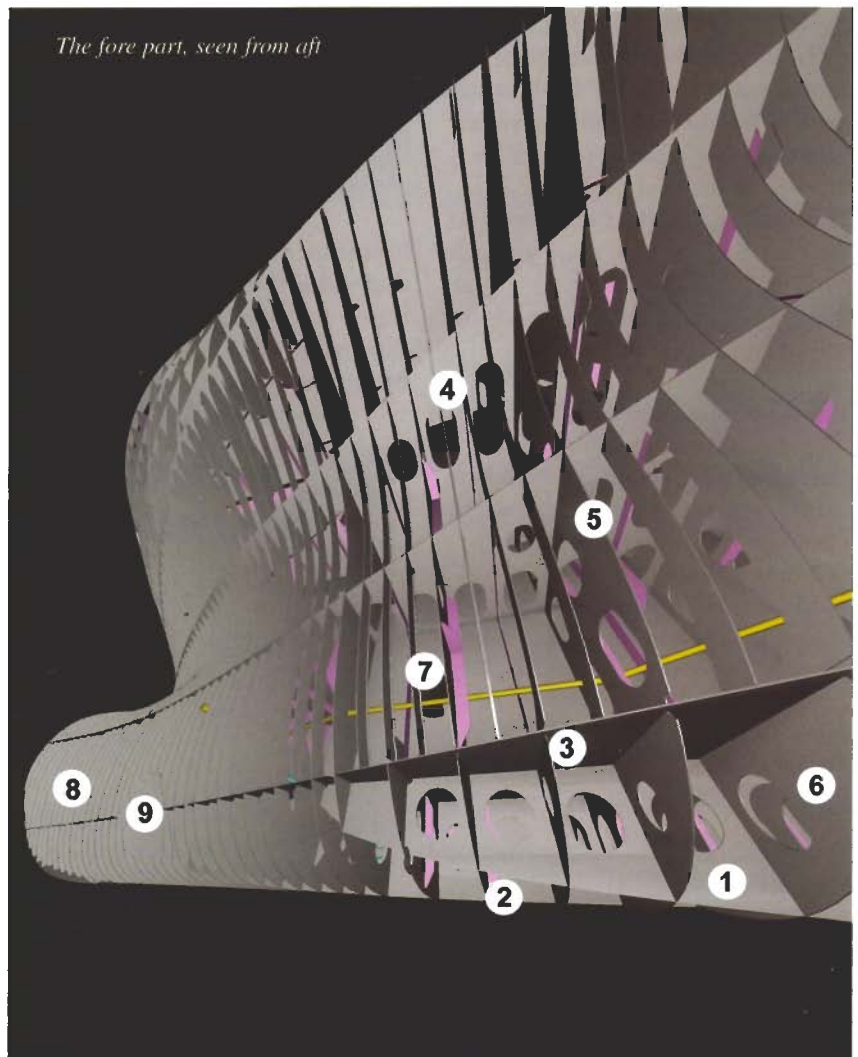

The fore part, seen from aft

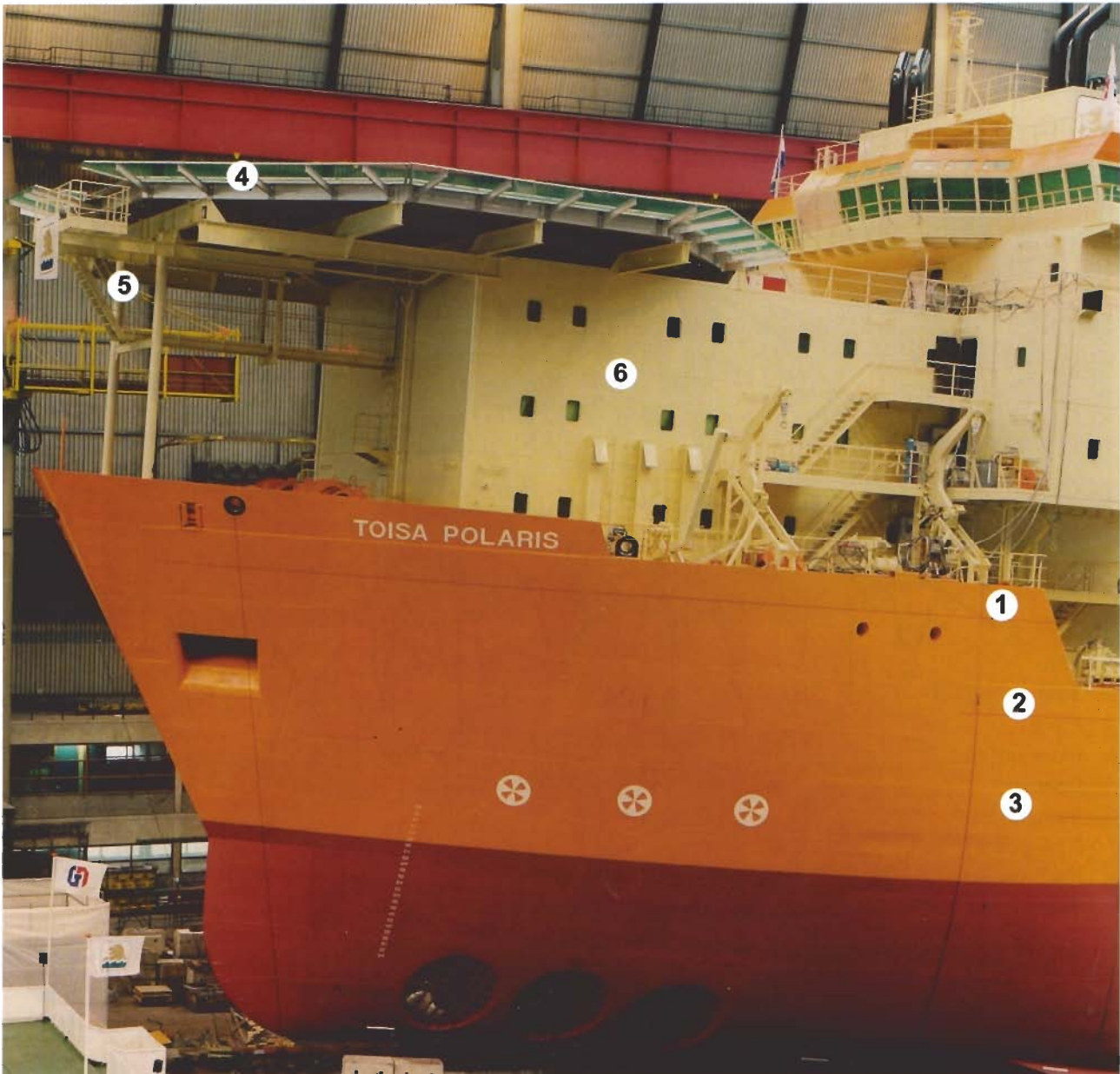

The picture above shows an Offshore Support Vessel. The number of bow thrusters already indicates that the ship is equipped with a Dynamic Positioning System (DP-system). The sheer strake is always the uppermost side shell-plate of a ship and on this ship, the three sheer strakes are clearly visible.

1. Sheer strake forecastle deck
2. Sheer strake tween deck
3. Sheer strake main deck
4. Helicopter platform
5. Escape route to or from the helicopter platform
6. Accommodation



Multipurpose support vessel

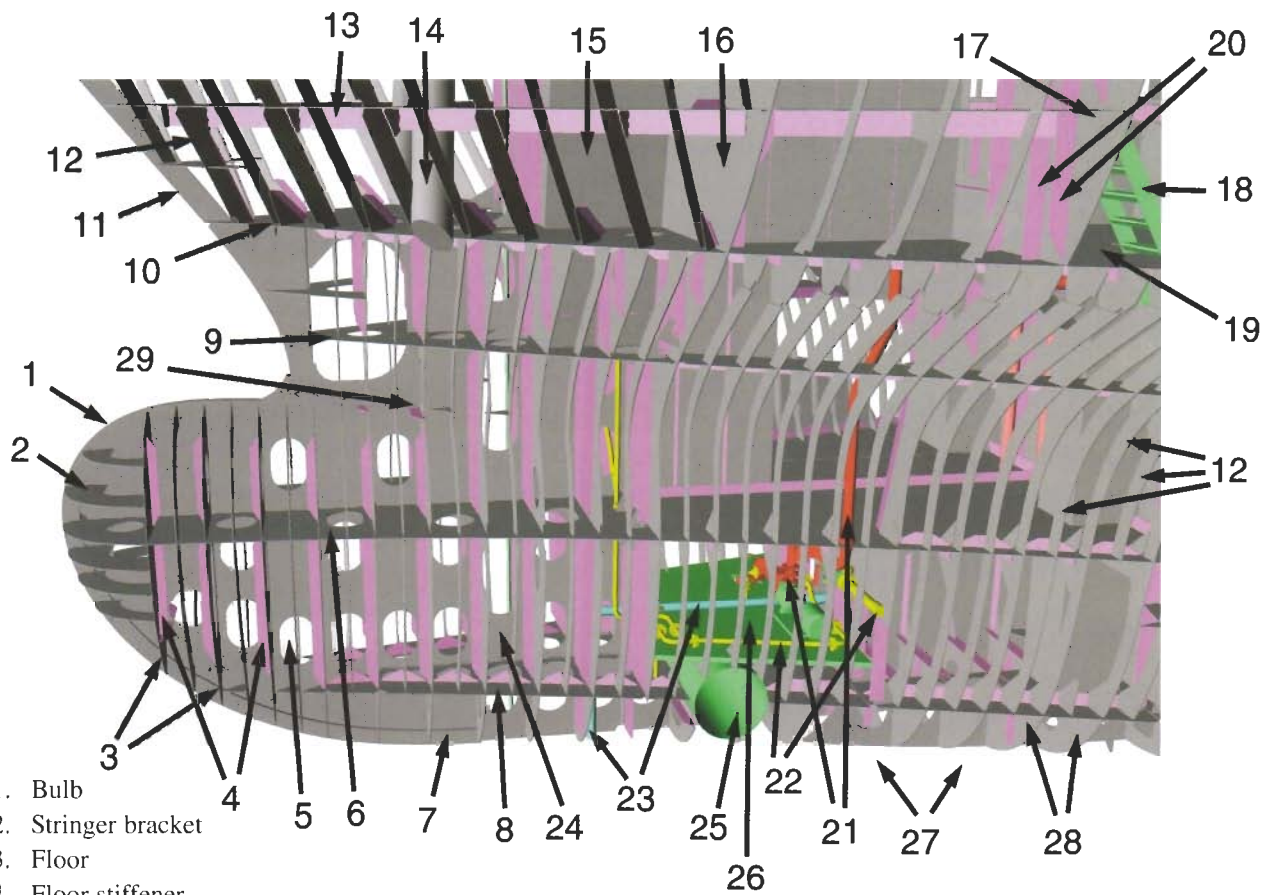

1. Bulb
2. Stringer bracket
3. Floor
4. Floor stiffener
5. Opening*
6. Stringer deck
7. Bow girder in bulb
8. Shell stringer
9. Transition of stringer deck to shell stringer
10. Bracket with flange
11. Girder bow
12. Shell frame (HP)
13. Shell stringer with flange
14. Hawse pipe
15. Chain locker
16. Watertight bulkhead (collision bulkhead)
17. Forecastle bulkhead
18. Stairway to the forecastle deck
19. Weather deck
20. Forecastle bulkhead frames
21. Emergency fire pump / bilge pump with emergency fire line and bilge line
22. Bilge line in bow-thruster room
23. Ballast line in fore-peak
24. Forepeak (water ballast)
25. Bow-thruster tunnel
26. Floor slab in bow-thruster room
27. Deeptank (water ballast)
28. Floors
29. Wash bulkhead at the centre line of the ship

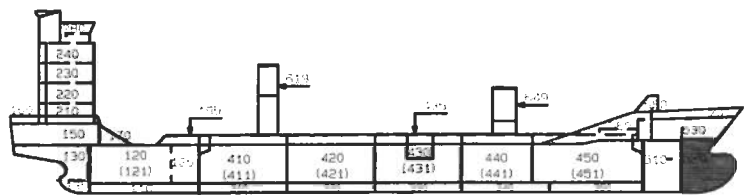

Location of the section in the ship

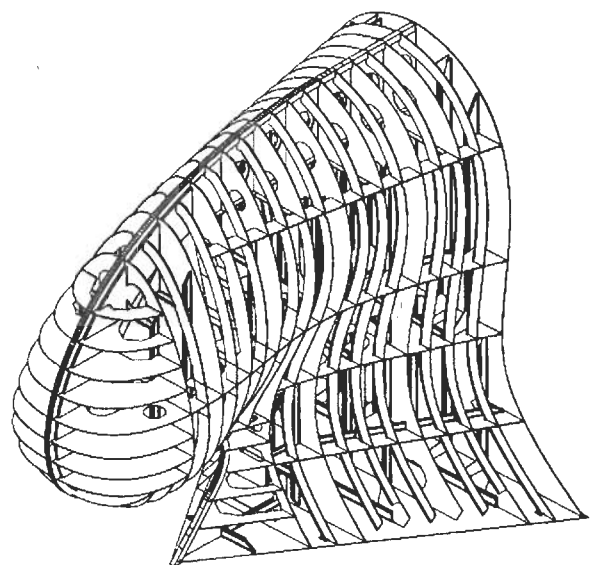

Assembly drawing

* NOTE: An opening cannot be blanked off whereas a manhole can be blanked off with a manhole cover, e.g. for access from one space to another space or tank.



Fitting of the shell plating



Forepeak, ready to be installed

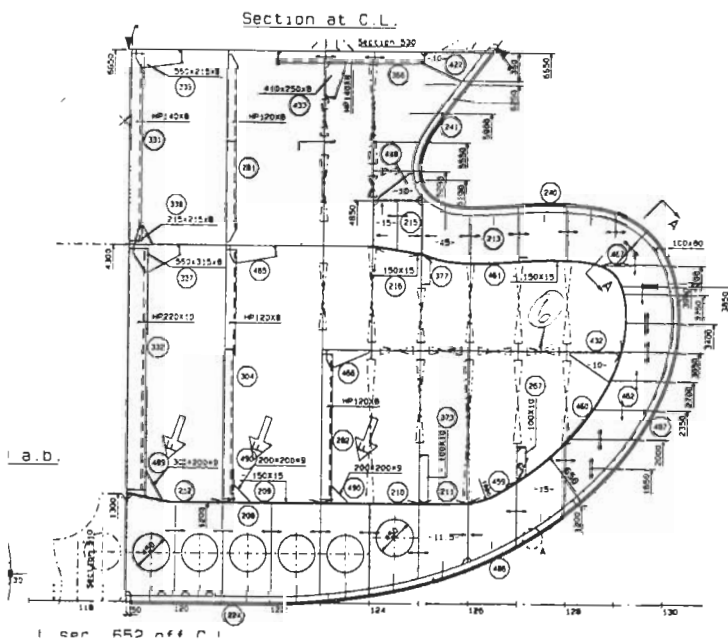

Longitudinal cross-section of the forepeak

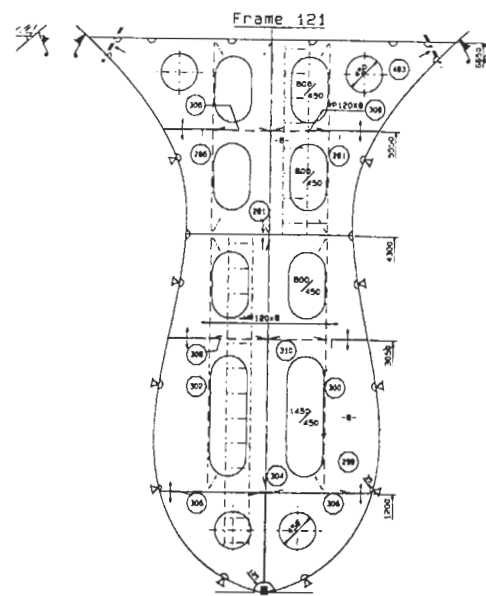

Transverse cross-section at frame 121

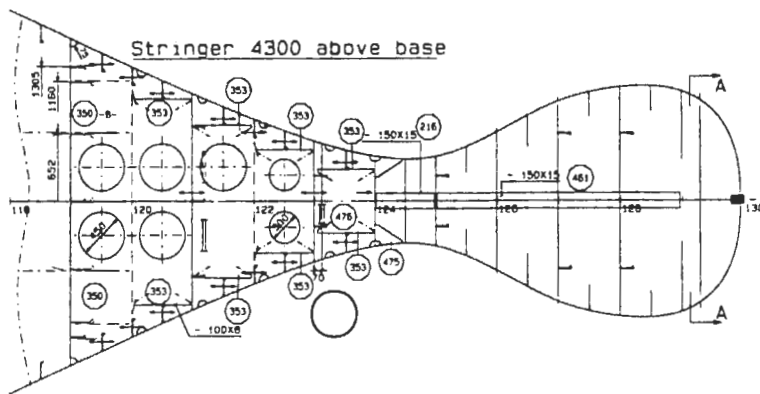

Horizontal cross-section at 4.30 m above the base line

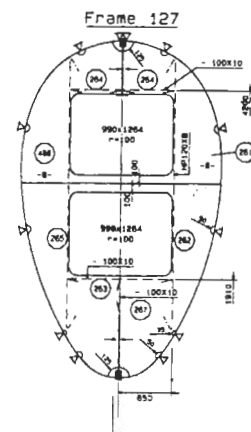

Transverse cross-section at frame 127



Location of the section in the ship

The drawing of the ship shown above gives a clear picture of the various stiffenings. Note that the web frames are never isolated but are always part of a ring frame. For every three framings there is a web frame. The stiffenings under the main deck run in the longitudinal direction. Directly underneath this is the icebelt; in this section there is an

extra frame for every frame. The ice strake can run all the way from forward to the place where the ship is at its widest.

1. The forward direction
2. Main deck
3. Deck longitudinals
4. Deckbeam
5. Double skin with longitudinal frames
6. Longitudinal frames
7. Additional intermediate framing for ice strengthening
8. Transverse frame

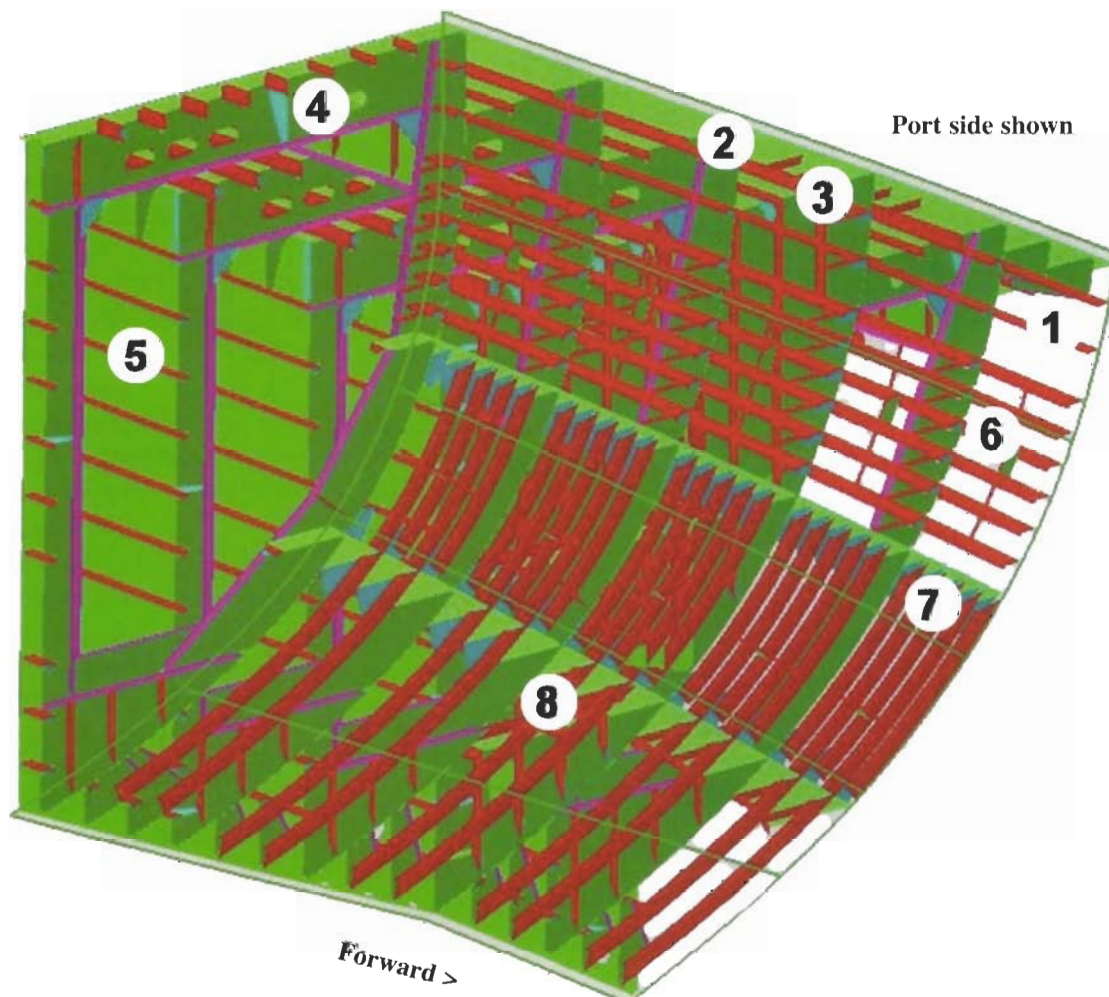

6 Accommodation

6.1 Introduction

In the past, the accommodation of the crew was not the most important aspect in the design phase. One reason for this was the large number of men in the crew compared to the present day. Thirty years ago (circa 1970) a crew of forty manned a vessel that would today have a crew of twenty. Due to the added workload of today's crew, pressure for improved facilities for the personnel is growing. Most cabins for example now have their own toilets and showers. As a result of smaller

crews and shorter lay days, the importance of recreational and leisure facilities has grown.

Part D – Fire safety measures for tankers.

6.2 Safety

In particular safety equipment demands focus on the prevention of fire. These demands are stated in the SOLAS resolution, chapter II-2 "Construction – Fire protection, Fire detection and Fire extinction". The chapter consists of the following parts:

- Part A – General
- Part B – Fire safety measures for passenger ships
- Part C – Fire safety measures for cargo ships

6.3 Environment

a. Vibrations

Vibrations are usually accompanied by sound or noise. Indeed, vibrations and noise often have the same source. On a ship those sources mostly are the propeller, the engines and even the waves at sea. Insulation techniques and prevention of local resonance are used to keep the vibrations in the accommodation within acceptable levels. (ISO-criteria: vibrations of 4-5 mm/sec are tolerated. Values larger than 10 mm/sec are unacceptable.)

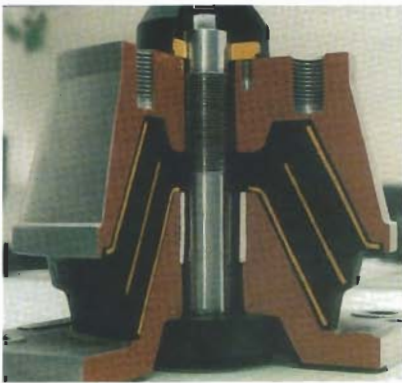

Cross-section of a flexible support

Flexible support of the engines

Flexible support of the (main) engine reduces the level of air sound. The flexible placing of the engine has two goals:

- reduction of the dynamic stress on the ship.
- reduction of dynamic forces on the engine foundation. Therefore less sound will be lead through the ship into the accommodation. If a hammer hits the foundation, the sound will travel through the construction and the sound can be heard in the foreship. If, however, a layer of rubber is placed between the foundation and the hammer, the sound will be largely absorbed.

Example of an abstract of the International Labour Organisation (ILO)

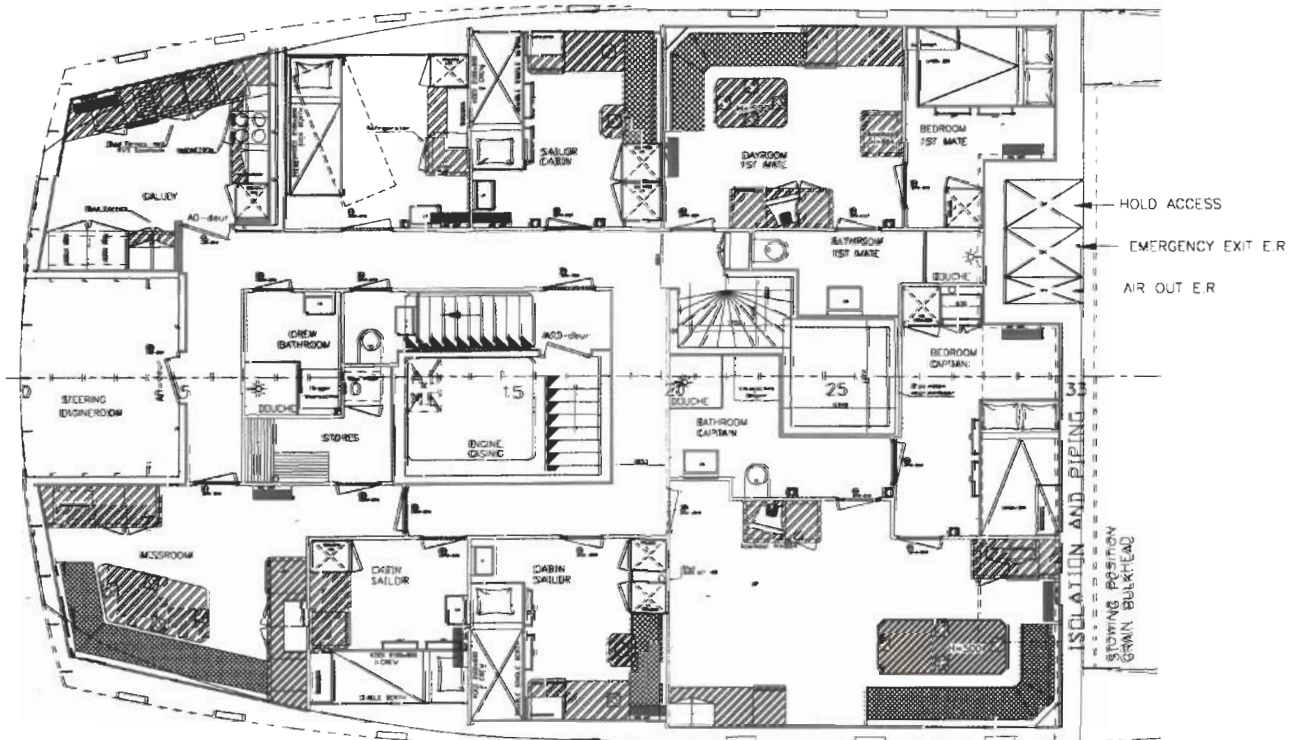

Ground plan of the accommodation on a coastal trade liner

1. Sufficient mess room accommodation shall be provided in all ships
2. In ships of less than 1,000 tons separate mess room accommodation shall be provided for -
 - (a) master and officers;
 - (b) petty officers and other ratings.
3. In ships of 1,000 tons and over, separate mess room accommodation shall be provided for -
 - (a) master and officers;
 - (b) deck department petty officers and other ratings;
 - (c) engine department petty officers and other ratings;

Provided that

 - (i) one of the two mess rooms for the petty officers and other ratings may be allotted to the petty officers and the other to the other ratings;
 - (ii) a single mess room may be provided for deck and engine department petty officers and other ratings in cases in which the organisations of shipowners and / or shipowners and the recognized bona fide trade unions of seafarers concerned have expressed a preference for such an agreement.
4. Adequate mess room accommodation shall be provided for the catering department, either by the provision of a separate mess room or by giving them the right to the use of the mess rooms assigned to other groups...

Example of an International Labour Organisation (ILO) extraction.

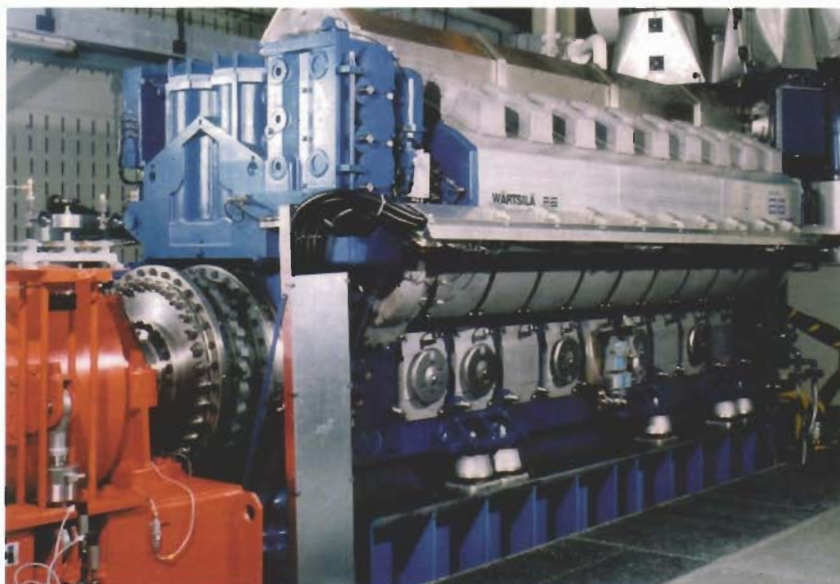

An engine placed on cushion mounts

b. Noise nuisance

Too much noise is disturbing and irritating and therefore has a negative impact on the working and living conditions on board the ship. Noise will affect:

- the communication in the engine room and the communication on the bridge. (The listening aspect of keeping watch is hindered)
- conversations in the common spaces.
- the peace in cabins where a low noise level is required and disturbance by music etc. from other spaces is not appreciated.
- condition of persons

(Disturbing) noises come from

- propulsion installation, propeller and auxiliaries
 - AC- and ventilation systems, cabin-refrigerators
 - Crew; music, TV, toilets, etc.
- Noise is expressed in decibels. The following maximum values apply for ships:
- day rooms, messroom etc.: 65 dB
 - cabins, sick bay.: 60 dB
 - galley, control rooms: 75 dB

c. Air conditioning

The air conditioning and climate control requirements of a space will depend on the temperature, humidity and number of air changes considered necessary. It goes without saying that a proper insulation of the accommodation is a prerequisite for the realisation of a good climate.

d. Lighting and Daylight

High demands are set for lighting in working and living spaces. Lighting armatures should be able to resist the vibrations on a ship and they should be easily accessible for maintenance.



Cabin with port-holes



Corridor

Windows (port-holes) in cabins and other spaces should have such dimensions and placing, that one is able to look outside both sitting down and standing up. There are also certain requirements for port-holes, like the design pressure and the positioning on the ship (e.g. not below the freeboard deck).



Bridge



Port-hole



Galley

6.4 Methods of insulation

Two methods of insulation widely used are:

a. The placement of rock wool plates.

- Walls

Plates of rock wool are attached to the welding studs that have already been placed on the steel plating. The drawing shows an example of fire protection and thermal insulation. The panels of the accommodation are free of contact with the insulation to prevent the transfer of vibrations. The panels are attached to, for instance, U-profiles which, in turn, are attached to the insulating floor.

- Flooring

To minimise disturbing sounds and to reduce the risk of fire, the floors (especially if they are directly above the engine room) are built as sprung floors. These floors can consist of multiple layers of steel

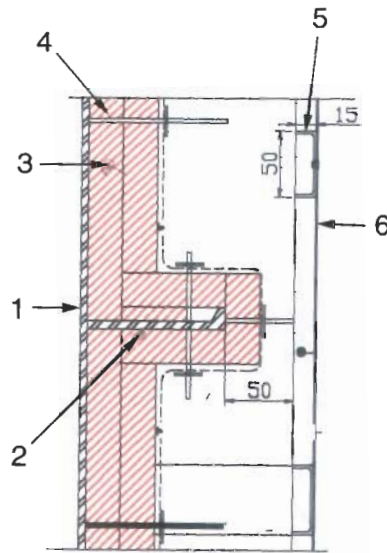

Fire and thermal insulation

1. Steel plate (outside of accommodation or inside boundary)
2. HP-profile
3. Glass wool
4. Welding stud
5. U-profile
6. Accommodation panel (a galvanised steel plate of 1 mm thickness)



Part of accommodation insulated by glass wool on welding pins

1. Weathertight door
2. Insulation on welding studs, covered by wire mesh
3. Moisture-proof aluminium foil

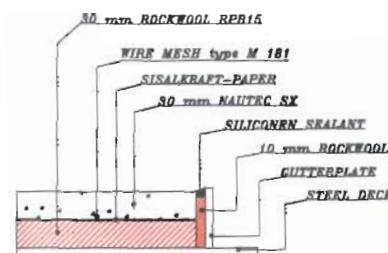

Sprung floor

wool with a large density (e.g. baffles) placed on the steel deck, covered by a hard ground slab.

b. Spray insulation

This form of spray insulation is sprayed on the bulkhead. Spray insulation can be used for thermal insulation, sound absorption and fire resistance (melting temperature is 750° C).



Applying insulation

6.5 Communication

Every cabin has to be equipped with a telephone and a terminal for a central antenna for radio and TV. For operational and safety reasons it is necessary that each member of the crew can be summoned or warned at any time and any place.

6.6 Maintenance

Cleaning and maintenance of the accommodation is a necessity for both hygiene and appearance. In general, the arrangement of the accommodation should be one which allows cleaning and maintenance to be fast and efficient. Things that have to be taken into account are:

- preventing dirt transfer from working to living spaces
- proper choice of materials (clean and easy to maintain)

In the design phase it is important to:

- include enclosed porches where dirty overalls can be taken off and hands can be washed.
- A locker on every deck in the accommodation



Lockers in the accommodation

6.7 Overview of the various spaces

Bridge

This is where all the means of communication and navigation are situated. Many ships have a control panel on the bridge connected to the engine room. From this point access to an item such as the ballast system which is located in the engine room can be achieved.

Cargo control room

On board tankers, loading and discharging is controlled from the cargo control room.

Galley.

The food is prepared here. It is situated near the mess-room to keep the walking distance as small as possible.

Laundry

A space located centrally with at least a washing machine and a drier.

Hospital

The arrangement of this space is subject to legal demands. Furthermore, it has to be easily accessible for a stretcher.

Cabins

These are more and more being standardised. For example: the captain, chief engineer, chief officer and other officers all have a cabin of similar size. Besides, there are maybe one or two other types of cabins. Nowadays, cabins can be finished completely at the working place (prefab). After placing on the ship only terminals for electricity, water, ventilation, heating etc have to be installed and connected.

Mess-rooms

Dining room

Duty-deck

On large ships, the lowest deck in the accommodation is a working deck where you can find the cargo-office, the captain's office, the board room, the galley and the mess-rooms. Apart from the bridge every space above this deck is private.

Duty-mess

If the food cannot be eaten in the mess-room, e.g. because there is too much work on deck or in the engine room, the duty mess is used.

Day-room

This is the focal point of social activities outside working hours.

Stores

- provisions
- bonded stores
- auxiliaries and tools for the engine room
- paint locker
- garbage locker.

Generally it is forbidden to dump garbage overboard.

Garbage is collected in an ordinary trash can or container with a press to reduce the space of the garbage.

- CO₂ -room
- Bathroom and toilets for the crew. Officers have a private bathroom and toilet. Lower ranks sometimes have a common facility.

CHAPTER 8

Closing arrangements



1. Pontoon hatch covers

1.1 General

1.2 Types of hatches

1.3 Positioning of a hatch

1.4 Distortions of the ship

1.5 Watertightness

1.6 Hatch cradle

1.7 Side-rolling hatch covers

2. Hydraulic folding hatches

3. Tween-deck hatches

3.1 Pontoon hatch

3.2 Folding hatch

4. Entrances

4.1 Side doors

4.2 Companion hatches

5. Miscellaneous

5.1 Accommodation doors

5.2 Watertight doors

5.3 Ventilation grills (louvres)

5.4 Manhole covers

5.5 Vent locking devices

5.6 Entrances to the ship

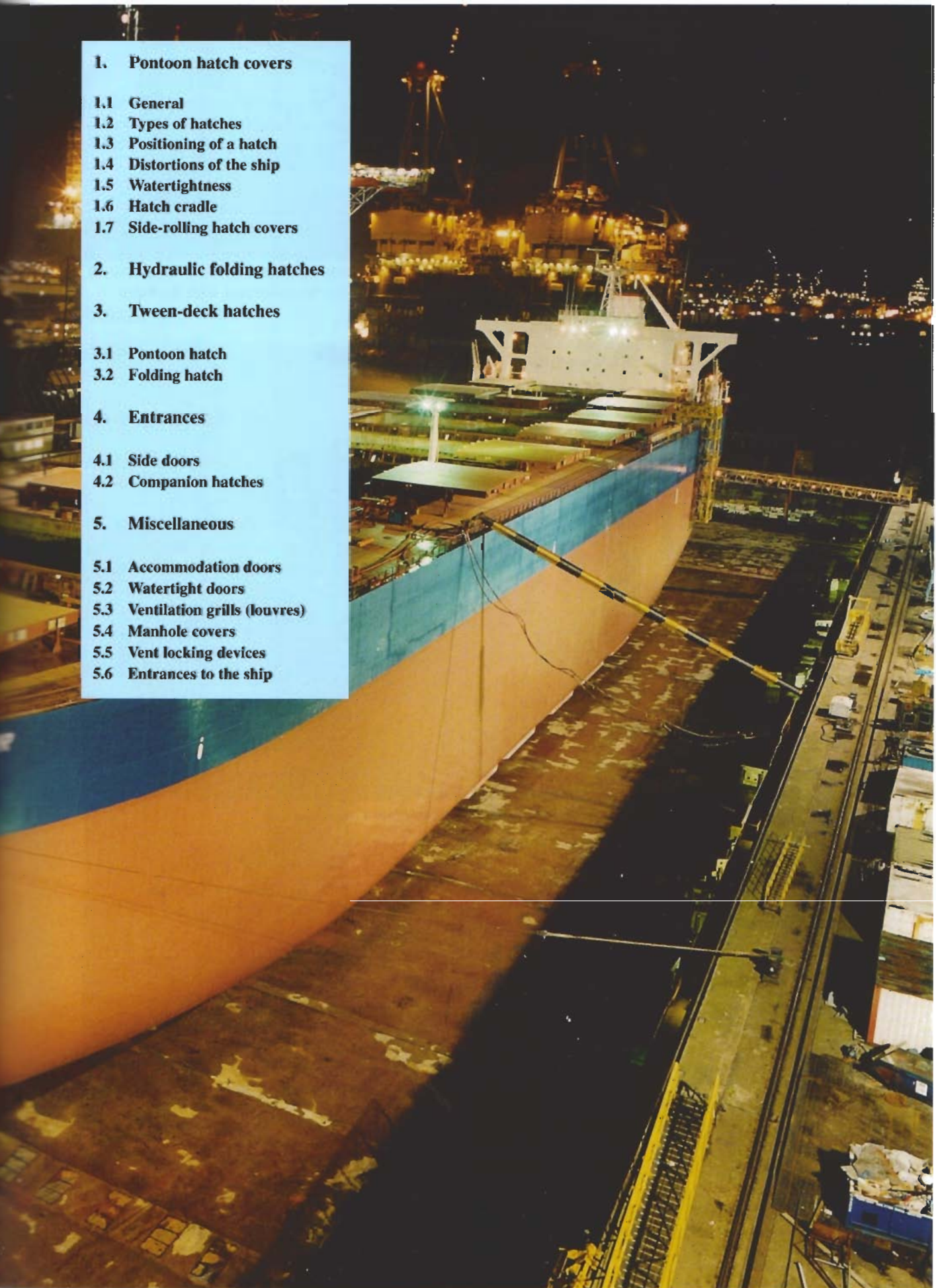

1 Pontoon hatch covers

1.1 General

The most common hatch cover nowadays on ships up to 10,000 tons is the pontoon hatch cover. Approximately 80-90% of these vessels use this system. The hatches (maximum weight 25 tons) are opened and closed by a hatch cradle, or a crane on the ship or on the quay. The hatch cradle can also move the pontoon hatch covers over the ship in the longitudinal direction. This system allows the hatch covers to be stacked on the coaming.

Reasons for buying pontoon hatch covers with a hatch cradle are:

- the system does not require a lot of maintenance
- tween decks and grain bulkheads can also be positioned with the hatch cradle.

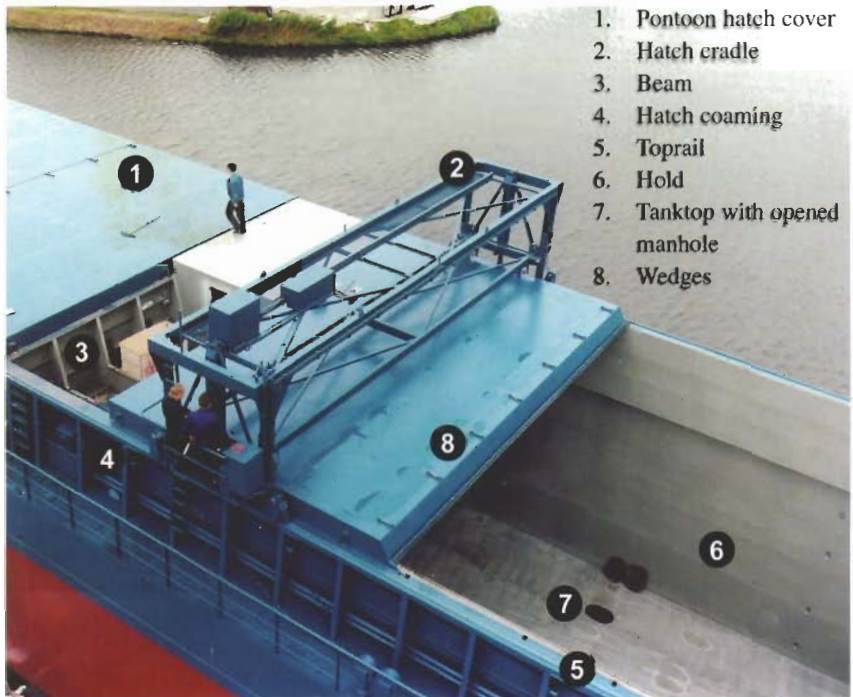

Coastal trade liner with a partially opened hatch

1.2 Types of hatches

Hatches can be divided into closing hatches, intermediate hatches and end hatches. If a hold is to be closed, then the intermediate hatches must be closed before the closing hatches, and the other way around when the hold is opened. Sometimes there is a short hatch in-between with a width of one metre or less; this is called a beam. These are not always present or necessary. The weight of a hatch can be somewhere between 10 and 25 tons.

Why a beam?

A beam acts as a small intermediate hatch and has the advantage that one can easily open just a part of the hatch covering. This is a big

advantage when it is raining. Sometimes the beam is left in place during cargo handling to absorb the stress between the sides of the hatch coaming.



Longitudinal drawing of the hatch arrangement (Various arrangements are possible)

1,6,7,13	End hatches
2,5,8,10,12	Closing hatches
3,4,9,11	Bottom hatches



Beam between two closing hatches

1. Beam
2. Closing hatch
3. Wedges

1.3 Positioning of a hatch

The positioning of pontoon hatch covers is more difficult than the positioning of hydraulic folding hatches. On the port and starboard sides of a pontoon hatch cover two profiles called centre punches are welded. When closing the hatch the centre punch engages in a recess in the top rail. The hatch is then locked on one side while on the other side the centre punch may have up to 60 mm of free space. As a result the pontoon hatch cover appears to move several millimetres over the sliding blocks in



Pontoon hatch covers. Struts can be placed in the U-profiles to fasten the deckload

1. Pontoon hatch cover
2. Toprail
3. Gliding block
4. Centre punch
5. Leading block
6. Wave breaker



Multi-purpose ship with pontoon hatch covers

1. End hatch
2. Closing hatch
3. Beam
4. Intermediate hatch

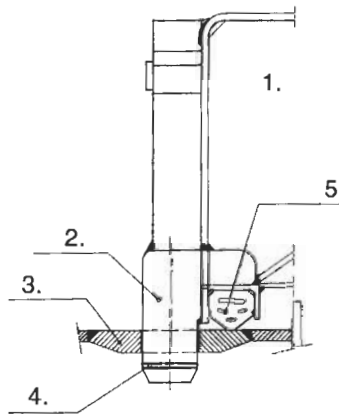

Immovable centre, transverse direction

1. Hatch
2. Centre punch
3. Toprail
4. Site for sealing by customs
5. Rubber packing

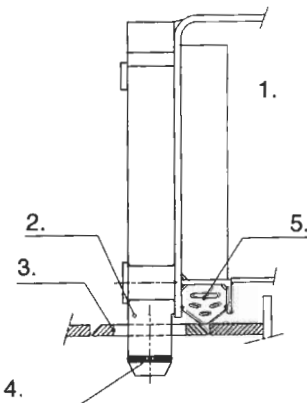

Movable centre, transverse direction

the transverse direction. This prevents the hatch from getting stuck if the width of the hold changes by a few millimetres.

Note: The gliding of the pontoon hatch cover is an apparent movement, not a real one. In reality the top rail is moving under the hatch.

1.4 Distortions of the ship

During loading and discharging the ship can be somewhat distorted. This phenomenon is called harbour deformation. The distortions can be prevented by the placing of one or more beams or hatches in the transverse direction. If, in spite of this, distortion still occurs, it can cause the hold walls and thereby the top rail to move several millimetres out of position.

Stainless steel gliding blocks are welded onto the top rail to guide the gliding of the hatches along the top rail.

Furthermore, the gliding blocks (5mm thick) prevent the hatch from sagging through the sealing rubber if there is too much weight on the hatch (deckload). Instead, the hatch rests on the gliding blocks. The sealing rubbers are allowed to be compressed up to 10 mm to prevent excessive wear.

It is not intended that the hatches absorb the forces acting on a ship in waves. This is why there is a movable and an immovable side.



Intermediate hatch

1. Rubber gasket
2. Impression strip (fore and aft direction)
3. Toprail
4. Pontoon hatch cover
5. Impression strip for the circumferential seam sealing
6. Hold

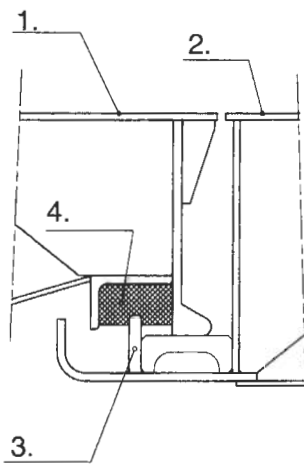

Circumferential seam sealing

1. Closing hatch
2. Intermediate hatch
3. Compression bar
4. Rubber gasket

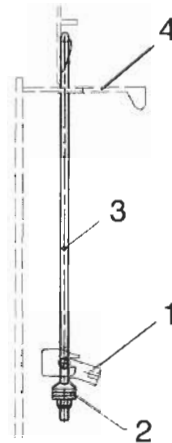
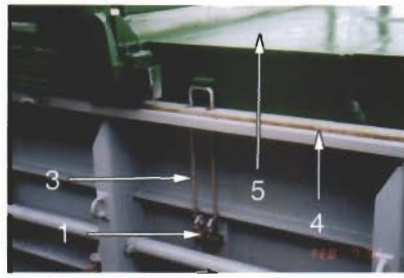

Cleat operated from below

1. Control position
2. Gasket of cleat
3. Handle of cleat
4. Top rail
5. Pontoon hatch

1.5 Watertightness

The pontoon hatch cover has to seal the hold watertight. This watertightness is achieved by:

- a. a gasket around the inside of the hatch cover
- b. cleats on the outer edge of the pontoon hatch cover
- c. wedges

a. To seal the pontoon hatch cover, a **rubber gasket** is put in place where the pontoon hatch cover rests on the hatch coaming / headlegde. The gasket is supported by an compression bar. If possible, the gasket has to be swabbed with vaseline once a week and kept clear of obstacles. In the athwart direction the gasket is in the closing hatch which rests on the compression bar of the intermediate hatch.

b. **Cleats** make sure that the rubber gasket is pressed sufficiently against the compression bar. There

are different types of cleats. Cleats can be attached on top or below the toprail by a control lever.

- c. **Wedges** placed along the full width of the hatch ensure the watertightness between two pontoon hatch covers.

Watertightness can be checked in two ways:

- The hose test. A powerful jet of water is sprayed against the joints of the pontoon hatch cover while simultaneously the hold is checked for leakage.
- With the aid of ultrasonic detection equipment. This is commonly used by charterers and P & I clubs prior to loading. This is commonly used when the ship is being built or after repairs when the bureau of classification inspects the hatches. A transmitter sender of sound waves is placed in the hold along with a detection microphone on top of the pontoon hatch cover. If the detector does not detect anything, the hatch is watertight. This test and the hose test are only random indications.

1.6 Hatch cradle

Ships that are equipped with pontoon hatch covers generally also have a hatch cradle to open and close the holds. Ships with a carrying capacity of more than 10000 tons (especially container ships) need a crane (on board or ashore) to open and close the hatches.

The lifting and lowering of the hatches by the hatch cradle is done by:

- hydraulic cylinders (up to 14 tons)
- steel cables operated by winches on the loading platform of the hatch cradle (up to 21 tons)

Hatch cradles are usually equipped with two storage cranes. These cranes are capable of:

- loading and discharging provisions and engine parts
- lifting of materials in and out of the hold
- carrying materials over the entire length of the ship.

1. Electromotor with hydraulic pump
2. Control box
3. Winches with steel cables for pontoon lifting

4. Storage crane
5. Control bob storage crane
6. Movable bridge
7. Columns
8. Wheel with hydromotor. Two of the four wheels are equipped with brakes.
9. Reel for the feeder cable

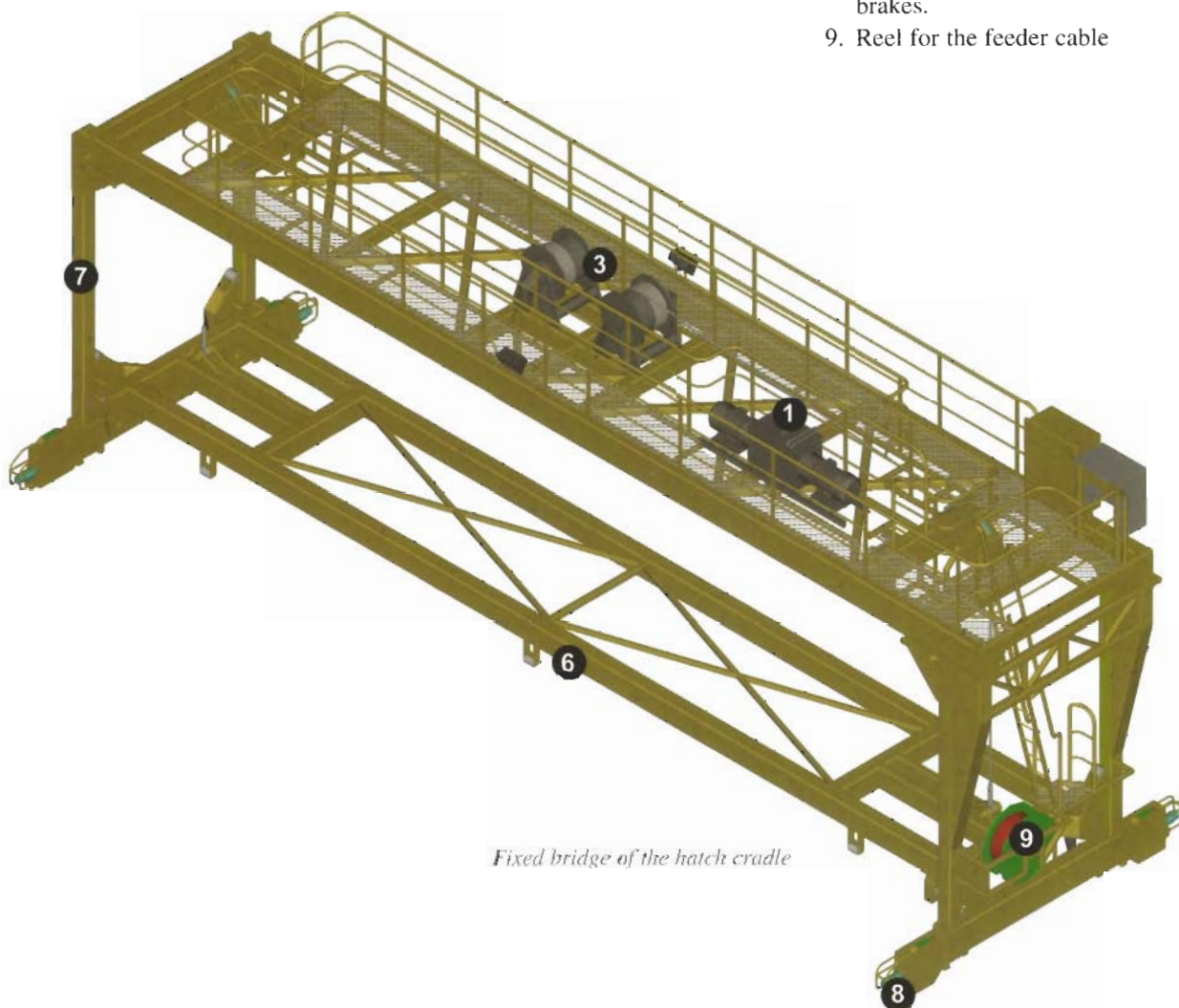

Fixed bridge of the hatch cradle



Top view of the hatch cradle, the fixed bridge



Top of the hatch crane



Ore carrier. Every hatch to be closed with one hatch cover

This crane can rotate 360°, but can not be topped or lowered. With the cradle one can also operate the working tray for work in the hold like:

- operating grain or separation bulkheads
- operating the supports for the tweendecks

be positioned anywhere in the hold by the hatch cradle. The bulkheads can then be used as tween decks or separation bulkheads.

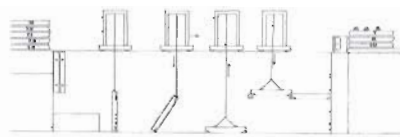

This drawing shows how, with the aid of the hatch cradle, the bulkheads can be utilised

- on the loading platform
- the bottom side near the gangway (BB and SB)
- speed brakes in the hydraulic system will immediately come into action in case of a hydraulic leak.

1.7 Side-rolling hatch covers

Hatch covers on large bulk carriers open and close in transverse direction. On large vessels especially, the hatch coamings have to withstand distortions of the ship as a result of the varying types of cargo, and the state of the sea. The hatches are opened and closed with chains or cogwheels. These are driven by (hydraulic) pumps located near the hatches. The individual hatchcovers have to be secured to the coamings by means of bolts etc.



The storage crane lifting provisions on board

The height of the working tray in the hold can be controlled by the person operating it. The steel cables that control the movable bridge can be disconnected and attached to a bulkhead. These bulkheads can then



Moving a pontoon hatch with a container crane

Safety on the hatch cradle:

- an optical signal with a bell if moving
- emergency stops on the hatch cradle:



Bulk carrier. Every hatch to be closed with one hatch cover

2 Hydraulic folding hatches

Folding hatches are opened and closed by means of hydraulic cylinders. The location of the cylinder depends on its type.



Folding hatch with cylinders on the outside

- a. Cylinders attached to the outside of the hatch use the head ledge as a fixed point. This type is only possible if it leaves enough walking space in the gangway (minimum of 60 cm).
- b. Cylinders which are supported by the beam. The pistons that push the hatch up or down are located at the main hinges.

Advantages of hydraulic folding hatches are:

- faster opening and closing (time = money)
- the hatches can cover the holds over the entire length of the ship (there is no hatch cradle blocking their way)

- easier to control, especially in bad weather
- more hatch area per hatch; this means that there are fewer transverse seams and therefore fewer rubber seals (e.g. instead of 10 pontoon hatch covers, only 8 folding hatches are required).

Disadvantages of folding hatches are:

- the high cost of acquisition
- the vulnerability of the hydraulic system

Safety devices:

- Ruptured hose safety system. This prevents the hydraulic system from emptying.
- If the control button is released (dead man's brake), the system will stop. For example, if the control button is on starboard a dead man's break should be installed on port side. Emergency breaks can also be installed.
- A safety hook. This prevents the opened hatches from slamming shut.



Partially opened hatch

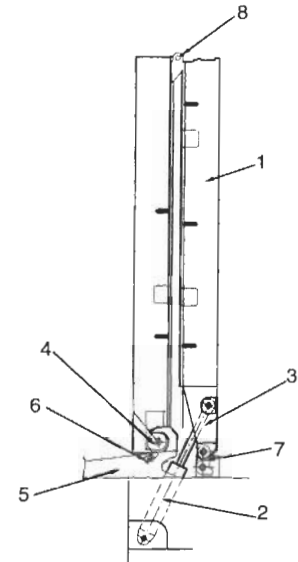

Cross-section of the folding hatch

1. Hatch
2. Cylinder
3. Stopper
4. Wheel
5. Ramp
6. Safety hook
7. Main hinges
8. Hinges between two parts of the hatch (hatch hinges)



ship with opened (hydraulic) folding hatches. The ship is being loaded with timber parcels

3 Tween deck hatches

Tween decks come in the following versions:

- pontoon hatch
- folding hatch

3.1 Pontoon hatch

Pontoon hatches are mostly found on multi-purpose ships where their function is twofold (see also chapter 8.1). Pontoon hatch covers can be placed both horizontally (tween deck) and vertically (grain or separation bulkheads). The positioning of the pontoons is done with the means available on the ship, like a hatch cradle or a crane. If the pontoons are not in use, they are stored in the store-position.



Horizontally placed pontoons as tweendeck

3.2 Folding hatch

Tween-deck folding hatches are common on ships that need multiple tween decks above one another such as reefers. In the case when there are three tween-decks, there is usually one tween-deck in which the folding hatch has thermal insulation. The folding hatches in tween-decks are mainly operated mechanically. The cargo runner of the crane is used to open the hatches.



Tweendecks with folding hatches on a reefer.

4 Entrances

4.1 Side doors

Side doors are found on ships with a large freeboard, like passenger liners. These vessels use this door to embark and disembark the passengers. Larger side doors (ramps) are used to load and discharge vehicles. Generally, these doors are controlled hydraulically (see also chapter 10). A side door locally weakens the strength of a ship. This has to be compensated for by a thicker skin plating and heavier construction parts.



An opened side door, equipped with hydraulic cylinders for opening and closing. Also shown in the photo a lifebuoy and the pilot ladder.

4.2 Companion hatches

Companion hatches come in many shapes and sizes. Some types are discussed below. Storage compartments often need a wide entrance because the stored parts can be quite large, like engine parts, lashing gear etc. The companion hatches can be opened manually or with the aid of a crane, a hatch cradle or a hydraulic system.



Hydraulically controlled entrance hatch

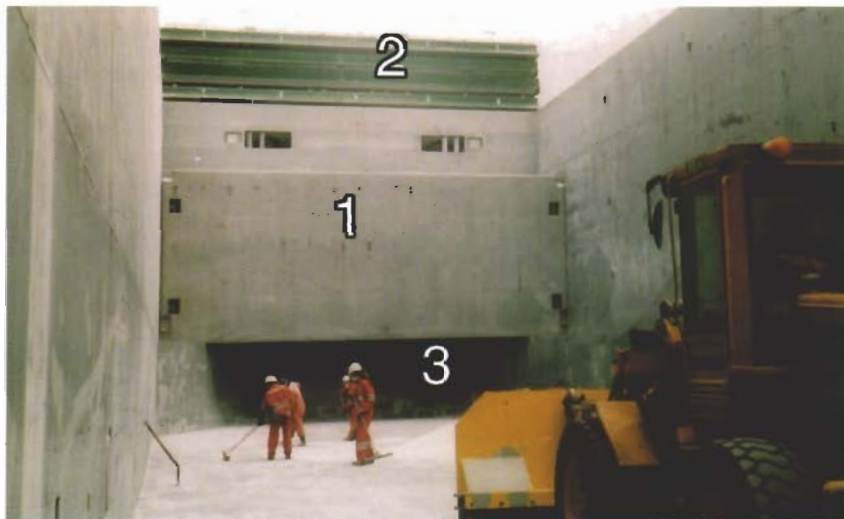

An almost completely discharged hold

1. Pontoon and bulkheads in storage
2. Pontoon hatch covers



A ship's crane opens a folding hatch

Companion hatches on oil tanks can be sealed from open air with a lid that makes the hatch impermeable to oil and gas. The lid itself is closed with

clamps. Just above the lid is a screw-thread on a wheel that is used to lift the lid and subsequently turn it away from the expansion trunk. The expansion trunk sometimes contains a smaller hatch that is used to take samples, determine the ullage and the temperature of the cargo.



A rotating tank-lid on an expansion trunk

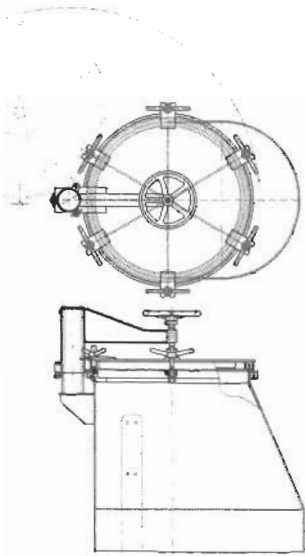

Cross section and top view of an expansion trunk with lid

5 Miscellaneous

5.1 Accommodation doors

Outside doors

Outside doors are weather tight. This means that, if the door is closed, it will only leak when submerged in water. The outside doors should be able to open and close with a single bar. The difference in the outside doors shown below is the number of closing points. This determines how watertight the doors are.

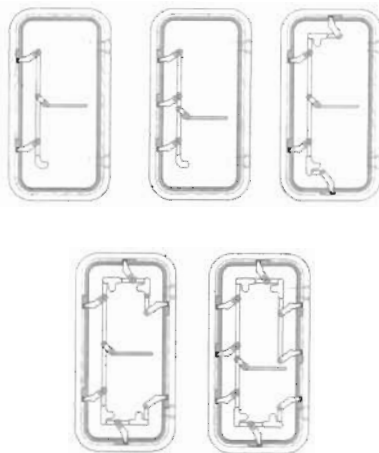

Types of outside doors that can be opened with just one bar



Outside door

Inside doors

These doors are behind the weather tight doors. The bureau of classification can demand that there is a fireproof zone in the accommodation. This can then be achieved by using metal fireproof inside doors.

5.2 Watertight doors

These are used in watertight bulkheads, for instance in the engine-room bulkhead. Watertight doors can be controlled at the actual location of the door as well as on the bridge. The control panel on the bridge indicates if a watertight door is opened or closed.

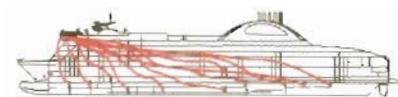

Overview of the watertight doors that can be controlled from the bridge



A watertight door

The doors are operated hydraulically. Even if the whole room is filled with water, the watertight doors should not leak.

5.3 Ventilation grills (louvres)

All the vents of the holds, the engine room and the accommodation are shielded by ventilation grills. These can be closed water- and airtight by a cover in case of bad weather or fire.



Ventilation grill with cover



Ventilation grill for the accommodation

5.4 Manhole covers

Manhole covers cover the access openings that are part of every tank, except for the cargo tanks. Manholes make it possible to inspect a tank.

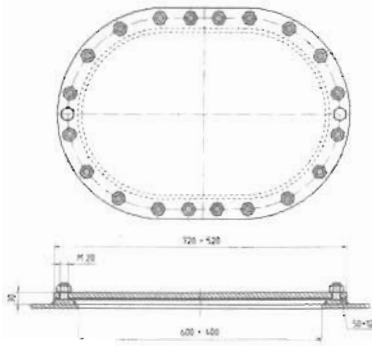

Cross-section and top view of a manhole cover

5.5 Vent locking devices

Tank bleeders

Every fluid-containing tank must have a means of venting in order to prevent over- and underpressure during emptying or filling. For this purpose, every tank has a venting pipe. This pipe ends on the freeboard deck in a tank bleeder that ensures that no seawater gets into the tank. In case of submersion of the tank

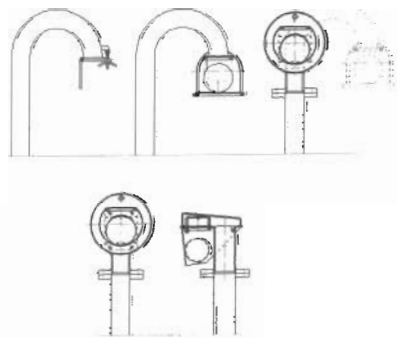

Some types of venting pipes

bleeder, the ball present inside the tank bleeder will float upwards until it is pressed against a rubber ring. This mechanism seals the pipe from the seawater. Tank bleeders can be implemented with:

- an overflow, capable of guiding the contents of the tank to another location
- an ullage opening where the depth of the liquid in the tank may be measured.
- a flameproof mesh (only in oil tanks)

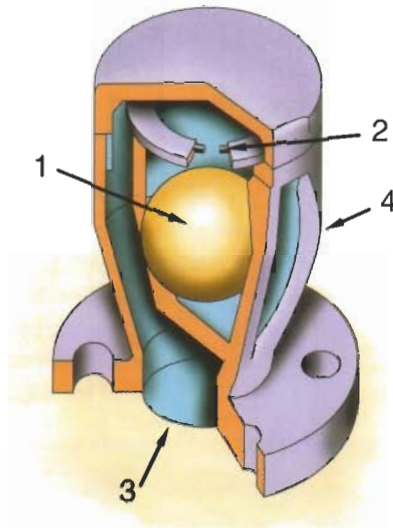

Drawing of the inside of a vent

1. Plastic ball
2. Rubber gasket
3. Vent opening
4. Air and water release pipe



Raised tank vents

Mushroom shaped vents

Mushroom shaped vents are only used for the venting and ventilation of the accommodation. They have to be closed in case of fire or bad weather. There are two ways of closing them, either manually rotating the top part or with a stop valve. They are a mechanical back-up when the air-conditioning does not work; under normal circumstances they are closed.

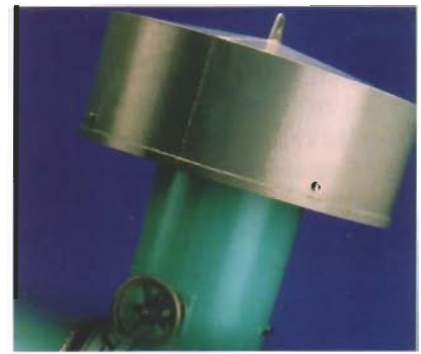

Mushroom shaped vent with a hand wheel

High speed pressure valves

High speed pressure valves are tank bleeders with the special characteristic that they let the gas escape only when a certain overpressure is reached, and not before that. The velocity of the escaping gas is so high (with a minimum of 30 m/sec) that it can never catch fire. The gas rapidly diffuses into the air and will not flow back to the ship.



Pressure / vacuum valve (P.V. valve)

They will also let air into the tank in case of underpressure, for example during the emptying of the tank. To ensure that no flames can get inside of the tank via this route, a fire resisting wire mesh covers the suction of the valve. The type of high speed pressure valves discussed here is the most widely used type on tankers. At the same time it is a safety device.

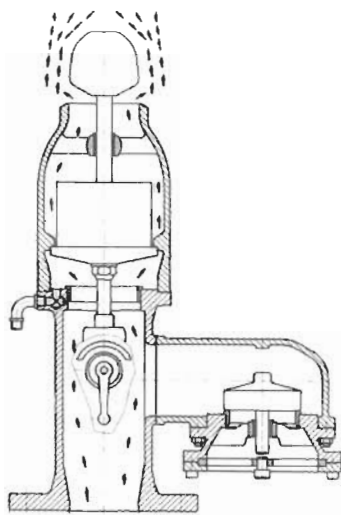

The arrows depict the path of the escaping gas

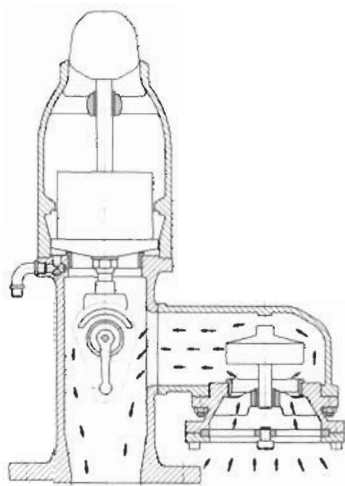

The arrows depict the path of the gas flowing in

All the parts mentioned in this section are either galvanised or made from stainless steel. The classification society determines which type of material is used.

5.6 Entrances to the ship

Accommodation ladder

Every ship needs means of getting people on board safely. Most vessels have two accommodation ladders, one on starboard and one on portside, preferably where the ship's side is straight. In general, the accommodation ladder is made of lightweight metal aluminium that makes it easy to handle. The staircase of the accommodation ladder is attached to a rotating platform so that, if necessary, it can turn away from the ship. On the quay the accommodation

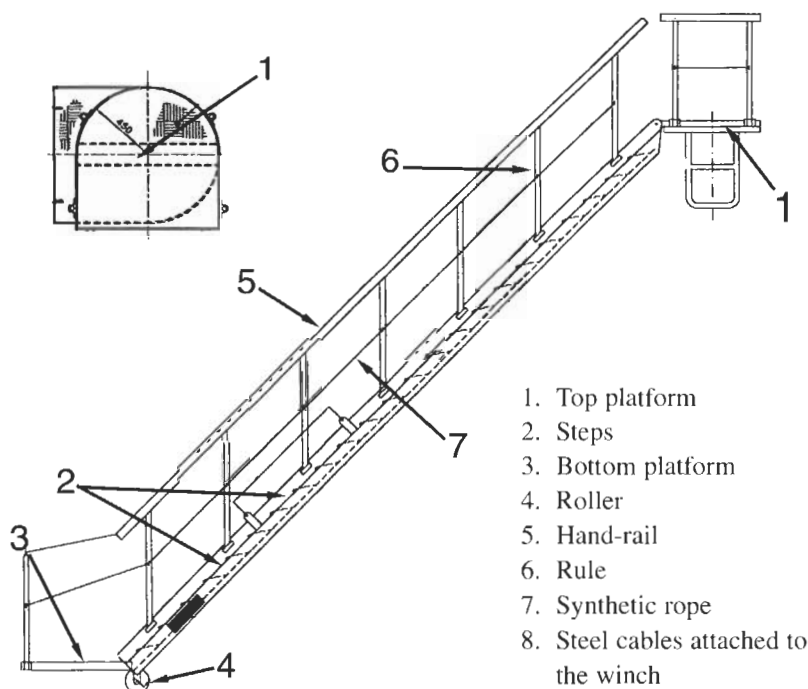

Side view of an accommodation ladder and top view of the platform:



Unfolded accommodation ladder.

Gangway

Many vessels have an aluminium gangway in addition to an accommodation ladder. This is used whenever the accommodation ladder cannot be used. The gangway is put into the right position by either a crane or by manpower.



Gangway on a passenger liner

ladder rests on a roller, which is at the bottom of the stairs. This roller ensures that the accommodation ladder does not jam as a result of changes in draught or movements of the ship. Lowering and lifting of the accommodation ladder is done by an electrically driven winch.

Compulsory safety measures:

- a safety net hanging under the gangway.
- a life buoy at the gangway with light

Pilot ladder

There are strict regulations governing pilot transfer. There are regulations for the pilot ladder, the bulwark ladder, the safety means and for the ways in which these are arranged. The pilot can refuse using the pilot ladder if the position or quality of the ladder is not in agreement with the regulations.

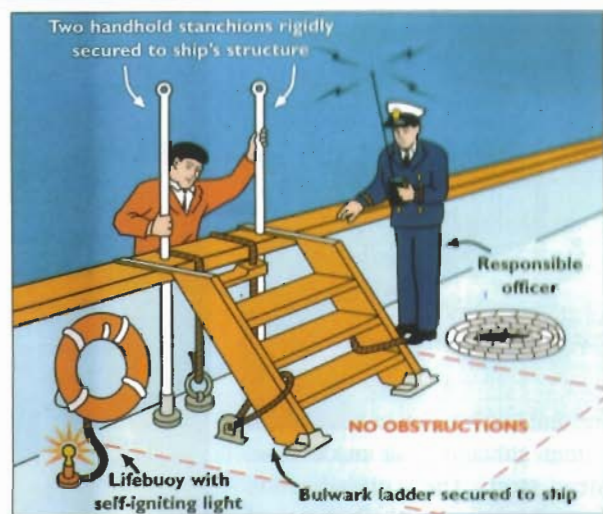
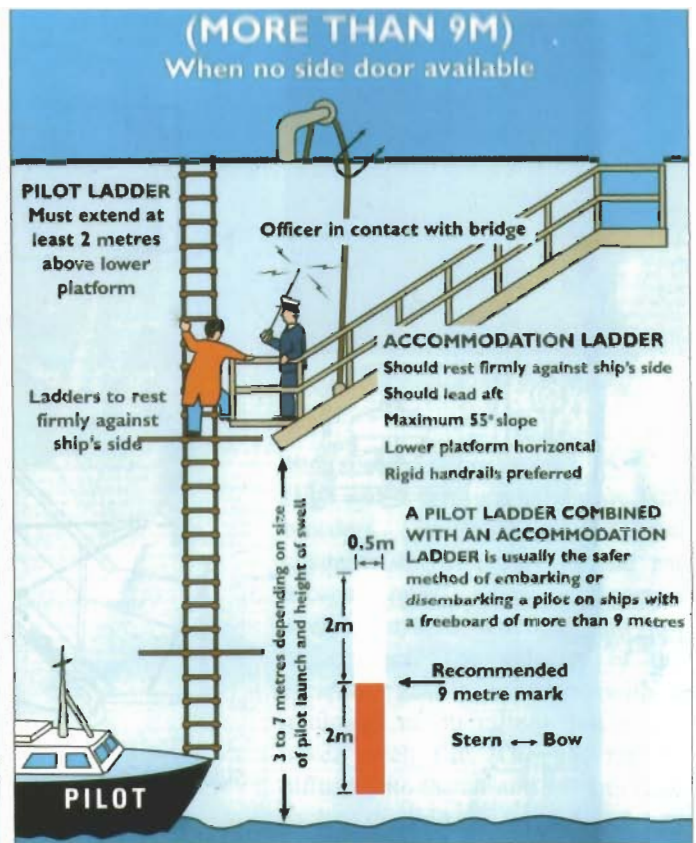
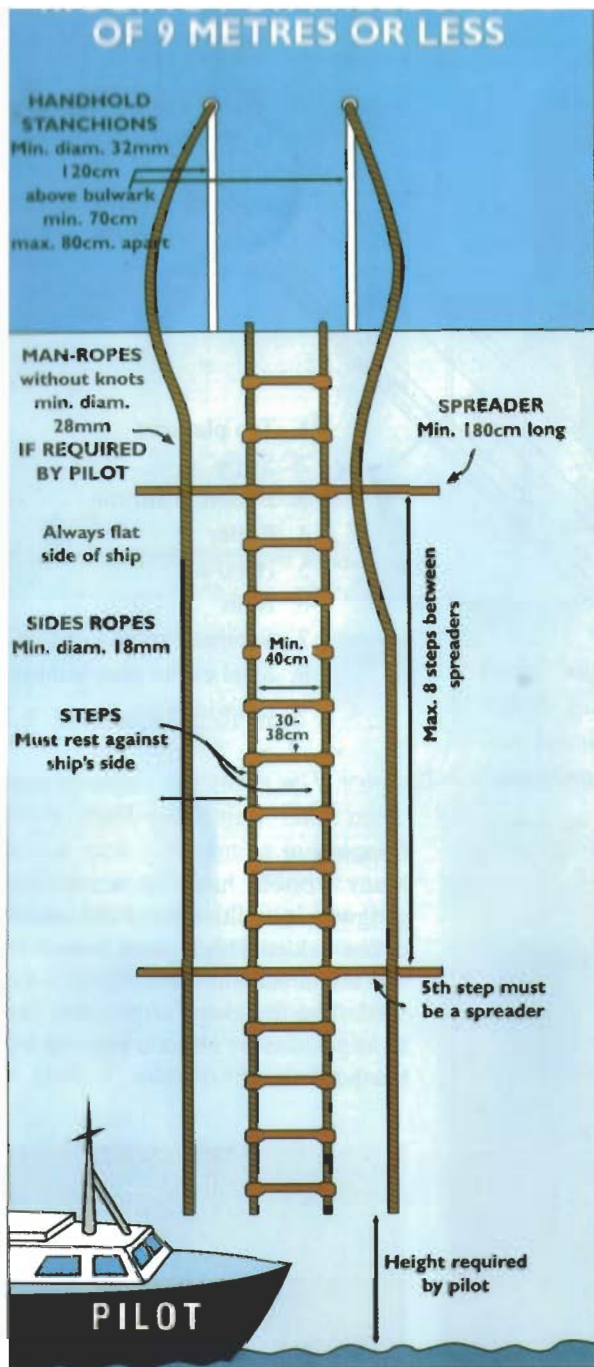

This drawing instructs how the pilot ladder and all the auxiliaries involved should be positioned in order for the pilot to safely board the ship. Taken with kind permission from: "Witherby & Co.LTD" in London

CHAPTER 9

Loading gear

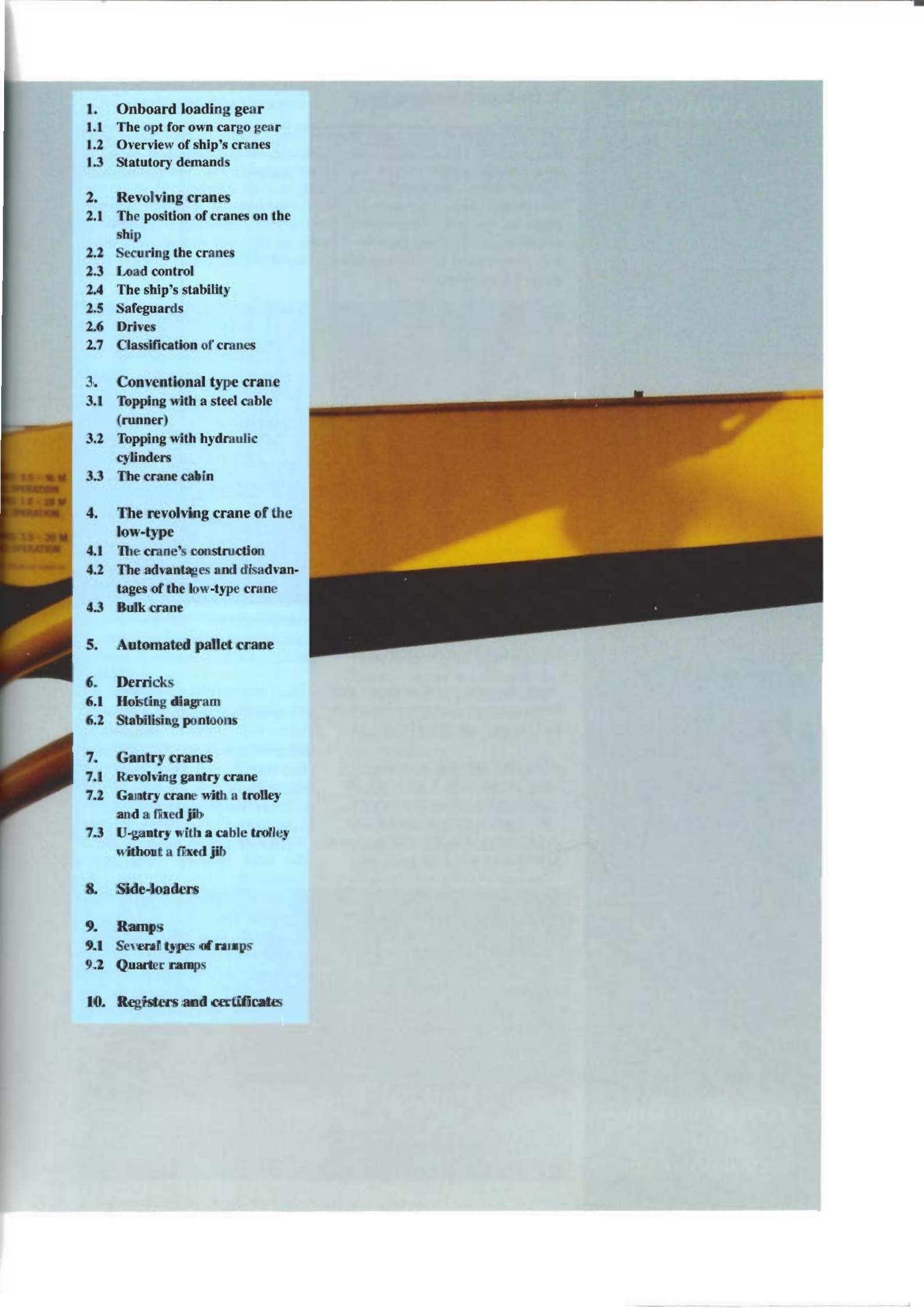

- 
- 1. Onboard loading gear**
 - 1.1 The opt for own cargo gear
 - 1.2 Overview of ship's cranes
 - 1.3 Statutory demands
 - 2. Revolving cranes**
 - 2.1 The position of cranes on the ship
 - 2.2 Securing the cranes
 - 2.3 Load control
 - 2.4 The ship's stability
 - 2.5 Safeguards
 - 2.6 Drives
 - 2.7 Classification of cranes
 - 3. Conventional type crane**
 - 3.1 Topping with a steel cable (runner)
 - 3.2 Topping with hydraulic cylinders
 - 3.3 The crane cabin
 - 4. The revolving crane of the low-type**
 - 4.1 The crane's construction
 - 4.2 The advantages and disadvantages of the low-type crane
 - 4.3 Bulk crane
 - 5. Automated pallet crane**
 - 6. Derricks**
 - 6.1 Hoisting diagram
 - 6.2 Stabilising pontoons
 - 7. Gantry cranes**
 - 7.1 Revolving gantry crane
 - 7.2 Gantry crane with a trolley and a fixed jib
 - 7.3 U-gantry with a cable trolley without a fixed jib
 - 8. Side-loaders**
 - 9. Ramps**
 - 9.1 Several types of ramps
 - 9.2 Quarter ramps
 - 10. Registers and certificates**

SHIP KNOWLEDGE

A MODERN ENCYCLOPEDIA

SHIPWISE

PAGE 8 **1**

THE SHAPE OF A SHIP

PAGE 22 **2**

SHIP'S TYPES

PAGE 44 **3**

THE BUILDING OF A SHIP

PAGE 68 **4**

FORCES ON A SHIP

PAGE 82 **5**

LAWS AND REGULATIONS

PAGE 104 **6**

CONSTRUCTION OF THE VARIOUS

SECTIONS

PAGE 126 **7**

CLOSING ARRANGEMENTS

PAGE 160 **8**

LOADING GEAR

PAGE 174 **9**

ANCHOR AND MOORING GEAR

PAGE 196 **10**

ENGINE ROOM

PAGE 216 **11**

PROPULSION AND STEERING GEAR

PAGE 244 **12**

ELECTRICAL INSTALLATIONS

PAGE 266 **13**

MAINTENANCE AND DOCKING

PAGE 280 **14**

SAFETY

PAGE 302 **15**

STABILITY

PAGE 322 **16**

CHAPTER 9 QUESTIONS

VISIT

WWW.DOKMAR.COM

1. Onboard loading gear

Transshipment is moving cargo into and from a means of conveyance, like a ship or a truck. Most cargo is moved with the aid of loading gear. Only very small and lightweight cargo is still moved by man-power. The loading gear is either present on the ship (self-discharger) or at the transfer yard. In the latter case the quay has a large array of mobile cranes capable of moving across the length of the quay. These cranes used to move exclusively on rails, but nowadays an increasing number of cranes are equipped with ordinary wheels with air-tyres and steering capabilities. This allows the cranes to move freely across the entire quay.



A mobile crane on pneumatic-tyres



A mobile container crane on rails

1.1 The opt for own cargo gear

There are many types of cargo gear for ships and just as many incentives for choosing one or the other:

- The charterer (who rents the ship) demands it. Why, is not the the shipping company's concern, but if not in possession of a self-discharging ship, the order goes to a competitor who does have one!
- The area of navigation demands it because the ports in that area lack cranes. This is often the case in Africa, South-America, Asia and in small ports and factory sites all over the world.
- In order to transport special cargo. This requires special attention, however is paid better in general. Special cargo is a one-time, large-scale transport like a complete factory, moved in sections.

Ship's cranes reduce the stability and the carrying capacity of a ship; they also cost money and require attention. On a general-cargo ship, two cranes, including foundation, represent 10% of the total building costs. Refrigerated vessels often have 7 or more (light) cranes on board which may cost as much as 20% of the total building costs. As a compromise it is possible that a ship is built without cranes, but with the necessary foundation (strengthening in several places on the ship) and piping systems. If cranes are then required, they can be installed without radical changes to the ship and without extra loss of time (if the cranes are ordered in advance).

1.2 Overview of ship's cranes

type of ship	dead weight	crane capacity	number of cranes
general cargo	<3000 dwt	25 t	none or 1 or two
feeders (300 TEU)	5000 dwt	40 t	2
feeders (600 TEU)	9000 dwt	40 t	2
containers / general cargo	10000 dwt	40 to 120 t	3
bulk	6000 dwt	25 to 30 t	6
bulk	70000 dwt	0	none
refrigerated cargo	10000 dwt	7 to 40 t	4 to 7

1.3 Statutory demands

The statutory demands for loading gear, including lifts, ramps, hoistable decks etc. are laid down in the ILO-convention 152 (International Labour Organisation). Compliance with the regulations is under the supervision of the Shipping Inspectorate and Classification Societies like Lloyds and Veritas.

Classification of loading gear can be according to:

- National law, which states that the ship checks the gear annually and a class check is done every 5 year.
- International regulations which state that the gear has to be checked every year by the Classification Bureau.

Division of tasks.

The inspections, certification and responsibilities are divided as follows:

- All ILO-152 tasks directly related to cargo handling (cranes, ramps etc.) are the responsibility of the Classification Society.
- All ILO-tasks related to safety, like entrance to the ship, hold or crane entrances and safety in the holds as well as supervising the Classification Societies are the responsibility of the Shipping Inspectorate.
- All tasks that do not result from the ILO-152 treaty like hoisting gear in the engine room, store cranes etc. are the responsibility of the shipping company, in compliance with national law.

Certificates

The items checked by the Classification Bureau are noted in the Register of Ship's Lifting Appliances and Cargo Handling Gear.

Excerpts from the ILO-152 treaty:

Every seagoing vessel must have a Register of Ship's Lifting Appliances and Cargo Handling Gear.

The inside cover of this register must state :

- The rules for the five-yearly inspections as stated in the ILO-rules and the rules of the Classification Society.
- Rules for the annual inspections
- Test certificates must be present for all parts of the loading gear that can wear through use and ageing, like:
 - the crane (complete)
 - the runner/topping lift wire(s)
 - the blocks and sheaves
 - the hoisting winch
 - the crane hook
 - attachments

The certificate must show which requirements are met for every part.

- Certificates are marked by a stamp with the signature of the surveyor, the surveyor's number and the date and place of testing.
- The bottom of the jib must show:
 - the maximum hoisting capacity
 - the range that goes with it (the horizontal distance between turning point and vertical runner). These figures must be clearly visible from the place where the cargo is hooked on to the cargo hook.

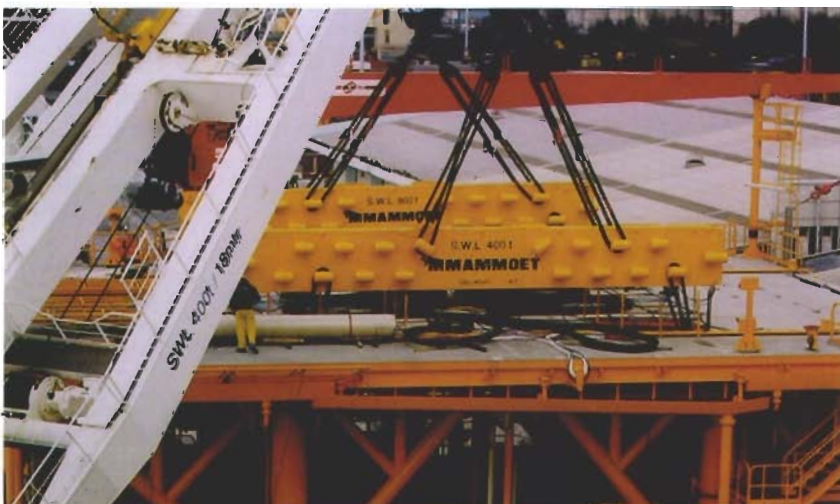

Indication of SWL and range of a large shearlegs floating crane

Example:

SWL 60 t (40 t)/16 m (28 m)

SWL means Safe Working Load and is 60 tons with a range of 16 metres and 40 tons with a range of 28 metres.

2. Revolving cranes

The picture below shows a ship with two common revolving cranes. The crane house is attached with a slewing bearing to a pillar, which is part of the ship. The slewing bearing is a very large double-turning bearing. An electrical or a hydraulic motor grabs in the pinion of the turning ring, which is a large ring-shaped cogwheel that rotates the crane. The crane cannot rotate unrestrictedly because of the electrical lines running to and from the crane.

The crane cabin is a steel construction with windows that give the crane driver a wide view of the area of activity. The wire drum(s), drive engine(s) and the controls and security are all located in the crane house. The diameter is 2-3 metres.

The crane jib is hinged to the crane house, making lowering and topping possible. The crane jib consists of one or two box beams. The jib is designed in such a way that it has the desired strength, while its weight is minimal and its stiffness is maximal. The different types of revolving cranes that are discussed below can be distinguished mainly on the basis of where the jib is attached to the crane house.



Deck crane



Feeder with deck cranes

1. Foundation
2. Slewing bearing
3. Crane house
4. Jib



Container feeder with revolving deck cranes

2.1 The position of cranes on the ship.

Masts and cranes used to be placed exclusively on the center line, but nowadays they are more and more moving towards the side of the ship.

The following remarks can be made on this:

- Positioning on the centre line of the ship is best for the ship's stability. The crane driver has a good view of the holds, but not of the quay. There is also no preference which side of the ship should be berthed against the quay.
- If all the cranes are positioned on one side of the ship, there is an adverse effect on the position of the ship's centre of gravity. Therefore, only large ships, where the mass of the cranes is very small compared to the ship's total mass, have this kind of arrangement. For the crane driver the view of the holds is not so good compared to the situation where all the cranes are on the centre line, but the view on the quay is greatly enhanced. In addition, the reach of the crane on the quay is also much improved.
- The change in position of the centre of mass away from the centre line is prevented when the cranes are positioned in an alternating fashion on the two sides the ship. But now some cranes are not on the side of the quay, which is bad for the view and reach of these cranes. This is not a disadvantage when the discharging is done from ship to ship (for instance with barges).
- If remote controls are used, the view from the crane cabin is of no importance. The crane driver can position himself wherever the view is the best.



The crane jibs secured in their supports

1. Pillar
2. Slewing bearing
3. Crane house
4. Jib
5. Support on neighbouring crane
6. Support on bridge house

- A neighbouring crane as support if the crane jib's length equals the distance between the two cranes.
- A support against the crane cabin to which the jib can be fastened when the crane is not in use.

2.2 Securing the cranes

All crane jibs undergo additional stress when the ship sails in waves. Therefore all jibs have a boom cradle as support to which they can be fastened during the voyage. This can be done in several ways:

- a fixed or moveable support, somewhere on the deck
- a fixed support against the forecastle, deck erection, the groyne or the poop deck.

2.3 Load control

a. Slewing velocity

Revolving cranes often have a very long cargo runner to which the load is attached. If the crane revolves, the initial velocity of the load will be smaller than the velocity of the jib. This initial velocity then builds up. When the jib has reached its final position and stops there, the load will still have momentum, which sends it past the position of the jib. The skills

The runner is the hoisting rope; manufacturers of winches often call the free hanging part of the runner the hoisting rope and the part that goes from the winch to the head of the jib the runner.

of the crane driver make that the load arrives at its proper location.

An objection to the revolving crane is that the horizontal momentum of the load makes it difficult to accurately position the load. High loading and discharging speeds can not be obtained therefore. In many cranes with a large range, the angular velocity, when revolving, is reduced automatically. This should be done because:

- The forces of accelerating and decelerating increase with the square of the range.
- The centrifugal forces, which give the load the tendency to leave its circular trajectory, increase as a function of the crane's range.
- Crane drivers can control the load up to a maximum angular velocity of 2.5-3 m/s.

b. Lifting capacity

The maximum lifting capacity of a drum winch is, on average, 10-25 tons. If the range increases, this force causes a greater moment on the crane (tipping moment). For this reason, the maximum load of all cranes depends on the range (inversely proportional). In some cranes, the maximum pulling force of the winch is automatically reduced when the range increases. This prevents that loads are lifted when the range is too large.

c. Lifting velocity

In some cranes it is possible to switch the winch manually from single work to double acting. In double acting, the maximum lifting force is larger and the lifting velocity smaller (inversely proportional). Often this happens automatically; if the winch has to lift heavy loads it will slow down.



Midship deck cranes (SWL 40 tons and range 28 metres)

1. Support on deckhouse
2. Support on the forecastle

2.4 The ship's stability

When working with cargo gear, the stability (GM_0) of the ship must be positive to such an extent, that it remains positive when a load is being lifted. Modern revolving cranes are allowed to cause a list of no more than 5 degrees. Too great a list can be prevented or reduced by pumping ballast water or fuel. In many ship's this is automated by an anti-heeling system that automatically pumps water from one wing tank to another.

In general, revolving cranes are hardly bothered by trim (the difference in draught forward and aft). Most cranes can tolerate a trim of 5 degrees, but there are also cranes with a maximum trim of 2 degrees.

One of the reasons for a maximum list and a maximum trim is that the slewing engine must overcome a larger part of the load's weight (this increases with the sine of the crane's angle with the vertical).

2.5 Safeguards

Some safety measures of revolving cranes are typical for these types of cranes, others apply to all crane types. General rules:

- A zero voltage device shall be present. If the power supply is restored after it has been interrupted, the crane must not start to operate on its own. Nowadays the main switch shuts off automatically. It can be turned on again when the crane driver is back in place and resets the controls.
- An overload safety shall be present. If any part of the crane experiences an overload, this part is immediately shut down. In case of an electrical crane motor any overload should also activate the brakes. If this does not happen, the load or the jib falls down, and when the crane is revolving it will be difficult to stop it.
- Emergency stops shall be present. Red emergency stop buttons shall be present within reach of the crane driver and wherever the regulations require them. When pushed, all movement of the crane is made

impossible. Emergency stops can only be reset locally.

- A hoist-limit switch shall be present. This is a limit switch that defines the highest position of the hook.
- Empty-drum safeguard. The hoisting cable shall be wrapped around the drum at least three times in order to acquire sufficient lifting capacity (friction).
- Sometimes an inclination-limit switch is present. This shuts down the crane when the angle of inclination becomes too large.

Specifically for revolving cranes:

- A limit switch for the highest and lowest position of the jib. This is also the maximum and minimum outreach limit.
- Turning-limit switch

2.6 Drives

Every crane has at least three engines: one for the runner, one for the topping of the jib and one for slewing. The engines can be driven either hydraulically or electrically. The hydraulic engines are powered by an electric motor; the actual forces in the crane, however, are generated by the hydraulic engine.

a. Hydraulic crane drives

The runner and the slewing both require revolving hydraulic engines; the topping of the jib is done with a hydraulic cylinder. The main slide valve is controlled with the main lever via the driver valve. The engine automatically stops moving in a direction when the crane reaches an extreme position. This is done with the aid of a limit switch and an end-switch. Of course, movement in the opposite direction is still possible.

The main slide valve often has a very ingenious construction that adapts the force and velocity of the winch engine to the position of the control lever. The main slide valve also keeps the brakes off when necessary. Furthermore, if the oil lines of a hydraulic engine are closed, the main slide valve can absorb the extra load.

b. Electric drives

The electrical drives of the ship's cranes receive their electricity from the ship's switchboard. For this purpose, the ship's 3-phase current is changed by an adjustable converter into either direct current (DC) or an alternating current with an adjustable frequency. The control lever operates the converter, which sends current to the engine and keeps the brakes off. In contrast to the hydraulic engines, the electrical engines can not absorb the forces of a load if the power supply is cut off. In case of a stop-command, the brakes are applied instantaneously to overcome this shortcoming. However, as a result of this, the brakes of an electric winch engine get worn faster than the brakes of a hydraulic winch motor.

As in hydraulic drives, excessive lifting, slacking, topping and slewing are prevented by a limit-switch. Of course, moving in the opposite direction is still possible.

2.7 Classification of cranes

Revolving cranes can be distinguished into the following types:

- conventional type
- low type
- automated pallet crane
- revolving gantry crane

3. Conventional type crane

The advantage that the conventional revolving cranes have over the low types is that during topping and slacking, the load remains at the same height. This horizontal level luffing / load travel is achieved by using the high position of the pulley block and the way that the runner reeves through. This ensures that it slacks the same distance as the top of the jib rises. When lowering, the same thing happens in reverse.

Conventional cranes can differ in the ways that the jib is slacked and topped:

- with a cable (runner)
- with (two) hydraulic cylinders

3.1 Topping with a steel cable (runner)

In topping and slacking with a cable, the crane jib is attached to the crane house as low as possible, just above the turning ring. A larger distance between the tip block of the runner and the fulcrum of the jib means a smaller force in the runner. Furthermore, the centre of gravity will be lower.

A possible danger in these types of cranes is that in case of a sudden list, a steep crane jib can smash against the crane cabin. This effect is amplified by the forces in the runner (running part). To prevent this, stops are used, but if there is a load hanging from the runner, both the load and the crane can be damaged.

The runner can be connected to the top of the jib, or to a point halfway.

3.2 Topping with hydraulic cylinders

The fulcrum is attached higher to the crane house if the crane jib is moved vertically by hydraulic cylinders. This is because the cylinders are attached to base of the jib at one end and to the base of the crane house at the other end. The cylinders are positioned to be on the sides of the crane cabin when the jib is completely topped. This means that

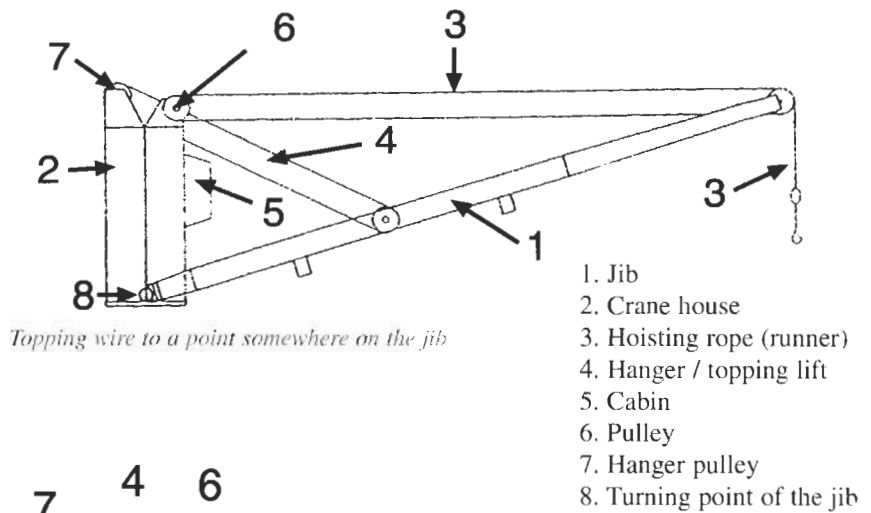

Topping wire to a point somewhere on the jib

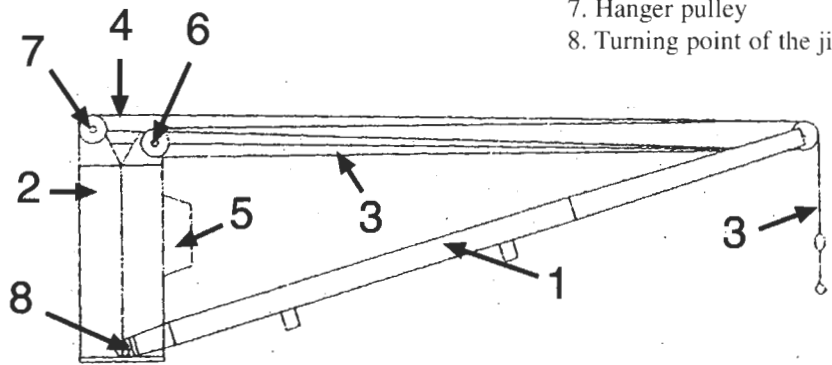

Topping wire to the top of the jib



Hanger crane

although the load can smash against the crane cabin, it cannot damage the cylinders.

Some typical numbers that apply to these cranes are:

- maximum lifting capacity of 16-60 tons
- maximum reach 22-34 metres

Using hydraulic cylinders for the topping of the jib has a number of advantages over topping with a steel cable:

- Slamming of the jib as a result of waves is prevented because double-acting hydraulic cylinders can absorb both pulling and pushing forces.
- Cylinders are easier to maintain than cables. The latter have to be replaced every five years.
- The jib cannot shoot through the top-position. This allows cranes with hydraulic cylinders to have a smaller range (2 metres) than cranes with runners (3 metres).

In the case of double runners, hook blocks are used instead of hooks.

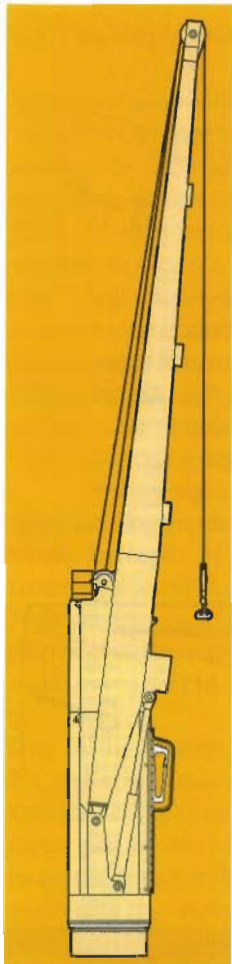

Topped crane with the topping cylinders adjacent to the crane hut

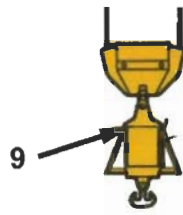

Hook block for double runners

1. Jib
2. Crane house
3. Hoisting rope
4. Topping cylinder
5. Crane cabin
6. Pulley
7. Hoisting winch
8. Cargohook
9. Hook block with swivel

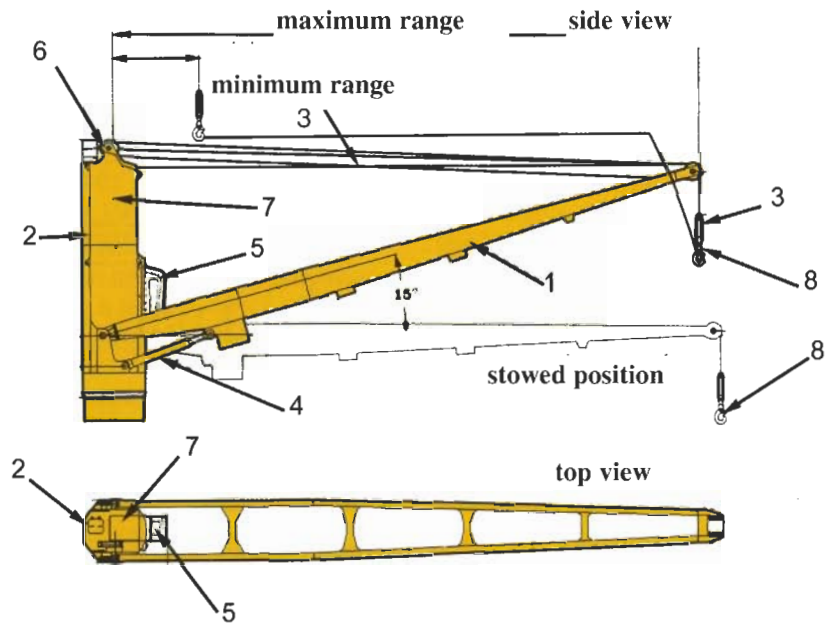

3.3 The crane cabin

The drawing below shows the arrangement of the crane winch, which is driven by an electric-hydraulic motor. An electric motor drives the hydraulic pump that, in turn, supplies oil to the hydraulic lifting and revolving motors. The oil absorbs the heat that is generated in this process and it is subsequently cooled in an oil-cooler by an automated ventilator; then it is pumped back to the hydraulic oil tank.

1. Crane cabin
2. Lever for topping and revolving
3. Lever for lifting
4. Jib
5. Hydraulic motor
6. Oil tank
7. Oil filter
8. Oil cooler
9. Limit switch
10. Drum for topping
11. Drum for hoisting
12. Pulley block

Revolving crane with hydraulic topping cylinders

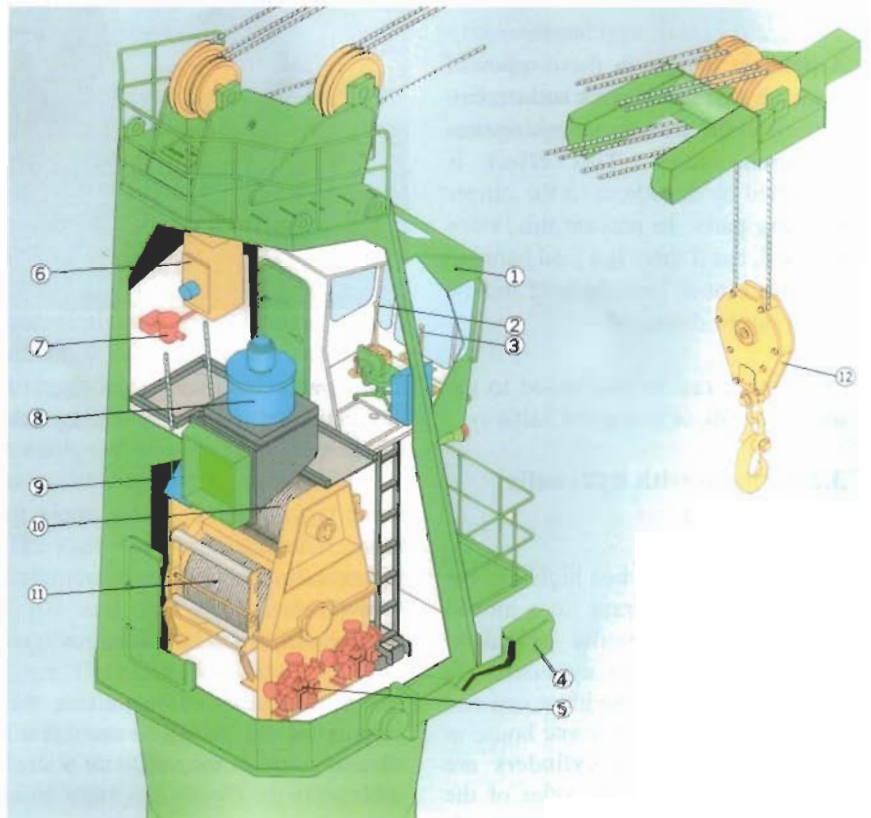

Crane cabin

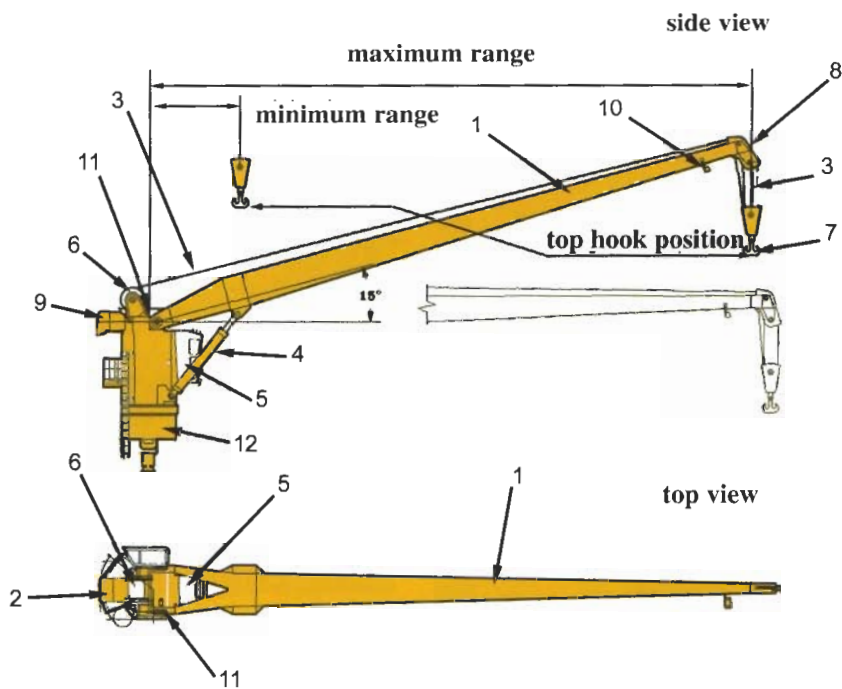

Revolving crane of the low type with hydraulic topping cylinders

4. The revolving crane of the low type

In cranes of the conventional type the crane houses are 8-15 metres above the slewing bearing. However, in cranes of the low type, this distance is approximately 5 metres. The crane cabin extends only just above the fulcrum of the forked jib, which fuses into one box-beam jib further away from the crane. The drum of the hoisting winch, which also serves as a pulley, is placed on top of the crane house. The lifting capacity of these cranes can vary between 10 and 150 tons, the range between 12 to 35 metres.

4.1 The crane's construction

The figures above show one of many versions of the low type cranes. A peculiarity of this crane is that the horizontal position is merely used to "park" the crane in the boom cradle:

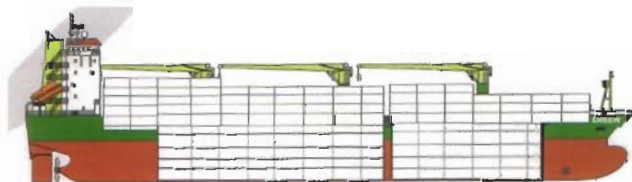

More containers fit beneath the jib without obscuring the view

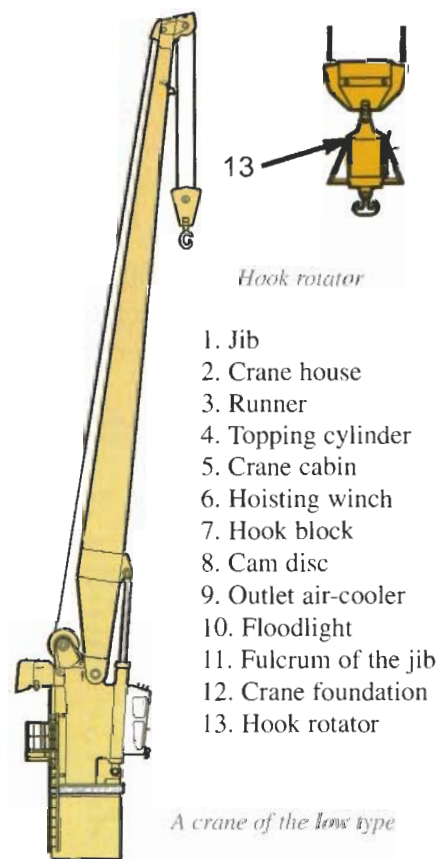

A crane of the low type

the boom rest. When operating, the crane should remain topped at least 15°, as indicated by the minimum and maximum range. All revolving cranes give the load a certain freedom of rotation. The runner itself, however, also has the tendency to entwine when being loaded or unloaded. For this reason, the hook is always connected to the runner via a swivel bearing, allowing the two parts to rotate independently.

When a double cargo runner is used, the hook block must not rotate relative to the crane jib because this will cause the two parts of the runner to get entangled. An electric-hydraulic hook rotator is used to prevent this and to prevent undesired rotation of the load.

Somewhere on the crane jib there is a cable reel that slacks and hoists the power cable via a number of guide sheaves, ensuring that it never hangs too loose or too tight and that it exactly follows the cargo-hook. This cable reel is controlled by the crane driver with the same (right) lever that the driver uses to control the hoisting winch.

4.2 The advantages and disadvantages of the low crane

- The jib of a low crane is much higher compared to a conventional crane where the top of the crane house is at the same height. This way the crane can still operate, even if there are many containers stacked on top of each other.
- The low crane has a lower weight and a lower centre of gravity compared to a conventional crane with the slewing bearing at the same height. This offers more stability and increases the cargo capacity.
- If containers are stacked at the same height, the low crane gives the bridge a better view.

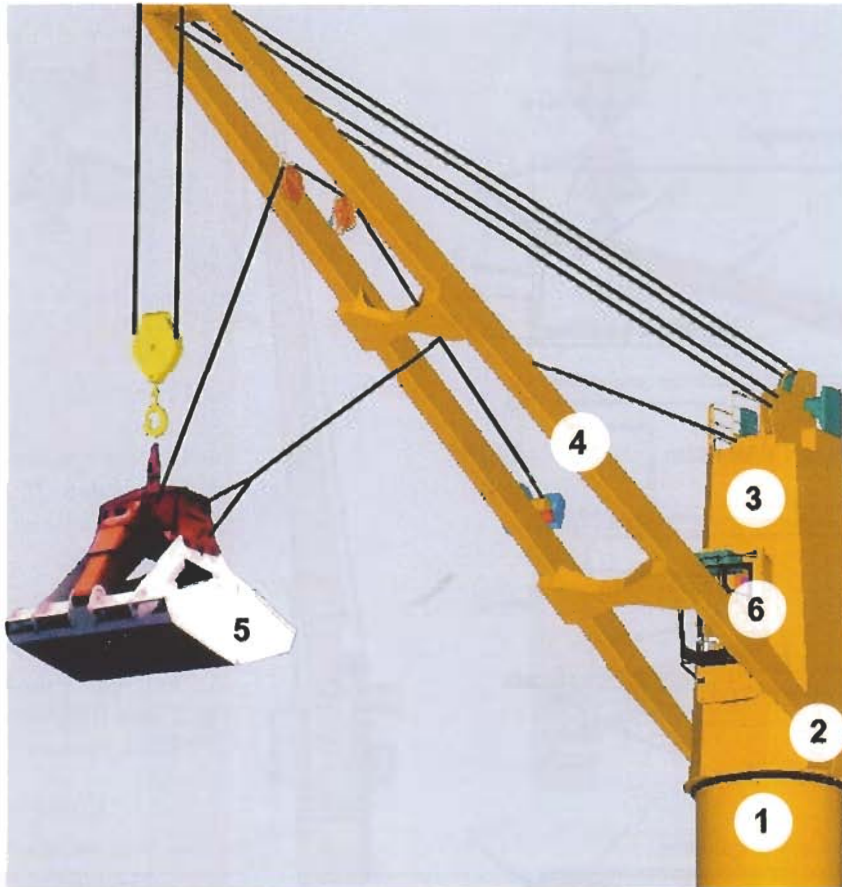

Bulk crane

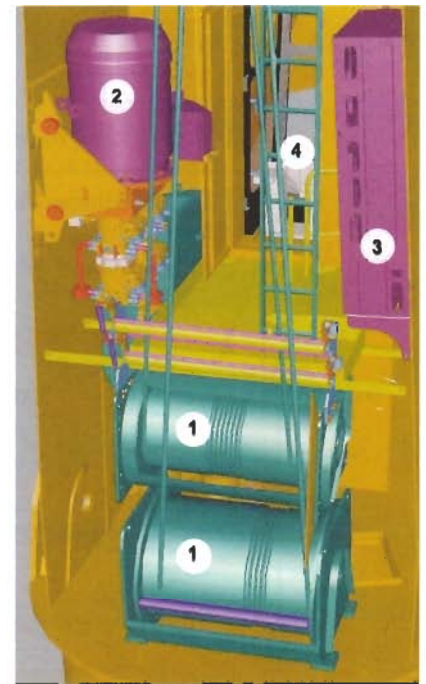

Crane house

1. Drums for wires
2. Hydraulic power pack
3. PLC control cabinet
4. Cabin



Ship with bulk cranes

1. Pedestal
2. Slewing bearing
3. Crane house
4. Jib
5. Grab
6. Cabin

4.3 Bulk crane

The bulk crane is a unit designed for loading grabs and logs on standard bulk carriers.



Reefer with pallet-swinger and conventional cranes

5 Automated pallet crane

The automated pallet crane or pallet swinger is a special type of revolving crane that is mainly used on refrigerated vessels. The pallet cage is suspended from four runners that run through sheaves at the sides of the jib. Changing the positions of the sheaves on the jib can alter the reach of the cage. In addition, on the end of the jib there is also a regular runner with a cargo-hook.

The cage has no freedom of rotation relative to the jib. When the jib rotates, the cage has to follow, hence the name pallet swinger.

The lifting capacity can vary between 8 to 20 tons and the reach between 9 to 20 metres. Pallet cranes can be semi-automated. This means that they can “remember” pre-programmed positions of loading and discharging, and after the starting-command has been given, they can execute the hoist path completely automatically.

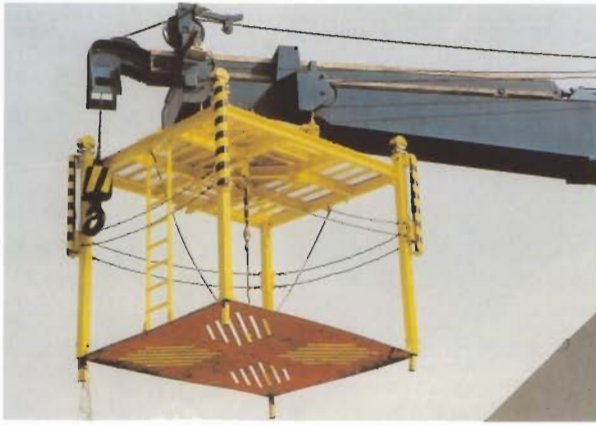

At the end of the pallet-swinger is a (yellow) pallet-cage

6 Derricks

It is not uncommon for general cargo ships to have revolving cranes with a lifting capacity of approximately 150 tons. If these vessels have even

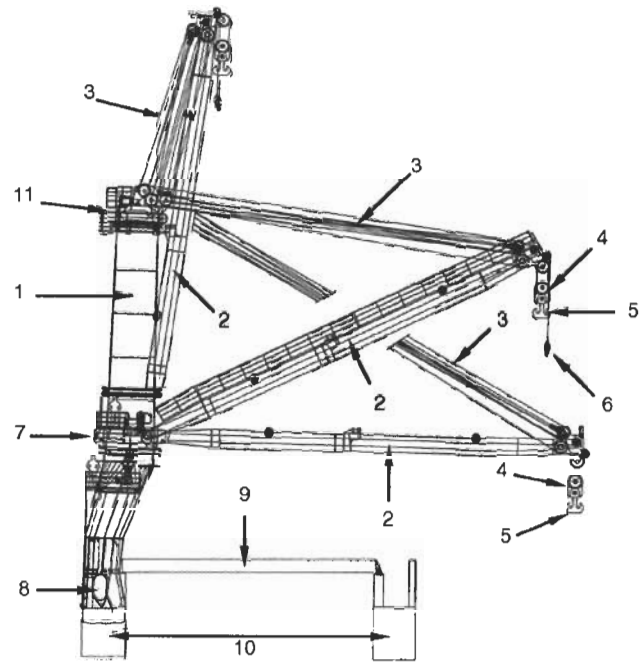

A derrick in three positions

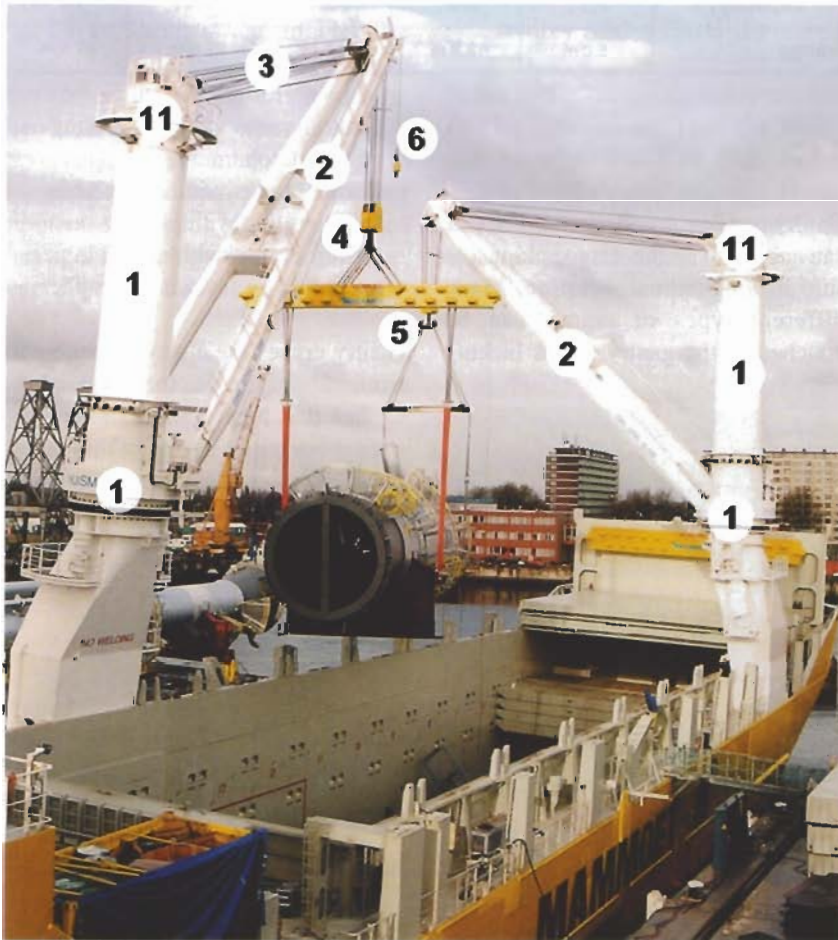

A heavy-lift ship with a heavy piece of cargo suspended from two cranes with spreaders

heavier cranes, with a lifting capacity of 150-500 tons, they are called heavy-lift ships. This type of ship carries "heavy cargo" and special loads. Heavy-lift ships usually have some special features like:

- A strengthened tank top. The tank top is the top side of the double bottom, and also the lowest deck of the hold.
- A powerful anti-heeling system, with a large pump and much larger ballast tanks than, for example, a RoRo-vessel.
- One or more stabilising pontoons
- Spreaders to which the slings are attached. The cargo is suspended from the slings.

In revolving cranes, the entire topping moment that is working on the crane is transferred to the ship's construction via the slewing bearing. This system, however, is not suitable for very large forces like the ones on heavy lift ships. Instead, derricks (mast cranes) are used.

A feature of a derrick is that the crane is built on, around and in a heavy, fixed mast. The crane house is replaced by a slewing platform to which the jib is attached in two places, whilst still being free to rotate. The pulley block and the fixed top blocks are located in the top of the mast. The top of the mast is free to

- | | |
|---|-------------------------------|
| 1. Mast | 6. Hook of auxiliary hoist |
| 2. Jib | 7. Slewing bearing |
| 3. Topping lift and running part of the hoisting rope | 8. Mast foundation / pedestal |
| 4. Hook block | 9. Hatch |
| 5. Cargo-hook | 10. Anti-heeling tanks |
| | 11. Top of the mast |

rotate relative to the mast and it rotates together with the jib. The derricks described here often have no crane cabin. The crane is remote-controlled by a control panel that either lies somewhere or is strapped onto the shoulders of an operator. The cranes depicted here are all driven electrically.

The hook block is made so heavy that it slacks itself. This is necessary, but requires a large weight because the runner is a very thick and therefore tough steel cable that does not slack easily.

6.1 Hoisting diagram

The capacity of a crane depends on the range and the maximum load of all the parts of the crane, together as well as apart. The right side of the graph shows the important impact of the range. The heeling angle is also clearly visible.

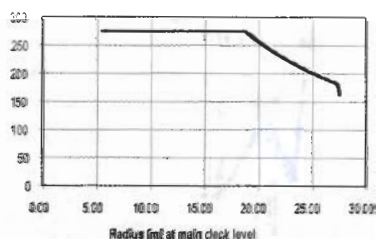

Hoisting diagram for a derrick

6.2 Stabilising pontoons

Stabilising pontoons are employed when the heeling tanks fail to reduce the list to an angle of less than 3°. The pontoons are necessary when the GM_0 may get smaller than 1 metre. They are rigidly attached to the sides of the ship at a distance of 0,5 metre in such a way that the ship and pontoon essentially become one.

A pontoon consists of four tanks that can be filled and emptied independently. The pontoon increases the GM_0 of the depicted ship by 0.4-0.8 metres. The pontoon can transfer both downward and upward forces. After use, the pontoons are emptied and brought back on board.

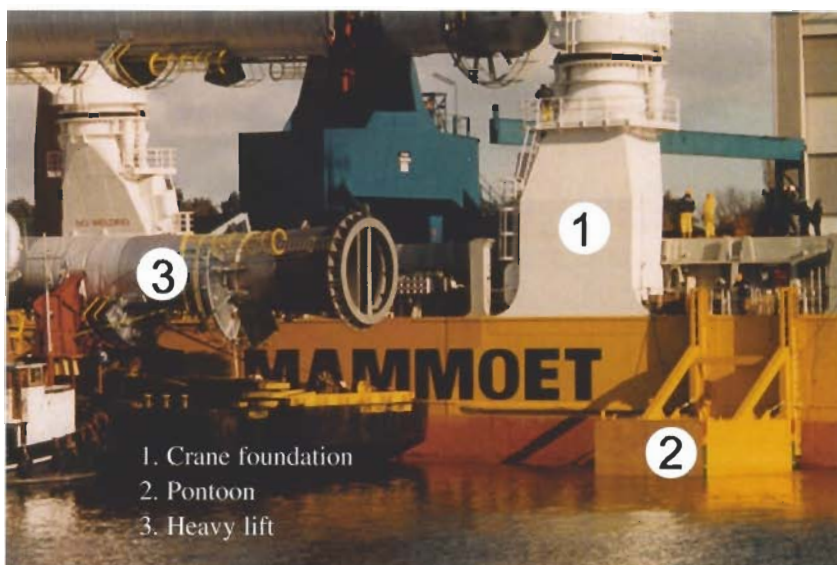

Heavy-lift ship with stabilising pontoon

jib angle	83°	49°	27°	13°	0°
lift capacity	275 t	275 t	203 t	186 t	162 t
range	5.0 m	18.8 m	25.0 m	27.0 m	27.5 m

7 Gantry cranes

Gantry cranes are deck cranes that can move, over the cargo, along the ship in longitudinal direction. Many different types of cranes can be attached to the gantry. Ships lacking



Multi-purpose ship with hatch cradle

their own cargo gear often use a simple gantry crane as a hatch cradle. Gantry cranes specifically for the handling of cargo can be distinguished into three main types:

- Gantry cranes with a revolving crane on top
- Gantry cranes with a moveable cable trolley with jib.
- Gantry cranes with a double portal and cable trolley without a jib.

Gantry cranes are always sensitive to trim; 2° often is the maximum. Cranes that have a cable trolley are even more sensitive and in this case a list of 2° is the maximum. If there is a revolving crane on top this maximum may be a little bit higher, but it will never be more than 5°.

In general, the four-point suspension of the hoist gives the gantry crane an excellent load control. This ensures that the load stays in line so that it can be deposited at the right place.

A disadvantage of gantry cranes is their massive weight that shifts the centre of gravity to a higher point. This reduces the stability and the carrying capacity. An advantage is that the ship hardly needs any strengthening; only the guide rails on deck need a strong foundation.

A characteristic of gantry cranes is the large reel on the side for the feeder cable.



Revolving gantry crane

The portal uses train wheels to ride over the guide rails. The travelling part uses pinions to mesh into the toothed rack, which is attached to the deck. Clamps on the sets of wheels fit around the rails without actually touching them in order to prevent the gantry from tipping over.

7.1 Revolving gantry crane

The revolving gantry crane is mostly used for containers and timber. The revolving crane cannot be topped. On the end of the jib there is a rotating head that, when the crane is revolving, is automatically kept in longitudinal direction. The four runners suspend a fully automated spreader that can pick up, for instance, containers from stacks or timber.



Gantry crane with trolley and fixed jib

The name parallel-swinger comes from both the swinging motion of the jib and from the automated parallel-mechanism that prevents the load from rotating. The depicted crane-type is driven electric-hydraulically.

7.2 Gantry crane with a trolley and a fixed jib

Some gantry cranes are equipped with folding side beams. Then the trolley can have a fixed jib. The trolley attached to the portal beams is a crane house that travels on rails; there are also wheels underneath the flanges of the rails to prevent tipping over.

The trolley has a fixed arm with four runners to which different spreaders can be attached. This type of gantry crane is used mainly for containers and timber. The propulsion is either electrical or electric-hydraulic. Similar to the traveling of the portal, with aid of pinions and toothed racks, the traveling of the trolley is also by pinions and toothed racks.



U-gantry with trolley on a container-ship

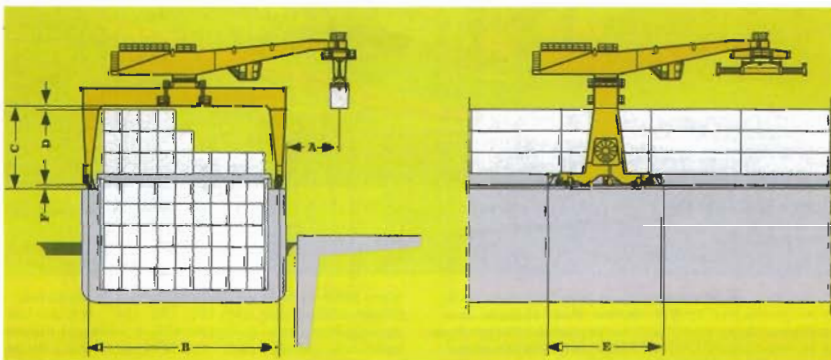

revolving gantry crane, side view and front view

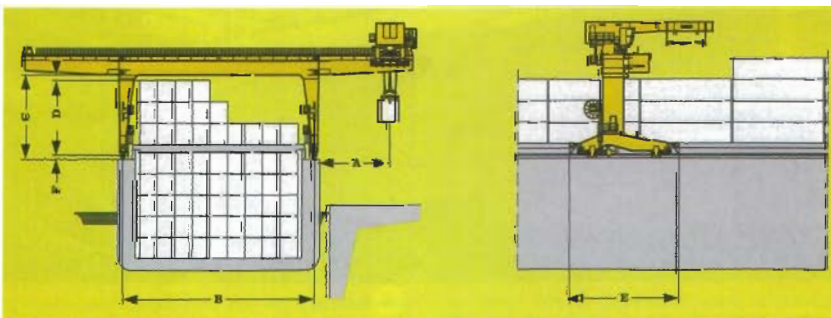

Gantry crane with a cable trolley and a fixed jib, front view and side view

7.3 U-gantry with a cable trolley without a fixed jib

The forces in a crane are distributed more equally in gantry cranes with two beams and a cable trolley without a jib than in a gantry crane with a fixed or rotating jib; there are more torsional forces in the latter. This allows the structure to be only slightly heavier than structures with only one beam. However, the crane cabin should be placed higher than in the other two types of gantry cranes because the load always remains some distance below it.

Similar to the other types of gantry cranes, this type can best be used for moving containers and parcels of timber, paper or other bundled cargo.

8 Side loaders

Side-load systems are used for the transshipment of small cargo units like pallets, rolls of paper and general cargo. The system comprises of one or more doors in the side of the ship, and one or more elevators situated behind these doors to transport the cargo from the ramp, at quay level, to the holds or vice versa.

The advantages of this loading system are:

- It has hardly any impact on the ship's stability because it adds almost no weight. Furthermore, the ramp lies low.
- A high transfer capacity. The cargo does not have to be transported over unnecessary distances. This minimises the waiting period.
- If the route over the quay to the ship is covered, loading and discharging can also be done when there is rain or snow.

The disadvantages are:

- The doors in the side of the ship reduce the longitudinal strength. This has to be compensated elsewhere by applying extra steel strengthening.
- The elevators reduce the available cargo volume
- It is unsuitable for heavy loads
- There is a maximum size for the cargo to fit the dimensions of the elevators.

Some characteristics of side-load systems:

- The maximum work load (of the elevator) is 8-20 tons
- The lifting speed of the elevator is 0.33-0.66 m/s (20-40 metres/minute)
- The locks of the side doors have to be checked before departure.



Fork lift places paper rolls on the ramp



Ship with three side-doors



Paper rolls on the elevator. The cargo is transported by the lift to the tween deck or the lower hold



A fork lift picks up paper rolls to convey them to the holds

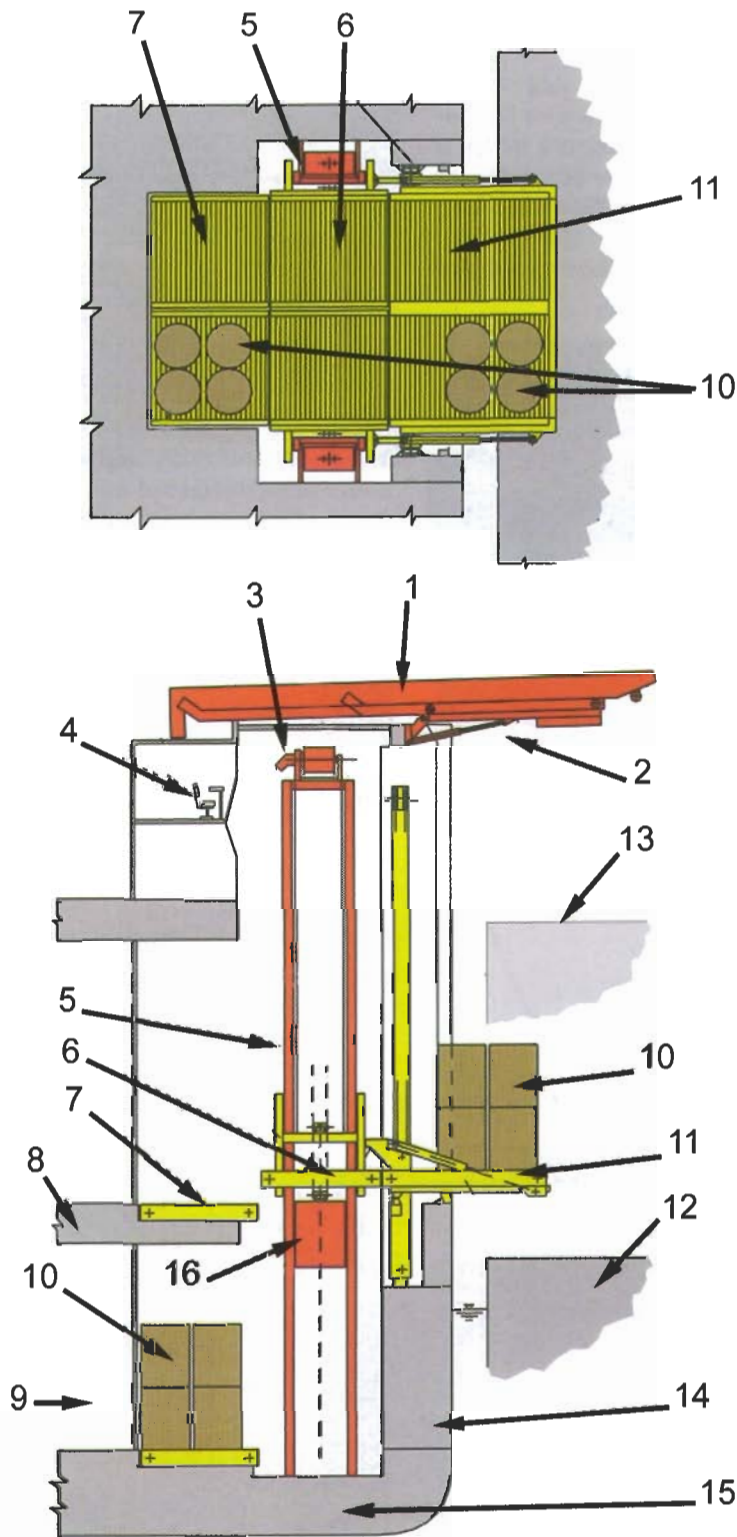

Side and top view of an elevator-system

- | | |
|-----------------------------------|-------------------------------|
| 1. Opened side door | 9. Lower deck |
| 2. Door-lifting mechanism | 10. Cargo (paper rolls) |
| 3. Hydraulic lifting system | 11. Ramp with roller conveyor |
| 4. Control room | 12. Quay |
| 5. Guide | 13. Maximum quay height |
| 6. Elevator | 14. Wing tank |
| 7. Roller conveyor for tween deck | 15. Double-bottom tank |
| 8. Tweendeck | 16. Counterweight |

9 Ramps

RoRo-vessels are ships where the cargo is driven on board via ramps. Loading and discharging can take place quickly because all the cargo is driven on board. An advantage of this is that the ship is independent from the shore facilities.

In general, ramps have sufficient length to be used both in high and low tides. Opening and closing is done with a winch or hydraulic cylinders. There are many safety measures for locking and sealing the side doors and ramps.

The most important types of ramps are:

- Straight ramps, extending straight from the fore, the aft or from the side.
- Quarter ramps, having an angle of 45° relative to the centreline.
- Slewing ramps, here the angle can be varied between +45° and -45° relative to the centreline.

Driving from the supply deck to the other decks also proceeds via ramps. These can be distinguished into:

- fixed ramps
- adjustable ramps
- car decks that also serve as ramps

9.1 Several types of ramps

- Straight ramps

The use of straight ramps on a ship means that the ship depends on the presence of an extending quay in the berthing place onto which the ramp can be placed. This requires a long quay and, if loading and discharging is done via the foreship and the aftship, the full length of the ship has to fit in the berthing place. However, this is not necessary if the straight ramps extend from the side of the ship.

- Straight ramp in the fore ship

The bow visor door in the fore ship has a very complicated shape because it is part of the streamlined profile of the ship's bow. The inside of this door has a flat edge with a rubber seal to make the door watertight. This outer door or visor absorbs the forces of the waves. For this reason there are high demands for fatigue, strength, locks, seals and safety. The stem should have a compulsory second watertight door that is part of the collision bulkhead. This second door is flat. As this door is placed at the collision bulkhead usually it is not possible to use this door as a ramp.

- Straight ramp in the aft ship

The aft ship can suffice with just one watertight door, which, if it is flat, is used as a ramp. In the picture on the right this is the case. The closed ramp protrudes above the aft ship. The pictures below show ramps that are not part of a door.



Ramp with flap



Stern door and ramp combined



Two-part stern door

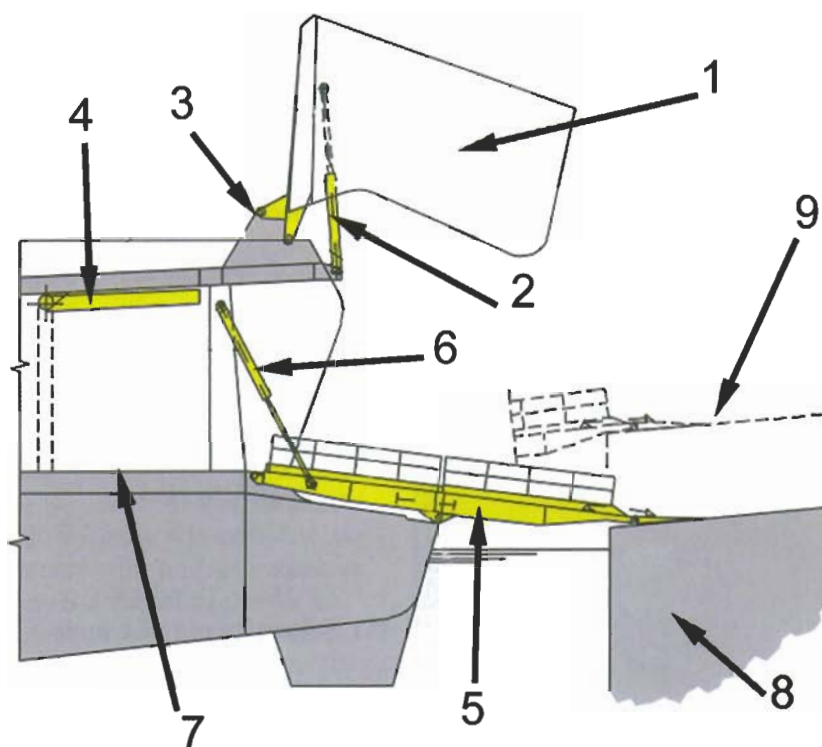

Principle of two-part ramp

1. Outer bow-door
2. Bow-door cylinders
3. Bow-door lock for open position
4. Inner bow-door in collision bulkhead
5. Two-part ramp
6. Ramp cylinders
7. Deck
8. Quay
9. Maximum quay height



Opened bow-visor and bow-door

- Straight ramp in the side

Straight ramps can also be located on the side and they are comparable to the straight ramps in the stern and to the side loaders discussed earlier. The ship designer tries to make the side ramp in such a manner that, when closed, it forms a seamless whole with the ship's skin. There are also high demands for locking, sealing and safety measures for these types of ramps.



Ship with quarter ramp and straight ramp in the side

9.2 Quarter ramps

A quarter ramp makes an angle of approximately 45° with the ship's centre line. This limits the orientations of the ship in berthing to the side where ramp is located. Quarter ramps can do with less quay length than straight ramps.

- Fixed inboard ramp

The figure on the next two pages depicts a ship with a fixed ramp that leads to the lower hold. This costs space because nothing can be stored underneath the ramp.

- Hoistable car decks

A hoistable car deck is depicted in the figure to the right. These can be used as tween decks, allowing two layers of cars to be transported above each other.

When the tweendeck is full, the ramp, complete with cars, is hoisted to the tweendeck position. The lower deck can be loaded when the ramp has been hoisted.



Ship with quarter ramp



Hoistable car deck



Ship with quarter ramp in dry-dock

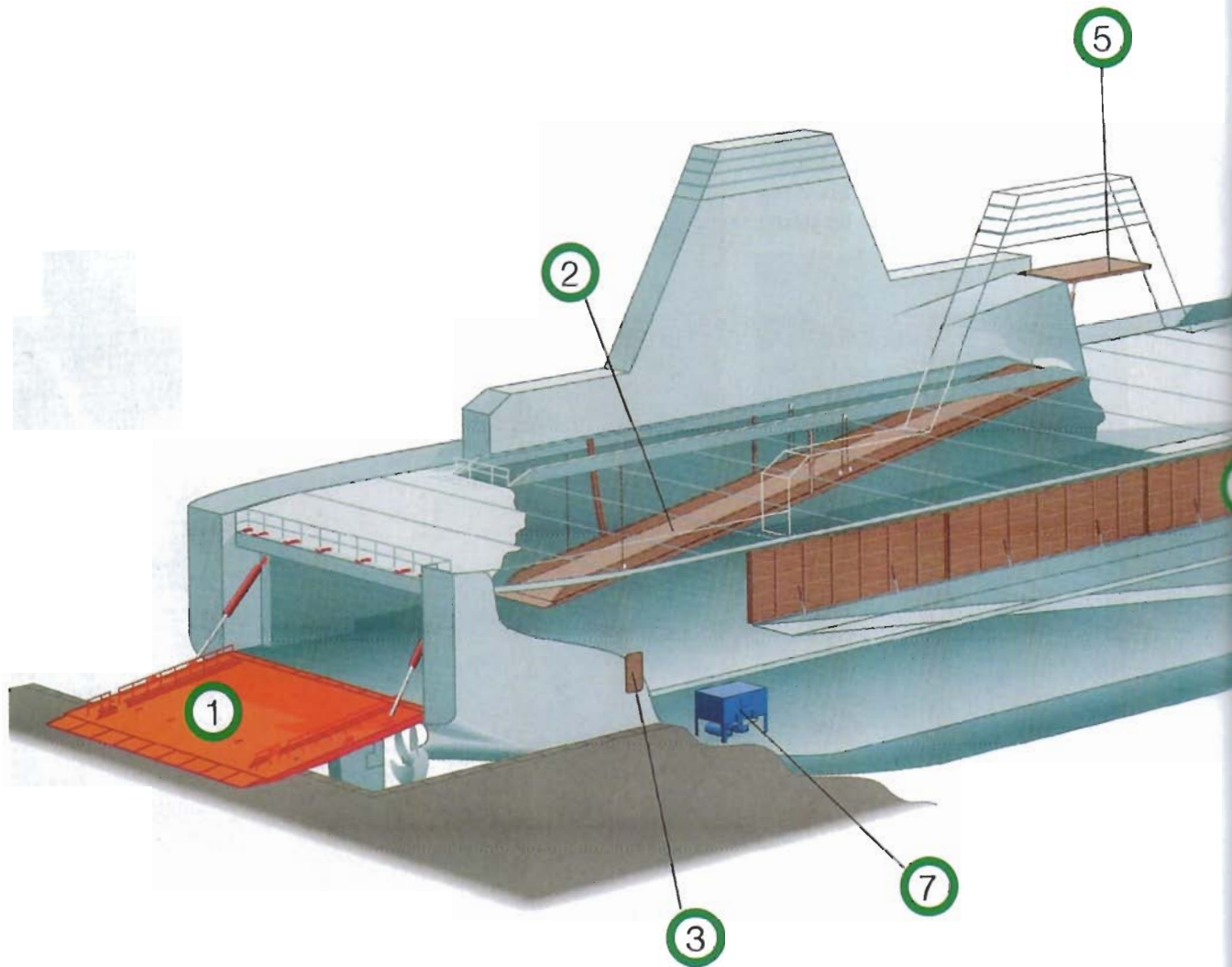

Ro Ro vessel:

1. Straight stern ramp/door
2. Hoistable ramp
3. Shell door
4. Fixed ramp with cover
5. Door
6. Car-deck access ramp
7. Hydraulic Power Pack
8. Hoistable car decks

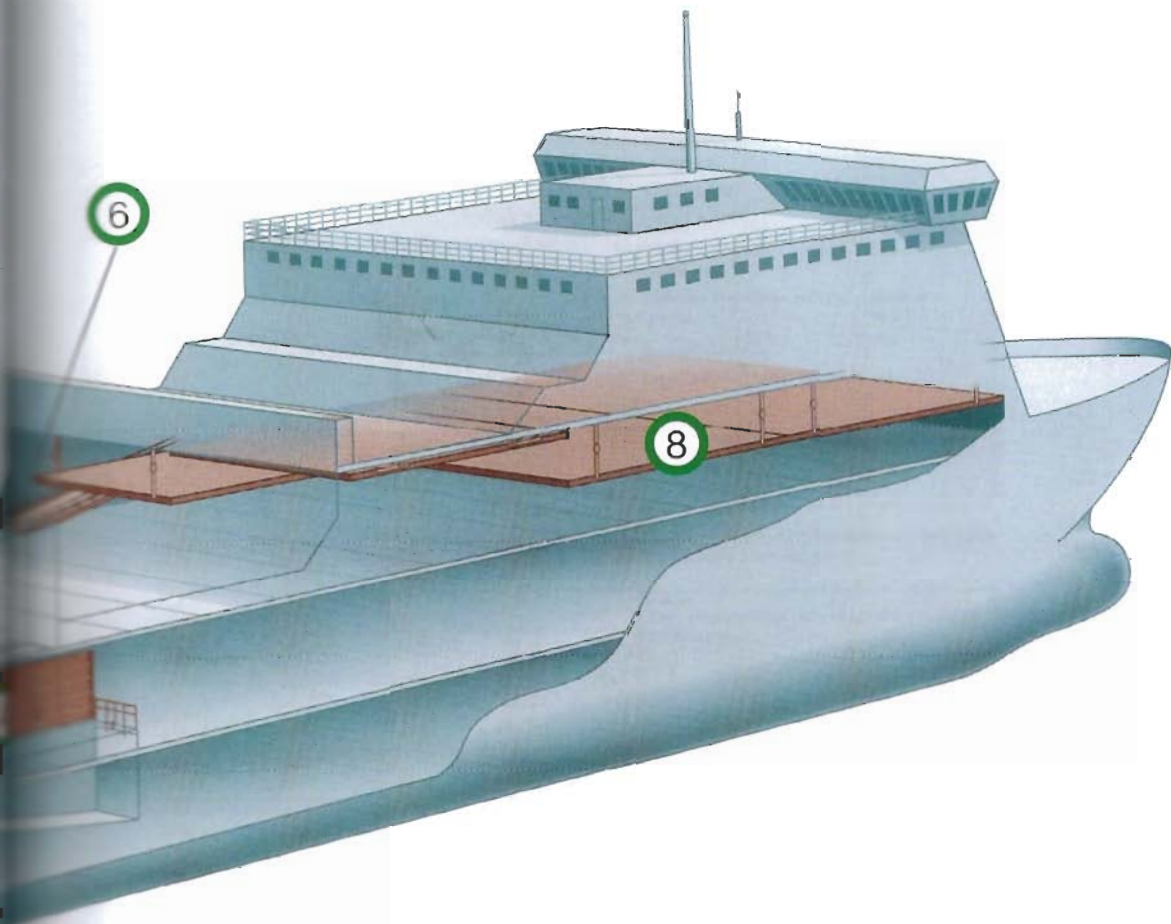

10 Registers and certificates

Lloyd's Register of Shipping

Register of Ship's Lifting Appliances and Cargo Handling Gear

Name of Ship SINGELGRACHT
 LR Number 9197375
 Official Number PCGM
 Port of Registry AMSTERDAM
 Owner CV SCHEEPVAARTONDERNEMING SINGELGRACHT
 Date of Issue 25 FEBRUARY 2000
 Class Notation of Lifting Appliance (if applicable) LA
 Surveyor's Signature 
 Lloyd's Register Office of Issue and Stamp 

This Register is the standard international as recommended by the International Labour Office in accordance with ILO Convention No. 152



Front page of the cargo handling gear register

PART I THOROUGH EXAMINATION OF LIFTING APPLIANCES



Note 1

Except for initial examinations, if all the Lifting Appliances are thoroughly examined on the same date it will be sufficient to enter in column 1 'All Lifting Appliances'. If not, or if an initial examination is conducted then the Lifting Appliances which have been thoroughly examined on the dates stated must be clearly indicated.

Note 2

The thorough examinations to be indicated in column 3 include:

- Initial
- 12-monthly
- Five-yearly
- Repair/damage
- Other thorough examinations

1 Situation and description of Lifting Appliances with distinguishing numbers or marks, if any which have been thoroughly examined (see Note 1).	2 Certificate Nos. Form: L.A.2 F.A.2U	3 Examination performed (see Note 2)	4 I certify that on the date to which I have appended by signature, the Lifting Appliances shown in column 1 were thoroughly examined and no defects affecting their safe working condition were found other than those shown in column 5 (Date, stamp and signature)	5 Remarks (to be dated and signed)
Side Loading System Nos. 1 through 5 Cargo Lifts	SMK 9840054/1	Initial		
Deck Cranes Nos. 1 through 3	SMK 9840054/3	Initial		

A page of the cargo handling gear register

1 Situation and description of lifting appliances (with distinguishing numbers or marks, if any) which have been tested and thoroughly examined	2 Angle to the horizontal or radius at which test load applied	3 Test load (tonnes)	4 Safe working load (SWL) at angle or radius shown in column 2 (tonnes)
Deck Cranes			
No. 1 deck crane at No. 1 cargo hold starboard	14.0 metres	132.0	120.0
	18.6 metres	99.0	90.0
	30.0 metres	55.0	50.0
No. 2 deck crane at No.2 cargo hold starboard	14.0 metres	132.0	120.0
	18.6 metres	99.0	90.0
	30.0 metres	55.0	50.0
No.3 deck crane at No.3 cargo hold starboard	14.0 metres	132.0	120.0
	18.6 metres	99.0	90.0
	30.0 metres	58.3	53.0

I certify that on the date to which I have appended my signature, the gear shown in column 1 was tested and thoroughly examined and no defects or permanent deformation were found; and that the safe working load is as shown.

Date 25 February 2000	Remarks The equipment have been assigned the Society's LA Notation.
Port Shimonoseki	
Signature - Surveyor to Lloyd's Register of Shipping <i>T. Yamato</i>	
T. Yamato	

This certificate is the standard international form as recommended by the International Labour Office in accordance with ILO Convention No. 152.

FORM 1380 (L.A.2) (04/90) 1/2

Lloyd's Register of Shipping, registered office: 71 Fenchurch Street, London EC3M 4BS

Method of testing (fragment)



CERTIFICATE OF TEST AND THOROUGH EXAMINATION OF LIFTING APPLIANCES

Page 1 of 2

Name of ship SCHIPPERSGRACHT	Certificate number SMK 9840054/1
LR entry no. 9197375	Official number
Call sign PCGM	
Port of registry Amsterdam	
Name of owner CV Scheepvaartbederfning Singelgracht	

1 Situation and description of lifting appliances (with distinguishing numbers or marks, if any) which have been tested and thoroughly examined	2 Angle to the horizontal or radius at which test load applied	3 Test load (tonnes)	4 Safe working load (SWL) at angle or radius shown in column 2 (tonnes)
Side Loading System			
No. 1 Cargo Lift at Fr. 135 starboard	-	20.0	16.0
No. 2 Cargo Lift at Fr. 133 starboard	-	20.0	16.0
No. 3 Cargo Lift at Fr. 118 starboard	-	20.0	16.0
No. 4 Cargo Lift at Fr. 102 starboard	-	20.0	16.0
No. 5 Cargo Lift at Fr. 87 starboard	-	20.0	16.0

Test certificate of elevator system (fragment)

CHAPTER 10

Anchor and mooring gear



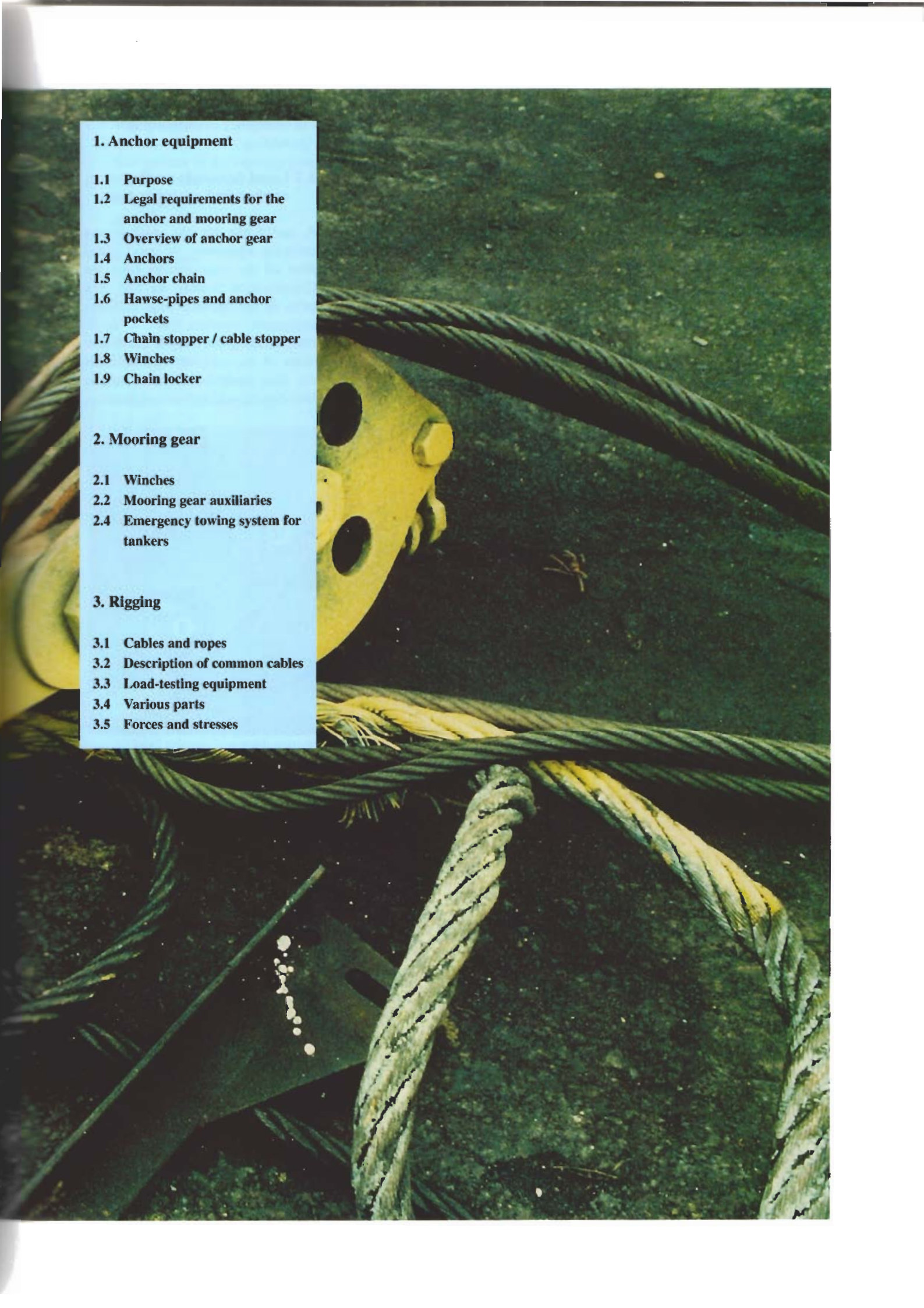

1. Anchor equipment

- 1.1 Purpose**
- 1.2 Legal requirements for the anchor and mooring gear**
- 1.3 Overview of anchor gear**
- 1.4 Anchors**
- 1.5 Anchor chain**
- 1.6 Hawse-pipes and anchor pockets**
- 1.7 Chain stopper / cable stopper**
- 1.8 Winches**
- 1.9 Chain locker**

2. Mooring gear

- 2.1 Winches**
- 2.2 Mooring gear auxiliaries**
- 2.4 Emergency towing system for tankers**

3. Rigging

- 3.1 Cables and ropes**
- 3.2 Description of common cables**
- 3.3 Load-testing equipment**
- 3.4 Various parts**
- 3.5 Forces and stresses**

SHIP KNOWLEDGE

A MODERN ENCYCLOPEDIA

SHIPWISE

PAGE 8 **1**

THE SHAPE OF A SHIP

PAGE 22 **2**

SHIP'S TYPES

PAGE 44 **3**

THE BUILDING OF A SHIP

PAGE 68 **4**

FORCES ON A SHIP

PAGE 82 **5**

LAWS AND REGULATIONS

PAGE 104 **6**

CONSTRUCTION OF THE VARIOUS SECTIONS

PAGE 126 **7**

CLOSING ARRANGEMENTS

PAGE 160 **8**

LOADING GEAR

PAGE 174 **9**

ANCHOR AND MOORING GEAR

PAGE 196 **10**

ENGINE ROOM

PAGE 216 **11**

PROPULSION AND STEERING GEAR

PAGE 244 **12**

ELECTRICAL INSTALLATIONS

PAGE 266 **13**

MAINTENANCE AND DOCKING

PAGE 280 **14**

SAFETY

PAGE 302 **15**

STABILITY

PAGE 322 **16**

CHAPTER 10 QUESTIONS

VISIT

WWW.DOKMAR.COM

1. Anchor equipment

1.1 Purpose

The purpose of the anchor gear (or ground tackle) is to fix the position of a ship in shallow water by using the seabed. Reasons for doing this can be:

- The ship has to wait until the berth becomes vacant
- To load or discharge cargo when a port does not have a berth for the ship, either temporarily or permanent.
- To help with manoeuvring if the ship does not have a bow thruster

- and / or no tugboats are available.
- In emergency cases to avoid grounding

1.2 Legal demands on the anchor and mooring gear.

A certificate for the anchor and mooring equipment is only issued after all the requirements from the Classification Society are met. The table on the opposite page indicates equipment numbers used to determine the minimum weights and dimensions of the anchors, chains, ropes etc. The equipment number can be found on the midship section drawing.

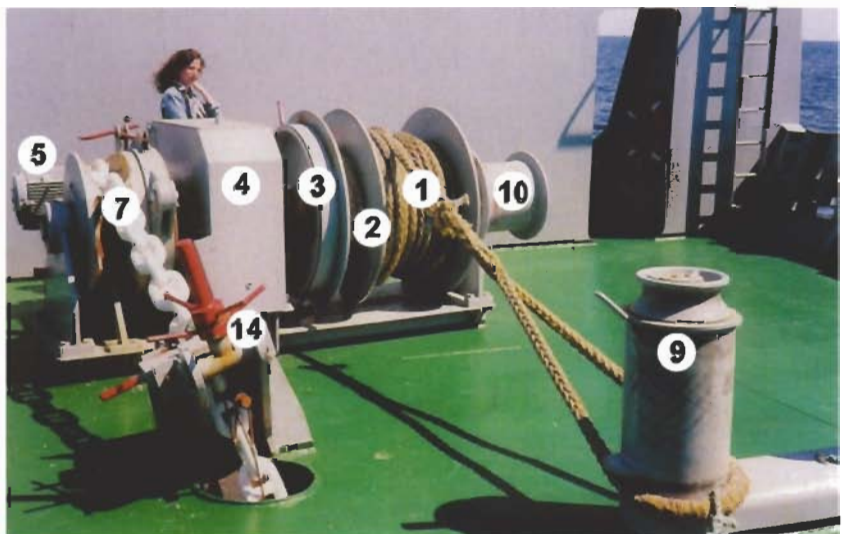

Anchor winch on general purpose ship with mooring drum and warping head (the numbers refer to the list on the opposite page).

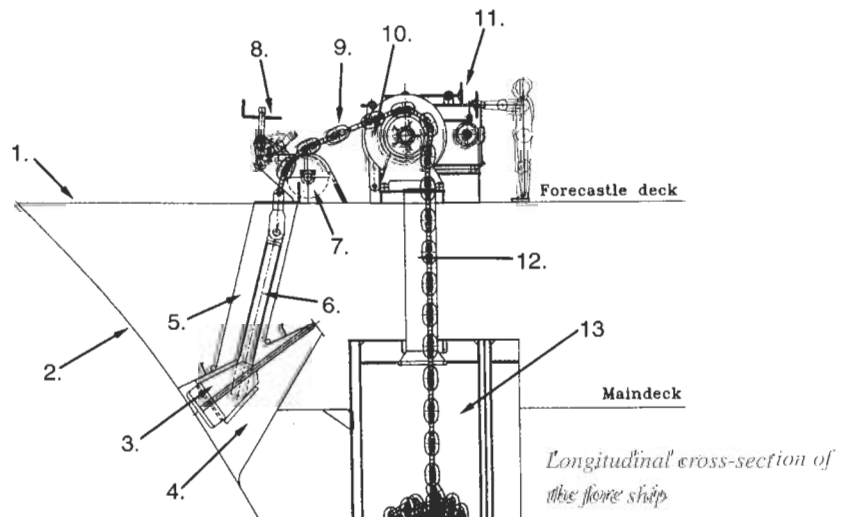

- | | | |
|--------------------|------------------------|---------------------|
| 1. Forecastle deck | 7. Guide roller | the brake band |
| 2. Stem | 8. Chain stopper with | and winch operation |
| 3. Anchor | securing | (up or down) |
| 4. Anchor pocket | 9. Anchor chain | 12. Spurling pipe |
| 5. Hawse pipe | 10. Windlass | 13. Chain locker |
| 6. Anchor shank | 11. Control levers for | |

1.3 Overview of anchor equipment

1. Storage part of the mooring drum
2. Pulling section of the drum (working part)
3. Brake band
4. Gear box
5. Electro-motor
6. Spurling pipe
7. Chain in the gypsy wheel
8. Dog clutch
9. Guide roller
10. Warping head
11. Hatch to chain locker
12. Guide roller, guide pulleys
13. Fairlead
14. Chain stopper, hawse pipe below
15. Bollard (double)

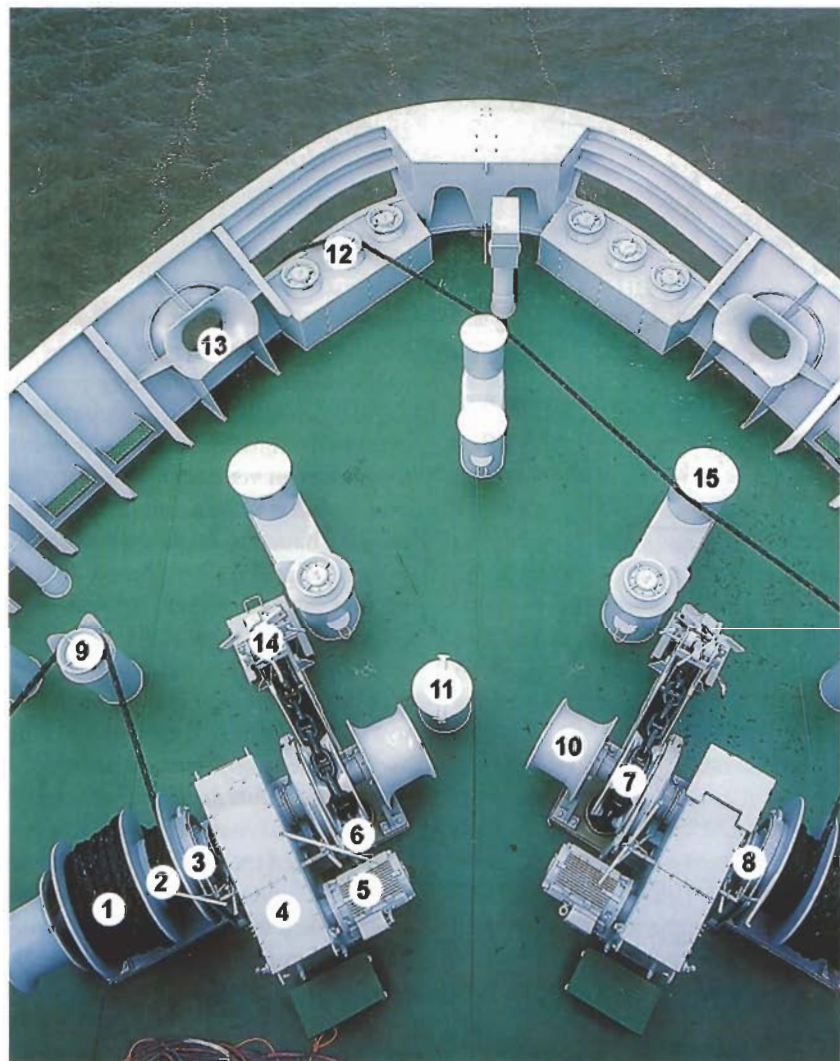

Foreccastle deck

EQUIPMENT NUMBER	STOCKLESS BOWER ANCHORS (WEIGHT)		STUDLINK CHAINCABLES			TOWING LINES		MOORING LINES		
	CONV. ANCHOR (kg)	HHP POOL® ANCHOR (kg)	TOTAL LENGTH (m)	ΔU2 (mm)	ΔU3 (mm)	LENGTH (m)	MBL (kN)	QUANTITY	LENGTH (m)	MBL EACH (kN)
550- 600	1740	1305	440	36	32	190	340	4	160	130
600- 660	1920	1440	440	38	34	190	370	4	160	145
660- 720	2100	1575	440	40	36	190	405	4	160	160
720- 780	2280	1710	467,5	42	36	190	440	4	170	170
780- 840	2460	1845	467,5	44	38	190	480	4	170	185
840- 910	2640	1980	467,5	46	40	190	520	4	170	200
910- 980	2850	2140	495	48	42	190	560	4	170	215
980-1060	3060	2295	495	50	44	200	600	4	180	230
1060-1140	3300	2475	495	50	46	200	645	4	180	250
1140-1220	3540	2655	522,5	52	46	200	690	4	180	270
1220-1300	3780	2835	522,5	54	48	200	740	4	180	285
1300-1390	4050	3040	522,5	56	50	200	785	4	180	305
1390-1480	4320	3240	550	58	50	200	835	4	180	325
1480-1570	4590	3445	550	60	52	220	890	5	190	325
1570-1670	4890	3670	550	62	54	220	940	5	190	335
1670-1790	5250	3940	577,5	64	56	220	1025	5	190	350

The equipment number can be calculated with the equation: $(\Delta^{2,5} + 2HB + 0,1A)$, where:

- Δ = displacement (weight of the ship) this term gives the influence of the displacement and the currents on the ship.
- BH = width and height, this term which determines the influence of frontal winds. (m^2)
- A = the lateral surface of the ship (above the water), which determines the influence of side winds. (m^2)

1.4 Anchors

Anchors are the final safety recourse of a ship. From the ancient times of the first boats, the men using them had a stone on some sling to keep the boat in position. Later developments show combinations with wood, ending in the stock-anchor with

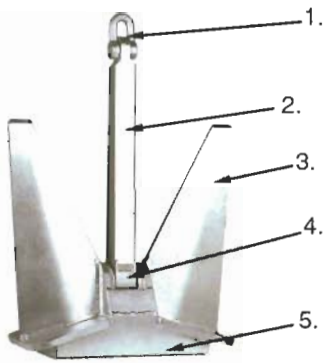

Pool anchor (HHP) Type HG "Pool N" anchor

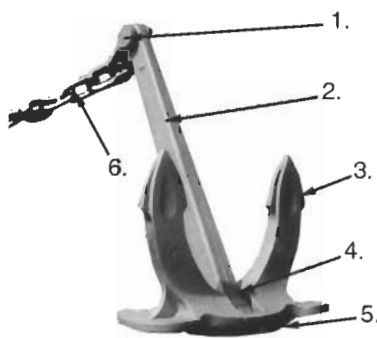

Hall anchor (conventional anchor)

1. Crown / shackle
2. Shank
3. Flukes
4. Crown pin
5. Crown plate
6. Anchor chain with swivel

wooden stock. When propulsion or steering fails, the seafarer has to rely on his anchoring equipment. It is therefore of utmost importance that this equipment is in good condition. A regular check of the condition of the anchor itself, the crown, anchor shackle, the chain cable, windlass, brake band and anchor securing arrangements is a master's obligation. In general, ships have two bow anchors and sometimes a stern anchor. There are two bow anchors for safety. Under normal circumstances one anchor is sufficient, but under severe weather conditions or in strong current both anchors may be needed. Also, if one anchor fails, the second anchor is a back-up. A ship is not allowed to sail from any port when one anchor has been lost. In general the Classification Bureau may allow departure, under the condition that replacement

is carried out at the earliest opportunity and that the vessel takes additional tug-assistance leaving and entering port.

The stern anchor is used to prevent ships (coastal-trade liners for example) from rotating due to the changes in a river-current.

Anchors can be distinguished as:
 - conventional types
 - HHP-anchors (high holding power)
 - SHHP-anchors (super high holding power)

Common conventional anchor types are: Spek, Hall, Union, Baldt. Spek anchors have the advantage of being fully balanced. Accepted HHP anchors are AC14, Pool and Danforth. CQR and plow-type anchors are only used on small craft. Various copies of accepted types are made all over the world. The conventional type is still used a lot and serves as a standard for newer types of anchor (see table). Conventional anchors are always cast. Newer types can also consist of plates (or other components) that are welded together. If the flukes are hollow, they tend to be more resistant towards bending forces.

Some anchors are fully balanced; this means that the centre of gravity lies so low that the anchor always leaves the water with the flukes vertical.

This has the following advantages:
 - an anchor recess that completely envelops the anchor can be used.

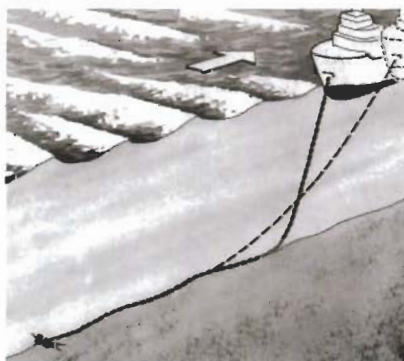

The total holding force is supplied by the anchor and (the weight) of the chain. The dashed lines in the drawing show that it is not dangerous if a ship floats away for a certain distance (a ship's length) from the original anchor-position.

- the shell cannot be easily damaged during heaving when the anchor flukes leave the water vertically.

The crown plate ensures that the flukes of the anchor penetrate the sea floor. In certain types of anchor, the flukes prevent the anchor from burying itself too deep in the sea bottom. The navy uses a specially developed HHP-anchor with an open crown plate (bottom plate). The advantage of this type of anchor is that it digs into the bottom very rapidly. For dredging and offshore jobs there are special anchors which have to be laid down by anchor run boats and are certified as recoverable mooring systems. HHP-anchors are allowed to be 25% lighter in weight because their holding force is twice as strong as that of a conventional anchor. The SHHP-anchors can be 50% lighter in weight, because their holding force is even larger, namely 4 times as large as with a conventional anchor. However, this type of anchor is not accepted by Class for normal



HHP-anchor with an open crown plate

ships and can only be used on yachts and special craft.

For Offshore and Dredging special very high holding power anchors are in use, which have to be laid down in position by a tugboat, a so-called 'anchor run boat', and also have to be lifted out by the same boat, using a separate wire attached to the crown of the anchor. These anchors are certified as Recoverable Mooring System. An example of such anchor is the Flipper Delta-anchor.



Stud link chain

1.5 Anchor chain

The chain runs from the chain locker, through the spurling pipe, via the gypsy wheel of the windlass through the hawse pipe, to the anchor. The anchor chain consists of links with studs to prevent kinks in the chain.

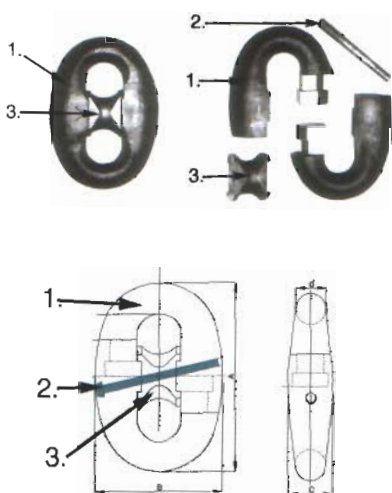

Kenter shackle

1. half link
2. locking pin
3. stud

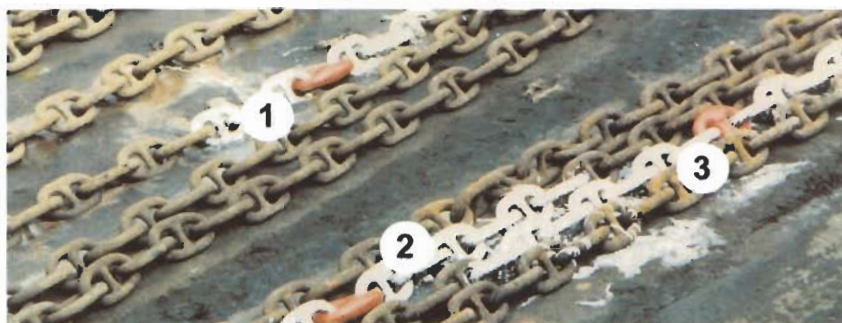

81 mm U3 Chain Quality

The required strength and length of the chain can be determined with the aid of the equipment numbers in the previous table. This table also distinguishes two main types of material-quality, namely U2 and U3. Not included in the table are the qualities U1, which has become obsolete, and U4, which is an offshore quality.

The anchor chain is composed of lengths (shackles), each with a length of 15 fathom ($15 \times 1,83 = 27,5$ m). The shackles are interconnected by a kenter shackle.

In order to keep track of the outboard chain-length, the paying out and heaving in of the anchor can be monitored by markings near each kenter shackle. The markings can be white paint and/or wire wound around the studs. The kenter itself is red.

The paid out chain length can also be monitored electronically, by sensors that carefully register how many times the gypsy wheel rotates. An

1. 3rd length or 'shackle'
2. 6th length or 'shackle'
3. 7th length or 'shackle'

advantage of this system is that when the anchor is hove in, the winch automatically slows down when the anchor chain is almost completely inside and stops completely when the anchor is home.

A D-shackle connects the anchor and the chain. A swivel is usually fixed on the chain and allows the anchor to rotate independently from the chain. The swivel can also be connected directly to the anchor.

Description of the images below:

1. Anchor shank
2. Anchor / link
3. Swivel
4. Open link
5. Enlarged link
6. Kenter shackle
7. Crown shackle

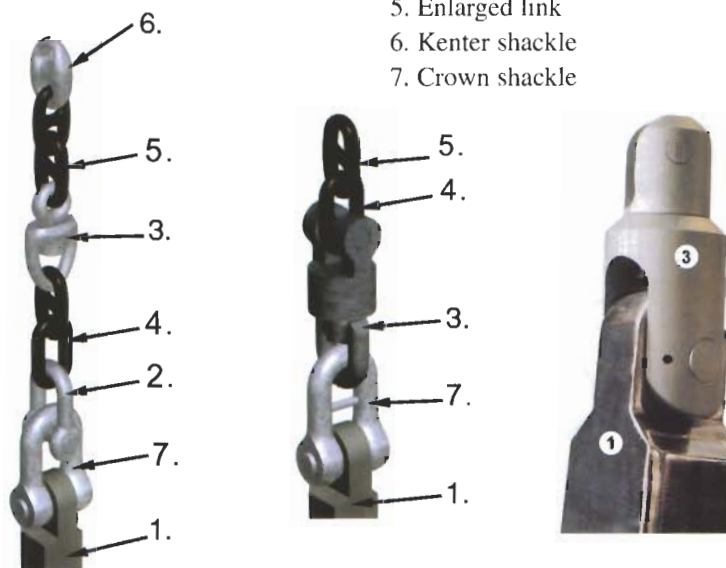

Different ways to connect the anchor to the chain



Flipper Delta-anchors on a deck of an AHTS

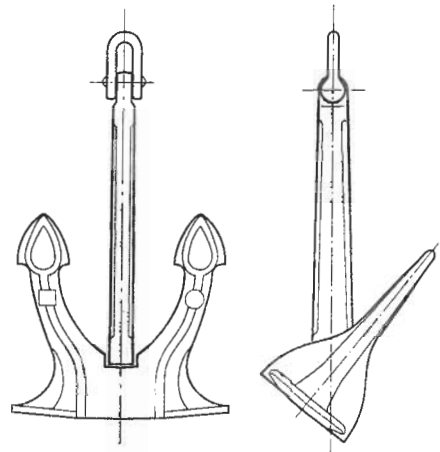

Spek anchor

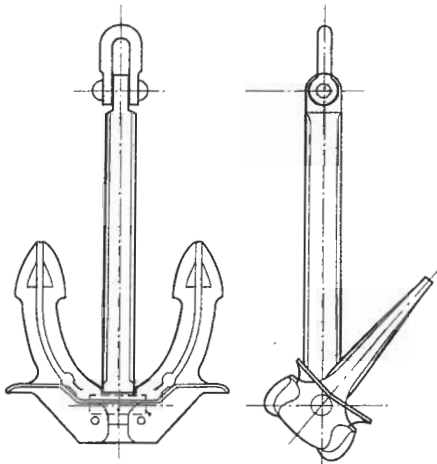

Hall anchor

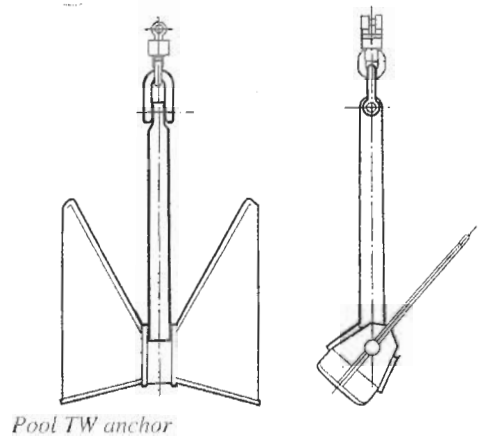

Pool TW anchor

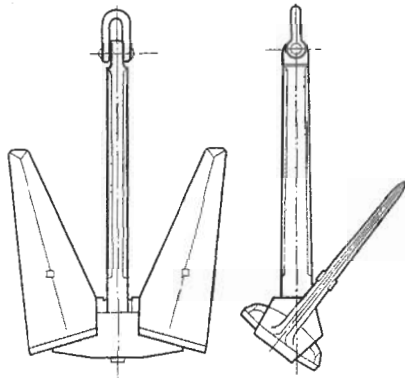

Pool N anchor

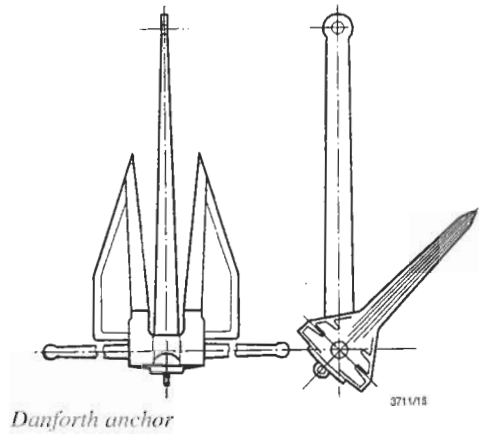

Danforth anchor

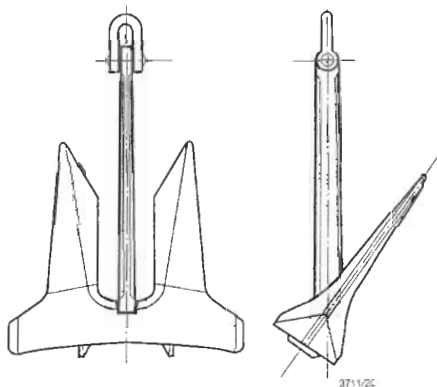

AC-14 anchor

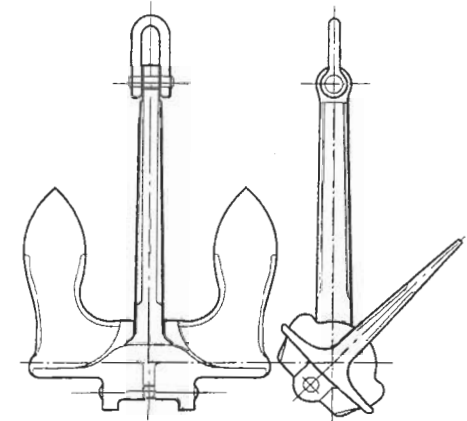

Baldt anchor

CERTIFICATE FOR ANCHOR CHAIN CABLE AND CHAIN CABLE FITTINGS

LR Office Qingdao	Date 31 July 2001	Certificate number QDO 0150680/7
Client/Manufacturer Zibo Anchor Chain Factory, Laiwu Steel Group, Ltd.	Purchaser Chongqing Marine & Industries Co., Ltd.	
Chain manufacturer (if different from above) -	Order number on manufacturer Z286	
Testing house name and address (if different from above) -	Work's order number -	
Material certificate numbers 0000808		

This certificate is issued to the above Client to certify that the Anchor Chain Cable and Chain Cable fittings, detailed herein, have been made, examined and tested in accordance with the Rules and Regulations of Lloyd's Register of Shipping, and also in accordance with the schedules under the UK Anchor and Chain Cable Rules 1970 = Statutory Instruments 1453 (British Flag Ships Only)

PARTICULARS OF FINISHED CHAIN CABLE AND FITTINGS			
Chain grade U3a	Nominal Diameter (mm) 40.0		
Total length of chain cable (m) Nil	Length of link (mm) Nil	Breadth of link (mm) Nil	Mass (tonnes) Nil
Number of enlarged shackles Nil	Number of swivels Nil	Number of lugged joining shackles End Shackle:15 (Fifteen)	Number of lugless joining shackles Nil
Proof load applied kN/⚖ 896.0	Break load applied kN/⚖ 1280.0	Approved alternative procedure for break test applied Yes <input type="checkbox"/> No <input type="checkbox"/>	
Break test frequency	Each (27.5m) length <input type="checkbox"/>	Every four (27.5m) lengths <input type="checkbox"/>	Each batch (fittings) <input checked="" type="checkbox"/>
Manufacturing process Forged	Heat treatment Quenched and Tempered		

MECHANICAL PROPERTIES - FINISHED CABLE AND FITTINGS											
Cast number	Cable/ Fitting	Yield strength N/mm ²	Tensile strength N/mm ²	Elong. %	Red. of Area %	Impact value - Joules				Location in way/clear of weld	
						Temp °C	1	2	3		Average
T2001183	End Shackle	591	741	22	63	0	186	179	186	183	base

CHEMICAL COMPOSITION - AS STATED BY MANUFACTURER													
Cast number	C%	Si%	Mn%	P%	S%	Al%	N%	Cr%	Cu%	Nb%	Ni%	V%	Mo%
T2001183	0.32	0.31	1.46	0.020	0.009	0.043	0.006	0.07	0.17	0.01	0.08	0.01	0.01

IDENTIFICATION MARKS		
a) LR and Office LR QDO	b) Certificate number 0150680/7-(1-15)	c) Proof load and grade PL896KN U3
Signature - Surveyor to Lloyd's Register of Shipping Z.S.Lu for D.Q.Liu and self		To be completed by the Surveyor verifying the equipment after placing on board Signature - Surveyor to Lloyd's Register of Shipping
Date 31.07.2001		Date
†delete where not applicable		Chain cable placed on board (name of vessel)

Should the Anchor Chain Cable or fittings described above be lost or destroyed, this certificate is to be returned to the Secretary of Lloyd's Register of Shipping, London, for cancellation. If the Anchor Chain Cable or fitting is impaired or otherwise altered, so as to destroy its identity with the certificate, the facts are to be reported to the Secretary, or one of L.R.'s Surveyors in order that the certificate may be altered accordingly.

1.6 Hawse-pipes and anchor pockets

The hawse pipe is a tube that leads the chain to the forecastle deck. A water-spray in the pipe cleans the chain during heaving of the anchor.

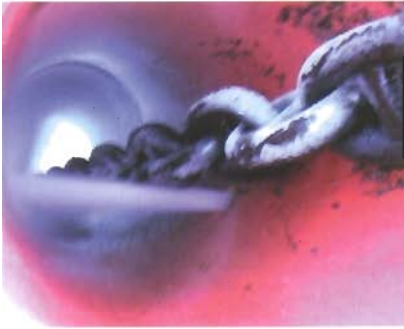

A water-spray installation in the hawse pipe

During heaving, the flukes of the anchor should be parallel to the ship's shell. A collar protects the part of the ship's shell around the hawsepipe. In



Ship without an anchor pocket

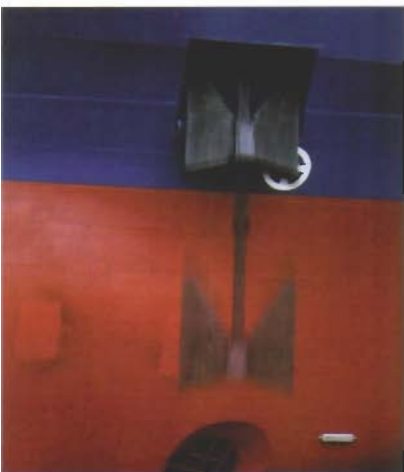

Anchor partly in pocket

addition to this, the plating is extra thick in this area.

Anchor pockets are sometimes made in the bow into which the anchors can be completely retracted.

The advantages of the anchor recesses:

- the anchors are protected from direct contact with waves.
- a loose anchor cannot bang against the shell (important on passenger liners)
- damage to the shell by floating ice can be prevented.
- prevention of fatigue damage to the anchor itself
- mooring wires do not get fouled

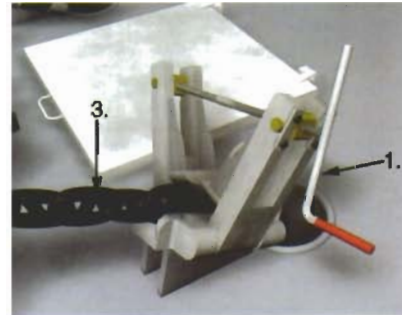

Spindle chain stopper

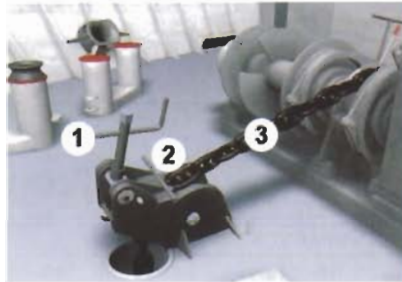

Chain stopper with tensioner



Tensioner

- | | |
|------------------|----------|
| 1. fixture | 3. chain |
| 2. cable stopper | 4. guard |

1.7 Chain stopper / cable stopper

The chain stopper absorbs the pull of the chain by diverting it to the hull. The chain stopper's holding force should be min. 80% of tensile breaking strength of the anchor chain. Furthermore, the hawse pipe's resistance absorbs 20% and the windlass should have a holding force of 45% of the minimum break load.

In most types of chain stoppers, the chain runs over a roller, equipped with a tensioner. The securing consists of a hook onto which both eyes of a steel wire are attached. This wire is put through a link of the chain and tensioned. This securing fixes the anchor in the recess thereby preventing banging of the anchor against the shell.

Cable stoppers are to be divided into anchor securings for when the vessel is at sea, and for when the vessel is riding at anchor. When the vessel is at sea, the anchor is held by the brake band, and a securing wire or preferably a high tensile chain, through the chain cable and attached to a strong point on the focsle deck. The windlass should not be engaged.

When riding at anchor the chain force on big ships is held by a transverse, hingeable bar, a strong back, incorporated in the guide roller above the hawse pipe secured on top of a flat link of the anchor chain, so that a vertical link cannot pass. The chain forces are then transferred to the ships construction. A wire as anchor securing at sea is insufficiently strong and vulnerable to chafing especially when not lashed through a link of the chain under a stud.

1.8 Winches

Anchor winches or capstans are used to heave in and pay out the anchors and anchor chains in a controlled way. The same winch can be used to operate a mooring drum. A clutch is used to connect / disconnect the gypsy wheel or the mooring drum to the main shaft. The anchor can be hoven if the gypsy wheel is coupled to the main shaft.

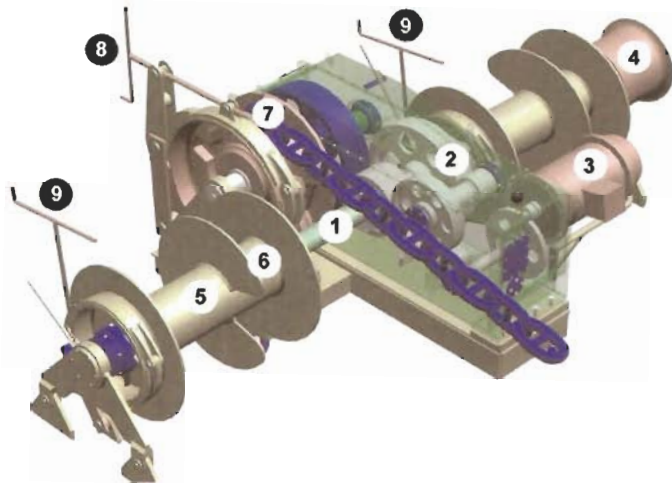

1. Main shaft
2. Gear box
3. Electric motor
4. Warping drum
5. Drum (storage part)
6. Drum (working part)
7. Gypsy wheel
8. Control lever for the band brake
9. Clutch with control lever

Anchor and mooring winch

The winches can be powered by:

- electricity; an electric motor rotates a cogwheel. The advantage of using an electric motor is that the noise is limited. Especially on passenger liners this is important.
- hydraulic systems. The cogwheels are driven by a hydraulic motor, which is connected to a hydraulic pump system located below the deck. Advantages of this system are that there is no risk of (electrical) sparks and furthermore, the system is gearless.
- electric-hydraulic. The set of pumps is incorporated in the winch instead of below deck. This means that there is no need for piping systems for the hydraulic oil.
- steam.

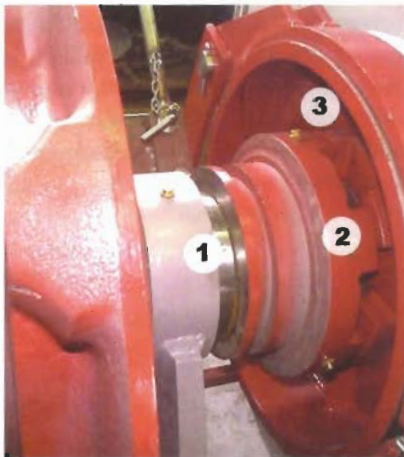

Winches on the forecastle and on the quarter deck of a car ferry

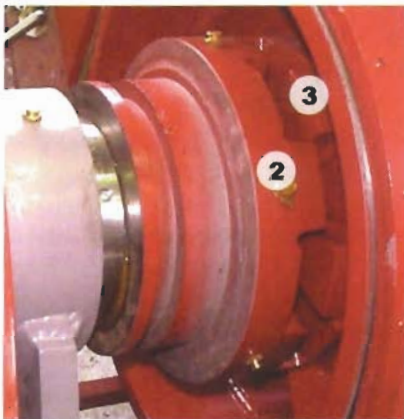

The main shaft is rotating, the warping end is the only part that is also rotating. The gypsy wheel and both drums are disconnected.

1.9 Chain locker

The anchor chain enters the chain locker via the spurling pipes. Chain lockers are high and narrow, making them self-trimming. This means that the stacked chain can not fall over in bad weather. A grill on the bottom of the chain locker makes sure that water, rust and mud can fall through. A (manual) bilge pump can drain the water.



Clawclutch out and in

1. Bearing
2. Sliding claw
3. Fixed claw



Pipe outside the chain locker, where the end link is connected. The wheel is used to secure a pin through the end link.

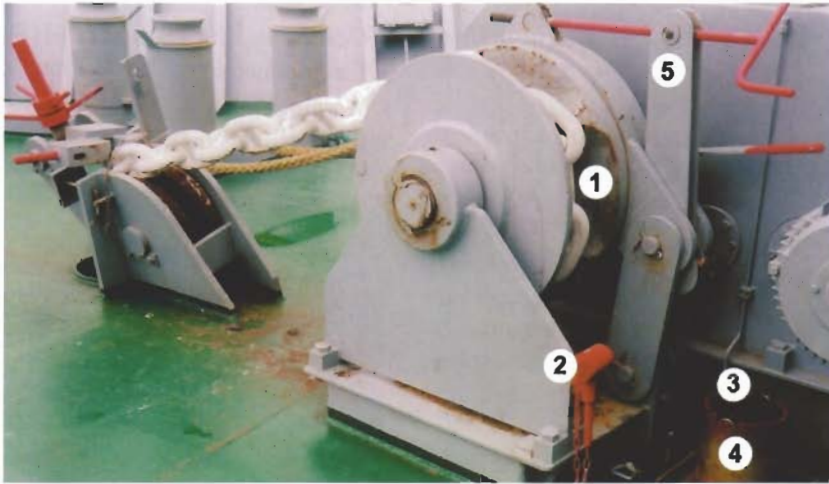

Windlass with anchor securing, guide roller and bitter-end connections

1. Nest sheave
2. Hammer
3. Set pen
4. Bitter-end connection
5. Brake band lever

In emergencies, the chain can be released by the bitter-end released outside the chain locker.

Possible types of chain release devices (bitter-end connection):

- remove the pin out of the last link of the chain with a hammer. The pin is located either below deck outside the chain locker or on deck, next to the windlass.
- a weak link in the final joint ensures that the chain breaks loose when the stress becomes too high. The breaking force must be less than the maximum holding force of the chain.
- The hand wheel can be used to release or attach the chain.

2 Mooring gear

2.1 Winches

- Drum

If the drum is made of one part, it serves both as head (storage) and as drawing and pulling drum. These types of drums are only suitable for steel wire and certain synthetics. If force is applied to a synthetic hawser, it may not slip through the layers of rope below. If this does happen, the rope gets foul. Sorting the rope out again takes a lot of time. If the drum consists of two parts, then the small part is the working drum and the other part is the storage part. The



Anchor windlass with mooring gear and warping head

1. Working part
2. Storage part
3. Warping end
4. Gipsy

tension in a rope (with a maximum of two layers) may only be applied on the working drum.

Suppose that the diameter of the drum is 30 cm, and 5 windings fit next to each other in two layers, then the pulling drum can pull in 10 metres of rope.

If the MBL (minimum break load) of the ropes is 100%, then the holding capacity of the drum is 80%, and the pulling force is approximately 1/3 of this. This rule applies to all the drums mentioned.

- warping drum

The warping drum is used:

- to heave in extra ropes, set them up and then fasten them on the bollards.
- to move the ship alongside the quay over short distances. If the warping drum is used, the gipsy wheels and the drums must not be coupled to the main shaft which would engage the anchor cable.

A rope may never stay on the warping drum because then the force exerted by the ship may well exceed the pulling force of the warping drum. The warping drum can absorb equal amounts of pulling force and brake force; the brake force of the drums, however, is three times as much as the pulling force due to the band brake.

- Self tensioning winches

Self tensioning winches can be set to a certain holding force. If this value is exceeded, then the winch automatically adjusts the length of wire to the new force (too much holding force: slacking; too little holding force: heaving). This system is frequently used by ships that load and discharge quickly (container ships and RoRo-vessels) or if there is a large tidal range in the port.



Control for the self tensioning winch

1. Control lever for the winch
2. Cooling fan
3. Control for the self-tension setting

- capstan

The capstan consists of a warping drum with a vertical drive shaft that is driven either electrically, hydraulically or electro-hydraulically. The capstan is usually placed on the aft-ship and, if the ship is very long, on the sides. If the capstan is combined with a gipsy wheel, it can be used to control the (stern) anchor i.e. a vertical anchor windlass.



Capstan

2.2 Mooring gear auxiliaries

One or more winches can be placed on the foreship, depending on the size of the ship and the preference of the owner. As shown in the picture, the warping drum, bollard and fairlead are preferably positioned in a straight line.

Hawses, leadways, guide pulleys and bollards.

A rope is guided from the shore via a panama chock, through the bulwark to a bollard or winch. The panama chock must be able to withstand large forces, because the direction of the rope changes inside the panama chock. The panama chock must be curved to prevent wear of the rope.

Roller fairleads can be made of vertical and horizontal rollers. Their function is the same as the panama chock. However, the roller fairleads cause less wear to the ropes.



panama chock



Foredeck of a tanker



Roller fairlead



Panama chock and roller fairlead

Rollers on deck serve to change the direction of the ropes. Both the roller fairleads and the guide pulleys are able to withstand a maximum of 32 tons of pulling force depending on the ship's size.

Bollards transfer the mooring forces to the ship's hull. The outsides of the bollards have a nose, which prevents the first few windings of the rope from slipping upwards. Above or below this, there is an eye to which the rope stopper can be attached. The stopper absorbs the forces in the rope can be

1. Warping head
2. Drum
3. Bollards
4. Eyes to connect the stoppers
5. Guide roller (fairlead)
6. Centre lead
7. Leadway
8. Head line
9. Forward spring



Bollard

1. Guide roller
2. Nose
3. Stopper eye

taken off the warping drum and placed on the bollard. The double bollard is provided with two ridges to prevent the rope from moving. A stopper lug has been fitted as rope stopper.

For the non-moving parts like panama chocks, the allowed force is 1/5 of the maximum static force that this part is able to sustain.



1. Head lines
2. Spring

2.3 Emergency towing system for tankers

In recent years a number of environmental disasters involving tankers has shown how difficult it is to make a connection with a ship in distress. The IMO demands that tankers with a carrying capacity of more than 20,000 tons have an emergency towing connection forward and aft.



Buoy of an emergency towing system

3. Rigging

3.1 Cables and ropes

General

Cables on ships are used:

- a. to moor the ship and maintain its position and for towing.
- b. for the cargo gear
- c. in fishing and dredging

The cables mentioned in a. are usually made of rope and called hawsers or lines. The cables used in b. and c. generally are steel cables. The latter are described in more detail in the section "description of common cables".

Rope can be made from either natural or synthetic fibres. Nowadays, with a few exceptions, most ropes are made from synthetic fibres. The synthetic fibres are manufactured from mineral oil products that have undergone a chemical process. The rotation of the threads is opposite to the strands, preventing the rope to unlay. Below some (of the many) types of ropes are categorised according to the way they have been stranded (plaited).

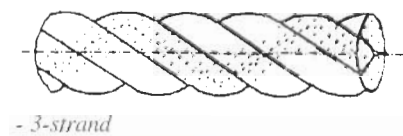

- 3-strand



- Parallel fibre core with mantle



- 4x2-strand braided



- Braided

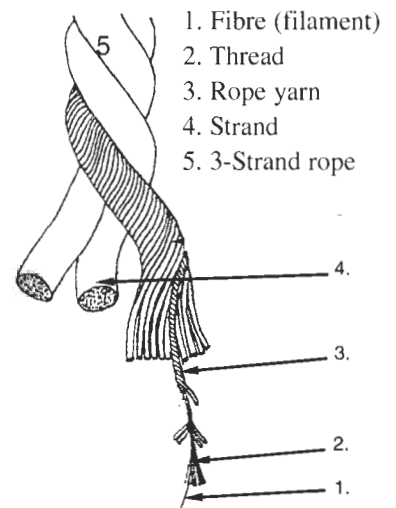

The drawing above shows how a rope can be composed

Some rope-types have a mantle. The purpose of the mantle is to keep the strands in the core together. This has the advantage that the strands in the core can be arranged in a parallel fashion: this gives the maximum tensile strength. The mantle itself rarely contributes to the tensile strength. The threads in the core need not be resistant to wear as the mantle provides the wear resistance. Therefore it is important that the wear resistance of the mantle is higher than the wear resistance of the core. A mantle keeps the cable round and compact, which reduces sensitivity to wear.

Some core-types that can be present in core-with-a-mantle-cables:

- braided
- stranded
- parallel strands
- parallel threads

The characteristics that are important when using or buying rope:

- **MBF.** (minimum break force) This is the minimum force in kN needed to break the rope.
- **Elasticity.**
- **Density.** The larger the density, the heavier the rope. It is important to know whether the density is smaller or larger than 1.000 t/m³, in other words: does the rope sink or float.
- **UV-resistance.** After several years, sunlight can degrade the rope.
- **Wear resistance.**
- **Construction.** The number of

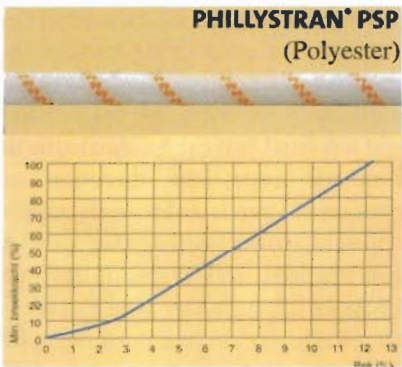
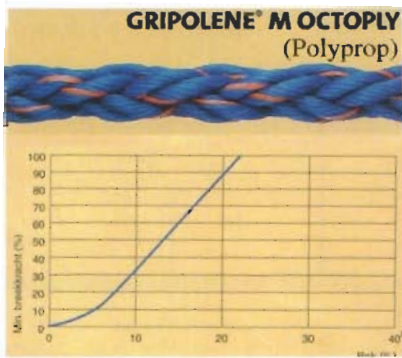

These graphs show that the elasticity of polypropylene is greater than that of polyester. At maximum load, the polypropylene stretches by 20% and the polyester by 12%.

strands and the way that the rope is plaited, the presence of a mantle.

- **Water-absorption**, expressed as a weight percentage of the rope.
- **Backlash** or snapback. This indicates if, in case of breaking, the rope falls "dead" on the deck, or snaps back. Rubber has a large backlash.
- **Creep limit**. This is the lengthening of the cable in time under constant tension
- **Chemical durability**. This indicates how well the rope can resist (the action of) chemicals.
- **A knot or splice** in a cable can reduce the strength by as much as 50%.
- **TCLL-value** (thousand cycle load level). This is the cyclic load level as a percentage and as an absolute value of the maximum load under wet conditions. This is the load at which a cable will break when it has undergone the load a 1000 times. For example, if the TCLL-value of a 100 tonf. cable is 50%, or 50 tonf, then the cable will break if subjected to a 50 tonf load a 1000 times

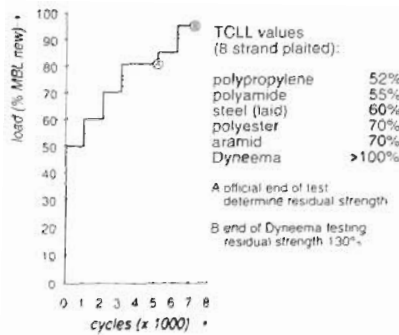

This graph shows the TOLL-values for a number of rope-types



3.2 Description of common cables

- a. High-grade cables
- b. Polyamide
- c. Polyester
- d. Polyolefines
- e. Natural rope
- f. Steel cables

a. High-grade cables

Aramid and High Module PolyEthylene (HMPE) are high-grade cables. Kevlar, Twaron and Technora are aramide brand names and Dyneema and Spectra are HMPE-brands. The difference between the two types is that the aramide has a lower (thus better) creep, but aramide

sinks whereas HMPE floats. High-grade cables are relatively new products and strengthwise they are comparable to steel cable of the same diameter. However, the price is 5-10 times as high as of steel cables.

Advantages over steel cables are:

- light-weight
- easy to manage
- non-conductive
- small backlash

b. Polyamide





Polyamide is better known as nylon. Polyamide ropes sink (density > 1.000 t/m³) and absorb water after being a few days in contact with water. The absorption of water adds 4% to the rope's weight. This can reduce the MBF by 10%. Polyamides have a large elasticity. A consequence of this is the backlash when parting. The rope sweeps over the deck and endangers the people present there. Certain types of polyamides can be spliced and re-used after the rope has snapped. However, especially cheap ropes are disposed of when they snap, and a new rope is ordered.

c. Polyester

Polyesters are very resistant to wear and very durable, both in wet and dry conditions. In mechanical characteristics polyester resembles nylon, except that it is more resistant to wear. Furthermore, polyester is more expensive. The density of nylon (1.14) is lower than of polyester (1.38) and the energy absorbing



Towing wire with a stretcher

PHILLYSTRAN® PSP		GRIPOLENE® M OCTOPLY		TIPTOLON® 3-STRAND		MANILLA II 3-STRAND					
											
SPECIFIC GRAVITY + 1.05 UV RESISTANCE + good ABRASION RESISTANCE + good CHEMICAL RESISTANCE + good ELONGATION + low graph		MELTING POINT CONSTRUCTION + approx. 250°C COLOUR + white MARKER YARN + orange		SPECIFIC GRAVITY + 1.01 UV RESISTANCE + good ABRASION RESISTANCE + good CHEMICAL RESISTANCE + good ELONGATION + low graph		CONSTRUCTION + 8 strand twisted TENSILE STRENGTH + 100% COLOUR + blue MARKER YARN + orange WATER ABSORPTION + 0.5%		MELTING POINT CONSTRUCTION + approx. 250°C COLOUR + white MARKER YARN + orange			
Nominal Diameter (mm)		MBF (kN)		Nominal Diameter (mm)		MBF (kN)		Nominal Diameter (mm)		MBF (kN)	
36		450		32		132		32		77,2	
48		578		38		166		36		94,8	
48		778		40		201		40		119	
52		878		44		241		48		148	
66		1270		48		288		48		185	

capacity of nylon is higher, making it more suitable to absorb large force variations. For this reason, nylon is often used as a stretcher, to protect steel cables from large shock loads.

d. Polyolefines

There are two types of polyolefine rope, namely high performance ropes and standard ropes. The difference between these two lies not just in the MBF, but also in the qualities like UV-sensitivity and wear resistance, which increase the durability of the rope. High performance ropes can also be found with a mantle. Polypropylene, polyethylene and mixtures of these compounds are polyolefines. Many high performance ropes like the Tipo-eight are also polyolefines.

Polyprop is a polyolefine-rope that is often used. Its advantages are:

- it floats
- it is relatively cheap

The disadvantages are:

- not very resistant to wear
- low TCLL-value
- short lifespan



An eye is spliced into a rope

e. Natural rope

Natural fibre rope has been replaced on most ships by synthetic ropes. In general, the only type of natural rope still in use on ships is manilla rope. Manilla rope is manufactured from the abaca fibre that is present in the leaf stalks of the manilla plant.

Although the resistance to chemicals and UV-light is good, the MBF is about 2-8 times smaller than the MBF of synthetic ropes. Manilla on ships is used for the pilot ladder, boat ropes of lifeboats and helicopter-nets. The reason for this is:

- manilla is less sensitive to fire and burns slower
- manilla is rough and hairy, therefore it does not slip easily, especially when wet.

f. Steel wire ropes

Steel cables or wire ropes have advantages and disadvantages. They are strong, cheap, have little elongation under tension, have a high wear resistance, but they are heavy, and they rust.

They are used where the circumstances allow or demand it, for instance for hoisting and luffing wires in cranes, mooring wires for tankers and bulkcarriers, anchor wires in dredging and offshore, towing wires for fishing and tugboats. In case of fire they are not immediately destroyed.

Steel wires are available in numerous constructions, depending on the requirements. There are basically two steel tensile strength grades: 1770 N/mm² and 1960 N/mm². Cables are made of a number of strands, turned in a long spiral around a core. The strands consist of a number of usually galvanised wires.

For flexible wire, the core is rope, and when flexibility is not necessary, the core is steel. A steel core makes a stronger wire. Rope core when oiled, lubricates the wire, but allows deformation under stress and bending. Steel wires need maintenance. Regularly greasing is essential.

The strength is optimal when different sizes of wires are used in the strands, so that the section is optimally filled with steel. Like ordinary rope, there are right hand and left hand laid cables. Analogue to synthetic rope, the direction of rotation of strands and wires is mostly opposite, called 'ordinary lay'. Other constructions and ways of lay are Cross Lay, Lang's Lay, Non-Rotating, etc. Each lay is used for specific purpose. During the fabrication process the wires in the strands can be pre-formed into the helical form which they get in the finished state, to reduce internal stresses in the rope. That prevents unspinning, and a broken wire does not stick out.

The construction of steel wire is given in a formula.

For example: Galvanised, Diam. 36 mm, 6 x 36 ws + iwrc. It means 36 mm diameter, 6 strands with each 36 galvanised wires, warrington seal (ws), and an independent wire rope core (irwc). Warrington seal is a means of constructing a wire rope from wires with different diameter, so that water ingress is limited.

Steel wire is mostly galvanised, but untreated steel wires also exist, and for special purposes stainless steel is used.



Life-boat tied with 19x7 steel wires

6X36WS + IWRC 1960 N/MM²



QUALITY	• galvanised	TYPE OF LAY	• regular lay
TENSILE STRENGTH	• 1960 N/mm ²	DIRECTION OF LAY	• right hand
TOTAL NUMBER OF STRANDS	• 13	GREASING	• yes
TOTAL NUMBER OF WIRES	• 265	ON REQUEST	• lang lay
TYPE OF CORE	• IWRC		• ungalvanised
NUMBER OF OUTER WIRES	• 84		• dry
NUMBER OF OUTER STRANDS	• 6		• left hand lay

Standard wire rope with steel core, general purpose use

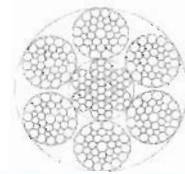

Nominal Diameter (mm)	MBF (kN)
8	44,7
9	51,0
10	69,8
11	84,4
12	100,0

7X19



QUALITY	• galvanised	TYPE OF LAY	• regular lay
TENSILE STRENGTH	• 1770 N/mm ²	DIRECTION OF LAY	• right hand lay
TOTAL NUMBER OF STRANDS	• 7	GREASING	• no
TOTAL NUMBER OF WIRES	• 133	ON REQUEST	• ungalvanised
TYPE OF CORE	• WSC		• greased
NUMBER OF OUTER WIRES	• 36		• left hand lay
NUMBER OF OUTER STRANDS	• 6		

Standard wire rope, mainly used in small diameters on winches

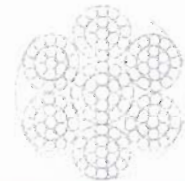

Nominal Diameter (mm)	MBF (kN)
8	37,6
10	58,7
12	84,6
14	115

6X19 + FC



QUALITY	• galvanised	TYPE OF LAY	• regular lay
TENSILE STRENGTH	• 1770 N/mm ²	DIRECTION OF LAY	• right hand lay
TOTAL NUMBER OF STRANDS	• 6	GREASING	• no
TOTAL NUMBER OF WIRES	• 114	ON REQUEST	• ungalvanised
TYPE OF CORE	• fibre		• greased
NUMBER OF OUTER WIRES	• 72		• left hand lay
NUMBER OF OUTER STRANDS	• 6		

Wire rope with fibre core



Nominal Diameter (mm)	MBF (kN)
8	34,8
10	54,4
12	78,3
14	107

19X7



QUALITY	• galvanised	TYPE OF LAY	• regular lay
TENSILE STRENGTH	• 1960 N/mm ²	DIRECTION OF LAY	• right hand lay
TOTAL NUMBER OF STRANDS	• 19	GREASING	• yes
TOTAL NUMBER OF WIRES	• 133	ON REQUEST	• lang lay
TYPE OF CORE	• WSC		• ungalvanised
NUMBER OF OUTER WIRES	• 72		• dry
NUMBER OF OUTER STRANDS	• 12		• left hand lay

Rotation resistant wire, used as hoisting rope



Nominal Diameter (mm)	MBF (kN)
8	41,1
10	64,3
12	92,6
14	126

3.3 Load testing equipment.

All equipment intended to be used in lifting gear needs to be certified. Regulations for lifting equipment and testing are internationally harmonized. This means that material qualities are checked, workmanship is judged and that a load test has to be carried out under the supervision of a regulating body. For ships this is normally the Classification Bureau.

All the items in hoisting gear must be covered by a certificate, stating an identification and a test. The load test is carried out to guarantee a Safe Working Load (SWL) or the Working Load Limit (WLL). A crane as a complete unit is tested by lifting a weight, and carrying out the normal movements like hoisting, lowering, slewing and topping. When the power to the crane is interrupted, the brake has to hold the load. The weight for testing is heavier than the WLL. For the smallest cranes this means 25 % overweight, for the biggest cranes it is 5 tons more than the WLL.

Individual small items belonging to the crane, such as the hook, shackles, etc. are normally tested at twice the WLL.



Testing the crane using water bags



Testing lifeboat davits using water bags

Test weights can be steel weights with a known mass; the modern variant is a water bag, which can be filled with water till the required mass is reached. A certified load cell indicates the weight. Water bags are available up to 35 tons.



3.4 Various parts

Various parts explained on these pages:

- End connections
- Shackles
- Turnbuckles or Bottle screws
- Thimbles
- Sockets.

A Talurit clamp, is an aluminium bush, which is pressed under high pressure at the position where normally a splice would be, replacing the time-consuming splicing. The pressing makes the original oval shaped bush into a cylindrical clamp, with the strength of the replaced splice. A talurit clamp is not to be used in bending situations.

- end connections

End connections are needed to be able to connect a wire to something else. Often shackles are used for the connection.



Safety hook

1. Brand or type marking
2. Chain size (chain 7/8 of an inch)
3. Class, grade 8 (high-grade steel)
4. Safety pin
5. Spring

- Shackles

Shackles can be divided into bow shackles and D-shackles. These can both come with or without a locking pin. Their general purpose is to connect certain parts to each other or to the ship. The Safe Working Load

(SWL) can vary from 0.5 ton up to over 1000 tons.

- Turnbuckles

Turnbuckles are used to connect and tension steel wire or lashing bars. The bottle screw consists of two screws, one with a left screw thread, and the other with a right screw thread. These are connected by a house.

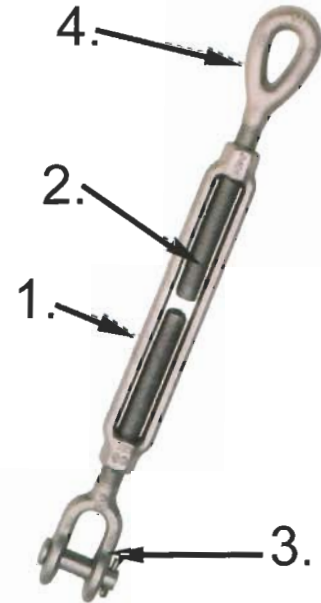

Turnbuckle



Bottle screw to tighten the foremast stay

1. House
2. Thread, one left-, one righthanded
3. Gaff
4. Eye



End links

Description of the above image:

- 1 Gaff socket with rolled connection
- 2 Cast spelter socket
- 3 Rolled eye terminal
- 4 Thimbled talurit eye
- 5 Spliced eye with thimble
- 6 Thimbled flamish eye, swaged.
- 7 Wedge socket (not allowed in hoisting).

- Safety hook

A safety hook is depicted in the figure below. It prevents the load from falling out of the hook, even if the load is resting. The hook can only be opened by pressing the safety pin.

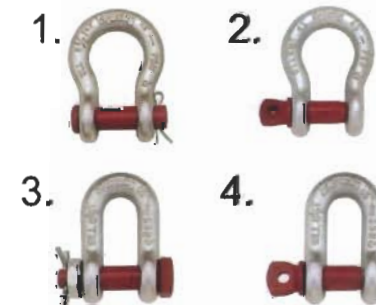

High tensile steel shackles. To obtain this high strength, after forging the shackles are subjected to heat treatment. (Quenched and Tempered)

1. Bow shackle with safety pin
2. Bow shackle with screw-bolt
3. D-shackle with safety bolt and nut
4. D-shackle with screw-bolt

- thimbles

A thimble is usually made of galvanised steel. Its function is to protect the eye of a cable from wear and damage.



Thimble

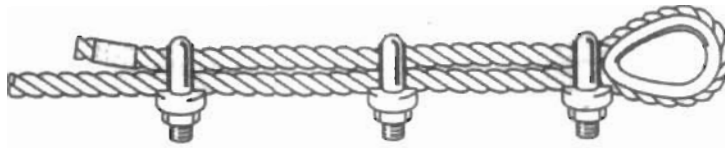

This is the correct way of applying the wire clamps to a cable (all U-bolts on the non-pulling part of the cable)

- Steel wire clamps

A steel wire clamp can be used to quickly make an eye in a cable. The U-bolt of the clamps should be attached to the part of the cable that is free from pulling forces. The bolts should be attached to the “dead” part, where no pulling forces are acting on the cable.

Steel wire clamps may not be used for lifting purposes, with an exception for guys and keg sockets to make sure that the cable does not slip.

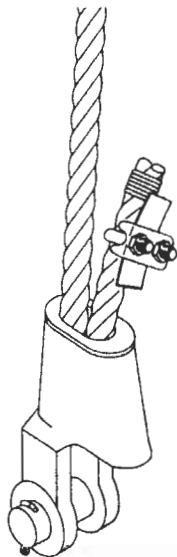

(Compulsory) wire clamp on a kegsocket

- Slings

When lifting objects, often slings are needed. A sling is a wire with at each end an eye spliced or clamped. The eye can be long or short, all depending on the purpose. When the item to be lifted has lugs welded on it, a sling with talurits and shackles can be used. In other cases long eyes are more versatile. These eyes can be talurit-clamped, but better is a flamish eye, with a swaged clamp. A flamish eye is a very simple but very strong splice. From a wire with an even number of strands, the strands are turned loose over the double length of the eye. Over that length the wire is

split in two sets of strands. Half the number of strands are laid in a bend in one direction, the other half into the other direction, meeting together in opposite direction, forming an eye. The strands are turned into each other, forming a wire. Where the ends come together a conical steel bush is placed on forehead, which is pressed together, preventing the wire ends from jumping loose.

The strongest sling is the grommet. A wire is turned around a circular rod, say six times the circumference, forming a cable, wherafter the rod is pulled out, and the wires, acting as strands, remain, turned around themselves. The ends are put away inside the rope. A grommet is very flexible and very strong. The heaviest grommets, for offshore lifts, reach a calculated MBL of 7500 tons. Testing is not possible, but the MBL of the individual wires is a known figure, found from a breaking test of a sample.



Cable-laid sling

Cable-laid slings are very heavy cables, constructed from steel cables with varying diameters, to fill the available diameter as well as possible. Eyes are spliced at each end. The built-up rope diameter can go as high as 350 mm. The calculated MBL can go as high as 4000 tons.

Modern slings are fabric. Woven from modern fibres very light and strong band-type slings are made, with one disadvantage: they can easily be damaged by sharp items. But strength-weight ratios can be extremely high, when modern fibres as Dyneema, Aramide, or other carbons are used. Very flexible and soft slings are made from Dyneema in long straight threads, not laid, inside a canvas tubing. This type of sling is very friendly to machined or polished steel objects.

3.5 Forces and stresses

- Some definitions

Safe Working Load (SWL) or Working Load Limit (WLL) is the maximum acceptable load on an item (shackle, hook, wire, derrick, crane, etc.).



Spreader with hook, SWL 6000 tons

Minimum Breaking Load (MBL) is the guaranteed minimum load at which an item, when tested to destruction as a sample for a large number of identical items, will fail. So, on average, most items will fail at a higher load. The load-stretch diagram below shows that the tested chain actually failed at a higher load than the MBL. The diagram also shows that proof loading by the manufacturer is done to 2.5 times the safe working load. For a re-certification test, the proof load will be 2 times the SWL. Normally used figures for the ratio WLL/MBL (or SWL/MBL) are:

- For chains: 1 : 4
- For steel wires and shackles: 1 : 5
- For ropes: 1 : 6
or 1 : 7

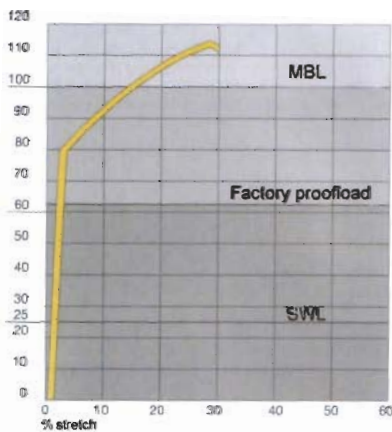

Load/stretch diagram of a grade 8 chain

- Forces in wires

The figure on the right shows the forces in a wire when a weight of 1000N is lifted, and how the force in a rope or wire increases as a function of the angle between the components. When that angle exceeds 90° the increase is excessive. Between 120° and 150° the forces run up to 1950N. The angle is therefore not allowed to exceed 120°. The material used for the wire does not influence the forces.

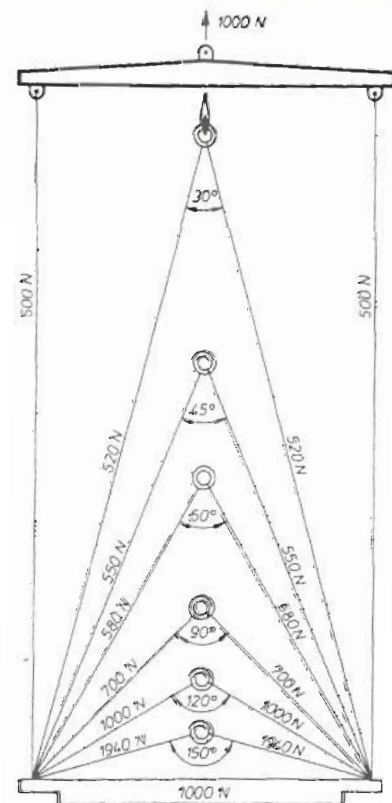

Heavy-duty bow shackles ready for testing



Blocks with rams horns of heavy cargo gear (400 tons SWL)



A medium-speed engine being loaded with own cargo gear

CHAPTER 11

Engine room



1. Propulsion
2. Engine types
3. Fuel
4. Cooling
5. Lubrication
6. Starting
7. Exhaust gas
8. Combustion air
9. Shafting
10. Electricity
11. Heating
12. Heat exchangers
13. Pumps
14. Safeguarding
15. Firefighting
16. Vibration and noise
17. Fresh water
18. Start up arrangement
19. Valves
20. Bilge-line arrangement
21. The ballast arrangement
22. Fire-fighting arrangement

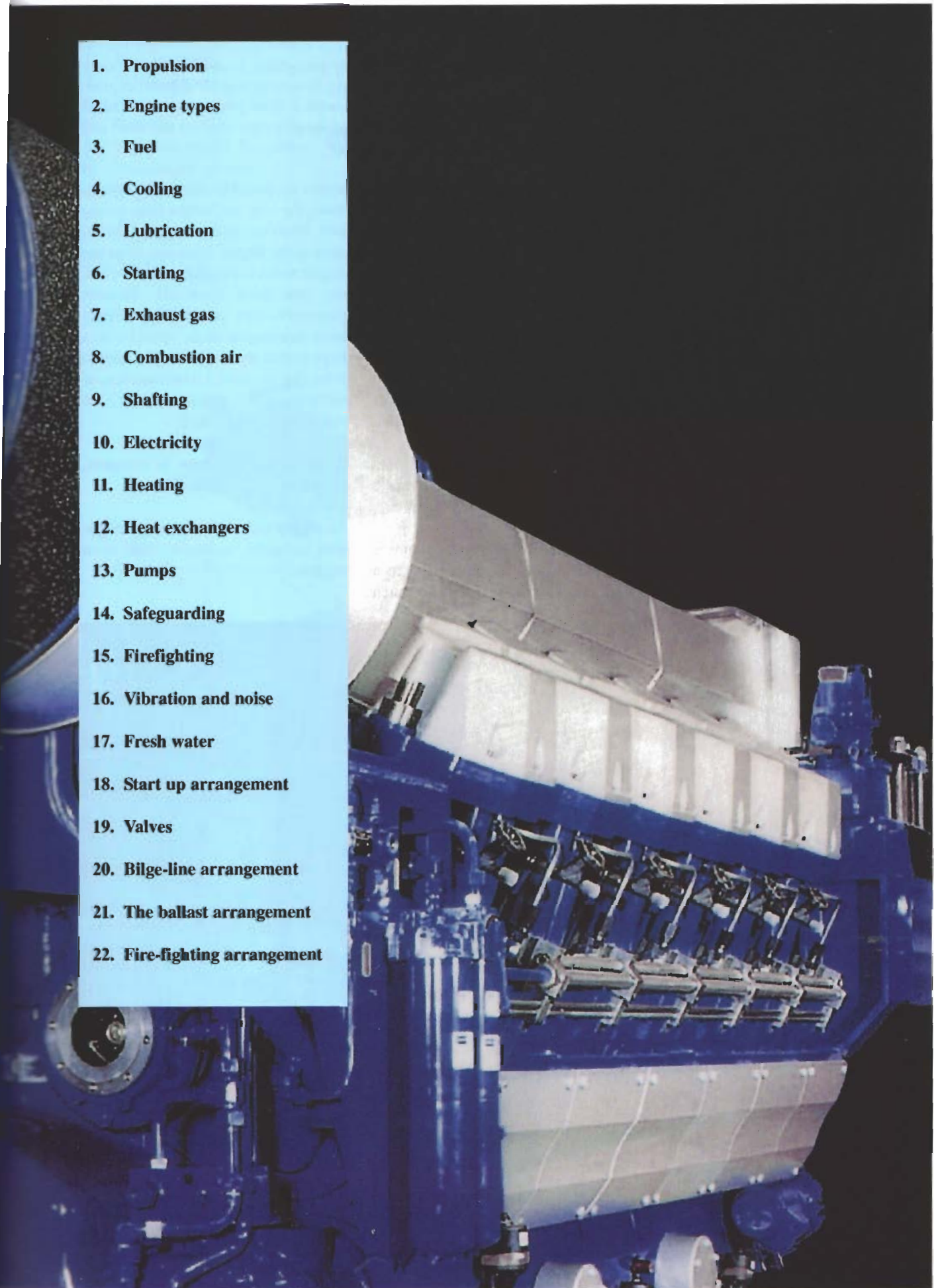

SHIP KNOWLEDGE

A MODERN ENCYCLOPEDIA

SHIPWISE

PAGE 8 **1**

THE SHAPE OF A SHIP

PAGE 22 **2**

SHIP'S TYPES

PAGE 44 **3**

THE BUILDING OF A SHIP

PAGE 68 **4**

FORCES ON A SHIP

PAGE 82 **5**

LAWS AND REGULATIONS

PAGE 104 **6**

CONSTRUCTION OF THE VARIOUS

SECTIONS

PAGE 126 **7**

CLOSING ARRANGEMENTS

PAGE 160 **8**

LOADING GEAR

PAGE 174 **9**

ANCHOR AND MOORING GEAR

PAGE 196 **10**

ENGINE ROOM

PAGE 216 **11**

PROPULSION AND STEERING GEAR

PAGE 244 **12**

ELECTRICAL INSTALLATIONS

PAGE 266 **13**

MAINTENANCE AND DOCKING

PAGE 280 **14**

SAFETY

PAGE 302 **15**

STABILITY

PAGE 322 **16**

CHAPTER 11 QUESTIONS

VISIT

WWW.DOKMAR.COM

1 Propulsion

The ship's propulsion is normally done by propellers. In most cases by only one. That propeller is rotated via a shafting system driven by a diesel engine. Again in most cases the propeller is one with a fixed pitch, with a so-called monobloc casting. The shafting consists of the propeller shaft or tail shaft and at least one intermediate shaft.

As a consequence of the fixed-pitch propeller, the main engine is normally a directly reversible diesel engine. A reversing gearbox is only found in combination with small engines.

More than one propeller systems are found on fast ships, such as passenger ships and ships which are restricted by draught, or where the total power needed is too much for one propeller.

The following is a description of a normal engine room of an average cargo-ship.

In most ships the engine room is installed aft and is compressed to a minimum length, to leave as much

length as possible for cargo, and to make the ship not longer than necessary. However, in the finer built hulls, such as the bigger container-ships the engine room is located more forward, say one third from aft. Modern passenger-ships and Ro-Ro vessels have their engine room spread over a large part of the ship's length, limited in height, to create a minimum loss of vertical space where cabins or vehicles can be located.

A ship's engine room is complex, complete, and compact.

An engine room of an average cargo-ship normally contains one main engine.

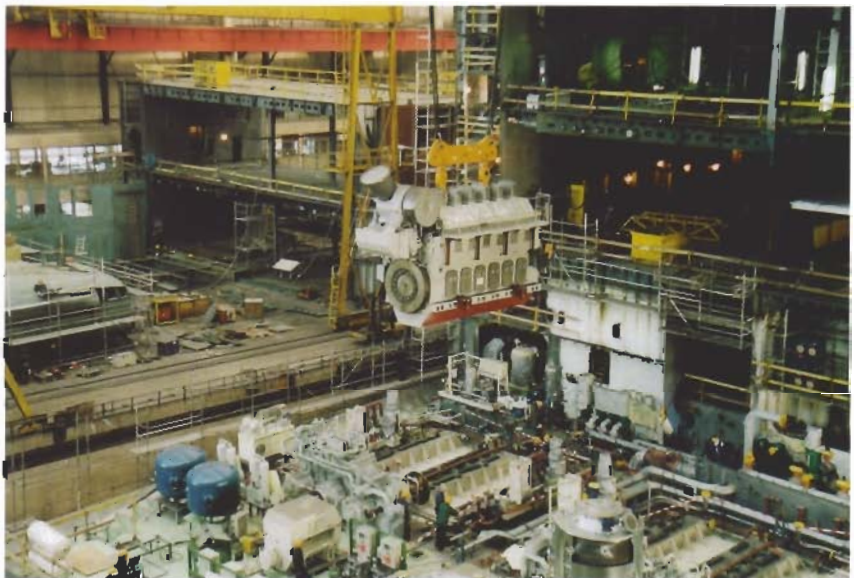

Installing a main engine on its foundation



Explanation of these 3D-images:

1. Bottom plating
2. Side keelsons
3. Floors
4. Tanktop
5. Top plate engine foundation
6. Foundation gearbox
7. Engine
8. Shafting
9. Gearbox
10. Sea inlet box

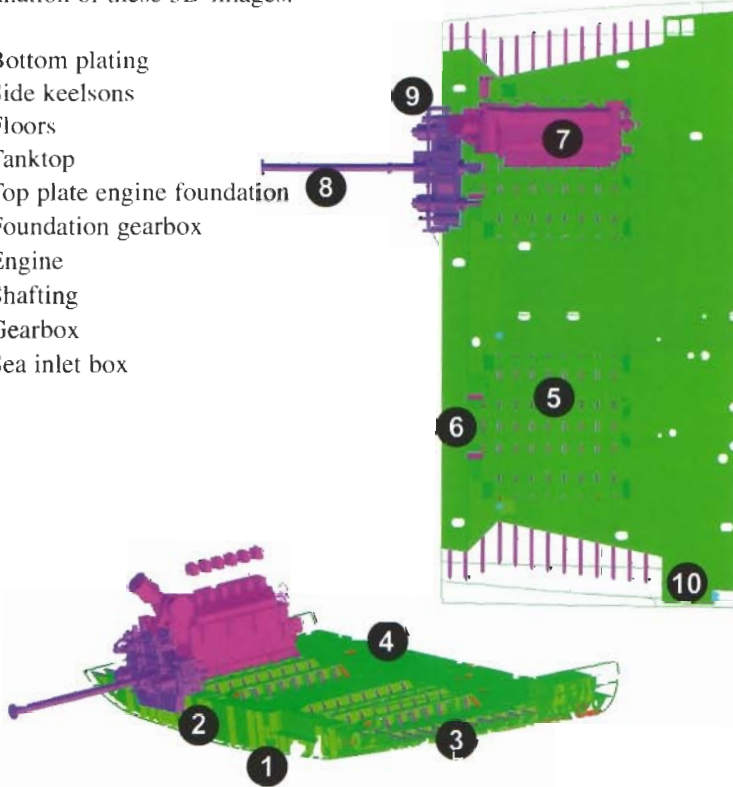

3D-photos of engine room parts

2 Engine types

Propulsion diesel engines can be divided into three groups:

1. **High-speed** four-stroke diesel engines, RPM above 960.

On this page you see an example of a high-speed engine.



High-speed V-engine for ferry Ør R0-Ra

RPM: Revolutions per minute



1. Turbocharger
2. Valve protection covers
3. Control panel
4. Protection of fuel pumps
5. Protection of camshaft
6. Crankcase cover
7. Nameplate
8. Camshaft cover
9. Aircooler

Medium-speed engine, 8 cylinders in line

2. Medium-speed four-stroke diesel engines, RPM ranging 240-960.

On this page you see two examples of medium-speed engines



Medium-speed four-stroke diesel engine, RPM ranging around 500

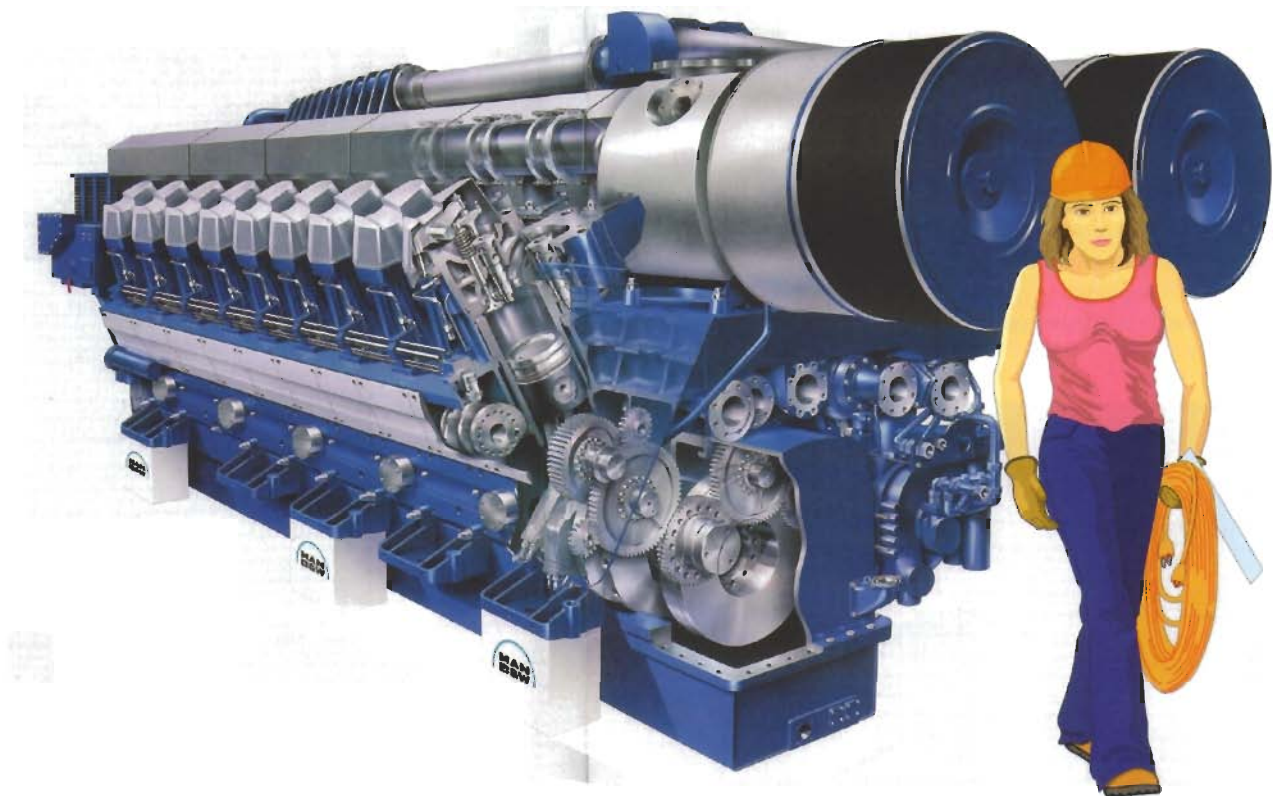

Medium-speed V-engine.

3. Low-speed engine (crosshead) two-stroke diesel engines, RPM range below 240.

The high-speed and medium-speed engines drive the propeller via a reduction gearbox to reduce the RPM. The slow-running engine is directly coupled to the propeller.



Low-speed engine for large container-ship.

Below: Low-speed engine for bulk carrier or tanker

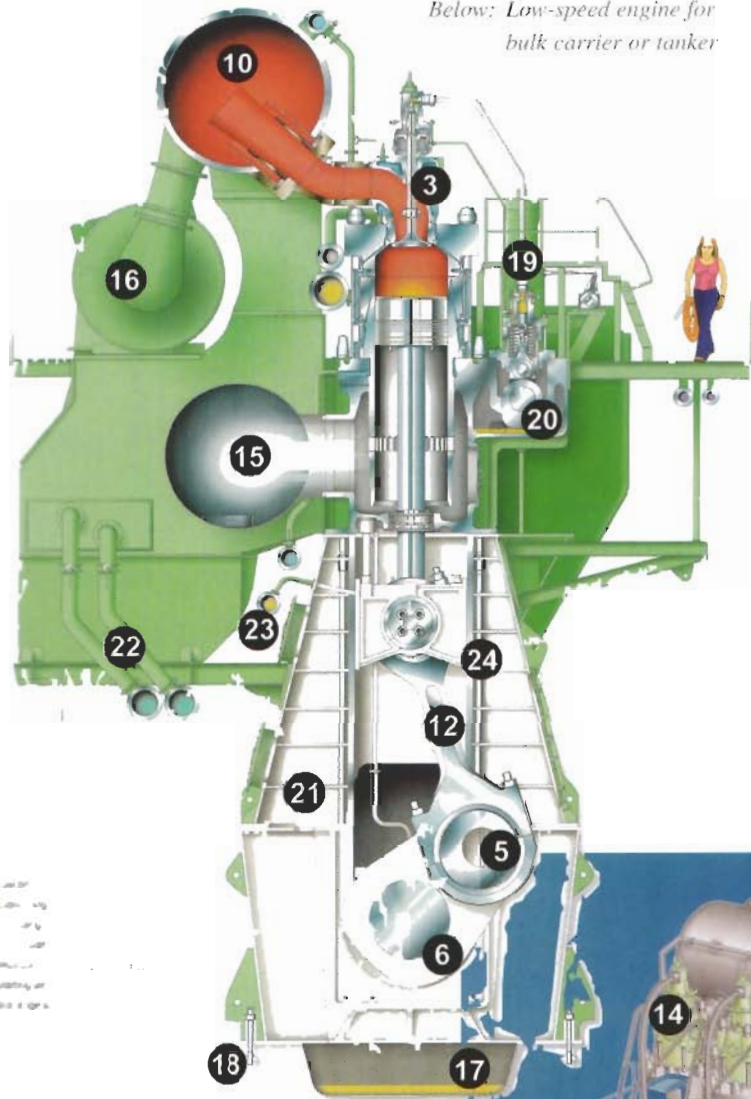

- | | |
|--------------------------|-------------------------------|
| 1. Cylinder | 13. Turning gear |
| 2. Piston | 14. Cylinder cover |
| 3. Exhaust valve | 15. Air receiver |
| 4. Crosshead bearing | 16. Turbo-charger |
| 5. Crankpin bearing | 17. Sump |
| 6. Crankshaft | 18. Foundation bolt |
| 7. Flywheel | 19. Fuel pump |
| 8. Crankcase door | 20. Camshaft |
| 9. Crankcase bed | 21. A-frame |
| 10. Exhaust gas receiver | 22. Cooling water (aircooler) |
| 11. Piston rod | 23. Lub. oil lines |
| 12. Connecting rod | 24. Tie rod |



Low-speed engine (crosshead) two-stroke diesel engine, RPM range 80 to 120.

The high-speed engines are found in the smaller ships, such as ships for inland navigation; medium-speed engines in all kinds of midsize vessels, tugboats or where height is a restriction, (e.g. Ro-Ro ships) The slow-running diesel is commonly used in all ships over 30,000 tons dwt.

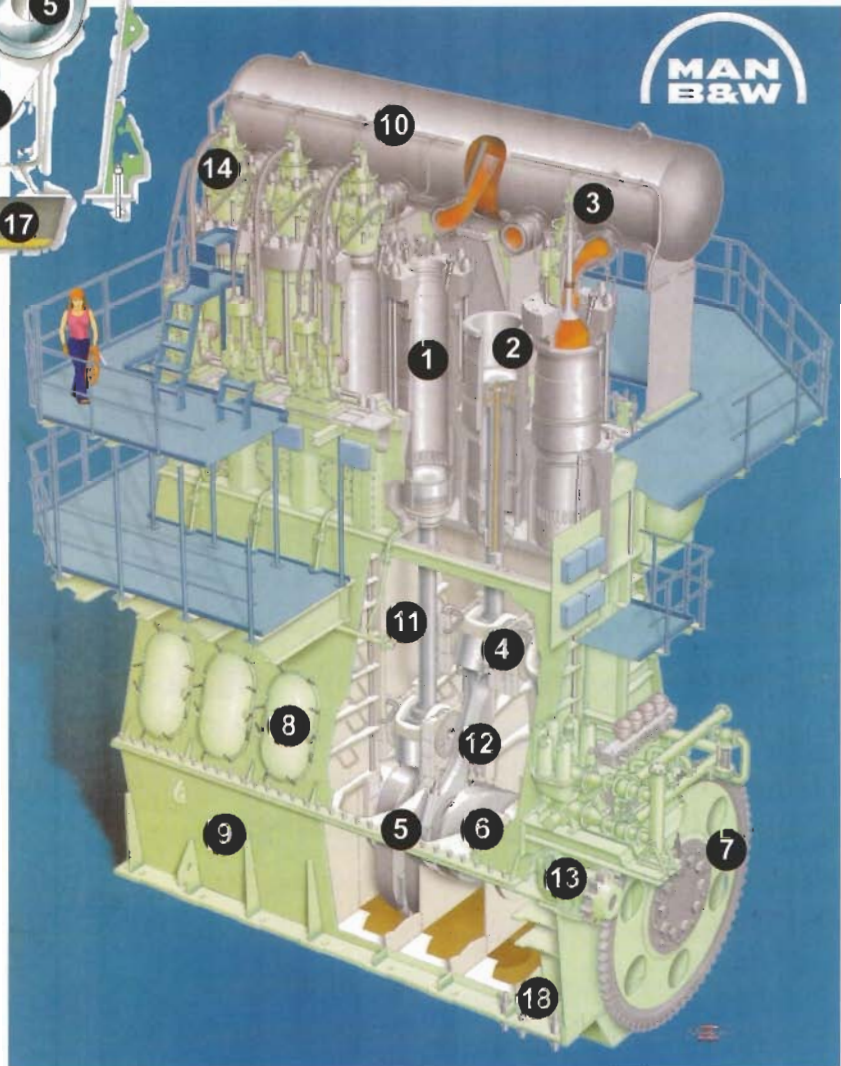

1. Crankshaft with counter weights
2. Connecting rod
3. Stepped piston
4. Cylinder liner
5. Fire ring with jet-cooling
6. Cylinder head
7. Individual cylinder jacket
8. Cylinder crankcase
9. Crankshaft-bearing cover
10. Lateral crankshaft-bearing bolt
11. Crankshaft-bearing bolt
12. Cylinder-head bolt
13. Camshaft fuel injection
14. Fuel pump
15. Fuel injection pipe
16. Push rod
17. Camshaft valve control
18. Rocker arm
19. Exhaust valve with propeller
20. Inlet valve
21. Starting valve
22. Injection nozzle
23. Charging-air pipe
24. Exhaust-gas pipe
25. Cooling-water pipes
26. Charging-air cooler
27. Exhaust-gas turbocharger
28. Adjusting device for injection time
29. Adjusting device for valve timing
30. Governor actuator

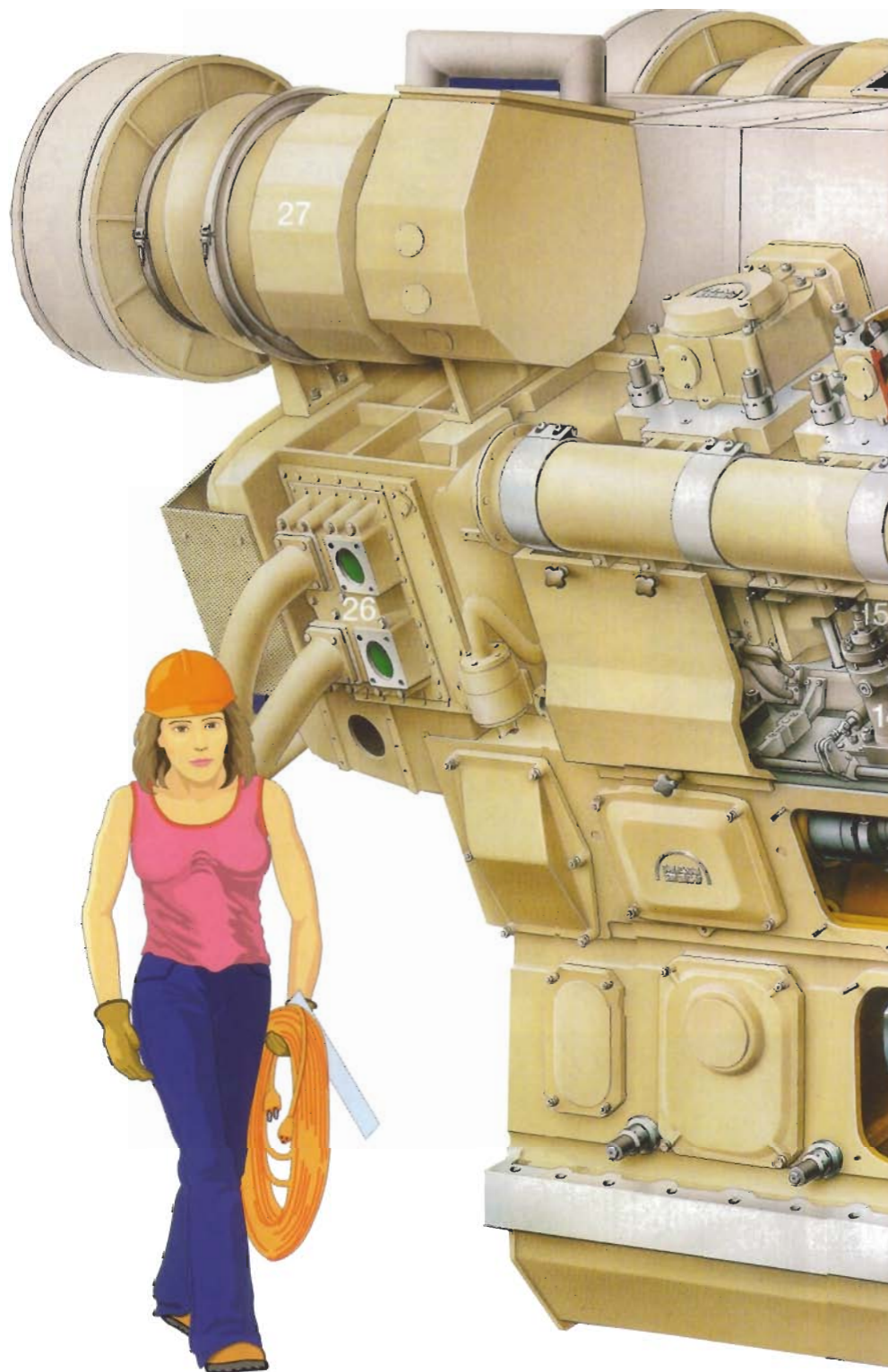

Medium-speed V-engine.

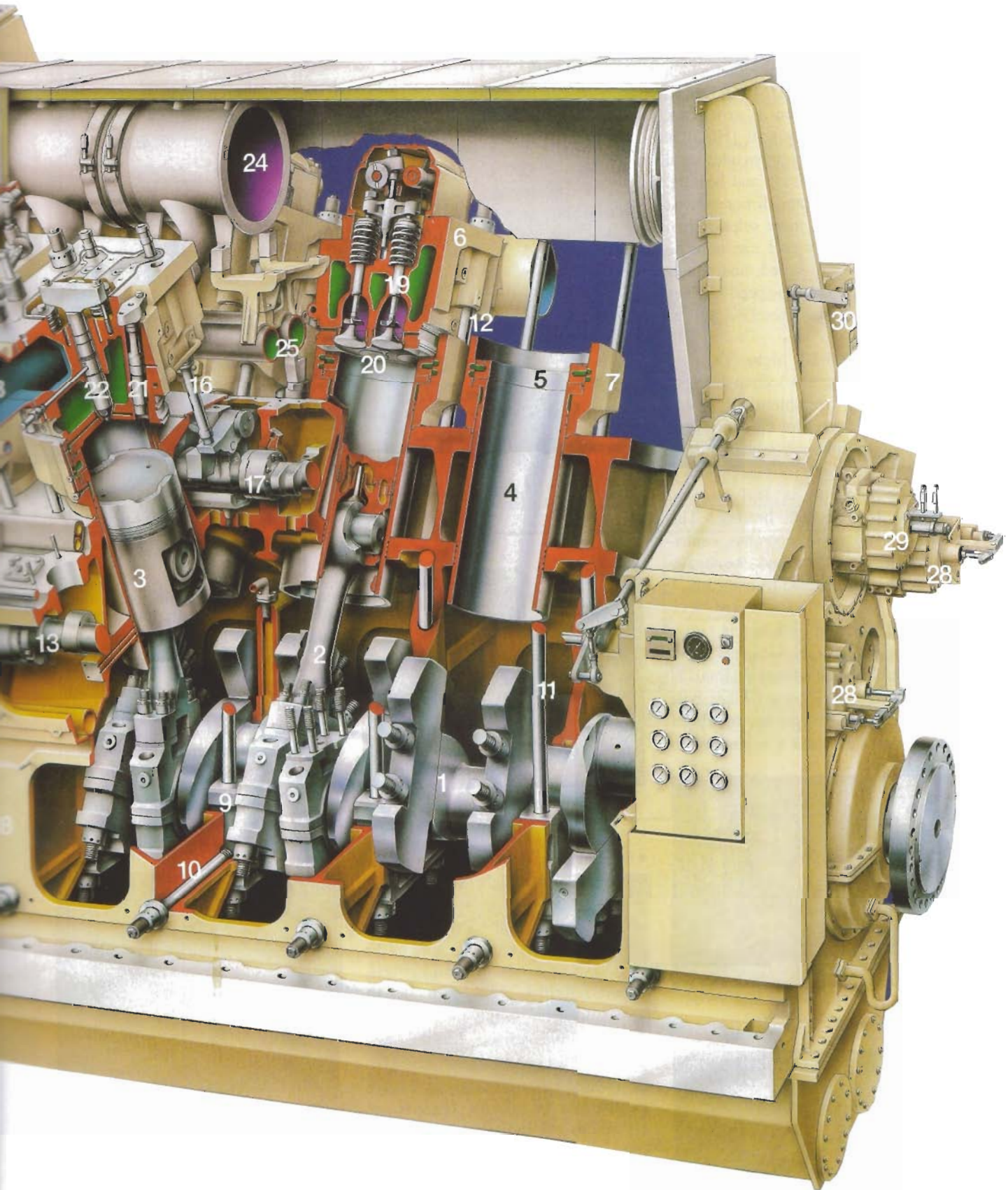

3. Fuel

The criterium for the choice between the engine types, apart from the size of the ship, the available space and the required power, is the fuel which can be used. Diesel oil (MDO) is best, produces least dirt, but is expensive. The so-called heavy fuel (HFO) is much cheaper, but requires additional systems as pre-cleaning and heating. It produces sludge and dirtier exhaust gases. It contains more sulphur than diesel. This heavy fuel can only be used in medium-speed and slow-running engines. High-speed engines require high-quality diesel oil.

The heavy fuel has a higher viscosity and cannot be pressed through injectors without treatment. It needs heating to increase viscosity and purifying to eliminate water and dirt particles, too big to pass the injectors. Heating is done in fuel heaters, mostly by electric heating. The cleaning is done in separators, centrifuges where water and the heavy particles are separated from the oil.

The fuel is stored on board in tanks, the bunkers. In cargo-ships often in the double-bottom tanks. Fuel is supplied normally by a bunker boat through a hose, straight into the ship's tanks. From this tank it is pumped to



Purifier



Fuel manifold on a large container-ship

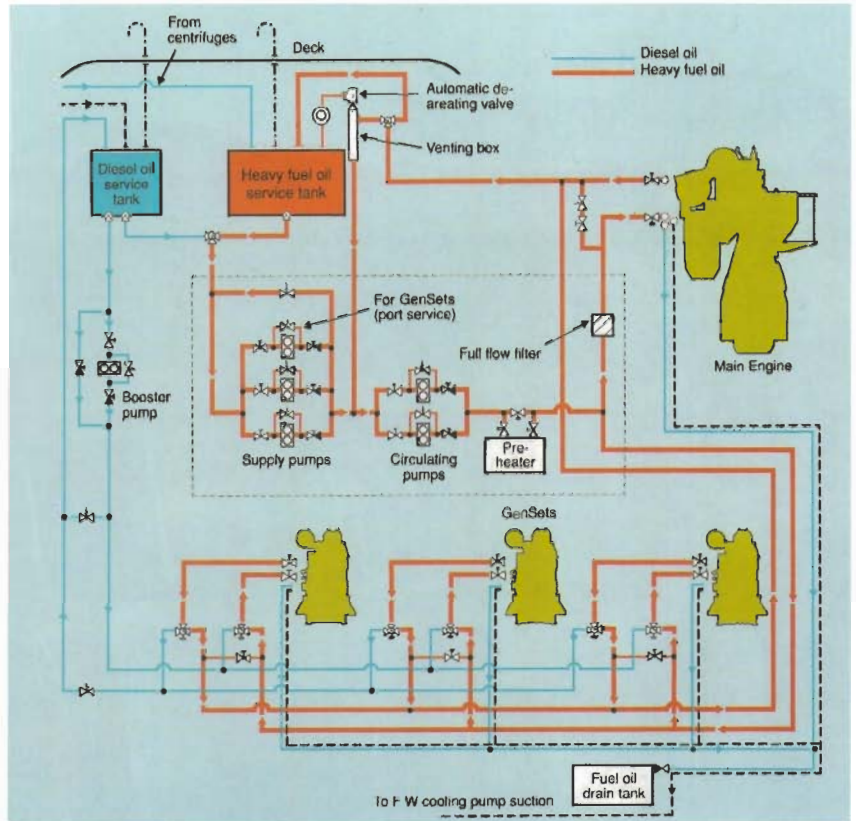

Fuel system



Fuel pumps

a smaller tank in the engine room, the settling tank, a high, vertical tank, where water and heavy dirt sinks down, and via a high suction the oil is pumped through the separators to the day tank, the clean-oil tank. The water and dirt go straight to the sludge tank. From the clean-oil tank the fuel is pumped by the low pressure fuel pump to the high pressure (HP) fuel pump which pumps it to the injector. There is one HP pump per cylinder. Surplus oil, depending on the demand of the engine, flows back to the day tank. The dirt from the separators goes to the sludge tank, to be disposed of ashore or by an incinerator.

4. Cooling

All diesel engines produce heat and need cooling. This can be achieved by air cooling, but more common is liquid (water) cooling. This can be done directly when the salt cooling water is pumped in and via a filter, passes the engine and is again pumped overboard. This is used in very small ships only, and also only when the ship is always in fresh water.



Water inlet filter

The bigger ships use a closed-circuit cooling system with water containing inhibitors, to protect the diesel engine against corrosion. The cooling liquid is then cooled in a heat-exchanger outside the diesel engine. The cooling medium is again seawater passing a filter and a heat-exchanger, and

finally pumped overboard. A separate seawater pump is then required. In small ships the heat-exchanger can be installed in a sea-chest which has natural circulation for seawater. That saves out another pump.



Cooling-water pumps

5. Lubrication

Each diesel engine needs lubrication. Normally this is done by pumping oil through the bearings and forced upwards from the crankcase towards the cylinder liners. Small engines have a built-in oil pump, larger engines have an external pump.



Cylinder lubricators

Oil is pumped through a filter into the engine. All the bearings have a separate outlet. After use the oil drips down into the crankcase, from where it falls into the main-engine sump tank below the engine. From that tank it is pumped via an oil cooler and a filter system to the engine again. The quality of the filtering is critical for the engine's service life. The filter

system can be complex. In a small engine it is only a filter, to be exchanged every so many hours. In big ships the oil is pumped through a very complicated micro-filter which has a built-in self-cleaning system via back-flushing. There are two parallel filters to avoid stopping the engine during filter change. The lubricating-oil pump is mostly a screw- or gear-type pump, where the output and pressure is constant,

contrary to a centrifugal pump. Lubrication in large engines is much more complicated. The lubricating oil also has a cooling function, particularly for the pistons.

In large engines, with a crosshead, these systems can be divided into crankcase lubrication, cylinder lubrication and cylinder-oil cooling.

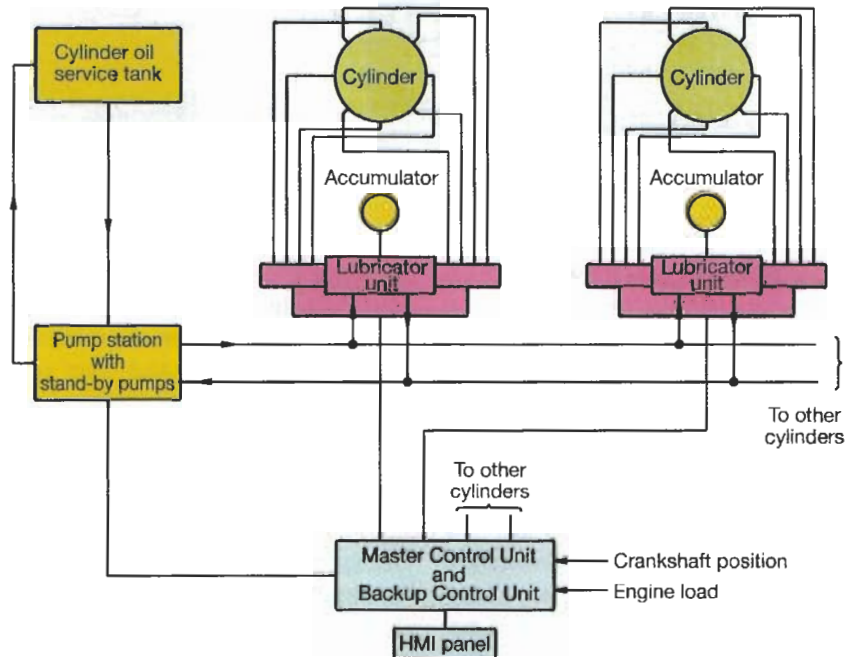

Cylinder lubrication

6. Starting



Starting-air receivers

Small engines are started using an electrically driven starting motor on batteries. The larger engines, however, are started using compressed air, released in the cylinders, through the starting air valves on the cylinder heads, in the same sequence as the

combustion sequence. The main air line from air vessel to engine contains a distributor, a rotating disc, driven by the engine crankshaft, with holes, leading air through to the appropriate cylinder. When the engine is turning, fuel is injected, and the air injection can be stopped. The compressed air is held in compressed



Starting-air compressors

air vessels, and kept under pressure and refilled by air compressors. The

required pressure is approx. 25 bar.

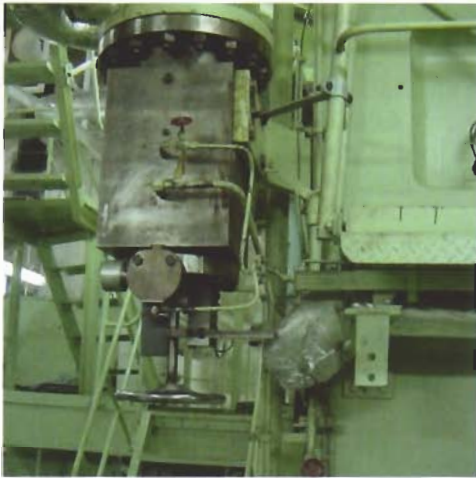

Main starting-air valve



Starting-air bottles

7. Exhaust gas

The combustion produces exhaust gas. This is a very hot mix of carbon dioxide, nitrogen oxides, unburnt oxygen, sulphur dioxide, and carbon (soot). The sulphur oxides are harmful. With water they form acids, corrosive to the steel exhaust pipes, and not environmentally friendly. This of course also counts for carbon dioxide, and the nitrogen oxides. Pressure is put on reduction of Nox and Sox.

The heat in the exhaust gas can be used to warm up fuel, and for other purposes, such as accommodation heating. In the exhaust-gas pipe a heat exchanger can be built in which water or another liquid is pumped through. When the liquid is water, and it evaporates, the heat-exchanger is called an exhaust-gas boiler. When it does not evaporate, the heater is called an exhaust-gas economiser.

8. Combustion air

The air needed in the cylinders for combustion, is normally drawn from the engine room. In small ships only an opening to atmosphere is sufficient, in big ships electrically driven ventilators supply the engine room with a large quantity of air, also to keep the engine-room temperature sufficiently low. The performance of

the engine can be boosted by supplying the cylinder with air of a higher pressure. More air means more fuel that can be burnt. And that again means more engine output.

The output of the engine is limited by the temperature of the exhaust gas. When the temperature in the cylinder becomes too high, damage can occur to outlet valves, cylinders etc. Therefore the air must have a certain overcapacity for cooling purposes

The quantity of air can be boosted further by compressing the air before it goes into the cylinder. The air can be compressed by using the velocity of the exhaust-gas. In the exhaust-gas line a turbine is fitted, driving a rotary

compressor. The air rises in temperature due to the compression. By cooling this air after compression, the pressure rises even more.

Cooling water from the main system is used for this air cooling, and also to cool the whole unit.

9. Shafting

The shafting arrangement transfers the torque produced by the engine to the propeller. In the most common, most simple and most reliable systems this is a monobloc casting. Controllable pitch propellers are also quite common, but more complex, expensive and more vulnerable to failures. They have, however, the advantage of the optimal pitch you need for each speed and a constant RPM, which gives the possibility of a main-engine driven (shaft) generator.

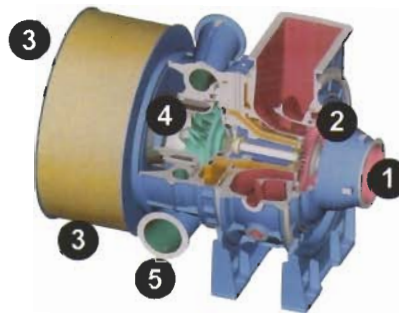

1. Exhaust-gas inlet
2. Exhaust-gas turbine
3. Air-inlet filter
4. Rotary compressor
5. Compressed air outlet



Main engine flywheel with intermediate shaft and main lubricating-oil pumps, electric motors



Shafting looking aft

Normally the shafting consists of one intermediate shaft and the tail shaft.

The intermediate shaft is needed to create access when the tailshaft needs to be withdrawn. The intermediate shaft is then to be laid aside. In the system are a number of bearings: one or two bearings on the intermediate shaft, and the bearings in the stern bush. The total number can vary depending on the length of the system and the weight of the shafts.

The aft-most shaft, the tail shaft, is supported by the stern bearing. It is located inside the after-peak tank, out of sight. This bearing is part of the stern tube, which is completely filled with lubricating oil so that the tail shaft rotates in oil.

At the aft side of the stern tube a complicated sealing system is fitted, to keep seawater outside and the oil inside the stern tube. This seal is located just forward of the propeller. The outer seal is protected by a surrounding ring, the rope-guard. At the forward end of the stern tube, where the shaft leaves the engine room a similar, but less complicated seal is fitted, again to retain the oil in the stern tube and not leaking it into

the engine room. The propeller is fitted on the tail shaft, normally with a press-on fit. The after end of the tail shaft is conical, fitting precisely in the conical hole of the propeller. Sometimes it is secured against turning by a key. But this is old-fashioned. The normal way nowadays is the so-called key-less fitting, where the propeller during the push-up is pressed by high oil-pressure on the conical surface.

A controllable pitch propeller is fitted with bolts on a flange at the after end of the tail shaft. Such a shaft has to be withdrawn outwards, which often makes removal of the rudder necessary. The shafting of a controllable pitch propeller (CPP) is much more complex, due to the hydraulic functions needed by the propeller, and which is distributed through hollow shafting.

A fixed-pitch propeller is normally a right-handed propeller. A controllable pitch propeller is left-handed, this to create astern properties similar to those of a fixed-pitch propeller.

10. Electricity

A ship has a considerable power consumption. Steering gear, lighting, ventilation, all the pumps, compressors, air-conditioning, etc. A diesel generator supplies the power.

At least two diesel generators are needed. When one fails, the other can take over. To allow proper maintenance of one diesel generator when the ship is in normal operation, and not to be at risk of insufficient redundancy, a third diesel generator is



Diesel generator

1. diesel engine
2. generator

normal. All three are identical, and each is capable of taking the complete electrical power demand at sea. The electricity produced is normally 3-phase current. When more than one generator is running the electric output can be connected through a circuit breaker to the bus-bars of the main switchboard in so-called parallel mode. A synchroniser-panel is installed in the switchboard, which only allows the circuit breaker to be closed when the generator which is to be switched on, is in phase with the other already running generator(s). Together they then feed one system. The diesel output power is controlled by a governor on each diesel engine that regulates the fuel quantity, while keeping the RPM constant. Big ships usually have generators that produce 440 volt and 60 Hertz (3-phase).

1. Generator
2. Engine
3. Gearbox
4. Shaft

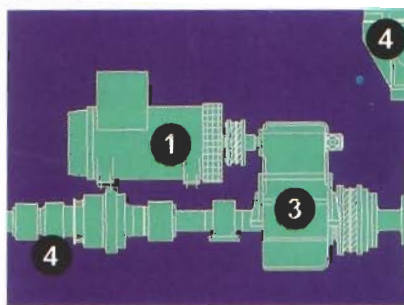
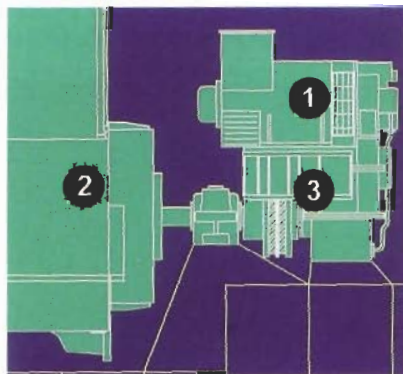

Various methods of driving a shaft generator, the "power take off" or PTO

A shaft-driven generator or PTO-generator (PTO means power-take-off) is becoming popular, mostly in combination with a controllable pitch propeller, to answer the requirement of the constant RPM. The main engine produces the rotating energy, burning cheap heavy fuel instead of expensive diesel oil. Parallel running between the diesel generators and the shaft generator is normally only possible for a short period i.e. the time to take over the load.



Turbo charger

To ensure electric power for essential functions (navigation lights, steering gear, bridge equipment, lighting in engine room and accommodation, etc.) in case of a total electric power failure, a so-called black-out, ships are equipped with an emergency generator. This generator feeds the emergency switchboard. It switches on automatically when this switchboard does no longer receive power from the main switchboard.

Large main engines produce so much heat in the exhaust gas that steam can be produced in an exhaust-gas boiler to the extent that a steam-turbine generator can supply the necessary electricity for at least the normal electricity demand at sea. A steam turbine then drives the alternator through a reduction gear box. This saves a diesel generator and the fuel for it. Such a system involves a complicated steam system, of high quality, with the necessary safety devices, a condenser, circulating pumps, cooling-water pumps, feed water and condensate pumps and accurate water treatment.

Electrical consumers are divided into two groups: essential and non-essential. In case of a power failure, the non-essential users are to be

switched off. Essential users such as steering gear, main engine lubeoil fuel and cooling-water pumps, navigation lighting and bridge equipment, are maintained as long as possible.

11. Heating

The heat produced by the engine is normally not sufficient for heating the ship, and the engine is not always running. Most ships therefore have a small oil-fired boiler, for accommodation heating and fuel heating. This oil-fired boiler can be combined with the exhaust-gas boiler. Ordinary cargo-ships can do with a small



Small boiler

boiler. Tankers generally have big boilers as they use steam to keep their cargo pumpable by heating, and often have steam-driven cargo pumps for the discharge of their cargo. In that case also the ballast pumps are steam driven.

Instead of steam, other liquids can be used for heat transfer, e.g. thermal oil. The advantage is that the system is simple. A disadvantage is that the oil brings a fire hazard with it.

12. Heat exchangers

Heat is produced at various places. This heat must be disposed of. Or, on



plate cooler

the other hand, liquids or air must be heated. Therefore a number of heat exchangers are found in every engine room:

Fresh cooling-water coolers: for cooling water

Fresh cooling-water heaters: pre-warming of diesels

Lubricating-oil coolers: one for each auxiliary diesel engine, attached to the engine, two for the main engine

Air coolers: for combustion air

Air heaters: for general heating, air-conditioning

Oil heaters: for fuel

Types: Straight-tube coolers, U-tube coolers, Plate coolers.



Rotary-vane steering gear

13. Pumps

Liquids are to be pumped through all the systems. For different media different pumps are used:

- For cooling water normally centrifugal pumps: low pressure, large quantity;
- For lubricating oil: screw type pumps: constant supply, constant pressure;
- For boiler feed water: two- or three-stage centrifugal pumps or piston pumps;
- For fire pumps: high pressure centrifugal pumps;
- For highly viscous fuels: gear type pumps;
- For dirty water, etc.: piston pumps, membrane pump.



Centrifugal pumps

To keep the engine room dry, there are so-called bilge pumps. There are normally three systems. A small pump capable of dealing with the normal small daily quantities. Pumping overboard is not allowed. This small pump pumps the dirty water (water and oil) into a bilge holding tank. From that tank the water is pumped by another small pump through a bilge water separator overboard, only when it is sufficiently clean. If not, it goes to another storage tank, the sludge tank. A second, bigger pump, can pump the bilge water from the engine room straight overboard, but this is only allowed in emergencies. A third possibility is to use the direct suction of the main cooling-water pumps. This huge capacity is for big leaks in emergencies.



Small bilge pump of the bilge-water separator

14. Safeguarding

The various machinery in the engine room is safeguarded by control systems. A simple diesel engine of 20 hp already has a lubricating oil pressure alarm. When the lubricating-

oil pressure is too low, a red light combined with a penetrating high noise will draw attention. The bigger the engine, the more safeguards. For example there are alarms for: Cooling-water too hot, cooling-water pressure low, lub oil level low, return lub oil temperature too high and so forth.

In a modern engine room which is arranged for controlled operation, all these alarms are brought to a control room where on screen the abnormality is shown, and remedial action can be taken. By human action, or even automatically.

When cooling water is too hot, for instance, the flow can be raised by opening a regulating valve. When the water temperature is too low, that same valve can reduce the flow. When that remedy fails: alarm.

15. Fire-fighting

Fire-fighting can be divided into prevention, alarming and real fire-fighting.

Prevention means to prevent by all means that the three requirements: heat oxygen and something combustible are together. The moment that it nevertheless happens then, the sooner it is detected, the more chance there is to fight it successfully. The main detection system is smoke detection. Ignition detection (flame detection) at strategic locations can be faster. Heat detection is another addition to the system. Mostly a mix of these detectors is installed.

When smoke, excessive heat or light flashes are detected, alarm bells are activated. The equipment to fight the fire is available in the engine room.

Portable extinguishers of various kinds, fire hoses with water from various pumps, portable foam extinguishers, and when the other systems fail, a total flooding installation using carbon dioxide, high expansion foam, or water related systems.

16. Vibration and noise

Diesel engines produce vibration pulses. Each combustion inside a cylinder produces a pulse conveyed via the foundation of the diesel engine into the ship.

The propeller is also a source of vibration. Firstly, the pressure field around the blades of the rotating propeller give pressure variations on the aft ship above the propeller. Secondly the blades when rotating through their cycle meet water with a different velocity at each location of that field. These actions produce pulses.

Each part of a ship has its own resonance frequency. When the pulses induced by some machinery meet the resonance frequency of a ship's component, and the pulse is sufficiently strong, vibration is the result. Noise is generated by air-vibration. Main sources are the exhaust system, the combustion explosions and the turbo chargers.

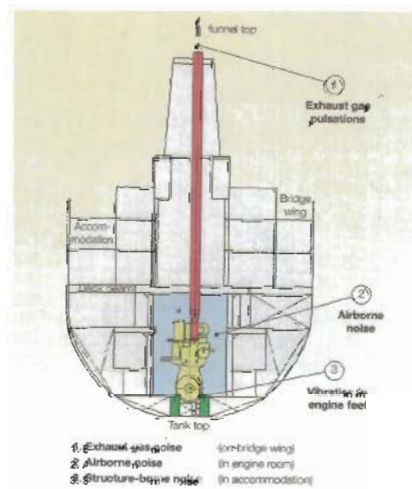

Vibration sources

17. Fresh water

Ships navigating the seas, make their own fresh water. Salt water, evaporated into steam and then brought into a condenser, produces condensate. And that is fresh water. When the pressure in the boiler is reduced below atmospheric, the boiling temperature is lower than 100 degrees C. This phenomenon creates the possibility to use the hot cooling water



Fresh water generator

after having done its work in cooling the main engine, to make fresh water. The cooling water is led through a heat exchanger inside the lower part of a drum, where the pressure is reduced using an ejector. The heat exchanger is submerged in clean seawater, that is boiling in the low-pressure atmosphere. The vapour

(steam) goes to the high part of the drum, where another heat exchanger with cold seawater acts as a condenser. From the tubes condensate is dripping. Below this condenser a conical dish is situated, where the condensate is collected. Through a drain line in the centre of the dish, the fresh water is transferred outside the drum.

A second way of making fresh water is filtering. Salt water is pumped under high pressure through a membrane with openings so small that salt molecules cannot pass. The water passes and comes out as fresh water. This process is called reverse osmosis.



reverse osmosis plant

18. Start up arrangement

In case of a total black-out, empty batteries and loss of starting air, the ship's crew must be able to start systems from zero. Usually the first build-up of power is done with a small air-compressor manual-start-diesel sometimes hand operated, by which a small air vessel can be brought under pressure, capable of starting a diesel generator. When that diesel is running and producing electric power, the systems can be activated one by one.

19. Valves

In ships many pipeline systems are installed, for the transport of various kinds of liquids, gases, and energy. In those systems valves are necessary and fitted in large numbers to stop or regulate flow, to connect numerous spaces or items to a system, or to isolate the system from open air or outside connections.

The most common valve types are:

Gate valves

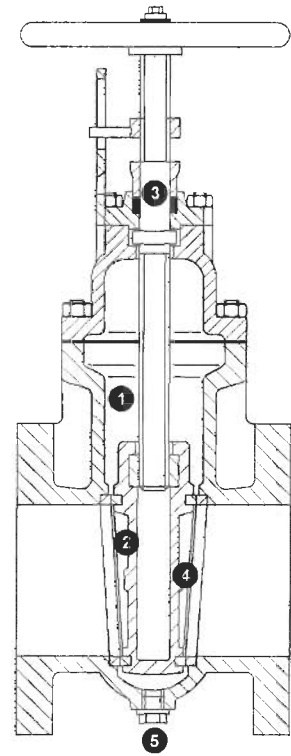

Gate valve

1. Housing
2. Wedge
3. Spindle
4. Sealing rings
5. Plug

A gate valve has a housing between two flanges where a wedge slides in and out, leaving the throughput completely open or closing the throughput completely or for partial flow restriction. The housing has sealing rings as seats for the wedge sides. The wedge also has a sealing ring at both sides, giving it double sealing. Normally the wedge is moved upwards and downwards using a threaded spindle guided by the removable top part of the housing and screwed into the wedge. The bottom of the housing is often provided with a plug, allowing checking the tightness of the valve without opening up. Materials for housing and wedge are cast iron, cast steel or bronze. The sealing rings are often bronze. All kinds of variation are possible, depending on the type of liquid, possible galvanic action and fluid velocity.

Advantages:

- 100 per cent throughput
- Two sealing surfaces
- Short building length
- Tightness control in situ

Disadvantages:

- Vertical dimensions, especially when fitted with hydraulic actuator
- Weight

Additional strengthening is needed when used in high pressure systems. In use for: cooling water, ballast water, bilge systems, cargo (oil) systems, firelines, foamlines, etc.

Globe valve

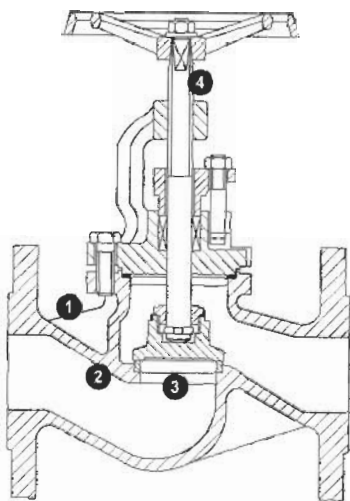

Globe valve

1. Housing
2. Separation
3. Disc
4. Spindle

It has a ball-shaped housing between two flanges, with a horizontal separation at half height, so configured that upper and lower part are open towards one flange each. In the separation is a circular hole, which can be closed with a disc, which is moved up and down with a threaded spindle. When the disc is kept loose from the spindle, the globe valve acts as a non-return valve. Materials for housing and cover are cast iron, bronze, stainless steel, etc. Disc and seat may be of bronze or stainless steel. This depends on the type of liquid pumped.

Advantages:

- Easy maintenance
- Easily adjustable flow
- Non-return possibility

Disadvantages:

- Restricted flow, turbulence
- Remote control only manually (extended spindle)

In use for: cooling water, steam, various clean water systems,

Butterfly valve



Butterfly valve, 1000 mm nominal diameter

1. Ring
2. Disc
3. Handle

A ring-shaped body, with the diameter of the pipeline that it is used for, a circular disc in the ring, which can be turned by a spindle. The ring is clamped between the flanges of the adjacent pipelines. The ring is provided with a rubber lining on the inside, forming a seat for the disc. In open position, the flow is hardly restricted: the disc is positioned in the direction of the flow. By turning the disc 90 degrees or nearly 90 degrees, the disc is closing against the rubber lining of the ring. The rubber lining can be vulcanised, or inter-changeable. There are also types with a removable seat. Materials: ring of cast steel or cast iron, disc of bronze, rubber lining of neoprene (oil resistant). Also fabricated with flanges on ring.

Advantages:

- Extremely short building length
- Light
- Nearly unrestricted flow
- Depending on type: easy overhaul
- Simple actuator (only 90 degrees movement)

Disadvantages:

- Difficult flow regulation

In use for: cooling water systems, sea water valves (overboards), cargo systems in VLCCs and ULCCs

Ball valve

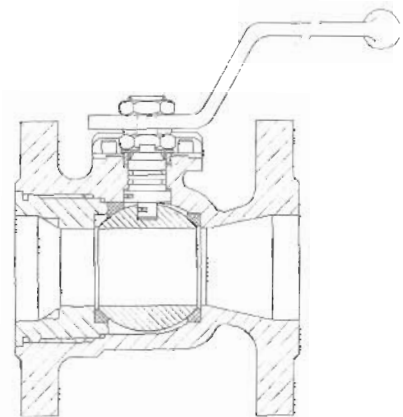

Ball valve

Ball-shaped housing between two flanges. At half length dividing flange. Inside the housing a seat ring for both flanges. A ball, with a tubular hole in the centre. Stem upwards, for rotation of ball, max. 90 degrees. Open means 100 per cent through-pass. Flow regulation by partial rotation of ball. Materials depending on use.

Advantages:

- Double seal
- Unrestricted flow when completely open, no turbulence.

Disadvantages:

- Expensive
- Heavy
- Difficult adjustment of both seals

In use mainly for chemicals. (Stainless steel housing and ball, PTFE sealing rings)

Apart from the above valve types there are numerous variations on the main types:

- Needle valves for accurate flow regulation are a variation of a globe valve.
- Spring-loaded valves are valves which can be closed by a spring, remote triggered. They are often basically a globe valve.
- Safety valves which open at a pressure higher than desired against a spring, are also often globe valves.
- Spade valves are gate valves with a flat closing spade.
- Non-return valves exist in numerous types:
 - * swing checkvalves in the discharge of a cargo pump,
 - * globe valves with loose disc in cooling systems,
 - * weight loaded swing check-valves in inert gas systems, etc.

20. Bilge-line arrangement

The bilge-line arrangement is an important safety system that is required by law. Rules made up by governments and classification societies have to comply with international SOLAS-rules.

The law states that the bilge-line arrangement, the ballast-line arrangement and the fire-fighting arrangement must be three independent systems that can take over the work of the other systems if necessary.

The purpose of the bilge-line arrangement is to pump water, which has entered the ship unwanted, out of the ship.

The ingress of water into the engine room or the holds after grounding, collision or as the result of fire-fighting can have serious consequences.

Condensation can occur when warm air hits a cold surface. In the most favourable circumstances the water flows down the sides into the bilge well and from there it can be pumped overboard. When the water remains on (relatively cold) cargo or seeps into the cargo, damage to the cargo may occur.

The pump capacity of the bilge pump is between 100 and 300 m³/hour. A hole in the side of the ship at 5 m below the water line means that a certain capacity, depending on the size of the hole is needed to remove the amount of incoming water. The formula to determine the capacity needed is:

$$V = a \times \sqrt{2 \times G \times D}$$

V = volume in m³/s incoming water,

a = area of the hole in m²

D = depth of the hole below the surface,

G = Gravity (9.81)

In the example this means that a hole of 5 * 5 cm makes up for 90 m³/hour and a hole of twice that size (7.1 * 7.1 cm) produces 180 m³ water/hour flowing into the ship.

Ships without hatch covers, so called "open ships" have to have additional pump capacity in the bilge-line arrangement to remove incoming seawater or rain (SOLAS art 59 sub 2). Small amounts of water can accumulate in the ship as a result of rain, especially in "open ships", or by condensation.

As soon as the holds are empty and clean, the bilge-line arrangement has to be tested. When it has been found in order, this is noted in the ship's journal.

For some kinds of dangerous goods, the bilge arrangement has to have the capability to pump bilge water from any individual cargo hold. Certification takes care of what kind of dangerous goods may be transported by a ship. The valve (in the engine room) in the bilge well must be fitted with a safety device to ensure that dangerous goods can not accidentally pass into the environment or inside the ship.

To determine the amount of fluid inside a bilge well or a ballast tank two systems have to be present.

- Manual.

Sounding with sounding tape using a sounding pipe that ends in a tank or a bilge well to measure the height of the fluid.

- With a remote control system

The fluid level can be read from an indicator in the engine room. (remote control). A float is placed in the bilge well and when the fluid level rises, so does the float. When the float reaches a certain level, an alarm is activated.

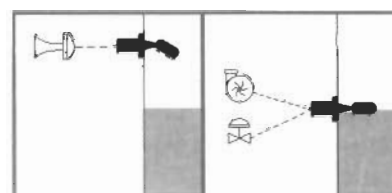

high level alarm

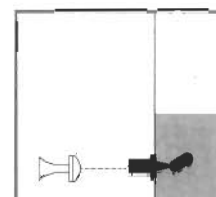

low level alarm

Schematic layout of the three main functions of magnetic float-switches

As soon as the alarm in the bilge well is activated, the bilge alarm on the alarm panel in the engine room is activated as well. With an un-manned engine room a muster alarm sounds on the bridge.

The bilge-line arrangement consists of the following parts:

1. Bilge pumps
2. Mountings
3. Main bilge line
4. Suction lines
5. Bilge well
6. Ejector
7. Bilge water cleaner / separator

1. Bilge pumps

These pumps must be available for immediate use when the ship is being emptied, even though they may be used for other purposes according to the regulations.

They must be self-priming. This means that they do not need help to take care of the water in the compartment where they are situated after they have been started.

2. Mountings (fittings)

In shipping mountings mean safety devices, valves, filters, distributors etc. Several suction lines are mounted on a manifold. The suction lines are fitted with valves to open or close the lines. To keep the capacity as high as possible, one valve at a time should be opened. When more valves are opened at the same time, the suction capacity in the well is reduced. Check valves are used as non-return valves.

Example:

The fluid removed from the bilge well must not be allowed to flow back to the bilge well. A non-return valve is placed in the suction line.

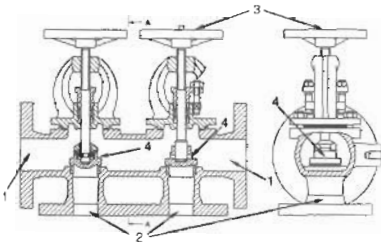

Distributor that can be fitted with non-return valves (bilge arrangement) or stop valves (ballast arrangement).

1. Suction of the pump
2. Suction from the bilge well
3. Hand wheel to operate the valve
4. Stop valve

The manifold is made of cast iron on the outside, with a bronze lining. Bronze is seawater resistant.

When a stop valve is opened there are two possibilities:

1. The water can flow in two directions
2. The water can flow one way only. A non-return valve can achieve this. These valves exist in two main designs:
 1. The valve can be opened or closed as is needed
 2. The valve is automatically operated and is solely used for safety reasons.

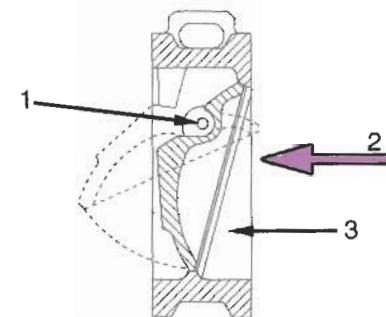
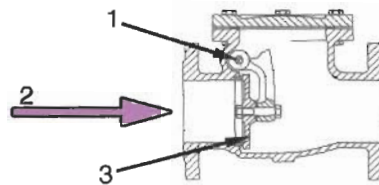

Two types of non-return valves.

1. Hinge point
2. Direction of flow
3. Closed valve (dotted lines: open valve)

3. Main bilge line.

The main bilge line is situated in the engine room and runs from the manifold to the suction side of the pumps. The suction lines run from the manifold to the compartments that are connected. The main bilge line is made of galvanized steel. The bilge arrangement in the engine room consists of one (compulsory) direct system and one indirect system. The indirect system operates through a manifold.

4. Suction lines

The suction lines run from the manifold through the double bottom to the bilge wells. Every well is connected to the manifold by a separate bilge line. This enables us to operate the bilge lines from the manifold in the engine room.

Bilge wells are usually situated at the fore and aft ends of the holds, both on starboard side and on port side, because the water flows to the lowest point in the hold. The position of this point is determined by the trim of the vessel. The suction lines are made of galvanized steel. Synthetic lines are not allowed because of the poor fire resistance of the material.

5. Bilge well

A bilge well has two compartments, separated by a bulkhead that extends to half or three quarters of the height of the well. A lid with small holes covers the well. As soon as the water reaches a certain height, it will flow to the well next to it. The suction part of the bilge line is situated in that part of the well.

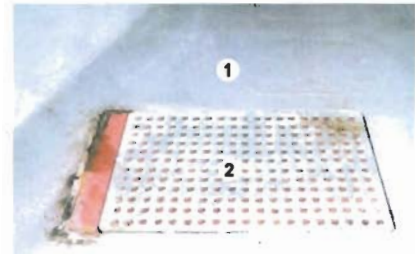

Hold with covered bilge well

1. Tank top
2. Lid of the bilge well

On emergency system that has its suction point at the lowest point in the engine room is compulsory. This system must be connected to the suction line of the seawater cooling-water pump or the general service pump when no seawater cooling-water pump is available.

6. Ejector

The ejector creates a vacuum by the speed of the water flowing past it. The pressure of the water flowing through the ejector is created by the fire-fighting pump, which can build a higher pressure than the bilge and ballast pumps. (See section 13)

7. Bilge-water cleaner/separator.

According to the MARPOL-treaty bilge water from the engine room must go to a separator to separate the oil from the water before it may be pumped overboard. This is to prevent pollution. The oil goes to a dirty-oil tank. This separator is compulsory for ships of more than 1000 GT.

The residue of oil in the water that is pumped overboard may not exceed 15 ppm (parts per million).

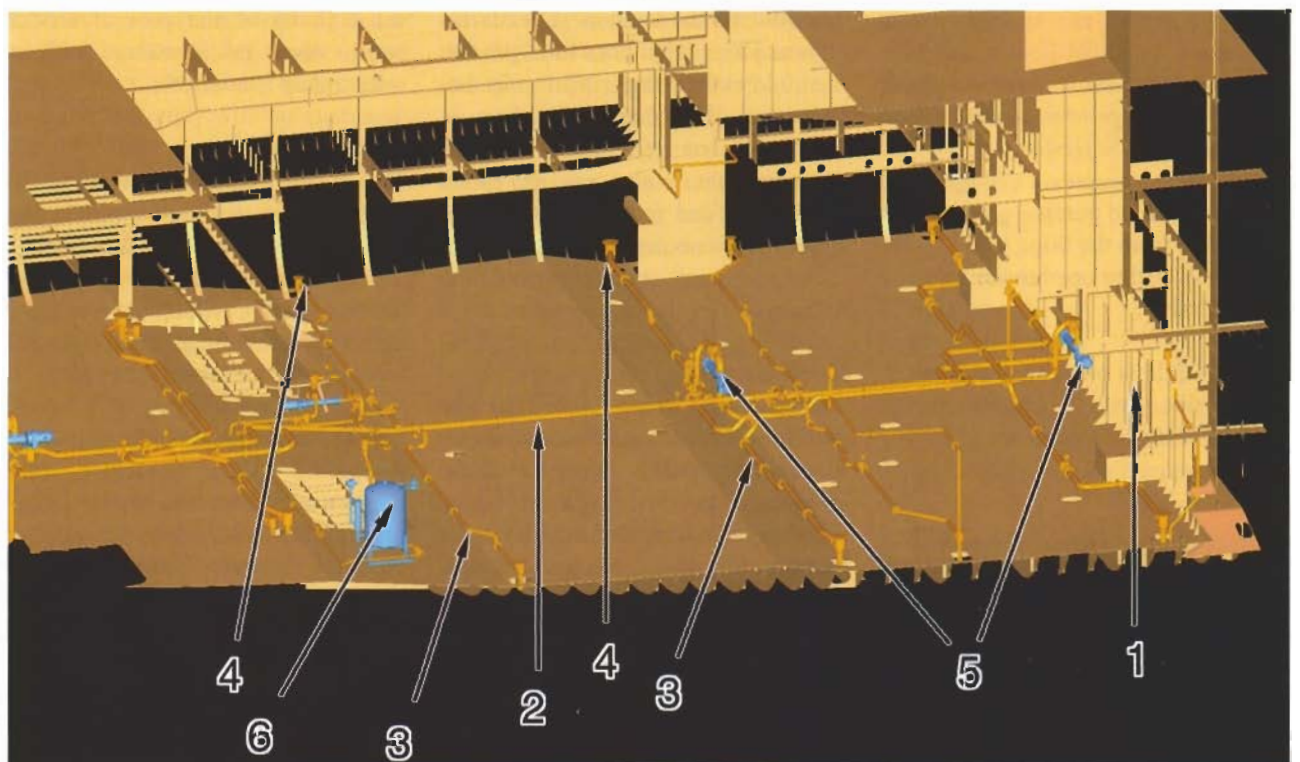
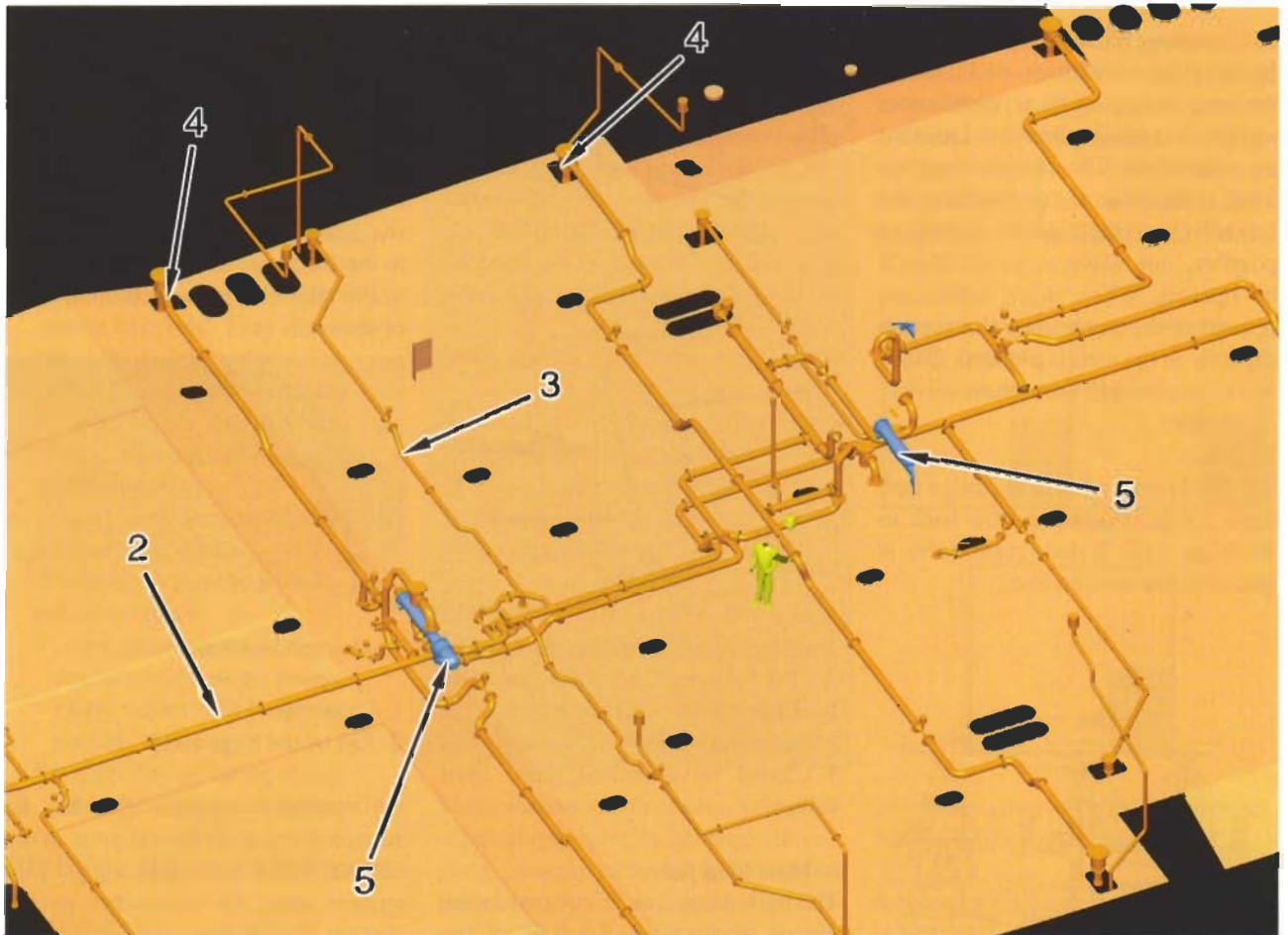

The bilge-line arrangement of a container vessel. Fig. 1 Part of the overview of the bilge arrangement
 Fig. 2 With strengthenings and construction parts of the engine room made visible.

- | | |
|--|--------------------------|
| 1. Engine-room bulkhead | 4. Suction heads. |
| 2. Main bilge line (in the engine room) | 5. Bilge pumps |
| 3. Suction lines | 6. Bilge water separator |

21. The ballast arrangement.

The ballast arrangement is used to pump seawater (weight) in or out of the ballast tanks. There are fewer rules for the ballast system than for the bilge arrangement as it is less important for the safety of the ship.

Reasons for taking ballast on board or shifting ballast are:

- To improve the stability of the ship, especially when the ship does not carry cargo.
- To alter the trim
- To reduce bending moments or shear forces
- To control the list during loading and discharging. Many ships use an anti-heeling system for this purpose.

An anti-heeling system is used to minimize the list (in port). Pumps with a large capacity (1000m³/hour) are placed in the vicinity of two tanks (one on port side and one on starboard side). These pumps can transfer water from one tank to the other at great speed. The system is fully automatic and much used on ships with cranes, container vessels and Ro-Ro vessels to reduce the list that can occur during cargo handling.

Forepeak tanks, deeptanks, double-bottom tanks, and wing tanks are usually used for ballast water.

The advantage of using ballast instead of fuel in the double bottom is that welding is allowed on the tanktop as a means of fastening the cargo. The owner of the vessel determines the ballast capacity. The duration of the voyage and the purpose of the ship will be taken into account when deciding on the available space for ballast and the capacity of the ballast pumps. Ballast pumps are usually also suitable to act as bilge pumps and thus they form an integrated part of the bilge arrangement, to the extent that a ballast pump may even serve as main bilge pump.

Contrary to the valves in the bilge arrangement, the valves in the ballast arrangement have to be two-way valves as the tanks must be filled or emptied according to the demand. Double bottom tanks can also be filled directly from outside through the sea-inlet. The wing tanks also can use this system, but the draught determines the efficiency of this system as the water will not get higher into the tanks than the draught allows. Nowadays the ballast system is often designed as a ring line.

Remote controlled valves are used to empty or fill the ballast tanks.

Ballast lines inside the double bottom may be made of synthetics.

Synthetics for piping systems.

More and more pipes on board are made of synthetics, not only for accommodation and sanitary means but also in ballast systems. The main advantage is the corrosion resistance of synthetics. The small weight is another advantage. The pipes are easier to handle on board as well as on the yard and the reduced weight allows the ship to carry more cargo.

Disadvantages are the sensitivity to temperature changes and the lower strength compared to steel.

Classification Societies often state that "synthetic pipes may be used when they have no adverse effect on the continuity of vital installations in case of fire or breakdown".

Means for repair of synthetic pipes are compulsory when a vessel makes use of synthetic pipes.

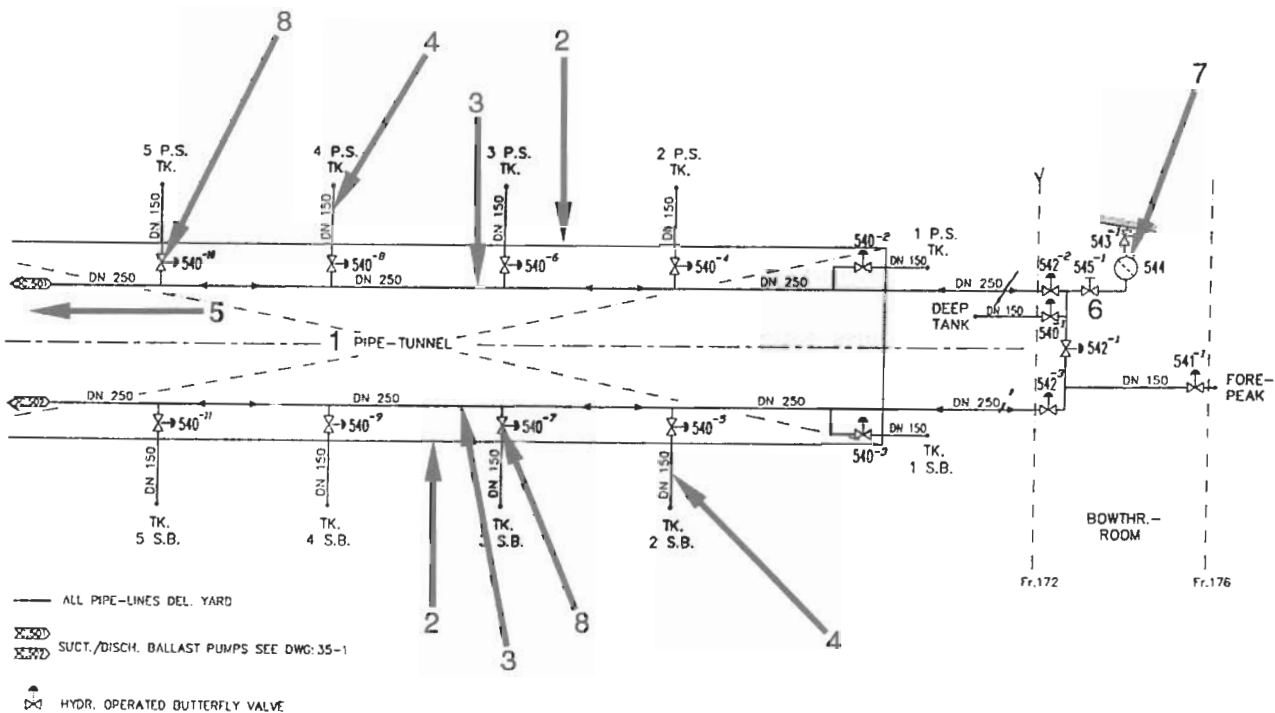

- | | | | |
|--------------|---|-----------------------------|------------------|
| 1. Duct keel | 4. Branches to the double-bottom tanks and wing tanks | 5. Direction of engine room | 8. Two-way valve |
| 2. Tank wall | | 6. Bow-thruster room | |
| 3. Ring line | | 7. Filter | |

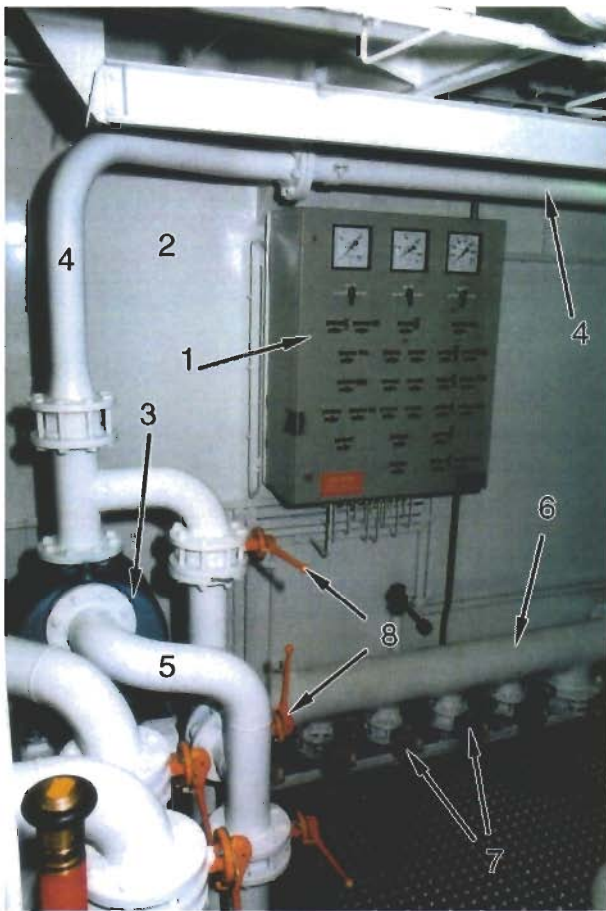

Ballast line made of synthetic fibres.

- 1 Tank sounding system
- 2 Engine-room bulkhead
- 3 Ballast pump
- 4 Pressure line
- 5 Suction line

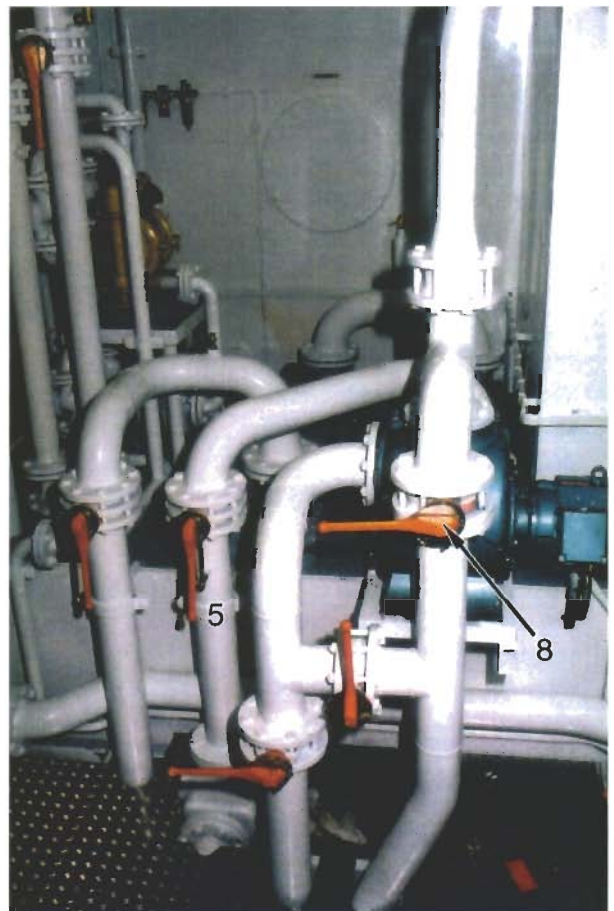

Ballast pump in the engine room, lines and (stop) valves

- 6 Main ballast line
- 7 Stop valves (butterfly valves) to open or close the lines to the ballast tanks
- 8 Butterfly valve

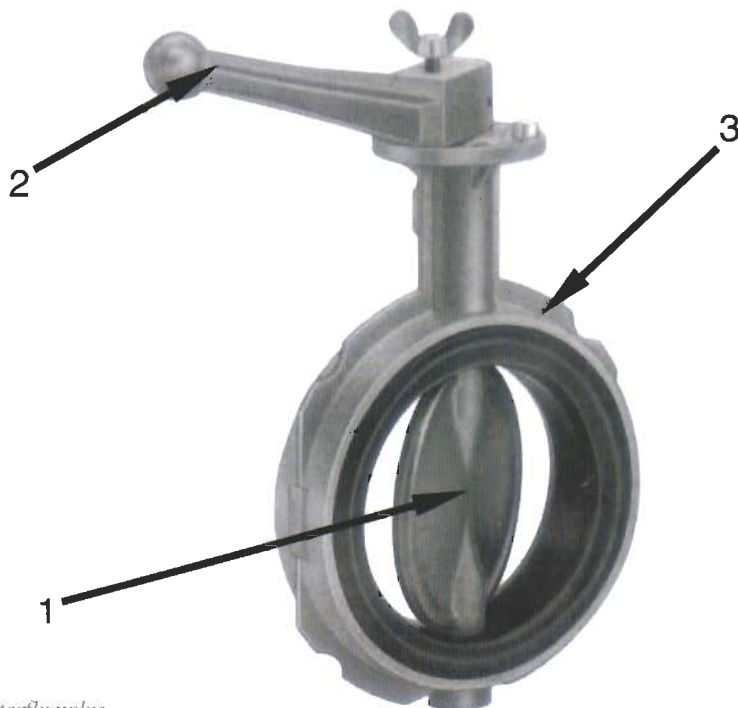

Butterfly valve

- 1 Valve (butterfly)
- 2 Operating handle
- 3 Valve casing

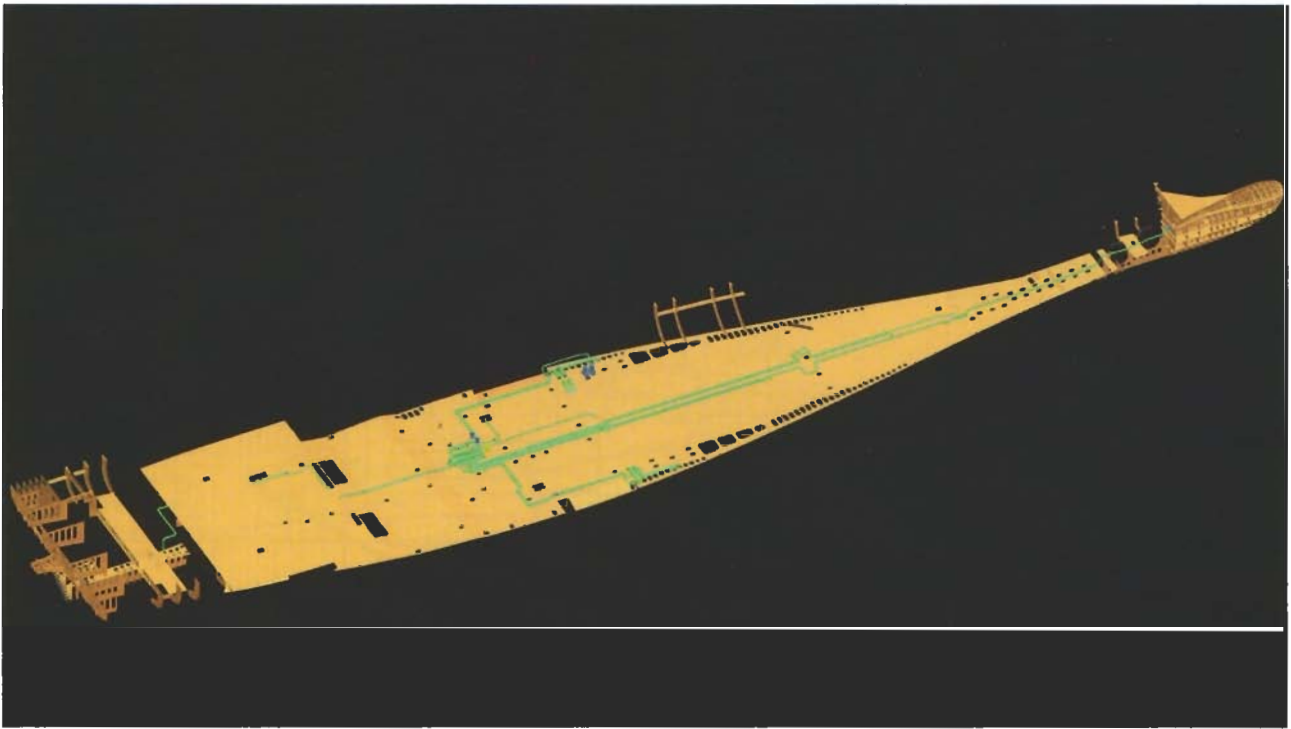

Ballast arrangement on a large container vessel. Each tank has its own connection. Ballasting and unballasting of each tank simultaneously is possible.

- 1 Overboard
- 2 Ballast distributor
- 3 Anti-heeling system
- 4 Lines to the tanks (in the duct keel)
- 5 Valves with remote control
- 6 Filter
- 7 Pump

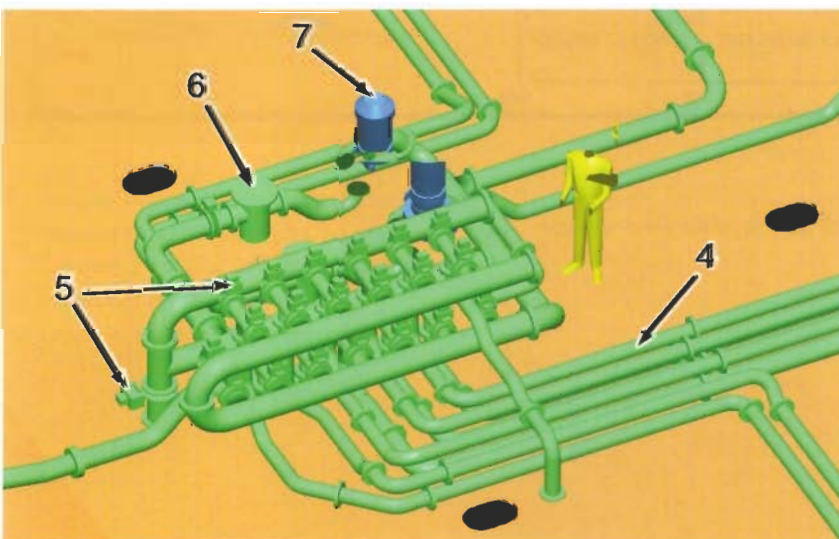
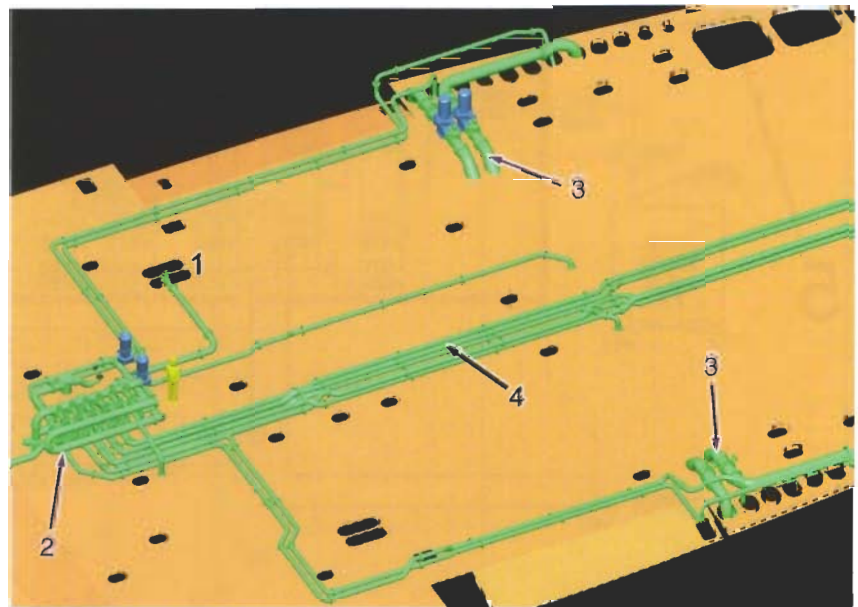

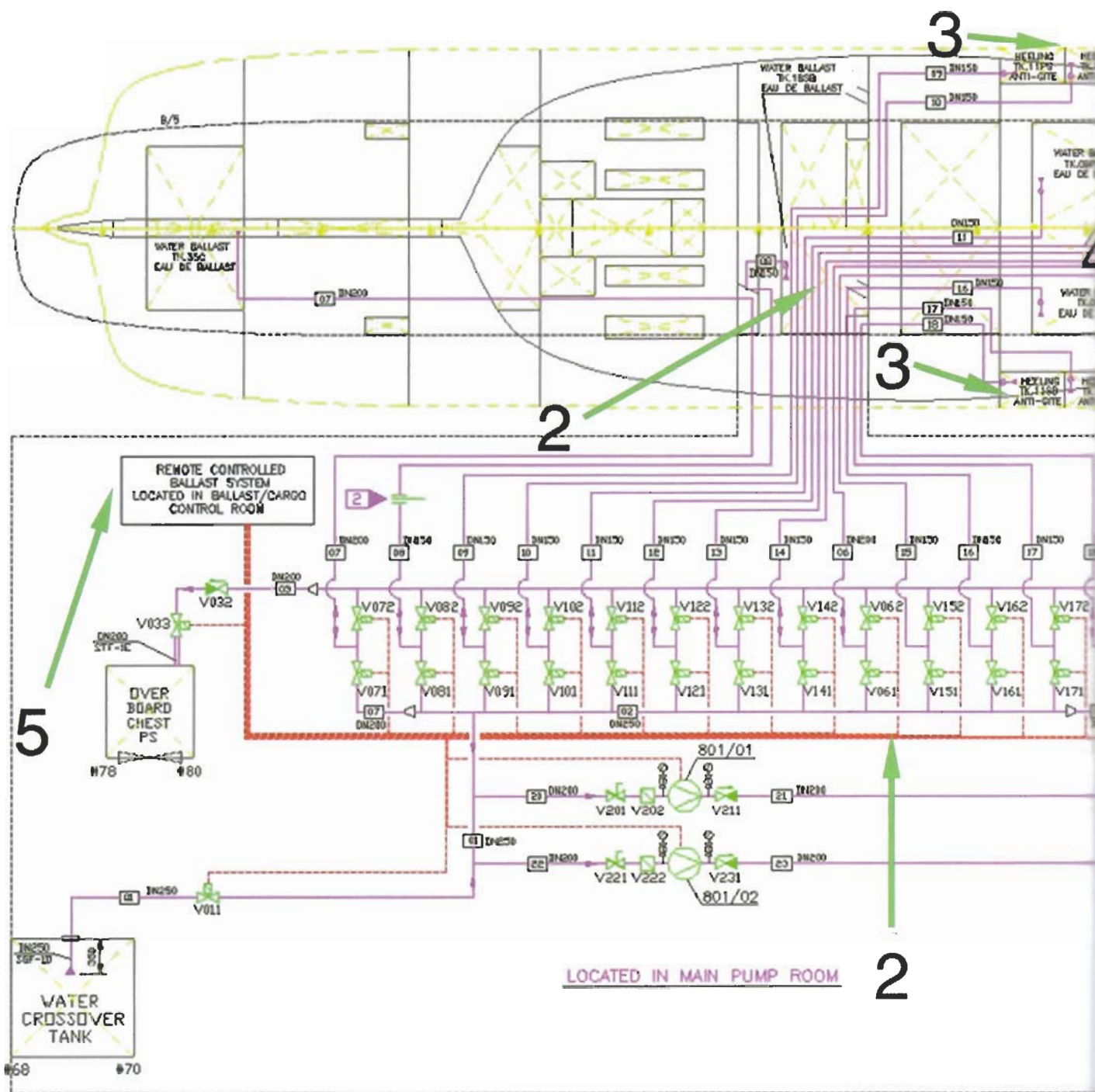

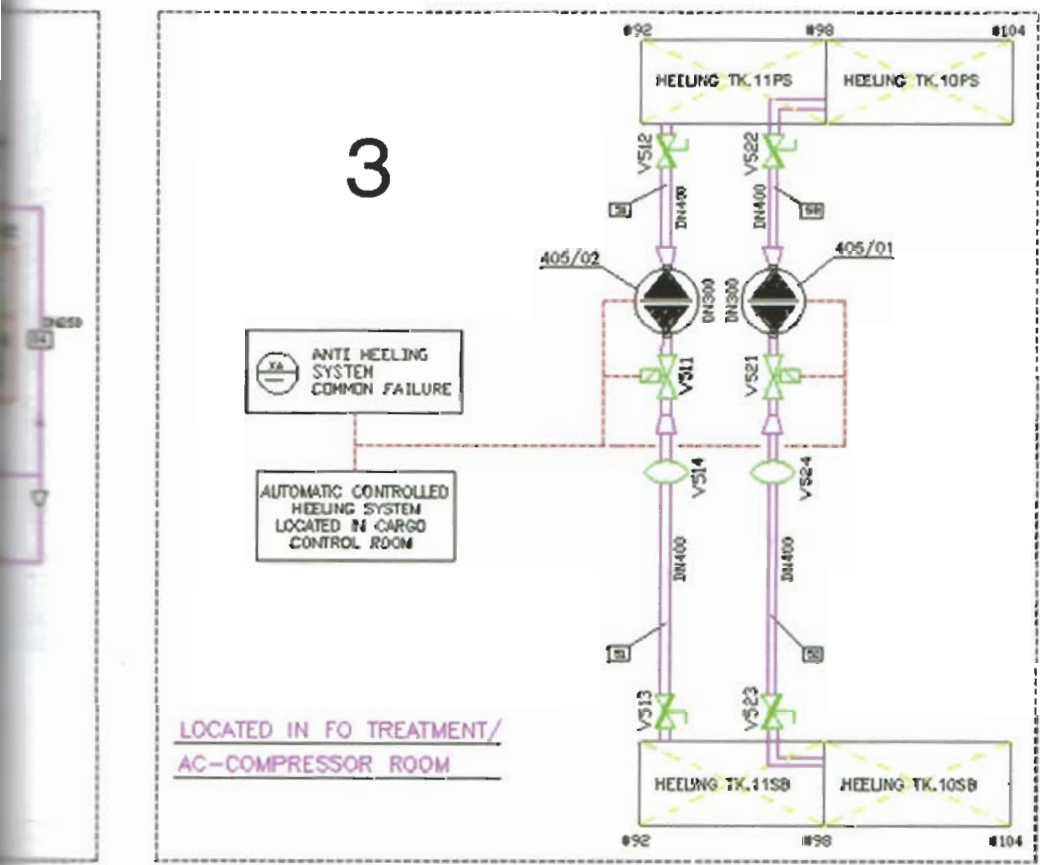
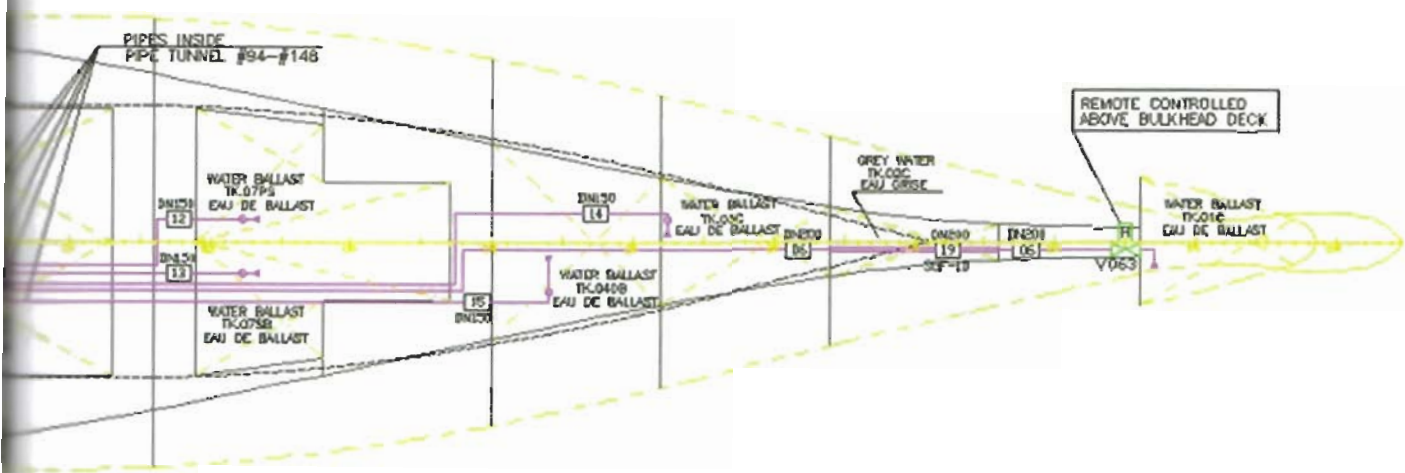

The numbers in above drawing correspond with the list on the previous page



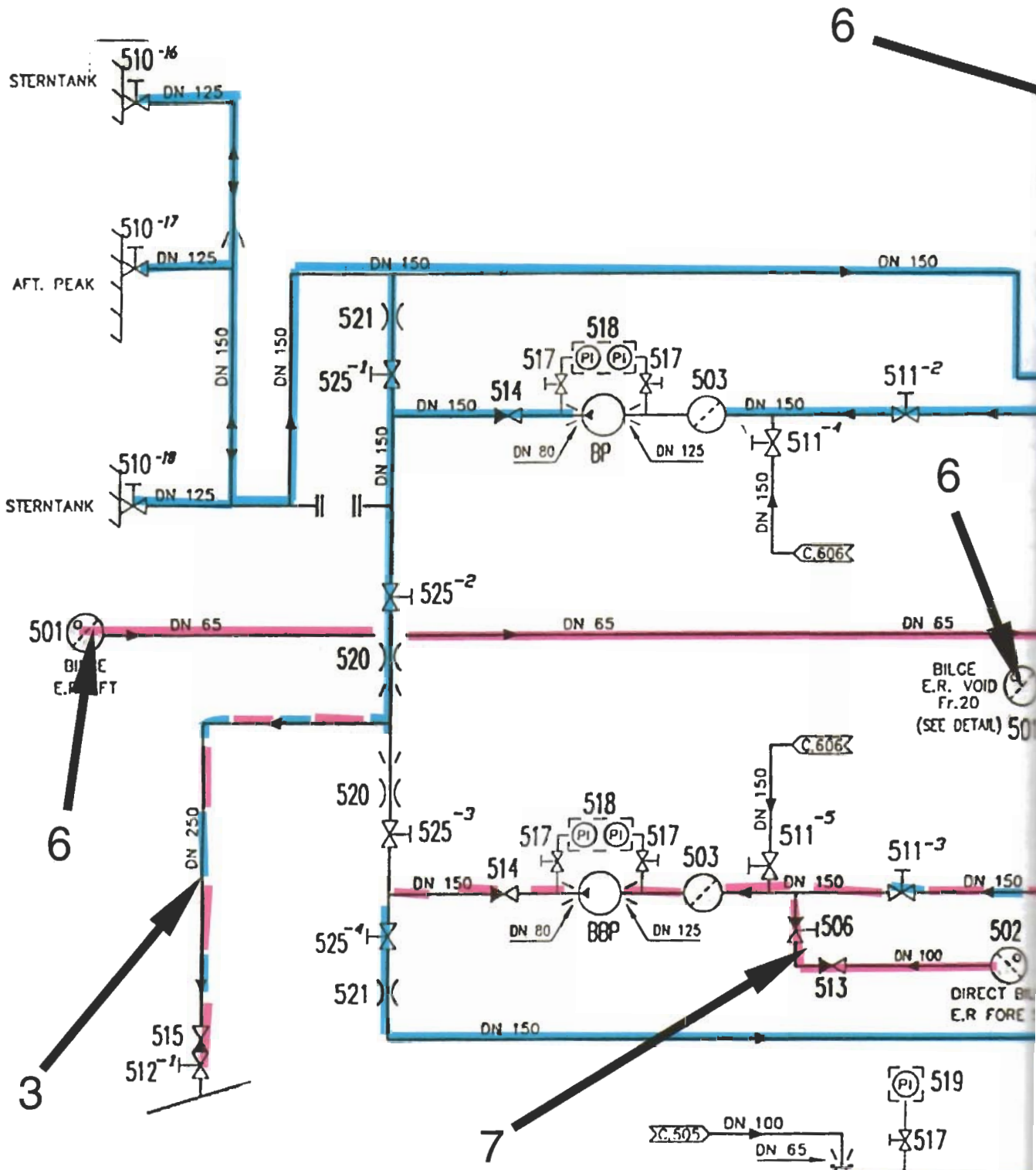

Heeling system to move water ballast from port to starboard or reverse, to control the list during loading and discharging, independent of the ballast system.



REMARK AS THE VESSEL IS SUITABLE FOR CARRYING DANGEROUS GOODS ACCORDING IMO REG. 54, THE VALVES MARKED WITH  MUST HAVE POSSIBILITY TO BE BLOCKED IN CLOSED POSITION (6x)

SUCTION / DISCHARGE TO BE DONE WITH TWO BALLAST TANKS SIMULTANEOUS (=2x DN 125)

ALL LINES MADE OF MILD STEEL AND HOT GALVANIZED AFTER MANUFACTURING DIMENSIONS ACCORDING "RECON" STANDARD LIST R-STD-1002 - "NORMAL WALLED" COLUMN 1

-  SUCT. FROM CROSS-OVER SEE DWG: 36-1 (2x)
-  DRIVING LIQUID FROM FI-FI PUMP SEE DWG: 35-2

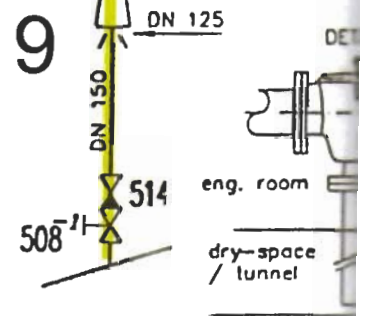

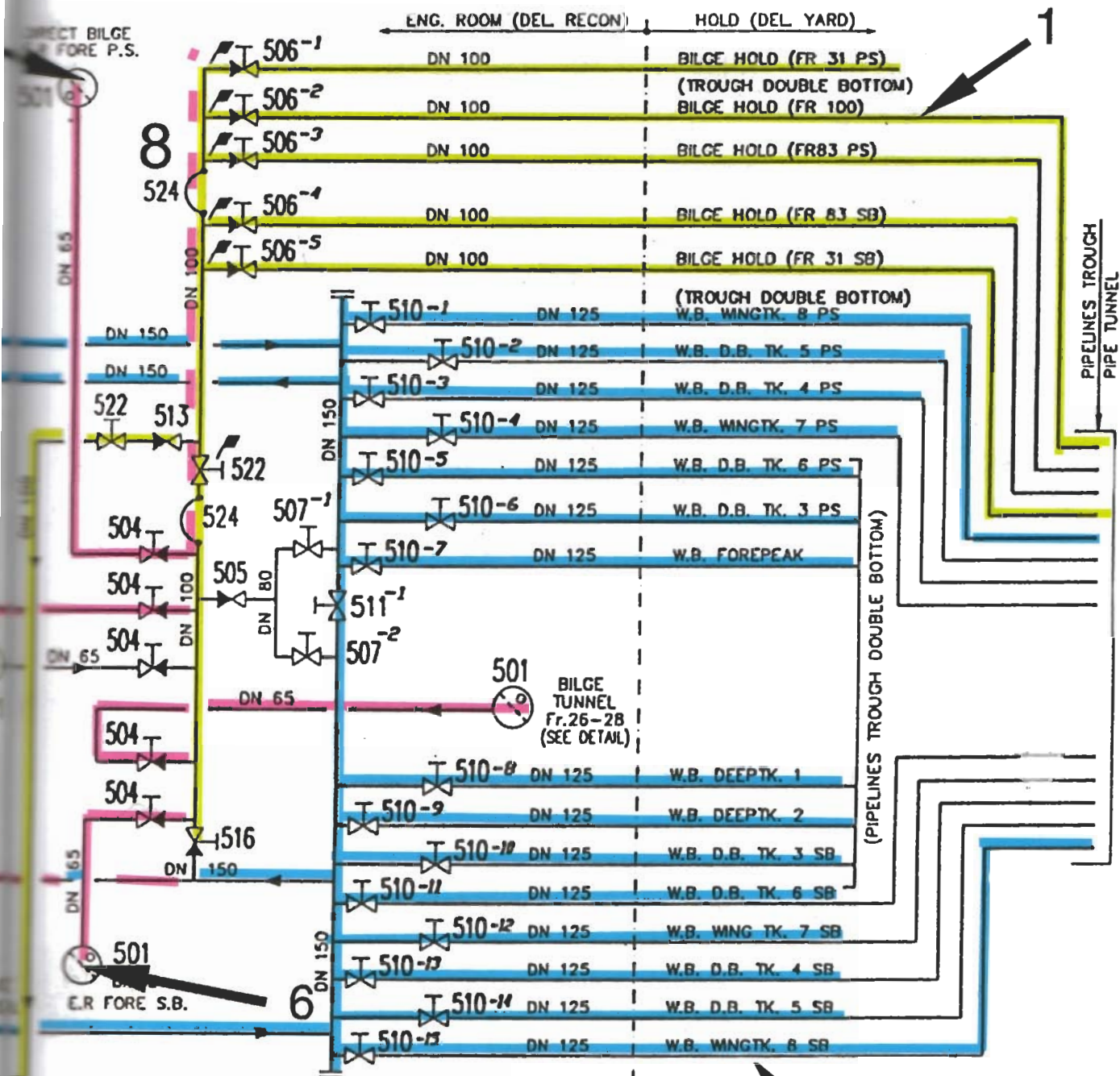

5

1. Bilge arrangement (yellow)
2. Ballast arrangement (blue)
3. Overboard (for bilge and ballast)
4. Engine room bulkhead
5. Main bilge line, from distributor to ejector and overboard
6. Engineroom bilge line, port side, starboard side, midship and aft. All fitted to the main bilge line.
7. Direct bilge arrangement from the engine room
8. Suction distributor chest
9. Ejector

4

2

Bilge and ballast arrangement on a container feeder

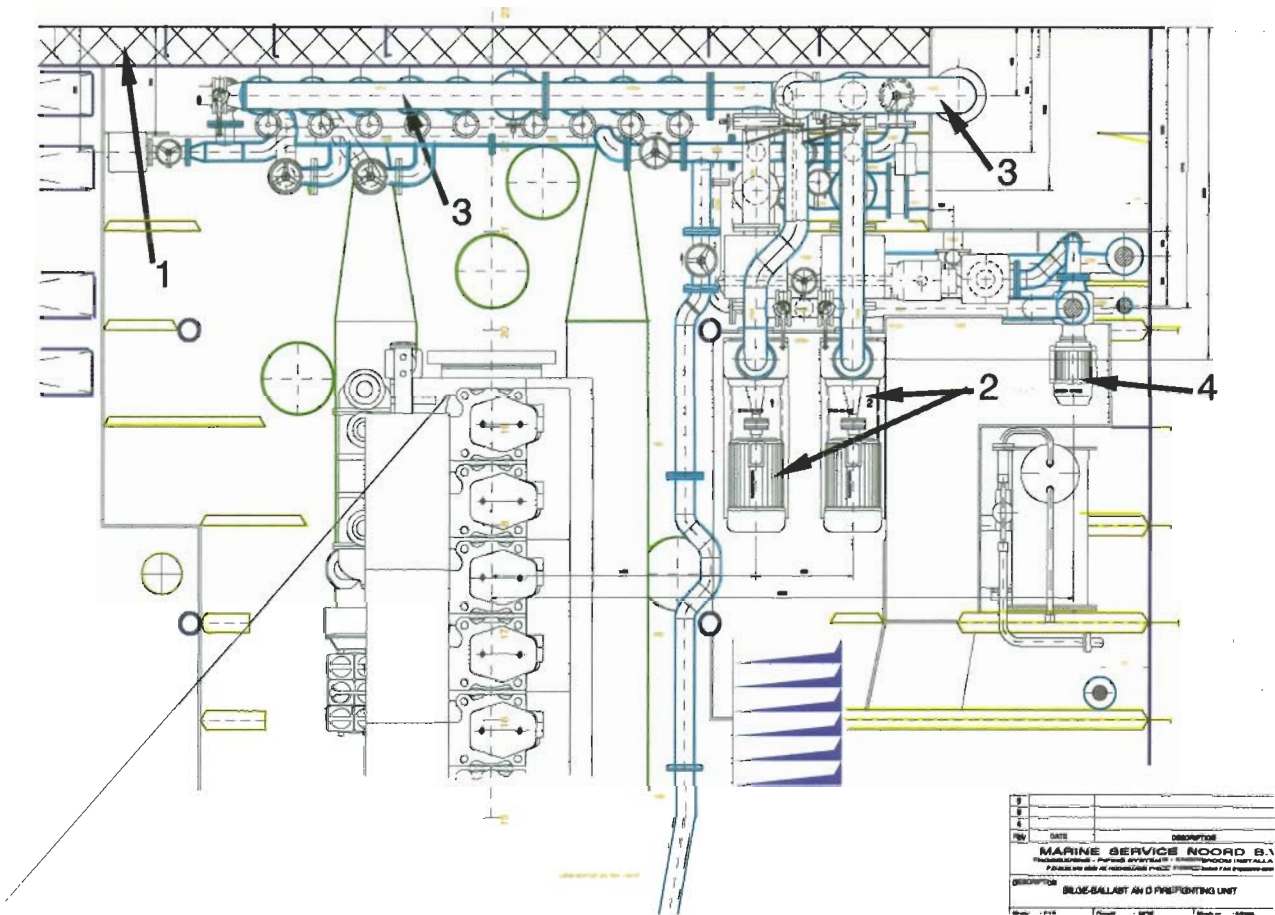

Top view of the forepart of the engine room

- 1 Engine room bulkhead (insulated)
- 2 Pumps
- 3 Ballast distributor
- 4 Fire-fighting pump

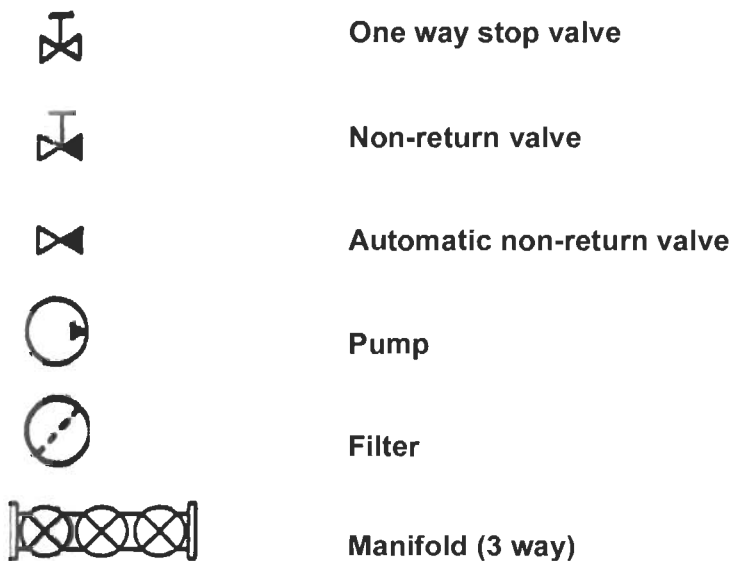

Common symbols

22 Fire-fighting arrangement

Fire on board ships has probably more often caused the loss of a ship than grounding, collision or bad weather. A good fire-fighting arrangement, conforming to legal requirements is therefore a necessity.

The fire-fighting arrangement has to transport seawater to the fire hydrants. The system consists of lines, pumps, valves with couplings, hoses, nozzles and spray installations.

A minimum of three fire-fighting pumps is compulsory on all ships. One of these pumps must be situated outside the engine room. This is the emergency fire-fighting pump. As close to the pump as possible, while

still on deck, an isolating valve must be placed. When shut, this valve, ensures that the rest of the bilge system remains isolated in the event of bilge lines in the emergency pump room compartment becoming damaged. The emergency pump may not be driven from the engine room but must be driven independently by a diesel engine or electrically driven by an emergency generator.

Both main pumps must deliver sufficient pressure. This pressure should be enough to get at least a pressure of 4 bar at the highest point on the ship (the bridge). There must be enough hydrants (connection point for fire hose) to ensure that every location on

the vessel can be reached by at least two hoses. In case of fire in the engine room an isolating valve outside the engine room must be shut to keep pressure on the fire line from the emergency fire pump.

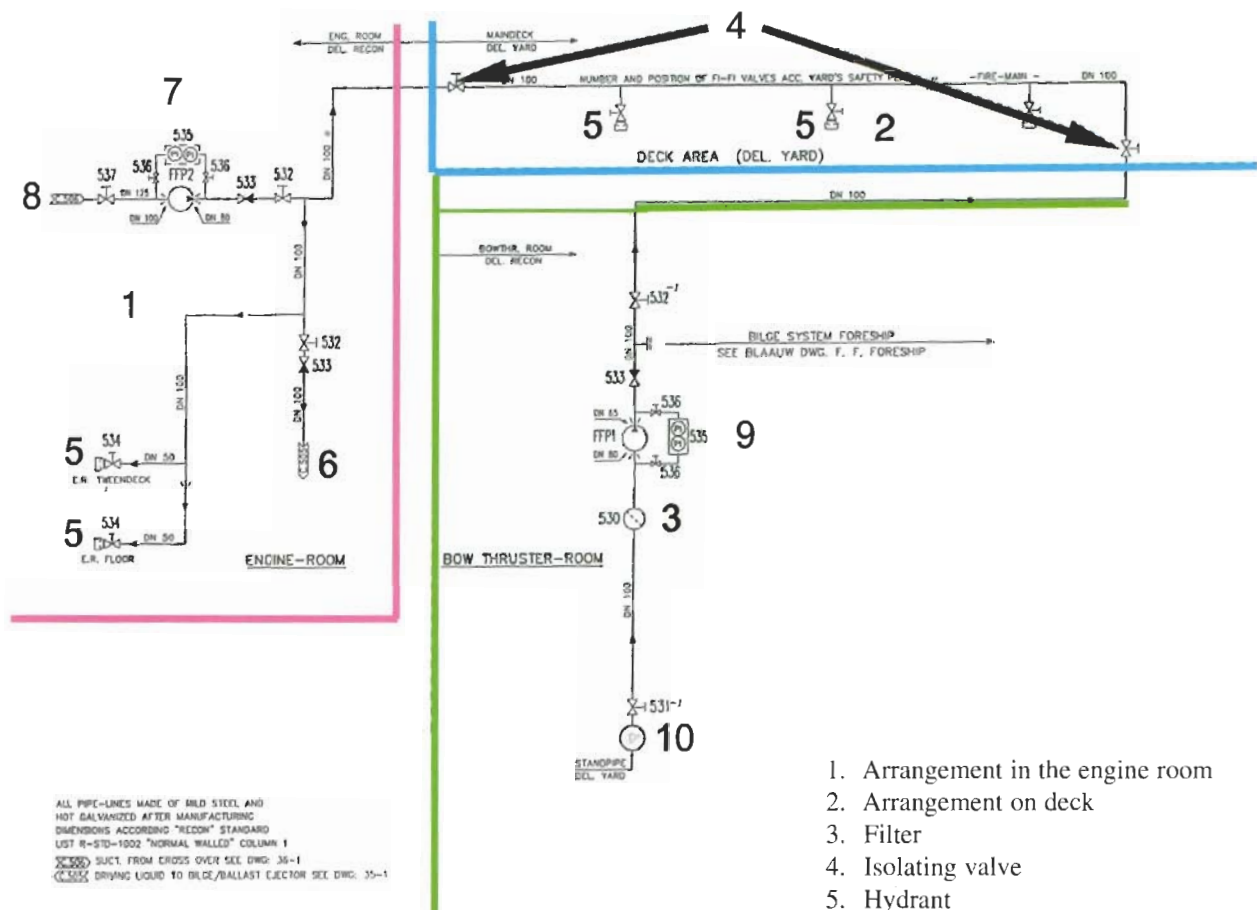

1. Arrangement in the engine room
2. Arrangement on deck
3. Filter
4. Isolating valve
5. Hydrant
6. Supply from general service pump
7. Main fire pump
8. Suction
9. Emergency fire pump
10. Sea valve

CHAPTER 12

Propulsion and steering gear

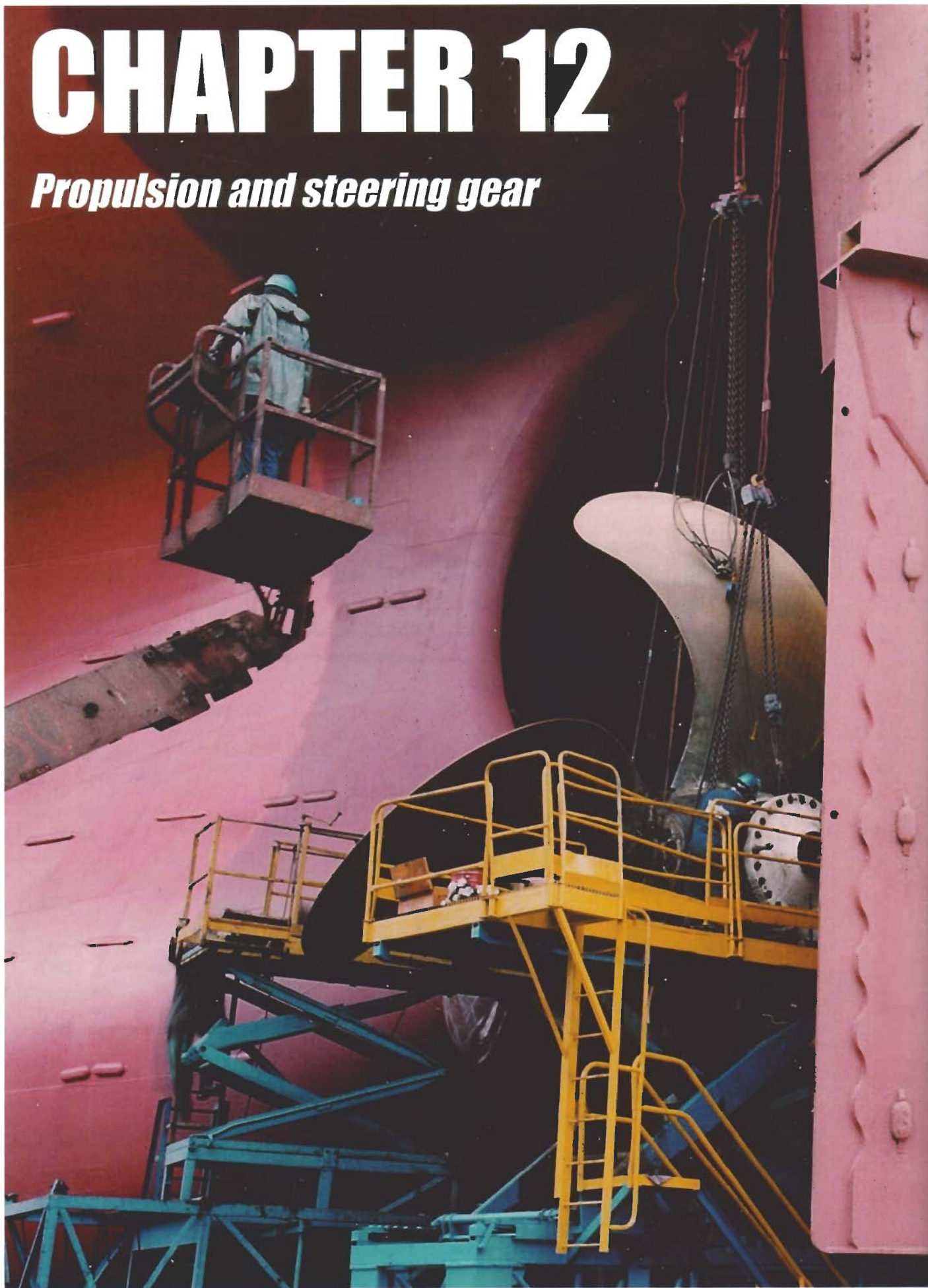



1. Propellers

1.1 General

1.2 Fixed propellers

1.3 Controllable pitch propellers

1.4 Nozzles

1.5 Rudder propellers

1.6 Electrical rudder propellers

1.7 Propeller shafting

2. Water-jet propulsion

3. Rudders

3.1 General

3.2 Types of rudders

3.3 Steering engines

SHIP KNOWLEDGE

A MODERN ENCYCLOPEDIA

SHIPWISE	PAGE 8	1
THE SHAPE OF A SHIP	PAGE 22	2
SHIP'S TYPES	PAGE 44	3
THE BUILDING OF A SHIP	PAGE 68	4
FORCES ON A SHIP	PAGE 82	5
LAWS AND REGULATIONS	PAGE 104	6
CONSTRUCTION OF THE VARIOUS SECTIONS	PAGE 126	7
CLOSING ARRANGEMENTS	PAGE 160	8
LOADING GEAR	PAGE 174	9
ANCHOR AND MOORING GEAR	PAGE 196	10
ENGINE ROOM	PAGE 216	11
PROPULSION AND STEERING GEAR	PAGE 244	12
ELECTRICAL INSTALLATIONS	PAGE 266	13
MAINTENANCE AND DOCKING	PAGE 280	14
SAFETY	PAGE 302	15
STABILITY	PAGE 322	16

CHAPTER 12 QUESTIONS VISIT
WWW.DOKMAR.COM

1. Propellers

1.1 General

In order for a ship to obtain a certain constant speed, a force needs to be exerted on the ship. The magnitude of this force depends on the ship's resistance at that particular speed. If the ship is travelling at constant speed the force exerted on the ship equals the resistance of the ship. The force that moves the ship can come from an outside source like a towing line or the wind, but generally the force is generated by a power source on the ship itself (engine). The propulsion system usually consists of the engine or turbine, reduction gearbox, propeller shaft and propeller.

The efficiency of a propeller takes an important place in the design-process of the propeller because its efficiency and the ship's fuel consumption are directly related.

The efficiency depends on the flow field of the propeller, which depends on the ship's underwater body, the power of the propeller, the number of blades, rotations per minute, the maximum possible propeller diameter, the blade surface area and the ship's speed.

If the diameter of the propeller increases, the rotations per minute can decrease; this generally increases the efficiency and reduces the fuel consumption.

The propeller pitch is the distance in the direction parallel to the propeller shaft that a point on the propeller covers in one revolution in a solid substance. Similar to a point on a corkscrew turning in a cork. When rotating in a fluid a propeller will have a (small) slip. Rotations or revolutions per minute are abbreviated as rpm.

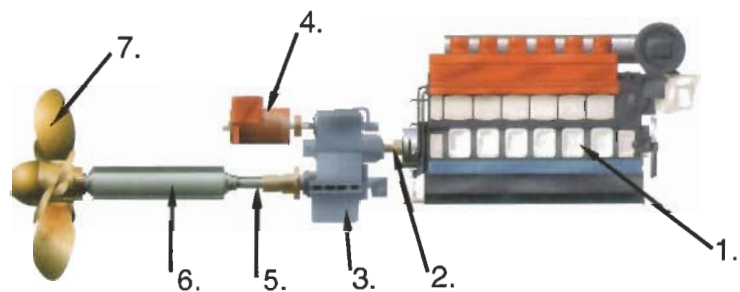

the propulsion system

- 1 Engine
2. Engine shaft
3. Reduction gear-box; this reduces the number of revolutions of the engine (e.g. 1000 rpm) to an acceptable rotation rate of the propeller (e.g. 200 rpm) The reduction is 5:1.
4. Shaft generator; this supplies the ship with electricity when the engine is running
5. Stern tube with bearing
6. Propeller shaft
7. Propeller

In short, the diameter of the propeller should be as large as possible so that a maximum amount of wake, caused by the ship's hull, is used. The choice for high efficiency with a large-diameter propeller and a low number of revolutions per minute is easily justifiable, but requires a significant investment.

RPM and the number of blades have influence on vibrations on board and the resonance frequency of the ship. Most ships use a 4-bladed propeller while 5-blade propellers are more common when a large power (20000 kW) is necessary.

However, more and more ships use the 5-bladed version nowadays, even when less power is needed. The 3-bladed propellers are used on ships with a high number of revolutions per minute and a low power (700 rpm, 600 kW).

The shape of the blades

Every propeller is designed individually, based on the specific demands set for this propeller. As a result of this, there is a large variety in shapes of blades.

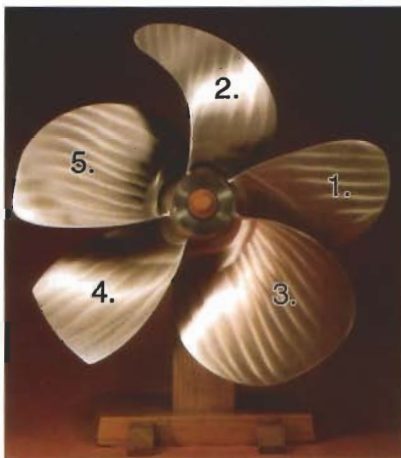

Different types of blades attached to a hub. This combination can never be used for actual propulsion

The remarks for each shape of blade apply to both the fixed and the controllable pitch propellers.

- Blade 1: Is hardly used anymore.
- Blade 2: Is used when there are strict demands regarding noise and vibrations on board.
- Blade 3: Is used when the rpm is high and, consequently, the diameter is small. A large blade surface area somewhat reduces the efficiency, but it is very favourable for the ability to stop the ship and for the reverse propulsion force.
- Blade 4: Is used in nozzles
- Blade 5: Is also used in nozzles if the noise and vibration levels have to be limited to a minimum..

Ship resistance

A ship encounters the following types of resistance:

a. Frictional resistance

The friction between the water and the ship's skin is the cause of this type of resistance. The water in the boundary layer will be accelerated by the ship's speed. This boundary layer becomes larger when the shell is fouled.

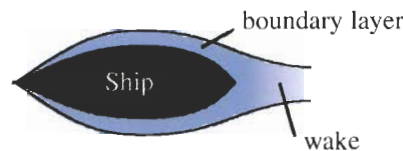

The wake of the ship

b. Pressure resistance

The ship's momentum pushes the water aside at the bow and as a result, the pressure of the water increases. This increase in pressure will also take place at the aft. The pressure will fall where the boundary layer is released.

c. Wave resistance

This is a result of wave-systems along the hull that originate from the differences in pressure. The use of a bulb at the stem can significantly decrease the wave-making resistance. The bulb generates its own wave system, which is designed to be opposite to the ship's wave system. These two wave systems then neutralize each other.

If the rate of flow of water (or air) is higher, then the pressure will be lower compared to the pressure in parts of the water where the rate of flow is lower. So in waves, water in a trough has a higher speed than water in a wave top. See also chapter 4 'design' and Bernoulli's law.

In oil tankers and container ships it can be seen very clearly that the bulb prevents an increase in pressure near the stem. The improved streamline of the ship's underwater body reduces a wave system around the ship. In suppliers and hopper suction dredgers, there is a large wave system present around the ship.



LNG-tanker with a well-designed bulb



Supplier without a bulb



Container ship with a bulb



Trawling hopper suction dredger without a bulb

d. Added resistance in waves

This type of resistance is caused by the pitching and rolling of the ship.

e. Air resistance

This depends on the vertical area above the waterline, which varies with the draught.

Types 'd' and 'e' are variable, depending on wave direction and wind direction as experienced by the ship.

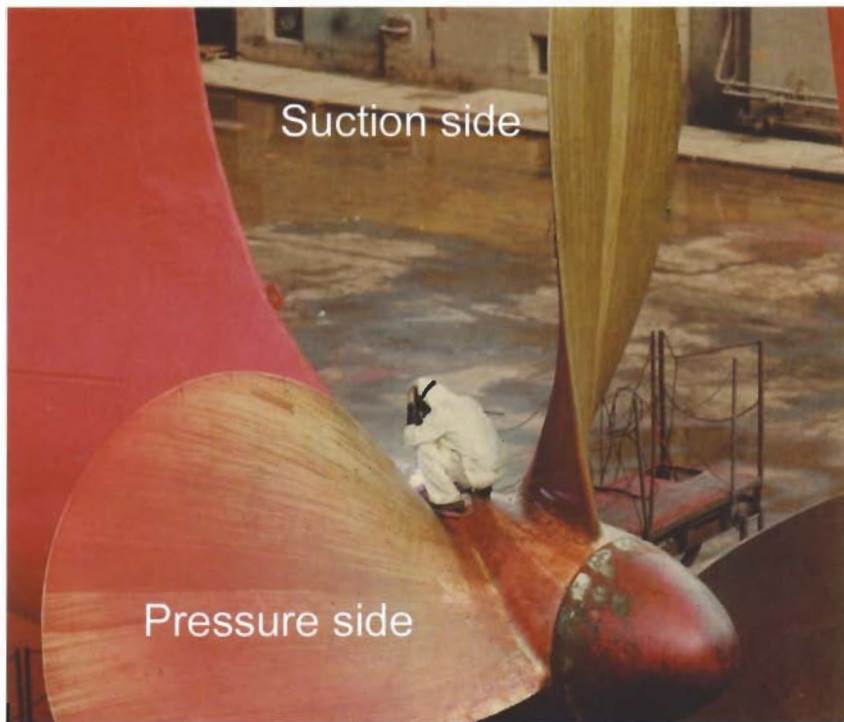

Fixed right-handed propeller on a tanker (deadweight 30,000 tons). Propeller being polished to reduce roughness, for less rotation friction and less fuel consumption.

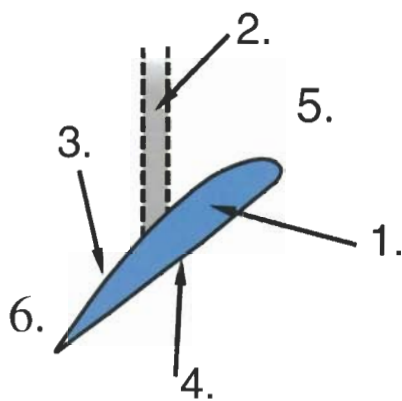

A drawing of the upper fixed propeller blade of a right-handed propeller seen from above

1. Cross-section of propeller blade
2. Propeller shaft
3. Suction side
4. Pressure side
5. Leading edge
6. Trailing edge

Pressure and suction sides of the propeller

The approach velocity of the water is a result of the ship's movement through the water. If the ship is lying still, this $V_e = 0$. The approach velocity can be calculated by subtracting the wake velocity from the ship's speed. The speed of rotation of the propeller and the approach velocity result in the speed (V). This V hits the propeller blade at a certain angle:

$$\alpha = 9^\circ - 10^\circ \text{ at service speed}$$

The speed of the incoming water creates an under-pressure on the forward side of the blade (suction side) and an over-pressure on the aft side of the blade (pressure side). The propeller blade acts as a wing profile. Propellers are usually viewed from

aft, therefore the pressure side is also called 'the face' and the suction side 'the back'.

Cavitation

As described above, the propeller pressure of a rotating propeller is not just the result of the water-pressure on the pressure side, but also of the underpressure on the other side of the propeller. Propellers that rotate rapidly can create an under-pressure that is so low that watervapour bubbles are being formed on the suction side of the propeller. These gas-bubbles implode continuously on the same spot and cause damage to the suction side of the blade. This is called cavitation. Severe cavitation causes:

- a reduction in propulsion power
- wear of the blades
- vibrations that bend the blades
- noise in the ship
- high cost to rectify

A proper working propeller often shows light cavitation which is not harmful.



Cavitation damage on a rudder blade



Cavitation damage on a rudder blade due to missing plug.

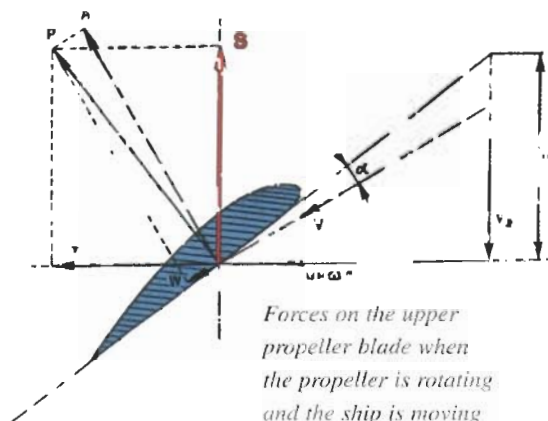

Forces on the upper propeller blade when the propeller is rotating and the ship is moving

- V_e = approach velocity = ship's speed - wake speed
- U = speed of rotation of the propeller
- $T \cdot r$ = angular velocity * radius
- V = resulting speed
- A = lift
- W = drag
- P = resulting force
- S = propulsion force (thrust)
- T = shaft moment

Propeller	Turning direction	Sailing direction	Direct propeller effect		Indirect propeller effect	
			Aft	Fore	Aft	Fore
right-handed	right	ahead	starboard	port		
right-handed	left	astern	port	starboard	port	starboard
left-handed	right	astern	starboard	port	starboard	port
left-handed	left	ahead	port	starboard		

Wheel effect of propellers

The influence of the propeller on the ship's manoeuvring ability

Propellers can be divided into right-handed and left-handed propellers. Ships with a fixed propeller usually have a right-handed version.

A right-handed propeller can be recognised in the following way. Stand aft of the propeller, look at the face and hold on to the top blade with both hands. If the right-hand side of the blade is furthest away, it is a right-handed propeller. If the ship is going ahead, a right-handed propeller is rotating clockwise.

If a propeller is rotating, the ship has the tendency to turn to a particular side, even if the rudder is in the mid-ships position and there are no additional forces acting on the ship. This effect is called the propeller effect or wheel effect (see the module on manoeuvring).

Propellers with adjustable blades (controllable pitch propellers, cpp) are often left-handed. When the ship goes astern, the effect of the propeller is the same as in a right-handed propeller going astern. Going ahead they have the same effect as a left-handed propeller. This is done not to confuse pilots. When going astern, the efficiency of the propeller can drop below 50%, depending on the type of blade and the type of propeller.

1.2 Fixed propellers

The propeller blades of a fixed propeller have a fixed position. As a consequence the direction of rotation of the propeller has to change if the ship is going astern. This is realised with a reversing clutch or a reversible engine. A reversing clutch, and therefore also the fixed propeller, is economical in ships up to 1250 kW.

The diameter of fixed propellers varies between 36 cm and 12 metres. The choice of a fixed or controllable pitch propeller (CPP) in ships up to 7000 kW depends on, among other things, the need for a shaft generator and the need for easy manoeuvring qualities.

Advantages of a fixed propeller over a controllable pitch propeller are:

- They are less fragile
- The propeller does not revolve when berthing, so it poses less danger to mooring boats and there is less risk of ropes getting entangled in the propeller.

Disadvantage: in adverse weather, the propeller may turn too heavily, this can hamper propulsion.



Installation of a fixed right-handed propeller with shaft

Fixed propellers also have a limited RPM for manoeuvring.

Alternative propeller designs

Propellers with tip plates have been invented around 1850, but have only recently been rediscovered. Tip plates are attached to the blade tips. The plates prevent the water from flowing

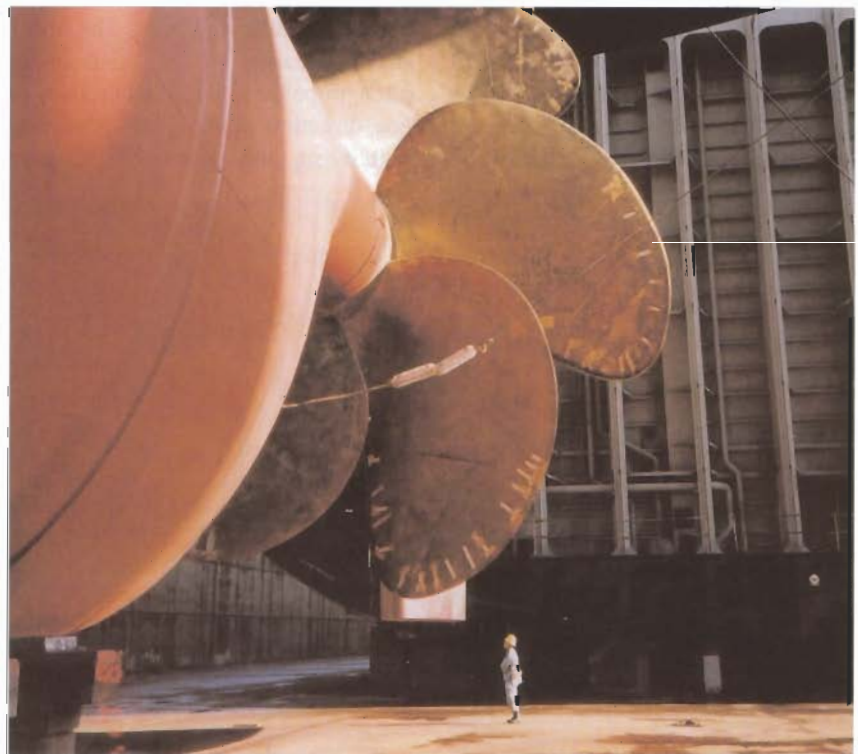

Fixed right-handed propeller of a container vessel (GT 80942) with a reversible engine. The propeller weighs 95 tons, has 6 blades and a diameter of 8.95m.

from pressure areas to the suction areas of the propeller too fast. This increases the efficiency by reducing the energy loss. The improved hydrodynamics of the water-flow caused by the tip-plate propellers also contribute to the reduction of vibrations and noise of the propeller.

Another development is the contra-rotating propeller. This system consists of two propellers placed one behind the other, which are driven by



Propeller with tip plates

means of concentric shafts (inner and outer shafts) with opposite directions of rotation. Both the number of blades and the diameter differ. The principle behind this system is that, normally, water is brought into rotation by the propeller, which results into a loss of energy. Adding a second propeller rotating in the opposite direction reduces the loss of

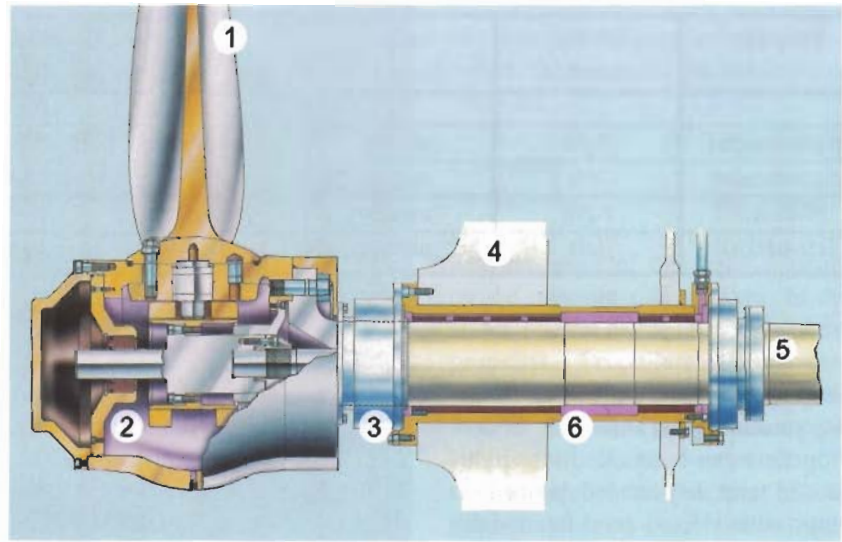

Drawing of a controllable pitch propeller with propeller shaft. The pitch adjustment of the blades is done via oil pressure through the hollow shaft. (For explanation of the numbers see next page.) The figures apply to a propeller with a diameter of 2.5 metres.

energy. The combined propellers can reduce the fuel-consumption by 15%.

1.3 Controllable Pitch Propellers (adjustable pitch propellers)

The blades of this type of propeller can be turned, thereby changing the propeller pitch. These propellers are more complicated than fixed-pitch propellers. The mechanism that adjusts the propeller pitch is located in the boss of the propeller. It is activated from the engine room, remotely controlled from the bridge by a hydraulic cylinder. The most striking feature of the controllable pitch propeller is that it only rotates in one direction, making the reversing clutch or the reversible engine

obsolete. Unlike the fixed-pitch propeller, the controllable pitch propeller is an integrated part of the propulsion system. This makes it possible that power and necessary propulsive forces can all be controlled by simply changing the positions of the blades.

The figure on the next page shows cross-sections of a propeller blade and the forces that act on that part of a rotating propeller blade.

On the left are the cross-sections and forces when the ship is going ahead. All the vectors point backwards, the ship is going forward.

Now the blades are rotated towards the zero-position. This means that the propulsive forces above and below are equal in magnitude, but opposite in direction. The nett propulsive force is zero, but the propeller still absorbs a large amount of energy that is converted to turbulence of the wake. To go astern, the blades are rotated even further, resulting in a forward propulsive force.

Safety precautions

1. The position of the blades can be changed manually without loss of propulsive force.
2. If the hydraulic system fails, the blades can be locked in the ahead position.

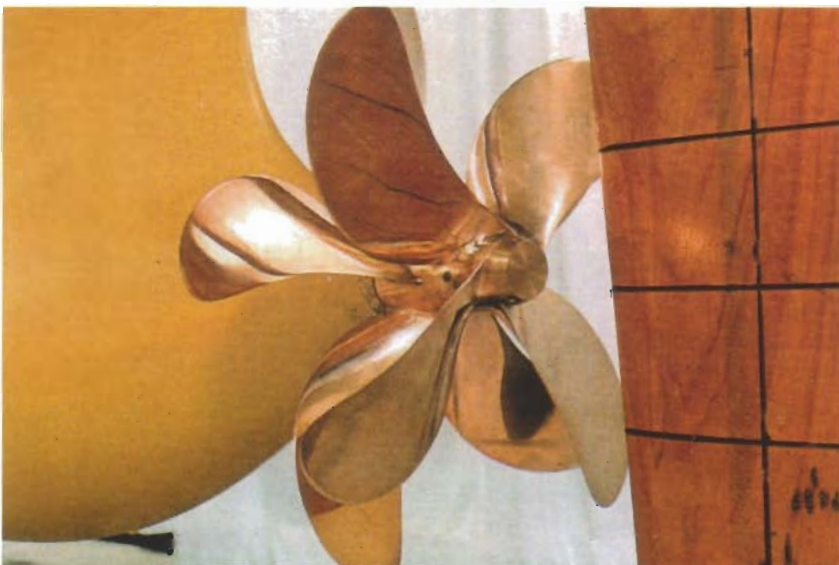

Model test of a contra-rotating propeller

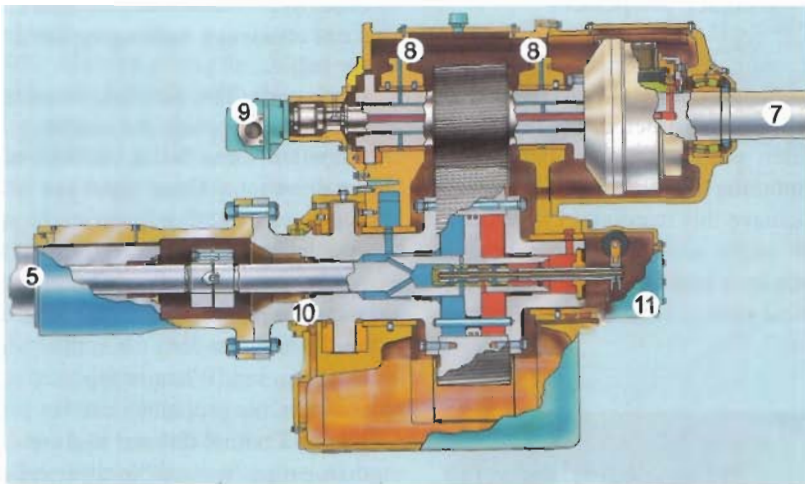

1. Propeller blade (tip speed 31,4 m/s)
2. Boss
3. Watertight / oil tight seal
4. Stern frame
5. Propeller shaft, 240 rpm
6. Stern tube
7. Intermediate shaft (to engine shaft)
8. Reduction gear box (1:2.5)
9. Mechanically driven lubricating oil pump
10. Collar shaft (thrust)
11. Actuating motor, coupled to a mechanism of bars that serves the blades

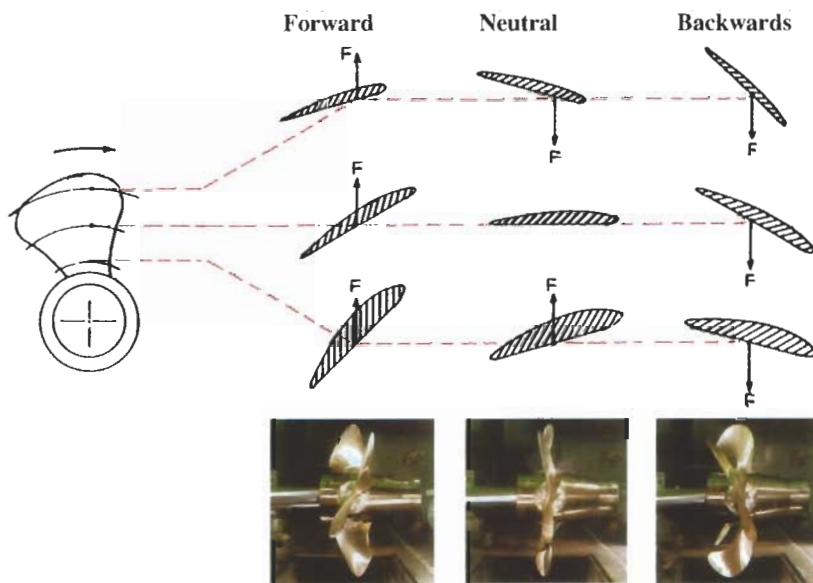

Drawings of a single propeller blade and its cross-sections. The pictures show the controllable pitch propeller; the upper blade is the blade in the drawings.

Advantages of a controllable pitch propeller

1. It can propel the ship at all speeds, even at very low speed without loss of power.
2. It can change quickly from ahead to astern and vice versa.
3. Improved efficiency on ships with alternating loads like fishing crafts and tugs.
4. It can easily be combined with a shaft generator (see on the right).
5. It can stop a ship with maximum power.

Disadvantage:

It is a vulnerable system due to the hydraulic components and many sealing rings. A damaged sealing ring results in oil pollution.

If the auxiliary generators provide the shaft generator with energy, it can also be used as:

- additional power supply during navigating
- emergency propulsion**

** If the shaft generator is to be used as an emergency propulsion, the main engine must be disconnected from the reduction gear box in order to prevent the cog wheels from being damaged.

Class does not prescribe this system and the maximum speed it can obtain. The system is sometimes used on small ships.

The shaft generator can supply the electrical power on a ship as long as the main engine keeps running. With controllable pitch propellers the generator frequency can be kept constant because the rpm of the engine remains constant. The engine drives the shaft generator via the reduction gearbox.

1.4 Nozzles

The purpose of a nozzle is to increase the propulsive force. This increase results from the fact that the propeller forces more water to flow through the nozzle. This water-flow has a higher velocity in the nozzle than the water outside and the resulting pressure gradient then creates the additional propulsive force. The efficiency of the nozzle is at a maximum when the water can pass unobstructed. This is why the top of the nozzle should always be as free as possible in relation to the aft body.

Not only does a nozzle increase the propulsive force, it also reduces noise and vibration levels. Furthermore, the incoming water-flow is more homogeneous in a nozzle, minimising local



Controllable pitch propeller in a fixed nozzle.

pressure differences that are responsible for cavitation and vibrations.

The combination of a propeller in a nozzle is often called a ducted propeller. In principle, the nozzle can be used on every type of vessel except on very fast ships like high-speed ferries where they have no increasing effect on the propulsive force. If the frictional resistance (caused by the nozzle) becomes

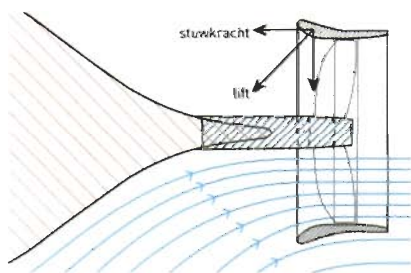

The lift force, created by the under-pressure on the outside of the nozzle

larger than the increase in propulsive force, there is a loss of efficiency. Nozzles are often used on inland vessels, hopper suction dredgers, tugs, fishing vessels and suppliers. The advantages and disadvantages of fixed or controllable pitch propellers are the same for propellers in a nozzle and propellers without one. For shallow draught ships the same thrust can be delivered with a smaller system diameter.

Nozzles come in two main types:

1. Fixed versions
2. Rotating versions
(see Section 1.5)

One particular type of fixed nozzles is the wing-nozzle. In spite of its modest dimensions, this still increases the propulsive force if the speed exceeds 12-18 knots.



Fixed propeller in a wing-nozzle

1.5 Rudder propellers

The main characteristic of rudder propellers is their ability to rotate like a rudder, unobstructed, the full 360°. Rudder propellers are also called 'azimuthing thrusters' or 'Z-drives'. To achieve this freedom of rotation, a right angle underwater-gear box is driven by a vertical power shaft. This vertical shaft is centered in the rudder stock.



Two rudder propellers in a nozzle, with 360° rotation.

A gear driven by a pinion is attached to the top of the rudder stock. This makes the unlimited rotation possible.

Nowadays, rudder propellers can have a power up to 7500 kW. There are several versions of rudder propellers, namely:

1. A fixed unit assembled in an assembly box. It can be equipped with a depth-adjustment system. When the ship is empty, the propeller can be lowered in

order to get sufficient propulsive force efficiency without the need for ballast.

2. Deck units. The diesel-drive units are placed on deck; the rudder propeller is attached to the back of the drive unit. These types can also have a depth-adjustment system.
3. A retractable unit. It can be withdrawn entirely into the ship and is only lowered when the ship is at sea. When in top position, the propellers can be part of a tunnel thruster and are then called 'retractable thrusters'. Not used for main propulsion.
4. Bow thrusters or stern thrusters are also called tunnel thrusters. They are based on a transverse propeller and a right angle underwater gearbox. These are used exclusively to position the bow with a starboard or port side thrust.

Types 1 and 2 function as main propulsion units while type 3 is an auxiliary propulsion unit. Type 4 is for low-speed manoeuvring.

The most important advantage of a rudder propeller is its ability to give optimal thrust in each rudder position.

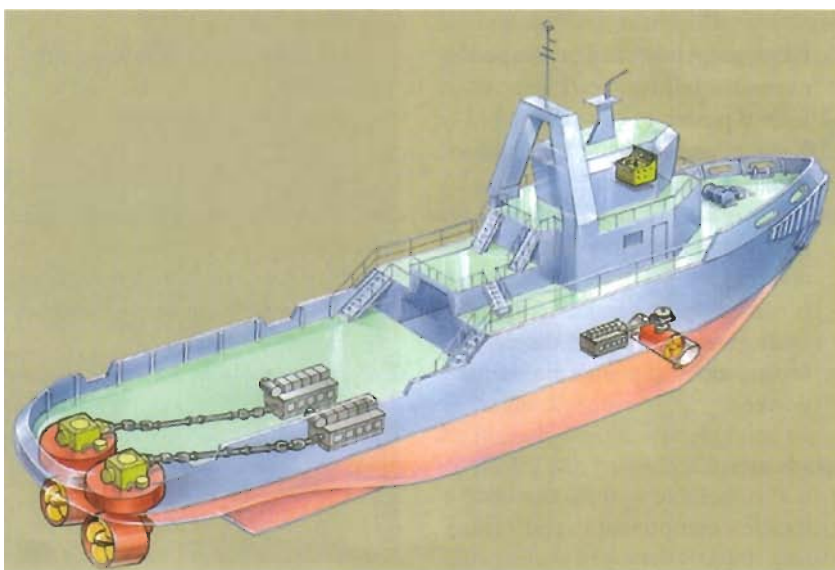

Tug boat equipped with two azimuthing thrusters and a bow thruster

Except for the tunnel thruster, all rudder propellers can steer the ship 360°, thereby giving the ship excellent manoeuvrability. Nowadays, modern electronic equipment for satellite navigation can be employed to couple the rudder propellers to the dynamic positioning system (DP-system). This can keep a ship in a predetermined position irrespective of the influences of currents and wind. Retractable thrusters are often used for this purpose. When the ship is in position, the azimuth thrusters are lowered and the ship switches to DP. Other advantages of the rudder propeller are the very compact engine room (because there is no need for a long propeller shaft); this results in lower installation costs as compared to a conventional propeller.

Rudder propeller installations are often used on passenger liners, cable ships, floating cranes, suppliers, dredgers, barges etc.

1. Horizontal connecting shaft from engine
2. Horizontal gearbox to vertical shaft
3. Vertical shaft
4. Vertical gearbox to horizontal propeller shaft
5. Nozzle
6. Fixed pitch propeller

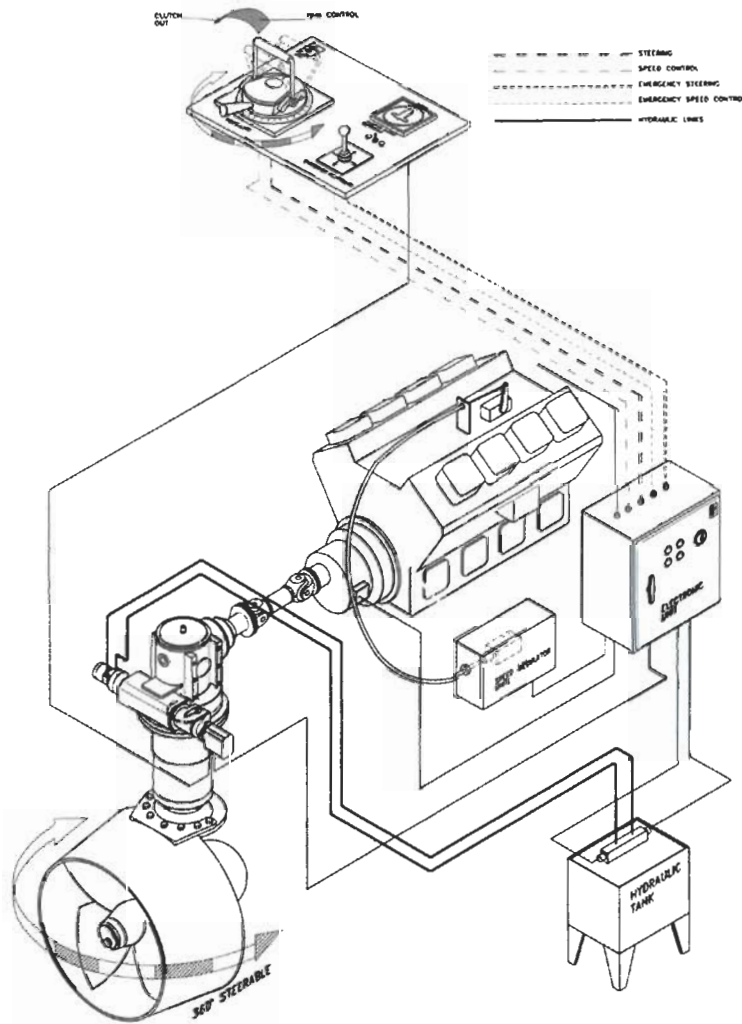

Schematic presentation of the command path from bridge control to the rudder propeller

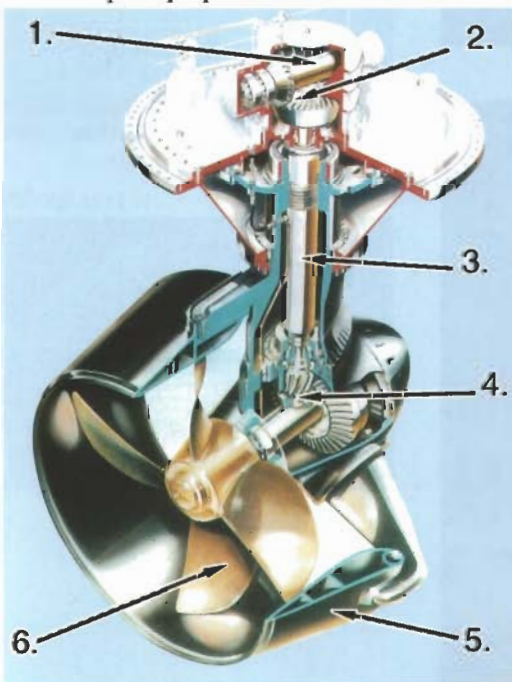

Cross-section of a rudder propeller



Aerial photograph of a supplier shows the optimal manoeuvring capabilities of a rudder propeller in combination with a bow thruster

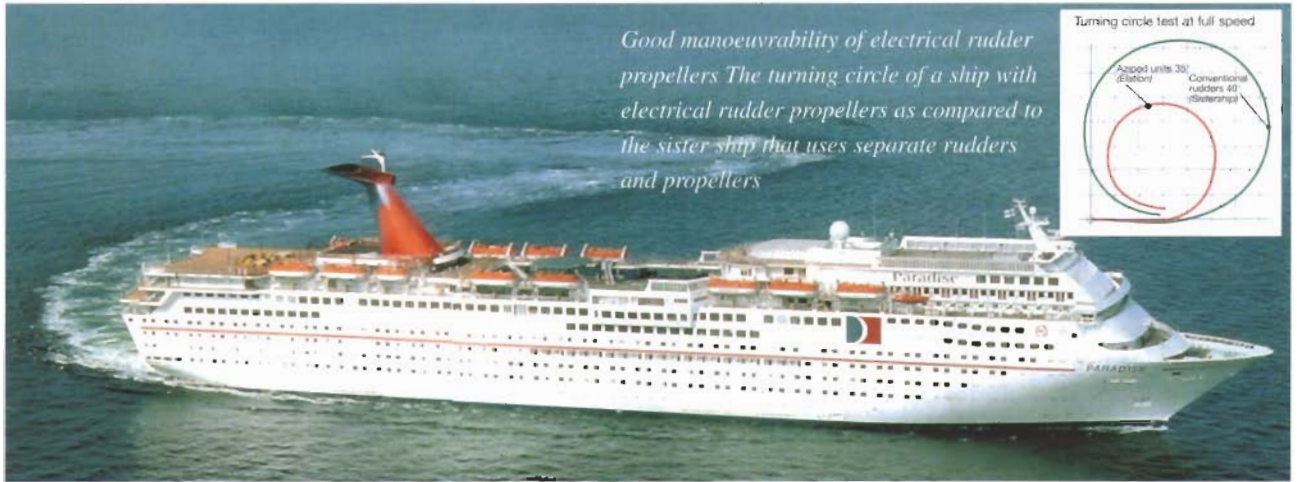

Good manoeuvrability of electrical rudder propellers. The turning circle of a ship with electrical rudder propellers as compared to the sister ship that uses separate rudders and propellers.

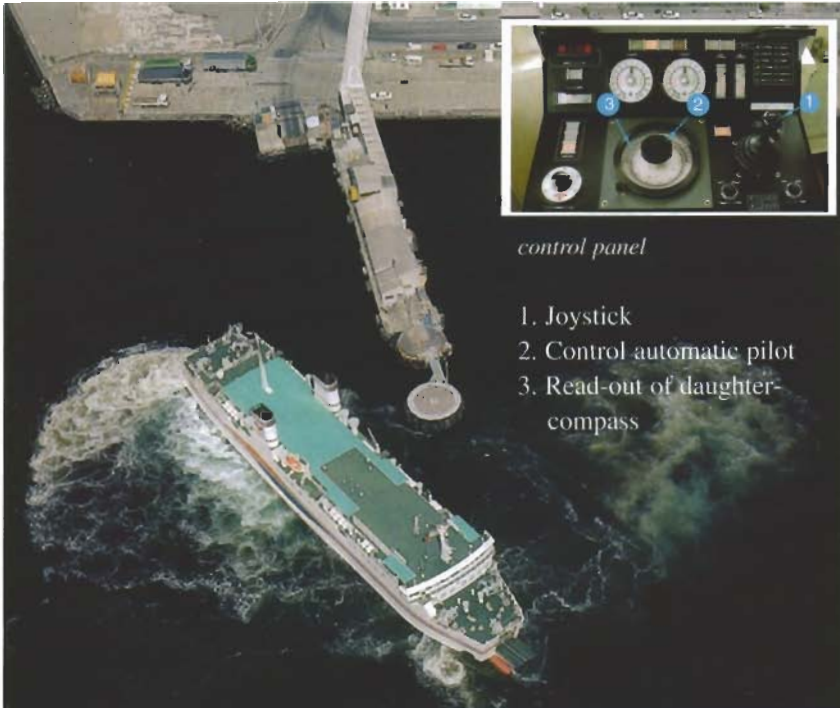
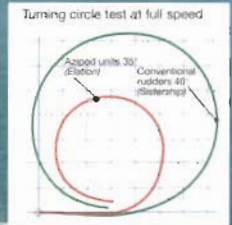

control panel

1. Joystick
2. Control automatic pilot
3. Read-out of daughter-compass

The joy stick on the control panel is a so-called 'one-man operated joy stick system' which controls the entire propulsion system and the rudders.

Aerial photograph of a ferry showing thruster wash

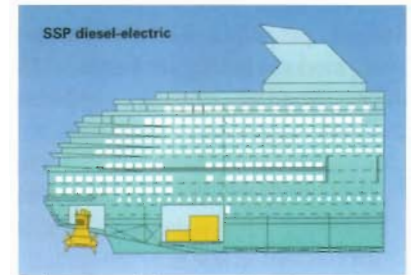

Drive via rudder propeller



Direct-drive engine to propeller

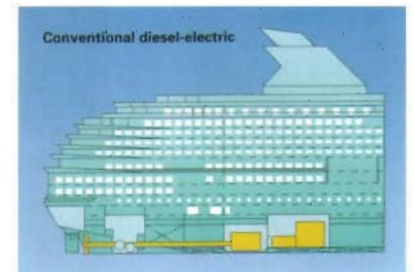

Diesel-electric drive



A cruise ship with 2 electrical rudder propellers that can rotate 360°.

1.6 Electrical rudder propellers

(Brands: Azipod, Dolphin, Mermaid, SSP)

The difference between the rudder propeller of paragraph 1.5 and the electric rudder propeller or podded propulsor is that the latter has its propulsion engine located outside the ship. The electrical engine with adjustable rpm is placed in a pod that is attached to the bottom of the ship. Every pod has a propeller attached to it, driven by the electric motor. There are two main types: a fixed pod with a rudder or a 360 degree rotating pod without a rudder. Both these types can either push or pull. The propeller is then located on the back or the front of the pod, respectively.

The electric rudder propeller does not require gearboxes, clutches, propeller shafts and rudders.

The diesel engines can be placed anywhere on the ship, as long as there is space available, unlike the ships with a mechanical drive where the engines are connected to the propeller by a long shaft and other parts.

So this propulsion system is a compact system that simplifies the design and construction of the ship as compared to conventional propulsion systems. Although the system was originally developed for icebreakers, it is now in use on suppliers, cruise ships, tankers, ferries and ships with a DP-system.

Advantages are:

1. It is possible to separate the power source and the propulsion system
2. It can combine the power supply of the auxiliaries and the propulsion system
3. Few vibrations and little noise
4. Excellent manoeuvring capabilities
5. Lower fuel-costs

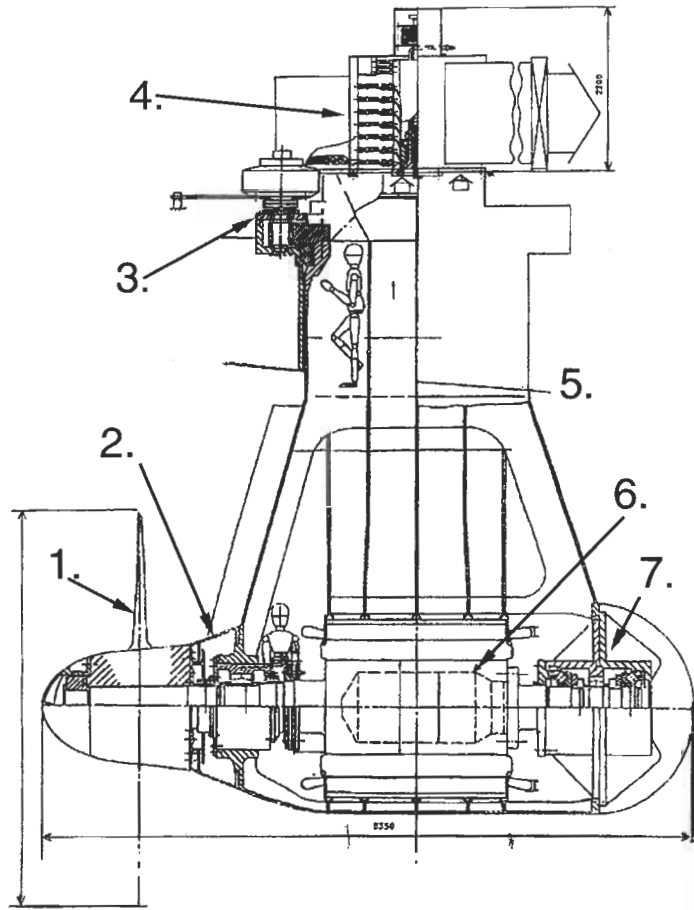

Cross-section of the azipod installation

- | | |
|---|---|
| 1. Propeller | 4. Collector rings for the transmission of data and power |
| 2. Bearing and shaft labyrinth (seal) | 5. Ship's bottom |
| 3. Hydraulic steering unit with toothed rim | 6. Electro-motor |
| | 7. Bearing (radial and thrust) |

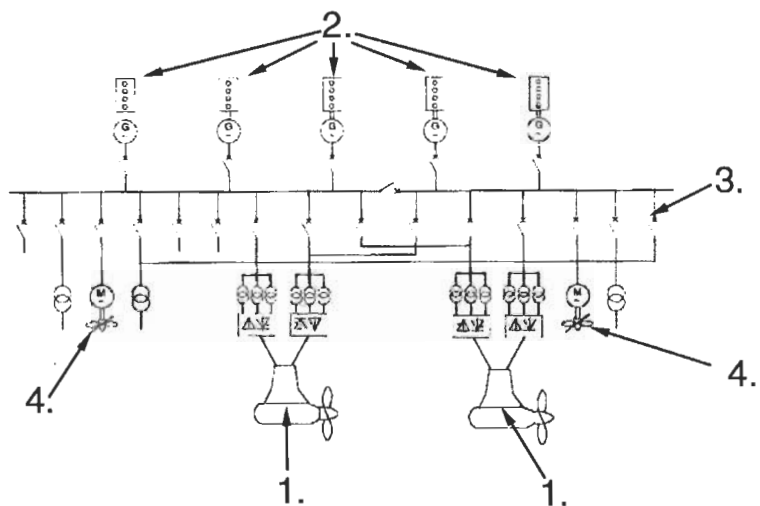

Schematic representation of the propulsion system with pods.

- | | |
|---|---|
| 1. Azipod with a 1200 volts cyclo-converter | energy for all the ship's systems like propulsion, AC, galley, watermakers etc. |
| 2. Five diesel engines coupled to 5 generators (2 times 11.2 MW and 3 times 8.4MW. These supply the | 3. Main grid, 11000 volts / 60 Hz |
| | 4. Bow thrusters |

1.7 Propeller shafting

The stern tube contains the bearings in which the propeller shaft is rotating. Usually, there are two bearings, the aftmost one being the longest. Close to this aft bearing is the sealing system that keeps the seawater out of the propeller shaft and the oil inside.

Bearing: that part of a machine in which a rotating part rests.

The front side of the stern tube is attached to the aft peak bulkhead, the aft part is attached to the stern or propeller post.

The sealing system must be able to withstand extreme conditions like:

- axial speeds up to 10 m/s
- water-pressure up to 3 bar
- axial and radial propeller shaft displacements of several millimetres
- the ship's vibration
- 6000 hours of rotation time per year, during 5 years

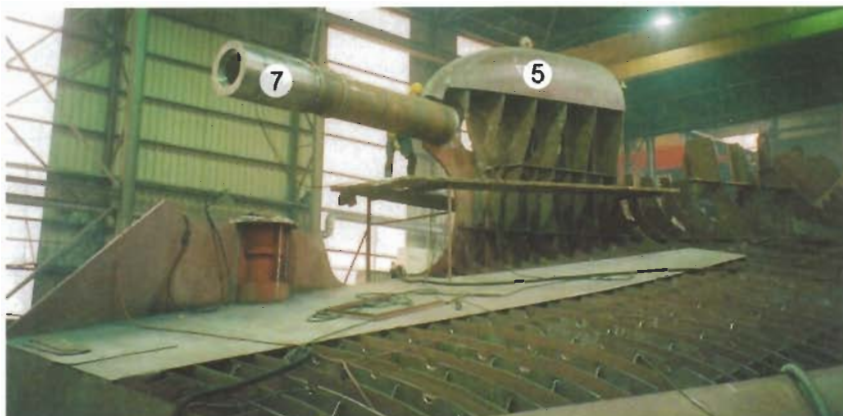

The stern tube is brought into the stern post



Stern post with a controllable pitch propeller

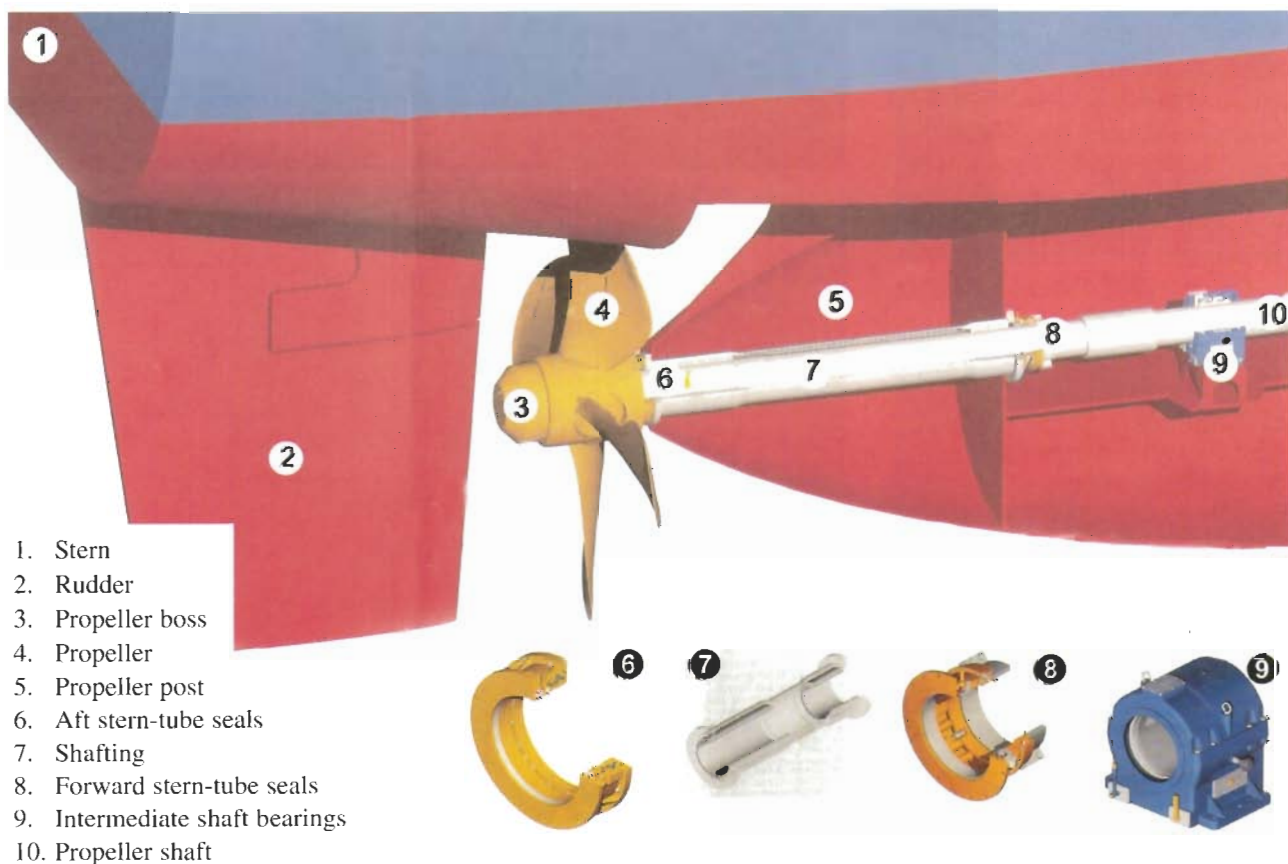

1. Stern
2. Rudder
3. Propeller boss
4. Propeller
5. Propeller post
6. Aft stern-tube seals
7. Shafting
8. Forward stern-tube seals
9. Intermediate shaft bearings
10. Propeller shaft

Stern post with shafting of a controllable pitch propeller

The lubricating agent between the propeller shaft and the shafting can be:

- oil
- water

a. Lubricating oil

Approximately 70% of all ships use oil as a lubricant for the propeller shaft. When oil is the lubricant, the bearing is usually made of white metal, and sometimes of synthetic material. The disadvantage of synthetics is that they poorly transmit the frictional heat between bearing and shaft. At the front side of the front bearing there is a sealing case, which prevents oil from leaking into the ship.

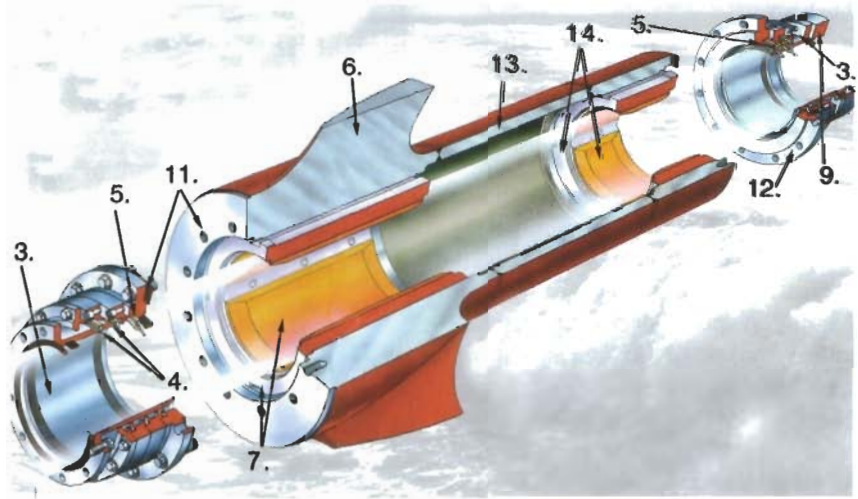

Stern bearing and seals

The sealing system at the backside consists of a sealing case and mostly three sealing rings. These sealing rings are made of synthetic rubber. The space between the two bearings is completely filled with lubricant. The aft seal prevents oil from leaking to the outside. The lubricant pressure is only slightly higher than the water pressure. So if seawater should somehow enter the two water-seals, the higher lubricant pressure prevents it from reaching the propeller shaft. Seawater could seriously damage the unprotected propeller shaft. The higher lubricant pressure is maintained by a small pressure tank (A), which is placed a few metres above the load line.

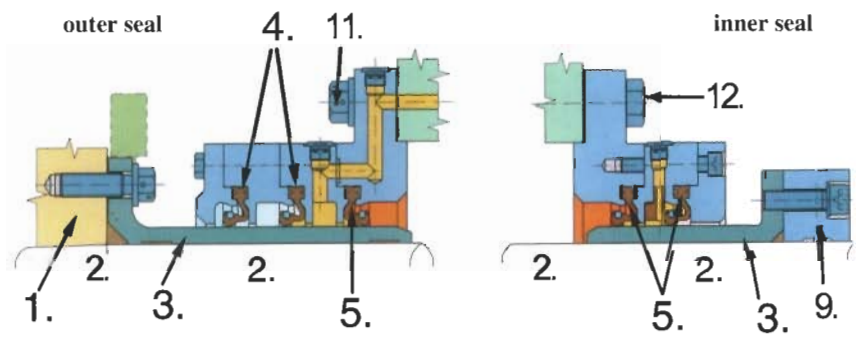

Outer and inner seals

Tank A is part of the main lubricating system, tank B contains lubricating oil for the seawater sealing rings. The oil in the main lubricating system is self-circulating due to the fact that warmer oil rises upwards. Tank C is both the drainage tank and the storage tank. If oil leakage should somehow occur, it is usually limited to small amounts. If not, drydocking is necessary. A chrome steel bush is fitted around both the propeller, shaft aft near the propeller and forward in way of the aft peak bulkhead. The space between the bush and the tube contains lubricant. The aft chrome steel liner is attached to the propeller boss with bolts, the chrome-steel liner of the forward bush is attached to the propeller shaft with a clamped ring. Around both bushes, attached to the ship, are non-rotating housings, where the sealing rings are fitted.

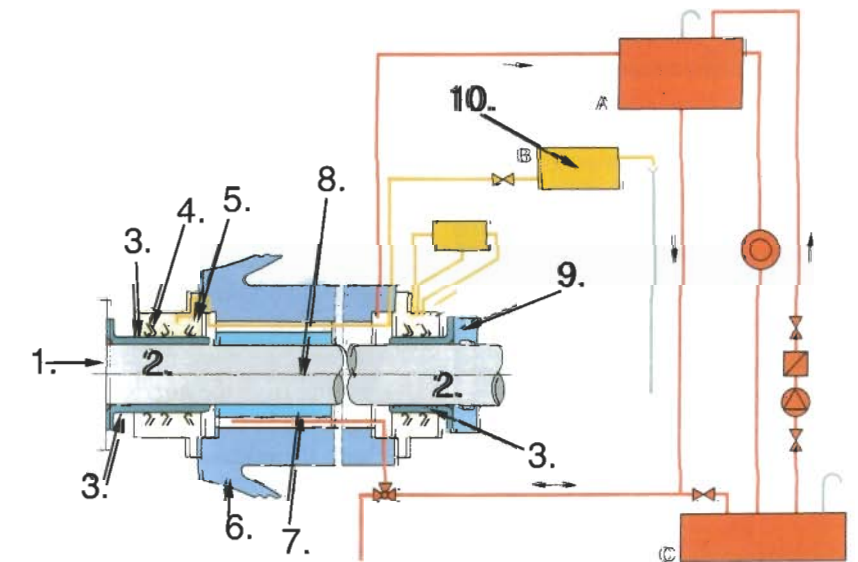

Closed system with lubricating oil

- | | |
|-----------------------|--|
| 1. Propeller boss | 9. Clamped ring |
| 2. Propeller shaft | 10. Oil tank |
| 3. Chrome-steel liner | 11. Fastening with bolts on the stern post |
| 4. Seawater seal | 12. Bolt attachment on the aft peak bulkhead |
| 5. Oil seal | 13. Stern tube |
| 6. Stern frame | 14. Forward bearing |
| 7. Aft bearing | |
| 8. Propeller shafting | |

Advantages of placing a chrome-steel bush are:

- it prevents the propeller shaft from getting into contact with seawater
- very resistant to wear

During dry docking, measures should be taken to determine how much the propeller shaft has sunk. This is indicative of the wear of the aft bearing. A special depth gauge, the so called 'poker gauge', is present on board that can measure the sagging of the shaft. Normal sagging is zero.

b. Water as a lubricant

When water is the lubricant for the propeller shaft, the bearings are made of rubber or synthetics. Water lubrication can be achieved with both open and closed systems. In the open system, the water is pushed out where the propeller shaft leaves the ship, thus preventing seawater from entering the ship. In the closed system, the water is pumped round the shaft, from fore to aft. This means that the water always has a slight over-pressure as compared to the seawater. The navy uses water lubrication because enemy vessels can detect lubricating oil. In some countries water lubrication is compulsory for local shipping to protect the environment.

1. Propeller boss
2. Shaft
3. Bearing (rubber, lignum vitae, tufuse)
4. Stern tube

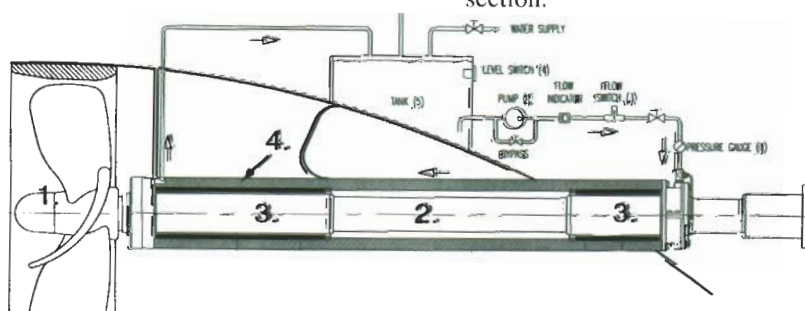

Water lubricated shaft system



Ship driven by waterjet propulsion



Full speed ahead

2 Water-jet propulsion

The main principles of the water-jet are:

- the impeller (propeller) draws in seawater through an inlet
- the same impeller adds head / pressure to the water flow
- when the water is pushed through a nozzle
- the nozzle converts the water pressure into a high-speed jet
- the acceleration of the water flow generates a thrust force that gives the ship its speed
- for sailing astern, the waterflow exiting from the nozzle can be reversed in the forward direction with the reverse plate and reverse section.

The same principle as for a water jet is applied in an aircraft jet engine, but here air is the medium instead of water. The principle is based on Newton's law $F = m \times a$, where F is the force in Newton, m the mass of the water and a is the acceleration of the water.

The waterjet has an electronic steering system. This means that the orders from the bridge are immediately processed by micro-processors. This makes it possible for the water-jet, engine and gearbox to be controlled directly from the bridge.

Along with yachts, a lot of passenger and car ferries, rescue and patrol boats are nowadays equipped with water jets. In 1998 the first cargo-ships were built with water-jet propulsion. The maximum speed of modern water-jets lies around 70-75 knots (approximately 135 km/h). The fastest ferries can reach a speed of approximately 50 knots.

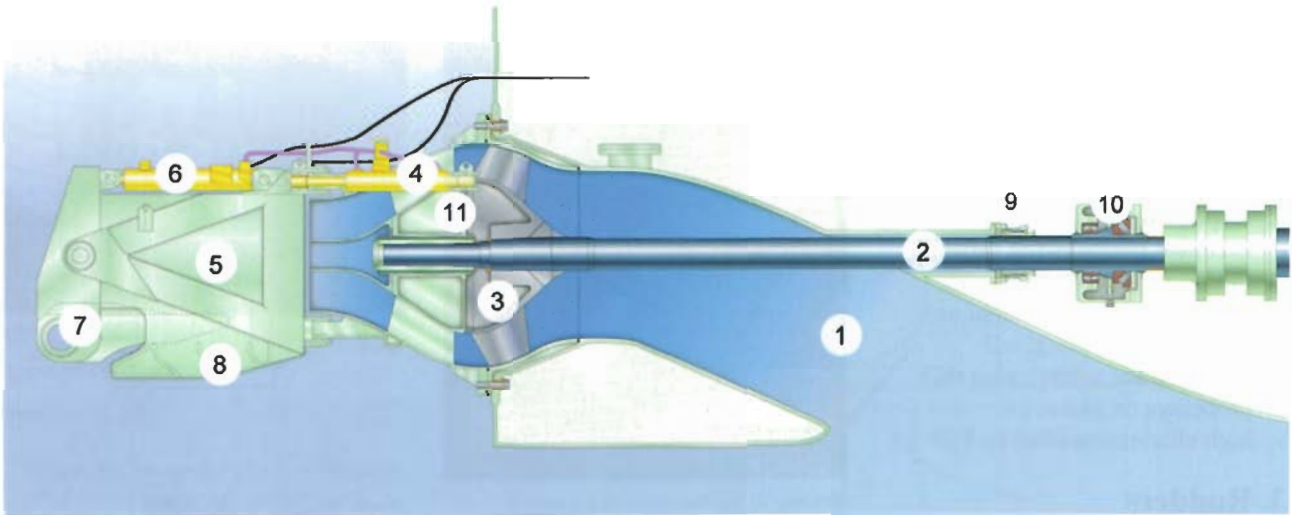

Cross-section of water jet (Wärtsilä Propulsion Jets)

1. Inlet
2. Driving shaft
3. Impeller
4. Hydraulic steering cylinder
5. Jetavator, steering part
6. Hydraulic cylinder that alters the direction of the propulsion
7. Reversing plate, can be moved by the cylinder
8. Reverse section
9. Sealing box to prevent water from entering the ship
10. Combined guide and thrust bearing
11. Nozzle



This picture shows the manoeuvring abilities of two car-ferries (60 metres in length) and two passenger ferries (40 metres in length)



Side view of a water jet full ahead

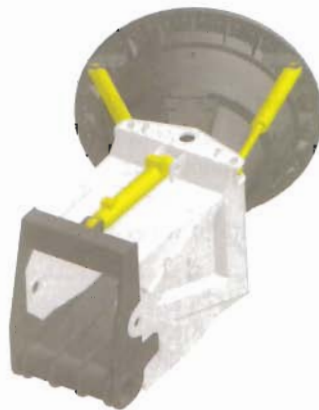

Top view of a water jet altering course to port side



Side view of a water jet full astern / reverse



Side view of a water jet zero thrust



Waterjet with reversing bucket



Waterjet with reversing bucket down

The advantages of water jets are:

- no rotating parts under water. This makes it safe to manoeuvre in shallow waters.
- less resistance, especially at higher speeds, because there are no fittings (e.g. the rudder) suspended below the ship.
- excellent manoeuvring capabilities. For instance, a ship can navigate sideways without any problems.
- less sensitive to cavitation than propellers on fast ships.
- high efficiencies of up to 72%

3. Rudders

3.1 General

The function of a rudder is to steer the ship. The rudder is usually located in the water-flow aft of the propeller. Depending on the type of ship, the area of the rudder is approximately 1.6% of the underwater lateral area (length x draught).

The rudder should be shaped in such a way that the water-flow can be directed as effectively as possible, coupled to a minimum resistance.

Giving the horizontal cross-section of the rudder a wing-profile satisfies these two demands. In fact, the rudder is a vertical wing, on which a lifting force is generated by the water-flow in the same way that an aeroplane wing, propeller blades and a nozzle get a lift. This is also known as the rudder force. The drag should be as small as possible. The lifting force gives a turning moment around the ship's centre of displacement: this is what rotates the ship.

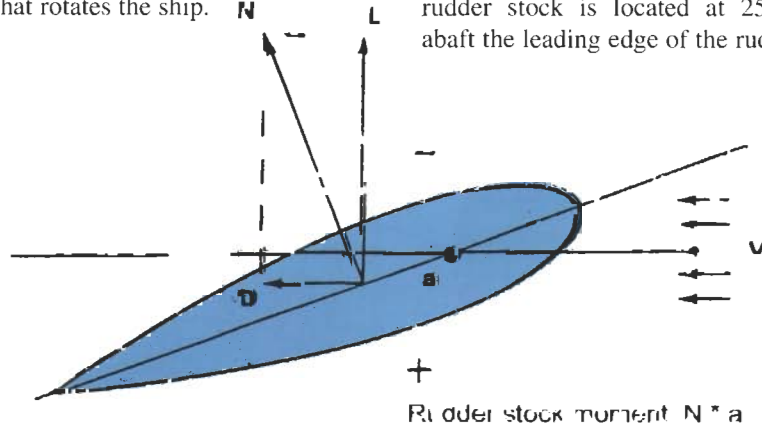

Horizontal cross-section of the rudder blade of a balance rudder



Setting in the heel of a flap rudder

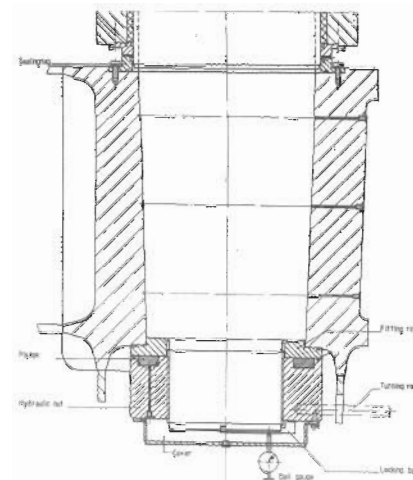

Conical connection between the rudder stock and the rudder blade

For slow speed manoeuvring the rudder should cover the propeller diameter as much as possible in order to make optimal use of the water-flow of the propeller.

The force that the steering engine must supply depends on the torque (force x distance) that must be applied to rotate the rudder.

This force is the resultant (N) in the drawing. The total moment depends on:

- the position of the rudder stock compared to the point of application of N
- the distance between the rudder stock and the leading edge of the rudder (balance).

When the rudder is free hanging, the rudder stock must also be able to absorb the total bending forces of the rudder (spade type).

Depending on the rudder-profile, the rudder stock is located at 25-47% abaft the leading edge of the rudder.



A controllable pitch propeller and a flap rudder of a multi-purpose vessel. The underside of the rudder stock can be seen in the rudder.

Most rudders are hollow and empty. The inside is stiffened with horizontal and vertical profiles.

Section 3.2 will only describe free-hanging rudders. In smaller vessels (like fishing boats), however, rudders are still supported in specially constructed heels, or with mariner rudders at half height (bigger ships)

Suspension of the rudder

The drawings and photos will give an idea of how rudders are supported.

- V = velocity of water-flow
- L = lift
- D = drag
- N = resultant force
- = under-pressure
- + = over-pressure
- a = distance between the rudder-stock and the point of application of N

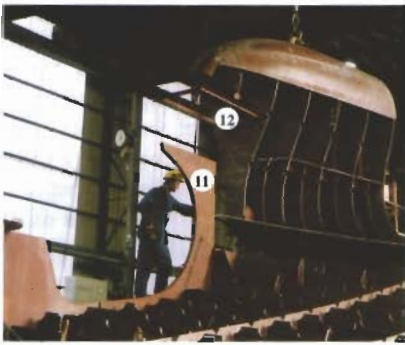

Construction of part of the aft ship of a container feeder

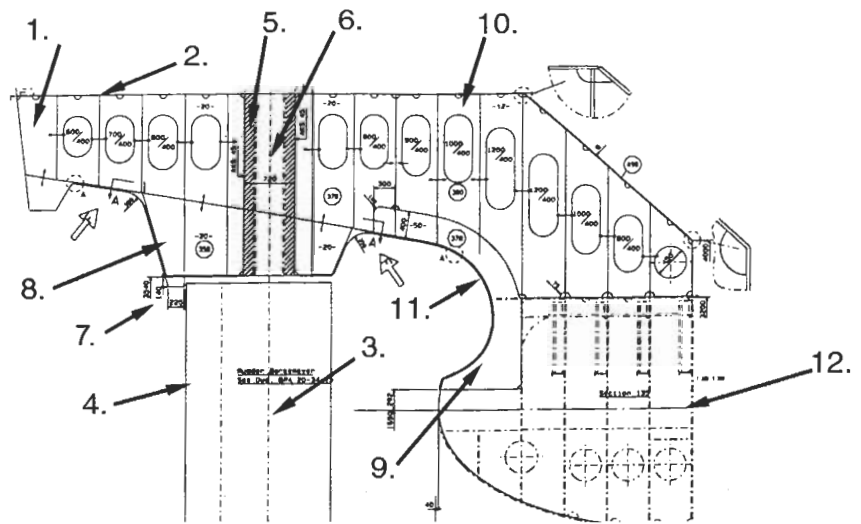

Side view of the ship's centre plane

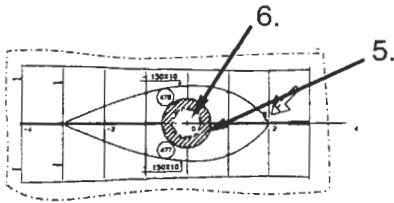

Top view

1. Transom
2. Steering flat
3. Aft perpendicular = rudder axle
4. Rudder
5. Rudder trunk
6. Space for the rudder stock
7. Ice-protection
8. Rudder dome (deadwood)
9. Stern post or propeller post
10. Wash bulkhead on centre line
11. Wing plate
12. Centre line propeller shaft
13. Side keelson
14. Floor plate

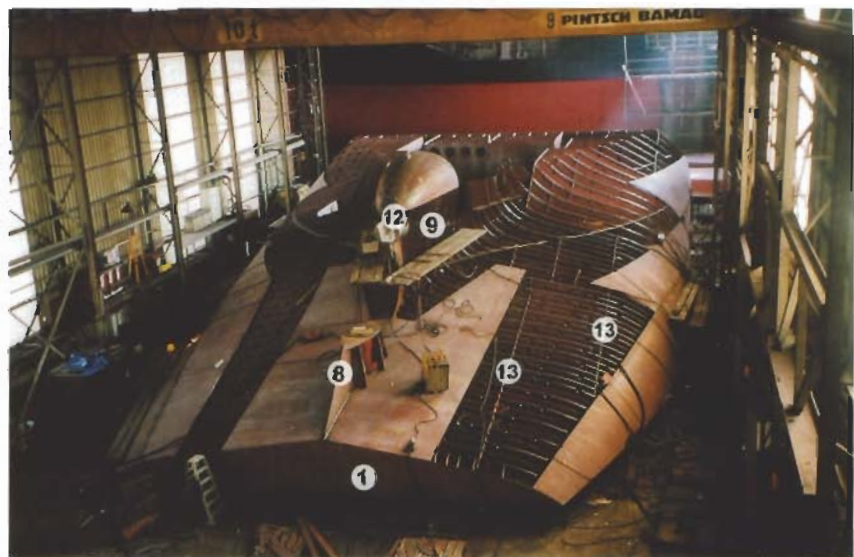

Construction of part of the aft ship of a container feeder

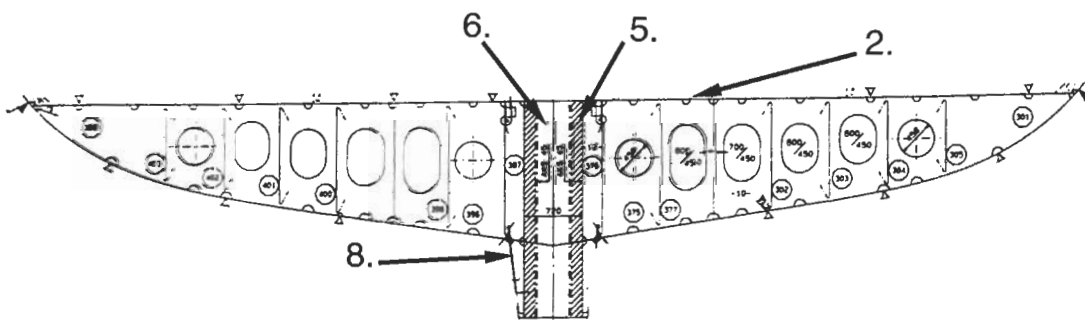

Frame at aft perpendicular (frame 0)

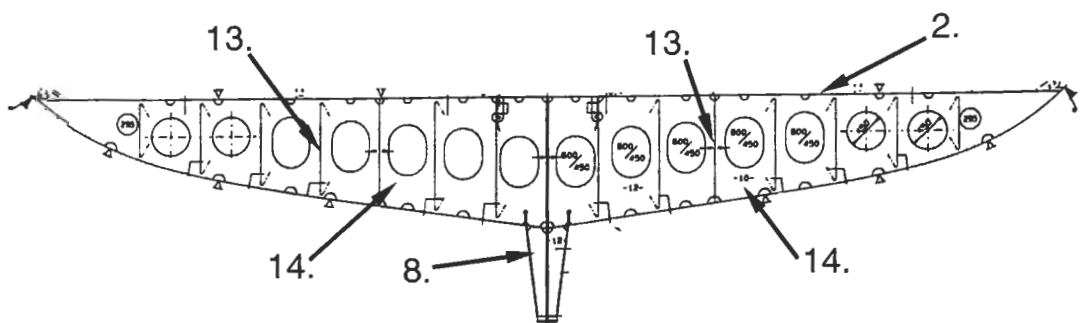

Frame number 2

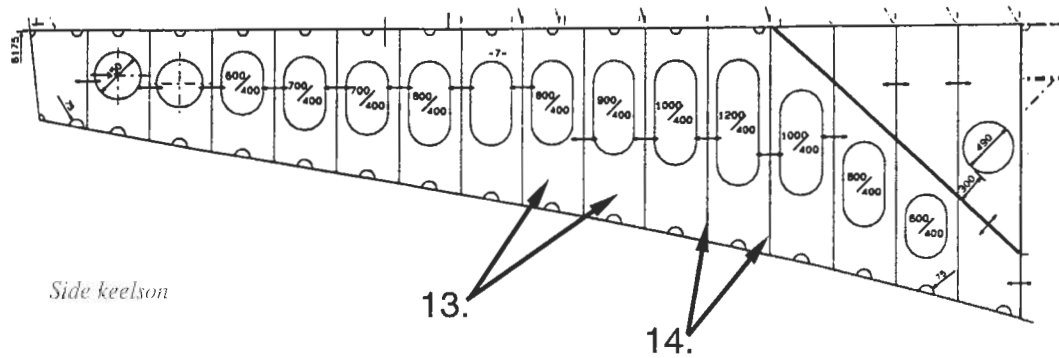

3.2 Types of rudders

The most common rudder-types are:

1. spade rudder
2. flap rudder
3. mariner rudder
4. fish-tail rudder

1. In terms of construction, the **spade rudder** is very simple because it has no supports. For this reason it is a very cheap rudder and it is widely applied, from yachts to fast ferries. The rudder becomes narrower from top to bottom.



A spade rudder on a reef, freely suspended from the rudder dome

2. The **flap rudder** has a hinged flap at the back of the rudder blade. This flap is moved mechanically by the flap guide at the top of the rudder in such a way that the flap's turning angle is twice as large as the turning angle of the main rudder blade. The steering methods of the flap differ per type of flap rudder. When the maximum rudder angle is 45°, the flap has a maximum angle of 90° with respect to the ship. In this rudder position it is



Two flap rudders under a large cargo ferry

possible that 40% of the ship's propulsive force is directed sideways. In combination with a bow thruster such a ship could navigate transversely.

Advantages of flap rudders are:

- extra manoeuvrability (that is, if the main rudder blade is as large as the spade rudder)
- course corrections can be performed with smaller rudder angles. This means that the ship loses less speed and therefore consumes less fuel

Disadvantages are:

- the price
- vulnerability
- the larger rudder forces require the rudder stock to be bigger.

Explanation of the image on the right:

1. Rudder blade
2. Rudder-stock in rudder trunk
3. Flap
4. Hinge line
5. Steering engine
6. Steering engine foundation
7. Gland and bearing
8. Rudder dome
9. Bearing with a diaphragm bush
10. Flap actuator

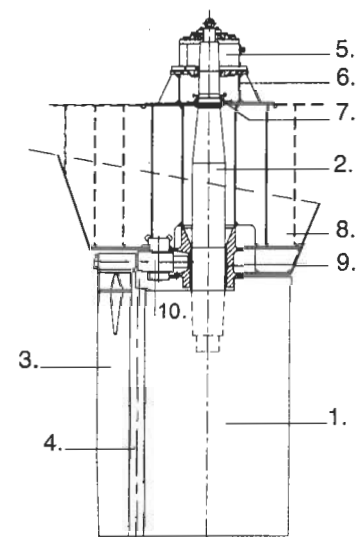

Flap rudder

3. The **mariner rudder** is used on large ships like container ships, bulk carriers, tankers and passenger liners. The stern post is integrated into the ship's construction and the mariner rudder is attached to the stern post with the ability to rotate. This results in a robust rudder. Disadvantages of this construction are that there is a larger risk of cavitation at the suspension points and that the cast construction is more expensive.



View of motor tanker 'Stratus' in drydock

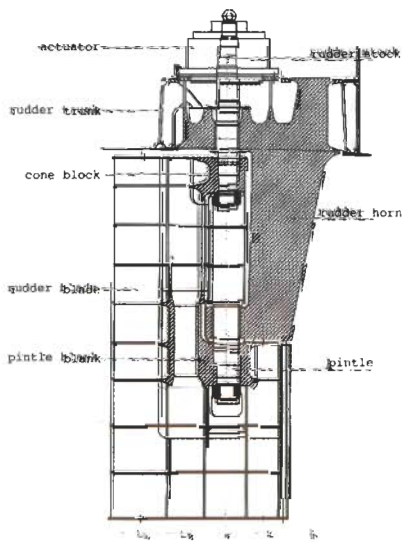

Construction of a mariner rudder



Removal of complete rudder, weight approximately 120 tons



Fitting of pintles to new bushings



Alignment of rudder and stock in shop

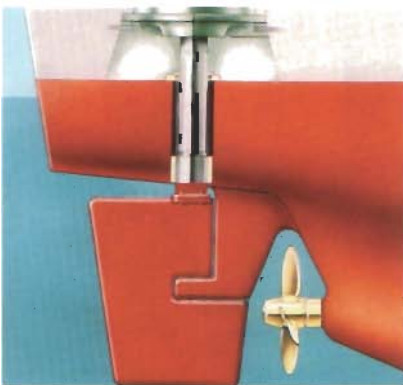

Mariner rudder

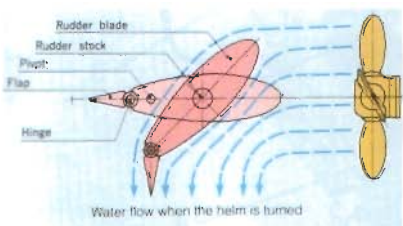

Current flows at maximum rudder angle

4. The **fishtail rudder** is generally used on smaller ships with a speed of less than 14 knots. The manoeuvring qualities of this type of rudder lie somewhere in between those of the spade rudder and the flap rudder.



Top view of a fish tail rudder

3.3 Steering engines

1. General

When it is decided, on the bridge, to alter the course, the automatic pilot or the helm is used to activate the steering engine, which, in turn, rotates the rudder-stock and the rudder. The rudder carrier supports the rudder-stock and the rudder. The rudder carrier also functions as a bearing around the rudder-stock, and it seals the rudder trunk to prevent seawater from entering the ship by a gland. SOLAS demands that every steering engine should be equipped with 2 sets of pumps and, consequently, also 2 servo sets, serving the hydraulic pumps. Both the ram and the rotary vane steering engines operate by hydraulic power. Both types of steering gear are equally common in shipping. The magnitude of the steer or rudder moment is expressed in kNm (kilo-Newton-meter). In general the greatest rudder moment occurs at 30-35 degrees.

2. Ram steering engines

In ram steering engines, the rudder stock is rotated by a tiller that, in turn, is controlled by the rams. A ram consists of a cylinder and a piston. The tiller and the rudder stock are often linked by a conical connection. Ram steering engines may have 1 ram, two rams or 4 rams. If the cylinders are double-acting, the steering engine can still operate through one of the cylinders when the other one fails. This is also a requirement of SOLAS.

1. Rudder stock
2. Tiller
3. Ram (piston + cylinder)
4. Hydraulic lines
5. Electro-motor
6. Protection of coupling between e-motor and hydr. power pack
7. Pump in tank filled with oil (power pack)

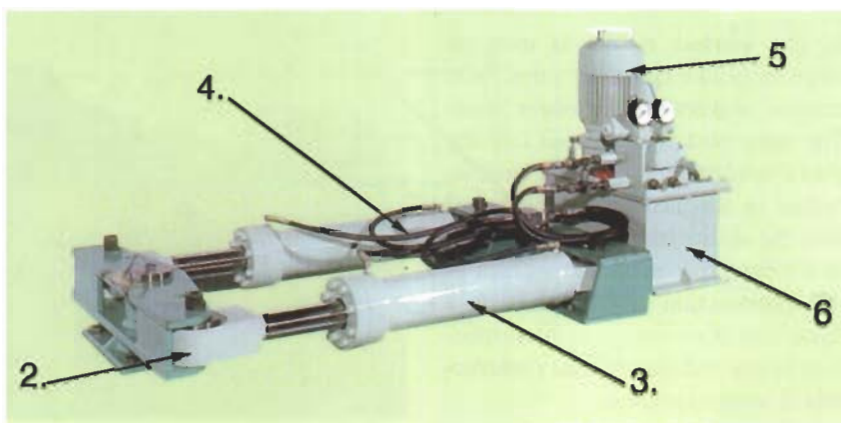

Double-acting cylinders in a ram steering engine of a small vessel

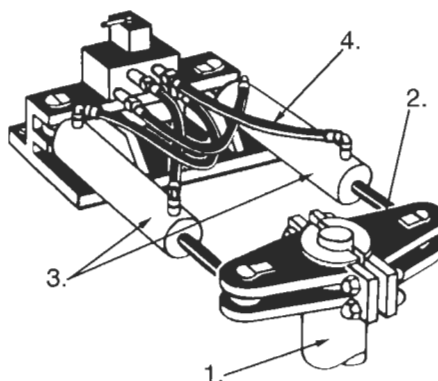

This steering engine has every component in pairs



Ram steering engine on a large ship (turning the rudder to starboard)

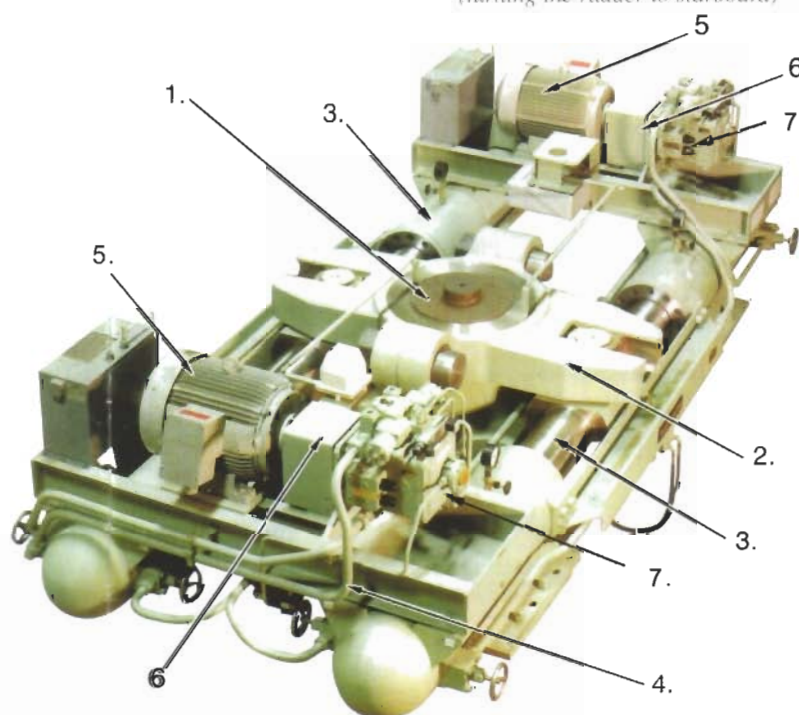

Ram steering engine of a large ship

3. Rotary vane steering engines

A rotary vane steering engine consists of a fixed casing. Inside the casing is the rotor to which wings are attached. This arrangement divides the house into four chambers, two high-pressure, two low-pressure ones. A valve block directs hydraulic oil at high pressure into the chambers simultaneously, pushing/rotating the rotor and subsequently the rudder. If the rudder is rotated to the other side, the high-pressure chambers become low-pressure chambers and vice versa. The rudder stock is located in the centre of the rotor; the rotor is pressed onto the conical section of the rudder stock. The wings and the fixed division blocks are provided with spring-loaded plates which are the seals between the high- and low-pressure oil chambers.

The advantages of a rotary vane steering engine over a ram steering engine are:

- it takes up less space
- it is easier to build in
- it has an integrated bearing
- it has a constant rudder moment

The disadvantage:

- it is not easy to repair and maintain.

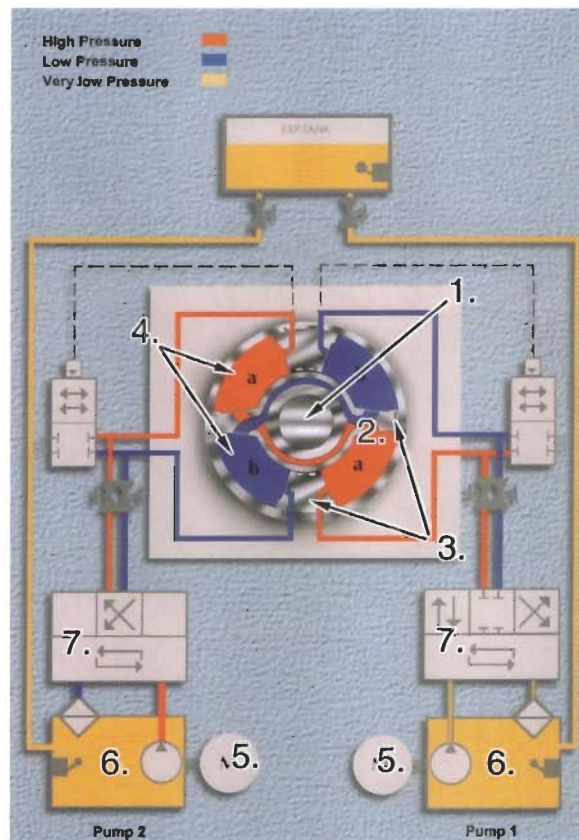

Schematic overview of a rotary vane steering engine

1. Space for rudder stock
2. Rotor with wings
3. Fixed division blocks with oil lines
4. Chambers (filled with oil)
5. Electric motor
6. Hydraulic pump in oil reservoir
7. Valve block

CHAPTER 13

Electrical installations



1. Preface electricity
2. Electrical installations
3. Insulated and earthed distribution systems
4. Basic design criteria
 - 4.1 Type of service
 - 4.2 Type of operation
5. Electromagnetic compatibility EMC.
6. Equipment
 - 6.1 Generators
 - 6.2 Electric motors
 - 6.3 Cables
 - 6.4 Switchboard and switchgear assemblies
 - 6.5 Circuit breakers and contactors
 - 6.6 Type-approved equipment
 - 6.7 Starting devices
 - 6.8 Emergency generator
7. Automation
 - 7.1 Alarm, monitoring and control systems
8. Communication systems
 - 8.1 Internal communication system
 - 8.2 External communication system
9. Navigation and nautical equipment
10. Dangerous areas
11. Operational settings
 - 11.1 Factory acceptance tests
 - 11.2 Harbour acceptance tests
 - 11.3 Sea trials



SHIP KNOWLEDGE

A MODERN ENCYCLOPEDIA

SHIPWISE

PAGE 8 **1**

THE SHAPE OF A SHIP

PAGE 22 **2**

SHIP'S TYPES

PAGE 44 **3**

THE BUILDING OF A SHIP

PAGE 68 **4**

FORCES ON A SHIP

PAGE 82 **5**

LAWS AND REGULATIONS

PAGE 104 **6**

CONSTRUCTION OF THE VARIOUS
SECTIONS

PAGE 126 **7**

CLOSING ARRANGEMENTS

PAGE 160 **8**

LOADING GEAR

PAGE 174 **9**

ANCHOR AND MOORING GEAR

PAGE 196 **10**

ENGINE ROOM

PAGE 216 **11**

PROPULSION AND STEERING GEAR

PAGE 244 **12**

ELECTRICAL INSTALLATIONS

PAGE 266 **13**

MAINTENANCE AND DOCKING

PAGE 280 **14**

SAFETY

PAGE 302 **15**

STABILITY

PAGE 322 **16**

CHAPTER 13 QUESTIONS
VISIT

WWW.DOKMAR.COM

1. Preface electricity

This chapter has the intention to explain the sequence of design, installation and commissioning of the electrical installations on board. Electricity comes in two basic types Direct Current (DC) and Alternating Current (AC). DC is either produced by static electricity as lightning, by a chemical process in batteries, fuel cells or by a dynamo converting mechanical energy into Direct Current.



Lightning, always an impressive waste of energy

DC can be stored in an accumulator and later retrieved when required, allowing for various capacities in generation and consumers. An example is a conventional diesel-electric submarine. In modern ships DC systems are limited to small installations or transitional sources of power. UPS units or uninterruptible power supply units are a combination of a battery-charger converting AC into DC, a battery storing the DC and a converter converting the DC into AC. These units are often used for computer power supplies where an uncontrolled shut-down would lead to loss of information or crash of the programme. Small units are used in transitional lighting fixtures. Disadvantages of DC systems are DC generators with collectors and brushes, complex switch-gear. Motors with collectors and brushes all require a lot of maintenance and get more complicated when the size increases.

The basic result of the simplest generator consisting of a moving magnet inside a coil is an alternating current, AC. Even a bicycle dynamo is such a device. For larger sizes the permanent magnet has been replaced by an electric DC magnet supplied through slip rings; Later the maintenance unfriendly slip rings were replaced by an exciter, a sort of

rotating AC transformer with rectifiers on the rotor. First AC was alternating current single phase, later it became rotating current 3-phase. Alternating current allows for simple switch gear. The current goes down to zero every cycle and the arc over an opened contact extinguishes itself as the voltage is zero.



AC generator under maintenance

Alternating current is a very suitable transport medium of energy for lighting, small power and for control signals. The conversion of AC single phase into rotating energy requires an auxiliary coil to define the direction.

Small electric single-phase motors have an auxiliary or starting winding. A logic evolution after the single-phase AC system is the three-phase AC or rotating current system.

The permanent magnet of the generator now rotates within three windings physically spaced 120 degrees from each other, creating an AC current in sequence in each of these windings. This rotating current makes it possible to power a simple AC squirrel-cage motor having the same three windings similarly spaced. Reversing is done by changing two phases, thereby changing the direction of the rotation field. A further advantage of this three-phase system is that when the load is equally divided over the phases, the sum of the three phase currents is zero, so that the zero or starpoint-conductor can be deleted or reduced in size. This effective distribution system is widely used on ships and shore installations.



A generator rotor

2. Electrical installations

Electric installations in ships are a very complete part of electrical engineering as they cover every aspect of power generation, switch-gearing and distribution to every type of consumer.

Also all types of automation and remote control are part of it as well as internal and external communication, navigation and nautical equipment. However, the basic difference with shore based electrical installations is the necessity to be self-supporting: that is, either to have the personnel and necessary spares on board, or to have the required redundancy to be able to reach the next port in case of a failure of a single system or component.

Some types of ships and offshore systems require this redundancy, not only in cases of electrical or mecha-



NAV-1 Bridge



NAV-1 Bridge console

anical failure but also in case of other events such as fire in a space or flooding of a space.

The way an installation is operated, is essential to appraise it, such as manned engine room versus unmanned, computerised control systems, one man on the bridge (the NAV-1 Notation).

All the above considerations will have their consequences for the basic design, including the location of equipment and the cable routing. Application of high-tech control and communication equipment and also application of high-powered semiconductor drives requires a study for electromagnetic compatibility (EMC) and the application of EMC measures.

3. Insulated and earthed distribution systems

The first AC ship's installations were small; the cable insulation quality was poor and redundancy by duplication was rare. To be able to continue to operate with a single earth fault these installations were insulated, without earthed neutrally. This enabled the ship to continue to operate while searching for the earth fault. Nowadays the installations are large and the capacitive coupling of the cable network to earth is large. Consequently the current resulting from the first earth fault can be something like some amperes, which is equivalent to a heater of some kilowatts at a location you do not know. It is also therefore wise to promote the 3-phase 4-wire neutral earthed distribution system, also because all other conditions, as voltage surges due to switching, are more alike to shore installations.

Marine electric equipment used to be specially made for ships but is now high-tech industrial equipment only adapted to the shipping environment.

4. Basic design criteria

The criteria, such as type of service (the expected location of the service of the ship), the type of operation by crew (both in the engine room and on the bridge), the redundancy criteria, basically take into account a single electric or mechanical failure, and the maintenance criteria for being self-supporting or being supported by a shore-based maintenance system, form the basis of the design.

The basic design inclusive of supporting information as short circuit calculations, one line diagrams, selectivity diagrams, material lists, lay-out drawings and an operational description is to be approved by the Classification Society. Also the requested Notation (quality code on certificate) of the ship is taken into account. Basic one-line diagrams show the principal lay-out of the electric installation indicating quantities and ratings of generators, electrical arrangement of main-busbars, showing also any separation and the division of the essential consumers over the busbar sections, power-supply circuits to distribution boxes and panels throughout the ship. A basic one-line diagram tells more of the electric installation than pages of specifications.

Selectivity is a sequence of settings of protective devices in order to switch off a faulty circuit as close to this fault as possible, leaving as many healthy circuits live as possible. This requires expensive and fast circuit breakers. When more circuit breakers are in series as in the case with sub-switchboards and further downstream circuit breakers the solution is more difficult. Maintenance on board modern ships is usually by a planned maintenance system, dividing the required checks and tests over the maintenance period. Furthermore, by measuring more parameters of the



Two diesel-electric inland waterway ferries in service between Texel and Den Helder, the Netherlands.



The two "Blue Star Sisters" after launching of the second vessel only four months after the launching of the first

installation and diagnostic programmes the expected failures can be predicted and appropriate measures can be taken at the next suitable port of call.

4.1 Type of service

Inland Waterways: this type of ship is limited in its operation area. Assistance in the form of help by a fire brigade or tugs is more likely to be available. The requirements for fire-pumps, emergency battery capacity or fuel tank contents are less than the requirements for unrestricted service. Also the requirements for communication equipment for inland waterways are less than those for coastal service.

Coastal service: coastal service ships operate in a limited area, in general covered by a local communication station and covered by some sort of service organisation. So again the requirements for battery rating, communication equipment and redundancy in essentials is limited, as help is available at short notice.



A brand-new coastguard vessel for coastal service at the fitting-out quay of the building yard

Unrestricted service: no help is to be expected from shore and thus the requirements for redundancy, battery-time, emergency generator capability are maximal by SOLAS rules

4.2 Type of operation

Manned: manned engine rooms are rare nowadays as they require more (expensive) crew and the engine room environment is usually warm, damp and noisy. Modern automation systems as remote-control systems and alarm and monitoring systems, make it possible to operate most engine rooms unmanned, at least during part of the time. In the normal day shift the engineers can execute planned maintenance and repair or replacement of defective parts. For small simple ships with simple electric installations and for small ships for countries where personnel is cheap, it may be feasible to design a manned engine room and delete the expensive and complicated automation for remote control, alarm and monitoring systems. Automatic starting of a stand-by generator set, automatic closing to a dead busbar after failure of the running set and automatic starting of all essential electric consumers is, however, a SOLAS requirement for all ships, whose propulsion depends on electrical power, also for those with manned engine rooms.

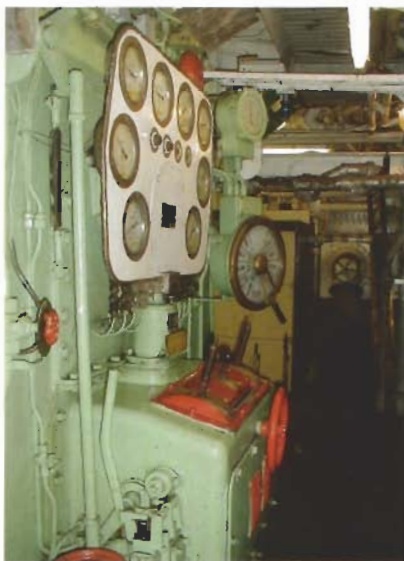

Manoeuvring stand in engine room of 50 year old passenger ship "Anastasis"

Unmanned: Notation UMS.

Most of the ships nowadays sail with unmanned engine rooms. As a consequence they require a fire detection system, automatic safety systems for machinery, remote control systems for machinery, automatic control systems for air compressors, automatic starting of stand-by pumps for propulsion auxiliaries as seawater pumps, freshwater pumps, lubricating oil pumps, fuel oil pumps, propeller hydraulic pumps and an alarm and monitoring system.

Above systems must be arranged in such a way that under normal operating conditions no manual intervention by engineers is required. Alarm and monitoring functions and safety functions must be independent from each other.

Engineer safety systems (dead man alarm) must be fitted in case a single engineer is in the engine room for maintenance or fault finding. Usually automatically started when an alarm is accepted at the engine control station.

One man on bridge: Notation NAV 1. Periodic operation of the ship under the supervision of a single watch keeper on the bridge is becoming normal practice on modern ships. The principles are the same as those for an engine room with one man on watch. The requirements are as follows: alarm and warning systems associated with navigation equipment shall be centralised and be both visual and audible for efficient identification. Other possibilities for the Notation of the navigation functions are Integrated Bridge Navigation



Bridge console, HSS "Discovery", a high-speed passenger ferry

Systems (Notation: IBS). These require in addition duplicated gyro-compasses, differential global positioning system, route-planning capabilities, auto-track capability, and electronic chart display.

5. Electromagnetic compatibility (EMC).

The shortest definition of EMC is the capability of neither to disturb nor be disturbed by the environment. This is applicable to all equipment on board of a ship. Disturbance is both radiated and conducted through the connecting cable network. EMC appears to be a complicated and time consuming exercise. It starts with listing the sensitive equipment and verifying their acceptance limits and then listing the disturbing equipment. A lot of this work has been done. This has been laid down in IEC 945 (International Electrical Committee). IEC 945 defines the susceptibility criteria for navigation and nautical equipment. Also the disturbing signals, frequency and power, or the environment one can expect on the open deck and inside a wheelhouse of a normal ship, are defined in this standard.

Most navigation and nautical equipment has been tested for approval to meet these criteria.



Top deck of a modern ship showing the compromise in installation of a transmitting disturbing radar aerial and the VHF receiver aeriels.



Auxiliary engine room of a ferry

6. Equipment

6.1 Generators

A generator is a simple device to convert mechanical energy into electrical energy. Usually they generate rotating current 50Hz or 60Hz leaving for direct-driven machines of the following engine speeds of 500/600 RPM, 600/720 RPM, 750/900 RPM, 1000/1200 RPM, 1500/1800 RPM and 3000/3600 RPM. The higher figures are mostly for smaller generator sets or turbine-driven machines.



Main-engine driven generator

6.2 Electric motors

Electric motors are simple devices to convert electrical energy into mechanical energy. AC squirrel cage motors have the same RPM restriction as AC generators. Motors are available in different casings for fitting on a foundation or flange for fitting to a pump. Also various protection classes against the ingress of solid particles and water are

available, and for use in an explosive environment increased safety “non-sparking types” and flame proof motors are available.

6.3 Cables

Cables form the connections between the different parts of the electric installation and are nowadays available as low-smoke, low toxic and even fire-resistant types. Application of such more sophisticated cables will reduce the consequences and damage of a fire. The commercially attractive PVC insulated types are vulnerable in case of fire. The insulation burns,

causing short circuits. They generate high quantities of toxic and corrosive gases which will damage a lot more of the installation than that damaged by the fire only. However, a disadvantage of the low smoke types of cables is that their mechanical properties are considerably less.



Cable trays and pipes in the corridor between the forward and aft engine room of a stone-dumping vessel



Electric driven pumps

6.4 Switchboards and switch-gear assemblies

Switchboards and other switchgear assemblies basically serve to connect and disconnect generators and consumers to the main power supply system. They contain also the protection devices of the generators, the cables and the consumers against overload and short-circuits. Switchboards and other control-gear assemblies can be operated by engineers, but servicing and maintenance and repairs should be carried out by specialists.

Laws in most countries issue a clear instruction of how to power a part of an installation safely, to carry out repairs and power up safely afterwards. It also defines skills and responsibilities of the operators and maintenance people. The main differences between an industrial switchboard and a marine switchboard are protection class IP23 with closed doors. In case of open doors, protection class IP20, handrails, door catchers in open position, measuring and indication instruments to be able to synchronise and for load sharing of both power and current etc.

When electric power is required for propulsion of the ship, the source of power is to be duplicated and the main busbar in the main switchboard is to be divided in two parts connected by a removable link for small installations up to full-size circuit breakers with selective protection devices for large installations. Duplicated essential consumers shall be supplied each from a side of the switchboard, or when supplied from distribution-boards from separate distribution-boards, each supplied from a side of the main switchboard. All of this with the same target that a single fault does neither impair the propulsion system nor impair the habitability for the crew. This single failure also includes a fire or other damage to a cable tray. Therefore the power cables and control cables to essential duplicated consumers shall be separated.

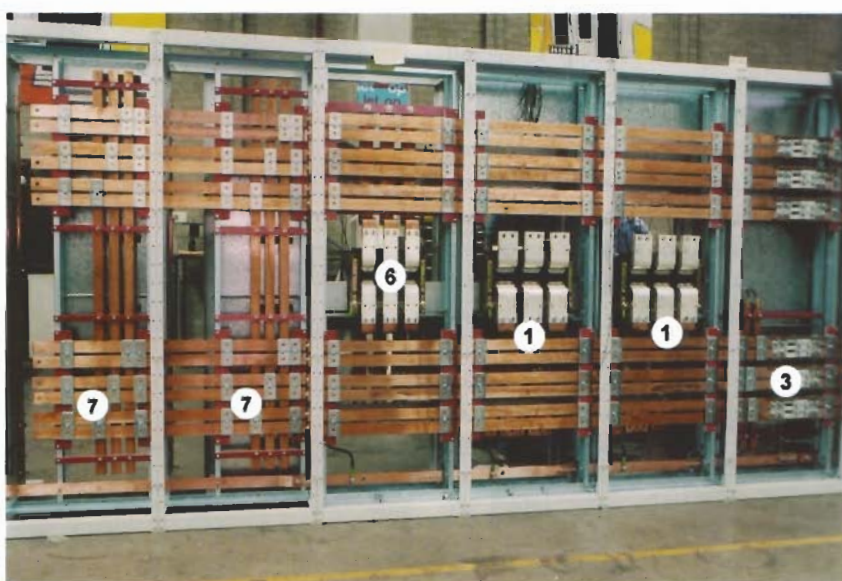

"Blue Star" main switchboard during factory testing

- 1 Generator circuit breaker
- 2 Auxiliary generator panel

- 3 Bus section panel
- 4 Auxiliary generator panel
- 5 Main-engine driven generator panel
- 6 Bow-thruster panel
- 7 Outgoing group panels

Synchronising equipment must consist of a check synchroniser, blocking a-synchronous closing of circuit breakers in any mode, also manual. The final emergency mode of closing (pressing the mechanical controls at the circuit breaker front) is allowed to be unprotected. Further the synchronising equipment is to consist of a double voltmeter and a double frequency meter giving the voltage and frequency of the busbar and those of the incoming machine. These instruments may also be replaced by a multi-function instrument per generator which enables the read-out of voltages between the phases and

between the phases and the neutral if applicable, phase currents, power, reactive power, frequency etc. Having the voltage and frequency right, this still does not mean that the busbar and incoming machines are synchronous. Synchronising lamps fitted between the same phase of the busbar and the incoming machine indicate synchronism when dark. Two of these lamps are normally fitted to avoid confusion with a broken bulb. A Delta voltmeter gives the same indication. The flashing of the lights or reading of the voltmeter also gives an indication of the frequency difference.

A synchronoscope operates like an AC motor with the stator connected to the busbar and the rotor with the pointer connected to the incoming supply. When synchronous the pointer is standing still at 12 o'clock. The frequency of the busbar and the incoming machine is thus the same and the voltage synchronous. If the incoming machine runs too fast, the pointer rotates clockwise; if too slow anti-clockwise

6.5 Circuit breakers and contactors

A circuit breaker is designed to close and interrupt a short-circuit current a few times only without maintenance. A contactor is designed to withstand thousands of times the starting currents of electric motors. A circuit breaker is therefore not suitable to start a large motor. Switching capabilities are given under different conditions. Some manufacturers give a capacity only once possible.



Circuit breaker Masterpact NT 1600 A

Moulded case circuit breakers, especially the current limiting types can be replaced as a complete unit only.

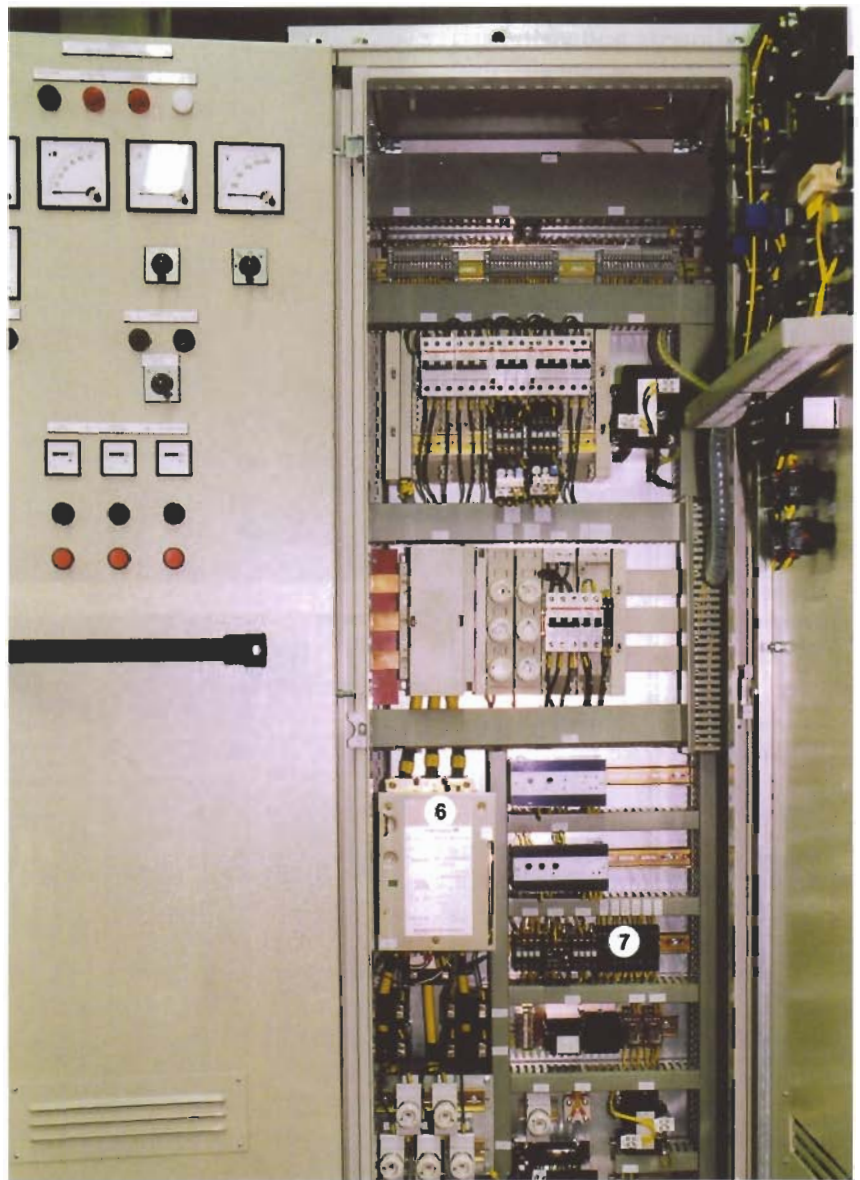

A synchronising panel showing:

<i>1. Circuit breaker closing pushbuttons</i>	<i>4. Speed control generator</i>
<i>2. Voltmeter busbar-generator</i>	<i>5. Synchronoscope</i>
<i>3. KW indicator</i>	<i>6. Main circuit breaker</i>
	<i>7. Synchronising equipment</i>



6.6 Type-approved equipment

Type-approved equipment is equipment tested to be suitable for the marine environment as stated in the classification rules.

The marine environment is defined as follows:

- Temperature air 45° centigrade (other figures can be agreed on restricted services)
- Temperature seawater 32° centigrade (other temperatures can be agreed on restricted services).
- Maximum humidity 95% non-condensing.
- Trim $\pm 5^\circ$
- Pitching $\pm 5^\circ$
- List $\pm 22.5^\circ$ roll $\pm 22.5^\circ$
- Vibration, Shock, radiated and conducted interference EMC
- Susceptibility to radiated and conducted interference EMC
- Voltage and frequency variations
- Total harmonic distortion
- Functionality of the equipment in general, performance data, accuracy etc.

All essential equipment shall be selected from the lists of type-tested equipment. If an equipment is not listed at least it shall fulfil the requirements for type-testing as available from the Classification Societies.

6.7 Starting devices

Starting devices are used to limit the in-rush current of a consumer when connected to the main power supply to an acceptable value. That is to a value that does not disturb the proper functioning of the other devices in the installation. Starting devices are also used to limit the starting torque of an electric motor, so to protect a delicate

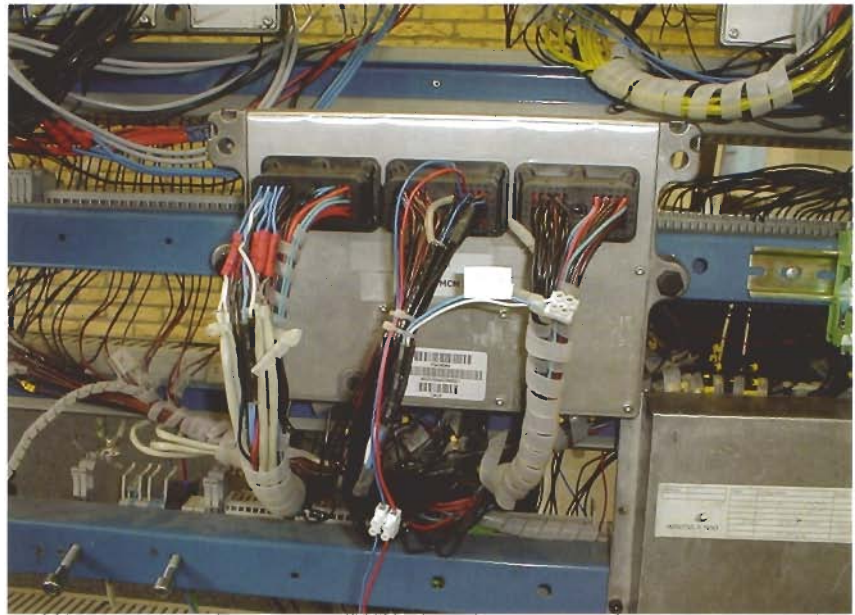

An engine-control system under type approval test in an EMC laboratory

gearbox from the harmful forces of the direct-on-line starting by starting star/delta or starting slowly by a frequency converter.



A starter drawer

6.8 Emergency generator

An emergency generator is a generator with the same characteristics as a main generator but located in a space separated from the main generators and independent of any equipment outside this space. So starting equipment such as an air bottle with a non-return valve of the engineroom starting air system, a separate fuel tank, an emergency switchboard in the same space as the generator set to limit the possibility of failure of the emergency system in case of failure of a space. This all to ensure continuity of emergency power as much as possible.

For large ships and ships carrying more than 32 passengers, the required capacity of the batteries for emergency lighting and communication is too big to handle practically. A separate emergency generator with its autonomous fuel tank, starting systems and switchboard, which automatically starts when the main power fails is required. Also the supply cables to the various emergency consumers is to be away from the spaces containing the main power sources.

An initial starting system, that is a starting system capable of starting the emergency generator without any help from outside with all normal starting gear out of order, is to be provided. This initial starting system may consist of a hand-started diesel-driven air compressor in case of air-started engines or a spare battery.



An emergency generator

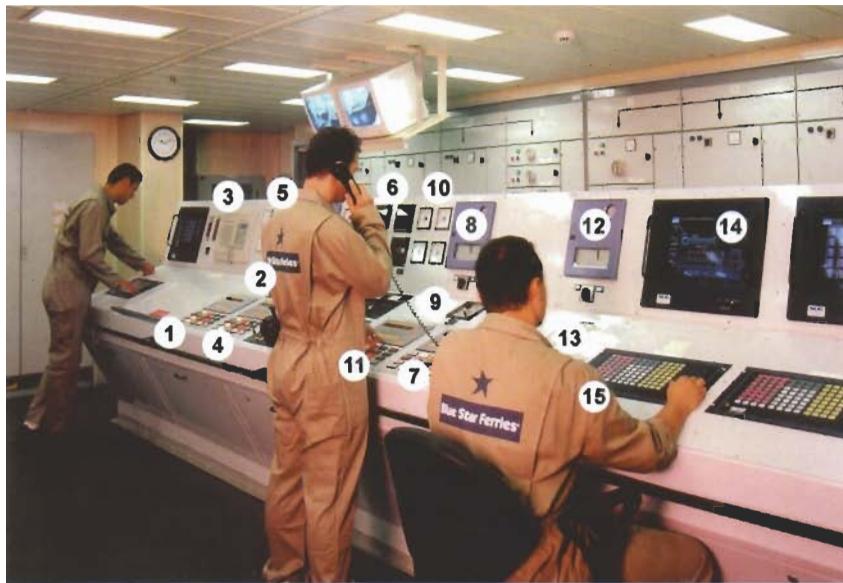

The engine control console of "Blue Stars" during the commissioning, containing:

- 1 Main engine 1 control and instrumentation
- 2 Emergency telegraph port shaft
- 3 Viscosity controller fuel main engines 1 and 3
- 4 Main engine 3 control and instrumentation
- 5 Main engine 1 and 3 RPM and Turboblower RPM indicators
- 6 Propeller pitch and RPM indicators pitch controls also change-over system for bridge control
- 7 Main engine 2 control and instrumentation
- 8 Viscosity controller fuel main engines 2 and 4
- 9 Emergency telegraph stbd shaft
- 10 Main engines 2 and 4 RPM and turboblower RPM indicators
- 11 Main engine 4 control and instrumentation
- 12 Viscosity controller fuel auxiliary engines
- 13 Automatic telephone system
- 14 Alarm and monitoring visual display units
- 15 Operator keyboards



Engine control system fitted to an engine

7. Automation

Automation is intended to make the operation of the installation more comfortable, easier, and last but certainly not least, make it possible to operate the system with less crew. It also facilitates automatic observation of systems, registration of failures and registration of service time. This to organise planned maintenance. It stands to reason that no computer system is able to motivate a crew to perform. Automation is also introduced to execute actions which are too complicated to be handled by a crew member within the available time. This is for instance applicable to a thruster-control system of a ship with 8 thrusters where the 8 azimuth and rpm control levers are substituted by a single joystick, creating the summary of the desired results of these 8 thrusters

However, the level of automation is dependent on a lot of factors, such as:

- requirements of the owner
- function of the ship
- cost reduction
- qualifications of the crew
- complexity of the installation
- rules and regulations of the Classification Society and the flagstate (registry)

It will be clear that first of all a cost/availability analysis has to be made before starting planning of automation.

Integration of systems, introduction of distributed control systems consisting of programmable logic controllers with remote input and output modules, connected through a two-wire bus system is now normal practice for larger systems. An operator friendly software package on a PC type work station is simplifying control and supervision in an unstoppable process. It reduces cost of cabling and manning. The problem is that the Rules and Regulations of both the Classification Societies and the laws of the national authorities are not suitable to include the constant process of change and improvement. Rules have to be made or read more flexible to express their intended function and not the way things are done in practice. Basically because these ways change all the time. Redundancy both in hardware and software, is a logical requirement. Software shall be made in a structured way and testing of the different parts and later the total system shall form part of the acceptance procedures. Software shall also be well documented, inclusive of changes and extensions. For essential systems, that is, systems required for sailing and for the habitability of the crew, sufficient back-up or emergency controls shall be fitted.

A summary of the most important systems which are available:

- Engine room alarm and monitoring system, usually consisting of simple displays giving status and analogue values.
- Marine operator work stations; more sophisticated systems also including control and presentation of engineroom systems by sophisticated graphics trends, that is, figures stored over a period of time; analyses, calculating relations between figures; calculation of running hours. Whatever you can think of, to make it more comfortable for the engineer to control and supervise an installation as well as possible. Automatic logging of all figures as required by the authorities etc.

- Tank gauging systems, from simply sounding figures heights to more sophisticated giving of tank contents in m³ or even in tons.
- Reefer monitoring systems. Here also from simple failure alarms to complete datalogging of the reefer temperature, CO₂ content over the whole voyage (to prove that transport was not to blame for cargo arriving damaged).
- Generator control and power management system, from minimum automatic starting of a stand-by generator in case of failure of the running generator and sequential restarting of all essentials to a complete load-dependent start-stop of the generator plant. Inclusive of automatic power reduction in case of failure of a running generator until the next generator has started, synchronised and taking load.
- Propulsion remote-control systems from straight-forward remote-control systems where each handle controls a single engine or propeller, to more state-of-the-art systems where the desired result is input, such as for example "move 25 metres to port, rotate with the rotating point astern through 90° clockwise". Track following, even a link in location, water depth and speed are feasible.

So in automation there is no technical limit and therefore a balance in expected results and cost shall be the basis for the design.

7.1 Alarm, monitoring and control systems

Alarm and monitoring systems are available in all sorts and sizes starting from a little self-contained unit for 10 digital alarms with a common output for a group alarm and an audible alarm with accept and reset facilities. Alarm and monitoring systems are intended to monitor and register automatically all the essential parameters of the installation and display any abnormality occurring. It saves time-consuming watchkeeping rounds, registers more and probably

more accurately the events, but is certainly no real replacement for an engineer finding a slowly growing small leak in a flange.

The alarms are presented by an illuminated "LED" and a nameplate. Depending on the size and intended Notation such as "manned" or "unmanned" engine room larger systems often composed of distributed input units linked together through a redundant network, still presenting the alarms as simple illuminated "LEDs" with a nameplate for identification. It can also initiate group alarms to the bridge instructing the bridge crew to reduce power or warn them for an automatic shutdown of the propulsion system. Most more complex systems facilitate a graphic display on a visual display unit or workstation with all kinds of software to enable analysing of the retrieved data. Automatic preparation of an engineer's logbook only to be signed is also possible.

Essential automation systems shall be composed of type-approved equipment and be subject to an acceptance test at the manufacturer's works under conditions as real as possible.

8. Communication systems

8.1 Internal communication systems

Talk-back system

The main station is normally installed in the wheelhouse and can communicate with each sub station. The sub-stations only can make a connection to the main station and not to the other sub-stations. Normally this system is installed in the wheelhouse, engine room, steering-gear room and on fore-deck and after-deck.

Automatic telephone system

With this system, which is identical to your telephone at home, duplex conversation between telephones is possible.

Sound powered telephone

This system is independent of the vessel's main power supply and meets the demands for emergency communication between vital positions on board such as wheelhouse and engine room. Most automatic telephone systems operate nowadays through a UPS system. Therefore the sound-powered system is getting obsolete

Public address system

With this system one way communication is possible. It is used to address large quantities of people and to page people. It is also used to give the general alarm signals. The system and cable network shall then meet the requirements for general alarm systems such as: duplicated amplifiers, separated circuits, fire resistant cables and other requirements to ensure that a single failure in the ship does not abuse the rest of the system outside the damaged area.

8.2 External communication systems

GMDSS stands for Global Maritime Distress and Safety System. It uses the satellite communications now available through the International Maritime Satellite (INMARSAT) System.

INMARSAT is a co-operative organisation, which includes about sixty countries. They fund and take compensation according to each member's use of the system. Geostationary satellites are sited about 36,000 kilometres over the equator to provide complete global coverage except in the extreme north and south arctic regions. The system



NAV-1 Bridge layout



GMDSS console.

provides automatic communication with an override facility for distress calls. Several service standards are provided.

9. Navigation and nautical equipment

Normally the following equipment is installed:

- One RADAR with ARPA function and rotating transmitting/receiving aerial usually X-band (frequency 8-12 GHz), wave length 3cm.
- A second radar is to be provided for ships bigger than 500 GRT. This is usually an S-band radar in the frequency range of 3-4 GHz, wave length 10 cm. The reason to select two radars with different frequency-bands is their different capability to cope with the environmental conditions such as fog, rain, sea-clutter etc.
- Two independent automatic position fixing systems: GPS or, more accurate, DGPS with omnidirectional satellite aerial and for DGPS also a parabolic differential aerial
- One Echosounder
- One log with speed and distance indication
- One magnetic standard compass
- One gyrocompass
- One automatic pilot



Bridge wing console.

Today's state-of-the-art wheelhouses can be arranged for operation and watchkeeping by one person only. Apart from wheelhouse layout requirements with respect to an all around view (view from the operator's position), facilities as route-planning (location usually a chart table), the communication GMDSS console and the navigation workstation with off-normal alarms and watchkeeper well-being check are to be fitted.

10. Dangerous areas

Dangerous areas are those areas where due to the continuous or part-time presence of gases or flammable liquids or even explosive dust, the risk of explosion exists.

Dangerous areas are, for example, the tanks of a tanker and the deck above, the cargo-handling area, pump room etc., but also the car-deck of a ferry where cars are stowed with fuel in their tanks, a helicopter refilling station on a yacht and a paint store or the hold of a dry-cargo ship certified for the carriage of dangerous goods.



Tanker deck IWW Tanker, a dangerous area

Cost-effective solution number one is not to install any electrical equipment in dangerous areas. The dangerous areas are divided into the following zones:

Zone 0 Areas where an explosive-gas atmosphere is continuously present or can be present. For example, a cargo tank of a crude oil tanker, oil products tanker or chemical tanker carrying flammable liquids other than liquefied gases having a flash point not exceeding 60 °C and for liquefied gases the cargo tank and the secondary barrier spaces.

Zone 1 Areas where an explosive-gas atmosphere will be periodically present during normal operation. For example, spaces adjacent to and below the top of the cargo tanks carrying crude oil, oil products etc. with a flash point not exceeding 60 °C. Spaces separated by a single deck or bulkhead from zone 0 areas, also cargo pump rooms and enclosed and semi-enclosed spaces in which pipes containing above cargoes are located. Also areas on open deck within 3 metres of any cargo tank outlet, cargo valve, cargo-pipe flange, cargo-pump room outlets, 6 metres radius from high pressure discharge valves and 2.4 metres above deck.



Detail of cargo-deck. Electrical control and monitoring equipment. The tank-level indication system with the blue cables is executed in intrinsically safe technology and the pump controls on the right in explosion-proof execution.

Zone 2 Areas where an explosive gas atmosphere is not present during normal operation and, if present, for a short period of time for tankers carrying products with a flash point above 60 °C.

This is the only zone defined for the dry-cargo ships and for Ro/Ro spaces of ferries if sufficiently ventilated. The explosive-gas atmosphere is considered not to be present during normal operation.

Caution. Liquefied natural gas (LNG) and the vapours from kerosine are heavier than air and any opening to a deck or lower space shall be subject to further study with respect to the zoning.



Engine-control room "Blue Star". During sea trials, specialists measure shaft RPM and torque to determine actual power, fuel consumption, etc.

The gases are divided into the following groups:

- Group I: methane such as expected in coal mines
- Group II: General industrial gases and gases from combustible liquids and combustible solids
- Group IIA: Propane
- Group IIB: Ethylene
- Group IIC: Hydrogen

Apart from the gas group, certified safe equipment shall also be selected on the basis of the maximum surface temperature during operation. This surface temperature shall be below the ignition temperature of the gas emitted by the cargo as is stated in the cargo lists. Temperature classes and maximum surface temperatures are as follows:

T1	below	450 °C
T2		300 °C
T3		200 °C
T4		135 °C
T5		100 °C
T6		85 °C

11. Operational settings

Before a ship goes into service, trials have to be performed; first in the factory the testing of the separate parts, afterwards the equipment when installed and finally at sea.

11.1 Factory acceptance tests

Setting for operation starts in the factory of the equipment makers. The individual equipment like generators, motors, switchboards and control-gear assemblies, transformers, alarm and monitoring systems, control systems and all other essential electric parts equipment are tested to prove that the equipment performs as specified.

11.2 Harbour acceptance tests

After the equipment has been installed on board the ship and connected/interconnected Harbour Acceptance Tests (HAT) are carried out to prove that the equipment is capable of

functioning together. An example are the load tests of a diesel-generator set or a switchboard combination. Further tests may include load dependent start-stop by a power management system with automatic reduction of propeller pitch and/or RPM of electric driven thrusters in case of overload of the generator plant. A lot of this can be done in the harbour as it does not require sailing conditions.

11.3 Sea trials

After successful completion of the HAT, the Sea Acceptance Tests (SAT) complete the programme of executing those tests which do require sailing. They consist of manoeuvring tests, stop tests, etc. All these tests shall be well documented to be able to use the facts and figures obtained as a reference for later.



Water resistance to load test of generators



Ferry alongside fitting-out quay during harbour acceptance tests

CHAPTER 14

Maintenance and docking

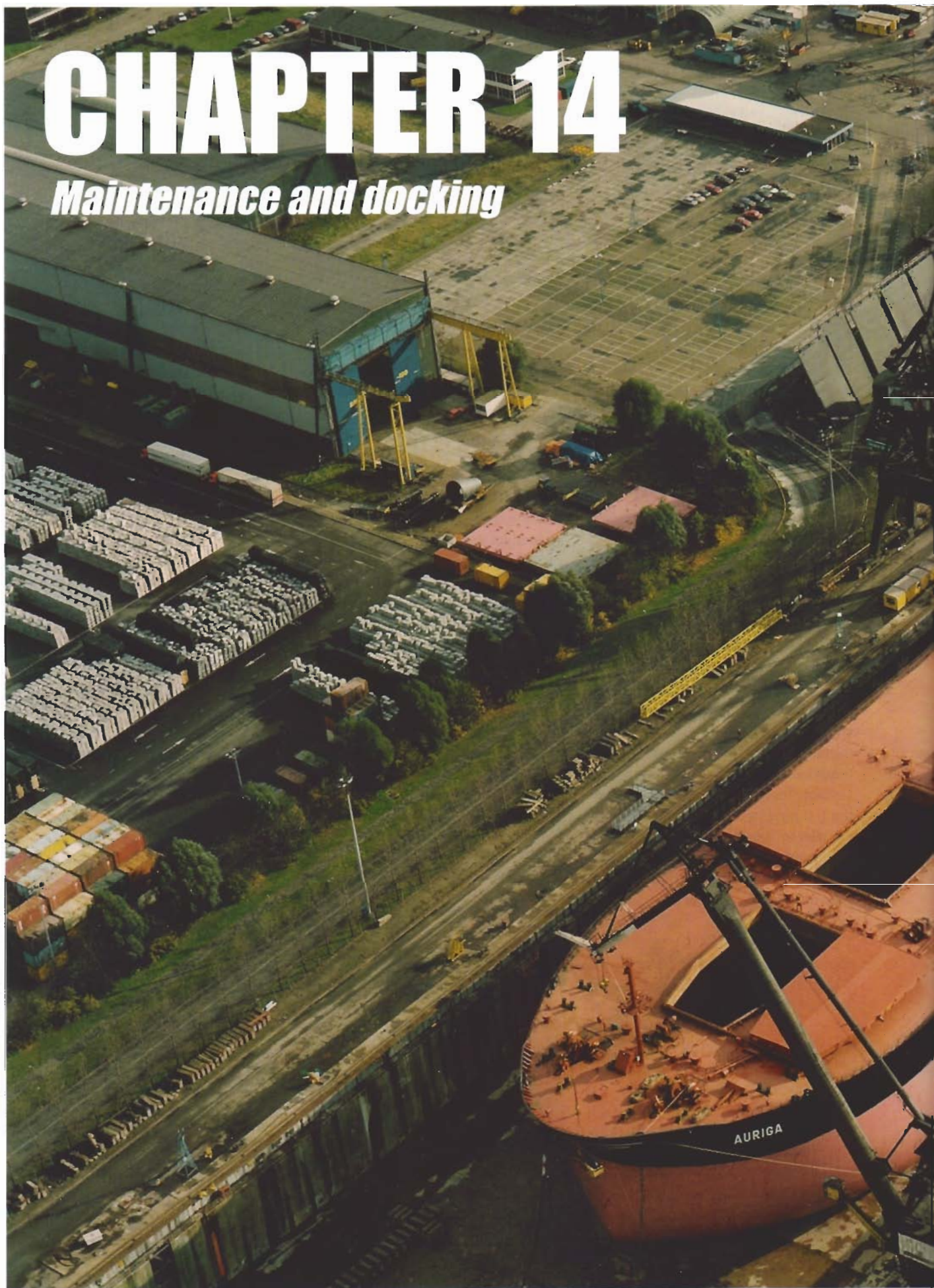

1. Construction materials for ships

- 1.1. Wood
- 1.2. Steel
- 1.3. Aluminium and its alloys
- 1.4. Copper and its alloys
- 1.5. Synthetic materials

2. Corrosion

- 2.1. The corrosion process
- 2.2. Protective layers

3. Paint

- 3.1. General
- 3.2. Conventional paint
- 3.2. Binary paint
- 3.3. Comparing the two painting systems

4. Painting

- 4.1. Pre-treatment
- 4.2. Applying the paint-layer
- 4.3. Thickness of the layer
- 4.4. Types of paint
- 4.5. Painting systems

5. Cathodic protection

- 5.1. Chemical reactions
- 5.2. Electro-chemical reactions
- 5.3. Sacrificial element
- 5.4. Sacrificial anodes
- 5.5. Impressed current

6. Antifouling

- 6.1. Fouling
- 6.2. The shell, the ideal surface for fouling
- 6.3. The purpose of antifouling
- 6.4. Types of antifouling used

7. Docking

- 7.1. Why dry-docking?
- 7.2. Methods of dry-docking
- 7.3. Preparing for dry-docking
- 7.4. Dry-docking
- 7.6. Refloating

8. Maintenance and repairs

- 8.1 Maintenance
- 8.2 Repairs
- 8.3 Modern ship-repairs
- 8.4 Conversion



SHIP KNOWLEDGE

A MODERN ENCYCLOPEDIA

SHIPWISE

PAGE 8 **1**

THE SHAPE OF A SHIP

PAGE 22 **2**

SHIP'S TYPES

PAGE 44 **3**

THE BUILDING OF A SHIP

PAGE 68 **4**

FORCES ON A SHIP

PAGE 82 **5**

LAWS AND REGULATIONS

PAGE 104 **6**

CONSTRUCTION OF THE VARIOUS
SECTIONS

PAGE 126 **7**

CLOSING ARRANGEMENTS

PAGE 160 **8**

LOADING GEAR

PAGE 174 **9**

ANCHOR AND MOORING GEAR

PAGE 196 **10**

ENGINE ROOM

PAGE 216 **11**

PROPULSION AND STEERING GEAR

PAGE 244 **12**

ELECTRICAL INSTALLATIONS

PAGE 266 **13**

MAINTENANCE AND DOCKING

PAGE 280 **14**

SAFETY

PAGE 302 **15**

STABILITY

PAGE 322 **16**

CHAPTER 14 QUESTIONS
VISIT
WWW.DOKMAR.COM

1. Construction materials for ships

This chapter is not about materials science, but about what materials are used in the construction of ships, and their characteristics. The emphasis will be on corrosion and maintenance.

1.1 Wood

Until the end of the 18th century wood was the only construction material for ships. Some of these ships had longer lives than their steel successors. Mine hunters have used wood as a construction material the longest of all the large ships. The only wood still found on modern ships is used for dunnage, decks, stairs and interior, especially on cruise ships. Though there certainly are very hard types of wood that do not rot, most types of wood must be protected against rotting. Wood used on decks does not get slippery and, unlike metals, it is not weakened by fatigue. A wooden overlay on a steel deck to avoid excessive corrosion must be applied with great care. Water must not be allowed to become entrapped between the wood and deck, to avoid excessive corrosion.

1.2 Steel

Since early 1800 the construction of vessels gradually evolved from wood, via composite building (wooden planks on steel frames) to 100% steel. Composite building was a mixture of iron framing and wooden side shell and deck, which allowed the builders to build vessels up to approximately 90 meter in length. The "birth" (1830) of the steam engine for ships speeded up the actual use of iron throughout the construction of the vessel. An important milestone was reached with the building of the famous "Great Eastern" between 1853 and 1858. A ship with a length of 200 metres, a beam of 25 metres and a depth of 17 metres. Around 1875 the steelmaking process gradually improved to what it is nowadays. Up to today (2003) steel is still the most popular material for the construction of ships because of its:

- technical and economical benefits
- strength
- suitability for welding
- adequate resistance to brittle fracture
- low cost & availability

Steel-making process

The various types of steel are fabricated on the basis of iron (ore) and/or scrap materials, in a steel-making process in which the basic material is heated up to approximately 1600° C. Then the refining process is initiated. Within this refining process certain excessive elements such as carbon, sulphur and phosphor will be removed in the shape of so-called "slag". Depending on the quality and type of steel needed, the refining process within a chosen steel-making process (basic oxygen converter, electric furnace & open-hearth process) will be completed. The differences in strength, toughness, hardness and weldability will be obtained by the addition of particular elements during the steel-making process in combination with the heat treatment during the fabrication of the plate material, forgings and castings. Additions can contain carbon, silicon, manganese, nickel, vanadium, chrome, etc.

Steel types

Steel used as a construction material for ships and other structures can be subdivided into groups:

a. Plate materials and profiles

- Mild Steel (MS)
Yield strength 235 N/mm²
- High Strength Steel (HS)
Yield strength 265 - 390 N/mm²
- Extra High Strength Steel (EHS)
Yield strength 420 - 690 N/mm²

Yield strength is the maximum allowable stress without creating plastic deformations and is used by designers to establish the actual drawing dimensions.

b. Steel forgings

Typical examples of forgings are crankshafts, propeller shafts, rudder stocks, engine components such as piston rods and crossheads etc.

c. Steel castings

Castings are fabricated for complex configurations such as stern frames, complex rudder components, anchors, pump casings, etc.

Stainless steel

Stainless steel is an alloy of steel, Cr (chrome) and Ni (nickel) and sometimes other elements. The surface of the steel is a neutralisation layer, which is an oxidised skin in the colour of the metal. This protects the material beneath it from oxidation (corrosion). Stainless steel is more noble than ordinary steel and will therefore corrode less.

1.3 Aluminium and its alloys

Aluminium is a very soft metal, but by choosing the right elements to form alloys, the strength and stiffness can be increased significantly. Aluminium is also non-magnetic, making it suitable for mine hunters. Even though aluminium is not a noble metal, corrosion is limited because the metal is covered by a very dense oxide-layer that protects the rest of the metal. If chemicals or electric currents remove the oxide layer, then corrosion will take place rapidly. The main advantage of using aluminium is its low weight. Despite the fact that aluminium is much softer than steel, it is much more difficult to work with. A drill gets stuck easily, it is much more difficult to get the surfaces smooth, a grindstone is soon clogged and it is impossible to weld it with a common welding apparatus. Aluminium is utilised for complete upper parts of passenger ships, mine hunters, yachts, lifeboats, high-speed light-weight motor ships and for parts that need to be lightweight or non-magnetic like the wheelhouse of a fishing vessel or the surroundings of the standard compass on larger ships.

1.4 Copper and its alloys

Brass

Brass is an alloy of the moderately noble copper and the less noble zinc. Aggressive water like seawater dissolves the zinc leaving the remaining copper very porous. Therefore brass is never used for parts that can



Cast steel rudderhorn

come in regular contact with seawater. For contact with fresh water and oil, brass is suitable for use in nipples, thermometers, manometers and many other shiny appliances. The binnacle of the standard compass is also usually made of brass.

Bronze (gun metal)

Bronze is an alloy of the moderately noble copper and the less noble tin. Bronze is seawater resistant and is therefore used in propellers, valves, coolers and almost all other parts that come into contact with seawater. Nowadays, the ship's bell is still made of bronze, but better alloys have been developed for the propellers. Bronze is still common in heat exchangers and pumps. Bronze is more noble than steel (iron) and can therefore affect the ship's steel. In very aggressive water, tin tends to slowly dissolve. This causes a bronze propeller to roughen slowly.

Materials for propellers

Nowadays every propeller factory has its own alloys for the different applications of propellers. Usually these alloys are similar to bronze, but with a more complicated composition. In almost all cases the alloys contain little or no iron (non-ferro alloys) and behave nobler than steel, which can cause corrosion of the steel. In exceptional cases, the propellers are made of stainless steel. The strongest nowadays is a copper-nickel-aluminium alloy.

Materials for heat exchangers

The housing, pipes and tube plates of a tube heat exchanger are almost always made of copper containing non-ferro alloys. In plate heat exchangers, the plates are made

entirely of stainless steel or titanium. In both cases, the alloy used is nobler than steel, which can be degraded by it. Heat exchangers can be found in the piping system of the ship, but also in a sea-chest, a box in the ship's shell that is open to seawater.

1.5 Synthetic materials

There are so many synthetics that it is impossible to treat them all in one paragraph. In general, synthetics are not sensitive to corrosion. However, ultra-violet radiation in sunlight and ageing can degrade the compounds. Synthetics are a-magnetic and can not be welded. In yacht-building synthetics are common. On larger ships, synthetics are used for piping systems because of their inability to conduct electricity and their insensitivity to corrosion. Nowadays paint is also largely synthetic. The ropes are not made of manilla anymore, but of one of many synthetic fibres. Synthetics are sometimes flammable, but are always weakened by heat more than metals. Metals like iron and aluminium can burn like torches and, when that happens, cannot be extinguished. Luckily metal constructions do not catch fire easily.

A commonly used synthetic construction material is Glass-fibre Reinforced Polyester (GRP). This is a composite material, consisting of woven or chopped (glass) fibres bound together by polyester. Other combinations of fibre and binder material can also be used, but mainly for high-tech applications. GRP is mainly used for parts where weight or non-corrosive properties are important. With the use of a mould it is possible to make complex shapes. Because of this expensive mould, GRP products are usually standard

parts, produced in large series, like piping, water-tight doors, etc. Even complete hulls of smaller ships (e.g. lifeboats, fast rescue boats, yachts, minesweepers) are built in GRP.

2. Corrosion

2.1 The corrosion process

From metallurgy it is known that iron is extracted from iron ore in blast furnaces by removing the oxygen from ores with a carbon-excess (coke). Almost all metals are extracted from the ore by removing oxygen or other compounds in a blast furnace. Corrosion is the reverse of this process; the metal recombines with oxygen or, sometimes, with other compounds. In many cases the result is a dense oxide-layer that protects the metal underneath. In the case of iron, however, the oxide is converted to a ferrous hydroxide by water. This gives the underlying metal no protection against further corrosion.

Corrosion can be accelerated if organisms are present on the metal surface. Outboard, this fouling increases the ship's resistance and inboard it can clog piping systems and exhaust boxes. Corrosion can also be accelerated with an electric current, and with stress.

The rest of this chapter will be devoted to steel corrosion, because steel is highly sensitive to corrosion.



Corrosion in a ballast tank of a tanker



Corrosion in a ballast tank of a tanker

To protect the ship against corrosion, the following measures or combinations of them are taken:

- Applying a protective layer (paint)
- Cathodic protection by using impressed current or sacrificial anodes
- The choice of other materials so as to reduce potential electric tension

- Temporary protective layers like conserving oil or grease. This method is mostly used in spare engine-parts.
- Inorganic top coats like an anodised layer (a very strong oxide layer) or enamel.
- Organic top coats like epoxy paint (2-component) or conventional paint (1-component) The first coat to be used as a primer to initially protect the steel against corrosion

2.2 Protective layers

A protective surface layer can counteract, stop or reduce the extent of the corrosion process. One of the following methods can be chosen:

Ships usually apply paint as the protective layer.



Microscopic image of rust

3. Paint

3.1 General

Paint is a liquid product that is meant to be applied on objects in a usually relatively thin layer. During and after applying the paint it creates a film that has the tendency to tighten into a thin continuous layer. On drying this film becomes a solid hard or tough layer that protects the surface it is covering from corroding. Paint is also used to embellish objects. Paint can be divided into:

- conventional paint
- physical drying paint
- oxidative drying paint
- chemically active paint or binary paints

3.2 Conventional paint

Real old-fashioned oil paint was made from linseed oil and turpentine. Later these were replaced by synthetic components. Single pot paints, that behave similar to oil paint, are called conventional paints. The paint can be used immediately after the can is opened and the contents stirred. Leftover paint can be stored in the closed can for future use. The conventional paints dry because:

- the solvent evaporates (physical drying)
- the binding agent reacts with oxygen from the air (oxidative drying and / or polymerisation)

Examples of conventional paints used on board:

- alkyd paint, chemical drying
- acrylic paint, physical drying
- vinyl paint, physical drying
- modified alkyd paint or alkyd resin slags, chemical drying

In general, conventional paints contain the following components:

- binding agent
- pigment
- solvent
- additives and fillers

Nowadays more and more environmental restrictions are being implemented related to the use of zinc chromates, lead, etc. Also chlorinated rubber systems and vinyl systems are no longer in use because of the high content of volatile organic compounds (e.g. toluene, benzene), restrictions however vary from country to country.

Water is used in both one (acrylics) or two-component (water-based epoxy) water-based products. These coatings however are not solvent free. In solvent-free coatings (epoxies) thinner is not normally used and if it is used, then only very little is added to extend potlife of mixed material for the application method depending on climatological conditions (temperature).

Binding agent

The purposes of the binding agent in the paint are:

- Coherence of the paint
- Connecting the pigment
- Adhering the paint to the base
- Influencing characteristics like gleam, elasticity, mechanical strength, wear resistance, resistance against chemicals and sunlight.

Binding agents can be composed of drying oils, synthetic resins, latex or a combination of these.

Pigment

Pigments are solid powders that give the paint its colour and coating properties. Furthermore, the pigments often prevent corrosion. Examples of these are zinc-chromate (yellow), zinc-phosphate, zinc powder (grey), lead seal (in red lead, orange, toxic, banned!). Pigments can also be additives that contribute to characteristics of the paint like gleam, filling, scouring and strength.

Solvents and thinners

Solvents and thinners are volatile liquids or mixtures of volatile liquids that dissolve and dilute the binding agent. After the paint is applied, they evaporate out of the solution. In

general the vapours are harmful to health and environment. These compounds are almost always inflammable and can form explosive mixtures with air. There are strict regulations for ventilation and breathing-protection when working with these compounds in closed spaces. It is difficult to distinguish solvents from thinners; the words solvent and thinner are often interchanged. Thinner is a much used diluent.

Fillings and additives

Additives are used to influence the characteristics of the paint like a matt surface, a rough surface (anti-slip paint), protection of the underlying material against heat, prevention of sagging and counteracting film forming.

3.3 Binary paint

In binary paints or two-component paints, the film forming and drying takes place by a chemical reaction between two components. A better name for these types of paints would be "chemically active paint". The components are:

- the base component
- the hardener



Mixing with a blender until the paint gets a uniform colour

The temperatures of the surroundings and the material to be painted have an important influence on the rate of the reaction. In dual-component paints, the two components are delivered and stored in two different cans. After the base component and hardener of the epoxy paint have been properly mixed, the mixed material should be given a certain time prior to application. This time is called "introduction time"; normally this takes about 10 minutes and is mentioned on the data sheet of the coating supplier. Leftover paint hardens and becomes useless. Examples of these types of paint are polyurethane and epoxy-paints.

3.4 Comparing the two paint-systems

The choice for a conventional or binary paint is governed by a large number of factors. The physical and chemical properties of binaries are superior to the conventional paints. But a tougher layer, longer gleam and greater resistance to water and chemicals are not equally important for every shipping company.

Some arguments that can influence the choice of paint-system are:

- the price of the paint
- purpose of the ship
- is the painting done by the crew (or the shipping company), during a voyage or during docking
- price of the pre-treatment

This last point depends on:

- the number of crew members
- where will the ship be sailing: in tropical areas; the crew can do a lot of maintenance; in arctic areas; maintenance can not be performed in water, but only in a dock.

The following becomes important when the crew does the painting:

- Conventional paint is simpler in use than binary paint.
- Single pot paint is easier to use than dual component paints

The paint-layer is loosening from a bad base or incorrect pre-treatment

4 Painting

4.1 Pre-treatment

For a good painting-result it is important that the material that is going to be painted, is pre-treated. Painting should be done under conditions where the effect of temperature and humidity changes is small. This is the reason that more and more ships are being painted in closed and acclimatised spaces. The pre-treatment is the base of a good protection for the material. The better the material is cleaned, the better the result will be. A good paint-system on a bad base is of little value. The base



Seven years of damage to the paintlayer. The cause: badly protected welded seams which may be caused by insufficient cleaning after welding prior to painting.



If the mill scale is not properly removed, it will eventually let go



If holes or cracks are not welded properly this may cause problems with cleaning and pre-treatment. This in turn can cause small blisters, that cause de-tacking of the paint-layer.



material can be cleaned in the following ways:

- with hand tools
- mechanical cleaning (with machines)
- chemical cleaning, especially degreasing
- thermal cleaning
- sandblasting / gritblasting
- waterjets

Hand tools

Manual cleaning is done with scaling hammers, scrapers, sandpaper and wire brushes. This pre-treatment method is very labour-intensive and qualitatively not very high-grade. It is used predominantly for local repairs of the paint-layer and sometimes for the treatment of welds and places already treated with an abrasive wheel.



Manual cleaning

Mechanical cleaning

This is done with mechanical scaling hammers, rotating wire brushes, abrasive wheels and abrasive discs. On board, needle-scaling hammers or chipping hammers are used almost exclusively. Of all the types of mechanical scaling hammers, this one is the best, although it is not very fast. The roughened surface is a good base for the paint layer.



A revolving brush

Rotating wire brushes, abrasive wheels and abrasive discs can yield the same result as the needle-scaling hammer, with the difference that the surface may become polished. If the



A pneumatic scaling hammer

metal surface is too smooth, the mechanical bonding between the metal surface and coating will be poor, leading in most cases to premature failing of the coating system. Almost all methods of cleaning with mechanical devices require breathing and hearing protection. The waste of removed old paint layers should be collected and disposed of properly.

Chemical cleaning

Chemical cleaning removes the old layer of paint and rust. For local paint jobs, paint-stripping compounds are used. In manufacturing, the cleaning is either done with acids or with staining. In all cases the cleaned material should be thoroughly flushed with fresh water.

Thermal cleaning

For local removal of paint, a paint stripper can be used. The heat softens the paint, which can subsequently be removed by tools. The paint stripper is not used on a large scale because of the fire-hazard and the toxic vapours that are released upon heating.

Gritblasting

Gritblasting is done by blasting granular materials at high speed with high-pressure air against the steel. The material is cleaned thoroughly and the surface is roughened which is essential to achieve a good mechanical bonding with the coating. The roughness can be adjusted by adjusting the size of the grit material during the gritblasting. The surface becomes covered with microscopic pits that are good for the tacking of the paint layer. The first layer of paint should be applied immediately after gritblasting to prevent moisture in the air for forming a new layer of rust on the bare steel.

Gritblasting is not done on a large scale on board because it requires a special installation. It can be done in dock though. This method is suitable for treating large areas; 20 m² per hour is feasible. Another advantage of gritblasting is that it can be used to remove the rust from complicated constructions, where other tools can not reach every nook and cranny. However, removing thick layers of paint or rust with this method takes a lot of time and is therefore not efficient. In the dock, gritblasting is usually limited to the outside of the skin and possibly the tanks. When gritblasting, it is important to pay attention to personal safety-protection for the ears, eyes and lungs.

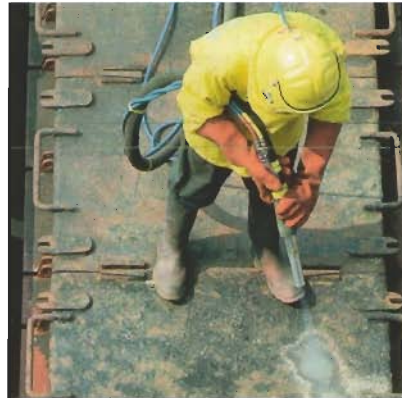

Local gritblasting. In some countries sandblasting is still applied, in most countries, however, it is no longer allowed due to health (lung) problems.

Waterjets

In this method, a high-pressure spraying pistol is used to spray water under a pressure of 200-250 bar on the surface. In a drydock it is used to remove chlorides, algae, barnacle shells etc. from the shell. When the water pressure is over 700 bar it is called high pressure hydro-jetting and over 1700 bar it is called ultra-high pressure hydro-jetting. One of the big advantages of hydro-jetting is that the soluble salts are removed and there is no 'dust'. The speed, quality and pressure determine the cleaning effects of this method. One of the disadvantages is that the surface is not roughened by this method. Waterjetting can be done on board, but is done more and more in dock. Due to the fact that it causes no dust it can be done while others are busy with repairs to for instance the propeller.



Hydro-jetting of the skin



Advanced technique for gritblasting, with special care to prevent excessive inconvenience caused by 'dust'.

4.2 Applying the paint-layer

Before the paint is applied one has to make sure that:

- the surface is clean of moisture, dust and grease
- the surface shows no signs of condensation, and there is no opportunity for the forming of condensate
- the outside temperature does not exceed 40°C, or becomes lower than the minimum processing temperature of the paint. Some paints can be used even at -5°C.
- the right paint is prepared; the binary paint is mixed in the proper proportions
- the paint is stirred well before use, for instance with the aid of a blender
- the correct tools are being used: brush, roller or spray. The paint spray is only used for large areas. Spraying makes sure that the paint layer is distributed evenly, and the layer thickness can become bigger than when a brush or a roller is used.

The material that is going to be painted should be at least 3 °C warmer than the dew point of the surrounding air. This can be tested by breathing against the surface. If there is condensation on the surface, it has to disappear within minutes.

The dew point is the temperature at which condensation starts, because at that temperature the maximum water-vapour pressure is reached. The relative humidity is then 100%. If the temperature then drops below the dew point, the water will condense on the coldest surfaces.

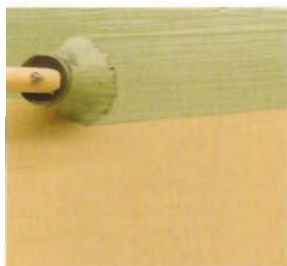

The stripes in the brush-"trail" should even out by themselves. This is not the case.

Ship Knowledge, a modern encyclopedia



If the paint is applied too thick, it will sag.



Painting with a brush. If the painting is done in a closed space, breathing protection is necessary.



Painting the deck with a brush



Sailor on a painting board



Applying paint with a roller



Paint-spraying

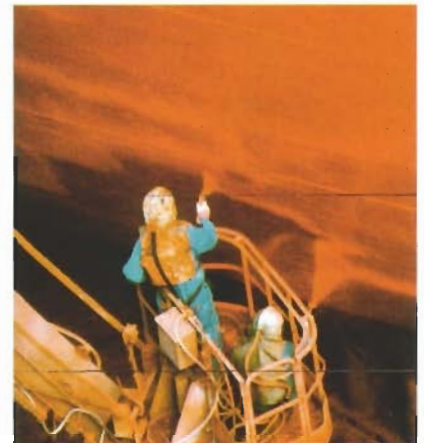

The two sprays are too close to each other; the sprayer on the left is too close to the ship's hull.



Welding or burning on the other side will cause damage to the paint-layer.

4.3 Thickness of the layer

The thickness of the paint-layer can be expressed as the wet layer-thickness or the dry layer-thickness, usually reported in micron or μm , 10^{-6} m . $1\mu = 0,001\text{ mm}$

Theoretical coverage (m^2/litre) =

$$\frac{10 * \text{solids in \%}}{\text{dryfilm thickness}}$$

This equation shows that if a paint with a high content of solids is used, fewer litres can cover more m^2 with a protective layer against corrosion. If the paint is applied with airless spray, the loss of paint in the form of mist is 20% -30%.

The sprayless factor to a large extent is influenced by:

- shape of the construction
- weather circumstances during application
- experience/skill paint-appliator



Ultra-sonic device to measure the thickness of the paint-layer

4.4 Types of paint

- Structural paint

Structural paints can be classified roughly according to the binding agent:

- one-component paints (single pot) like:
 - * acrylic paint and vinyl coats (physical drying)
 - * alkyd paint (chemically drying)
- Binary paints (or dual-component paint) like:
 - * epoxy paints
 - * polyurethane paints

- Shop primers

Shop primers are used as temporary protective layers directly after the steel plates have been rolled, cut and sandblasted.

Requirements to shop primers are:

- To prevent the forming of rust during the storage of the steel and the construction of the ship.
- They must be able to absorb the speed of the welding without the forming of gaseous holes.
- The shop primer should also be suitable as a base for the final paint layers.

- Not harmful to welder

Nowadays only binary shop primers (low zinc ethyl silicate) are used. The shop primers give the gridblasted steel up to nine months protection, depending on the local conditions.

- Zinc containing ethyl silicate or zinc epoxy

This is used if there is a great chance of mechanical damage. The zinc sacrifices itself when the layer is damaged. It is applied as a single layer with maximum thickness of 75 and 50 micron respectively. It is often used in tanktops and hatches.

4.5 Painting systems

A steel-conservation system is built up of a protective primer, the coating and the finishing layer. This system unifies active (see section 5) and passive corrosion prevention. Passive corrosion protection means that the metal is sealed off from the influence of water, air and chemicals. Each type of paint is more or less passively protecting. The permeability of a dry paint film depends on the type of paint, but even more on the layer thickness and the number of layers. The higher number of layers and the higher total thickness, the less is the permeability. In general the selected coating system and the area of the vessel (underwater area / topsides / ballast tanks etc.) determine the number of coats.

5. Cathodic protection

To understand how cathodic protection works, it is necessary to look in more detail into the corrosion process. In this undesired chemical effect, the material can react with different chemicals in its surroundings. The reactions can be divided into:

- chemical reactions
- electrochemical reactions

These reactions take place exclusively at the surface of the metal. It is possible that microscopic pits are formed by corrosion on the metal's surface. The corrosion can also penetrate existing cracks.

5.1 Chemical reactions

In almost all chemical reactions, there is a charge transfer between the reactants. If this exchange of charge is a local effect, then the reaction is called a chemical reaction, and the resulting corrosion chemical corrosion.

An example of this is the reaction between bare steel and oxygen from the air. A thin oxide layer rapidly covering the metal, forms at the surface. All metals form such an oxide layer. The characteristics of this first (dry) layer are of great importance to the further course of the corrosion process, and to the adhesion of the paint layer.

If water comes into contact with the iron oxide, the compounds react to give the product iron hydroxide (rust). The rust is very porous, and therefore oxidation continues. The first oxide layer of stainless materials is not affected by water. Between the metal and the oxide layer a lack of oxygen arises which is the reason that the oxide layer cannot develop any further.

5.2 Electrochemical reactions

Many compounds have the tendency to dissolve charged particles (ions) into water. Ions can move freely in water. Compounds that always behave in this way are acids, bases, soluble salts, metals and some gases. A consequence of the ion-mobility is that chemical reactions and the incidental electrical current are not necessary local, they can stretch out over a much larger area. These electro-chemical reactions do not just come to a halt.

Every metal in contact with water has the tendency to generate positive ions. This makes the water more positive and the metal more negative. If a metal is less noble, it will have a stronger tendency to generate these ions and thus become more negative. Alternatively, if the metal is more noble, then it will have a weaker tendency to generate positive ions and will thus be less negative. In general:

- gold is more noble than copper
- copper is more noble than tin
- tin is more noble than iron
- iron is more noble than zinc
- zinc is more noble than aluminium.

5.3 Sacrificial element (galvanic corrosion)

When two different metals are in contact with each other and with water (even a small amount), then the less noble metal will have a lower electrical potential than the more noble metal. This potential difference and the contact between the metals generates an electric current between the two metals, running from the precious to the less noble metal.

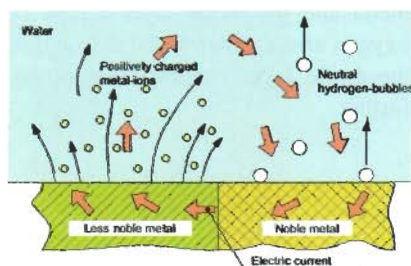

Galvanic corrosion

The continuous flow of current to the less noble metal causes it to generate more ions that dissolve into the water. This way the metal slowly disappears into the water. This dissolving of metal ions is called an anodic reaction and the metal that is dissolving is called the anode.

Electrochemical corrosion can also take place if a metal is not composed homogeneously. Objects in seawater that are made of brass (an alloy of zinc and copper) are very sensitive to this; the zinc dissolves leaving a porous copper behind. This is called de-alloying. If there is no intervention, then all the anodic material (zinc) will dissolve until all of it is completely dissolved.

Electrochemical reactions on ships can take place in the following places:

- between the propeller and the surrounding steel
- between copper-containing parts (e.g. heat-exchangers) and the steel parts of a piping system.
- Between aluminium parts and the steel parts of the ship.

Electrochemical corrosion mainly occurs at places where the paint is damaged by ice, after contact with derelicts and the normal wear through mooring and departure, tugs that come alongside etc. Turbulence, speed of the water and higher temperatures of the water and salinity increase the corroding process.

Eliminating the corrosion current can prevent electro-chemical corrosion. This goal can be achieved in several ways:

- insulating the metal on the water-side by painting it. This prevents the metal from contact with the oxygen and the electrolyte. If the paint-layer stays intact, this works. As soon as the layer is damaged, the corrosion begins.
- reversing the current by using a sacrificial anode of a very base metal
- reversing the current by creating an opposite potential. ICCP system. (Impressed Current)

5.4 Sacrificial anodes

Cathodic protection using sacrificial anodes is called passive cathodic protection. Blocks of zinc and aluminium are welded onto the ship in different places using steel strips. These anodes have such a low potential that they “suck” the current out of the ship’s exposed steel, faster than currents can enter the skin via the copper-containing parts. These work by dissolving because they are less noble, so as long as there is less noble metal, the anodes work. If the paint-layer below the waterline is damaged, there will be an electric current from the water into the metal. If the damage is extensive, then the anodes will dissolve faster. When the anodes have been dissolved, the other metals will start to dissolve.



Sacrificial anodes on the propeller duct

The pros and cons of sacrificial anodes are:

Advantage:

- low investment costs

Disadvantage:

- the limited life-span of the anodes; 1 to 5 years and difficult to predict
- floating ice, irregular dissolving and other damaging factors can diminish the protection quite unexpectedly. This can lead to damaging of the steel.



All the zinc is still present. The skin shows no fouling or wear. This ship did not break due to a corroded skin, but it broke from the inside due to corrosion in the ballast tanks

- there is a chance of overprotection, especially when the anodes have just been applied. This can damage the paint-systems.

5.5 Impressed current

In the ICCP-system (impressed current cathodic protection), a large positive current is applied to the water. As a result, current flows into the ship's steel wherever it is in contact with the seawater inducing a cathodic reaction that protects the steel against corrosion. To achieve this, a rectifier is connected to the ship's steel with the negative exit. The positive exit is connected to two or more anodes in the ship's skin. These insulated anodes are embedded in the skin to prevent damage by floating ice and are made of inert materials (inert is another word for non-reactive). Sometimes the very noble (but very expensive) metal

platinum is used, but more often the anodes are made from a mixture of high-grade metal oxides (MMO, mixed metal oxides). Oxides cannot oxidate again. The selected oxides do not dissolve in water. If the anodic reaction has no metals to consume, the reaction will produce small bubbles of oxygen, which are not without harm to the skin. The strength of the impressed current can range between 10 A and 600 A, the

exact value depending on the size of the ship, the amount of damaged paint layer, the speed of the ship and the salinity of the seawater. The voltage can be as high as 20-30 V, depending on the number and positioning of the anodes. Where the shell is in direct contact with the seawater, this voltage is reduced to 1,5-2,5 V. The pros and cons of the ICCP-system are:

Advantages:

- a minimum of maintenance is required
- high reliability
- action can be controlled at any moment
- an automatic regulator can adapt the current with the use of reference electrodes if a change in the water-composition (fresh, brackish, salt) or damage to the paint-layer requires this.
- the high investment costs (compared to a sacrificial-system) will recover itself in approximately 6 years.

Disadvantages:

- the costs of acquisition are significantly higher than those of a sacrificial system
- If the ICCP-system is wrongly tuned it can cause extensive damage to the ship below the waterline.



Regulator



Anode in the skin



Reference electrode seen from inside

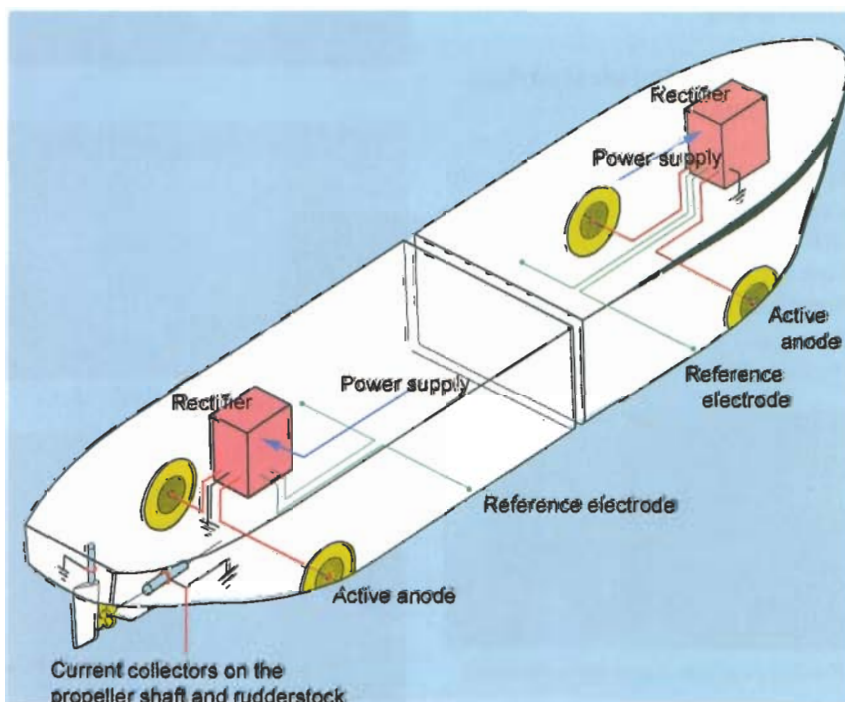

Principle of impressed current



Special paint layer around the anode



Earthing brush

- some paint systems are damaged quickly when the ICCP-system is overprotecting (the current is too high).

Some remarks on cathodic protection and related matters:

- ICCP-system is mostly used on ships with a length exceeding 40 metres
- Fast ships like patrol vessels and hydrofoil boats are always protected by the ICCP-system
- Aluminium ships can not be protected passively
- In ships with a lubricated propeller shaft, the shafting should be equipped with a strong current collector. If this is not the case, the current will flow from the propeller to bearings or gear wheels of the engine or gearbox. This can cause extensive damage.
- If the current collector is tuned wrongly and the shafting has a faulty earthing, the gear wheels and the bearings can be destroyed very quickly
- The rudder stock has to be equipped with a good earthing if the rudder is to be part of the cathodic protection system
- Stainless steel, for instance in the propeller shaft, is protected against corrosion by a dense oxide layer called the neutralisation layer. If this layer is damaged it will not fully restore itself. The new layer is not impermeable, so corrosion cannot be stopped. A wrongly tuned ICCP-installation can destroy the neutralisation layer of the stainless steel if it comes into contact with seawater. This does not happen in a lubricated propeller shafting.

6. Antifouling

The main purpose of antifouling is to keep the skin smooth. By preventing organisms from damaging the paint-layer and the steel under-neath, it also offers protection against corrosion.

6.1 Fouling

Fouling is an umbrella term for waterplants (algae and weeds) and animals (barnacles, polyps, mussels, anemones). The number of organisms that are considered fouling is as high as 4000-5000. The fouling can be divided into two categories according to the size of the adult organisms:

- macrofouling, made up of animals and plants
- microfouling. This is a slimy mass, a sticky mix of bacteria and other micro-organisms. The adhesion of the microfouling is weaker than the adhesion of macrofouling.



Mussel fouling

6.2 The shell, the ideal surface for fouling

Spores and larvae easily deposit onto slow-moving rough surfaces. A smooth surface in combination with high speed is a less ideal foundation. Some chemicals and metal-ions like those from copper are toxic for these organisms.



Fouling in places where the antifouling has gone

The growing organisms get their nourishment out of the water flowing along the hull. A ship that is moving slowly (0-10 knots) has the ideal combination of a solid surface and a good supply of food. The roughness of the shell is caused by corrosion, flaking of too many paint-layers, wrong use of cathodic protection and mechanical damage. The growing process of fouling is quite intricate. It depends on geographical, climatological, and oceanographic circumstances, the season, nature of the material and the sailing pattern. For instance, the sailing pattern of a container ship (short berthing time) differs from the pattern of a dredger (alternating high and low speed, long and short stops) which again differs from the pattern of a supplier (long stops, interrupted by intensive sailing). Fouling increases the ship's resistance and reduces the velocity by 10 or 15% at equal engine power. To keep the original velocity, the engine-power has to be increased by 23-38%. The fuel consumption increases then by 25-40%.

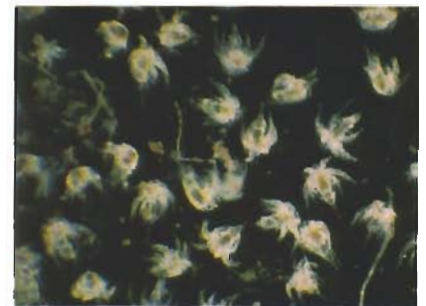

Larvae

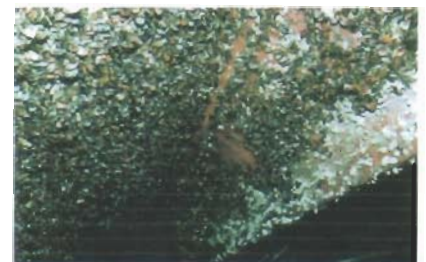

Acorn shells, mussels and other shells



Green algae fouling

6.3 The purpose of antifouling

The main purpose of antifouling paint on ships is to save money. This is accomplished because:

- if there is no antifouling, the ship's resistance increases and, as a result, the fuel consumption also increases.
- if antifouling is used, the ship can spend less time in dock for defouling.
- fouling causes the paint-layer to be damaged. This increases corrosion, and thus the maintenance costs.

6.4 Types of antifouling used

Most antifouling paints in shipping are of the self-polishing type. Self-polishing means that the paint-layer (a polymer) is slowly, layer by layer, degraded by the seawater. This releases compounds that prevent fouling in a controlled manner.

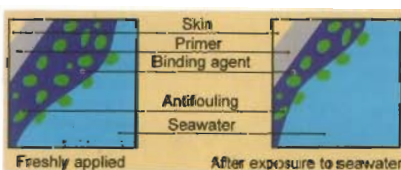

Self-polishing antifouling

There are three main types of antifouling:

- tin-containing antifouling
- tin-free antifouling
- copper-containing antifouling

The difference is not always very clear; for instance, some tin-containing antifouling also contain copper.

The tin-antifouling contains TBT, tributyltin. This toxic compound kills both micro and macrofouling when it first attaches to the skin. So it works by killing the larvae of barnacle shells and the spores of algae. The layer-thickness of the antifouling is adjusted to the life of the paint. This does not need to last longer than five years because the Classification Societies demand that the ship dry-docks at least every five years.

TBT is not just toxic to fouling but also to many other forms of marine life. In slow sailing or berthing, the local concentration of TBT can become so high that many marine organisms show deformations.

In the future, TBT and copper-containing antifouling will be banned. IMO is already deliberating on this subject. After 2003 it is likely that only tin-free antifouling is permitted; these are already available.

7. Docking

7.1 Why dry-docking?

- The SOLAS treaty requires it. (Chapter 1, Reg 10-V) This chapter states that every ship should be dry-docked at least twice every 5 years. The max. time-lapse between two dry-dockings should not exceed three years. Only when special provisions have been made during construction one of the dry-dockings may be replaced by an in water survey.
- Demanded by the bureau of classification. The demands from the Classification Societies are generally in compliance with SOLAS requirements.
- Damage below the waterline as a result of:
 - * collision
 - * running aground
 - * bad or no maintenance
- Inspection when the ship is going to be sold.

7.2 Methods of dry-docking

- floating dock.
- excavated dock (graving dock)
- patent slip.
- lift and subsequent horizontal transport of the ship.

Floating dock

A floating dock is, in fact, a pontoon with on both sides in longitudinal direction a vertical sponson. The pontoon and a part of each dockwall are divided into a number of tanks. To dock, the following has to be done:

- the tanks are filled with water so the dock submerges partly.
- the ship navigates into the dock
- the tanks are emptied, the dock rises to the surface and the ship is lifted out of the water.

The front and/or the back of the sponsons are usually equipped with bridges to connect both sides. On top of the sponsons one can find:

- mobile crane
- capstans and bollards



Antifouling at the end of its life and worn out. Time for repainting. The spraying pattern on the skin is still visible. The outermost layer of antifouling is still partly visible on the overlap. In between it has disappeared completely.

Electric motors are located in the upper part or dry room of the sponsons. These motors operate the ballast pumps that are located low in the tank.

The manual controls of the inlet and outlet valves are also located in this compartment. Opening the inlet valves fills the tanks and lowers the dock. To raise the dock, the pumps are started and the outlet valves are



Repair-department of a dockyard with two floating docks



A floating dry-dock. Data: length = 217 metres, width (internal)= 32 metres, draught above blocks = 7.5 metres, lifting capacity = 25,000 tons.

1. Keel blocks
2. Side blocks
3. Side sponson
4. Rails for the crane

opened.

The ship rests on the keel blocks that are placed on the tanktop of the dock. These keel blocks are 1 - 1.25 metres apart and each can carry a weight of



Tanker being built in a dry-dock

100-150 tons.

Side (bilge) blocks are used to keep the ship stable in the dock. They keep the ship in balance and are placed close to the turn of the bilge. All side blocks have to be placed in such a way that the forces they exert on the ship's hull are absorbed by the reinforcements present in the ship like side keelsons and longitudinal bulkheads. The centre line bulkheads and the cross frames of the dock also have to be taken into account. The positions of the blocks, the rise of bottom, the bottom plugs and other important data have to be indicated in the docking plan. The rise of floor makes it necessary for the side blocks to have the correct height so that the weight of the ship is evenly distributed over the keel and the side blocks. The dock master is responsible for the placing of the blocks as indicated in the docking plan of the ship.

Excavated dock

The excavated dock (graving dock) is closed using a door. The dock floor slightly slopes towards the opening. The pump room is also located near the opening. Most characteristics of the excavated dock are the same as those of a floating dock.



Construction in an excavated dock



Huge ship in dock



A view under the ship standing in a dock (normal dock block-arrangement)



Ship supported by special dock block-arrangement with enlarged height (in a graving dock).

Patent slip

The patent slip lifts the ship in the athwart direction. Cradles placed on rails roll into the water, until they are underneath the ship. If the cradles are pulled back up again, they take the ship with them. The patent slip is used mostly for ships with a length of up to 140 meters.



Ship on a patent slip

Ship lift

The ship lift consists of a platform and below that a number of cradles (approximately 14). The cradles are used to lower the platform into the water. After this the ship navigates above the platform, which is lifted in its turn by winches. The ship can then be moved horizontally over the shipyard in both the fore and aft direction and the athwart direction. This method is suitable for ships up to a length of 125 metres.

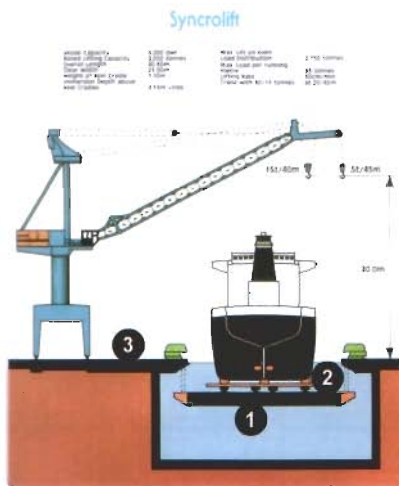

Ship lift

1. Platform
2. Cradles
3. Dockyard

7.3 Preparing for dry-docking

As mentioned before, the dockmaster has to determine the position of the ship and the side blocks in the dock in accordance with the dock plan. If possible, the ship should have no cargo on board. If there is still cargo on board, then docking can only take place in close consultation with the classification society. The structural integrity of the ship may require additional blocks to be placed. The ship should enter the dock preferably on even keel. A floating dock can be positioned with the same trim as the ship. The maximum allowable trim of the dock differs per dock.

7.4 Dry-docking

When the ship has entered the dock, the dock master is responsible for the dry-docking. The ship must be in the exact middle of the dock, before the

dock is pumped dry. The ship is positioned correctly by dock winches attached to the fore and aft, both on port and starboard side. The dockmaster gives the orders to the operators of the winches. The exact middle of the dock is indicated by a cable and a plumb line, which are suspended between the two sides. Another method is to use a measuring rule to determine the distance between the edges of the dock and both the ship's sides at the fore and aft. The ship will touch the docking blocks when the draught of the side sponsons equals the ship's draught. The draught of the sponsons is the draught above the keel blocks. The ship is buoyant when it touches the docking blocks. The stability of the ship will decrease if the weight exerted by the ship on the dock blocks increases. The apparent rise of centre of gravity 'G' is faster than the rise of the metacentre 'M', in other words: G catches up with M. Bilge or side holders have to be placed before the stability becomes zero (GM=0). A critical moment for the floating dock arises when several decimetres of water, still present on the dock-floor, start to move. A large area of free floating fluid can come into motion. Before the dock is dry, all water-cooled engines and auxiliaries on the ship have to be shut down. If the ship has air-cooled auxiliaries, these can keep supplying the ship with power. If these are not present, electricity from the shore must be utilised. A requirement of the shipyard is that the ship is connected to the shorebased fire-fighting installation by means of hoses to the (international) shore connection.

7.5 Refloating

Before the dock is flooded to undock the ship, the presence of all the plugs, grills, anodes, inlet and outlet valves, manhole covers etc. has to be checked.

The ship should leave the dock in the same ballast condition as when it entered. This means that ballast tanks have to be refilled. This is done from the dock with pumps and hoses. When the ship is floating again, the

engine room compartment and bilge wells have to be checked to determine if there is any leakage. Repairs to double bottom tanks and side shell must be tested prior to undocking.

8. Maintenance and repairs

8.1 Maintenance

Ships maintenance is usually divided into HULL and ENGINE maintenance.

Hull maintenance is normally done in drydock. A ship has to be drydocked twice every five years. This is basically for examination by Class of the underwater parts. When no repairs are to be carried out, it means only examination, cleaning and repainting of the ship's outside hull. Maintenance of decks, and everything inside the shell-plating is usually done by the ship's crew. When the ship is set dry in drydock, the outside of the hull is cleaned using high-pressure water jets, at least 100 Bar, to remove dirt and fouling, and to make the hull ready for repainting. Oily spots, if any, are removed with special solvents. Rusty spots are specially cleaned using



The old paint-layer is removed by gritblasting

sand-discing, gritblasting, hydro (water) blasting, with water of 700 to 2000 Bar as cleaning method. The original paint system of these spots is to be restored, whereafter the entire outside hull can be painted as wished by the owner. Sometimes, when the roughness of the underwater hull has become too high, due to numerous layers of paint and local touch-ups, the entire underwater part is blasted to remove all the rust and paint, and to start the paint system as from new.

SECTION FR.153

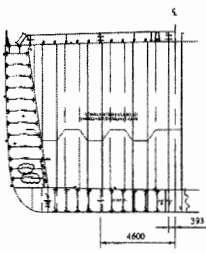

SECTION FR.182

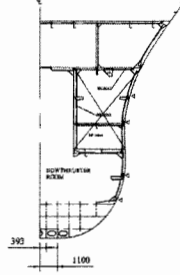

PRINCIPAL PARTICULARS

Length o.a.	139.95 M
Length p.p.	134.70 M
Rule length Bur. Ver.	132.31 M
Breadth moulded	21.00 M
Depth moulded	10.60 M
Draft summer freeboard CA.	8.06 M
Design Draft	6.90 M
Deadweight (6.90mtr)	appr. 11700 ton
Deadweight (8.06 mtr)	appr. 14800 ton
Draft scantling	8.10 M
Total engine output	5400kW
Service speed	14 Kn
Gross tonnage	appr. 8550 GT

CAPACITIES

Cargotanks 100%	appr. 16000 m3
Slobtank	appr. 380 m3
Washwater / ballast tank	appr. 247 m3
Ballast water	appr. 6014 m3
Potable water	appr. 99 m3
HFO	appr. 714 m3
Gasoil	appr. 97 m3

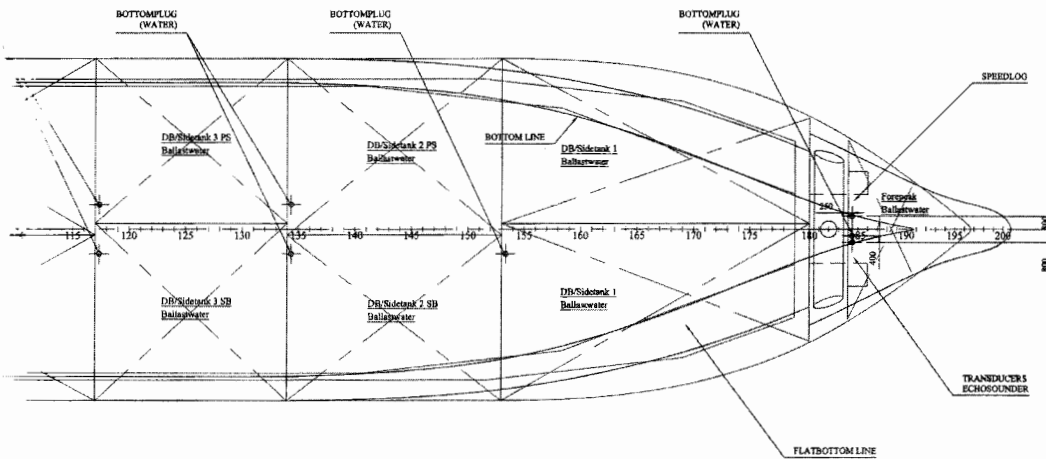
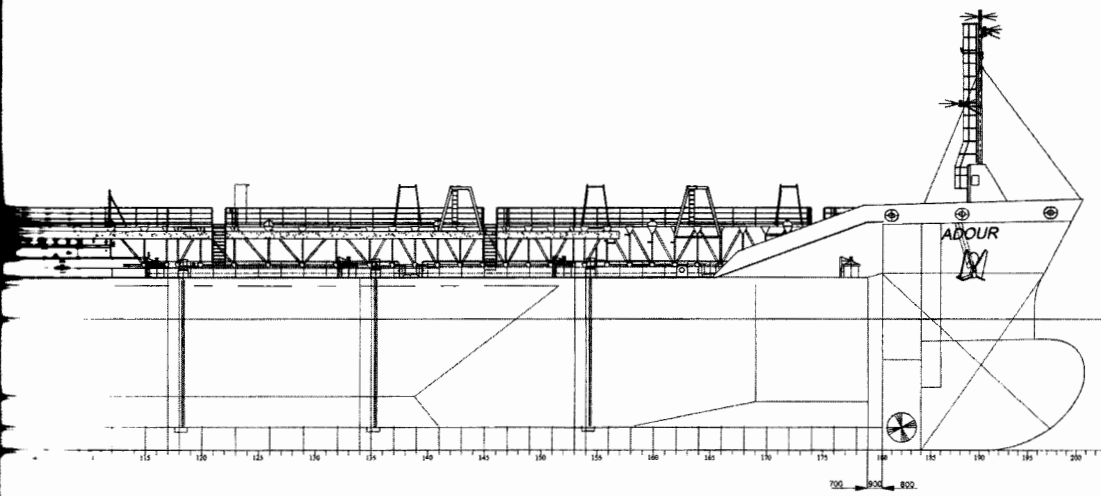

BOTTOMPLUG (OIL) 1x
SCALE 1:2.5

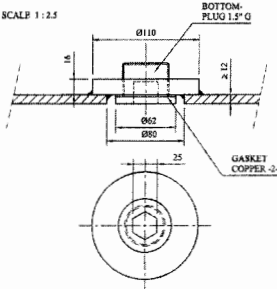

WIJZ.: B Corrected bottomline	25-10-01	GK
WIJZ.: A Addit 2 bottomplugs	12-10-01	✓



26 Rue de CAMPILLEAU 33520 BRUGES (FRANCE)
Tel (33)06 18 15 14 / Fax (33) 56 87 84 74 / Telex 300628 Petro

DATE	1	1	SCALE: 1:150	DATE: 30-07-01
REVISION			DATE: 12-10-01	

DOCKING ARR. AND DETAILS A0

Niestern Sander bv
 MEMBER OF CONSIGNEE INTERNATIONAL
 Postb. 178 P.O. AC DELFT, NL
 E-Mail: Niestern@Consigne.nl
 Telephone: 0206-417979
 Fax: 0206-417129
 ROYKONNOR 814
 TRAFIKKONNOR 1040
 GIESEMELLES VOORBEREIDING
 CAD-TUURBOEL, GEM. NAAMLOZE VENNOOTSCHAP

The paint supplier gives advice, and keeps control of cleaning and application. Depending on the age of the ship, size, speed, cost and the requirements of the trade, the paint system is chosen, from simply one coat of tar to more expensive systems as vinyl, chlorinated rubber, epoxy or polyurethane underground followed by various coats of sophisticated anti-foulings.



Classification surveyor

After drying, and cleaning, the vessel has to be examined in dry-dock by the Classification surveyor, normally accompanied by the owner's representative and the shipyard in order to investigate the condition of the underwater parts. No defects underwater are to be neglected, to prevent unforeseen repairs during operational time. Emphasis shall be put on rudder and propeller, tailshaft, indents, damage, paint-condition, corrosion, fractures, weldings, and inlet and outlet pipe-stubs. Defects affecting Class are to be dealt with. Minor defects not requested to be repaired by Class, can be left as are, as per owners choice.



Anchors and chaincables are lowered. Blasting and painting is in progress..

As already mentioned, the rudder and rudder stock have to be examined, clearance of rudder bearings is to be measured and sea-inlet boxes are to be opened up, cleaned and painted internally, mostly the same procedure as for the outside hull.

The tailshaft and propeller have to be examined and the tailshaft wear-down measured. This gives information about the condition of the stern-bush bearing. Standard every five years, the tailshaft has to be withdrawn, to examine the shaft, and to examine the stern-bush bearing. The propeller is then suspended using special tools from the yard. Simultaneously the tailshaft seal is opened up and overhauled.



Preparing propeller and tailshaft for proper fit on conical part prior to installation on board



Controllable-pitch propeller shafts and keyless propeller shafts do not need to be withdrawn at five year intervals, they can be left for a longer time.

When the clearance of rudder bearings has become too big, the rudder has to be lifted out of the pintles, and the relevant bearings have to be renewed. The bigger the ship, the heavier the rudder. For a VLCC (Very Large Crude Carrier) the rudder weight can be 100 tons or more. Rudder posts, which often are lifted for access to the rudder, follow the same pattern. Special lifting gear must be available at the yard.

Anchors and chain cables are to be lowered and laid out, and measured up, to establish the loss of thickness due to corrosion and/or wear. When too thin, chains are to be replaced. Inspection of anchors and chains and their measurements are required at least every five years. When the anchors and chains are lying in the dry-dock, it is



Exchange of crank shaft

customary to clean the chain lockers, which themselves have to be examined for class and Special Survey. Another standard item of the dry-dock repair list is opening and overhaul of sea-inlet and overboard valves. They need cleaning, inspection, disc-grinding of seats and repacking of stern glands at least once in five years.

Most of engine maintenance is done while the ship is in operation, partly during voyage. Items which only can be done when the ship is not underway are done in port. The Classification Societies request the shipowner to show to them each surveyable item once every five years. Surveyable items are engine parts or systems essential for the safe navigation of the vessel, and are listed on board and ashore. This survey can be done at the end of the five year Special Survey cycle, or on a continuous basis during the whole period. Under certain circumstances part of the surveys can be done by the ships chief engineer when he or she is specially qualified. He then has to submit details of what he has seen and done. Some engine parts need more attention than once in five years: coolers, pistons, turbo chargers, etc. Maintenance of items which are too big or too difficult or which simply cannot be done afloat, is done at a shipyard. This is usually not a newbuilding yard, but a specialized repair yard.

8.2 Repairs

Repair yards have equipment totally different from newbuilding yards. Their dry-docks are deeper: A ship in operation is heavier and has consequently more draught than an empty newly built hull. Also cranes do not need to have the lifting capacity of those in a newbuilding yard. They need height, more than huge lifting capacity. The workshops are differently equipped: other machines, for small and sometimes big repair work. The workers need to have a different skills from new-builders and have to be more flexible and more used to changes. Also the locations of repair-yards are often different from the newbuilding yards. To minimize deviation from the normal trade, they are found in the big loading and discharge ports or underway on route between common discharge and loading ports, especially for large tankers and bulk carriers.

Repair yards are used to normal maintenance work, but must have the flexibility to carry out repairs. When during the dry-dock inspection a problem is observed, there should be capacity to deal with this immediately, depending on the extent of the problem. Therefore, repair yards need to have more than one dry-dock for similar ships, and are specialized for certain sizes and types of ships.



Damaged bow



A new bow



The bow brought in position.



The new bow is attached

Typical repairs are related to certain ship types. Bulk carriers always have work to be done to hatchcovers, crude tankers to pipelines in the tanks and pump room and to valves, hopper dredgers to bottom-valves, container ships to container guides, etc.

A repair yard always has shops and/or departments for hull, machinery, pipe repairs, electrical repairs, wood-work, and cleaning and painting. Often specific and/or specialist jobs are subcontracted to separate companies.

Common repairs to hulls are steel renewals, in dry-dock and afloat, such as repairs of an indent caused by a collision with a jetty, steel renewals resulting from grab discharge, local corrosion or from grounding. Grounding damage can vary in size from a small indent to a whole flat bottom. Fire damage also often involves steel repairs.

Repairs to shell plating often come with the problem of shape. Nearly all ships have different forms, and when a hull plate is not in the flat bottom or ship's side, the curved shape has to be restored. When the newbuilding offsets (tables measured from the original newbuilding mould), are available, the relevant part of the hull can be drawn up, and the shape can easily be established from this real-size drawing. Or, when the damage is on the portside, measurements are to be taken on the starboard side. Nowadays, there is a growing number of new-building and repair yards that use more modern computer systems for establishing the profile of shell plates. In the dry-dock laser instruments measure the shell plating. The results are fed into a specially designed computer programme which calculates and gives an accurate profile of the shell plating. This computer programme will also give the necessary information to the machine operators whose job it is to cut the new steel plates.

8.3 Modern ship-repairs

When there is damage to the ship, usually below the waterline, the ship has to dock at a repair-yard to survey the damage. After the survey, the parts that have to be replaced can be fabricated, e.g. the skin with the stiffenings and other strengthening parts. Then they can be installed. The most time-consuming factor is the retracing of the original form of the hull, which can cause a relatively long period in dock.

When the yard uses a modern, 3-D CAD/CAM computer programme this process can be done a lot quicker. More and more of these programmes are used by modern ship-yards. Shortly after the damage has occurred, the extent of the damage can be investigated and upon inspection by the surveyor, insurance party and the owner, the extent of repairs will be agreed on. Then the

preparations can be started up by the selected repair-yard, preferably by preparing prefabricated sections on the basis of the CAD/CAM programme if available.

Depending on the extent of the damage the ship can proceed on its voyage and the lay time can be reduced as far as possible. Only when the sections that have to be replaced are fully constructed, will the ship have to go to a dry dock for repairs. This way the sailing time lost is as little as possible, which is the primary goal for the shipowner.

On repair yards the use of these programmes is not wide spread, whereas in new-building it is quite common.

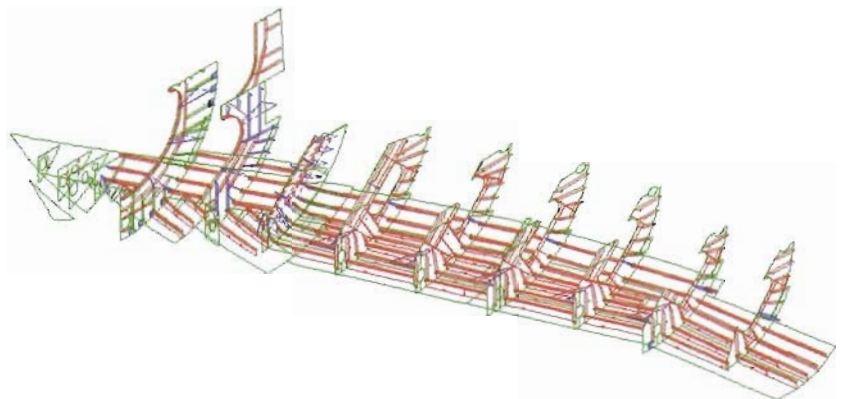

Ship's shape in Tribon Lines

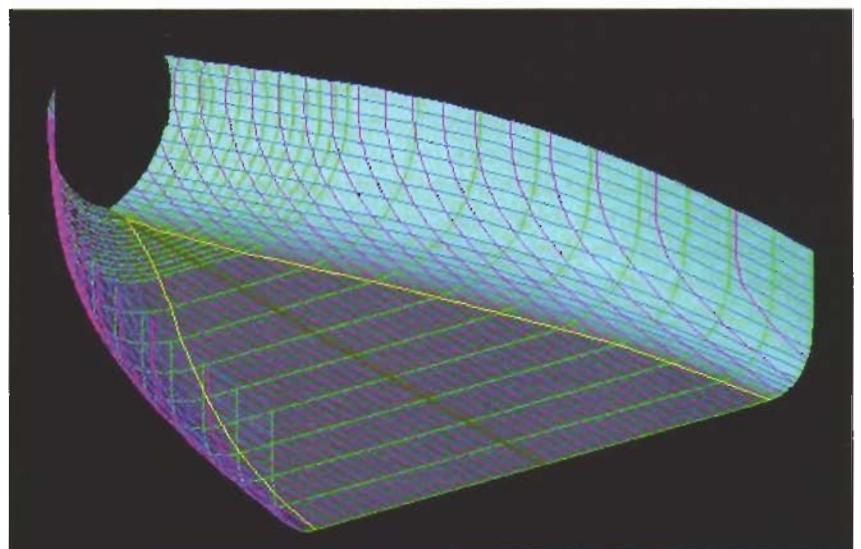



Bottom damage



Part cut out



New part lowered...



...and brought in position to be attached

8.4 Conversion

Related to ship repairs, more than to newbuilding, is carrying out conversions. Existing ships are sometimes modified into something totally different from the original ship. Bulk carriers are converted into drill ships or into pipelayers; tankers are getting a second life as FPSUs, Floating Production and Storage Units, cargo-ships or tankers are simply lengthened, an existing aft ship with

engine room is coupled to a completely new fore ship; original steam propulsion is changed to diesel propulsion; passenger ships are upgraded with more cabins, from emigrant transport into cruise ship, or from ferry into floating hospital, etc. A special field is work related to offshore oil and gas exploration and production. Due to the continuous change in requirements for certain

jobs, drilling units, storage systems, or transport barges often have to be modified before they can carry out the next job. This kind of work is also normally done at a repair yard. Sometimes they use newbuilding capacity, for instance, to have a new midbody built in case of a lengthening, or simply the new parts needed are made.



A passenger ship is being lengthened to increase capacity.

CHAPTER 15

Safety



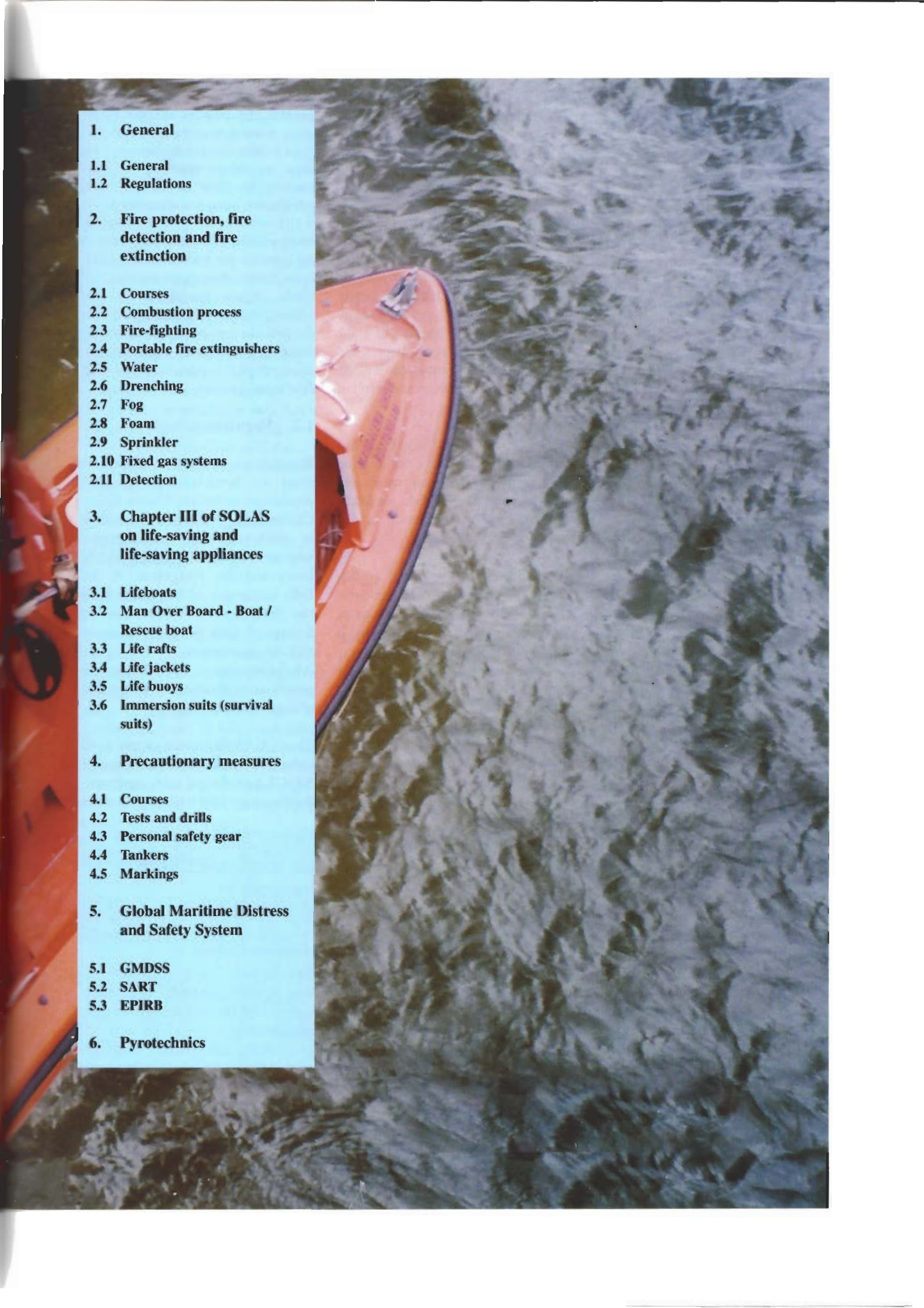

1. General

1.1 General

1.2 Regulations

2. Fire protection, fire detection and fire extinction

2.1 Courses

2.2 Combustion process

2.3 Fire-fighting

2.4 Portable fire extinguishers

2.5 Water

2.6 Drenching

2.7 Fog

2.8 Foam

2.9 Sprinkler

2.10 Fixed gas systems

2.11 Detection

3. Chapter III of SOLAS on life-saving and life-saving appliances

3.1 Lifeboats

3.2 Man Over Board - Boat / Rescue boat

3.3 Life rafts

3.4 Life jackets

3.5 Life buoys

3.6 Immersion suits (survival suits)

4. Precautionary measures

4.1 Courses

4.2 Tests and drills

4.3 Personal safety gear

4.4 Tankers

4.5 Markings

5. Global Maritime Distress and Safety System

5.1 GMDSS

5.2 SART

5.3 EPIRB

6. Pyrotechnics

SHIP KNOWLEDGE

A MODERN ENCYCLOPEDIA

SHIPWISE

PAGE 8

1

THE SHAPE OF A SHIP

PAGE 22

2

SHIP'S TYPES

PAGE 44

3

THE BUILDING OF A SHIP

PAGE 68

4

FORCES ON A SHIP

PAGE 82

5

LAWS AND REGULATIONS

PAGE 104

6

CONSTRUCTION OF THE VARIOUS

SECTIONS

PAGE 126

7

CLOSING ARRANGEMENTS

PAGE 160

8

LOADING GEAR

PAGE 174

9

ANCHOR AND MOORING GEAR

PAGE 196

10

ENGINE ROOM

PAGE 216

11

PROPULSION AND STEERING GEAR

PAGE 244

12

ELECTRICAL INSTALLATIONS

PAGE 266

13

MAINTENANCE AND DOCKING

PAGE 280

14

SAFETY

PAGE 302

15

STABILITY

PAGE 322

16

CHAPTER 15 QUESTIONS

VISIT

WWW.DOKMAR.COM

1. General

1.1 General

Safety on board ships is an important issue. Normally, at sea, sometimes very far from any possible assistance, there is nobody who can be called upon for help. Of course one should have a good ship, with sufficient stability, water- & weathertight, and properly equipped. However, safety on a ship is not guaranteed by availability on board of the (compulsory) safety items and systems. Safety cannot be bought. Most of the accidents are the result of human error.

Navigation of course, has to be carried out correctly and safely, not to bring your own ship into danger, but also other ships at sea. No risks should be taken. Safety of navigation is discussed in another chapter.

Preventing by recognition, rectification and avoidance by all personnel of unsafe actions and/or situations, at all times and at all places on board is of utmost importance.

Since July 2002 all ships (and their ashore offices) have to be certified under the International Safety Management Code (ISM Code), and the crew has to work in accordance with the Safety Management System. The SMS is a set of rules, accurately

describing how to apply safety in general and how to use the safety gear. Courses and regular drills are to be held in order to achieve that the crew is safety conscious. This teaches the crew to use the right equipment in case of an accident. In a crisis situation logical thinking of many people is blocked. They tend to act instinctively using the things they have learnt during the courses and drills. When situations are not trained, and thus unfamiliar they tend to panic. In case of fire, especially on tankers, insufficiently trained people have jumped overboard, often with fatal consequences.

1.2 Regulations

Regulations concerning safety on ships are formulated by an IMO department called the Marine Safety Committee (MSC). This Committee is assisted by nine subcommittees who are responsible for the STCW treaty and fire prevention. At the IMO conference of November 1974 the International Convention of Safety of Life At Sea, in short: SOLAS, was passed.

All the regulations of IMO, after the procedure of ratification, have international validity.

The SOLAS Regulations apply to all ships over 150 GT for radio and over 500 GT for radio and safety equipment. Ratification by the relevant flag states

Chapter I:	General provisions
Chapter II-1:	Construction - Structure, subdivision and stability, machinery and electrical installations
Chapter II-2:	Construction - Fire protection, fire detection and fire extinction
Chapter III:	Life-saving appliances and arrangements
Chapter IV:	Radio communications
Chapter V:	Safety of navigation
Chapter VI:	Carriage of cargoes
Chapter VII:	Carriage of dangerous goods
Chapter VIII:	Nuclear ships
Chapter IX:	Management of the safe operation of ships
Chapter X:	Safety measures for high-speed craft
Chapter XI:	Special measures to enhance maritime safety
Chapter XII:	Additional measures for bulk carriers
Appendix:	Certificates

An overview of the index of SOLAS

means that they will adopt the regulations in their national laws. SOLAS starts with Chapter I dictating the necessary certificates a ship should carry, and regulations about control of same. Chapter II holds regulations regarding the construction of ships:

- Subdivision to prevent sinking in case of water entering the ship and prevention of quantities of water coming inside the ship large enough to bring her in danger.
- Stability requirements, both for the intact ship and the damaged ship.
- Regulations concerning machinery.
- Fireprevention in the form of insulation of bulkheads such that it forms a sufficient barrier against fire not to let it spread over the whole ship, but to enable adequate fire fighting

2 Fire protection, fire detection and fire extinction

2.1 Courses

The most important issue of course, is protection. Protection through construction is, as said above, arranged in Chapter II-1. It prescribes the positions of bulkheads, materials of subdivision, use of non-flammable materials, fire proof doors, fire-proof insulation etc. The basis is, that the three elements of combustion: flammable material, heat and oxygen should not get together.

2.2 Combustion process

For the better understanding of this paragraph we will now look more closely at the theory of combustion.

Combustion is a chemical reaction when some compound reacts with oxygen. This compound will form a chemical bond with oxygen under the release of heat and the formation of new compounds. This process is known as oxidation. Combustion is happening everywhere unnoticed, for example in the human body or in corrosion like the rusting of iron. An actual fire will only occur in case of a combination of those factors. If one of these factors is removed, there will

be no fire and if there already is a fire it will be extinguished. Fire prevention and fire fighting is based on this principle. The required factors are shown in the fire triangle. If just one side of the triangle is taken out of the equation, then the fire will cease.

The ignition

To start a process of combustion more than the three factors are needed. The heat that is necessary to start the fire must fulfil some requirements. For a solid or a liquid to ignite there has to be some vapour or gaseous product. This is the case when the compound

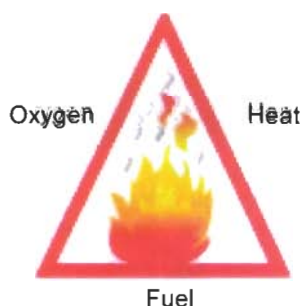

The fire triangle

is heated until enough vapours and gases have been generated to form a flammable mixture. The lowest temperature at which this situation occurs is called the flashpoint.

However, it is possible that when the flashpoint is reached, the combustion will cease after ignition. The reason for this is an incomplete mixing of gas and air. The lowest temperature at which combustion will continue after ignition is called the ignition temperature. At this temperature, enough vapour is formed to sustain combustion; the heat balance is in equilibrium. A necessity for sus-

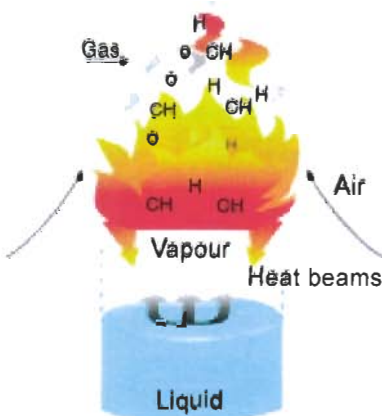

Combustion of a liquid

taining combustion after ignition is that a sufficient amount of heat is released in the process. This is the case when more heat is produced than can be absorbed by the surroundings. Combustion is also possible without ignition from outside. If enough heat is pumped into the fuel, the temperature may become so high that it will ignite spontaneously. The lowest temperature at which this can occur is called the (spontaneous) combustion temperature.

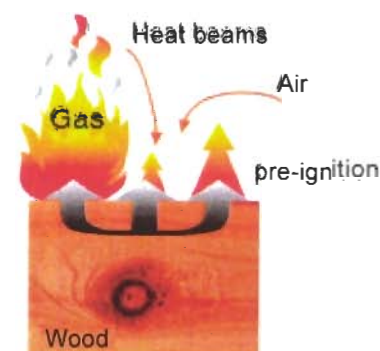

Ignition and combustion of a solid

A catalyst is a compound that accelerates a chemical process without being consumed.

An everyday example of this is the combustion of a sugar cube. You can not light a sugar cube with a match or lighter. However, when you put some ash on the cube, you will be able to set fire to the sugar. The ash is working as a catalyst. In essence, a catalyst reduces the energy needed for a process in comparison with the process in the absence of the catalyst.

The fire pentacle

From the preceding it becomes clear that the fire triangle alone does not suffice; the oxygen/fuel ratio is also very important in the ignition and sustaining of a fire. Next to this, a fire cannot start without a catalyst. If there is no catalyst in the vicinity of the fuel then (over-)heating can still start the combustion process because the fuel will form its own catalyst. The general catalyst in combustion is water vapour. If the two factors oxygen/fuel ratio and catalyst are added to the fire triangle you obtain a fire pentacle.



The fire pentacle

Fire classes

Fire classes highlight the characteristics of combustion depending on the type of fuel. The fire class is used to determine which method of fire-fighting is most suitable for the particular fuel.

Class of flammable goods

A	Solids	Wood, paper, textile, plastics
B	Liquids	Liquifying goods, petrol, alcohol, stearine, fat, tar, paint
C	Gases	LPG, butane, propane
D	Metals	Magnesium, aluminium, titanium, zirconium, sodium, potassium

Overview of fire classes and the types of fuels

2.3 Fire-fighting

When there is a fire, all attempts are to be made to get it extinguished. There are various means of fire-fighting, with different objectives: take away heat, oxygen or the flammable material, to prevent combustion as described above. Removing the flammable material sounds easy, but is often the most difficult way.

Sand as an extinguishing medium is excellent, but not on ships. In the past a sandbox near the boilers was



Powder extinguisher



CO₂ -extinguisher

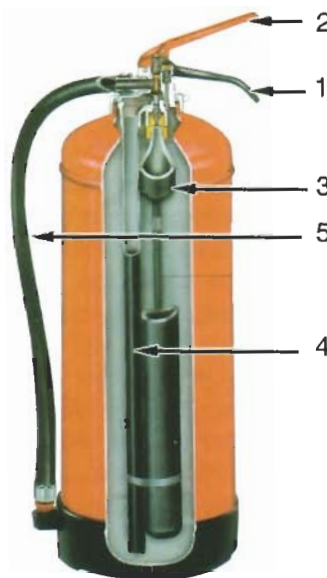

Cross-section of a powder extinguisher

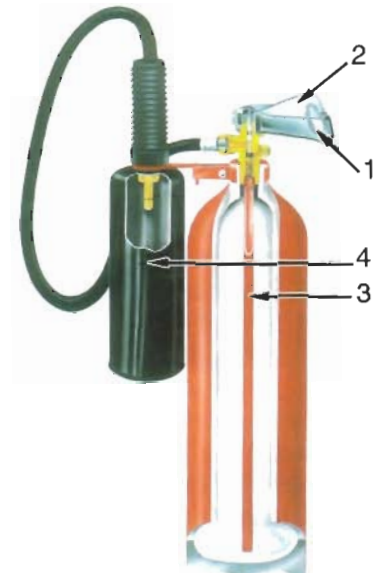

Cross-section of CO₂-extinguisher

1. Carrying handle
2. Control lever
3. Outlet pipe
4. Snow horn
5. Blow-out pipe



Foam trolley

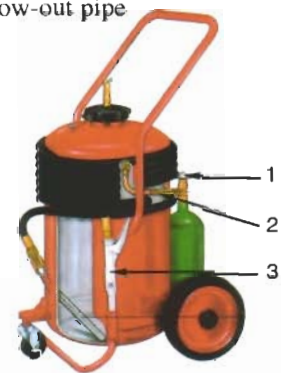

Cross-section of a foam extinguisher

normal, but nowadays it has been replaced by a portable powder extinguisher. Oil fires when oil blows out of a hole under great pressure, can be extinguished using a controlled explosion. It blows all the oxygen and flammable gas away. But again, not suitable on board a ship.

2.4 Portable fire extinguishers

The first line of defence on board usually is the portable fire-extinguisher. Dry-powder, CO₂ or foam. Dry-powder extinguishers, usually with 6 kg powder, are placed in the accommodation and other easily accessible spaces. In the engine room a 20 kg unit has to be available, and also on tankers in way of the manifold, during loading and discharging operations.

The powder is available in three categories:

- A for fire in solids,
- B for fire in liquids, and
- C for fire in gases.

Usually the extinguishers are filled with a mixture of the three powders, making them versatile. The extinguisher consists of a closed container with powder, and inside a compressed gas (carbon dioxide) cartridge. A pin when hit, opens the cartridge, bringing the container under pressure, and blowing the powder out.

CO₂ portable extinguishers are to be used in case of electrical fires in a switchboard, and oil fires, for instance in the uptake of a galley.

Portable foam extinguishers are in use in engine rooms, but are more and more being replaced by powder extinguishers.

Spare charges for the extinguishers or a sufficient supply of all types of fire extinguisher are required to be stored on board.

Explanation of the lefthand pictures:

1. valve for opening the cylinder
2. blow-out pipe
3. fire extinguisher gun

When a fire is too big to be dealt with by portable extinguishers, systems with more capacity are available:

2.5 Water

Water takes away the heat. The most versatile, easiest and at sea the cheapest medium available for extinguishing a fire.

Therefore ships are provided with fire pumps and a pipe line system that runs throughout the ship. Spaced at regular distances there are hydrants supplied by the pipeline system. So when hoses are connected to the hydrants all parts of the ship may be reached.

The pipe-line system must be supplied by two fire pumps, situated in the engine room, each having sufficient capacity and pressure for the whole system. An emergency fire pump, individually driven, is located in a separate fire protected compartment. This pump is to have a sufficient output to supply two hoses. Near each hydrant a hose must be stored, fitted with a dual-purpose nozzle: for a solid jet, and for spray. The hydrants are so constructed that a fire-hose is easy to attach. (three systems: Snap-on, Storz, London Fire-Brigade).

In case of a fire while the ship is in port, there has to be the so-called: International Shore Connection, a standardised piece of pipe, to which the local fire-brigade can connect their water supply to pressurize the ship's fire main.

Fixed pressure water spraying system

Various systems have been developed to spray water in or over areas, which are vulnerable in case of fire.

2.6 Drenching

Ro-Ro vessels have in their cardecks open sprinklers, operated from a central fire-control room. When a fire-alarm comes in, the fire is located by the related alarm head, and after inspection, by an officer or via closed circuit TV; the valve of the relevant area of the car deck can be opened manually. The capacity is much

higher than of ordinary sprinklers systems. The cargo, trucks, trailers, vehicles are much more dangerous than a cabin. Deck scuppers must have a capacity which can cope with the water quantity, so as not to cause loss of stability due to the free surface effect of the water. This system is also called: deluge system.

2.7 Fog

A relatively new development is water fog. Fresh water is pressurised through very fine nozzles so that the water comes out as a fog. Whereas sprinklers splash everything from above with water, the fog fills the space with a cloud, going everywhere, also underneath furniture etc.

2.8 Foam

Water can be mixed with chemicals, so that when let through a pipe where it can be mixed with air, foam is developed. There are three systems:

- High-expansion foam,
- Pre-Mix ordinary foam and
- Foam made in a proportionator.

The foam-forming chemical is normally ox-blood or an artificial equivalent. The mixing rate is 4-5 %. Both low and high expansion foam can be used in spaces like engine rooms, it can fill the whole space, through a system of nozzles, strategically placed, without doing much harm to the equipment. The water is the coolant.

Ordinary foam, pre-mix or mixed with water via a proportionator, which is a venturi tube where in the narrow part of the tube the foam liquid is injected, is used on tankers, to lay a blanket over the deck, like on airfields on a runway. It closes a fire from the air, and thus from oxygen. Foam in small quantities can be used via Foam Applicators, usually two units in the engine room. It is a small drum with foam liquid, connected to the throat of a venturi tube which is connected to a firehose. When spraying water, the foam liquid is sucked up and mixed with the water, producing foam.

2.9 Sprinkler

In each cabin, depending on area, one or more sprinkler heads are fitted in the deckhead. These sprinkler heads are connected to a pipeline supplied by a pressurised vessel filled with water. A glass crystal closes the pipe. When heat is developed in the space, the glass crystal breaks, water flows out and is diverted by a roset in to an umbrella shaped water fountain. When the pressure in the water vessel drops, a pressostat starts a fire pump, providing the vessel with water, to keep the flow going. The pressostat also triggers the firealarm.



*Sprinkler with heat detector:
If a rise in temperature causes the red liquid to expand, it will break the glass and shoot down the nozzle. Subsequently, the water is driven out in the form of mist. The colour of the liquid indicates the working temperature, for example 68°C.*

2.10 Fixed gas systems

Fixed gas fire-systems: Filling a space with a gas which reduces the oxygen content, or which is an anti-catalyst. It reduces the oxygen content to a level at which fire cannot exist, but can only be used in closed compartments.

Most in use: Carbon-dioxide total flooding systems for engine rooms and cargo holds, consisting of a battery of bottles of CO₂ under high pressure (200 bar), which can be blown empty into engine room or cargo hold, creating an atmosphere with insufficient oxygen to allow combustion. Before releasing CO₂ into a space, that space has to be free of people, and all openings to outside

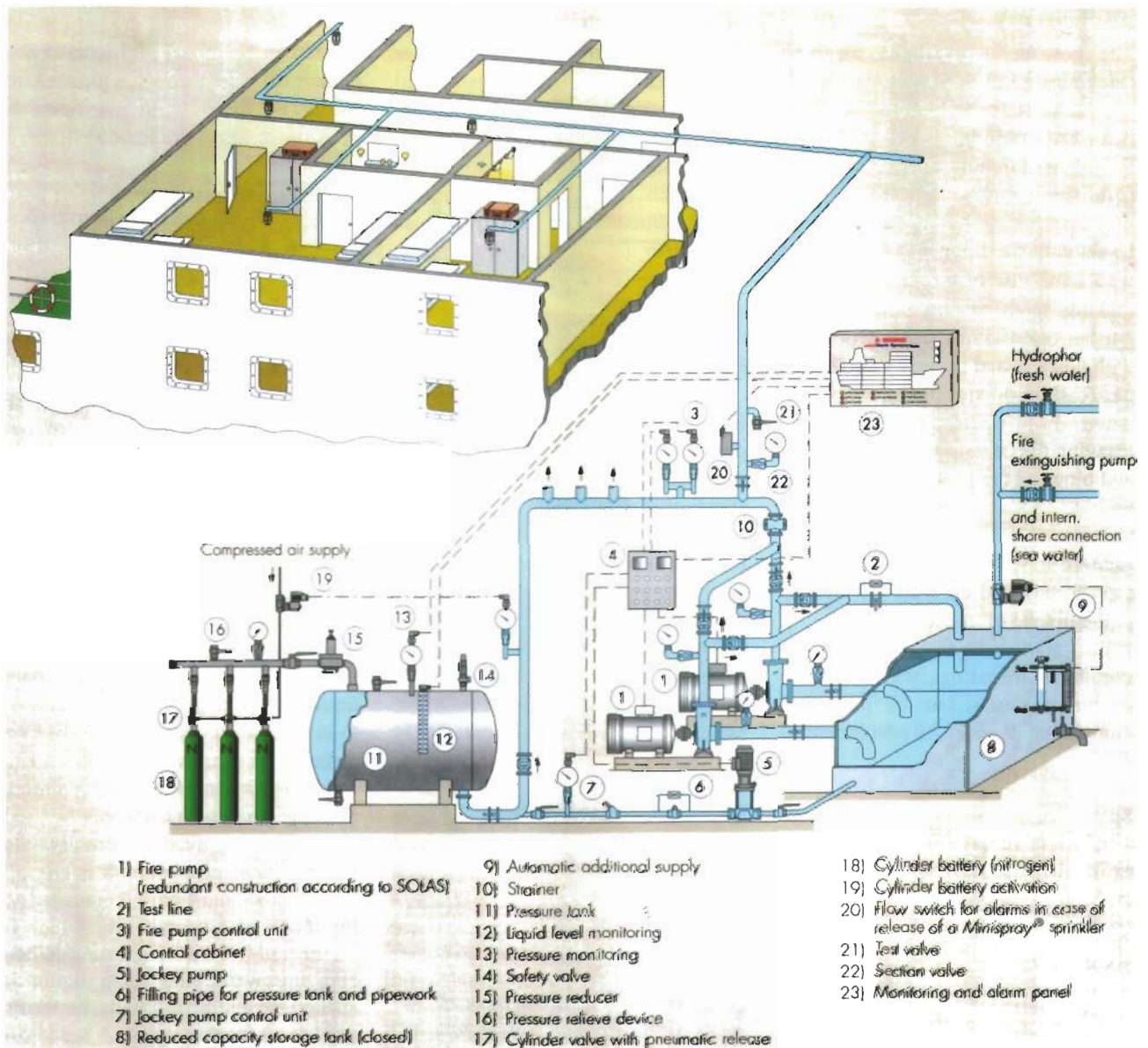

Sprinkler system

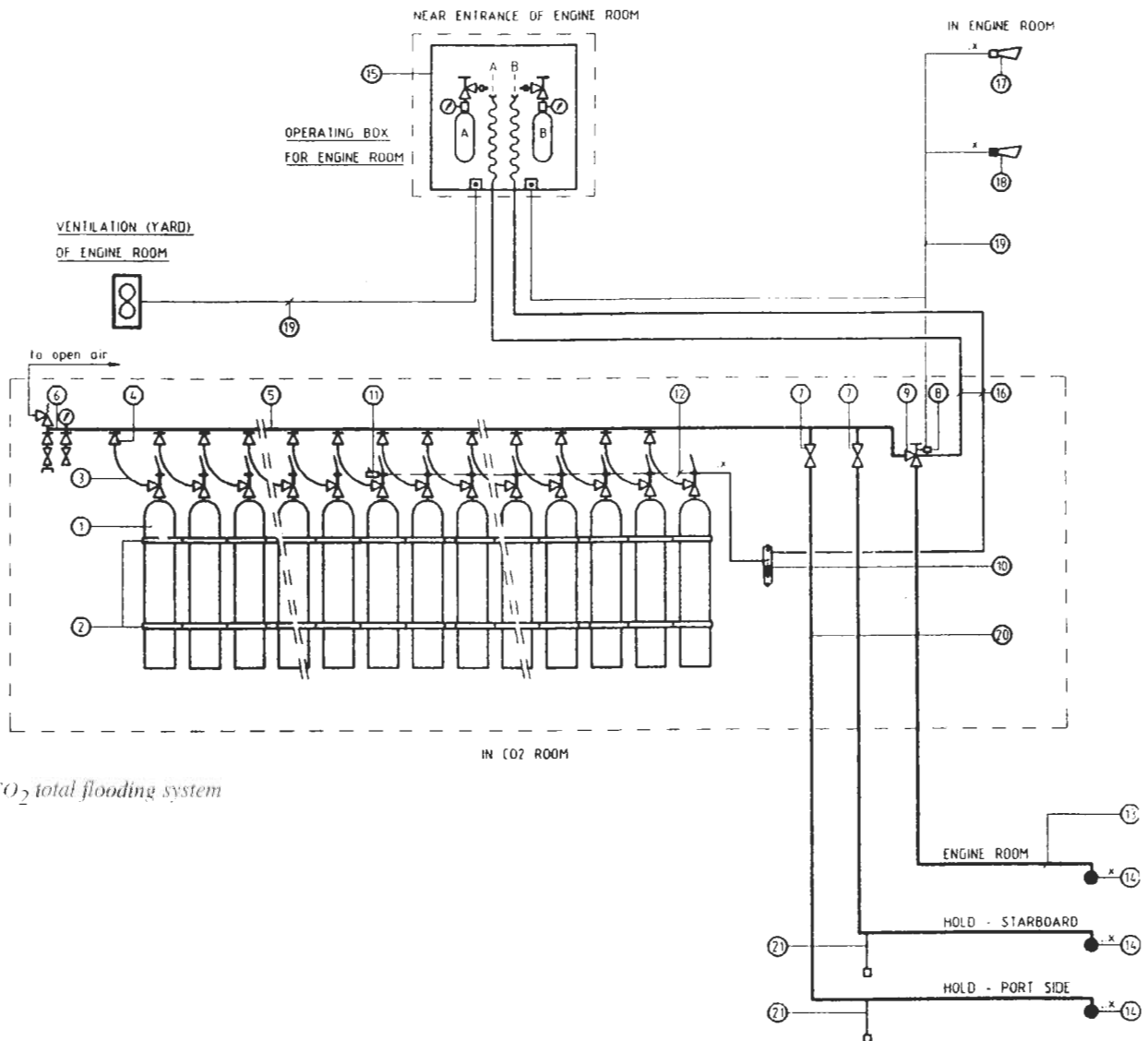

VOL% CO ₂	Symptoms after breathing CO ₂
0.03	normal CO ₂ -concentration
0.5	TLV and MAC-value
1.8	Increase in lung ventilation by 50% (hyperventilation)
2.5	Increase in lung ventilation by 100%
3	Light stupefaction, less accurate hearing, faster heartbeat and higher blood pressure
4	Increase in ventilation by 300%, heartbeat and blood pressure
5	Symptoms of poisoning after 30 minutes; headaches, dizziness, transpiration
8	Dizziness, stunning and unconsciousness
9	Breathing difficulty, drop in arterial blood pressure, congestion, death within 4 hours
10	Disorientation and dizziness
12	Immediate unconsciousness, death within minutes
20	Narcosis, immediate unconsciousness, death by suffocation

TLV = Threshold Limit Value
 MAC = Maximum Allowable Concentration
 Congestion = accumulation of blood



CO₂-cylinders



Compulsory suction

have to be closed and mechanical ventilation, if any, has to be stopped. CO₂ is very dangerous for people. Therefore opening of the bottles and the necessary valves in the pipelines to the affected location are protected with a number of safety measures. Opening the cabinet with the (locked) valves for opening the pilot bottles gives a loud alarm in the engine room. Carbondioxide, although very effective, is very dangerous to people. A large number of fatal accidents has necessitated the search for less harmful alternatives, first found in Halon. For a number of years this was in use, but being a CFK, was abandoned in connection with environmental consequences. There are a number of Halon replacements, but these are so expensive that CO₂ nowadays is mostly installed in new buildings, again, since Halon is forbidden.

2.11 Detection

For successful fire-fighting, the early detection is of utmost importance. Then a person notices a fire or smoke, he has to raise the alarm. Throughout the ship buttons are installed, which when pressed create bells ringing, for everybody to hear.

Engine room

In an unmanned engine room, or an engine room which is operated from a control room, a fire-detection system has to be installed. Smoke-, heat- and flame-detectors are fitted in strategic (high) locations, so that in case of fire it is detected soonest. Three types of detectors are in use: for smoke, heat and flames. For smoke normally a radio-active isotope which triggers an alarm when the radiation is obstructed, contacts the alarm cabinet, which gives alarm. The alarm cabinet is usually in the wheelhouse. The alarm activates bells, ringing loudly throughout the ship. At the cabinet can be seen which loop is activated. Each loop covers a certain area in the engine room. In each loop also heat and flame detectors are fitted. The heat detector reacts to a sudden rise in temperature, the flame detector to light shattering. Testing of smoke detectors can be

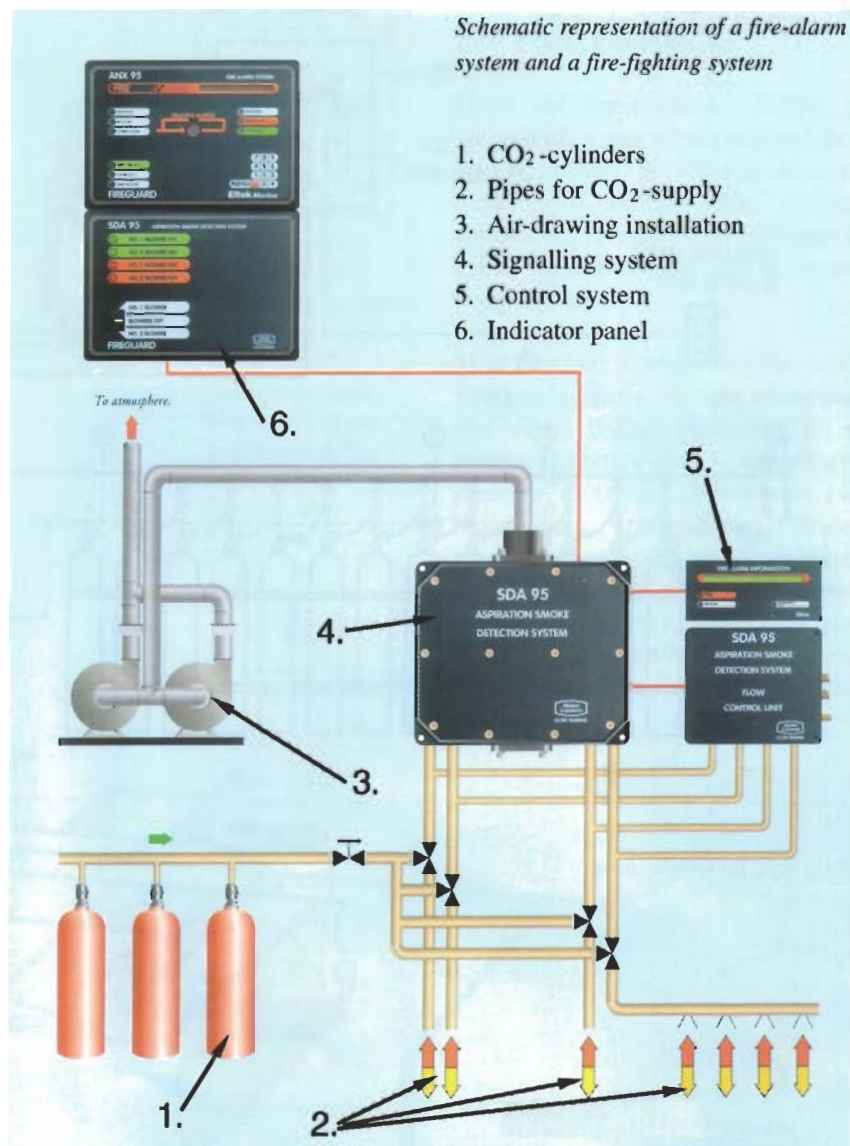

done using a small smoke source or a special gas; heat detectors use a cigarette lighter, and flame detectors an ordinary battery torch.

Cargo holds

Fire in cargo holds can be detected through Sample Extraction. To detect smoke in cargo holds of dry cargo ships, there is an arrangement where gas is extracted from each cargo hold, or cargo-compartment. This gas is drawn via a pipeline, one for each compartment, towards a cabinet, usually in the fire control room or on the bridge, where in its simplest form the samples of each space are checked one by one by leading the samples through a glass tube with a light behind and a photo-electric cell the other side. When the light is obstructed, an alarm is raised. Investigation and action must then be undertaken by the ship's staff. The

CO₂ battery has a special trigger and can be released at will into the relevant hold.

Fire extinction

Each ship has to be provided with at least two firemen's outfits, complete with breathing apparatus. This is a heat-resistant suit, with boots, gloves and helmet, to go close to a fire, when necessary for fire-fighting or for evacuation of people in danger. In



Fireproof boots



Light-weight aluminium fireproof suit, enabling to get close to fires and heat.

case of smoke, the Breathing Apparatus (BA) set is to be used. The BA set comprises a compressed air bottle, and a smoke mask.



The BA set

A further action against fire in engine rooms, or to stop an already ongoing fire, is the closing from outside the engine room of the valves, via which flammable liquids, (fuel oil, diesel, etc) is coming from tanks into the various engine room systems. These so-called quick-closing valves are spring-loaded valves, which, when triggered, are immediately closed by the spring. Activation can be pneumatic, hydraulic or simply with a wire. Coupled to this preventive action is the stopping of all ventilation to and from the engine room, and closing of openings, by flaps, doors, etc, and stopping oil pumps.

Modern ships are provided with a fire-control station. In big ships this is a room in the accommodation, accessible from outside, with a fire-door to the rest of the space. The fire-control station, depending on the type of ship, comprises the following:

- a display of the fire alarm system,
- the cabinet with the operation handles of the quick-closing valves,
- stop-buttons of the mechanical ventilation,
- the smoke extraction cabinet,
- the remote operation cabinet of the CO₂ fire-extinguishing system,
- a firemen's outfit including a breathing apparatus set,
- other related equipment.

The fire control station is normally also the mustering point for the fire-defence group.

A help for everybody is the Fire Control Plan, a general arrangement drawing of the ship, showing all the safety appliances. This plan is at various places posted on the walls, and also in a red container near the gangway, for the shore firebrigade, when the ship is in port or at a shipyard.

Fire alarm

The Fire Alarm, a bell ringing loudly, at intervals of a few seconds, can be activated manually by pushing a button in a little red box, behind glass. The alarm buttons are installed throughout the ship. Also, when fire has been detected by a detection system, it activates the alarm. Resetting of the alarm can only be done at the main display, usually on the bridge. On the display can be seen which button, in which zone or detection-loop, was activated. A zone or loop can be isolated when repairs are carried out and smoke at that location is inevitable (engine room workshop).



Cylinder containing the safety plan, easily accessible for the fire-fighters

SHIP			CALA PEVERO			MUSTER LIST		SAFETY OFFICER	
			LIFE SAVING APPLIANCES						
LIST N°	CABIN N°	RANK	LIFE SAVING APPLIANCES PREPARATION	ABANDON SHIP	FIRE ON BOARD	MAN OVER BOARD	ECOLOGY	FIRST AID	
1	C2	MASTER	BRIDGE SQUAD LEADER IN OVERBOARDING	ON THE BRIDGE RELEASE EMERGENCY SIGNAL IN VHF CONTACT WITH CHIEF AND CHIEF GIVES ORDER TO ABANDON THE SHIP (FFB SEAT No 17)	ON THE BRIDGE IN VHF CONTACT WITH BRIDGE SQUAD No 1 AND 2 AND ENGINE SQUAD IN CASE OF NEED GIVES AN ORDER FOR USE CO2	ON THE BRIDGE IN GENERAL DIRECTION OF MANOEUVERING	ON THE BRIDGE IN GENERAL COMMAND IN VHF CONTACT WITH CHIEF AND CHIEF	ON THE BRIDGE / RADIO ROOM PROVIDES THE MEDICAL ASSISTANCE IN CASE OF NEED	
2	C8	CHIEF OFFICER	INTERVENTION SQUAD No 1 LEADER IN VHF CONTACT WITH MASTER AND CHIEF ENGINEER ENIGURES FOR PROPER SQUAD ORGANIZATION	IN VHF CONTACT WITH MASTER AND CHIEF ENGINEER ENIGURES THAT FFB SLEEP HOOKS ARE RELEASED RELEASE FFB AND STEER THE LIFEBOAT FFB SEAT No 18	IN VHF CONTACT WITH MASTER AND CHIEF ENGINEER LEADING INTERVENTION SQUAD No 1 AND SUBCOORDINATE INTERVENTION SQUAD No 2	AT BOAT DECK IN VHF CONTACT WITH THE MASTER ORGANISES RESCUE BOAT LOWERING AND RECOVERING	ORGANIZES ACTION ON SCENE IN VHF CONTACT WITH THE MASTER AND CHIEF ENGINEER	ORGANIZES ACTION ON SCENE IN VHF CONTACT WITH THE MASTER	
3	C8	2ND OFFICER	INTERVENTION SQUAD No 2 LEADER IN VHF CONTACT WITH CHIEF OFFICER	ORGANIZE FOR LIFE RAFTS LOWERING ATTENDE EMERGENCY TO FFB LIFT TO EMBARK - CLOSES FFB DOOR FFB SEAT No 19	IN VHF CONTACT WITH MASTER AND CHIEF OFFICER LEADING INTERVENTION SQUAD No 2	EMERGENCY RESCUE BOAT FOR RESCUE OPERATION WITH AB No 12	ON THE BRIDGE	ON THE BRIDGE	
4	M7	3RD OFFICER	BRIDGE SQUAD AT MASTER DISPOSAL	BRINGS NAVIGATION EQUIPMENT AND NAUTICAL CHARTS TO FFB CHECK IF THE TAB IS PLACED IN CASE OF NEED LABELS FOR INJURED PERSONS FFB SEAT No 8	ON THE BRIDGE AT MASTER DISPOSAL IN CASE OF NEED PROVIDE THE FIRST AID TO INJURED PERSONS	ON THE BRIDGE PROVIDE THE SEARCH LIGHT ALDS LAMP AND LINE THROWING APPARATUS IN CASE OF NEED PROVIDE THE FIRST AID	AT MASTER DISPOSAL	IN PRIMARY ORGANIZES SUPPORTING SQUAD No 2 TO BRING STRETCHER AND FIRST AID MATERIALS ON SCENE	
5	C7	DECK CADET	BRIDGE SQUAD AT MASTER DISPOSAL	BRIDGE SQUAD TO FFB FFB SEAT No 1	ON THE BRIDGE AT MASTER DISPOSAL	ON THE BRIDGE LOOK-OUT AT MASTER DISPOSAL	AT MASTER DISPOSAL	AT MASTER DISPOSAL	
6	C1	CHIEF ENGINEER	ENGINE ROOM SQUAD LEADER IN CONTACT WITH MASTER AND CHIEF OFF	IN VHF CONTACT WITH MASTER AND CHIEF FFB SEAT No 15	IN ENGINE ROOM LEADS THE OPERATIONS IN CASE OF NEED RELEASE CO2 SYSTEM	IN THE ENGINE ROOM IN DIRECTION OF MANOEUVERING IN CASE OF NEED PROVIDES MANOEUVERING SPEED	COORDINATES OPERATIONS IN VHF CONTACT WITH THE MASTER AND CHIEF OFFICER	AT MASTER DISPOSAL	
7	C8	2ND ENGINEER	ENGINE ROOM SQUAD AT CHIEF ENGINEER DISPOSAL	AT CHIEF ENGINEER DISPOSAL FFB SEAT No 14	KEEPS AN EMERGENCY PLAN EFFICIENT AT CHIEF ENGINEER DISPOSAL	IN THE ENGINE ROOM AT CHIEF ENGINEER DISPOSAL	AT CHIEF ENGINEER DISPOSAL	AT CHIEF ENGINEER DISPOSAL	
8	C8	2ND ENGINEER	INTERVENTION SQUAD No 2 AT 2ND OFFICER DISPOSAL	AT CHIEF ENGINEER DISPOSAL BRINGS AN EXTRA SUPPLY OF WATER TO FFB FFB SEAT No 9	AT FIRE STATION AWAKING FOR ORDER TO START DOWN THE VENTILATION AND DICH CLOSE HULL VALVES	AT BOAT DECK PROVIDE THE RESCUE BOAT ENGINE STARTING	AT CHIEF ENGINEER DISPOSAL	AT DISPOSAL	

	<p>BRIDGE SQUAD</p> <p>MASTER</p> <p>3RD MATE</p> <p>DECK CADET</p>	<p>ENGINE ROOM SQUAD</p> <p>CHIEF ENGINEER</p> <p>2ND ENGINEER</p> <p>ELECTRICIAN</p>	<p>INTERVENTION SQUAD No 1</p> <p>CHIEF OFFICER</p> <p>BOOUM</p> <p>AB No 12</p> <p>AB No 13</p>	<p>INTERVENTION SQUAD No 2</p> <p>2ND OFFICER</p> <p>3RD ENGINEER</p> <p>AB No 14</p> <p>D.S.</p>	<p>SUPPORTING SQUAD No 1</p> <p>ENGINE CADET</p> <p>ENGINE FITTER</p> <p>OILER</p>	<p>SUPPORTING SQUAD No 2</p> <p>COOK</p> <p>MESSMAN</p>
--	--	--	---	--	---	--

<p>GENERAL EMERGENCY</p> <p>SEVEN OR MORE SHORT BLASTS FOLLOWED WITH ONE LONG BLAST</p> <p>When the signal has been sounded the passengers and the crew should put on the warm-garments and verify shoes as quick as possible. Go to the muster station (wearing the rigid helmet and the jacket) where the master or his substitute (chief officer) gives instructions according to the afore muster list.</p>	<p>FIRE ON BOARD</p> <p>TWO LONG BLASTS FOLLOWED WITH CONTINUOUS SOUND OF BELL</p> <p>When the signal has been sounded put on the warm-garments and verify shoes as quick as possible. Go to the destination given in the muster list without exception. Full-time crew members.</p>	<p>SPECIAL DUTIES</p> <p>CHIEF OFFICER - Art. 20A & Reg. 1 is the person responsible in general organization of safety for various kind of emergency and in towing of the crew preparing and performing the safety drills, check up for condition of the muster drills (related to lowering and recovering gear) as well as maintenance and condition of personal life saving appliances. Ensure the condition of the lighting equipment (except those distributed for the engine room) and communication equipment for emergency use (VHF) for the crew.</p> <p>CHIEF ENGINEER - Art. 20B & Reg. 1 is the person responsible in general organization of safety for various kind of emergency and in towing of the engine room, as well as maintenance and condition of personal life saving appliances. Ensure the condition of the lighting equipment (except those distributed for the engine room) and communication equipment for emergency use (VHF) for the crew.</p>
--	---	---

An example of a Muster List

Muster list

A Muster list, for everybody to look at, with names and functions of everybody, updated every voyage, and the special tasks during fire or other calamities, is fitted on the walls at various places: wheel house, mess-rooms and fire-control room .

3. Chapter III of SOLAS on life-saving and life-saving appliances

3.1 Lifeboats

Lifeboats on each side of the ship, capable of accommodating everybody on board on each side, or one free-fall-lifeboat at the poop with capacity for the whole complement are the most important items. In case of lifeboats on both sides, one boat is the man-over-board boat, or rescue-boat. The inventory of the lifeboats is accurately laid down in regulations,

and has to be checked regularly. Main items are food, water, a first-aid kit, medicines, a searchlight, diesel fuel for 24 hours, two bilge pumps, distress signals, fishing gear, tools like axes and engine-tools, spares etc.

Since a few years lifeboats have to be totally enclosed. On tankers they have to be provided with an internal air-supply through compressed air bottles, so that the boat can get away

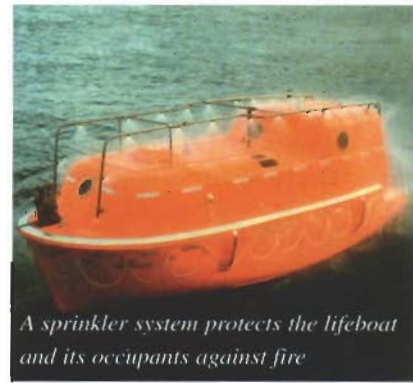

A sprinkler system protects the lifeboat and its occupants against fire



Launch of a free-fall boat from a height of 20 metres



Different views of a free-fall lifeboat

through burning oil on the water. Therefore also a sprinkler system is installed, to cool the outside of the boat.

The capacity of the lifeboats is depending on the number of people carried on board. On either side the whole complement, as stated on the safety equipment certificate, in one or more boats, must be accommodated. A free-fall boat has to take every person on board.

Every lifeboat must have a diesel engine, starting by batteries and backed-up by manual-start.

Lifeboats must be able to be lowered with a ship listing 20 degrees and with a trim of 10 degrees. An (enclosed) lifeboat must have sufficient stability to upright itself.

Lifeboats and davits are made in various ways. All systems are made such that no power is needed from the ship's systems to lower a lifeboat.

Lifeboat installations that use gravity as an energy source are usually of the "free fall" type. The installation is positioned at the aft of the ship, ensuring that trim and list have a minimum of influence on the launch.

Prior to the launch, the mate moves a lever up and down which, in turn, controls the release hook hydraulically. At this point, the diesel engine is already running so that the boat can navigate away from the ship immediately after the launch. The seats in the boat are positioned with the backs facing towards the front of the lifeboat. This helps to absorb the substantial forces acting during the launch.

The free-fall lifeboat can be lifted back on board of the ship with an auxiliary of the launch installation, even when the weather is not optimal. In most types of installations this auxiliary is a U-shaped lever with a winch and a cable that can rotate in such a way that the lifeboat can come back on board of the ship. Both the lever and the winch are operated hydraulically. The oil pressure is

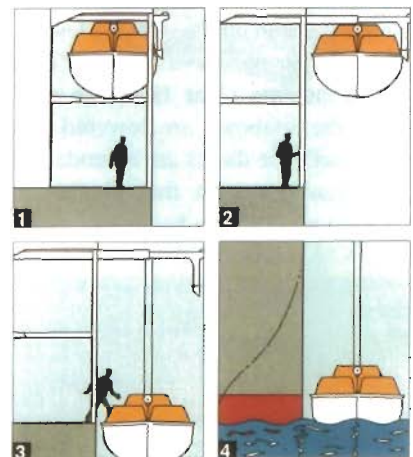

These drawings show stepwise how a lifeboat with occupants is brought into the water.



Lifeboats launched with stored power davits

supplied by an integrated “power pack”. If the path of the free fall is obstructed by some obstacle(s), then free fall is not an option and a controlled launch will have to take place.

In case the ship sinks or keels over, the lifeboat must have sufficient buoyancy to detach itself from the launching system.

The most common lifeboat/davit combination is 'gravity davits' at either side of the ship. The boat goes down by its own weight, after removing a number of securings and seafastenings, by simply lifting the brake handle of the winch.

Another launching method is to use “stored power davits”. This system is mainly used on passenger liners because the system does not require much space. The lifeboats are hanging in the davits. During launch, these telescopic davits extend until the lifeboat is clear from the ship. Then the lifeboats are lowered into the water. The davits are extended by a hydraulic system that obtains its (stored) power from batteries.



- | | |
|--|---------------------------------|
| 1. life buoy with light and smoke signal | 4. MOB -boat |
| 2. locker with fire hose | 5. Lowerable raft |
| 3. life buoy | 6. Crane for raft and MOB -boat |
| | 7. Free-fall lifeboat |

3.2 Man Over Board-boat / Rescue boat.

Man Over Board-boat / Rescue boat (MOB-boat). In case of a free-fall lifeboat, there has to be a separate MOB-boat, under a crane. Again with compulsory inventory. Special suits for 3 crewmembers are important. Ships carrying passengers need to have a fast rescue boat, capable of being lowered into the water when the ship is still making headway.



Raft in container



MOB -boat with crane. The crane can also bring the boat back on board.

3.3 Life rafts

Inflatable Life rafts are available on each side for the whole complement. They are to be dropped overboard, where an attached line arranges the inflation. In case the ship sinks, the raft is released by a hydrostatic release. The line has a weak link, which breaks, to prevent the ship taking the raft down. Large ships have an additional 6-person liferaft forward, and some very large container ships with midships accommodation, one aft. When a ship has a



A launched raft



Permanent MOB -boat. If the boat is suspended from the crane, it can be lowered by pulling the triangle.

free-fall boat, one life raft has to be situated below a crane, normally the MOB crane, so that the liferaft can be lowered in inflated condition.



Lowerable life raft

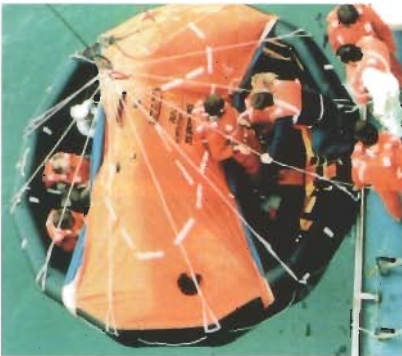

Lowerable life raft



The sinking ship pulls the boat line and the raft is inflated.



The last (weak) connecting line breaks and the survivors can climb into the inflated life raft.

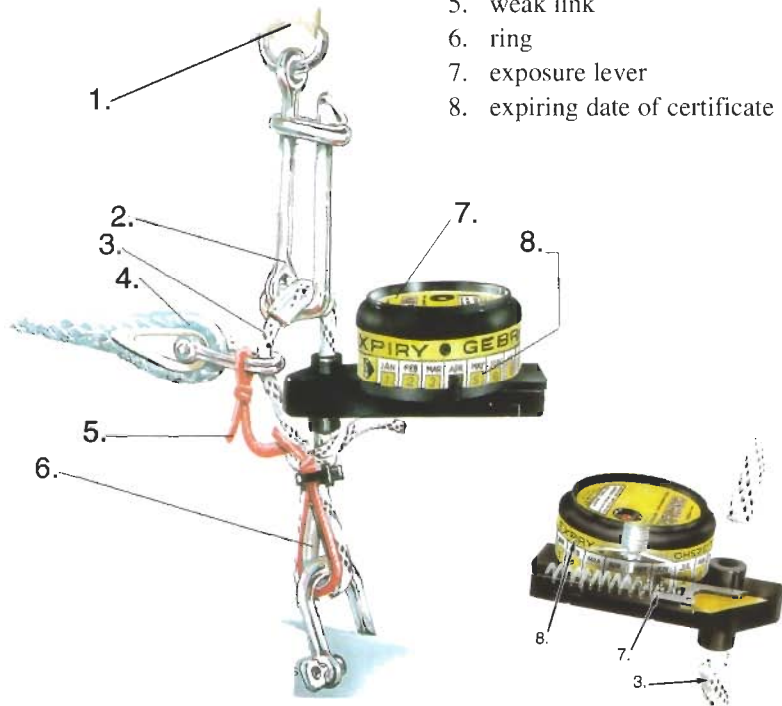

Hydrostatic release

Explanation of the numbers used in the image below:

1. lashing strap around raft
2. pelican hook
3. connecting line
4. painter
5. weak link
6. ring
7. exposure lever
8. expiring date of certificate

3.4 Life jackets

There is to be one for everybody, and provided with light and whistle. There are mostly stored in the cabins, some-times in boxes near the lifeboats. Also a few life jackets are to be stored in places where people work: in the engine room, on the bridge and in the forecastle space. A lifejacket has to be made of watertight and fire retarding material with sufficient buoyancy. Furthermore, it has to upright an unconscious person who is face down in the water and has to keep his mouth 12 cm above the water.

They have to be provided with reflective material. A whistle and a light have to be attached. In case of children on board, special, smaller lifejackets need to be provided.

In case of inflatable life jackets, they need to have two airchambers and are to be serviced every year.



Life jacket with belt, a whistle and reflecting strips.

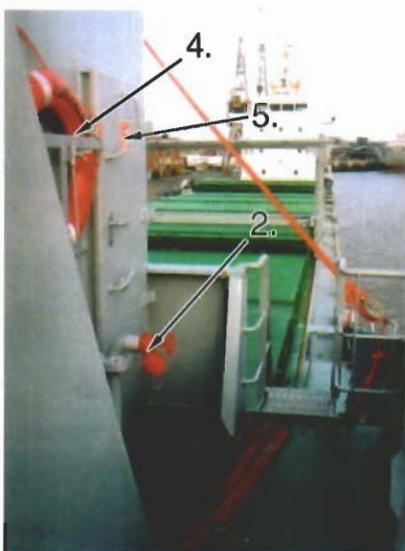

Safety means forward

1. fire hose
2. pipe branching with a snap-on coupling
3. powder extinguisher
4. life buoy
5. safety sticker F (Fire)

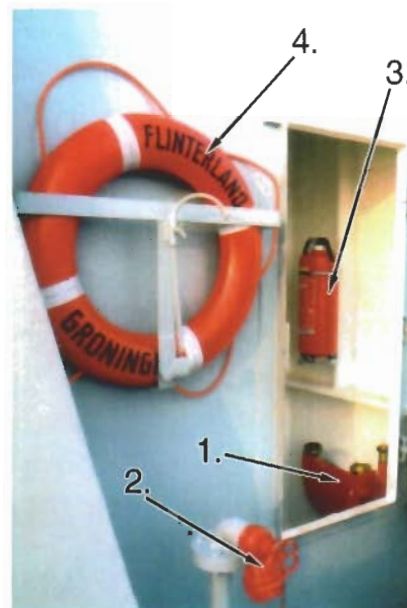

Safety means forward, now with open door

3.5 Life buoys

They comprise a number of buoys, attached to the handrails, some with floating line, some with a floating light, some without attachments. On both bridge wings there has to be a life buoy, installed such, that when released, it drops into the sea. Attached to these buoys are a floating smoke light and a light signal.



Life buoy with light and marking

3.6 Immersion suits (Survival suits)

At least three per lifeboat are required. Some flag states require immersion suits for everybody on board. However, this is not required when the lifeboats are totally enclosed. Hypothermia is the most dangerous threat to people in lifeboats. Especially in open lifeboats, which are still very much in use on older ships. In that case there must be for everybody a Thermo Protective Aid (TPA), a protecting bag, keeping the body heat inside. Or an Immersion suit for everybody. An Immersion suit has to be worn together with a life jacket. The insulating quality of immersion suits has to be such that the body temperature has not dropped more than 2 °C after 6 hours in water with a temperature between 0 and 2 °C.



Survival suit. It has to be worn in combination with a life belt to stabilise the head in case the person wearing it becomes unconscious.



Light and smoke signal

4. Precautionary measures

4.1 Courses

To work professionally with all the above materials and items, the ships crew needs education. Before signing on, everybody needs a certificate of competency.

This certificate can only be obtained when the individual is in possession of the proper diplomas, sufficient sea-service and a number of certificates obtained after fulfilling certain safety courses.

4.1 TRAINING MATRIX CARGO SHIPS								PRELIMINARY VERSION 01/2001					add. for TANKERS	
TRAINING	familiarization (ship specific)	basic training	proficiency in survival crafts etc.	proficiency in fast rescue boats	advanced fire fighting for seafarers	ship's health care B	ship's health care O (*)	ship management	radar observer	radar navigator	Marcom A GOC (**)	Marcom B (ROC)	tanker familiarization	specialized training programme
Guide on Training... chapter 5, paragraph	5.1	5.2	5.3a	5.3b	5.4	5.5	5.6	5.7	5.8a	5.8b	5.9	5.10	5.11	5.12
Holdlers of Dutch diploma's only														
COMPETENCE:														
master														
chief mate														
watchkeeping officer														
chief engineer														
2nd engineer														
watchkeeping eng.														
1st maritime officer														
maritime officer														
ship's cook														
ratings														
validity in months	n.a.	s.s.	s.s.	60	60	60	60	n.a.	n.a.	n.a.	n.a.	n.a.	n.a.	s.s.

LEGEND:

- = initial training as part of the curriculum of nautical colleges in the Netherlands
- = applicable to ships certified for an unlimited area (GMDSS sea areas A3 and A4)
- = required for at minimum 2 officers in charge of a navigational watch (presently all officers in charge of a navigational watch)
- = mandatory
- = mandatory only for designated crew (according to the vessel's manning plan or muster list)
- = not applicable to certificates of competence < 3000 GT and/or < 3000 kW
- = not applicable
- = no refresher training required in case of 1 year sea service during the past 5 years

Training matrix in accordance with 1995 STCW-treaty. The table shows an overview of required exercises for working on passenger ships, safety exercises are included. The table is made by the Royal Association of Dutch Owners (KVNR), in collaboration with the Association of Dredging and Civil engineering companies (VBKO) and the Shipping Inspectorate. The data in the table has a temporary status and is based on the situation in the spring of 2002. The matrix for cargo ships is somewhat different. No training in handling large groups of people in emergencies is included here.

4.2 Tests and drills.

To respond fast and efficiently in case of an accident, people need to be trained. Regular drills, fire-drills, and abandon-ship drills, have to be carried out, and are compulsory. It is important that the drills are as realistic as possible. On completion of the drill an evaluation has to be made, where the shortcomings of the group or the individuals are to be discussed, and, if necessary, some theory is reviewed. The drills are to be entered in the ship's logbook. Drills on board with liferafts is difficult. That has to be done at shore institutes. The same counts for distress signals.



Boat drill



Fire drill

Exercise	How many times?
Abandon ship	Monthly
Fire-fighting	Monthly
Man over board	Monthly
Emergency Steering	Once every three months

4.3 Personal safety gear

During normal daily work, also safety measures have to be taken. Personal safety items for normal work are: Safety helmet, Ear-protection, Eye-protection, Gloves, Safety-shoes, Coveralls, Lifebelt, etc.

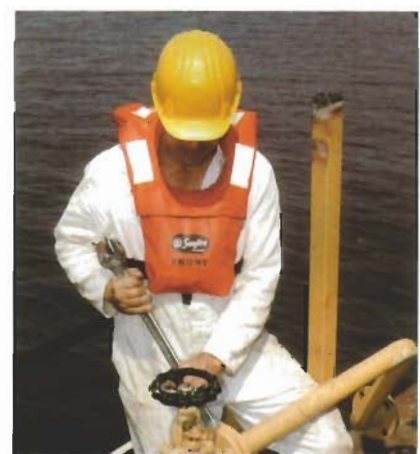

Safety helmet and a self-inflating life jacket. This life jacket can only be used during work.

MARS 200031

Saved by a Safety Helmet

A 2nd Mate was in charge on the deck of a ship which was at anchor and loading containers from barges. As a container was being loaded on to the 3rd layer by stevedores a twistlock fell from a height of about 8 metres. It hit the 2nd Mate on his helmet and touched his body causing an abrasion on his chest and a contusion on his left thigh. Because of the heavy impact on his head he was sent ashore to see a doctor.

An X-Ray was taken and he was declared fit to return to the vessel but put on light duties. This emphasises the importance of wearing personal protective equipment, without his helmet the 2nd Mate would probably have died.



Some examples of filter masks. The left one also protects the eyes from poison.



Water and chemical proof boots

Working with cargo, requires the relevant safety measures related to that cargo. Especially when working with chemicals. Often special suits have to be worn, special gloves and boots, breathing apparatuses, etc.



Testing the foam pump on a tanker



Arrows of direction



Lighting system



Pipe with colour code and arrows indicating the direction of the liquid flow

4.4 Tankers

For tankers there are special safety measures, like additional fire-fighting systems, such as foam to cover the deck; fire and / or explosion prevention by inert gas above the cargo, alarms for full tank or risk of overflow, and special safety measures for the cargo-pump room.

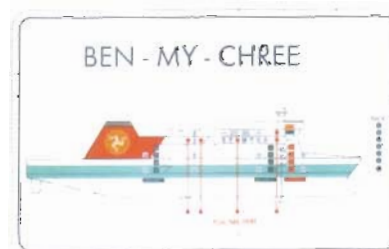

Sticker showing your position on board



Entrance door with name and technical marking

4.5 Markings

Many items on board ships are identified by markings, often stickers. All safety gear, wherever stored, has to be indicated by a sticker. Escape routes are pointed out by a sticker,

Near the life rafts instructions on how to use the life rafts are to be displayed, i.e. preparation and launching.

Markings should make something clear in a simple and fast way. For instance, on ships carrying passengers station numbers are useful for orientation of the passengers on the ship. However, the markings are important for both crew and passengers in case of an emergency. The markings show the exits and the location of life-saving appliances. This is made easier by the use of arrows on the walls or a lighting-system for passengerways and staircases. These escape route markings (green) in the accommodation are compulsory according to the IMO-regulations. Not only the escape route must be marked, but also all means of safety. The markings on these should be photoluminescent. This means that they light up when no light shines on them.

There are pipes running throughout the ship, most of them in the engine room. A large variety of liquids is being pumped through these pipes and in the interest of safety it should be clearly indicated what liquid runs through what pipe. This is not only important for the crew, but also for people less familiar with the ship. To achieve this all the pipes have a colour (either paint or coloured tape) that stands for the liquid in that pipe.

Farbcode: Colour code:	Farbe: Colour:	Medien (allgemein): Media (general):
BU Blue		Frischwasser Fresh water
GN Green		Seewasser Seawater
SR Silver		Dampf Steam
RD Red		Feuerbekämpfung / Feuerschutz Fire fighting / Fire protection
YEO Yellow-ochre		Enflammable Gase Flammable gases
WH White		Luft im Ventilationssystemen Air in ventilation systems
BN Brown		Kraftstoffe Fuels
OG Orange		Oil (nicht zum Kraftstoffgebrauch) Oil other than fuel
VT Violet		Sauren, Laugen Acids, alkalis
GY Grey		Nichtbrennbare Gase Non flammable gases
MN Maroon		Medien (trocken und feucht) Masses (dry and wet)
BK Black		Abwasser / Abgase Waste media
FD		Fließrichtung Flow direction

Colour code for pipes

There are many large and small rooms and spaces on a ship. In general each has a door or an entrance hatch. But before the door or hatch is opened, it is important to know what is in that particular space, especially at night or in bad weather. This is why every door or hatch carries the name of the room behind it, sometimes with some technical marking.

5 Global Maritime Distress and Safety System (GMDSS)

5.1 GMDSS

GMDSS is legally required, as agreed upon in the SOLAS 74 Amendment in which the distress and safety radio traffic is regulated. All passenger liners and ships larger than 300 GT are obliged to have GMDSS. GMDSS ensures that, irrespective of the ship's location, reliable shore to ship and ship to shore communication is possible using radio and/or satellites. All information regarding transmitting and receiving, and the frequencies used, can be found in the "Admiralty List of Radio Signals", Volume 5. GMDSS also includes the NAVTEX receiver, which receives and prints weather forecasts and warnings as

well as distress messages, and watertight (GMDSS) walkie-talkies for communication in case of distress.



SART attached to the liferaft

5.2 SART (Search and Rescue Transponder)

Life rafts and lifeboats are difficult to see on radar because of their poor radar-reflecting properties. To overcome this problem, a device (SART) has been developed that, on receiving a radio signal, answers by transmitting a radio signal of the same frequency. This makes the life raft or lifeboat visible on the radar screen. When the ship is evacuated, one individual, indicated on the Muster List, is responsible for bringing the SART from the bridge, to the life raft or lifeboat. The SART has a range of approximately 30 miles.

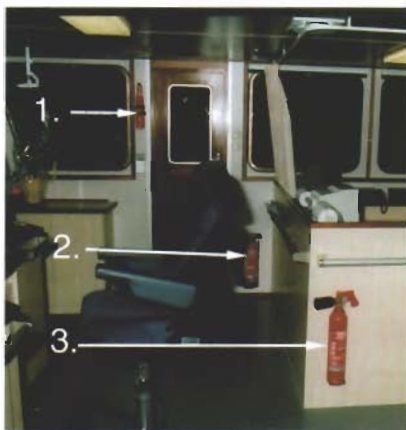

Bridge, starboard side

1. SART
2. Powder extinguisher
3. CO₂-extinguisher 2 kg

5.3 EPIRB (Emergency Position Indicating Radio Beacon)

The EPIRB is of use in case the ship is sinking so fast that the crew does not have the time to warn the world of the disaster. As in the case of the life raft, the water pressure will activate a hydrostatic release and the EPIRB will rise to the surface. As soon as the EPIRB is activated it will start to transmit the MMSI-number* of the ship to a satellite which, in turn, will warn a ground station. The ground station then warns the nearest coast guard station. (*MMSI= Maritime Mobile Ship's Identification)

The coast guard will direct ships and aeroplanes as soon as the approximate position of the ship in distress is determined. When the EPIRB starts transmitting, a bearing can be taken and the position can be determined.



Aft side of the bridge

1. EPIRB
2. Life buoy with light and smoke signal

6. Pyrotechnics

A visual form of communication are the Distress Signals:

Red Parachute Signals, must be available in or near the wheelhouse (12) and in each lifeboat (4). They are rockets, which can be fired out of hand, and can be seen from a great distance. To be fired in the hope somebody notices. The general meaning is: I need help.

Hand flares, in lifeboats (6) and rescue boat (4). These are very bright burning torches, which are to be held in then hand. Used to draw attention, or to let know the own location.

Smoke signals, in each lifeboat (2). A tin can, when lit to be put in the water. They remain afloat and produce a thick orange smoke, clearly visible from airplanes.

Line throwing apparatus, 4 pieces in or near the wheelhouse. These are rockets, which when fired by a gun, draw a long thin line behind them. The purpose is to shoot a line to another ship, as a first step to esta-



Parachute light



Hand torch



Smoke signal



Linethrowing apparatus (four in one box)

blish for instance a towing connection. With the thin line a somewhat heavier line can be pulled in, connected to a hawser.

CHAPTER 16

Stability

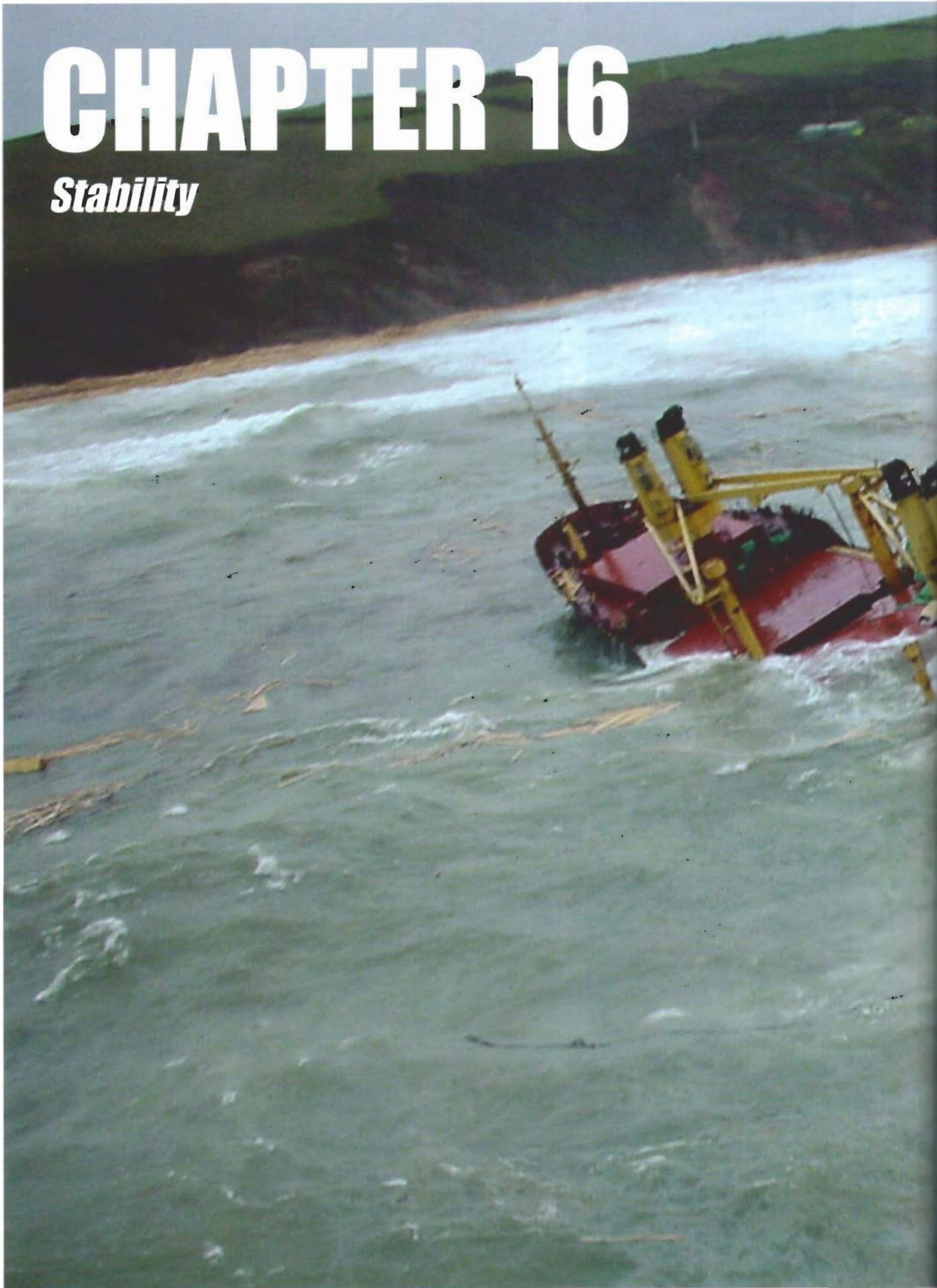

1. Introduction

2. Intact stability

3. Stability of damaged ships

4. Rules and regulations

5. How to take damage stability into account on board.



SHIP KNOWLEDGE

A MODERN ENCYCLOPEDIA

SHIPWISE

PAGE 8 1

THE SHAPE OF A SHIP

PAGE 22 2

SHIP'S TYPES

PAGE 44 3

THE BUILDING OF A SHIP

PAGE 68 4

FORCES ON A SHIP

PAGE 82 5

LAWS AND REGULATIONS

PAGE 104 6

CONSTRUCTION OF THE VARIOUS SECTIONS

PAGE 126 7

CLOSING ARRANGEMENTS

PAGE 160 8

LOADING GEAR

PAGE 174 9

ANCHOR AND MOORING GEAR

PAGE 196 10

ENGINE ROOM

PAGE 216 11

PROPULSION AND STEERING GEAR

PAGE 244 12

ELECTRICAL INSTALLATIONS

PAGE 266 13

MAINTENANCE AND DOCKING

PAGE 280 14

SAFETY

PAGE 302 15

STABILITY

PAGE 322 16

CHAPTER 16 QUESTIONS

VISIT

WWW.DOKMAR.COM

1. Introduction

Why does a ship float in spite of being constructed from heavy materials like steel? The reason for this is that the gravitational force that pulls the ship downwards is balanced by the upward water pressure on the hull. Of course a prerequisite for this is that the ship is watertight below the waterline. When the weight of the ship becomes so large that the upward pressure is less than the actual weight, the ship will sink.

The water around the ship exerts a force on the ship that is directed perpendicular to the water surface. If the ship floats, this force equals the weight of the water that is displaced by the ship. This is called Archimedes' law which states that an object that is totally or partially submerged in a liquid, experiences an upward force that equals the weight of the liquid displaced.

The magnitude of the upward force depends on the volume of the ship's underwater body. The displacement resulting in an upward force is called the buoyancy. If the ship has only buoyancy and no spare buoyancy above the waterline, then the slightest increase in weight of the ship would cause it to sink. It is therefore very important that the ship possesses a certain amount of spare buoyancy. The spare buoyancy comprises all cargo and engine spaces above the waterline, but also the accommodation, deckhouses and other deck erections. All the spaces that contribute to the spare buoyancy must meet the demand that they are watertight or can be closed watertight.

2. Intact stability

Ships are designed to float upright.

Stability is the ability of a totally submerged or partly submerged body floating upright, when brought out of balance, to come back to the upright position when the reason for the list does not longer exist.

Difference is made between longitudinal stability and transverse stability. The longitudinal stability is normally sufficient, so it will not be

taken into consideration here. We will look at transverse stability only. When in the following the word stability is mentioned, transverse stability is meant.

Stability for small list angles of 6 degrees is called Initial Stability.

When a floating body is brought in a listing position, without adding or removing weight, at the lower side of the body a buoyancy wedge is formed and filled, and at the high side a wedge is lost. When the volume of the submerged part during listing does not change, both wedges have the same volume.

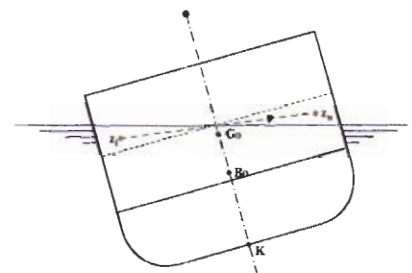

Due to the above wedges, the centre of buoyancy (B) of the whole submerged part is moving from the initial position towards the direction of the low side, where a wedge is formed, by the formation and loss of the wedges. The locations of B at

Metacentre (M): The point the virtually suspended ship is attached to. If the centre of gravity G is located below M, then the stability is positive. If the centre of gravity G is located above M, then the stability is negative. The ship runs a great risk of capsizing as a consequence of the latter. The distance between M and B (see below) depends on the draught and the width of the waterline.

varying angles are all on a virtual curve.

A body can be brought to a list in all directions. Not only transversely or longitudinally. We only look at two models, transverse and longitudinal, which are at right angles to each other, and we look at a ship's body.

When looked at the transverse model, the body, now a midship section of a normal ship, is brought to a list (ϕ), with a small angle. The buoyancy force has a vertical direction, a vector, originating in B, and pointing upwards, perpendicular to the waterline. Where this line crosses the plane of stem and stern, (the midships plane, centreline plane) the Transverse Metacentre point (M) is found.

For each angle of list there is a Metacentre Point. At a larger angle, the position of M can be significantly different from that at a very small angle.

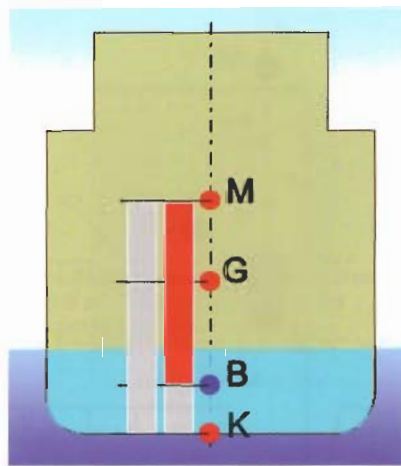
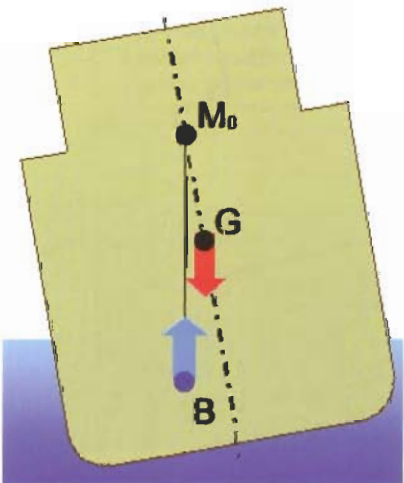
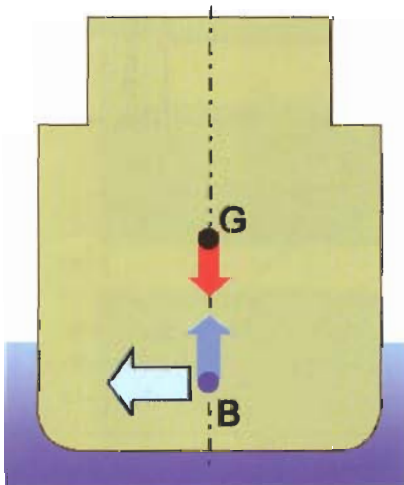

$$MB = I_b / Vol$$

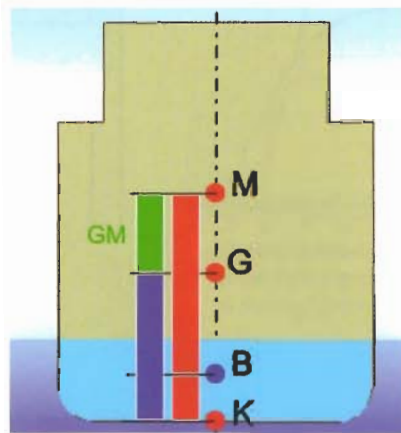

$$MG = MB + BK - GK$$

For calculations, the location of M can be found with the formula:

$$MB = I_b / Vol$$

MB is the vertical distance between the centre of buoyancy (B) and the metacentre point (M),

I_b is the transverse moment of inertia of the waterline,

Vol is the volume of the submerged part, the displacement.

Both can be found in the hydrostatic tables of the vessel. Or they can be calculated of course. These calculations can be found in more specific books.

We need to know the value of MG, because that distance is a measure for the righting lever. From G, the centre of gravity of the ship, the weight of the vessel is working downward, as a vector. The buoyancy, a vector through B working vertically upwards, goes through M.

The MG value is found from:

$$MG = MB + BK - GK$$

BK can be found in the hydrostatic tables, which have to be on board.

GK has to be calculated from GK-empty-ship (found in the ship-builders particulars) plus the total influence of all the added weights.

Added weights are cargo, fuel, water, ballast, personal belongings, food, etc., everything not belonging to the empty ship.

MG can be positive (M above G), negative (M below G) or zero (M = G). Please note that we are talking about initial stability, very small angles of list.

When MG is negative in upright position, at a larger angle the value can become positive. Again it does not necessarily mean that the ship is going to capsize.

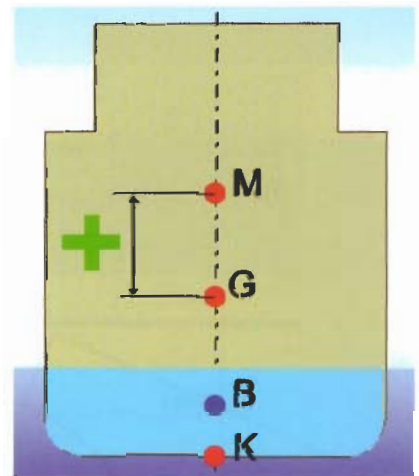

MG is positive in this drawing

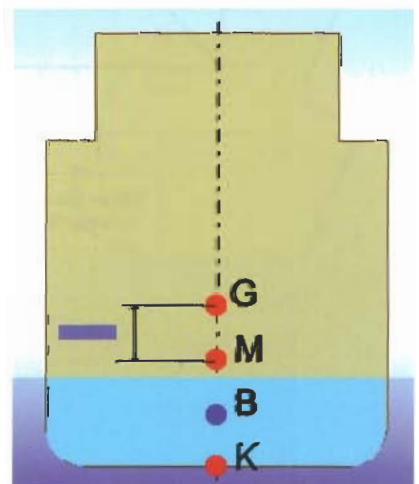

MG is negative in this drawing

The length of the lever is

$$GZ = MG \sin(\phi)$$

This is called the static lever of initial stability.

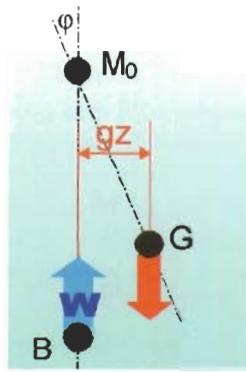

$$GZ = MG \sin(\phi)$$

These levers can be calculated for various angles. The curve of these levers is called 'curve of static levers', values in m. When multiplied with the ship's weight P, in the particular condition, in metric tons, the curve is called 'curve of static stability', values in tm.

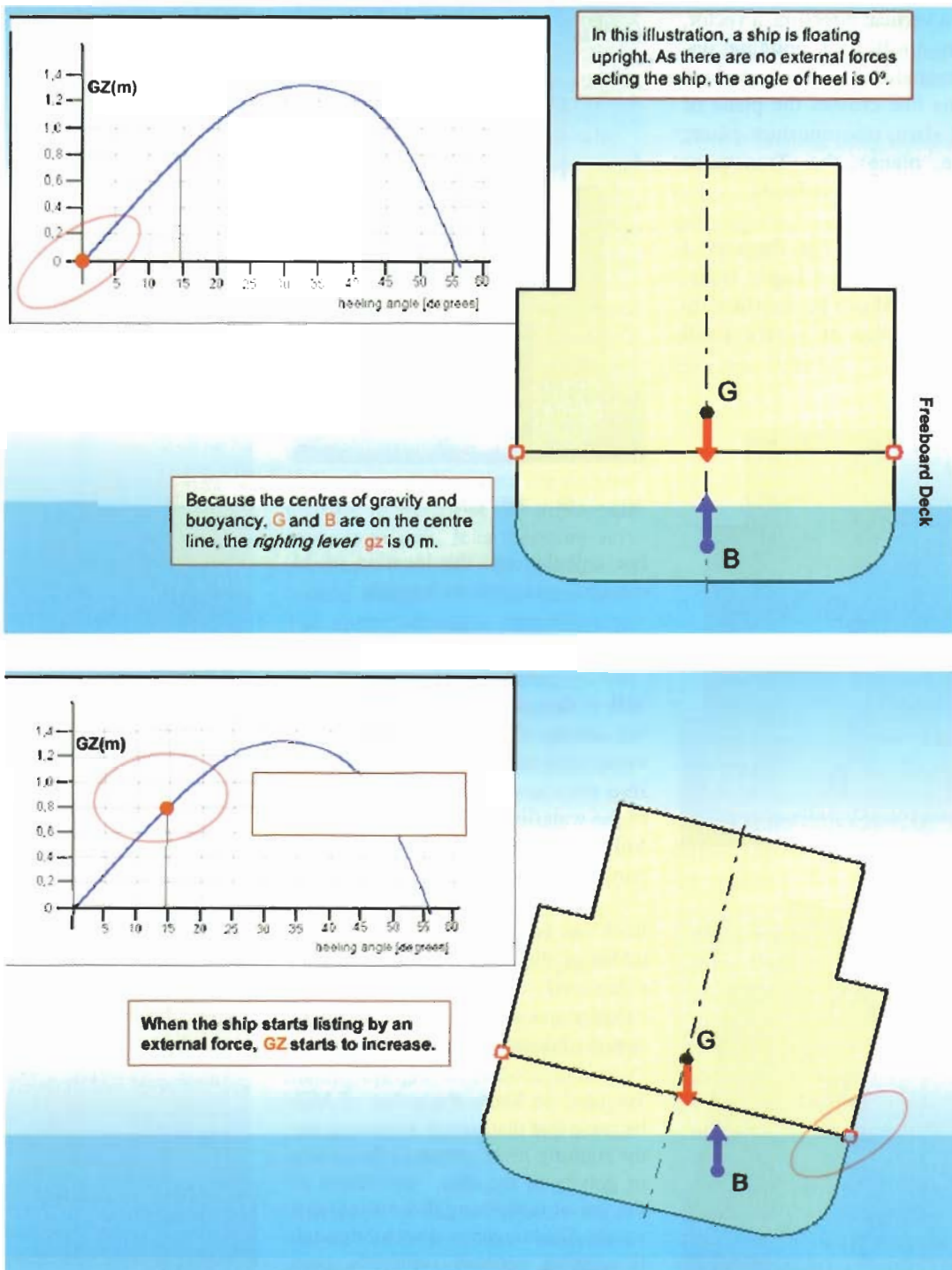

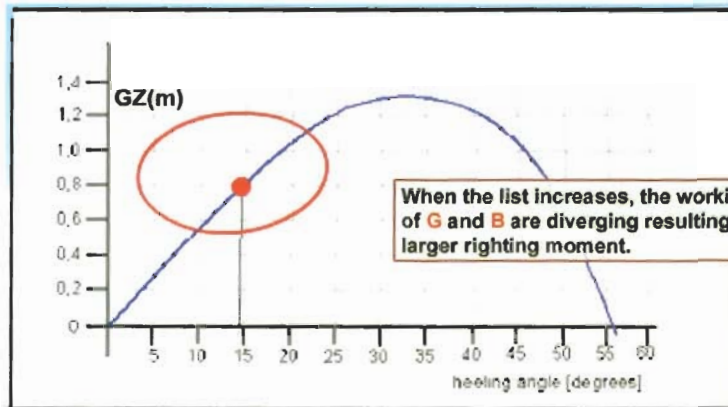

When the list increases, the working lines of **G** and **B** are diverging resulting in a larger righting moment.

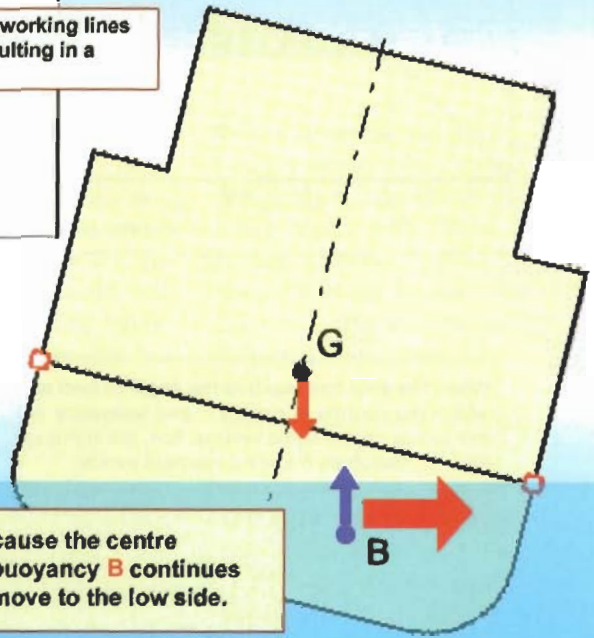

Because the centre of buoyancy **B** continues to move to the low side.

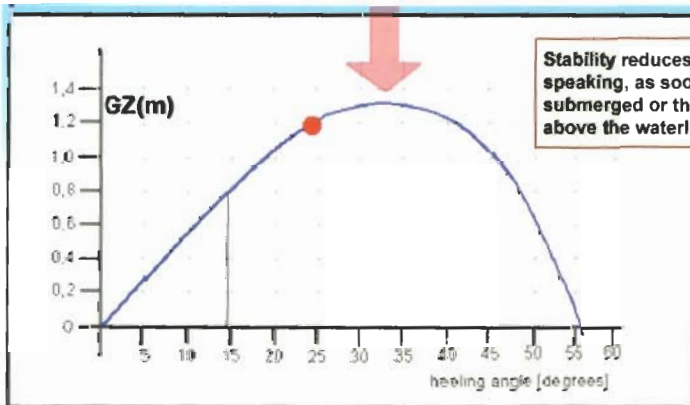

Stability reduces, generally speaking, as soon as the deck is submerged or the bilge rises above the waterline.

In this phase the bilge rises out of water resulting in a decrease in the water plane area and also in the **BM**.

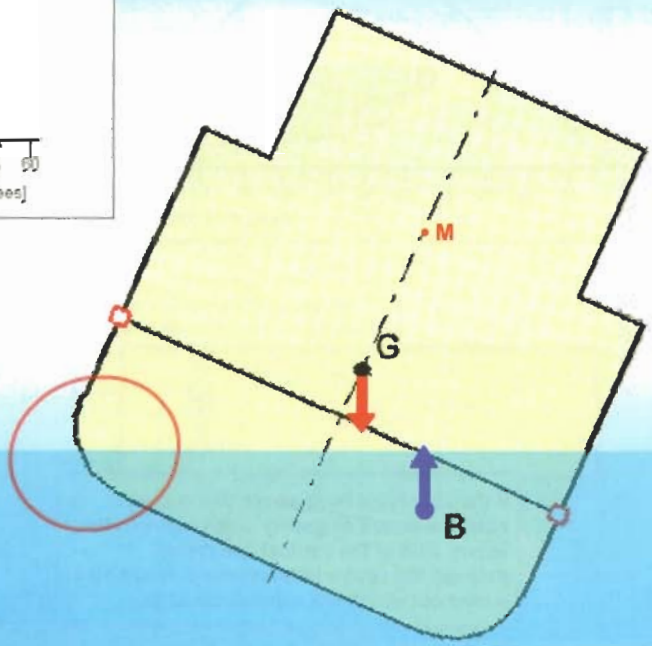

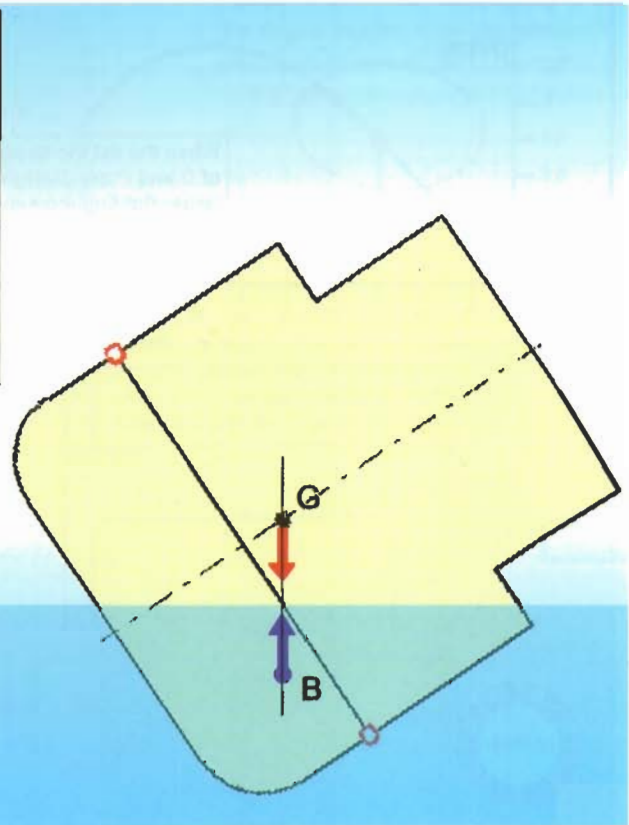
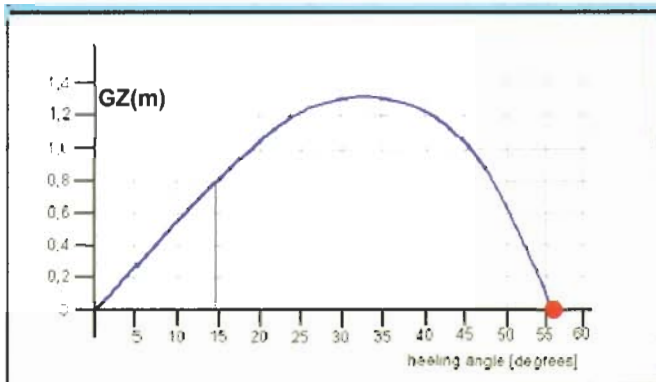

When the ship has reached the angle of heel at which the centres of gravity **G** and buoyancy **B** are acting on the same vertical line, the righting lever **gz** becomes 0 and no moment exists.

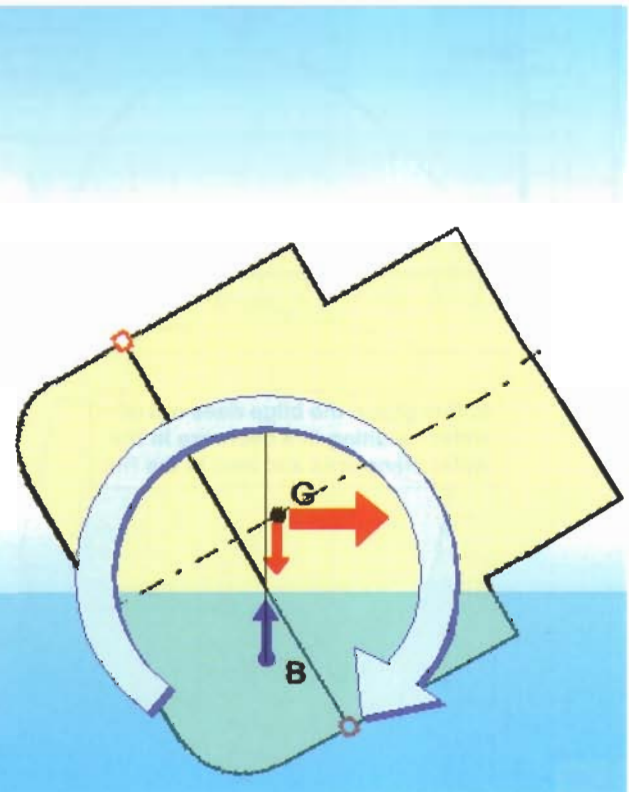
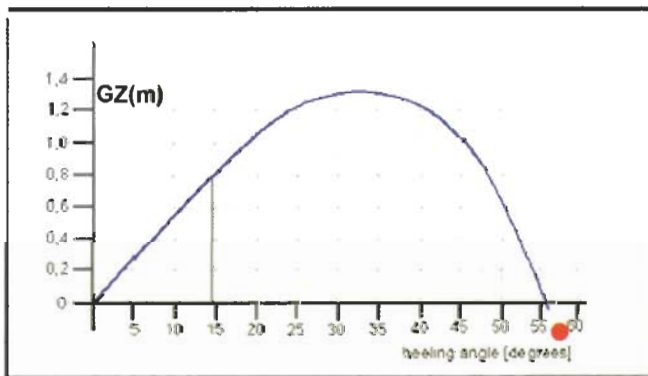

If the ship is inclined above this angle of heel, the centre of gravity **G** will move to the wrong side of the vertical line drawn through the centre of buoyancy **B** resulting in a moment which will capsize the ship.

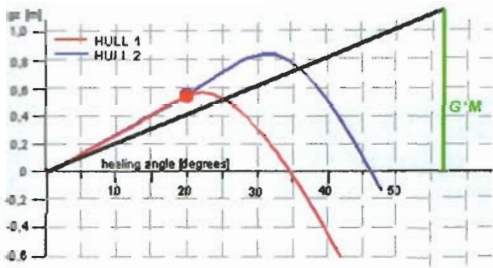

Higher ships have higher stability

a

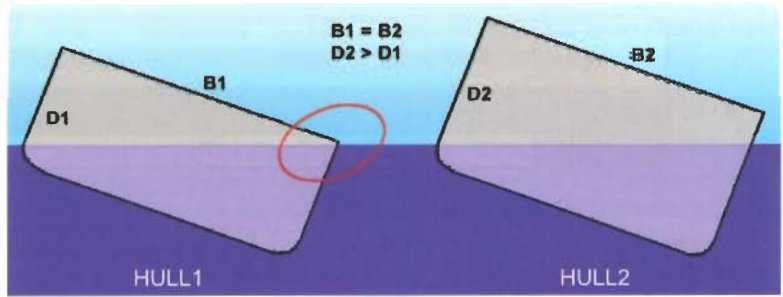

Both ships have the same GM value, but a different stability range (respectively 34° and 47°). The breadth is the same for both vessels. The depth of hull 2 is greater than the depth of hull 1.

Normal GM values are very much depending on the ship's type. Passenger ships are designed to have a low GM, 0.5 metre or so, to get a long rolling time for the sake of passenger comfort.

Bulk carriers loaded with ore have a very high GM, due to the centre of gravity of the cargo being very low. When loaded with grain or coal, the hold is full, and GM is lower. Tankers have similar values, where also the influence of free surface has to be taken into consideration. Wide ships with shallow draught like barges, or an empty tanker or bulk carrier, have

large initial stability. Narrow, slender ships, like passenger ships, or a large container-ships with deep draught and with a high freeboard have a small initial stability. This results for the wide ship in short rolling hauls, and for the narrow ship in long hauls. However, when at the wide ship the deck is immersed, the stability reduces fast, whereas with the narrow ship, with a high freeboard, the stability only gets larger. This as a result of the moment of inertia of the waterline, reducing in the case of the barge, and getting larger in the case of the passenger ship.

During design this all has to be taken into consideration and carefully calculated and all the possible cargo and ballast conditions have to be checked for.

Positive influences on stability:

A higher beam at the waterline means a much higher moment of inertia, and thus a higher MB. When ships are lacking stability, often so called blister tanks or sponsons are added, making the ship wider over the length of the parallel midbody.

Negative influences on stability:

Heavy deck cargo brings G up. In freezing conditions with fog or spray, ships with many masts and derricks could suffer from 'icing': deposits of ice on high locations bringing G to dangerously high levels. Fishing ships have capsized due to icing. Heavy pieces of cargo hanging in a ship's crane cause stability problems. Free surfaces of liquids in compartments can have a large negative influence. A relatively thin layer of seawater on a RoRo cargo-deck can, when the ship rolls, run all water to

Consider a ship with a car deck seen in the picture.

At first water is added on the car deck.

The influence of this can be seen directly from the GZ-curve.

500 m³

Heeling angle [degrees]	GZ [m] - No Water (Red)	GZ [m] - With Water (Blue)
0	0.0	0.0
10	0.4	0.4
20	0.7	0.7
30	0.9	0.8
40	1.0	0.9
50	0.8	0.6
60	0.4	0.2
70	0.0	0.0

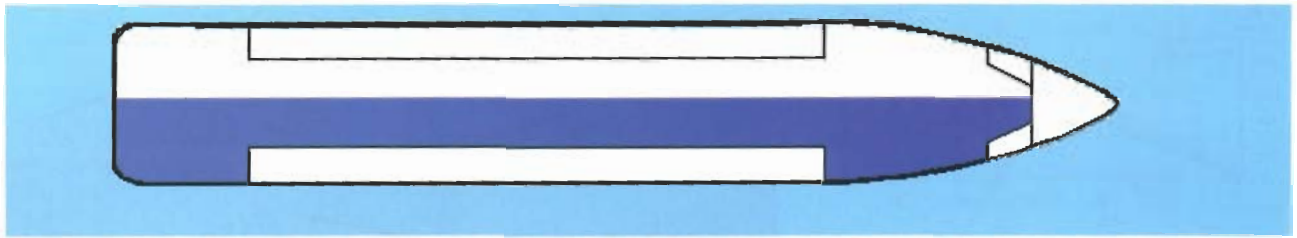

Next, the amount of water on the car deck is increased at a constant rate.

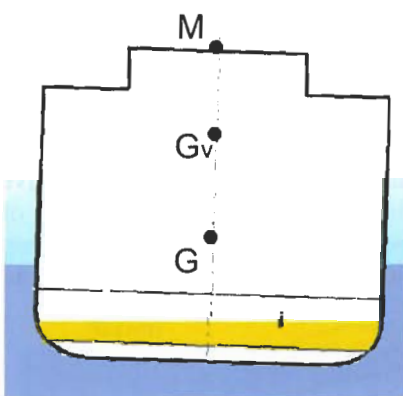
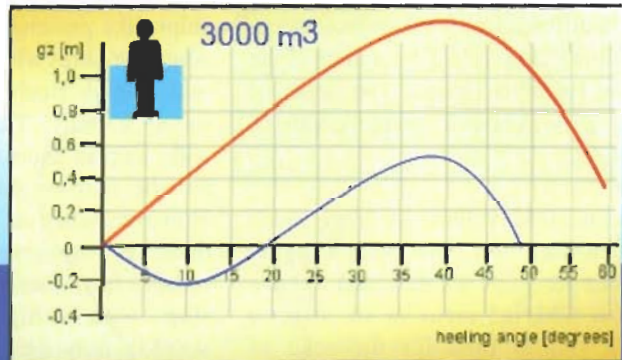
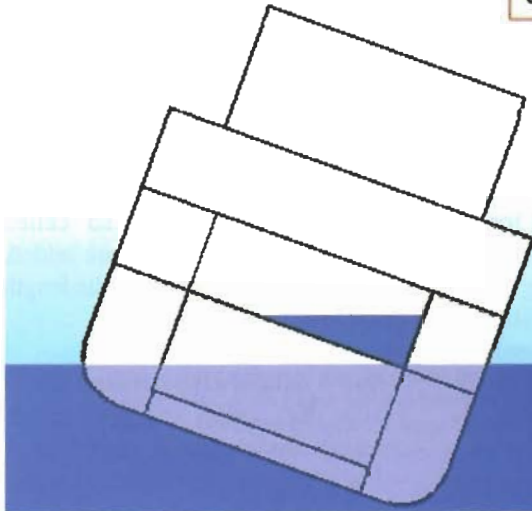

$$GG_v = \frac{i}{V}$$

$$i = \frac{LB^3}{12}$$

i = moment of inertia of the free surface area of water on deck
 L = length of the cardeck
 B = breadth of the cardeck

one side, bringing the centre of gravity of the 'cargo' to the ship's side, and bring the ship into danger. Tankers therefore always have longitudinal bulkheads, to limit the sideways movement of the centre of gravity of the content of each tank.

A major negative effect is caused by a hole in the ship. Due to a collision or some other event a leak may be caused and water can flow into the ship, creating a free liquid surface.

3. Stability of damaged ships

Suppose that a ship never can get a leakage. This would mean that the ship can do without additional measures like transverse and longitudinal watertight bulkheads, dividing the ship in watertight compartments. If a ship gets a leakage, but does not list or trim due to this leakage, this ship would sink slowly, upright, but would not be in immediate danger. However, usually the incoming water does not distribute evenly but will move in port- or starboard direction, thereby pushing the ship over. This listing can happen so fast that it can capsize the ship in a matter of minutes. In recent years there have been fatal accidents

with Ro-Ro carriers where water entered the ship after a ramp had been smashed away by the sea. The consequence of a leakage is influenced by the permeability of the space. If the compartment is filled with objects which absorb little or no water, little or no additional water can flow in.

A Ro-Ro ship which has capsized because the incoming water was allowed to flow freely across the entire width of the ship. The ship did not have watertight bulkheads in order to allow the cars to move freely to the stern of the ship unhindered. This has disastrous consequences in case water flows in.



Below a short explanation follows of the preceding. The water (a liquid) that can flow from port side to starboard side is in fact a weight ($1 \text{ m}^3 \text{ water} = 1 \text{ ton water}$) that exerts a turnover force on the ship. If the liquid inside a tank or hold can move freely, this is called the free surface effect, which will cause a turn over moment.

Permeability:

The extent to which a compartment can be filled with water is the permeability. The effect of incoming water on the stability will be:

- maximal if the compartment is empty (permeability = 1)
- minimal if the compartment is completely filled with for instance Styrofoam or a liquid. (permeability = 0).

The permeability of an engine room is approximately 0.85. The higher the permeability of a compartment, the more volume can be occupied by leakage, the lower the remaining buoyancy.

This is further explained in the (exaggerated) drawings shown below.

NB: The list drawn is a random picture of a complete roll of the ship. This roll (from port side to starboard side etc.) lasts only a few seconds and can be caused by waves.

Turn over moment:

A turn over moment usually causes a list. This can be caused by:

- shifting cargo
- loading and discharging of heavy loads with a crane
- waves
- a collision
- water on deck

Explanation of the abbreviations used in the below drawings:

- G = Centre of gravity
- Bo = Centre of buoyancy (no list)
- Bφ = Buoyancy by heel to port or starboard (external force)
- Bφ = Buoyancy by list to port or starboard (internal force)
- Mo = Initial metacentre
- GM = Metacentrec height
- KM = The height of initial meta-centre above the keel
- K = Keel
- D = Displacement (D)
- F = - Displacement (-D)
- φ = heeling angle
- GoG'' = virtual loss of GM
- GZ = lever GZ, righting lever, the horizontal distance between the centre of gravity and the vertical through the centre of buoyancy.

Moment of static stability
 $= D \times GZ = D \times GM \sin \varphi$

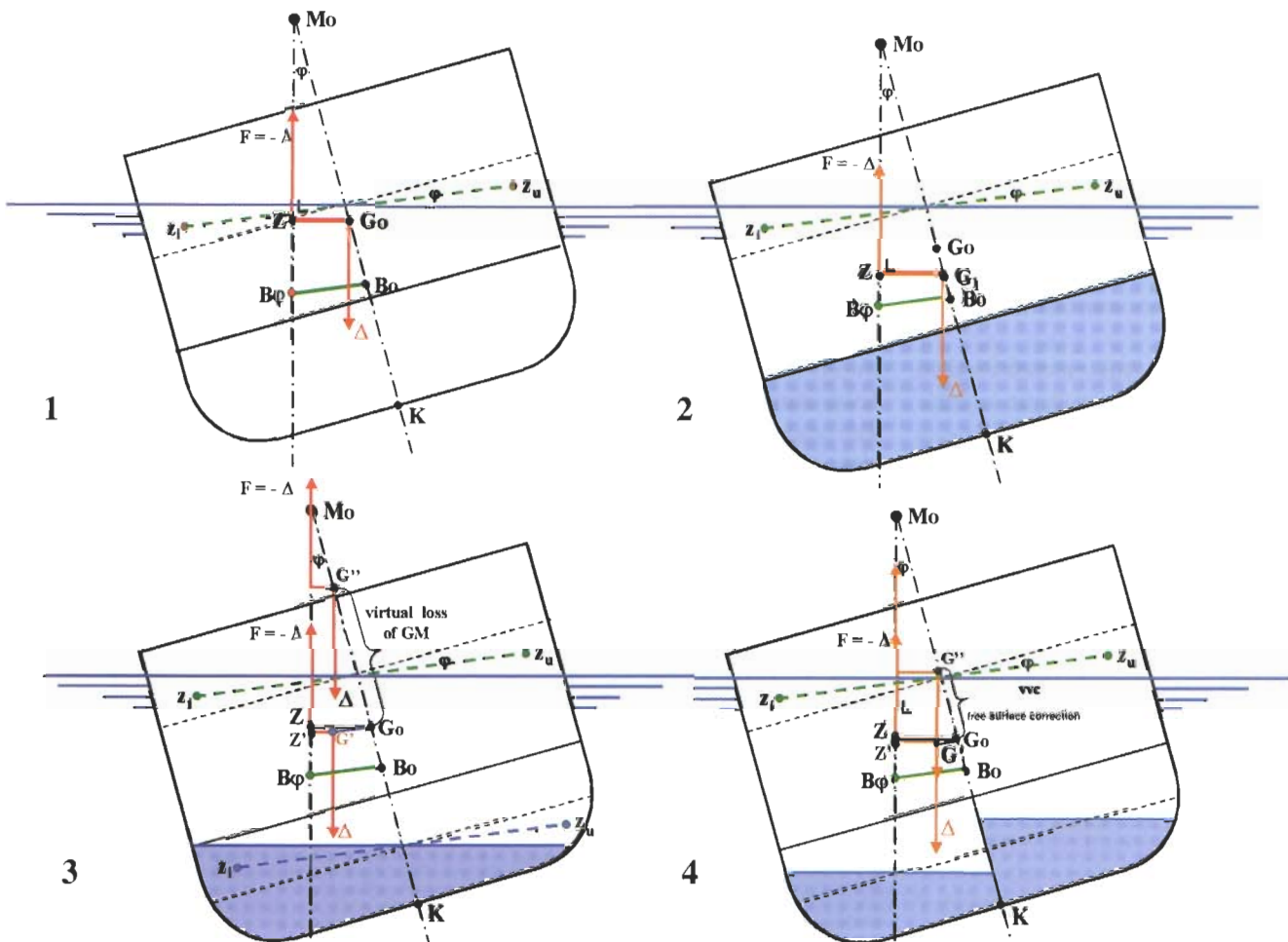

The magnitude of the translation of G depends on:

- the length of the flooded hold or tank
- the width of the flooded hold or tank

If the distance along which the liquid can move in the athwart direction is halved by a bulkhead (see drawing 4), then the negative influence on the stability will be reduced significantly. In drawing 4, the translation of G is only 1/4 of the situation depicted in drawing 3. The distance GG_1 can be calculated with the formula:

$$GG_1 = \frac{\text{Length tank} * (\text{Breadth tank})^3}{12 * \text{vessel displacement}}$$

The magnitude of a moment is determined by a force (weight) and the distance of that force to a fixed point. Example:

1. A child (30 kilos) and his father (60 kilos) are sitting on a seesaw. The distances to the turning point of the seesaw are 2 and 1 metres respectively. In spite of the difference in weight, both the father and the child exert the same moment on the turning point of the seesaw. (30x2 and 60x1 respectively). The seesaw is in equilibrium.

2. If a weight of 100 tons is moved 1 metre on a ship, the same effect on the trim can be achieved by moving 1 ton a hundred metres. In both cases the moment is 100 tm.

This illustrates how even a limited amount of liquid can cause a large moment on the ship if the liquid is allowed to move freely over the full width of the ship.

The above formula shows that the amount of water is not important.

Only the length and width of the compartment matter. Flooding of one or more compartments on a ship can have the following consequences:

- deeper draught
- list
- altering trim
- change in stability

All these changes start from the moment the water enters the ship.

The choice of (not) placing bulkheads for economic reasons deserves some attention. Some types of ships prefer not to have bulkheads because these hinder the transport of cargo or the loading and discharging. Examples of these ships are heavy-cargo ships and RoRo-vessels. In tankers however, the presence of bulkheads is important for the separation of different cargoes. The choice between watertight transverse bulkheads and centre line bulkheads is of lesser importance if both result in the creation of smaller watertight sealed spaces.

4. Rules and regulations

It is obvious from the previous section that the free-liquid surface resulting from a leak in a compartment should not pose a direct danger to the ship. The size of a compartment is therefore subjected to regulations as determined by the SOLAS-convention and the IMO. There are three types of regulations:

a. Calculations of submersion and trim.

This calculations check if there is enough spare buoyancy to keep the ship floating after a compartment has been completely filled with water*. The assumption was made that a ship sinks vertically as a result of the leakage. The spare buoyancy is enough to compensate for the increased draught. So the number and

SOLAS vs IMO

The SOLAS-treaties must be incorporated into the national laws. The IMO-regulations are optional. However, in practice most nations also incorporate the IMO-regulations into their national laws.

In the past, many computational methods have been used to determine the number of bulkheads on a ship that are necessary for the safety. These are called damage stability calculations.

the positions of the bulkheads were related to the buoyancy and the spare buoyancy**. After the Titanic disaster these calculations were implemented by SOLAS. The experiences of the Second World War proved that these SOLAS-rules were not adequate because of the assumption that a ship sinks vertically. Instead, many ships first capsized before sinking.

*The reason was that a ship with leakage must not submerge below the maximum immersion line. This is an imaginary line on the hull that runs 76 mm below the bulkhead deck. The bulkhead deck is the first deck above which the bulkheads are not watertight. This deck should remain above the waterline across its entire length, thus preventing leakage from leaky compartment into others resulting in the sinking of the ship. It is assumed that the ship sinks vertically, that is, without list.

**The maximum distance (floodable length L) between two watertight bulkheads is calculated for a large number of points P going from the aft to the fore. Every space that is created in this way has the point P at half this length. The volume of these compartments is chosen in such a way that

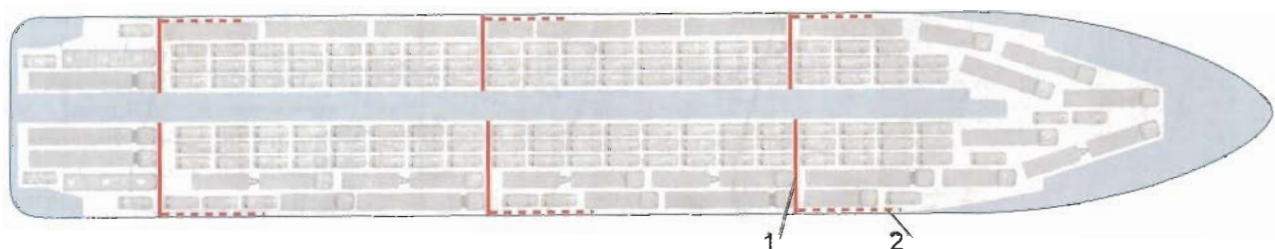

Car deck of a Ro-Ro with doors to reduce the free surface of any liquid flooding the deck.

1. The doors in closed position
2. The doors in stored position

the ship has enough spare buoyancy after the compartment has sprung a leak. The ship submerges a little but the bulkhead deck remains above the maximum immersion line. In order to get a quick view of the maximum distance between the watertight bulkheads across the entire length of the ship, the lengths L are plotted vertically in the points P. The resulting curve is called the Bulkhead Graph.

Distance from APP in metres	Floodable length in metres
00.00	20.32
05.00	10.32
10.00	11.35
15.00	13.42
20.00	17.56
25.00	17.09
30.00	11.54
35.00	09.14
40.00	08.96
45.00	14.06
50.00	24.02
53.75	31.52

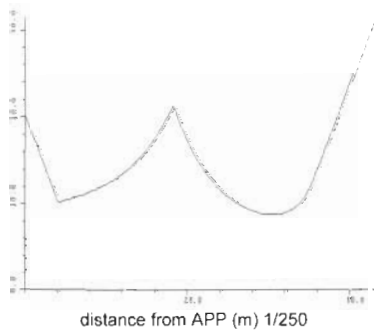

Bulkhead Graph (graph of floodable lengths)



Produced by M. Straten, Nijmegen

A (shortened) calculation of the floodable lengths, beginning in the aft perpendicular and the resulting bulkhead graph is shown below. The table and the curve are for the yacht depicted below.

Depending on the regulations, the ship shall be able to survive a one-compartment damage or a two-compartment damage. A two-compartment damage can occur if the ship is struck at a bulkhead separating two compartments. The combined length of the two compartments should then be smaller than the floodable length to survive the damage.

b. Calculation of floodable lengths. (trim and stability in case of a leak, assuming certain well-defined types of damage)

A drawback of the method described in a. is that a possible list is not taken into account. The method described here (b) to determine the number and positions of the bulk-heads does take the loss of stability into account and also assumes some well-defined types of damage. These calculations are called deterministic leakage calculations.

A drawback of this method is the exact definition of the damage. A ship that is designed by this method can live up to all the demands, but still sink if the damage is 1 cm bigger than the model assumes.

c. probabilistic leakage calculations (Calculations of the chance of surviving in case of damage)

This method tries to capture the possibilities that the damage is greater than assumed in the model. A probability is assigned to every type of damage, as is the probability of

surviving this damage. The sum of all these probabilities is a number between 0 and 1 and represents the chance of surviving in case the ship is damaged. The regulations derived from this method also include a minimum survival chance. These probabilistic leakage calculations currently apply to:

- passenger liners (IMO resolution A265) as an alternative to the SOLAS rules (resolution A265 still encompasses some deterministic rules)
- cargo ships with dry cargo, longer than 80 metres (measured over the closed hull).

In order to estimate the centre of gravity of the leakage, a number of uncertain parameters are of major importance. For instance:

- What positions does the water, occupy, especially in rooms with an irregular shape.
- Trim. List
- The possibility of trapped air-bubbles.

5.How to take damage stability into account on board.

The stability must be calculated for every voyage the ship makes, and of course the stability has to fulfil the various rules and regulations. The weight distribution can differ per trip as can many other parameters. Factors that are of importance to the damage stability are:

- kind of cargo (permeability)
- wing and double-bottom tanks; filled or empty
- does the liquid stay in a leaky tank or does it flow out?

A lot of calculations and thorough knowledge of rules and regulations are required in order to determine the influence of all these factors. Furthermore, the chances of survival (probabilistic calculations) should also be incorporated into these calculations. In practice it is impossible to execute the calculations without the aid of a computer.

A computer with a loading programme is required on board if one wants to be able to do the calculations on the ship. After all the weight data have been fed into this computer, the position of the centre of gravity (G) above the keel (K) can be calculated.

The regulations concerning damage stability usually only mention the maximum allowed heeling angles. Sometimes the possibility of counter flooding is incorporated.

Counter flooding is (partly) filling a compartment or tank at the opposite side of the ship. Often used in passenger liners, even automatic systems are used.

The maximum KG is the number that indicates how high point G may be above the keel in agreement with the requirements made in SOLAS with regard to the stability of a ship.

NB: the maximum KG depends on the draught/displacement and these factors must be taken into account.

Index

Accommodation	155	Chain locker	205
Accommodation doors	169	Chain stopper	204
Accommodation ladder	171	Chase vessel	67
Aft ship	134	Chemical tankers	52
Air conditioning	156	Circuit breakers	274
Air draught	26	Clamps	214
Aircraft carrier	57	Classification	107
Alarm, fire	311	Coastal trade liners	48
Alloys	283	Coefficients	28
Aluminium	283	Combustion air	226
Amphibious	59	Communication	157
Anchor chain	201	Communication systems	277
Anchor equipment	198	Companion hatches	168
Anchor Handling Tug (ANT)	67	Construction plan	37
Anchor pockets	204	Contactors	274
Anchors	199	Container ships	48
Anodes	290	Controllable pitch propellers	250
Antifouling	292	Conventional type crane	181
Anti-heeling system	235	Conversion	301
Automation	276	Cooling	224
B/D	27	Copper	283
B/T	26	Corrosion	284
Ball valve	231	Corvettes	58
Ballast arrangement	235	Courses	316
Base line	24	Crane vessel	63
Bending moments	86	Cranes	177
Bilge keel	147	Crew boat	66
Bilge line	232	Crude oil tankers	51
Bilge water cleaner	233	Cruise ships	53
Bilge well	233	Cruisers	58
Block coefficient	29	Cutter suction dredger	57
Bollards	207	CWL	24
Breadth	25	Damage stability	330
Bridge	158	Day room	158
Bulbous bow	150	Deadweight	28
Bulk carriers	52	Deck line	24
Bulk crane	184	Delivery	80
Butterfly valve	231	Depth	26
Cabins	158	Derricks	185
Cable laying ships	57	Design department	74
Cable stopper	204	Destroyer	58
Cables	208	Detection	310
Camber	26	Diagonal stresses	96
Capacity plan	37	Diagonals	30
Capesize	52	Dimensions	25
Capstan	206	Displacement	27, 28
Car decks	191	Diving Support Vessel (DSV)	67
Cargo capacity	28	Docking	293
Cargo gear	176	Docking arrangement	297
Cargo gear registry	194	Docking plan	37
Cathodic protection	289	Docking stresses	96
Cattle ships	54	Documents	112
Cavitation	248	Doors	169
Certificates	107	Double bottom	140

Double hull tanker	132	GM	329
Dynamic Positioning (DP)	62	GMDSS	319
Draught	25	Gritblasting	287
Dredgers	56	Gross tonnage	27
Drilling ship	62	Guarantee	80
Drills	317	Guide pulleys	207
Drum	206	GZ	326
Dry-docking	295	Handy size	52
Duty deck	158	Hatch cradle	164
Duty mess	158	Hatches	162
Dynamic	84	Hawse pipes	204
Electric motors	272	Hawses	207
Electrical installations	269	Heat exchangers	228
Electrical rudder propellers	255	Heating	228
Electricity	227, 268	Heavy-cargo ships	50
Electro-chemical reaction	290	High-grade cables	209
EMC	271	History	46
Emergency generator	275	Hoisting diagram	186
Emergency towing system	208	Holds	128
End connection	213	Hook	213
Engine room	138, 218	Hospital	158
Engineering	74	Hydraulic folding hatches	167
Entrances	168, 171	Ice breakers	56
EPIRB	320	IMO	106
Equipment number	199	Impressed current	291
Excavated dock	294	Insulated and earthed distribution systems	269
Exhaust gas	226	Insulation	157
Extinguishers	307	Intact stability	324
Fast Attack Craft	58	ISM code	108
Feeders (container)	49	ISO	109
Ferry	53	Jack-ups	61
Fire	305	KG (GK)	325, 334
Fire fighting arrangement	243	L/B	26
Fishing vessels	54	L/D	26
Fixed Production Platforms	64	Landing craft	59
Fixed propellers	249	Launch	79
Flap rudder	262	Laundry	158
Floating dock	293	Leadways	207
Folding hatches	167	Length	25
Foreship	149	Lifeboats	312
Forecastle	149	Life buoys	316
Fouling	292	Life jackets	315
FPSO	64	Life rafts	314
Freeboard	26	Lighting	156
Fresh water	229	Lines plan	30
Frigates	58	Load control	179
FSO	65	Load curve	86
Fuel	224	Load line	24
Galley	158	Load testing equipment	212
Gangway	171	Loading gear	176
Gantry	186	Loading programme	88
Gas tankers	50	Local stress	96
General arrangement	72	Logistics	79
General arrangement plan	34	Longitudinal framing system	100
Generators	272	Longitudinal reinforcements	88
Globe valve	231	Longitudinal strength	84

Louvres	169	Prismatic coefficient	29
Low-speed engine	220	Production	78
Lubrication	225	Propeller blades	247
Maintenance	295	Propeller shafting	256
Manhole covers	170	Propellers	246
Mariner rudder	263	Proportions	26
Markings	318	Propulsion	218
MARPOL	107	Pumps	228
Materials	282	Pyrotechnics	320
Medium speed engine	220	Quarter	191
Meta-centre	324	Ram steering engines	264
MG	325	Ramps	189
Midship section coefficient	29	Reefers	50
Mine Counter Measure Vessels (MSV)	58	Refrigerated ships	50
Module	63	Register ton	27
Mooring gear	206	Repairs	299
Moulded dimensions	24	Rescue boat	314
Multi-purpose ship	48	Resistance	247
Multi-purpose Support Vessel	67	Revolving cranes	178
Mushroom shaped vents	170	Rigging	208
Muster list	312	Rise of floor	26
Natural rope	210	Roll-on Roll-off (RoRo)	53
NAV 1	271	Ropes	208
Navigation equipment	278	Rotary vane steering engine	265
Navy vessels	57	Rudder propellers	252
Nett tonnage	27	Rudders	260
Noise	229	Sacrificial element	290
Noise nuisance	156	Safety plan	37, 311
Nozzles	251	SART	319
OBO carrier	53	Seismic Survey vessel	61
Offshore	59	Self-tension winch	206
Offshore Patrol Vessel	58	Semi-submersible drilling unit	62
Ordinates	30	Semisubs	65
Paint	285	Shackle	213
Painting	286	Shafting	226, 256
Pallet crane	184	Shear	26
Panamax	52	Sheering forces	84
Panting stresses	96	Sheering stress curve	86
Patent slip	294	Shell expansion	37
Permeability	331	Ship lift	295
Perpendicular	24	Shuttle tanker	65
Personal safety gear	317	Side doors	168
Pilot ladder	171	Side loaders	188
Pipelaying barges	65	Side rolling hatchcovers	166
Pitch	246	Skeg	136
Pitching stresses	96	Slings	214
Planning	75	SOLAS	107
Platform Supply Vessel (PSV)	66	SOLAS vs IMO	332
Plimsoll mark	24	Spade rudder	262
Polyamide	209	Specialist knowledge	74
Polyester	209	Sprinkler	308
Polyolefines	210	Stabilising pontoons	186
Pontoon hatch	168	Standardised ships	70
Pontoon hatch covers	162	Stand-by vessel	67
Preliminary sketch	71	Starting devices	275
Pressure valves	170	Static	84

Steel	282
Steel wire rope	210
Steering engines	264
Stiffeners	98
Stiffening	98
Stores	158
Submarines	58
Support vessels	59
Survey drawings	34
Survival suits	316
Switchboards	273
SWL	212
Synthetic ropes	208
Synthetics	235, 283
Talurit clamp	213
Tank bleeders	170
Tankers	50
Tender	74
Tension Leg Platform (TLP)	64
Test	317
Thimbles	213
Tip plates	250
Torsion of the hull	96
Trailing hopper suction dredger	56
Transverse framing system	100
Trawlers	54
Trial test	80
Trim	25
Tugs	55
Turn of bilge	26
Turnbuckles	213
Turnover moment	331
Tweendeck hatches	169
UMS	271
Underwater body	28
Valves	230
Vent locking devices	170
Ventilation grills	169
Vents	170
Verticals	30
Vibration	229
Vibration stresses	96
Vibrations	155
Volumes	27
Waterjet propulsion	258
Waterline	24
Waterlines	30
Waterplane coefficient	28
Watertight doors	169
Weights	27
Winches	204
Wing tanks	140
WLL	212
Wood	282
Yachts	54

Reproduced with kind permission of

Keppel Verolme BV Rozenburg - The Netherlands	Cover, 6, 22/23, 29, 44/45, 52, 56, 57, 61, 62, 65, 68/69, 104/105, 160/161, 166,
/ Voets & v. Leeuwen, Zuidland - The Netherlands	167, 191, 244/245, 248, 263, 280/281, 287, 294, 298, 299, 300, 301
Dutch Pilotage Organisation, Rotterdam - The Netherlands	8,9
Robert Das, Villeneuve-Loubet - France	10,11 20,21
P&O Nedlloyd, Rotterdam - The Netherlands	12, 13, 31, 49, 80,
Robert Das	14,15
Jo tankers, Spijkenisse - The Netherlands	16,17
Frank Mohn, Spijkenisse - The Netherlands	16,17
Hans Meijer, UK	18, 66, 67
Rolls-Royce, Pernis - The Netherlands	18/19, 265
Scheepswerf v.d. Werff&Visser, Jinsum - The Netherlands	21
K. van Dokkum, Enkhuizen - The Netherlands	25, 27, 28, 41, 48, 49, 55, 88, 110, 143, 146, 147, 149, 153, 163, 166, 169, 170, 176,
	198, 206, 256, 257, 311, 316, 318, 320
Vuyk Engineering Center (VEC), Groningen - The Netherlands	25,37, 131, 134, 135, 138, 139, 140, 141, 142, 144, 145, 147, 149, 150, 152, 153,
	198, 261
Rik te Pas, Delfzijl - The Netherlands	26
Feederlines BV Groningen -The Netherlands	28
Martijn van Engeland, TU-Delft - The Netherlands	29, 30, 31, 85, 99
SARC BV, Bussum - The Netherlands	32,33, 333
BigLift Shipping BV, Amsterdam - The Netherlands	33, 50, 177, 185, 186
Niestern Sander bv, Delfzijl - The Netherlands	34, 35, 36, 72/73, 294, 297
Splithoff Beheer BV, Amsterdam - The Netherlands	39, 48, 188, 194, 195
Seatrade Groningen, Groningen - The Netherlands	40, 50, 90/91, 92/93, 94/95, 110, 112, 168, 184, 185, 208, 224, 225, 226, 227, 228,
	229, 230, 311, 312, 317
RAH Management BV, Rhoon - The Netherlands	41
van der Giessen-de Noord, Krimpen aan den IJssel, The Netherlands	41, 53, 68/69, 78, 79, 126/127, 129, 137, 148, 151, 154, 218, 219, 266/267, 270,
	272, 276
Anthony Veder Rederijzaken BV, Rotterdam - The Netherlands	42, 214
GB Shipping Services BV, Dordrecht - The Netherlands	42, 46, 52
Holland America Line, Spijkenisse - The Netherlands	47, 54, 78, 254
Royal Navy, Den Helder - The Netherlands	47, 58, 59
Peters BV Scheepswerf, Kampen - The Netherlands	48
Dockwise Shipping BV, Breda - The Netherlands	50
Nagasaki Shipyard & Machinery Works, Japan	51
VroonBV, Breskens - The Netherlands	51, 52, 54
Cornelis Vrolijk's Visserij Mij BV, IJmuiden - The Netherlands	55
SvitzerWijsmuller, IJmuiden - The Netherlands	55, 322/323, 330
Smit, Rotterdam - The Netherlands	55
Lloyd's Register, Rotterdam - The Netherlands	56, 71, 106, 203, 298
IHC Holland, Kinderdijk / Sliedrecht - The Netherlands	56, 57, 247
IHC Gusto Engineering BV, Schiedam - The Netherlands	61, 62, 64, 65, 66
Heerema, Leiden - The Netherlands	63
Kvaerner - Masa, Sweden	63
Jotun BV	64, 129, 284, 285, 286, 287, 288, 289, 290, 291, 292, 293, 296
Flying Focus, Castricum - The Netherlands	65, 167
Allseas Engineering bv, Delft - The Netherlands	65, 66, 268
GenChart BV, Capelle a/d IJssel - The Netherlands	70, 179, 183, 302/303
MARIN, Wageningen - The Netherlands	75
Bas Spruit, Delfzijl - The Netherlands	82/83, 86
Germanischer Lloyd, Hamburg - Germany	89, 97
Willy Becker, Hamburg - Germany	96
Hans ten Katen, Rotterdam - The Netherlands	96, 109, 196/197, 201, 209, 215, 248, 284
W. Smit, Lies - The Netherlands	98
NAPA OY, Helsinki - Finland	100, 101, 132, 133, 139, 325, 326, 327, 328, 329, 330
ARL Albacore Research Ltd, Canada / Bender Shipbuilding & Repair Co., Inc, USA	102/103
Nippon Kaiji Kyokai, Tokyo - Japan	107, 108
MITSUBI Eengineering & Shipbuilding Co, LTD, Tokyo - Japan	128
Sigma Coatings Marine Division, Uithoorn - The Netherlands	129

Wijnne & Barends BV, Delfzijl - The Netherlands	130, 167
ABB Industry Oy, Helsinki - Finland	136
Delta Marine, Raisio - Finland	136, 234, 237, 238, 239
Helmers, Hoogezand - The Netherlands	155, 156, 157
Rubber Design, Heerjansdam - The Netherlands	155, 156
Flinter Groningen BV, Paterswolde - The Netherlands	158, 309, 319
Coops & Nieborg BV, Hoogezand - The Netherlands	162, 164, 165, 168
Roden Staal BV, Roden - The Netherlands	163, 164, 167
Winel BV, Assen - The Netherlands	168, 169, 170
Winteb, Winschoten - The Netherlands	170
MME Group, Ridderkerk - The Netherlands	171
Witherby & Co LTD, London - UK	172
Genchart BV (Mr B. Jobse), Capelle a/d IJssel - The Netherlands	174/175, 184, 190, 301, 332
Liebherr Maritime Benelux BV, Utrecht - The Netherlands	176, 178, 181, 182, 183, 187
Tille Shipyards, Kootsterille - The Netherlands	178
Huisman - Itrec, Schiedam - The Netherlands	185
TTS - Mongstad AS, Isdalsto - Norway	189, 190
SEC, Groningen - The Netherlands	199, 200, 201, 204, 205, 206, 207
Wortelboer BV, Rotterdam - The Netherlands	201
Lankhorst, Sneek - The Netherlands	208, 209, 210, 211, 213
Proofload, Oss - The Netherlands	212
Hendrik Veder BV, Rotterdam - The Netherlands	214
MAN Rollo, Zoetermeer - The Netherlands	216/217, 220, 221, 222/223, 224, 227, 229
Kongsberg, Spijkenisse - The Netherlands	220
Econosto, Capelle aan de IJssel - The Netherlands	230, 231, 232, 233
Marine Service Noord BV, Westerbroek - The Netherlands	236, 242
Wartsila Propulsion, Drunen - The Netherlands	246, 247, 250, 258, 259
Promac BV, Zaltbommel - The Netherlands	250/251, 264
Kawasaki, Japan	252
HRP Thruster Systems bv, Krimpen a/d Lek - The Netherlands	252, 253
Siemens, Hamburg - Germany	253, 254
Cedervall, Sweden	256
Thyssen, Hamburg - Germany	257
Karnewa Group, Kristinehamn - Sweden	258, 259
Bot Groningen BV, Groningen - The Netherlands	262, 263
Hatlapa, Uetersen - Germany	264
Allseas, Delft - The Netherlands	268, 65, 66
Rene Borstlap, Rotterdam - The Netherlands	268, 269, 270, 271, 272, 274, 275, 276, 277, 278, 279
TESO, Texel - The Netherlands	270
Croon, Rotterdam - The Netherlands	273
Schneider, Haarlem - The Netherlands	274
Niehuis & van den Berg BV, Rotterdam - The Netherlands	294
Ajax Fire Protection Systems BV, Amsterdam - The Netherlands	305, 306, 308, 309
Minimax GmbH, Bad Oldesloe - Germany	308
Heien Larssen, Drammen - Norway	310
Umoe Schat-Harding BV, Utrecht - The Netherlands	313
Fr. Fassmer & Co, Berne/Motzen - Germany	313, 314
Stocznia Ustka S.A., Poland	314
De Wolf Products, Yerseke - The Netherlands	315, 316
Hammar, Germany	315
Royal Dutch Shipping Company Association (KVRN), Rotterdam - The Netherlands	317
Crewsaver, Hampshire - UK	317
Drager, Lubeck - Germany	318
H. Marahrens, Bremen - Germany	318
McMurdo, Portsmouth - UK	318
Comet, Bremerhaven - Germany	320
Loek Peters, Amsterdam - The Netherlands	331
SARC, Bussum - The Netherlands / M. Straten, Nijmegen - The Netherlands	333

Ship Knowledge is the book that tells you all about ships and shipping. The parts and systems which together form a modern ship are dealt with, from design drafts up to the finished construction, including paint systems and legal aspects.



Detailed descriptions of the various subjects as well as the use of many drawings, cross-section drawings and pictures, all in full colour, make the book perfectly readable for everybody interested in shipping.

After reading this book you'll no longer think of a ship as a dead object, but consider it a completely self-supporting entity embodying all the modern techniques also to be found in a small town.

An indispensable book for anyone interested in modern shipping! Considering the ever growing number of foreign crew on board European vessels and in the offshore industry with consequently a growing demand for English language readers and text-books.

"Ship Knowledge" will certainly prove to be an asset, not only for use at nautical colleges within Europe, but as a work of reference for everyone employed afloat nowadays.

