

UNIVERSITY OF ST. MICHAEL'S COLLEGE



3 1761 01856376 7





THE LOEB CLASSICAL LIBRARY

FOUNDED BY JAMES LOEB, LL.D.

EDITED BY

† T. E. PAGE, C.H., LITT.D.

† E. CAPPS, PH.D., LL.D.

† W. H. D. ROUSE, LITT.D.

L. A. POST, M.A. E. H. WARMINGTON, M.A., F.R.HIST.SOC.

GREEK MATHEMATICS

II

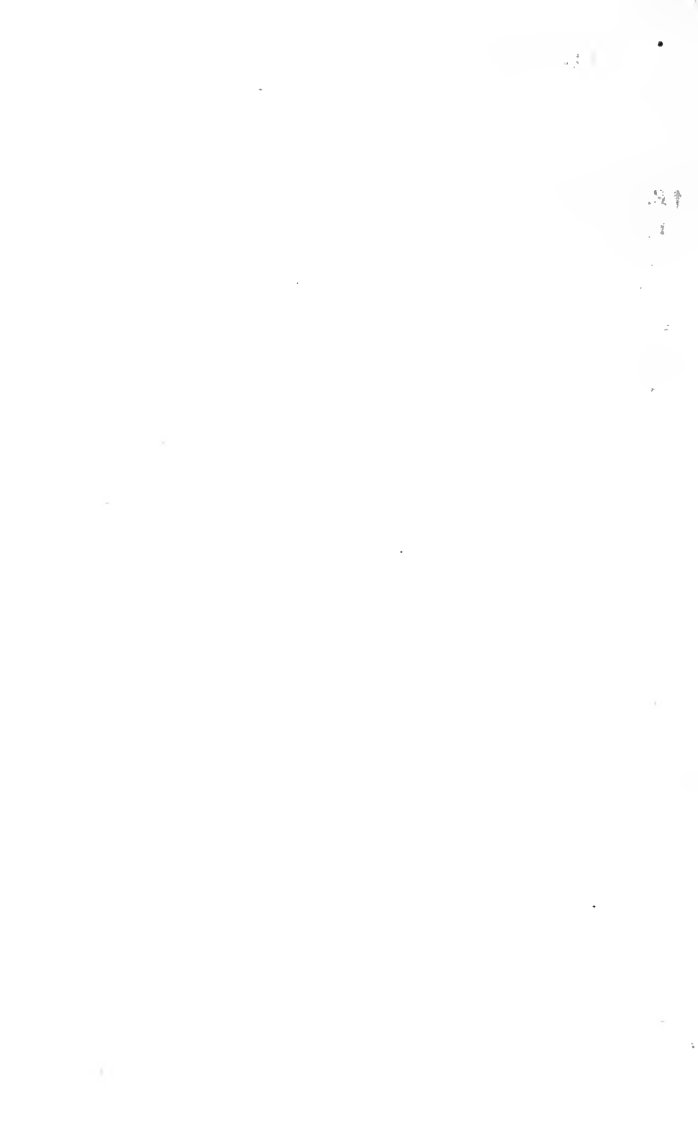

SELECTIONS
ILLUSTRATING THE HISTORY OF
GREEK MATHEMATICS

WITH AN ENGLISH TRANSLATION BY
IVOR THOMAS

FORMERLY SCHOLAR OF ST. JOHN'S AND SENIOR DEMY
OF MAGDALEN COLLEGE, OXFORD

IN TWO VOLUMES
II
FROM ARISTARCHUS TO PAPPUS



LONDON
WILLIAM HEINEMANN LTD
CAMBRIDGE, MASSACHUSETTS
HARVARD UNIVERSITY PRESS
MCMLVII

First printed 1941
Reprinted 1951, 1957

Printed in Great Britain

CONTENTS OF VOLUME II

	PAGE
XVI. ARISTARCHUS OF SAMOS—	
(a) General	2
(b) Distances of the sun and moon	4
(c) Continued fractions (\hat{r})	14
 XVII. ARCHIMEDES—	
(a) General	18
(b) Surface and volume of the cylinder and sphere	40
(c) Solution of a cubic equation	126
(d) Conoids and spheroids—	
(i) Preface	164
(ii) Two lemmas	164
(iii) Volume of a segment of a paraboloid of revolution	170
(e) The spiral of Archimedes—	
(i) Definitions	182
(ii) Fundamental property	184
(iii) A verging	186
(iv) Property of the subtangent	190
(f) Semi-regular solids	194

CONTENTS

	PAGE
(g) System of expressing large numbers	198
(h) Indeterminate analysis: the <i>Cattle Problem</i>	202
(i) Mechanics: centres of gravity—	
(i) Postulates	206
(ii) Principle of the lever	208
(iii) Centre of gravity of a parallelogram	216
(j) Mechanical method in geometry	220
(k) Hydrostatics—	
(i) Postulates	242
(ii) Surface of fluid at rest	244
(iii) Solid immersed in a fluid	248
(iv) Stability of a paraboloid of revolution	252

XVIII. ERATOSTHENES—

(a) General	260
(b) On means	262
(c) The <i>Platonicus</i>	264
(d) Measurement of the earth	266

XIX. APOLLONIUS OF PERGA—

(a) The conic sections—	
(i) Relation to previous works	276
(ii) Scope of the work	280
(iii) Definitions	284
(iv) Construction of the sections	288
(v) Fundamental properties	304
(vi) Transition to new diameter	328

CONTENTS

	PAGE
(b) Other works—	
(i) General	336
(ii) <i>On the Cutting-off of a Ratio</i>	336
(iii) <i>On the Cutting-off of an Area</i>	338
(iv) <i>On Determinate Section</i>	338
(v) <i>On Tangencies</i>	340
(vi) <i>On Plane Loci</i>	344
(vii) <i>On Vergings</i>	344
(viii) <i>On the dodecahedron and the icosahedron</i>	348
(ix) Principles of mathematics	348
(x) <i>On the Cochlias</i>	350
(xi) On unordered irrationals	350
(xii) Measurement of a circle	352
(xiii) Continued multiplications	352
(xiv) <i>On the Burning Mirror</i>	356

XX. LATER DEVELOPMENTS IN GEOMETRY—

(a) Classification of curves	360
(b) Attempts to prove the parallel postulate—	
(i) General	366
(ii) Posidonius and Geminus	370
(iii) Ptolemy	372
(iv) Proclus	382
(c) Isoperimetric figures	386
(d) Division of zodiac circle into 360 parts: Hypsicles	394
(e) Handbooks—	
(i) Cleomedes	396
(ii) Theon of Smyrna	400

CONTENTS

	PAGE
XXI. TRIGONOMETRY—	
1. Hipparchus and Menelaus	406
2. Ptolemy—	
(a) General	408
(b) Table of sines—	
(i) Introduction	412
(ii) $\sin 18^\circ$ and $\sin 36^\circ$	414
(iii) $\sin^2 \theta + \cos^2 \theta = 1$	420
(iv) Ptolemy's theorem	422
(v) $\sin (\theta - \phi) = \sin \theta \cos \phi -$ $\cos \theta \sin \phi$	424
(vi) $\sin^2 \frac{1}{2}\theta = \frac{1}{2}(1 - \cos \theta)$	428
(vii) $\cos (\theta + \phi) = \cos \theta \cos \phi -$ $\sin \theta \sin \phi$	430
(viii) Method of interpolation	434
(ix) The table	442
(c) Menelaus's theorem—	
(i) Lemmas	446
(ii) The theorem	458
 XXII. MENSURATION : HERON OF ALEX- ANDRIA—	
(a) Definitions	466
(b) Measurement of areas and volumes—	
(i) Area of a triangle given the sides	470
(ii) Volume of a spire	476
(iii) Division of a circle	482
(iv) Measurement of an irregu- lar area	484

CONTENTS

	PAGE
(c) Mechanics	488
(d) Optics : equality of angles of incidence and reflection	496
(e) Quadratic equations	502
(f) Indeterminate analysis	504

XXIII. ALGEBRA : DIOPHANTUS—

(a) General	512
(b) Notation	518
(c) Determinate equations—	
(i) Pure determinate equations	524
(ii) Quadratic equations	526
(iii) Simultaneous equations leading to a quadratic	536
(iv) Cubic equation	538
(d) Indeterminate equations—	
(i) Indeterminate equations of the second degree—	
(a) Single equations	540
(β) Double equations	542
(ii) Indeterminate equations of higher degree	548
(e) Theory of numbers : sums of squares	550
(f) Polygonal numbers	560

XXIV. REVIVAL OF GEOMETRY : PAPPUS OF ALEXANDRIA—

(a) General	564
(b) Problems and theorems	566

CONTENTS

	PAGE
(c) The theory of means	568
(d) The paradoxes of Erycinus	570
(e) The regular solids	572
(f) Extension of Pythagoras's theorem	574
(g) Circles inscribed in the $\alpha\rho\beta\eta\lambda\omicron\varsigma$	578
(h) Spiral on a sphere	580
(i) Isoperimetric figures	588
(j) Apparent form of a circle	592
(k) The <i>Treasury of Analysis</i>	596
(l) Locus with respect to five or six lines	600
(m) Anticipation of Guldin's theorem	604
(n) Lemmas to the treatises—	
(i) To the <i>Determinate Section</i> of Apollonius	606
(ii) To the <i>Porisms</i> of Euclid	610
(o) Mechanics	614
INDEX	622
LIST OF ANCIENT TEXTS CITED	650
INDEX OF GREEK TERMS	655

XVI. ARISTARCHUS OF SAMOS

XVI. ARISTARCHUS OF SAMOS

(a) GENERAL

Aët. i. 15. 5 ; *Doxographi Graeci*, ed. Diels 313. 16-18

Ἄρισταρχος Σάμιος μαθηματικὸς ἀκουστῆς Στράτωνος φῶς εἶναι τὸ χρῶμα τοῖς ὑποκειμένοις ἐπιπίπτον.

Archim. *Aren.* 1, Archim. ed. Heiberg ii. 218. 7-18

Ἄρισταρχος δὲ ὁ Σάμιος ὑποθεσίων τινῶν ἐξέδωκεν γραφάς, ἐν αἷς ἐκ τῶν ὑποκειμένων συμβαίνει τὸν κόσμον πολλαπλάσιον εἶμεν τοῦ νῦν εἰρημένου. ὑποτίθεται γὰρ τὰ μὲν ἀπλανέα τῶν ἄστρον καὶ τὸν ἄλιον μένειν ἀκίνητον, τὰν δὲ γὰν περιφέρεσθαι περὶ τὸν ἄλιον κατὰ κύκλου περιφέρειαν, ὅς ἐστιν ἐν μέσῳ τῷ δρόμῳ κείμενος, τὰν δὲ τῶν ἀπλανέων ἄστρον σφαῖραν περὶ τὸ

* Strato of Lampsacus was head of the Lyceum from 288/287 to 270/269 B.C. The next extract shows that Aristarchus formulated his heliocentric hypothesis before Archimedes wrote the *Sand-Reckoner*, which can be shown to have been written before 216 B.C. From Ptolemy, *Syntaxis* iii. 2, Aristarchus is known to have made an observation of the summer solstice in 281/280 B.C. He is ranked by Vitruvius, *De Architectura* i. 1. 17 among those rare men, such as Philolaus, Archytas, Apollonius, Eratosthenes,

XVI. ARISTARCHUS OF SAMOS

(a) GENERAL

Aëtius i. 15. 5 ; *Doxographi Graeci*, ed. Diels 313. 16-18

ARISTARCHUS of Samos, a mathematician and pupil of Strato,^a held that colour was light impinging on a substratum.

Archimedes, *Sand-Reckoner* 1, Archim. ed. Heiberg
ii. 218. 7-18

Aristarchus of Samos produced a book based on certain hypotheses, in which it follows from the premises that the universe is many times greater than the universe now so called. His hypotheses are that the fixed stars and the sun remain motionless, that the earth revolves in the circumference of a circle about the sun, which lies in the middle of the orbit, and that the sphere of the fixed stars, situated

Archimedes and Scopinas of Syracuse, who were equally proficient in all branches of science. Vitruvius, *loc. cit.* ix. 8. 1, is also our authority for believing that he invented a sun-dial with a hemispherical bowl. His greatest achievement, of course, was the hypothesis that the earth moves round the sun, but as that belongs to astronomy it can be mentioned only casually here. A full and admirable discussion will be found in Heath, *Aristarchus of Samos : The Ancient Copernicus*, together with a critical text of Aristarchus's only extant work.

GREEK MATHEMATICS

αὐτὸ κέντρον τῷ ἄλιῳ κειμέναν τῷ μεγέθει ταλικαύταν εἶμεν, ὥστε τὸν κύκλον, καθ' ὃν τὰν γῶν ὑποτίθεται περιφέρεσθαι, τοιαύταν ἔχειν ἀναλογίαν ποτὶ τὰν τῶν ἀπλανέων ἀποστασίαν, οἷαν ἔχει τὸ κέντρον τᾶς σφαίρας ποτὶ τὰν ἐπιφάνειαν.

Plut. *De facie in orbe lunae* 6, 922 F-923 A

Καὶ ὁ Λεύκιος γελάσας, "Μόνον," εἶπεν, "ὦ τάν, μὴ κρίσιν ἡμῖν ἀσεβείας ἐπαγγελίης, ὥσπερ Ἀρίσταρχον ᾤετο δεῖν Κλεάνθης τὸν Σάμιον ἀσεβείας προσκαλεῖσθαι τοὺς Ἕλληνας, ὡς κινουῦντα τοῦ κόσμου τὴν ἐστίαν, ὅτι τὰ φαινόμενα σώζειν ἀνὴρ ἐπειράτο, μένειν τὸν οὐρανὸν ὑποτιθέμενος, ἐξελίττεσθαι δὲ κατὰ λοξοῦ κύκλου τὴν γῆν, ἅμα καὶ περὶ τὸν αὐτῆς ἄξονα δινουμένην."

(b) DISTANCES OF THE SUN AND MOON

Aristarch. Sam. *De Mag. et Dist. Solis et Lunae*, ed. Heath (*Aristarchus of Samos: The Ancient Copernicus*) 352. 1-354. 6

⟨Ἵποθέσεις¹⟩

α'. Τὴν σελήνην παρὰ τοῦ ἡλίου τὸ φῶς λαμβάνειν.

β'. Τὴν γῆν σημείου τε καὶ κέντρου λόγον ἔχειν πρὸς τὴν τῆς σελήνης σφαῖραν.

γ'. Ὅταν ἡ σελήνη διχότομος ἡμῖν φαίνεται,

¹ ὑποθέσεις add. Heath.

* Aristarchus's last hypothesis, if taken literally, would mean that the sphere of the fixed stars is infinite. All that he implies, however, is that in relation to the distance of the

ARISTARCHUS OF SAMOS

about the same centre as the sun, is so great that the circle in which he supposes the earth to revolve has such a proportion to the distance of the fixed stars as the centre of the sphere bears to its surface.^a

Plutarch, *On the Face in the Moon* 6, 922 F-923 A

Lucius thereupon laughed and said : " Do not, my good fellow, bring an action against me for impiety after the manner of Cleanthes, who held that the Greeks ought to indict Aristarchus of Samos on a charge of impiety because he set in motion the hearth of the universe ; for he tried to save the phenomena by supposing the heaven to remain at rest, and the earth to revolve in an inclined circle, while rotating at the same time about its own axis." ^b

(b) DISTANCES OF THE SUN AND MOON

Aristarchus of Samos, *On the Sizes and Distances of the Sun and Moon*, ed. Heath (*Aristarchus of Samos : The Ancient Copernicus*) 352. 1-354. 6

HYPOTHESES

1. The moon receives its light from the sun.
2. The earth has the relation of a point and centre to the sphere in which the moon moves.^c
3. When the moon appears to us halved, the great

fixed stars the diameter of the earth's orbit may be neglected. The phrase appears to be traditional (v. Aristarchus's second hypothesis, *infra*).

^b Heraclides of Pontus (along with Ecphantus, a Pythagorean) had preceded Aristarchus in making the earth revolve on its own axis, but he did not give the earth a motion of translation as well.

^c Lit. " sphere of the moon."

GREEK MATHEMATICS

νεύειν εἰς τὴν ἡμετέραν ὄψιν τὸν διορίζοντα τό τε σκιερὸν καὶ τὸ λαμπρὸν τῆς σελήνης μέγιστον κύκλον.

δ'. Ὄταν ἡ σελήνη διχότομος ἡμῖν φαίνεται, τότε αὐτὴν ἀπέχει τοῦ ἡλίου ἔλασσον τεταρτημορίου τῷ τοῦ τεταρτημορίου τριακοστῷ.

ε'. Τὸ τῆς σκιᾶς πλάτος σεληνῶν εἶναι δύο.

ς'. Τὴν σελήνην ὑποτείνειν ὑπὸ πεντεκαίδεκατον μέρος ζωδίου.

Ἐπιλογίζεται οὖν τὸ τοῦ ἡλίου ἀπόστημα ἀπὸ τῆς γῆς τοῦ τῆς σελήνης ἀποστήματος μείζον μὲν ἢ ὀκτωκαδεκαπλάσιον, ἔλασσον δὲ ἢ εἰκοσάπλάσιον, διὰ τῆς περὶ τὴν διχοτομίαν ὑποθέσεως· τὸν αὐτὸν δὲ λόγον ἔχειν τὴν τοῦ ἡλίου διάμετρον πρὸς τὴν τῆς σελήνης διάμετρον. τὴν δὲ τοῦ ἡλίου διάμετρον πρὸς τὴν τῆς γῆς διάμετρον μείζονα μὲν λόγον ἔχειν ἢ ὄν τὰ $\bar{\iota}\theta$ πρὸς $\bar{\gamma}$, ἔλασσονα δὲ ἢ ὄν $\bar{\mu}\gamma$ πρὸς $\bar{\epsilon}$, διὰ τοῦ εὐρεθέντος περὶ τὰ ἀποστήματα λόγου, τῆς $\langle \tau\epsilon^1 \rangle$ περὶ τὴν σκιὰν ὑποθέσεως, καὶ τοῦ τὴν σελήνην ὑπὸ πεντεκαίδεκατον μέρος ζωδίου ὑποτείνειν.

Ibid., Prop. 7, ed. Heath 376. 1-380. 28

Τὸ ἀπόστημα ὃ ἀπέχει ὁ ἥλιος ἀπὸ τῆς γῆς τοῦ

¹ $\tau\epsilon$ add. Heath.

^a Lit. "verges towards our eye." For "verging," v. vol. i. p. 244 n. a. Aristarchus means that the observer's eye lies in the plane of the great circle in question. A great circle is a circle described on the surface of the sphere and having the same centre as the sphere; as the Greek implies, a great circle is the "greatest circle" that can be described on the sphere.

ARISTARCHUS OF SAMOS

circle dividing the dark and the bright portions of the moon is in the direction of our eye.^a

4. When the moon appears to us halved, its distance from the sun is less than a quadrant by one-thirtieth of a quadrant.^b

5. The breadth of the earth's shadow is that of two moons.^c

6. The moon subtends one-fifteenth part of a sign of the zodiac.^d

It may now be proved that *the distance of the sun from the earth is greater than eighteen times, but less than twenty times, the distance of the moon*—this follows from the hypothesis about the halved moon; that *the diameter of the sun has the aforesaid ratio to the diameter of the moon*; and that *the diameter of the sun has to the diameter of the earth a ratio which is greater than 19 : 3 but less than 43 : 6*—this follows from the ratio discovered about the distances, the hypothesis about the shadow, and the hypothesis that the moon subtends one-fifteenth part of a sign of the zodiac.

Ibid., Prop. 7, ed. Heath 376. 1-380. 28

The distance of the sun from the earth is greater than

^b *i.e.*, is less than 90° by 3° , and so is 87° . The true value is $89^\circ 50'$.

^c *i.e.*, the breadth of the earth's shadow where the moon traverses it during an eclipse. The figure is presumably based on records of eclipses. Hipparchus made the figure $2\frac{1}{2}$ for the time when the moon is at its mean distance, and Ptolemy a little less than $2\frac{2}{3}$ for the time when the moon is at its greatest distance.

^d *i.e.*, the angular diameter of the moon is one-fifteenth of 30° , or 2° . The true value is about $\frac{1}{2}^\circ$, and in the *Sand-Reckoner* (Archim. ed. Heiberg ii. 222. 6-8) Archimedes says that Aristarchus "discovered that the sun appeared to be about $\frac{1}{720}$ th part of the circle of the Zodiac"; as he believed

GREEK MATHEMATICS

ἀποστήματος οὗ ἀπέχει ἡ σελήνη ἀπὸ τῆς γῆς
μείζον μὲν ἐστὶν ἢ ὀκτωκαιδεκαπλάσιον, ἔλασσον
δὲ ἢ εἰκοσαπλάσιον.

Ἐστω γὰρ ἡλίου μὲν κέντρον τὸ Α, γῆς δὲ τὸ
Β, καὶ ἐπιζευχθεῖσα ἡ ΑΒ ἐκβεβλήσθω, σελήνης
δὲ κέντρον διχοτόμου οὔσης τὸ Γ, καὶ ἐκβεβλήσθω
διὰ τῆς ΑΒ καὶ τοῦ Γ ἐπίπεδον, καὶ ποιείτω
τομὴν ἐν τῇ σφαίρᾳ, καθ' ἧς φέρεται τὸ κέντρον
τοῦ ἡλίου, μέγιστον κύκλον τὸν ΑΔΕ, καὶ ἐπ-
εζεύχθωσαν αἱ ΑΓ, ΓΒ, καὶ ἐκβεβλήσθω ἡ ΒΓ
ἐπὶ τὸ Δ.

Ἐσται δὴ, διὰ τὸ τὸ Γ σημεῖον κέντρον εἶναι
τῆς σελήνης διχοτόμου οὔσης, ὀρθὴ ἢ ὑπὸ τῶν

that the sun and moon had the same angular diameter he must, therefore, have found the approximately correct angular diameter of $\frac{1}{2}^\circ$ after writing his treatise *On the Sizes and Distances of the Sun and Moon*.

GREEK MATHEMATICS

ΑΓΒ. ἤχθω δὴ ἀπὸ τοῦ Β τῆ ΒΑ πρὸς ὀρθὰς ἢ ΒΕ. ἔσται δὴ ἢ ΕΔ περιφέρεια τῆς ΕΔΑ περιφερείας λ'. ὑπόκειται γάρ, ὅταν ἢ σελήνη διχότομος ἡμῖν φαίνεται, ἀπέχειν ἀπὸ τοῦ ἡλίου ἔλασσον τεταρτημορίου τῶ τοῦ τεταρτημορίου λ'. ὥστε καὶ ἢ ὑπὸ τῶν ΕΒΓ γωνία ὀρθῆς ἐστὶ λ'. συμπληρώσω δὴ τὸ ΑΕ παραλληλόγραμμον, καὶ ἐπεζεύχθω ἢ ΒΖ. ἔσται δὴ ἢ ὑπὸ τῶν ΖΒΕ γωνία ἡμίσεια ὀρθῆς. τεμήσθω ἢ ὑπὸ τῶν ΖΒΕ γωνία δίχα τῆ ΒΗ εὐθεία· ἢ ἄρα ὑπὸ τῶν ΗΒΕ γωνία τέταρτον μέρος ἐστὶν ὀρθῆς. ἀλλὰ καὶ ἢ ὑπὸ τῶν ΔΒΕ γωνία λ' ἐστὶ μέρος ὀρθῆς· λόγος ἄρα τῆς ὑπὸ τῶν ΗΒΕ γωνίας πρὸς τὴν ὑπὸ τῶν ΔΒΕ γωνίαν (ἐστὶν¹) ὄν (ἔχει²) τὰ ιε πρὸς τὰ δύο· οἷων γάρ ἐστὶν ὀρθὴ γωνία ξ, τοιούτων ἐστὶν ἢ μὲν ὑπὸ τῶν ΗΒΕ ιε, ἢ δὲ ὑπὸ τῶν ΔΒΕ δύο. καὶ ἐπεὶ ἢ ΗΕ πρὸς τὴν ΕΘ μείζονα λόγον ἔχει ἢπερ ἢ ὑπὸ τῶν ΗΒΕ γωνία πρὸς τὴν ὑπὸ τῶν ΔΒΕ γωνίαν, ἢ ἄρα ΗΕ πρὸς τὴν ΕΘ μείζονα λόγον ἔχει ἢπερ τὰ ιε πρὸς τὰ β. καὶ ἐπεὶ ἴση ἐστὶν ἢ ΒΕ τῆ ΕΖ, καὶ ἐστὶν ὀρθὴ ἢ πρὸς τῶ Ε, τὸ ἄρα ἀπὸ τῆς ΖΒ τοῦ ἀπὸ ΒΕ διπλάσιόν ἐστὶν· ὡς δὲ τὸ ἀπὸ ΖΒ πρὸς τὸ ἀπὸ ΒΕ, οὕτως ἐστὶ τὸ ἀπὸ ΖΗ πρὸς τὸ ἀπὸ ΗΕ· τὸ ἄρα ἀπὸ ΖΗ τοῦ ἀπὸ ΗΕ διπλάσιόν ἐστὶ. τὰ δὲ $\overline{\mu\theta}$ τῶν $\overline{\kappa\epsilon}$ ἐλάσσονά ἐστὶν ἢ διπλάσια, ὥστε τὸ ἀπὸ ΖΗ πρὸς τὸ ἀπὸ ΗΕ μείζονα λόγον ἔχει ἢ (ὄν τὰ³) $\overline{\mu\theta}$ πρὸς $\overline{\kappa\epsilon}$ · καὶ ἢ ΖΗ ἄρα πρὸς τὴν ΗΕ μείζονα λόγον

¹ ἐστὶν add. Nizze.

² ἔχει add. Wallis.

³ ὄν τὰ add. Wallis.

* Lit. "circumference," as in several other places in this proposition.

ARISTARCHUS OF SAMOS

From B let BE be drawn at right angles to BA. Then the arc ^a EΔ will be one-thirtieth of the arc EΔA; for, by hypothesis, when the moon appears to us halved, its distance from the sun is less than a quadrant by one-thirtieth of a quadrant [Hypothesis 4]. Therefore the angle EBF is also one-thirtieth of a right angle. Let the parallelogram AE be completed, and let BZ be joined. Then the angle ZBE will be one-half of a right angle. Let the angle ZBE be bisected by the straight line BH; then the angle HBE is one-fourth part of a right angle. But the angle ΔBE is one-thirtieth part of a right angle; therefore angle HBE : angle ΔBE = 15 : 2; for, of those parts of which a right angle contains 60, the angle HBE contains 15 and the angle ΔBE contains 2.

Now since

$$HE : E\Theta > \text{angle HBE} : \text{angle } \Delta BE,^b$$

therefore $HE : E\Theta > 15 : 2$.

And since $BE = EZ$, and the angle at E is right, therefore

$$ZB^2 = 2BE^2.$$

But $ZB^2 : BE^2 = ZH^2 : HE^2$.

Therefore $ZH^2 = 2HE^2$.

Now $49 < 2 \cdot 25$,

so that $ZH^2 : HE^2 > 49 : 25$.

Therefore $ZH : HE > 7 : 5$.

^b Aristarchus's assumption is equivalent to the theorem

$$\frac{\tan \alpha}{\tan \beta} > \frac{\alpha}{\beta},$$

where $\beta < \alpha \leq \frac{1}{2}\pi$. Euclid's proof in *Optics* 8 is given in vol. i. pp. 502-505.

ἔχει ἢ $\langle \delta\upsilon\nu^1 \rangle$ τὰ ζ̄ πρὸς τὰ ε̄· καὶ συνθέντι ἢ ZE ἄρα πρὸς τὴν EH μείζονα λόγον ἔχει ἢ $\delta\upsilon\nu$ τὰ $\bar{\iota}\beta$ πρὸς τὰ ε̄, τουτέστιν, ἢ $\delta\upsilon\nu$ $\langle \tau\acute{\alpha}^2 \rangle$ λς̄ πρὸς τὰ $\bar{\iota}\epsilon$. ἐδείχθη δὲ καὶ ἢ HE πρὸς τὴν EΘ μείζονα λόγον ἔχουσα ἢ $\delta\upsilon\nu$ τὰ $\bar{\iota}\epsilon$ πρὸς τὰ δύο· δι' ἴσου ἄρα ἢ ZE πρὸς τὴν EΘ μείζονα λόγον ἔχει ἢ $\delta\upsilon\nu$ τὰ λς̄ πρὸς τὰ δύο, τουτέστιν, ἢ $\delta\upsilon\nu$ τὰ $\bar{\iota}\eta$ πρὸς $\bar{\alpha}$ · ἢ ἄρα ZE τῆς EΘ μείζων ἐστὶν ἢ $\bar{\iota}\eta$. ἢ δὲ ZE ἴση ἐστὶν τῇ BE· καὶ ἢ BE ἄρα τῆς EΘ μείζων ἐστὶν ἢ $\bar{\iota}\eta$ · πολλῶ ἄρα ἢ BH τῆς ΘE μείζων ἐστὶν ἢ $\bar{\iota}\eta$. ἀλλ' ὡς ἢ BΘ πρὸς τὴν ΘE, οὕτως ἐστὶν ἢ AB πρὸς τὴν BΓ, διὰ τὴν ὁμοιότητα τῶν τριγώνων· καὶ ἢ AB ἄρα τῆς BΓ μείζων ἐστὶν ἢ $\bar{\iota}\eta$. καὶ ἔστιν ἢ μὲν AB τὸ ἀπόστημα ὃ ἀπέχει ὁ ἥλιος ἀπὸ τῆς γῆς, ἢ δὲ ΓB τὸ ἀπόστημα ὃ ἀπέχει ἡ σελήνη ἀπὸ τῆς γῆς· τὸ ἄρα ἀπόστημα ὃ ἀπέχει ὁ ἥλιος ἀπὸ τῆς γῆς τοῦ ἀποστήματος, οὐδ' ἀπέχει ἡ σελήνη ἀπὸ τῆς γῆς, μείζον ἐστὶν ἢ $\bar{\iota}\eta$.

Λέγω δὴ ὅτι καὶ ἔλασσον ἢ $\bar{\kappa}$. ἤχθω γὰρ διὰ τοῦ Δ τῇ EB παράλληλος ἢ ΔK, καὶ περὶ τὸ ΔKB τρίγωνον κύκλος γεγράφθω ὁ ΔKB· ἔσται δὴ αὐτοῦ διάμετρος ἢ ΔB, διὰ τὸ ὀρθὴν εἶναι τὴν πρὸς τῷ K γωνίαν. καὶ ἐνηρμόσθω ἢ ΒΛ ἐξαγώνου. καὶ ἐπεὶ ἢ ὑπὸ τῶν ΔBE γωνία λ' ἐστὶν ὀρθῆς, καὶ ἢ ὑπὸ τῶν BΔK ἄρα λ' ἐστὶν ὀρθῆς· ἢ ἄρα BK περιφέρεια ξ' ἐστὶν τοῦ ὄλου κύκλου. ἔστιν δὲ καὶ ἢ ΒΛ ἕκτον μέρος τοῦ ὄλου κύκλου· ἢ ἄρα ΒΛ περιφέρεια τῆς BK περιφέρειας $\bar{\iota}$ ἐστίν. καὶ ἔχει ἢ ΒΛ περιφέρεια πρὸς τὴν BK περιφέρειαν μείζονα λόγον ἢπερ ἢ ΒΛ

¹ $\delta\upsilon\nu$ add. Wallis.

² τὰ add. Wallis.

ARISTARCHUS OF SAMOS

Therefore, *componendo*, $ZE : EH > 12 : 5$,
 that is, $ZE : EH > 36 : 15$.

But it was also proved that

$$HE : E\Theta > 15 : 2.$$

Therefore, *ex aequali*,^a $ZE : E\Theta > 36 : 2$,
 that is, $ZE : E\Theta > 18 : 1$.

Therefore ZE is greater than eighteen times EΘ. And ZE is equal to BE. Therefore BE is also greater than eighteen times EΘ. Therefore BH is much greater than eighteen times ΘE.

But $B\Theta : \Theta E = AB : B\Gamma$,

by similarity of triangles. Therefore AB is also greater than eighteen times BΓ. And AB is the distance of the sun from the earth, while ΓB is the distance of the moon from the earth; therefore the distance of the sun from the earth is greater than eighteen times the distance of the moon from the earth.

I say now that it is less than twenty times. For through Δ let ΔK be drawn parallel to EB, and about the triangle ΔKB let the circle ΔKB be drawn; its diameter will be ΔB, by reason of the angle at K being right. Let BA, the side of a hexagon, be fitted into the circle. Then, since the angle ΔBE is one-thirtieth of a right angle, therefore the angle BΔK is also one-thirtieth of a right angle. Therefore the arc BK is one-sixtieth of the whole circle. But BA is one-sixth part of the whole circle.

Therefore $\text{arc } BA = 10 \cdot \text{arc } BK$.

And the arc BA has to the arc BK a ratio greater

^a For the proportion *ex aequali*, v. vol. i. pp. 448-451.

GREEK MATHEMATICS

εὐθεία πρὸς τὴν ΒΚ εὐθείαν· ἡ ἄρα ΒΛ εὐθεία τῆς ΒΚ εὐθείας ἐλάσσων ἐστὶν ἢ ἰ. καὶ ἔστιν αὐτῆς διπλῆ ἢ ΒΔ· ἡ ἄρα ΒΔ τῆς ΒΚ ἐλάσσων ἐστὶν ἢ $\bar{\kappa}$. ὡς δὲ ἡ ΒΔ πρὸς τὴν ΒΚ, ἡ ΑΒ πρὸς <τὴν> ΒΓ, ὥστε καὶ ἡ ΑΒ τῆς ΒΓ ἐλάσσων ἐστὶν ἢ $\bar{\kappa}$. καὶ ἔστιν ἡ μὲν ΑΒ τὸ ἀπόστημα ὃ ἀπέχει ὁ ἥλιος ἀπὸ τῆς γῆς, ἡ δὲ ΒΓ τὸ ἀπόστημα ὃ ἀπέχει ἡ σελήνη ἀπὸ τῆς γῆς· τὸ ἄρα ἀπόστημα ὃ ἀπέχει ὁ ἥλιος ἀπὸ τῆς γῆς τοῦ ἀποστήματος, οὗ ἀπέχει ἡ σελήνη ἀπὸ τῆς γῆς, ἔλασσόν ἐστὶν ἢ $\bar{\kappa}$. ἐδείχθη δὲ καὶ μείζον ἢ $\bar{\eta}$.

(c) CONTINUED FRACTIONS (?)

Ibid., Prop. 13, ed. Heath 396. 1-2

Ἔχει δὲ καὶ τὰ $\bar{\zeta}\lambda\kappa\alpha$ πρὸς $\bar{\delta\nu}$ μείζονα λόγον ἢ περ τὰ $\bar{\pi\eta}$ πρὸς $\bar{\mu\epsilon}$.

Ibid., Prop. 15, ed. Heath 406. 23-24

Ἔχει δὲ καὶ ὁ $\overset{\zeta\rho\omicron\epsilon}{M}$ $\bar{\epsilon\omega\omicron\epsilon}$ πρὸς $\overset{\sigma\rho\omicron\gamma}{M}$ $\bar{\epsilon\phi}$ μείζονα λόγον ἢ ὃν τὰ $\bar{\mu\gamma}$ πρὸς $\bar{\lambda\zeta}$.

¹ τὴν add. Wallis.

^a This is proved in Ptolemy's *Syntaxis* i. 10, v. *infra*, pp. 435-439.

^b If $\frac{7921}{4050}$ is developed as a continued fraction, we obtain the approximation $1 + \frac{1}{1 + \frac{1}{21 + \frac{1}{2}}}$, which is $\frac{88}{45}$. Similarly, if $\frac{71755875}{61735500}$ or $\frac{21261}{18292}$ is developed as a continued fraction, we

ARISTARCHUS OF SAMOS

than that which the straight line BA has to the straight line BK.^a

Therefore $BA < 10 \cdot BK$.

And $B\Delta = 2 \cdot BA$.

Therefore $B\Delta < 20 \cdot BK$.

But $B\Delta : BK = AB : B\Gamma$.

Therefore $AB < 20 \cdot B\Gamma$.

And AB is the distance of the sun from the earth, while BΓ is the distance of the moon from the earth; therefore the distance of the sun from the earth is less than twenty times the distance of the moon from the earth. And it was proved to be greater than eighteen times.

(c) CONTINUED FRACTIONS (?)

Ibid., Prop. 13, ed. Heath 396. 1-2

But 7921 has to 4050 a ratio greater than that which 88 has to 45.

Ibid., Prop. 15, ed. Heath 406. 23-24

But 71755875 has to 61735500 a ratio greater than that which 43 has to 37.^b

obtain the approximation $1 + \frac{1}{6} + \frac{1}{6}$ or $\frac{43}{37}$. The latter result was first noticed in 1823 by the Comte de Fortia D'Urban (*Traité d'Aristarque de Samos*, p. 186 n. 1), who added: "Ainsi les Grecs, malgré l'imperfection de leur numération, avaient des méthodes semblables aux nôtres." Though these relations are hardly sufficient to enable us to say that the Greeks knew how to develop continued fractions, they lend some support to the theory developed by D'Arcy W. Thompson in *Mind*, xxxviii. pp. 43-55, 1929.

111

112

113

114

115

116

117

118

119

120

121

122

123

124

125

126

127

128

129

130

131

132

133

134

135

136

137

138

139

140

XVII. ARCHIMEDES

XVII. ARCHIMEDES

(a) GENERAL

Tzetzes, *Chil.* ii. 103-144

Ὁ Ἀρχιμήδης ὁ σοφός, μηχανητῆς ἐκεῖνος,
τῷ γένει Συρακούσιος ἦν, γέρων γεωμέτρης,
Χρόνοός τε ἑβδομήκοντα καὶ πέντε παρελαύνων,
Ὅστις εἰργάσατο πολλὰς μηχανικὰς δυνάμεις,
καὶ τῇ τρισπάστῳ μηχανῇ χειρὶ λαϊᾷ καὶ μόνη
Πεντεμυριομέδιμνον καθείλκυσε ὀλκάδα
καὶ τοῦ Μαρκέλλου στρατηγοῦ ποτε δὲ τῶν
Ῥωμαίων
τῇ Συρακούσῃ κατὰ γῆν προσβάλλοντος καὶ
πόντον,
Τινὰς μὲν πρῶτον μηχαναῖς ἀνείλκυσε ὀλκάδας
καὶ πρὸς τὸ Συρακούσιον τεῖχος μετεωρίσας
αὐτάνδρους πάλιν τῷ βυθῷ κατεπέμπεν ἄθρόως,
Μαρκέλλου δ' ἀποστήσαντος μικρὸν τι τὰς ὀλκάδας
Ὁ γέρων πάλιν ἅπαντας ποιεῖ Συρακουσίου

* A life of Archimedes was written by a certain Heraclides —perhaps the Heraclides who is mentioned by Archimedes himself in the preface to his book *On Spirals* (Archim. ed. Heiberg ii. 2. 3) as having taken his books to Dositheus. We know this from two references by Eutocius (Archim. ed. Heiberg iii. 228. 20, Apollon. ed. Heiberg ii. 163. 3, where, however, the name is given as Ἡράκλειος), but it has not survived. The surviving writings of Archimedes, together with the commentaries of Eutocius of Ascalon (*f.* A.D. 520), have been edited by J. L. Heiberg in three volumes of the Teubner series (references in this volume are to the 2nd ed., Leipzig, 1910-1915). They have been put into mathematical notation by T. L. Heath, *The Works of Archimedes* (Cam-

XVII. ARCHIMEDES ^c

(a) GENERAL

Tzetzes, *Book of Histories* ii. 103-144 ^b

ARCHIMEDES the wise, the famous maker of engines, was a Syracusan by race, and worked at geometry till old age, surviving five-and-seventy-years ^c; he reduced to his service many mechanical powers, and with his triple-pulley device, using only his left hand, he drew a vessel of fifty thousand medimni burden. Once, when Marcellus, the Roman general, was assaulting Syracuse by land and sea, first by his engines he drew up some merchant-vessels, lifted them up against the wall of Syracuse, and sent them in a heap again to the bottom, crews and all. When Marcellus had withdrawn his ships a little distance, the old man gave all the Syracusans power to lift

bridge, 1897), supplemented by *The Method of Archimedes* (Cambridge, 1922), and have been translated into French by Paul Ver Eecke, *Les Œuvres complètes d'Archimède* (Brussels, 1921).

^b The lines which follow are an example of the "political" (πολιτικός, popular) verse which prevailed in Byzantine times. The name is given to verse composed by accent instead of quantity, with an accent on the last syllable but one, especially an iambic verse of fifteen syllables. The twelfth-century Byzantine pedant, John Tzetzes, preserved in his *Book of Histories* a great treasure of literary, historical, theological and scientific detail, but it needs to be used with caution. The work is often called the *Chiliades* from its arbitrary division by its first editor (N. Gerbel, 1546) into books of 1000 lines each—it actually contains 12,674 lines.

^c As he perished in the sack of Syracuse in 212 B.C., he was therefore born about 287 B.C.

Μετεωρίζειν δύνασθαι λίθους ἀμαξιαίους
 Καὶ τὸν καθένα πέμποντας¹ βυθίζειν τὰς ὀλκάδας.
 Ὡς Μάρκελλος δ' ἀπέστησε βολὴν ἐκείνας τόξου,
 Ἐξάγωνόν τι κάτοπτρον ἐτέκτηνεν ὁ γέρων,
 Ἀπὸ δὲ διαστήματος συμμέτρου τοῦ κατόπτρου
 Μικρὰ τοιαῦτα κάτοπτρα θεῖς τετραπλᾶ γωνίαις
 Κινούμενα λεπίσι τε καὶ τισι γιγγλυμίαις,
 Μέσον ἐκείνο τέθεικεν ἀκτίνων τῶν ἡλίου
 Μεσημβρινῆς καὶ θερινῆς καὶ χειμεριωτάτης.
 Ἀνακλωμένων δὲ λοιπὸν εἰς τοῦτο τῶν ἀκτίνων
 Ἐξάψις ἦρθη φοβερὰ πυρώδης ταῖς ὀλκάσι,
 Καὶ ταύτας ἀπετέφρωσεν ἐκ μήκους τοξοβόλου.
 Οὔτω νικᾷ τὸν Μάρκελλον ταῖς μηχαναῖς ὁ γέρων.
 Ἔλεγε δὲ καὶ δωριστί, φωνῇ Συρακουσίᾳ·
 “ Πᾶ βῶ, καὶ χαριστίωνι τὰν γὰν κινήσω πᾶσαν.”

¹ πέμποντας Cary, πέμποντα codd.

^a Unfortunately, the earliest authority for this story is Lucian, *Hipp.* 2: τὸν δὲ (sc. Ἀρχιμήδην) τὰς τῶν πολεμίων τριήρεις καταφλέξαντα τῇ τέχνῃ. It is also found in Galen, *Περὶ κρασ.* iii. 2, and Zonaras xiv. 3 relates it on the authority of Dion Cassius, but makes Proclus the hero of it.

^b Further evidence is given by Tzetzes, *Chil.* xii. 995 and Eutocius (Archim. ed. Heiberg iii. 132. 5-6) that Archimedes wrote in the Doric dialect, but the extant text of his best-known works, *On the Sphere and Cylinder* and the *Measurement of a Circle*, retains only one genuine trace of its original Doric—the form τῆνον. Partial losses have occurred in other books, the *Sand-Reckoner* having suffered least. The subject is fully treated by Heiberg, *Quaestiones Archimedeae*, pp. 69-94, and in a preface to the second volume of his edition of Archimedes he indicates the words which he has restored to their Doric form despite the manuscripts; his text is adopted in this selection.

The loss of the original Doric is not the only defect in the

ARCHIMEDES

stones large enough to load a waggon and, hurling them one after the other, to sink the ships. When Marcellus withdrew them a bow-shot, the old man constructed a kind of hexagonal mirror, and at an interval proportionate to the size of the mirror he set similar small mirrors with four edges, moved by links and by a form of hinge, and made it the centre of the sun's beams—its noon-tide beam, whether in summer or in mid-winter. Afterwards, when the beams were reflected in the mirror, a fearful kindling of fire was raised in the ships, and at the distance of a bow-shot he turned them into ashes.^a In this way did the old man prevail over Marcellus with his weapons. In his Doric ^b dialect, and in its Syracusan variant, he declared: "If I have somewhere to stand, I will move the whole earth with my *chariston*."^c

text. The hand of an interpolator—often not particularly skilful—can be repeatedly detected, and there are many loose expressions which Archimedes would not have used, and occasional omissions of an essential step in his argument. Sometimes the original text can be inferred from the commentaries written by Eutocius, but these extend only to the books *On the Sphere and Cylinder*, the *Measurement of a Circle*, and *On Plane Equilibriums*. A partial loss of Doric forms had already occurred by the time of Eutocius, and it is believed that the works most widely read were completely recast a little later in the school of Isidorus of Miletus to make them more easily intelligible to pupils.

^c The instrument is otherwise mentioned by Simplicius (*in Aristot. Phys.*, ed. Diels 1110. 2-5) and it is implied that it was used for weighing: ταύτη δὲ τῇ ἀναλογίᾳ τοῦ κινουίντος καὶ τοῦ κινουμένου καὶ τοῦ διαστήματος τὸ σταθμιστικὸν ὄργανον τὸν καλούμενον χαριστίωνα συστήσας ὁ Ἄρχιμήδης ὡς μέχρι παντὸς τῆς ἀναλογίας προχωρούσης ἐκόμπασεν ἐκείνο τὸ "πᾶ βῶ καὶ κινῶ τὰν γᾶν." As Tzetzes in another place (*Chil.* iii. 61: ὁ γῆν ἀνασπῶν μηχανῇ τῇ τρισπᾶστω βουῶν "ὅπα βῶ καὶ σαλεύσω τὴν χθόνα") writes of a triple-pulley device in the same connexion, it may be presumed to have been of this nature.

ARCHIMEDES

Whether, as Diodorus^a asserts, Syracuse was betrayed and the citizens went in a body to Marcellus, or, as Dion^b tells, it was plundered by the Romans, while the citizens were keeping a night festival to Artemis, he died in this fashion at the hands of one of the Romans. He was stooping down, drawing some diagram in mechanics, when a Roman came up and began to drag him away to take him prisoner. But he, being wholly intent at the time on the diagram, and not perceiving who was tugging at him, said to the man: "Stand away, fellow, from my diagram."^c As the man continued pulling, he turned round and, realizing that he was a Roman, he cried, "Somebody give me one of my engines." But the Roman, scared, straightway slew him, a feeble old man but wonderful in his works.

Plutarch, *Marcellus* xiv. 7-xvii. 7

Archimedes, who was a kinsman and friend of King Hiero, wrote to him that with a given force it was possible to move any given weight; and emboldened, as it is said, by the strength of the proof, he averred that, if there were another world and he could go to it, he would move this one. Hiero was amazed and besought him to give a practical demonstration of the problem and show some great object moved by a small force; he thereupon chose a three-masted merchantman among the king's ships which had been hauled ashore with great labour by a large band of men, and after putting on board many men and the usual cargo, sitting some distance away and without any special effort, he pulled gently with his hand at coming "πὰρ κεφαλάν" ἔφη "καὶ μὴ παρὰ γραμμάν"—"Let them come at my head," he said, "but not at my line."

GREEK MATHEMATICS

ἡρέμα τῇ χειρὶ σείων ἀρχὴν τινα πολυσπάστου προσηγάγετο λείως καὶ ἀπταιστως καὶ ὡσπερ διὰ θαλάττης ἐπιθέουσαν. ἐκπλαγεῖς οὖν ὁ βασιλεὺς καὶ συννοήσας τῆς τέχνης τὴν δύναμιν, ἔπεισε τὸν Ἀρχιμήδην ὅπως αὐτῷ τὰ μὲν ἀμυνομένῳ, τὰ δ' ἐπιχειροῦντι μηχανήματα κατασκευάσῃ πρὸς πᾶσαν ιδέαν πολιορκίας, οἷς αὐτὸς μὲν οὐκ ἐχρήσατο, τοῦ βίου τὸ πλείστον ἀπόλεμον καὶ πανηγυρικὸν βιώσας, τότε δ' ὑπῆρχε τοῖς Συρακουσίοις εἰς δέον ἢ παρασκευὴ καὶ μετὰ τῆς παρασκευῆς ὁ δημιουργός.

Ὡς οὖν προσέβαλον οἱ Ῥωμαῖοι διχόθεν, ἐκπληξίς ἦν τῶν Συρακουσίων καὶ σιγὴ διὰ δέος, μηδὲν ἂν ἀνθέξειν πρὸς βίαν καὶ δύναμιν οἰομένων τοσαύτην. σχάσαντος δὲ τὰς μηχανὰς τοῦ Ἀρχιμήδους ἅμα τοῖς μὲν πεζοῖς ἀπῆντα τοξεύματά τε παντοδαπὰ καὶ λίθων ὑπέρογκα μεγέθη, ροίζω καὶ τάχει καταφερομένων ἀπίστῳ, καὶ μηδενὸς ὄλως τὸ βρίθος στέγοντος ἀθρόους ἀνατρεπόντων τοὺς ὑποπίπτοντας καὶ τὰς τάξεις συγχεόντων, ταῖς δὲ ναυσὶν ἀπὸ τῶν τειχῶν ἄφνω ὑπεραιωρούμεναι κεραῖαι τὰς μὲν ὑπὸ βρίθους στηρίζοντος ἄνωθεν ὠθοῦσαι κατέδνον εἰς βυθόν, τὰς δὲ χερσὶ σιδηραῖς ἢ στόμασιν εἰκασμένοις γεράνων ἀνασπῶσαι πρῶραθεν ὀρθὰς ἐπὶ πρύμναν ἐβάπτιζον,

* πολυσπάστος. Galen, in *Hipp. De Artic.* iv. 47 uses the same word. Tzetzes (*loc. cit.*) speaks of a triple-pulley device (τῇ τρισπάστῳ μηχανῇ) in the same connexion, and Oribasius, *Coll. med.* xlix. 22 mentions the τρισπαστος as an invention of Archimedes; he says that it was so called because it had three ropes, but Vitruvius says it was thus named because it had three wheels. Athenaeus v. 207 a-b says that a *helix* was used. Heath, *The Works of Archimedes*,

ARCHIMEDES

the end of a compound pulley ^a and drew the vessel smoothly and evenly towards himself as though she were running along the surface of the water. Astonished at this, and understanding the power of his art, the king persuaded Archimedes to construct for him engines to be used in every type of siege warfare, some defensive and some offensive ; he had not himself used these engines because he spent the greater part of his life remote from war and amid the rites of peace, but now his apparatus proved of great advantage to the Syracusans, and with the apparatus its inventor.^b

Accordingly, when the Romans attacked them from two elements, the Syracusans were struck dumb with fear, thinking that nothing would avail against such violence and power. But Archimedes began to work his engines and hurled against the land forces all sorts of missiles and huge masses of stones, which came down with incredible noise and speed ; nothing at all could ward off their weight, but they knocked down in heaps those who stood in the way and threw the ranks into disorder. Furthermore, beams were suddenly thrown over the ships from the walls, and some of the ships were sent to the bottom by means of weights fixed to the beams and plunging down from above ; others were drawn up by iron claws, or crane-like beaks, attached to the prow and were

p. xx, suggests that the vessel, once started, was kept in motion by the system of pulleys, but the first impulse was given by a machine similar to the *κοχλίας* described by Pappus viii. ed. Hultsch 1066, 1108 ff., in which a cog-wheel with oblique teeth moves on a cylindrical helix turned by a handle.

^b Similar stories of Archimedes' part in the defence are told by Polybius viii. 5. 3-5 and Livy xxiv. 34.

GREEK MATHEMATICS

ἢ δι' ἀντιτόνων ἔνδον ἐπιστρεφόμεναι καὶ περιηγόμεναι τοῖς ὑπὸ τὸ τεῖχος πεφυκόσι κρημνοῖς καὶ σκοπέλοις προσήρασσον, ἅμα φθόρῳ πολλῶ τῶν ἐπιβατῶν συντριβομένων. πολλάκις δὲ μετέωρος ἐξαρθεῖσα ναῦς ἀπὸ τῆς θαλάσσης δεῦρο κἀκείσε περιδινουμένη καὶ κρεμαμένη θέαμα φρικῶδες ἦν, μέχρι οὗ τῶν ἀνδρῶν ἀπορριφέντων καὶ διασφενδουθηθέντων κενὴ προσπέσοι τοῖς τείχεσιν ἢ περιολίσθοι τῆς λαβῆς ἀνείσης. ἦν δὲ ὁ Μάρκελλος ἀπὸ τοῦ ζεύγματος ἐπήγε μηχανήν, σαμβύκη μὲν ἐκαλεῖτο δι' ὁμοιότητά τινα σχήματος πρὸς τὸ μουσικὸν ὄργανον, ἔτι δὲ ἄπωθεν αὐτῆς προσφερομένης πρὸς τὸ τεῖχος ἐξήλατο λίθος δεκατάλαντος ὀλκήν, εἶτα ἕτερος ἐπὶ τούτῳ καὶ τρίτος, ὧν οἱ μὲν αὐτῇ¹ ἐμπεσόντες μεγάλῳ κτύπῳ καὶ κλύδωνι τῆς μηχανῆς τὴν τε βᾶσιν συνηλόησαν καὶ τὸ γόμφωμα διέσεισαν καὶ διέσπασαν τοῦ ζεύγματος, ὥστε τὸν Μάρκελλον ἀπορούμενον αὐτόν τε ταῖς ναυσὶν ἀποπλεῖν κατὰ τάχος καὶ τοῖς πεζοῖς ἀναχώρησιν παρεγγυῆσαι.

Βουλευομένοις δὲ ἔδοξεν αὐτοῖς ἔτι νυκτός, ἂν δύνωνται, προσμῖξαι τοῖς τείχεσι· τοὺς γὰρ τόνους, οἷς χρῆσθαι τὸν Ἀρχιμήδην, ρύμην ἔχοντας ὑπερπετεῖς ποιήσεσθαι τὰς τῶν βελῶν ἀφέσεις, ἐγγύθεν δὲ καὶ τελέως ἀπράκτους εἶναι διάστημα τῆς πληγῆς οὐκ ἐχούσης. ὁ δ' ἦν, ὡς ἔοικεν, ἐπὶ ταῦτα πάλαι παρεσκευασμένος ὀργάνων τε συμμετρους πρὸς πᾶν διάστημα κινήσεις καὶ βέλη βραχέα, καὶ διὰ (τὸ τεῖχος²) οὐ μεγάλων, πολλῶν

¹ αὐτῇ Coraës, αὐτῆς codd.

² τὸ τεῖχος add. Sintenis ex Polyb.

ARCHIMEDES

plunged down on their sterns, or were twisted round and turned about by means of ropes within the city, and dashed against the cliffs set by Nature under the wall and against the rocks, with great destruction of the crews, who were crushed to pieces. Often there was the fearful sight of a ship lifted out of the sea into mid-air and whirled about as it hung there, until the men had been thrown out and shot in all directions, when it would fall empty upon the walls or slip from the grip that had held it. As for the engine which Marcellus was bringing up from the platform of ships, and which was called *sambuca* from some resemblance in its shape to the musical instrument,^a while it was still some distance away as it was being carried to the wall a stone ten talents in weight was discharged at it, and after this a second and a third ; some of these, falling upon it with a great crash and sending up a wave, crushed the base of the engine, shook the framework and dislodged it from the barrier, so that Marcellus in perplexity sailed away in his ships and passed the word to his land forces to retire.

In a council of war it was decided to approach the walls, if they could, while it was still night ; for they thought that the ropes used by Archimedes, since they gave a powerful impetus, would send the missiles over their heads and would fail in their object at close quarters since there was no space for the cast. But Archimedes, it seems, had long ago prepared for such a contingency engines adapted to all distances and missiles of short range, and through openings in the

^a The *σαμβύκη* was a triangular musical instrument with four strings. Polybius (viii. 6) states that Marcellus had eight quinqueremes in pairs locked together, and on each pair a "sambuca" had been erected ; it served as a pent-house for raising soldiers on to the battlements.

GREEK MATHEMATICS

δὲ καὶ συνεχῶν τρημάτων (ὄντων¹), οἱ σκορπίοι βραχύτονοι μὲν, ἐγγύθεν δὲ πλήξαι παρεστήκεσαν ἀόρατοι τοῖς πολεμίοις.

Ὡς οὖν προσέμιξαν οἰόμενοι λανθάνειν, αὐθις αὐτῶν βέλεσι πολλοῖς ἐντυγχάνοντες καὶ πληγαῖς, πετρῶν μὲν ἐκ κεφαλῆς ἐπ' αὐτοὺς φερομένων ὥσπερ πρὸς κάθετον, τοῦ δὲ τείχους τοξεύματα πανταχόθεν ἀναπέμποντος, ἀνεχώρουν ὀπίσω. κἀνταῦθα πάλιν αὐτῶν εἰς μῆκος ἐκτεταγμένων, βελῶν ἐκθεόντων καὶ καταλαμβανόντων ἀπιόντας ἐγένετο πολὺς μὲν αὐτῶν φθόρος, πολὺς δὲ τῶν νεῶν συγκρουσμός, οὐδὲν ἀντιδρᾶσαι τοὺς πολεμίους δυναμένων. τὰ γὰρ πλείστα τῶν ὀργάνων ὑπὸ τὸ τείχος ἐσκευοποίητο τῷ Ἀρχιμήδει, καὶ θεομαχοῦσιν ἐώκεσαν οἱ Ῥωμαῖοι, μυρίων αὐτοῖς κακῶν ἐξ ἀφανοῦς ἐπιχειρομένων.

Οὐ μὴν ἄλλ' ὁ Μάρκελλος ἀπέφυγέ τε καὶ τοὺς σὺν ἑαυτῷ σκώπτων τεχνίτας καὶ μηχανοποιούς ἔλεγεν· “οὐ παυσόμεθα πρὸς τὸν γεωμετρικὸν τοῦτον Βριάρεων πολεμοῦντες, ὃς ταῖς μὲν ναυσὶν² ἡμῶν κ्βαθίζει ἐκ τῆς θαλάσσης, τὴν δὲ σαμβύκην ραπίζων³ μετ' αἰσχύνης ἐκβέβληκε, τοὺς δὲ μυθικοὺς ἐκατόγχειρας ὑπεραίρει τοσαῦτα βάλλων ἅμα βέλη καθ' ἡμῶν;” τῷ γὰρ ὄντι πάντες οἱ λοιποὶ Συρακούσιοι σῶμα τῆς Ἀρχιμήδους παρασκευῆς ἦσαν, ἣ δὲ κινουσα πάντα καὶ στρέφουσα ψυχὴ μία, τῶν μὲν ἄλλων ὄπλων ἀτρέμα κειμένων, μόνοις δὲ τοῖς ἐκείνου τότε τῆς πόλεως χρωμένης καὶ πρὸς ἄμυναν καὶ πρὸς ἀσφάλειαν. τέλος δὲ τοὺς Ῥωμαίους οὕτω περιφόβους γεγονότας ὄρων ὁ Μάρκελλος ὥστ', εἰ καλῶδιον ἢ ξύλον ὑπὲρ τοῦ

¹ ὄντων add. Sintenis ex Polyb.

ARCHIMEDES

wall, small in size but many and continuous, short-ranged engines called scorpions could be trained on objects close at hand without being seen by the enemy.

When, therefore, the Romans approached the walls, thinking to escape notice, once again they were met by the impact of many missiles; stones fell down on them almost perpendicularly, the wall shot out arrows at them from all points, and they withdrew to the rear. Here again, when they were drawn up some distance away, missiles flew forth and caught them as they were retiring, and caused much destruction among them; many of the ships, also, were dashed together and they could not retaliate upon the enemy. For Archimedes had made the greater part of his engines under the wall, and the Romans seemed to be fighting against the gods, inasmuch as countless evils were poured upon them from an unseen source.

Nevertheless Marcellus escaped, and, twitting his artificers and craftsmen, he said: "Shall we not cease fighting against this geometrical Briareus, who uses our ships like cups to ladle water from the sea, who has whipped our *sambuca* and driven it off in disgrace, and who outdoes all the hundred-handed monsters of fable in hurling so many missiles against us all at once?" For in reality all the other Syracusans were only a body for Archimedes' apparatus, and his the one soul moving and turning everything: all other weapons lay idle, and the city then used his alone, both for offence and for defence. In the end the Romans became so filled with fear that, if they saw a little piece of rope or of wood projecting over

³ ταῖς μὲν ναυσὶν . . . ῥαπίζων an anonymous correction from Polybius, τὰς μὲν ναῦς ἡμῶν καθίζων πρὸς τὴν θάλασσαν παίζων codd.

GREEK MATHEMATICS

τείχους μικρὸν ὄφθειν προτεινόμενον, τοῦτο ἐκείνο, μηχανὴν τινα κινεῖν ἐπ' αὐτοὺς Ἀρχιμήδη βοῶντας ἀποτρέπεσθαι καὶ φεύγειν, ἀπέσχετο μάχης ἀπάσης καὶ προσβολῆς, τὸ λοιπὸν ἐπὶ τῷ χρόνῳ τὴν πολιορκίαν θέμενος.

Τηλικούτον μέντοι φρόνημα καὶ βάθος ψυχῆς καὶ τοσοῦτον ἐκέκτητο θεωρημάτων πλοῦτον Ἀρχιμήδης ὥστε, ἐφ' οἷς ὄνομα καὶ δόξαν οὐκ ἀνθρωπίνης, ἀλλὰ δαιμονίου τινὸς ἔσχε συνέσεως, μηθὲν ἐθελῆσαι σύγγραμμα περὶ τούτων ἀπολιπεῖν, ἀλλὰ τὴν περὶ τὰ μηχανικὰ πραγματείαν καὶ πᾶσαν ὅλως τέχνην χρείας ἐφαπτομένην ἀγεννῆ καὶ βάνουσον ἠγησάμενος, εἰς ἐκείνα καταθέσθαι μόνα τὴν αὐτοῦ φιλοτιμίαν οἷς τὸ καλὸν καὶ περιττὸν ἀμιγῆς τοῦ ἀναγκαίου πρόσσεστιν, ἀσύγκριτα μὲν ὄντα τοῖς ἄλλοις, ἔριν δὲ παρέχοντα πρὸς τὴν ὕλην τῇ ἀποδείξει, τῆς μὲν τὸ μέγεθος καὶ τὸ κάλλος, τῆς δὲ τὴν ἀκρίβειαν καὶ τὴν δύναμιν ὑπερφυῆ παρεχομένης· οὐ γὰρ ἔστιν ἐν γεωμετρίᾳ χαλεπώτερας καὶ βαρυτέρας ὑποθέσεις ἐν ἀπλουτέροις λαβεῖν καὶ καθαρωτέροις στοιχείοις γραφομένας. καὶ τοῦθ' οἱ μὲν εὐφυῖα τοῦ ἀνδρὸς προσάπτουσιν, οἱ δὲ ὑπερβολῇ τινι πόνου νομίζουσιν ἀπόνως πεποιημένῳ καὶ ραδίως ἕκαστον εἰκόσ γεγενῆσθαι. ζητῶν μὲν γὰρ οὐκ ἂν τις εὖροι δι' αὐτοῦ τὴν ἀπόδειξιν, ἅμα δὲ τῇ μαθήσει παρίσταται δόξα τοῦ κἂν αὐτὸν εὐρεῖν· οὕτω λείαν ὁδὸν ἄγει καὶ ταχείαν ἐπὶ τὸ δεικνύμενον. οὐκ οὐδὲ ἀπιστῆσαι τοῖς περὶ αὐτοῦ λεγομένοις ἐστίν, ὡς ὑπ' οἰκείας δῆ τινος καὶ συνοίκου θελγόμενος αἰεὶ σειρήνος ἐλέληστο καὶ σίτου καὶ θεραπείας σώματος ἐξέλειπε, βία δὲ πολλάκις ἐλκόμενος ἐπ' ἄλειμμα καὶ

ARCHIMEDES

the wall, they cried, "There it is, Archimedes is training some engine upon us," and fled; seeing this Marcellus abandoned all fighting and assault, and for the future relied on a long siege.

Yet Archimedes possessed so lofty a spirit, so profound a soul, and such a wealth of scientific inquiry, that although he had acquired through his inventions a name and reputation for divine rather than human intelligence, he would not deign to leave behind a single writing on such subjects. Regarding the business of mechanics and every utilitarian art as ignoble and vulgar, he gave his zealous devotion only to those subjects whose elegance and subtlety are untrammelled by the necessities of life; these subjects, he held, cannot be compared with any others; in them the subject-matter vies with the demonstration, the former possessing strength and beauty, the latter precision and surpassing power; for it is not possible to find in geometry more difficult and weighty questions treated in simpler and purer terms. Some attribute this to the natural endowments of the man, others think it was the result of exceeding labour that everything done by him appeared to have been done without labour and with ease. For although by his own efforts no one could discover the proof, yet as soon as he learns it, he takes credit that he could have discovered it: so smooth and rapid is the path by which he leads to the conclusion. For these reasons there is no need to disbelieve the stories told about him—how, continually bewitched by some familiar siren dwelling with him, he forgot his food and neglected the care of his body; and how, when he was dragged by main force, as often happened, to the

¹ ἀγείν Bryan, ἀγείν codd.

GREEK MATHEMATICS

λουτρόν, ἐν ταῖς ἐσχάrais ἔγραφε σχήματα τῶν γεωμετρικῶν, καὶ τοῦ σώματος ἀηλιμμένου διήγε τῷ δακτύλῳ γραμμὰς, ὑπὸ ἡδονῆς μεγάλης κάτοχος ὢν καὶ μουσόληπτος ἀληθῶς. πολλῶν δὲ καὶ καλῶν εὐρετῆς γεγονῶς λέγεται τῶν φίλων δεηθῆναι καὶ τῶν συγγενῶν ὅπως αὐτοῦ μετὰ τὴν τελευτὴν ἐπιστήσωσι τῷ τάφῳ τὸν περιλαμβάνοντα τὴν σφαῖραν ἐντὸς κύλινδρον, ἐπιγράψαντες τὸν λόγον τῆς ὑπεροχῆς τοῦ περιέχοντος στερεοῦ πρὸς τὸ περιεχόμενον.

Ibid. xix. 4-6

Μάλιστα δὲ τὸ Ἀρχιμήδους πάθος ἠνίασε Μάρκελλον. ἔτυχε μὲν γὰρ αὐτός τι καθ' ἑαυτὸν ἀνασκοπῶν ἐπὶ διαγράμματος· καὶ τῇ θεωρίᾳ δεδωκῶς ἅμα τὴν τε διάνοιαν καὶ τὴν πρόσοψιν οὐ προήσθητο τὴν καταδρομὴν τῶν Ῥωμαίων οὐδὲ τὴν ἄλωσιν τῆς πόλεως, ἄφνω δὲ ἐπιστάντος αὐτῷ στρατιώτου καὶ κελεύοντος ἀκολουθεῖν πρὸς Μάρκελλον οὐκ ἐβούλετο πρὶν ἢ τελέσαι τὸ πρόβλημα καὶ καταστήσαι πρὸς τὴν ἀπόδειξιν. ὁ δὲ ὀργισθεὶς καὶ σπασάμενος τὸ ξίφος ἀνείλεν αὐτόν. ἕτεροι μὲν οὖν λέγουσιν ἐπιστῆναι μὲν εὐθὺς ὡς ἀποκτενοῦντα ξιφήρη τὸν Ῥωμαῖον, ἐκείνον δ' ἰδόντα δεῖσθαι καὶ ἀντιβολεῖν ἀναμείναι βραχὺν χρόνον, ὡς μὴ καταλίπη τὸ ζητούμενον ἀτελές καὶ ἀθεώρητον, τὸν δὲ οὐ φροντίσαντα διαχρήσασθαι. καὶ τρίτος ἐστὶ λόγος, ὡς κομίζοντι πρὸς Μάρκελλον αὐτῷ τῶν μαθηματικῶν ὀργάνων σκιόθηρα καὶ σφαίρας καὶ γωνίας, αἷς ἐναρμόττει

* Cicero, when quaestor in Sicily, found this tomb over-

ARCHIMEDES

place for bathing and anointing, he would draw geometrical figures in the hearths, and draw lines with his finger in the oil with which his body was anointed, being overcome by great pleasure and in truth inspired of the Muses. And though he made many elegant discoveries, he is said to have besought his friends and kinsmen to place on his grave after his death a cylinder enclosing a sphere, with an inscription giving the proportion by which the including solid exceeds the included.^a

Ibid. xix. 4-6

But what specially grieved Marcellus was the death of Archimedes. For it chanced that he was alone, examining a diagram closely ; and having fixed both his mind and his eyes on the object of his inquiry, he perceived neither the inroad of the Romans nor the taking of the city. Suddenly a soldier came up to him and bade him follow to Marcellus, but he would not go until he had finished the problem and worked it out to the demonstration. Thereupon the soldier became enraged, drew his sword and dispatched him. Others, however, say that the Roman came upon him with drawn sword intending to kill him at once, and that Archimedes, on seeing him, besought and entreated him to wait a little while so that he might not leave the question unfinished and only partly investigated ; but the soldier did not understand and slew him. There is also a third story, that as he was carrying to Marcellus some of his mathematical instruments, such as sundials, spheres and

grown with vegetation, but still bearing the cylinder with the sphere, and he restored it (*Tusc. Disp.* v. 64-66). The theorem proving the proportion is given *infra*, pp. 124-127.

GREEK MATHEMATICS

τὸ τοῦ ἡλίου μέγεθος πρὸς τὴν ὄψιν, στρατιῶται περιτυχόντες καὶ χρυσιὸν ἐν τῷ τεύχει δόξαντες φέρειν ἀπέκτειναν. ὅτι μέντοι Μάρκελλος ἤλγησε καὶ τὸν αὐτόχειρα τοῦ ἀνδρὸς ἀπεστράφη καθάπερ ἐναγῆ, τοὺς δὲ οἰκείους ἀνευρῶν ἐτίμησεν, ὁμολογεῖται.

Papp. *Coll.* viii. 11. 19, ed. Hultsch 1060. 1-4

Τῆς αὐτῆς δὲ ἐστὶν θεωρίας τὸ δοθὲν βάρος τῆ δοθείσῃ δυνάμει κινήσαι· τοῦτο γὰρ Ἀρχιμήδους μὲν εὕρημα [λέγεται]¹ μηχανικόν, ἐφ' ᾧ λέγεται εἰρηκέναι· “δός μοί (φησι) ποῦ στῶ καὶ κινῶ τὴν γῆν.”

Diod. Sic. i. 34. 2

Ποταμόχωστος γὰρ οὔσα καὶ κατάρρυτος πολλοὺς καὶ πανταδαποὺς ἐκφέρει καρπούς, τοῦ μὲν ποταμοῦ διὰ τὴν κατ' ἔτος ἀνάβασιν νεαρὰν ἰλὺν αἰεὶ καταχέοντος, τῶν δ' ἀνθρώπων ῥαδίως ἅπασαν ἀρδευόντων διὰ τινος μηχανῆς, ἣν ἐπενόησε μὲν Ἀρχιμήδης ὁ Συρακόσιος, ὀνομάζεται δὲ ἀπὸ τοῦ σχήματος κοχλίας.

Ibid. v. 37. 3

Τὸ πάντων παραδοξότατον, ἀπαρύτουσι τὰς ῥύσεις τῶν ὑδάτων τοῖς Αἰγυπτιακοῖς λεγομένοις κοχλίας, οὓς Ἀρχιμήδης ὁ Συρακόσιος εὗρεν, ὅτε παρέβαλεν εἰς Αἴγυπτον.

¹ λέγεται om. Hultsch.

^a Diodorus is writing of the island in the delta of the Nile.

^b It may be inferred that he studied with the successors of Euclid at Alexandria, and it was there perhaps that he made the acquaintance of Conon of Samos, to whom, as

ARCHIMEDES

angles adjusted to the apparent size of the sun, some soldiers fell in with him and, under the impression that he carried treasure in the box, killed him. What is, however, agreed is that Marcellus was distressed, and turned away from the slayer as from a polluted person, and sought out the relatives of Archimedes to do them honour.

Pappus, *Collection* viii. 11. 19, ed. Hultsch 1060. 1-4

To the same type of inquiry belongs the problem: *To move a given weight by a given force.* This is one of Archimedes' discoveries in mechanics, whereupon he is said to have exclaimed: "Give me somewhere to stand and I will move the earth."

Diodorus Siculus i. 34. 2

As it is made of silt watered by the river after being deposited, it^a bears an abundance of fruits of all kinds; for in the annual rising the river continually pours over it fresh alluvium, and men easily irrigate the whole of it by means of a certain instrument conceived by Archimedes of Syracuse, and which gets its name because it has the form of a spiral or *screw*.

Ibid. v. 37. 3

Most remarkable of all, they draw off streams of water by the so-called Egyptian screws, which Archimedes of Syracuse invented when he went by ship to Egypt.^b

the preface to his books *On the Sphere and Cylinder* shows, he used to communicate his discoveries before publication, and Eratosthenes of Cyrene, to whom he sent the *Method* and probably the *Cattle Problem*.

GREEK MATHEMATICS

Vitr. *De Arch.* ix., Praef. 9-12

Archimedis vero cum multa miranda inventa et varia fuerint, ex omnibus etiam infinita sollertia id quod exponam videtur esse expressum. Nimium Hiero Syracusis auctus regia potestate, rebus bene gestis cum auream coronam votivam diis immortalibus in quodam fano constituisset ponendam, manupretio locavit faciendam et aurum ad sacoma adpendit redemptori. Is ad tempus opus manu factum subtiliter regi adprobavit et ad sacoma pondus coronae visus est praestitisse. Posteaquam indicium est factum dempto auro tantundem argenti in id coronarium opus admixtum esse, indignatus Hiero se contemptum esse neque inveniens qua ratione id furtum deprehenderet, rogavit Archimeden uti insumeret sibi de eo cogitationem. Tunc is cum haberet eius rei curam, casu venit in balineum ibique cum in solium descenderet, animadvertit quantum corporis sui in eo insideret tantum aquae extra solium effluere. Idque cum eius rei rationem explicationis ostendisset, non est moratus sed exsiluit gaudio motus de solio et nudus vadens domum versus significabat clara voce invenisse quod quaereret. Nam currens identidem graece clamabat *εὕρηκα εὕρηκα*.

Tum vero ex eo inventionis ingressu duas fecisse dicitur massas aequo pondere quo etiam fuerat corona, unam ex auro et alteram ex argento. Cum ita fecisset, vas amplum ad summa labra implevit

^a " I have found, I have found."

ARCHIMEDES

Vitruvius, *On Architecture* ix., Preface 9-1

Archimedes made many wonderful discoveries of different kinds, but of all these that which I shall now explain seems to exhibit a boundless ingenuity. When Hiero was greatly exalted in the royal power at Syracuse, in return for the success of his policy he determined to set up in a certain shrine a golden crown as a votive offering to the immortal gods. He let out the work for a stipulated payment, and weighed out the exact amount of gold for the contractor. At the appointed time the contractor brought his work skilfully executed for the king's approval, and he seemed to have fulfilled exactly the requirement about the weight of the crown. Later information was given that gold had been removed and an equal weight of silver added in the making of the crown. Hiero was indignant at this disrespect for himself, and, being unable to discover any means by which he might unmask the fraud, he asked Archimedes to give it his attention. While Archimedes was turning the problem over, he chanced to come to the place of bathing, and there, as he was sitting down in the tub, he noticed that the amount of water which flowed over the tub was equal to the amount by which his body was immersed. This indicated to him a means of solving the problem, and he did not delay, but in his joy leapt out of the tub and, rushing naked towards his home, he cried out with a loud voice that he had found what he sought. For as he ran he repeatedly shouted in Greek, *heureka, heureka*.^a

Then, following up his discovery, he is said to have made two masses of the same weight as the crown, the one of gold and the other of silver. When he had so done, he filled a large vessel right up to the brim

GREEK MATHEMATICS

aqua, in quo demisit argenteam massam. Cuius quanta magnitudo in vase depressa est, tantum aquae effluxit. Ita exempta massa quanto minus factum fuerat refudit sextario mensus, ut eodem modo quo prius fuerat ad labra aequaretur. Ita ex eo invenit quantum pondus argenti ad certam aquae mensuram responderet.

Cum id expertus esset, tum auream massam similiter pleno vase demisit et ea exempta eadem ratione mensura addita invenit deesse aquae non tantum sed minus, quanto minus magno corpore eodem pondere auri massa esset quam argenti. Postea vero repleto vase in eadem aqua ipsa corona demissa invenit plus aquae defluxisse in coronam quam in auream eodem pondere massam, et ita ex eo quod defuerit plus aquae in corona quam in massa, ratiocinatus apprehendit argenti in auro mixtionem et manifestum furtum redemptoris.

* The method may be thus expressed analytically.

Let w be the weight of the crown, and let it be made up of a weight w_1 of gold and a weight w_2 of silver, so that $w = w_1 + w_2$.

Let the crown displace a volume v of water.

Let the weight w of gold displace a volume v_1 of water; then a weight w_1 of gold displaces a volume $\frac{w_1}{w} \cdot v_1$ of water.

Let the weight w of silver displace a volume v_2 of water;

ARCHIMEDES

with water, into which he dropped the silver mass. The amount by which it was immersed in the vessel was the amount of water which overflowed. Taking out the mass, he poured back the amount by which the water had been depleted, measuring it with a pint pot, so that as before the water was made level with the brim. In this way he found what weight of silver answered to a certain measure of water.

When he had made this test, in like manner he dropped the golden mass into the full vessel. Taking it out again, for the same reason he added a measured quantity of water, and found that the deficiency of water was not the same, but less; and the amount by which it was less corresponded with the excess of a mass of silver, having the same weight, over a mass of gold. After filling the vessel again, he then dropped the crown itself into the water, and found that more water overflowed in the case of the crown than in the case of the golden mass of identical weight; and so, from the fact that more water was needed to make up the deficiency in the case of the crown than in the case of the mass, he calculated and detected the mixture of silver with the gold and the contractor's fraud stood revealed.^a

then a weight w_2 of silver displaces a volume $\frac{w_2}{w} \cdot v_2$ of water.

$$\begin{aligned} \text{It follows that} \quad v &= \frac{w_1}{w} \cdot v_1 + \frac{w_2}{w} \cdot v_2 \\ &= \frac{w_1 v_1 + w_2 v_2}{w_1 + w_2}, \end{aligned}$$

$$\text{so that} \quad \frac{w_1}{w_2} = \frac{v_2 - v}{v - v_1}.$$

For an alternative method of solving the problem, *v. infra*, pp. 248-251.

GREEK MATHEMATICS

(b) SURFACE AND VOLUME OF THE CYLINDER AND SPHERE

Archim. *De Sphaera et Cyl.* i., Archim. ed. Heiberg
i. 2-132. 3

Ἀρχιμήδης Δοσιθέῳ χαίρειν

Πρότερον μὲν ἀπέσταλκά σοι τῶν ὑφ' ἡμῶν τεθεωρημένων γράψας μετὰ ἀποδείξεως, ὅτι πᾶν τμήμα τὸ περιεχόμενον ὑπὸ τε εὐθείας καὶ ὀρθογωνίου κώνου τομῆς ἐπίτριτόν ἐστι τριγώνου τοῦ βάσιν τὴν αὐτὴν ἔχοντος τῷ τμήματι καὶ ὕψος ἴσον· ὕστερον δὲ ἡμῖν ὑποπεσόντων θεωρημάτων ἀξίων λόγου¹ πεπραγματεύμεθα περὶ τὰς ἀποδείξεις αὐτῶν. ἔστιν δὲ τάδε· πρῶτον μὲν, ὅτι πάσης σφαίρας ἢ ἐπιφάνεια τετραπλασία ἐστὶν τοῦ μεγίστου κύκλου τῶν ἐν αὐτῇ· ἔπειτα δέ, ὅτι παντὸς τμήματος σφαίρας τῇ ἐπιφανείᾳ ἴσος ἐστὶ κύκλος, οὗ ἢ ἐκ τοῦ κέντρου ἴση ἐστὶ τῇ εὐθείᾳ τῇ ἀπὸ τῆς κορυφῆς τοῦ τμήματος ἀγομένη ἐπὶ τὴν περιφέρειαν τοῦ κύκλου, ὅς ἐστι βᾶσις τοῦ τμήματος·

¹ ἀξίων λόγου cod., ἀνελέγκτων conī. Heath.

* The chief results of this book are described in the prefatory letter to Dositheus. In this selection as much as possible is given of what is essential to finding the proportions between the surface and volume of the sphere and the surface and volume of the enclosing cylinder, which Archimedes regarded as his crowning achievement (*supra*, p. 32). In the case of the surface, the whole series of propositions is reproduced so that the reader may follow in detail the majestic chain of reasoning by which Archimedes, starting from seemingly remote premises, reaches the desired conclusion; in the case of the volume only the final proposition (34) can be given, for reasons of space, but the reader will be able to prove the omitted theorems for himself. *Pari passu* with

ARCHIMEDES

(b) SURFACE AND VOLUME OF THE CYLINDER AND SPHERE

Archimedes. *On the Sphere and Cylinder* i., Archim. ed. Heiberg i. 2-132. 3^a

Archimedes to Dositheus greeting

On a previous occasion I sent you, together with the proof, so much of my investigations as I had set down in writing, namely, that *any segment bounded by a straight line and a section of a right-angled cone is four-thirds of the triangle having the same base as the segment and equal height.*^b Subsequently certain theorems deserving notice occurred to me, and I have worked out the proofs. They are these: first, that *the surface of any sphere is four times the greatest of the circles in it*^c; then, that *the surface of any segment of a sphere is equal to a circle whose radius is equal to the straight line drawn from the vertex of the segment to the circumference of the circle which is the base of the segment*^d; and,

this demonstration, Archimedes finds the surface and volume of any segment of a sphere. The method in each case is to inscribe in the sphere or segment of a sphere, and to circumscribe about it, figures composed of cones and frusta of cones. The sphere or segment of a sphere is intermediate in surface and volume between the inscribed and circumscribed figures, and in the limit, when the number of sides in the inscribed and circumscribed figures is indefinitely increased, it would become identical with them. It will readily be appreciated that Archimedes' method is fundamentally the same as integration, and on p. 116 n. b this will be shown trigonometrically.

^b This is proved in Props. 17 and 24 of the *Quadrature of the Parabola*, sent to Dositheus of Pelusium with a prefatory letter, v. pp. 228-243, *infra*.

^c *De Sphaera et Cyl.* i. 30. "The greatest of the circles," here and elsewhere, is equivalent to "a great circle."

^d *Ibid.* i. 42, 43.

πρὸς δὲ τούτοις, ὅτι πάσης σφαίρας ὁ κύλινδρος ὁ βάσιν μὲν ἔχων ἴσην τῷ μεγίστῳ κύκλῳ τῶν ἐν τῇ σφαίρᾳ, ὕψος δὲ ἴσον τῇ διαμέτρῳ τῆς σφαίρας αὐτός τε ἡμιόλιός ἐστιν τῆς σφαίρας, καὶ ἡ ἐπιφάνεια αὐτοῦ τῆς ἐπιφανείας τῆς σφαίρας. ταῦτα δὲ τὰ συμπτώματα τῇ φύσει προσηύχθηεν περὶ τὰ εἰρημένα σχήματα, ἠγνοεῖτο δὲ ὑπὸ τῶν πρὸ ἡμῶν περὶ γεωμετρίαν ἀνεστραμμένων οὐδενὸς αὐτῶν ἐπινοηκότος, ὅτι τούτων τῶν σχημάτων ἐστὶν συμμετρία. . . . ἐξέσται δὲ περὶ τούτων ἐπισκέψασθαι τοῖς δυνησομένοις. ὤφειλε μὲν οὖν Κόνωνος ἔτι ζῶντος ἐκδίδοσθαι ταῦτα· τήνον γὰρ ὑπολαμβάνομεν πού μάλιστα ἂν δύνασθαι κατανοῆσαι ταῦτα καὶ τὴν ἀρμόζουσαν ὑπὲρ αὐτῶν ἀπόφασιν ποιήσασθαι· δοκιμάζοντες δὲ καλῶς ἔχειν μεταδιδόναι τοῖς οἰκείοις τῶν μαθημάτων ἀποστέλλομέν σοι τὰς ἀποδείξεις ἀναγράψαντες, ὑπὲρ ὧν ἐξέσται τοῖς περὶ τὰ μαθήματα ἀναστρεφόμενοις ἐπισκέψασθαι. ἐρρωμένως.

Γράφονται πρῶτον τὰ τε ἀξιώματα καὶ τὰ λαμβανόμενα εἰς τὰς ἀποδείξεις αὐτῶν.

Ἀξιώματα

α'. Εἰσὶ τινες ἐν ἐπιπέδῳ καμπύλαι γραμμαὶ πεπερασμέναι, αἱ τῶν τὰ πέρατα ἐπιζευγνουσῶν αὐτῶν εὐθειῶν ἤτοι ὅλαι ἐπὶ τὰ αὐτὰ εἰσιν ἢ οὐδὲν ἔχουσιν ἐπὶ τὰ ἕτερα.

β'. Ἐπὶ τὰ αὐτὰ δὴ κοίλην καλῶ τὴν τοιαύτην γραμμὴν, ἐν ἣ ἔαν δύο σημείων λαμβανομένων

* *De Sphaera et Cyl.* i. 34 coroll. The surface of the cylinder here includes the bases.

ARCHIMEDES

further, that, *in the case of any sphere, the cylinder having its base equal to the greatest of the circles in the sphere, and height equal to the diameter of the sphere, is one-and-a-half times the sphere, and its surface is one-and-a-half times the surface of the sphere.*^a Now these properties were inherent in the nature of the figures mentioned, but they were unknown to all who studied geometry before me, nor did any of them suspect such a relationship in these figures.^b . . . But now it will be possible for those who have the capacity to examine these discoveries of mine. They ought to have been published while Conon was still alive, for I opine that he more than others would have been able to grasp them and pronounce a fitting verdict upon them; but, holding it well to communicate them to students of mathematics, I send you the proofs that I have written out, which proofs will now be open to those who are conversant with mathematics. Farewell.

In the first place, the axioms and the assumptions used for the proofs of these theorems are here set out.

AXIOMS ^c

1. There are in a plane certain finite bent lines which either lie wholly on the same side of the straight lines joining their extremities or have no part on the other side.

2. I call *concave in the same direction* a line such that, if any two points whatsoever are taken on it, either

^b In the omitted passage which follows, Archimedes compares his discoveries with those of Eudoxus; it has already been given, vol. i. pp. 408-411.

^c These so-called axioms are more in the nature of definitions.

GREEK MATHEMATICS

ὁποιωνοῦν αἱ μεταξὺ τῶν σημείων εὐθεῖαι ἦτοι πᾶσαι ἐπὶ τὰ αὐτὰ πίπτουσιν τῆς γραμμῆς, ἢ τινὲς μὲν ἐπὶ τὰ αὐτά, τινὲς δὲ κατ' αὐτῆς, ἐπὶ τὰ ἕτερα δὲ μηδεμία.

γ'. Ὁμοίως δὴ καὶ ἐπιφάνειαι τινὲς εἰσιν πεπερασμένοι, αὐταὶ μὲν οὐκ ἐν ἐπιπέδῳ, τὰ δὲ πέρατα ἔχουσαι ἐν ἐπιπέδῳ, αἱ τοῦ ἐπιπέδου, ἐν ᾧ τὰ πέρατα ἔχουσιν, ἦτοι ὅλαι ἐπὶ τὰ αὐτὰ ἔσονται ἢ οὐδὲν ἔχουσιν ἐπὶ τὰ ἕτερα.

δ'. Ἐπὶ τὰ αὐτὰ δὴ κοίλας καλῶ τὰς τοιαύτας ἐπιφανείας, ἐν αἷς ἂν δύο σημείων λαμβανομένων αἱ μεταξὺ τῶν σημείων εὐθεῖαι ἦτοι πᾶσαι ἐπὶ τὰ αὐτὰ πίπτουσιν τῆς ἐπιφανείας, ἢ τινὲς μὲν ἐπὶ τὰ αὐτά, τινὲς δὲ κατ' αὐτῆς, ἐπὶ τὰ ἕτερα δὲ μηδεμία.

ε'. Τομέα δὲ στερεὸν καλῶ, ἐπειδὴν σφαῖραν κῶνος τέμνη κορυφὴν ἔχων πρὸς τῷ κέντρῳ τῆς σφαίρας, τὸ ἐμπεριεχόμενον σχῆμα ὑπὸ τε τῆς ἐπιφανείας τοῦ κώνου καὶ τῆς ἐπιφανείας τῆς σφαίρας ἐντὸς τοῦ κώνου.

ς'. Ῥόμβον δὲ καλῶ στερεόν, ἐπειδὴν δύο κῶνοι τὴν αὐτὴν βάσιν ἔχοντες τὰς κορυφὰς ἔχουσιν ἐφ' ἐκάτερα τοῦ ἐπιπέδου τῆς βάσεως, ὅπως οἱ ἄξονες αὐτῶν ἐπ' εὐθείας ὡς κείμενοι, τὸ ἐξ ἀμφοῖν τοῖν κῶνοιν συγκεῖμενον στερεὸν σχῆμα.

Λαμβανόμενα

Λαμβάνω δὲ ταῦτα·

α'. Τῶν τὰ αὐτὰ πέρατα ἔχουσῶν γραμμῶν ἐλαχίστην εἶναι τὴν εὐθείαν.

ARCHIMEDES

all the straight lines joining the points fall on the same side of the line, or some fall on one and the same side while others fall along the line itself, but none fall on the other side.

3. Similarly also there are certain finite surfaces, not in a plane themselves but having their extremities in a plane, and such that they will either lie wholly on the same side of the plane containing their extremities or will have no part on the other side.

4. I call *concave in the same direction* surfaces such that, if any two points on them are taken, either the straight lines between the points all fall upon the same side of the surface, or some fall on one and the same side while others fall along the surface itself, but none falls on the other side.

5. When a cone cuts a sphere, and has its vertex at the centre of the sphere, I call the figure comprehended by the surface of the cone and the surface of the sphere within the cone a *solid sector*.

6. When two cones having the same base have their vertices on opposite sides of the plane of the base in such a way that their axes lie in a straight line, I call the solid figure formed by the two cones a *solid rhombus*.

POSTULATES

I make these postulates :

1. Of all lines which have the same extremities the straight line is the least.^a

^a Proclus (*in Eucl.*, ed. Friedlein 110. 10-14) saw in this statement a connexion with Euclid's definition of a straight line as lying evenly with the points on itself: ὁ δ' αὖ Ἀρχιμήδης τὴν εὐθείαν ὠρίσατο γραμμὴν ἐλαχίστην τῶν τὰ αὐτὰ πέρατα ἔχουσῶν. διότι γάρ, ὡς ὁ Εὐκλείδιος λόγος φησίν, ἐξ ἴσου κείται τοῖς ἐφ' ἑαυτῆς σημείοις, διὰ τοῦτο ἐλαχίστη ἐστὶν τῶν τὰ αὐτὰ πέρατα ἔχουσῶν.

GREEK MATHEMATICS

β'. Τῶν δὲ ἄλλων γραμμῶν, ἂν ἐν ἐπιπέδῳ οὔσαι τὰ αὐτὰ πέρατα ἔχωσιν, ἀνίσους εἶναι τὰς τοιαύτας, ἐπειδὴν ὧσιν ἀμφοτέραι ἐπὶ τὰ αὐτὰ κοίλαι, καὶ ἦτοι ὅλη περιλαμβάνηται ἢ ἑτέρα αὐτῶν ὑπὸ τῆς ἑτέρας καὶ τῆς εὐθείας τῆς τὰ αὐτὰ πέρατα ἐχούσης αὐτῆ, ἢ τινὰ μὲν περιλαμβάνηται, τινὰ δὲ κοινὰ ἔχη, καὶ ἐλάσσονα εἶναι τὴν περιλαμβανομένην.

γ'. Ὁμοίως δὲ καὶ τῶν ἐπιφανειῶν τῶν τὰ αὐτὰ πέρατα ἐχουσῶν, ἂν ἐν ἐπιπέδῳ τὰ πέρατα ἔχωσιν, ἐλάσσονα εἶναι τὴν ἐπίπεδον.

δ'. Τῶν δὲ ἄλλων ἐπιφανειῶν καὶ τὰ αὐτὰ πέρατα ἐχουσῶν, ἂν ἐν ἐπιπέδῳ τὰ πέρατα ἦ, ἀνίσους εἶναι τὰς τοιαύτας, ἐπειδὴν ὧσιν ἀμφοτέραι ἐπὶ τὰ αὐτὰ κοίλαι, καὶ ἦτοι ὅλη περιλαμβάνηται ὑπὸ τῆς ἑτέρας ἢ ἑτέρα ἐπιφάνεια καὶ τῆς ἐπιπέδου τῆς τὰ αὐτὰ πέρατα ἐχούσης αὐτῆ, ἢ τινὰ μὲν περιλαμβάνηται, τινὰ δὲ κοινὰ ἔχη, καὶ ἐλάσσονα εἶναι τὴν περιλαμβανομένην.

ε'. Ἐτι δὲ τῶν ἀνίσων γραμμῶν καὶ τῶν ἀνίσων ἐπιφανειῶν καὶ τῶν ἀνίσων στερεῶν τὸ μείζον τοῦ ἐλάσσονος ὑπερέχει τοιούτῳ, ὃ συντιθέμενον αὐτὸ ἑαυτῷ δυνατόν ἐστιν ὑπερέχει παντὸς τοῦ προτεθέντος τῶν πρὸς ἄλληλα λεγομένων.

Τούτων δὲ ὑποκειμένων, ἂν εἰς κύκλον πολύγωνον ἐγγραφῆ, φανερόν, ὅτι ἡ περίμετρος τοῦ ἐγγραφέντος πολυγώνου ἐλάσσων ἐστὶν τῆς τοῦ κύκλου περιφερείας· ἐκάστη γὰρ τῶν τοῦ πολυγώνου πλευρῶν ἐλάσσων ἐστὶ τῆς τοῦ κύκλου περιφερείας τῆς ὑπὸ τῆς αὐτῆς ἀποτεμνομένης.

^a This famous "Axiom of Archimedes" is, in fact, generally used by him in the alternative form in which it is proved

ARCHIMEDES

2. Of other lines lying in a plane and having the same extremities, [any two] such are unequal when both are concave in the same direction and one is either wholly included between the other and the straight line having the same extremities with it, or is partly included by and partly common with the other ; and the included line is the lesser.

3. Similarly, of surfaces which have the same extremities, if those extremities be in a plane, the plane is the least.

4. Of other surfaces having the same extremities, if the extremities be in a plane, [any two] such are unequal when both are concave in the same direction, and one surface is either wholly included between the other and the plane having the same extremities with it, or is partly included by and partly common with the other ; and the included surface is the lesser.

5. Further, of unequal lines and unequal surfaces and unequal solids, the greater exceeds the less by such a magnitude as, when added to itself, can be made to exceed any assigned magnitude among those comparable with one another.^a

With these premises, *if a polygon be inscribed in a circle, it is clear that the perimeter of the inscribed polygon is less than the circumference of the circle ; for each of the sides of the polygon is less than the arc of the circle cut off by it.*

in Euclid x. 1, for which *v.* vol. i. pp. 452-455. The axiom can be shown to be equivalent to Dedekind's principle, that a section of the rational points in which they are divided into two classes is made by a single point. Applied to straight lines, it is equivalent to saying that there is a complete correspondence between the aggregate of real numbers and the aggregate of points in a straight line ; *v.* E. W. Hobson, *The Theory of Functions of a Real Variable*, 2nd ed., vol. i. p. 55.

GREEK MATHEMATICS

α'

Ἐὰν περὶ κύκλον πολύγωνον περιγραφῆ, ἡ τοῦ περιγραφέντος πολυγώνου περίμετρος μείζων ἐστὶν τῆς περιμέτρου τοῦ κύκλου.

Περὶ γὰρ κύκλον πολύγωνον περιγεγράφθω τὸ ὑποκείμενον. λέγω, ὅτι ἡ περίμετρος τοῦ πολυγώνου μείζων ἐστὶν τῆς περιμέτρου τοῦ κύκλου.

Ἐπεὶ γὰρ συναμφοτέρως ἡ ΒΑΛ μείζων ἐστὶ τῆς ΒΑ περιφερείας διὰ τὸ τὰ αὐτὰ πέρατα ἔχουσαν περιλαμβάνειν τὴν περιφέρειαν, ὁμοίως δὲ καὶ συναμφοτέρως μὲν ἡ ΔΓ, ΓΒ τῆς ΔΒ, συναμφοτέρως δὲ ἡ ΛΚ, ΚΘ τῆς ΛΘ, συναμφοτέρως δὲ ἡ ΖΗΘ τῆς ΖΘ, ἔτι δὲ συναμφοτέρως ἡ ΔΕ, ΕΖ τῆς ΔΖ, ὅλη ἄρα ἡ περίμετρος τοῦ πολυγώνου μείζων ἐστὶ τῆς περιφερείας τοῦ κύκλου.

* It is here indicated, as in Prop. 3, that Archimedes added a figure to his own demonstration.

ARCHIMEDES

Prop. 1

If a polygon be circumscribed about a circle, the perimeter of the circumscribed polygon is greater than the circumference of the circle.

For let the polygon be circumscribed about the circle as below.^a I say that the perimeter of the polygon is greater than the circumference of the circle.

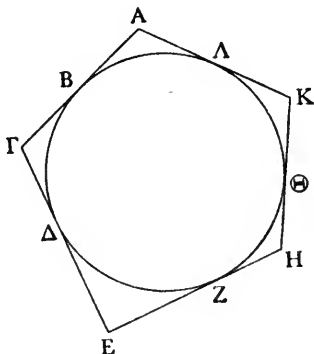

For since $BA + A\Lambda > \text{arc } B\Lambda,$

owing to the fact that they have the same extremities as the arc and include it, and similarly

$$\Delta\Gamma + \Gamma B > [\text{arc}] \Delta B,$$

$$\Lambda K + K\Theta > [\text{arc}] \Lambda\Theta,$$

$$ZH + H\Theta > [\text{arc}] Z\Theta,$$

and further $\Delta E + EZ > [\text{arc}] \Delta Z,$

therefore the whole perimeter of the polygon is greater than the circumference of the circle.

β'

Δύο μεγεθῶν ἀνίσων δοθέντων δυνατόν ἐστὶν εὐρεῖν δύο εὐθείας ἀνίσους, ὥστε τὴν μείζονα εὐθείαν πρὸς τὴν ἐλάσσονα λόγον ἔχει ἐλάσσονα ἢ τὸ μείζον μέγεθος πρὸς τὸ ἔλασσον.

Ἐστω δύο μεγέθη ἄνισα τὰ ΑΒ, Δ, καὶ ἔστω μείζον τὸ ΑΒ. λέγω, ὅτι δυνατόν ἐστὶ δύο εὐθείας ἀνίσους εὐρεῖν τὸ εἰρημένον ἐπίταγμα ποιούσας.

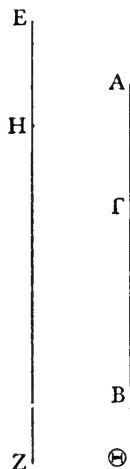

Κείσθω διὰ τὸ β' τοῦ α' τῶν

Εὐκλείδου τῷ Δ ἴσον τὸ ΒΓ, καὶ κείσθω τις εὐθεῖα γραμμὴ ἡ ΖΗ· τὸ δὲ ΓΑ ἑαυτῷ ἐπισυντιθέμενον ὑπερέξει τοῦ Δ. πεπολλαπλασιάσθω οὖν, καὶ ἔστω τὸ ΑΘ, καὶ ὁσαυπλάσιόν ἐστὶ τὸ ΑΘ τοῦ ΑΓ, τοσαυταπλάσιος ἔστω ἡ ΖΗ τῆς ΗΕ· ἔστιν ἄρα, ὡς τὸ ΘΑ πρὸς ΑΓ, οὕτως ἡ ΖΗ πρὸς ΗΕ· καὶ ἀνάπαλιν ἐστὶν, ὡς ἡ ΕΗ πρὸς ΗΖ, οὕτως τὸ ΑΓ πρὸς ΑΘ. καὶ ἐπεὶ μείζον ἐστὶν τὸ ΑΘ τοῦ Δ, τουτέστι τοῦ ΓΒ, τὸ ἄρα ΓΑ πρὸς τὸ ΑΘ λόγον ἐλάσσονα ἔχει ἢ περ τὸ ΓΑ πρὸς ΓΒ. ἀλλ' ὡς

τὸ ΓΑ πρὸς ΑΘ, οὕτως ἡ ΕΗ πρὸς ΗΖ· ἡ ΕΗ ἄρα πρὸς ΗΖ ἐλάσσονα λόγον ἔχει ἢ περ τὸ ΓΑ πρὸς ΓΒ· καὶ συνθέντι ἡ ΕΖ [ἄρα]¹ πρὸς ΖΗ ἐλάσσονα λόγον ἔχει ἢ περ τὸ ΑΒ πρὸς ΒΓ [διὰ λήμμα].² ἴσον δὲ τὸ ΒΓ τῷ Δ· ἡ ΕΖ ἄρα πρὸς ΖΗ ἐλάσσονα λόγον ἔχει ἢ περ τὸ ΑΒ πρὸς τὸ Δ.

ARCHIMEDES

Prop. 2

Given two unequal magnitudes, it is possible to find two unequal straight lines such that the greater straight line has to the less a ratio less than the greater magnitude has to the less.

Let AB, Δ be two unequal magnitudes, and let AB be the greater. I say that it is possible to find two unequal straight lines satisfying the aforesaid requirement.

By the second proposition in the first book of Euclid let $B\Gamma$ be placed equal to Δ , and let ZH be any straight line; then ΓA , if added to itself, will exceed Δ . [Post. 5.] Let it be multiplied, therefore, and let the result be $A\Theta$, and as $A\Theta$ is to $A\Gamma$, so let ZH be to HE ; therefore

$$\Theta A : A\Gamma = ZH : HE \quad [\text{cf. Eucl. v. 15}]$$

and conversely, $EH : HZ = A\Gamma : A\Theta$.

[Eucl. v. 7, coroll.]

And since

$$A\Theta > \Delta \\ > \Gamma B,$$

therefore $\Gamma A : A\Theta < \Gamma A : \Gamma B$. [Eucl. v. 8]

But $\Gamma A : A\Theta = EH : HZ$;

therefore $EH : HZ < \Gamma A : \Gamma B$;

componendo, $EZ : ZH < AB : B\Gamma$.^a

Now $B\Gamma = \Delta$;

therefore $EZ : ZH < AB : \Delta$.

^a This and related propositions are proved by Eutocius [Archim. ed. Heiberg iii. 16. 11–18. 22] and by Pappus, *Coll.* ed. Hultsch 684. 20 ff. It may be simply proved thus. If $a : b < c : d$, it is required to prove that $a + b : b < c + d : d$. Let e be taken so that $a : b : e : d$. Then $e : d < c : d$. Therefore $e < c$, and $e + d : d < c + d : d$. But $e : d : d = a + b : b$ (*ex hypothesi, componendo*). Therefore $a + b : b < c + d : d$.

¹ ἄρα om. Heiberg.

² διὰ λήμμα om. Heiberg.

GREEK MATHEMATICS

Εὐρημέναι εἰσὶν ἄρα δύο εὐθεῖαι ἄνισοι ποιούσαι τὸ εἰρημένον ἐπίταγμα [τουτέστιν τὴν μείζονα πρὸς τὴν ἐλάσσονα λόγον ἔχειν ἐλάσσονα ἢ τὸ μείζον μέγεθος πρὸς τὸ ἔλασσον].¹

γ'

Δύο μεγεθῶν ἀνίσων δοθέντων καὶ κύκλου δυνατόν ἐστὶν εἰς τὸν κύκλον πολύγωνον ἐγγράψαι καὶ ἄλλο περιγράψαι, ὅπως ἢ τοῦ περιγραφομένου πολυγώνου πλευρὰ πρὸς τὴν τοῦ ἐγγραφομένου πολυγώνου πλευρὰν ἐλάσσονα λόγον ἔχη ἢ τὸ μείζον μέγεθος πρὸς τὸ ἔλαττον.

Ἐστω τὰ δοθέντα δύο μεγέθη τὰ Α, Β, ὁ δὲ δοθεὶς κύκλος ὁ ὑποκείμενος. λέγω οὖν, ὅτι δυνατόν ἐστι ποιεῖν τὸ ἐπίταγμα.

Εὐρήσθωσαν γὰρ δύο εὐθεῖαι αἱ Θ, ΚΛ, ὧν μείζων ἔστω ἢ Θ, ὥστε τὴν Θ πρὸς τὴν ΚΛ

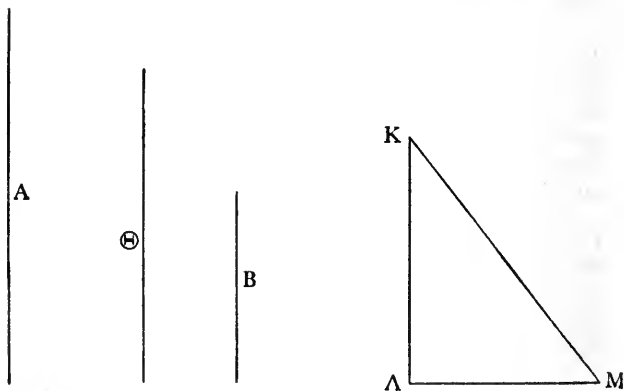

ARCHIMEDES

Accordingly there have been discovered two unequal straight lines fulfilling the aforesaid requirement.

Prop. 3

Given two unequal magnitudes and a circle, it is possible to inscribe a [regular] polygon in the circle and to circumscribe another, in such a manner that the side of the circumscribed polygon has to the side of the inscribed polygon a ratio less than that which the greater magnitude has to the less.

Let A, B be the two given magnitudes, and let the

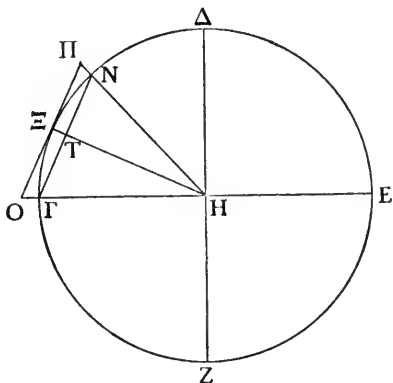

given circle be that set out below. I say then that it is possible to do what is required.

For let there be found two straight lines Θ , $K\Lambda$, of which Θ is the greater, such that Θ has to $K\Lambda$ a ratio

¹ ΤΟΥΤΕΣΤΙΝ . . . ἔλασσον verba subditiva esse suspicatur Heiberg.

GREEK MATHEMATICS

ἐλάσσονα λόγον ἔχειν ἢ τὸ μείζον μέγεθος πρὸς τὸ
 ἕλαττον, καὶ ἤχθω ἀπὸ τοῦ Λ τῇ ΛK πρὸς ὀρθὰς
 ἢ ΛM , καὶ ἀπὸ τοῦ K τῇ Θ ἴση κατήχθω ἢ KM
 [δυνατὸν γὰρ τοῦτο],¹ καὶ ἤχθωσαν τοῦ κύκλου
 δύο διάμετροι πρὸς ὀρθὰς ἀλλήλαις αἱ ΓE , ΔZ .
 τέμνοντες οὖν τὴν ὑπὸ τῶν $\Delta\text{H}\Gamma$ γωνίαν δίχα
 καὶ τὴν ἡμίσειαν αὐτῆς δίχα καὶ αἰεὶ τοῦτο
 ποιοῦντες λείβομέν τινα γωνίαν ἐλάσσονα ἢ δι-
 πλασίαν τῆς ὑπὸ ΛKM . λελείφθω καὶ ἔστω ἡ
 ὑπὸ $\text{NH}\Gamma$, καὶ ἐπεζεύχθω ἡ $\text{N}\Gamma$. ἡ ἄρα $\text{N}\Gamma$
 πολυγώνου ἐστὶ πλευρὰ ἰσοπλεύρου [ἐπεὶπερ ἡ
 ὑπὸ $\text{NH}\Gamma$ γωνία μετρεῖ τὴν ὑπὸ $\Delta\text{H}\Gamma$ ὀρθὴν
 οὔσαν, καὶ ἡ $\text{N}\Gamma$ ἄρα περιφέρεια μετρεῖ τὴν $\Gamma\Delta$
 τέταρτον οὔσαν κύκλου· ὥστε καὶ τὸν κύκλον
 μετρεῖ. πολυγώνου ἄρα ἐστὶ πλευρὰ ἰσοπλεύρου·
 φανερόν γάρ ἐστι τοῦτο].² καὶ τετμήσθω ἡ ὑπὸ
 $\Gamma\text{H}\text{N}$ γωνία δίχα τῇ $\text{H}\Xi$ εὐθείᾳ, καὶ ἀπὸ τοῦ Ξ
 ἐφαπτέσθω τοῦ κύκλου ἡ $\text{O}\Xi\Pi$, καὶ ἐκβεβλή-
 σθωσαν αἱ $\text{H}\text{N}\Pi$, $\text{H}\Gamma\text{O}$. ὥστε καὶ ἡ PO πολυ-
 γώνου ἐστὶ πλευρὰ τοῦ περιγραφομένου περὶ τὸν
 κύκλον καὶ ἰσοπλεύρου [φανερόν, ὅτι καὶ ὁμοίου
 τῷ ἐγγραφομένῳ, οὗ πλευρὰ ἡ $\text{N}\Gamma$].³ ἐπεὶ δὲ
 ἐλάσσων ἐστὶν ἢ διπλασία ἡ ὑπὸ $\text{NH}\Gamma$ τῆς ὑπὸ
 ΛKM , διπλασία δὲ τῆς ὑπὸ $\text{TH}\Gamma$, ἐλάσσων ἄρα
 ἡ ὑπὸ $\text{TH}\Gamma$ τῆς ὑπὸ ΛKM . καὶ εἰσιν ὀρθαὶ αἱ
 πρὸς τοῖς Λ , Γ . ἡ ἄρα MK πρὸς ΛK μείζονα λόγον
 ἔχει ἢπερ ἡ ΓH πρὸς HT . ἴση δὲ ἡ ΓH τῇ $\text{H}\Xi$.
 ὥστε ἡ $\text{H}\Xi$ πρὸς HT ἐλάσσονα λόγον ἔχει, του-
 τέστιν ἡ PO πρὸς $\text{N}\Gamma$, ἢπερ ἡ MK πρὸς $\text{K}\Lambda$.
 ἔτι δὲ ἡ MK πρὸς $\text{K}\Lambda$ ἐλάσσονα λόγον ἔχει ἢπερ
 τὸ A πρὸς τὸ B . καὶ ἐστὶν ἡ μὲν PO πλευρὰ

ARCHIMEDES

less than that which the greater magnitude has to the less [Prop. 2], and from Λ let ΛM be drawn at right angles to ΛK , and from K let KM be drawn equal to Θ , and let there be drawn two diameters of the circle, ΓE , ΔZ , at right angles one to another. If we bisect the angle $\Delta H \Gamma$ and then bisect the half and so on continually we shall leave a certain angle less than double the angle $\Lambda K M$. Let it be left and let it be the angle $N H \Gamma$, and let $N \Gamma$ be joined; then $N \Gamma$ is the side of an equilateral polygon. Let the angle $\Gamma H N$ be bisected by the straight line $H \Xi$, and through Ξ let the tangent $O \Xi \Pi$ be drawn, and let $H N \Pi$, $H \Gamma O$ be produced; then ΠO is a side of an equilateral polygon circumscribed about the circle. Since the angle $N H \Gamma$ is less than double the angle $\Lambda K M$ and is double the angle $T H \Gamma$, therefore the angle $T H \Gamma$ is less than the angle $\Lambda K M$. And the angles at Λ , T are right; therefore

$$MK : \Lambda K > \Gamma H : HT.^a$$

But $\Gamma H = H \Xi$.

Therefore $H \Xi : HT < MK : K \Lambda$,

that is, $\Pi O : N \Gamma < MK : K \Lambda$.^b

Further, $MK : K \Lambda < A : B$.^c

[Therefore $\Pi O : N \Gamma < A : B$.]

^a This is proved by Eutocius and is equivalent to the assertion that if $a < \beta \leq \frac{\pi}{2}$, $\text{cosec } \beta > \text{cosec } a$.

^b For $H \Xi : HT = \Pi O : N \Gamma$, since $H \Xi : HT = O \Xi : \Gamma T = 2O \Xi : 2\Gamma T = \Pi O : \Gamma N$.

^c For by hypothesis $\Theta : K \Lambda < A : B$, and $\Theta = MK$.

¹ δυνατόν . . . τοῦτο om. Heiberg.

² ἐπέπερ . . . τοῦτο om. Heiberg.

³ φανερόν . . . ἡ $N \Gamma$ om. Heiberg.

GREEK MATHEMATICS

τοῦ περιγραφομένου πολυγώνου, ἢ δὲ ΓΝ τοῦ ἐγγραφομένου· ὅπερ προέκειτο εὐρεῖν.

ε΄

Κύκλου δοθέντος καὶ δύο μεγεθῶν ἀνίσων περιγράψαι περὶ τὸν κύκλον πολύγωνον καὶ ἄλλο ἐγγράψαι, ὥστε τὸ περιγραφέν πρὸς τὸ ἐγγραφέν ἐλάσσονα λόγον ἔχειν ἢ τὸ μείζον μέγεθος πρὸς τὸ ἔλασσον.

Ἐκκείσθω κύκλος ὁ Α καὶ δύο μεγέθη ἄνισα

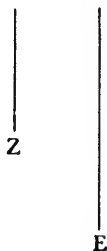
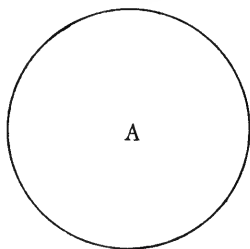

τὰ Ε, Ζ καὶ μείζον τὸ Ε· δεῖ οὖν πολύγωνον ἐγγράψαι εἰς τὸν κύκλον καὶ ἄλλο περιγράψαι, ἵνα γένηται τὸ ἐπιταχθέν.

Λαμβάνω γὰρ δύο εὐθείας ἀνίσους τὰς Γ, Δ, ὧν μείζων ἔστω ἡ Γ, ὥστε τὴν Γ πρὸς τὴν Δ

ARCHIMEDES

And ΠO is a side of the circumscribed polygon, ΓN of the inscribed ; which was to be found.

Prop. 5

Given a circle and two unequal magnitudes, to circumscribe a polygon about the circle and to inscribe another, so that the circumscribed polygon has to the inscribed polygon a ratio less than the greater magnitude has to the less.

Let there be set out the circle A and the two unequal magnitudes E, Z , and let E be the greater ; it is therefore required to inscribe a polygon in the circle and to circumscribe another, so that what is required may be done.

For I take two unequal straight lines Γ, Δ , of which let Γ be the greater, so that Γ has to Δ a ratio

GREEK MATHEMATICS

ἐλάσσονα λόγον ἔχει ἢ τὴν E πρὸς τὴν Z . καὶ τῶν Γ , Δ μέσης ἀνάλογον ληφθείσης τῆς H μείζων ἄρα καὶ ἢ Γ τῆς H . περιγεγράφθω δὴ περὶ κύκλον πολύγωνον καὶ ἄλλο ἐγγεγράφθω, ὥστε τὴν τοῦ περιγραφέντος πολυγώνου πλευρὰν πρὸς τὴν τοῦ ἐγγραφέντος ἐλάσσονα λόγον ἔχει ἢ τὴν Γ πρὸς τὴν H [καθὼς ἐμάθομεν]¹. διὰ τοῦτο δὴ καὶ ὁ διπλάσιος λόγος τοῦ διπλασίου ἐλάσσων ἐστί. καὶ τοῦ μὲν τῆς πλευρᾶς πρὸς τὴν πλευρὰν διπλάσιός ἐστι ὁ τοῦ πολυγώνου πρὸς τὸν πολύγωνον [ὅμοια γάρ],² τῆς δὲ Γ πρὸς τὴν H ὁ τῆς Γ πρὸς τὴν Δ . καὶ τὸ περιγραφέν ἄρα πολύγωνον πρὸς τὸ ἐγγραφέν ἐλάσσονα λόγον ἔχει ἢπερ ἢ Γ πρὸς τὴν Δ . πολλῶ ἄρα τὸ περιγραφέν πρὸς τὸ ἐγγραφέν ἐλάσσονα λόγον ἔχει ἢπερ τὸ E πρὸς τὸ Z .

η'

Ἐὰν περὶ κώνου ἰσοσκελῆ πυραμὶς περιγραφῆ, ἢ ἐπιφάνεια τῆς πυραμίδος χωρὶς τῆς βάσεως ἴση ἐστὶν τριγώνῳ βάσιν μὲν ἔχοντι τὴν ἴσην τῇ περιμέτρῳ τῆς βάσεως, ὕψος δὲ τὴν πλευρὰν τοῦ κώνου. . . .

θ'

Ἐὰν κώνου τινὸς ἰσοσκελοῦς εἰς τὸν κύκλον, ὃς ἐστὶ βάσις τοῦ κώνου, εὐθεῖα γραμμὴ ἐμπέση, ἀπὸ δὲ τῶν περάτων αὐτῆς εὐθεῖαι γραμμαὶ ἀχθῶσιν ἐπὶ τὴν κορυφὴν τοῦ κώνου, τὸ περιληφθὲν τρίγωνον ὑπὸ τε τῆς ἐμπεσοῦσης καὶ τῶν ἐπιζευχθεισῶν ἐπὶ τὴν κορυφὴν ἔλασσον ἐστὶ τῆς

ARCHIMEDES

less than that which E has to Z [Prop. 2]; if a mean proportional H be taken between Γ , Δ , then Γ will be greater than H [Eucl. vi. 13]. Let a polygon be circumscribed about the circle and another inscribed, so that the side of the circumscribed polygon has to the side of the inscribed polygon a ratio less than that which Γ has to H [Prop. 3]; it follows that the duplicate ratio is less than the duplicate ratio. Now the duplicate ratio of the sides is the ratio of the polygons [Eucl. vi. 20], and the duplicate ratio of Γ to H is the ratio of Γ to Δ [Eucl. v. Def. 9]; therefore the circumscribed polygon has to the inscribed polygon a ratio less than that which Γ has to Δ ; by much more therefore the circumscribed polygon has to the inscribed polygon a ratio less than that which E has to Z.

Prop. 8

If a pyramid be circumscribed about an isosceles cone, the surface of the pyramid without the base is equal to a triangle having its base equal to the perimeter of the base [of the pyramid] and its height equal to the side of the cone. . . .^a

Prop. 9

If in an isosceles cone a straight line [chord] fall in the circle which is the base of the cone, and from its extremities straight lines be drawn to the vertex of the cone, the triangle formed by the chord and the lines joining it to

^a The "side of the cone" is a generator. The proof is obvious.

¹ καθὼς ἐμάθομεν om. Heiberg.

² ὅμοια γάρ om. Heiberg.

GREEK MATHEMATICS

ἐπιφανείας τοῦ κώνου τῆς μεταξύ τῶν ἐπὶ τὴν κορυφήν ἐπιζευχθειῶν.

Ἔστω κώνου ἰσοσκελοῦς βάσις ὁ $ΑΒΓ$ κύκλος, κορυφή δὲ τὸ $Δ$, καὶ διήχθω τις εἰς αὐτὸν εὐθεῖα ἢ $ΑΓ$, καὶ ἀπὸ τῆς κορυφῆς ἐπὶ τὰ $Α, Γ$ ἐπεζεύχθωσαν αἱ $ΑΔ, ΔΓ$. λέγω, ὅτι τὸ $ΑΔΓ$ τρίγωνον

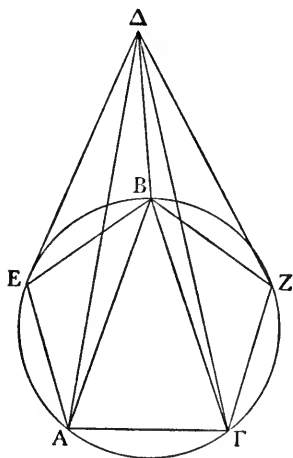

ἔλασσόν ἐστιν τῆς ἐπιφανείας τῆς κωνικῆς τῆς μεταξύ τῶν $ΑΔΓ$.

Τετμήσθω ἡ $ΑΒΓ$ περιφέρεια δίχα κατὰ τὸ $Β$, καὶ ἐπεζεύχθωσαν αἱ $ΑΒ, ΒΓ, ΔΒ$. ἔσται δὴ τὰ $ΑΒΔ, ΒΓΔ$ τρίγωνα μείζονα τοῦ $ΑΔΓ$ τριγώνου.¹ ὧ δὴ ὑπερέχει τὰ εἰρημένα τρίγωνα τοῦ $ΑΔΓ$ τριγώνου, ἔστω τὸ $Θ$. τὸ δὴ $Θ$ ἦτοι τῶν $ΑΒ, ΒΓ$ τμημάτων ἔλασσόν ἐστιν ἢ οὐ.

ARCHIMEDES

the vertex will be less than the surface of the cone between the lines drawn to the vertex.

Let the circle $AB\Gamma$ be the base of an isosceles cone, let Δ be its vertex, let the straight line $A\Gamma$ be drawn in it, and let $A\Delta$, $\Delta\Gamma$ be drawn from the vertex to A , Γ ; I say that the triangle $A\Delta\Gamma$ is less than the surface of the cone between $A\Delta$, $\Delta\Gamma$.

Let the arc $AB\Gamma$ be bisected at B , and let AB , ΓB , ΔB be joined; then the triangles $AB\Delta$, $B\Gamma\Delta$ will be greater than the triangle $A\Delta\Gamma$.^a Let Θ be the excess by which the aforesaid triangles exceed the triangle $A\Delta\Gamma$. Now Θ is either less than the sum of the segments AB , $B\Gamma$ or not less.

^a For if h be the length of a generator of the isosceles cone, triangle $AB\Delta = \frac{1}{2}h \cdot AB$, triangle $B\Gamma\Delta = \frac{1}{2}h \cdot B\Gamma$, triangle $A\Delta\Gamma = \frac{1}{2}h \cdot A\Gamma$, and $AB + B\Gamma > A\Gamma$.

¹ ἔσται . . . τριγώνου: ex Eutocio videtur Archimedem scripsisse: μείζονα ἄρα ἐστὶ τὰ $AB\Delta$, $B\Gamma\Delta$ τρίγωνα τοῦ $A\Delta\Gamma$ τριγώνου.

Ἔστω μὴ ἔλασσον πρότερον. ἐπεὶ οὖν δύο εἰσὶν ἐπιφάνειαι ἢ τε κωνικὴ ἢ μεταξὺ τῶν $\Lambda\Delta\text{B}$ μετὰ τοῦ AEB τμήματος καὶ ἢ τοῦ $\Lambda\Delta\text{B}$ τριγώνου τὸ αὐτὸ πέρασ ἔχουσαι τὴν περίμετρον τοῦ τριγώνου τοῦ $\Lambda\Delta\text{B}$, μείζων ἔσται ἢ περιλαμβάνουσα τῆς περιλαμβανομένης· μείζων ἄρα ἐστὶν ἢ κωνικὴ ἐπιφάνεια ἢ μεταξὺ τῶν $\Lambda\Delta\text{B}$ μετὰ τοῦ AEB τμήματος τοῦ $\Lambda\text{B}\Delta$ τριγώνου. ὁμοίως δὲ καὶ ἢ μεταξὺ τῶν $\text{B}\Delta\Gamma$ μετὰ τοῦ ΓZB τμήματος μείζων ἐστὶν τοῦ $\text{B}\Delta\Gamma$ τριγώνου· ὅλη ἄρα ἢ κωνικὴ ἐπιφάνεια μετὰ τοῦ Θ χωρίου μείζων ἐστὶ τῶν εἰρημένων τριγώνων. τὰ δὲ εἰρημένα τρίγωνα ἴσα ἐστὶν τῷ τε $\Lambda\Delta\Gamma$ τριγώνῳ καὶ τῷ Θ χωρίῳ. κοινὸν ἀφηρήσθω τὸ Θ χωρίον· λοιπὴ ἄρα ἢ κωνικὴ ἐπιφάνεια ἢ μεταξὺ τῶν $\Lambda\Delta\Gamma$ μείζων ἐστὶν τοῦ $\Lambda\Delta\Gamma$ τριγώνου.

Ἔστω δὴ τὸ Θ ἔλασσον τῶν AB , $\text{B}\Gamma$ τμημάτων. τέμνοντες δὴ τὰς AB , $\text{B}\Gamma$ περιφερείας δίχα καὶ τὰς ἡμισείας αὐτῶν δίχα λείψομεν τμήματα ἐλάσσονα ὄντα τοῦ Θ χωρίου. λελείφθω τὰ ἐπὶ τῶν AE , EB , BZ , $\text{Z}\Gamma$ εὐθειῶν, καὶ ἐπεξεύχθωσαν αἱ ΔE , ΔZ . πάλιν τοίνυν κατὰ τὰ αὐτὰ ἢ μὲν ἐπιφάνεια τοῦ κώνου ἢ μεταξὺ τῶν $\Lambda\Delta\text{E}$ μετὰ τοῦ ἐπὶ τῆς AE τμήματος μείζων ἐστὶν τοῦ $\Lambda\Delta\text{E}$ τριγώνου, ἢ δὲ μεταξὺ τῶν $\text{E}\Delta\text{B}$ μετὰ τοῦ ἐπὶ τῆς EB τμήματος μείζων ἐστὶν τοῦ $\text{E}\Delta\text{B}$ τριγώνου· ἢ ἄρα ἐπιφάνεια ἢ μεταξὺ τῶν $\Lambda\Delta\text{B}$ μετὰ τῶν ἐπὶ τῶν AE , EB τμημάτων μείζων ἐστὶν τῶν $\Lambda\Delta\text{E}$, $\text{E}\Delta\text{B}$ τριγώνων. ἐπεὶ δὲ τὰ $\Lambda\text{E}\Delta$, $\Delta\text{E}\text{B}$ τρίγωνα μείζονά ἐστιν τοῦ $\Lambda\text{B}\Delta$ τριγώνου, καθὼς δέδεικται, πολλῶ ἄρα ἢ ἐπιφάνεια τοῦ κώνου ἢ μεταξὺ τῶν $\Lambda\Delta\text{B}$ μετὰ τῶν ἐπὶ τῶν AE ,

ARCHIMEDES

Firstly, let it be not less. Then since there are two surfaces, the surface of the cone between $A\Delta$, ΔB together with the segment AEB and the triangle $A\Delta B$, having the same extremity, that is, the perimeter of the triangle $A\Delta B$, the surface which includes the other is greater than the included surface [Post. 3]; therefore the surface of the cone between the straight lines $A\Delta$, ΔB together with the segment AEB is greater than the triangle $A\Delta B$. Similarly the [surface of the cone] between $B\Delta$, $\Delta\Gamma$ together with the segment ΓZB is greater than the triangle $B\Delta\Gamma$; therefore the whole surface of the cone together with the area Θ is greater than the aforesaid triangles. Now the aforesaid triangles are equal to the triangle $A\Delta\Gamma$ and the area Θ . Let the common area Θ be taken away; therefore the remainder, the surface of the cone between $A\Delta$, $\Delta\Gamma$ is greater than the triangle $A\Delta\Gamma$.

Now let Θ be less than the segments AB , $B\Gamma$. Bisecting the arcs AB , $B\Gamma$ and then bisecting their halves, we shall leave segments less than the area Θ [Eucl. xii. 2]. Let the segments so left be those on the straight lines AE , EB , BZ , $Z\Gamma$, and let ΔE , ΔZ be joined. Then once more by the same reasoning the surface of the cone between $A\Delta$, ΔE together with the segment AE is greater than the triangle $A\Delta E$, while that between $E\Delta$, ΔB together with the segment EB is greater than the triangle $E\Delta B$; therefore the surface between $A\Delta$, ΔB together with the segments AE , EB is greater than the triangles $A\Delta E$, $E\Delta B$. Now since the triangles $A\Delta E$, $\Delta E B$ are greater than the triangle $A\Delta B$, as was proved, by much more therefore the surface of the cone between $A\Delta$, ΔB together with the segments AE , EB is

GREEK MATHEMATICS

ΕΒ τμημάτων μείζων ἐστὶ τοῦ ΑΔΒ τριγώνου. διὰ τὰ αὐτὰ δὴ καὶ ἡ ἐπιφάνεια ἡ μεταξὺ τῶν ΒΔΓ μετὰ τῶν ἐπὶ τῶν ΒΖ, ΖΓ τμημάτων μείζων ἐστὶν τοῦ ΒΔΓ τριγώνου· ὅλη ἄρα ἡ ἐπιφάνεια ἡ μεταξὺ τῶν ΑΔΓ μετὰ τῶν εἰρημένων τμημάτων μείζων ἐστὶ τῶν ΑΒΔ, ΔΒΓ τριγώνων. ταῦτα δὲ ἐστὶν ἴσα τῷ ΑΔΓ τριγώνῳ καὶ τῷ Θ χωρίῳ· ὧν τὰ εἰρημένα τμήματα ἐλάσσονα τοῦ Θ χωρίου· λοιπὴ ἄρα ἡ ἐπιφάνεια ἡ μεταξὺ τῶν ΑΔΓ μείζων ἐστὶν τοῦ ΑΔΓ τριγώνου.

ι'

Ἐὰν ἐπιφανύουσαι ἀχθῶσιν τοῦ κύκλου, ὅς ἐστι βάσις τοῦ κώνου, ἐν τῷ αὐτῷ ἐπιπέδῳ οὔσαι τῷ κύκλῳ καὶ συμπίπτουσαι ἀλλήλαις, ἀπὸ δὲ τῶν ἀφῶν καὶ τῆς συμπτώσεως ἐπὶ τὴν κορυφὴν τοῦ κώνου εὐθεῖαι ἀχθῶσιν, τὰ περιεχόμενα τρίγωνα ὑπὸ τῶν ἐπιφανουσῶν καὶ τῶν ἐπὶ τὴν κορυφὴν τοῦ κώνου ἐπιζευχθεισῶν εὐθειῶν μείζονά ἐστὶν τῆς τοῦ κώνου ἐπιφανείας τῆς ἀπολαμβανομένης ὑπ' αὐτῶν. . . .

ιβ'

. . . Τούτων δὴ δεδειγμένων φανερόν [ἐπὶ μὲν τῶν προειρημένων],¹ ὅτι, ἐὰν εἰς κῶνον ἰσοσκελῆ πυραμῖς ἐγγραφῆ, ἡ ἐπιφάνεια τῆς πυραμίδος χωρὶς τῆς βάσεως ἐλάσσων ἐστὶ τῆς κωνικῆς ἐπιφανείας [ἕκαστον γὰρ τῶν περιεχόντων τὴν πυραμίδα τριγώνων ἔλασσόν ἐστὶν τῆς κωνικῆς ἐπιφανείας τῆς μεταξὺ τῶν τοῦ τριγώνου πλευρῶν· ὥστε καὶ ὅλη ἡ ἐπιφάνεια τῆς πυραμίδος χωρὶς τῆς

ARCHIMEDES

greater than the triangle $A\Delta B$. By the same reasoning the surface between $B\Delta$, $\Delta\Gamma$ together with the segments BZ , $Z\Gamma$ is greater than the triangle $B\Delta\Gamma$; therefore the whole surface between $A\Delta$, $\Delta\Gamma$ together with the aforesaid segments is greater than the triangles $AB\Delta$, $\Delta B\Gamma$. Now these are equal to the triangle $A\Delta\Gamma$ and the area Θ ; and the aforesaid segments are less than the area Θ ; therefore the remainder, the surface between $A\Delta$, $\Delta\Gamma$ is greater than the triangle $A\Delta\Gamma$.

Prop. 10

If tangents be drawn to the circle which is the base of an [isosceles] cone, being in the same plane as the circle and meeting one another, and from the points of contact and the point of meeting straight lines be drawn to the vertex of the cone, the triangles formed by the tangents and the lines drawn to the vertex of the cone are together greater than the portion of the surface of the cone included by them. . . .^a

Prop. 12

. . . From what has been proved it is clear that, if a pyramid is inscribed in an isosceles cone, the surface of the pyramid without the base is less than the surface of the cone [Prop. 9], and that, if a pyramid

^a The proof is on lines similar to the preceding proposition.

¹ ἐπὶ . . . προειρημένων om. Heiberg.

GREEK MATHEMATICS

βάσεως ἐλάσσων ἐστὶ τῆς ἐπιφανείας τοῦ κώνου χωρὶς τῆς βάσεως],¹ καὶ ὅτι, ἐὰν περὶ κώνον ἰσοσκελῆ πυραμὶς περιγραφῆ, ἡ ἐπιφάνεια τῆς πυραμίδος χωρὶς τῆς βάσεως μείζων ἐστὶν τῆς ἐπιφανείας τοῦ κώνου χωρὶς τῆς βάσεως [κατὰ τὸ συνεχὲς ἐκείνω].²

Φανερόν δὲ ἐκ τῶν ἀποδεδειγμένων, ὅτι τε, ἐὰν εἰς κύλινδρον ὀρθὸν πρίσμα ἐγγραφῆ, ἡ ἐπιφάνεια τοῦ πρίσματος ἢ ἐκ τῶν παραλληλογράμμων συγκειμένη ἐλάσσων ἐστὶ τῆς ἐπιφανείας τοῦ κυλίνδρου χωρὶς τῆς βάσεως [ἔλασσον γὰρ ἕκαστον παραλληλόγραμμον τοῦ πρίσματος ἐστὶ τῆς καθ' αὐτὸ τοῦ κυλίνδρου ἐπιφανείας],³ καὶ ὅτι, ἐὰν περὶ κύλινδρον ὀρθὸν πρίσμα περιγραφῆ, ἡ ἐπιφάνεια τοῦ πρίσματος ἢ ἐκ τῶν παραλληλογράμμων συγκειμένη μείζων ἐστὶ τῆς ἐπιφανείας τοῦ κυλίνδρου χωρὶς τῆς βάσεως.

ιγ'

Παντὸς κυλίνδρου ὀρθοῦ ἡ ἐπιφάνεια χωρὶς τῆς βάσεως ἴση ἐστὶ κύκλῳ, οὗ ἡ ἐκ τοῦ κέντρου μέσον λόγον ἔχει τῆς πλευρᾶς τοῦ κυλίνδρου καὶ τῆς διαμέτρου τῆς βάσεως τοῦ κυλίνδρου.

*Ἐστω κυλίνδρου τινὸς ὀρθοῦ βᾶσις ὁ Α κύκλος, καὶ ἔστω τῇ μὲν διαμέτρῳ τοῦ Α κύκλου ἴση ἡ ΓΔ, τῇ δὲ πλευρᾷ τοῦ κυλίνδρου ἡ ΕΖ, ἐχέτω δὲ μέσον λόγον τῶν ΔΓ, ΕΖ ἢ Η, καὶ κείσθω κύκλος, οὗ ἡ ἐκ τοῦ κέντρου ἴση ἐστὶ τῇ Η, ὁ Β· δεικτέον, ὅτι ὁ Β κύκλος ἴσος ἐστὶ τῇ ἐπιφάνειᾳ τοῦ κυλίνδρου χωρὶς τῆς βάσεως.

Εἰ γὰρ μή ἐστὶν ἴσος, ἦτοι μείζων ἐστὶ ἢ

ARCHIMEDES

is circumscribed about an isosceles cone, the surface of the pyramid without the base is greater than the surface of the cone without the base [Prop. 10].

From what has been demonstrated it is also clear that, if a right prism be inscribed in a cylinder, the surface of the prism composed of the parallelograms is less than the surface of the cylinder excluding the bases ^a [Prop. 11], and if a right prism be circumscribed about a cylinder, the surface of the prism composed of the parallelograms is greater than the surface of the cylinder excluding the bases.

Prop. 13

The surface of any right cylinder excluding the bases ^b is equal to a circle whose radius is a mean proportional between the side of the cylinder and the diameter of the base of the cylinder.

Let the circle A be the base of a right cylinder, let $\Gamma\Delta$ be equal to the diameter of the circle A, let EZ be equal to the side of the cylinder, let H be a mean proportional between $\Delta\Gamma$, EZ, and let there be set out a circle, B, whose radius is equal to H; it is required to prove that the circle B is equal to the surface of the cylinder excluding the bases.^b

For if it is not equal, it is either greater or less.

^a Here, and in other places in this and the next proposition, Archimedes must have written *χωρίς τῶν βάσεων*, not *χωρίς τῆς βάσεως*.

^b See preceding note.

¹ ἕκαστον . . . βάσεως. Heiberg suspects that this demonstration is interpolated. Why give a proof of what is φανερόν?

² κατὰ . . . ἐκείνω om. Heiberg.

³ ἔλασσον . . . ἐπιφανείας. Heiberg suspects that this proof is interpolated.

GREEK MATHEMATICS

ἐλάσσων. ἔστω πρότερον, εἰ δυνατόν, ἐλάσσων.
 δύο δὴ μεγεθῶν ὄντων ἀνίσων τῆς τε ἐπιφανείας
 τοῦ κυλίνδρου καὶ τοῦ Β κύκλου δυνατόν ἐστὶν εἰς
 τὸν Β κύκλον ἰσόπλευρον πολύγωνον ἐγγράψαι
 καὶ ἄλλο περιγράψαι, ὥστε τὸ περιγραφὲν πρὸς
 τὸ ἐγγραφὲν ἐλάσσονα λόγον ἔχειν τοῦ, ὃν ἔχει
 ἡ ἐπιφάνεια τοῦ κυλίνδρου πρὸς τὸν Β κύκλον.
 νοείσθω δὴ περιγεγραμμένον καὶ ἐγγεγραμμένον,
 καὶ περὶ τὸν Α κύκλον περιγεγράφθω εὐθύγραμμον
 ὁμοιον τῷ περὶ τὸν Β περιγεγραμμένῳ, καὶ
 ἀναγεγράφθω ἀπὸ τοῦ εὐθυγράμμου πρίσμα· ἔσται
 δὴ περὶ τὸν κύλινδρον περιγεγραμμένον. ἔστω
 δὲ καὶ τῇ περιμέτρῳ τοῦ εὐθυγράμμου τοῦ περὶ

• One ms. has the marginal note, "equalis altitudinis
 chylindro," on which Heiberg comments: "nec hoc
 omiserat Archimedes." Heiberg notes several places in
 which the text is clearly not that written by Archimedes.

ARCHIMEDES

Let it first be, if possible, less. Now there are two unequal magnitudes, the surface of the cylinder and the circle B, and it is possible to inscribe in the circle B an equilateral polygon, and to circumscribe another, so that the circumscribed has to the inscribed a ratio

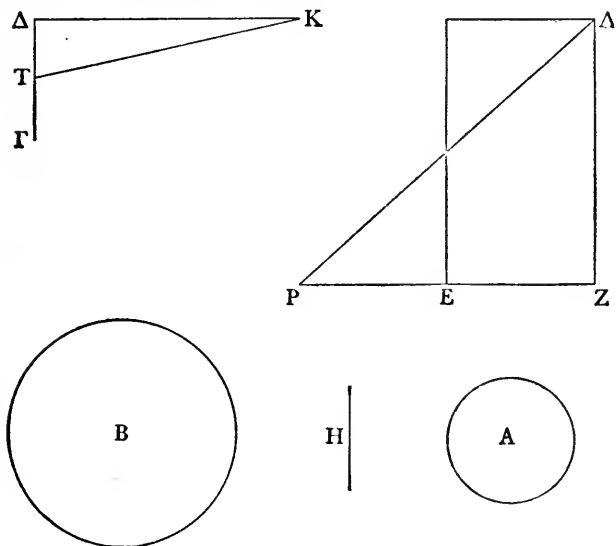

less than that which the surface of the cylinder has to the circle B [Prop. 5]. Let the circumscribed and inscribed polygons be imagined, and about the circle A let there be circumscribed a rectilinear figure similar to that circumscribed about B, and on the rectilinear figure let a prism be erected^a; it will be circumscribed about the cylinder. Let $K\Delta$ be equal

τὸν Α κύκλον ἴση ἢ ΚΔ καὶ τῇ ΚΔ ἴση ἢ ΛΖ, τῆς δὲ ΓΔ ἡμίσεια ἔστω ἢ ΓΤ· ἔσται δὴ τὸ ΚΔΤ τρίγωνον ἴσον τῷ περιγεγραμμένῳ εὐθύγραμμῳ περὶ τὸν Α κύκλον [ἐπειδὴ βάσιν μὲν ἔχει τῇ περιμέτρῳ ἴσην, ὕψος δὲ ἴσον τῇ ἐκ τοῦ κέντρου τοῦ Α κύκλου],¹ τὸ δὲ ΕΛ παραλληλόγραμμον τῇ ἐπιφανείᾳ τοῦ πρίσματος τοῦ περὶ τὸν κύλινδρον περιγεγραμμένου [ἐπειδὴ περιέχεται ὑπὸ τῆς πλευρᾶς τοῦ κυλίνδρου καὶ τῆς ἴσης τῇ περιμέτρῳ τῆς βάσεως τοῦ πρίσματος].² κείσθω δὴ τῇ ΕΖ ἴση ἢ ΕΡ· ἴσον ἄρα ἔστιν τὸ ΖΡΛ τρίγωνον τῷ ΕΛ παραλληλογράμμῳ, ὥστε καὶ τῇ ἐπιφανείᾳ τοῦ πρίσματος. καὶ ἐπεὶ ὁμοιά ἐστὶν τὰ εὐθύγραμμα τὰ περὶ τοὺς Α, Β κύκλους περιγεγραμμένα, τὸν αὐτὸν ἔξει λόγον [τὰ εὐθύγραμμα],³ ὅνπερ αἱ ἐκ τῶν κέντρων δυνάμει· ἔξει ἄρα τὸ ΚΤΔ τρίγωνον πρὸς τὸ περὶ τὸν Β κύκλον εὐθύγραμμον λόγον, ὃν ἢ ΤΔ πρὸς Η δυνάμει [αἱ γὰρ ΤΔ, Η ἴσαι εἰσὶν ταῖς ἐκ τῶν κέντρων]. ἀλλ' ὃν ἔχει λόγον ἢ ΤΔ πρὸς Η δυνάμει, τοῦτον ἔχει τὸν λόγον ἢ ΤΔ πρὸς ΡΖ μήκει [ἢ γὰρ Η τῶν ΤΔ, ΡΖ μέση ἐστὶ ἀνάλογον διὰ τὸ καὶ τῶν ΓΔ, ΕΖ· πῶς δὲ τοῦτο; ἐπεὶ γὰρ ἴση ἐστὶν ἢ μὲν ΔΤ τῇ ΤΓ, ἢ δὲ ΡΕ τῇ ΕΖ, διπλασία ἄρα ἐστὶν ἢ ΓΔ τῆς ΤΔ, καὶ ἢ ΡΖ τῆς ΡΕ· ἔστιν ἄρα, ὡς ἢ ΔΓ πρὸς ΔΤ, οὕτως ἢ ΡΖ πρὸς ΖΕ. τὸ ἄρα ὑπὸ τῶν ΓΔ, ΕΖ ἴσον ἐστὶν τῷ ὑπὸ τῶν ΤΔ, ΡΖ. τῷ δὲ ὑπὸ τῶν ΓΔ, ΕΖ ἴσον ἐστὶν τὸ ἀπὸ Η· καὶ τῷ ὑπὸ τῶν ΤΔ, ΡΖ ἴσον ἐστὶ τὸ ἀπὸ τῆς Η. ἔστιν ἄρα,

¹ ἐπειδὴ . . . κύκλου om. Heiberg.

² ἐπειδὴ . . . πρίσματος om. Heiberg.

³ τὰ εὐθύγραμμα om. Torellius.

ARCHIMEDES

to the perimeter of the rectilinear figure about the circle A, let ΛZ be equal to $K\Delta$, and let ΓT be half of $\Gamma\Delta$; then the triangle $K\Delta T$ will be equal to the rectilinear figure circumscribed about the circle A,^a while the parallelogram $E\Lambda$ will be equal to the surface of the prism circumscribed about the cylinder.^b Let EP be set out equal to EZ ; then the triangle ZPA is equal to the parallelogram $E\Lambda$ [Eucl. i. 41], and so to the surface of the prism. And since the rectilinear figures circumscribed about the circles A, B are similar, they will stand in the same ratio as the squares on the radii^c; therefore the triangle $K\Delta T$ will have to the rectilinear figure circumscribed about the circle B the ratio $T\Delta^2 : H^2$.

But $T\Delta^2 : H^2 = T\Delta : PZ$.^d

^a Because the base $K\Delta$ is equal to the perimeter of the polygon, and the altitude ΔT is equal to the radius of the circle A, *i.e.*, to the perpendiculars drawn from the centre of A to the sides of the polygon.

^b Because the base ΛZ is made equal to ΔK and so is equal to the perimeter of the polygon forming the base of the prism, while the altitude EZ is equal to the side of the cylinder and therefore to the height of the prism.

^c Eutocius supplies a proof based on Eucl. xii. 1, which proves a similar theorem for inscribed figures.

^d For, by hypothesis, $H^2 = \Delta\Gamma \cdot EZ$
 $= 2T\Delta \cdot \frac{1}{2}PZ$
 $= T\Delta \cdot PZ$

Heiberg would delete the demonstration in the text on the ground of excessive verbosity, as Nizze had already perceived to be necessary.

ὡς ἡ $\Gamma\Delta$ πρὸς H , οὕτως ἡ H πρὸς PZ . ἔστιν ἄρα, ὡς ἡ $\Gamma\Delta$ πρὸς PZ , τὸ ἀπὸ τῆς $\Gamma\Delta$ πρὸς τὸ ἀπὸ τῆς H . εἶν γὰρ τρεῖς εὐθείαι ἀνάλογον ὦσιν, ἔστιν, ὡς ἡ πρώτη πρὸς τὴν τρίτην, τὸ ἀπὸ τῆς πρώτης εἶδος πρὸς τὸ ἀπὸ τῆς δευτέρας εἶδος τὸ ὅμοιον καὶ ὁμοίως ἀναγεγραμμένον¹. ὃν δὲ λόγον ἔχει ἡ $\Gamma\Delta$ πρὸς PZ μήκει, τοῦτον ἔχει τὸ $\text{ΚΤ}\Delta$ τρίγωνον πρὸς τὸ $\text{Ρ}\Lambda\text{Ζ}$ [ἐπειδήπερ ἴσαι εἰσὶν αἱ $\text{Κ}\Delta$, $\Lambda\text{Ζ}$]². τὸν αὐτὸν ἄρα λόγον ἔχει τὸ $\text{ΚΤ}\Delta$ τρίγωνον πρὸς τὸ εὐθύγραμμον τὸ περὶ τὸν B κύκλον περιγεγραμμένον, ὅνπερ τὸ $\text{ΤΚ}\Delta$ τρίγωνον πρὸς τὸ $\text{Ρ}\text{Ζ}\Lambda$ τρίγωνον. ἴσον ἄρα ἐστὶν τὸ $\text{Ζ}\Lambda\text{Ρ}$ τρίγωνον τῷ περὶ τὸν B κύκλον περιγεγραμμένῳ εὐθυγράμμῳ· ὥστε καὶ ἡ ἐπιφάνεια τοῦ πρίσματος τοῦ περὶ τὸν A κύλινδρον περιγεγραμμένου τῷ εὐθυγράμμῳ τῷ περὶ τὸν B κύκλον ἴση ἐστίν. καὶ ἐπεὶ ἐλάσσονα λόγον ἔχει τὸ εὐθύγραμμον τὸ περὶ τὸν B κύκλον πρὸς τὸ ἐγγεγραμμένον ἐν τῷ κύκλῳ τοῦ, ὃν ἔχει ἡ ἐπιφάνεια τοῦ A κυλίνδρου πρὸς τὸν B κύκλον, ἐλάσσονα λόγον ἔξει καὶ ἡ ἐπιφάνεια τοῦ πρίσματος τοῦ περὶ τὸν κύλινδρον περιγεγραμμένου πρὸς τὸ εὐθύγραμμον τὸ ἐν τῷ κύκλῳ τῷ B ἐγγεγραμμένον ἢπερ ἡ ἐπιφάνεια τοῦ κυλίνδρου πρὸς τὸν B κύκλον· καὶ ἐναλλάξ· ὅπερ ἀδύνατον [ἡ μὲν γὰρ ἐπιφάνεια τοῦ πρίσματος τοῦ περιγεγραμμένου περὶ τὸν κύλινδρον μείζων οὔσα δέδεικται τῆς ἐπιφανείας τοῦ κυλίνδρου, τὸ δὲ ἐγγεγραμμένον εὐθύγραμμον ἐν τῷ B κύκλῳ ἐλασσόν ἐστὶν τοῦ B κύκλου]³. οὐκ ἄρα ἐστὶν ὁ B κύκλος ἐλάσσων τῆς ἐπιφανείας τοῦ κυλίνδρου.

¹ ἡ γὰρ . . . ὁμοίως ἀναγεγραμμένον om. Heiberg.

² ἐπειδήπερ . . . $\text{Κ}\Delta$, $\Lambda\text{Ζ}$ om. Heiberg.

ARCHIMEDES

And $T\Delta : PZ = \text{triangle } K\Delta : \text{triangle } P\Lambda Z$.^a

Therefore the ratio which the triangle $K\Delta$ has to the rectilinear figure circumscribed about the circle B is the same as the ratio of the triangle $TK\Delta$ to the triangle $PZ\Delta$. Therefore the triangle $TK\Delta$ is equal to the rectilinear figure circumscribed about the circle B [Eucl. v. 9]; and so the surface of the prism circumscribed about the cylinder A is equal to the rectilinear figure about B . And since the rectilinear figure about the circle B has to the inscribed figure in the circle a ratio less than that which the surface of the cylinder A has to the circle B [*ex hypothesi*], the surface of the prism circumscribed about the cylinder will have to the rectilinear figure inscribed in the circle B a ratio less than that which the surface of the cylinder has to the circle B ; and, *permutando*, [the prism will have to the cylinder a ratio less than that which the rectilinear figure inscribed in the circle B has to the circle B]^b; which is absurd.^c Therefore the circle B is not less than the surface of the cylinder.

^a By Eucl. vi. 1, since $\Lambda Z = K\Delta$.

^b From Eutocius's comment it appears that Archimedes wrote, in place of *καὶ ἐναλλάξ ὅπερ ἀδύνατον* in our text: *ἐναλλάξ ἄρα ἐλάσσονα λόγον ἔχει τὸ πρίσμα πρὸς τὸν κύλινδρον ἢ πρὸς τὸ ἐγγεγραμμένον εἰς τὸν B κύκλον πολύγωνον πρὸς τὸν B κύκλον ὅπερ ἄτοπον*. This is what I translate.

^c For the surface of the prism is greater than the surface of the cylinder [Prop. 12], but the inscribed figure is less than the circle B ; the explanation in our text to this effect is shown to be an interpolation by the fact that Eutocius supplies a proof in his own words.

³ ἢ μὲν . . . τοῦ B κύκλου om. Heiberg ex Eutocio.

GREEK MATHEMATICS

Ἔστω δὴ, εἰ δυνατόν, μείζων. πάλιν δὴ νοεῖσθω εἰς τὸν Β κύκλον εὐθύγραμμον ἐγγεγραμμένον καὶ ἄλλο περιγεγραμμένον, ὥστε τὸ περιγεγραμμένον πρὸς τὸ ἐγγεγραμμένον ἐλάσσονα λόγον ἔχειν ἢ τὸν Β κύκλον πρὸς τὴν ἐπιφάνειαν τοῦ κυλίνδρου, καὶ ἐγγεγράθω εἰς τὸν Α κύκλον πολυγώνον ὁμοιον τῷ εἰς τὸν Β κύκλον ἐγγεγραμμένῳ, καὶ πρίσμα ἀναγεγράθω ἀπὸ τοῦ ἐν τῷ κύκλῳ ἐγγεγραμμένου πολυγώνου· καὶ πάλιν ἡ ΚΔ ἴση ἔστω τῇ περιμέτρῳ τοῦ εὐθυγράμμου τοῦ ἐν τῷ Α κύκλῳ ἐγγεγραμμένου, καὶ ἡ ΖΛ ἴση αὐτῇ ἔστω. ἔσται δὴ τὸ μὲν ΚΤΔ τρίγωνον μείζον τοῦ εὐθυγράμμου τοῦ ἐν τῷ Α κύκλῳ ἐγγεγραμμένου [διότι βάσιν μὲν ἔχει τὴν περίμετρον αὐτοῦ, ὕψος δὲ μείζον τῆς ἀπὸ τοῦ κέντρου ἐπὶ μίαν πλευρὰν τοῦ πολυγώνου ἀγομένης καθέτου],¹ τὸ δὲ ΕΛ παραλληλόγραμμον ἴσον τῇ ἐπιφανείᾳ τοῦ πρίσματος τῇ ἐκ τῶν παραλληλογράμμων συγκεκλιμένη [διότι περιέχεται ὑπὸ τῆς πλευρᾶς τοῦ κυλίνδρου καὶ τῆς ἴσης τῇ περιμέτρῳ τοῦ εὐθυγράμμου, ὃ ἔστιν βάσις τοῦ πρίσματος]. ὥστε καὶ τὸ ΡΛΖ τρίγωνον ἴσον ἐστὶ τῇ ἐπιφανείᾳ τοῦ πρίσματος. καὶ ἐπεὶ ὁμοιά ἐστι τὰ εὐθύγραμμα τὰ ἐν τοῖς Α, Β κύκλοις ἐγγεγραμμένα, τὸν αὐτὸν ἔχει λόγον πρὸς ἄλληλα, ὃν αἱ ἐκ τῶν κέντρων αὐτῶν δυνάμει. ἔχει δὲ καὶ τὰ ΚΤΔ, ΖΡΛ τρίγωνα πρὸς ἄλληλα λόγον, ὃν αἱ ἐκ τῶν κέντρων τῶν κύκλων δυνάμει· τὸν αὐτὸν ἄρα λόγον ἔχει

¹ διότι . . . καθέτου om. Heiberg.

^o For the base ΚΔ is equal to the perimeter of the polygon and the altitude ΔΤ, which is equal to the radius of the

ARCHIMEDES

Now let it be, if possible, greater. Again, let there be imagined a rectilinear figure inscribed in the circle B, and another circumscribed, so that the circumscribed figure has to the inscribed a ratio less than that which the circle B has to the surface of the cylinder [Prop. 5], and let there be inscribed in the circle A a polygon similar to the figure inscribed in the circle B, and let a prism be erected on the polygon inscribed in the circle [A]; and again let $K\Delta$ be equal to the perimeter of the rectilinear figure inscribed in the circle A, and let $Z\Lambda$ be equal to it. Then the triangle $KT\Delta$ will be greater than the rectilinear figure inscribed in the circle A,^a and the parallelogram $E\Lambda$ will be equal to the surface of the prism composed of the parallelograms^b; and so the triangle $P\Lambda Z$ is equal to the surface of the prism. And since the rectilinear figures inscribed in the circles A, B are similar, they have the same ratio one to the other as the squares of their radii [Eucl. xii. 1]. But the triangles $KT\Delta$, $ZP\Lambda$ have one to the other the same ratio as the squares of the radii^c; therefore the rectilinear figure inscribed in

circle A, is greater than the perpendiculars drawn from the centre of the circle to the sides of the polygon; but Heiberg regards the explanation to this effect in the text as an interpolation.

^b Because the base $Z\Lambda$ is made equal to $K\Delta$, and so is equal to the perimeter of the polygon forming the base of the prism, while the altitude EZ is equal to the side of the cylinder and therefore to the height of the prism.

^c For triangle $KT\Delta$: triangle $ZP\Lambda = T\Delta : ZP$
 $= T\Delta^2 : H^2$

[cf. p. 71 n. d.]

But $T\Delta$ is equal to the radius of the circle A, and H to the radius of the circle B.

GREEK MATHEMATICS

τὸ εὐθύγραμμον τὸ ἐν τῷ Α κύκλῳ ἐγγεγραμμένον πρὸς τὸ εὐθύγραμμον τὸ ἐν τῷ Β ἐγγεγραμμένον καὶ τὸ ΚΤΔ τρίγωνον πρὸς τὸ ΛΖΡ τρίγωνον. ἔλασσον δέ ἐστι τὸ εὐθύγραμμον τὸ ἐν τῷ Α κύκλῳ ἐγγεγραμμένον τοῦ ΚΤΔ τριγώνου· ἔλασσον ἄρα καὶ τὸ εὐθύγραμμον τὸ ἐν τῷ Β κύκλῳ ἐγγεγραμμένον τοῦ ΖΡΛ τριγώνου· ὥστε καὶ τῆς ἐπιφανείας τοῦ πρίσματος τοῦ ἐν τῷ κυλίνδρῳ ἐγγεγραμμένου· ὅπερ ἀδύνατον [ἐπεὶ γὰρ ἐλάσσονα λόγον ἔχει τὸ περιγεγραμμένον εὐθύγραμμον περὶ τὸν Β κύκλον πρὸς τὸ ἐγγεγραμμένον ἢ ὁ Β κύκλος πρὸς τὴν ἐπιφάνειαν τοῦ κυλίνδρου, καὶ ἐναλλάξ, μείζον δέ ἐστι τὸ περιγεγραμμένον περὶ τὸν Β κύκλον τοῦ Β κύκλου, μείζον ἄρα ἐστὶν τὸ ἐγγεγραμμένον ἐν τῷ Β κύκλῳ τῆς ἐπιφανείας τοῦ κυλίνδρου· ὥστε καὶ τῆς ἐπιφανείας τοῦ πρίσματος].¹ οὐκ ἄρα μείζων ἐστὶν ὁ Β κύκλος τῆς ἐπιφανείας τοῦ κυλίνδρου. ἐδείχθη δέ, ὅτι οὐδὲ ἐλάσσων· ἴσος ἄρα ἐστίν.

ιδ'

Παντὸς κώνου ἰσοσκελοῦς χωρὶς τῆς βάσεως ἡ ἐπιφάνεια ἴση ἐστὶ κύκλῳ, οὗ ἡ ἐκ τοῦ κέντρου μέσον λόγον ἔχει τῆς πλευρᾶς τοῦ κώνου καὶ τῆς ἐκ τοῦ κέντρου τοῦ κύκλου, ὅς ἐστιν βᾶσις τοῦ κώνου.

"Ἐστω κώνος ἰσοσκελής, οὗ βᾶσις ὁ Α κύκλος, ἡ δὲ ἐκ τοῦ κέντρου ἔστω ἡ Γ, τῆ δὲ πλευρᾶ τοῦ

¹ ἐπεὶ . . . πρίσματος om. Heiberg.

^a For since the figure circumscribed about the circle B has to the inscribed figure a ratio less than that which the circle B has to the surface of the cylinder [*ex hypothesi*], and the circle B is less than the circumscribed figure, therefore the

ARCHIMEDES

the circle A has to the rectilinear figure inscribed in the circle B the same ratio as the triangle $KT\Delta$ has to the triangle ΛZP . But the rectilinear figure inscribed in the circle A is less than the triangle $KT\Delta$; therefore the rectilinear figure inscribed in the circle B is less than the triangle $ZP\Lambda$; and so it is less than the surface of the prism inscribed in the cylinder; which is impossible.^a Therefore the circle B is not greater than the surface of the cylinder. But it was proved not to be less. Therefore it is equal.

Prop. 14

The surface of any cone without the base is equal to a circle, whose radius is a mean proportional between the side of the cone and the radius of the circle which is the base of the cone.

Let there be an isosceles cone, whose base is the circle A, and let its radius be Γ , and let Δ be equal inscribed figure is greater than the surface of the cylinder, and *a fortiori* is greater than the surface of the prism [Prop. 12]. An explanation on these lines is found in our text, but as the corresponding proof in the first half of the proposition was unknown to Eutocius, this also must be presumed an interpolation.

GREEK MATHEMATICS

κώνου ἔστω ἴση ἢ Δ, τῶν δὲ Γ, Δ μέση ἀνάλογον ἢ Ε, ὁ δὲ Β κύκλος ἐχέτω τὴν ἐκ τοῦ κέντρου τῆ Ε ἴσην· λέγω, ὅτι ὁ Β κύκλος ἐστὶν ἴσος τῆ ἐπιφάνειά τοῦ κώνου χωρὶς τῆς βάσεως.

Εἰ γὰρ μὴ ἐστὶν ἴσος, ἤτοι μείζων ἐστὶν ἢ ἐλάσσων. ἔστω πρότερον ἐλάσσων. ἔστι δὴ δύο μεγέθη ἄνισα ἣ τε ἐπιφάνεια τοῦ κώνου καὶ ὁ Β κύκλος, καὶ μείζων ἢ ἐπιφάνεια τοῦ κώνου· δυνατὸν ἄρα εἰς τὸν Β κύκλον πολύγωνον ἰσόπλευρον ἐγγράψαι καὶ ἄλλο περιγράψαι ὅμοιον τῷ ἐγγεγραμμένῳ, ὥστε τὸ περιγεγραμμένον πρὸς τὸ ἐγγεγραμμένον ἐλάσσονα λόγον ἔχειν τοῦ, ὃν ἔχει ἢ ἐπιφάνεια τοῦ κώνου πρὸς τὸν Β κύκλον. νοείσθω δὴ καὶ περὶ τὸν Α κύκλον πολύγωνον περιγεγραμμένον ὅμοιον τῷ περὶ τὸν Β κύκλον περιγεγραμμένῳ, καὶ ἀπὸ τοῦ περὶ τὸν Α κύκλον περιγεγραμμένου πολυγώνου πυραμὶς ἀνεστάτω ἀναγεγραμμένη τὴν αὐτὴν κορυφὴν ἔχουσα τῷ κώνῳ. ἐπεὶ οὖν ὅμοιά ἐστὶν τὰ πολύγωνα τὰ περὶ

ARCHIMEDES

to the side of the cone, and let E be a mean proportional between Γ , Δ , and let the circle B have its

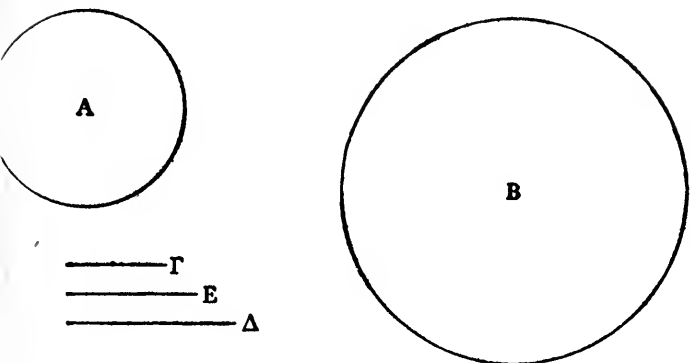

radius equal to E ; I say that the circle B is equal to the surface of the cone without the base.

For if it is not equal, it is either greater or less. First let it be less. Then there are two unequal magnitudes, the surface of the cone and the circle B , and the surface of the cone is the greater; it is therefore possible to inscribe an equilateral polygon in the circle B and to circumscribe another similar to the inscribed polygon, so that the circumscribed polygon has to the inscribed polygon a ratio less than that which the surface of the cone has to the circle B [Prop. 5]. Let this be imagined, and about the circle A let a polygon be circumscribed similar to the polygon circumscribed about the circle B , and on the polygon circumscribed about the circle A let a pyramid be raised having the same vertex as the cone. Now since the polygons circumscribed about

GREEK MATHEMATICS

τοὺς Α, Β κύκλους περιγεγραμμένα, τὸν αὐτὸν ἔχει λόγον πρὸς ἄλληλα, ὃν αἱ ἐκ τοῦ κέντρου δυνάμει πρὸς ἄλληλας, τουτέστιν ὃν ἔχει ἡ Γ πρὸς Ε δύναμει, τουτέστιν ἡ Γ πρὸς Δ μήκει. ὃν δὲ λόγον ἔχει ἡ Γ πρὸς Δ μήκει, τοῦτον ἔχει τὸ περιγεγραμμένον πολύγωνον περὶ τὸν Α κύκλον πρὸς τὴν ἐπιφάνειαν τῆς πυραμίδος τῆς περιγεγραμμένης περὶ τὸν κῶνον [ἡ μὲν γὰρ Γ ἴση ἐστὶ τῇ ἀπὸ τοῦ κέντρου καθέτῳ ἐπὶ μίαν πλευρὰν τοῦ πολυγώνου, ἡ δὲ Δ τῇ πλευρᾷ τοῦ κώνου· κοινὸν δὲ ὕψος ἢ περίμετρος τοῦ πολυγώνου πρὸς τὰ ἡμίση τῶν ἐπιφανειῶν]¹. τὸν αὐτὸν ἄρα λόγον ἔχει τὸ εὐθύγραμμον τὸ περὶ τὸν Α κύκλον πρὸς τὸ εὐθύγραμμον τὸ περὶ τὸν Β κύκλον καὶ αὐτὸ τὸ εὐθύγραμμον πρὸς τὴν ἐπιφάνειαν τῆς πυραμίδος τῆς περιγεγραμμένης περὶ τὸν κῶνον· ὥστε ἴση ἐστὶν ἡ ἐπιφάνεια τῆς πυραμίδος τῷ εὐθυγράμμῳ τῷ περὶ τὸν Β κύκλον περιγεγραμμένῳ. ἐπεὶ οὖν ἐλάσσονα λόγον ἔχει τὸ εὐθύγραμμον τὸ περὶ τὸν Β κύκλον περιγεγραμμένον πρὸς τὸ ἐγγεγραμμένον ἢπερ ἡ ἐπιφάνεια τοῦ κώνου πρὸς τὸν Β κύκλον, ἐλάσσονα λόγον ἔξει ἡ ἐπιφάνεια τῆς πυραμίδος τῆς περὶ τὸν κῶνον περιγεγραμμένης πρὸς τὸ εὐθύγραμμον τὸ ἐν τῷ Β κύκλῳ ἐγγεγραμμένον ἢπερ ἡ ἐπιφάνεια τοῦ κώνου πρὸς τὸν Β κύκλον· ὅπερ ἀδύνατον [ἡ μὲν γὰρ ἐπιφάνεια τῆς πυραμίδος μείζων οὖσα δέδεικται τῆς ἐπιφανείας τοῦ κώνου, τὸ δὲ ἐγγεγραμμένον εὐθύγραμμον ἐν τῷ Β κύκλῳ ἐλάσσον ἐστὶ τοῦ Β κύκλου].² οὐκ ἄρα ὁ Β κύκλος ἐλάσσων ἐστὶ τῆς ἐπιφανείας τοῦ κώνου.

ARCHIMEDES

the circles A, B are similar, they have the same ratio one toward the other as the square of the radii have one toward the other, that is $\Gamma^2 : E^2$, or $\Gamma : \Delta$ [Eucl. vi. 20, coroll. 2]. But $\Gamma : \Delta$ is the same ratio as that of the polygon circumscribed about the circle A to the surface of the pyramid circumscribed about the cone ^a; therefore the rectilinear figure about the circle A has to the rectilinear figure about the circle B the same ratio as this rectilinear figure [about A] has to the surface of the pyramid circumscribed about the cone; therefore the surface of the pyramid is equal to the rectilinear figure circumscribed about the circle B. Since the rectilinear figure circumscribed about the circle B has towards the inscribed [rectilinear figure] a ratio less than that which the surface of the cone has to the circle B, therefore the surface of the pyramid circumscribed about the cone will have to the rectilinear figure inscribed in the circle B a ratio less than that which the surface of the cone has to the circle B; which is impossible.^b Therefore the circle B will not be less than the surface of the cone.

^a For the circumscribed polygon is equal to a triangle, whose base is equal to the perimeter of the polygon and whose height is equal to Γ , while the surface of the pyramid is equal to a triangle having the same base and height Δ [Prop. 8]. There is an explanation to this effect in the Greek, but so obscurely worded that Heiberg attributes it to an interpolator.

^b For the surface of the pyramid is greater than the surface of the cone [Prop. 12], while the inscribed polygon is less than the circle B.

¹ ἡ μὲν . . . ἐπιφανειῶν om. Heiberg.

² ἡ μὲν . . . τοῦ B κύκλου om. Heiberg.

GREEK MATHEMATICS

Λέγω δὴ, ὅτι οὐδὲ μείζων. εἰ γὰρ δυνατόν ἐστιν, ἔστω μείζων. πάλιν δὴ νοείσθω εἰς τὸν Β κύκλον πολύγωνον ἐγγεγραμμένον καὶ ἄλλο περιγεγραμμένον, ὥστε τὸ περιγεγραμμένον πρὸς τὸ ἐγγεγραμμένον ἐλάσσονα λόγον ἔχειν τοῦ, ὃν ἔχει ὁ Β κύκλος πρὸς τὴν ἐπιφάνειαν τοῦ κώνου, καὶ εἰς τὸν Α κύκλον νοείσθω ἐγγεγραμμένον πολύγωνον ὅμοιον τῷ εἰς τὸν Β κύκλον ἐγγεγραμμένῳ, καὶ ἀναγεγράφθω ἀπ' αὐτοῦ πυραμὶς τὴν αὐτὴν κορυφὴν ἔχουσα τῷ κώνῳ. ἐπεὶ οὖν ὅμοιά ἐστι τὰ ἐν τοῖς Α, Β κύκλοις ἐγγεγραμμένα, τὸν αὐτὸν ἔξει λόγον πρὸς ἄλληλα, ὃν αἱ ἐκ τῶν κέντρων δυνάμει πρὸς ἀλλήλας· τὸν αὐτὸν ἄρα λόγον ἔχει τὸ πολύγωνον πρὸς τὸ πολύγωνον καὶ ἡ Γ πρὸς τὴν Δ μήκει. ἡ δὲ Γ πρὸς τὴν Δ μείζονα λόγον ἔχει ἢ τὸ πολύγωνον τὸ ἐν τῷ Α κύκλῳ ἐγγεγραμμένον πρὸς τὴν ἐπιφάνειαν τῆς πυραμίδος τῆς ἐγγεγραμμένης εἰς τὸν κώνον [ἡ γὰρ ἐκ τοῦ κέντρου τοῦ Α κύκλου πρὸς τὴν πλευρὰν τοῦ κώνου μείζονα λόγον ἔχει ἢ περ ἢ ἀπὸ τοῦ κέντρου ἀγομένη κάθετος ἐπὶ μίαν πλευρὰν τοῦ πολυγώνου πρὸς τὴν ἐπὶ τὴν πλευρὰν τοῦ πολυγώνου κάθετον ἀγομένην ἀπὸ τῆς κορυφῆς τοῦ κώνου]¹. μεί-

¹ ἡ γὰρ . . . τοῦ κώνου om. Heiberg.

* Eutocius supplies a proof. ΖΘΚ is the polygon inscribed in the circle Α (of centre Α), ΑΗ is drawn perpendicular to

ARCHIMEDES

I say now that neither will it be greater. For if it is possible, let it be greater. Then again let there be imagined a polygon inscribed in the circle B and another circumscribed, so that the circumscribed has to the inscribed a ratio less than that which the circle B has to the surface of the cone [Prop. 5], and in the circle A let there be imagined an inscribed polygon similar to that inscribed in the circle B, and on it let there be drawn a pyramid having the same vertex as the cone. Since the polygons inscribed in the circles A, B are similar, therefore they will have one toward the other the same ratio as the squares of the radii have one toward the other; therefore the one polygon has to the other polygon the same ratio as Γ to Δ [Eucl. vi. 20, coroll. 2]. But Γ has to Δ a ratio greater than that which the polygon inscribed in the circle A has to the surface of the pyramid inscribed in the cone^a; therefore the polygon in-

$K\Theta$ and meets the circle in M, Λ is the vertex of the isosceles cone (so that ΔH is perpendicular to $K\Theta$), and HN is drawn parallel to MA to meet ΔA in N. Then the area of the polygon inscribed in the circle = $\frac{1}{2}$ perimeter of polygon $\cdot AH$, and the area of the pyramid inscribed in the cone = $\frac{1}{2}$ perimeter of polygon $\cdot \Delta H$, so that the area of the polygon has to the area of the pyramid the ratio $AH : \Delta H$. Now, by similar triangles, $AM : MA = AH : HN$, and $AH : HN > AH : HA$, for $HA > HN$. Therefore $AM : MA > AH : HA$; that is, $\Gamma : \Delta$ exceeds the ratio of the polygon to the surface of the pyramid.

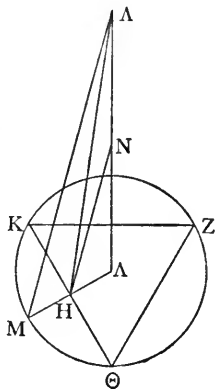

GREEK MATHEMATICS

ζονα ἄρα λόγον ἔχει τὸ πολύγωνον τὸ ἐν τῷ Α κύκλῳ ἐγγεγραμμένον πρὸς τὸ πολύγωνον τὸ ἐν τῷ Β ἐγγεγραμμένον ἢ αὐτὸ τὸ πολύγωνον πρὸς τὴν ἐπιφάνειαν τῆς πυραμίδος· μείζων ἄρα ἐστὶν ἢ ἐπιφάνεια τῆς πυραμίδος τοῦ ἐν τῷ Β πολυγώνου ἐγγεγραμμένου. ἐλάσσονα δὲ λόγον ἔχει τὸ πολύγωνον τὸ περὶ τὸν Β κύκλον περιγεγραμμένον πρὸς τὸ ἐγγεγραμμένον ἢ ὁ Β κύκλος πρὸς τὴν ἐπιφάνειαν τοῦ κώνου· πολλῶ ἄρα τὸ πολύγωνον τὸ περὶ τὸν Β κύκλον περιγεγραμμένον πρὸς τὴν ἐπιφάνειαν τῆς πυραμίδος τῆς ἐν τῷ κώνῳ ἐγγεγραμμένης ἐλάσσονα λόγον ἔχει ἢ ὁ Β κύκλος πρὸς τὴν ἐπιφάνειαν τοῦ κώνου· ὅπερ ἀδύνατον [τὸ μὲν γὰρ περιγεγραμμένον πολύγωνον μείζον ἐστὶν τοῦ Β κύκλου, ἢ δὲ ἐπιφάνεια τῆς πυραμίδος τῆς ἐν τῷ κώνῳ ἐλάσσων ἐστὶ τῆς ἐπιφανείας τοῦ κώνου].¹ οὐκ ἄρα οὐδὲ μείζων ἐστὶν ὁ κύκλος τῆς ἐπιφανείας τοῦ κώνου. ἐδείχθη δέ, ὅτι οὐδὲ ἐλάσσων· ἴσος ἄρα.

ις'

Ἐὰν κώνος ἰσοσκελῆς ἐπιπέδῳ τμηθῆ παραλλήλῳ τῇ βάσει, τῇ μεταξὺ τῶν παραλλήλων ἐπιπέδων ἐπιφάνεια τοῦ κώνου ἴσος ἐστὶ κύκλος, οὗ ἢ ἐκ τοῦ κέντρου μέσον λόγον ἔχει τῆς τε πλευρᾶς τοῦ κώνου τῆς μεταξὺ τῶν παραλλήλων ἐπιπέδων καὶ τῆς ἴσης ἀμφοτέραις ταῖς ἐκ τῶν κέντρων τῶν κύκλων τῶν ἐν τοῖς παραλλήλοις ἐπιπέδοις.

Ἐστω κώνος, οὗ τὸ διὰ τοῦ ἄξονος τρίγωνον ἴσον τῷ ΑΒΓ, καὶ τετμήσθω παραλλήλῳ ἐπιπέδῳ τῇ βάσει, καὶ ποιείτω τομὴν τὴν ΔΕ, ἄξων δὲ τοῦ κώνου ἔστω ὁ ΒΗ κύκλος δέ τις ἐκκείσθω, οὗ ἢ

ARCHIMEDES

scribed in the circle A has to the polygon inscribed in the circle B a ratio greater than that which the same polygon [inscribed in the circle A] has to the surface of the pyramid ; therefore the surface of the pyramid is greater than the polygon inscribed in B. Now the polygon circumscribed about the circle B has to the inscribed polygon a ratio less than that which the circle B has to the surface of the cone ; by much more therefore the polygon circumscribed about the circle B has to the surface of the pyramid inscribed in the cone a ratio less than that which the circle B has to the surface of the cone ; which is impossible.* Therefore the circle is not greater than the surface of the cone. And it was proved not to be less ; therefore it is equal.

Prop. 16

If an isosceles cone be cut by a plane parallel to the base, the portion of the surface of the cone between the parallel planes is equal to a circle whose radius is a mean proportional between the portion of the side of the cone between the parallel planes and a straight line equal to the sum of the radii of the circles in the parallel planes.

Let there be a cone, in which the triangle through the axis is equal to $AB\Gamma$, and let it be cut by a plane parallel to the base, and let [the cutting plane] make the section ΔE , and let BH be the axis of the cone,

* For the circumscribed polygon is greater than the circle B, but the surface of the inscribed pyramid is less than the surface of the cone [Prop. 12] ; the explanation to this effect in the text is attributed by Heiberg to an interpolator.

¹ τὸ μὲν . . . τοῦ κώνου om. Heiberg.

GREEK MATHEMATICS

ἐκ τοῦ κέντρου μέση ἀνάλογόν ἐστι τῆς τε $\Lambda\Delta$ καὶ συναμφοτέρου τῆς ΔZ , $\text{H}\Lambda$, ἔστω δὲ κύκλος ὁ Θ .

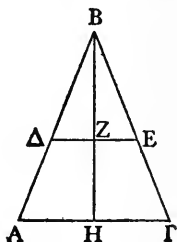
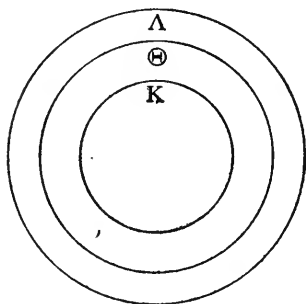

λέγω, ὅτι ὁ Θ κύκλος ἴσος ἐστὶ τῇ ἐπιφανείᾳ τοῦ κώνου τῆ μεταξὺ τῶν ΔE , $\text{A}\Gamma$.

Ἐκκείσθωσαν γὰρ κύκλοι οἱ Λ , K , καὶ τοῦ μὲν K κύκλου ἢ ἐκ τοῦ κέντρου δυνάσθω τὸ ὑπὸ $\text{B}\Delta Z$, τοῦ δὲ Λ ἢ ἐκ τοῦ κέντρου δυνάσθω τὸ ὑπὸ BAH . ὁ μὲν ἄρα Λ κύκλος ἴσος ἐστὶν τῇ ἐπιφανείᾳ τοῦ $\text{A}\text{B}\Gamma$ κώνου, ὁ δὲ K κύκλος ἴσος ἐστὶ τῇ ἐπιφανείᾳ τοῦ $\Delta E\text{B}$. καὶ ἐπεὶ τὸ ὑπὸ τῶν $\text{B}\Lambda$, AH ἴσον ἐστὶ τῷ τε ὑπὸ τῶν $\text{B}\Delta$, ΔZ καὶ τῷ ὑπὸ τῆς $\Lambda\Delta$ καὶ συναμφοτέρου τῆς ΔZ , AH διὰ τὸ παράλληλον εἶναι τὴν ΔZ τῇ AH , ἀλλὰ τὸ μὲν ὑπὸ AB , AH δύναται ἢ ἐκ τοῦ κέντρου τοῦ Λ κύκλου, τὸ δὲ ὑπὸ $\text{B}\Delta$, ΔZ δύναται ἢ ἐκ τοῦ κέντρου τοῦ K κύκλου, τὸ δὲ ὑπὸ τῆς $\Delta\Lambda$ καὶ συναμφοτέρου τῆς ΔZ , AH δύναται ἢ ἐκ τοῦ κέντρου τοῦ Θ , τὸ ἄρα ἀπὸ τῆς ἐκ τοῦ κέντρου τοῦ Λ κύκλου ἴσον ἐστὶ τοῖς ἀπὸ τῶν ἐκ τῶν κέντρων τῶν K , Θ κύκλων· ὥστε καὶ ὁ Λ κύκλος ἴσος ἐστὶ τοῖς K , Θ κύκλοις.

ARCHIMEDES

and let there be set out a circle whose radius is a mean proportional between $A\Delta$ and the sum of ΔZ , HA , and let Θ be the circle ; I say that the circle Θ is equal to the portion of the surface of the cone between ΔE , $A\Gamma$.

For let the circles Λ , K be set out, and let the square of the radius of K be equal to the rectangle contained by $B\Delta$, ΔZ , and let the square of the radius of Λ be equal to the rectangle contained by BA , AH ; therefore the circle Λ is equal to the surface of the cone $AB\Gamma$, while the circle K is equal to the surface of the cone ΔEB [Prop. 14]. And since

$$BA \cdot AH = B\Delta \cdot \Delta Z + A\Delta \cdot (\Delta Z + AH)$$

because ΔZ is parallel to AH ,^a while the square of the radius of Λ is equal to $AB \cdot AH$, the square of the radius of K is equal to $B\Delta \cdot \Delta Z$, and the square of the radius of Θ is equal to $A\Delta \cdot (\Delta Z + AH)$, therefore the square on the radius of the circle Λ is equal to the sum of the squares on the radii of the circles K , Θ ; so that the circle Λ is equal to the sum of the circles

^a The proof is given by Eutocius as follows :

$$BA : AH = B\Delta : \Delta Z$$

$$\therefore BA \cdot \Delta Z = B\Delta \cdot AH. \quad [\text{Eucl. vi. 16}]$$

$$\text{But } BA \cdot \Delta Z = B\Delta \cdot \Delta Z + A\Delta \cdot \Delta Z. \quad [\text{Eucl. ii. 1}]$$

$$\therefore B\Delta \cdot AH = B\Delta \cdot \Delta Z + A\Delta \cdot \Delta Z.$$

Let $\Delta A \cdot AH$ be added to both sides.

$$\text{Then } B\Delta \cdot AH + \Delta A \cdot AH,$$

$$i.e. \quad BA \cdot AH = B\Delta \cdot \Delta Z + A\Delta \cdot \Delta Z + A\Delta \cdot AH.$$

GREEK MATHEMATICS

ἀλλ' ὁ μὲν Λ ἴσος ἐστὶ τῇ ἐπιφανείᾳ τοῦ ΒΑΓ κώνου, ὁ δὲ Κ τῇ ἐπιφανείᾳ τοῦ $\Delta\text{ΒΕ}$ κώνου· λοιπὴ ἄρα ἡ ἐπιφάνεια τοῦ κώνου ἡ μεταξὺ τῶν παραλλήλων ἐπιπέδων τῶν $\Delta\text{Ε}$, ΑΓ ἴση ἐστὶ τῷ Θ κύκλῳ.

κα'

Ἐὰν εἰς κύκλον πολύγωνον ἐγγραφῆ ἄρτιο-πλευρόν τε καὶ ἰσόπλευρον, καὶ διαχθῶσιν εὐθεῖαι ἐπιζευγνύουσαι τὰς πλευρὰς τοῦ πολυγώνου, ὥστε αὐτὰς παραλλήλους εἶναι μιᾷ ὁποιοῦν τῶν ὑπὸ δύο πλευρὰς τοῦ πολυγώνου ὑποτείνουσῶν, αἱ ἐπιζευγνύουσαι πᾶσαι πρὸς τὴν τοῦ κύκλου διάμετρον τοῦτον ἔχουσι τὸν λόγον, ὃν ἔχει ἡ ὑποτείνουσα τὰς μιᾷ ἐλάσσονας τῶν ἡμίσεων πρὸς τὴν πλευρὰν τοῦ πολυγώνου.

Ἐστω κύκλος ὁ ΑΒΓΔ , καὶ ἐν αὐτῷ πολύγωνον ἐγγεγράφθω τὸ ΑΕΖΒΗΘΓΜΝΔΛΚ , καὶ ἐπεξεύχθωσαν αἱ ΕΚ , ΖΛ , ΒΔ , ΗΝ , ΘΜ · δῆλον δὴ, ὅτι παράλληλοί εἰσιν τῇ ὑπὸ δύο πλευρὰς τοῦ πολυγώνου ὑποτείνουσῃ· λέγω οὖν, ὅτι αἱ εἰρημέναι πᾶσαι πρὸς τὴν τοῦ κύκλου διάμετρον τὴν ΑΓ τὸν αὐτὸν λόγον ἔχουσι τῷ τῆς ΓΕ πρὸς ΕΑ .

Ἐπεξεύχθωσαν γὰρ αἱ ΖΚ , ΛΒ , ΗΔ , ΘΝ · παράλληλος ἄρα ἡ μὲν ΖΚ τῇ ΕΑ , ἡ δὲ ΒΛ τῇ ΖΚ , καὶ ἔτι ἡ μὲν ΔΗ τῇ ΒΛ , ἡ δὲ ΘΝ τῇ ΔΗ , καὶ ἡ ΓΜ τῇ ΘΝ [καὶ ἐπεὶ δύο παράλληλοί εἰσιν αἱ ΕΑ , ΚΖ , καὶ δύο διηγμέναι εἰσὶν αἱ ΕΚ , ΑΟ]¹· ἔστιν ἄρα, ὡς ἡ ΕΞ πρὸς ΞΑ , ὁ ΚΞ πρὸς ΞΟ . ὡς δ' ἡ ΚΞ πρὸς ΞΟ , ἡ ΖΠ πρὸς ΠΟ , ὡς δὲ

¹ καὶ ἐπεὶ . . . ΕΚ , ΑΟ om. Heiberg.

ARCHIMEDES

K, Θ . But Λ is equal to the surface of the cone $BA\Gamma$, while K is equal to the surface of the cone ΔBE ; therefore the remainder, the portion of the surface of the cone between the parallel planes ΔE , $A\Gamma$, is equal to the circle Θ .

Prop. 21

If a regular polygon with an even number of sides be inscribed in a circle, and straight lines be drawn joining the angles ^a of the polygon, in such a manner as to be parallel to any one whatsoever of the lines subtended by two sides of the polygon, the sum of these connecting lines bears to the diameter of the circle the same ratio as the straight line subtended by half the sides less one bears to the side of the polygon.

Let $AB\Gamma\Delta$ be a circle, and in it let the polygon $AEZBH\Theta\Gamma MN\Delta\Lambda K$ be inscribed, and let $E\Lambda$, $Z\Lambda$, $B\Delta$, HN , ΘM be joined; then it is clear that they are parallel to a straight line subtended by two sides of the polygon ^b; I say therefore that the sum of the aforementioned straight lines bears to $A\Gamma$, the diameter of the circle, the same ratio as ΓE bears to EA .

For let ZK , ΛB , $H\Delta$, ΘN be joined; then ZK is parallel to EA , $B\Lambda$ to ZK , also ΔH to $B\Lambda$, ΘN to ΔH and ΓM to ΘN ^c; therefore

$$E\Xi : \Xi A = K\Xi : \Xi O.$$

But $K\Xi : \Xi O = Z\Pi : \Pi O$, [Eucl. vi. 4

^a "Sides" according to the text, but Heiberg thinks Archimedes probably wrote *γωνίας* where we have *πλευράς*.

^b For, because the arcs $K\Lambda$, EZ are equal, $\angle EKZ = \angle KZA$ [Eucl. iii. 27]; therefore EK is parallel to ΛZ ; and so on.

^c For, as the arcs AK , EZ are equal, $\angle AEK = \angle EKZ$, and therefore AE is parallel to ZK ; and so on.

GREEK MATHEMATICS

ἡ ΖΠ πρὸς ΠΟ, ἡ ΛΠ πρὸς ΠΡ, ὡς δὲ ἡ ΛΠ πρὸς ΠΡ, οὕτως ἡ ΒΣ πρὸς ΣΡ, καὶ ἔτι, ὡς ἡ μὲν ΒΣ πρὸς ΣΡ, ἡ ΔΣ πρὸς ΣΤ, ὡς δὲ ἡ ΔΣ πρὸς ΣΤ, ἡ ΗΥ πρὸς ΥΤ, καὶ ἔτι, ὡς ἡ μὲν ΗΥ

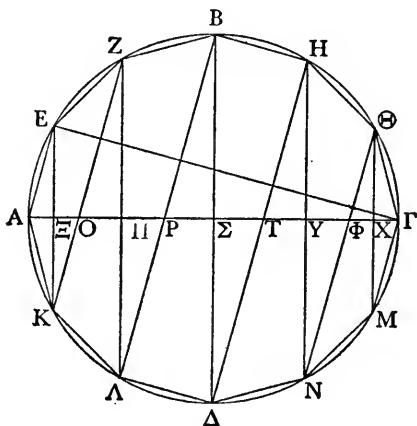

πρὸς ΥΤ, ἡ ΝΥ πρὸς ΥΦ, ὡς δὲ ἡ ΝΥ πρὸς ΥΦ, ἡ ΘΧ πρὸς ΧΦ, καὶ ἔτι, ὡς μὲν ἡ ΘΧ πρὸς ΧΦ, ἡ ΜΧ πρὸς ΧΓ [καὶ πάντα ἄρα πρὸς πάντα ἐστίν, ὡς εἰς τῶν λόγων πρὸς ἓνα]¹. ὡς ἄρα ἡ ΕΞ πρὸς ΞΑ, οὕτως αἱ ΕΚ, ΖΛ, ΒΔ, ΗΝ, ΘΜ πρὸς τὴν ΑΓ διάμετρον. ὡς δὲ ἡ ΕΞ πρὸς ΞΑ, οὕτως ἡ ΓΕ πρὸς ΕΑ· ἔσται ἄρα καί, ὡς ἡ ΓΕ πρὸς ΕΑ, οὕτω πᾶσαι αἱ ΕΚ, ΖΛ, ΒΔ, ΗΝ, ΘΜ πρὸς τὴν ΑΓ διάμετρον.

¹ καὶ . . . ἓνα om. Heiberg.

ARCHIMEDES

while	$Z\Pi : \Pi O = \Lambda\Pi : \Pi P,$	[<i>ibid.</i>
and	$\Lambda\Pi : \Pi P = B\Sigma : \Sigma P.$	[<i>ibid.</i>
Again,	$B\Sigma : \Sigma P = \Delta\Sigma : \Sigma T,$	[<i>ibid.</i>
while	$\Delta\Sigma : \Sigma T = H\Upsilon : \Upsilon T.$	[<i>ibid.</i>
Again,	$H\Upsilon : \Upsilon T = N\Upsilon : \Upsilon\Phi,$	[<i>ibid.</i>
while	$N\Upsilon : \Upsilon\Phi = \Theta X : X\Phi.$	[<i>ibid.</i>
Again,	$\Theta X : X\Phi = M X : X\Gamma,$	[<i>ibid.</i>
therefore	$E\Xi : \Xi A = EK + Z\Lambda + B\Delta + HN +$ $\Theta M : A\Gamma.$ ^a	[Eucl. v. 12
But	$E\Xi : \Xi A = \Gamma E : EA ;$	[Eucl. vi. 4
therefore	$\Gamma E : EA = EK + Z\Lambda + B\Delta + HN +$ $\Theta M : A\Gamma.$ ^b	

• By adding all the antecedents and consequents, for

$$\begin{aligned}
 E\Xi : \Xi A &= E\Xi + K\Xi + Z\Pi + \Lambda\Pi + B\Sigma + \Delta\Sigma + H\Upsilon + N\Upsilon + \Theta X + \\
 &\quad M X : \Xi A + \Xi O + \Pi O + \Pi P + \Sigma P + \Sigma T + \Upsilon T + \Upsilon\Phi \\
 &\quad + X\Phi + X\Gamma \\
 &= EK + Z\Lambda + B\Delta + HN + \Theta M : A\Gamma.
 \end{aligned}$$

• If the polygon has $4n$ sides, then

$$\angle E\Gamma K = \frac{\pi}{2n} \quad \text{and} \quad EK : A\Gamma = \sin \frac{\pi}{2n},$$

$$\angle Z\Gamma\Lambda = \frac{2\pi}{2n} \quad \text{and} \quad Z\Lambda : A\Gamma = \sin \frac{2\pi}{2n},$$

$$\angle \Theta\Gamma M = (2n - 1) \frac{\pi}{2n} \quad \text{and} \quad \Theta M : A\Gamma = \sin (2n - 1) \frac{\pi}{2n}.$$

. . .

Further, $\angle A\Gamma E = \frac{\pi}{4n}$ and $\Gamma E : EA = \cot \frac{\pi}{4n}.$

Therefore the proposition shows that

$$\sin \frac{\pi}{2n} + \sin \frac{2\pi}{2n} + \dots + \sin (2n - 1) \frac{\pi}{2n} = \cot \frac{\pi}{4n}.$$

GREEK MATHEMATICS

κγ'

Ἐστω ἐν σφαίρα μέγιστος κύκλος ὁ ΑΒΓΔ, καὶ ἐγγεγράφθω εἰς αὐτὸν πολύγωνον ἰσόπλευρον, τὸ

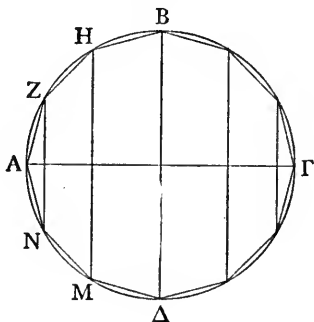

δὲ πλῆθος τῶν πλευρῶν αὐτοῦ μετρεῖσθω ὑπὸ τετράδος, αἱ δὲ ΑΓ, ΔΒ διάμετροι ἔστωσαν. εἰ δὲ μενούσης τῆς ΑΓ διαμέτρου περιενεχθῆ ὁ ΑΒΓΔ κύκλος ἔχων τὸ πολύγωνον, δῆλον, ὅτι ἡ μὲν περιφέρεια αὐτοῦ κατὰ τῆς ἐπιφανείας τῆς σφαίρας ἐνεχθήσεται, αἱ δὲ τοῦ πολυγώνου γωνίαι χωρὶς τῶν πρὸς τοῖς Α, Γ σημείοις κατὰ κύκλων περιφερειῶν ἐνεχθήσονται ἐν τῇ ἐπιφανείᾳ τῆς σφαίρας γεγραμμένων ὀρθῶν πρὸς τὸν ΑΒΓΔ κύκλον· διάμετροι δὲ αὐτῶν ἔσονται αἱ ἐπιζευγνύουσαι τὰς γωνίας τοῦ πολυγώνου παρὰ τὴν ΒΔ οὔσαι. αἱ δὲ τοῦ πολυγώνου πλευραὶ κατὰ τινων κώνων ἐνεχθήσονται, αἱ μὲν ΑΖ, ΑΝ κατ' ἐπιφανείας κώνου, οὗ βᾶσις μὲν ὁ κύκλος ὁ περὶ διάμετρον τὴν ΖΝ, κορυφή δὲ τὸ Α σημεῖον, αἱ δὲ

ARCHIMEDES

Prop. 23

Let $AB\Gamma\Delta$ be the greatest circle in a sphere, and let there be inscribed in it an equilateral polygon, the number of whose sides is divisible by four, and let $A\Gamma, \Delta B$ be diameters. If the diameter $A\Gamma$ remain stationary and the circle $AB\Gamma\Delta$ containing the polygon be rotated, it is clear that the circumference of the circle will traverse the surface of the sphere, while the angles of the polygon, except those at the points A, Γ , will traverse the circumferences of circles described on the surface of the sphere at right angles to the circle $AB\Gamma\Delta$; their diameters will be the [straight lines] joining the angles of the polygon, being parallel to $B\Delta$. Now the sides of the polygon will traverse certain cones; AZ, AN will traverse the surface of a cone whose base is the circle about the diameter ZN and whose vertex is the point A ; $ZH,$

GREEK MATHEMATICS

ZH, MN κατά τινας κωνικῆς ἐπιφανείας οἰσθήσονται, ἧς βάσις μὲν ὁ κύκλος ὁ περὶ διάμετρον τὴν MH, κορυφή δὲ τὸ σημεῖον, καθ' ὃ συμβάλλουσιν ἐκβαλλόμεναι αἱ ZH, MN ἀλλήλαις τε καὶ τῇ ΑΓ, αἱ δὲ BH, ΜΔ πλευραὶ κατὰ κωνικῆς ἐπιφανείας οἰσθήσονται, ἧς βάσις μὲν ἐστὶν ὁ κύκλος ὁ περὶ διάμετρον τὴν ΒΔ ὀρθὸς πρὸς τὸν ΑΒΓΔ κύκλον, κορυφή δὲ τὸ σημεῖον, καθ' ὃ συμβάλλουσιν ἐκβαλλόμεναι αἱ BH, ΔΜ ἀλλήλαις τε καὶ τῇ ΓΑ· ὁμοίως δὲ καὶ αἱ ἐν τῷ ἐτέρῳ ἡμικυκλίῳ πλευραὶ κατὰ κωνικῶν ἐπιφανειῶν οἰσθήσονται πάλιν ὁμοίων ταύταις. ἔσται δὴ τι σχῆμα ἐγγεγραμμένον ἐν τῇ σφαίρα ὑπὸ κωνικῶν ἐπιφανειῶν περιεχόμενον τῶν προειρημένων, οὗ ἡ ἐπιφάνεια ἐλάσσων ἔσται τῆς ἐπιφανείας τῆς σφαίρας.

Διαιρεθείσης γὰρ τῆς σφαίρας ὑπὸ τοῦ ἐπιπέδου τοῦ κατὰ τὴν ΒΔ ὀρθοῦ πρὸς τὸν ΑΒΓΔ κύκλον ἡ ἐπιφάνεια τοῦ ἐτέρου ἡμισφαιρίου καὶ ἡ ἐπιφάνεια τοῦ σχήματος τοῦ ἐν αὐτῷ ἐγγεγραμμένου τὰ αὐτὰ πέρατα ἔχουσιν ἐν ἐνὶ ἐπιπέδῳ· ἀμφοτέρων γὰρ τῶν ἐπιφανειῶν πέρασ ἐστὶν τοῦ κύκλου ἡ περιφέρεια τοῦ περὶ διάμετρον τὴν ΒΔ ὀρθοῦ πρὸς τὸν ΑΒΓΔ κύκλον· καὶ εἰσιν ἀμφοτέραι ἐπὶ τὰ αὐτὰ κοῖλαι, καὶ περιλαμβάνεται αὐτῶν ἡ ἕτερα ὑπὸ τῆς ἕτερας ἐπιφανείας καὶ τῆς ἐπιπέδου τῆς τὰ αὐτὰ πέρατα ἐχούσης αὐτῇ. ὁμοίως δὲ καὶ τοῦ ἐν τῷ ἐτέρῳ ἡμισφαιρίῳ σχήματος ἡ ἐπιφάνεια ἐλάσσων ἐστὶν τῆς τοῦ ἡμισφαιρίου ἐπιφανείας· καὶ ὅλη οὖν ἡ ἐπιφάνεια τοῦ σχήματος τοῦ ἐν τῇ σφαίρα ἐλάσσων ἐστὶν τῆς ἐπιφανείας τῆς σφαίρας.

* Archimedes would not have omitted to make the deduc-

ARCHIMEDES

MN will traverse the surface of a certain cone whose base is the circle about the diameter MH and whose vertex is the point in which ZH, MN produced meet one another and with AF ; the sides BH, $M\Delta$ will traverse the surface of a cone whose base is the circle about the diameter $B\Delta$ at right angles to the circle $AB\Gamma\Delta$ and whose vertex is the point in which BH, ΔM produced meet one another and with ΓA ; in the same way the sides in the other semicircle will traverse surfaces of cones similar to these. As a result there will be inscribed in the sphere and bounded by the aforesaid surfaces of cones a figure whose surface will be less than the surface of the sphere.

For, if the sphere be cut by the plane through $B\Delta$ at right angles to the circle $AB\Gamma\Delta$, the surface of one of the hemispheres and the surface of the figure inscribed in it have the same extremities in one plane; for the extremity of both surfaces is the circumference of the circle about the diameter $B\Delta$ at right angles to the circle $AB\Gamma\Delta$; and both are concave in the same direction, and one of them is included by the other surface and the plane having the same extremities with it.^a Similarly the surface of the figure inscribed in the other hemisphere is less than the surface of the hemisphere; and therefore the whole surface of the figure in the sphere is less than the surface of the sphere.

tion, from Postulate 4, that the surface of the figure inscribed in the hemisphere is less than the surface of the hemisphere.

κδ'

Ἡ τοῦ ἐγγραφομένου σχήματος εἰς τὴν σφαῖραν ἐπιφάνεια ἴση ἐστὶ κύκλῳ, οὗ ἢ ἐκ τοῦ κέντρου δύναται τὸ περιεχόμενον ὑπὸ τε τῆς πλευρᾶς τοῦ σχήματος καὶ τῆς ἴσης πάσαις ταῖς ἐπιζευγνουύσαις τὰς πλευρὰς τοῦ πολυγώνου παραλλήλοις οὔσαις τῇ ὑπὸ δύο πλευρὰς τοῦ πολυγώνου ὑποτεινούσῃ εὐθείᾳ.

Ἐστω ἐν σφαίρα μέγιστος κύκλος ὁ ΑΒΓΔ, καὶ ἐν αὐτῷ πολύγωνον ἐγγεγράφθω ἰσόπλευρον, οὗ αἱ πλευραὶ ὑπὸ τετραδὸς μετροῦνται, καὶ ἀπὸ τοῦ πολυγώνου τοῦ ἐγγεγραμμένου νοείσθω τι εἰς τὴν σφαῖραν ἐγγραφέν σχῆμα, καὶ ἐπεζεύχθωσαν αἱ ΕΖ, ΗΘ, ΓΔ, ΚΛ, ΜΝ παράλληλοι οὔσαι τῇ ὑπὸ δύο πλευρὰς ὑποτεινούσῃ εὐθείᾳ, κύκλος δέ τις ἐκκείσθω ὁ Ξ, οὗ ἢ ἐκ τοῦ κέντρου δυνάσθω τὸ περιεχόμενον ὑπὸ τε τῆς ΑΕ καὶ τῆς ἴσης ταῖς ΕΖ, ΗΘ, ΓΔ, ΚΛ, ΜΝ· λέγω, ὅτι ὁ κύκλος οὗτος ἴσος ἐστὶ τῇ ἐπιφανείᾳ τοῦ εἰς τὴν σφαῖραν ἐγγραφομένου σχήματος.

Ἐκκείσθωσαν γὰρ κύκλοι οἱ Ο, Π, Ρ, Σ, Τ, Υ, καὶ τοῦ μὲν Ο ἢ ἐκ τοῦ κέντρου δυνάσθω τὸ περιεχόμενον ὑπὸ τε τῆς ΕΑ καὶ τῆς ἡμισείας τῆς ΕΖ, ἢ δὲ ἐκ τοῦ κέντρου τοῦ Π δυνάσθω τὸ περιεχόμενον ὑπὸ τε τῆς ΕΑ καὶ τῆς ἡμισείας τῶν ΕΖ, ΗΘ, ἢ δὲ ἐκ τοῦ κέντρου τοῦ Ρ δυνάσθω τὸ περιεχόμενον ὑπὸ τῆς ΕΑ καὶ τῆς ἡμισείας τῶν ΗΘ, ΓΔ, ἢ δὲ ἐκ τοῦ κέντρου τοῦ Σ δυνάσθω τὸ περιεχόμενον ὑπὸ τε τῆς ΕΑ καὶ τῆς ἡμισείας τῶν ΓΔ, ΚΛ, ἢ δὲ ἐκ τοῦ κέντρου τοῦ Τ δυνάσθω τὸ περιεχόμενον ὑπὸ τε τῆς ΑΕ καὶ τῆς ἡμισείας

ARCHIMEDES

Prop. 24

The surface of the figure inscribed in the sphere is equal to a circle, the square of whose radius is equal to the rectangle contained by the side of the figure and a straight line equal to the sum of the straight lines joining the angles of the polygon, being parallel to the straight line subtended by two sides of the polygon.

Let $AB\Gamma\Delta$ be the greatest circle in a sphere, and in it let there be inscribed an equilateral polygon, the number of whose sides is divisible by four, and, starting from the inscribed polygon, let there be imagined a figure inscribed in the sphere, and let EZ , $H\Theta$, $\Gamma\Delta$, $K\Lambda$, MN be joined, being parallel to the straight line subtended by two sides; now let there be set out a circle Ξ , the square of whose radius is equal to the rectangle contained by AE and a straight line equal to the sum of EZ , $H\Theta$, $\Gamma\Delta$, $K\Lambda$, MN ; I say that this circle is equal to the surface of the figure inscribed in the sphere.

For let the circles O , Π , P , Σ , T , Υ be set out, and let the square of the radius of O be equal to the rectangle contained by EA and the half of EZ , let the square of the radius of Π be equal to the rectangle contained by EA and the half of $EZ + H\Theta$, let the square of the radius of P be equal to the rectangle contained by EA and the half of $H\Theta + \Gamma\Delta$, let the square of the radius of Σ be equal to the rectangle contained by EA and the half of $\Gamma\Delta + K\Lambda$, let the square of the radius of T be equal to the rectangle

GREEK MATHEMATICS

τῶν ΚΛ, ΜΝ, ἡ δὲ ἐκ τοῦ κέντρου τοῦ Υἱ δυνάσθω τὸ περιεχόμενον ὑπὸ τε τῆς ΑΕ καὶ τῆς ἡμισείας τῆς ΜΝ. διὰ δὴ ταῦτα ὁ μὲν Ο κύκλος ἴσος ἐστὶ τῇ ἐπιφανείᾳ τοῦ ΑΕΖ κώνου, ὁ δὲ Π τῇ ἐπιφανείᾳ τοῦ κώνου τῇ μεταξύ τῶν ΕΖ, ΗΘ, ὁ δὲ Ρ τῇ μεταξύ τῶν ΗΘ, ΓΔ, ὁ δὲ Σ τῇ μεταξύ τῶν

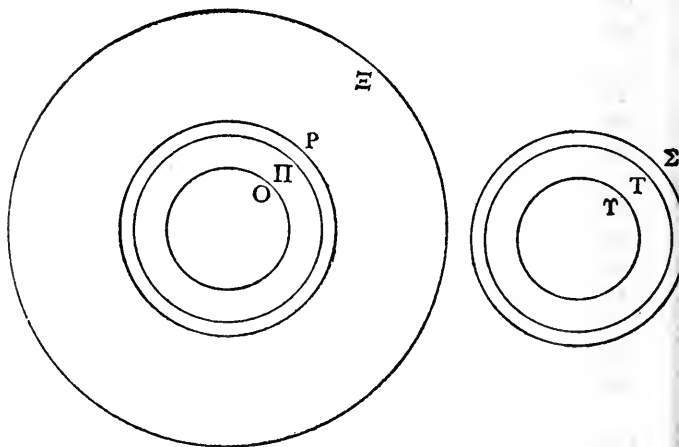

ΔΓ, ΚΛ, καὶ ἔτι ὁ μὲν Τ ἴσος ἐστὶ τῇ ἐπιφανείᾳ τοῦ κώνου τῇ μεταξύ τῶν ΚΛ, ΜΝ, ὁ δὲ Υἱ τῇ τοῦ ΜΒΝ κώνου ἐπιφανείᾳ ἴσος ἐστίν· οἱ πάντες ἄρα κύκλοι ἴσοι εἰσὶν τῇ τοῦ ἐγγεγραμμένου σχήματος ἐπιφανείᾳ. καὶ φανερόν, ὅτι αἱ ἐκ τῶν κέντρων τῶν Ο, Π, Ρ, Σ, Τ, Υἱ κύκλων δύνανται τὸ περιεχόμενον ὑπὸ τε τῆς ΑΕ καὶ δις τῶν ἡμίσεων τῆς ΕΖ, ΗΘ, ΓΔ, ΚΛ, ΜΝ, αἱ ὅλαι εἰσὶν

ARCHIMEDES

contained by AE and the half of $K\Lambda + MN$, and let the square of the radius of Y be equal to the rectangle contained by AE and the half of MN . Now by these constructions the circle O is equal to the surface of the cone AEZ [Prop. 14], the circle Π is equal to the surface of the conical frustum between EZ and $H\Theta$, the circle P is equal to the surface of the conical frustum between $H\Theta$ and $\Gamma\Delta$, the circle Σ is

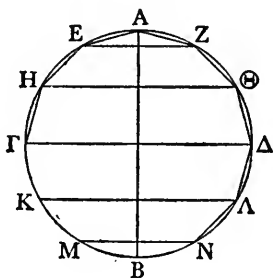

equal to the surface of the conical frustum between $\Delta\Gamma$ and $K\Lambda$, the circle T is equal to the surface of the conical frustum between $K\Lambda$, MN [Prop. 16], and the circle Y is equal to the surface of the cone MBN [Prop. 14]; the sum of the circles is therefore equal to the surface of the inscribed figure. And it is manifest that the sum of the squares of the radii of the circles O , Π , P , Σ , T , Y is equal to the rectangle contained by AE and twice the sum of the halves of EZ , $H\Theta$, $\Gamma\Delta$, $K\Lambda$, MN , that is to say, the sum of EZ ,

GREEK MATHEMATICS

αί EZ, ΗΘ, ΓΔ, ΚΛ, ΜΝ· αἱ ἄρα ἐκ τῶν κέντρων τῶν Ο, Π, Ρ, Σ, Τ, Υ κύκλων δύνανται τὸ περιεχόμενον ὑπὸ τε τῆς ΑΕ καὶ πασῶν τῶν EZ, ΗΘ, ΓΔ, ΚΛ, ΜΝ. ἀλλὰ καὶ ἡ ἐκ τοῦ κέντρου τοῦ Ξ κύκλου δύναται τὸ ὑπὸ τῆς ΑΕ καὶ τῆς συγκειμένης ἐκ πασῶν τῶν EZ, ΗΘ, ΓΔ, ΚΛ, ΜΝ· ἡ ἄρα ἐκ τοῦ κέντρου τοῦ Ξ κύκλου δύναται τὰ ἀπὸ τῶν ἐκ τῶν κέντρων τῶν Ο, Π, Ρ, Σ, Τ, Υ κύκλων· καὶ ὁ κύκλος ἄρα ὁ Ξ ἴσος ἐστὶ τοῖς Ο, Π, Ρ, Σ, Τ, Υ κύκλοις. οἱ δὲ Ο, Π, Ρ, Σ, Τ, Υ κύκλοι ἀπεδείχθησαν ἴσοι τῇ εἰρημένῃ τοῦ σχήματος ἐπιφανείᾳ· καὶ ὁ Ξ ἄρα κύκλος ἴσος ἔσται τῇ ἐπιφανείᾳ τοῦ σχήματος.

κε'

Τοῦ ἐγγεγραμμένου σχήματος εἰς τὴν σφαῖραν ἡ ἐπιφάνεια ἡ περιεχομένη ὑπὸ τῶν κωνικῶν ἐπιφανειῶν ἐλάσσων ἐστὶν ἢ τετραπλασία τοῦ μεγίστου κύκλου τῶν ἐν τῇ σφαίρᾳ.

Ἐστω ἐν σφαίρᾳ μέγιστος κύκλος ὁ ΑΒΓΔ, καὶ ἐν αὐτῷ ἐγγεγράφθω πολύγωνον [ἀρτιόγωνον] ἰσόπλευρον, οὗ αἱ πλευραὶ ὑπὸ τετράδος μετροῦνται, καὶ ἀπ' αὐτοῦ νοείσθω ἐπιφάνεια ἡ ὑπὸ τῶν

* If the radius of the sphere is a this proposition shows that
Surface of inscribed figure = circle Ξ

$$= \pi \cdot AE \cdot (EZ + H\Theta + \Gamma\Delta + \text{ΚΛ} + \text{ΜΝ}).$$

Now $AE = 2a \sin \frac{\pi}{4n}$, and by p. 91 n. b

ARCHIMEDES

$H\Theta, \Gamma\Delta, K\Lambda, MN$; therefore the sum of the squares of the radii of the circles O, Π, P, Σ, T, Y is equal to the rectangle contained by AE and the sum of $EZ, H\Theta, \Gamma\Delta, K\Lambda, MN$. But the square of the radius of the circle Ξ is equal to the rectangle contained by AE and a straight line made up of $EZ, H\Theta, \Gamma\Delta, K\Lambda, MN$ [*ex hypothesi*] ; therefore the square of the radius of the circle Ξ is equal to the sum of the squares of the radii of the circles O, Π, P, Σ, T, Y ; and therefore the circle Ξ is equal to the sum of the circles O, Π, P, Σ, T, Y . Now the sum of the circles O, Π, P, Σ, T, Y was shown to be equal to the surface of the aforesaid figure ; and therefore the circle Ξ will be equal to the surface of the figure.^a

Prop. 25

The surface of the figure inscribed in the sphere and bounded by the surfaces of cones is less than four times the greatest of the circles in the sphere.

Let $AB\Gamma\Delta$ be the greatest circle in a sphere, and in it let there be inscribed an equilateral polygon, the number of whose sides is divisible by four, and, starting from it, let a surface bounded by surfaces of

$$EZ + H\Theta + \Gamma\Delta + K\Lambda + MN = 2a \left[\sin \frac{\pi}{2n} + \sin \frac{2\pi}{2n} + \dots + \sin (2n-1) \frac{\pi}{2n} \right].$$

$$\begin{aligned} \therefore \text{Surface of inscribed figure} &= 4\pi a^2 \sin \frac{\pi}{4n} \left[\sin \frac{\pi}{2n} + \sin \frac{2\pi}{2n} \right. \\ &\quad \left. + \dots + \sin (2n-1) \frac{\pi}{2n} \right] \\ &= 4\pi a^2 \cos \frac{\pi}{4n} \end{aligned}$$

[by p. 91 n. b.]

κωνικῶν ἐπιφανειῶν περιεχομένη· λέγω, ὅτι ἡ ἐπιφάνεια τοῦ ἐγγραφέντος ἐλάσσων ἐστὶν ἢ τετραπλασία τοῦ μεγίστου κύκλου τῶν ἐν τῇ σφαίρα.

Ἐπεζεύχθωσαν γὰρ αἱ ὑπὸ δύο πλευρὰς ὑπὸ τείνουσαι τοῦ πολυγώνου αἱ ΕΙ, ΘΜ καὶ ταύταις παράλληλοι αἱ ΖΚ, ΔΒ, ΗΛ, ἐκκείσθω δέ τις κύκλος ὁ Ρ, οὗ ἡ ἐκ τοῦ κέντρου δύναται τὸ ὑπὸ τῆς ΕΑ καὶ τῆς ἴσης πάσαις ταῖς ΕΙ, ΖΚ, ΒΔ, ΗΛ, ΘΜ· διὰ δὴ τὸ προδειχθὲν ἴσος ἐστὶν ὁ κύκλος τῇ τοῦ εἰρημένου σχήματος ἐπιφάνειᾳ. καὶ ἐπεὶ ἐδείχθη, ὅτι ἐστὶν, ὡς ἡ ἴση πάσαις ταῖς ΕΙ, ΖΚ, ΒΔ, ΗΛ, ΘΜ πρὸς τὴν διάμετρον τοῦ κύκλου τὴν ΑΓ, οὕτως ἡ ΓΕ πρὸς ΕΑ, τὸ ἄρα ὑπὸ τῆς ἴσης πάσαις ταῖς εἰρημέναις καὶ τῆς ΕΑ, τουτέστιν τὸ ἀπὸ τῆς ἐκ τοῦ κέντρου τοῦ Ρ κύκλου, ἴσον ἐστὶν τῷ ὑπὸ τῶν ΑΓ, ΓΕ. ἀλλὰ καὶ τὸ ὑπὸ ΑΓ, ΓΕ ἔλασσόν ἐστι τοῦ ἀπὸ τῆς ΑΓ· ἔλασσον ἄρα ἐστὶν τὸ ἀπὸ τῆς ἐκ τοῦ κέντρου τοῦ Ρ τοῦ ἀπὸ τῆς ΑΓ [ἐλάσσων ἄρα ἐστὶν ἡ ἐκ τοῦ κέντρου τοῦ Ρ τῆς ΑΓ· ὥστε ἡ διάμετρος τοῦ Ρ κύκλου ἐλάσσων ἐστὶν ἢ διπλασία τῆς διαμέτρου τοῦ ΑΒΓΔ κύκλου, καὶ δύο ἄρα τοῦ ΑΒΓΔ κύκλου διαμέτροι μείζους εἰσὶ τῆς διαμέτρου τοῦ Ρ κύκλου, καὶ τὸ τετράκις ἀπὸ τῆς διαμέτρου τοῦ ΑΒΓΔ κύκλου, τουτέστι τῆς ΑΓ, μείζον ἐστὶ τοῦ ἀπὸ τῆς τοῦ Ρ κύκλου διαμέτρου. ὡς δὲ τὸ τετράκις ἀπὸ τῆς ΑΓ πρὸς τὸ ἀπὸ τῆς τοῦ Ρ κύκλου διάμετρον, οὕτως τέσσαρες κύκλοι οἱ ΑΒΓΔ πρὸς τὸν Ρ κύκλον· τέσσαρες ἄρα κύκλοι οἱ ΑΒΓΔ μείζους εἰσὶν τοῦ Ρ κύκλου]¹. ὁ ἄρα κύκλος ὁ Ρ ἐλάσσων ἐστὶν ἢ τετραπλάσιος τοῦ

¹ ἐλάσσων . . . κύκλου om. Heiberg.

ARCHIMEDES

cones be imagined ; I say that the surface of the inscribed figure is less than four times the greatest of the circles inscribed in the sphere.

For let EI, Θ M, subtended by two sides of the polygon, be joined, and let ZK, Δ B, H Λ be parallel

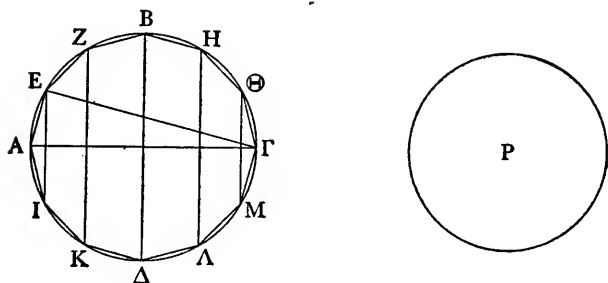

to them, and let there be set out a circle P, the square of whose radius is equal to the rectangle contained by EA and a straight line equal to the sum of EI, ZK, Δ B, H Λ , Θ M ; by what has been proved above, the circle is equal to the surface of the aforesaid figure. And since it was proved that the ratio of the sum of EI, ZK, Δ B, H Λ , Θ M to A Γ , the diameter of the circle, is equal to the ratio of Γ E to EA [Prop. 21], therefore

$$EA \cdot (EI + ZK + \Delta B + H\Lambda + \Theta M)$$

that is, the square on the radius of the circle P

$$= A\Gamma \cdot \Gamma E. \quad [\text{Eucl. vi. 16}]$$

But $A\Gamma \cdot \Gamma E < A\Gamma^2$. [Eucl. iii. 15]

Therefore the square on the radius of P is less than the square on A Γ ; therefore the circle P is less

GREEK MATHEMATICS

μεγιστου κύκλου. ὁ δὲ Ρ κύκλος ἴσος ἐδείχθη τῇ εἰρημένη ἐπιφανείᾳ τοῦ σχήματος· ἡ ἄρα ἐπιφάνεια τοῦ σχήματος ἐλάσσων ἐστὶν ἢ τετραπλασία τοῦ μεγιστου κύκλου τῶν ἐν τῇ σφαίρα.

κῆ'

Ἐστω ἐν σφαίρα μέγιστος κύκλος ὁ ΑΒΓΔ, περὶ δὲ τὸν ΑΒΓΔ κύκλον περιγεγράψθω πολύγωνον ἰσόπλευρόν τε καὶ ἰσογώνιον, τὸ δὲ πλήθος τῶν πλευρῶν αὐτοῦ μετρείσθω ὑπὸ τετράδος, τὸ δὲ περὶ τὸν κύκλον περιγεγραμμένον πολύγωνον κύκλος περιγεγραμμένος περιλαμβανέτω περὶ τὸ αὐτὸ κέντρον γινόμενος τῷ ΑΒΓΔ. μενούσης δὲ τῆς ΕΗ περιενεχθήτω τὸ ΕΖΗΘ ἐπίπεδον, ἐν ᾧ τό τε πολύγωνον καὶ ὁ κύκλος· δῆλον οὖν, ὅτι ἡ μὲν περιφέρεια τοῦ ΑΒΓΔ κύκλου κατὰ τῆς ἐπιφανείας τῆς σφαίρας οἰσθήσεται, ἡ δὲ περιφέρεια τοῦ ΕΖΗΘ κατ' ἄλλης ἐπιφανείας σφαίρας τὸ

ARCHIMEDES

than four times the greatest circle. But the circle P was proved equal to the aforesaid surface of the figure; therefore the surface of the figure is less than four times the greatest of the circles in the sphere.

Prop. 28

Let $AB\Gamma\Delta$ be the greatest circle in a sphere, and about the circle $AB\Gamma\Delta$ let there be circumscribed

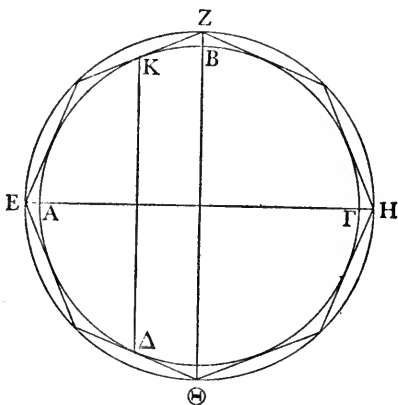

an equilateral and equiangular polygon, the number of whose sides is divisible by four, and let a circle be described about the polygon circumscribing the circle, having the same centre as $AB\Gamma\Delta$. While EH remains stationary, let the plane $EZH\Theta$, in which lie both the polygon and the circle, be rotated; it is clear that the circumference of the circle $AB\Gamma\Delta$ will traverse the surface of the sphere, while the circumference of $EZH\Theta$ will traverse the surface of another

GREEK MATHEMATICS

αὐτὸ κέντρον ἐχούσης τῇ ἐλάσσονι οἰσθήσεται, αἱ δὲ ἀφαί, καθ' ἃς ἐπιψαύουσιν αἱ πλευραί, γράφουσιν κύκλους ὀρθοὺς πρὸς τὸν ΑΒΓΔ κύκλον ἐν τῇ ἐλάσσονι σφαίρα, αἱ δὲ γωνίαι τοῦ πολυγώνου χωρὶς τῶν πρὸς τοῖς Ε, Η σημείοις κατὰ κύκλων περιφερειῶν οἰσθήσονται ἐν τῇ ἐπιφανείᾳ τῆς μείζονος σφαίρας γεγραμμένων ὀρθῶν πρὸς τὸν ΕΖΗΘ κύκλον, αἱ δὲ πλευραὶ τοῦ πολυγώνου κατὰ κωνικῶν ἐπιφανειῶν οἰσθήσονται, καθάπερ ἐπὶ τῶν πρὸ τούτου· ἔσται οὖν τὸ σχῆμα τὸ περιεχόμενον ὑπὸ τῶν ἐπιφανειῶν τῶν κωνικῶν περὶ μὲν τὴν ἐλάσσονα σφαῖραν περιγεγραμμένον, ἐν δὲ τῇ μείζονι ἐγγεγραμμένον. ὅτι δὲ ἡ ἐπιφάνεια τοῦ περιγεγραμμένου σχήματος μείζων ἐστὶ τῆς ἐπιφανείας τῆς σφαίρας, οὕτως δειχθήσεται.

*Ἐστω γὰρ ἡ ΚΔ διάμετρος κύκλου τινὸς τῶν ἐν τῇ ἐλάσσονι σφαίρα τῶν Κ, Δ σημείων ὄντων, καθ' ἃ ἄπτονται τοῦ ΑΒΓΔ κύκλου αἱ πλευραὶ τοῦ περιγεγραμμένου πολυγώνου. διηρημένης δὲ τῆς σφαίρας ὑπὸ τοῦ ἐπιπέδου τοῦ κατὰ τὴν ΚΔ ὀρθοῦ πρὸς τὸν ΑΒΓΔ κύκλον καὶ ἡ ἐπιφάνεια τοῦ περιγεγραμμένου σχήματος περὶ τὴν σφαῖραν διαιρεθήσεται ὑπὸ τοῦ ἐπιπέδου. καὶ φανερόν, ὅτι τὰ αὐτὰ πέρατα ἔχουσιν ἐν ἐπιπέδῳ· ἀμφοτέρων γὰρ τῶν ἐπιπέδων πέρασ ἐστὶν ἡ τοῦ κύκλου περιφέρεια τοῦ περὶ διάμετρον τὴν ΚΔ ὀρθοῦ πρὸς τὸν ΑΒΓΔ κύκλον· καὶ εἰσιν ἀμφοτέρας ἐπὶ τὰ αὐτὰ κοίλαι, καὶ περιλαμβάνεται ἡ ἑτέρα αὐτῶν ὑπὸ τῆς ἑτέρας ἐπιφανείας καὶ τῆς ἐπιπέδου τῆς τὰ αὐτὰ πέρατα ἐχούσης· ἐλάσσων οὖν ἐστὶν ἡ περιλαμβανομένη τοῦ τμήματος τῆς σφαίρας ἐπιφάνεια τῆς ἐπιφανείας τοῦ σχήματος τοῦ περι-

ARCHIMEDES

sphere, having the same centre as the lesser sphere ; the points of contact in which the sides touch [the smaller circle] will describe circles on the lesser sphere at right angles to the circle $AB\Gamma\Delta$, and the angles of the polygon, except those at the points E, H will traverse the circumferences of circles on the surface of the greater sphere at right angles to the circle $EZH\Theta$, while the sides of the polygon will traverse surfaces of cones, as in the former case ; there will therefore be a figure, bounded by surfaces of cones, described about the lesser sphere and inscribed in the greater. That the surface of the circumscribed figure is greater than the surface of the sphere will be proved thus.

Let $K\Delta$ be a diameter of one of the circles in the lesser sphere, K, Δ being points at which the sides of the circumscribed polygon touch the circle $AB\Gamma\Delta$. Now, since the sphere is divided by the plane containing $K\Delta$ at right angles to the circle $AB\Gamma\Delta$, the surface of the figure circumscribed about the sphere will be divided by the same plane. And it is manifest that they ^a have the same extremities in a plane ; for the extremity of both surfaces ^b is the circumference of the circle about the diameter $K\Delta$ at right angles to the circle $AB\Gamma\Delta$; and they are both concave in the same direction, and one of them is included by the other and the plane having the same extremities ; therefore the included surface of the segment of the sphere is less than the surface of

^a *i.e.*, the surface formed by the revolution of the circular segment $K\Delta$ and the surface formed by the revolution of the portion $K \dots E \dots \Delta$ of the polygon.

^b In the text $\acute{\epsilon}\pi\iota\pi\acute{\epsilon}\delta\omega\nu$ should obviously be $\acute{\epsilon}\pi\iota\phi\alpha\nu\epsilon\iota\omega\nu$.

¹ $\alpha\acute{\iota}$ πλευραι Heiberg ; om. codd.

GREEK MATHEMATICS

γεγραμμένου περιὶ αὐτήν. ὁμοίως δὲ καὶ ἡ τοῦ λοιποῦ τμήματος τῆς σφαίρας ἐπιφάνεια ἐλάσσων ἐστὶν τῆς ἐπιφανείας τοῦ σχήματος τοῦ περιγεγραμμένου περιὶ αὐτήν· δῆλον οὖν, ὅτι καὶ ὅλη ἡ ἐπιφάνεια τῆς σφαίρας ἐλάσσων ἐστὶ τῆς ἐπιφανείας τοῦ σχήματος τοῦ περιγεγραμμένου περιὶ αὐτήν.

κθ'

Τῇ ἐπιφανείᾳ τοῦ περιγεγραμμένου σχήματος περιὶ τὴν σφαῖραν ἴσος ἐστὶ κύκλος, οὗ ἡ ἐκ τοῦ κέντρου ἴσον δύναται τῷ περιεχομένῳ ὑπὸ τε μιᾶς πλευρᾶς τοῦ πολυγώνου καὶ τῆς ἴσης πάσαις ταῖς ἐπιζευγνυούσαις τὰς γωνίας τοῦ πολυγώνου οὔσαις παρά τινα τῶν ὑπὸ δύο πλευρᾶς τοῦ πολυγώνου ὑποτείνουσῶν.

Τὸ γὰρ περιγεγραμμένον περιὶ τὴν ἐλάσσονα σφαῖραν ἐγγέγραπται εἰς τὴν μείζονα σφαῖραν· τοῦ δὲ ἐγγεγραμμένου ἐν τῇ σφαίρᾳ περιεχομένου ὑπὸ τῶν ἐπιφανειῶν τῶν κωνικῶν δέδεικται ὅτι τῇ ἐπιφανείᾳ ἴσος ἐστὶν ὁ κύκλος, οὗ ἡ ἐκ τοῦ κέντρου δύναται τὸ περιεχόμενον ὑπὸ τε μιᾶς πλευρᾶς τοῦ πολυγώνου καὶ τῆς ἴσης πάσαις ταῖς ἐπιζευγνυούσαις τὰς γωνίας τοῦ πολυγώνου οὔσαις παρά τινα τῶν ὑπὸ δύο πλευρᾶς ὑποτείνουσῶν· δῆλον οὖν ἐστὶ τὸ προειρημένον.

^a If the radius of the inner sphere is a and that of the outer sphere a' , and the regular polygon has $4n$ sides, then

$$a' = a \operatorname{csc} \frac{\pi}{4n}.$$

This proposition shows that

Area of figure circumscribed
to circle of radius a = Area of figure inscribed in
circle of radius a'

ARCHIMEDES

the figure circumscribed about it [Post. 4]. Similarly the surface of the remaining segment of the sphere is less than the surface of the figure circumscribed about it; it is clear therefore that the whole surface of the sphere is less than the surface of the figure circumscribed about it.

Prop. 29

The surface of the figure circumscribed about the sphere is equal to a circle, the square of whose radius is equal to the rectangle contained by one side of the polygon and a straight line equal to the sum of all the straight lines joining the angles of the polygon, being parallel to one of the straight lines subtended by two sides of the polygon.

For the figure circumscribed about the lesser sphere is inscribed in the greater sphere [Prop. 28]; and it has been proved that the surface of the figure inscribed in the sphere and formed by surfaces of cones is equal to a circle, the square of whose radius is equal to the rectangle contained by one side of the polygon and a straight line equal to the sum of all the straight lines joining the angles of the polygon, being parallel to one of the straight lines subtended by two sides [Prop. 24]; what was aforesaid is therefore obvious.^a

$$= 4\pi a'^2 \sin \frac{\pi}{4n} \left[\sin \frac{\pi}{2n} + \sin \frac{2\pi}{2n} + \dots + \sin (2n-1) \frac{\pi}{2n} \right],$$

$$\text{or } 4\pi a'^2 \cos \frac{\pi}{4n} \text{ [by p. 91 n. b]}$$

$$= 4\pi a^3 \sec^2 \frac{\pi}{4n} \sin \frac{\pi}{4n} \left[\sin \frac{\pi}{2n} + \sin \frac{2\pi}{2n} + \dots + \sin (2n-1) \frac{\pi}{2n} \right],$$

$$\text{or } 4\pi a^2 \sec \frac{\pi}{4n}.$$

λ'

Τοῦ σχήματος τοῦ περιγεγραμμένου περὶ τὴν σφαῖραν ἢ ἐπιφάνεια μείζων ἐστὶν ἢ τετραπλασία τοῦ μεγίστου κύκλου τῶν ἐν τῇ σφαίρα.

Ἐστω γὰρ ἡ τε σφαῖρα καὶ ὁ κύκλος καὶ τὰ ἄλλα τὰ αὐτὰ τοῖς πρότερον προκειμένοις, καὶ ὁ Λ κύκλος ἴσος τῇ ἐπιφανείᾳ ἔστω τοῦ προκειμένου περιγεγραμμένου περὶ τὴν ἐλάσσονα σφαῖραν.

Ἐπεὶ οὖν ἐν τῷ $EZH\Theta$ κύκλῳ πολύγωνον

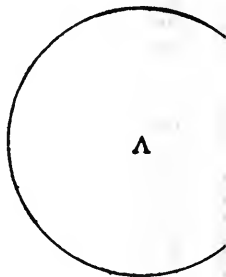
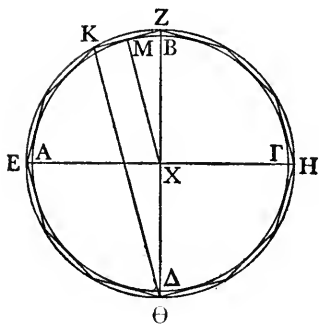

ἰσόπλευρον ἐγγέγραπται καὶ ἄρτιογώνιον, αἱ ἐπιζευγνύουσαι τὰς τοῦ πολυγώνου πλευρὰς παράλληλοι οὖσαι τῇ $Z\Theta$ πρὸς τὴν $Z\Theta$ τὸν αὐτὸν λόγον ἔχουσιν, ὅν ἡ ΘK πρὸς KZ . ἴσον ἄρα ἐστὶν τὸ περιεχόμενον σχῆμα ὑπὸ τε μιᾶς πλευρᾶς τοῦ πολυγώνου καὶ τῆς ἴσης πάσαις ταῖς ἐπιζευγνύουσαις τὰς γωνίας τοῦ πολυγώνου τῷ περιεχομένῳ ὑπὸ τῶν $Z\Theta K$. ὥστε ἡ ἐκ τοῦ κέντρου τοῦ Λ κύκλου ἴσον δύναται τῷ ὑπὸ $Z\Theta K$ μείζων ἄρα

ARCHIMEDES

Prop. 30

The surface of the figure circumscribed about the sphere is greater than four times the greatest of the circles in the sphere.

For let there be both the sphere and the circle and the other things the same as were posited before, and let the circle Λ be equal to the surface of the given figure circumscribed about the lesser sphere.

Therefore since in the circle $EZH\Theta$ there has been inscribed an equilateral polygon with an even number of angles, the [sum of the straight lines] joining the sides of the polygon, being parallel to $Z\Theta$, have the same ratio to $Z\Theta$ as ΘK to KZ [Prop. 21]; therefore the rectangle contained by one side of the polygon and the straight line equal to the sum of the straight lines joining the angles of the polygon is equal to the rectangle contained by $Z\Theta$, ΘK [Eucl. vi. 16]; so that the square of the radius of the circle Λ is equal to the rectangle contained by $Z\Theta$, ΘK

GREEK MATHEMATICS

ἐστὶν ἡ ἐκ τοῦ κέντρου τοῦ Λ κύκλου τῆς ΘK . ἡ δὲ ΘK ἴση ἐστὶ τῇ διαμέτρῳ τοῦ $\text{AB}\Gamma\Delta$ κύκλου [διπλασία γὰρ ἐστὶν τῆς $\text{X}\Sigma$ οὔσης ἐκ τοῦ κέντρου τοῦ $\text{AB}\Gamma\Delta$ κύκλου].¹ δῆλον οὖν, ὅτι μείζων ἐστὶν ἡ τετραπλάσιος ὁ Λ κύκλος, τουτέστιν ἡ ἐπιφάνεια τοῦ περιγεγραμμένου σχήματος περὶ τὴν ἐλάσσονα σφαῖραν, τοῦ μεγίστου κύκλου τῶν ἐν τῇ σφαίρα.

λγ'

Πάσης σφαίρας ἡ ἐπιφάνεια τετραπλασία ἐστὶ τοῦ μεγίστου κύκλου τῶν ἐν αὐτῇ.

Ἐστω γὰρ σφαῖρά τις, καὶ ἔστω τετραπλάσιος τοῦ μεγίστου κύκλου ὁ Λ . λέγω, ὅτι ὁ Λ ἴσος ἐστὶν τῇ ἐπιφανείᾳ τῆς σφαίρας.

Εἰ γὰρ μή, ἦτοι μείζων ἐστὶν ἡ ἐλάσσων. ἔστω πρότερον μείζων ἡ ἐπιφάνεια τῆς σφαίρας τοῦ κύκλου. ἔστι δὴ δύο μεγέθη ἄνισα ἢ τε ἐπιφάνεια τῆς σφαίρας καὶ ὁ Λ κύκλος· δυνατὸν ἄρα ἐστὶ λαβεῖν δύο εὐθείας ἀνίσους, ὥστε τὴν μείζονα πρὸς τὴν ἐλάσσονα λόγον ἔχειν ἐλάσσονα τοῦ, ὃν ἔχει ἡ

¹ διπλασία . . . κύκλου om. Heiberg.

• Because $Z\Theta > \Theta\text{K}$ [Eucl. iii. 15].

ARCHIMEDES

[Prop. 29]. Therefore the radius of the circle Λ is greater than ΘK .^a Now ΘK is equal to the diameter of the circle $AB\Gamma\Delta$; it is therefore clear that the circle Λ , that is, the surface of the figure circumscribed about the lesser sphere, is greater than four times the greatest of the circles in the sphere.

Prop. 33

The surface of any sphere is four times the greatest of the circles in it.

For let there be a sphere, and let A be four times the greatest circle; I say that A is equal to the surface of the sphere.

For if not, either it is greater or less. First, let the surface of the sphere be greater than the circle.

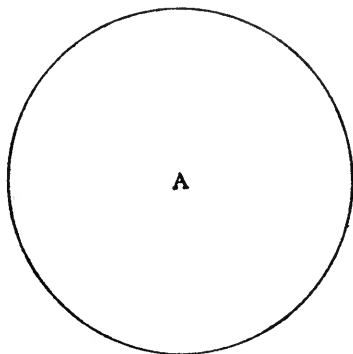

Then there are two unequal magnitudes, the surface of the sphere and the circle A ; it is therefore possible to take two unequal straight lines so that the greater bears to the less a ratio less than that which the sur-

GREEK MATHEMATICS

ἐπιφάνεια τῆς σφαίρας πρὸς τὸν κύκλον. εἰλήφθωσαν αἱ Β, Γ, καὶ τῶν Β, Γ μέση ἀνάλογον ἔστω ἡ Δ, νοείσθω δὲ καὶ ἡ σφαῖρα ἐπιπέδῳ τετμημένη διὰ τοῦ κέντρου κατὰ τὸν ΕΖΗΘ κύκλον, νοείσθω δὲ καὶ εἰς τὸν κύκλον ἐγγεγραμμένον καὶ περιγεγραμμένον πολυγώνον, ὥστε ὅμοιον εἶναι τὸ περιγεγραμμένον τῷ ἐγγεγραμμένῳ πολυγώνῳ καὶ τὴν τοῦ περιγεγραμμένου πλευρὰν ἐλάσσονα λόγον ἔχει τοῦ, ὃν ἔχει ἡ Β πρὸς Δ [καὶ ὁ διπλάσιος ἄρα λόγος τοῦ διπλασίου λόγου ἐστὶν ἐλάσσων. καὶ τοῦ μὲν τῆς Β πρὸς Δ διπλάσιός ἐστὶν ὁ τῆς Β πρὸς τὴν Γ, τῆς δὲ πλευρᾶς τοῦ περιγεγραμμένου πολυγώνου πρὸς τὴν πλευρὰν τοῦ ἐγγεγραμμένου διπλάσιος ὁ τῆς ἐπιφανείας τοῦ περιγεγραμμένου στερεοῦ πρὸς τὴν ἐπιφάνειαν τοῦ ἐγγεγραμμένου]¹. ἡ ἐπιφάνεια ἄρα τοῦ περιγεγραμμένου σχήματος περὶ τὴν σφαῖραν πρὸς τὴν ἐπιφάνειαν τοῦ ἐγγεγραμμένου σχήματος ἐλάσσονα λόγον ἔχει ἢ περὶ ἡ ἐπιφάνεια τῆς σφαίρας πρὸς τὸν Α κύκλον· ὅπερ ἄτοπον· ἡ μὲν γὰρ ἐπιφάνεια τοῦ περιγεγραμμένου τῆς ἐπιφανείας τῆς σφαίρας μείζων ἐστίν, ἡ δὲ ἐπιφάνεια τοῦ ἐγγεγραμμένου σχήματος τοῦ Α κύκλου ἐλάσσων ἐστὶ [δέδεικται γὰρ ἡ ἐπιφάνεια τοῦ ἐγγεγραμμένου ἐλάσσων τοῦ μεγίστου κύκλου τῶν ἐν τῇ σφαίρᾳ ἢ τετραπλασία, τοῦ δὲ μεγίστου κύκλου τετραπλάσιός ἐστὶν ὁ Α κύκλος]². οὐκ ἄρα ἡ ἐπιφάνεια τῆς σφαίρας μείζων ἐστὶ τοῦ Α κύκλου.

¹ καὶ . . . ἐγγεγραμμένου om. Heiberg.

² δέδεικται . . . κύκλος "repetitionem inutilem Prop. 25," om. Heiberg.

ARCHIMEDES

face of the sphere bears to the circle [Prop. 2]. Let B , Γ be so taken, and let Δ be a mean proportional between B , Γ , and let the sphere be imagined as cut

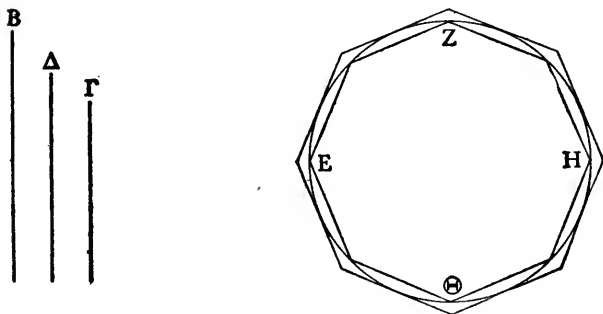

through the centre along the [plane of the] circle $EZH\Theta$, and let there be imagined a polygon inscribed in the circle and another circumscribed about it in such a manner that the circumscribed polygon is similar to the inscribed polygon and the side of the circumscribed polygon has [to the side of the inscribed polygon]^a a ratio less than that which B has to Δ [Prop. 3]. Therefore the surface of the figure circumscribed about the sphere has to the surface of the inscribed figure a ratio less than that which the surface of the sphere has to the circle A ; which is absurd; for the surface of the circumscribed figure is greater than the surface of the sphere [Prop. 28], while the surface of the inscribed figure is less than the circle A [Prop. 25]. Therefore the surface of the sphere is not greater than the circle A .

^a Archimedes would not have omitted: *πρὸς τὴν τοῦ ἐγγεγραμμένου.*

GREEK MATHEMATICS

Λέγω δὴ, ὅτι οὐδὲ ἐλάσσων. εἰ γὰρ δυνατόν, ἔστω· καὶ ὁμοίως εὐρήσθωσαν αἱ Β, Γ εὐθεῖαι, ὥστε τὴν Β πρὸς Γ ἐλάσσονα λόγον ἔχειν τοῦ, ὃν ἔχει ὁ Α κύκλος πρὸς τὴν ἐπιφάνειαν τῆς σφαίρας, καὶ τῶν Β, Γ μέση ἀνάλογον ἢ Δ, καὶ ἐγγεγραφθῶ καὶ περιγεγραφθῶ πάλιν, ὥστε τὴν τοῦ περιγεγραμμένου ἐλάσσονα λόγον ἔχειν τοῦ τῆς Β πρὸς Δ [καὶ τὰ διπλάσια ἄρα]¹. ἢ ἐπιφάνεια ἄρα τοῦ περιγεγραμμένου πρὸς τὴν ἐπιφάνειαν τοῦ ἐγγεγραμμένου ἐλάσσονα λόγον ἔχει ἢπερ [ἢ Β πρὸς Γ. ἢ δὲ Β πρὸς Γ ἐλάσσονα λόγον ἔχει ἢπερ]² ὁ Α κύκλος πρὸς τὴν ἐπιφάνειαν τῆς σφαίρας· ὅπερ ἄτοπον· ἢ μὲν γὰρ τοῦ περιγεγραμμένου ἐπιφάνεια μείζων ἐστὶ τοῦ Α κύκλου, ἢ δὲ τοῦ ἐγγεγραμμένου ἐλάσσων τῆς ἐπιφανείας τῆς σφαίρας.

Οὐκ ἄρα οὐδὲ ἐλάσσων ἢ ἐπιφάνεια τῆς σφαίρας τοῦ Α κύκλου. ἐδείχθη δέ, ὅτι οὐδὲ μείζων· ἢ ἄρα ἐπιφάνεια τῆς σφαίρας ἴση ἐστὶ τῷ Α κύκλῳ, τουτέστι τῷ τετραπλασίῳ τοῦ μεγίστου κύκλου.

¹ καὶ . . . ἄρα om. Heiberg.

² ἢ Β . . . ἢπερ om. Heiberg.

^a Archimedes would not have omitted these words.

^b On p. 100 n. a it was proved that the area of the inscribed figure is

$$4\pi a^2 \sin \frac{\pi}{n} \left[\sin \frac{\pi}{2n} + \sin \frac{2\pi}{2n} + \dots + \sin (2n-1) \frac{\pi}{2n} \right],$$

or $4\pi a^2 \cos \frac{\pi}{4n}$.

On p. 108 n. a it was proved that the area of the circumscribed figure is

$$4\pi a^2 \sec^2 \frac{\pi}{4n} \sin \frac{\pi}{4n} \left[\sin \frac{\pi}{2n} + \sin \frac{2\pi}{2n} + \dots + \sin (2n-1) \frac{\pi}{2n} \right],$$

or $4\pi a^2 \sec \frac{\pi}{4n}$.

ARCHIMEDES

I say now that neither is it less. For, if possible let it be ; and let the straight lines B, Γ be similarly found, so that B has to Γ a less ratio than that which the circle A has to the surface of the sphere, and let Δ be a mean proportional between B, Γ , and let [polygons] be again inscribed and circumscribed, so that the [side] of the circumscribed polygon has [to the side of the inscribed polygon] ^a a less ratio than that of B to Δ ; then the surface of the circumscribed polygon has to the surface of the inscribed polygon a ratio less than that which the circle A has to the surface of the sphere ; which is absurd ; for the surface of the circumscribed polygon is greater than the circle A , while that of the inscribed polygon is less than the surface of the sphere.

Therefore the surface of the sphere is not less than the circle A . And it was proved not to be greater ; therefore the surface of the sphere is equal to the circle A , that is to four times the greatest circle.^b

When n is indefinitely increased, the inscribed and circumscribed figures become identical with one another and with the circle, and, since $\cos \frac{\pi}{4n}$ and $\sec \frac{\pi}{4n}$ both become unity, the above expressions both give the area of the circle as $4\pi a^2$.

But the first expressions are, when n is indefinitely increased, precisely what is meant by the integral

$$4\pi a^2 \cdot \frac{1}{2} \int_0^\pi \sin \phi \, d\phi,$$

which is familiar to every student of the calculus as the formula for the area of a sphere and has the value $4\pi a^2$.

Thus Archimedes' procedure is equivalent to a genuine integration, but when it comes to the last stage, instead of saying, " Let the sides of the polygon be indefinitely

Πᾶσα σφαῖρα τετραπλασία ἐστὶ κώνου τοῦ βάσιν μὲν ἔχοντος ἴσην τῷ μεγίστῳ κύκλῳ τῶν ἐν τῇ σφαίρᾳ, ὕψος δὲ τὴν ἐκ τοῦ κέντρου τῆς σφαίρας.

Ἐστω γὰρ σφαῖρά τις καὶ ἐν αὐτῇ μέγιστος κύκλος ὁ ΑΒΓΔ. εἰ οὖν μὴ ἐστὶν ἡ σφαῖρα τε-

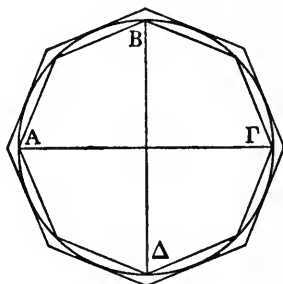
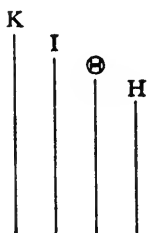

τραπλασία τοῦ εἰρημένου κώνου, ἔστω, εἰ δυνατόν, μείζων ἢ τετραπλασία· ἔστω δὲ ὁ Ξ κώνος βάσιν μὲν ἔχων τετραπλασίαν τοῦ ΑΒΓΔ κύκλου, ὕψος δὲ ἴσον τῇ ἐκ τοῦ κέντρου τῆς σφαίρας· μείζων οὖν ἐστὶν ἡ σφαῖρα τοῦ Ξ κώνου. ἔσται δὴ δύο μεγέθη ἄνισα ἢ τε σφαῖρα καὶ ὁ κώνος· δυνατόν οὖν δύο εὐθείας λαβεῖν ἀνίσους, ὥστε ἔχειν τὴν

increased," he prefers to prove that the area of the sphere cannot be either greater or less than $4\pi a^2$. By this double *reductio ad absurdum* he avoids the logical difficulties of dealing with indefinitely small quantities, difficulties that were not fully overcome until recent times.

The procedure by which in this same book Archimedes

ARCHIMEDES

Prop. 34

Any sphere is four times as great as the cone having a base equal to the greatest of the circles in the sphere and height equal to the radius of the sphere.

For let there be a sphere in which $AB\Gamma\Delta$ is the greatest circle. If the sphere is not four times the



aforesaid cone, let it be, if possible, greater than four times ; let Ξ be a cone having a base four times the circle $AB\Gamma\Delta$ and height equal to the radius of the sphere ; then the sphere is greater than the cone Ξ . Accordingly there will be two unequal magnitudes, the sphere and the cone ; it is therefore possible to take two unequal straight lines so that

finds the surface of the segment of a sphere is equivalent to the integration

$$\pi a^2 \int^{\alpha} 2 \sin \theta \, d\theta = 2\pi a^2 (1 - \cos \alpha).$$

Concurrently Archimedes finds the volumes of a sphere and segment of a sphere. He uses the same inscribed and circumscribed figures, and the procedure is equivalent to multiplying the above formulae by $\frac{1}{3}\alpha$ throughout. Other "integrations" effected by Archimedes are the volume of a segment of a paraboloid of revolution, the volume of a segment of a hyperboloid of revolution, the volume of a segment of a spheroid, the area of a spiral and the area of a segment of a parabola. He also finds the area of an ellipse, but not by a method equivalent to integration. The subject is fully treated by Heath, *The Works of Archimedes*, pp. cxlii-cliv, to whom I am much indebted in writing this note.

GREEK MATHEMATICS

μείζονα πρὸς τὴν ἐλάσσονα ἐλάσσονα λόγον τοῦ, ὃν ἔχει ἡ σφαῖρα πρὸς τὸν Ξ κῶνον. ἔστωσαν οὖν αἱ K, H , αἱ δὲ I, Θ εἰλημμένοι, ὥστε τῷ ἴσῳ ἀλλήλων ὑπερέχειν τὴν K τῆς I καὶ τὴν I τῆς Θ καὶ τὴν Θ τῆς H , νοείσθω δὲ καὶ εἰς τὸν $AB\Gamma\Delta$ κύκλον ἐγγεγραμμένον πολύγωνον, οὗ τὸ πλήθος τῶν πλευρῶν μετρείσθω ὑπὸ τετραδος, καὶ ἄλλο περιγεγραμμένον ὅμοιον τῷ ἐγγεγραμμένῳ, καθάπερ ἐπὶ τῶν πρότερον, ἡ δὲ τοῦ περιγεγραμμένου πολυγώνου πλευρὰ πρὸς τὴν τοῦ ἐγγεγραμμένου ἐλάσσονα λόγον ἐχέτω τοῦ, ὃν ἔχει ἡ K πρὸς I , καὶ ἔστωσαν αἱ AG, BD διάμετροι πρὸς ὀρθὰς ἀλλήλαις. εἰ οὖν μενούσης τῆς AG διαμέτρου περινεχθείη τὸ ἐπίπεδον, ἐν ᾧ τὰ πολύγωνα, ἔσται σχήματα¹ τὸ μὲν ἐγγεγραμμένον ἐν τῇ σφαίρᾳ, τὸ δὲ περιγεγραμμένον, καὶ ἕξει τὸ περιγεγραμμένον πρὸς τὸ ἐγγεγραμμένον τριπλασίονα λόγον ἢ περ ἡ πλευρὰ τοῦ περιγεγραμμένου πρὸς τὴν τοῦ ἐγγεγραμμένου εἰς τὸν $AB\Gamma\Delta$ κύκλον. ἡ δὲ πλευρὰ πρὸς τὴν πλευρὰν ἐλάσσονα λόγον ἔχει ἢ περ ἡ K πρὸς τὴν I . ὥστε τὸ σχῆμα τὸ περιγεγραμμένον ἐλάσσονα λόγον ἔχει ἢ τριπλασίονα τοῦ K πρὸς I .

¹ σχήματα Heiberg, τὸ σχῆμα codd.

^a Eutocius supplies a proof on these lines. Let the lengths of K, I, Θ, H be a, b, c, d . Then $a - b = b - c = c - d$, and it is required to prove that $a : d > a^3 : b^3$.

Take x such that

$$a : b = b : x.$$

Then

$$a - b : a = b - x : b,$$

and since $a > b$,

$$a - b > b - x.$$

But, by hypothesis,

$$a - b = b - c.$$

Therefore

$$b - c > b - x,$$

and so

$$x > c.$$

ARCHIMEDES

the greater will have to the less a less ratio than that which the sphere has to the cone Ξ . Therefore let the straight lines K, H , and the straight lines I, Θ , be so taken that K exceeds I , and I exceeds Θ and Θ exceeds H by an equal quantity; let there be imagined inscribed in the circle $AB\Gamma\Delta$ a polygon the number of whose sides is divisible by four; let another be circumscribed similar to that inscribed so that, as before, the side of the circumscribed polygon has to the side of the inscribed polygon a ratio less than that $K : I$; and let $A\Gamma, B\Delta$ be diameters at right angles. Then if, while the diameter $A\Gamma$ remains stationary, the surface in which the polygons lie be revolved, there will result two [solid] figures, one inscribed in the sphere and the other circumscribed, and the circumscribed figure will have to the inscribed the triplicate ratio of that which the side of the circumscribed figure has to the side of the figure inscribed in the circle $AB\Gamma\Delta$ [Prop. 32]. But the ratio of the one side to the other is less than $K : I$ [*ex hypothesi*]; and so the circumscribed figure has [to the inscribed] a ratio less than $K^3 : I^3$. But $^a K : H > K^3 : I^3$; by much more there-

Again, take y such that $b : z = x : y$.

Then, as before $b - x > x - y$.

Therefore, *a fortiori*, $b - c > x - y$.

But, by hypothesis, $b - c = c - d$.

Therefore $c - d > x - y$.

But $x > c$,

and so $y > d$.

But, by hypothesis, $a : b = b : x = x : y$,

$a : y = a^3 : b^3$ [Eucl. v. Def. 10, also vol. i.
p. 258 n. b.]

Therefore $a : d > a^3 : b^3$.

ἔχει δὲ καὶ ἡ K πρὸς H μείζονα λόγον ἢ τριπλάσιον τοῦ, ὃν ἔχει ἡ K πρὸς I [τοῦτο γὰρ φανερόν διὰ λημμάτων]¹. πολλῶ ἄρα τὸ περιγραφέν πρὸς τὸ ἐγγραφέν ἐλάσσονα λόγον ἔχει τοῦ, ὃν ἔχει ἡ K πρὸς H . ἡ δὲ K πρὸς H ἐλάσσονα λόγον ἔχει ἤπερ ἡ σφαῖρα πρὸς τὸν Ξ κώνον· καὶ ἐναλλάξ· ὅπερ ἀδύνατον· τὸ γὰρ σχῆμα τὸ περιγεγραμμένον μείζον ἐστὶ τῆς σφαίρας, τὸ δὲ ἐγγεγραμμένον ἐλασσον τοῦ Ξ κώνου [διότι ὁ μὲν Ξ κώνος τετραπλάσιός ἐστὶ τοῦ κώνου τοῦ βάσιν μὲν ἔχοντος ἴσην τῷ $AB\Gamma\Delta$ κύκλῳ, ὕψος δὲ ἴσον τῇ ἐκ τοῦ κέντρου τῆς σφαίρας, τὸ δὲ ἐγγεγραμμένον σχῆμα ἐλασσον τοῦ εἰρημένου κώνου ἢ τετραπλάσιον].² οὐκ ἄρα μείζων ἢ τετραπλασία ἡ σφαῖρα τοῦ εἰρημένου.

*Ἐστω, εἰ δυνατόν, ἐλάσσων ἢ τετραπλασία· ὥστε ἐλάσσων ἐστὶν ἡ σφαῖρα τοῦ Ξ κώνου. εἰλήφθωσαν δὴ αἱ K , H εὐθεῖαι, ὥστε τὴν K μείζονα εἶναι τῆς H καὶ ἐλάσσονα λόγον ἔχειν πρὸς αὐτὴν τοῦ, ὃν ἔχει ὁ Ξ κώνος πρὸς τὴν σφαῖραν, καὶ αἱ Θ , I ἐκκείσθωσαν, καθὼς πρότερον, καὶ εἰς τὸν $AB\Gamma\Delta$ κύκλον νοείσθω πολύγωνον ἐγγεγραμμένον καὶ ἄλλο περιγεγραμμένον, ὥστε τὴν πλευρὰν τοῦ περιγεγραμμένου πρὸς τὴν πλευρὰν τοῦ ἐγγεγραμμένου ἐλάσσονα λόγον ἔχειν ἤπερ ἡ K πρὸς I , καὶ τὰ ἄλλα κατεσκευασμένα τὸν αὐτὸν τρόπον τοῖς πρότερον· ἔξει ἄρα καὶ τὸ περιγεγραμμένον στερεὸν σχῆμα πρὸς τὸ ἐγγεγραμμένον τριπλασίονα λόγον ἤπερ ἡ πλευρὰ τοῦ περιγεγραμμένου περὶ τὸν $AB\Gamma\Delta$ κύκλον πρὸς τὴν τοῦ ἐγγεγραμμένου. ἡ δὲ πλευρὰ πρὸς τὴν πλευρὰν ἐλάσσονα λόγον ἔχει

ARCHIMEDES

fore the circumscribed figure has to the inscribed a ratio less than $K : H$. But $K : H$ is a ratio less than that which the sphere has to the cone Ξ [*ex hypothesi*]; [therefore the circumscribed figure has to the inscribed a ratio less than that which the sphere has to the cone Ξ]; and *permutando*, [the circumscribed figure has to the sphere a ratio less than that which the inscribed figure has to the cone]^a; which is impossible; for the circumscribed figure is greater than the sphere [Prop. 28], but the inscribed figure is less than the cone Ξ [Prop. 27]. Therefore the sphere is not greater than four times the aforesaid cone.

Let it be, if possible, less than four times, so that the sphere is less than the cone Ξ . Let the straight lines K, H be so taken that K is greater than H and $K : H$ is a ratio less than that which the cone Ξ has to the sphere [Prop. 2]; let the straight lines Θ, I be placed as before; let there be imagined in the circle $AB\Gamma\Delta$ one polygon inscribed and another circumscribed, so that the side of the circumscribed figure has to the side of the inscribed a ratio less than $K : I$; and let the other details in the construction be done as before. Then the circumscribed solid figure will have to the inscribed the triplicate ratio of that which the side of the figure circumscribed about the circle $AB\Gamma\Delta$ has to the side of the inscribed figure [Prop. 32]. But the ratio of the sides

* A marginal note in one *ms.* gives these words, which Archimedes would not have omitted.

¹ τοῦτο . . . λημμάτων om. Heiberg.

² διότι . . . τετραπλάσιον om. Heiberg.

GREEK MATHEMATICS

ἤπερ ἡ K πρὸς I . ἔξει οὖν τὸ σχῆμα τὸ περιγεγραμ-
 μένον πρὸς τὸ ἐγγεγραμμένον ἐλάσσονα λόγον ἢ
 τριπλάσιον τοῦ, ὃν ἔχει ἡ K πρὸς τὴν I . ἡ δὲ K
 πρὸς τὴν H μείζονα λόγον ἔχει ἢ τριπλάσιον τοῦ,
 ὃν ἔχει ἡ K πρὸς τὴν I . ὥστε ἐλάσσονα λόγον ἔχει
 τὸ σχῆμα τὸ περιγεγραμμένον πρὸς τὸ ἐγγεγραμ-
 μένον ἢ ἡ K πρὸς τὴν H . ἡ δὲ K πρὸς τὴν H
 ἐλάσσονα λόγον ἔχει ἢ ὁ Ξ κώνος πρὸς τὴν σφαῖραν.
 ὅπερ ἀδύνατον· τὸ μὲν γὰρ ἐγγεγραμμένον ἔλασσόν
 ἐστὶ τῆς σφαίρας, τὸ δὲ περιγεγραμμένον μείζον
 τοῦ Ξ κώνου. οὐκ ἄρα οὐδὲ ἐλάσσων ἐστὶν ἢ
 τετραπλασία ἢ σφαῖρα τοῦ κώνου τοῦ βάσιν μὲν
 ἔχοντος ἴσην τῷ $AB\Gamma\Delta$ κύκλῳ, ὕψος δὲ τὴν ἴσην
 τῇ ἐκ τοῦ κέντρου τῆς σφαίρας. ἐδείχθη δέ, ὅτι
 οὐδὲ μείζων· τετραπλασία ἄρα.

[Πόρισμα]¹

Προδεδειγμένων δὲ τούτων φανερόν, ὅτι πᾶς
 κύλινδρος βάσιν μὲν ἔχων τὸν μέγιστον κύκλον
 τῶν ἐν τῇ σφαίρα, ὕψος δὲ ἴσον τῇ διαμέτρῳ τῆς
 σφαίρας, ἡμιόλιός ἐστὶ τῆς σφαίρας καὶ ἡ ἐπι-
 φάνεια αὐτοῦ μετὰ τῶν βάσεων ἡμιολία τῆς
 ἐπιφανείας τῆς σφαίρας.

Ὁ μὲν γὰρ κύλινδρος ὁ προειρημένος ἑξαπλάσιός
 ἐστὶ τοῦ κώνου τοῦ βάσιν μὲν ἔχοντος τὴν αὐτὴν,
 ὕψος δὲ ἴσον τῇ ἐκ τοῦ κέντρου, ἡ δὲ σφαῖρα
 δέδεικται τοῦ αὐτοῦ κώνου τετραπλασία οὔσα.
 δῆλον οὖν, ὅτι ὁ κύλινδρος ἡμιόλιός ἐστὶ τῆς
 σφαίρας. πάλιν, ἐπεὶ ἡ ἐπιφάνεια τοῦ κυλίνδρου
 χωρὶς τῶν βάσεων ἴση δέδεικται κύκλῳ, οὗ ἡ ἐκ

¹ πόρισμα. The title is not found in some mss.

ARCHIMEDES

is less than $K : I$ [*ex hypothesi*]; therefore the circumscribed figure has to the inscribed a ratio less than $K^3 : I^3$. But $K : H > K^3 : I^3$; and so the circumscribed figure has to the inscribed a ratio less than $K : H$. But $K : H$ is a ratio less than that which the cone Ξ has to the sphere [*ex hypothesi*]; [therefore the circumscribed figure has to the inscribed a ratio less than that which the cone Ξ has to the sphere]^a; which is impossible; for the inscribed figure is less than the sphere [Prop. 28], but the circumscribed figure is greater than the cone Ξ [Prop. 31, coroll.]. Therefore the sphere is not less than four times the cone having its base equal to the circle $AB\Gamma\Delta$, and height equal to the radius of the sphere. But it was proved that it cannot be greater; therefore it is four times as great.

[COROLLARY]

From what has been proved above it is clear that *any cylinder having for its base the greatest of the circles in the sphere, and having its height equal to the diameter of the sphere, is one-and-a-half times the sphere, and its surface including the bases is one-and-a-half times the surface of the sphere.*

For the aforesaid cylinder is six times the cone having the same basis and height equal to the radius [from Eucl. xii. 10], while the sphere was proved to be four times the same cone [Prop. 34]. It is obvious therefore that the cylinder is one-and-a-half times the sphere. Again, since the surface of the cylinder excluding the bases has been proved equal to a circle

^a These words, which Archimedes would not have omitted, are given in a marginal note to one ms.

GREEK MATHEMATICS

τοῦ κέντρου μέση ἀνάλογόν ἐστὶ τῆς τοῦ κυλίνδρου πλευρᾶς καὶ τῆς διαμέτρου τῆς βάσεως, τοῦ δὲ εἰρημένου κυλίνδρου τοῦ περὶ τὴν σφαῖραν ἢ πλευρὰ ἴση ἐστὶ τῇ διαμέτρῳ τῆς βάσεως [δῆλον, ὅτι ἡ μέση αὐτῶν ἀνάλογον ἴση γίνεται τῇ διαμέτρῳ τῆς βάσεως],¹ ὁ δὲ κύκλος ὁ τὴν ἐκ τοῦ κέντρου ἔχων ἴσην τῇ διαμέτρῳ τῆς βάσεως τετραπλάσιός ἐστὶ τῆς βάσεως, τουτέστι τοῦ μεγίστου κύκλου τῶν ἐν τῇ σφαίρα, ἔσται ἄρα καὶ ἡ ἐπιφάνεια τοῦ κυλίνδρου χωρὶς τῶν βάσεων τετραπλασία τοῦ μεγίστου κύκλου· ὅλη ἄρα μετὰ τῶν βάσεων ἡ ἐπιφάνεια τοῦ κυλίνδρου ἑξαπλασία ἔσται τοῦ μεγίστου κύκλου. ἔστιν δὲ καὶ ἡ τῆς σφαίρας ἐπιφάνεια τετραπλασία τοῦ μεγίστου κύκλου. ὅλη ἄρα ἡ ἐπιφάνεια τοῦ κυλίνδρου ἡμιολία ἐστὶ τῆς ἐπιφανείας τῆς σφαίρας.

(c) SOLUTION OF A CUBIC EQUATION

Archim. *De Sphaera et Cyl.* ii., Prop. 4, Archim. ed.
Heiberg i. 186. 15–192. 6

Τὴν δοθείσαν σφαῖραν τεμεῖν, ὥστε τὰ τμήματα τῆς σφαίρας πρὸς ἄλληλα λόγον ἔχειν τὸν αὐτὸν τῷ δοθέντι.

¹ δῆλον . . . βάσεως om. Heiberg.

* As the geometrical form of proof is rather diffuse, and may conceal from the casual reader the underlying nature of the operation, it may be as well to state at the outset the various stages of the proof. The problem is to cut a given sphere by a plane so that the segments shall have a given ratio, and the stages are :

(a) Analysis of this main problem in which it is reduced to a particular case of the general problem, "so to cut a given straight line ΔZ at X that XZ bears to the given

ARCHIMEDES

whose radius is a mean proportional between the side of the cylinder and the diameter of the base [Prop. 13], and the side of the aforementioned cylinder circumscribing the sphere is equal to the diameter of the base, while the circle having its radius equal to the diameter of the base is four times the base [Eucl. xii. 2], that is to say, four times the greatest of the circles in the sphere, therefore the surface of the cylinder excluding the bases is four times the greatest circle; therefore the whole surface of the cylinder, including the bases, is six times the greatest circle. But the surface of the sphere is four times the greatest circle. Therefore the whole surface of the cylinder is one-and-a-half times the surface of the sphere.

(c) SOLUTION OF A CUBIC EQUATION

Archimedes, *On the Sphere and Cylinder* ii.,
Prop. 4, Archim. ed. Heiberg i. 186. 15-192. 6

To cut a given sphere, so that the segments of the sphere shall have, one towards the other, a given ratio.^a

straight line the same ratio as a given area bears to the square on ΔX ''; in algebraical notation, to solve the equation

$$\frac{a-x}{b} = \frac{c^2}{x^2}, \text{ or } x^2(a-x) = bc^2.$$

(b) Analysis of this general problem, in which it is shown that the required point can be found as the intersection of a parabola [$ax^2 = c^2y$] and a hyperbola [$(a-x)y = ab$]. It is stated, for the time being without proof, that $x^2(a-x)$ is greatest when $x = \frac{2}{3}a$; in other words, that for a real solution $bc^2 > \frac{4}{27}a^3$.

(c) Synthesis of this general problem, according as bc^2 is greater than, equal to, or less than $\frac{4}{27}a^3$. If it be greater, there is no real solution; if equal, there is one real solution; if less, there are two real solutions.

(d) Proof that $x^2(a-x)$ is greatest when $x = \frac{2}{3}a$, deferred

GREEK MATHEMATICS

Ἐστω ἡ δοθεῖσα σφαῖρα ἡ ΑΒΓΔ· δεῖ δὴ αὐτὴν τεμεῖν ἐπιπέδῳ, ὥστε τὰ τμήματα τῆς σφαίρας πρὸς ἄλληλα λόγον ἔχειν τὸν δοθέντα.

Τετμήσθω διὰ τῆς ΑΓ ἐπιπέδῳ· λόγος ἄρα τοῦ ΑΔΓ τμήματος τῆς σφαίρας πρὸς τὸ ΑΒΓ τμήμα τῆς σφαίρας δοθείς. τετμήσθω δὲ ἡ σφαῖρα διὰ τοῦ κέντρου, καὶ ἔστω ἡ τομὴ μέγιστος κύκλος ὁ ΑΒΓΔ, κέντρον δὲ τὸ Κ καὶ διάμετρος ἡ ΔΒ, καὶ πεποιήσθω, ὡς μὲν συναμφοτέρος ἡ ΚΔΧ πρὸς ΔΧ, οὕτως ἡ ΡΧ πρὸς ΧΒ, ὡς δὲ συναμφοτέρος ἡ ΚΒΧ πρὸς ΒΧ, οὕτως ἡ ΛΧ πρὸς ΧΔ, καὶ ἐπεζεύχθωσαν αἱ ΑΛ, ΛΓ, ΑΡ, ΡΓ· ἴσος ἄρα ἔστιν ὁ μὲν ΑΔΓ κῶνος τῷ ΑΔΓ τμήματι τῆς σφαίρας, ὁ δὲ ΑΡΓ τῷ ΑΒΓ· λόγος ἄρα καὶ τοῦ ΑΔΓ κώνου πρὸς τὸν ΑΡΓ κῶνον δοθείς. ὡς δὲ ὁ κῶνος πρὸς τὸν κῶνον, οὕτως ἡ ΛΧ πρὸς ΧΡ [ἐπεὶπερ τὴν αὐτὴν βάσιν ἔχουσιν τὸν περιδιάμετρον τὴν ΑΓ κύκλον]¹. λόγος ἄρα καὶ τῆς ΛΧ πρὸς ΧΡ δοθείς. καὶ διὰ ταῦτά τοῖς πρό-

¹ ἐπεὶπερ . . . κύκλον om. Heiberg.

in (b). This is done in two parts, by showing that (1) if x has any value less than $\frac{2}{3}a$, (2) if x has any value greater than $\frac{2}{3}a$, then $x^2(a-x)$ has a smaller value than when $x = \frac{2}{3}a$.

(e) Proof that, if $bc^2 < \frac{4}{27}a^3$, there are always two real solutions.

(f) Proof that, in the particular case of the general problem to which Archimedes has reduced his original problem, there is always a real solution.

(g) Synthesis of the original problem.

Of these stages, (a) and (g) alone are found in our texts of Archimedes; but Eutocius found stages (b)-(d) in an old book, which he took to be the work of Archimedes; and he added stages (e) and (f) himself. When it is considered that all these stages are traversed by rigorous geometrical

ARCHIMEDES

Let $AB\Gamma\Delta$ be the given sphere; it is required so to cut it by a plane that the segments of the sphere shall have, one towards the other, the given ratio.

Let it be cut by the plane $A\Gamma$; then the ratio of the segment $A\Delta\Gamma$ of the sphere to the segment $AB\Gamma$ of the sphere is given. Now let the sphere be cut through the centre [by a plane perpendicular to the plane through $A\Gamma$], and let the section be the great circle $AB\Gamma\Delta$ of centre K and diameter ΔB , and let [Λ , P be taken on $B\Delta$ produced in either direction so that]

$$K\Delta + \Delta X : \Delta X = PX : XB,$$

$$KB + BX : BX = \Lambda X : X\Delta,$$

and let $\Lambda\Lambda$, $\Lambda\Gamma$, AP , $P\Gamma$ be joined; then the cone $\Lambda\Lambda\Gamma$ is equal to the segment $A\Delta\Gamma$ of the sphere, and

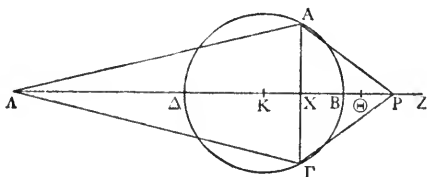

the cone $AP\Gamma$ to the segment $AB\Gamma$ [Prop. 2]; therefore the ratio of the cone $\Lambda\Lambda\Gamma$ to the cone $AP\Gamma$ is given. But cone $\Lambda\Lambda\Gamma$: cone $AP\Gamma = \Lambda X : XP$.^a Therefore the ratio $\Lambda X : XP$ is given. And in the

methods, the solution must be admitted a veritable *tour de force*. It is strictly analogous to the modern method of solving a cubic equation, but the concept of a cubic equation did not, of course, come within the purview of the ancient mathematicians.

^a Since they have the same base.

GREEK MATHEMATICS

τερον διὰ τῆς κατασκευῆς, ὡς ἡ $\Lambda\Delta$ πρὸς $\text{Κ}\Delta$, ἡ $\text{Κ}\text{Β}$ πρὸς $\text{Β}\text{Ρ}$ καὶ ἡ $\Delta\text{Χ}$ πρὸς $\text{Χ}\text{Β}$. καὶ ἐπεὶ ἐστίν, ὡς ἡ $\text{Ρ}\text{Β}$ πρὸς $\text{Β}\text{Κ}$, ἡ $\text{Κ}\Delta$ πρὸς $\Lambda\Delta$, συνθέντι, ὡς ἡ $\text{Ρ}\text{Κ}$ πρὸς $\text{Κ}\text{Β}$, τουτέστι πρὸς $\text{Κ}\Delta$, οὕτως ἡ $\text{Κ}\Lambda$ πρὸς $\Lambda\Delta$. καὶ ὅλη ἄρα ἡ $\text{Ρ}\Lambda$ πρὸς ὅλην τὴν $\text{Κ}\Lambda$ ἐστίν, ὡς ἡ $\text{Κ}\Lambda$ πρὸς $\Lambda\Delta$. ἴσον ἄρα τὸ ὑπὸ τῶν $\text{Ρ}\Lambda\Delta$ τῶ ἀπὸ $\Lambda\text{Κ}$. ὡς ἄρα ἡ $\text{Ρ}\Lambda$ πρὸς $\Lambda\Delta$, τὸ ἀπὸ $\text{Κ}\Lambda$ πρὸς τὸ ἀπὸ $\Lambda\Delta$. καὶ ἐπεὶ ἐστίν, ὡς ἡ $\Lambda\Delta$ πρὸς $\Delta\text{Κ}$, οὕτως ἡ $\Delta\text{Χ}$ πρὸς $\text{Χ}\text{Β}$, ἔσται ἀνάπαλιν καὶ συνθέντι, ὡς ἡ $\text{Κ}\Lambda$ πρὸς $\Lambda\Delta$, οὕτως ἡ $\text{Β}\Delta$ πρὸς $\Delta\text{Χ}$ [καὶ ὡς ἄρα τὸ ἀπὸ $\text{Κ}\Lambda$ πρὸς τὸ ἀπὸ $\Lambda\Delta$, οὕτως τὸ ἀπὸ $\text{Β}\Delta$ πρὸς τὸ ἀπὸ $\Delta\text{Χ}$. πάλιν, ἐπεὶ ἐστίν, ὡς ἡ $\Lambda\text{Χ}$ πρὸς $\Delta\text{Χ}$, συναμφοότερος ἡ $\text{Κ}\text{Β}$, $\text{Β}\text{Χ}$ πρὸς $\text{Β}\text{Χ}$, διελόντι, ὡς ἡ $\Lambda\Delta$ πρὸς $\Delta\text{Χ}$, οὕτως ἡ $\text{Κ}\text{Β}$ πρὸς $\text{Β}\text{Χ}$].¹ καὶ κείσθω τῇ $\text{Κ}\text{Β}$ ἴση ἡ $\text{Β}\text{Ζ}$. ὅτι γὰρ ἐκτὸς τοῦ Ρ πεσεῖται, δῆλον [καὶ ἐστίν, ὡς ἡ $\Lambda\Delta$ πρὸς $\Delta\text{Χ}$, οὕτως ἡ $\text{Ζ}\text{Β}$ πρὸς $\text{Β}\text{Χ}$. ὥστε καί, ὡς ἡ $\Delta\Lambda$ πρὸς $\Lambda\text{Χ}$, ἡ $\text{Β}\text{Ζ}$ πρὸς $\text{Ζ}\text{Χ}$].² ἐπεὶ δὲ λόγος ἐστὶ τῆς $\Delta\Lambda$ πρὸς $\Lambda\text{Χ}$ δοθείς, καὶ τῆς $\text{Ρ}\Lambda$ ἄρα πρὸς $\Lambda\text{Χ}$ λόγος ἐστὶ

¹ καὶ . . . πρὸς $\text{Β}\text{Χ}$. The words καὶ . . . ἀπὸ $\Delta\text{Χ}$ are shown by Eutocius's comment to be an interpolation. The words πάλιν . . . πρὸς $\text{Β}\text{Χ}$ and καὶ . . . πρὸς $\text{Ζ}\text{Χ}$ must also be interpolated, as, in order to prove that $\Delta\Lambda : \Lambda\text{Χ}$ is given, Eutocius first proves that $\text{Β}\text{Ζ} : \text{Ζ}\text{Χ} = \Delta\Lambda : \Lambda\text{Χ}$, which he would hardly have done if Archimedes had himself provided the proof.

² καὶ . . . πρὸς $\text{Ζ}\text{Χ}$; v. preceding note.

* This is proved by Eutocius thus :

Since	$\text{Κ}\Delta + \Delta\text{Χ} : \Delta\text{Χ} = \text{Ρ}\text{Χ} : \text{Χ}\text{Β}$,
<i>dirimendo</i> ,	$\text{Κ}\Delta : \Delta\text{Χ} = \text{Ρ}\text{Β} : \text{Β}\text{Χ}$,
and <i>permutando</i> ,	$\text{Κ}\Delta : \text{Β}\text{Ρ} = \Delta\text{Χ} : \text{Χ}\text{Β}$,
<i>i.e.</i> ,	$\text{Κ}\text{Β} : \text{Β}\text{Ρ} = \Delta\text{Χ} : \text{Χ}\text{Β}$.
Again, since	$\text{Κ}\text{Β} + \text{Β}\text{Χ} : \text{Χ}\text{Β} = \Lambda\text{Χ} : \text{Χ}\Delta$,

ARCHIMEDES

same way as in a previous proposition [Prop. 2], by construction,

$$\Lambda\Delta : K\Delta = KB : BP = \Delta X : XB.^a$$

And since $PB : BK = K\Delta : \Lambda\Delta$, [Eucl. v. 7, coroll.

componendo, $PK : KB = K\Lambda : \Lambda\Delta$, [Eucl. v. 18

i.e., $PK : K\Delta = K\Lambda : \Lambda\Delta$.

\therefore $P\Lambda : K\Lambda = K\Lambda : \Lambda\Delta$. [Eucl. v. 12

\therefore $P\Lambda \cdot \Lambda\Delta = \Lambda K^2$. [Eucl. vi. 17

\therefore $P\Lambda : \Lambda\Delta = K\Lambda^2 : \Lambda\Delta^2$.

And since $\Lambda\Delta : \Delta K = \Delta X : XB$,

invertendo et componendo, $K\Lambda : \Lambda\Delta = B\Delta : \Delta X$. [Eucl. v. 7, coroll. and v. 18

Let BZ be placed equal to KB. It is plain that [Z] will fall beyond P.^b Since the ratio $\Delta\Lambda : \Lambda X$ is given, therefore the ratio $P\Lambda : \Lambda X$ is given.^c Then,

dirimendo et permutando $\Delta X : XB = \Lambda\Delta : \Delta K$.

Now $\Delta X : XB = KB : BP$.

Therefore $\Lambda\Delta : \Delta K = \Delta X : XB = KB : BP$.

^b Since $X\Delta : XB = KB : BP$, and $\Delta X > XB$, $\therefore KB > BP$.
 $\therefore BZ > BP$.

^c As Eutocius's note shows, what Archimedes wrote was: "Since the ratio $\Delta\Lambda : \Lambda X$ is given, and the ratio $P\Lambda : \Lambda X$, therefore the ratio $P\Lambda : \Lambda\Delta$ is also given." Eutocius's proof is:

Since $KB + BX : BX = \Lambda X : X\Delta$,

$\therefore ZX : XB = \Lambda X : X\Delta$;

$\therefore XZ : ZB = X\Lambda : \Lambda\Delta$;

$\therefore BZ : ZX = \Lambda\Delta : \Lambda X$.

But the ratio $BZ : ZX$ is given because ZB is equal to the radius of the given sphere and BX is given. Therefore $\Lambda\Delta : \Lambda X$ is given.

Again, since the ratio of the segments is given, the ratio of

GREEK MATHEMATICS

δοθείς. ἐπεὶ οὖν ὁ τῆς ΡΛ πρὸς ΛΧ λόγος συν-
 ἤπται ἔκ τε τοῦ, ὃν ἔχει ἡ ΡΛ πρὸς ΛΔ, καὶ ἡ
 ΔΛ πρὸς ΛΧ, ἀλλ' ὡς μὲν ἡ ΡΛ πρὸς ΛΔ, τὸ
 ἀπὸ ΔΒ πρὸς τὸ ἀπὸ ΔΧ, ὡς δὲ ἡ ΔΛ πρὸς ΛΧ,
 οὕτως ἡ ΒΖ πρὸς ΖΧ, ὁ ἄρα τῆς ΡΛ πρὸς ΛΧ
 λόγος συνῆπται ἔκ τε τοῦ, ὃν ἔχει τὸ ἀπὸ ΒΔ
 πρὸς τὸ ἀπὸ ΔΧ, καὶ ἡ ΒΖ πρὸς ΖΧ. πεποιήσθω
 δέ, ὡς ἡ ΡΛ πρὸς ΛΧ, ἡ ΒΖ πρὸς ΖΘ. λόγος δὲ
 τῆς ΡΛ πρὸς ΛΧ δοθείς. λόγος ἄρα καὶ τῆς ΖΒ
 πρὸς ΖΘ δοθείς. δοθείσα δὲ ἡ ΒΖ—ἴση γάρ ἐστι
 τῇ ἐκ τοῦ κέντρον· δοθείσα ἄρα καὶ ἡ ΖΘ. καὶ
 ὁ τῆς ΒΖ ἄρα λόγος πρὸς ΖΘ συνῆπται ἔκ τε τοῦ,
 ὃν ἔχει τὸ ἀπὸ ΒΔ πρὸς τὸ ἀπὸ ΔΧ, καὶ ἡ ΒΖ
 πρὸς ΖΧ. ἀλλ' ὁ ΒΖ πρὸς ΖΘ λόγος συνῆπται
 ἔκ τε τοῦ τῆς ΒΖ πρὸς ΖΧ καὶ τοῦ τῆς ΖΧ πρὸς
 ΖΘ [κοινὸς ἀφηρήσθω ὁ τῆς ΒΖ πρὸς ΖΧ]¹.
 λοιπὸν ἄρα ἐστίν, ὡς τὸ ἀπὸ ΒΔ, τουτέστι δοθέν,
 πρὸς τὸ ἀπὸ ΔΧ, οὕτως ἡ ΧΖ πρὸς ΖΘ, τουτέστι
 πρὸς δοθέν. καὶ ἐστὶν δοθείσα ἡ ΖΔ εὐθεῖα·
 εὐθείαν ἄρα δοθείσαν τὴν ΔΖ τεμεῖν δεῖ κατὰ τὸ
 Χ καὶ ποιεῖν, ὡς τὴν ΧΖ πρὸς δοθείσαν [τὴν ΖΘ],²
 οὕτως τὸ δοθέν [τὸ ἀπὸ ΒΔ]² πρὸς τὸ ἀπὸ ΔΧ.
 τοῦτο οὕτως ἀπλῶς μὲν λεγόμενον ἔχει διορισμόν,

¹ κοινὸς . . . πρὸς ΖΧ. Eutocius's comment shows that these words are interpolated.

² τὴν ΖΘ, τὸ ἀπὸ ΒΔ. Eutocius's comments show these words to be glosses.

the cones ΛΑΓ, ΑΡΓ is also given, and therefore the ratio ΛΧ : ΧΡ. Therefore the ratio ΡΛ : ΛΧ is given. Since the ratios ΡΛ : ΛΧ and ΛΔ : ΛΧ are given, it follows that the ratio ΡΛ : ΛΔ is given.

ARCHIMEDES

since the ratio $P\Lambda : \Lambda X$ is composed of the ratios $P\Lambda : \Lambda\Delta$ and $\Delta\Lambda : \Lambda X$,

and since $P\Lambda : \Lambda\Delta = \Delta B^2 : \Delta X^2$,^a

$$\Delta\Lambda : \Lambda X = BZ : ZX,$$

therefore the ratio $P\Lambda : \Lambda X$ is composed of the ratios $\Delta B^2 : \Delta X^2$ and $BZ : ZX$. Let $[\Theta$ be chosen so that]

$$P\Lambda : \Lambda X = BZ : Z\Theta.$$

Now the ratio $P\Lambda : \Lambda X$ is given; therefore the ratio $ZB : Z\Theta$ is given. Now BZ is given—for it is equal to the radius; therefore $Z\Theta$ is also given. Therefore ^b the ratio $BZ : Z\Theta$ is composed of the ratios $\Delta B^2 : \Delta X^2$ and $BZ : ZX$. But the ratio $BZ : Z\Theta$ is composed of the ratios $BZ : ZX$ and $ZX : Z\Theta$. Therefore, the remainder ^c $\Delta B^2 : \Delta X^2 = XZ : Z\Theta$, in which ΔB^2 and $Z\Theta$ are given. And the straight line $Z\Delta$ is given; therefore *it is required so to cut the given straight line ΔZ at X that XZ bears to a given straight line the same ratio as a given area bears to the square on ΔX .* When the problem is stated in this general form,^d it is necessary to investigate the limits of possibility,

• For
$$P\Lambda : \Lambda\Delta = \Lambda K^2 : \Delta\Lambda^2$$

$$= \Delta B^2 : \Delta X^2.$$

^b “Therefore” refers to the last equation.

^c *i.e.* the remainder in the process given fully by Eutocius as follows:

$$(\Delta B^2 : \Delta X^2) \cdot (BZ : ZX) = BZ : \Theta Z = (BZ : ZX) \cdot (XZ : Z\Theta).$$

Removing the common element $BZ : ZX$ from the extreme terms, we find that the remainder $\Delta B^2 : \Delta X^2 = XZ : Z\Theta$.

^d In algebraic notation, if $\Delta X = x$ and $\Delta Z = a$, while the given straight line is b and the given area is c^2 , then

$$\frac{a-x}{b} = \frac{c^2}{x^2},$$

or

$$x^2(a-x) = bc^2.$$

GREEK MATHEMATICS

προστιθεμένων δὲ τῶν προβλημάτων τῶν ἐνθάδε ὑπαρχόντων [τουτέστι τοῦ τε διπλασίαν εἶναι τὴν ΔB τῆς BZ καὶ τοῦ μείζονα τῆς $Z\Theta$ τὴν ZB , ὡς κατὰ τὴν ἀνάλυσιν]¹ οὐκ ἔχει διορισμόν· καὶ ἔσται τὸ πρόβλημα τοιοῦτον· δύο δοθεισῶν εὐθειῶν τῶν $B\Delta$, BZ καὶ διπλασίας οὔσης τῆς $B\Delta$ τῆς BZ καὶ σημείου ἐπὶ τῆς BZ τοῦ Θ τεμῆν τὴν ΔB κατὰ τὸ X καὶ ποιεῖν, ὡς τὸ ἀπὸ $B\Delta$ πρὸς τὸ ἀπὸ ΔX , τὴν XZ πρὸς $Z\Theta$. ἐκάτερα δὲ ταῦτα ἐπὶ τέλει ἀναλυθήσεται τε καὶ συντεθήσεται.

Eutoc. *Comm. in Archim. De Sphaera et Cyl.* ii., Archim. ed. Heiberg iii. 130. 17–150. 22

Ἐπὶ τέλει μὲν τὸ προρηθὲν ἐπηγγείλατο δεῖξαι, ἐν οὐδενὶ δὲ τῶν ἀντιγράφων εὐρεῖν ἔνεστι τὸ ἐπάγγελμα. ὅθεν καὶ Διονυσόδωρον μὲν εὐρίσκομεν μὴ τῶν αὐτῶν ἐπιτυχόντα, ἀδυνατήσαντα δὲ ἐπιβαλεῖν τῷ καταλειφθέντι λήμματι, ἐφ' ἑτέραν ὁδὸν τοῦ ὅλου προβλήματος ἐλθεῖν, ἦντινα ἐξῆς γράψομεν· Διοκλῆς μέντοι καὶ αὐτὸς ἐν τῷ Περὶ πυρίων αὐτῷ συγγεγραμμένῳ βιβλίῳ ἐπηγγέλλαι νομίζων τὸν Ἀρχιμήδη, μὴ πεποιηκέναι δὲ τὸ ἐπάγγελμα, αὐτὸς ἀναπληροῦν ἐπεχείρησεν, καὶ τὸ ἐπιχείρημα ἐξῆς γράψομεν· ἔστιν γὰρ καὶ αὐτὸ οὐδένα μὲν ἔχον πρὸς τὰ παραλελειμμένα λόγον, ὁμοίως δὲ τῷ Διονυσόδωρῳ δι' ἑτέρας ἀποδείξεως κατασκευάζον τὸ πρόβλημα. ἔν τινι μέντοι παλαιῷ

¹ τουτέστι . . . ἀνάλυσιν. Eutocius's notes make it seem likely that these words are interpolated.

ARCHIMEDES

but under the conditions of the present case no such investigation is necessary.^a In the present case the problem will be of this nature: *Given two straight lines* $B\Delta$, BZ , *in which* $B\Delta = 2BZ$, *and a point* Θ *upon* BZ , *so to cut* ΔB *at* X *that*

$$B\Delta^2 : \Delta X^2 = XZ : Z\Theta ;$$

and the analysis and synthesis of both problems will be given at the end.^b

Eutocius, Commentary on Archimedes' Sphere and Cylinder ii., Archim. ed. Heiberg iii. 130. 17-150. 22

He promised that he would give at the end a proof of what is stated, but the fulfilment of the promise cannot be found in any of his extant writings. Dionysodorus also failed to light on it, and, being unable to tackle the omitted lemma, he approached the whole problem in an altogether different way, which I shall describe in due course. Diocles, indeed, in his work *On Burning Mirrors* maintained that Archimedes made the promise but had not fulfilled it, and he undertook to supply the omission himself, which attempt I shall also describe in its turn; it bears, however, no relation to the missing discussion, but, like that of Dionysodorus, it solves the problem by a construction reached by a different proof. But

general problem requires a *diorismos*, for which *v. vol. i. p. 151 n. h* and *p. 396 n. a*. In algebraic notation, there must be limiting conditions if the equation

$$x^2(a-x) = bc^2$$

is to have a real root lying between 0 and a .

^b Having made this promise, Archimedes proceeded to give the formal synthesis of the problem which he had thus reduced.

βιβλίῳ—οὐδὲ γὰρ τῆς εἰς πολλὰ ζητήσεως ἀπέστη-
 μεν—ἐντετύχαμεν θεωρήμασι γεγραμμένοις οὐκ
 ὀλίγην μὲν τὴν ἐκ τῶν παισμάτων ἔχουσι
 ἀσάφειαν περί τε τὰς καταγραφὰς πολυτρόπως
 ἡμαρτημένοις, τῶν μέντοι ζητουμένων εἶχον τὴν
 ὑπόστασιν, ἐν μέρει δὲ τὴν Ἀρχιμήδει φίλην
 Δωρίδα γλῶσσαν ἀπέσωζον καὶ τοῖς συνήθεσι τῷ
 ἀρχαίῳ τῶν πραγμάτων ὀνόμασιν ἐγγράπτο τῆς
 μὲν παραβολῆς ὀρθογωνίου κώνου τομῆς ὀνομαζο-
 μένης, τῆς δὲ ὑπερβολῆς ἀμβλυγωνίου κώνου
 τομῆς, ὡς ἐξ αὐτῶν διανοεῖσθαι, μὴ ἄρα καὶ αὐτὰ
 εἶη τὰ ἐν τῷ τέλει ἐπηγγελμένα γράφεσθαι. ὅθεν
 σπουδαιότερον ἐντυγχάνοντες αὐτὸ μὲν τὸ ῥητόν,
 ὡς γέγραπται, διὰ πλῆθος, ὡς εἴρηται, τῶν παι-
 σμάτων δυσχερὲς εὐρόντες τὰς ἐννοίας κατὰ μικρὸν
 ἀποσυλήσαντες κοινοτέρα καὶ σαφεστέρα κατὰ τὸ
 δυνατὸν λέξει γράφομεν. καθόλου δὲ πρῶτον τὸ
 θεώρημα γραφήσεται, ἵνα τὸ λεγόμενον ὑπ' αὐτοῦ
 σαφηνισθῆ περι τῶν διορισμῶν· εἶτα καὶ τοῖς
 ἀναλελυμένοις ἐν τῷ προβλήματι προσαρμοσθή-
 σεται.

“Εὐθείας δοθείσης τῆς AB καὶ ἐτέρας τῆς AG
 καὶ χωρίου τοῦ Δ προκείσθω λαβεῖν ἐπὶ τῆς AB
 σημεῖον ὡς τὸ E , ὥστε εἶναι, ὡς τὴν AE πρὸς
 AG , οὕτω τὸ Δ χωρίον πρὸς τὸ ἀπὸ EB .

“Γεγονέτω, καὶ κείσθω ἡ AG πρὸς ὀρθὰς τῇ
 AB , καὶ ἐπιζευχθεῖσα ἡ GE διήχθω ἐπὶ τὸ Z , καὶ
 ἤχθω διὰ τοῦ Γ τῇ AB παράλληλος ἡ GH , διὰ
 δὲ τοῦ B τῇ AG παράλληλος ἡ ZBH συμπίπτουσα

ARCHIMEDES

in a certain ancient book—for I pursued the inquiry thoroughly—I came upon some theorems which, though far from clear owing to errors and to manifold faults in the diagrams, nevertheless gave the substance of what I sought, and furthermore preserved in part the Doric dialect beloved by Archimedes, while they kept the names favoured by ancient custom, the parabola being called a section of a right-angled cone and the hyperbola a section of an obtuse-angled cone; in short, I felt bound to consider whether these theorems might not be what he had promised to give at the end. For this reason I applied myself with closer attention, and, although it was difficult to get at the true text owing to the multitude of the mistakes already mentioned, gradually I routed out the meaning and now set it out, so far as I can, in more familiar and clearer language. In the first place the theorem will be treated generally, in order to make clear what he says about the limits of possibility; then will follow the special form it takes under the conditions of his analysis of the problem.

“ Given a straight line AB and another straight line $A\Gamma$ and an area Δ , let it be required to find a point E on AB such that $AE : A\Gamma = \Delta : EB^2$.

“ Suppose it found, and let $A\Gamma$ be at right angles to AB , and let ΓE be joined and produced to Z , and through Γ let ΓH be drawn parallel to AB , and through B let ZBH be drawn parallel to $A\Gamma$, meeting

GREEK MATHEMATICS

έκατέρα τῶν ΓΕ, ΓΗ, καὶ συμπληρώσθω τὸ ΗΘ παραλληλόγραμμον, καὶ, διὰ τοῦ Ε ὁποτέρᾳ τῶν ΓΘ, ΗΖ παράλληλος ἦχθω ἡ ΚΕΛ, καὶ τῷ Δ ἴσον ἔστω τὸ ὑπὸ ΓΗΜ.

“ Ἐπεὶ οὖν ἐστίν, ὡς ἡ ΕΑ πρὸς ΑΓ, οὕτως τὸ Δ πρὸς τὸ ἀπὸ ΕΒ, ὡς δὲ ἡ ΕΑ πρὸς ΑΓ; οὕτως ἡ ΓΗ πρὸς ΗΖ, ὡς δὲ ἡ ΓΗ πρὸς ΗΖ, οὕτως τὸ ἀπὸ ΓΗ πρὸς τὸ ὑπὸ ΓΗΖ, ὡς ἄρα τὸ ἀπὸ ΓΗ πρὸς τὸ ὑπὸ ΓΗΖ, οὕτως τὸ Δ πρὸς τὸ ἀπὸ ΕΒ, τουτέστι πρὸς τὸ ἀπὸ ΚΖ· καὶ ἐναλλάξ, ὡς τὸ ἀπὸ ΓΗ πρὸς τὸ Δ, τουτέστι πρὸς τὸ ὑπὸ ΓΗΜ, οὕτως τὸ ὑπὸ ΓΗΖ πρὸς τὸ ἀπὸ ΖΚ. ἀλλ’ ὡς τὸ ἀπὸ ΓΗ πρὸς τὸ ὑπὸ ΓΗΜ, οὕτως ἡ ΓΗ πρὸς ΗΜ· καὶ ὡς ἄρα ἡ ΓΗ πρὸς ΗΜ, οὕτως τὸ ὑπὸ ΓΗΖ πρὸς τὸ ἀπὸ ΖΚ. ἀλλ’ ὡς ἡ ΓΗ πρὸς ΗΜ, τῆς ΗΖ κοινοῦ ὕψους λαμβανομένης οὕτως τὸ ὑπὸ ΓΗΖ πρὸς τὸ ὑπὸ ΜΗΖ· ὡς ἄρα τὸ ὑπὸ ΓΗΖ πρὸς τὸ ὑπὸ ΜΗΖ, οὕτως τὸ ὑπὸ ΓΗΖ πρὸς τὸ ἀπὸ ΖΚ· ἴσον ἄρα τὸ ὑπὸ ΜΗΖ τῷ ἀπὸ ΖΚ. εἰ ἄρα περὶ ἄξονα τὴν ΖΗ

ARCHIMEDES

both ΓE and ΓH , and let the parallelogram $H\Theta$ be completed, and through E let $K\epsilon A$ be drawn parallel

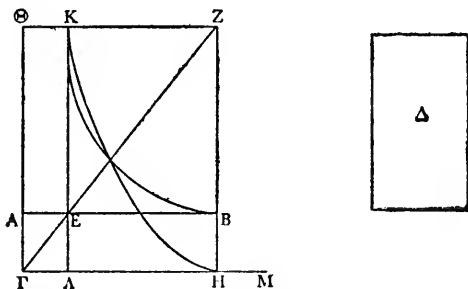

to either $\Gamma\Theta$ or HZ , and let [M be taken so that]

$$\Gamma H \cdot HM = \Delta.$$

“ Then, since $EA : A\Gamma = \Delta : EB^2$ [*ex hyp.*

and $EA : A\Gamma = \Gamma H : HZ$,

and $\Gamma H : HZ = \Gamma H^2 : \Gamma H \cdot HZ$,

$$\begin{aligned} \therefore \Gamma H^2 : \Gamma H \cdot HZ &= \Delta : EB^2 \\ &= \Delta : KZ^2; \end{aligned}$$

and, *permutando*, $\Gamma H^2 : \Delta$ [$= \Gamma H \cdot HZ : ZK^2$],

i.e., $\Gamma H^2 : \Gamma H \cdot HM = \Gamma H \cdot HZ : ZK^2$.

But $\Gamma H^2 : \Gamma H \cdot HM = \Gamma H : HM$;

$$\therefore \Gamma H : HM = \Gamma H \cdot HZ : ZK^2.$$

But, by taking a common altitude HZ ,

$$\Gamma H : HM = \Gamma H \cdot HZ : MH \cdot HZ;$$

$$\therefore \Gamma H \cdot HZ : MH \cdot HZ = \Gamma H \cdot HZ : ZK^2;$$

$$\therefore MH \cdot HZ = ZK^2.$$

GREEK MATHEMATICS

γραφῆ δια τοῦ Η παραβολή, ὥστε τὰς καταγο-
 μένας δύνασθαι παρὰ τὴν ΗΜ, ἤξει δια τοῦ Κ,
 καὶ ἔσται θέσει δεδομένη δια τὸ δεδομένην εἶναι
 τὴν ΗΜ τῷ μεγέθει περιέχουσαν μετὰ τῆς ΗΓ
 δεδομένης δοθὲν τὸ Δ· τὸ ἄρα Κ ἄπτεται θέσει
 δεδομένης παραβολῆς. γεγράφθω οὖν, ὡς εἴρηται,
 καὶ ἔστω ὡς ἡ ΗΚ.

“ Πάλιν, ἐπειδὴ τὸ ΘΛ χωρίον ἴσον ἐστὶ τῷ
 ΓΒ, τουτέστι τὸ ὑπὸ ΘΚΛ τῷ ὑπὸ ΑΒΗ, εἰάν
 δια τοῦ Β περιῶ ἀσυμπτώτους τὰς ΘΓ, ΓΗ γραφῆ
 ὑπερβολή, ἤξει δια τοῦ Κ δια τὴν ἀντιστροφὴν
 τοῦ ἡ' θεωρήματος τοῦ δευτέρου βιβλίου τῶν
 Ἀπολλωνίου Κωνικῶν στοιχείων, καὶ ἔσται θέσει
 δεδομένη δια τὸ καὶ ἑκατέραν τῶν ΘΓ, ΓΗ, ἔτι
 μὴν καὶ τὸ Β τῇ θέσει δεδόσθαι. γεγράφθω, ὡς
 εἴρηται, καὶ ἔστω ὡς ἡ ΚΒ· τὸ ἄρα Κ ἄπτεται
 θέσει δεδομένης ὑπερβολῆς. ἦπτετο δὲ καὶ θέσει
 δεδομένης παραβολῆς· δέδοται ἄρα τὸ Κ. καὶ
 ἐστὶν ἀπ' αὐτοῦ κάθετος ἡ ΚΕ ἐπὶ θέσει δεδομένην
 τὴν ΑΒ· δέδοται ἄρα τὸ Ε. ἐπεὶ οὖν ἐστὶν, ὡς
 ἡ ΕΑ πρὸς τὴν δοθείσαν τὴν ΑΓ, οὕτως δοθὲν τὸ
 Δ πρὸς τὸ ἀπὸ ΕΒ, δύο στερεῶν, ὧν βάσεις τὸ
 ἀπὸ ΕΒ καὶ τὸ Δ, ὕψη δὲ αἱ ΕΑ, ΑΓ, ἀντιπεπόν-

* Let $AB = a$, $AG = b$, and $\Delta = GH$. $HM = c^2$, so that $HM = \frac{c^2}{a}$.
 Then if HG be taken as the axis of x and HZ as the axis of y ,
 the equation of the parabola is

$$x^2 = \frac{c^2}{a}y,$$

and the equation of the hyperbola is

$$(a - x)y = ab.$$

Their points of intersection give solutions of the equation

$$x^2(a - x) = bc^2,$$

ARCHIMEDES

If, therefore, a parabola be drawn through H about the axis ZH with the parameter HM, it will pass through K [Apoll. *Con.* i. 11, converse], and it will be given in position because HM is given in magnitude [Eucl. *Data* 57], comprehending with the given straight line HI the given area Δ ; therefore K lies on a parabola given in position. Let it then be drawn, as described, and let it be HK.

“ Again, since the area $\Theta\Lambda = \Gamma B$ [Eucl. i. 43

i.e., $\Theta K \cdot K\Lambda = AB \cdot BH$,

if a hyperbola be drawn through B having $\Theta\Gamma$, ΓH for asymptotes, it will pass through K by the converse to the eighth theorem of the second book of Apollonius's *Elements of Conics*, and it will be given in position because both the straight lines $\Theta\Gamma$, ΓH , and also the point B, are given in position. Let it be drawn, as described, and let it be KB; therefore K lies on a hyperbola given in position. But it lies also on a parabola given in position; therefore K is given.^a And KE is the perpendicular drawn from it to the straight line AB given in position; therefore E is given. Now since the ratio of EA to the given straight line $A\Gamma$ is equal to the ratio of the given area Δ to the square on EB, we have two solids, whose bases are the square on EB and Δ and whose altitudes are EA, $A\Gamma$, and the bases are inversely pro-

to which, as already noted, Archimedes had reduced his problem. (*N.B.*—The axis of x is for convenience taken in a direction contrary to that which is usual; with the usual conventions, we should get slightly different equations.)

GREEK MATHEMATICS

θασιν αἱ βάσεις τοῖς ὕψεσιν· ὥστε ἴσα ἐστὶ τὰ στερεά· τὸ ἄρα ἀπὸ EB ἐπὶ τὴν EA ἴσον ἐστὶ τῷ δοθέντι τῷ Δ ἐπὶ δοθείσαν τὴν ΓΑ. ἀλλὰ τὸ ἀπὸ BE ἐπὶ τὴν EA μέγιστόν ἐστι πάντων τῶν ὁμοίως λαμβανομένων ἐπὶ τῆς ΒΑ, ὅταν ἢ διπλασία ἢ BE τῆς EA, ὡς δειχθήσεται· δεῖ ἄρα τὸ δοθὲν ἐπὶ τὴν δοθείσαν μὴ μείζον εἶναι τοῦ ἀπὸ τῆς BE ἐπὶ τὴν EA.

“ Συντεθήσεται δὲ οὕτως· ἔστω ἡ μὲν δοθείσα εὐθεία ἡ AB, ἄλλη δέ τις δοθείσα ἡ AG, τὸ δὲ δοθὲν χωρίον τὸ Δ, καὶ δέον ἔστω τεμεῖν τὴν AB, ὥστε εἶναι, ὡς τὸ ἐν τμήμα πρὸς τὴν δοθείσαν τὴν AG, οὕτως τὸ δοθὲν τὸ Δ πρὸς τὸ ἀπὸ τοῦ λοιποῦ τμήματος.

“ Εἰλήφθω τῆς AB τρίτον μέρος ἡ AE· τὸ ἄρα Δ ἐπὶ τὴν AG ἤτοι μείζον ἐστὶ τοῦ ἀπὸ τῆς BE ἐπὶ τὴν EA ἢ ἴσον ἢ ἔλασσον.

“ Εἰ μὲν οὖν μείζον ἐστίν, οὐ συντεθήσεται, ὡς ἐν τῇ ἀναλύσει δέδεικται· εἰ δὲ ἴσον ἐστί, τὸ E σημεῖον ποιήσει τὸ πρόβλημα. ἴσων γὰρ ὄντων τῶν στερεῶν ἀντιπεπόνθασιν αἱ βάσεις τοῖς ὕψεσιν, καὶ ἐστίν, ὡς ἡ EA πρὸς AG, οὕτως τὸ Δ πρὸς τὸ ἀπὸ BE.

“ Εἰ δὲ ἔλασσόν ἐστὶ τὸ Δ ἐπὶ τὴν AG τοῦ ἀπὸ BE ἐπὶ τὴν EA, συντεθήσεται οὕτως· κείσθω ἡ AG πρὸς ὀρθὰς τῇ AB, καὶ διὰ τοῦ Γ τῇ AB παρ-

* In our algebraical notation, $x^2(a-x)$ is a maximum when $x = \frac{2}{3}a$. We can easily prove this by the calculus. For, by differentiating and equating to zero, we see that $x^2(a-x)$ has

ARCHIMEDES

portional to the altitudes ; therefore the solids are equal [Eucl. xi. 34] ; therefore

$$EB^2 \cdot EA = \Delta \cdot \Gamma A,$$

in which both Δ and ΓA are given. But, of all the figures similarly taken upon BA , $BE^2 \cdot BA$ is greatest when $BE = 2EA$,^a as will be proved ; it is therefore necessary that the product of the given area and the given straight line should not be greater than

$$BE^2 \cdot EA.$$
^b

“ The synthesis is as follows : Let AB be the given straight line,^c let $A\Gamma$ be any other given straight line, let Δ be the given area, and let it be required to cut AB so that the ratio of one segment to the given straight line $A\Gamma$ shall be equal to the ratio of the given area Δ to the square on the remaining segment.

“ Let AE be taken, the third part of AB ; then $\Delta \cdot A\Gamma$ is greater than, equal to or less than $BE^2 \cdot EA$.

“ If it is greater, no synthesis is possible, as was shown in the analysis ; if it is equal, the point E satisfies the conditions of the problem. For in equal solids the bases are inversely proportional to the altitudes, and $EA : A\Gamma = \Delta : BE^2$.

“ If $\Delta \cdot A\Gamma$ is less than $BE^2 \cdot EA$, the synthesis is thus accomplished : let $A\Gamma$ be placed at right angles to AB , and through Γ let ΓZ be drawn parallel to

a stationary value when $2ax - 3x^2 = 0$, *i.e.*, when $x = 0$ (which gives a minimum value) or $x = \frac{2}{3}a$ (which gives a maximum). No such easy course was open to Archimedes.

^a Sc. “ not greater than $BE^2 \cdot EA$ when $BE = 2EA$.”

^b Figure on p. 146.

GREEK MATHEMATICS

άλληλος ἤχθω ἢ ΓΖ, διὰ δὲ τοῦ Β τῆ ΑΓ παράλληλος ἤχθω ἢ ΒΖ καὶ συμπιπέτω τῆ ΓΕ ἐκβληθείση κατὰ τὸ Η, καὶ συμπεπληρώσθω τὸ ΖΘ παραλληλόγραμμον, καὶ διὰ τοῦ Ε τῆ ΖΗ παράλληλος ἤχθω ἢ ΚΕΛ. ἐπεὶ οὖν τὸ Δ ἐπὶ τὴν ΑΓ ἔλασσόν ἐστι τοῦ ἀπὸ ΒΕ ἐπὶ τὴν ΕΑ, ἔστιν, ὡς ἢ ΕΑ πρὸς ΑΓ, οὕτως τὸ Δ πρὸς ἔλασσόν τι τοῦ ἀπὸ τῆς ΒΕ, τουτέστι τοῦ ἀπὸ τῆς ΗΚ. ἔστω οὖν, ὡς ἢ ΕΑ πρὸς ΑΓ, οὕτως τὸ Δ πρὸς τὸ ἀπὸ ΗΜ, καὶ τῷ Δ ἴσον ἔστω τὸ ὑπὸ ΓΖΝ. ἐπεὶ οὖν ἐστιν, ὡς ἢ ΕΑ πρὸς ΑΓ, οὕτως τὸ Δ, τουτέστι τὸ ὑπὸ ΓΖΝ, πρὸς τὸ ἀπὸ ΗΜ, ἀλλ' ὡς ἢ ΕΑ πρὸς ΑΓ, οὕτως ἢ ΓΖ πρὸς ΖΗ, ὡς δὲ ἢ ΓΖ πρὸς ΖΗ, οὕτως τὸ ἀπὸ ΓΖ πρὸς τὸ ὑπὸ ΓΖΗ, καὶ ὡς ἄρα τὸ ἀπὸ ΓΖ πρὸς τὸ ὑπὸ ΓΖΗ, οὕτως τὸ ὑπὸ ΓΖΝ πρὸς τὸ ἀπὸ ΗΜ· καὶ ἐναλλάξ, ὡς τὸ ἀπὸ ΓΖ πρὸς τὸ ὑπὸ ΓΖΝ, οὕτως τὸ ὑπὸ ΓΖΗ πρὸς τὸ ἀπὸ ΗΜ. ἀλλ' ὡς τὸ ἀπὸ ΓΖ πρὸς τὸ ὑπὸ ΓΖΝ, ἢ ΓΖ πρὸς ΖΝ, ὡς δὲ ἢ ΓΖ πρὸς ΖΝ, τῆς ΖΗ κοινου ὕψους λαμβανομένης οὕτως τὸ ὑπὸ ΓΖΗ πρὸς τὸ ὑπὸ ΝΖΗ· καὶ ὡς ἄρα τὸ ὑπὸ ΓΖΗ πρὸς τὸ ὑπὸ ΝΖΗ, οὕτως τὸ ὑπὸ ΓΖΗ πρὸς τὸ ἀπὸ ΗΜ· ἴσον ἄρα ἐστὶ τὸ ἀπὸ ΗΜ τῷ ὑπὸ ΗΖΝ.

“ Ἐὰν ἄρα διὰ τοῦ Ζ περὶ ἄξονα τὴν ΖΗ γράψωμεν παραβολὴν, ὥστε τὰς καταγομένας δύνασθαι παρὰ τὴν ΖΝ, ἤξει διὰ τοῦ Μ. γεγράφθω, καὶ ἔστω ὡς ἢ ΜΕΖ. καὶ ἐπεὶ ἴσον ἐστὶ τὸ ΘΛ τῷ ΑΖ, τουτέστι τὸ ὑπὸ ΘΚΛ τῷ ὑπὸ ΑΒΖ, ἐὰν διὰ

ARCHIMEDES

AB, and through B let BZ be drawn parallel to AΓ, and let it meet ΓE produced at H, and let the parallelogram ZΘ be completed, and through E let KEA be drawn parallel to ZH. Now

since $\Delta \cdot A\Gamma < BE^2 \cdot EA,$

$\therefore EA : A\Gamma = \Delta : (\text{the square of some quantity less than } BE)$
 $= \Delta : (\text{the square of some quantity less than } HK).$

Let $EA : A\Gamma = \Delta : HM^2,$

and let $\Delta = \Gamma Z \cdot ZN.$

Then $EA : A\Gamma = \Delta : HM^2$
 $= \Gamma Z \cdot ZN : HM^2.$

But $EA : A\Gamma = \Gamma Z : ZH,$

and $\Gamma Z : ZH = \Gamma Z^2 : \Gamma Z \cdot ZH ;$

$\therefore \Gamma Z^2 : \Gamma Z \cdot ZH = \Gamma Z \cdot ZN : HM^2 ;$

and *permutando*, $\Gamma Z^2 : \Gamma Z \cdot ZN = \Gamma Z \cdot ZH : HM^2.$

But $\Gamma Z^2 : \Gamma Z \cdot ZN = \Gamma Z : ZN,$

and $\Gamma Z : ZN = \Gamma Z \cdot ZH : NZ \cdot ZH,$

by taking a common altitude ZH ;

and $\therefore \Gamma Z \cdot ZH : NZ \cdot ZH = \Gamma Z \cdot ZH : HM^2 ;$

$\therefore HM^2 = HZ \cdot ZN.$

“ Therefore if we describe through Z a parabola about the axis ZH and with parameter ZN, it will pass through M. Let it be described, and let it be as MΞZ. Then since

$$\Theta\Lambda = AZ, \quad [\text{Eucl. i. 43}]$$

i.e. $\Theta K \cdot K\Lambda = AB \cdot BZ,$

GREEK MATHEMATICS

τοῦ Β περιὶ ἀσύμπτωτους τὰς ΘΓ, ΓΖ γράψωμεν ὑπερβολήν, ἥξει διὰ τοῦ Κ διὰ τὴν ἀντιστροφὴν

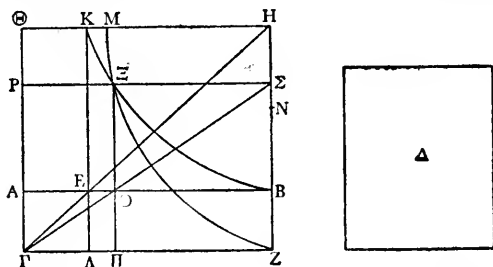

τοῦ ἡ' θεωρήματος τῶν Ἀπολλωνίου Κωνικῶν στοιχείων. γεγράφθω, καὶ ἔστω ὡς ἡ ΒΚ τέμνουσα τὴν παραβολὴν κατὰ τὸ Ε, καὶ ἀπὸ τοῦ Ε ἐπὶ τὴν ΑΒ κάθετος ἤχθω ἡ ΕΟΠ, καὶ διὰ τοῦ Ε τῇ ΑΒ παράλληλος ἤχθω ἡ ΡΞΣ. ἐπεὶ οὖν ὑπερβολὴ ἐστὶν ἡ ΒΕΚ, ἀσύμπτωτοι δὲ αἱ ΘΓ, ΓΖ, καὶ παράλληλοι ἡγμέναι εἰσὶν αἱ ΡΞΠ ταῖς ΑΒΖ, ἴσον ἐστὶ τὸ ὑπὸ ΡΞΠ τῷ ὑπὸ ΑΒΖ· ὥστε καὶ τὸ ΡΟ τῷ ΟΖ. εἰ ἄρα ἀπὸ τοῦ Γ ἐπὶ τὸ Σ ἐπιζευχθῆ εὐθεῖα, ἥξει διὰ τοῦ Ο. ἐρχέσθω, καὶ ἔστω ὡς ἡ ΓΟΣ. ἐπεὶ οὖν ἐστὶν, ὡς ἡ ΟΑ πρὸς ΑΓ, οὕτως ἡ ΟΒ πρὸς ΒΣ, τουτέστιν ἡ ΓΖ πρὸς ΖΣ, ὡς δὲ ἡ ΓΖ πρὸς ΖΣ, τῆς ΖΝ κοινῆ ὕψους λαμβανομένης οὕτως τὸ ὑπὸ ΓΖΝ πρὸς τὸ ὑπὸ ΣΖΝ, καὶ ὡς ἄρα ἡ ΟΑ πρὸς ΑΓ, οὕτως τὸ ὑπὸ ΓΖΝ πρὸς τὸ ὑπὸ ΣΖΝ. καὶ ἐστὶ τῷ μὲν ὑπὸ ΓΖΝ ἴσον τὸ Δ χωρίον, τῷ δὲ ὑπὸ ΣΖΝ ἴσον τὸ ἀπὸ ΣΕ, τουτέστι τὸ ἀπὸ ΒΟ, διὰ τὴν παραβολὴν· ὡς ἄρα ἡ ΟΑ πρὸς ΑΓ, οὕτως τὸ Δ

ARCHÍMEDES

if we describe through B a hyperbola in the asymptotes $\Theta\Gamma, \Gamma Z$, it will pass through K by the converse of the eighth theorem [of the second book] of Apollonius's *Elements of Conics*. Let it be described, and let it be as BK cutting the parabola in Ξ , and from Ξ let $\Xi O\Pi$ be drawn perpendicular to AB, and through Ξ let $P\Xi\Sigma$ be drawn parallel to AB. Then since B Ξ K is a hyperbola and $\Theta\Gamma, \Gamma Z$ are its asymptotes, while $P\Xi, \Xi\Pi$ are parallel to AB, BZ,

$$P\Xi \cdot \Xi\Pi = AB \cdot BZ; \quad [\text{Apoll. ii. 12}]$$

$$\therefore PO = OZ.$$

Therefore if a straight line be drawn from Γ to Σ it will pass through O [Eucl. i. 43, converse]. Let it be drawn, and let it be as $\Gamma O\Sigma$. Then since

$$\begin{aligned} OA : A\Gamma &= OB : B\Sigma && [\text{Eucl. vi. 4}] \\ &= \Gamma Z : Z\Sigma, \end{aligned}$$

$$\text{and} \quad \Gamma Z : Z\Sigma = \Gamma Z \cdot ZN : \Sigma Z \cdot ZN,$$

by taking a common altitude ZN,

$$\therefore OA : A\Gamma = \Gamma Z \cdot ZN : \Sigma Z \cdot ZN.$$

And $\Gamma Z \cdot ZN = \Delta$, $\Sigma Z \cdot ZN = \Sigma\Xi^2 = BO^2$, by the property of the parabola [Apoll. i. 11].

$$\therefore OA : A\Gamma = \Delta : BO^2;$$

χωρίον πρὸς τὸ ἀπὸ τῆς ΒΟ. εἴληπται ἄρα τὸ Ο σημεῖον ποιοῦν τὸ πρόβλημα.

“Ὅτι δὲ διπλασίας οὔσης τῆς ΒΕ τῆς ΕΑ τὸ ἀπὸ τῆς ΒΕ ἐπὶ τὴν ΕΑ μέγιστόν ἐστι πάντων τῶν ὁμοίως λαμβανομένων ἐπὶ τῆς ΒΑ, δειχθήσεται οὕτως. ἔστω γάρ, ὡς ἐν τῇ ἀναλύσει, πάλιν δοθεῖσα εὐθεῖα πρὸς ὀρθὰς τῇ ΑΒ ἢ ΑΓ, καὶ ἐπιζευχθεῖσα ἢ ΓΕ ἐκβεβλήσθω καὶ συμπιπτέτω τῇ διὰ τοῦ Β παραλλήλῳ ἡγμένη τῇ ΑΓ κατὰ τὸ Ζ, καὶ διὰ τῶν Γ, Ζ παράλληλοι τῇ ΑΒ ἤχθωσαν αἱ ΘΖ, ΓΗ, καὶ ἐκβεβλήσθω ἢ ΓΑ ἐπὶ τὸ Θ, καὶ ταύτη παράλληλος διὰ τοῦ Ε ἤχθω ἢ ΚΕΛ, καὶ γεγονέτω, ὡς ἢ ΕΑ πρὸς ΑΓ, οὕτως τὸ ὑπὸ ΓΗΜ πρὸς τὸ ἀπὸ ΕΒ· τὸ ἄρα ἀπὸ ΒΕ ἐπὶ τὴν ΕΑ ἴσον ἐστὶ τῷ ὑπὸ ΓΗΜ ἐπὶ τὴν ΑΓ διὰ τὸ δυὸ στερεῶν ἀντιπεπονθέναι τὰς βάσεις τοῖς ὕψεσιν. λέγω οὖν, ὅτι τὸ ὑπὸ ΓΗΜ ἐπὶ τὴν ΑΓ μέγιστόν ἐστι πάντων τῶν ὁμοίως ἐπὶ τῆς ΒΑ λαμβανομένων.

“Γεγράφθω γάρ διὰ τοῦ Η περι ἄξονα τὴν ΖΗ παραβολή, ὥστε τὰς καταγομένας δύνασθαι παρὰ τὴν ΗΜ· ἤξει δὴ διὰ τοῦ Κ, ὡς ἐν τῇ ἀναλύσει δέδεικται, καὶ συμπεσεῖται ἐκβαλλομένη τῇ ΘΓ παραλλήλῳ οὔση τῇ διαμέτρῳ τῆς τομῆς διὰ τὸ ἔβδομον καὶ εἰκοστὸν θεώρημα τοῦ πρώτου βιβλίου τῶν Ἀπολλωνίου Κωνικῶν στοιχείων. ἐκβεβλήσθω καὶ συμπιπτέτω κατὰ τὸ Ν, καὶ διὰ τοῦ Β περι ἀσυμπτώτους τὰς ΝΓΗ γεγράφθω ὑπερβολή· ἤξει ἄρα διὰ τοῦ Κ, ὡς ἐν τῇ ἀναλύσει εἴρηται. ἐρχέσθω οὖν ὡς ἢ ΒΚ, καὶ ἐκβληθείση τῇ ΖΗ ἴση κείσθω ἢ ΗΞ, καὶ ἐπεζεύχθω ἢ ΞΚ

ARCHIMEDES

therefore the point O has been found satisfying the conditions of the problem.

“ That $BE^2 \cdot EA$ is the greatest of all the figures similarly taken upon BA when $BE = 2EA$ will be thus proved. Let there again be, as in the analysis, a given straight line AI at right angles to AB ,^a and let IE be joined and let it, when produced, meet at Z the line through B drawn parallel to AI , and through I, Z let θZ , $I\Gamma$ be drawn parallel to AB , and let IA be produced to θ , and through E let KEA be drawn parallel to it, and let

$$EA : AI = I\Gamma \cdot HM : EB^2 ;$$

then $BE^2 \cdot EA = (\Gamma H \cdot HM) \cdot AI$,

owing to the fact that in two [equal] solids the bases are inversely proportional to the altitudes. I assert, then, that $(\Gamma H \cdot HM) \cdot AI$ is the greatest of all the figures similarly taken upon BA.

“ For let there be described through H a parabola about the axis ZH and with parameter HM ; it will pass through K, as was proved in the analysis, and, if produced, it will meet $\theta\Gamma$, being parallel to the axis^b of the parabola, by the twenty-seventh theorem of the first book of Apollonius's *Elements of Conics*.^c Let it be produced, and let it meet at N, and through B let a hyperbola be drawn in the asymptotes NI , $I\Gamma$; it will pass through K, as was shown in the analysis. Let it be described as BK, and let ZH be produced to Ξ so that $ZH = H\Xi$, and let ΞK be joined

^a Figure on p. 151.

^b Lit. “ diameter,” in accordance with Archimedes' usage.

^c Apoll. i. 26 in our texts.

GREEK MATHEMATICS

καὶ ἐκβεβλήσθω ἐπὶ τὸ Ο· φανερὸν ἄρα, ὅτι ἐφάπτεται τῆς παραβολῆς διὰ τὴν ἀντιστροφὴν τοῦ τετάρτου καὶ τριακοστοῦ θεωρήματος τοῦ πρώτου βιβλίου τῶν Ἀπολλωνίου Κωνικῶν στοιχείων. ἐπεὶ οὖν διπλῆ ἐστὶν ἡ ΒΕ τῆς ΕΑ—οὕτως γὰρ ὑπόκειται—τουτέστιν ἡ ΖΚ τῆς ΚΘ,

• Apoll. i. 33 in our texts.

GREEK MATHEMATICS

καὶ ἔστιν ὁμοιον τὸ ΟΘΚ τρίγωνον τῷ ΕΖΚ
 τριγώνῳ, διπλασία ἐστὶ καὶ ἡ ΕΚ τῆς ΚΟ. ἔστιν
 δὲ καὶ ἡ ΕΚ τῆς ΚΠ διπλῆ διὰ τὸ καὶ τὴν ΕΖ
 τῆς ΕΗ καὶ παράλληλον εἶναι τὴν ΠΗ τῇ ΚΖ.
 ἴση ἄρα ἡ ΟΚ τῇ ΚΠ. ἡ ἄρα ΟΚΠ ψαύουσα τῆς
 ὑπερβολῆς καὶ μεταξὺ οὔσα τῶν ἀσυμπτῶτων δίχα
 τέμνεται· ἐφάπτεται ἄρα τῆς ὑπερβολῆς διὰ τὴν
 ἀντιστροφὴν τοῦ τρίτου θεωρήματος τοῦ δευτέρου
 βιβλίου τῶν Ἀπολλωνίου Κωνικῶν στοιχείων.
 ἐφήπτετο δὲ καὶ τῆς παραβολῆς κατὰ τὸ αὐτὸ Κ.
 ἡ ἄρα παραβολὴ τῆς ὑπερβολῆς ἐφάπτεται κατὰ
 τὸ Κ.

“ Νενοήσθω οὖν καὶ ἡ ὑπερβολὴ προσεκβαλ-
 λομένη ὡς ἐπὶ τὸ Ρ, καὶ εἰλήφθω ἐπὶ τῆς ΑΒ
 τυχὸν σημεῖον τὸ Σ, καὶ διὰ τοῦ Σ τῇ ΚΛ παράλ-
 ληλος ἤχθω ἡ ΤΣΥ καὶ συμβαλλέτω τῇ ὑπερβολῇ
 κατὰ τὸ Τ, καὶ διὰ τοῦ Τ τῇ ΓΗ παράλληλος
 ἤχθω ἡ ΦΤΧ. ἐπεὶ οὖν διὰ τὴν ὑπερβολὴν καὶ
 τὰς ἀσυμπτῶτους ἴσον ἐστὶ τὸ ΦΥ τῷ ΓΒ, κοινού
 ἀφαιρεθέντος τοῦ ΓΣ ἴσον γίνεται τὸ ΦΣ τῷ ΣΗ,
 καὶ διὰ τοῦτο ἡ ἀπὸ τοῦ Γ ἐπὶ τὸ Χ ἐπιζευγνυ-
 μένη εὐθεῖα ἥξει διὰ τοῦ Σ. ἐρχέσθω καὶ ἔστω
 ὡς ἡ ΓΣΧ. καὶ ἐπεὶ τὸ ἀπὸ ΨΧ ἴσον ἐστὶ τῷ
 ὑπὸ ΧΗΜ διὰ τὴν παραβολὴν, τὸ ἀπὸ ΤΧ ἔλασσόν

^a In the same notation as before, the condition $BE^2 \cdot EA = (GH \cdot HM) \cdot AG$ is $\frac{4}{27}a^3 = bc^2$; and Archimedes has proved that, when this condition holds, the parabola $x^2 = \frac{c^2}{a}y$ touches the hyperbola $(a - x)y = ab$ at the point $(\frac{2}{3}a, 3b)$ because they both touch at this point the same straight line, that is the

ARCHIMEDES

$O\theta K$ is similar to the triangle ΞZK , so that $\Xi K = 2KO$. But $\Xi K = 2K\Pi$ because $\Xi Z = 2\Xi H$ and ΠH is parallel to KZ ; therefore $OK = K\Pi$. Therefore $OK\Pi$, which meets the hyperbola and lies between the asymptotes, is bisected; therefore, by the converse of the third theorem of the second book of Apollonius's *Elements of Conics*, it is a tangent to the hyperbola. But it touches the parabola at the same point K . Therefore the parabola touches the hyperbola at K .^a

“ Let the hyperbola be therefore conceived as produced to P , and upon AB let any point Σ be taken, and through Σ let $T\Sigma Y$ be drawn parallel to $K\Lambda$ and let it meet the hyperbola at T , and through T let ΦTX be drawn parallel to ΓH . Now by virtue of the property of the hyperbola and its asymptotes, $\Phi Y = \Gamma B$, and, the common element $\Gamma\Sigma$ being subtracted, $\Phi\Sigma = \Sigma H$, and therefore the straight line drawn from Γ to X will pass through Σ [Eucl. i. 43, conv.]. Let it be drawn, and let it be as $\Gamma\Sigma X$. Then since, in virtue of the property of the parabola,

$$\Psi X^2 = XH \cdot HM, \quad [\text{Apoll. i. 11}]$$

line $9bx - ay - 3ab = 0$, as may easily be shown. We may prove this fact in the following simple manner. Their points of intersection are given by the equation

$$x^2(a - x) = bc^2,$$

which may be written

$$x^3 - ax^2 + \frac{4}{27}a^3 = \frac{4}{27}a^3 - bc^2,$$

or
$$\left(x - \frac{2}{3}a\right)^2 \left(x + \frac{a}{3}\right) = \frac{4}{27}a^3 - bc^2.$$

Therefore, when $bc^2 = \frac{4}{27}a^3$ there are two coincident solutions, $x = \frac{2}{3}a$, lying between 0 and a , and a third solution

$x = -\frac{a}{3}$, outside that range.

ἔστι τοῦ ὑπὸ ΧΗΜ. γεγονέτω οὖν τῶ ἀπὸ ΤΧ ἴσον τὸ ὑπὸ ΧΗΩ. ἐπεὶ οὖν ἔστιν, ὡς ἡ ΣΑ πρὸς ΑΓ, οὕτως ἡ ΓΗ πρὸς ΗΧ, ἀλλ' ὡς ἡ ΓΗ πρὸς ΗΧ, τῆς ΗΩ κοινοῦ ὕψους λαμβανομένης οὕτως τὸ ὑπὸ ΓΗΩ πρὸς τὸ ὑπὸ ΧΗΩ καὶ πρὸς τὸ ἴσον αὐτῶ τὸ ἀπὸ ΧΤ, τουτέστι τὸ ἀπὸ ΒΣ, τὸ ἄρα ἀπὸ ΒΣ ἐπὶ τὴν ΣΑ ἴσον ἐστὶ τῶ ὑπὸ ΓΗΩ ἐπὶ τὴν ΓΑ. τὸ δὲ ὑπὸ ΓΗΩ ἐπὶ τὴν ΓΑ ἔλασσόν ἐστι τοῦ ὑπὸ ΓΗΜ ἐπὶ τὴν ΓΑ. τὸ ἄρα ἀπὸ ΒΣ ἐπὶ τὴν ΣΑ ἔλαττόν ἐστι τοῦ ἀπὸ ΒΕ ἐπὶ τὴν ΕΑ. ὁμοίως δὴ δειχθήσεται καὶ ἐπὶ πάντων τῶν σημείων τῶν μεταξὺ λαμβανομένων τῶν Ε, Β.

“ Ἄλλὰ δὴ εἰλήφθω μεταξὺ τῶν Ε, Α σημείων τὸ ζ . λέγω, ὅτι καὶ οὕτως τὸ ἀπὸ τῆς ΒΕ ἐπὶ τὴν ΕΑ μείζον ἐστὶ τοῦ ἀπὸ Β ζ ἐπὶ τὴν ζ Α.

“ Τῶν γὰρ αὐτῶν κατεσκευασμένων ἤχθω διὰ τοῦ ζ τῇ ΚΛ παράλληλος ἡ ζ Ρ καὶ συμβαλλέτω τῇ ὑπερβολῇ κατὰ τὸ Ρ. συμβαλεῖ γὰρ αὐτῇ διὰ τὸ παράλληλος εἶναι τῇ ἀσυμπτώτῳ· καὶ διὰ τοῦ Ρ παράλληλος ἀχθείσα τῇ ΑΒ ἢ Α'ΡΒ' συμβαλλέτω τῇ ΗΖ ἐκβαλλομένη κατὰ τὸ Β'. καὶ ἐπεὶ πάλιν διὰ τὴν ὑπερβολὴν ἴσον ἐστὶ τὸ Γ' ζ τῶ ΑΗ, ἡ ἀπὸ τοῦ Γ ἐπὶ τὸ Β' ἐπιζευγνυμένη εὐθεῖα ἤξει διὰ τοῦ ζ . ἐρχέσθω καὶ ἔστω ὡς ἡ Γ ζ Β'. καὶ ἐπεὶ πάλιν διὰ τὴν παραβολὴν ἴσον ἐστὶ τὸ ἀπὸ Α'Β' τῶ ὑπὸ Β'ΗΜ, τὸ ἄρα ἀπὸ ΡΒ' ἔλασσόν ἐστι τοῦ ὑπὸ Β'ΗΜ. γεγονέτω τὸ ἀπὸ ΡΒ' ἴσον τῶ ὑπὸ Β'ΗΩ. ἐπεὶ οὖν ἔστιν, ὡς ἡ ζ Α πρὸς ΑΓ, οὕτως ἡ ΓΗ πρὸς ΗΒ', ἀλλ' ὡς ἡ ΓΗ πρὸς ΗΒ', τῆς

^a Figure on p. 156.

ARCHIMEDES

$$\therefore TX^2 < XH \cdot HM.$$

$$\text{Let } TX^2 = XH \cdot H\Omega.$$

$$\text{Then since } \Sigma A : A\Gamma = \Gamma H : HX,$$

$$\text{while } \Gamma H : HX = \Gamma H \cdot H\Omega : XH \cdot H\Omega,$$

by taking a common altitude $H\Omega$,

$$= \Gamma H \cdot H\Omega : XT^2$$

$$= \Gamma H \cdot H\Omega : B\Sigma^2,$$

$$\therefore B\Sigma^2 \cdot \Sigma A = (\Gamma H \cdot H\Omega) \cdot \Gamma A.$$

$$\text{But } (\Gamma H \cdot H\Omega) \cdot \Gamma A < (\Gamma H \cdot HM) \cdot \Gamma A ;$$

$$\therefore B\Sigma^2 \cdot \Sigma A < BE^2 \cdot EA.$$

This can be proved similarly for all points taken between E, B .

“ Now let there be taken a point ζ between E, A . I assert that in this case also $BE^2 \cdot EA > B\zeta \cdot \zeta A$.

“ With the same construction, let $\zeta\sigma P$ be drawn ^a through ζ parallel to $K\Lambda$ and let it meet the hyperbola at P ; it will meet the hyperbola because it is parallel to an asymptote [Apoll. ii. 13]; and through P let $A'PB'$ be drawn parallel to AB and let it meet HZ produced in B' . Since, in virtue of the property of the hyperbola, $\Gamma'\zeta = AH$, the straight line drawn from Γ to B' will pass through ζ [Eucl. i. 43, conv.]. Let it be drawn and let it be as $\Gamma\zeta B'$. Again, since, in virtue of the property of the parabola,

$$A'B'^2 = B'H \cdot HM,$$

$$\therefore PB'^2 < B'H \cdot HM.$$

$$\text{Let } PB'^2 = B'H \cdot H\Omega.$$

$$\text{Then since } \zeta A : A\Gamma = \Gamma H : HB',$$

$$\text{while } \Gamma H : HB' = \Gamma H \cdot H\Omega : B'H \cdot H\Omega,$$

ARCHIMEDES

by taking a common altitude $H\Omega$,

$$= \Gamma H \cdot H\Omega : PB'^2$$

$$= \Gamma H \cdot H\Omega : B\zeta^2,$$

$$\therefore B\zeta^2 \cdot \zeta A = (\Gamma H \cdot H\Omega) \cdot \Gamma A.$$

And $\Gamma H \cdot HM > \Gamma H \cdot H\Omega$;

$$\therefore BE^2 \cdot EA > B\zeta^2 \cdot \zeta A.$$

τὴν $\epsilon\alpha$. ὁμοίως δὴ δειχθήσεται καὶ ἐπὶ πάντων τῶν σημείων τῶν μεταξύ τῶν E, A λαμβανομένων. ἐδείχθη δὲ καὶ ἐπὶ πάντων τῶν μεταξύ τῶν E, B πάντων ἄρα τῶν ἐπὶ τῆς AB ὁμοίως λαμβανομένων μέγιστόν ἐστιν τὸ ἀπὸ τῆς BE ἐπὶ τὴν EA , ὅταν ἢ διπλασία ἢ BE τῆς EA ."

Ἐπιστῆσαι δὲ χρῆ καὶ τοῖς ἀκολουθοῦσιν κατὰ τὴν εἰρημένην καταγραφὴν. ἐπεὶ γὰρ δέδεικται τὸ ἀπὸ $B\Sigma$ ἐπὶ τὴν ΣA καὶ τὸ ἀπὸ $B\epsilon$ ἐπὶ τὴν ϵA ἔλασσον τοῦ ἀπὸ BE ἐπὶ τὴν EA , δυνατόν ἐστι καὶ τοῦ δοθέντος χωρίου ἐπὶ τὴν δοθείσαν ἐλάσσονος ὄντος τοῦ ἀπὸ τῆς BE ἐπὶ τὴν EA κατὰ δύο σημεία τὴν AB τεμνομένην ποιεῖν τὸ ἐξ ἀρχῆς πρόβλημα. τοῦτο δὲ γίνεται, εἰ νοήσαιμεν περὶ διάμετρον τὴν XH γραφομένην παραβολὴν, ὥστε τὰς καταγομένας δύνασθαι παρὰ τὴν $H\Omega$. ἢ γὰρ τοιαύτη παραβολὴ πάντως ἔρχεται διὰ τοῦ T . καὶ ἐπειδὴ ἀνάγκη αὐτὴν συμπίπτειν τῇ ΓN παραλλήλῳ οὔσῃ τῇ διαμέτρῳ, δῆλον, ὅτι τέμνει τὴν ὑπερβολὴν καὶ κατ' ἄλλο σημεῖον ἀνωτέρω τοῦ K , ὡς ἐνταῦθα κατὰ τὸ P , καὶ ἀπὸ τοῦ P ἐπὶ τὴν AB κάθετος ἀγομένη, ὡς ἐνταῦθα ἢ $P\epsilon$, τέμνει τὴν AB κατὰ τὸ ϵ , ὥστε τὸ ϵ σημεῖον ποιεῖν τὸ πρό-

^a There is some uncertainty where the quotation from Archimedes ends and Eutocius's comments are resumed. Heiberg, with some reason, makes Eutocius resume his comments at this point.

^b In the mss. the figures on pp. 150 and 156 are com-

ARCHIMEDES

This can be proved similarly for all points taken between E, A. And it was proved for all points between E, B; therefore for all figures similarly taken upon AB, $BE^2 \cdot EA$ is greatest when $BE = 2EA$.”

The following consequences ^a should also be noticed in the aforementioned figure.^b Inasmuch as it has been proved that

$$B\Sigma^2 \cdot \Sigma A < BE^2.$$

and

$$B\varsigma^2 \cdot \varsigma A < BE^2 \cdot EA,$$

if the product of the given space and the given straight line is less than $BE^2 \cdot EA$, it is possible to cut AB in two points satisfying the conditions of the original problem.^c This comes about if we conceive a parabola described about the axis XH with parameter HΩ; for such a parabola will necessarily pass through T.^d And since it must necessarily meet ΓN, being parallel to a diameter [Apoll. Con. i. 26], it is clear that it cuts the hyperbola in another point above K, as at P in this case, and a perpendicular drawn from P to AB, as Pϖ in this case, will cut AB in ϖ, so that the point ϖ satisfies the conditions of the

bined; in this edition it is convenient, for the sake of clarity, to give separate figures.

^c With the same notation as before this may be stated:

when $bc^2 < \frac{4}{27}a^3$, there are always two real solutions of the cubic equation $x^2(a-x) = bc^2$ lying between 0 and a . If the cubic has two real roots it must, of course, have a third real root as well, but the Greeks did not recognize negative solutions.

^d By Apoll. i. 11, since $TX^2 = XH \cdot H\Omega$.

βλημα, καὶ ἴσον γίνεσθαι τὸ ἀπὸ ΒΣ ἐπὶ τὴν ΣΑ τῶ ἀπὸ Βς ἐπὶ τὴν ΣΑ, ὡς ἐστὶ διὰ τῶν προειρημένων ἀποδείξεων ἐμφανές. ὥστε δυνατοῦ ὄντος ἐπὶ τῆς ΒΑ δύο σημεῖα λαμβάνειν ποιούντα τὸ ζητούμενον, ἕξεστιν, ὁπότερόν τις βούλοιο, λαμβάνειν ἢ τὸ μεταξὺ τῶν Ε, Β ἢ τὸ μεταξὺ τῶν Ε, Α. εἰ μὲν γὰρ τὸ μεταξὺ τῶν Ε, Β, ὡς εἴρηται, τῆς διὰ τῶν Η, Τ σημείων γραφομένης παραβολῆς κατὰ δύο σημεῖα τεμνούσης τὴν ὑπερβολὴν τὸ μὲν ἐγγύτερον τοῦ Η, τουτέστι τοῦ ἄξονος τῆς παραβολῆς, εὐρήσει τὸ μεταξὺ τῶν Ε, Β, ὡς ἐνταῦθα τὸ Τ εὐρίσκει τὸ Σ, τὸ δὲ ἀπωτέρω τὸ μεταξὺ τῶν Ε, Α, ὡς ἐνταῦθα τὸ Ρ εὐρίσκει τὸ Σ.

Καθόλου μὲν οὖν οὕτως ἀναλέλυται καὶ συντίθεται τὸ πρόβλημα· ἵνα δὲ καὶ τοῖς Ἀρχιμηδεῖοις ῥήμασιν ἐφαρμοσθῆ, νενοήσθω ὡς ἐν αὐτῇ τῇ τοῦ ῥήτου καταγραφῇ διάμετρος μὲν τῆς σφαίρας ἢ ΔΒ, ἢ δὲ ἐκ τοῦ κέντρου ἢ ΒΖ, καὶ ἢ δεδομένη ἢ ΖΘ. κατηντήσαμεν ἄρα, φησὶν, εἰς τὸ “ τὴν ΔΖ τεμεῖν κατὰ τὸ Χ, ὥστε εἶναι, ὡς τὴν ΧΖ πρὸς τὴν δοθείσαν, οὕτως τὸ δοθὲν πρὸς τὸ ἀπὸ τῆς ΔΧ. τοῦτο δὲ ἀπλῶς μὲν λεγόμενον ἔχει διορισμόν.” εἰ γὰρ τὸ δοθὲν ἐπὶ τὴν δοθείσαν μείζον ἐτύγγχανεν τοῦ ἀπὸ τῆς ΔΒ ἐπὶ τὴν ΒΖ, ἀδύνατον ἦν τὸ πρόβλημα, ὡς δέδεικται, εἰ δὲ ἴσον, τὸ Β σημεῖον ἐποίει τὸ πρόβλημα, καὶ οὕτως δὲ οὐδὲν ἦν πρὸς τὴν ἐξ ἀρχῆς Ἀρχιμήδους πρόθεσιν· ἢ γὰρ σφαῖρα οὐκ ἐτέμνετο εἰς τὸν δοθέντα

* Archimedes' figure is re-drawn (v. page 162) so that B, Z come on the left of the figure and Δ on the right, instead of B, Z on the right and Δ on the left.

^b v. *supra*, p. 133.

ARCHIMEDES

problem, and $B\Sigma^2 \cdot \Sigma A = B\zeta^2 \cdot \zeta A$, as is clear from the above proof. Inasmuch as it is possible to take on BA two points satisfying what is sought, it is permissible to take whichever one wills, either the point between E, B or that between E, A. If we choose the point between E, B, the parabola described through the points H, T will, as stated, cut the hyperbola in two points; of these the one nearer to H, that is to the axis of the parabola, will determine the point between E, B, as in this case T determines Σ , while the point farther away will determine the point between E, A, as in this case P determines ζ .

The analysis and synthesis of the general problem have thus been completed; but in order that it may be harmonized with Archimedes' words, let there be conceived, as in Archimedes' own figure,^a a diameter ΔB of the sphere, with radius [equal to] BZ, and a given straight line Z Θ . We are therefore faced with the problem, he says, "so to cut ΔZ at X that XZ bears to the given straight line the same ratio as the given area bears to the square on ΔX . When the problem is stated in this general form, it is necessary to investigate the limits of possibility."^b If therefore the product of the given area and the given straight line chanced to be greater than $\Delta B^2 \cdot BZ$,^c the problem would not admit a solution, as was proved, and if it were equal the point B would satisfy the conditions of the problem, which also would be of no avail for the purpose Archimedes set himself at the outset; for the sphere would not be

^a For $\Delta B = \frac{2}{3}\Delta Z$ [*ex hyp.*], and so ΔB in the figure on p. 162 corresponds with BE in the figure on p. 146, while BZ in the figure on p. 162 corresponds with EA in the figure on p. 146.

GREEK MATHEMATICS

λόγον. ἀπλῶς ἄρα λεγόμενον εἶχεν προσδιορισμόν·
 “ προστιθεμένων δὲ τῶν προβλημάτων τῶν ἐνθάδε

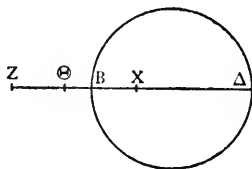

ὑπαρχόντων,” τουτέστι τοῦ τε διπλασίαν εἶναι τὴν ΔB τῆς ZB καὶ τοῦ μείζονα εἶναι τὴν BZ τῆς $Z\Theta$,
 “ οὐκ ἔχει διορισμόν.” τὸ γὰρ ἀπὸ ΔB τὸ δοθὲν
 ἐπὶ τὴν $Z\Theta$ τὴν δοθείσαν ἔλαττόν ἐστι τοῦ ἀπὸ
 τῆς ΔB ἐπὶ τὴν BZ διὰ τὸ τὴν BZ τῆς $Z\Theta$ μείζονα
 εἶναι, οὐπερ ὑπάρχοντος ἐδείξαμεν δυνατόν, καὶ
 ὅπως προβαίνει τὸ πρόβλημα.

^a Eutocius proceeds to give solutions of the problem by Dionysodorus and Diocles, by whose time, as he has explained, Archimedes' own solution had already disappeared. Dionysodorus solves the less general equation by means of the intersection of a parabola and a rectangular hyperbola; Diocles solves the general problem by the intersection of an ellipse with a rectangular hyperbola, and his proof is both ingenious and intricate. Details may be consulted in Heath, *H.G.M.* ii. 46-49 and more fully in Heath, 162

ARCHIMEDES

cut in the given ratio. Therefore when the problem was stated generally, an investigation of the limits of possibility was necessary as well; "but under the conditions of the present case," that is, if $\Delta B = 2ZB$ and $BZ > Z\Theta$, "no such investigation is necessary." For the product of the given area ΔB^2 into the given straight line $Z\Theta$ is less than the product of ΔB^2 into BZ by reason of the fact that BZ is greater than $Z\Theta$, and we have shown that in this case there is a solution, and how it can be effected.^a

The Works of Archimedes, pp. cxxiii-cxli, which deals with the whole subject of cubic equations in Greek mathematical history. It is there pointed out that the problem of finding mean proportionals is equivalent to the solution of a pure cubic equation, $\frac{a^3}{x^3} = \frac{a}{b}$, and that Menaechmus's solution, by the intersection of two conic sections (v. vol. i. pp. 278-283), is the precursor of the method adopted by Archimedes, Dionysodorus and Diocles. The solution of cubic equations by means of conics was, no doubt, found easier than a solution by the manipulation of parallelepipeds, which would have been analogous to the solution of quadratic equations by the application of areas (v. vol. i. pp. 186-215). No other examples of the solution of cubic equations have survived, but in his preface to the book *On Conoids and Spheroids* Archimedes says the results there obtained can be used to solve other problems, including the following, "from a given spheroidal figure or conoid to cut off, by a plane drawn parallel to a given plane, a segment which shall be equal to a given cone or cylinder, or to a given sphere" (Archim. ed. Heiberg i. 258. 11-15); the case of the paraboloid of revolution does not lead to a cubic equation, but those of the spheroid and hyperboloid of revolution do lead to cubics, which Archimedes may be presumed to have solved. The conclusion reached by Heath is that Archimedes solved completely, so far as the real roots are concerned, a cubic equation in which the term in x is absent: and as all cubic equations can be reduced to this form, he may be regarded as having solved geometrically the general cubic.

GREEK MATHEMATICS

(d) CONOIDS AND SPHEROIDS

(i.) Preface

Archim. *De Con. et Sphaer.*, Praef., Archim. ed. Heiberg
i. 246. 1-14

Ἀρχιμήδης Δοσιθέω εὖ πράττειν.

Ἀποστέλλω τοι γράψας ἐν τῷδε τῷ βιβλίῳ τῶν τε λοιπῶν θεωρημάτων τὰς ἀποδείξεις, ὧν οὐκ εἶχες ἐν τοῖς πρότερον ἀπεσταλμένοις, καὶ ἄλλων ὕστερον ποτεξευρημένων, ἃ πρότερον μὲν ἤδη πολλάκις ἐγχειρήσας ἐπισκέπτεσθαι δύσκολον ἔχειν τι φανείσας μοι τὰς εὐρέσιος αὐτῶν ἀπόρησα· διόπερ οὐδὲ συνεξεδόθεν τοῖς ἄλλοις αὐτὰ τὰ προβεβλημένα. ὕστερον δὲ ἐπιμελέστερον ποτ' αὐτοῖς γενόμενος ἐξεῦρον τὰ ἀπορηθέντα. ἦν δὲ τὰ μὲν λοιπὰ τῶν προτέρων θεωρημάτων περὶ τοῦ ὀρθογωνίου κωνοειδέος προβεβλημένα, τὰ δὲ νῦν ἐντι ποτεξευρημένα περὶ τε ἀμβλυγωνίου κωνοειδέος καὶ περὶ σφαιροειδέων σχημάτων, ὧν τὰ μὲν παραμάκεα, τὰ δὲ ἐπιπλατέα καλέω.

(ii.) Two Lemmas

Ibid., Lemma ad Prop. 1, Archim. ed. Heiberg
i. 260. 17-24

Εἴ κα ἕωντι μεγέθεα ὅποσαοῦν τῷ ἴσῳ ἀλλάλων

^a In the books *On the Sphere and Cylinder*, *On Spirals* and on the *Quadrature of a Parabola*.

^b *i.e.*, the paraboloid of revolution.

^c *i.e.*, the hyperboloid of revolution.

^d An *oblong spheroid* is formed by the revolution of an

ARCHIMEDES

(d) CONOIDS AND SPHEROIDS

(i.) *Preface*

Archimedes, *On Conoids and Spheroids*, Preface,
Archim. ed. Heiberg i. 246. 1-14

Archimedes to Dositheus greeting.

I have written out and now send you in this book the proofs of the remaining theorems, which you did not have among those sent to you before,^a and also of some others discovered later, which I had often tried to investigate previously but their discovery was attended with some difficulty and I was at a loss over them ; and for this reason not even the propositions themselves were forwarded with the rest. But later, when I had studied them more carefully, I discovered what had left me at a loss before. Now the remainder of the earlier theorems were propositions about the *right-angled conoid*^b ; but the discoveries now added relate to an *obtuse-angled conoid*^c and to *spheroidal figures*, of which I call some *oblong* and others *flat*.^d

(ii.) *Two Lemmas*

Ibid., Lemma to Prop. 1, Archim. ed. Heiberg
i. 260. 17-24

If there be a series of magnitudes, as many as you please, in which each term exceeds the previous term by an

ellipse about its major axis, a *flat spheroid* by the revolution of an ellipse about its minor axis.

In the remainder of our preface Archimedes gives a number of definitions connected with those solids. They are of importance in studying the development of Greek mathematical terminology.

GREEK MATHEMATICS

ὑπερέχοντα, ἢ δὲ ἅ ὑπεροχὰ ἴσα τῷ ἐλαχίστῳ, καὶ ἄλλα μεγέθεα τῷ μὲν πλήθει ἴσα τούτοις, τῷ δὲ μεγέθει ἕκαστον ἴσον τῷ μεγίστῳ, πάντα τὰ μεγέθεα, ὧν ἐστὶν ἕκαστον ἴσον τῷ μεγίστῳ, πάντων μὲν τῶν τῷ ἴσῳ ὑπερεχόντων ἐλάσσονα ἐσσοῦνται ἢ διπλάσια, τῶν δὲ λοιπῶν χωρὶς τοῦ μεγίστου μείζονα ἢ διπλάσια. ἅ δὲ ἀπόδειξις τούτου φανερά.

Ibid., Prop. 1, Archim. ed. Heiberg l. 260. 26-261. 22

Εἴ κα μεγέθεα ὅποσαοῦν τῷ πλήθει ἄλλοις μεγέθεσιν ἴσοις τῷ πλήθει κατὰ δύο τὸν αὐτὸν λόγον ἔχωντι τὰ ὁμοίως τεταγμένα, λέγεται δὲ τὰ τε πρῶτα μεγέθεα ποτ' ἄλλα μεγέθεα ἢ πάντα ἢ τινα αὐτῶν ἐν λόγοις ὁποιοιοῦν, καὶ τὰ ὕστερον ποτ' ἄλλα μεγέθεα τὰ ὁμόλογα ἐν τοῖς αὐτοῖς λόγοις, πάντα τὰ πρῶτα μεγέθεα ποτὶ πάντα, ἃ λέγονται, τὸν αὐτὸν ἐξοῦντι λόγον, ὃν ἔχοντι πάντα τὰ ὕστερον μεγέθεα ποτὶ πάντα, ἃ λέγονται.

Ἔστω τινὰ μεγέθεα τὰ Α, Β, Γ, Δ, Ε, Ζ ἄλλοις μεγέθεσιν ἴσοις τῷ πλήθει τοῖς, Η, Θ, Ι, Κ, Λ, Μ

* If h is the common difference, the first series is $h, 2h, 3h, \dots, nh$, and the second series is nh, nh, \dots to n terms, its sum obviously being n^2h . The lemma asserts that

$$2(h + 2h + 3h + \dots + \overline{n-1}h) < n^2h < 2(h + 2h + 3h + \dots + nh).$$

It is proved in the book *On Spirals*, Prop. 11. The proof is geometrical, lines being placed side by side to represent the

ARCHIMEDES

equal quantity, which common difference is equal to the least term, and if there be a second series of magnitudes, equal to the first in number, in which each term is equal to the greatest term [in the first series], the sum of the magnitudes in the series in which each term is equal to the greatest term is less than double of the sum of the magnitudes differing by an equal quantity, but greater than double of the sum of those magnitudes less the greatest term. The proof of this is clear.^a

Ibid., Prop. 1, Archim. ed. Heiberg i. 260. 26–261. 22

If there be a series of magnitudes, as many as you please, and it be equal in number to another series of magnitudes, and the terms have the same ratio two by two, and if any or all of the first series of magnitudes form any proportion with another series of magnitudes, and if the second series of magnitudes form the same proportion with the corresponding terms of another series of magnitudes, the sum of the first series of magnitudes bears to the sum of those with which they are in proportion the same ratio as the sum of the second series of magnitudes bears to the sums of the terms with which they are in proportion.

Let the series of magnitudes A, B, Γ, Δ, E, Z be equal in number to the series of magnitudes H, Θ, I,

terms of the arithmetical progression and produced until each is equal to the greatest term. It is equivalent to this algebraical proof:

Let	$S_n = h + 2h + 3h + \dots + nh.$
Then	$S_n = nh + (n-1)h + (n-2)h + \dots + h.$
Adding,	$2S_n = n(n+1)h,$
and so	$2S_{n-1} = (n-1)nh.$
Therefore	$2S_{n-1} < n^2h < 2S_n.$

GREEK MATHEMATICS

κατὰ δύο τὸν αὐτὸν ἔχοντα λόγον, καὶ ἐχέτω τὸ μὲν Α ποτὶ τὸ Β τὸν αὐτὸν λόγον, ὃν τὸ Η ποτὶ τὸ Θ, τὸ δὲ Β ποτὶ τὸ Γ, ὃν τὸ Θ ποτὶ τὸ Ι, καὶ τὰ ἄλλα ὁμοίως τούτοις, λεγέσθω δὲ τὰ μὲν Α, Β, Γ, Δ, Ε, Ζ μεγέθεα ποτ' ἄλλα μεγέθεα τὰ Ν, Ξ, Ο, Π, Ρ, Σ ἐν λόγοις ὁποιοιοῦν, τὰ δὲ Η, Θ, Ι, Κ, Λ, Μ ποτ' ἄλλα τὰ Τ, Υ, Φ, Χ, Ψ, Ω, τὰ ὁμόλογα ἐν τοῖς αὐτοῖς λόγοις, καὶ ὃν μὲν ἔχει λόγον τὸ Α ποτὶ τὸ Ν, τὸ Η ἐχέτω ποτὶ τὸ Τ, ὃν δὲ λόγον ἔχει τὸ Β ποτὶ τὸ Ξ, τὸ Θ ἐχέτω ποτὶ τὸ Υ, καὶ τὰ ἄλλα ὁμοίως τούτοις· δεικτέον, ὅτι πάντα τὰ Α, Β, Γ, Δ, Ε, Ζ ποτὶ πάντα τὰ Ν, Ξ, Ο, Π, Ρ, Σ τὸν αὐτὸν ἔχοντι λόγον, ὃν πάντα τὰ Η, Θ, Ι, Κ, Λ, Μ ποτὶ πάντα τὰ Τ, Υ, Φ, Χ, Ψ, Ω.

• Since	$N : A = T : H, A : B = H : \Theta,$	[<i>ex hyp.</i>]
∴ <i>ex aequo</i>	$N : B = T : \Theta.$	[Eucl. v. 22]
But	$B : \Xi = \Theta : \Upsilon;$	[<i>ex hyp.</i>]
∴ <i>ex aequo</i>	$N : \Xi = T : \Upsilon.$	[Eucl. v. 22]

Similarly

$$\Xi : O = \Upsilon : \Phi, O : \Pi = \Phi : X, \Pi : P = X : \Psi, P : \Sigma = \Psi : \Omega.$$

Now since	$A : B = H : \Theta,$	[<i>ex hyp.</i>]
∴ <i>componendo</i>	$A + B : A = H + \Theta : H,$	[Eucl. v. 18]
<i>i.e., permutando</i>	$A + B : H + \Theta = A : H.$	[Eucl. v. 16]
But since	$N : A = T : H,$	[<i>ex hyp.</i>]
∴	$A : H = N : T$	[Eucl. v. 16]
	$= \Xi : \Upsilon$	[<i>ibid.</i>]
	$= O : \Phi$	[<i>ibid.</i>]
	$= \Gamma : I.$	[<i>ibid.</i>]
∴	$A + B : H + \Theta = \Gamma : I.$	
∴	$A + B + \Gamma : H + \Theta + I = \Gamma : I$	[Eucl. v. 18]
	$= O : \Phi$	[Eucl. v. 16]

ARCHIMEDES

K, Λ, M, and let them have the same ratio two by two, so that

$$A : B = H : \Theta, B : \Gamma = \Theta : I,$$

and so on, and let the series of magnitudes A, B, Γ, Δ, E, Z form any proportion with another series of magnitudes N, Ξ, O, Π, P, Σ, and let H, Θ, I, K, Λ, M form the same proportion with the corresponding terms of another series, T, Υ, Φ, X, Ψ, Ω so that

$$A : N = H : T, B : \Xi = \Theta : \Upsilon,$$

and so on ; it is required to prove that

$$\frac{A + B + \Gamma + \Delta + E + Z}{N + \Xi + O + \Pi + P + \Sigma} = \frac{H + \Theta + I + K + \Lambda + M}{T + \Upsilon + \Phi + X + \Psi + \Omega} \quad \text{a}$$

$$= \Pi : X \quad \text{[}i\text{bid.}$$

$$= \Delta : K. \quad \text{[}i\text{bid.}$$

By pursuing this method it may be proved that

$$A + B + \Gamma + \Delta + E + Z : H + \Theta + I + K + \Lambda + M = A : H,$$

or, *permutando*,

$$A + B + \Gamma + \Delta + E + Z : A = H + \Theta + I + K + \Lambda + M : H. \quad (1)$$

Now $N : \Xi = T : \Upsilon$;

∴ *componendo et permutando*,

$$N + \Xi : T + \Upsilon = \Xi : \Upsilon \quad \text{[Eucl. v. 18, v. 16}$$

$$= O : \Phi; \quad \text{[Eucl. v. 16}$$

whence $N + \Xi + O : T + \Upsilon + \Phi = O : \Phi$, [Eucl. v. 18

and so on until we obtain

$$N + \Xi + O + \Pi + P + \Sigma : T + \Upsilon + \Phi + X + \Psi + \Omega = N : T. \quad (2)$$

But $A : N = H : T$; [*ex hyp.*

∴ by (1) and (2),

$$\frac{A + B + \Gamma + \Delta + E + Z}{N + \Xi + O + \Pi + P + \Sigma} = \frac{H + \Theta + I + K + \Lambda + M}{T + \Upsilon + \Phi + X + \Psi + \Omega}$$

Q.E.D.

GREEK MATHEMATICS

(iii.) *Volume of a Segment of a Paraboloid of Revolution*

Ibid., Prop. 21, Archim. ed. Heiberg i. 344. 21-354. 20

Πάν τμᾶμα ὀρθογωνίου κωνοειδέος ἀποτετμα-
 μένον ἐπιπέδῳ ὀρθῶ ποτὶ τὸν ἄξονα ἡμιόλιόν ἐστι
 τοῦ κώνου τοῦ βάσιν ἔχοντος τὰν αὐτὰν τῷ τμάματι
 καὶ ἄξονα.

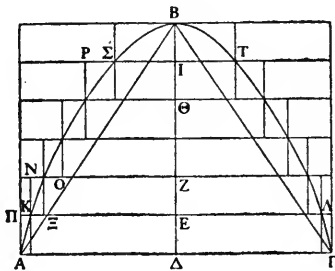

Ἐστω γὰρ τμᾶμα ὀρθογωνίου κωνοειδέος ἀπο-
 τετμαμένον ὀρθῶ ἐπιπέδῳ ποτὶ τὸν ἄξονα, καὶ
 τμαθέντος αὐτοῦ ἐπιπέδῳ ἄλλῳ διὰ τοῦ ἄξονος
 τᾶς μὲν ἐπιφανείας τομὰ ἔστω ἡ $AB\Gamma$ ὀρθογωνίου
 κώνου τομὰ, τοῦ δὲ ἐπιπέδου τοῦ ἀποτέμνοντος
 τὸ τμᾶμα ἡ ΓA εὐθεῖα, ἄξων δὲ ἔστω τοῦ τμά-
 ματος ἡ $B\Delta$, ἔστω δὲ καὶ κῶνος τὰν αὐτὰν βάσιν
 ἔχων τῷ τμάματι καὶ ἄξονα τὸν αὐτόν, οὗ κορυφὰ
 τὸ B . δεικτέον, ὅτι τὸ τμᾶμα τοῦ κωνοειδέος
 ἡμιόλιόν ἐστι τοῦ κώνου τούτου.

Ἐκκείσθω γὰρ κῶνος ὁ Ψ ἡμιόλιος ἐὼν τοῦ
 κώνου, οὗ βάσις ὁ περὶ διάμετρον τὰν AG , ἄξων
 δὲ ἡ $B\Delta$, ἔστω δὲ καὶ κύλινδρος βάσιν μὲν ἔχων

ARCHIMEDES

(iii.) *Volume of a Segment of a Paraboloid of Revolution*

Ibid., Prop. 21, Archim. ed. Heiberg i. 344. 21–354. 20

Any segment of a right-angled conoid cut off by a plane perpendicular to the axis is one-and-a-half times the cone having the same base as the segment and the same axis.

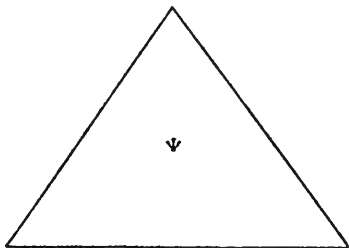

For let there be a segment of a right-angled conoid cut off by a plane perpendicular to the axis, and let it be cut by another plane through the axis, and let the section be the section of a right-angled cone $AB\Gamma$,^a and let ΓA be a straight line in the plane cutting off the segment, and let $B\Delta$ be the axis of the segment, and let there be a cone, with vertex B , having the same base and the same axis as the segment. It is required to prove that the segment of the conoid is one-and-a-half times this cone.

For let there be set out a cone Ψ one-and-a-half times as great as the cone with base about the diameter $A\Gamma$ and with axis $B\Delta$, and let there be a

^a It is proved in Prop. 11 that the section will be a parabola.

GREEK MATHEMATICS

τὸν κύκλον τὸν περὶ διάμετρον τὰν ΑΓ, ἄξονα δὲ τὰν ΒΔ· ἐσσεῖται οὖν ὁ Ψ κῶνος ἡμίσεος τοῦ κυλίνδρου [ἐπεὶπερ ἡμιόλιός ἐστὶν ὁ Ψ κῶνος τοῦ αὐτοῦ κώνου].¹ λέγω, ὅτι τὸ τμᾶμα τοῦ κωνοειδέος ἴσον ἐστὶ τῷ Ψ κώνῳ.

Εἰ γὰρ μὴ ἐστὶν ἴσον, ἦτοι μείζον ἐντι ἢ ἔλασσον. ἔστω δὴ πρότερον, εἰ δυνατόν, μείζον. ἐγγεγράφθω δὴ σχῆμα στερεὸν εἰς τὸ τμᾶμα, καὶ ἄλλο περιγεγράφθω ἐκ κυλίνδρων ὕψος ἴσον ἐχόντων συγκείμενον, ὥστε τὸ περιγραφέν σχῆμα τοῦ ἐγγραφέντος ὑπερέχειν ἐλάσσονι, ἢ ἀλίκῳ ὑπερέχει τὸ τοῦ κωνοειδέος τμᾶμα τοῦ Ψ κώνου, καὶ ἔστω τῶν κυλίνδρων, ἐξ ὧν σύγκειται τὸ περιγραφέν σχῆμα, μέγιστος μὲν ὁ βάσιν ἔχων τὸν κύκλον τὸν περὶ διάμετρον τὰν ΑΓ, ἄξονα δὲ τὰν ΕΔ, ἐλάχιστος δὲ ὁ βάσιν μὲν ἔχων τὸν κύκλον τὸν περὶ διάμετρον τὰν ΣΤ, ἄξονα δὲ τὰν ΒΙ, τῶν δὲ κυλίνδρων, ἐξ ὧν σύγκειται τὸ ἐγγραφέν σχῆμα, μέγιστος μὲν ἔστω ὁ βάσιν ἔχων τὸν κύκλον τὸν περὶ διάμετρον τὰν ΚΛ, ἄξονα δὲ τὰν ΔΕ, ἐλάχιστος δὲ ὁ βάσιν μὲν ἔχων τὸν κύκλον τὸν περὶ διάμετρον τὰν ΣΤ, ἄξονα δὲ τὰν ΘΙ, ἐκβεβλήσθω δὲ τὰ ἐπίπεδα πάντων τῶν κυλίνδρων ποτὶ τὰν

¹ ἐπεὶπερ . . . κώνου om. Heiberg.

* For the cylinder is three times, and the cone Ψ one-and-a-
172

ARCHIMEDES

cylinder having for its base the circle about the diameter $A\Gamma$ and for its axis $B\Delta$; then the cone Ψ is one-half of the cylinder^a; I say that the segment of the conoid is equal to the cone Ψ .

If it be not equal, it is either greater or less. Let it first be, if possible, greater. Then let there be inscribed in the segment a solid figure and let there be circumscribed another solid figure made up of cylinders having an equal altitude,^b in such a way that the circumscribed figure exceeds the inscribed figure by a quantity less than that by which the segment of the conoid exceeds the cone Ψ [Prop. 19]; and let the greatest of the cylinders composing the circumscribed figure be that having for its base the circle about the diameter $A\Gamma$ and for axis $E\Delta$, and let the least be that having for its base the circle about the diameter ΣT and for axis BI ; and let the greatest of the cylinders composing the inscribed figure be that having for its base the circle about the diameter $K\Lambda$ and for axis ΔE , and let the least be that having for its base the circle about the diameter ΣT and for axis ΘI ; and let the planes of all the cylinders be

half times, as great as the same cone; but because *τοῦ αὐτοῦ κώνου* is obscure and *ἐπέπερ* often introduces an interpolation, Heiberg rejects the explanation to this effect in the text.

^b Archimedes has used those inscribed and circumscribed figures in previous propositions. The paraboloid is generated by the revolution of the parabola $AB\Gamma$ about its axis $B\Delta$. Chords $K\Lambda . . . \Sigma T$ are drawn in the parabola at right angles to the axis and at equal intervals from each other. From the points where they meet the parabola, perpendiculars are drawn to the next chords. In this way there are built up inside and outside the parabola "staggered" figures consisting of decreasing rectangles. When the parabola revolves, the rectangles become cylinders, and the segment of the paraboloid lies between the inscribed set of cylinders and the circumscribed set of cylinders.

GREEK MATHEMATICS

ἐπιφάνειαν τοῦ κυλίνδρου τοῦ βάσιν ἔχοντος τὸν κύκλον τὸν περὶ διάμετρον τὰν ΑΓ, ἄξονα δὲ τὰν ΒΔ· ἐσσεῖται δὴ ὁ ὅλος κύλινδρος διηρημένος εἰς κυλίνδρους τῷ μὲν πλήθει ἴσους τοῖς κυλίνδροις τοῖς ἐν τῷ περιγεγραμμένῳ σχήματι, τῷ δὲ μέγθει ἴσους τῷ μεγίστῳ αὐτῶν. καὶ ἐπεὶ τὸ περιγεγραμμένον σχῆμα περὶ τὸ τμᾶμα ἐλάσσονι ὑπερέχει τοῦ ἐγγεγραμμένου σχήματος ἢ τὸ τμᾶμα τοῦ κώνου, δῆλον, ὅτι καὶ τὸ ἐγγεγραμμένον σχῆμα ἐν τῷ τμᾶματι μείζον ἐστὶ τοῦ Ψ κώνου. ὁ δὴ πρῶτος κύλινδρος τῶν ἐν τῷ ὅλῳ κυλίνδρῳ ὁ ἔχων ἄξονα τὰν ΔΕ ποτὶ τὸν πρῶτον κύλινδρον τῶν ἐν τῷ ἐγγεγραμμένῳ σχήματι τὸν ἔχοντα ἄξονα τὰν ΔΕ τὸν αὐτὸν ἔχει λόγον, ὃν ἂ ΔΑ ποτὶ τὰν ΚΕ δυνάμει· οὗτος δὲ ἐστὶν ὁ αὐτὸς τῷ, ὃν ἔχει ἂ ΒΔ ποτὶ τὰν ΒΕ, καὶ τῷ, ὃν ἔχει ἂ ΔΑ ποτὶ τὰν ΕΞ. ὁμοίως δὲ δειχθήσεται καὶ ὁ δεύτερος κύλινδρος τῶν ἐν τῷ ὅλῳ κυλίνδρῳ ὁ ἔχων ἄξονα τὸν ΕΖ ποτὶ τὸν δεύτερον κύλινδρον τῶν ἐν τῷ ἐγγεγραμμένῳ σχήματι τὸν αὐτὸν ἔχει λόγον, ὃν ἂ ΠΕ, τουτέστιν ἂ ΔΑ, ποτὶ τὰν ΖΟ, καὶ τῶν ἄλλων κυλίνδρων ἕκαστος τῶν ἐν τῷ ὅλῳ κυλίνδρῳ ἄξονα ἔχόντων ἴσον τῷ ΔΕ ποτὶ ἕκαστον τῶν κυλίνδρων τῶν ἐν τῷ ἐγγεγραμμένῳ σχήματι ἄξονα ἔχόντων τὸν αὐτὸν ἔξει τοῦτον τὸν λόγον, ὃν ἂ ἡμίσεια τᾶς διαμέτρου τᾶς βάσιος αὐτοῦ ποτὶ τὰν ἀπολελαμμέναν ἀπ' αὐτᾶς μεταξύ τᾶν ΑΒ, ΒΔ εὐθειᾶν· καὶ πάντες οὖν οἱ κυλίνδροι οἱ ἐν τῷ κυλίνδρῳ, οὗ βάσις μὲν ἐστὶν ὁ κύκλος ὁ περὶ διάμετρον τὰν ΑΓ, ἄξων δὲ [ἐστὶν]¹ ἂ ΔΙ εὐθεῖα, ποτὶ πάντα τοὺς κυλίνδρους τοὺς ἐν τῷ ἐγγεγραμμένῳ σχήματι τὸν αὐτὸν ἐξοῦντι λόγον, ὃν

ARCHIMEDES

produced to the surface of the cylinder having for its base the circle about the diameter $ΑΓ$ and for axis $ΒΔ$; then the whole cylinder is divided into cylinders equal in number to the cylinders in the circumscribed figure and in magnitude equal to the greatest of them. And since the figure circumscribed about the segment exceeds the inscribed figure by a quantity less than that by which the segment exceeds the cone, it is clear that the figure inscribed in the segment is greater than the cone $Ψ$.^a Now the first cylinder of those in the whole cylinder, that having $ΔΕ$ for its axis, bears to the first cylinder in the inscribed figure, which also has $ΔΕ$ for its axis, the ratio $ΔΑ^2 : ΚΕ^2$ [Eucl. xii. 11 and xii. 2]; but $ΔΑ^2 : ΚΕ^2 = ΒΔ : ΒΕ$ ^b $= ΔΑ : ΕΞ$. Similarly it may be proved that the second cylinder of those in the whole cylinder, that having $ΕΖ$ for its axis, bears to the second cylinder in the inscribed figure the ratio $ΠΕ : ΖΟ$, that is, $ΔΑ : ΖΟ$, and each of the other cylinders in the whole cylinder, having its axis equal to $ΔΕ$, bears to each of the cylinders in the inscribed figure, having the same axis in order, the same ratio as half the diameter of the base bears to the part cut off between the straight lines $ΑΒ$, $ΒΔ$; and therefore the sum of the cylinders in the cylinder having for its base the circle about the diameter $ΑΓ$ and for axis the straight line $ΔΙ$ bears to the sum of the cylinders in the inscribed figure the same ratio as the sum of

^a Because the circumscribed figure is greater than the segment.

^b By the property of the parabola; *v. Quadr. parab.* 3.

¹ $ἐστιν$ om. Heiberg.

GREEK MATHEMATICS

pāσαι αἱ εὐθεῖαι αἱ ἐκ τῶν κέντρων τῶν κύκλων, οἳ ἐντι βάσεις τῶν εἰρημένων κυλίνδρων, ποτὶ πάσας τὰς εὐθείας τὰς ἀπολελαμμένας ἀπ' αὐτῶν μεταξὺ τῶν AB, ΒΔ. αἱ δὲ εἰρημένοι εὐθεῖαι τῶν εἰρημένων χωρὶς τῆς ΑΔ μείζονές ἐντι ἢ διπλάσιαι· ὥστε καὶ οἱ κυλίνδροι πάντες οἱ ἐν τῷ κυλίνδρῳ, οὗ ἄξων ὁ ΔΙ, μείζονές ἐντι ἢ διπλάσιοι τοῦ ἐγγεγραμμένου σχήματος· πολλῶ ἄρα καὶ ὁ ὅλος κύλινδρος, οὗ ἄξων ἁ ΔΒ, μείζων ἐντι ἢ διπλασίῳν τοῦ ἐγγεγραμμένου σχήματος. τοῦ δὲ Ψ κώνου ἦν διπλασίῳν· ἔλασσον ἄρα τὸ ἐγγεγραμμένον σχῆμα τοῦ Ψ κώνου· ὅπερ ἀδύνατον· ἐδείχθη γὰρ μείζων. οὐκ ἄρα ἐστὶν μείζων τὸ κωνοειδὲς τοῦ Ψ κώνου.

Ὁμοίως δὲ οὐδὲ ἔλασσον· πάλιν γὰρ ἐγγεγράφθω τὸ σχῆμα καὶ περιγεγράφθω, ὥστε ὑπερέχει [ἕκαστον]¹ ἐλάσσονι, ἢ ἀλίκῳ ὑπερέχει ὁ Ψ κώνος τοῦ κωνοειδέος, καὶ τὰ ἄλλα τὰ αὐτὰ τοῖς πρότερον κατεσκευάσθω. ἐπεὶ οὖν ἔλασσόν ἐστι τὸ ἐγγεγραμμένον σχῆμα τοῦ τμήματος, καὶ τὸ ἐγγραφὲν τοῦ περιγραφέντος ἐλάσσονι λείπεται ἢ τὸ τμήμα τοῦ Ψ κώνου, δῆλον, ὡς ἔλασσόν ἐστι τὸ περιγραφὲν σχῆμα τοῦ Ψ κώνου. πάλιν δὲ ὁ

¹ ἕκαστον om. Heiberg, ἕκαστον ἐκάστου Torelli (for ἐκάτερον ἐκατέρου).

i.e.,

$$\frac{\text{First cylinder in whole cylinder}}{\text{First cylinder in inscribed figure}} = \frac{\Delta\Lambda}{\Xi\Xi'}$$

$$\frac{\text{Second cylinder in whole cylinder}}{\text{Second cylinder in inscribed figure}} = \frac{\text{E}\Pi}{\text{Z}\Theta'}$$

and so on.

$$\therefore \frac{\text{Whole cylinder}}{\text{Inscribed figure}} = \frac{\Delta\Lambda + \text{E}\Pi + \dots}{\Xi\Xi' + \text{Z}\Theta' + \dots}$$

ARCHIMEDES

the radii of the circles, which are the bases of the aforesaid cylinders, bears to the sum of the straight lines cut off from them between AB , $B\Delta$.^a But the sum of the aforesaid straight lines is greater than double of the aforesaid straight lines without $A\Delta$ ^b; so that the sum of the cylinders in the cylinder whose axis is ΔI is greater than double of the inscribed figure; therefore the whole cylinder, whose axis is ΔB , is greater by far than double of the inscribed figure. But it was double of the cone Ψ ; therefore the inscribed figure is less than the cone Ψ ; which is impossible, for it was proved to be greater. Therefore the conoid is not greater than the cone Ψ .

Similarly [it can be shown] not to be less; for let the figure be again inscribed and another circumscribed so that the excess is less than that by which the cone Ψ exceeds the conoid, and let the rest of the construction be as before. Then because the inscribed figure is less than the segment, and the inscribed figure is less than the circumscribed by some quantity less than the difference between the segment and the cone Ψ , it is clear that the circumscribed figure is less than the cone Ψ . Again, the first

This follows from Prop. 1, for

$$\frac{\text{First cylinder in whole cylinder}}{\text{Second cylinder in whole cylinder}} = 1 = \frac{\Delta A}{EII},$$

and so on, and thus the other condition of the theorem is satisfied.

^b For $\Delta A, E\Xi, ZO \dots$ is a series diminishing in arithmetical progression, and $\Delta A, EII \dots$ is a series, equal in number, in which each term is equal to the greatest in the arithmetical progression. Therefore, by the Lemma to Prop. 1,

$$\Delta A + EII + \dots > 2(E\Xi + ZO + \dots).$$

GREEK MATHEMATICS

πρῶτος κύλινδρος τῶν ἐν τῷ ὅλῳ κυλίνδρῳ ὁ ἔχων
 ἄξονα τὰν ΔΕ ποτὶ τὸν πρῶτον κύλινδρον τῶν ἐν
 τῷ περιγεγραμμένῳ σχήματι τὸν τὸν αὐτὸν ἔχοντα
 ἄξονα τὰν ΕΔ τὸν αὐτὸν ἔχει λόγον, ὃν τὸ ἀπὸ
 τᾶς ΑΔ τετράγωνον ποτὶ τὸ αὐτό, ὁ δὲ δεύτερος
 κύλινδρος τῶν ἐν τῷ ὅλῳ κυλίνδρῳ ὁ ἔχων ἄξονα
 τὰν ΕΖ ποτὶ τὸν δεύτερον κύλινδρον τῶν ἐν τῷ
 περιγεγραμμένῳ σχήματι τὸν ἔχοντα ἄξονα τὰν
 ΕΖ τὸν αὐτὸν ἔχει λόγον, ὃν ἂ ΔΑ ποτὶ τὰν ΚΕ
 δυνάμει· οὗτος δὲ ἐστὶν ὁ αὐτὸς τῷ, ὃν ἔχει ἂ ΒΔ
 ποτὶ τὰν ΒΕ, καὶ τῷ, ὃν ἔχει ἂ ΔΑ ποτὶ τὰν ΕΞ·
 καὶ τῶν ἄλλων κυλίνδρων ἕκαστος τῶν ἐν τῷ ὅλῳ
 κυλίνδρῳ ἄξονα ἐχόντων ἴσον τᾷ ΔΕ ποτὶ ἕκαστον
 τῶν κυλίνδρων τῶν ἐν τῷ περιγεγραμμένῳ σχήματι
 ἄξονα ἐχόντων τὸν αὐτὸν, ἔξει τοῦτον τὸν λόγον,
 ὃν ἂ ἡμίσεια τᾶς διαμέτρου τᾶς βάσιος αὐτοῦ ποτὶ
 τὰν ἀπολελαμμέναν ἀπ' αὐτᾶς μεταξὺ τᾶν ΑΒ,
 ΒΔ εὐθειᾶν· καὶ πάντες οὖν οἱ κύλινδροι οἱ ἐν τῷ
 ὅλῳ κυλίνδρῳ, οὗ ἄξων ἐστὶν ἂ ΒΔ εὐθεῖα, ποτὶ
 πάντας τοὺς κυλίνδρους τοὺς ἐν τῷ περιγεγραμ-
 μένῳ σχήματι τὸν αὐτὸν ἐξοῦντι λόγον, ὃν πᾶσαι
 αἱ εὐθεῖαι ποτὶ πᾶσας τὰς εὐθείας. αἱ δὲ εὐθεῖαι
 πᾶσαι αἱ ἐκ τῶν κέντρων τῶν κύκλων, οἱ βάσιές
 ἐντι τῶν κυλίνδρων, τᾶν εὐθειᾶν πασᾶν τᾶν ἀπο-
 λελαμμέναν ἀπ' αὐτᾶν σὺν τᾷ ΑΔ ἐλάσσονές ἐντι

- As before,

$$\begin{array}{l}
 \text{First cylinder in whole cylinder} \quad \frac{\Delta A}{\Delta A} \\
 \text{First cylinder in circumscribed figure} \quad = \frac{\Delta A}{\Delta A} \\
 \text{Second cylinder in whole cylinder} \quad \frac{\Delta A}{\text{ΕΞ}} = \frac{\text{ΕΠ}}{\text{ΕΞ}} \\
 \text{Second cylinder in circumscribed figure} \quad = \frac{\Delta A}{\text{ΕΞ}} = \frac{\text{ΕΠ}}{\text{ΕΞ}}
 \end{array}$$

and so on.

ARCHIMEDES

cylinder of those in the whole cylinder, having ΔE for its axis, bears to the first cylinder of those in the circumscribed figure, having the same axis $E\Delta$, the ratio $A\Delta^2 : A\Delta^2$; the second cylinder in the whole cylinder, having EZ for its axis, bears to the second cylinder in the circumscribed figure, having EZ also for its axis, the ratio $\Delta A^2 : KE^2$; this is the same as $B\Delta : BE$, and this is the same as $\Delta A : E\Xi$; and each of the other cylinders in the whole cylinder, having its axis equal to ΔE , will bear to the corresponding cylinder in the circumscribed figure, having the same axis, the same ratio as half the diameter of the base bears to the portion cut off from it between the straight lines $AB, B\Delta$; and therefore the sum of the cylinders in the whole cylinder, whose axis is the straight line $B\Delta$, bears to the sum of the cylinders in the circumscribed figure the same ratio as the sum of the one set of straight lines bears to the sum of the other set of straight lines.^a But the sum of the radii of the circles which are the bases of the cylinders is less than double of the sum of the straight lines cut off from them together with $A\Delta$ ^b; it is therefore clear

And

$$\frac{\text{First cylinder in whole cylinder}}{\text{Second cylinder in whole cylinder}} = 1 = \frac{\Delta A}{E\Gamma}$$

and so on.

Therefore the conditions of Prop. 1 are satisfied and

$$\frac{\text{Whole cylinder}}{\text{Circumscribed figure}} = \frac{\Delta A + E\Gamma + \dots}{\Delta A + E\Xi + \dots}$$

^b As before, $\Delta A, E\Xi \dots$ is a series diminishing in arithmetical progression, and $\Delta A, E\Gamma \dots$ is a series, equal in number, in which each term is equal to the greatest in the arithmetical progression.

Therefore, by the Lemma to Prop. 1,

$$\Delta A + E\Gamma + \dots < 2(\Delta A + E\Xi + \dots).$$

GREEK MATHEMATICS

ἢ διπλάσιαι· δῆλον οὖν, ὅτι καὶ οἱ κυλίνδρῳι πάντες οἱ ἐν τῷ ὅλῳ κυλίνδρῳ ἐλάσσονές ἐντι ἢ διπλάσιοι τῶν κυλίνδρων τῶν ἐν τῷ περιγεγραμμένῳ σχήματι· ὁ ἄρα κύλινδρος ὁ βάσιν ἔχων τὸν κύκλον τὸν περὶ διάμετρον τὰν ΑΓ, ἄξονα δὲ τὰν ΒΔ, ἐλάσσων ἐστὶν ἢ διπλασίῳν τοῦ περιγεγραμμένου σχήματος. οὐκ ἔστι δέ, ἀλλὰ μείζων ἢ διπλάσιος· τοῦ γὰρ Ψ κώνου διπλασίῳν ἐστί, τὸ δὲ περιγεγραμμένον σχῆμα ἔλαττον ἐδείχθη τοῦ Ψ κώνου. οὐκ ἄρα ἐστὶν οὐδὲ ἔλασσον τὸ τοῦ κωνοειδέος τμᾶμα τοῦ Ψ κώνου. ἐδείχθη δέ, ὅτι οὐδὲ μείζον ἡμιόλιον ἄρα ἐστὶν τοῦ κώνου τοῦ βάσιν ἔχοντος τὰν αὐτὰν τῷ τμᾶματι καὶ ἄξονα τὸν αὐτόν.

^a Archimedes' proof may be shown to be equivalent to an integration, as Heath has done (*The Works of Archimedes*, cxlvii-cxlviii).

For, if n be the number of cylinders in the whole cylinder, and $\Delta\delta = nh$, Archimedes has shown that

$$\frac{\text{Whole cylinder}}{\text{Inscribed figure}} = \frac{n^2h}{h + 2h + 3h + \dots + (n-1)h} > 2, \quad [\text{Lemma to Prop. 1}]$$

and

$$\frac{\text{Whole cylinder}}{\text{Circumscribed figure}} = \frac{n^2h}{n + 2h + 3h + \dots + nh} < 2. \quad [\textit{ibid.}]$$

In Props. 19 and 20 he has meanwhile shown that, by increasing n sufficiently, the inscribed and circumscribed figures can be made to differ by less than any assigned volume.

ARCHIMEDES

that the sum of all the cylinders in the whole cylinder is less than double of the cylinders in the circumscribed figure ; therefore the cylinder having for its base the circle about the diameter $A\Gamma$ and for axis $B\Delta$ is less than double of the circumscribed figure. But it is not, for it is greater than double ; for it is double of the cone Ψ , and the circumscribed figure was proved to be less than the cone Ψ . Therefore the segment of the conoid is not less than the cone Ψ . But it was proved not to be greater ; therefore it is one-and-a-half times the cone having the same base as the segment and the same axis.^a

When n is increased, h is diminished, but their product remains constant ; let $nh=c$.

Then the proof is equivalent to an assertion that, when n is indefinitely increased,

limit of $h[h+2h+3h+\dots+(n-1)h]=\frac{1}{2}c^2$,

which, in the notation of the integral calculus reads,

$$\int_0^c x dx = \frac{1}{2}c^2.$$

If the paraboloid is formed by the revolution of the parabola $y^2=ax$ about its axis, we should express the volume of a segment as

$$\int_0^c \pi y^2 dx,$$

or
$$\pi a \int_0^c x dx.$$

The constant does not appear in Archimedes' proof because he merely compares the volume of the segment with the cone, and does not give its absolute value. But his method is seen to be equivalent to a genuine integration.

As in other cases, Archimedes refrains from the final step of making the divisions in his circumscribed and inscribed figures indefinitely large ; he proceeds by the orthodox method of *reductio ad absurdum*.

GREEK MATHEMATICS

(e) THE SPIRAL OF ARCHIMEDES

(i.) Definitions

Archim. *De Lin. Spir.*, Deff., Archim. ed. Heiberg II.
44. 17-46. 21

α'. Εἴ κα εὐθεία ἐπιζευχθῆ γραμμὰ ἐν ἐπιπέδῳ καὶ μένοντος τοῦ ἐτέρου πέρατος αὐτᾶς ἰσοταχέως περιενεχθεῖσα ὄσακισοῦν ἀποκατασταθῆ πάλιν, ὅθεν ὤρμασεν, ἅμα δὲ τᾷ γραμμᾷ περιαγομένα φέρηται τι σαμεῖον ἰσοταχέως αὐτὸ ἐαυτῷ κατὰ τᾶς εὐθείας ἀρξάμενον ἀπὸ τοῦ μένοντος πέρατος, τὸ σαμεῖον ἔλικα γράψει ἐν τῷ ἐπιπέδῳ.

β'. Καλείσθω οὖν τὸ μὲν πέρασ τᾶς εὐθείας τὸ μένον περιαγομένας αὐτᾶς ἀρχὰ τᾶς ἔλικος.

γ'. Ἄ δὲ θέσις τᾶς γραμμᾶς, ἀφ' ἧς ἀρξάτο ἡ εὐθεία περιφέρεισθαι, ἀρχὰ τῆς περιφορᾶς.

δ'. Εὐθεία, ἂν μὲν ἐν τᾷ πρώτῃ περιφορᾷ διαπορευθῆ τὸ σαμεῖον τὸ κατὰ τᾶς εὐθείας φερόμενον, πρώτα καλείσθω, ἂν δ' ἐν τᾷ δευτέρῃ περιφορᾷ τὸ αὐτὸ σαμεῖον διανύσῃ, δευτέρα, καὶ αἱ ἄλλαι ὁμοίως ταύταις ὁμωνύμως ταῖς περιφοραῖς καλείσθωσαν.

ε'. Τὸ δὲ χωρίον τὸ περιλαφθὲν ὑπὸ τε τᾶς ἔλικος τᾶς ἐν τᾷ πρώτῃ περιφορᾷ γραφείσας καὶ τᾶς εὐθείας, ἃ ἔστιν πρώτα, πρῶτον καλείσθω, τὸ δὲ περιλαφθὲν ὑπὸ τε τᾶς ἔλικος τᾶς ἐν τᾷ δευτέρῃ περιφορᾷ γραφείσας καὶ τᾶς εὐθείας τᾶς δευτέρας δεύτερον καλείσθω, καὶ τὰ ἄλλα ἐξῆς οὕτω καλείσθω.

ς'. Καὶ εἴ κα ἀπὸ τοῦ σαμεῖου, ὃ ἔστιν ἀρχὰ τᾶς ἔλικος, ἀχθῆ τις εὐθεία γραμμὰ, τᾶς εὐθείας ταύτας

ARCHIMEDES

(e) THE SPIRAL OF ARCHIMEDES

(i.) *Definitions*

Archimedes, *On Spirals*, Definitions, Archim. ed.
Heiberg ii. 44. 17-46. 21

1. If a straight line drawn in a plane revolve uniformly any number of times about a fixed extremity until it return to its original position, and if, at the same time as the line revolves, a point move uniformly along the straight line, beginning at the fixed extremity, the point will describe a *spiral* in the plane.

2. Let the extremity of the straight line which remains fixed while the straight line revolves be called the *origin* of the spiral.

3. Let the position of the line, from which the straight line began to revolve, be called the *initial line* of the revolution.

4. Let the distance along the straight line which the point moving along the straight line traverses in the first turn be called the *first distance*, let the distance which the same point traverses in the second turn be called the *second distance*, and in the same way let the other distances be called according to the number of turns.

5. Let the area comprised between the first turn of the spiral and the first distance be called the *first area*, let the area comprised between the second turn of the spiral and the second distance be called the *second area*, and let the remaining areas be so called in order.

6. And if any straight line be drawn from the origin, let [points] on the side of this straight line in

τὰ ἐπὶ τὰ αὐτά, ἐφ' ἃ καὶ ἡ περιφορὰ γένηται, προαγόμενα καλείσθω, τὰ δὲ ἐπὶ θάτερα ἐπόμενα.

ζ'. Ὁ τε γραφεὶς κύκλος κέντρῳ μὲν τῷ σαμείῳ, ὃ ἔστιν ἀρχὰ τῆς ἑλικος, διαστήματι δὲ τῇ εὐθείᾳ, ἃ ἔστιν πρῶτα, πρῶτος καλείσθω, ὁ δὲ γραφεὶς κέντρῳ μὲν τῷ αὐτῷ, διαστήματι δὲ τῇ διπλασίᾳ εὐθείᾳ δεύτερος καλείσθω, καὶ οἱ ἄλλοι δὲ ἐξῆς τούτοις τὸν αὐτὸν τρόπον.

(ii.) *Fundamental Property*

Ibid., Prop. 14, Archim. ed. Heiberg ii. 50. 9-52. 15

Εἴ κα ποτὶ τὰν ἑλικά τὰν ἐν τῇ πρῶτῃ περιφορᾷ γεγραμμένας ποτιπεσῶντι δύο εὐθεῖαι ἀπὸ τοῦ σαμείου, ὃ ἔστιν ἀρχὰ τῆς ἑλικος, καὶ ἐκβληθῶντι ποτὶ τὰν τοῦ πρῶτου κύκλου περιφέρειαν, τὸν αὐτὸν ἐξοῦντι λόγον αἱ ποτὶ τὰν ἑλικά ποτιπίπτουσαι ποτ' ἀλλάλας, ὧν αἱ περιφέρειαι τοῦ κύκλου αἱ μεταξὺ τοῦ πέρατος τῆς ἑλικος καὶ τῶν περάτων τῶν ἐκβληθεισῶν εὐθειῶν τῶν ἐπὶ τῆς περιφέρειᾳς γινομένων, ἐπὶ τὰ προαγόμενα λαμβανομενῶν τῶν περιφερειῶν ἀπὸ τοῦ πέρατος τῆς ἑλικος.

Ἐστω ἑλιξ ἡ ΑΒΓΔΕΘ ἐν τῇ πρῶτῃ περιφορᾷ γεγραμμένη, ἀρχὰ δὲ τῆς μὲν ἑλικος ἔστω τὸ Α σαμείον, ἡ δὲ ΘΑ εὐθεῖα ἀρχὰ τῆς περιφορᾶς ἔστω, καὶ κύκλος ὁ ΘΚΗ ἔστω ὁ πρῶτος, ποτιπιπτόντων δὲ ἀπὸ τοῦ Α σαμείου ποτὶ τὰν ἑλικά αἱ ΑΕ, ΑΔ καὶ ἐκπιπτόντων ποτὶ τὰν τοῦ κύκλου περιφέρειαν ἐπὶ τὰ Ζ, Η. δεικτέον, ὅτι τὸν αὐτὸν ἔχοντι λόγον ἡ ΑΕ ποτὶ τὰν ΑΔ, ὧν ἡ ΘΚΖ περιφέρεια ποτὶ τὰν ΘΚΗ περιφέρειαν.

Περιοιόμενας γὰρ τῆς ΑΘ γραμμῆς δῆλον, ὡς

ARCHIMEDES

the direction of the revolution be called *forward*, and let those on the other side be called *rearward*.

7. Let the circle described with the origin as centre and the first distance as radius be called the *first circle*, let the circle described with the same centre and double of the radius of the first circle^a be called the *second circle*, and let the remaining circles in order be called after the same manner.

(ii.) *Fundamental Property*

Ibid., Prop. 14, Archim. ed. Heiberg ii. 50. 9-52. 15

If, from the origin of the spiral, two straight lines be drawn to meet the first turn of the spiral and produced to meet the circumference of the first circle, the lines drawn to the spiral will have the same ratio one to the other as the arcs of the circle between the extremity of the spiral and the extremities of the straight lines produced to meet the circumference, the arcs being measured in a forward direction from the extremity of the spiral.

Let $AB\Gamma\Delta E\Theta$ be the first turn of a spiral, let the point A be the origin of the spiral, let ΘA be the initial line, let ΘKH be the first circle, and from the point A let $AE, A\Delta$ be drawn to meet the spiral and be produced to meet the circumference of the circle at Z, H. It is required to prove that $AE : A\Delta = \text{arc } \Theta KZ : \text{arc } \Theta KH$.

When the line $A\Theta$ revolves it is clear that the point

^a *i.e.*, with radius equal to the sum of the radii of the first and second circles.

ARCHIMEDES

Θ moves uniformly round the circumference ΘKH of the circle while the point A , which moves along the straight line, traverses the line $A\Theta$; the point Θ which moves round the circumference of the circle traverses the arc ΘKZ while A traverses the straight line AE ; and furthermore the point A traverses the line $A\Delta$ in the same time as Θ traverses the arc ΘKH , each moving uniformly; it is clear, therefore, that $AE : A\Delta = \text{arc } \Theta KZ : \text{arc } \Theta KH$ [Prop. 2].

Similarly it may be shown that if one of the straight lines be drawn to the extremity of the spiral the same conclusion follows.^a

(iii.) *A Verging*^b

Ibid., Prop. 7, Archim. ed. Heiberg ii. 22. 14–24. 7

With the same data and the chord in the circle produced,^c it is possible to draw a line from the centre to meet

• In Prop. 15 Archimedes shows (using different letters, however) that if $AE, A\Delta$ are drawn to meet the *second* turn of the spiral, while AZ, AH are drawn, as before, to meet the circumference of the *first* circle, then

$$AE : A\Delta = \text{arc } \Theta KZ + \text{circumference of first circle} : \text{arc } \Theta KH + \text{circumference of first circle},$$

and so on for higher turns.

In general, if E, Δ lie on the n th turn of the spiral, and the circumference of the first circle is c , then

$$AE : A\Delta = \text{arc } \Theta KZ + \overline{n - 1c} : \text{arc } \Theta KH + \overline{n - 1c}.$$

These theorems correspond to the equation of the curve $r = a\theta$ in polar co-ordinates.

^b This theorem is essential to the one that follows.

^c See n. a on this page.

¹ δέδεικται . . . πρώτοις om. Heiberg.

κέντρου ποτιβαλεῖν ποτὶ τὰν ἐκβεβλημέναν, ὥστε τὰν μεταξὺ τᾶς περιφερείας καὶ τᾶς ἐκβεβλημένας ποτὶ τὰν ἐπιζευχθεῖσαν ἀπὸ τοῦ πέρατος τᾶς ἐναπολαφθείσας ποτὶ τὸ πέρας τᾶς ἐκβεβλημένας τὸν ταχθέντα λόγον ἔχειν, εἴ καὶ ὁ δοθεὶς λόγος μείζων ἢ τοῦ, ὃν ἔχει ἡ ἡμίσεια τᾶς ἐν τῷ κύκλῳ δεδομένας ποτὶ τὰν ἀπὸ τοῦ κέντρου κάθετον ἐπ' αὐτὰν ἀγμέναν.

Δεδόσθω τὰ αὐτά, καὶ ἔστω ἡ ἐν τῷ κύκλῳ γραμμὰ ἐκβεβλημένα, ὁ δὲ δοθεὶς λόγος ἔστω, ὃν ἔχει ἡ Ζ ποτὶ τὰν Η, μείζων τοῦ, ὃν ἔχει ἡ ΓΘ ποτὶ τὰν ΘΚ· μείζων οὖν ἔσσειται καὶ τοῦ, ὃν ἔχει ἡ ΚΓ ποτὶ ΓΛ. ὃν δὴ λόγον ἔχει ἡ Ζ ποτὶ Η τοῦτον ἔξει ἡ ΚΓ ποτὶ ἐλάσσονα τᾶς ΓΛ. ἐχέτω ποτὶ ΙΝ νεύουσαν ἐπὶ τὸ Γ—δυνατὸν δέ ἐστὶν οὕτως τέμνειν—καὶ πεσειται ἐντὸς τᾶς ΓΛ, ἐπειδὴ ἐλάσσων ἐστὶ τᾶς ΓΛ. ἐπεὶ οὖν τὸν αὐτὸν ἔχει λόγον ἡ ΚΓ ποτὶ ΙΝ, ὃν ἡ Ζ ποτὶ Η, καὶ ἡ ΕΙ ποτὶ ΙΓ τὸν αὐτὸν ἔξει λόγον, ὃν ἡ Ζ ποτὶ τὰν Η.

* ΑΓ is a chord in a circle of centre K, and BN is the diameter drawn parallel to ΑΓ and produced. From K, ΚΘ is drawn perpendicular to ΑΓ, and ΓΛ is drawn perpendicular to ΚΓ so as to meet the diameter in Λ. Archimedes asserts that it is possible to draw KE to meet the circle in I and ΑΓ produced in E so that ΕΙ : ΙΓ = Ζ : Η, an assigned ratio, provided that Ζ : Η > ΓΘ : ΘΚ. The straight line ΠΙ meets ΒΑ in Ν. In Prop. 5 Archimedes has proved a similar proposition when ΑΓ is a tangent, and in Prop. 6 he has proved the proposition for the case where the positions of I, Γ are reversed.

^b For triangle ΠΙΕ is similar to triangle ΚΙΝ, and therefore ΚΙ : ΙΝ = ΕΙ : ΙΓ [Eucl. vi. 4]; and ΚΙ = ΚΓ.

^c The type of problem known as νεύσεις, *vergings*, has already been encountered (vol. i. p. 244 n. a). In this proposition, as in Props. 5 and 6, Archimedes gives no hint how

ARCHIMEDES

the produced chord so that the distance between the circumference and the produced chord shall bear to the distance between the extremity of the line intercepted [by the circle] and the extremity of the produced chord an assigned ratio, provided that the given ratio is greater than that which half of the given chord in the circle bears to the perpendicular drawn to it from the centre.

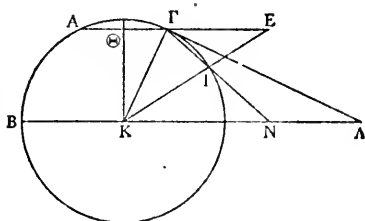

H —————

Z' —————

Let the same things be given,^a and let the chord in the circle be produced, and let the given ratio be $Z : H$, and let it be greater than $\Gamma\Theta : \Theta K$; therefore it will be greater than $K\Gamma : \Gamma\Lambda$ [Eucl. vi. 4]. Then $Z : H$ is equal to the ratio of $K\Gamma$ to some line less than $\Gamma\Lambda$ [Eucl. v. 10]. Let it be to IN verging upon Γ —for it is possible to make such an intercept—and IN will fall within $\Gamma\Lambda$, since it is less than $\Gamma\Lambda$.

Then since $K\Gamma : IN = Z : H$,
therefore^b $EI : I\Gamma = Z : H$.^c

the construction is to be accomplished, though he was presumably familiar with a solution.

In the figure of the text, let T be the foot of the perpen-

GREEK MATHEMATICS

(iv.) *Property of the Subtangent*

Ibid., Prop. 20, Archim. ed. Heiberg ii. 72. 4-74. 26

Εἴ κα τᾶς ἑλικος τᾶς ἐν τᾷ πρώτῃ περιφορᾷ γεγραμμένας εὐθεῖα γραμμὰ ἐπιψαύῃ μὴ κατὰ τὸ πέρασ τᾶς ἑλικος, ἀπὸ δὲ τᾶς ἀφᾶς ἐπὶ τὴν ἀρχὰν τᾶς ἑλικος εὐθεῖα ἐπιζευχθῆ, καὶ κέντρῳ μὲν τᾷ ἀρχᾷ τᾶς ἑλικος, διαστήματι δὲ τᾷ ἐπιζευχθείσῃ κύκλος γραφῆ, ἀπὸ δὲ τᾶς ἀρχᾶς τᾶς ἑλικος ἀχθῆ τις ποτ' ὀρθὰς τᾷ ἀπὸ τᾶς ἀφᾶς ἐπὶ τὴν ἀρχὰν τᾶς ἑλικος ἐπιζευχθείσῃ, συμπεσεῖται αὐτὰ ποτὶ τὴν ἐπιψαύουσαν, καὶ ἔσσειται ἅ μεταξὺ εὐθεῖα τᾶς τε συμπτώσιος καὶ τᾶς ἀρχᾶς τᾶς ἑλικος ἴσα τᾷ περιφερείᾳ τοῦ γραφέντος κύκλου τᾷ μεταξὺ τᾶς ἀφᾶς καὶ τᾶς τομᾶς, καθ' ἃν τέμνει ὁ γραφεὶς κύκλος τὴν ἀρχὰν τᾶς περιφορᾶς, ἐπὶ τὰ προαγοῦμενα λαμβανομένας τᾶς περιφερείας ἀπὸ τοῦ σαμείου τοῦ ἐν τᾷ ἀρχᾷ τᾶς περιφορᾶς.

*Εστω ἑλιξ, ἐφ' ἧς ἅ ΑΒΓΔ, ἐν τᾷ πρώτῃ περιφορᾷ γεγραμμένα, καὶ ἐπιψαυέτω τις αὐτᾶς εὐθεῖα ἅ ΕΖ κατὰ τὸ Δ, ἀπὸ δὲ τοῦ Δ ποτὶ τὴν

dicular from Γ to ΒΔ, and let Δ be the other extremity of the diameter through Β. Let the unknown length KN= x , let ΓT= a , KT= b , ΒΔ= $2c$, and let IN= k , a given length.

Then

$$NI \cdot N\Gamma = N\Delta \cdot NB,$$

i.e.,

$$k\sqrt{a^2 + (x-b)^2} = (x-c)(x+c),$$

which, after rationalization, is an equation of the fourth degree in x .

Alternatively, if we denote NΓ by y , we can determine x and y by the two equations

$$\begin{aligned} y^2 &= a^2 + (x-b)^2, \\ ky &= x^2 - c^2, \end{aligned}$$

ARCHIMEDES

(iv.) *Property of the Subtangent*

Ibid., Prop. 20, Archim. ed. Heiberg ii. 72. 4-74. 26

If a straight line touch the first turn of the spiral other than at the extremity of the spiral, and from the point of contact a straight line be drawn to the origin, and with the origin as centre and this connecting line as radius a circle be drawn, and from the origin a straight line be drawn at right angles to the straight line joining the point of contact to the origin, it will meet the tangent, and the straight line between the point of meeting and the origin will be equal to the arc of the circle between the point of contact and the point in which the circle cuts the initial line, the arc being measured in the forward direction from the point on the initial line.

Let $AB\Gamma\Delta$ lie on the first turn of a spiral, and let

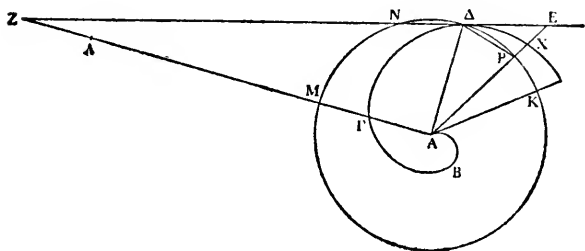

the straight line EZ touch it at Δ , and from Δ let $A\Delta$

so that values of x and y satisfying the conditions of the problem are given by the points of intersection of a certain parabola and a certain hyperbola.

The whole question of *vergings*, including this problem, is admirably discussed by Heath, *The Works of Archimedes*, c-cxxii.

GREEK MATHEMATICS

ἀρχὰν τῆς ἑλικὸς ἐπέζευχθῶ ἀ ΑΔ, καὶ κέντρῳ μὲν τῷ Α, διαστήματι δὲ τῷ ΑΔ κύκλος γεγράφθῳ ὁ ΔΜΝ, τεμνέτω δ' οὗτος τὴν ἀρχὰν τῆς περιφορᾶς κατὰ τὸ Κ, ἄχθῳ δὲ ἀ ΖΑ ποτὶ τὴν ΑΔ ὀρθά. ὅτι μὲν οὖν αὐτὰ συμπύπτει, δῆλον· ὅτι δὲ καὶ ἴσα ἐστὶν ἀ ΖΑ εὐθεῖα τῆ ΚΜΝΔ περιφερείᾳ, δεικτέον.

Εἰ γὰρ μή, ἦτοι μείζων ἐστὶν ἢ ἐλάσσων. ἔστω, εἰ δυνατόν, πρότερον μείζων, λελάφθῳ δέ τις ἀ ΛΑ τῆς μὲν ΖΑ εὐθείας ἐλάσσων, τῆς δὲ ΚΜΝΔ περιφερείας μείζων. πάλιν δὴ κύκλος ἐστὶν ὁ ΚΜΝ καὶ ἐν τῷ κύκλῳ γραμμὰ ἐλάσσων τῆς διαμέτρου ἀ ΔΝ καὶ λόγος, ὃν ἔχει ἀ ΔΑ ποτὶ ΑΛ, μείζων τοῦ, ὃν ἔχει ἀ ἡμίσεια τῆς ΔΝ ποτὶ τὴν ἀπὸ τοῦ Α κάθετον ἐπ' αὐτὴν ἀγμέναν· δυνατόν οὖν ἐστὶν ἀπὸ τοῦ Α ποτιβαλεῖν τὴν ΑΕ ποτὶ τὴν ΝΔ ἐκβεβλημένην, ὥστε τὴν ΕΡ ποτὶ τὴν ΔΡ τὸν αὐτὸν ἔχει λόγον, ὃν ἀ ΔΑ ποτὶ τὴν ΑΛ· δέδεικται γὰρ τοῦτο δυνατόν εἶναι· ἔξει οὖν καὶ ἀ ΕΡ ποτὶ τὴν ΑΡ τὸν αὐτὸν λόγον, ὃν ἀ ΔΡ ποτὶ τὴν ΑΛ. ἀ δὲ ΔΡ ποτὶ τὴν ΑΛ ἐλάσσονα λόγον ἔχει ἢ ἀ ΔΡ περιφέρεια ποτὶ τὴν ΚΜΔ περιφέρειαν, ἐπεὶ ἀ μὲν ΔΡ ἐλάσσων ἐστὶ τῆς ΔΡ περιφερείας, ἀ δὲ ΑΛ μείζων τῆς ΚΜΔ περιφερείας· ἐλάσσονα οὖν λόγον ἔχει ἀ ΕΡ εὐθεῖα ποτὶ ΡΑ ἢ ἀ ΔΡ περιφέρεια ποτὶ τὴν ΚΜΔ περιφέρειαν· ὥστε καὶ ἀ ΑΕ ποτὶ ΑΡ ἐλάσσονα λόγον ἔχει ἢ ἀ ΚΜΡ περιφέρεια ποτὶ τὴν ΚΜΔ περι-

^a For in Prop. 16 the angle ΑΔΖ was shown to be acute.

^b For ΔΝ touches the spiral and so can have no part within the spiral, and therefore cannot pass through Α; therefore it is a chord of the circle and less than the diameter.

^c For, if a perpendicular be drawn from Α to ΔΝ, it bisects

ARCHIMEDES

be drawn to the origin, and with centre A and radius $A\Delta$ let the circle ΔMN be described, and let this circle cut the initial line at K, and let ZA be drawn at right angles to $A\Delta$. That it will meet $[Z\Delta]$ is clear ^a; it is required to prove that the straight line ZA is equal to the arc $KMN\Delta$.

If not, it is either greater or less. Let it first be, if possible, greater, and let ΛA be taken less than the straight line ZA, but greater than the arc $KMN\Delta$ [Prop. 4]. Again, KMN is a circle, and in this circle ΔN is a line less than the diameter,^b and the ratio $\Delta A : \Lambda A$ is greater than the ratio of half ΔN to the perpendicular drawn to it from A ^c; it is therefore possible to draw from A a straight line ΛE meeting $N\Delta$ produced in such a way that

$$EP : \Delta P = \Delta A : \Lambda A ;$$

for this has been proved possible [Prop. 7]; therefore

$$EP : AP = \Delta P : \Lambda A.^d$$

But $\Delta P : \Lambda A < \text{arc } \Delta P : \text{arc } KM\Delta$,

since ΔP is less than the arc ΔP , and ΛA is greater than the arc $KM\Delta$;

$\therefore EP : PA < \text{arc } \Delta P : \text{arc } KM\Delta$;

$\therefore AE : AP < \text{arc } KMP : \text{arc } KM\Delta$.

[Eucl. v. 18

ΔN [Eucl. iii. 3] and divides triangle ΔAZ into two triangles of which one is similar to triangle ΔAZ [Eucl. vi. 8]; therefore

$$\Delta A : AZ = \frac{1}{2}N\Delta : (\text{perpendicular from A to } N\Delta).$$

[Eucl. vi. 4

But $AZ > \Lambda A$;

$\therefore \Delta A : \Lambda A > \frac{1}{2}N\Delta : (\text{perpendicular from A to } N\Delta)$.

^d For $\Delta A = AP$, being a radius of the same circle; and the proportion follows *permutando*.

GREEK MATHEMATICS

φέρειαν. ὄν δὲ λόγον ἔχει ἃ ΚΜΡ ποτὶ τὰν ΚΜΔ περιφέρειαν, τοῦτον ἔχει ἃ ΧΑ ποτὶ ΑΔ· ἐλάσσονα ἄρα λόγον ἔχει ἃ ΕΑ ποτὶ ΑΡ ἢ ἃ ΑΧ ποτὶ ΔΑ· ὅπερ ἐστὶν ἀδύνατον. οὐκ ἄρα μείζων ἃ ΖΑ τὰς ΚΜΔ περιφερείας. ὁμοίως δὲ τοῖς πρότερον δειχθήσεται, ὅτι οὐδὲ ἐλάσσων ἐστὶν ἴσα ἄρα.

(f) SEMI-REGULAR SOLIDS

Papp. *Coll.* v. 19, ed. Hultsch i. 352. 7-354. 10

Πολλὰ γὰρ ἐπινοῆσαι δυνατὸν στερεὰ σχήματα παντοίας ἐπιφανείας ἔχοντα, μᾶλλον δ' ἂν τις ἀξιώσει λόγου τὰ τετάχθαι δοκοῦντα [καὶ τούτων πολὺ πλεόν τούς τε κώνους καὶ κυλίνδρους καὶ τὰ καλούμενα πολύεδρα].¹ ταῦτα δ' ἐστὶν οὐ μόνον τὰ παρὰ τῷ θειοτάτῳ Πλάτωνι πέντε σχήματα, τουτέστιν τετράεδρόν τε καὶ ἑξάεδρον, ὀκτάεδρόν τε καὶ δωδεκάεδρον, πέμπτον δ' εἰκοσάεδρον, ἀλλὰ καὶ τὰ ὑπὸ Ἀρχιμήδους εὑρεθέντα τρισκαίδεκα τὸν ἀριθμὸν ὑπὸ ἰσοπλεύρων μὲν καὶ ἰσογωνίων οὐχ ὁμοίων δὲ πολυγώνων περιεχόμενα.

¹ καὶ . . . πολύεδρα om. Hultsch.

* This part of the proof involves a *verging* assumed in Prop. 8, just as the earlier part assumed the *verging* of Prop. 7. The *verging* of Prop. 8 has already been described (vol. i. p. 350 n. b) in connexion with Pappus's comments on it.

^b Archimedes goes on to show that the theorem is true even if the tangent touches the spiral in its second or some higher turn, not at the extremity of the turn; and in Props. 18 and 19 he has shown that the theorem is true if the tangent should touch at an extremity of a turn.

ARCHIMEDES

Now arc KMP : arc KMΔ = XA : AΔ ; [Prop. 14

∴ EA : AP < AX : ΔA ;

which is impossible. Therefore ZA is not greater than the arc KMΔ. In the same way as above it may be shown to be not less ^a ; therefore it is equal.^b

(f) SEMI-REGULAR SOLIDS

Pappus, *Collection* v. 19, ed. Hultsch i. 352. 7-354. 10

Although many solid figures having all kinds of surfaces can be conceived, those which appear to be regularly formed are most deserving of attention. Those include not only the five figures found in the godlike Plato, that is, the tetrahedron and the cube, the octahedron and the dodecahedron, and fifthly the icosahedron,^c but also the solids, thirteen in number, which were discovered by Archimedes^d and are contained by equilateral and equiangular, but not similar, polygons.

As Pappus (ed. Hultsch 302. 14-18) notes, the theorem can be established without recourse to propositions involving *solid loci* (for the meaning of which see vol. i. pp. 348-349), and proofs involving only "plane" methods have been developed by Tannery, *Mémoires scientifiques*, i., 1912, pp. 300-316 and Heath, *H.G.M.* ii. 556-561. It must remain a puzzle why Archimedes chose his particular method of proof, especially as Heath's proof is suggested by the figures of Props. 6 and 9 ; Heath (*loc. cit.*, p. 557) says " it is scarcely possible to assign any reason except his definite predilection for the form of proof by *reductio ad absurdum* based ultimately on his famous ' Lemma ' or Axiom."

^a For the five regular solids, see vol. i. pp. 216-225.

^d Heron (*Definitions* 104, ed. Heiberg 66. 1-9) asserts that two were known to Plato. One is that described as P_2 below, but the other, said to be bounded by eight squares and six triangles, is wrongly given.

GREEK MATHEMATICS

Τὸ μὲν γὰρ πρῶτον ὀκτάεδρόν ἐστιν περιεχόμενον ὑπὸ τριγώνων δ καὶ ἑξαγώνων δ .

Τρία δὲ μετὰ τοῦτο τεσσαρεσκαίδεκάεδρα, ὧν τὸ μὲν πρῶτον περιέχεται τριγώνοις η καὶ τετραγώνοις ϵ , τὸ δὲ δεύτερον τετραγώνοις ϵ καὶ ἑξαγώνοις η , τὸ δὲ τρίτον τριγώνοις η καὶ ὀκταγώνοις ϵ .

Μετὰ δὲ ταῦτα ἑκκαικκοσάεδρά ἐστιν δύο, ὧν τὸ μὲν πρῶτον περιέχεται τριγώνοις η καὶ τετραγώνοις $\overline{\eta}$, τὸ δὲ δεύτερον τετραγώνοις $\overline{\beta}$, ἑξαγώνοις η καὶ ὀκταγώνοις ϵ .

Μετὰ δὲ ταῦτα δυοκαιτριακοντάεδρά ἐστιν τρία, ὧν τὸ μὲν πρῶτον περιέχεται τριγώνοις $\bar{\kappa}$ καὶ πενταγώνοις $\overline{\beta}$, τὸ δὲ δεύτερον πενταγώνοις $\overline{\beta}$ καὶ ἑξαγώνοις $\bar{\kappa}$, τὸ δὲ τρίτον τριγώνοις $\bar{\kappa}$ καὶ δεκαγώνοις $\overline{\beta}$.

Μετὰ δὲ ταῦτα ἓν ἐστιν ὀκτωκαιτριακοντάεδρον περιεχόμενον ὑπὸ τριγώνων $\overline{\lambda\beta}$ καὶ τετραγώνων ϵ .

Μετὰ δὲ τοῦτο δυοκαιεξηκοντάεδρά ἐστι δύο, ὧν τὸ μὲν πρῶτον περιέχεται τριγώνοις $\bar{\kappa}$ καὶ τετραγώνοις $\bar{\lambda}$ καὶ πενταγώνοις $\overline{\beta}$, τὸ δὲ δεύτερον τετραγώνοις $\bar{\lambda}$ καὶ ἑξαγώνοις $\bar{\kappa}$ καὶ δεκαγώνοις $\overline{\beta}$.

Μετὰ δὲ ταῦτα τελευταῖόν ἐστιν δυοκαιεννηκοντάεδρον, ὃ περιέχεται τριγώνοις $\bar{\pi}$ καὶ πενταγώνοις $\overline{\beta}$.

^a For the purposes of n. b, the thirteen polyhedra will be designated as $P_1, P_2 \dots P_{13}$.

^b Kepler, in his *Harmonice mundi* (*Opera*, 1864, v. 123-126), appears to have been the first to examine these figures systematically, though a method of obtaining some is given in a scholium to the Vatican ms. of Pappus. If a solid angle of a regular solid be cut by a plane so that the same length is cut off from each of the edges meeting at the solid angle,

ARCHIMEDES

The first is a figure of eight bases, being contained by four triangles and four hexagons [P_1].^a

After this come three figures of fourteen bases, the first contained by eight triangles and six squares [P_2], the second by six squares and eight hexagons [P_3], and the third by eight triangles and six octagons [P_4].

After these come two figures of twenty-six bases, the first contained by eight triangles and eighteen squares [P_5], the second by twelve squares, eight hexagons and six octagons [P_6].

After these come three figures of thirty-two bases, the first contained by twenty triangles and twelve pentagons [P_7], the second by twelve pentagons and twenty hexagons [P_8], and the third by twenty triangles and twelve decagons [P_9].

After these comes one figure of thirty-eight bases, being contained by thirty-two triangles and six squares [P_{10}].

After this come two figures of sixty-two bases, the first contained by twenty triangles, thirty squares and twelve pentagons [P_{11}], the second by thirty squares, twenty hexagons and twelve decagons [P_{12}].

After these there comes lastly a figure of ninety-two bases, which is contained by eighty triangles and twelve pentagons [P_{13}].^b

the section is a regular polygon which is a triangle, square or pentagon according as the solid angle is composed of three, four or five plane angles. If certain equal lengths be cut off in this way from all the solid angles, regular polygons will also be left in the faces of the solid. This happens (i) obviously when the cutting planes bisect the edges of the solid, and (ii) when the cutting planes cut off a smaller length from each edge in such a way that a regular polygon is left in each face with double the number of sides. This method gives (1) from the tetrahedron, P_1 ; (2) from the

GREEK MATHEMATICS

(g) SYSTEM OF EXPRESSING LARGE NUMBERS

Archim. *Aren.* 3, Archim. ed. Heiberg ii. 236. 17-240. 1

“Α μὲν οὖν ὑποτίθεμαι, ταῦτα· χρήσιμον δὲ εἶμεν ὑπολαμβάνω τὰν κατονόμαξιν τῶν ἀριθμῶν ῥηθῆμεν, ὅπως καὶ τῶν ἄλλων οἱ τῷ βιβλίῳ μὴ περιτετευχότες τῷ ποτὶ Ζεῦξιππον γεγραμμένῳ μὴ πλανῶνται διὰ τὸ μηδὲν εἶμεν ὑπὲρ αὐτὰς ἐν τῷδε τῷ βιβλίῳ προειρημένον. συμβαίνει δὴ τὰ ὀνόματα τῶν ἀριθμῶν ἐς τὸ μὲν τῶν μυρίων ὑπάρχειν ἀμὴν παραδεδομένα, καὶ ὑπὲρ τὸ τῶν μυρίων [μὲν]¹ ἀποχρεόντως γινώσκομες μυριάδων ἀριθμὸν λέγοντες ἔστε ποτὶ τὰς μυρίας μυριάδας. ἔστων οὖν ἀμὴν οἱ μὲν νῦν εἰρημένοι ἀριθμοὶ ἐς τὰς μυρίας μυριάδας πρῶτοι καλουμένοι, τῶν δὲ πρῶτων ἀριθμῶν αἱ μύριαι μυριάδες μονὰς καλείσθω δευτέρων ἀριθμῶν, καὶ ἀριθμείσθων τῶν δευτέρων μονάδες καὶ ἐκ τῶν μονάδων δεκάδες καὶ ἑκατοντάδες καὶ χιλιάδες καὶ μυριάδες ἐς τὰς μυρίας μυριάδας. πάλιν δὲ καὶ αἱ μύριαι μυριάδες τῶν δευτέρων ἀριθμῶν μονὰς καλείσθω τρίτων ἀριθμῶν, καὶ ἀριθμείσθων τῶν τρίτων ἀριθμῶν μονάδες καὶ ἀπὸ τῶν μονάδων δεκάδες καὶ ἑκατοντάδες καὶ χιλιάδες καὶ μυριάδες ἐς τὰς μυρίας μυριάδας. τὸν αὐτὸν δὲ τρόπον καὶ τῶν τρίτων ἀριθμῶν μύριαι μυριάδες μονὰς καλείσθω τετάρτων ἀριθμῶν,

¹ μὲν om. Heiberg.

cube, P_2 and P_4 ; (3) from the octahedron, P_2 and P_3 ; (4) from the icosahedron, P_7 and P_8 ; (5) from the dodecahedron, P_7 and P_8 . It was probably the method used by Plato.

Four more of the semi-regular solids are obtained by first cutting all the edges symmetrically and equally by planes parallel to the edges, and then cutting off angles. This

198

ARCHIMEDES

(g) SYSTEM OF EXPRESSING LARGE NUMBERS

Archimedes, *Sand-Reckoner* 3, Archim. ed.

Heiberg ii. 236. 17-240. 1

Such are then the assumptions I make; but I think it would be useful to explain the naming of the numbers, in order that, as in other matters, those who have not come across the book sent to Zeuxippus may not find themselves in difficulty through the fact that there had been no preliminary discussion of it in this book. Now we already have names for the numbers up to a myriad [10^4], and beyond a myriad we can count in myriads up to a myriad myriads [10^8]. Therefore, let the aforesaid numbers up to a myriad myriads be called *numbers of the first order* [numbers from 1 to 10^8], and let a myriad myriads of numbers of the first order be called a unit of *numbers of the second order* [numbers from 10^8 to 10^{16}], and let units of the numbers of the second order be enumerable, and out of the units let there be formed tens and hundreds and thousands and myriads up to a myriad myriads. Again, let a myriad myriads of numbers of the second order be called a unit of *numbers of the third order* [numbers from 10^{16} to 10^{24}], and let units of numbers of the third order be enumerable, and from the units let there be formed tens and hundreds and thousands and myriads up to a myriad myriads. In the same manner, let a myriad myriads of numbers of the third order be gives (1) from the cube, P_5 and P_6 ; (2) from the icosahedron, P_{11} ; (3) from the dodecahedron, P_{12} .

The two remaining solids are more difficult to obtain; P_{10} is the *snub cube* in which each solid angle is formed by the angles of four equilateral triangles and one square; P_{13} is the *snub dodecahedron* in which each solid angle is formed by the angles of four equilateral triangles and one regular pentagon.

GREEK MATHEMATICS

καὶ αἱ τῶν τετάρτων ἀριθμῶν μύριαι μυριάδες μονὰς καλείσθω πέμπτων ἀριθμῶν, καὶ αἰ οὕτως προάγοντες οἱ ἀριθμοὶ τὰ ὀνόματα ἔχόντων ἐς τὰς μυριακισμυριοστῶν ἀριθμῶν μυρίας μυριάδας.

Ἀποχρέοντι μὲν οὖν καὶ ἐπὶ τοσοῦτον οἱ ἀριθμοὶ γινγνωσκομένοι, ἔξεστι δὲ καὶ ἐπὶ πλέον προάγειν. ἔστων γὰρ οἱ μὲν νῦν εἰρημένοι ἀριθμοὶ πρώτας περιόδου καλουμένοι, ὁ δὲ ἔσχατος ἀριθμὸς τῆς πρώτας περιόδου μονὰς καλείσθω δευτέρας περιόδου πρώτων ἀριθμῶν. πάλιν δὲ καὶ αἱ μύριαι μυριάδες τῆς δευτέρας περιόδου πρώτων ἀριθμῶν μονὰς καλείσθω τῆς δευτέρας περιόδου δευτέρων ἀριθμῶν. ὁμοίως δὲ καὶ τούτων ὁ ἔσχατος μονὰς καλείσθω δευτέρας περιόδου τρίτων ἀριθμῶν, καὶ αἰ οὕτως οἱ ἀριθμοὶ προάγοντες τὰ ὀνόματα ἔχόντων τῆς δευτέρας περιόδου ἐς τὰς μυριακισμυριοστῶν ἀριθμῶν μυρίας μυριάδας.

Πάλιν δὲ καὶ ὁ ἔσχατος ἀριθμὸς τῆς δευτέρας περιόδου μονὰς καλείσθω τρίτας περιόδου πρώτων ἀριθμῶν, καὶ αἰ οὕτως προαγόντων ἐς τὰς μυριακισμυριοστῆς περιόδου μυριακισμυριοστῶν ἀριθμῶν μυρίας μυριάδας.

* Expressed in full, the last number would be 1 followed by 80,000 million millions of ciphers. Archimedes uses this system to show that it is more than sufficient to express the number of grains of sand which it would take to fill the universe, basing his argument on estimates by astronomers of the sizes and distances of the sun and moon and their relation to the size of the universe and allowing a wide margin for safety. Assuming that a poppy-head (for so *μήκων* is here to be understood, not "poppy-seed," v. D'Arcy W. Thompson, *The Classical Review*, lvi. (1942), p. 75) would contain not more than 10,000 grains of sand, and that its diameter is not less than a finger's breadth, and having proved that the

ARCHIMEDES

called a unit of *numbers of the fourth order* [numbers from 10^{24} to 10^{32}], and let a myriad myriads of numbers of the fourth order be called a unit of *numbers of the fifth order* [numbers from 10^{32} to 10^{40}], and let the process continue in this way until the designations reach a myriad myriads taken a myriad myriad times [$10^8 \cdot 10^8$].

It is sufficient to know the numbers up to this point, but we may go beyond it. For let the numbers now mentioned be called *numbers of the first period* [1 to $10^8 \cdot 10^8$], and let the last number of the first period be called a unit of *numbers of the first order of the second period* [$10^8 \cdot 10^8$ to $10^8 \cdot 10^8 \cdot 10^8$]. And again, let a myriad myriads of numbers of the first order of the second period be called a unit of *numbers of the second order of the second period* [$10^8 \cdot 10^8 \cdot 10^8$ to $10^8 \cdot 10^8 \cdot 10^{16}$]. Similarly let the last of these numbers be called a unit of *numbers of the third order of the second period* [$10^8 \cdot 10^8 \cdot 10^{16}$ to $10^8 \cdot 10^8 \cdot 10^{24}$], and let the process continue in this way until the designations of numbers in the second period reach a myriad myriads taken a myriad myriad times [$10^8 \cdot 10^8 \cdot 10^8 \cdot 10^8$, or $(10^8 \cdot 10^8)^2$].

Again, let the last number of the second period be called a unit of *numbers of the first order of the third period* [$(10^8 \cdot 10^8)^2$ to $(10^8 \cdot 10^8)^2 \cdot 10^8$], and let the process continue in this way up to a myriad myriad units of *numbers of the myriad myriadth order of the myriad myriadth period* [$(10^8 \cdot 10^8)^{10^8}$ or $10^8 \cdot 10^{16}$].^a

sphere of the fixed stars is less than 10^7 times the sphere in which the sun's orbit is a great circle, Archimedes shows that the number of grains of sand which would fill the universe is less than "10,000,000 units of the eighth order of numbers," or 10^{63} . The work contains several references important for the history of astronomy.

GREEK MATHEMATICS

(h) INDETERMINATE ANALYSIS : THE CATTLE PROBLEM

Archim. (?) *Prob. Bov.*, Archim. ed. Heiberg
ii. 528. 1-532. 9

Πρόβλημα

ὅπερ Ἀρχιμήδης ἐν ἐπιγράμμασιν εὐρῶν τοῖς ἐν Ἀλεξανδρείᾳ περὶ ταῦτα πραγματευομένοις ζητεῖν ἀπέστειλεν ἐν τῇ πρὸς Ἐρατοσθένην τὸν Κυρηναῖον ἐπιστολῇ.

Πληθὺν Ἡελίοιο βοῶν, ὧ ξεῖνε, μέτρησον
φροντίδ' ἐπιστήσας, εἰ μετέχεις σοφίης,
πόσση ἄρ' ἐν πεδίοις Σικελῆς ποτ' ἐβόσκετο νήσου
Θρινακίης τετραχῆ στίφεια δασσαμένη
χροιὴν ἀλλάσσοντα· τὸ μὲν λευκοῖο γάλακτος,
κυανέω δ' ἕτερον χρώματι λαμπόμενον,
ἄλλο γε μὲν ξανθόν, τὸ δὲ ποικίλον. ἐν δὲ ἐκάστῳ
στίφει ἔσαν ταῦροι πλήθει βριθόμενοι
συμμετρίας τοιῆσδε τετευχότες· ἀργότριχας μὲν
κυανέων ταύρων ἡμίσει ἠδὲ τρίτῳ
καὶ ξανθοῖς σύμπασιν ἴσους, ὧ ξεῖνε, νόησον,
αὐτὰρ κυανέους τῷ τετράτῳ τε μέρει
μικτοχρόων καὶ πέμπτῳ, ἔτι ξανθοῖσι τε πᾶσιν.
τοὺς δ' ὑπολειπομένους ποικιλόχρωτας ἄθρει
ἀργεννῶν ταύρων ἕκτῳ μέρει ἐβδομάτῳ τε
καὶ ξανθοῖς αὐτοὺς πᾶσιν ἰσαζόμενους.
θηλείαισι δὲ βουσί τὰδ' ἔπλετο· λευκότριχες μὲν
ἦσαν συμπάσης κυανέης ἀγέλης
τῷ τριτάτῳ τε μέρει καὶ τετράτῳ ἀτρεκὲς ἴσαι·
αὐτὰρ κυάνεαι τῷ τετράτῳ τε πάλιν
μικτοχρόων καὶ πέμπτῳ ὁμοῦ μέρει ἰσάζοντο
σὺν ταύροις πάσαις εἰς νομὸν ἐρχομέναις.

ARCHIMEDES

(h) INDETERMINATE ANALYSIS: THE CATTLE PROBLEM

Archimedes (?), *Cattle Problem*,^a Archim. ed. Heiberg
ii. 528. 1-532. 9

A PROBLEM

which Archimedes solved in epigrams, and which he communicated to students of such matters at Alexandria in a letter to Eratosthenes of Cyrene.

If thou art diligent and wise, O stranger, compute the number of cattle of the Sun, who once upon a time grazed on the fields of the Thrinacian isle of Sicily, divided into four herds of different colours, one milk white, another a glossy black, the third yellow and the last dappled. In each herd were bulls, mighty in number according to these proportions: Understand, stranger, that the white bulls were equal to a half and a third of the black together with the whole of the yellow, while the black were equal to the fourth part of the dappled and a fifth, together with, once more, the whole of the yellow. Observe further that the remaining bulls, the dappled, were equal to a sixth part of the white and a seventh, together with all the yellow. These were the proportions of the cows: The white were precisely equal to the third part and a fourth of the whole herd of the black; while the black were equal to the fourth part once more of the dappled and with it a fifth part, when all, including the bulls, went to pasture together. Now

^a It is unlikely that the epigram itself, first edited by G. E. Lessing in 1773, is the work of Archimedes, but there is ample evidence from antiquity that he studied the actual problem. The most important papers bearing on the subject have already been mentioned (vol. i. p. 16 n. c), and further references to the literature are given by Heiberg *ad loc.*

GREEK MATHEMATICS

ξανθοτρίχων δ' ἀγέλης πέμπτω μέρει ἠδὲ καὶ ἕκτω
 ποικίλαι ἰσάριθμον πλήθος ἔχον τετραχῆ.
 ξανθαὶ δ' ἠριθμεύντο μέρους τρίτου ἡμίσει ἴσαι
 ἀργεννῆς ἀγέλης ἑβδομάτῳ τε μέρει.
 ξεῖνε, σὺ δ', Ἡελίοιο βόες πόσαι, ἀτρεκὲς εἰπών,
 χωρὶς μὲν ταύρων ζατρεφέων ἀριθμόν,
 χωρὶς δ' αὖ, θήλειαι ὄσαι κατὰ χροιάν ἕκασται,
 οὐκ αἰδρίς κε λέγοι' οὐδ' ἀριθμῶν ἀδαής,
 οὐ μὴν πῶ γε σοφοῖς ἐναρίθμιος. ἀλλ' ἴθι φράζευ
 καὶ τάδε πάντα βοῶν Ἡελίοιο πάθη.
 ἀργότριχες ταῦροι μὲν ἐπεὶ μιξαίατο πληθὺν
 κυανέοις, ἴσταντ' ἔμπεδον ἰσόμετροι
 εἰς βάθος εἰς εὐρὸς τε, τὰ δ' αὖ περιμήκεα πάντη
 πῖμπλαντο πλήθους¹ Θρινακίης πεδία.
 ξανθοὶ δ' αὖτ' εἰς ἓν καὶ ποικίλοι ἀθροισθέντες
 ἴσταντ' ἀμβολάδην ἐξ ἑνὸς ἀρχόμενοι
 σχῆμα τελειοῦντες τὸ τρικράσπεδον οὔτε προσόντων
 ἀλλοχρόων ταύρων οὔτ' ἐπιλειπομένων.
 ταῦτα συνεξευρῶν καὶ ἐνὶ πραπίδεςσιν ἀθροίσας
 καὶ πληθέων ἀποδοῦς, ξεῖνε, τὰ πάντα μέτρα
 ἔρχεο κυδιόων νικηφόρος ἴσθι τε πάντως
 κεκριμένος ταύτῃ γ' ὄμπνιος ἐν σοφίῃ.

¹ πλήθους Krumbiegel, πλίνθου cod.

^a *i.e.* a fifth and a sixth both of the males and of the females.

^b At a first glance this would appear to mean that the sum of the number of white and black bulls is a square, but this makes the solution of the problem intolerably difficult. There is, however, an easier interpretation. If the bulls are packed together so as to form a square figure, their number need not be a square, since each bull is longer than it is broad. The simplified condition is that the sum of the number of white and black bulls shall be a rectangle.

ARCHIMEDES

the dappled in four parts^a were equal in number to a fifth part and a sixth of the yellow herd. Finally the yellow were in number equal to a sixth part and a seventh of the white herd. If thou canst accurately tell, O stranger, the number of cattle of the Sun, giving separately the number of well-fed bulls and again the number of females according to each colour, thou wouldst not be called unskilled or ignorant of numbers, but not yet shalt thou be numbered among the wise. But come, understand also all these conditions regarding the cows of the Sun. When the white bulls mingled their number with the black, they stood firm, equal in depth and breadth,^b and the plains of Thrinacia, stretching far in all ways, were filled with their multitude. Again, when the yellow and the dappled bulls were gathered into one herd they stood in such a manner that their number, beginning from one, grew slowly greater till it completed a triangular figure, there being no bulls of other colours in their midst nor none of them lacking. If thou art able, O stranger, to find out all these things and gather them together in your mind, giving all the relations, thou shalt depart crowned with glory and knowing that thou hast been adjudged perfect in this species of wisdom.^c

• If

X, x are the numbers of white bulls and cows respectively,

Y, y " " " black " " "

Z, z " " " yellow " " "

W, w " " " dappled " " "

the first part of the epigram states that

$$(a) \quad X = \left(\frac{1}{2} + \frac{1}{3}\right)Y + Z \quad . \quad . \quad . \quad . \quad (1)$$

$$Y = \left(\frac{1}{4} + \frac{1}{6}\right)W + Z \quad . \quad . \quad . \quad . \quad (2)$$

$$W = \left(\frac{1}{8} + \frac{1}{7}\right)X + Z \quad . \quad . \quad . \quad . \quad (3)$$

GREEK MATHEMATICS

(i) MECHANICS : CENTRES OF GRAVITY

(i.) Postulates

Archim. *De Plan. Aequil.*, Deff., Archim. ed.
Heiberg ii. 124. 3-126. 3

α'. Αἰτούμεθα τὰ ἴσα βάρεια ἀπὸ ἴσων μακέων ἰσορροπεῖν, τὰ δὲ ἴσα βάρεια ἀπὸ τῶν ἀνίσων μακέων μὴ ἰσορροπεῖν, ἀλλὰ ῥέπειν ἐπὶ τὸ βάρος τὸ ἀπὸ τοῦ μείζονος μάκεος.

(b)	$x = (\frac{1}{3} + \frac{1}{4})(Y + y)$	• • • •	(4)
	$y = (\frac{1}{4} + \frac{1}{5})(W + w)$	• • • •	(5)
	$w = (\frac{1}{5} + \frac{1}{6})(Z + z)$	• • • •	(6)
	$z = (\frac{1}{6} + \frac{1}{7})(X + x)$	• • • •	(7)

The second part of the epigram states that

$X + Y =$ a rectangular number	• •	(8)
$Z + W =$ a triangular number	• • •	(9)

This was solved by J. F. Wurm, and the solution is given by A. Amthor, *Zeitschrift für Math. u. Physik. (Hist.-litt. Abtheilung)*, xxv. (1880), pp. 153-171, and by Heath, *The Works of Archimedes*, pp. 319-326. For reasons of space, only the results can be noted here.

Equations (1) to (7) give the following as the values of the unknowns in terms of an unknown integer n :

$X = 10366482n$	$x = 7206360n$
$Y = 7460514n$	$y = 4893246n$
$Z = 4149387n$	$z = 5439213n$
$W = 7358060n$	$w = 3515820n$

We have now to find a value of n such that equation (9) is also satisfied—equation (8) will then be simultaneously satisfied. Equation (9) means that

$$Z + W = \frac{p(p+1)}{2},$$

where p is some positive integer, or

$$(4149387 + 7358060)n = \frac{p(p+1)}{2},$$

ARCHIMEDES

(i) MECHANICS : CENTRES OF GRAVITY

(i.) Postulates

Archimedes, *On Plane Equilibriums*,^a Definitions,
Archim. ed. Heiberg ii. 124. 3-126. 3

1. I postulate that equal weights at equal distances balance, and equal weights at unequal distances do not balance, but incline towards the weight which is at the greater distance.

i.e.
$$2471 \cdot 4657n = \frac{p(p+1)}{2} \bullet$$

This is found to be satisfied by

$$n = 3^3 \cdot 4349,$$

and the final solution is

$X = 1217263415886$	$x = 846192410280$
$Y = 876035935422$	$y = 574579625058$
$Z = 487233469701$	$z = 638688708099$
$W = 864005479380$	$w = 412838131860$

and the total is 5916837175686.

If equation (8) is taken to be that $X + Y =$ a square number, the solution is much more arduous; Amthor found that in this case,

$$W = 1598 \langle \overline{206541} \rangle,$$

where $\langle \overline{206541} \rangle$ means that there are 206541 more digits to follow, and the whole number of cattle = 7766 $\langle \overline{206541} \rangle$. Merely to write out the eight numbers, Amthor calculates, would require a volume of 660 pages, so we may reasonably doubt whether the problem was really framed in this more difficult form, or, if it were, whether Archimedes solved it.

^a This is the earliest surviving treatise on mechanics; it presumably had predecessors, but we may doubt whether mechanics had previously been developed by rigorous geometrical principles from a small number of assumptions. References to the principle of the lever and the parallelogram of velocities in the Aristotelian *Mechanics* have already been given (vol. i. pp. 430-433).

β'. εἴ κα βαρέων ἰσορροπεόντων ἀπό τινων μακέων ποτὶ τὸ ἕτερον τῶν βαρέων ποτιτεθῆ, μὴ ἰσορροπεῖν, ἀλλὰ ῥέπειν ἐπὶ τὸ βάρος ἐκείνο, ᾧ ποτετέθη.

γ'. Ὀμοίως δὲ καί, εἴ κα ἀπὸ τοῦ ἐτέρου τῶν βαρέων ἀφαιρεθῆ τι, μὴ ἰσορροπεῖν, ἀλλὰ ῥέπειν ἐπὶ τὸ βάρος, ἀφ' οὗ οὐκ ἀφηρέθη.

δ'. Τῶν ἴσων καὶ ὁμοίων σχημάτων ἐπιπέδων ἐφαρμοζομένων ἐπ' ἄλλαλα καὶ τὰ κέντρα τῶν βαρέων ἐφαρμόζει ἐπ' ἄλλαλα.

ε'. Τῶν δὲ ἀνίσων, ὁμοίων δέ, τὰ κέντρα τῶν βαρέων ὁμοίως ἐσσεῖται κείμενα. ὁμοίως δὲ λέγομεν σαμεῖα κέεσθαι ποτὶ τὰ ὁμοῖα σχήματα, ἀφ' ὧν ἐπὶ τὰς ἴσας γωνίας ἀγόμεναι εὐθεῖαι ποιέοντι γωνίας ἴσας ποτὶ τὰς ὁμολόγους πλευράς.

ς'. Εἴ κα μεγέθεα ἀπὸ τινων μακέων ἰσορροπέωντι, καὶ τὰ ἴσα αὐτοῖς ἀπὸ τῶν αὐτῶν μακέων ἰσορροπήσει.

ζ'. Παντὸς σχήματος, οὗ κα ἡ περίμετρος ἐπὶ τὰ αὐτὰ κοίλα ἦ, τὸ κέντρον τοῦ βάρους ἐντὸς εἴμεν δεῖ τοῦ σχήματος.

(ii.) *Principle of the Lever*

Ibid., Props. 6 et 7, Archim. ed. Heiberg ii. 132. 13-138. 8

ς'

Τὰ σύμμετρα μεγέθεα ἰσορροπέοντι ἀπὸ μακέων ἀντιπεπονηθῶς τὸν αὐτὸν λόγον ἐχόντων τοῖς βάρεσιν.

*Ἐστω σύμμετρα μεγέθεα τὰ Α, Β, ὧν κέντρα τὰ Α, Β, καὶ μᾶκος ἔστω τι τὸ ΕΔ, καὶ ἔστω, ὡς τὸ Α ποτὶ τὸ Β, οὕτως τὸ ΔΓ μᾶκος ποτὶ τὸ ΓΕ

ARCHIMEDES

2. If weights at certain distances balance, and something is added to one of the weights, they will not remain in equilibrium, but will incline towards that weight to which the addition was made.

3. Similarly, if anything be taken away from one of the weights, they will not remain in equilibrium, but will incline towards the weight from which nothing was subtracted.

4. When equal and similar plane figures are applied one to the other, their centres of gravity also coincide.

5. In unequal but similar figures, the centres of gravity will be similarly situated. By points similarly situated in relation to similar figures, I mean points such that, if straight lines be drawn from them to the equal angles, they make equal angles with the corresponding sides.

6. If magnitudes at certain distances balance, magnitudes equal to them will also balance at the same distances.

7. In any figure whose perimeter is concave in the same direction, the centre of gravity must be within the figure.

(ii.) *Principle of the Lever*

Ibid., Props. 6 and 7, Archim. ed. Heiberg
ii. 132. 13-138. 8

Prop. 6

Commensurable magnitudes balance at distances reciprocally proportional to their weights.

Let A, B be commensurable magnitudes with centres [of gravity] A, B, and let EΔ be any distance, and let

$$A : B = \Delta\Gamma : \Gamma E ;$$

GREEK MATHEMATICS

μᾶκος· δεικτέον, ὅτι τοῦ ἐξ ἀμφοτέρων τῶν Α, Β συγκειμένου μεγέθους κέντρον ἐστὶ τοῦ βάρους τὸ Γ.

Ἐπεὶ γὰρ ἐστὶν, ὡς τὸ Α ποτὶ τὸ Β, οὕτως τὸ ΔΓ ποτὶ τὸ ΓΕ, τὸ δὲ Α τῷ Β σύμμετρον, καὶ τὸ ΓΔ ἄρα τῷ ΓΕ σύμμετρον, τουτέστιν εὐθεία τῆ εὐθείᾳ· ὥστε τῶν ΕΓ, ΓΔ ἐστὶ κοινὸν μέτρον. ἔστω δὴ τὸ Ν, καὶ κείσθω τῆ μὲν ΕΓ ἴσα ἑκάτερα τῶν ΔΗ, ΔΚ, τῆ δὲ ΔΓ ἴσα ἡ ΕΛ. καὶ ἐπεὶ ἴσα

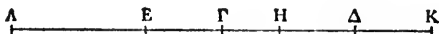
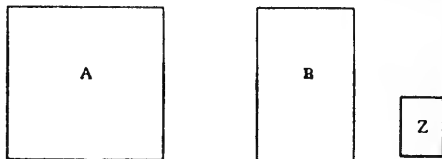

Ν

ἡ ΔΗ τῆ ΓΕ, ἴσα καὶ ἡ ΔΓ τῆ ΕΗ· ὥστε καὶ ἡ ΛΕ ἴσα τῆ ΕΗ. διπλασία ἄρα ἡ μὲν ΛΗ τῆς ΔΓ, ἡ δὲ ΗΚ τῆς ΓΕ· ὥστε τὸ Ν καὶ ἑκάτεραν τῶν ΛΗ, ΗΚ μετρεῖ, ἐπειδήπερ καὶ τὰ ἡμίσεια αὐτῶν. καὶ ἐπεὶ ἐστὶν, ὡς τὸ Α ποτὶ τὸ Β, οὕτως ἡ ΔΓ ποτὶ ΓΕ, ὡς δὲ ἡ ΔΓ ποτὶ ΓΕ, οὕτως ἡ ΛΗ ποτὶ ΗΚ—διπλασία γὰρ ἑκάτερα ἑκατέρας—καὶ ὡς ἄρα τὸ Α ποτὶ τὸ Β, οὕτως ἡ ΛΗ ποτὶ ΗΚ. ὅσαπλασίων δὲ ἐστὶν ἡ ΛΗ τῆς Ν, τοσαυ-

ARCHIMEDES

it is required to prove that the centre of gravity of the magnitude composed of both A, B is Γ .

Since $A : B = \Delta\Gamma : \Gamma E$,

and A is commensurate with B, therefore $\Gamma\Delta$ is commensurate with ΓE , that is, a straight line with a straight line [Eucl. x. 11]; so that $E\Gamma$, $\Gamma\Delta$ have a common measure. Let it be N, and let ΔH , ΔK be each equal to $E\Gamma$, and let $E\Lambda$ be equal to $\Delta\Gamma$. Then since $\Delta H = \Gamma E$, it follows that $\Delta\Gamma = EH$; so that $\Lambda EE = H$. Therefore $\Lambda H = 2\Delta\Gamma$ and $HK = 2\Gamma E$; so that N measures both ΛH and HK , since it measures their halves [Eucl. x. 12]. And since

$$A : B = \Delta\Gamma : \Gamma E,$$

while $\Delta\Gamma : \Gamma E = \Lambda H : HK$ —

for each is double of the other—

therefore $A : B = \Lambda H : HK$.

Now let Z be the same part of A as N is of ΛH ;

ταπλασίων ἔστω καὶ τὸ A τοῦ Z . ἔστιν ἄρα, ὡς ἂν ΛH ποτὶ N , οὕτως τὸ A ποτὶ Z . ἔστι δὲ καί, ὡς ἂν KH ποτὶ ΛH , οὕτως τὸ B ποτὶ A . δι' ἴσου ἄρα ἐστίν, ὡς ἂν KH ποτὶ N , οὕτως τὸ B ποτὶ Z . ἰσάκις ἄρα πολλαπλασίων ἐστίν ἂν KH τῆς N καὶ τὸ B τοῦ Z . ἐδείχθη δὲ τοῦ Z καὶ τὸ A πολλαπλάσιον ἑόν. ὥστε τὸ Z τῶν A, B κοινόν ἐστι μέτρον. διαιρεθείσας οὖν τῆς μὲν ΛH εἰς τὰς τῆ N ἴσας, τοῦ δὲ A εἰς τὰ τῶ Z ἴσα, τὰ ἐν τῇ ΛH τμήματα ἰσομεγέθηα τῇ N ἴσα ἐσσεύεται τῶ πλήθει τοῖς ἐν τῷ A τμαμάτεσσιν ἴσοις εὐοῦσιν τῶ Z . ὥστε, ἂν ἐφ' ἕκαστον τῶν τμαμάτων τῶν ἐν τῇ ΛH ἐπιτεθῆ μέγεθος ἴσον τῶ Z τὸ κέντρον τοῦ βάρους ἔχον ἐπὶ μέσου τοῦ τμήματος, τὰ τε πάντα μεγέθη ἴσα ἐντὶ τῶ A , καὶ τοῦ ἐκ πάντων συγκειμένου κέντρον ἐσσεύεται τοῦ βάρους τὸ E . ἄρτια τε γάρ ἐστι τὰ πάντα τῶ πλήθει, καὶ τὰ ἐφ' ἑκάτερα τοῦ E ἴσα τῶ πλήθει διὰ τὸ ἴσαν εἶμεν τὰν ΛE τῆ HE .

Ὅμοίως δὲ δειχθήσεται, ὅτι καὶ ἐφ' ἕκαστον τῶν ἐν τῇ KH τμαμάτων ἐπιτεθῆ μέγεθος ἴσον τῶ Z κέντρον τοῦ βάρους ἔχον ἐπὶ τοῦ μέσου τοῦ τμήματος, τὰ τε πάντα μεγέθη ἴσα ἐσσεύεται τῶ B , καὶ τοῦ ἐκ πάντων συγκειμένου κέντρον τοῦ βάρους ἐσσεύεται τὸ Δ . ἐσσεύεται οὖν τὸ μὲν A ἐπικείμενον κατὰ τὸ E , τὸ δὲ B κατὰ τὸ Δ . ἐσσεύεται δὴ μεγέθη ἴσα ἀλλάλοις ἐπ' εὐθείας κείμενα, ὧν τὰ κέντρα τοῦ βάρους ἴσα ἀπ' ἀλλάλων διέστακεν, [συγκείμενα]¹ ἄρτια τῶ πλήθει. δῆλον οὖν, ὅτι τοῦ ἐκ πάντων συγκειμένου μεγέθους κέντρον ἐστὶ τοῦ βάρους ἂν διχοτομία τῆς εὐθείας τῆς ἐχούσας τὰ κέντρα τῶν μέσων μεγεθῶν. ἐπεὶ δ' ἴσαι ἐντὶ

ARCHIMEDES

then $\Lambda H : N = A : Z.$ [Eucl. v., Def. 5

And $KH : \Lambda H = B : A ;$ [Eucl. v. 7, coroll.

therefore, *ex aequo*,

$KH : N = B : Z ;$ [Eucl. v. 22

therefore Z is the same part of B as N is of KH . Now A was proved to be a multiple of Z ; therefore Z is a common measure of A, B . Therefore, if ΛH is divided into segments equal to N and A into segments equal to Z , the segments in ΛH equal in magnitude to N will be equal in number to the segments of A equal to Z . It follows that, if there be placed on each of the segments in ΛH a magnitude equal to Z , having its centre of gravity at the middle of the segment, the sum of the magnitudes will be equal to A , and the centre of gravity of the figure compounded of them all will be E ; for they are even in number, and the numbers on either side of E will be equal because $\Lambda E = HE$. [Prop. 5, coroll. 2.]

Similarly it may be proved that, if a magnitude equal to Z be placed on each of the segments [equal to N] in KH , having its centre of gravity at the middle of the segment, the sum of the magnitudes will be equal to B , and the centre of gravity of the figure compounded of them all will be Δ [Prop. 5, coroll. 2]. Therefore A may be regarded as placed at E , and B at Δ . But they will be a set of magnitudes lying on a straight line, equal one to another, with their centres of gravity at equal intervals, and even in number; it is therefore clear that the centre of gravity of the magnitude compounded of them all is the point of bisection of the line containing the centres [of gravity] of the middle magnitudes [from Prop. 5, coroll. 2].

¹ συγκείμενα om. Heiberg.

GREEK MATHEMATICS

ἄ μὲν ΛΕ τῆ ΓΔ, ἄ δὲ ΕΓ τῆ ΔΚ, καὶ ὅλα ἄρα ἄ ΛΓ ἴσα τῆ ΓΚ· ὥστε τοῦ ἐκ πάντων μεγέθους κέντρον τοῦ βάρους τὸ Γ σημεῖον. τοῦ μὲν ἄρα Α κειμένου κατὰ τὸ Ε, τοῦ δὲ Β κατὰ τὸ Δ, ἰσορροποῦντι κατὰ τὸ Γ.

ζ'

Καὶ τοίνυν, εἴ κα ἀσύμμετρα ἔωντι τὰ μεγέθη, ὁμοίως ἰσορροποῦντι ἀπὸ μακέων ἀντιπεπονηθότως τὸν αὐτὸν λόγον ἔχόντων τοῖς μεγέθεσιν.

Ἔστω ἀσύμμετρα μεγέθη τὰ ΑΒ, Γ, μάκκα δὲ τὰ ΔΕ, ΕΖ, ἐχέτω δὲ τὸ ΑΒ ποτὶ τὸ Γ τὸν αὐτὸν λόγον, ὃν καὶ τὸ ΕΔ ποτὶ τὸ ΕΖ μάκος· λέγω, ὅτι τοῦ ἐξ ἀμφοτέρων τῶν ΑΒ, Γ κέντρον τοῦ βάρους ἐστὶ τὸ Ε.

Εἰ γὰρ μὴ ἰσορροπήσει τὸ ΑΒ τεθὲν ἐπὶ τῷ Ζ τῷ Γ τεθέντι ἐπὶ τῷ Δ, ἤτοι μείζον ἐστὶ τὸ ΑΒ

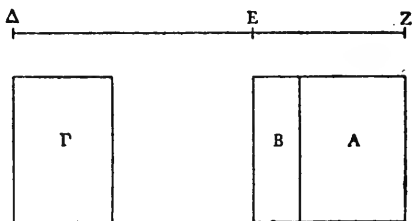

τοῦ Γ ἢ ὥστε ἰσορροπεῖν [τῷ Γ]¹ ἢ οὔ. ἔστω μείζον, καὶ ἀφηρήσθω ἀπὸ τοῦ ΑΒ ἔλασσον τῆς ὑπεροχᾶς, ᾧ μείζον ἐστὶ τὸ ΑΒ τοῦ Γ ἢ ὥστε ἰσορροπεῖν, ὥστε [τὸ]² λοιπὸν τὸ Α σύμμετρον

ARCHIMEDES

And since $\Lambda E = \Gamma \Delta$ and $E\Gamma = \Delta K$, therefore $\Lambda\Gamma = \Gamma K$; so that the centre of gravity of the magnitude compounded of them all is the point Γ . Therefore if A is placed at E and B at Δ , they will balance about Γ .

Prop. 7

And now, if the magnitudes be incommensurable, they will likewise balance at distances reciprocally proportional to the magnitudes.

Let $(A + B)$, Γ be incommensurable magnitudes,^a and let ΔE , EZ be distances, and let

$$(A + B) : \Gamma = E\Delta : EZ ;$$

I say that the centre of gravity of the magnitude composed of both $(A + B)$, Γ is E .

For if $(A + B)$ placed at Z do not balance Γ placed at Δ , either $(A + B)$ is too much greater than Γ to balance or less. Let it [first] be too much greater, and let there be subtracted from $(A + B)$ a magnitude less than the excess by which $(A + B)$ is too much greater than Γ to balance, so that the remainder A is

^a As becomes clear later in the proof, the first magnitude is regarded as made up of two parts— A , which is commensurate with Γ and B , which is not commensurate; if $(A + B)$ is too big for equilibrium with Γ , then B is so chosen that, when it is taken away, the remainder A is still too big for equilibrium with Γ . Similarly if $(A + B)$ is too small for equilibrium.

¹ τῶν Γ om. Eutocius.

² τὸ om. Eutocius.

εἴμεν τῷ Γ. ἐπεὶ οὖν σύμμετρά ἐστι τὰ Α, Γ
μεγέθεα, καὶ ἐλάσσονα λόγον ἔχει τὸ Α ποτὶ τὸ
Γ ἢ ἂ ΔΕ ποτὶ ΕΖ, οὐκ ἰσορροποῦντι τὰ Α, Γ
ἀπὸ τῶν ΔΕ, ΕΖ μακέων, τεθέντος τοῦ μὲν Α
ἐπὶ τῷ Ζ, τοῦ δὲ Γ ἐπὶ τῷ Δ. διὰ ταῦτά δ', οὐδ'
εἰ τὸ Γ μείζον ἐστὶν ἢ ὥστε ἰσορροπεῖν τῷ ΑΒ.

(iii.) *Centre of Gravity of a Parallelogram*

Ibid., Props. 9 et 10, Archim. ed. Heiberg ii. 140. 16-144. 4

θ'

Παντὸς παραλληλογράμμου τὸ κέντρον τοῦ
βάρους ἐστὶν ἐπὶ τᾶς εὐθείας τᾶς ἐπιζευγνυούσας
τὰς διχοτομίας τᾶν κατ' ἐναντίον τοῦ παραλλη-
λογράμμου πλευρᾶν.

* Ἐστω παραλληλόγραμμον τὸ ΑΒΓΔ, ἐπὶ δὲ
τὰν διχοτομίαν τᾶν ΑΒ, ΓΔ ἂ ΕΖ· φημι δὴ, ὅτι
τοῦ ΑΒΓΔ παραλληλογράμμου τὸ κέντρον τοῦ
βάρους ἐσσεῖται ἐπὶ τᾶς ΕΖ.

Μὴ γάρ, ἀλλ', εἰ δυνατόν, ἔστω τὸ Θ, καὶ ἄχθω
παρὰ τὰν ΑΒ ἂ ΘΙ. τᾶς [δὲ]¹ δὴ ΕΒ διχοτομου-
μένας αἰεὶ ἐσσεῖταιί ποκα ἂ καταλειπομένα ἐλάσσων

¹ δὲ om. Heiberg.

* The proof is incomplete and obscure; it may be thus completed.

Since

$$A : \Gamma < \Delta E : EZ,$$

Δ will be depressed, which is impossible, since there has been taken away from (A + B) a magnitude less than the deduc-

ARCHIMEDES

commensurate with Γ . Then, since A, Γ are commensurable magnitudes, and

$$A : \Gamma < \Delta E : EZ,$$

A, Γ will not balance at the distances $\Delta E, EZ$, A being placed at Z and Γ at Δ . By the same reasoning, they will not do so if Γ is greater than the magnitude necessary to balance $(A + B)$.^a

(iii.) *Centre of Gravity of a Parallelogram* ^b

Ibid., Props. 9 and 10, Archim. ed. Heiberg
ii. 140. 16–144. 4

Prop. 9

The centre of gravity of any parallelogram is on the straight line joining the points of bisection of opposite sides of the parallelogram.

Let $AB\Gamma\Delta$ be a parallelogram, and let EZ be the straight line joining the mid-points of $AB, \Gamma\Delta$; then I say that the centre of gravity of the parallelogram $AB\Gamma\Delta$ will be on EZ .

For if it be not, let it, if possible, be Θ , and let ΘI be drawn parallel to AB . Now if EB be bisected, and the half be bisected, and so on continually, there will be left some line less than $I\Theta$; [let EK be less than

tion necessary to produce equilibrium, so that Z remains depressed. Therefore $(A + B)$ is not greater than the magnitude necessary to produce equilibrium; in the same way it can be proved not to be less; therefore it is equal.

^b The centres of gravity of a triangle and a trapezium are also found by Archimedes in the first book; the second book is wholly devoted to finding the centres of gravity of a parabolic segment and of a portion of it cut off by a parallel to the base.

GREEK MATHEMATICS

τᾶς ΙΘ· καὶ διηρήσθω ἑκατέρα τᾶν ΑΕ, ΕΒ εἰς τὰς τῆ ΕΚ ἴσας, καὶ ἀπὸ τῶν κατὰ τὰς διαιρέσεις

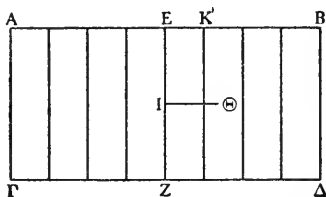

σαμείων ἄχθωσαν παρὰ τὰν ΕΖ· διαιρεθήσεται δὴ τὸ ὅλον παραλληλόγραμμον εἰς παραλληλόγραμμα τὰ ἴσα καὶ ὁμοῖα τῷ ΚΖ. τῶν οὖν παραλληλογράμμων τῶν ἴσων καὶ ὁμοίων τῷ ΚΖ ἐφαρμοζομένων ἐπ' ἄλλαλα καὶ τὰ κέντρα τοῦ βάρους αὐτῶν ἐπ' ἄλλαλα πεσοῦνται. ἐσσοῦνται δὴ μεγέθει τινα, παραλληλόγραμμα ἴσα τῷ ΚΖ, ἄρτια τῷ πλήθει, καὶ τὰ κέντρα τοῦ βάρους αὐτῶν ἐπ' εὐθείας κείμενα, καὶ τὰ μέσα ἴσα, καὶ πάντα τὰ ἐφ' ἑκάτερα τῶν μέσων αὐτά τε ἴσα ἐντὶ καὶ αἱ μεταξύ τῶν κέντρων εὐθεῖαι ἴσαι· τοῦ ἐκ πάντων αὐτῶν ἄρα συγκειμένου μεγέθους τὸ κέντρον ἐσσεῖται τοῦ βάρους ἐπὶ τᾶς εὐθείας τᾶς ἐπιζευγνουσᾶς τὰ κέντρα τοῦ βάρους τῶν μέσων χωρίων. οὐκ ἔστι δέ· τὸ γὰρ Θ ἐκτός ἐστι τῶν μέσων παραλληλογράμμων. φανερόν οὖν, ὅτι ἐπὶ τᾶς ΕΖ εὐθείας τὸ κέντρον ἐστὶ τοῦ βάρους τοῦ ΑΒΓΔ παραλληλογράμμου.

ι'

Παντὸς παραλληλογράμμου τὸ κέντρον τοῦ βάρους ἐστὶ τὸ σαμεῖον, καθ' ὃ αἱ διαμέτροι συμπύπτοντι.

ARCHIMEDES

Θ ,] and let each of AE , EB be divided into parts equal to EK , and from the points of division let straight lines be drawn parallel to EZ ; then the whole parallelogram will be divided into parallelograms equal and similar to KZ . Therefore, if these parallelograms equal and similar to KZ be applied to each other, their centres of gravity will also coincide [Post. 4]. Thus there will be a set of magnitudes, being parallelograms equal to KZ , which are even in number and whose centres of gravity lie on a straight line, and the middle magnitudes will be equal, and the magnitudes on either side of the middle magnitudes will also be equal, and the straight lines between their centres [of gravity] will be equal; therefore the centre of gravity of the magnitude compounded of them all will be on the straight line joining the centres of gravity of the middle areas [Prop. 5, coroll. 2]. But it is not; for Θ lies without the middle parallelograms. It is therefore manifest that the centre of gravity of the parallelogram $AB\Gamma\Delta$ will be on the straight line EZ .

Prop. 10

The centre of gravity of any parallelogram is the point in which the diagonals meet.

GREEK MATHEMATICS

Ἐστω παραλληλόγραμμον τὸ ΑΒΓΔ καὶ ἐν αὐτῷ αἱ ΕΖ δίχα τέμνουσα τὰς ΑΒ, ΓΔ, αἱ δὲ ΚΛ

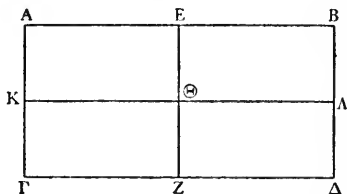

τὰς ΑΓ, ΒΔ· ἔστιν δὴ τοῦ ΑΒΓΔ παραλληλογράμμου τὸ κέντρον τοῦ βάρους ἐπὶ τὰς ΕΖ· δέδεικται γὰρ τοῦτο. διὰ ταῦτά δὲ καὶ ἐπὶ τὰς ΚΛ· τὸ Θ ἄρα σημεῖον κέντρον τοῦ βάρους. κατὰ δὲ τὸ Θ αἱ διαμέτροι τοῦ παραλληλογράμμου συμπέπτοντι· ὥστε δέδεικται τὸ προτεθέν.

(j) MECHANICAL METHOD IN GEOMETRY

Archim. *Meth.*, Praef., Archim. ed. Heiberg
ii. 426. 3-430. 22

Ἀρχιμήδης Ἐρατοσθένει εὖ πράττειν . . .
Ὅρων δέ σε, καθάπερ λέγω, σπουδαῖον καὶ φιλοσοφίας προεστῶτα ἀξιολόγως καὶ τὴν ἐν τοῖς

* According to Heath (*H.G.M.* ii. 21), Wallis has observed that Archimedes might seem, "as it were of set purpose to have covered up the traces of his investigation, as if he had grudged posterity the secret of his method of inquiry, while he wished to extort from them assent to his results." A comparison of the *Method* with other treatises now reveals to us how Archimedes found the areas and volumes of certain figures. His method was to balance elements of the figure against elements of another figure whose mensuration was

220

ARCHIMEDES

For let $AB\Gamma\Delta$ be a parallelogram, and in it let EZ bisect AB , $\Gamma\Delta$ and let $K\Lambda$ bisect $A\Gamma$, $B\Delta$; now the centre of gravity of the parallelogram $AB\Gamma\Delta$ is on EZ —for this has been proved. By the same reasoning it lies on $K\Lambda$; therefore the point Θ is the centre of gravity. And the diagonals of the parallelogram meet at Θ ; so that the proposition has been proved.

(j) MECHANICAL METHOD IN GEOMETRY^a

Archimedes, *The Method*,^b Preface, Archim. ed. Heiberg
ii. 426. 3–430. 22

Archimedes to Eratosthenes^c greeting . . .

Moreover, seeing in you, as I say, a zealous student and a man of considerable eminence in philosophy,

known. This gave him the result, and then he proved it by rigorous geometrical methods based on the principle of *reductio ad absurdum*.

The case of the parabola is particularly instructive. In the *Method*, Prop. 1, Archimedes conceives a segment of a parabola as made up of straight lines, and by his mechanical method he proves that the segment is four-thirds of the triangle having the same base and equal height. In his *Quadrature of a Parabola*, Prop. 14, he conceives the parabola as made up of a large number of trapezia, and by mechanical methods again reaches the same result. This is more satisfactory, but still not completely rigorous, so in Prop. 24 he proves the theorem without any help from mechanics by *reductio ad absurdum*.

^b The *Method* had to be classed among the lost works of Archimedes until 1906, when it was discovered at Constantinople by Heiberg in the *ms.* which he has termed C. Unfortunately the *ms.* is often difficult to decipher, and students of the text should consult Heiberg's edition. Moreover, the diagrams have to be supplied as they are undecipherable in the *ms.*

^c For Eratosthenes, *v. infra*, pp. 260–273 and vol. i. pp. 100–103, 256–261, and 290–299.

GREEK MATHEMATICS

μαθήμασιν κατὰ τὸ ὑποπίπτον θεωρίαν τετιμηκότα ἔδοκίμασα γράψαι σοι καὶ εἰς τὸ αὐτὸ βιβλίον ἐξορίσαι τρόπου τινὸς ιδιότητα, καθ' ὃν σοι παρεχόμενον ἔσται λαμβάνειν ἀφορμὰς εἰς τὸ δύνασθαι τινα τῶν ἐν τοῖς μαθήμασι θεωρεῖν διὰ τῶν μηχανικῶν. τοῦτο δὲ πέπεισμαι χρήσιμον εἶναι οὐδὲν ἦσσον καὶ εἰς τὴν ἀπόδειξιν αὐτῶν τῶν θεωρημάτων. καὶ γὰρ τινα τῶν πρότερον μοι φανέντων μηχανικῶς ὕστερον γεωμετρικῶς ἀπεδείχθη διὰ τὸ χωρὶς ἀποδείξεως εἶναι τὴν διὰ τούτου τοῦ τρόπου θεωρίαν· ἐτοιμότερον γὰρ ἔστι προλαβόντα διὰ τοῦ τρόπου γινώσιν τινα τῶν ζητημάτων πορίσασθαι τὴν ἀπόδειξιν μᾶλλον ἢ μηδενὸς ἐγνωσμένου ζητεῖν. . . . γράφομεν οὖν πρῶτον τὸ καὶ πρῶτον φανέν διὰ τῶν μηχανικῶν, ὅτι πᾶν τμήμα ὀρθογωνίου κώνου τομῆς ἐπίτритόν ἐστιν τριγώνου τοῦ βάσιν ἔχοντος τὴν αὐτὴν καὶ ὕψος ἴσον.

Ibid., Prop. 1, Archim. ed. Heiberg ii. 434. 14-438. 21

Ἐστω τμήμα τὸ ΑΒΓ περιεχόμενον ὑπὸ εὐθείας τῆς ΑΓ καὶ ὀρθογωνίου κώνου τομῆς τῆς ΑΒΓ, καὶ τετμήσθω δίχα ἢ ΑΓ τῷ Δ, καὶ παρὰ τὴν διάμετρον ἤχθω ἢ ΔΒΕ, καὶ ἐπεξεύχθωσαν αἱ ΑΒ, ΒΓ.

Λέγω, ὅτι ἐπίτритόν ἐστιν τὸ ΑΒΓ τμήμα τοῦ ΑΒΓ τριγώνου.

Ἠχθωσαν ἀπὸ τῶν Α, Γ σημείων ἢ μὲν ΑΖ παρὰ τὴν ΔΒΕ, ἢ δὲ ΓΖ ἐπιψαύουσα τῆς τομῆς, καὶ ἐκβεβλήσθω ἢ ΓΒ ἐπὶ τὸ Κ, καὶ κείσθω τῇ ΓΚ ἴση ἢ ΚΘ. νοείσθω ζυγὸς ὁ ΓΘ καὶ μέσον

ARCHIMEDES

who gives due honour to mathematical inquiries when they arise, I have thought fit to write out for you and explain in detail in the same book the peculiarity of a certain method, with which furnished you will be able to make a beginning in the investigation by mechanics of some of the problems in mathematics. I am persuaded that this method is no less useful even for the proof of the theorems themselves. For some things first became clear to me by mechanics, though they had later to be proved geometrically owing to the fact that investigation by this method does not amount to actual proof; but it is, of course, easier to provide the proof when some knowledge of the things sought has been acquired by this method rather than to seek it with no prior knowledge. . . . At the outset therefore I will write out the very first theorem that became clear to me through mechanics, that *any segment of a section of a right-angled cone is four-thirds of the triangle having the same base and equal height.*

Ibid., Prop. 1, Archim. ed. Heiberg ii. 434. 14-438. 21

Let $AB\Gamma$ be a segment bounded by the straight line $A\Gamma$ and the section $AB\Gamma$ of a right-angled cone, and let $A\Gamma$ be bisected at Δ , and let ΔBE be drawn parallel to the axis, and let AB , $B\Gamma$ be joined.

I say that the segment $AB\Gamma$ is four-thirds of the triangle $AB\Gamma$.

From the points A , Γ let AZ be drawn parallel to ΔBE , and let ΓZ be drawn to touch the section, and let ΓB be produced to K , and let $K\Theta$ be placed equal to ΓK . Let $\Gamma\Theta$ be imagined to be a balance

ARCHIMEDES

with mid-point K , and let $MΞ$ be drawn parallel to $EΔ$.

Then since $ΓBA$ is a parabola,^a and $ΓZ$ touches it, and $ΓΔ$ is a semi-ordinate, $EB = BΔ$ —for this is proved in the elements ^b; for this reason, and because ZA , $MΞ$ are parallel to $EΔ$, $MN = NΞ$ and $ZK = KA$ [Eucl. vi. 4, v. 9]. And since

$$ΓA : AΞ = MΞ : ΞO, \quad [\textit{Quad. parab. 5}, \\ \text{Eucl. v. 18}$$

and $ΓA : AΞ = ΓK : KN$, [Eucl. vi. 2, v. 18

while $ΓK = KΘ$,

therefore $ΘK : KN = MΞ : ΞO$.

And since the point N is the centre of gravity of the straight line $MΞ$, inasmuch as $MN = NΞ$ [Lemma 4], if we place $TH = ΞO$, with $Θ$ for its centre of gravity, so that $TΘ = ΘH$ [Lemma 4], then $TΘH$ will balance $MΞ$ in its present position, because $ΘN$ is cut

^a Archimedes would have said "section of a right-angled cone"—*ὀρθογωνίου κώνου τομὰ*.

^b The reference will be to the *Elements of Conics* by Euclid and Aristaeus for which v. vol. i. pp. 486-491 and *infra*, p. 280 n. a; cf. similar expressions in *On Conoids and Spheroids*, Prop. 3 and *Quadrature of a Parabola*, Prop. 3; the theorem is *Quadrature of a Parabola*, Prop. 2.

¹ τοῦτο . . . δείκνυται om. Heiberg. It is probably an interpolator's reference to a marginal lemma.

τὴν ΘΝ τοῖς ΤΗ, ΜΞ βάρεσιν, καὶ ὡς τὴν ΘΚ πρὸς ΚΝ, οὕτως τὴν ΜΞ πρὸς τὴν ΗΤ· ὥστε τοῦ ἐξ ἀμφοτέρων βάρους κέντρον ἐστὶν τοῦ βάρους τὸ Κ. ὁμοίως δὲ καί, ὅσαι ἂν ἀχθῶσιν ἐν τῷ ΖΑΓ τριγώνῳ παράλληλοι τῇ ΕΔ, ἰσορροπήσουσιν αὐτοῦ μένουσαι ταῖς ἀπολαμβανομέναις ἀπ' αὐτῶν ὑπὸ τῆς τομῆς μετενεχθείσαις ἐπὶ τὸ Θ, ὥστε εἶναι τοῦ ἐξ ἀμφοτέρων κέντρον τοῦ βάρους τὸ Κ. καὶ ἐπεὶ ἐκ μὲν τῶν ἐν τῷ ΓΖΑ τριγώνῳ τὸ ΓΖΑ τρίγωνον συνέστηκεν, ἐκ δὲ τῶν ἐν τῇ τομῇ ὁμοίως τῇ ΕΟ λαμβανομένων συνέστηκε τὸ ΑΒΓ τμήμα, ἰσορροπήσει ἄρα τὸ ΖΑΓ τρίγωνον αὐτοῦ μένον τῷ τμήματι τῆς τομῆς τεθέντι περὶ κέντρον τοῦ βάρους τὸ Θ κατὰ τὸ Κ σημεῖον, ὥστε τοῦ ἐξ ἀμφοτέρων κέντρον εἶναι τοῦ βάρους τὸ Κ. τετμήσθω δὴ ἡ ΓΚ τῷ Χ, ὥστε τριπλασίαν εἶναι τὴν ΓΚ τῆς ΚΧ· ἔσται ἄρα τὸ Χ σημεῖον κέντρον βάρους τοῦ ΑΖΓ τριγώνου· δέδεικται γὰρ ἐν τοῖς Ἴσορροπικοῖς. ἐπεὶ οὖν ἰσόρροπον τὸ ΖΑΓ τρίγωνον αὐτοῦ μένον τῷ ΒΑΓ τμήματι κατὰ τὸ Κ τεθέντι περὶ τὸ Θ κέντρον τοῦ βάρους, καὶ ἐστὶν τοῦ ΖΑΓ τριγώνου κέντρον βάρους τὸ Χ, ἔστιν ἄρα, ὡς τὸ ΑΖΓ τρίγωνον πρὸς τὸ ΑΒΓ τμήμα κείμενον περὶ τὸ Θ κέντρον, οὕτως ἡ ΘΚ πρὸς ΧΚ. τριπλασία δὲ ἐστὶν ἡ ΘΚ τῆς ΚΧ· τριπλασίον ἄρα καὶ τὸ ΑΖΓ τρίγωνον τοῦ ΑΒΓ τμήματος. ἔστι δὲ καὶ τὸ ΖΑΓ τρίγωνον τετραπλάσιον τοῦ ΑΒΓ τριγώνου διὰ τὸ ἴσην εἶναι τὴν μὲν ΖΚ τῇ ΚΑ, τὴν δὲ ΑΔ τῇ ΔΓ· ἐπίτριτον ἄρα ἐστὶν τὸ ΑΒΓ τμήμα τοῦ ΑΒΓ τριγώνου. [τοῦτο οὖν φανερόν ἐστιν].¹

¹ τοῦτο . . . ἐστὶν om. Heiberg.

ARCHIMEDES

in the inverse proportion of the weights TH, MΞ,
and $\Theta K : KN = MΞ : HT$;

therefore the centre of gravity of both [TH, MΞ] taken together is K. In the same way, as often as parallels to EΔ are drawn in the triangle ZΑΓ, these parallels, remaining in the same position, will balance the parts cut off from them by the section and transferred to Θ, so that the centre of gravity of both together is K. And since the triangle ΓΖΑ is composed of the [straight lines drawn] in ΓΖΑ, and the segment ΑΒΓ is composed of the lines in the section formed in the same way as ΞΟ, therefore the triangle ΖΑΓ in its present position will be balanced about K by the segment of the section placed with Θ for its centre of gravity, so that the centre of gravity of both combined is K. Now let ΓΚ be cut at Χ so that ΓΚ = 3ΚΧ; then the point Χ will be the centre of gravity of the triangle ΑΖΓ; for this has been proved in the books *On Equilibriums*.^a Then since the triangle ΖΑΓ in its present position is balanced about K by the segment ΒΑΓ placed so as to have Θ for its centre of gravity, and since the centre of gravity of the triangle ΖΑΓ is Χ, therefore the ratio of the triangle ΑΖΓ to the segment ΑΒΓ placed about Θ as its centre [of gravity] is equal to ΘΚ : ΧΚ. But ΘΚ = 3ΚΧ; therefore

$$\text{triangle } AZ\Gamma = 3 \cdot \text{segment } AB\Gamma.$$

And $\text{triangle } Z\Lambda\Gamma = 4 \cdot \text{triangle } AB\Gamma,$

because $ZK = KA$ and $A\Delta = \Delta\Gamma$;

therefore $\text{segment } AB\Gamma = \frac{4}{3} \text{triangle } AB\Gamma.$

^a Cf. *De Plan. Equil.* i. 15.

GREEK MATHEMATICS

¹Τοῦτο δὴ διὰ μὲν τῶν νῦν εἰρημένων οὐκ ἀποδέδεικται, ἔμφασιν δέ τινα πεποίηκε τὸ συμπέρασμα ἀληθὲς εἶναι· διόπερ ἡμεῖς ὀρῶντες μὲν οὐκ ἀποδειγμένον, ὑπονοοῦντες δὲ τὸ συμπέρασμα ἀληθὲς εἶναι, τάξομεν τὴν γεωμετρομένην ἀπόδειξιν ἔξευρόντες αὐτοὶ τὴν ἐκδοθεῖσαν πρότερον.¹

Archim. *Quadr. Parab.*, Praef., Archim. ed. Heiberg ii.
262. 2-266. 4

¹Ἀρχιμήδης Δοσιθέω εὖ πράττειν.

¹Ἀκούσας Κόνωνα μὲν τετελευτηκέσαι, ὃς ἦν οὐδὲν ἐπιλείπων ἡμῖν ἐν φιλίᾳ, τὴν δὲ Κόνωνος γνώριμον γεγενῆσθαι καὶ γεωμετρίας οἰκείον εἶμεν τοῦ μὲν τετελευτηκότος εἵνεκεν ἐλυπήθημεν ὡς καὶ φίλου τοῦ ἀνδρὸς γεναμένου καὶ ἐν τοῖς μαθημάτεσσι θαυμαστοῦ τινος, ἐπροχειριζάμεθα δὲ ἀποστεῖλαί τοι γράψαντες, ὡς Κόνωνι γράφειν ἐγνωκότες ἡμεῖς, γεωμετρικῶν θεωρημάτων, ὃ πρότερον μὲν οὐκ ἦν τεθεωρημένον, νῦν δὲ ὑφ' ἡμῶν τεθεώρηται, πρότερον μὲν διὰ μηχανικῶν εὑρεθέν, ἔπειτα δὲ καὶ διὰ τῶν γεωμετρικῶν ἐπιδειχθέν. τῶν μὲν οὖν πρότερον περὶ γεωμετρίαν πραγματευθέντων ἐπεχείρησάν τινες γράφειν ὡς δυνατὸν ἐὼν κύκλῳ τῷ δοθέντι καὶ κύκλου τμήματι τῷ δοθέντι χωρίον εὐρεῖν εὐθύγραμμον ἴσον, καὶ μετὰ ταῦτα τὸ περιεχόμενον χωρίον ὑπό τε τῆς

¹ τοῦτο . . . πρότερον. In the ms. the whole paragraph from τοῦτο to πρότερον comes at the beginning of Prop. 2; it is more appropriate at the end of Prop. 1.

ARCHIMEDES

This, indeed, has not been actually demonstrated by the arguments now used, but they have given some indication that the conclusion is true ; seeing, therefore, that the theorem is not demonstrated, but suspecting that the conclusion is true, we shall have recourse ^a to the geometrical proof which I myself discovered and have already published.^b

Archimedes, *Quadrature of a Parabola*, Preface, Archim.
ed. Heiberg ii. 262. 2-266. 4

Archimedes to Dositheus greeting.

On hearing that Conon, who fulfilled in the highest degree the obligations of friendship, was dead, but that you were an acquaintance of Conon and also versed in geometry, while I grieved for the death of a friend and an excellent mathematician, I set myself the task of communicating to you, as I had determined to communicate to Conon, a certain geometrical theorem, which had not been investigated before, but has now been investigated by me, and which I first discovered by means of mechanics and later proved by means of geometry. Now some of those who in former times engaged in mathematics tried to find a rectilinear area equal to a given circle ^c and to a given segment of a circle, and afterwards they tried to square the area bounded by the section

^a I have followed Heath's rendering of *τάξομεν*, which seems more probable than Heiberg's "suo loco proponemus," though it is a difficult meaning to extract from *τάξομεν*.

^b Presumably *Quadr. Parab.* 24, the second of the proofs now to be given. The theorem has not been demonstrated, of course, because the triangle and the segment may not be supposed to be composed of straight lines.

^c This seems to indicate that Archimedes had not at this time written his own book *On the Measurement of a Circle*. For attempts to square the circle, v. vol. i. pp. 308-347.

GREEK MATHEMATICS

ὄλου τοῦ κώνου τομᾶς καὶ εὐθείας τετραγωνίζειν ἐπειρῶντο λαμβάνοντες οὐκ εὐπαραχώρητα λήμματα, διόπερ αὐτοῖς ὑπὸ τῶν πλείστων οὐκ εὐρισκόμενα ταῦτα κατεγνώσθην. τὸ δὲ ὑπ' εὐθείας τε καὶ ὀρθογωνίου κώνου τομᾶς τμᾶμα περιεχόμενον οὐδένα τῶν προτέρων ἐγχειρήσαντα τετραγωνίζειν ἐπιστάμεθα, ὃ δὴ νῦν ὑφ' ἀμῶν εὐρηται· δείκνυται γάρ, ὅτι πᾶν τμᾶμα περιεχόμενον ὑπὸ εὐθείας καὶ ὀρθογωνίου κώνου τομᾶς ἐπίτριτόν ἐστι τοῦ τριγώνου τοῦ βάσιν ἔχοντος τὰν αὐτὰν καὶ ὕψος ἴσον τῷ τμᾶματι λαμβανομένου τοῦδε τοῦ λήμματος ἐς τὰν ἀπόδειξιν αὐτοῦ· τῶν ἀνίσων χωρίων τὰν ὑπεροχάν, ἧ ὑπερέχει τὸ μείζον τοῦ ἐλάσσονος, δυνατὸν εἶμεν αὐτὰν ἑαυτᾶ συντιθεμέναν παντὸς ὑπερέχειν τοῦ προτεθέντος πεπερασμένου χωρίου.* κέχρηται δὲ καὶ οἱ πρότερον γεωμέτραι τῷδε τῷ λήμματι· τοὺς τε γὰρ κύκλους διπλασίονα λόγον ἔχειν ποτ' ἀλλάλους τῶν διαμέτρων ἀποδεδείχασιν αὐτῷ τούτῳ τῷ λήμματι χρωμένοι, καὶ τὰς σφαίρας ὅτι τριπλασίονα λόγον ἔχοντι ποτ' ἀλλάλας τῶν διαμέτρων, ἔτι δὲ καὶ ὅτι πᾶσα πυραμὶς τρίτον μέρος ἐστὶ τοῦ πρίσματος τοῦ τὰν αὐτὰν βάσιν ἔχοντος τῆ πυραμίδι καὶ ὕψος ἴσον· καὶ διότι πᾶς κῶνος τρίτον μέρος ἐστὶ τοῦ κυλίνδρου τοῦ τὰν αὐτὰν βάσιν ἔχοντος τῷ κῶνῳ καὶ ὕψος ἴσον, ὁμοῖον τῷ προειρημένῳ λήμματι λαμβάνοντες ἔγραφον. συμβαίνει δὲ τῶν προειρημένων θεωρημάτων ἕκαστον μηδενὸς ἴσσον τῶν ἄνευ τούτου τοῦ λήμματος ἀποδεδειγμένων πεπιστευκέναι· ἀρκεῖ δὲ ἐς τὰν ὁμοίαν πίστιν τούτοις ἀναγμένων τῶν ὑφ' ἀμῶν ἐκδιδομένων. ἀναγράφαντες οὖν αὐτοῦ τὰς ἀποδείξεις ἀποστέλλομεν

ARCHIMEDES

of the whole cone and a straight line,^a assuming lemmas far from obvious, so that it was recognized by most people that the problem had not been solved. But I do not know that any of my predecessors has attempted to square the area bounded by a straight line and a section of a right-angled cone, the solution of which problem I have now discovered ; for it is shown that *any segment bounded by a straight line and a section of a right-angled cone is four-thirds of the triangle which has the same base and height equal to the segment*, and for the proof this lemma is assumed : *given [two] unequal areas, the excess by which the greater exceeds the less can, by being added to itself, be made to exceed any given finite area.* Earlier geometers have also used this lemma : for, by using this same lemma, they proved that circles are to one another in the duplicate ratio of their diameters, and that spheres are to one another in the triplicate ratio of their diameters, and also that any pyramid is a third part of the prism having the same base as the pyramid and equal height ; and, further, by assuming a lemma similar to that aforesaid, they proved that any cone is a third part of the cylinder having the same base as the cone and equal height.^b In the event, each of the aforesaid theorems has been accepted, no less than those proved without this lemma ; and it will satisfy me if the theorems now published by me obtain the same degree of acceptance. I have therefore written out the proofs, and now send them, first

^a A "section of the whole cone" is probably a section cutting right through it, *i.e.*, an ellipse, but the expression is odd.

^b For this lemma, *v. supra*, p. 46 n. a.

GREEK MATHEMATICS

πρῶτον μὲν, ὡς διὰ τῶν μηχανικῶν ἐθεωρήθη, μετὰ ταῦτα δὲ καί, ὡς διὰ τῶν γεωμετρομένων ἀποδείκνυται. προγράφεται δὲ καὶ στοιχεῖα κωνικὰ χρεῖαν ἔχοντα ἐς τὰς ἀποδείξιν. ἔρρωσο.

Ibid., Prop. 14, Archim. ed. Heiberg ii. 284. 24-290. 17

Ἔστω τμήμα τὸ ΒΘΓ περιεχόμενον ὑπὸ εὐθείας καὶ ὀρθογωνίου κώνου τομᾶς. ἔστω δὴ πρῶτον

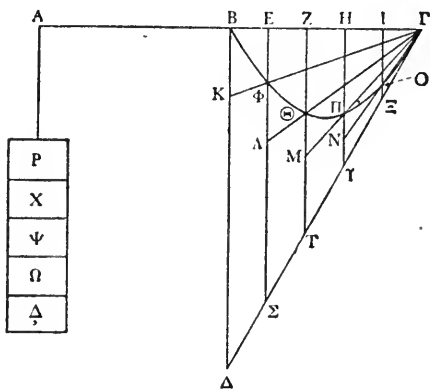

ἡ ΒΓ ποτ' ὀρθὰς τῆ διαμέτρῳ, καὶ ἄχθω ἀπὸ μὲν τοῦ Β σημείου ἡ ΒΔ παρὰ τὴν διάμετρον, ἀπὸ δὲ τοῦ Γ ἡ ΓΔ ἐπιφανύουσα τῆς τοῦ κώνου τομᾶς κατὰ τὸ Γ· ἐσσεῖται δὴ τὸ ΒΓΔ τρίγωνον ὀρθογώνιον. διηρήσθω δὴ ἡ ΒΓ ἐς ἴσα τμήματα ὅποσαοῦν τὰ ΒΕ, ΕΖ, ΖΗ, ΗΙ, ΙΓ, καὶ ἀπὸ τῶν τομᾶν ἄχθωσαν παρὰ τὴν διάμετρον αἱ ΕΣ, ΖΤ, ΗΥ, ΙΞ, ἀπὸ δὲ τῶν σημείων, καθ' ἡ τέμνοντι

ARCHIMEDES

as they were investigated by means of mechanics, and also as they may be proved by means of geometry. By way of preface are included the elements of conics which are needed in the demonstration. Farewell.

Ibid., Prop. 14, Archim. ed. Heiberg ii. 284. 24-290. 17

Let $B\Theta\Gamma$ be a segment bounded by a straight line and a section of a right-angled cone. First let $B\Gamma$ be at right angles to the axis, and from B let $B\Delta$ be drawn parallel to the axis, and from Γ let $\Gamma\Delta$ be drawn touching the section of the cone at Γ ; then the triangle $B\Gamma\Delta$ will be right-angled [Eucl. i. 29]. Let $B\Gamma$ be divided into any number of equal segments $BE, EZ, ZH, HI, I\Gamma$, and from the points of section let $E\Sigma, ZT, HY, I\Xi$ be drawn parallel to the axis, and from the points in which these cut the

αὐται τὰν τοῦ κώνου τομάν, ἐπεζεύχθωσαν ἐπὶ τὸ Γ καὶ ἐκβεβλήσθωσαν. φαιμι δὴ τὸ τρίγωνον τὸ ΒΔΓ τῶν μὲν τραπεζίων τῶν ΚΕ, ΛΖ, ΜΗ, ΝΙ καὶ τοῦ ΞΙΓ τριγώνου ἔλασσον εἶμεν ἢ τριπλάσιον, τῶν δὲ τραπεζίων τῶν ΖΦ, ΗΘ, ΙΠ καὶ τοῦ ΙΟΓ τριγώνου μείζον [ἐστίν]¹ ἢ τριπλάσιον.

Διάχθω γὰρ εὐθεῖα ἃ ΑΒΓ, καὶ ἀπολελάφθω ἃ ΑΒ ἴσα τῇ ΒΓ, καὶ νοείσθω ζύγιον τὸ ΑΓ· μέσον δὲ αὐτοῦ ἐσσεῖται τὸ Β· καὶ κρεμάσθω ἐκ τοῦ Β, κρεμάσθω δὲ καὶ τὸ ΒΔΓ ἐκ τοῦ ζυγοῦ κατὰ τὰ Β, Γ, ἐκ δὲ τοῦ θατέρου μέρους τοῦ ζυγοῦ κρεμάσθω τὰ Ρ, Χ, Ψ, Ω, Δ χωρία κατὰ τὸ Α, καὶ ἰσορροπείτω τὸ μὲν Ρ χωρίον τῷ ΔΕ τραπεζίῳ οὕτως ἔχοντι, τὸ δὲ Χ τῷ ΖΣ τραπεζίῳ, τὸ δὲ Ψ τῷ ΤΗ, τὸ δὲ Ω τῷ ΥΙ, τὸ δὲ Δ τῷ ΞΙΓ τριγώνῳ· ἰσορροπήσει δὴ καὶ τὸ ὅλον τῷ ὅλῳ· ὥστε τριπλάσιον ἂν εἶη τὸ ΒΔΓ τρίγωνον τοῦ ΡΧΨΩΔ χωρίου. καὶ ἐπεὶ ἐστίν τμᾶμα τὸ ΒΓΘ, ὃ περιέχεται ὑπὸ τε εὐθείας καὶ ὀρθογωνίου κώνου τομᾶς, καὶ ἀπὸ μὲν τοῦ Β παρὰ τὰν διάμετρον ἄκται ἃ ΒΔ, ἀπὸ δὲ τοῦ Γ ἃ ΓΔ ἐπιψαύουσα τᾶς τοῦ κώνου τομᾶς κατὰ τὸ Γ, ἄκται δέ τις καὶ ἄλλα παρὰ τὰν διάμετρον ἃ ΣΕ, τὸν αὐτὸν ἔχει λόγον ἃ ΒΓ ποτὶ τὰν ΒΕ, ὃν ἃ ΣΕ ποτὶ τὰν ΕΦ· ὥστε καὶ ἃ ΒΑ ποτὶ τὰν ΒΕ τὸν αὐτὸν ἔχει λόγον, ὃν τὸ ΔΕ τραπέζιον ποτὶ τὸ ΚΕ. ὁμοίως δὲ δειχθήσεται ἃ ΑΒ ποτὶ τὰν ΒΖ τὸν αὐτὸν ἔχουσα λόγον, ὃν τὸ ΣΖ τραπέζιον ποτὶ τὸ ΛΖ, ποτὶ δὲ τὰν ΒΗ, ὃν τὸ ΤΗ ποτὶ τὸ ΜΗ, ποτὶ δὲ τὰν ΒΙ, ὃν τὸ ΥΙ ποτὶ τὸ ΝΙ. ἐπεὶ οὖν ἐστὶ τραπέζιον τὸ ΔΕ τὰς

¹ ἐστίν om. Heiberg.

ARCHIMEDES

section of the cone let straight lines be drawn to Γ and produced. Then I say that the triangle $B\Delta\Gamma$ is less than three times the trapezia KE , ΛZ , MH , NI and the triangle $\Xi I\Gamma$, but greater than three times the trapezia $Z\Phi$, $H\Theta$, III and the triangle $IO\Gamma$.

For let the straight line $AB\Gamma$ be drawn, and let AB be cut off equal to $B\Gamma$, and let AG be imagined to be a balance; its middle point will be B ; let it be suspended from B , and let the triangle $B\Delta\Gamma$ be suspended from the balance at B , Γ , and from the other part of the balance let the areas P , X , Ψ , Ω , Δ be suspended at A , and let the area P balance the trapezium ΔE in this position, let X balance the trapezium $Z\Sigma$, let Ψ balance TH , let Ω balance YI , and let Δ balance the triangle $\Xi I\Gamma$; then the whole will balance the whole; so that the triangle $B\Delta\Gamma$ will be three times the area $P + X + \Psi + \Omega + \Delta$ [Prop. 6]. And since $B\Gamma\Theta$ is a segment bounded by a straight line and a section of a right-angled cone, and $B\Delta$ has been drawn from B parallel to the axis, and $\Gamma\Delta$ has been drawn from Γ touching the section of a cone at Γ , and another straight line ΣE has been drawn parallel to the axis,

$$B\Gamma : BE = \Sigma E : E\Phi ; \quad [\text{Prop. 5}]$$

therefore $BA : BE = \text{trapezium } \Delta E : \text{trapezium } KE$.^a

Similarly it may be proved that

$$AB : BZ = \Sigma Z : \Lambda Z,$$

$$AB : BH = TH : MH,$$

$$AB : BI = YI : NI.$$

Therefore, since ΔE is a trapezium with right angles

^a For $BA = B\Gamma$ and $\Delta E : KE = \Sigma E : E\Phi$.

μὲν ποτὶ τοῖς Β, Ε σαμείους γωνίας ὀρθὰς ἔχον,
 τὰς δὲ πλευρὰς ἐπὶ τὸ Γ νευούσας, ἰσορροπεῖ δέ
 τι χωρίον αὐτῷ τὸ Ρ κρεμάμενον ἐκ τοῦ ζυγοῦ
 κατὰ τὸ Α οὕτως ἔχοντος τοῦ τραπέζιου, ὡς νῦν
 κεῖται, καὶ ἔστιν, ὡς ἂ ΒΑ ποτὶ τὰν ΒΕ, οὕτως
 τὸ ΔΕ τραπέζιον ποτὶ τὸ ΚΕ, μείζον ἄρα ἐστὶν
 τὸ ΚΕ χωρίον τοῦ Ρ χωρίου· δέδεικται γὰρ τοῦτο.
 πάλιν δὲ καὶ τὸ ΖΣ τραπέζιον τὰς μὲν ποτὶ τοῖς
 Ζ, Ε γωνίας ὀρθὰς ἔχον, τὰν δὲ ΣΤ νεύουσαν ἐπὶ
 τὸ Γ, ἰσορροπεῖ δὲ αὐτῷ χωρίον τὸ Χ ἐκ τοῦ ζυγοῦ
 κρεμάμενον κατὰ τὸ Α οὕτως ἔχοντος τοῦ τραπε-
 ζίου, ὡς νῦν κεῖται, καὶ ἔστιν, ὡς μὲν ἂ ΑΒ ποτὶ
 τὰν ΒΕ, οὕτως τὸ ΖΣ τραπέζιον ποτὶ τὸ ΖΦ, ὡς
 δὲ ἂ ΑΒ ποτὶ τὰν ΒΖ, οὕτως τὸ ΖΣ τραπέζιον
 ποτὶ τὸ ΛΖ· εἶη οὖν κα τὸ Χ χωρίον τοῦ μὲν ΛΖ
 τραπέζιου ἔλασσον, τοῦ δὲ ΖΦ μείζον· δέδεικται
 γὰρ καὶ τοῦτο. διὰ τὰ αὐτὰ δὴ καὶ τὸ Ψ χωρίον
 τοῦ μὲν ΜΗ τραπέζιου ἔλασσον, τοῦ δὲ ΘΗ μείζον,
 καὶ τὸ Ω χωρίον τοῦ μὲν ΝΟΙΗ τραπέζιου ἔλασσον,
 τοῦ δὲ ΠΙ μείζον, ὁμοίως δὲ καὶ τὸ Δ χωρίον τοῦ
 μὲν ΕΙΓ τριγώνου ἔλασσον, τοῦ δὲ ΓΙΟ μείζον.
 ἐπεὶ οὖν τὸ μὲν ΚΕ τραπέζιον μείζον ἐστὶ τοῦ Ρ
 χωρίου, τὸ δὲ ΛΖ τοῦ Χ, τὸ δὲ ΜΗ τοῦ Ψ, τὸ
 δὲ ΝΙ τοῦ Ω, τὸ δὲ ΕΙΓ τρίγωνον τοῦ Δ, φανερόν,
 ὅτι καὶ πάντα τὰ εἰρημένα χωρία μείζονά ἐστι τοῦ
 ΡΧΨΩΔ χωρίου. ἔστιν δὲ τὸ ΡΧΨΩΔ τρίτον
 μέρος τοῦ ΒΓΔ τριγώνου· δῆλον ἄρα, ὅτι τὸ ΒΓΔ
 τρίγωνον ἔλασσόν ἐστὶν ἢ τριπλάσιον τῶν ΚΕ,
 ΛΖ, ΜΗ, ΝΙ τραπέζιων καὶ τοῦ ΕΙΓ τριγώνου.
 πάλιν, ἐπεὶ τὸ μὲν ΖΦ τραπέζιον ἔλασσόν ἐστὶ
 τοῦ Χ χωρίου, τὸ δὲ ΘΗ τοῦ Ψ, τὸ δὲ ΙΠ τοῦ Ω,
 τὸ δὲ ΙΟΓ τρίγωνον τοῦ Δ, φανερόν, ὅτι καὶ πάντα

ARCHIMEDES

at the points B, E and with sides converging on Γ , and it balances the area P suspended from the balance at A, if the trapezium be in its present position, while

$$BA : BE = \Delta E : KE,$$

therefore $KE > P$;

for this has been proved [Prop. 10]. Again, since $Z\Sigma$ is a trapezium with right angles at the points Z, E and with ΣT converging on Γ , and it balances the area X suspended from the balance at A, if the trapezium be in its present position, while

$$AB : BE = Z\Sigma : Z\Phi,$$

$$AB : BZ = Z\Sigma : \Lambda Z,$$

therefore $\Lambda Z > X > Z\Phi$;

for this also has been proved [Prop. 12]. By the same reasoning

$$MH > \Psi > \Theta H,$$

and $NOIH > \Omega > \Pi I,$

and similarly $\Xi I\Gamma > \Delta > \Gamma IO.$

Then, since $KE > P$, $\Lambda Z > X$, $MH > \Psi$, $NI > \Omega$, $\Xi I\Gamma > \Delta$, it is clear that the sum of the aforesaid areas is greater than the area $P + X + \Psi + \Omega + \Delta$. But

$$P + X + \Psi + \Omega + \Delta = \frac{1}{3} B\Gamma\Delta ; \quad [\text{Prop. 6}]$$

it is therefore plain that

$$B\Gamma\Delta < 3(KE + \Lambda Z + MH + NI + \Xi I\Gamma).$$

Again, since $Z\Phi < X$, $\Theta H < \Psi$, $\Pi I < \Omega$, $IO\Gamma < \frac{1}{3}\Delta$, it is

GREEK MATHEMATICS

τὰ εἰρημένα ἐλάσσονά ἐστι τοῦ $\Delta\Omega\Psi\chi$ χωρίου· φανερόν οὖν, ὅτι καὶ τὸ $B\Delta\Gamma$ τρίγωνον μείζον ἐστὶν ἢ τριπλάσιον τῶν ΦZ , ΘH , ΙΠ τραπεζίων καὶ τοῦ ΙΓΟ τριγώνου, ἔλασσον δὲ ἢ τριπλάσιον τῶν προγεγραμμένων.

Ibid., Prop. 24, Archim. ed. Heiberg ii. 312. 2-314. 27

Πᾶν τμᾶμα τὸ περιεχόμενον ὑπὸ εὐθείας καὶ ὀρθογωνίου κώνου τομᾶς ἐπίτριτόν ἐστι τριγώνου τοῦ τὰν αὐτὰν βάσιν ἔχοντος αὐτῷ καὶ ὕψος ἴσον.

Ἐστω γὰρ τὸ $A\Delta B E \Gamma$ τμᾶμα περιεχόμενον ὑπὸ εὐθείας καὶ ὀρθογωνίου κώνου τομᾶς, τὸ δὲ $AB\Gamma$ τρίγωνον ἔστω τὰν αὐτὰν βάσιν ἔχον τῷ τμᾶματι

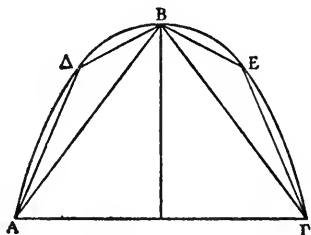

καὶ ὕψος ἴσον, τοῦ δὲ $AB\Gamma$ τριγώνου ἔστω ἐπίτριτον τὸ K χωρίου. δεικτέον, ὅτι ἴσον ἐστὶ τῷ $A\Delta B E \Gamma$ τμᾶματι.

Εἰ γὰρ μὴ ἐστὶν ἴσον, ἤτοι μείζον ἐστὶν ἢ ἔλασσον. ἔστω πρότερον, εἰ δυνατόν, μείζον τὸ $A\Delta B E \Gamma$ τμᾶμα τοῦ K χωρίου. ἐνέγραψα δὴ τὰ $A\Delta B$, $B E \Gamma$ τρίγωνα, ὡς εἴρηται, ἐνέγραψα δὲ καὶ εἰς τὰ περιλειπόμενα τμᾶματα ἄλλα τρίγωνα τὰν αὐτὰν

ARCHIMEDES

clear that the sum of the aforesaid areas is greater than the area $\Delta + \Omega + \Psi + X$;

it is therefore manifest that

$$B\Delta\Gamma > 3(\Phi Z + \Theta H + \text{III} + \text{I}\Gamma\text{O}),^a$$

but is less than thrice the aforementioned areas.^b

Ibid., Prop. 24, Archim. ed. Heiberg ii. 312. 2-314. 27

Any segment bounded by a straight line and a section of a right-angled cone is four-thirds of the triangle having the same base and equal height.

For let $A\Delta BE\Gamma$ be a segment bounded by a straight line and a section of a right-angled cone, and let $AB\Gamma$ be a triangle having the same base as the segment and equal height, and let the area K be four-thirds of the triangle $AB\Gamma$. It is required to prove that it is equal to the segment $A\Delta BE\Gamma$.

For if it is not equal, it is either greater or less. Let the segment $A\Delta BE\Gamma$ first be, if possible, greater than the area K . Now I have inscribed the triangles $A\Delta B$, $BE\Gamma$, as aforesaid,^c and I have inscribed in the remaining segments other triangles having the same

^a For $B\Delta\Gamma = 3(P + X + \Psi + \Omega + \Delta) > 3(\Delta + \Omega + \Psi + X)$.

^b In Prop. 15 Archimedes shows that the same theorem holds good even if $B\Gamma$ is not at right angles to the axis. It is then proved in Prop. 16, by the method of exhaustion, that the segment is equal to one-third of the triangle $B\Gamma\Delta$. This is done by showing, on the basis of the "Axiom of Archimedes," that by taking enough parts the difference between the circumscribed and the inscribed figures can be made as small as we please. It is equivalent to integration. From this it is easily proved that the segment is equal to four-thirds of a triangle with the same base and equal height (Prop. 17).

^c In earlier propositions Archimedes has used the same procedure as he now describes. Δ , E are the points in which the diameter through the mid-points of AB , $B\Gamma$ meet the curve.

GREEK MATHEMATICS

βάσιν ἔχοντα τοῖς τμαμάτεσσι καὶ ὕψος τὸ αὐτό, καὶ ἀεὶ εἰς τὰ ὕστερον γινόμενα τμάματα ἐγγράφω δύο τρίγωνα τὰν αὐτὰν βάσιν ἔχοντα τοῖς τμαμάτεσσι καὶ ὕψος τὸ αὐτό· ἐσσοῦνται δὴ τὰ καταλειπόμενα τμάματα ἐλάσσονα τᾶς ὑπεροχᾶς, ἧ ὑπερέχει τὸ ΑΔΒΕΓ τμᾶμα τοῦ Κ χωρίου. ὥστε τὸ ἐγγραφόμενον πολύγωνον μείζον ἐσσεῖται τοῦ Κ· ὅπερ ἀδύνατον. ἐπεὶ γάρ ἐστιν ἐξῆς κείμενα χωρία ἐν τῷ τετραπλασίονι λόγῳ, πρῶτον μὲν τὸ ΑΒΓ τρίγωνον τετραπλάσιον τῶν ΑΔΒ, ΒΕΓ τριγώνων, ἔπειτα δὲ αὐτὰ ταῦτα τετραπλάσια τῶν εἰς τὰ ἐπόμενα τμάματα ἐγγραφέντων καὶ ἀεὶ οὕτω, δῆλον, ὡς σύμπαντα τὰ χωρία ἐλάσσονά ἐστιν ἢ ἐπίτριτα τοῦ μεγίστου, τὸ δὲ Κ ἐπίτριτόν ἐστι τοῦ μεγίστου χωρίου. οὐκ ἄρα ἐστὶν μείζον τὸ ΑΔΒΕΓ τμᾶμα τοῦ Κ χωρίου.

Ἔστω δέ, εἰ δυνατόν, ἔλασσον. κείσθω δὴ τὸ μὲν ΑΒΓ τρίγωνον ἴσον τῷ Ζ, τοῦ δὲ Ζ τέταρτον τὸ Η, καὶ ὁμοίως τοῦ Η τὸ Θ, καὶ ἀεὶ ἐξῆς τιθέσθω, ἕως κα γένηται τὸ ἔσχατον ἔλασσον τᾶς

^a This was proved geometrically in Prop. 23, and is proved generally in Eucl. ix. 35. It is equivalent to the summation

$$1 + \left(\frac{1}{2}\right) + \left(\frac{1}{2}\right)^2 + \dots + \left(\frac{1}{2}\right)^{n-1} = \frac{1}{1} - \frac{1}{2} \left(\frac{1}{2}\right)^{n-1} \\ = \frac{1 - \left(\frac{1}{2}\right)^n}{1 - \frac{1}{2}}.$$

ARCHIMEDES

base as the segments and equal height, and so on continually I inscribe in the resulting segments two

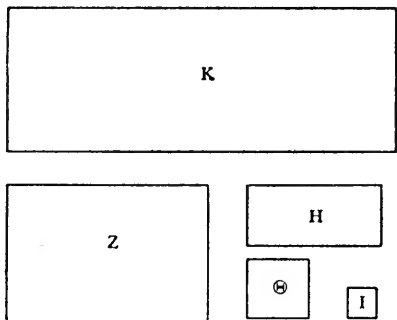

triangles having the same base as the segments and equal height ; then there will be left [at some time] segments less than the excess by which the segment $A\Delta BEI'$ exceeds the area K [Prop. 20, coroll.]. Therefore the inscribed polygon will be greater than K ; which is impossible. For since the areas successively formed are each four times as great as the next, the triangle ABI' being four times the triangles $A\Delta B$, $BE\Gamma$ [Prop. 21], then these last triangles four times the triangles inscribed in the succeeding segments, and so on continually, it is clear that the sum of all the areas is less than four-thirds of the greatest [Prop. 23],^a and K is equal to four-thirds of the greatest area. Therefore the segment $A\Delta BE\Gamma$ is not greater than the area K .

Now let it be, if possible, less. Then let

$$Z = AB\Gamma, H = \frac{1}{4}Z, \theta = \frac{1}{4}H,$$

and so on continually, until the last [area] is less than

GREEK MATHEMATICS

ὑπεροχᾶς, ἃ ὑπερέχει τὸ Κ χωρίον τοῦ τμήματος, καὶ ἔστω ἔλασσον τὸ Ι. ἔστιν δὴ τὰ Ζ, Η, Θ, Ι χωρία καὶ τὸ τρίτον τοῦ Ι ἐπίτριτα τοῦ Ζ. ἔστιν δὲ καὶ τὸ Κ τοῦ Ζ ἐπίτριτον· ἴσον ἄρα τὸ Κ τοῖς Ζ, Η, Θ, Ι καὶ τῷ τρίτῳ μέρει τοῦ Ι. ἐπεὶ οὖν τὸ Κ χωρίον τῶν μὲν Ζ, Η, Θ, Ι χωρίων ὑπερέχει ἐλάσσονι τοῦ Ι, τοῦ δὲ τμήματος μείζονι τοῦ Ι, δῆλον, ὡς μείζονά ἐντι τὰ Ζ, Η, Θ, Ι χωρία τοῦ τμήματος· ὅπερ ἀδύνατον· ἐδείχθη γάρ, ὅτι, ἐὰν ἦ ὅποσαοῦν χωρία ἐξῆς κείμενα ἐν τετραπλασίονι λόγῳ, τὸ δὲ μέγιστον ἴσον ἢ τῷ εἰς τὸ τμήμα ἐγγραφομένῳ τριγώνῳ, τὰ σύμπαντα χωρία ἐλάσσονα ἐσσεῖται τοῦ τμήματος. οὐκ ἄρα τὸ ΑΔΒΕΓ τμήμα ἔλασσόν ἐστι τοῦ Κ χωρίου. ἐδείχθη δέ, ὅτι οὐδὲ μείζον· ἴσον ἄρα ἐστὶν τῷ Κ. τὸ δὲ Κ χωρίον ἐπίτριτόν ἐστι τοῦ τριγώνου τοῦ ΑΒΓ· καὶ τὸ ΑΔΒΕΓ ἄρα τμήμα ἐπίτριτόν ἐστι τοῦ ΑΒΓ τριγώνου.

(k) HYDROSTATICS

(i.) Postulates

Archim. *De Corpor. Fluit.* i., Archim. ed. Heiberg
ii. 318. 2-8

Ὑποκείσθω τὸ ὑγρὸν φύσιν ἔχον τοιαύταν, ὥστε τῶν μερέων αὐτοῦ τῶν ἐξ ἴσου κειμένων καὶ συν-

* The Greek text of the book *On Floating Bodies*, the earliest extant treatise on hydrostatics, first became available in 1906 when Heiberg discovered at Constantinople the ms. which he terms C. Unfortunately many of the readings are doubtful, and those who are interested in the text should consult the Teubner edition. Still more unfortunately, it is incomplete; but, as the whole treatise was translated into Latin in 1269 by William of Moerbeke from a Greek ms.

ARCHIMEDES

the excess by which the area K exceeds the segment [Eucl. x. 1], and let I be [the area] less [than this excess]. Now

$$Z + H + \Theta + I + \frac{1}{3}I = \frac{4}{3}Z. \quad [\text{Prop. 23}]$$

But $K = \frac{4}{3}Z$;

therefore $K = Z + H + \Theta + I + \frac{1}{3}I$.

Therefore since the area K exceeds the areas Z , H , Θ , I by an excess less than I , and exceeds the segment by an excess greater than I , it is clear that the areas Z , H , Θ , I are greater than the segment; which is impossible; for it was proved that, if there be any number of areas in succession such that each is four times the next, and the greatest be equal to the triangle inscribed in the segment, then the sum of the areas will be less than the segment [Prop. 22]. Therefore the segment $A\Delta BE\Gamma$ is not less than the area K . And it was proved not to be greater; therefore it is equal to K . But the area K is four-thirds of the triangle $AB\Gamma$; and therefore the segment $A\Delta BE\Gamma$ is four-thirds of the triangle $AB\Gamma$.

(k) HYDROSTATICS

(i.) Postulates

Archimedes, *On Floating Bodies* ^a i., Archim. ed.
Heiberg ii. 318. 2-8

Let the nature of a fluid be assumed to be such that, of its parts which lie evenly and are continuous, since lost, it is possible to supply the missing parts in Latin, as is done for part of Prop. 2. From a comparison with the Greek, where it survives, William's translation is seen to be so literal as to be virtually equivalent to the original. In each case Heiberg's figures are taken from William's translation, as they are almost unrecognizable in C; for convenience in reading the Greek, the figures are given the appropriate Greek letters in this edition.

GREEK MATHEMATICS

εχέων ἐόντων ἐξωθειῖσθαι τὸ ἦσσον θλιβόμενον ὑπὸ τοῦ μᾶλλον θλιβομένου, καὶ ἕκαστον δὲ τῶν μερέων αὐτοῦ θλίβεσθαι τῷ ὑπεράνω αὐτοῦ ὑγρῷ κατὰ κάθετον ἐόντι, εἴ κα μὴ τὸ ὑγρὸν ἦ καθειργμένον ἐν τιμῇ καὶ ὑπὸ ἄλλου τινὸς θλιβόμενον.

Ibid. i., Archim. ed. Heiberg ii. 336. 14-16

Ὑποκείσθω, τῶν ἐν τῷ ὑγρῷ ἄνω φερομένων ἕκαστον ἀναφέρεσθαι κατὰ τὴν κάθετον τὴν διὰ τοῦ κέντρου τοῦ βάρους αὐτοῦ ἀγμένην.

(ii.) *Surface of Fluid at Rest*

Ibid. i., Prop. 2, Archim. ed. Heiberg ii. 319. 7-320. 30

Omnis humidi consistentis ita, ut maneat inmotum, superficies habebit figuram sperae habentis centrum idem cum terra.

Intelligatur enim humidum consistens ita, ut maneat non motum, et secetur ipsius superficies plano per centrum terrae, sit autem terrae centrum K, superficiei autem sectio linea ABGD. Dico itaque,

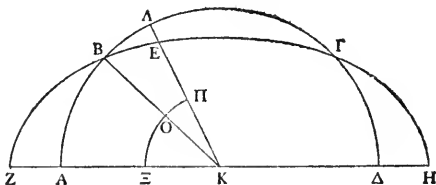

lineam ABGD circuli esse periferiam, centrum autem ipsius K.

Si enim non est, rectae a K ad lineam ABGD

ARCHIMEDES

that which is under the lesser pressure is driven along by that under the greater pressure, and each of its parts is under pressure from the fluid which is perpendicularly above it, except when the fluid is enclosed in something and is under pressure from something else.

Ibid. i., Archim. ed. Heiberg ii. 336. 14-16

Let it be assumed that, of bodies which are borne upwards in a fluid, each is borne upwards along the perpendicular drawn through its centre of gravity.^a

(ii.) *Surface of Fluid at Rest*

Ibid. i., Prop. 2,^b Archim. ed. Heiberg ii. 319. 7-320. 30

The surface of any fluid at rest is the surface of a sphere having the same centre as the earth.

For let there be conceived a fluid at rest, and let its surface be cut by a plane through the centre of the earth, and let the centre of the earth be K, and let the section of the surface be the curve ABΓΔ. Then I say that the curve ABΓΔ is an arc of a circle whose centre is K.

For if it is not, straight lines drawn from K to the

^a These are the only assumptions, other than the assumptions of Euclidean geometry, made in this book by Archimedes; if the object of mathematics be to base the conclusions on the fewest and most "self-evident" axioms, Archimedes' treatise *On Floating Bodies* must indeed be ranked highly.

^b The earlier part of this proposition has to be given from William of Moerbeke's translation. The diagram is here given with the appropriate Greek letters.

GREEK MATHEMATICS

occurrentes non erunt aequales. Sumatur itaque aliqua recta, quae est quarundam quidem a K occurrentium ad lineam $ABGD$ maior, quarundam autem minor, et centro quidem K , distantia autem sumptae lineae circulus describatur; cadet igitur periferia circuli habens hoc quidem extra lineam $ABGD$, hoc autem intra, quoniam quae ex centro quarundam quidem a K occurrentium ad lineam $ABGD$ est maior, quarundam autem minor. Sit igitur descripti circuli periferia quae ZBH , et a B ad K recta ducatur, et copulentur quae ZK , KEL aequales facientes angulos, describatur autem et centro K periferia quaedam quae XOP in plano et in humido; partes itaque humidi quae secundum XOP periferiam ex aequo sunt positae et continuae inuicem. Et premuntur quae quidem secundum XO periferiam humido quod secundum ZB locum, quae autem secundum periferiam OP humido quod secundum BE locum; inaequaliter igitur premuntur partes humidi quae secundum periferiam XO ei quae [η]¹ κατὰ τὰν $ΟΠ$. ὥστε ἐξωθήσονται τὰ ἦσσον θλιβόμενα ὑπὸ τῶν μᾶλλον θλιβομένων. οὐ μένει ἄρα τὸ ὑγρόν. ὑπέκειτο δὲ καθεστακὸς εἶμεν ὥστε μένειν ἀκίνητον. ἀναγκαῖον ἄρα τὰν $ΑΒΓΔ$ γραμμὰν κύκλου περιφέρειαν εἶμεν καὶ κέντρον αὐτᾶς τὸ K . ὁμοίως δὴ δειχθήσεται καί, ὅπως κα ἄλλως ἂ ἐπιφάνεια τοῦ ὑγροῦ ἐπιπέδῳ τμαθῆ διὰ τοῦ κέντρου τᾶς γᾶς, ὅτι ἂ τομὰ ἐσσεῖται κύκλου περιφέρεια, καὶ κέντρον αὐτᾶς ἐσσεῖται, ὃ καὶ τᾶς γᾶς ἐστι κέντρον. δῆλον οὖν, ὅτι ἂ ἐπιφάνεια τοῦ ὑγροῦ καθεστακὸτος ἀκινήτου σφαίρας ἔχει τὸ σχῆμα τὸ αὐτὸ κέντρον ἐχούσας τᾶ γᾶ, ἐπειδὴ

¹ η om. Heiberg.

ARCHIMEDES

curve $AB\Gamma\Delta$ will not be equal. Let there be taken, therefore, any straight line which is greater than some of the straight lines drawn from K to the curve $AB\Gamma\Delta$, but less than others, and with centre K and radius equal to the straight line so taken let a circle be described; the circumference of the circle will fall partly outside the curve $AB\Gamma\Delta$, partly inside, inasmuch as its radii are greater than some of the straight lines drawn from K to the curve $AB\Gamma\Delta$, but less than others. Let the arc of the circle so described be ZBH , and from B let a straight line be drawn to K , and let ZK , KEA be drawn making equal angles [with KB], and with centre K let there be described, in the plane and in the fluid, an arc $\Xi O\Pi$; then the parts of the fluid along $\Xi O\Pi$ lie evenly and are continuous [*v. supra*, p. 243]. And the parts along the arc ΞO are under pressure from the portion of the fluid between it and ZB , while the parts along the arc $O\Pi$ are under pressure from the portion of the fluid between it and BE ; therefore the parts of the fluid along ΞO and the parts of the fluid along $O\Pi$ are under unequal pressures; so that the parts under the lesser pressure are thrust along by the parts under the greater pressure [*v. supra*, p. 245]; therefore the fluid will not remain at rest. But it was postulated that the fluid would remain unmoved; therefore the curve $AB\Gamma\Delta$ must be an arc of a circle with centre K . Similarly it may be shown that, in whatever other manner the surface be cut by a plane through the centre of the earth, the section is an arc of a circle and its centre will also be the centre of the earth. It is therefore clear that the surface of the fluid remaining at rest has the form of a sphere with the same centre as the earth, since it is such

GREEK MATHEMATICS

τοιαύτα ἐστίν, ὥστε διὰ τοῦ αὐτοῦ σαμείου τμαθεῖσαν τὰν τομὰν ποιεῖν περιφέρειαν κύκλου κέντρον ἔχοντος τὸ σαμείον, δι' οὗ τέμνεται τῷ ἐπιπέδῳ.

(iii.) *Solid immersed in a Fluid*

Ibid. i., Prop. 7, Archim. ed. Heiberg ii. 332. 21-336. 13

Τὰ βαρύτερα τοῦ ὑγροῦ ἀφεθέντα εἰς τὸ ὑγρὸν οἰσεῖται κάτω, ἔστ' ἂν καταβᾶντι, καὶ ἐσσοῦνται κουφότερα ἐν τῷ ὑγρῷ τοσοῦτον, ὅσον ἔχει τὸ βάρος τοῦ ὑγροῦ τοῦ ταλικούτον ὄγκον ἔχοντος, ἀλίκος ἐστίν ὁ τοῦ στερεοῦ μεγέθεος ὄγκος.

“Ὅτι μὲν οὖν οἰσεῖται ἐς τὸ κάτω, ἔστ' ἂν καταβᾶντι, δῆλον· τὰ γὰρ ὑποκάτω αὐτοῦ μέρεα τοῦ ὑγροῦ θλιβησοῦνται μᾶλλον τῶν ἐξ ἴσου αὐτοῖς κειμένων μερέων, ἐπειδὴ βαρύτερον ὑπόκειται τὸ στερεὸν μέγεθος τοῦ ὑγροῦ· ὅτι δὲ κουφότερα ἐσσοῦνται, ὡς εἴρηται, δειχθήσεται.

“Ἐστω τι μέγεθος τὸ Α, ὃ ἐστὶ βαρύτερον τοῦ ὑγροῦ, βάρος δὲ ἔστω τοῦ μὲν ἐν ᾧ Α μεγέθεος τὸ ΒΓ, τοῦ δὲ ὑγροῦ τοῦ ἴσον ὄγκον ἔχοντος τῷ Α τὸ Β. δεικτέον, ὅτι τὸ Α μέγεθος ἐν τῷ ὑγρῷ ἐὼν βάρος ἔξει ἴσον τῷ Γ.

Λελάφθω γάρ τι μέγεθος τὸ ἐν ᾧ τὸ Δ κουφότερον τοῦ ὑγροῦ τοῦ ἴσον ὄγκον ἔχοντος αὐτῷ, ἔστω δὲ τοῦ μὲν ἐν ᾧ τὸ Δ μεγέθεος βάρος ἴσον τῷ Β βάρει, τοῦ δὲ ὑγροῦ τοῦ ἴσον ὄγκον ἔχοντος τῷ Δ μεγέθει τὸ βάρος ἔστω ἴσον τῷ ΒΓ βάρει.

* Or, as we should say, “lighter by the weight of fluid displaced.”

ARCHIMEDES

that, when it is cut [by a plane] always passing through the same point, the section is an arc of a circle having for centre the point through which it is cut by the plane [Prop. 1].

(iii.) *Solid immersed in a Fluid*

Ibid. i., Prop. 7, Archim. ed. Heiberg ii. 332. 21–336. 13

Solids heavier than a fluid will, if placed in the fluid, sink to the bottom, and they will be lighter [if weighed] in the fluid by the weight of a volume of the fluid equal to the volume of the solid.^a

That they will sink to the bottom is manifest ; for the parts of the fluid under them are under greater pressure than the parts lying evenly with them, since it is postulated that the solid is heavier than water ; that they will be lighter, as aforesaid will be [thus] proved.

Let A be any magnitude heavier than the fluid, let the weight of the magnitude A be $B + \Gamma$, and let the weight of fluid having the same volume as A be B. It is required to prove that in the fluid the magnitude A will have a weight equal to Γ .

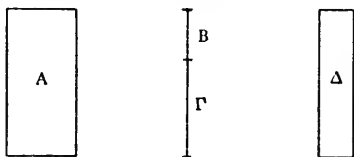

For let there be taken any magnitude Δ lighter than the same volume of the fluid such that the weight of the magnitude Δ is equal to the weight B, while the weight of the fluid having the same volume as the magnitude Δ is equal to the weight $B + \Gamma$.

συντεθέντων δὴ ἐς τὸ αὐτὸ τῶν μεγεθῶν, ἐν οἷς τὰ A , Δ , τὸ τῶν συναμφοτέρων μέγεθος ἰσοβαρὲς ἐσσεῖται τῷ ὑγρῷ· ἔστι γὰρ τῶν μεγεθῶν συναμφοτέρων τὸ βάρος ἴσον συναμφοτέροις τοῖς βάρεσιν τῷ τε $B\Gamma$ καὶ τῷ B , τοῦ δὲ ὑγροῦ τοῦ ἴσον ὄγκον ἔχοντος ἀμφοτέροις τοῖς μεγέθεσι τὸ βάρος ἴσον ἐστὶ τοῖς αὐτοῖς βάρεσιν. ἀφεθέντων οὖν τῶν μεγεθῶν ἐς τὸ ὑγρὸν ἰσορροποῦνται τῷ ὑγρῷ καὶ οὔτε εἰς τὸ ἄνω οἰσοῦνται οὔτε εἰς τὸ κάτω· διὸ τὸ μὲν ἐν ω A μέγεθος οἰσεῖται ἐς τὸ κάτω καὶ τοσαῦτα βία ὑπὸ τοῦ ἐν ω Δ μέγεθος ἀνέλκεται ἐς τὸ ἄνω, τὸ δὲ ἐν ω Δ μέγεθος, ἐπεὶ κουφώτερόν ἐστι τοῦ ὑγροῦ, ἀνοισεῖται εἰς τὸ ἄνω τοσαῦτα βία, ὅσον ἐστὶ τὸ Γ βάρος· δέδεικται γάρ, ὅτι τὰ κουφώτερα τοῦ ὑγροῦ μεγέθεα στερεὰ βιασθέντα ἐς τὸ ὑγρὸν ἀναφέρονται τοσαῦτα βία ἐς τὸ ἄνω, ὅσον ἐστὶ τὸ βάρος, ω βαρύτερόν ἐστι τοῦ μεγέθεος τὸ ὑγρὸν τὸ ἴσογκον τῷ μεγέθει. ἔστι δὲ τῷ Γ βάρει βαρύτερον τοῦ Δ μέγεθεος τὸ ὑγρὸν τὸ ἴσον ὄγκον ἔχον τῷ Δ · δῆλον οὖν, ὅτι καὶ τὸ ἐν ω A μέγεθος ἐς τὸ κάτω οἰσεῖται τοσοῦτω βάρει, ὅσον ἐστὶ τὸ Γ .

^a This proposition suggests a method, alternative to that given by Vitruvius (*v. supra*, pp. 36-39, especially p. 38 n. a), whereby Archimedes may have discovered the proportions of gold and silver in King Hiero's crown.

Let w be the weight of the crown, and let w_1 and w_2 be the weights of gold and silver in it respectively, so that $w = w_1 + w_2$.

Take a weight w of gold and weigh it in a fluid, and let the loss of weight be P_1 . Then the loss of weight when a weight w_1 of gold is weighed in the fluid, and consequently the weight of fluid displaced, will be $\frac{w_1}{w} \cdot P_1$.

ARCHIMEDES

Then if we combine the magnitudes A , Δ , the combined magnitude will be equal to the weight of the same volume of the fluid ; for the weight of the combined magnitudes is equal to the weight $(B + \Gamma) \div B$, while the weight of the fluid having the same volume as both the magnitudes is equal to the same weight. Therefore, if the [combined] magnitudes are placed in the fluid, they will balance the fluid, and will move neither upwards nor downwards [Prop. 3] ; for this reason the magnitude A will move downwards, and will be subject to the same force as that by which the magnitude Δ is thrust upwards, and since Δ is lighter than the fluid it will be thrust upwards by a force equal to the weight Γ ; for it has been proved that when solid magnitudes lighter than the fluid are forcibly immersed in the fluid, they will be thrust upwards by a force equal to the difference in weight between the magnitude and an equal volume of the fluid [Prop. 6]. But the fluid having the same volume as Δ is heavier than the magnitude Δ by the weight Γ ; it is therefore plain that the magnitude A will be borne upwards by a force equal to Γ .^a

Now take a weight w of silver and weigh it in the fluid, and let the loss of weight be P_1 . Then the loss of weight when a weight w_2 of silver is weighed in the fluid, and consequently the weight of fluid displaced, will be $\frac{w_2}{w} \cdot P_1$.

Finally, weigh the crown itself in the fluid, and let the loss of weight, and consequently the weight of fluid displaced, be P .

It follows that
$$\frac{w_1}{w} \cdot P_1 + \frac{w_2}{w} \cdot P_2 = P,$$

whence

$$\frac{w_1}{w_2} = \frac{P_2 - P}{P - P_1}.$$

GREEK MATHEMATICS

(iv.) *Stability of a Paraboloid of Revolution*

Ibid. ii., Prop. 2, Archim. ed. Heiberg ii. 348. 10-352. 19

Τὸ ὀρθὸν τμᾶμα τοῦ ὀρθογωνίου κωνοειδέος, ὅταν τὸν ἄξονα ἔχη μὴ μείζονα ἢ ἡμιόλιον τᾶς μέχρι τοῦ ἄξονος, πάντα λόγον ἔχον ποτὶ τὸ ὑγρὸν τῷ βάρει, ἀφεθὲν εἰς τὸ ὑγρὸν οὕτως, ὥστε τὰν βάσιν αὐτοῦ μὴ ἄπτεσθαι τοῦ ὑγροῦ, τεθὲν κεκλιμένον οὐ μενεῖ κεκλιμένον, ἀλλὰ ἀποκαταστασεῖται ὀρθόν. ὀρθὸν δὲ λέγω καθεστακέναι τὸ τοιοῦτο τμᾶμα, ὅποταν τὸ ἀποτετμακὸς αὐτὸ ἐπίπεδον παρὰ τὰν ἐπιφάνειαν ἢ τοῦ ὑγροῦ.

Ἔστω τμᾶμα ὀρθογωνίου κωνοειδέος, οἷον εἴρηται, καὶ κείσθω κεκλιμένον. δεικτέον, ὅτι οὐ μενεῖ, ἀλλ' ἀποκαταστασεῖται ὀρθόν.

Τμαθέντος δὴ αὐτοῦ ἐπιπέδῳ διὰ τοῦ ἄξονος ὀρθῶ ποτὶ τὸ ἐπίπεδον τὸ ἐπὶ τᾶς ἐπιφανείας τοῦ ὑγροῦ τμᾶματος ἔστω τομὰ ἁ ΑΠΟΛ ὀρθογωνίου κώνου τομὰ, ἄξων δὲ τοῦ τμᾶματος καὶ διάμετρος τᾶς τομᾶς ἁ ΝΟ, τᾶς δὲ τοῦ ὑγροῦ ἐπιφανείας τομὰ ἁ ΙΣ. ἐπεὶ οὖν τὸ τμᾶμα οὐκ ἐστὶν ὀρθόν, οὐκ ἂν εἶη παράλληλος ἁ ΑΛ τῇ ΙΣ· ὥστε οὐ ποιήσει ὀρθὰν γωνίαν ἁ ΝΟ ποτὶ τὰν ΙΣ. ἄχθω

* Writing of the treatise *On Floating Bodies*, Heath (*H.G.M.* ii. 94-95) justly says: "Book ii., which investigates fully the conditions of stability of a right segment of a paraboloid of revolution floating in a fluid for different values of the specific gravity and different ratios between the axis or height of the segment and the principal parameter of the generating parabola, is a veritable *tour de force* which must be read in full to be appreciated."

† In this technical term the "axis" is the axis of the

ARCHIMEDES

(iv.) *Stability of a Paraboloid of Revolution* ^a

Ibid. ii., Prop. 2, Archim. ed. Heiberg ii. 348. 10-352. 19

If there be a right segment of a right-angled conoid, whose axis is not greater than one-and-a-half times the line drawn as far as the axis,^b and whose weight relative to the fluid may have any ratio, and if it be placed in the fluid in an inclined position in such a manner that its base do not touch the fluid, it will not remain inclined but will return to the upright position. I mean by returning to the upright position the figure formed when the plane cutting off the segment is parallel to the surface of the fluid.

Let there be a segment of a right-angled conoid, such as has been stated, and let it be placed in an inclined position. It is required to prove that it will not remain there but will return to the upright position.

Let the segment be cut by a plane through the axis perpendicular to the plane which forms the surface of the fluid, and let $\text{AΠO}\Lambda$ be the section of the segment, being a section of a right-angled cone [*De Con. et Sphaer.* 11], and let NO be the axis of the segment and the axis of the section, and let $\text{I}\Sigma$ be the section of the surface of the liquid. Then since the segment is not upright, AA will not be parallel to $\text{I}\Sigma$; and therefore NO will not make a right angle

right-angled cone from which the generating parabola is derived. The *latus rectum* is "the line which is double of the line drawn as far as the axis" (*ἡ διπλασία τῆς μέχρι τοῦ ἄξονος*); and so the condition laid down by Archimedes is that the axis of the segment of the paraboloid of revolution shall not be greater than three-quarters of the *latus rectum* or *principal parameter* of the generating parabola.

ARCHIMEDES

with $I\Sigma$. Therefore let $K\Omega$ be drawn parallel [to $I\Sigma$] and touching the section of the cone at Π , and from Π let $\Pi\Phi$ be drawn parallel to NO ; then $\Pi\Phi$ bisects $I\Sigma$ —for this is proved in the [*Elements of*] *Conics*.^a Let $\Pi\Phi$ be cut so that $\Pi B = 2B\Phi$, and let NO be cut at P so that $OP = 2PN$; then P will be the centre of gravity of the greater segment of the solid, and B that of $\Pi\Omega\Sigma$; for it is proved in the books *On Equilibriums* that the centre of gravity of any segment of a right-angled conoid is at the point dividing the axis in such a manner that the segment towards the vertex of the axis is double of the remainder.^b Now if the solid segment $\Pi\Omega\Sigma$ be taken away from the whole, the centre of gravity of the remainder will lie upon the straight line $B\Gamma$; for it has been proved in the *Elements of Mechanics* that if any magnitude be taken away not having the same centre of gravity as the whole magnitude, the centre of gravity of the remainder will be on the straight line joining the centres [of gravity] of the whole magnitude and of the part

^a Presumably in the works of Aristaeus or Euclid, but it is also *Quad. Parab.* 1.

^b The proof is not in any extant work by Archimedes.

GREEK MATHEMATICS

ἀφηρημένου ἐκβεβλημένας ἐπὶ τὰ αὐτά, ἐφ' ἃ τὸ κέντρον τοῦ ὄλου μεγέθεός ἐστιν. ἐκβεβλήσθω δὴ ἡ ΒΡ ἐπὶ τὸ Γ, καὶ ἔστω τὸ Γ τὸ κέντρον τοῦ βάρους τοῦ λοιποῦ μεγέθεος. ἐπεὶ οὖν ἡ ΝΟ τῆς μὲν ΟΡ ἡμιολία, τῆς δὲ μέχρι τοῦ ἄξονος οὐ μείζων ἢ ἡμιολία, δηλόν, ὅτι ἡ ΡΟ τῆς μέχρι τοῦ ἄξονος οὐκ ἐστὶ μείζων· ἡ ΠΡ ἄρα ποτὶ τὴν ΚΩ γωνίας ἀνίσους ποιεῖ, καὶ ἡ ὑπὸ τῶν ΡΠΩ γίνεται ὀξεῖα· ἡ ἀπὸ τοῦ Ρ ἄρα κάθετος ἐπὶ τὴν ΠΩ ἀγομένα μεταξὺ πεσεῖται τῶν Π, Ω. πιπτέτω ὡς ἡ ΡΘ· ἡ ΡΘ ἄρα ὀρθά ἐστιν ποτὶ τὸ <ἀποτετμακός>¹ ἐπίπεδον, ἐν ᾧ ἐστὶν ἡ ΣΙ, ὃ ἐστὶν ἐπὶ τῆς ἐπιφανείας τοῦ ὑγροῦ. ἄχθωσαν δὴ τινες ἀπὸ τῶν Β, Γ παρὰ τὴν ΡΘ· ἐνεχθήσεται δὴ τὸ μὲν ἐκτὸς τοῦ ὑγροῦ τοῦ μεγέθεος εἰς τὸ κάτω κατὰ τὴν διὰ τοῦ Γ ἀγομέναν κάθετον· ὑπόκειται γὰρ ἕκαστον τῶν βαρέων εἰς τὸ κάτω φέρεσθαι κατὰ τὴν κάθετον τὴν διὰ τοῦ κέντρου ἀγομέναν· τὸ δὲ ἐν τῷ ὑγρῷ μέγεθος, ἐπεὶ κουφότερον γίνεται τοῦ ὑγροῦ, ἐνεχθήσεται εἰς τὸ ἄνω κατὰ τὴν κάθετον τὴν διὰ τοῦ Β ἀγομέναν. ἐπεὶ δὲ οὐ κατὰ τὴν αὐτὴν κάθετον ἀλλάλοις ἀντιθλίβονται, οὐ μενεῖ τὸ σχῆμα, ἀλλὰ τὰ μὲν κατὰ τὸ Α εἰς τὸ ἄνω ἐνεχθήσεται, τὰ δὲ κατὰ τὸ Λ εἰς τὸ κάτω, καὶ τοῦτο αἰεὶ ἐσσεῖται, ἕως ἂν ὀρθὸν ἀποκατασταθῇ.

¹ ἀποτετμακός, cf. *supra*, p. 252 line 8; Heiberg prints κ . . . ος.

^a If the normal at Π meets the axis in Μ, then ΟΜ is greater than "the line drawn as far as the axis" except in the case where Π coincides with the vertex, which case is excluded by the conditions of this proposition. Hence ΟΜ is always greater than ΟΡ; and because the angle ΩΠΜ is right, the angle ΩΠΡ must be acute.

ARCHIMEDES

taken away, produced from the extremity which is the centre of gravity of the whole magnitude [*De Plan. Aequil.* i. 8]. Let BP then be produced to Γ , and let Γ be the centre of gravity of the remaining magnitude. Then, since $NO = \frac{3}{2} \cdot OP$, and $NO \succ \frac{3}{2} \cdot$ (the line drawn as far as the axis), it is clear that $PO \succ$ (the line drawn as far as the axis); therefore ΠP makes unequal angles with $K\Omega$, and the angle $\Pi P \Omega$ is acute^a; therefore the perpendicular drawn from P to $\Pi\Omega$ will fall between Π, Ω . Let it fall as $P\Theta$; then $P\Theta$ is perpendicular to the cutting plane containing ΣI , which is on the surface of the fluid. Now let lines be drawn from B, Γ parallel to $P\Theta$; then the portion of the magnitude outside the fluid will be subject to a downward force along the line drawn through Γ —for it is postulated that each weight is subject to a downward force along the perpendicular drawn through its centre of gravity^b; and since the magnitude in the fluid is lighter than the fluid,^c it will be subject to an upward force along the perpendicular drawn through B.^d But, since they are not subject to contrary forces along the same perpendicular, the figure will not remain at rest but the portion on the side of A will move upwards and the portion on the side of Λ will move downwards, and this will go on continually until it is restored to the upright position.

^b Cf. *supra*, p. 245; possibly a similar assumption to this effect has fallen out of the text.

^c A tacit assumption, which limits the generality of the opening statement of the proposition that the segment may have any weight relative to the fluid.

^d v. *supra*, p. 251.

XVIII. ERATOSTHENES

XVIII. ERATOSTHENES

(a) GENERAL

Suidas, *s.v.* Ἐρατοσθένης

Ἐρατοσθένης, Ἀγλαοῦ, οἱ δὲ Ἀμβροσίου· Κυρηναῖος, μαθητῆς φιλοσόφου Ἀρίστωνος Χίου, γραμματικοῦ δὲ Λυσανίου τοῦ Κυρηναίου καὶ Καλλιμάχου τοῦ ποιητοῦ. μετεπέμφθη δὲ ἐξ Ἀθηνῶν ὑπὸ τοῦ τρίτου Πτολεμαίου καὶ διέτριψε μέχρι τοῦ πέμπτου. διὰ δὲ τὸ δευτερεύειν ἐν παντὶ εἶδει παιδείας τοῖς ἄκροις ἐγγίσαντα¹ Βῆτα² ἐπεκλήθη. οἱ δὲ καὶ δεύτερον ἢ νέον Πλάτωνα, ἄλλοι Πένταθλον ἐκάλεσαν. ἐτέχθη δὲ ρκς' Ὀλυμ-

¹ ἐγγίσαντα Meursius, ἐγγίσασι Adler.

² Βῆτα Gloss. in Psalmos, Hesych. Mil., τὰ βήματα codd.

⁴ Several of Eratosthenes' achievements have already been described—his solution of the Delian problem (vol. i. pp. 290-297), and his *sieve* for finding successive odd numbers (vol. i. pp. 100-103). Archimedes, as we have seen, dedicated the *Method* to him, and the *Cattle Problem*, as we have also seen, is said to have been sent through him to the Alexandrian mathematicians. It is generally supposed that Ptolemy credits him with having calculated the distance between the tropics (or twice the obliquity of the ecliptic) at 11/83rds. of a complete circle or 47° 29' 39", but Ptolemy's meaning is not clear. Eratosthenes also calculated the distances of the sun and moon from the earth and the size of the sun. Fragments of an astronomical poem which he wrote under the title

XVIII. ERATOSTHENES ^a

(a) GENERAL

Suidas, *s.v.* *Eratosthenes*

ERATOSTHENES, son of Aglaus, others say of Ambrosius; a Cyrenean, a pupil of the philosopher Ariston of Chios, of the grammarian Lysanias of Cyrene and of the poet Callimachus ^b; he was sent for from Athens by the third Ptolemy ^c and stayed till the fifth. ^d Owing to taking second place in all branches of learning, though approaching the highest excellence, he was called *Beta*. Others called him a *Second* or *New Plato*, and yet others *Pentathlon*. He was born in the 126th Olympiad ^e and died at the age

Hermes have survived. He was the first person to attempt a scientific chronology from the siege of Troy in two separate works, and he wrote a geographical work in three books. His writings are critically discussed in Bernhardt's *Eratosthenica* (Berlin, 1822).

^b Callimachus, the famous poet and grammarian, was also a Cyrenean. He opened a school in the suburbs of Alexandria and was appointed by Ptolemy Philadelphus chief librarian of the Alexandrian library, a post which he held till his death *c.* 240 B.C. Eratosthenes later held the same post.

^c Euergetes I (reigned 246–221 B.C.), who sent for him to be tutor to his son and successor Philopator (*v.* vol. i. pp. 256, 296).

^d Epiphanes (reigned 204–181 B.C.).

^e 276–273 B.C.

GREEK MATHEMATICS

πιάδι καὶ ἐτελεύτησεν π ἐτῶν γεγονώς, ἀποσχόμενος τροφῆς διὰ τὸ ἀμβλυώττειν, μαθητὴν ἐπίσημον καταλιπὼν Ἀριστοφάνην τὸν Βυζάντιον· οὐδὲ πάλιν Ἀρίσταρχος μαθητῆς. μαθηταὶ δὲ αὐτοῦ Μνασέας καὶ Μένανδρος καὶ Ἄριστις. ἔγραψε δὲ φιλόσοφα καὶ ποιήματα καὶ ἱστορίας, Ἀστρονομίαν ἢ Καταστερισμούς,¹ Περὶ τῶν κατὰ φιλοσοφίαν αἰρέσεων, Περὶ ἀλυπίας, διαλόγους πολλοὺς καὶ γραμματικὰ συχνά.

(b) ON MEANS

Papp. Coll. vii. 3, ed. Hultsch 636. 18-25

Τῶν δὲ προειρημένων τοῦ Ἀναλυομένου βιβλίων ἡ τάξις ἐστὶν τοιαύτη . . . Ἐρατοσθένους περὶ μεσοτήτων δύο.

Papp. Coll. vii. 21, ed. Hultsch 660. 18-662. 18

Τῶν τόπων καθόλου οἱ μὲν εἰσιν ἐφεκτικοί, ὡς καὶ Ἀπολλώνιος πρὸ τῶν ἰδίων στοιχείων λέγει σημείου μὲν τόπον σημείον, γραμμῆς δὲ τόπον γραμμῆν, ἐπιφανείας δὲ ἐπιφάνειαν, στερεοῦ δὲ στερεόν, οἱ δὲ διεξοδικοί, ὡς σημείου μὲν γραμμῆν, γραμμῆς δ' ἐπιφάνειαν, ἐπιφανείας δὲ στερεόν,

¹ Καταστερισμούς coni. Portus, Καταστηρίγμους codd.

* Not, of course, Aristarchus of Samos, the mathematician, but the celebrated Samothracian grammarian.

^b Mnaseas was the author of a work entitled Περὶ πλοῦς, whose three sections dealt with Europe, Asia and Africa, and a collection of oracles given at Delphi.

^c This work is extant, but is not thought to be genuine in

ERATOSTHENES

of eighty of voluntary starvation, having lost his sight; he left a distinguished pupil, Aristophanes of Byzantium; of whom in turn Aristarchus^a was a pupil. Among his pupils were Mnaseas,^b Menander and Aristis. He wrote philosophical works, poems and histories, *Astronomy* or *Placings Among the Stars*,^c *On Philosophical Divisions*, *On Freedom from Pain*, many dialogues and numerous grammatical works.

(b) ON MEANS

Pappus, *Collection* vii. 3, ed. Hultsch 636. 18-25

The order of the aforesaid books in the *Treasury of Analysis* is as follows . . . the two books of Eratosthenes *On Means*.^d

Pappus, *Collection* vii. 21, ed. Hultsch 660. 18-662. 18

Loci in general are termed *fixed*, as when Apollonius at the beginning of his own *Elements* says the locus of a point is a point, the locus of a line is a line, the locus of a surface is a surface and the locus of a solid is a solid; or *progressive*, as when it is said that the locus of a point is a line, the locus of a line is a surface and the locus of a surface is a solid; or *circumambient* as

its extant form; it contains a mythology and description of the constellations under forty-four heads. The general title Ἀστρονομία may be a mistake for Ἀστροθεσία; elsewhere it is alluded to under the title Κατάλογοι.

^d The inclusion of this work in the *Treasury of Analysis*, along with such works as those of Euclid, Aristaeus and Apollonius, shows that it was a standard treatise. It is not otherwise mentioned, but the *loci with reference to means* referred to in the passage from Pappus next cited were presumably discussed in it.

GREEK MATHEMATICS

οἱ δὲ ἀναστροφικοί, ὡς σημείου μὲν ἐπιφάνειαν, γραμμῆς δὲ στερεόν. [. . . οἱ δὲ ὑπὸ Ἐρατοσθένους ἐπιγραφέντες τόποι πρὸς μεσότητος ἐκ τῶν προειρημένων εἰσὶν τῷ γένει, ἀπὸ δὲ τῆς ιδιότητος τῶν ὑποθέσεων . . . ἐκείνοις.]¹

(c) THE " PLATONICUS "

Theon Smyr., ed. Hiller 81. 17-82. 5

Ἐρατοσθένης δὲ ἐν τῷ Πλατωνικῷ φησι, μὴ ταῦτόν εἶναι διάστημα καὶ λόγον. ἐπειδὴ λόγος μὲν ἐστὶ δύο μεγεθῶν ἢ πρὸς ἄλληλα ποιά σχέσις, γίνεται δ' αὕτη καὶ ἐν διαφόροις (καὶ ἐν ἀδιαφόροις).² οἷον ἐν ᾧ λόγῳ ἐστὶ τὸ αἰσθητὸν πρὸς τὸ νοητόν, ἐν τούτῳ δόξα πρὸς ἐπιστήμην, καὶ διαφέρει καὶ τὸ νοητὸν τοῦ ἐπιστητοῦ ᾧ καὶ ἡ δόξα τοῦ αἰσθητοῦ. διάστημα δὲ ἐν διαφέρουσι μόνον, ἢ κατὰ τὸ μέγεθος ἢ κατὰ ποιότητα ἢ κατὰ θέσιν ἢ ἄλλως ὅπως οὖν. δῆλον δὲ καὶ ἐντεῦθεν,

¹ The passage of which this forms the concluding sentence is attributed by Hultsch to an interpolator. To fill the lacuna before ἐκείνοις he suggests ἀνόμοιοι ἐκείνοις, following Halley's rendering, "diversa sunt ab illis."

² καὶ ἐν ἀδιαφόροις add. Hiller.

^a Tannery conjectured that these were the loci of points such that their distances from three fixed lines provided a "médiété," i.e., loci (straight lines and conics) which can be represented in trilinear co-ordinates by such equations as

$$2y = x + z, y^2 = xz, y(x + z) = 2xz, x(x - y) = z(y - z), \\ x(x - y) = y(y - z);$$

these represent respectively the arithmetic, geometric and harmonic means, and the means subcontrary to the harmonic and geometric means (v. vol. i. pp. 122-125). Zeuthen has

ERATOSTHENES

when it is said that the locus of a point is a surface and the locus of a line is a solid. [. . . the loci described by Eratosthenes as having reference to means belong to one of the aforesaid classes, but from a peculiarity in the assumptions are unlike them.]^a

(c) THE " PLATONICUS "

Theon of Smyrna, ed. Hiller 81. 17-82. 5

Eratosthenes in the *Platonicus*^b says that *interval* and *ratio* are not the same. Inasmuch as a ratio is a sort of relationship of two magnitudes one towards the other,^c there exists a ratio both between terms that are different and also between terms that are not different. For example, the ratio of the perceptible to the intelligible is the same as the ratio of opinion to knowledge, and the difference between the intelligible and the known is the same as the difference of opinion from the perceptible.^d But there can be an interval only between terms that are different, according to magnitude or quality or position or in some other way. It is thence clear that ratio is

an alternative conjecture on similar lines (*Die Lehre von den Kegelschnitten im Altertum*, pp. 320-321).

^b Theon cites this work in one other passage (ed. Hiller 2. 3-12) telling how Plato was consulted about the doubling of the cube; it has already been cited (vol. i. p. 256). Eratosthenes' own solution of the problem has already been given in vol. i. pp. 290-297, and a letter purporting to be from Eratosthenes to Ptolemy Euergetes is given in vol. i. pp. 256-261. Whether the *Platonicus* was a commentary on Plato or a dialogue in which Plato was an interlocutor cannot be decided.

^c Cf. Eucl. v. Def. 3, cited in vol. i. p. 444.

^d A reference to Plato, *Rep.* vi. 509 D—511 E, vii. 517 A—518 B.

GREEK MATHEMATICS

ὅτι λόγος διαστήματος ἕτερον· τὸ γὰρ ἡμισυ πρὸς τὸ διπλάσιον <καὶ τὸ διπλάσιον πρὸς τὸ ἡμισυ>¹ λόγον μὲν οὐ τὸν αὐτὸν ἔχει, διάστημα δὲ τὸ αὐτό.

(d) MEASUREMENT OF THE EARTH

Cleom. *De motu circ.* i. 10. 52, ed. Ziegler 94. 23-100. 23

Καὶ ἡ μὲν τοῦ Ποσειδωνίου ἔφοδος περὶ τοῦ κατὰ τὴν γῆν μεγέθους τοιαύτη, ἡ δὲ τοῦ Ἐρατοσθένους γεωμετρικῆς ἐφόδου ἐχομένη, καὶ δοκούσά τι ἀσαφέστερον ἔχειν. ποιήσει δὲ σαφῆ τὰ λεγόμενα ὑπ' αὐτοῦ τάδε προϋποτιθεμένων ἡμῶν. ὑποκείσθω ἡμῖν πρῶτον μὲν κἀνταῦθα, ὑπὸ τῷ αὐτῷ μεσημβρινῷ κείσθαι Σνήνην καὶ Ἀλεξάνδρειαν, καὶ δεύτερον, τὸ διάστημα τὸ μεταξὺ τῶν πόλεων πεντακισχιλίων σταδίων εἶναι, καὶ τρίτον, τὰς καταπεμπομένας ἀκτῖνας ἀπὸ διαφόρων μερῶν τοῦ ἡλίου ἐπὶ διάφορα τῆς γῆς μέρη παραλλήλους εἶναι· οὕτως γὰρ ἔχειν αὐτὰς οἱ γεωμέτραι ὑποτίθενται. τέταρτον ἐκεῖνο ὑποκείσθω, δεικνύμενον παρὰ τοῖς γεωμέτραις, τὰς εἰς παραλλήλους ἐμπιπτούσας εὐθείας τὰς ἐναλλάξ γωνίας ἴσας ποιεῖν, πέμπτον, τὰς ἐπὶ ἴσων γωνιῶν βεβηκυίας περιφερείας ὁμοίας εἶναι, τουτέστι τὴν αὐτὴν ἀναλογίαν καὶ τὸν αὐτὸν λόγον ἔχειν πρὸς τοὺς οἰκείους κύκλους, δεικνυμένου καὶ τούτου παρὰ τοῖς γεωμέτραις. ὁπότεν γὰρ περιφέρειαι ἐπὶ ἴσων γωνιῶν ὡσι βεβηκυῖαι, ἂν μία ἡτισοῦν

¹ καὶ . . . ἡμισυ add. Hiller.

^a The difference between ratio and interval is explained a little more neatly by Theon himself (ed. Hiller 81. 6-9): 266

ERATOSTHENES

different from interval ; for the relationship of the half to the double and of the double to the half does not furnish the same ratio, but it does furnish the same interval.^a

(d) MEASUREMENT OF THE EARTH

Cleomedes,^b *On the Circular Motion of the Heavenly Bodies* i. 10. 52, ed. Ziegler 94. 23–100. 23

Such then is Posidonius's method of investigating the size of the earth, but Eratosthenes' method depends on a geometrical argument, and gives the impression of being more obscure. What he says will, however, become clear if the following assumptions are made. Let us suppose, in this case also, first that Syene and Alexandria lie under the same meridian circle ; secondly, that the distance between the two cities is 5000 stades ; and thirdly, that the rays sent down from different parts of the sun upon different parts of the earth are parallel ; for the geometers proceed on this assumption. Fourthly, let us assume that, as is proved by the geometers, straight lines falling on parallel straight lines make the alternate angles equal, and fifthly, that the arcs subtended by equal angles are similar, that is, have the same proportion and the same ratio to their proper circles—this also being proved by the geometers. For whenever arcs of circles are subtended by equal angles, if any one of these is (say) one-tenth

διαφέρει δὲ διάστημα καὶ λόγος, ἐπειδὴ διάστημα μὲν ἐστὶ τὸ μεταξὺ τῶν ὁμογενῶν τε καὶ ἀνίσων ὄρων, λόγος δὲ ἀπλῶς ἢ τῶν ὁμογενῶν ὄρων πρὸς ἀλλήλους σχέσις.

^b Cleomedes probably wrote about the middle of the first century B.C. His handbook *De motu circulari corporum caelestium* is largely based on Posidonius.

GREEK MATHEMATICS

αὐτῶν δέκατον ἢ μέρος τοῦ οἰκείου κύκλου, καὶ αἱ λοιπαὶ πᾶσαι δέκατα μέρη γενήσονται τῶν οἰκείων κύκλων.

Τούτων ὁ κατακρατήσας οὐκ ἂν χαλεπῶς τὴν ἔφοδον τοῦ Ἐρατοσθένους καταμάθοι ἔχουσιν οὕτως. ὑπὸ τῷ αὐτῷ κείσθαι μεσημβρινῶ φησι Συήνην καὶ Ἀλεξάνδρειαν. ἐπεὶ οὖν μέγιστοι τῶν ἐν τῷ κόσμῳ οἱ μεσημβρινοί, δεῖ καὶ τοὺς ὑποκειμένους τούτοις τῆς γῆς κύκλους μεγίστους εἶναι ἀναγκαίως. ὥστε ἡλίκον ἂν τὸν διὰ Συήνης καὶ Ἀλεξανδρείας ἦκοντα κύκλον τῆς γῆς ἢ ἔφοδος ἀποδείξει αὕτη, τηλικούτος καὶ ὁ μέγιστος ἔσται τῆς γῆς κύκλος. φησὶ τοίνυν, καὶ ἔχει οὕτως, τὴν Συήνην ὑπὸ τῷ θερινῷ τροπικῷ κείσθαι κύκλῳ. ὁπόταν οὖν ἐν καρκίνῳ γενόμενος ὁ ἥλιος καὶ θερινὰς ποιῶν τροπὰς ἀκριβῶς μεσουρανήσῃ, ἄσκιοι γίνονται οἱ τῶν ὠρολογίων γνώμονες ἀναγκαίως, κατὰ κάθετον ἀκριβῆ τοῦ ἡλίου ὑπερκειμένου· καὶ τοῦτο γίνεσθαι λόγος ἐπὶ σταδίους τριακοσίου τὴν διάμετρον. ἐν Ἀλεξανδρείᾳ δὲ τῇ αὐτῇ ὥρᾳ ἀποβάλλουσιν οἱ τῶν ὠρολογίων γνώμονες σκιάν, ἅτε πρὸς ἄρκτω μᾶλλον τῆς Συήνης ταύτης τῆς πόλεως κειμένης. ὑπὸ τῷ αὐτῷ μεσημβρινῷ τοίνυν καὶ μεγίστῳ κύκλῳ τῶν πόλεων κειμένων, ἂν περιαγάγωμεν περιφέρειαν ἀπὸ τοῦ ἄκρου τῆς τοῦ γνώμονος σκιάς ἐπὶ τὴν βάσιν αὐτῆν τοῦ γνώμονος τοῦ ἐν Ἀλεξανδρείᾳ ὠρολογίου, αὕτη ἢ περιφέρεια τμήμα γενήσεται τοῦ μεγίστου τῶν ἐν τῇ σκάφῃ κύκλων, ἐπεὶ μεγίστῳ κύκλῳ ὑπόκειται ἢ τοῦ ὠρολογίου σκάφη. εἰ οὖν ἐξῆς νοήσαιμεν εὐθείας διὰ τῆς γῆς ἐκβαλλομένας ἀφ' ἑκατέρου τῶν γνωμόνων, πρὸς τῷ κέντρῳ τῆς γῆς

ERATOSTHENES

of its proper circle, all the remaining arcs will be tenth parts of their proper circles.

Anyone who has mastered these facts will have no difficulty in understanding the method of Eratosthenes, which is as follows. Syene and Alexandria, he asserts, are under the same meridian. Since meridian circles are great circles in the universe, the circles on the earth which lie under them are necessarily great circles also. Therefore, of whatever size this method shows the circle on the earth through Syene and Alexandria to be, this will be the size of the great circle on the earth. He then asserts, as is indeed the case, that Syene lies under the summer tropic. Therefore, whenever the sun, being in the Crab at the summer solstice, is exactly in the middle of the heavens, the pointers of the sundials necessarily throw no shadows, the sun being in the exact vertical line above them ; and this is said to be true over a space 300 stades in diameter. But in Alexandria at the same hour the pointers of the sundials throw shadows, because this city lies farther to the north than Syene. As the two cities lie under the same meridian great circle, if we draw an arc from the extremity of the shadow of the pointer to the base of the pointer of the sundial in Alexandria, the arc will be a segment of a great circle in the bowl of the sundial, since the bowl lies under the great circle. If then we conceive straight lines produced in order from each of the pointers through the earth, they

συμπεσοῦνται. ἐπεὶ οὖν τὸ ἐν Συήνῃ ὠρολόγιον κατὰ κάθετον ὑπόκειται τῷ ἡλίῳ, ἂν ἐπινοήσωμεν εὐθείαν ἀπὸ τοῦ ἡλίου ἤκουσαν ἐπ' ἄκρον τὸν τοῦ ὠρολογίου γνώμονα, μία γενήσεται εὐθεῖα ἢ ἀπὸ τοῦ ἡλίου μέχρι τοῦ κέντρου τῆς γῆς ἤκουσα. εἰάν οὖν ἑτέραν εὐθείαν νοήσωμεν ἀπὸ τοῦ ἄκρου τῆς σκιᾶς τοῦ γνώμονος δι' ἄκρου τοῦ γνώμονος ἐπὶ τὸν ἡλιον ἀναγομένην ἀπὸ τῆς ἐν Ἀλεξανδρείᾳ σκάφης, αὕτη καὶ ἡ προειρημένη εὐθεῖα παράλληλοι γενήσονται ἀπὸ διαφόρων γε τοῦ ἡλίου μερῶν ἐπὶ διάφορα μέρη τῆς γῆς διήκουσαι. εἰς ταύτας τοίνυν παραλλήλους οὔσας ἐμπίπτει εὐθεῖα ἢ ἀπὸ τοῦ κέντρου τῆς γῆς ἐπὶ τὸν ἐν Ἀλεξανδρείᾳ γνώμονα ἤκουσα, ὥστε τὰς ἐναλλάξ γωνίας ἴσας ποιεῖν· ὧν ἡ μὲν ἐστὶ πρὸς τῷ κέντρῳ τῆς γῆς κατὰ σύμπτωσιν τῶν εὐθειῶν, αἱ ἀπὸ τῶν ὠρολογίων ἤχθησαν ἐπὶ τὸ κέντρον τῆς γῆς, γινομένη, ἡ δὲ κατὰ σύμπτωσιν ἄκρου τοῦ ἐν Ἀλεξανδρείᾳ γνώμονος καὶ τῆς ἀπ' ἄκρου τῆς σκιᾶς αὐτοῦ ἐπὶ τὸν ἡλιον διὰ τῆς πρὸς αὐτὸν ψαύσεως ἀναχθείσης γεγεννημένη. καὶ ἐπὶ μὲν ταύτης βέβηκε περιφέρεια ἢ ἀπ' ἄκρου τῆς σκιᾶς τοῦ γνώμονος ἐπὶ τὴν βάσιν αὐτοῦ περιαχθεῖσα, ἐπὶ δὲ τῆς πρὸς τῷ κέντρῳ τῆς γῆς ἢ ἀπὸ Συήνης διήκουσα εἰς Ἀλεξάνδρειαν. ὅμοιαι τοίνυν αἱ περιφέρειαί εἰσιν ἀλλήλαις ἐπ' ἴσων γε γωνιῶν βεβηκυῖαι. ὃν ἄρα λόγον ἔχει ἢ ἐν τῇ σκάφῃ πρὸς τὸν οἰκεῖον κύκλον, τοῦτον ἔχει τὸν λόγον καὶ ἡ ἀπὸ Συήνης εἰς Ἀλεξάνδρειαν ἤκουσα. ἡ δὲ γε ἐν τῇ σκάφῃ πεντηκοστὸν μέρος εὐρίσκεται τοῦ οἰκείου κύκλου. δεῖ οὖν ἀναγκαίως καὶ τὸ ἀπὸ Συήνης εἰς Ἀλεξάνδρειαν διάστημα πεντηκοστὸν εἶναι μέρος τοῦ

ERATOSTHENES

will meet at the centre of the earth. Now since the sundial at Syene is vertically under the sun, if we conceive a straight line drawn from the sun to the top of the pointer of the sundial, the line stretching from the sun to the centre of the earth will be one straight line. If now we conceive another straight line drawn upwards from the extremity of the shadow of the pointer of the sundial in Alexandria, through the top of the pointer to the sun, this straight line and the aforesaid straight line will be parallel, being straight lines drawn through from different parts of the sun to different parts of the earth. Now on these parallel straight lines there falls the straight line drawn from the centre of the earth to the pointer at Alexandria, so that it makes the alternate angles equal; one of these is formed at the centre of the earth by the intersection of the straight lines drawn from the sundials to the centre of the earth; the other is at the intersection of the top of the pointer in Alexandria and the straight line drawn from the extremity of its shadow to the sun through the point where it meets the pointer. Now this latter angle subtends the arc carried round from the extremity of the shadow of the pointer to its base, while the angle at the centre of the earth subtends the arc stretching from Syene to Alexandria. But the arcs are similar since they are subtended by equal angles. Whatever ratio, therefore, the arc in the bowl of the sundial has to its proper circle, the arc reaching from Syene to Alexandria has the same ratio. But the arc in the bowl is found to be the fiftieth part of its proper circle. Therefore the distance from Syene to Alexandria must necessarily be a fiftieth part of the great

GREEK MATHEMATICS

μεγίστου τῆς γῆς κύκλου· καὶ ἔστι τοῦτο σταδίων πεντακισχιλίων. ὁ ἄρα σύμπας κύκλος γίνεται μυριάδων εἴκοσι πέντε. καὶ ἡ μὲν Ἐρατοσθένους ἔφοδος τοιαύτη.

Heron, *Dioptra* 36, ed. H. Schöne 302. 10-17

Δέον δὲ ἔστω, εἰ τύχοι, τὴν μεταξὺ Ἀλεξανδρείας καὶ Ῥώμης ὁδὸν ἐκμετρήσαι τὴν ἐπ' εὐθείας, τὴν γε ἐπὶ κύκλου περιφερείας μεγίστου τοῦ ἐν τῇ γῆ, προσομολογουμένου τοῦ ὅτι περίμετρος τῆς γῆς σταδίων ἐστὶ μ καὶ ἔτι β , ὡς ὁ μάλιστα τῶν ἄλλων ἀκριβέστερον πεπραγματευμένος Ἐρατοσθένης δείκνυσιν ἐν <τῶ>¹ ἐπιγραφομένῳ Περὶ τῆς ἀναμετρήσεως τῆς γῆς.

¹ τῶ add. H. Schöne.

^a The attached figure will help to elucidate Cleomedes.

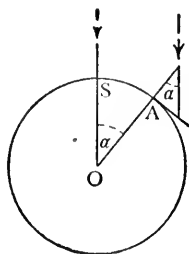

S is Syene and A Alexandria; the centre of the earth is O. The sun's rays at the two places are represented by the broken straight lines. If α be the angle made by the sun's rays with the pointer of the sundial at Alexandria (OA produced), the angle SOA is also equal to α , or one-fiftieth of four right angles. The arc SA is known to be 5000 stades and it follows that the whole circumference of the earth must be 250000 stades.

ERATOSTHENES

circle of the earth. And this distance is 5000 stades. Therefore the whole great circle is 250000 stades. Such is the method of Eratosthenes.^a

Heron, *Dioptra* 36, ed. H. Schöne 302. 10-17

Let it be required, perchance, to measure the distance between Alexandria and Rome along the arc of a great circle,^b on the assumption that the perimeter of the earth is 252000 stades, as Eratosthenes, who investigated this question more accurately than others, shows in the book which he wrote *On the Measurement of the Earth*.^c

^b Lit. "along the circumference of the greatest circle on the earth."

^c Strabo (ii. 5. 7) and Theon of Smyrna (ed. Hiller 124. 10-12) also give Eratosthenes' measurement as 252000 stades against the 250000 of Cleomedes. "The reason of the discrepancy is not known; it is possible that Eratosthenes corrected 250000 to 252000 for some reason, perhaps in order to get a figure divisible by 60 and, incidentally, a round number (700) of stades for one degree. If Pliny (*N.H.* xii. 13. 53) is right in saying that Eratosthenes made 40 stades equal to the Egyptian *σχοῖνος*, then, taking the *σχοῖνος* at 12000 Royal cubits of 0.525 metres, we get 300 such cubits, or 157.5 metres, *i.e.*, 516.73 feet, as the length of the stade. On this basis 252000 stades works out to 24662 miles, and the diameter of the earth to about 7850 miles, only 50 miles shorter than the true polar diameter, a surprisingly close approximation, however much it owes to happy accidents in the calculation" (Heath, *H.G.M.* ii. 107).

11
12
13

14
15

16
17

18
19

20
21

22
23

24
25

26
27

28
29

30
31

32
33

34
35

36
37

38
39

40
41

XIX. APOLLONIUS OF PERGA

XIX. APOLLONIUS OF PERGA

(a) THE CONIC SECTIONS

(i.) *Relation to Previous Works*

Eutoc. *Comm. in Con.*, Apoll. Perg. ed. Heiberg ii.
168. 5-170. 26

Ἀπολλώνιος ὁ γεωμέτρης, ὃ φίλε ἑταῖρε Ἀνθέμειε, γέγονε μὲν ἐκ Πέργης τῆς ἐν Παμφυλίᾳ ἐν χρόνοις τοῦ Εὐεργέτου Πτολεμαίου, ὡς ἱστορεῖ Ἡράκλειος ὁ τὸν βίον Ἀρχιμήδους γράφων, ὃς καὶ φησι τὰ κωνικὰ θεωρήματα ἐπινοῆσαι μὲν πρῶτον τὸν Ἀρχιμήδη, τὸν δὲ Ἀπολλώνιον αὐτὰ εὐρόντα ὑπὸ Ἀρχιμήδους μὴ ἐκδοθέντα ἰδιοποιήσασθαι, οὐκ ἀληθεύων κατὰ γε τὴν ἐμὴν. ὃ τε γὰρ Ἀρχιμήδης ἐν πολλοῖς φαίνεται ὡς παλαιότερας τῆς στοιχειώσεως τῶν κωνικῶν μεμνημένος, καὶ ὁ Ἀπολλώνιος οὐχ ὡς ἰδίας ἐπινοίας γράφει· οὐ γὰρ ἂν ἔφη “ ἐπὶ πλέον καὶ καθόλου μᾶλλον

^a Scarcely anything more is known of the life of one of the greatest geometers of all time than is stated in this brief reference. From Pappus, *Coll.* vii., ed. Hultsch 67 (quoted in vol. i. p. 488), it is known that he spent much time at Alexandria with Euclid's successors. Ptolemy Euergetes reigned 246-221 B.C., and as Ptolemaeus Chennus (apud Photii *Bibl.*, cod. exc., ed. Bekker 151 b 18) mentions an astro-
276

XIX. APOLLONIUS OF PERGA

(a) THE CONIC SECTIONS

(i.) *Relation to Previous Works*

Eutocius, *Commentary on Apollonius's Conics*,
Apoll. Perg. ed. Heiberg ii. 168. 5-170. 26

APOLLONIUS the geometer, my dear Anthemius, flourished at Perga in Pamphylia during the time of Ptolemy Euergetes,^a as is related in the life of Archimedes written by Heraclius,^b who also says that Archimedes first conceived the theorems in conics and that Apollonius, finding they had been discovered by Archimedes but not published, appropriated them for himself, but in my opinion he errs. For in many places Archimedes appears to refer to the elements of conics as an older work, and moreover Apollonius does not claim to be giving his own discoveries; otherwise he would not have described his purpose as "to investigate these properties more fully and more

nomer named Apollonius who flourished in the time of Ptolemy Philopator (221-204 B.C.), the great geometer is probably meant. This fits in with Apollonius's dedication of Books iv.-viii. of his *Conics* to King Attalus I (247-197 B.C.). From the preface to Book i., quoted *infra* (p. 281), we gather that Apollonius visited Eudemus at Pergamum, and to Eudemus he dedicated the first two books of the second edition of his work.

^b More probably Heraclides, *v. supra*, p. 18 n. a.

GREEK MATHEMATICS

ἐξειργάσθαι ταῦτα παρὰ τὰ ὑπὸ τῶν ἄλλων γε-
 γραμμένα.” ἀλλ’ ὅπερ φησὶν ὁ Γέμιος ἀληθές
 ἔστιν, ὅτι οἱ παλαιοὶ κῶνον ὀρίζομενοι τὴν τοῦ
 ὀρθογωνίου τριγώνου περιφορὰν μενούσης μιᾶς
 τῶν περὶ τὴν ὀρθὴν εἰκότως καὶ τοὺς κῶνους
 πάντας ὀρθοὺς ὑπελάμβανον γίνεσθαι καὶ μίαν
 τομὴν ἐν ἐκάστῳ, ἐν μὲν τῷ ὀρθογωνίῳ τὴν νῦν
 καλουμένην παραβολήν, ἐν δὲ τῷ ἀμβλυγωνίῳ τὴν
 ὑπερβολήν, ἐν δὲ τῷ ὀξυγωνίῳ τὴν ἔλλειψιν· καὶ
 ἔστι παρ’ αὐτοῖς εὐρεῖν οὕτως ὀνομαζομένας τὰς
 τομὰς. ὥσπερ οὖν τῶν ἀρχαίων ἐπὶ ἑνὸς ἐκάστου
 εἶδους τριγώνου θεωρησάντων τὰς δύο ὀρθὰς
 πρότερον ἐν τῷ ἰσοπλεύρῳ καὶ πάλιν ἐν τῷ ἰσο-
 σκελεῖ καὶ ὕστερον ἐν τῷ σκαληνῷ οἱ μεταγενέ-
 στεροι καθολικὸν θεώρημα ἀπέδειξαν τοιοῦτο·
 παντὸς τριγώνου αἱ ἐντὸς τρεῖς γωνίαι δυσὶν ὀρθαῖς
 ἴσαι εἰσίν· οὕτως καὶ ἐπὶ τῶν τοῦ κῶνου τομῶν·
 τὴν μὲν γὰρ λεγομένην ὀρθογωνίου κῶνου τομὴν
 ἐν ὀρθογωνίῳ μόνον κῶνῳ ἐθεώρουν τεμνομένην
 ἐπιπέδῳ ὀρθῷ πρὸς μίαν πλευρὰν τοῦ κῶνου, τὴν
 δὲ τοῦ ἀμβλυγωνίου κῶνου τομὴν ἐν ἀμβλυγωνίῳ
 γινομένην κῶνῳ ἀπεδείκνυσαν, τὴν δὲ τοῦ ὀξυ-
 γωνίου ἐν ὀξυγωνίῳ, ὁμοίως ἐπὶ πάντων τῶν
 κῶνων ἄγοντες τὰ ἐπίπεδα ὀρθὰ πρὸς μίαν πλευρὰν
 τοῦ κῶνου· δηλοῖ δὲ καὶ αὐτὰ τὰ ἀρχαῖα ὀνόματα
 τῶν γραμμῶν. ὕστερον δὲ Ἀπολλώνιος ὁ Περ-
 γαῖος καθόλου τι ἐθεώρησεν, ὅτι ἐν παντὶ κῶνῳ
 καὶ ὀρθῷ καὶ σκαληνῷ πᾶσαι αἱ τομαὶ εἰσι κατὰ
 διάφορον τοῦ ἐπιπέδου πρὸς τὸν κῶνον προσβολήν·
 ὃν καὶ θαυμάσαντες οἱ κατ’ αὐτὸν γενόμενοι διὰ
 τὸ θαυμάσιον τῶν ὑπ’ αὐτοῦ δεδειγμένων κωνικῶν
 θεωρημάτων μέγαν γεωμέτρην ἐκάλουν. ταῦτα

APOLLONIUS OF PERGA

generally than is done in the works of others." ^a But what Geminus says is correct : defining a cone as the figure formed by the revolution of a right-angled triangle about one of the sides containing the right angle, the ancients naturally took all cones to be right with one section in each—in the right-angled cone the section now called the parabola, in the obtuse-angled the hyperbola, and in the acute-angled the ellipse ; and in this may be found the reason for the names they gave to the sections. Just as the ancients, investigating each species of triangle separately, proved that there were two right angles first in the equilateral triangle, then in the isosceles, and finally in the scalene, whereas the more recent geometers have proved the general theorem, that *in any triangle the three internal angles are equal to two right angles*, so it has been with the sections of the cone ; for the ancients investigated the so-called *section of a right-angled cone* in a right-angled cone only, cutting it by a plane perpendicular to one side of the cone, and they demonstrated the *section of an obtuse-angled cone* in an obtuse-angled cone and the *section of an acute-angled cone* in the acute-angled cone, in the cases of all the cones drawing the planes in the same way perpendicularly to one side of the cone ; hence, it is clear, the ancient names of the curves. But later Apollonius of Perga proved generally that all the sections can be obtained in any cone, whether right or scalene, according to different relations of the plane to the cone. In admiration for this, and on account of the remarkable nature of the theorems in conics proved by him, his contemporaries called him the "Great

^a This comes from the preface to Book i., *v. infra*, p. 283.

GREEK MATHEMATICS

μὲν οὖν ὁ Γέμινος ἐν τῷ ἕκτῳ φησὶ τῆς Τῶν μαθημάτων θεωρίας.

(ii.) *Scope of the Work*

Apoll. *Conic.* i., Praef., Apoll. Perg. ed. Heiberg
i. 2. 2-4. 28

Ἀπολλώνιος Εὐδήμῳ χαίρειν.

Εἰ τῷ τε σώματι εὖ ἐπανάγεις καὶ τὰ ἄλλα κατὰ γνώμην ἐστὶ σοι, καλῶς ἂν ἔχοι, μετρίως δὲ ἔχομεν καὶ αὐτοί. καθ' ὃν δὲ καιρὸν ἤμην μετὰ σου ἐν Περγάμῳ, ἐθεώρουν σε σπεύδοντα μετασχεῖν τῶν πεπραγμένων ἡμῖν κωνικῶν· πέπομφα οὖν σοι τὸ πρῶτον βιβλίον διορθωσάμενος, τὰ δὲ λοιπά, ὅταν εὐαρεστήσωμεν, ἐξαποστελοῦμεν· οὐκ ἀμνημονεῖν γὰρ οἶομαί σε παρ' ἐμοῦ ἀκηκοότα, διότι τὴν περὶ ταῦτα ἔφοδον ἐποίησάμην ἀξιωθείς ὑπὸ Ναυκράτους τοῦ γεωμέτρου, καθ' ὃν καιρὸν ἐσχόλαζε

* Menaechmus, as shown in vol. i. pp. 278-283, and more particularly p. 283 n. a, solved the problem of the doubling of the cube by means of the intersection of a parabola with a hyperbola, and also by means of the intersection of two parabolas. This is the earliest mention of the conic sections in Greek literature, and therefore Menaechmus (fl. 360-350 B.C.) is generally credited with their discovery; and as Eratosthenes' epigram (vol. i. p. 296) speaks of "cutting the cone in the triads of Menaechmus," he is given credit for discovering the ellipse as well. He may have obtained them all by the method suggested by Geminus, but Heath (*H.G.M.* ii. 111-116) gives cogent reasons for thinking that he may have obtained his rectangular hyperbola by a section of a right-angled cone parallel to the axis.

A passage already quoted (vol. i. pp. 486-489) from Pappus (ed. Hultsch 672. 18-678. 24) informs us that treatises on the conic sections were written by Aristaeus and Euclid. Aristaeus' work, in five books, was entitled *Solid Loci*; Euclid's

APOLLONIUS OF PERGA

Geometer." Geminus relates these details in the sixth book of his *Theory of Mathematics*.^a

(ii.) *Scope of the Work*

Apollonius, *Conics* i., Preface, Apoll. Perg. ed. Heiberg
i. 2. 2-4. 28

Apollonius to Eudemus^b greeting.

If you are in good health and matters are in other respects as you wish, it is well; I am pretty well too. During the time I spent with you at Pergamum, I noticed how eager you were to make acquaintance with my work in conics; I have therefore sent to you the first book, which I have revised, and I will send the remaining books when I am satisfied with them. I suppose you have not forgotten hearing me say that I took up this study at the request of Naucrates the geometer, at the time when he came

Conics was in four books. The work of Aristaeus was obviously more original and more specialized; that of Euclid was admittedly a compilation largely based on Aristaeus. Euclid flourished about 300 B.C. As noted in vol. i. p. 495 n. a, the focus-directrix property must have been known to Euclid, and probably to Aristaeus; curiously, it does not appear in Apollonius's treatise.

Many properties of conics are assumed in the works of Archimedes without proof and several have been encountered in this work; they were no doubt taken from the works of Aristaeus or Euclid. As the reader will notice, Archimedes' terminology differs in several respects from that of Apollonius, apart from the fundamental difference on which Geminus laid stress.

The history of the conic sections in antiquity is admirably treated by Zeuthen, *Die Lehre von den Kegelschnitten im Altertum* (1886) and Heath, *Apollonius of Perga*, xvii-clvi.

^b Not, of course, the pupil of Aristotle who wrote the famous *History of Geometry*, unhappily lost.

GREEK MATHEMATICS

παρ' ἡμῖν παραγενηθεῖς εἰς Ἀλεξάνδρειαν, καὶ διότι πραγματεύσαντες αὐτὰ ἐν ὀκτὼ βιβλίοις ἐξ αὐτῆς μεταδεδώκαμεν αὐτὰ εἰς τὸ σπουδαιότερον διὰ τὸ πρὸς ἔκπλω αὐτὸν εἶναι οὐ διακαθάραντες, ἀλλὰ πάντα τὰ ὑποπίπτοντα ἡμῖν θέντες ὡς ἔσχατον ἐπελευσόμενοι. ὅθεν καιρὸν νῦν λαβόντες αἰεὶ τὸ τυγχάνον διορθώσεως ἐκδίδομεν. καὶ ἐπεὶ συμβέβηκε καὶ ἄλλους τινὰς τῶν συμμεμιχότων ἡμῖν μετεληφέναι τὸ πρῶτον καὶ τὸ δεῦτερον βιβλίον πρὶν ἢ διορθωθῆναι, μὴ θαυμάσης, ἐὰν περιπίπτῃς αὐτοῖς ἐτέρως ἔχουσιν.

Ἐκ τῶν ὀκτὼ βιβλίων τὰ πρῶτα τέσσαρα πέπτωκεν εἰς ἀγωγὴν στοιχειώδη, περιέχει δὲ τὸ μὲν πρῶτον τὰς γενέσεις τῶν τριῶν τομῶν καὶ τῶν ἀντικειμένων καὶ τὰ ἐν αὐταῖς ἀρχικὰ συμπτώματα ἐπὶ πλέον καὶ καθόλου μᾶλλον ἐξεργασμένα παρὰ τὰ ὑπὸ τῶν ἄλλων γεγραμμένα, τὸ δὲ δεῦτερον τὰ περὶ τὰς διαμέτρους καὶ τοὺς ἄξονας τῶν τομῶν συμβαίοντα καὶ τὰς ἀσυμπτώτους καὶ ἄλλα γενικὴν καὶ ἀναγκαίαν χρεῖαν παρεχόμενα πρὸς τοὺς διορισμούς· τινὰς δὲ διαμέτρους καὶ τινὰς ἄξονας καλῶ, εἰδήσεις ἐκ τούτου τοῦ βιβλίου. τὸ δὲ τρίτον πολλὰ καὶ παράδοξα θεωρήματα χρήσιμα πρὸς τε τὰς συνθέσεις τῶν στερεῶν τόπων καὶ τοὺς διορισμούς, ὧν τὰ πλεῖστα καὶ κάλλιστα ξένα, ἃ καὶ κατανοήσαντες συνείδομεν μὴ συντιθέμενον ὑπὸ Εὐκλείδου τὸν ἐπὶ τρεῖς καὶ τέσσαρας γραμμὰς τόπον, ἀλλὰ μόριον τὸ τυχὸν αὐτοῦ καὶ τοῦτο οὐκ εὐτυχῶς· οὐ γὰρ ἦν δυνατόν ἄνευ τῶν προσευρημένων ἡμῖν τελειωθῆναι τὴν

* A necessary observation, because Archimedes had used the terms in a different sense.

APOLLONIUS OF PERGA

to Alexandria and stayed with me, and that, when I had completed the investigation in eight books, I gave them to him at once, a little too hastily, because he was on the point of sailing, and so I was not able to correct them, but put down everything as it occurred to me, intending to make a revision at the end. Accordingly, as opportunity permits, I now publish on each occasion as much of the work as I have been able to correct. As certain other persons whom I have met have happened to get hold of the first and second books before they were corrected, do not be surprised if you come across them in a different form.

Of the eight books the first four form an elementary introduction. The first includes the methods of producing the three sections and the opposite branches [of the hyperbola] and their fundamental properties, which are investigated more fully and more generally than in the works of others. The second book includes the properties of the diameters and the axes of the sections as well as the asymptotes, with other things generally and necessarily used in determining limits of possibility ; and what I call diameters and axes you will learn from this book.^a The third book includes many remarkable theorems useful for the syntheses of solid loci and for determining limits of possibility ; most of these theorems, and the most elegant, are new, and it was their discovery which made me realize that Euclid had not worked out the synthesis of the locus with respect to three and four lines, but only a chance portion of it, and that not successfully ; for the synthesis could not be completed without the theorems discovered by me.^b

^b For this locus, and Pappus's comments on Apollonius's claims, v. vol. i. pp. 486-489.

GREEK MATHEMATICS

σύνθεσιν. τὸ δὲ τέταρτον, ποσαχῶς αἱ τῶν κώνων τομαὶ ἀλλήλαις τε καὶ τῇ τοῦ κύκλου περιφέρειᾷ συμβάλλουσι, καὶ ἄλλα ἐκ περισσοῦ, ὧν οὐδέτερον ὑπὸ τῶν πρὸ ἡμῶν γέγραπται, κώνου τομῆ ἢ κύκλου περιφέρεια κατὰ πόσα σημεῖα συμβάλλουσι.

Τὰ δὲ λοιπὰ ἐστὶ περιουσιαστικώτερα· ἔστι γὰρ τὸ μὲν περὶ ἐλαχίστων καὶ μεγίστων ἐπὶ πλέον, τὸ δὲ περὶ ἴσων καὶ ὁμοίων κώνου τομῶν, τὸ δὲ περὶ διοριστικῶν θεωρημάτων, τὸ δὲ προβλημάτων κωνικῶν διωρισμένων. οὐ μὴν ἀλλὰ καὶ πάντων ἐκδοθέντων ἕξεστι τοῖς περιτυγχάνουσι κρίνειν αὐτά, ὡς ἂν αὐτῶν ἕκαστος αἰρήται. εὐτύχει.

(iii.) Definitions

Ibid., Deff., Apoll. Perg. ed. Heiberg i. 6. 2-8. 20

Ἐὰν ἀπὸ τινος σημείου πρὸς κύκλου περιφέρειαν, ὅς οὐκ ἔστιν ἐν τῷ αὐτῷ ἐπιπέδῳ τῷ σημείῳ, εὐθεῖα ἐπιζευχθεῖσα ἐφ' ἑκάτερα προσεκβληθῆ, καὶ μένοντος τοῦ σημείου ἢ εὐθεῖα περιενεχθεῖσα περὶ τὴν τοῦ κύκλου περιφέρειαν εἰς τὸ αὐτὸ πάλιν ἀποκατασταθῆ, ὅθεν ἤρξατο φέρεσθαι, τὴν γραφείσαν ὑπὸ τῆς εὐθείας ἐπιφάνειαν, ἣ σύγκειται ἐκ δύο ἐπιφανειῶν κατὰ κορυφὴν ἀλλήλαις κειμένων, ὧν ἑκάτερα εἰς ἄπειρον αὐξεται τῆς

* Only the first four books survive in Greek. Books v.-vii. have survived in Arabic, but Book viii. is wholly lost. Halley (Oxford, 1710) edited the first seven books, and his edition is still the only source for Books vi. and vii. The first four books have since been edited by Heiberg (Leipzig, 1891-1893) and Book v. (up to Prop. 7) by L. Nix (Leipzig, 1889). The 284

APOLLONIUS OF PERGA

The fourth book investigates how many times the sections of cones can meet one another and the circumference of a circle ; in addition it contains other things, none of which have been discussed by previous writers, namely, in how many points a section of a cone or a circumference of a circle can meet [the opposite branches of hyperbolas].

The remaining books are thrown in by way of addition : one of them discusses fully *minima* and *maxima*, another deals with equal and similar sections of cones, another with theorems about the determinations of limits, and the last with determinate conic problems. When they are all published it will be possible for anyone who reads them to form his own judgement. Farewell.^a

(iii.) *Definitions*

Ibid., Definitions, Apoll. Perg. ed. Heiberg i. 6. 2-8. 20

If a straight line be drawn from a point to the circumference of a circle, which is not in the same plane with the point, and be produced in either direction, and if, while the point remains stationary, the straight line be made to move round the circumference of the circle until it returns to the point whence it set out, I call the surface described by the straight line a *conical surface* ; it is composed of two surfaces lying vertically opposite to each other, of which each surviving books have been put into mathematical notation by T. L. Heath, *Apollonius of Perga* (Cambridge, 1896) and translated into French by Paul Ver Eecke, *Les Coniques d'Apollonius de Perga* (Bruges, 1923).

In ancient times Eutocius edited the first four books with a commentary which still survives and is published in Heiberg's edition. Serenus and Hypatia also wrote commentaries, and Pappus a number of lemmas.

GREEK MATHEMATICS

γραφοῦσης εὐθείας εἰς ἄπειρον προσεκβαλλομένης, καλῶ κωνικὴν ἐπιφάνειαν, κορυφὴν δὲ αὐτῆς τὸ μεμενηκὸς σημεῖον, ἄξονα δὲ τὴν διὰ τοῦ σημείου καὶ τοῦ κέντρου τοῦ κύκλου ἀγομένην εὐθείαν.

Κώνον δὲ τὸ περιεχόμενον σχῆμα ὑπὸ τε τοῦ κύκλου καὶ τῆς μεταξὺ τῆς τε κορυφῆς καὶ τῆς τοῦ κύκλου περιφερείας κωνικῆς ἐπιφανείας, κορυφὴν δὲ τοῦ κώνου τὸ σημεῖον, ὃ καὶ τῆς ἐπιφανείας ἐστὶ κορυφή, ἄξονα δὲ τὴν ἀπὸ τῆς κορυφῆς ἐπὶ τὸ κέντρον τοῦ κύκλου ἀγομένην εὐθείαν, βάσιν δὲ τὸν κύκλον.

Τῶν δὲ κώνων ὀρθοὺς μὲν καλῶ τοὺς πρὸς ὀρθὰς ἔχοντας ταῖς βάσεις τοὺς ἄξονας, σκαληνοὺς δὲ τοὺς μὴ πρὸς ὀρθὰς ἔχοντας ταῖς βάσεις τοὺς ἄξονας.

Πάσης καμπύλης γραμμῆς, ἥτις ἐστὶν ἐν ἐνὶ ἐπιπέδῳ, διάμετρον μὲν καλῶ εὐθείαν, ἥτις ἡγμένη ἀπὸ τῆς καμπύλης γραμμῆς πάσας τὰς ἀγομένας ἐν τῇ γραμμῇ εὐθείας εὐθεία τινὶ παραλλήλους δίχα διαιρεῖ, κορυφὴν δὲ τῆς γραμμῆς τὸ πέρασ τῆς εὐθείας τὸ πρὸς τῇ γραμμῇ, τεταγμένως δὲ ἐπὶ τὴν διάμετρον κατῆχθαι ἐκάστην τῶν παραλλήλων.

Ὅμοίως δὲ καὶ δύο καμπύλων γραμμῶν ἐν ἐνὶ ἐπιπέδῳ κειμένων διάμετρον καλῶ πλαγίαν μὲν, ἥτις εὐθεῖα τέμνουσα τὰς δύο γραμμὰς πάσας τὰς ἀγομένας ἐν ἑκατέρᾳ τῶν γραμμῶν παρά τινα εὐθείαν δίχα τέμνει, κορυφὰς δὲ τῶν γραμμῶν τὰ πρὸς ταῖς γραμμαῖς πέρατα τῆς διαμέτρου, ὀρθίαν δέ, ἥτις κειμένη μεταξὺ τῶν δύο γραμμῶν πάσας τὰς ἀγομένας παραλλήλους εὐθείας εὐθεία τινὶ καὶ ἀπολαμβανομένας μεταξὺ τῶν γραμμῶν δίχα

APOLLONIUS OF PERGA

extends to infinity when the straight line which describes them is produced to infinity ; I call the fixed point the *vertex*, and the straight line drawn through this point and the centre of the circle I call the *axis*.

The figure bounded by the circle and the conical surface between the vertex and the circumference of the circle I term a *cone*, and by the *vertex of the cone* I mean the point which is the vertex of the surface, and by the *axis* I mean the straight line drawn from the vertex to the centre of the circle, and by the *base* I mean the circle.

Of cones, I term those *right* which have their axes at right angles to their bases, and *scalene* those which have their axes not at right angles to their bases.

In any plane curve I mean by a *diameter* a straight line drawn from the curve which bisects all straight lines drawn in the curve parallel to a given straight line, and by the *vertex of the curve* I mean the extremity of the straight line on the curve, and I describe each of the parallels as being drawn *ordinate-wise* to the diameter.

Similarly, in a pair of plane curves I mean by a *transverse diameter* a straight line which cuts the two curves and bisects all the straight lines drawn in either curve parallel to a given straight line, and by the *vertices of the curves* I mean the extremities of the diameter on the curves ; and by an *erect diameter* I mean a straight line which lies between the two curves and bisects the portions cut off between the curves of all straight lines drawn parallel to a given

GREEK MATHEMATICS

τέμνει, τεταγμένως δὲ ἐπὶ τὴν διάμετρον κατῆχθαι ἐκάστην τῶν παραλλήλων.

Συζυγεῖς καλῶ διαμέτρους [δύο]¹ καμπύλης γραμμῆς καὶ δύο καμπύλων γραμμῶν εὐθείας, ὧν ἐκάτερα διάμετρος οὔσα τὰς τῆ ἑτέρα παραλλήλους δίχα διαιρεῖ.

Ἄξονα δὲ καλῶ καμπύλης γραμμῆς καὶ δύο καμπύλων γραμμῶν εὐθείαν, ἣτις διάμετρος οὔσα τῆς γραμμῆς ἢ τῶν γραμμῶν πρὸς ὀρθὰς τέμνει τὰς παραλλήλους.

Συζυγεῖς καλῶ ἄξονας καμπύλης γραμμῆς καὶ δύο καμπύλων γραμμῶν εὐθείας, αἵτινες διάμετροι οὔσαι συζυγεῖς πρὸς ὀρθὰς τέμνουσι τὰς ἀλλήλων παραλλήλους.

(iv.) Construction of the Sections

Ibid., Props. 7-9, Apoll. Perg. ed. Heiberg i. 22. 26-36. 5

ζ'

Ἐὰν κώνος ἐπιπέδῳ τμηθῆ διὰ τοῦ ἄξονος, τμηθῆ δὲ καὶ ἑτέρῳ ἐπιπέδῳ τέμνοντι τὸ ἐπίπεδον, ἐν ᾧ ἔστιν ἡ βάσις τοῦ κώνου, κατ' εὐθείαν πρὸς ὀρθὰς οὔσαν ἥτοι τῆ βάσει τοῦ διὰ τοῦ ἄξονος τριγώνου ἢ τῆ ἐπ' εὐθείας αὐτῆ, αἱ ἀγόμεναι εὐθεῖαι ἀπὸ τῆς γενηθείσης τομῆς ἐν τῆ τοῦ κώνου ἐπιφανείᾳ, ἣν ἐποίησε τὸ τέμνον ἐπίπεδον, παράλληλοι τῆ πρὸς ὀρθὰς τῆ βάσει τοῦ τριγώνου εὐθείᾳ ἐπὶ τὴν κοινὴν τομὴν πεσοῦνται τοῦ τέμ-

¹ δύο om. Heiberg.

* This proposition defines a conic section in the most general way with reference to any diameter. It is only much

APOLLONIUS OF PERGA

straight line ; and I describe each of the parallels as drawn *ordinate-wise to the diameter*.

By *conjugate diameters* in a curve or pair of curves I mean straight lines of which each, being a diameter, bisects parallels to the other.

By an *axis* of a curve or pair of curves I mean a straight line which, being a diameter of the curve or pair of curves, bisects the parallels at right angles.

By *conjugate axes* in a curve or pair of curves I mean straight lines which, being conjugate diameters, bisect at right angles the parallels to each other.

(iv.) *Construction of the Sections*

Ibid., Props. 7-9, Apoll. Perg. ed. Heiberg i. 22. 26-36. 5

Prop. 7^a

If a cone be cut by a plane through the axis, and if it be also cut by another plane cutting the plane containing the base of the cone in a straight line perpendicular to the base of the axial triangle,^b or to the base produced, a section will be made on the surface of the cone by the cutting plane, and straight lines drawn in it parallel to the straight line perpendicular to the base of the axial triangle will meet the common section of the cutting plane and the axial

later in the work (i. 52-58) that the principal axes are introduced as diameters at right angles to their ordinates. The proposition is an excellent example of the generality of Apollonius's methods.

Apollonius followed rigorously the Euclidean form of proof. In consequence his general enunciations are extremely long and often can be made tolerable in an English rendering only by splitting them up ; but, though Apollonius seems to have taken a malicious pleasure in their length, they are formed on a perfect logical pattern without a superfluous word.

^b Lit. " the triangle through the axis."

GREEK MATHEMATICS

νοντος ἐπιπέδου καὶ τοῦ διὰ τοῦ ἄξονος τριγώνου καὶ προσεκβαλλόμεναι ἕως τοῦ ἐτέρου μέρους τῆς τομῆς δίχα τμηθήσονται ὑπ' αὐτῆς, καὶ ἐὰν μὲν ὀρθὸς ἢ ὁ κώνος, ἢ ἐν τῇ βάσει εὐθεῖα πρὸς ὀρθὰς ἔσται τῇ κοινῇ τομῇ τοῦ τέμνοντος ἐπιπέδου καὶ τοῦ διὰ τοῦ ἄξονος τριγώνου, ἐὰν δὲ σκαληνός, οὐκ αἰεὶ πρὸς ὀρθὰς ἔσται, ἀλλ' ὅταν τὸ διὰ τοῦ ἄξονος ἐπίπεδον πρὸς ὀρθὰς ἢ τῇ βάσει τοῦ κώνου.

Ἔστω κώνος, οὗ κορυφή μὲν τὸ Α σημεῖον, βάση δὲ ὁ ΒΓ κύκλος, καὶ τετμήσθω ἐπιπέδῳ διὰ

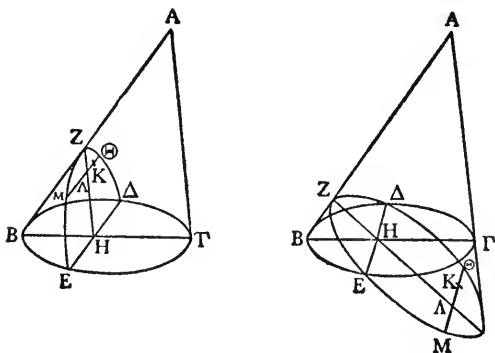

τοῦ ἄξονος, καὶ ποιείτω τομὴν τὸ ΑΒΓ τρίγωνον. τετμήσθω δὲ καὶ ἐτέρῳ ἐπιπέδῳ τέμνοντι τὸ ἐπίπεδον, ἐν ᾧ ἔστιν ὁ ΒΓ κύκλος, κατ' εὐθείαν τὴν ΔΕ ἢτοι πρὸς ὀρθὰς οὔσαν τῇ ΒΓ ἢ τῇ ἐπ' εὐθείᾳ αὐτῇ, καὶ ποιείτω τομὴν ἐν τῇ ἐπιφανείᾳ τοῦ κώνου τὴν ΔΖΕ· κοινὴ δὲ τομὴ τοῦ τέμνοντος ἐπιπέδου καὶ τοῦ ΑΒΓ τριγώνου ἢ ΖΗ. καὶ

APOLLONIUS OF PERGA

triangle and, if produced to the other part of the section, will be bisected by it; if the cone be right, the straight line in the base will be perpendicular to the common section of the cutting plane and the axial triangle; but if it be scalene, it will not in general be perpendicular, but only when the plane through the axis is perpendicular to the base of the cone.

Let there be a cone whose vertex is the point A and whose base is the circle $B\Gamma$, and let it be cut by a

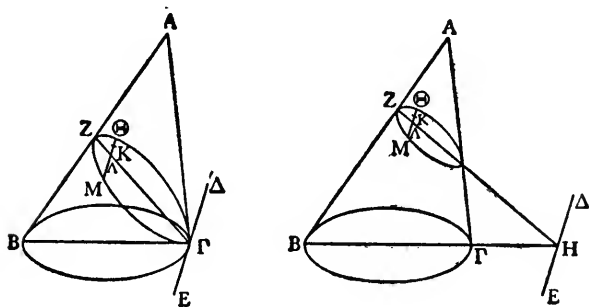

plane through the axis, and let the section so made be the triangle $AB\Gamma$. Now let it be cut by another plane cutting the plane containing the circle $B\Gamma$ in a straight line ΔE which is either perpendicular to $B\Gamma$ or to $B\Gamma$ produced, and let the section made on the surface of the cone be ΔZE ^a; then the common section of the cutting plane and of the triangle $AB\Gamma$

^a This applies only to the first two of the figures given in the MSS.

GREEK MATHEMATICS

εἰλήφθω τι σημεῖον ἐπὶ τῆς ΔΖΕ τομῆς τὸ Θ, καὶ ἤχθω διὰ τοῦ Θ τῇ ΔΕ παράλληλος ἢ ΘΚ. λέγω, ὅτι ἢ ΘΚ συμβαλεῖ τῇ ΖΗ καὶ ἐκβαλλομένη ἕως τοῦ ἐτέρου μέρους τῆς ΔΖΕ τομῆς δίχα τμηθήσεται ὑπὸ τῆς ΖΗ εὐθείας.

Ἐπεὶ γὰρ κῶνος, οὗ κορυφή μὲν τὸ Α σημεῖον, βάσις δὲ ὁ ΒΓ κύκλος, τέτμηται ἐπιπέδῳ διὰ τοῦ ἄξονος, καὶ ποιεῖ τομὴν τὸ ΑΒΓ τρίγωνον, εἰληπται δέ τι σημεῖον ἐπὶ τῆς ἐπιφανείας, ὃ μὴ ἐστὶν ἐπὶ πλευρᾶς τοῦ ΑΒΓ τριγώνου, τὸ Θ, καὶ ἐστὶ κάθετος ἢ ΔΗ ἐπὶ τὴν ΒΓ, ἢ ἄρα διὰ τοῦ Θ τῇ ΔΗ παράλληλος ἀγομένη, τουτέστιν ἢ ΘΚ, συμβαλεῖ τῷ ΑΒΓ τριγώνῳ καὶ προσεκβαλλομένη ἕως τοῦ ἐτέρου μέρους τῆς ἐπιφανείας δίχα τμηθήσεται ὑπὸ τοῦ τριγώνου. ἐπεὶ οὖν ἢ διὰ τοῦ Θ τῇ ΔΕ παράλληλος ἀγομένη συμβάλλει τῷ ΑΒΓ τριγώνῳ καὶ ἐστὶν ἐν τῷ διὰ τῆς ΔΖΕ τομῆς ἐπιπέδῳ, ἐπὶ τὴν κοινὴν ἄρα τομὴν πεσεῖται τοῦ τέμνοντος ἐπιπέδου καὶ τοῦ ΑΒΓ τριγώνου. κοινὴ δὲ τομὴ ἐστὶ τῶν ἐπιπέδων ἢ ΖΗ· ἢ ἄρα διὰ τοῦ Θ τῇ ΔΕ παράλληλος ἀγομένη πεσεῖται ἐπὶ τὴν ΖΗ· καὶ προσεκβαλλομένη ἕως τοῦ ἐτέρου μέρους τῆς ΔΖΕ τομῆς δίχα τμηθήσεται ὑπὸ τῆς ΖΗ εὐθείας.

Ἦτοι δὴ ὁ κῶνος ὀρθός ἐστὶν, ἢ τὸ διὰ τοῦ ἄξονος τρίγωνον τὸ ΑΒΓ ὀρθόν ἐστὶ πρὸς τὸν ΒΓ κύκλον, ἢ οὐδέτερον.

Ἐστω πρότερον ὁ κῶνος ὀρθός· εἴη ἂν οὖν καὶ τὸ ΑΒΓ τρίγωνον ὀρθόν πρὸς τὸν ΒΓ κύκλον. ἐπεὶ οὖν ἐπίπεδον τὸ ΑΒΓ πρὸς ἐπίπεδον τὸ ΒΓ ὀρθόν ἐστὶ, καὶ τῇ κοινῇ αὐτῶν τομῇ τῇ ΒΓ ἐν ἐνὶ τῶν ἐπιπέδων τῷ ΒΓ πρὸς ὀρθὰς ἦκται ἢ ΔΕ,

APOLLONIUS OF PERGA

is ZH . Let any point Θ be taken on ΔZE , and through Θ let ΘK be drawn parallel to ΔE . I say that ΘK intersects ZH and, if produced to the other part of the section ΔZE , it will be bisected by the straight line ZH .

For since the cone, whose vertex is the point A and base the circle $B\Gamma$, is cut by a plane through the axis and the section so made is the triangle $AB\Gamma$, and there has been taken any point Θ on the surface, not being on a side of the triangle $AB\Gamma$, and ΔH is perpendicular to $B\Gamma$, therefore the straight line drawn through Θ parallel to ΔH , that is ΘK , will meet the triangle $AB\Gamma$ and, if produced to the other part of the surface, will be bisected by the triangle [Prop. 6]. Therefore, since the straight line drawn through Θ parallel to ΔE meets the triangle $AB\Gamma$ and is in the plane containing the section ΔZE , it will fall upon the common section of the cutting plane and the triangle $AB\Gamma$. But the common section of those planes is ZH ; therefore the straight line drawn through Θ parallel to ΔE will meet ZH ; and if it be produced to the other part of the section ΔZE it will be bisected by the straight line ZH .

Now the cone is right, or the axial triangle $AB\Gamma$ is perpendicular to the circle $B\Gamma$, or neither.

First, let the cone be right; then the triangle $AB\Gamma$ will be perpendicular to the circle $B\Gamma$ [Def. 3; Eucl. xi. 18]. Then since the plane $AB\Gamma$ is perpendicular to the plane $B\Gamma$, and ΔE is drawn in one of the planes perpendicular to their common section $B\Gamma$, therefore

ἡ ΔΕ ἄρα τῷ ΑΒΓ τριγώνῳ ἐστὶ πρὸς ὀρθάς· καὶ πρὸς πάσας ἄρα τὰς ἀπτομένας αὐτῆς εὐθείας καὶ οὐσας ἐν τῷ ΑΒΓ τριγώνῳ ὀρθή ἐστίν. ὥστε καὶ πρὸς τὴν ΖΗ ἐστὶ πρὸς ὀρθάς.

Μὴ ἔστω δὴ ὁ κῶνος ὀρθός. εἰ μὲν οὖν τὸ διὰ τοῦ ἄξονος τρίγωνον ὀρθὸν ἐστὶ πρὸς τὸν ΒΓ κύκλον, ὁμοίως δεῖξομεν, ὅτι καὶ ἡ ΔΕ τῇ ΖΗ ἐστὶ πρὸς ὀρθάς. μὴ ἔστω δὴ τὸ διὰ τοῦ ἄξονος τρίγωνον τὸ ΑΒΓ ὀρθὸν πρὸς τὸν ΒΓ κύκλον. λέγω, ὅτι οὐδὲ ἡ ΔΕ τῇ ΖΗ ἐστὶ πρὸς ὀρθάς. εἰ γὰρ δυνατόν, ἔστω· ἐστὶ δὲ καὶ τῇ ΒΓ πρὸς ὀρθάς· ἡ ἄρα ΔΕ ἑκατέρα τῶν ΒΓ, ΖΗ ἐστὶ πρὸς ὀρθάς. καὶ τῷ διὰ τῶν ΒΓ, ΖΗ ἐπιπέδῳ ἄρα πρὸς ὀρθάς ἐστὶ. τὸ δὲ διὰ τῶν ΒΓ, ΗΖ ἐπιπέδον ἐστὶ τὸ ΑΒΓ· καὶ ἡ ΔΕ ἄρα τῷ ΑΒΓ τριγώνῳ ἐστὶ πρὸς ὀρθάς. καὶ πάντα ἄρα τὰ δι' αὐτῆς ἐπίπεδα τῷ ΑΒΓ τριγώνῳ ἐστὶ πρὸς ὀρθάς. ἐν δέ τι τῶν διὰ τῆς ΔΕ ἐπιπέδων ἐστὶν ὁ ΒΓ κύκλος· ὁ ΒΓ ἄρα κύκλος πρὸς ὀρθάς ἐστὶ τῷ ΑΒΓ τριγώνῳ. ὥστε καὶ τὸ ΑΒΓ τρίγωνον ὀρθὸν ἔσται πρὸς τὸν ΒΓ κύκλον· ὅπερ οὐχ ὑπόκειται. οὐκ ἄρα ἡ ΔΕ τῇ ΖΗ ἐστὶ πρὸς ὀρθάς.

Πόρισμα

Ἐκ δὴ τούτου φανερόν, ὅτι τῆς ΔΖΕ τομῆς διάμετρος ἐστὶν ἡ ΖΗ, ἐπεὶπερ τὰς ἀγομένας παραλλήλους εὐθείας τινὶ τῇ ΔΕ δίχα τέμνει, καὶ ὅτι δυνατόν ἐστὶν ὑπὸ τῆς διαμέτρου τῆς ΖΗ παραλλήλους τινὰς δίχα τέμνεσθαι καὶ μὴ πρὸς ὀρθάς.

ἦ'

Ἐὰν κῶνος ἐπιπέδῳ τμηθῇ διὰ τοῦ ἄξονος,

APOLLONIUS OF PERGA

ΔE is perpendicular to the triangle $AB\Gamma$ [Eucl. xi. Def. 4]; and therefore it is perpendicular to all the straight lines in the triangle $AB\Gamma$ which meet it [Eucl. xi. Def. 3]. Therefore it is perpendicular to ZH .

Now let the cone be not right. Then, if the axial triangle is perpendicular to the circle $B\Gamma$, we may similarly show that ΔE is perpendicular to ZH . Now let the axial triangle $AB\Gamma$ be not perpendicular to the circle $B\Gamma$. I say that neither is ΔE perpendicular to ZH . For if it is possible, let it be; now it is also perpendicular to $B\Gamma$; therefore ΔE is perpendicular to both $B\Gamma, ZH$. And therefore it is perpendicular to the plane through $B\Gamma, ZH$ [Eucl. xi. 4]. But the plane through $B\Gamma, HZ$ is $AB\Gamma$; and therefore ΔE is perpendicular to the triangle $AB\Gamma$. Therefore all the planes through it are perpendicular to the triangle $AB\Gamma$ [Eucl. xi. 18]. But one of the planes through ΔE is the circle $B\Gamma$; therefore the circle $B\Gamma$ is perpendicular to the triangle $AB\Gamma$. Therefore the triangle $AB\Gamma$ is perpendicular to the circle $B\Gamma$; which is contrary to hypothesis. Therefore ΔE is not perpendicular to ZH .

Corollary

From this it is clear that ZH is a diameter of the section ΔZE [Def. 4], inasmuch as it bisects the straight lines drawn parallel to the given straight line ΔE , and also that parallels can be bisected by the diameter ZH without being perpendicular to it.

Prop. 8

If a cone be cut by a plane through the axis, and it be

APOLLONIUS OF PERGA

also cut by another plane cutting the base of the cone in a line perpendicular to the base of the axial triangle, and if the diameter of the section made on the surface be either parallel to one of the sides of the triangle or meet it beyond the vertex of the cone, and if the surface of the cone and the cutting plane be produced to infinity, the section will also increase to infinity, and a straight line can be drawn from the section of the cone parallel to the straight line in the base of the cone so as to cut off from the diameter of the section towards the vertex an intercept equal to any given straight line.

Let there be a cone whose vertex is the point A and base the circle $B\Gamma$, and let it be cut by a plane through the axis, and let the section so made be the triangle

GREEK MATHEMATICS

γωνον· τετμήσθω δὲ καὶ ἑτέρω ἐπιπέδῳ τέμνοντι τὸν ΒΓ κύκλον κατ' εὐθείαν τὴν ΔΕ πρὸς ὀρθὰς οὖσαν τῇ ΒΓ, καὶ ποιείτω τομὴν ἐν τῇ ἐπιφανείᾳ τὴν ΔΖΕ γραμμὴν· ἡ δὲ διάμετρος τῆς ΔΖΕ τομῆς ἡ ΖΗ ἦτοι παράλληλος ἔστω τῇ ΑΓ ἢ ἐκβαλλομένη συμπίπτει αὐτῇ ἐκτὸς τοῦ Α σημείου. λέγω, ὅτι καί, ἐὰν ἦ τε τοῦ κώνου ἐπιφάνεια καὶ τὸ τέμνον ἐπίπεδον ἐκβάλληται εἰς ἄπειρον, καὶ ἡ ΔΖΕ τομὴ εἰς ἄπειρον αὐξηθήσεται.

Ἐκβεβλήσθω γὰρ ἡ τε τοῦ κώνου ἐπιφάνεια καὶ τὸ τέμνον ἐπίπεδον· φανερόν δὴ, ὅτι καὶ αἱ ΑΒ, ΑΓ, ΖΗ συνεκβληθήσονται. ἐπεὶ ἡ ΖΗ τῇ ΑΓ ἦτοι παράλληλος ἔστιν ἢ ἐκβαλλομένη συμπίπτει αὐτῇ ἐκτὸς τοῦ Α σημείου, αἱ ΖΗ, ΑΓ ἄρα ἐκβαλλόμεναι ὡς ἐπὶ τὰ Γ, Η μέρη οὐδέποτε συμπεσοῦνται. ἐκβεβλήσθωσαν οὖν, καὶ εἰλήφθω τι σημεῖον ἐπὶ τῆς ΖΗ τυχόν τὸ Θ, καὶ διὰ τοῦ Θ σημείου τῇ μὲν ΒΓ παράλληλος ἦχθω ἡ ΚΘΛ, τῇ δὲ ΔΕ παράλληλος ἡ ΜΘΝ· τὸ ἄρα διὰ τῶν ΚΛ, ΜΝ ἐπίπεδον παράλληλόν ἐστι τῷ διὰ τῶν ΒΓ, ΔΕ. κύκλος ἄρα ἐστὶ τὸ ΚΛΜΝ ἐπίπεδον. καὶ ἐπεὶ τὰ Δ, Ε, Μ, Ν σημεία ἐν τῷ τέμνοντί ἐστιν ἐπιπέδῳ, ἔστι δὲ καὶ ἐν τῇ ἐπιφανείᾳ τοῦ κώνου, ἐπὶ τῆς κοινῆς ἄρα τομῆς ἐστίν· ἠϋξῆται ἄρα ἡ ΔΖΕ μέχρι τῶν Μ, Ν σημείων. αὐξηθείσης ἄρα τῆς ἐπιφανείας τοῦ κώνου καὶ τοῦ τέμνοντος ἐπιπέδου μέχρι τοῦ ΚΛΜΝ κύκλου ἠϋξῆται καὶ ἡ ΔΖΕ τομὴ μέχρι τῶν Μ, Ν σημείων. ὁμοίως δὲ δείξομεν, ὅτι καί, ἐὰν εἰς ἄπειρον ἐκβάλληται ἡ τε τοῦ κώνου ἐπιφάνεια καὶ τὸ τέμνον ἐπίπεδον, καὶ ἡ ΜΔΖΕΝ τομὴ εἰς ἄπειρον αὐξηθήσεται.

Καὶ φανερόν, ὅτι πάσῃ τῇ δοθείσῃ εὐθείᾳ ἴσην

APOLLONIUS OF PERGA

$AB\Gamma$; now let it be cut by another plane cutting the circle $B\Gamma$ in the straight line ΔE perpendicular to $B\Gamma$, and let the section made on the surface be the curve ΔZE ; let ZH , the diameter of the section ΔZE , be either parallel to $A\Gamma$ or let it, when produced, meet $A\Gamma$ beyond the point A . I say that if the surface of the cone and the cutting plane be produced to infinity, the section ΔZE will also increase to infinity.

For let the surface of the cone and the cutting plane be produced ; it is clear that the straight lines, AB , $A\Gamma$, ZH are simultaneously produced. Since ZH is either parallel to $A\Gamma$ or meets it, when produced, beyond the point A , therefore ZH , $A\Gamma$ when produced in the directions H , Γ , will never meet. Let them be produced accordingly, and let there be taken any point Θ at random upon ZH , and through the point Θ let $K\Theta\Lambda$ be drawn parallel to $B\Gamma$, and let $M\Theta N$ be drawn parallel to ΔE ; the plane through $K\Lambda$, MN is therefore parallel to the plane through $B\Gamma$, ΔE [Eucl. xi. 15]. Therefore the plane $K\Lambda MN$ is a circle [Prop. 4]. And since the points Δ , E , M , N are in the cutting plane, and are also on the surface of the cone, they are therefore upon the common section ; therefore ΔZE has increased to M , N . Therefore, when the surface of the cone and the cutting plane increase up to the circle $K\Lambda MN$, the section ΔZE increases up to the points M , N . Similarly we may prove that, if the surface of the cone and the cutting plane be produced to infinity, the section $M\Delta ZEN$ will increase to infinity.

And it is clear that there can be cut off from the

GREEK MATHEMATICS

ἀπολήψεται τις ἀπὸ τῆς $Z\Theta$ εὐθείας πρὸς τῷ Z σημείῳ. ἔαν γὰρ τῇ δοθείσῃ ἴσην θῶμεν τὴν $Z\Xi$ καὶ διὰ τοῦ Ξ τῇ ΔE παράλληλον ἀγάγωμεν, συμπεσεῖται τῇ τομῇ, ὥσπερ καὶ ἡ διὰ τοῦ Θ ἀπεδείχθη συμπίπτουσα τῇ τομῇ κατὰ τὰ M, N σημεία· ὥστε ἄγεται τις εὐθεῖα συμπίπτουσα τῇ τομῇ παράλληλος οὖσα τῇ ΔE ἀπολαμβάνουσα ἀπὸ τῆς ZH εὐθείαν ἴσην τῇ δοθείσῃ πρὸς τῷ Z σημείῳ.

θ'

Ἐὰν κῶνος ἐπιπέδῳ τμηθῇ συμπίπτουσι μὲν ἑκατέρᾳ πλευρᾷ τοῦ διὰ τοῦ ἄξονος τριγώνου, μήτε δὲ παρὰ τὴν βάσιν ἠγμένῳ μήτε ὑπεναντίως, ἡ τομῇ οὐκ ἔσται κύκλος.

Ἐστω κῶνος, οὗ κορυφή μὲν τὸ A σημείον,

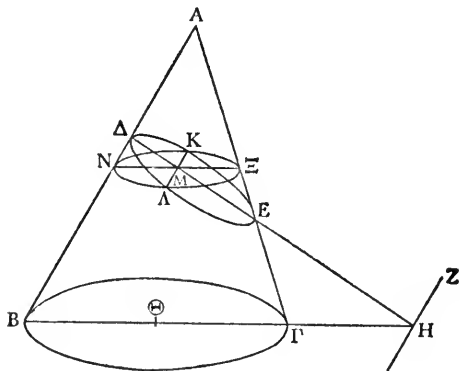

βάσις δὲ ὁ $B\Gamma$ κύκλος, καὶ τετμήσθω ἐπιπέδῳ τινὶ μήτε παραλλήλῳ ὄντι τῇ βάσει μήτε ὑπ-

300

APOLLONIUS OF PERGA

straight line $Z\Theta$ in the direction of the point Z an intercept equal to any given straight line. For if we place $Z\Xi$ equal to the given straight line and through Ξ draw a parallel to ΔE , it will meet the section, just as the parallel through Θ was shown to meet the section at the points M, N ; therefore a straight line parallel to ΔE has been drawn to meet the section so as to cut off from ZH in the direction of the point Z an intercept equal to the given straight line.

Prop. 9

If a cone be cut by a plane meeting either side of the axial triangle, but neither parallel to the base nor subcontrary,^a the section will not be a circle.

Let there be a cone whose vertex is the point A and base the circle $B\Gamma$, and let it be cut by a plane neither parallel to the base nor subcontrary, and let

• In the figure of this theorem, the section of the cone by the plane ΔE would be a *subcontrary section* (*ὑπεναντία τομή*) if the triangle $A\Delta E$ were similar to the triangle $AB\Gamma$, but in a contrary sense, *i.e.*, if angle $A\Delta E = \text{angle } A\Gamma B$. Apollonius proves in i. 5 that subcontrary sections of the cone are circles; it was proved in i. 4 that all sections parallel to the base are circles.

GREEK MATHEMATICS

εναντίως, καὶ ποιείτω τομὴν ἐν τῇ ἐπιφανείᾳ τὴν ΔΚΕ γραμμὴν. λέγω, ὅτι ἡ ΔΚΕ γραμμὴ οὐκ ἔσται κύκλος.

Εἰ γὰρ δυνατόν, ἔστω, καὶ συμπιπέτω τὸ τέμνον ἐπίπεδον τῇ βάσει, καὶ ἔστω τῶν ἐπιπέδων κοινὴ τομὴ ἡ ΖΗ, τὸ δὲ κέντρον τοῦ ΒΓ κύκλου ἔστω τὸ Θ, καὶ ἀπ' αὐτοῦ κάθετος ἤχθω ἐπὶ τὴν ΖΗ ἢ ΘΗ, καὶ ἐκβεβλήσθω διὰ τῆς ΗΘ καὶ τοῦ ἄξονος ἐπίπεδον καὶ ποιείτω τομὰς ἐν τῇ κωνικῇ ἐπιφανείᾳ τὰς ΒΑ, ΑΓ εὐθείας. ἐπεὶ οὖν τὰ Δ, Ε, Η σημεῖα ἐν τε τῷ διὰ τῆς ΔΚΕ ἐπιπέδῳ ἐστίν, ἔστι δὲ καὶ ἐν τῷ διὰ τῶν Α, Β, Γ, τὰ ἄρα Δ, Ε, Η σημεῖα ἐπὶ τῆς κοινῆς τομῆς τῶν ἐπιπέδων ἐστίν· εὐθεῖα ἄρα ἐστίν ἡ ΗΕΔ. εἰλήφθω δὴ τι ἐπὶ τῆς ΔΚΕ γραμμῆς σημεῖον τὸ Κ, καὶ διὰ τοῦ Κ τῇ ΖΗ παράλληλος ἤχθω ἡ ΚΛ· ἔσται δὴ ἴση ἡ ΚΜ τῇ ΜΛ. ἡ ἄρα ΔΕ διάμετρος ἐστὶ τοῦ ΔΚΛΕ κύκλου. ἤχθω δὴ διὰ τοῦ Μ τῇ ΒΓ παράλληλος ἡ ΝΜΞ· ἐστὶ δὲ καὶ ἡ ΚΛ τῇ ΖΗ παράλληλος· ὥστε τὸ διὰ τῶν ΝΞ, ΚΜ ἐπίπεδον παράλληλόν ἐστὶ τῷ διὰ τῶν ΒΓ, ΖΗ, τουτέστι τῇ βάσει, καὶ ἔσται ἡ τομὴ κύκλος. ἔστω ὁ ΝΚΞ. καὶ ἐπεὶ ἡ ΖΗ τῇ ΒΗ πρὸς ὀρθάς ἐστὶ, καὶ ἡ ΚΜ τῇ ΝΞ πρὸς ὀρθάς ἐστίν· ὥστε τὸ ὑπὸ τῶν ΝΜΞ ἴσον ἐστὶ τῷ ἀπὸ τῆς ΚΜ. ἐστὶ δὲ τὸ ὑπὸ τῶν ΔΜΕ ἴσον τῷ ἀπὸ τῆς ΚΜ· κύκλος γὰρ ὑπόκειται ἡ ΔΚΕΛ γραμμὴ, καὶ διάμετρος αὐτοῦ ἡ ΔΕ. τὸ ἄρα ὑπὸ τῶν ΝΜΞ ἴσον ἐστὶ τῷ ὑπὸ ΔΜΕ. ἐστὶν ἄρα ὡς ἡ ΜΝ πρὸς ΜΔ, οὕτως ἡ ΕΜ πρὸς ΜΞ. ὁμοιον ἄρα ἐστὶ τὸ ΔΜΝ τρίγωνον τῷ ΞΜΕ τριγώνῳ, καὶ ἡ ὑπὸ ΔΝΜ γωνία ἴση ἐστὶ τῇ ὑπὸ ΜΕΞ. ἀλλὰ

APOLLONIUS OF PERGA

the section so made on the surface be the curve ΔKE . I say that the curve ΔKE will not be a circle.

For, if possible, let it be, and let the cutting plane meet the base, and let the common section of the planes be ZH , and let the centre of the circle $B\Gamma$ be Θ , and from it let ΘH be drawn perpendicular to ZH , and let the plane through $H\Theta$ and the axis be produced, and let the sections made on the conical surface be the straight lines BA , $A\Gamma$. Then since the points Δ , E , H are in the plane through ΔKE , and are also in the plane through A , B , Γ , therefore the points Δ , E , H are on the common section of the planes; therefore $HE\Delta$ is a straight line [Eucl. xi. 3]. Now let there be taken any point K on the curve ΔKE , and through K let $K\Lambda$ be drawn parallel to ZH ; then KM will be equal to $M\Lambda$ [Prop. 7]. Therefore ΔE is a diameter of the circle $\Delta KE\Lambda$ [Prop. 7, coroll.]. Now let $NM\Xi$ be drawn through M parallel to $B\Gamma$; but $K\Lambda$ is parallel to ZH ; therefore the plane through $N\Xi$, KM is parallel to the plane through $B\Gamma$, ZH [Eucl. xi. 15], that is to the base, and the section will be a circle [Prop. 4]. Let it be $NK\Xi$. And since ZH is perpendicular to BH , KM is also perpendicular to $N\Xi$ [Eucl. xi. 10]; therefore $NM \cdot M\Xi = KM^2$. But $\Delta M \cdot ME = KM^2$; for the curve $\Delta KE\Lambda$ is by hypothesis a circle, and ΔE is a diameter in it. Therefore $NM \cdot M\Xi = \Delta M \cdot ME$. Therefore $MN : M\Delta = EM : M\Xi$. Therefore the triangle ΔMN is similar to the triangle ΞME , and the angle ΔNM is equal to the angle $ME\Xi$.

GREEK MATHEMATICS

ἡ ὑπὸ ΔNM γωνία τῇ ὑπὸ $AB\Gamma$ ἔστιν ἴση παράλληλος γὰρ ἡ NE τῇ $B\Gamma$. καὶ ἡ ὑπὸ $AB\Gamma$ ἄρα ἴση ἐστὶ τῇ ὑπὸ $ME\Xi$. ὑπεναντία ἄρα ἐστὶν ἡ τομῇ· ὅπερ οὐχ ὑπόκειται. οὐκ ἄρα κύκλος ἐστὶν ἡ ΔKE γραμμῆ.

(v.) *Fundamental Properties*

Ibid., Props. 11-14, Apoll. Perg. ed. Heiberg i. 36. 26-58. 7

ια'

Ἐὰν κώνος ἐπιπέδῳ τμηθῇ διὰ τοῦ ἄξονος, τμηθῇ δὲ καὶ ἑτέρῳ ἐπιπέδῳ τέμνοντι τὴν βάσιν τοῦ κώνου κατ' εὐθείαν πρὸς ὀρθὰς οὖσαν τῇ βάσει τοῦ διὰ τοῦ ἄξονος τριγώνου, ἔτι δὲ ἡ διάμετρος τῆς τομῆς παράλληλος ἢ μιᾷ πλευρᾷ τοῦ διὰ τοῦ ἄξονος τριγώνου, ἥτις ἂν ἀπὸ τῆς τομῆς τοῦ κώνου παράλληλος ἀχθῇ τῇ κοινῇ τομῇ τοῦ τέμνοντος ἐπιπέδου καὶ τῆς βάσεως τοῦ κώνου μέχρι τῆς διαμέτρου τῆς τομῆς, δυνήσεται τὸ περιεχόμενον ὑπὸ τε τῆς ἀπολαμβανομένης ὑπ' αὐτῆς ἀπὸ τῆς διαμέτρου πρὸς τῇ κορυφῇ τῆς τομῆς καὶ ἄλλης τινὸς εὐθείας, ἣ λόγον ἔχει πρὸς τὴν μεταξὺ τῆς τοῦ κώνου γωνίας καὶ τῆς κορυφῆς τῆς τομῆς, ὅν τὸ τετράγωνον τὸ ἀπὸ τῆς βάσεως τοῦ διὰ τοῦ ἄξονος τριγώνου πρὸς τὸ περιεχόμενον ὑπὸ τῶν λοιπῶν τοῦ τριγώνου δύο πλευρῶν· καλείσθω δὲ ἡ τοιαύτη τομῇ παραβολή.

Ἐστω κώνος, οὗ τὸ A σημεῖον κορυφή, βάσις δὲ ὁ $B\Gamma$ κύκλος, καὶ τετμήσθω ἐπιπέδῳ διὰ τοῦ ἄξονος, καὶ ποιείτω τομῆν τὸ $AB\Gamma$ τρίγωνον, τετμήσθω δὲ καὶ ἑτέρῳ ἐπιπέδῳ τέμνοντι τὴν βάσιν τοῦ κώνου κατ' εὐθείαν τὴν ΔE πρὸς ὀρθὰς

APOLLONIUS OF PERGA

But the angle ΔNM is equal to the angle $AB\Gamma$; for $N\Xi$ is parallel to $B\Gamma$; and therefore the angle $AB\Gamma$ is equal to the angle $ME\Xi$. Therefore the section is subcontrary [Prop. 5]; which is contrary to hypothesis. Therefore the curve ΔKE is not a circle.

(v.) *Fundamental Properties*

Ibid., Props. 11-14, Apoll. Perg. ed. Heiberg i. 36. 26-58. 7

Prop. 11

Let a cone be cut by a plane through the axis, and let it be also cut by another plane cutting the base of the cone in a straight line perpendicular to the base of the axial triangle, and further let the diameter of the section be parallel to one side of the axial triangle; then if any straight line be drawn from the section of the cone parallel to the common section of the cutting plane and the base of the cone as far as the diameter of the section, its square will be equal to the rectangle bounded by the intercept made by it on the diameter in the direction of the vertex of the section and a certain other straight line; this straight line will bear the same ratio to the intercept between the angle of the cone and the vertex of the segment as the square on the base of the axial triangle bears to the rectangle bounded by the remaining two sides of the triangle; and let such a section be called a parabola.

For let there be a cone whose vertex is the point A and whose base is the circle $B\Gamma$, and let it be cut by a plane through the axis, and let the section so made be the triangle $AB\Gamma$, and let it be cut by another plane cutting the base of the cone in the straight line

GREEK MATHEMATICS

οὕσαν τῇ ΒΓ, καὶ ποιείτω τομὴν ἐν τῇ ἐπιφανείᾳ τοῦ κώνου τὴν ΔΖΕ, ἣ δὲ διάμετρος τῆς τομῆς ἢ ΖΗ παράλληλος ἔστω μιᾷ πλευρᾷ τοῦ διὰ τοῦ ἄξονος τριγώνου τῇ ΑΓ, καὶ ἀπὸ τοῦ Ζ σημείου τῇ ΖΗ εὐθείᾳ πρὸς ὀρθὰς ἤχθω ἢ ΖΘ, καὶ πεποιήσθω, ὡς τὸ ἀπὸ ΒΓ πρὸς τὸ ὑπὸ ΒΑΓ, οὕτως ἢ ΖΘ πρὸς ΖΑ, καὶ εἰλήφθω τι σημεῖον ἐπὶ τῆς τομῆς τυχὸν τὸ Κ, καὶ διὰ τοῦ Κ τῇ ΔΕ παράλληλος ἢ ΚΛ. λέγω, ὅτι τὸ ἀπὸ τῆς ΚΛ ἴσον ἐστὶ τῷ ὑπὸ τῶν ΘΖΛ.

*Ἠχθω γὰρ διὰ τοῦ Λ τῇ ΒΓ παράλληλος ἢ ΜΝ· ἔστι δὲ καὶ ἢ ΚΛ τῇ ΔΕ παράλληλος· τὸ ἄρα διὰ τῶν ΚΛ, ΜΝ ἐπίπεδον παράλληλόν ἐστὶ τῷ διὰ τῶν ΒΓ, ΔΕ ἐπιπέδῳ, τουτέστι τῇ βάσει τοῦ κώνου. τὸ ἄρα διὰ τῶν ΚΛ, ΜΝ ἐπίπεδον κύκλος ἐστίν, οὗ διάμετρος ἢ ΜΝ. καὶ ἔστι κάθετος ἐπὶ τὴν ΜΝ ἢ ΚΛ, ἐπεὶ καὶ ἢ ΔΕ ἐπὶ τὴν ΒΓ· τὸ ἄρα ὑπὸ τῶν ΜΛΝ ἴσον ἐστὶ τῷ ἀπὸ τῆς ΚΛ. καὶ ἐπεὶ ἐστίν, ὡς τὸ ἀπὸ τῆς ΒΓ πρὸς τὸ ὑπὸ τῶν ΒΑΓ, οὕτως ἢ ΘΖ πρὸς ΖΑ, τὸ δὲ

APOLLONIUS OF PERGA

ΔE perpendicular to $B\Gamma$, and let the section so made on the surface of the cone be ΔZE , and let ZH , the diameter of the section, be parallel to $A\Gamma$, one side of the axial triangle, and from the point Z let $Z\Theta$ be drawn perpendicular to ZH , and let $B\Gamma^2 : BA \cdot A\Gamma = Z\Theta : ZA$, and let any point K be taken at random on the section, and through K let $K\Lambda$ be drawn parallel to ΔE . I say that $K\Lambda^2 = \Theta Z \cdot Z\Lambda$.

For let MN be drawn through Λ parallel to $B\Gamma$; but $K\Lambda$ is parallel to ΔE ; therefore the plane through

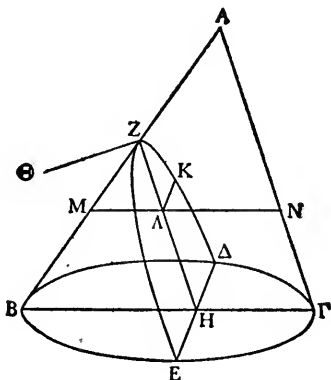

$K\Lambda$, MN is parallel to the plane through $B\Gamma$, ΔE [Eucl. xi. 15], that is to the base of the cone. Therefore the plane through $K\Lambda$, MN is a circle, whose diameter is MN [Prop. 4]. And $K\Lambda$ is perpendicular to MN , since ΔE is perpendicular to $B\Gamma$ [Eucl. xi. 10]; therefore

$$M\Lambda \cdot \Lambda N = K\Lambda^2.$$

And since $B\Gamma^2 : BA \cdot A\Gamma = \Theta Z : ZA$,

ἀπὸ τῆς ΒΓ πρὸς τὸ ὑπὸ τῶν ΒΑΓ λόγον ἔχει τὸν συγκείμενον ἐκ τε τοῦ, ὃν ἔχει ἡ ΒΓ πρὸς ΓΑ καὶ ἡ ΒΓ πρὸς ΒΑ, ὁ ἄρα τῆς ΘΖ πρὸς ΖΑ λόγος σύγκειται ἐκ τοῦ τῆς ΒΓ πρὸς ΓΑ καὶ τοῦ τῆς ΓΒ πρὸς ΒΑ. ἀλλ' ὡς μὲν ἡ ΒΓ πρὸς ΓΑ, οὕτως ἡ ΜΝ πρὸς ΝΑ, τουτέστιν ἡ ΜΛ πρὸς ΛΖ, ὡς δὲ ἡ ΒΓ πρὸς ΒΑ, οὕτως ἡ ΜΝ πρὸς ΜΑ, τουτέστιν ἡ ΛΜ πρὸς ΜΖ, καὶ λοιπὴ ἡ ΝΛ πρὸς ΖΑ. ὁ ἄρα τῆς ΘΖ πρὸς ΖΑ λόγος σύγκειται ἐκ τοῦ τῆς ΜΛ πρὸς ΛΖ καὶ τοῦ τῆς ΝΛ πρὸς ΖΑ. ὁ δὲ συγκείμενος λόγος ἐκ τοῦ τῆς ΜΛ πρὸς ΛΖ καὶ τοῦ τῆς ΛΝ πρὸς ΖΑ ὁ τοῦ ὑπὸ ΜΑΝ ἐστὶ πρὸς τὸ ὑπὸ ΛΖΑ. ὡς ἄρα ἡ ΘΖ πρὸς ΖΑ, οὕτως τὸ ὑπὸ ΜΑΝ πρὸς τὸ ὑπὸ ΛΖΑ. ὡς δὲ ἡ ΘΖ πρὸς ΖΑ, τῆς ΖΛ κοινοῦ ὕψους λαμβανομένης οὕτως τὸ ὑπὸ ΘΖΛ πρὸς τὸ ὑπὸ ΛΖΑ. ὡς ἄρα τὸ ὑπὸ ΜΑΝ πρὸς τὸ ὑπὸ ΛΖΑ, οὕτως τὸ ὑπὸ ΘΖΛ πρὸς τὸ ὑπὸ ΛΖΑ. ἴσον ἄρα ἐστὶ τὸ ὑπὸ ΜΑΝ τῷ ὑπὸ ΘΖΛ. τὸ δὲ ὑπὸ ΜΑΝ ἴσον ἐστὶ τῷ ἀπὸ τῆς ΚΛ. καὶ τὸ ἀπὸ τῆς ΚΛ ἄρα ἴσον ἐστὶ τῷ ὑπὸ τῶν ΘΖΛ.

Καλείσθω δὲ ἡ μὲν τοιαύτη τομὴ παραβολή, ἡ δὲ ΘΖ παρ' ἣν δύνανται αἱ καταγόμεναι τεταγμένως ἐπὶ τὴν ΖΗ διάμετρον, καλείσθω δὲ καὶ ὀρθία.

ιβ'

Ἐὰν κῶνος ἐπιπέδῳ τμηθῆ διατὸ ἄξονος, τμηθῆ δὲ καὶ ἑτέρῳ ἐπιπέδῳ τέμνοντι τὴν βάσιν

^a A parabola (παραβολή) because the square on the ordinate ΚΛ is applied (παραβαλεῖν) to the parameter ΘΖ in the form

APOLLONIUS OF PERGA

while $BF^2 : BA \cdot A\Gamma = (B\Gamma' : \Gamma A)(B\Gamma' : BA)$,
 therefore $\Theta Z : ZA = (B\Gamma' : \Gamma A)(\Gamma B : BA)$.
 But $B\Gamma' : \Gamma A = MN : NA$
 $= M\Lambda : \Lambda Z$, [Eucl. vi. 4
 and $B\Gamma' : BA = MN : MA$
 $= \Lambda M : MZ$ [*ibid.*
 $= N\Lambda : ZA$. [Eucl. vi. 2
 Therefore $\Theta Z : ZA = (M\Lambda : \Lambda Z)(N\Lambda : ZA)$.
 But $(M\Lambda : \Lambda Z)(\Lambda N : ZA) = M\Lambda \cdot \Lambda N : \Lambda Z \cdot ZA$.
 Therefore $\Theta Z : ZA = M\Lambda \cdot \Lambda N : \Lambda Z \cdot ZA$.
 But $\Theta Z : ZA = \Theta Z \cdot Z\Lambda : \Lambda Z \cdot ZA$,
 by taking a common height $Z\Lambda$;
 therefore $M\Lambda \cdot \Lambda N : \Lambda Z \cdot ZA = \Theta Z \cdot Z\Lambda : \Lambda Z \cdot ZA$.
 Therefore $M\Lambda \cdot \Lambda N = \Theta Z \cdot Z\Lambda$. [Eucl. v. 9
 But $M\Lambda \cdot \Lambda N = K\Lambda^2$;
 and therefore $K\Lambda^2 = \Theta Z \cdot Z\Lambda$.

Let such a section be called a *parabola*, and let ΘZ be called the *parameter of the ordinates* to the diameter ZH , and let it also be called the *erect side* (*latus rectum*).^a

Prop. 12

Let a cone be cut by a plane through the axis, and let it be cut by another plane cutting the base of the cone in of the rectangle $\Theta Z \cdot Z\Lambda$, and is exactly equal to this rectangle. It was Apollonius's most distinctive achievement to have based his treatment of the conic sections on the Pythagorean theory of the *application of areas* (*παραβολή τῶν χωρίων*), for which *v. vol. i. pp. 186-215*. The explanation of the term *latus rectum* will become more obvious in the cases of the hyperbola and the ellipse; *v. infra*, p. 317 n. a.

GREEK MATHEMATICS

τοῦ κώνου κατ' εὐθείαν πρὸς ὀρθὰς οὖσαν τῇ βάσει τοῦ διὰ τοῦ ἄξονος τριγώνου, καὶ ἡ διάμετρος τῆς τομῆς ἐκβαλλομένη συμπίπτῃ μιᾷ πλευρᾷ τοῦ διὰ τοῦ ἄξονος τριγώνου ἐκτὸς τῆς τοῦ κώνου κορυφῆς, ἣτις ἂν ἀπὸ τῆς τομῆς ἀχθῆ παραλληλὸς τῇ κοινῇ τομῇ τοῦ τέμνοντος ἐπιπέδου καὶ τῆς βάσεως τοῦ κώνου, ἕως τῆς διαμέτρου τῆς τομῆς δυνήσεται τι χωρίον παρακείμενον παρά τινα εὐθείαν, πρὸς ἣν λόγον ἔχει ἡ ἐπ' εὐθείας μὲν οὖσα τῇ διαμέτρῳ τῆς τομῆς, ὑποτείνουσα δὲ τὴν ἐκτὸς τοῦ τριγώνου γωνίαν, ὃν τὸ τετράγωνον τὸ ἀπὸ τῆς ἡγμένης ἀπὸ τῆς κορυφῆς τοῦ κώνου παρά τὴν διάμετρον τῆς τομῆς ἕως τῆς βάσεως τοῦ τριγώνου πρὸς τὸ περιεχόμενον ὑπὸ τῶν τῆς βάσεως τμημάτων, ὧν ποιεῖ ἡ ἀχθεῖσα, πλάτος ἔχον τὴν ἀπολαμβανομένην ὑπ' αὐτῆς ἀπὸ τῆς διαμέτρου πρὸς τῇ κορυφῇ τῆς τομῆς, ὑπερβάλλον εἶδει ὁμοίῳ τε καὶ ὁμοίως κειμένῳ τῷ περιεχομένῳ ὑπὸ τε τῆς ὑποτείνουσας τὴν ἐκτὸς γωνίαν τοῦ τριγώνου καὶ τῆς παρ' ἣν δύνανται αἱ καταγόμεναι· καλείσθω δὲ ἡ τοιαύτη τομὴ ὑπερβολή.

Ἐστω κώνος, οὗ κορυφὴ μὲν τὸ Α σημεῖον, βάσις δὲ ὁ ΒΓ κύκλος, καὶ τετμήσθω ἐπιπέδῳ διὰ τοῦ ἄξονος, καὶ ποιείτω τομὴν τὸ ΑΒΓ τρίγωνον, τετμήσθω δὲ καὶ ἑτέρῳ ἐπιπέδῳ τέμνοντι τὴν βάσιν τοῦ κώνου κατ' εὐθείαν τὴν ΔΕ πρὸς ὀρθὰς οὖσαν τῇ ΒΓ βάσει τοῦ ΑΒΓ τριγώνου, καὶ ποιείτω τομὴν ἐν τῇ ἐπιφανείᾳ τοῦ κώνου τὴν ΔΖΕ γραμμὴν, ἡ δὲ διάμετρος τῆς τομῆς ἡ ΖΗ ἐκβαλλομένη συμπίπτῃ μιᾷ πλευρᾷ τοῦ ΑΒΓ τριγώνου τῇ ΑΓ ἐκτὸς τῆς τοῦ κώνου κορυφῆς κατὰ τὸ Θ, καὶ διὰ τοῦ Α τῇ διαμέτρῳ τῆς τομῆς

APOLLONIUS OF PERGA

a straight line perpendicular to the base of the axial triangle, and let the diameter of the section, when produced, meet one side of the axial triangle beyond the vertex of the cone; then if any straight line be drawn from the section of the cone parallel to the common section of the cutting plane and the base of the cone as far as the diameter of the section, its square will be equal to the area applied to a certain straight line; this line is such that the straight line subtending the external angle of the triangle, lying in the same straight line with the diameter of the section, will bear to it the same ratio as the square on the line drawn from the vertex of the cone parallel to the diameter of the section as far as the base of the triangle bears to the rectangle bounded by the segments of the base made by the line so drawn; the breadth of the applied figure will be the intercept made by the ordinate on the diameter in the direction of the vertex of the section; and the applied figure will exceed by a figure similar and similarly situated to the rectangle bounded by the straight line subtending the external angle of the triangle and the parameter of the ordinates; and let such a section be called a hyperbola.

Let there be a cone whose vertex is the point A and whose base is the circle $B\Gamma$, and let it be cut by a plane through the axis, and let the section so made be the triangle $AB\Gamma$, and let it be cut by another plane cutting the base of the cone in the straight line ΔE perpendicular to $B\Gamma$, the base of the triangle $AB\Gamma$, and let the section so made on the surface of the cone be the curve ΔZE , and let ZH , the diameter of the section, when produced, meet $A\Gamma$, one side of the triangle $AB\Gamma$, beyond the vertex of the cone at Θ , and through A let AK be drawn parallel to ZH , the

APOLLONIUS OF PERGA

diameter of the section, and let it cut $B\Gamma$, and from Z let $Z\Lambda$ be drawn perpendicular to ZH , and let $KA^2 : BK \cdot K\Gamma = Z\Theta : Z\Lambda$, and let there be taken at random any point M on the section, and through M let MN be drawn parallel to ΔE , and through N let $NO\Xi$ be drawn parallel to $Z\Lambda$, and let $\Theta\Lambda$ be joined and produced to Ξ , and through Λ, Ξ , let $\Lambda O, \Xi\Pi$ be drawn parallel to ZN . I say that the square on MN is equal to $Z\Xi$, which is applied to the straight line $Z\Lambda$, having ZN for its breadth, and exceeding by the figure $\Lambda\Xi$ which is similar to the rectangle contained by $\Theta Z, Z\Lambda$.

For let PNS be drawn through N parallel to $B\Gamma$; but NM is parallel to ΔE ; therefore the plane through

GREEK MATHEMATICS

ἄρα διὰ τῶν MN, PΣ ἐπίπεδον παράλληλόν ἐστι τῷ διὰ τῶν ΒΓ, ΔΕ, τουτέστι τῇ βάσει τοῦ κώνου. ἂν ἄρα ἐκβληθῇ τὸ διὰ τῶν MN, PΣ ἐπίπεδον, ἢ τομὴ κύκλος ἔσται, οὗ διάμετρος ἡ PΝΣ. καὶ ἔστιν ἐπ' αὐτὴν κάθετος ἡ MN· τὸ ἄρα ὑπὸ τῶν PΝΣ ἴσον ἐστὶ τῷ ἀπὸ τῆς MN. καὶ ἐπεὶ ἔστιν, ὡς τὸ ἀπὸ AK πρὸς τὸ ὑπὸ BKΓ, οὕτως ἡ ΖΘ πρὸς ΖΛ, ὁ δὲ τοῦ ἀπὸ τῆς AK πρὸς τὸ ὑπὸ BKΓ λόγος σύγκειται ἔκ τε τοῦ, ὃν ἔχει ἡ AK πρὸς ΚΓ καὶ ἡ AK πρὸς KB, καὶ ὁ τῆς ΖΘ ἄρα πρὸς τὴν ΖΛ λόγος σύγκειται ἔκ τοῦ, ὃν ἔχει ἡ AK πρὸς ΚΓ καὶ ἡ AK πρὸς KB. ἀλλ' ὡς μὲν ἡ AK πρὸς ΚΓ, οὕτως ἡ ΘΗ πρὸς ΗΓ, τουτέστιν ἡ ΘΝ πρὸς ΝΣ, ὡς δὲ ἡ AK πρὸς KB, οὕτως ἡ ΖΗ πρὸς ΗΒ, τουτέστιν ἡ ΖΝ πρὸς NP. ὁ ἄρα τῆς ΘΖ πρὸς ΖΛ λόγος σύγκειται ἔκ τε τοῦ τῆς ΘΝ πρὸς ΝΣ καὶ τοῦ τῆς ΖΝ πρὸς NP ὁ τοῦ ὑπὸ τῶν ΘNZ ἐστὶ πρὸς τὸ ὑπὸ τῶν ΣNP· καὶ ὡς ἄρα τὸ ὑπὸ τῶν ΘNZ πρὸς τὸ ὑπὸ τῶν ΣNP, οὕτως ἡ ΘΖ πρὸς ΖΛ, τουτέστιν ἡ ΘΝ πρὸς ΝΞ. ἀλλ' ὡς ἡ ΘΝ πρὸς ΝΞ, τῆς ΖΝ κοινοῦ ὕψους λαμβανομένης οὕτως τὸ ὑπὸ τῶν ΘNZ πρὸς τὸ ὑπὸ τῶν ΖNΞ. καὶ ὡς ἄρα τὸ ὑπὸ τῶν ΘNZ πρὸς τὸ ὑπὸ τῶν ΣNP, οὕτως τὸ ὑπὸ τῶν ΘNZ πρὸς τὸ ὑπὸ τῶν ΞNZ. τὸ ἄρα ὑπὸ ΣNP ἴσον ἐστὶ τῷ ὑπὸ ΞNZ. τὸ δὲ ἀπὸ MN ἴσον ἐδείχθη τῷ ὑπὸ ΣNP· καὶ τὸ ἀπὸ τῆς MN ἄρα ἴσον ἐστὶ τῷ ὑπὸ τῶν ΞNZ. τὸ δὲ ὑπὸ ΞNZ ἐστὶ τὸ ΞΖ παραλληλόγραμμον. ἢ ἄρα

APOLLONIUS OF PERGA

MN, PΣ is parallel to the plane through BΓ, ΔE [Eucl. xi. 15], that is to the base of the cone. If, then, the plane through MN, PΣ be produced, the section will be a circle with diameter PNΣ [Prop. 4]. And MN is perpendicular to it ; therefore

$$PN \cdot N\Sigma = MN^2.$$

And since $AK^2 : BK \cdot K\Gamma = Z\Theta : Z\Lambda$,

while $AK^2 : BK \cdot K\Gamma = (AK : K\Gamma)(AK : KB)$,

therefore $Z\Theta : Z\Lambda = (AK : K\Gamma)(AK : KB)$.

But $AK : K\Gamma = \Theta H : H\Gamma$,

i.e., $= \Theta N : N\Sigma$, [Eucl. vi. 4

and $AK : KB = ZH : HB$,

i.e., $= ZN : NP$. [*ibid.*

Therefore $\Theta Z : Z\Lambda = (\Theta N : N\Sigma)(ZN : NP)$.

But $(\Theta N : N\Sigma)(ZN : NP) = \Theta N \cdot NZ : \Sigma N \cdot NP$;

and therefore

$$\begin{aligned} \Theta N \cdot NZ : \Sigma N \cdot NP &= \Theta Z : Z\Lambda \\ &= \Theta N : N\xi. \end{aligned} \quad [\textit{ibid.}]$$

But $\Theta N : N\xi = \Theta N \cdot NZ : ZN \cdot N\xi$,

by taking a common height ZN.

And therefore

$$\Theta N \cdot NZ : \Sigma N \cdot NP = \Theta N \cdot NZ : \xi N \cdot NZ.$$

Therefore $\Sigma N \cdot NP = \xi N \cdot NZ$. [Eucl. v. 9

But $MN^2 = \Sigma N \cdot NP$,

as was proved ;

and therefore $MN^2 = \xi N \cdot NZ$.

But the rectangle $\xi N \cdot NZ$ is the parallelogram ξZ .

GREEK MATHEMATICS

MN δύναται τὸ ΞZ , ὃ παράκειται παρὰ τὴν ΖΛ, πλάτος ἔχον τὴν ΖΝ, ὑπερβάλλον τῷ ΛΞ ὁμοίῳ ὄντι τῷ ὑπὸ τῶν ΘΖΛ. καλείσθω δὲ ἡ μὲν τοιαύτη τομὴ ὑπερβολή, ἡ δὲ ΛΖ παρ' ἣν δύνανται αἱ ἐπὶ τὴν ΖΗ καταγόμεναι τεταγμένως· καλείσθω δὲ ἡ αὐτὴ καὶ ὀρθία, πλαγία δὲ ἡ ΖΘ.

ιγ'

Ἐὰν κώνος ἐπιπέδῳ τμηθῆ διατὸ ἄξονος, τμηθῆ δὲ καὶ ἑτέρῳ ἐπιπέδῳ συμπίπτοντι μὲν ἑκατέρᾳ πλευρᾷ τοῦ διατὸ ἄξονος τριγώνου, μήτε δὲ παρὰ τὴν βάσιν τοῦ κώνου ἡγμένῳ μήτε ὑπεναντίως, τὸ δὲ ἐπίπεδον, ἐν ᾧ ἐστὶν ἡ βάσις τοῦ κώνου, καὶ τὸ τέμνον ἐπίπεδον συμπίπτῃ κατ' εὐθείαν πρὸς ὀρθὰς οὔσαν ἥτοι τῇ βάσει τοῦ διατὸ ἄξονος τριγώνου ἢ τῇ ἐπ' εὐθείας αὐτῇ, ἥτις ἂν ἀπὸ τῆς τομῆς τοῦ κώνου παράλληλος ἀχθῆ τῇ κοινῇ τομῇ τῶν ἐπιπέδων ἕως τῆς διαμέτρου τῆς τομῆς, δυνήσεται τι χωρίον παρακείμενον παρά τινα εὐθείαν, πρὸς ἣν λόγον ἔχει ἡ διάμετρος τῆς τομῆς, ὃν τὸ τετράγωνον τὸ ἀπὸ τῆς ἡγμένης ἀπὸ τῆς κορυφῆς τοῦ κώνου παρὰ τὴν διάμετρον τῆς τομῆς ἕως τῆς βάσεως τοῦ τριγώνου πρὸς τὸ περιεχόμενον ὑπὸ τῶν ἀπολαμβανομένων ὑπ' αὐτῆς πρὸς ταῖς τοῦ τριγώνου εὐθείαις, πλάτος ἔχον τὴν ἀπολαμβανομένην ὑπ' αὐτῆς ἀπὸ τῆς διαμέτρου πρὸς τῇ κορυφῇ τῆς τομῆς, ἐλλείπον εἶδει ὁμοίῳ τε καὶ ὁμοίως κειμένῳ τῷ περιεχομένῳ ὑπὸ τε τῆς διαμέτρου καὶ τῆς παρ' ἣν δύνανται· καλείσθω δὲ ἡ τοιαύτη τομὴ ἔλλειψις.

Ἐστω κώνος, οὗ κορυφὴ μὲν τὸ Α σημείον,

APOLLONIUS OF PERGA

Therefore the square on MN is equal to ΞZ , which is applied to $Z\Lambda$, having ZN for its breadth, and exceeding by $\Lambda\Xi$ similar to the rectangle contained by ΘZ , $Z\Lambda$. Let such a section be called a *hyperbola*, let ΛZ be called *the parameter to the ordinates* to ZH ; and let this line be also called the *erect side* (*latus rectum*), and $Z\Theta$ the *transverse side*.^a

Prop. 13

Let a cone be cut by a plane through the axis, and let it be cut by another plane meeting each side of the axial triangle, being neither parallel to the base nor subcontrary, and let the plane containing the base of the cone meet the cutting plane in a straight line perpendicular either to the base of the axial triangle or to the base produced; then if a straight line be drawn from any point of the section of the cone parallel to the common section of the planes as far as the diameter of the section, its square will be equal to an area applied to a certain straight line; this line is such that the diameter of the section will bear to it the same ratio as the square on the line drawn from the vertex of the cone parallel to the diameter of the section as far as the base of the triangle bears to the rectangle contained by the intercepts made by it on the sides of the triangle; the breadth of the applied figure will be the intercept made by it on the diameter in the direction of the vertex of the section; and the applied figure will be deficient by a figure similar and similarly situated to the rectangle bounded by the diameter and the parameter; and let such a section be called an ellipse.

Let there be a cone, whose vertex is the point A

^a The *erect* and *transverse* side, that is to say, of the figure ($\epsilon\lambda\delta\omicron\varsigma$) applied to the diameter. In the case of the parabola, the transverse side is infinite.

GREEK MATHEMATICS

βάσις δὲ ὁ ΒΓ κύκλος, καὶ τετμήσθω ἐπιπέδῳ διὰ τοῦ ἄξονος, καὶ ποιείτω τομὴν τὸ ΑΒΓ τρίγωνον, τετμήσθω δὲ καὶ ἑτέρῳ ἐπιπέδῳ συμπύκνουσι μὲν ἑκατέρᾳ πλευρᾷ τοῦ διὰ τοῦ ἄξονος τριγώνου, μήτε δὲ παραλλήλῳ τῇ βάσει τοῦ κώνου μήτε ὑπεναντίως ἡγμένῳ, καὶ ποιείτω τομὴν ἐν τῇ ἐπιφανείᾳ τοῦ κώνου τὴν ΔΕ γραμμὴν· κοινὴ

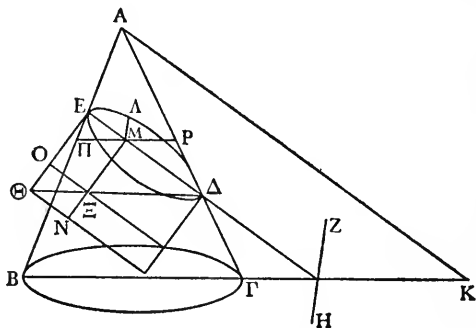

δὲ τομὴ τοῦ τέμνοντος ἐπιπέδου καὶ τοῦ, ἐν ᾧ ἐστὶν ἡ βάση τοῦ κώνου, ἔστω ἡ ΖΗ πρὸς ὀρθὰς οὔσα τῇ ΒΓ, ἡ δὲ διάμετρος τῆς τομῆς ἔστω ἡ ΕΔ, καὶ ἀπὸ τοῦ Ε τῇ ΕΔ πρὸς ὀρθὰς ἤχθω ἡ ΕΘ, καὶ διὰ τοῦ Α τῇ ΕΔ παράλληλος ἤχθω ἡ ΑΚ, καὶ πεποιήσθω ὡς τὸ ἀπὸ ΑΚ πρὸς τὸ ὑπὸ ΒΚΓ, οὕτως ἡ ΔΕ πρὸς τὴν ΕΘ, καὶ εἰλήφθω τι σημεῖον ἐπὶ τῆς τομῆς τὸ Λ, καὶ διὰ τοῦ Λ τῇ ΖΗ παράλληλος ἤχθω ἡ ΛΜ. λέγω, ὅτι ἡ ΛΜ δύναται τι χωρίον, ὃ παράκειται παρὰ τὴν ΕΘ, πλάτος ἔχον τὴν ΕΜ, ἑλλείπον εἶδει ὁμοίῳ τῷ ὑπὸ τῶν ΔΕΘ.

Ἐπεξεύχθω γὰρ ἡ ΔΘ, καὶ διὰ μὲν τοῦ Μ τῇ

APOLLONIUS OF PERGA

and whose base is the circle $B\Gamma$, and let it be cut by a plane through the axis, and let the section so made be the triangle $AB\Gamma$, and let it be cut by another plane meeting either side of the axial triangle, being drawn neither parallel to the base nor subcontrary, and let the section made on the surface of the cone be the curve ΔE ; let the common section of the cutting plane and of that containing the base of the cone be ZH , perpendicular to $B\Gamma$, and let the diameter of the section be $E\Delta$, and from E let $E\Theta$ be drawn perpendicular to $E\Delta$, and through A let AK be drawn parallel to $E\Delta$, and let $AK^2 : BK \cdot K\Gamma = \Delta E : E\Theta$, and let any point Λ be taken on the section, and through Λ let ΛM be drawn parallel to ZH . I say that the square on ΛM is equal to an area applied to the straight line $E\Theta$, having EM for its breadth, and being deficient by a figure similar to the rectangle contained by ΔE , $E\Theta$.

For let $\Delta\Theta$ be joined, and through M let $M\Xi N$ be

$\Theta\Xi$ παράλληλος ἤχθω ἢ $M\Xi N$, διὰ δὲ τῶν Θ, Ξ
 τῆ EM παράλληλοι ἤχθωσαν αἱ $\Theta N, \Xi O$, καὶ διὰ
 τοῦ M τῆ $B\Gamma$ παράλληλος ἤχθω ἢ $ΠΜΡ$. ἐπεὶ
 οὖν ἢ $ΠΡ$ τῆ $B\Gamma$ παράλληλός ἐστιν, ἔστι δὲ καὶ
 ἢ ΛM τῆ ZH παράλληλος, τὸ ἄρα διὰ τῶν ΛM ,
 $ΠΡ$ ἐπίπεδον παράλληλόν ἐστι τῷ διὰ τῶν ZH ,
 $B\Gamma$ ἐπιπέδῳ, τουτέστι τῆ βάσει τοῦ κώνου. εἰ
 ἄρα ἐκβληθῆ διὰ τῶν $\Lambda M, ΠΡ$ ἐπίπεδον, ἢ τομὴ
 κύκλος ἔσται, οὗ διάμετρος ἢ $ΠΡ$. καὶ ἐστὶ
 κάθετος ἐπ' αὐτὴν ἢ ΛM . τὸ ἄρα ὑπὸ τῶν $ΠΜΡ$
 ἴσον ἐστὶ τῷ ἀπὸ τῆς ΛM . καὶ ἐπεὶ ἐστὶν, ὡς τὸ
 ἀπὸ τῆς AK πρὸς τὸ ὑπὸ τῶν $BK\Gamma$, οὕτως ἢ $E\Delta$
 πρὸς τὴν $E\Theta$, ὁ δὲ τοῦ ἀπὸ τῆς AK πρὸς τὸ ὑπὸ
 τῶν $BK\Gamma$ λόγος σύγκειται ἐκ τοῦ, ὃν ἔχει ἢ AK
 πρὸς KB , καὶ ἢ AK πρὸς $K\Gamma$, ἀλλ' ὡς μὲν ἢ AK
 πρὸς KB , οὕτως ἢ EH πρὸς HB , τουτέστιν ἢ
 EM πρὸς $M\Pi$, ὡς δὲ ἢ AK πρὸς $K\Gamma$, οὕτως ἢ
 ΔH πρὸς $H\Gamma$, τουτέστιν ἢ ΔM πρὸς $M\rho$, ὁ ἄρα
 τῆς ΔE πρὸς τὴν $E\Theta$ λόγος σύγκειται ἐκ τε τοῦ
 τῆς EM πρὸς $M\Pi$ καὶ τοῦ τῆς ΔM πρὸς $M\rho$. ὁ
 δὲ συγκείμενος λόγος ἐκ τε τοῦ, ὃν ἔχει ἢ EM
 πρὸς $M\Pi$, καὶ ἢ ΔM πρὸς $M\rho$, ὁ τοῦ ὑπὸ τῶν
 $EM\Delta$ ἐστὶ πρὸς τὸ ὑπὸ τῶν $ΠΜΡ$. ἔστιν ἄρα ὡς
 τὸ ὑπὸ τῶν $EM\Delta$ πρὸς τὸ ὑπὸ τῶν $ΠΜΡ$, οὕτως
 ἢ ΔE πρὸς τὴν $E\Theta$, τουτέστιν ἢ ΔM πρὸς τὴν
 $M\Xi$. ὡς δὲ ἢ ΔM πρὸς $M\Xi$, τῆς ME κοινοῦ
 ὕψους λαμβανομένης, οὕτως τὸ ὑπὸ ΔME πρὸς τὸ
 ὑπὸ ΞME . καὶ ὡς ἄρα τὸ ὑπὸ ΔME πρὸς τὸ ὑπὸ
 $ΠΜΡ$, οὕτως τὸ ὑπὸ ΔME πρὸς τὸ ὑπὸ ΞME .
 ἴσον ἄρα ἐστὶ τὸ ὑπὸ $ΠΜΡ$ τῷ ὑπὸ ΞME . τὸ δὲ
 ὑπὸ $ΠΜΡ$ ἴσον ἐδείχθη τῷ ἀπὸ τῆς ΛM . καὶ τὸ
 ὑπὸ ΞME ἄρα ἐστὶν ἴσον τῷ ἀπὸ τῆς ΛM . ἢ ΛM

APOLLONIUS OF PERGA

drawn parallel to ΘE , and through Θ , Ξ , let ΘN , ΞO be drawn parallel to EM , and through M let ΠMP be drawn parallel to $B\Gamma$. Then since ΠP is parallel to $B\Gamma$, and ΔM is parallel to ZH , therefore the plane through ΔM , ΠP is parallel to the plane through ZH , $B\Gamma$ [Eucl. xi. 15], that is to the base of the cone. If, therefore, the plane through ΔM , ΠP be produced, the section will be a circle with diameter ΠP [Prop. 4]. And ΔM is perpendicular to it; therefore

$$\Pi M \cdot MP = \Delta M^2.$$

And since $AK^2 : BK \cdot K\Gamma = E\Delta : E\Theta$,

and $AK^2 : BK \cdot K\Gamma = (AK : KB)(AK : K\Gamma)$,

while $AK : KB = EH : HB$

$$= EM : M\Pi, \quad [\text{Eucl. vi. 4}]$$

and $AK : K\Gamma = \Delta H : H\Gamma$

$$= \Delta M : MP, \quad [\textit{ibid.}]$$

therefore $\Delta E : E\Theta = (EM : M\Pi)(\Delta M : MP)$.

But $(EM : M\Pi)(\Delta M : MP) = EM \cdot M\Delta : \Pi M \cdot MP$.

Therefore

$$EM \cdot M\Delta : \Pi M \cdot MP = \Delta E : E\Theta$$

$$= \Delta M : M\Xi. \quad [\textit{ibid.}]$$

But $\Delta M : M\Xi = \Delta M \cdot ME : \Xi M \cdot ME$,

by taking a common height ME .

Therefore $\Delta M \cdot ME : \Pi M \cdot MP = \Delta M \cdot ME : \Xi M \cdot ME$.

Therefore $\Pi M \cdot MP = \Xi M \cdot ME$. [Eucl. v. 9]

But $\Pi M \cdot MP = \Delta M^2$,

as was proved;

and therefore $\Xi M \cdot ME = \Delta M^2$.

GREEK MATHEMATICS

ἄρα δύναται τὸ ΜΟ, ὃ παράκειται παρὰ τὴν ΘΕ, πλάτος ἔχον τὴν ΕΜ, ἑλλείπον εἶδει τῷ ΟΝ ὁμοίῳ ὄντι τῷ ὑπὸ ΔΕΘ. καλείσθω δὲ ἡ μὲν τοιαύτη τομὴ ἑλλειψις, ἡ δὲ ΕΘ παρ' ἣν δύνανται αἱ καταγόμεναι ἐπὶ τὴν ΔΕ τεταγμένως, ἡ δὲ αὐτὴ καὶ ὀρθία, πλαγία δὲ ἡ ΕΔ.

ιδ'

Ἐὰν αἱ κατὰ κορυφὴν ἐπιφάνειαι ἐπιπέδῳ τμηθῶσι μὴ διὰ τῆς κορυφῆς, ἔσται ἐν ἑκατέρᾳ τῶν ἐπιφανειῶν τομὴ ἡ καλουμένη ὑπερβολή, καὶ τῶν δύο τομῶν ἡ τε διάμετρος ἡ αὐτὴ ἔσται, καὶ παρ' ἧς δύνανται αἱ ἐπὶ τὴν διάμετρον καταγόμεναι παράλληλοι τῇ ἐν τῇ βάσει τοῦ κώνου εὐθεία ἴσαι, καὶ τοῦ εἶδους ἡ πλαγία πλευρὰ κοινὴ ἡ μεταξὺ τῶν κορυφῶν τῶν τομῶν· καλείσθωσαν δὲ αἱ τοιαῦται τομαὶ ἀντικείμεναι.

Ἐστῶσαν αἱ κατὰ κορυφὴν ἐπιφάνειαι, ὧν κορυφὴ τὸ Α σημείον, καὶ τετμήσθωσαν ἐπιπέδῳ μὴ διὰ τῆς κορυφῆς, καὶ ποιείτω ἐν τῇ ἐπιφανείᾳ τομὰς τὰς ΔΕΖ, ΗΘΚ. λέγω, ὅτι ἑκατέρᾳ τῶν ΔΕΖ, ΗΘΚ τομῶν ἔστιν ἡ καλουμένη ὑπερβολή.

^a Let p be the parameter of a conic section and d the corresponding diameter, and let the diameter of the section and the tangent at its extremity be taken as axes of co-ordinates (in general oblique). Then Props. 11-13 are equivalent to the Cartesian equations.

APOLLONIUS OF PERGA

Therefore the square on ΛM is equal to MO , which is applied to ΘE , having EM for its breadth, and being deficient by the figure ON similar to the rectangle $\Delta E \cdot E\Theta$. Let such a section be called an *eclipse*, let $E\Theta$ be called *the parameter to the ordinates to ΔE* , and let this line be called *the erect side (latus rectum)*, and $E\Delta$ the *transverse side*.^a

Prop. 14

If the vertically opposite surfaces [of a double cone] be cut by a plane not through the vertex, there will be formed on each of the surfaces the section called a hyperbola, and the diameter of both sections will be the same, and the parameter to the ordinates drawn parallel to the straight line in the base of the cone will be equal, and the transverse side of the figure will be common, being the straight line between the vertices of the sections; and let such sections be called opposite.

Let there be vertically opposite surfaces having the point A for vertex, and let them be cut by a plane not through the vertex, and let the sections so made on the surface be ΔEZ , $H\Theta K$. I say that each of the sections ΔEZ , $H\Theta K$ is the so-called hyperbola.

$$\text{and } y^2 = px \qquad \qquad \qquad (\text{the parabola}),$$

$$y^2 = px \pm \frac{p}{a}x^2 \quad (\text{the hyperbola and ellipse respectively}).$$

It is the essence of Apollonius's treatment to express the fundamental properties of the conics as equations between *areas*, whereas Archimedes had given the fundamental properties of the central conics as *proportions*

$$y^2 : (a^2 \pm x^2) = a^2 : b^2.$$

This form is, however, equivalent to the Cartesian equations referred to axes through the centre.

GREEK MATHEMATICS

Ἐστω γὰρ ὁ κύκλος, καθ' οὗ φέρεται ἡ τὴν ἐπιφάνειαν γράφουσα εὐθεῖα, ὁ ΒΔΓΖ, καὶ ἤχθω

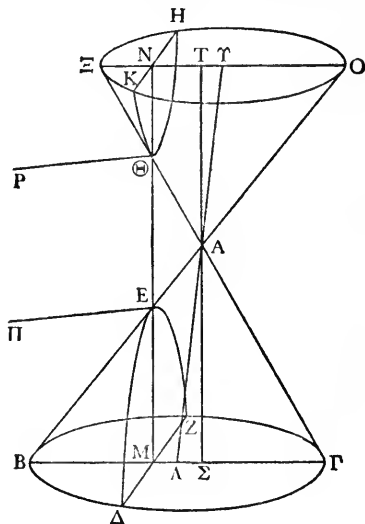

ἐν τῇ κατὰ κορυφήν ἐπιφανείᾳ παράλληλον αὐτῷ ἐπίπεδον τὸ ΕΗΟΚ· κοινὰ δὲ τομαὶ τῶν ΗΘΚ, ΖΕΔ τομῶν καὶ τῶν κύκλων αἱ ΖΔ, ΗΚ· ἔσονται δὴ παράλληλοι. ἄξων δὲ ἔστω τῆς κωνικῆς ἐπιφανείας ἡ ΛΑΥ εὐθεῖα, κέντρα δὲ τῶν κύκλων τὰ Λ, Υ, καὶ ἀπὸ τοῦ Λ ἐπὶ τὴν ΖΔ κάθετος ἀχθείσα ἐκβεβλήσθω ἐπὶ τὰ Β, Γ σημεῖα, καὶ διὰ τῆς ΒΓ καὶ τοῦ ἄξονος ἐπίπεδον ἐκβεβλήσθω· ποιήσει δὴ τομὰς ἐν μὲν τοῖς κύκλοις παραλλήλους εὐθείας τὰς ΕΟ, ΒΓ, ἐν δὲ τῇ ἐπιφανείᾳ τὰς ΒΑΟ, ΓΑΞ·

APOLLONIUS OF PERGA

For let $B\Delta\Gamma Z$ be the circle round which revolves the straight line describing the surface, and in the vertically opposite surface let there be drawn parallel to it a plane ΞHOK ; the common sections of the sections HOK , $ZE\Delta$ and of the circles [Prop. 4] will be $Z\Delta$, HK ; and they will be parallel [Eucl. xi. 16]. Let the axis of the conical surface be ΛAY , let the centres of the circles be Λ , Y , and from Λ let a perpendicular be drawn to $Z\Delta$ and produced to the points B , Γ , and let the plane through $B\Gamma$ and the axis be produced; it will make in the circles the parallel straight lines ΞO , $B\Gamma$, and on the surface BAO , $\Gamma A\Xi$;

GREEK MATHEMATICS

ἔσται δὴ καὶ ἡ $\Xi\Theta$ τῇ HK πρὸς ὀρθάς, ἐπειδὴ καὶ ἡ $B\Gamma$ τῇ $Z\Delta$ ἔστι πρὸς ὀρθάς, καὶ ἔστιν ἑκατέρα παράλληλος. καὶ ἐπεὶ τὸ διὰ τοῦ ἄξονος ἐπίπεδον ταῖς τομαῖς συμβάλλει κατὰ τὰ M, N σημεῖα ἐντὸς τῶν γραμμῶν, δῆλον, ὡς καὶ τὰς γραμμὰς τέμνει τὸ ἐπίπεδον. τεμνέτω κατὰ τὰ Θ, E . τὰ ἄρα M, E, Θ, N σημεῖα ἔν τε τῷ διὰ τοῦ ἄξονός ἐστιν ἐπιπέδῳ καὶ ἐν τῷ ἐπιπέδῳ, ἐν ᾧ εἰσιν αἱ γραμμαὶ εὐθεῖα ἄρα ἔστιν ἡ $ME\Theta N$ γραμμὴ. καὶ φανερόν, ὅτι τά τε Ξ, Θ, A, Γ ἐπ' εὐθείας ἔστι καὶ τὰ B, E, A, O . ἔν τε γὰρ τῇ κωνικῇ ἐπιφανείᾳ ἔστι καὶ ἐν τῷ διὰ τοῦ ἄξονος ἐπιπέδῳ. ἤχθωσαν δὴ ἀπὸ μὲν τῶν Θ, E τῇ ΘE πρὸς ὀρθάς αἱ $\Theta P, E\Pi$, διὰ δὲ τοῦ A τῇ $ME\Theta N$ παράλληλος ἤχθω ἡ $\Sigma A T$, καὶ πεποιήσθω, ὡς μὲν τὸ ἀπὸ τῆς $A\Sigma$ πρὸς τὸ ὑπὸ $B\Sigma\Gamma$, οὕτως ἡ ΘE πρὸς $E\Pi$, ὡς δὲ τὸ ἀπὸ τῆς $A T$ πρὸς τὸ ὑπὸ $O T \Xi$, οὕτως ἡ $E\Theta$ πρὸς ΘP . ἐπεὶ οὖν κώνος, οὗ κορυφὴ μὲν τὸ A σημεῖον, βάσις δὲ ὁ $B\Gamma$ κύκλος, τέτμηται ἐπιπέδῳ διὰ τοῦ ἄξονος, καὶ πεποιήκε τομὴν τὸ $AB\Gamma$ τρίγωνον, τέτμηται δὲ καὶ ἑτέρῳ ἐπιπέδῳ τέμνοντι τὴν βάσιν τοῦ κώνου κατ' εὐθείαν τὴν $\Delta M Z$ πρὸς ὀρθάς οὖσαν τῇ $B\Gamma$, καὶ πεποιήκε τομὴν ἐν τῇ ἐπιφανείᾳ τὴν $\Delta E Z$, ἡ δὲ διάμετρος ἡ ME ἐκβαλλομένη συμπέπτωκε μιᾷ πλευρᾷ τοῦ διὰ τοῦ ἄξονος τριγώνου ἐκτὸς τῆς κορυφῆς τοῦ κώνου, καὶ διὰ τοῦ A σημείου τῇ διαμέτρῳ τῆς τομῆς τῇ EM παράλληλος ἤκται ἡ $A\Sigma$, καὶ ἀπὸ τοῦ E τῇ EM πρὸς ὀρθάς ἤκται ἡ $E\Pi$, καὶ ἔστιν ὡς τὸ ἀπὸ $A\Sigma$ πρὸς τὸ ὑπὸ $B\Sigma\Gamma$, οὕτως ἡ $E\Theta$ πρὸς $E\Pi$, ἡ μὲν $\Delta E Z$ ἄρα τομὴ ὑπερβολὴ ἔστιν, ἡ δὲ $E\Pi$ παρ' ἣν δύνανται αἱ ἐπὶ τὴν EM καταγόμεναι τεταγμένως, πλαγία

APOLLONIUS OF PERGA

now ΞO will be perpendicular to HK , since $B\Gamma$ is perpendicular to $Z\Delta$, and each is parallel [Eucl. xi. 10]. And since the plane through the axis meets the sections at the points M, N within the curves, it is clear that the plane cuts the curves. Let it cut them at the points Θ, E ; then the points M, E, Θ, N are both in the plane through the axis and in the plane containing the curves; therefore the line $ME\Theta N$ is a straight line [Eucl. xi. 3]. And it is clear that Ξ, Θ, A, Γ are on a straight line, and also B, E, A, O ; for they are both on the conical surface and in the plane through the axis. Now let $\Theta P, E\Pi$ be drawn from Θ, E perpendicular to ΘE , and through A let ΣAT be drawn parallel to $ME\Theta N$, and let

$$A\Sigma^2 : B\Sigma \cdot \Sigma\Gamma = \Theta E : E\Pi,$$

and

$$AT^2 : OT \cdot T\Xi = E\Theta : \Theta P.$$

Then since the cone, whose vertex is the point A and whose base is the circle $B\Gamma$, is cut by a plane through the axis, and the section so made is the triangle $AB\Gamma$, and it is cut by another plane cutting the base of the cone in the straight line ΔMZ perpendicular to $B\Gamma$, and the section so made on the surface is ΔEZ , and the diameter ME produced meets one side of the axial triangle beyond the vertex of the cone, and $A\Sigma$ is drawn through the point A parallel to the diameter of the section EM , and $E\Pi$ is drawn from E perpendicular to EM , and $A\Sigma^2 : B\Sigma \cdot \Sigma\Gamma = E\Theta : E\Pi$, therefore the section ΔEZ is a hyperbola, in which $E\Pi$ is the parameter to the ordinates to EM , and ΘE is the

GREEK MATHEMATICS

δὲ τοῦ εἵδους πλευρὰ ἡ ΘΕ. ὁμοίως δὲ καὶ ἡ ΗΘΚ ὑπερβολὴ ἐστίν, ἧς διάμετρος μὲν ἡ ΘΝ, ἡ δὲ ΘΡ παρ' ἣν δύνανται αἱ ἐπὶ τὴν ΘΝ καταγόμεναι τεταγμένως, πλαγία δὲ τοῦ εἵδους πλευρὰ ἡ ΘΕ.

Λέγω, ὅτι ἴση ἐστὶν ἡ ΘΡ τῇ ΕΠ. ἐπεὶ γὰρ παράλληλός ἐστίν ἡ ΒΓ τῇ ΞΟ, ἔστιν ὡς ἡ ΑΣ πρὸς ΣΓ, οὕτως ἡ ΑΤ πρὸς ΤΞ, καὶ ὡς ἡ ΑΣ πρὸς ΣΒ, οὕτως ἡ ΑΤ πρὸς ΤΟ. ἀλλ' ὁ τῆς ΑΣ πρὸς ΣΓ λόγος μετὰ τοῦ τῆς ΑΣ πρὸς ΣΒ ὁ τοῦ ἀπὸ ΑΣ ἐστὶ πρὸς τὸ ὑπὸ ΒΣΓ, ὁ δὲ τῆς ΑΤ πρὸς ΤΞ μετὰ τοῦ τῆς ΑΤ πρὸς ΤΟ ὁ τοῦ ἀπὸ ΑΤ πρὸς τὸ ὑπὸ ΞΤΟ· ἔστιν ἄρα ὡς τὸ ἀπὸ ΑΣ πρὸς τὸ ὑπὸ ΒΣΓ, οὕτως τὸ ἀπὸ ΑΤ πρὸς τὸ ὑπὸ ΞΤΟ. καὶ ἐστὶν ὡς μὲν τὸ ἀπὸ ΑΣ πρὸς τὸ ὑπὸ ΒΣΓ, ἡ ΘΕ πρὸς ΕΠ, ὡς δὲ τὸ ἀπὸ ΑΤ πρὸς τὸ ὑπὸ ΞΤΟ, ἡ ΘΕ πρὸς ΘΡ· καὶ ὡς ἄρα ἡ ΘΕ πρὸς ΕΠ, ἡ ΕΘ πρὸς ΘΡ. ἴση ἄρα ἐστὶν ἡ ΕΠ τῇ ΘΡ.

(vi.) *Transition to New Diameter*

Ibid., Prop. 50, Apoll. Perg. ed. Heiberg i. 148. 17-154. 8

ν'

Ἐὰν ὑπερβολῆς ἢ ἐλλείψεως ἢ κύκλου περιφερείας εὐθεῖα ἐπιψαύουσα συμπύπτη τῇ διαμέτρῳ, καὶ διὰ τῆς ἀφῆς καὶ τοῦ κέντρου εὐθεῖα ἐκβληθῆ, ἀπὸ δὲ τῆς κορυφῆς ἀναχθεῖσα εὐθεῖα παρὰ τεταγμένως κατηγμένην συμπύπτη τῇ διὰ τῆς ἀφῆς καὶ

* Apollonius is the first person known to have recognized the opposite branches of a hyperbola as portions of the same

APOLLONIUS OF PERGA

transverse side of the figure [Prop. 12]. Similarly $H\Theta K$ is a hyperbola, in which ΘN is a diameter, ΘP is the parameter to the ordinates to ΘN , and ΘE is the transverse side of the figure.

I say that $\Theta P = E\Pi$. For since $B\Gamma$ is parallel to ΞO ,

$$A\Sigma : \Sigma\Gamma = AT : T\Xi,$$

and

$$A\Sigma : \Sigma B = AT : TO.$$

But

$$(A\Sigma : \Sigma\Gamma)(A\Sigma : \Sigma B) = A\Sigma^2 : B\Sigma \cdot \Sigma\Gamma,$$

and

$$(AT : T\Xi)(AT : TO) = AT^2 : \Xi T \cdot TO.$$

Therefore

$$A\Sigma^2 : B\Sigma \cdot \Sigma\Gamma = AT^2 : \Xi T \cdot TO.$$

But

$$A\Sigma^2 : B\Sigma \cdot \Sigma\Gamma = \Theta E : E\Pi,$$

while

$$AT^2 : \Xi T \cdot TO = \Theta E : \Theta P;$$

therefore

$$\Theta E : E\Pi = E\Theta : \Theta P.$$

Therefore

$$E\Pi = \Theta P. \quad [\text{Eucl. v. 9}]$$

(vi.) *Transition to New Diameter*

Ibid., Prop. 50, Apoll. Perg. ed. Heiberg i. 148. 17-154. 8

Prop. 50

In a hyperbola, ellipse or circumference of a circle let a straight line be drawn to touch [the curve] and meet the diameter, and let the straight line through the point of contact and the centre be produced, and from the vertex let a straight line be drawn parallel to a straight line drawn ordinate-wise so as to meet the straight line drawn

curve. It is his practice, however, where possible to discuss the single-branch hyperbola (or the hyperbola *simpliciter* as he would call it) together with the ellipse and circle, and to deal with the opposite branches separately. But occasionally, as in i. 30, the double-branch hyperbola and the ellipse are included in one enunciation.

GREEK MATHEMATICS

τοῦ κέντρου ἡγμένη εὐθεία, καὶ ποιηθῆ, ὡς τὸ τμήμα τῆς ἐφαπτομένης τὸ μεταξὺ τῆς ἀφῆς καὶ τῆς ἀνηγμένης πρὸς τὸ τμήμα τῆς ἡγμένης διὰ τῆς ἀφῆς καὶ τοῦ κέντρου τὸ μεταξὺ τῆς ἀφῆς καὶ τῆς ἀνηγμένης, εὐθειά τις πρὸς τὴν διπλασίαν τῆς ἐφαπτομένης, ἥτις ἂν ἀπὸ τῆς τομῆς ἀχθῆ ἐπὶ τὴν διὰ τῆς ἀφῆς καὶ τοῦ κέντρου ἡγμένην εὐθείαν παράλληλος τῇ ἐφαπτομένη, δυνήσεται τι χωρίον ὀρθογώνιον παρακείμενον παρὰ τὴν πορισθεῖσαν, πλάτος ἔχον τὴν ἀπολαμβανομένην ὑπ' αὐτῆς πρὸς τῇ ἀφῆ, ἐπὶ μὲν τῆς ὑπερβολῆς ὑπερβάλλον εἶδει ὁμοίω τῷ περιεχομένω ὑπὸ τῆς διπλασίας τῆς μεταξὺ τοῦ κέντρου καὶ τῆς ἀφῆς καὶ τῆς πορισθείσης εὐθείας, ἐπὶ δὲ τῆς ἔλλειψως καὶ τοῦ κύκλου ἔλλειπον.

Ἔστω ὑπερβολὴ ἢ ἔλλειψις ἢ κύκλου περιφέρεια, ἥς διάμετρος ἢ AB , κέντρον δὲ τὸ Γ , ἐφαπτομένη δὲ ἢ ΔE , καὶ ἐπιζευχθεῖσα ἢ ΓE ἐκβεβλήσθω ἐφ' ἑκάτερα, καὶ κείσθω τῇ $E\Gamma$ ἴση ἢ ΓK , καὶ διὰ τοῦ B τεταγμένως ἀνήχθω ἢ BZH , διὰ δὲ τοῦ E τῇ $E\Gamma$ πρὸς ὀρθὰς ἤχθω ἢ $E\Theta$, καὶ γινέσθω, ὡς ἢ ZE πρὸς $E\Theta$, οὕτως ἢ $E\Theta$ πρὸς τὴν διπλασίαν τῆς $E\Delta$, καὶ ἐπιζευχθεῖσα ἢ ΘK ἐκβεβλήσθω, καὶ εἰλήφθω τι ἐπὶ τῆς τομῆς σημεῖον τὸ Λ , καὶ δι' αὐτοῦ τῇ $E\Delta$ παράλληλος ἤχθω ἢ $\Lambda M\Xi$, τῇ δὲ

^a To save space, the figure is here given for the hyperbola only ; in the mss. there are figures for the ellipse and circle as well.

The general enunciation is not easy to follow, but the particular enunciation will make it easier to understand. The

APOLLONIUS OF PERGA

through the point of contact and the centre, and let the segment of the tangent between the point of contact and the line drawn ordinate-wise bear to the segment of the line drawn through the point of contact and the centre between the point of contact and the line drawn ordinate-wise the same ratio as a certain straight line bears to double the tangent; then if any straight line be drawn from the section parallel to the tangent so as to meet the straight line drawn through the point of contact and the centre, its square will be equal to a certain rectilineal area applied to the postulated straight line, having for its breadth the intercept between it and the point of contact, in the case of the hyperbola exceeding by a figure similar to the rectangle bounded by double the straight line between the centre and the point of contact and the postulated straight line, in the case of the ellipse and circle falling short.^a

In a hyperbola, ellipse or circumference of a circle, with diameter AB and centre Γ , let ΔE be a tangent, and let ΓE be joined and produced in either direction, and let ΓK be placed equal to $E\Gamma$, and through B let BZH be drawn ordinate-wise, and through E let $E\Theta$ be drawn perpendicular to $E\Gamma$, and let $ZE : EH = E\Theta : 2E\Delta$, and let ΘK be joined and produced, and let any point Λ be taken on the section, and through it let $\Lambda M\Xi$ be drawn parallel to $E\Delta$ and purpose of this important proposition is to show that, if any other diameter be taken, the ordinate-property of the conic with reference to this diameter has the same form as the ordinate-property with reference to the original diameter. The theorem amounts to a transformation of co-ordinates from the original diameter and the tangent at its extremity to any diameter and the tangent at its extremity. In succeeding propositions, showing how to construct conics from certain data, Apollonius introduces the axes for the first time as special cases of diameters.

GREEK MATHEMATICS

ΒΗ ἢ ΛΡΝ, τῇ δὲ ΕΘ ἢ ΜΠ. λέγω, ὅτι τὸ ἀπὸ ΛΜ ἴσον ἐστὶ τῷ ὑπὸ ΕΜΠ.

Ἦχθω γὰρ διὰ τοῦ Γ τῇ ΚΠ παράλληλος ἢ ΓΣΟ. καὶ ἐπεὶ ἴση ἐστὶν ἢ ΕΓ τῇ ΓΚ, ὡς δὲ ἢ

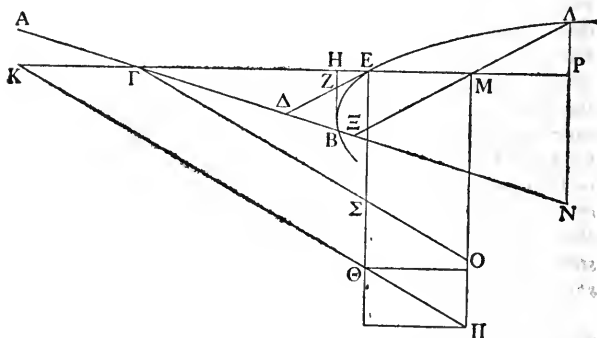

ΕΓ πρὸς ΚΓ, ἢ ΕΣ πρὸς ΣΘ, ἴση ἄρα καὶ ἢ ΕΣ τῇ ΣΘ. καὶ ἐπεὶ ἐστὶν, ὡς ἢ ΖΕ πρὸς ΕΗ, ἢ ΘΕ πρὸς τὴν διπλασίαν τῆς ΕΔ, καὶ ἐστὶ τῆς ΕΘ ἡμίσεια ἢ ΕΣ, ἔστιν ἄρα, ὡς ἢ ΖΕ πρὸς ΕΗ, ἢ ΣΕ πρὸς ΕΔ. ὡς δὲ ἢ ΖΕ πρὸς ΕΗ, ἢ ΛΜ πρὸς ΜΡ· ὡς ἄρα ἢ ΛΜ πρὸς ΜΡ, ἢ ΣΕ πρὸς ΕΔ. καὶ ἐπεὶ τὸ ΡΝΓ τρίγωνον τοῦ ΗΒΓ τριγώνου, τουτέστι τοῦ ΓΔΕ, ἐπὶ μὲν τῆς ὑπερβολῆς μείζον ἐδείχθη, ἐπὶ δὲ τῆς ἐλλείψεως καὶ τοῦ κύκλου ἔλασσον τῷ ΛΝΞ, κοινῶν ἀφαιρεθέντων ἐπὶ μὲν τῆς ὑπερβολῆς τοῦ τε ΕΓΔ τριγώνου καὶ τοῦ ΝΡΜΞ τετραπλεύρου, ἐπὶ δὲ τῆς ἐλλείψεως καὶ τοῦ κύκλου τοῦ ΜΞΓ τριγώνου, τὸ ΛΜΡ τρίγωνον τῷ ΜΕΔΞ τετραπλεύρῳ ἐστὶν ἴσον. καὶ ἐστὶ

APOLLONIUS OF PERGA

$\Lambda P N$ parallel to $B H$, and let $M H$ be drawn parallel to $E \Theta$. I say that $\Lambda M^2 = E M \cdot M H$.

For through Γ let $\Gamma \Sigma O$ be drawn parallel to $K H$. Then since

$$E \Gamma = \Gamma K$$

and $E \Gamma : \Gamma K = E \Sigma : \Sigma O$, [Eucl. vi. 2]

therefore $E \Sigma = \Sigma O$.

And since $Z E : E H = \Theta E : 2 E \Delta$,

and $E \Sigma = \frac{1}{2} E \Theta$,

therefore $Z E : E H = \Sigma E : E \Delta$.

But $Z E : E H = \Lambda M : M P$; [Eucl. vi. 4]

therefore $\Lambda M : M P = \Sigma E : E \Delta$.

And since it has been proved [Prop. 43] that in the hyperbola

triangle $P N \Gamma =$ triangle $H B \Gamma +$ triangle $\Lambda N \Xi$,

i.e., triangle $P N \Gamma =$ triangle $\Gamma \Delta E +$ triangle $\Lambda N \Xi$,^a

while in the ellipse and the circle

triangle $P N \Gamma$ = triangle $H B \Gamma -$
triangle $\Lambda N \Xi$,

i.e., triangle $P N \Gamma +$ triangle $\Lambda N \Xi =$ triangle $\Gamma \Delta E$,^b

therefore by taking away the common elements—in the hyperbola the triangle $E \Gamma \Delta$ and the quadrilateral $N P M \Xi$, in the ellipse and the circle the triangle $M \Xi \Gamma$,

triangle $\Lambda M P =$ quadrilateral $M E \Delta \Xi$.

^a For this step *v.* Eutocius's comment on Prop. 43.

^b See Eutocius.

GREEK MATHEMATICS

παράλληλος ἡ ΜΞ τῇ ΔΕ, ἡ δὲ ὑπὸ ΛΜΡ τῇ ὑπὸ ΕΜΞ ἔστιν ἴση· ἴσον ἄρα ἔστι τὸ ὑπὸ ΛΜΡ τῷ ὑπὸ τῆς ΕΜ καὶ συναμφοτέρου τῆς ΕΔ, ΜΞ. καὶ ἐπεὶ ἔστιν, ὡς ἡ ΜΓ πρὸς ΓΕ, ἢ τε ΜΞ πρὸς ΕΔ καὶ ἡ ΜΟ πρὸς ΕΣ, ὡς ἄρα ἡ ΜΟ πρὸς ΕΣ, ἡ ΜΞ πρὸς ΔΕ. καὶ συνθέντι, ὡς συναμψότερος ἡ ΜΟ, ΣΕ πρὸς ΕΣ, οὕτως συναμψότερος ἡ ΜΞ, ΕΔ πρὸς ΕΔ· ἐναλλάξ, ὡς συναμψότερος ἡ ΜΟ, ΣΕ πρὸς συναμψότερον τὴν ΞΜ, ΕΔ ἢ ΣΕ πρὸς ΕΔ. ἀλλ' ὡς μὲν συναμψότερος ἡ ΜΟ, ΕΣ πρὸς συναμψότερον τὴν ΜΞ, ΔΕ, τὸ ὑπὸ συναμφοτέρου τῆς ΜΟ, ΕΣ καὶ τῆς ΕΜ πρὸς τὸ ὑπὸ συναμφοτέρου τῆς ΜΞ, ΕΔ καὶ τῆς ΕΜ, ὡς δὲ ἡ ΣΕ πρὸς ΕΔ, ἡ ΖΕ πρὸς ΕΗ, τουτέστιν ἡ ΛΜ πρὸς ΜΡ, τουτέστι τὸ ἀπὸ ΛΜ πρὸς τὸ ὑπὸ ΛΜΡ· ὡς ἄρα τὸ ὑπὸ συναμφοτέρου τῆς ΜΟ, ΕΣ καὶ τῆς ΜΞ πρὸς τὸ ὑπὸ συναμφοτέρου τῆς ΜΞ, ΕΔ καὶ τῆς ΕΜ, τὸ ἀπὸ ΛΜ πρὸς τὸ ὑπὸ ΛΜΡ. καὶ ἐναλλάξ, ὡς τὸ ὑπὸ συναμφοτέρου τῆς ΜΟ, ΕΣ καὶ τῆς ΜΞ πρὸς τὸ ἀπὸ ΜΛ, οὕτως τὸ ὑπὸ συναμφοτέρου τῆς ΜΞ, ΕΔ καὶ τῆς ΜΞ πρὸς τὸ ὑπὸ ΛΜΡ. ἴσον δὲ τὸ ὑπὸ ΛΜΡ τῷ ὑπὸ τῆς ΜΞ καὶ συναμφοτέρου τῆς ΜΞ, ΕΔ· ἴσον ἄρα καὶ τὸ ἀπὸ ΛΜ τῷ ὑπὸ ΕΜ καὶ συναμφοτέρου τῆς ΜΟ, ΕΣ. καὶ ἔστιν ἡ μὲν ΣΕ τῇ ΣΘ ἴση, ἡ δὲ ΣΘ τῇ ΟΠ· ἴσον ἄρα τὸ ἀπὸ ΛΜ τῷ ὑπὸ ΕΜΠ.

APOLLONIUS OF PERGA

But $MΞ$ is parallel to $ΔE$ and angle $ΛMP =$ angle $EMΞ$ (Eucl. i. 15] ;

therefore $ΛM \cdot MP = EM \cdot (EΔ + MΞ)$.

And since $MΓ : ΓE = MΞ : EΔ$,

and $MΓ : ΓE = MO : EΣ$,
[Eucl. vi. 4

therefore $MO : EΣ = MΞ : ΔE$.

Componendo, $MO + ΣE : EΣ = MΞ + EΔ : EΔ$;

and *permutando*

$$MO + ΣE : ΞM + EΔ = ΣE : EΔ.$$

But $MO + ΣE : ΞM + EΔ = (MO + EΣ) \cdot EM : (MΞ + EΔ) \cdot EM$,

and $ΣE : EΔ = ZE : EH$
 $= ΛM : MP$
[Eucl. vi. 4

$$= ΛM^2 : ΛM \cdot MP ;$$

therefore

$$(MO + EΣ) \cdot ME : (MΞ + EΔ) \cdot EM = ΛM^2 : ΛM \cdot MP.$$

And *permutando*

$$(MO + EΣ) \cdot ME : MΛ^2 = (MΞ + EΔ) \cdot ME : ΛM \cdot MP.$$

But $ΛM \cdot MP = ME \cdot (MΞ + EΔ)$;

therefore $ΛM^2 = EM \cdot (MO + EΣ)$.

And $ΣE = ΣΘ$, while $ΣΘ = OΠ$ [Eucl. i. 34] ;

therefore $ΛM^2 = EM \cdot MΠ$.

GREEK MATHEMATICS

(b) OTHER WORKS

(i.) *General*

Papp. *Coll.* vii. 3, ed. Hultsch 636. 18-23

Τῶν δὲ προειρημένων τοῦ Ἀναλυομένου βιβλίων ἡ τάξις ἐστὶν τοιαύτη· Εὐκλείδου Δεδομένων βιβλίον $\bar{\alpha}$, Ἀπολλωνίου Λόγου ἀποτομῆς $\bar{\beta}$, Χωρίου ἀποτομῆς $\bar{\beta}$, Διωρισμένης τομῆς δύο, Ἐπαφῶν δύο, Εὐκλείδου Πορισμάτων τρία, Ἀπολλωνίου Νεύσεων δύο, τοῦ αὐτοῦ Τόπων ἐπιπέδων δύο, Κωνικῶν $\bar{\eta}$.

(ii.) *On the Cutting-off of a Ratio*

Ibid. vii. 5-6, ed. Hultsch 640. 4-22

Τῆς δ' Ἀποτομῆς τοῦ λόγου βιβλίων ὄντων $\bar{\beta}$ πρότασις ἐστὶν μία ὑποδιηρημένη, διὸ καὶ μίαν πρότασιν οὕτως γράφω· διὰ τοῦ δοθέντος σημείου εὐθείαν γραμμὴν ἀγαγεῖν τέμνουσαν ἀπὸ τῶν τῆ θέσει δοθεισῶν δύο εὐθειῶν πρὸς τοῖς ἐπ' αὐτῶν δοθείσι σημείοις λόγον ἐχούσας τὸν αὐτὸν τῷ δοθέντι. τὰς δὲ γραφὰς διαφόρους γενέσθαι καὶ πλῆθος λαβεῖν συμβέβηκεν ὑποδιαίρέσεως γενομένης ἕνεκα τῆς τε πρὸς ἀλλήλας θέσεως τῶν διδομένων εὐθειῶν καὶ τῶν διαφόρων πτώσεων τοῦ διδομένου σημείου καὶ διὰ τὰς ἀναλύσεις καὶ συνθέσεις αὐτῶν τε καὶ τῶν διορισμῶν. ἔχει γὰρ τὸ μὲν πρῶτον βιβλίον τῶν Λόγου ἀποτομῆς

* Unhappily the only work by Apollonius which has survived, in addition to the *Conics*, is *On the Cutting-off of a*
336

APOLLONIUS OF PERGA

(b) OTHER WORKS

(i.) *General*

Pappus, *Collection* vii. 3, ed. Hultsch 636. 18-23

The order of the aforesaid books in the *Treasury of Analysis* is as follows: the one book of Euclid's *Data*, the two books of Apollonius's *On the Cutting-off of a Ratio*, his two books *On the Cutting-off of an Area*, his two books *On Determinate Section*, his two books *On Tangencies*, the three books of Euclid's *Porisms*, the two books of Apollonius's *On Vergings*, the two books of the same writer *On Plane Loci*, his eight books of *Conics*.^a

(ii.) *On the Cutting-off of a Ratio*

Ibid. vii. 5-6, ed. Hultsch 640. 4-22

In the two books *On the Cutting-off of a Ratio* there is one enunciation which is subdivided, for which reason I state one enunciation thus: *Through a given point to draw a straight line cutting off from two straight lines given in position intercepts, measured from two given points on them, which shall have a given ratio.* When the subdivision is made, this leads to many different figures according to the position of the given straight lines in relation one to another and according to the different cases of the given point, and owing to the analysis and the synthesis both of these cases and of the propositions determining the limits of possibility. The first book of those *On the Cutting-off of a Ratio*, and that only in Arabic. Halley published a Latin translation in 1706. But the contents of the other works are indicated fairly closely by Pappus's references.

GREEK MATHEMATICS

τόπους ξ , πτώσεις $\overline{\kappa\delta}$, διορισμούς δὲ $\bar{\epsilon}$, ὧν τρεῖς μὲν εἰσιν μέγιστοι, δύο δὲ ἐλάχιστοι. . . . τὸ δὲ δεύτερον βιβλίον Λόγου ἀποτομῆς ἔχει τόπους $\overline{\iota\delta}$, πτώσεις δὲ $\overline{\xi\gamma}$, διορισμούς δὲ τοὺς ἐκ τοῦ πρώτου ἀπάγεται γὰρ ὅλον εἰς τὸ πρῶτον.

(iii.) *On the Cutting-off of an Area*

Ibid. vii. 7, ed. Hultsch 640. 26-642. 5

Τῆς δ' Ἀποτομῆς τοῦ χωρίου βιβλία μὲν ἐστὶν δύο, πρόβλημα δὲ κὰν τούτοις ἐν ὑποδιαιρούμενον δῖς, καὶ τούτων μία πρότασις ἐστὶν τὰ μὲν ἄλλα ὁμοίως ἔχουσα τῇ προτέρα, μόνῳ δὲ τούτῳ διαφέρουσα τῷ δεῖν τὰς ἀποτεμνομένας δύο εὐθείας ἐν ἐκείνῃ μὲν λόγον ἔχούσας δοθέντα ποιεῖν, ἐν δὲ ταύτῃ χωρίον περιεχούσας δοθέν.

(iv.) *On Determinate Section*

Ibid. vii. 9, ed. Hultsch 642. 19-644. 16

Ἐξῆς τούτοις ἀναδέδονται τῆς Διωρισμένης τομῆς βιβλία β , ὧν ὁμοίως τοῖς πρότερον μίαν πρότασιν πάρεστιν λέγειν, διεζευγμένην δὲ ταύτην.

^a The Arabic text shows that Apollonius first discussed the cases in which the lines are parallel, then the cases in which the lines intersect but one of the given points is at the point of intersection ; in the second book he proceeds to the general case, but shows that it can be reduced to the case where one

APOLLONIUS OF PERGA

Ratio contains seven loci, twenty-four cases and five determinations of the limits of possibility, of which three are maxima and two are minima. . . . The second book *On the Cutting-off of a Ratio* contains fourteen loci, sixty-three cases and the same determinations of the limits of possibility as the first; for they are all reduced to those in the first book.^a

(iii.) *On the Cutting-off of an Area*

Ibid. vii. 7, ed. Hultsch 640. 26-642. 5

In the work *On the Cutting-off of an Area* there are two books, but in them there is only one problem, twice subdivided, and the one enunciation is similar in other respects to the preceding, differing only in this, that in the former work the intercepts on the two given lines were required to have a given ratio, in this to comprehend a given area.^b

(iv.) *On Determinate Section*

Ibid. vii. 9, ed. Hultsch 642. 19-644. 16

Next in order after these are published the two books *On Determinate Section*, of which, as in the previous cases, it is possible to state one comprehen-

of the given points is at the intersection of the two lines. By this means the problem is reduced to the application of a rectangle. In all cases Apollonius works by analysis and synthesis.

^b Halley attempted to restore this work in his edition of the *De sectione rationis*. As in that treatise, the general case can be reduced to the case where one of the given points is at the intersection of the two lines, and the problem is reduced to the application of a certain rectangle.

GREEK MATHEMATICS

τὴν δοθείσαν ἄπειρον εὐθείαν ἐνὶ σημείῳ τεμείν, ὥστε τῶν ἀπολαμβανομένων εὐθειῶν πρὸς τοῖς ἐπ' αὐτῆς δοθείσι σημείοις ἦτοι τὸ ἀπὸ μιᾶς τετράγωνον ἢ τὸ ὑπὸ δύο ἀπολαμβανομένων περιεχόμενον ὀρθογώνιον δοθέντα λόγον ἔχει ἦτοι πρὸς τὸ ἀπὸ μιᾶς τετράγωνον ἢ πρὸς τὸ ὑπὸ μιᾶς ἀπολαμβανομένης καὶ τῆς ἔξω δοθείσης ἢ πρὸς τὸ ὑπὸ δύο ἀπολαμβανομένων περιεχόμενον ὀρθογώνιον, ἐφ' ὁπότερα χρὴ τῶν δοθέντων σημείων. . . . ἔχει δὲ τὸ μὲν πρῶτον βιβλίον προβλήματα $\bar{\xi}$, ἐπιτάγματα $\bar{\iota\varsigma}$, διορισμοὺς $\bar{\epsilon}$, ὧν μεγίστους μὲν δ , ἐλάχιστον δὲ ἕνα. . . . τὸ δὲ δεύτερον Διωρισμένης τομῆς ἔχει προβλήματα $\bar{\gamma}$, ἐπιτάγματα $\bar{\theta}$, διορισμοὺς $\bar{\gamma}$.

(v.) *On Tangencies*

Ibid. vii. 11, ed. Hultsch 644. 23-646. 19

Ἐξῆς δὲ τούτοις τῶν Ἐπαφῶν ἐστὶν βιβλία δύο. προτάσεις δὲ ἐν αὐτοῖς δοκοῦσιν εἶναι πλείονες, ἀλλὰ καὶ τούτων μίαν τίθεμεν οὕτως ἔχουσιν ἐξῆς· σημείων καὶ εὐθειῶν καὶ κύκλων τριῶν ὁποῖωνοῦν θέσει δοθέντων κύκλον ἀγαγεῖν δι' ἐκάστου τῶν δοθέντων σημείων, εἰ δοθείη, ἢ ἐφαπτόμενον ἐκάστης τῶν δοθεισῶν γραμμῶν. ταύτης διὰ

^a As the Greeks never grasped the conception of one point being two *coincident* points, it was not possible to enunciate this problem so concisely as we can do: *Given four points A, B, C, D on a straight line, of which A may coincide with C and B with D, to find another point P on the same straight line such that AP · CP : BP · DP has a given value.* If $AP \cdot CP = \lambda \cdot BP \cdot DP$, where A, B, C, D, λ are given, the determination of P is equivalent to the solution of a quadratic equation, which the Greeks could achieve by means of the

APOLLONIUS OF PERGA

sive enunciation thus: *To cut a given infinite straight line in a point so that the intercepts between this point and given points on the line shall furnish a given ratio, the ratio being that of the square on one intercept, or the rectangle contained by two, towards the square on the remaining intercept, or the rectangle contained by the remaining intercept and a given independent straight line, or the rectangle contained by two remaining intercepts, whichever way the given points [are situated]. . . .* The first book contains six problems, sixteen subdivisions and five limits of possibility, of which four are maxima and one is a minimum. . . . The second book *On Determinate Section* contains three problems, nine subdivisions, and three limits of possibility.^a

(v.) *On Tangencies*

Ibid. vii. 11, ed. Hultsch 644, 23-646. 19

Next in order are the two books *On Tangencies*. Their enunciations are more numerous, but we may bring these also under one enunciation thus stated: *Given three entities, of which any one may be a point or a straight line or a circle, to draw a circle which shall pass through each of the given points, so far as it is points which are given, or to touch each of the given lines.*^b In

application of areas. But the fact that limits of possibility, and maxima and minima were discussed leads Heath (*H.G.M.* ii. 180-181) to conjecture that Apollonius investigated the series of point-pairs determined by the equation for different values of λ , and that "the treatise contained what amounts to a complete *Theory of Involution*." The importance of the work is shown by the large number of lemmas which Pappus collected.

^b The word "lines" here covers both the straight lines and the circles.

GREEK MATHEMATICS

πλήθη τῶν ἐν ταῖς ὑποθέσεσι δεδομένων ὁμοίων ἢ ἀνομοίων κατὰ μέρος διαφόρους προτάσεις ἀναγκαῖον γίνεσθαι δέκα· ἐκ τῶν τριῶν γὰρ ἀνομοίων γενῶν τριάδες διάφοροι ἄτακτοι γίνονται ἱ. ἦτοι γὰρ τὰ διδόμενα τρία σημεῖα ἢ τρεῖς εὐθεῖαι ἢ δύο σημεῖα καὶ εὐθεῖα ἢ δύο εὐθεῖαι καὶ σημείον ἢ δύο σημεῖα καὶ κύκλος ἢ δύο κύκλοι καὶ σημείον ἢ δύο εὐθεῖαι καὶ κύκλος ἢ δύο κύκλοι καὶ εὐθεῖα ἢ σημείον καὶ εὐθεῖα καὶ κύκλος ἢ τρεῖς κύκλοι. τούτων δύο μὲν τὰ πρῶτα δέδεικται ἐν τῷ δ' βιβλίῳ τῶν πρώτων Στοιχείων, διὸ παρίει μὴ γράφων· τὸ μὲν γὰρ τριῶν δοθέντων σημείων μὴ ἐπ' εὐθείας ὄντων τὸ αὐτὸ ἐστὶν τῷ περὶ τὸ δοθὲν τρίγωνον κύκλον περιγράψαι, τὸ δὲ γ̄ δοθεισῶν εὐθειῶν μὴ παραλλήλων οὐσῶν, ἀλλὰ τῶν τριῶν συμπιπτουσῶν, τὸ αὐτὸ ἐστὶν τῷ εἰς τὸ δοθὲν τρίγωνον κύκλον ἐγγράψαι· τὸ δὲ δύο παραλλήλων οὐσῶν καὶ μιᾶς ἐμπιπτούσης ὡς μέρος ὄν τῆς β' ὑποδιαίρέσεως προγράφεται ἐν τούτοις πάντων. καὶ τὰ ἐξῆς 5 ἐν τῷ πρώτῳ βιβλίῳ τὰ δὲ λειπόμενα δύο, τὸ δύο δοθεισῶν εὐθειῶν καὶ κύκλου ἢ τριῶν δοθέντων κύκλων μόνον ἐν τῷ δευτέρῳ βιβλίῳ διὰ τὰς πρὸς ἀλλήλους θέσεις τῶν κύκλων τε καὶ εὐθειῶν πλείονας οὔσας καὶ πλειόνων διορισμῶν δεομένας.

* Eucl. iv. 5 and 4.

† The last problem, to describe a circle touching three

APOLLONIUS OF PERGA

this problem, according to the number of like or unlike entities in the hypotheses, there are bound to be, when the problem is subdivided, ten enunciations. For the number of different ways in which three entities can be taken out of the three unlike sets is ten. For the given entities must be (1) three points or (2) three straight lines or (3) two points and a straight line or (4) two straight lines and a point or (5) two points and a circle or (6) two circles and a point or (7) two straight lines and a circle or (8) two circles and a straight line or (9) a point and a straight line and a circle or (10) three circles. Of these, the first two cases are proved in the fourth book of the first *Elements*,^a for which reason they will not be described; for to describe a circle through three points, not being in a straight line, is the same thing as to circumscribe a given triangle, and to describe a circle to touch three given straight lines, not being parallel but meeting each other, is the same thing as to inscribe a circle in a given triangle; the case where two of the lines are parallel and one meets them is a subdivision of the second problem but is here given first place. The next six problems in order are investigated in the first book, while the remaining two, the case of two given straight lines and a circle and the case of three circles, are the sole subjects of the second book on account of the manifold positions of the circles and straight lines with respect one to another and the need for numerous investigations of the limits of possibility.^b

given circles, has been investigated by many famous geometers, including Newton (*Arithmetica Universalis*, Prob. 47). The lemmas given by Pappus enable Heath (*H.G.M.* ii. 182-185) to restore Apollonius's solution—a "plane" solution depending only on the straight line and circle.

GREEK MATHEMATICS

(vi.) *On Plane Loci*

Ibid. vii. 23, ed. Hultsch 662. 19-664. 7

Οἱ μὲν οὖν ἀρχαῖοι εἰς τὴν τῶν ἐπιπέδων τούτων¹ τόπων τάξιν ἀποβλέποντες ἐστοιχείωσαν ἧς ἀμελήσαντες οἱ μετ' αὐτοὺς προσέθησαν ἑτέρους, ὡς οὐκ ἀπείρων τὸ πλῆθος ὄντων, εἰ θέλοι τις προσγράφειν οὐ τῆς τάξεως ἐκείνης ἐχόμενα. θήσω οὖν τὰ μὲν προσκείμενα ὕστερα, τὰ δ' ἐκ τῆς τάξεως πρότερα μᾶ περιλαβῶν προτάσει ταύτη·

Ἐὰν δύο εὐθεῖαι ἀχθῶσιν ἤτοι ἀπὸ ἐνὸς δεδομένου σημείου ἢ ἀπὸ δύο καὶ ἤτοι ἐπ' εὐθείας ἢ παράλληλοι ἢ δεδομένην περιέχουσαι γωνίαν καὶ ἤτοι λόγον ἔχουσαι πρὸς ἀλλήλας ἢ χωρίον περιέχουσαι δεδομένον, ἀπτηται δὲ τὸ τῆς μιᾶς πέρας ἐπιπέδου τόπου θέσει δεδομένου, ἄψεται καὶ τὸ τῆς ἑτέρας πέρας ἐπιπέδου τόπου θέσει δεδομένου ὅτε μὲν τοῦ ὁμογενοῦς, ὅτε δὲ τοῦ ἑτέρου, καὶ ὅτε μὲν ὁμοίως κειμένου πρὸς τὴν εὐθεῖαν, ὅτε δὲ ἐναντίως. ταῦτα δὲ γίνεται παρὰ τὰς διαφορὰς τῶν ὑποκειμένων.

(vii.) *On Vergings*

Ibid. vii. 27-28, ed. Hultsch 670. 4-672. 3

Νεύειν λέγεται γραμμὴ ἐπὶ σημείον, ἐὰν ἐπεκβαλλομένη ἐπ' αὐτὸ παραγίνηται [. . .]

¹ τούτων is attributed by Hultsch to dittography.

^a These words follow the passage (quoted *supra*, pp. 262-265) wherein Pappus divides loci into ἐφεκτικοί, διεξοδικοί and ἀναστροφικοί.

^b It is not clear what straight line is meant—probably the most obvious straight line in each figure.

APOLLONIUS OF PERGA

(vi.) *On Plane Loci*

Ibid. vii. 23, ed. Hultsch 662. 19-664. 7

The ancients had regard to the arrangement^a of these plane loci with a view to instruction in the elements; heedless of this consideration, their successors have added others, as though the number could not be infinitely increased if one were to make additions from outside that arrangement. Accordingly I shall set out the additions later, giving first those in the arrangement, and including them in this single enunciation:

If two straight lines be drawn, from one given point or from two, which are in a straight line or parallel or include a given angle, and either bear a given ratio one towards the other or contain a given rectangle, then, if the locus of the extremity of one of the lines be a plane locus given in position, the locus of the extremity of the other will also be a plane locus given in position, which will sometimes be of the same kind as the former, sometimes of a different kind, and will sometimes be similarly situated with respect to the straight line,^b sometimes contrariwise. These different cases arise according to the differences in the suppositions.^c

(vii.) *On Vergings*^d

Ibid. vii. 27-28, ed. Hultsch 670. 4-672. 3

A line is said to *verge* to a point if, when produced, it passes through the point. [. . .] The general

^a Pappus proceeds to give seven other enunciations from the first book and eight from the second book. These have enabled reconstructions of the work to be made by Fermat, van Schooten and Robert Simson.

^d Examples of vergings have already been encountered several times; *v.* pp. 186-189 and vol. i. p. 244 n. *a*.

GREEK MATHEMATICS

προβλήματος δὲ ὄντος καθολικοῦ τούτου· δύο δοθεισῶν γραμμῶν θέσει θεῖναι μεταξύ τούτων εὐθείαν τῷ μεγέθει δεδομένην νεύουσαν ἐπὶ δοθέν σημείον, ἐπὶ τούτου τῶν ἐπὶ μέρους διάφορα τὰ ὑποκείμενα ἔχόντων, ἃ μὲν ἦν ἐπίπεδα, ἃ δὲ στερεά, ἃ δὲ γραμμικά, τῶν δ' ἐπιπέδων ἀποκληρώσαντες τὰ πρὸς πολλὰ χρησιμώτερα ἔδειξαν τὰ προβλήματα ταῦτα·

Θέσει δεδομένων ἡμικυκλίου τε καὶ εὐθείας πρὸς ὀρθὰς τῇ βάσει ἢ δύο ἡμικυκλίων ἐπ' εὐθείας ἔχόντων τὰς βάσεις θεῖναι δοθεῖσαν τῷ μεγέθει εὐθείαν μεταξύ τῶν δύο γραμμῶν νεύουσαν ἐπὶ γωνίαν ἡμικυκλίου·

Καὶ ῥόμβου δοθέντος καὶ ἐπεκβεβλημένης μιᾶς πλευρᾶς ἀρμόσαι ὑπὸ τὴν ἐκτὸς γωνίαν δεδομένην τῷ μεγέθει εὐθείαν νεύουσαν ἐπὶ τὴν ἀντικρυς γωνίαν·

Καὶ θέσει δοθέντος κύκλου ἐναρμόσαι εὐθείαν μεγέθει δεδομένην νεύουσαν ἐπὶ δοθέν·

Τούτων δὲ ἐν μὲν τῷ πρώτῳ τεύχει δέδεικται τὸ ἐπὶ τοῦ ἐνὸς ἡμικυκλίου καὶ εὐθείας ἔχον πτώσεις δ καὶ τὸ ἐπὶ τοῦ κύκλου ἔχον πτώσεις δύο καὶ τὸ ἐπὶ τοῦ ῥόμβου πτώσεις ἔχον β, ἐν δὲ τῷ δευτέρῳ τεύχει τὸ ἐπὶ τῶν δύο ἡμικυκλίων τῆς ὑποθέσεως πτώσεις ἐχούσης ι, ἐν δὲ ταύταις ὑποδιαίρέσεις πλείονες διοριστικαὶ ἔνεκα τοῦ δεδομένου μεγέθους τῆς εὐθείας.

APOLLONIUS OF PERGA

problem is: *Two straight lines being given in position, to place between them a straight line of given length so as to verge to a given point.* When it is subdivided the subordinate problems are, according to differences in the suppositions, sometimes plane, sometimes solid, sometimes linear. Among the plane problems, a selection was made of those more generally useful, and these problems have been proved:

Given a semicircle and a straight line perpendicular to the base, or two semicircles with their bases in a straight line, to place a straight line of given length between the two lines and verging to an angle of the semicircle [or of one of the semicircles];

Given a rhombus with one side produced, to insert a straight line of given length in the external angle so that it verges to the opposite angle;

Given a circle, to insert a chord of given length verging to a given point.

Of these, there are proved in the first book four cases of the problem of one semicircle and a straight line, two cases of the circle, and two cases of the rhombus; in the second book there are proved ten cases of the problem in which two semicircles are assumed, and in these there are numerous subdivisions concerned with limits of possibility according to the given length of the straight line.^a

^a A restoration of Apollonius's work *On Vergings* has been attempted by several writers, most completely by Samuel Horsley (Oxford, 1770). A lemma by Pappus enables Apollonius's construction in the case of the rhombus to be restored with certainty; v. Heath, *H.G.M.* ii. 190-192.

GREEK MATHEMATICS

(viii.) *On the Dodecahedron and the Icosahedron*

Hypsiel. [Eucl. *Elem.* xiv.], Eucl. ed. Heiberg
v. 6. 19-8. 5

Ὁ αὐτὸς κύκλος περιλαμβάνει τὸ τε τοῦ δωδεκαέδρου πεντάγωνον καὶ τὸ τοῦ εἰκοσαέδρου τρίγωνον τῶν εἰς τὴν αὐτὴν σφαῖραν ἐγγραφομένων. τοῦτο δὲ γράφεται ὑπὸ μὲν Ἀρισταίου ἐν τῷ ἐπιγραφομένῳ Ἐπιπέδων ἔστι σχημάτων συγκρίσει, ὑπὸ δὲ Ἀπολλωνίου ἐν τῇ δευτέρᾳ ἐκδόσει τῆς Συγκρίσεως τοῦ δωδεκαέδρου πρὸς τὸ εἰκοσαέδρον, ὅτι ἐστίν, ὡς ἢ τοῦ δωδεκαέδρου ἐπιφάνεια πρὸς τὴν τοῦ εἰκοσαέδρου ἐπιφάνειαν, οὕτως καὶ αὐτὸ τὸ δωδεκαέδρον πρὸς τὸ εἰκοσαέδρον διὰ τὸ τὴν αὐτὴν εἶναι κάθετον ἀπὸ τοῦ κέντρου τῆς σφαίρας ἐπὶ τὸ τοῦ δωδεκαέδρου πεντάγωνον καὶ τὸ τοῦ εἰκοσαέδρου τρίγωνον.

(ix.) *Principles of Mathematics*

Marin. in *Eucl. Dat.*, Eucl. ed. Heiberg vi. 234. 13-17

Διὸ τῶν ἀπλούστερον¹ καὶ μιᾷ τινι διαφορᾷ περιγράφειν τὸ δεδομένον προθεμένων οἱ μὲν τεταγμένον, ὡς Ἀπολλώνιος ἐν τῇ Περὶ νεύσεων καὶ

¹ ἀπλούστερον Heiberg, ἀπλουστέρων cod.

APOLLONIUS OF PERGA

(viii.) *On the Dodecahedron and the Icosahedron*

Hypsicles [Euclid, *Elements* xiv.],^a Eucl. ed. Heiberg
v. 6. 19-8. 5

The pentagon of the dodecahedron and the triangle of the icosahedron ^b inscribed in the same sphere can be included in the same circle. For this is proved by Aristaeus in the work which he wrote *On the Comparison of the Five Figures*,^c and it is proved by Apollonius in the second edition of his work *On the Comparison of the Dodecahedron and the Icosahedron* that the surface of the dodecahedron bears to the surface of the icosahedron the same ratio as the volume of the dodecahedron bears to the volume of the icosahedron, by reason of there being a common perpendicular from the centre of the sphere to the pentagon of the dodecahedron and the triangle of the icosahedron.

(ix.) *Principles of Mathematics*

Marinus, *Commentary on Euclid's Data*, Eucl. ed.
Heiberg vi. 234. 13-17

Therefore, among those who made it their aim to define the datum more simply and with a single *differentia*, some called it the *assigned*, such as Apollonius in his book *On Vergings* and in his

^a The so-called fourteenth book of Euclid's *Elements* is really the work of Hypsicles, for whom *v. infra*, pp. 394-397.

^b For the regular solids *v. vol. i. pp. 216-225*. The face of the dodecahedron is a pentagon and the face of the icosahedron a triangle.

^c A proof is given by Hypsicles as Prop. 2 of his book. Whether the Aristaeus is the same person as the author of the *Solid Loci* is not known.

GREEK MATHEMATICS

ἐν τῇ Καθόλου πραγματείᾳ, οἱ δὲ γνώριμον, ὡς Διόδωρος.

(x.) *On the Cochlias*

Procl. in *Eucl. i.*, ed. Friedlein 105. 1-6

Τὴν περὶ τὸν κύλινδρον ἔλिका γραφομένην, ὅταν εὐθείας κινουμένης περὶ τὴν ἐπιφάνειαν τοῦ κυλίνδρου σημείον ὁμοταχῶς ἐπ' αὐτῆς κινῆται. γίνεται γὰρ ἔλιξ, ἧς ὁμοιομερῶς πάντα τὰ μέρη πᾶσιν ἐφαρμόζει, καθάπερ Ἀπολλώνιος ἐν τῷ Περὶ τοῦ κοχλίου γράμματι δείκνυσιν.

(xi.) *On Unordered Irrationals*

Procl. in *Eucl. i.*, ed. Friedlein 74. 23-24

Τὰ Περὶ τῶν ἀτάκτων ἀλόγων, ἃ ὁ Ἀπολλώνιος ἐπὶ πλέον ἐξεργάσατο.

Schol. i. in *Eucl. Elem. x.*, *Eucl. ed. Heiberg*
v. 414. 10-16

Ἐν μὲν οὖν τοῖς πρώτοις περὶ συμμετρων καὶ ἀσυμμετρων διαλαμβάνει πρὸς τὴν φύσιν αὐτῶν αὐτὰ ἐξετάζων, ἐν δὲ τοῖς ἐξῆς περὶ ῥητῶν καὶ ἀλόγων οὐ πασῶν· τινὲς γὰρ αὐτῷ ὡς ἐνιστάμενοι ἐγκαλοῦσιν· ἀλλὰ τῶν ἀπλουστάτων εἰδῶν, ὧν

* Heath (*H.G.M.* ii. 192-193) conjectures that this work must have dealt with the fundamental principles of mathematics, and to it he assigns various remarks on such subjects attributed to Apollonius by Proclus, and in particular his attempts to prove the axioms. The different ways in which entities are said to be given are stated in the definitions quoted from Euclid's *Data* in vol. i. pp. 478-479.

APOLLONIUS OF PERGA

General Treatise,^a others the *known*, such as Diodorus.^b

(x.) *On the Cochlias*

Proclus, *On Euclid* i., ed. Friedlein 105. 1-6

The cylindrical helix is described when a point moves uniformly along a straight line which itself moves round the surface of a cylinder. For in this way there is generated a helix which is *homoeomeric*, any part being such that it will coincide with any other part, as is shown by Apollonius in his work *On the Cochlias*.

(xi.) *On Unordered Irrationals*

Proclus, *On Euclid* i., ed. Friedlein 74. 23-24

The theory of *unordered irrationals*, which Apollonius fully investigated.

Euclid, *Elements* x., Scholium i.,^c ed. Heiberg
v. 414. 10-16

Therefore in the first [theorems of the tenth book] he treats of symmetrical and asymmetrical magnitudes, investigating them according to their nature, and in the succeeding theorems he deals with rational and irrational quantities, but not all, which is held up against him by certain detractors; for he dealt only with the simplest kinds, by the combination of which

^b Possibly Diodorus of Alexandria, for whom v. vol. i. p. 300 and p. 301 n. b.

^c In *Studien über Euklid*, p. 170, Heiberg conjectured that this scholium was extracted from Pappus's commentary, and he has established his conjecture in *Videnskabernes Selskabs Skrifter*, 6 Raekke, hist.-philos. Afd. ii. p. 236 seq. (1888).

GREEK MATHEMATICS

συντιθεμένων γίνονται ἄπειροι ἄλογοι, ὧν τινὰς καὶ ὁ Ἀπολλώνιος ἀναγράφει.

(xii.) *Measurement of a Circle*

Eutoc. *Comm. in Archim. Dim. Circ.*, Archim.
ed. Heiberg iii. 258. 16-22

Ἰστέον δέ, ὅτι καὶ Ἀπολλώνιος ὁ Περγαῖος ἐν τῷ Ὠκυτοκίῳ ἀπέδειξεν αὐτὸ δι' ἀριθμῶν ἐτέρων ἐπὶ τὸ σύνεγγυς μᾶλλον ἀγαγών. τοῦτο δὲ ἀκριβέστερον μὲν εἶναι δοκεῖ, οὐ χρήσιμον δὲ πρὸς τὸν Ἀρχιμήδους σκοπὸν· ἔφαμεν γὰρ αὐτὸν σκοπὸν ἔχειν ἐν τῷδε τῷ βιβλίῳ τὸ σύνεγγυς εὐρεῖν διὰ τὰς ἐν τῷ βίῳ χρείας.

(xiii.) *Continued Multiplications*

Papp. *Coll.* ii. 17-21, ed. Hultsch 18. 23-24. 20¹

Τούτου δὴ προτεθεωρημένου πρόδηλον, πῶς ἔστιν τὸν δοθέντα στίχον πολλαπλασιάσαι καὶ εἰπεῖν τὸν γενόμενον ἀριθμὸν ἐκ τοῦ τὸν πρῶτον ἀριθμὸν ὃν εἴληφε τὸ πρῶτον τῶν γραμμᾶτων ἐπὶ τὸν δεύτερον ἀριθμὸν ὃν εἴληφε τὸ δεύτερον τῶν γραμμᾶτων πολλαπλασιασθῆναι καὶ τὸν γενόμενον ἐπὶ τὸν τρίτον ἀριθμὸν ὃν εἴληφε τὸ τρίτον γράμμα

¹ The extensive interpolations are omitted.

^a Pappus's commentary on Eucl. *Elem.* x. was discovered in an Arabic translation by Woepcke (*Mémoires présentées par divers savans à l'Académie des sciences*, 1856, xiv.). It contains several references to Apollonius's work, of which one is thus translated by Woepcke (p. 693): "Enfin, Apollonius distingue les espèces des irrationnelles ordonnées, et

APOLLONIUS OF PERGA

an infinite number of irrationals are formed, of which latter Apollonius also describes some.^a

(xii.) *Measurement of a Circle*

Eutocius, *Commentary on Archimedes' Measurement of a Circle*, Archim. ed. Heiberg iii. 258. 16-22

It should be noticed, however, that Apollonius of Perga proved the same thing (*sc.* the ratio of the circumference of a circle to the diameter) in the *Quick-deliverer* by a different calculation leading to a closer approximation. This appears to be more accurate, but it is of no use for Archimedes' purpose; for we have stated that his purpose in this book was to find an approximation suitable for the everyday needs of life.^b

(xiii.) *Continued Multiplications* °

Pappus, *Collection* ii. 17-21, ed. Hultsch 18. 23-24. 20^d

This theorem having first been proved, it is clear how to multiply together a given verse and to tell the number which results when the number represented by the first letter is multiplied into the number represented by the second letter and the product is multiplied into the number represented by the third

découvert la science des quantités appelées (irrationnelles) inordonnées, dont il produisit un très-grand nombre par des méthodes exactes."

^b We do not know what the approximation was.

^c Heiberg (*Apollon. Perg.* ed. Heiberg ii. 124, n. 1) suggests that these calculations were contained in the *'Ωκυτόκιον*, but there is no definite evidence.

^d The passages, chiefly detailed calculations, adjudged by Hultsch to be interpolations are omitted.

GREEK MATHEMATICS

καὶ κατὰ τὸ ἐξῆς περαίνεσθαι μεχρὶ τοῦ διεξο-
δεύεσθαι τὸν στίχον, ὃν εἶπεν Ἀπολλώνιος ἐν
ἀρχῇ οὕτως·

Ἄρτέμιδος κλείτε κράτος ἕξοχον ἐννέα κούραι
(τὸ δὲ κλείτέ φησιν ἀντὶ τοῦ ὑπομνήσατε).

Ἐπεὶ οὖν γράμματά ἐστιν λη τοῦ στίχου, ταῦτα
δὲ περιέχει ἀριθμοὺς δέκα τοὺς $\bar{\rho} \bar{\tau} \bar{\sigma} \bar{\tau} \bar{\rho} \bar{\tau} \bar{\sigma} \bar{\chi} \bar{\upsilon} \bar{\rho}$,
ὧν ἕκαστος ἐλάσσων μὲν ἐστὶν χιλιάδος μετρεῖται
δὲ ὑπὸ ἑκατοντάδος, καὶ ἀριθμοὺς $\bar{\iota}\zeta$ τοὺς $\bar{\mu} \bar{\iota} \bar{\omicron} \bar{\kappa}$
 $\bar{\lambda} \bar{\iota} \bar{\kappa} \bar{\omicron} \bar{\xi} \bar{\omicron} \bar{\omicron} \bar{\nu} \bar{\nu} \bar{\nu} \bar{\kappa} \bar{\omicron} \bar{\iota}$, ὧν ἕκαστος ἐλάσσων μὲν
ἐστὶν ἑκατοντάδος μετρεῖται δὲ ὑπὸ δεκάδος, καὶ
τοὺς λοιποὺς $\bar{\iota}\alpha$ τοὺς $\bar{\alpha} \bar{\epsilon} \bar{\delta} \bar{\epsilon} \bar{\epsilon} \bar{\alpha} \bar{\epsilon} \bar{\epsilon} \bar{\epsilon} \bar{\alpha} \bar{\alpha}$, ὧν
ἕκαστος ἐλάσσων δεκάδος, εἰάν ἄρα τοῖς μὲν δέκα
ἀριθμοῖς ὑποτάξωμεν ἰσαριθμοὺς δέκα κατὰ τάξιν
ἑκατοντάδος, τοῖς δὲ $\bar{\iota}\zeta$ ὁμοίως ὑποτάξωμεν
δεκάδας $\bar{\iota}\zeta$, φανερὸν ἐκ τοῦ ἀνώτερου λογιστικοῦ
θεωρήματος ἰβ' ὅτι δέκα ἑκατοντάδες μετὰ τῶν
 $\bar{\iota}\zeta$ δεκάδων ποιοῦσι μυριάδας ἐνναπλᾶς δέκα.

Ἐπεὶ δὲ καὶ πυθμένες ὁμοῦ τῶν μετρούμενων
ἀριθμῶν ὑπὸ ἑκατοντάδος καὶ τῶν μετρούμενων
ὑπὸ δεκάδος εἰσὶν οἱ ὑποκείμενοι $\bar{\kappa}\zeta$

$$\begin{array}{c} \bar{\alpha} \bar{\gamma} \bar{\beta} \bar{\gamma} \bar{\alpha} \bar{\gamma} \bar{\beta} \bar{\zeta} \bar{\delta} \bar{\alpha} \\ \bar{\delta} \bar{\alpha} \bar{\zeta} \bar{\beta} \bar{\gamma} \bar{\alpha} \bar{\beta} \bar{\zeta} \bar{\zeta} \bar{\zeta} \bar{\epsilon} \bar{\epsilon} \bar{\epsilon} \bar{\beta} \bar{\zeta} \bar{\alpha}, \end{array}$$

* Apollonius, it is clear from Pappus, had a system of *tetrads* for calculations involving big numbers, the unit being the *myriad* or fourth power of 10. The tetrads are called *μυριάδες ἀπλαῖ*, *μυριάδες διπλαῖ*, *μυριάδες τριπλαῖ*, *simple myriads*, *double myriads*, *triple myriads* and so on, by which are meant 10000, 10000², 10000³ and so on. In the text of 354

APOLLONIUS OF PERGA

letter and so on in order until the end of the verse which Apollonius gave in the beginning, that is

Ἀρτέμιδος κλείτε κράτος ἕξοχον ἐννέα κούραι

(where he says κλείτε for ὑπομνήσατε, *recall to mind*).

Since there are thirty-eight letters in the verse, of which ten, namely $\bar{\rho} \bar{\tau} \bar{\sigma} \bar{\tau} \bar{\rho} \bar{\tau} \bar{\sigma} \bar{\chi} \bar{\upsilon} \bar{\rho}$ (= 100, 300, 200, 300, 100, 300, 200, 600, 400, 100), represent numbers less than 1000 and divisible by 100, and seventeen, namely $\bar{\mu} \bar{\iota} \bar{\omicron} \bar{\kappa} \bar{\lambda} \bar{\iota} \bar{\kappa} \bar{\omicron} \bar{\xi} \bar{\omicron} \bar{\omicron} \bar{\nu} \bar{\nu} \bar{\kappa} \bar{\omicron} \bar{\iota}$ (= 40, 10, 70, 20, 30, 10, 20, 70, 60, 70, 70, 50, 50, 50, 20, 70, 10), represent numbers less than 100 and divisible by 10, while the remaining eleven, namely, $\bar{\alpha} \bar{\epsilon} \bar{\delta} \bar{\epsilon} \bar{\epsilon} \bar{\alpha} \bar{\epsilon} \bar{\epsilon} \bar{\alpha} \bar{\alpha}$ (= 1, 5, 4, 5, 5, 1, 5, 5, 5, 1, 1), represent numbers less than 10, then if for those ten numbers we substitute an equal number of hundreds, and if for the seventeen numbers we similarly substitute seventeen tens, it is clear from the above arithmetical theorem, the twelfth, that the ten hundreds together with the seventeen tens make $10 \cdot 10000^9$.^a

And since the bases of the numbers divisible by 100 and those divisible by 10 are the following twenty-seven

1, 3, 2, 3, 1, 3, 2, 6, 4, 1
4, 1, 7, 2, 3, 1, 2, 7, 6, 7, 7, 5, 5, 5, 2, 7, 1,

Pappus they are sometimes abbreviated to μ^α , μ^β , μ^γ and so on.

From Pappus, though the text is defective, Apollonius's procedure in multiplying together powers of 10 can be seen to be equivalent to adding the indices of the separate powers of 10, and then dividing by 4 to obtain the power of the myriad which the product contains. If the division is exact, the number is the n -myriad, say, meaning 10000^n . If there is a remainder, 3, 2 or 1, the number is 1000, 100 or 10 times the n -myriad as the case may be.

GREEK MATHEMATICS

ἀλλὰ καὶ τῶν ἐλασσόνων δεκάδος εἰσὶν $\bar{\iota}\alpha$, τουτέστιν ἀριθμοὶ οἱ

$$\bar{\alpha} \bar{\epsilon} \bar{\delta} \bar{\epsilon} \bar{\epsilon} \bar{\alpha} \bar{\epsilon} \bar{\epsilon} \bar{\epsilon} \bar{\alpha} \bar{\alpha},$$

ἐὰν τὸν ἐκ τούτων τῶν $\bar{\iota}\alpha$ καὶ τὸν ἐκ τῶν $\bar{\kappa}\zeta$ πυθμένων στερεὸν δι' ἀλλήλων πολλαπλασιάσωμεν, ἔσται ὁ στερεὸς μυριάδων τετραπλῶν $\bar{\iota}\theta$ καὶ τριπλῶν $\bar{\varsigma}\lambda\varsigma$ καὶ διπλῶν $\bar{\eta}\upsilon\pi$.

Αὗται δὴ συμπολλαπλασιαζόμεναι ἐπὶ τὸν ἐκ τῶν ἑκατοντάδων καὶ δεκάδων στερεόν, τουτέστι τὰς προκειμένας μυριάδας ἐνναπλᾶς δέκα, ποιούσιν μυριάδας τρισκαιδεκαπλᾶς $\bar{\rho}\varsigma\varsigma$, δωδεκαπλᾶς $\bar{\tau}\xi\eta$, ἐνδεκαπλᾶς $\bar{\delta}\omega$.

(xiv.) *On the Burning Mirror*

Fragmentum mathematicum Bobiense 113. 28-33, ed.
Belger, *Hermes*, xvi., 1881, 279-280 ¹

Οἱ μὲν οὖν παλαιοὶ ὑπέλαβον τὴν ἕξαψιν ποιεῖσθαι περὶ τὸ κέντρον τοῦ κατόπτρου, τοῦτο δὲ ψεῦδος Ἀπολλώνιος μάλα δεόντως . . . (ἐν τῷ) πρὸς τοὺς κατοπτρικοὺς ἔδειξεν, καὶ περὶ τίνα δὲ τόπον ἢ ἐκπύρωσις ἔσται, διασεσάφηκεν ἐν τῷ Περὶ τοῦ πυρίου.

¹ As amended by Heiberg, *Zeitschrift für Mathematik und Physik*, xxviii., 1883, hist. Abth. 124-125.

APOLLONIUS OF PERGA

while there are eleven less than ten, that is the numbers

1, 5, 4, 5, 5, 1, 5, 5, 5, 1, 1,

if we multiply together the solid number formed by these eleven with the solid number formed by the twenty-seven the result will be the solid number

$$19 \cdot 10000^4 + 6036 \cdot 10000^3 + 8480 \cdot 10000^2.$$

When these numbers are multiplied into the solid number formed by the hundreds and the tens, that is with $10 \cdot 10000^9$ as calculated above, the result is

$$196 \cdot 10000^{13} + 368 \cdot 10000^{12} + 4800 \cdot 10000^{11}.$$

(xiv.) *On the Burning Mirror*

Fragmentum mathematicum Bobiense 113. 28-33,^a ed.
Belger, *Hermes*, xvi., 1881, 279-280

The older geometers thought that the burning took place at the centre of the mirror, but Apollonius very suitably showed this to be false . . . in his work on mirrors, and he explained clearly where the kindling takes place in his works *On the Burning Mirror*.^b

^a This fragment is attributed to Anthemius by Heiberg, but its antiquated terminology leads Heath (*H.G.M.* ii. 194) to suppose that it is much earlier.

^b Of Apollonius's other achievements, his solution of the problem of finding two mean proportionals has already been mentioned (vol. i. p. 267 n. b) and sufficiently indicated; for his astronomical work the reader is referred to Heath, *H.G.M.* ii. 195-196.

XX. LATER DEVELOPMENTS IN
GEOMETRY

XX. LATER DEVELOPMENTS IN GEOMETRY

(a) CLASSIFICATION OF CURVES

Procl. in *Eucl.* i., ed. Friedlein 111. 1-112. 11

Διαιρεῖ δ' αὖ τὴν γραμμὴν ὁ Γέμιμος¹ πρῶτον μὲν εἰς τὴν ἀσύνθετον καὶ τὴν σύνθετον—καλεῖ δὲ σύνθετον τὴν κεκλασμένην καὶ γωνίαν ποιούσαν—ἔπειτα τὴν ἀσύνθετον² εἰς τε τὴν σχηματοποιούσαν καὶ τὴν ἐπ' ἄπειρον ἐκβαλλομένην, σχῆμα λέγων ποιεῖν τὴν κυκλικήν, τὴν τοῦ θυρεοῦ, τὴν κιττοειδῆ, μὴ ποιεῖν δὲ τὴν τοῦ ὀρθογωνίου κώνου τομήν, τὴν τοῦ ἀμβλυγωνίου, τὴν κογχοειδῆ, τὴν εὐθείαν, πάσας τὰς τοιαύτας. καὶ πάλιν κατ' ἄλλον τρόπον τῆς ἀσυνθέτου γραμμῆς τὴν μὲν ἀπλὴν εἶναι, τὴν δὲ μικτὴν, καὶ τῆς ἀπλῆς τὴν μὲν σχῆμα ποιεῖν ὡς τὴν κυκλικήν, τὴν δὲ ἀόριστον εἶναι ὡς τὴν εὐθείαν, τῆς δὲ μικτῆς τὴν μὲν ἐν τοῖς ἐπιπέδοις εἶναι, τὴν δὲ ἐν τοῖς στερεοῖς, καὶ τῆς ἐν ἐπιπέδοις τὴν μὲν ἐν αὐτῇ συμπίπτειν ὡς τὴν κιττοειδῆ, τὴν δ' ἐπ' ἄπειρον ἐκβάλλεσθαι, τῆς δὲ ἐν στερεοῖς

¹ Γέμιμος Tittel, Γεμίμος Friedlein.

² σύνθετον codd., correxi.

* No great new developments in geometry were made by the Greeks after the death of Apollonius, probably through

360

XX. LATER DEVELOPMENTS IN GEOMETRY ^a

(a) CLASSIFICATION OF CURVES

Proclus, *On Euclid* i., ed. Friedlein 111. 1-112. 11

GEMINUS first divides lines into the *incomposite* and the *composite*, meaning by composite the broken line forming an angle; and then he divides the *incomposite* into those *forming a figure* and those *extending without limit*, including among those forming a figure the circle, the ellipse and the cissoid, and among those not forming a figure the parabola, the hyperbola, the conchoid, the straight line, and all such lines. Again, in another manner he says that some *incomposite* lines are *simple*, others *mixed*, and among the *simple* are some *forming a figure*, such as the circle, and others *indeterminate*, such as the straight line, while the *mixed* include both *lines on planes* and *lines on solids*, and among the lines on planes are lines *meeting themselves*, such as the cissoid, and others *extending without limit*, and among lines on solids are

the limits imposed by their methods, and the recorded additions to the corpus of Greek mathematics may be described as reflections upon existing work or "stock-taking." On the basis of geometry, however, the new sciences of trigonometry and mensuration were founded, as will be described, and the revival of geometry by Pappus will also be reserved for separate treatment.

GREEK MATHEMATICS

τὴν μὲν κατὰ τὰς τομὰς ἐπινοεῖσθαι τῶν στερεῶν, τὴν δὲ περὶ τὰ στερεὰ ὑφίστασθαι. τὴν μὲν γὰρ ἔλικα τὴν περὶ σφαῖραν ἢ κῶνον περὶ τὰ στερεὰ ὑφειστάσθαι, τὰς δὲ κωνικὰς τομὰς ἢ τὰς σπειρικὰς ἀπὸ τοιαύδε τομῆς γεννᾶσθαι τῶν στερεῶν. ἐπινοηθῆσθαι δὲ ταύτας τὰς τομὰς τὰς μὲν ὑπὸ Μεναιχμοῦ τὰς κωνικὰς, ὁ καὶ Ἐρατοσθένους ἱστορῶν λέγει· “μὴ δὲ Μεναιχιμίουσ κωνοτομεῖν τριάδας”· τὰς δὲ ὑπὸ Περσέως, ὅς καὶ τὸ ἐπίγραμμα ἐποίησεν ἐπὶ τῇ εὐρέσει—

Τρεῖς γραμμὰς ἐπὶ πέντε τομαῖς εὐρῶν ἐλικώδεις¹
Περσεὺς τῶν δ' ἔνεκεν δαίμονας ἰλάσατο.

αἱ μὲν δὴ τρεῖς τομαὶ τῶν κῶνων εἰσὶν παραβολὴ καὶ ὑπερβολὴ καὶ ἔλλειψις, τῶν δὲ σπειρικῶν τομῶν ἡ μὲν ἐστὶν ἐμπεπλεγμένη, εἰκυῖα τῇ τοῦ ἵππου πέδη, ἡ δὲ κατὰ τὰ μέσα πλατύνεται, ἐξ ἑκατέρου δὲ ἀπολήγει μέρους, ἡ δὲ παραμήκης οὐσα τῷ μὲν μέσῳ διαστήματι ἐλάττονι χρῆται, εὐρύνεται δὲ ἐφ' ἑκάτερα. τῶν δὲ ἄλλων μίξεων τὸ πλήθος ἀπεραντόν ἐστιν· καὶ γὰρ στερεῶν σχημάτων πλήθος ἐστὶν ἄπειρον καὶ τομαὶ αὐτῶν συνίστανται πολυειδεῖς.

Ibid., ed. Friedlein 356. 8-12

Καὶ γὰρ Ἀπολλώνιος ἐφ' ἑκάστης τῶν κωνικῶν γραμμῶν τί τὸ σύμπτωμα δείκνυσι, καὶ ὁ Νικομήδης ἐπὶ τῶν κογχοειδῶν, καὶ ὁ Ἰππίας ἐπὶ

¹ ἐλικώδεις Knoche, εὐρῶν τὰς σπειρικὰς λέγων codd.

^a v. vol. i. pp. 296-297.

^b For Perseus, v. p. 364 n. a and p. 365 n. b.

LATER DEVELOPMENTS IN GEOMETRY

lines conceived as *formed by sections* of the solids and lines *formed round the solids*. The helix round the sphere or cone is an example of the lines formed round solids, and the conic sections or the spiric curves are generated by various sections of solids. Of these sections, the conic sections were discovered by Menaechmus, and Eratosthenes in his account says: "Cut not the cone in the triads of Menaechmus"^a; and the others were discovered by Perseus,^b who wrote an epigram on the discovery—

Three spiric lines upon five sections finding,
Perseus thanked the gods therefor.

Now the three conic sections are the parabola, the hyperbola and the ellipse, while of the spiric sections one is *interlaced*, resembling the horse-fetter, another is widened out in the middle and contracts on each side, a third is elongated and is narrower in the middle, broadening out on either side. The number of the other mixed lines is unlimited; for the number of solid figures is infinite and there are many different kinds of section of them.

Ibid., ed. Friedlein 356. 8-12

For Apollonius shows for each of the conic curves what is its property, as does Nicomedes for the

GREEK MATHEMATICS

τῶν τετραγωνιζουσῶν, καὶ ὁ Περσεὺς ἐπὶ τῶν σπειρικῶν.

Ibid., ed. Friedlein 119. 8-17

“Ὁ δὲ συμβαίνειν φασὲν κατὰ τὴν σπειρικὴν ἐπιφάνειαν· κατὰ γὰρ κύκλου νοεῖται στροφὴν ὀρθοῦ διαμένοντος καὶ στρεφομένου περὶ τὸ αὐτὸ σημεῖον, ὃ μὴ ἐστὶ κέντρον τοῦ κύκλου, διὸ καὶ τριχῶς ἡ σπείρα γίνεται, ἥ γὰρ ἐπὶ τῆς περιφερείας ἐστὶ τὸ κέντρον ἢ ἐντὸς ἢ ἐκτός. καὶ εἰ μὲν ἐπὶ τῆς περιφερείας ἐστὶ τὸ κέντρον, γίνεται σπείρα συνεχῆς, εἰ δὲ ἐντὸς, ἡ ἐμπεπλεγμένη, εἰ δὲ ἐκτός, ἡ διεχῆς. καὶ τρεῖς αἱ σπειρικαὶ τομαὶ κατὰ τὰς τρεῖς ταύτας διαφοράς.

^a Obviously the work of Perseus was on a substantial scale to be associated with these names, but nothing is known of him beyond these two references. He presumably flourished after Euclid (since the conic sections were probably well developed before the spiric sections were tackled) and before Geminus (since Proclus relies on Geminus for his knowledge of the spiric curves). He may therefore be placed between 300 and 75 B.C.

Nicomedes appears to have flourished between Eratosthenes and Apollonius. He is known only as the inventor of the conchoid, which has already been fully described (vol. i. pp. 298-309).

It is convenient to recall here that about a century later flourished Diocles, whose discovery of the cissoid has already been sufficiently noted (vol. i. pp. 270-279). He has also been referred to as the author of a brilliant solution of the problem of dividing a cone in a given ratio, which is equivalent to the solution of a cubic equation (*supra*, p. 162 n. a). The Dionysodorus who solved the same problem (*ibid.*) may have been the Dionysodorus of Caunus mentioned in the Herculaneum Roll, No. 1044 (so W. Schmidt in *Bibliotheca mathematica*, iv. pp. 321-325), a younger contemporary of Apollonius; he is presumably the same person as the

LATER DEVELOPMENTS IN GEOMETRY

conchoid and Hippias for the quadratics and Perseus for the spiric curves.^a

Ibid., ed. Friedlein 119. 8-17

We say that this is the case with the spiric surface ; for it is conceived as generated by the revolution of a circle remaining perpendicular [to a given plane] and turning about a fixed point which is not its centre. Hence there are three forms of spire according as the centre is on the circumference, or within it, or without. If the centre is on the circumference, the spire generated is said to be *continuous*, if within *interlaced*, and if without *open*. And there are three spiric sections according to these three differences.^b

Dionysodorus mentioned by Heron, *Metrica* ii. 13 (cited *infra*, p. 481), as the author of a book *On the Spire*.

^b This last sentence is believed to be a slip, perhaps due to too hurried transcription from Geminus. At any rate, no satisfactory meaning can be obtained from the sentence as it stands. Tannery (*Mémoires scientifiques* ii. pp. 24-28) interprets Perseus' epigram as meaning "three curves in addition to five sections." He explains the passages thus: Let a be the radius of the generating circle, c the distance of the centre of the generating circle from the axis of revolution, d the perpendicular distance of the plane of section (assumed to be parallel to the axis of revolution) from the axis of revolution. Then in the *open* spire, in which $c > a$, there are five different cases:

(1) $c + a > d > c$. The curve is an oval.

(2) $d = c$. Transition to (3).

(3) $c > d > c - a$. The curve is a closed curve narrowest in the middle.

(4) $d = c - a$. The curve is the *hippopede* (horse-fetter), which is shaped like the figure of 8 (*v. vol. i. pp. 414-415* for the use of this curve by Eudoxus).

(5) $c - a > d > 0$. The section consists of two symmetrical ovals.

Tannery identifies the "five sections" of Perseus with these five types of section of the open spire ; the three curves

GREEK MATHEMATICS

(b) ATTEMPTS TO PROVE THE PARALLEL POSTULATE

(i.) General

Procl. in *Eucl.* i., ed. Friedlein 191. 16-193. 9

“Καὶ ἐὰν εἰς δύο εὐθείας εὐθεία ἐμπίπτουσα τὰς ἐντὸς καὶ ἐπὶ τὰ αὐτὰ μέρη γωνίας δύο ὀρθῶν ἐλάττονας ποιῇ, ἐκβαλλομένας τὰς εὐθείας ἐπ’ ἄπειρον συμπίπτειν, ἐφ’ ἃ μέρη εἰσὶν αἱ τῶν δύο ὀρθῶν ἐλάττονας.”

Τοῦτο καὶ παντελῶς διαγράφειν χρή τῶν αἰτημάτων· θεώρημα γάρ ἐστι, πολλὰς μὲν ἀπορίας ἐπιδεχόμενον, ἃς καὶ ὁ Πτολεμαῖος ἐν τινι βιβλίῳ διαλύσαι προύθετο, πολλῶν δὲ εἰς ἀπόδειξιν δεόμενον καὶ ὄρων καὶ θεωρημάτων. καὶ τό γε ἀντιστρέφον καὶ ὁ Ευκλείδης ὡς θεώρημα δείκνυσιν. ἴσως δὲ ἂν τινες ἀπατώμενοι καὶ τοῦτο τάττειν ἐν τοῖς αἰτήμασιν ἀξιώσειαν, ὡς διὰ τὴν ἐλάττωσιν τῶν δύο ὀρθῶν αὐτόθεν τὴν πίστιν παρεχόμενον

described by Proclus are (1), (3) and (4). When the spire is *continuous* or closed, $c=a$ and there are only three sections corresponding to (1), (2) and (3); (4) and (5) reduce to two equal circles touching one another. But the *interlaced* spire, in which $c < a$, gives three new types of section, and in these Tannery sees his “three curves in addition to five sections.” There are difficulties in the way of accepting this interpretation, but no better has been proposed.

Further passages on the spire by Heron, including a formula for its volume, are given *infra*, pp. 476-483.

* *Eucl.* i. Post. 5, for which *v. vol.* i. pp. 442-443, especially *n. c.*

Aristotle (*Anal. Prior.* ii. 16, 65 a 4) alludes to a *petitio principii* current in his day among those who “think they establish the theory of parallels”—τὰς παραλλήλους γράφειν. As Heath notes (*The Thirteen Books of Euclid's Elements*,

LATER DEVELOPMENTS IN GEOMETRY

(b) ATTEMPTS TO PROVE THE PARALLEL POSTULATE

(i.) *General*

Proclus, *On Euclid* i., ed. Friedlein 191. 16-193. 9

"If a straight line falling on two straight lines make the interior angles on the same side less than two right angles, the two straight lines, if produced indefinitely, meet on that side on which are the angles less than two right angles." ^a

This ought to be struck right out of the Postulates; for it is a theorem, and one involving many difficulties, which Ptolemy set himself to resolve in one of his books, and for its proof it needs a number of definitions as well as theorems. Euclid actually proves its converse as a theorem. Possibly some would erroneously consider it right to place this assumption among the Postulates, arguing that, as the angles are less than two right angles, there is

vol. i. pp. 191-192), Philoponus's comment on this passage suggests that the *petitio principii* lay in a *direction* theory of parallels. Euclid appears to have admitted the validity of the criticism and, by *assuming* his famous postulate once and for all, to have countered any logical objections.

Nevertheless, as the extracts here given will show, ancient geometers were not prepared to accept the undemonstrable character of the postulate. Attempts to prove it continued to be made until recent times, and are summarized by R. Bonola, "Sulla teoria delle parallele e sulle geometrie non-euclidee" in *Questioni riguardanti la geometria elementare*, and by Heath, *loc. cit.*, pp. 204-219. The chapter on the subject in W. Rouse Ball's *Mathematical Essays and Recreations*, pp. 307-326, may also be read with profit. Attempts to prove the postulate were abandoned only when it was shown that, by not conceding it, alternative geometries could be built.

τῆς τῶν εὐθειῶν συνεύσεως καὶ συμπτώσεως. πρὸς οὓς ὁ Γεμῖνος ὀρθῶς ἀπήντησε λέγων ὅτι παρ' αὐτῶν ἐμάθομεν τῶν τῆς ἐπιστήμης ταύτης ἡγεμόνων μὴ πάνυ προσέχειν τὸν νοῦν ταῖς πιθαναῖς φαντασίαις εἰς τὴν τῶν λόγων τῶν ἐν γεωμετρίᾳ παραδοχὴν. ὅμοιον γὰρ φησι καὶ Ἀριστοτέλης ῥητορικὸν ἀποδείξεις ἀπαιτεῖν καὶ γεωμέτρου πιθανολογοῦντος ἀνέχεσθαι, καὶ ὁ παρὰ τῷ Πλάτῳ Συμμίας, ὅτι " τοῖς ἐκ τῶν εἰκότων τὰς ἀποδείξεις ποιουμένοις σύννοια οὖσιν ἀλαζόσι." κἀνταῦθα τοίνυν τὸ μὲν ἡλαττωμένων τῶν ὀρθῶν συνεύειν τὰς εὐθείας ἀληθές καὶ ἀναγκαῖον, τὸ δὲ συνενούσας ἐπὶ πλέον ἐν τῷ ἐκβάλλεσθαι συμπεσεῖσθαι ποτε πιθανόν, ἀλλ' οὐκ ἀναγκαῖον, εἰ μὴ τις ἀποδείξειεν λόγος, ὅτι ἐπὶ τῶν εὐθειῶν τοῦτο ἀληθές. τὸ γὰρ εἶναί τινας γραμμὰς συνιούσας μὲν ἐπ' ἄπειρον, ἀσυμπτώτους δὲ ὑπαρχούσας, καίτοι δοκοῦν ἀπίθανον εἶναι καὶ παράδοξον, ὅμως ἀληθές ἐστι καὶ πεφώραται ἐπ' ἄλλων εἰδῶν τῆς γραμμῆς. μήποτε οὖν τοῦτο καὶ ἐπὶ τῶν εὐθειῶν δυνατόν, ὅπερ ἐπ' ἐκείνων τῶν γραμμῶν; ἕως γὰρ ἂν δι' ἀποδείξεως αὐτὸ καταδησώμεθα, περισπᾶ τὴν φαντασίαν τὰ ἐπ' ἄλλων δεικνύμενα γραμμῶν. εἰ δὲ καὶ οἱ διαμφισβητοῦντες λόγοι πρὸς τὴν σύμπτωσιν πολὺ τὸ πληκτικὸν ἔχοιεν, πῶς οὐχὶ πολλῶ πλέον ἂν τὸ πιθανόν τοῦτο καὶ τὸ ἄλογον ἐκβάλλοιμεν τῆς ἡμετέρας παραδοχῆς;

Ἄλλ' ὅτι μὲν ἀπόδειξιν χρῆ ζητεῖν τοῦ προκειμένου θεωρήματος δῆλον ἐκ τούτων, καὶ ὅτι

* For Geminus, v. *infra*, p. 370 n. c.

LATER DEVELOPMENTS IN GEOMETRY

immediate reason for believing that the straight lines converge and meet. To such, Geminus ^a rightly rejoined that we have learnt from the pioneers of this science not to incline our mind to mere plausible imaginings when it is a question of the arguments to be used in geometry. For Aristotle ^b says it is as reasonable to demand scientific proof from a rhetorician as to accept mere plausibilities from a geometer, and Simmias is made to say by Plato ^c that he "recognizes as quacks those who base their proofs on probabilities." In this case the convergence of the straight lines by reason of the lessening of the right angles is true and necessary, but the statement that, since they converge more and more as they are produced, they will some time meet is plausible but not necessary, unless some argument is produced to show that this is true in the case of straight lines. For the fact that there are certain lines which converge indefinitely but remain non-secant, although it seems improbable and paradoxical, is nevertheless true and well-established in the case of other species of lines. May not this same thing be possible in the case of straight lines as happens in the case of those other lines? For until it is established by rigid proof, the facts shown in the case of other lines may turn our minds the other way. And though the controversial arguments against the meeting of the two lines should contain much that is surprising, is that not all the more reason for expelling this merely plausible and irrational assumption from our accepted teaching?

It is clear that a proof of the theorem in question must be sought, and that it is alien to the special

^b *Eth. Nic.* i. 3. 4, 1094 b 25-27.

^c *Phaedo* 92 D.

τῆς τῶν αἰτημάτων ἐστὶν ἀλλότριον ιδιότητος, πῶς δὲ ἀποδεικτέον αὐτὸ καὶ διὰ ποίων λόγων ἀναιρετέον τὰς πρὸς αὐτὸ φερομένας ἐνστάσεις, τηνικαῦτα λεκτέον, ἥνίκα ἂν καὶ ὁ στοιχειωτῆς αὐτοῦ μέλλῃ ποιείσθαι μνήμην ὡς ἐναργεῖ προσχρώμενος. τότε γὰρ ἀναγκαῖον αὐτοῦ δεῖξαι τὴν ἐνάργειαν οὐκ ἀναποδείκτως προφαινομένην ἀλλὰ δι' ἀποδείξεων γνώριμον γιγνομένην.

(ii.) *Posidonius and Geminus*

Ibid., ed. Friedlein 176. 5-10

Καὶ ὁ μὲν Εὐκλείδης τοῦτον ὀρίζειται τὸν τρόπον τὰς παραλλήλους εὐθείας, ὁ δὲ Ποσειδώνιος, παράλληλοι, φησὶν, εἰσὶν αἱ μῆτε συνεύουσαι μῆτε ἀπονεύουσαι ἐν ἐνὶ ἐπιπέδῳ, ἀλλ' ἴσας ἔχουσαι

^a *i.e.*, Eucl. i. 28.

^b Posidonius was a Stoic and the teacher of Cicero; he was born at Apamea and taught at Rhodes, flourishing 151-135 B.C. He contributed a number of definitions to elementary geometry, as we know from Proclus, but is more famous for a geographical work *On the Ocean* (lost but copiously quoted by Strabo) and for an astronomical work *Περὶ μετεώρων*. In this he estimated the circumference of the earth (*v. supra*, p. 267) and he also wrote a separate work on the size of the sun.

^c As with so many of the great mathematicians of antiquity, we know practically nothing about Geminus's life, not even his date, birthplace or the correct spelling of his name. As he wrote a commentary on Posidonius's *Περὶ μετεώρων*, we have an upper limit for his date, and "the view most generally accepted is that he was a Stoic philosopher, born probably in the island of Rhodes, and a pupil of Posidonius, and that he wrote about 73-67 B.C." (Heath, *H.G.M.* ii. 223). Further details may be found in Manitius's edition of the so-called *Gemini elementa astronomiae*.

Geminus wrote an encyclopaedic work on mathematics

LATER DEVELOPMENTS IN GEOMETRY

character of the Postulates. But how it should be proved, and by what sort of arguments the objections made against it may be removed, must be stated at the point where the writer of the *Elements* is about to recall it and to use it as obvious.^a Then it will be necessary to prove that its obvious character does not appear independently of proof, but by proof is made a matter of knowledge.

(ii.) *Posidonius*^b and *Geminus*^c

Ibid., ed. Friedlein 176. 5-10

Such is the manner in which Euclid defines parallel straight lines, but Posidonius says that parallels are lines in one plane which neither converge nor diverge

which is referred to by ancient writers under various names, but that used by Eutocius (Τῶν μαθημάτων θεωρία, v. *supra*, pp. 280-281) was most probably the actual title. It is unfortunately no longer extant, but frequent references are made to it by Proclus, and long extracts are preserved in an Arabic commentary by an-Nairizi.

It is from this commentary that Geminus is known to have attempted to prove the parallel-postulate by a definition of parallels similar to that of Posidonius. The method is reproduced in Heath, *H.G.M.* ii. 228-230. It tacitly assumes "Playfair's axiom," that through a given point only one parallel can be drawn to a given straight line; this axiom—which was explicitly stated by Proclus in his commentary on Eucl. i. 30 (Procl. in *Eucl.* i., ed. Friedlein 374. 18-375. 3)—is, in fact, equivalent to Euclid's Postulate 5. Saccheri noted an even more fundamental objection, that, before Geminus's definition of parallels can be used, it has to be proved that the locus of points equidistant from a straight line is a straight line; and this cannot be done without some equivalent postulate. Nevertheless, Geminus deserves to be held in honour as the author of the first known attempt to prove the parallel-postulate, a worthy predecessor to Lobachewsky and Riemann.

GREEK MATHEMATICS

πάσας τὰς καθέτους τὰς ἀγομένας ἀπὸ τῶν τῆς
ἐτέρας σημείων ἐπὶ τὴν λοιπὴν.

(iii.) *Ptolemy*

Ibid., ed. Friedlein 362. 12-363. 18

Ἄλλ' ὅπως μὲν ὁ Στοιχειωτῆς δείκνυσιν ὅτι δύο ὀρθαῖς ἴσων οὐσῶν τῶν ἐντὸς αἱ εὐθεῖαι παράλληλοί εἰσι, φανερὸν ἐκ τῶν γεγραμμένων. Πτολεμαῖος δὲ ἐν οἷς ἀποδείξει προέθετο τὰς ἀπ' ἐλαττόνων ἢ δύο ὀρθῶν ἐκβαλλομένας συμπίπτειν, ἐφ' ἃ μέρη εἰσὶν αἱ τῶν δύο ὀρθῶν ἐλάσσονες, τοῦτο πρὸ πάντων δεικνὺς τὸ θεώρημα τὸ δυεῖν ὀρθαῖς ἴσων ὑπαρχουσῶν τῶν ἐντὸς παραλλήλους εἶναι τὰς εὐθείας οὕτω πως δείκνυσιν.

Ἔστωσαν δύο εὐθεῖαι αἱ AB , $\Gamma\Delta$, καὶ τεμνέτω τις αὐτὰς εὐθεῖα ἢ $EZH\Theta$, ὥστε τὰς ὑπο BZH

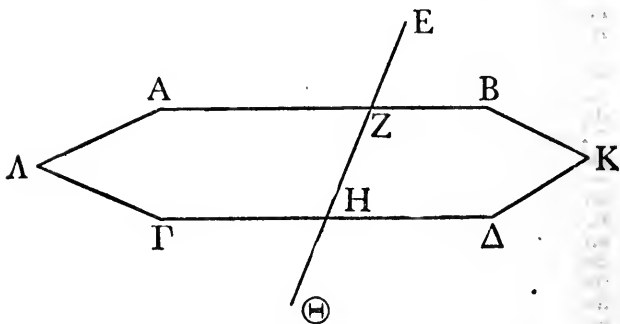

καὶ ὑπὸ $ZH\Delta$ γωνίας δύο ὀρθαῖς ἴσας ποιεῖν.
λέγω ὅτι παράλληλοί εἰσιν αἱ εὐθεῖαι, τουτέστιν

LATER DEVELOPMENTS IN GEOMETRY

but the perpendiculars drawn from points on one of the lines to the other are all equal.

(iii.) *Ptolemy* ^a

Ibid., ed. Friedlein 362. 12-363. 18

How the writer of the *Elements* proves that, if the interior angles be equal to two right angles, the straight lines are parallel is clear from what has been written. But Ptolemy, in the work ^b in which he attempted to prove that straight lines produced from angles less than two right angles will meet on the side on which the angles are less than two right angles, first proved this theorem, that if *the interior angles be equal to two right angles the lines are parallel*, and he proves it somewhat after this fashion.

Let the two straight lines be $AB, \Gamma\Delta$, and let any straight line $EZH\Theta$ cut them so as to make the angles BZH and $ZH\Delta$ equal to two right angles. I say that the straight lines are parallel, that is they are non-

^a For the few details known about Ptolemy, v. *infra*, p. 408 and n. *b*.

^b This work is not otherwise known.

GREEK MATHEMATICS

ἀσύμπτωτοί εἰσιν. εἰ γὰρ δυνατόν, συμπιπτεύωσαν ἐκβαλλόμεναι αἱ ΒΖ, ΗΔ κατὰ τὸ Κ. ἐπεὶ οὖν εὐθεία ἢ ΗΖ ἐφέστηκεν ἐπὶ τὴν ΑΒ, δύο ὀρθαῖς ἴσας ποιεῖ τὰς ὑπὸ ΑΖΗ, ΒΖΗ γωνίας. ὁμοίως δέ, ἐπεὶ ἢ ΗΖ ἐφέστηκεν ἐπὶ τὴν ΓΔ, δύο ὀρθαῖς ἴσας ποιεῖ τὰς ὑπὸ ΓΗΖ, ΔΗΖ γωνίας. αἱ τέσσαρες ἄρα αἱ ὑπὸ ΑΖΗ, ΒΖΗ, ΓΗΖ, ΔΗΖ τέτρασιν ὀρθαῖς ἴσαι εἰσίν, ὧν αἱ δύο αἱ ὑπὸ ΒΖΗ, ΖΗΔ δύο ὀρθαῖς ὑπόκεινται ἴσαι. λοιπαὶ ἄρα αἱ ὑπὸ ΑΖΗ, ΓΗΖ καὶ αὗται δύο ὀρθαῖς ἴσαι. εἰ οὖν αἱ ΖΒ, ΗΔ δύο ὀρθαῖς ἴσων οὐσῶν τῶν ἐντὸς ἐκβαλλόμεναι συνέπεσον κατὰ τὸ Κ, καὶ αἱ ΖΑ, ΗΓ ἐκβαλλόμεναι συμπεσοῦνται. δύο γὰρ ὀρθαῖς καὶ αἱ ὑπὸ ΑΖΗ, ΓΗΖ ἴσαι εἰσίν. ἢ γὰρ κατ' ἀμφοτέρα συμπεσοῦνται αἱ εὐθεῖαι, ἢ κατ' οὐδέτερα, εἶπερ καὶ αὗται κἀκεῖναι δύο ὀρθαῖς εἰσιν ἴσαι. συμπιπτεύωσαν οὖν αἱ ΖΑ, ΗΓ κατὰ τὸ Λ. αἱ ἄρα ΛΑΒΚ, ΛΓΔΚ εὐθεῖαι χωρίον περιέχουσιν, ὅπερ ἀδύνατον. οὐκ ἄρα δυνατόν ἐστὶν δύο ὀρθαῖς ἴσων οὐσῶν τῶν ἐντὸς συμπίπτειν τὰς εὐθείας. παράλληλοι ἄρα εἰσίν.

Ibid., ed. Friedlein 365. 5–367. 27

Ἦδη μὲν οὖν καὶ ἄλλοι τινὲς ὡς θεώρημα προτάξαντες τοῦτο αἴτημα παρὰ τῷ Στοιχειωτῇ ληφθὲν ἀποδείξεως ἤξιωσαν. δοκεῖ δὲ καὶ ὁ Πτολεμαῖος

* There is a Common Notion to this effect interpolated in the text of Euclid ; v. vol. i. pp. 444 and 445 n. a.

† The argument would have been clearer if it had been proved that the two interior angles on one side of ΖΗ were severally equal to the two interior angles on the other side, that is ΒΖΗ = ΓΗΖ and ΔΗΖ = ΑΖΗ ; whence, if ΖΑ, ΗΓ meet at Λ, the triangle ΖΗΛ can be rotated about the mid-

LATER DEVELOPMENTS IN GEOMETRY

secant. For, if it be possible, let BZ , $H\Delta$, when produced, meet at K . Then since the straight line HZ stands on AB , it makes the angles AZH , BZH equal to two right angles [Eucl. i. 13]. Similarly, since HZ stands on $\Gamma\Delta$, it makes the angles ΓHZ , ΔHZ equal to two right angles [*ibid.*]. Therefore the four angles AZH , BZH , ΓHZ , ΔHZ are equal to four right angles, and of them two, BZH , $ZH\Delta$, are by hypothesis equal to two right angles. Therefore the remaining angles AZH , ΓHZ are also themselves equal to two right angles. If then, the interior angles being equal to two right angles, ZB , $H\Delta$ meet at K when produced, ZA , $H\Gamma$ will also meet when produced. For the angles AZH , ΓHZ are also equal to two right angles. Therefore the straight lines will either meet on both sides or on neither, since these angles also are equal to two right angles. Let ZA , $H\Gamma$ meet, then, at Λ . Then the straight lines ΛABK , $\Lambda\Gamma\Delta K$ enclose a space, which is impossible.^a Therefore it is not possible that, if the interior angles be equal to two right angles, the straight lines should meet. Therefore they are parallel.^b

Ibid., ed. Friedlein 365. 5-367. 27

Therefore certain others already classed as a theorem this postulate assumed by the writer of the *Elements* and demanded a proof. Ptolemy appears

point of ZH so that ZH lies where HZ is in the figure, while ZK , HK lie along the sides $H\Gamma$, ZA respectively: and therefore $H\Gamma$, ZA must meet at the point where K falls.

The proof is based on the assumption that two straight lines cannot enclose a space. But Riemann devised a geometry in which this assumption does not hold good, for all straight lines having a common point have another point common also.

GREEK MATHEMATICS

αὐτὸ δεικνύναι ἐν τῷ περὶ τοῦ τὰς ἀπ' ἐλαττόνων ἢ δύο ὀρθῶν ἐκβαλλομένας συμπίπτειν, καὶ δείκνυσι πολλὰ προλαβῶν τῶν μέχρι τοῦδε τοῦ θεωρήματος ὑπὸ τοῦ Στοιχειωτοῦ προαποδεδειγμένων. καὶ ὑποκείσθω πάντα εἶναι ἀληθῆ, ἵνα μὴ καὶ ἡμεῖς ὄχλον ἐπεισάγωμεν ἄλλον, καὶ ὡς λημμάτιον τοῦτο δείκνυσθαι διὰ τῶν προειρημένων· ἐν δὲ καὶ τοῦτο τῶν προδεδειγμένων τὸ τὰς ἀπὸ δυεῖν ὀρθαῖς ἴσων ἐκβαλλομένας μηδαμῶς συμπίπτειν. λέγω τοίνυν ὅτι καὶ τὸ ἀνάπαλιν ἀληθές, καὶ τὸ παραλλήλων οὐσῶν τῶν εὐθειῶν καὶ τεμνομένων ὑπὸ μιᾶς εὐθείας τὰς ἐντὸς καὶ ἐπὶ τὰ αὐτὰ μέρη γωνίας δύο ὀρθαῖς ἴσας εἶναι. ἀνάγκη γὰρ τὴν τέμνουσαν τὰς παραλλήλους ἢ δύο ὀρθαῖς ἴσας ποιεῖν τὰς ἐντὸς καὶ ἐπὶ τὰ αὐτὰ μέρη γωνίας ἢ δύο ὀρθῶν ἐλάσσους ἢ μείζους. ἔστωσαν οὖν παράλληλοι αἱ AB , $\Gamma\Delta$, καὶ ἐμπίπτέτω εἰς αὐτὰς ἡ HZ ; λέγω ὅτι οὐ ποιεῖ δύο ὀρθῶν μείζους τὰς ἐντὸς καὶ ἐπὶ τὰ αὐτά. εἰ γὰρ αἱ ὑπὸ AZH , ΓHZ δύο

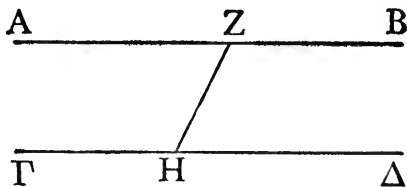

ὀρθῶν μείζους, αἱ λοιπαὶ αἱ ὑπὸ BZH , ΔHZ δύο ὀρθῶν ἐλάσσους. ἀλλὰ καὶ δύο ὀρθῶν μείζους αἱ αὐταί· οὐδὲν γὰρ μᾶλλον αἱ AZ , ΓH παράλληλοι ἢ ZB , $H\Delta$, ὥστε εἰ ἡ ἐμπεσοῦσα εἰς τὰς AZ , ΓH δύο ὀρθῶν μείζους ποιεῖ τὰς ἐντὸς, καὶ

LATER DEVELOPMENTS IN GEOMETRY

to have proved it in his book on the proposition that *straight lines drawn from angles less than two right angles meet if produced*, and he uses in the proof many of the propositions proved by the writer of the *Elements* before this theorem. Let all these be taken as true, in order that we may not introduce another mass of propositions, and by means of the aforesaid propositions this theorem is proved as a lemma, that *straight lines drawn from two angles together equal to two right angles do not meet when produced*^a—for this is common to both sets of preparatory theorems. I say then that the converse is also true, that *if parallel straight lines be cut by one straight line the interior angles on the same side are equal to two right angles*.^b For the straight line cutting the parallel straight lines must make the interior angles on the same side equal to two right angles or less or greater. Let $AB, \Gamma\Delta$ be parallel straight lines, and let HZ cut them; I say that it does not make the interior angles on the same side greater than two right angles. For if the angles $AZH, \Gamma HZ$ are greater than two right angles, the remaining angles $BZH, \Delta HZ$ are less than two right angles.^c But these same angles are greater than two right angles; for $AZ, \Gamma H$ are not more parallel than $ZB, H\Delta$, so that if the straight line falling on $AZ, \Gamma H$ make the interior angles greater than two right angles, the same straight line falling

^a This is equivalent to Eucl. i. 28.

^b This is equivalent to Eucl. i. 29.

^c By Eucl. i. 13, for the angles AZH, BZH are together equal to two right angles and so are the angles $\Gamma HZ, \Delta HZ$.

GREEK MATHEMATICS

ἢ εἰς τὰς ΖΒ, ΗΔ ἐμπίπτουσα δύο ὀρθῶν ποιήσει μείζους τὰς ἐντὸς· ἀλλ' αἱ αὐταὶ καὶ δύο ὀρθῶν ἐλάσσους· αἱ γὰρ τέσσαρες αἱ ὑπὸ ΑΖΗ, ΓΗΖ, ΒΖΗ, ΔΗΖ τέτρασιν ὀρθαῖς ἴσαι· ὅπερ ἀδύνατον. ὁμοίως δὴ δεῖξομεν ὅτι εἰς τὰς παραλλήλους ἐμπίπτουσα οὐ ποιεῖ δύο ὀρθῶν ἐλάσσους τὰς ἐντὸς καὶ ἐπὶ τὰ αὐτὰ μέρη γωνίας. εἰ δὲ μήτε μείζους μήτε ἐλάσσους ποιεῖ τῶν δύο ὀρθῶν, λείπεται τὴν ἐμπίπτουσαν δύο ὀρθαῖς ἴσας ποιεῖν τὰς ἐντὸς καὶ ἐπὶ τὰ αὐτὰ μέρη γωνίας.

Τούτου δὴ οὖν προδεδειγμένου τὸ προκείμενον ἀναμφισβητήτως ἀποδείκνυται. λέγω γὰρ ὅτι ἐὰν εἰς δύο εὐθείας εὐθεῖα ἐμπίπτουσα τὰς ἐντὸς καὶ ἐπὶ τὰ αὐτὰ μέρη γωνίας δύο ὀρθῶν ἐλάσσονας ποιῇ, συμπεσοῦνται αἱ εὐθεῖαι ἐκβαλλόμεναι, ἐφ' ἃ μέρη εἰσὶν αἱ τῶν δύο ὀρθῶν ἐλάσσονες. μὴ γὰρ συμπίπτέωσαν. ἀλλ' εἰ ἀσύμπτωτοί εἰσιν, ἐφ' ἃ μέρη αἱ τῶν δύο ὀρθῶν ἐλάσσονες, πολλῶ μάλλον ἔσονται ἀσύμπτωτοί ἐπὶ θάτερα, ἐφ' ἃ τῶν δύο εἰσὶν ὀρθῶν αἱ μείζονες, ὥστε ἐφ' ἑκάτερα ἂν εἶεν ἀσύμπτωτοί αἱ εὐθεῖαι. εἰ δὲ τοῦτο, παράλληλοί εἰσιν. ἀλλὰ δέδεικται ὅτι ἢ εἰς τὰς παραλλήλους ἐμπίπτουσα τὰς ἐντὸς καὶ ἐπὶ τὰ αὐτὰ μέρη δύο ὀρθαῖς ἴσας ποιήσει γωνίας. αἱ αὐταὶ ἄρα καὶ δύο ὀρθαῖς ἴσαι καὶ δύο ὀρθῶν ἐλάσσονες, ὅπερ ἀδύνατον.

Ταῦτα προδεδειχὼς ὁ Πτολεμαῖος καὶ κατα-

* See note c on p. 377.

† The fallacy lies in the assumption that "AZ, GH are not more parallel than ZB, HD," so that the angles BZH, ΔΗΖ must also be greater than two right angles. This assump-

LATER DEVELOPMENTS IN GEOMETRY

on ZB , $H\Delta$ also makes the interior angles greater than two right angles ; but these same angles are less than two right angles, for the four angles AZH , ΓHZ , BZH , ΔHZ are equal to four right angles ^a ; which is impossible. Similarly we may prove that a straight line falling on parallel straight lines does not make the interior angles on the same side less than two right angles. But if it make them neither greater nor less than two right angles, the only conclusion left is that the transversal makes the interior angles on the same side equal to two right angles.^b

With this preliminary proof, the theorem in question is proved beyond dispute. I mean that *if a straight line falling on two straight lines make the interior angles on the same side less than two right angles, the two straight lines, if produced, will meet on that side on which are the angles less than two right angles.* For [, if possible,] let them not meet. But if they are non-secant on the side on which are the angles less than two right angles, by much more will they be non-secant on the other side, on which are the angles greater than two right angles, so that the straight lines would be non-secant on both sides. Now if this should be so, they are parallel. But it has been proved that a straight line falling on parallel straight lines makes the interior angles on the same side equal to two right angles. Therefore the same angles are both equal to and less than two right angles, which is impossible.

Having first proved these things and squarely faced tion is equivalent to the hypothesis that through a given point only one parallel can be drawn to a given straight line ; but this hypothesis can be proved equivalent to Euclid's postulate. It is known as "Playfair's Axiom," but is, in fact, stated by Proclus in his note on Eucl. i. 31.

GREEK MATHEMATICS

τήσας εἰς τὸ προκείμενον ἀκριβέστερόν τι προσ-
 θεῖναι βούλεται καὶ δεῖξαι ὅτι, ἐὰν εἰς δύο εὐθείας
 εὐθεῖα ἐμπίπτουσα τὰς ἐντὸς καὶ ἐπὶ τὰ αὐτὰ
 μέρη δύο ὀρθῶν ποιῆ ἑλάσσονας, οὐ μόνον οὐκ
 εἰσὶν ἀσύμπτωτοι αἱ εὐθεῖαι, ὡς δέδεικται, ἀλλὰ
 καὶ ἡ σύμπτωση αὐτῶν κατ' ἐκείνα γίνεται τὰ
 μέρη, ἐφ' ἃ αἱ τῶν δύο ὀρθῶν ἑλάσσονες, οὐκ ἐφ'
 ἃ αἱ μείζονες. ἔστωσαν γὰρ δύο εὐθεῖαι αἱ ΑΒ,
 ΓΔ καὶ ἐμπίπτουσα εἰς αὐτὰς ἡ ΕΖΗΘ ποιείτω
 τὰς ὑπὸ ΑΖΗ καὶ ὑπὸ ΓΗΖ δύο ὀρθῶν ἑλάσσους.

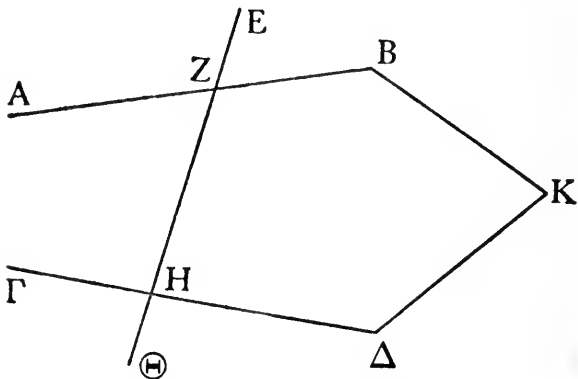

αἱ λοιπαὶ ἄρα μείζους δύο ὀρθῶν. ὅτι μὲν [οὖν]¹
 οὐκ ἀσύμπτωτοι αἱ εὐθεῖαι δέδεικται. εἰ δὲ συμ-
 πίπτουσιν, ἢ ἐπὶ τὰ Α, Γ συμπεσοῦνται, ἢ ἐπὶ
 τὰ Β, Δ. συμπιπέτωσαν ἐπὶ τὰ Β, Δ κατὰ τὸ
 Κ. ἐπεὶ οὖν αἱ μὲν ὑπὸ ΑΖΗ καὶ ΓΗΖ δύο
 ὀρθῶν εἰσὶν ἑλάσσους, αἱ δὲ ὑπὸ ΑΖΗ, ΒΖΗ δύο
 ὀρθαῖς ἴσαι, κοινῆς ἀφαιρεθείσης τῆς ὑπὸ ΑΖΗ,
 380

LATER DEVELOPMENTS IN GEOMETRY

the theorem in question, Ptolemy tries to make a more precise addition and to prove that, if a straight line falling on two straight lines make the interior angles on the same side less than two right angles, not only are the straight lines not non-secant, as has been proved, but their meeting takes place on that side on which the angles are less than two right angles, and not on the side on which they are greater. For let $AB, \Gamma\Delta$ be two straight lines and let $EZH\Theta$ fall on them and make the angles AZH, \GammaHZ less than two right angles. Then the remaining angles are greater than two right angles [Eucl. i. 13]. Now it has been proved that the straight lines are not non-secant. If they meet, they will meet either on the side of A, Γ or on the side of B, Δ . Let them meet on the side of B, Δ at K . Then since the angles AZH, \GammaHZ are less than two right angles, while the angles AZH, BZH are equal to two right angles, when the common angle AZH is taken away, the angle ΓHZ will be less

¹ οὐν is clearly out of place.

GREEK MATHEMATICS

ἡ ὑπὸ ΓΗΖ ἐλάσσων ἔσται τῆς ὑπὸ ΒΖΗ. τριγώνου ἄρα τοῦ ΚΖΗ ἢ ἐκτὸς τῆς ἐντὸς καὶ ἀπεναντίον ἐλάσσων, ὅπερ ἀδύνατον. οὐκ ἄρα κατὰ ταῦτα συμπίπτουσιν. ἀλλὰ μὴν συμπίπτουσι. κατὰ θάτερα ἄρα ἡ σύμπτωσις αὐτῶν ἔσται, καθ' ἃ αἱ τῶν δύο ὀρθῶν εἰσιν ἐλάσσονες.

(iv.) *Proclus*

Ibid., ed. Friedlein 371. 23-373. 2

Τούτου δὴ προϋποθεθέντος λέγω ὅτι, εἰς παραλλήλων εὐθειῶν τὴν ἑτέραν τέμνει τις εὐθεῖα, τεμεῖ καὶ τὴν λοιπὴν.

Ἐστῶσαν γὰρ παράλληλοι αἱ ΑΒ, ΓΔ, καὶ τεμνέτω τὴν ΑΒ ἡ ΕΖΗ. λέγω ὅτι τὴν ΓΔ τεμεῖ.

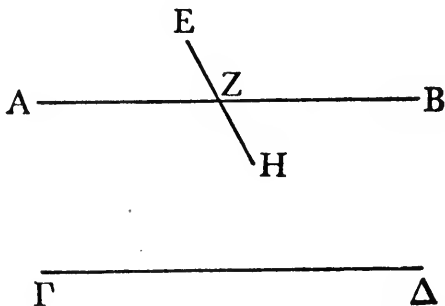

Ἐπεὶ γὰρ δύο εὐθεῖαί εἰσιν ἀφ' ἑνὸς σημείου τοῦ Ζ, εἰς ἄπειρον ἐκβαλλόμεναι αἱ ΒΖ, ΖΗ, παντὸς μεγέθους μείζονα ἔχουσι διάστασιν, ὥστε καὶ τούτου, ὅσον ἔστι τὸ μεταξὺ τῶν παραλλήλων.

LATER DEVELOPMENTS IN GEOMETRY

than the angle BZH. Therefore the exterior angle of the triangle KZH will be less than the interior and opposite angle, which is impossible [Eucl. i. 16]. Therefore they will not meet on this side. But they do meet. Therefore their meeting will be on the other side, on which the angles are less than two right angles.

(iv.) *Proclus*

Ibid., ed. Friedlein 371. 23-373. 2

This having first been assumed, I say that, *if any straight line cut one of parallel straight lines, it will cut the other also.*

For let AB, $\Gamma\Delta$ be parallel straight lines, and let EZH cut AB. I say that it will cut $\Gamma\Delta$.

For since BZ, ZH are two straight lines drawn from one point Z, they have, when produced indefinitely, a distance greater than any magnitude, so that it will also be greater than that between the parallels.

GREEK MATHEMATICS

ὅταν οὖν μείζον ἀλλήλων διαστῶσιν τῆς τούτων διαστάσεως τεμείῃ ἢ ΖΗ τὴν ΓΔ. εἰ ἄρα παραλλήλων τὴν ἑτέραν τέμνη τις εὐθεία, τεμεί καὶ τὴν λοιπὴν.

Τούτου προαποδείχθεντος ἀκολουθῶς δεῖξομεν τὸ προκείμενον. ἔστωσαν γὰρ δύο εὐθεῖαι αἱ ΑΒ, ΓΔ, καὶ ἐμπιπτέτω εἰς αὐτὰς ἢ ΕΖ ἐλάσσονας δύο ὀρθῶν ποιούσα τὰς ὑπὸ ΒΕΖ, ΔΖΕ.¹ λέγω ὅτι συμπεσοῦνται αἱ εὐθεῖαι κατὰ ταῦτα τὰ μέρη, ἐφ' ᾧ αἱ τῶν δύο ὀρθῶν εἰσιν ἐλάσσους.

Ἐπειδὴ γὰρ αἱ ὑπὸ ΒΕΖ, ΔΖΕ ἐλάσσους εἰσὶ δύο ὀρθῶν, τῇ ὑπεροχῇ τῶν δύο ὀρθῶν ἔστω ἴση ἢ ὑπὸ ΘΕΒ. καὶ ἐκβεβλήσθω ἢ ΘΕ ἐπὶ τὸ Κ. ἐπεὶ οὖν εἰς τὰς ΚΘ, ΓΔ ἐμπέπτωκεν ἢ ΕΖ καὶ ποιεῖ τὰς ἐντὸς δύο ὀρθαῖς ἴσας τὰς ὑπὸ ΘΕΖ, ΔΖΕ, παράλληλοί εἰσιν αἱ ΘΚ, ΓΔ εὐθεῖαι. καὶ τέμνει τὴν ΚΘ ἢ ΑΒ· τεμεί ἄρα καὶ τὴν ΓΔ διὰ τὸ προοδηγούμενον. συμπεσοῦνται ἄρα αἱ ΑΒ, ΓΔ κατὰ τὰ μέρη ἐκεῖνα, ἐφ' ᾧ αἱ τῶν δύο ὀρθῶν ἐλάσσονες, ὥστε δέδεικται τὸ προκείμενον.

¹ ΔΕΖ codd., correxi.

* The method is ingenious, but Clavius detected the flaw, which lies in the initial assumption, taken from Aristotle, that two divergent straight lines will eventually be so far apart that a perpendicular drawn from a point on one to the other will be greater than any assigned distance; Clavius draws attention to the conchoid of Nicomedes (*v. vol. i. pp. 298-301*), which continually approaches its asymptote, and therefore continually gets farther away from the tangent at the vertex; but the perpendicular from any point on the curve to that tangent will always be less than the distance between the tangent and the asymptote.

LATER DEVELOPMENTS IN GEOMETRY

Whenever, therefore, they are at a distance from one another greater than the distance between the parallels, ZH will cut $\Gamma\Delta$. If, therefore, any straight line cuts one of parallels, it will cut the other also.

This having first been established, we shall prove in turn the theorem in question. For let AB , $\Gamma\Delta$ be two straight lines, and let EZ fall on them so as to

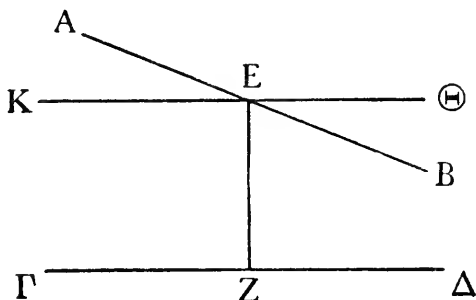

make the angles BEZ , ΔZE less than two right angles. I say that the straight lines will meet on that side on which are the angles less than two right angles.

For since the angles BEZ , ΔZE are less than two right angles, let the angle ΘEB be equal to the excess of the two right angles. And let ΘE be produced to K . Then since EZ falls on $K\Theta$, $\Gamma\Delta$ and makes the interior angles ΘEZ , ΔZE equal to two right angles, the straight lines ΘK , $\Gamma\Delta$ are parallel. And AB cuts $K\Theta$; therefore, by what was before shown, it will also cut $\Gamma\Delta$. Therefore AB , $\Gamma\Delta$ will meet on that side on which are the angles less than two right angles, so that the theorem in question is proved.^a

GREEK MATHEMATICS

(c) ISOPERIMETRIC FIGURES

Theon. Alex. in Ptol. Math. Syn. Comm. i. 3, ed. Rome, *Studi e Testi*, lxxii. (1936), 354. 19-357. 22

“ Ὡσαύτως δ' ὅτι, τῶν ἴσην περίμετρον ἔχόντων σχημάτων διαφόρων, ἐπειδὴ μείζονά ἐστιν τὰ πολυγωνότερα, τῶν μὲν ἐπιπέδων ὁ κύκλος γίνεται μείζων, τῶν δὲ στερεῶν ἡ σφαῖρα.”

Ποιησόμεθα δὴ τὴν τούτων ἀπόδειξιν ἐν ἐπιτομῇ ἐκ τῶν Ζηνοδώρῳ δεδειγμένων ἐν τῷ Περὶ ἰσοπεριμέτρων σχημάτων.

Τῶν ἴσην περίμετρον ἔχόντων τεταγμένων εὐ-

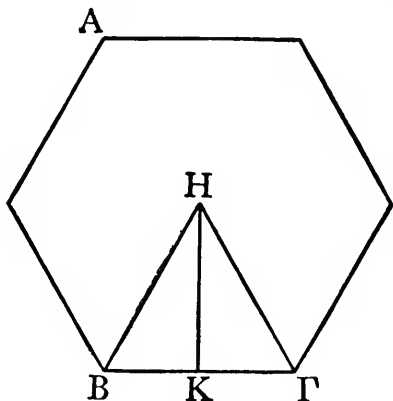

• Ptolemy, *Math. Syn.* i. 3, ed. Heiberg i. pars i. 13. 16-19.

• Zenodorus, as will shortly be seen, cites a proposition by Archimedes, and therefore must be later in date than Archimedes; as he follows the style of Archimedes closely, he is generally put not much later. Zenodorus's work is not

LATER DEVELOPMENTS IN GEOMETRY

(c) ISOPERIMETRIC FIGURES

Theon of Alexandria, *Commentary on Ptolemy's Syntaxis* i. 3, ed. Rome, *Studi e Testi*, lxxii. (1936), 354. 19-357. 22

“ In the same way, since the greatest of the various figures having an equal perimeter is that which has most angles, the circle is the greatest among plane figures and the sphere among solid.^a ”

We shall give the proof of these propositions in a summary taken from the proofs by Zenodorus^b in his book *On Isoperimetric Figures*.

Of all rectilinear figures having an equal perimeter—

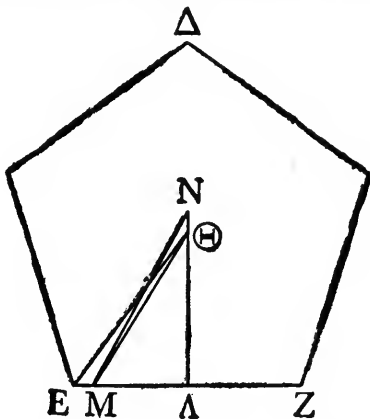

extant, but Pappus also quotes from it extensively (*Coll.* v. *ad init.*), and so does the passage edited by Hultsch (*Papp. Coll.*, ed. Hultsch 1138-1165) which is extracted from an introduction to Ptolemy's *Syntaxis* of uncertain authorship (v. Rome, *Studi e Testi*, liv., 1931, pp. xiii-xvii). It is disputed which of these versions is the most faithful.

GREEK MATHEMATICS

θυγράμμων σχημάτων, λέγω δὴ ἰσοπλεύρων τε καὶ ἰσογωνίων, τὸ πολυγωνώτερον μείζον ἔστιν.

*Ἐστω γὰρ ἰσοπερίμετρα ἰσόπλευρά τε καὶ ἰσογώνια τὰ $AB\Gamma$, ΔEZ , πολυγωνώτερον δὲ ἔστω τὸ $AB\Gamma$. λέγω, ὅτι μείζον ἔστιν τὸ $AB\Gamma$.

Εἰλήφθω γὰρ τὰ κέντρα τῶν περὶ τὰ $AB\Gamma$, ΔEZ πολύγωνα περιγραφομένων κύκλων τὰ H , Θ , καὶ ἐπεζεύχθωσαν αἱ HB , $H\Gamma$, ΘE , ΘZ . καὶ ἔτι ἀπὸ τῶν H , Θ ἐπὶ τὰς $B\Gamma$, EZ κάθετοι ἤχθωσαν αἱ HK , $\Theta\Lambda$. ἐπεὶ οὖν πολυγωνώτερόν ἔστιν τὸ $AB\Gamma$ τοῦ ΔEZ , πλεονάκεις ἢ $B\Gamma$ τὴν τοῦ $AB\Gamma$ περίμετρον καταμετρεῖ ἤπερ ἢ EZ τὴν τοῦ ΔEZ . καὶ εἰσιν ἴσαι αἱ περίμετροι. μείζων ἄρα ἢ EZ τῆς $B\Gamma$. ὥστε καὶ ἢ EL τῆς BK . κείσθω τῇ BK ἴση ἢ LM , καὶ ἐπεζεύχθω ἢ ΘM . καὶ ἐπεὶ ἔστιν ὡς ἢ EZ εὐθεία πρὸς τὴν τοῦ ΔEZ πολυγώνου περίμετρον οὕτως ἢ ὑπὸ $E\Theta Z$ πρὸς δ ὀρθάς, διὰ τὸ ἰσόπλευρον εἶναι τὸ πολύγωνον καὶ ἴσας ἀπολαμβάνειν περιφερείας τοῦ περιγραφομένου κύκλου καὶ τὰς πρὸς τῷ κέντρῳ γωνίας τὸν αὐτὸν ἔχειν λόγον ταῖς περιφερείαις ἐφ' ὧν βεβήκασιν, ὡς δὲ ἢ τοῦ ΔEZ περίμετρος, τουτέστιν ἢ τοῦ $AB\Gamma$, πρὸς τὴν $B\Gamma$ οὕτως αἱ δ ὀρθαὶ πρὸς τὴν ὑπὸ $BH\Gamma$, δι' ἴσου ἄρα ὡς ἢ EZ πρὸς $B\Gamma$, τουτέστιν ἢ EL πρὸς LM , οὕτως καὶ ἢ ὑπὸ $E\Theta Z$ γωνία πρὸς τὴν ὑπὸ $BH\Gamma$, τουτέστιν ἢ ὑπὸ $E\Theta\Lambda$ πρὸς τὴν ὑπὸ BHK . καὶ ἐπεὶ ἢ EL πρὸς LM μείζονα λόγον ἔχει ἤπερ ἢ ὑπὸ $E\Theta\Lambda$ γωνία πρὸς τὴν ὑπὸ $M\Theta\Lambda$, ὡς ἐξῆς δείξομεν, ὡς δὲ ἢ EL

* ΘZ is not, in fact, joined in the ms. figures.

† This is proved in a lemma immediately following the proposition by drawing an arc of a circle with Θ as centre

LATER DEVELOPMENTS IN GEOMETRY

I mean equilateral and equiangular figures—the greatest is that which has most angles.

For let $AB\Gamma$, ΔEZ be equilateral and equiangular figures having equal perimeters, and let $AB\Gamma$ have the more angles. I say that $AB\Gamma$ is the greater.

For let H , Θ be the centres of the circles circumscribed about the polygons $AB\Gamma$, ΔEZ , and let HB , $H\Gamma$, ΘE , ΘZ^a be joined. And from H , Θ let HK , $\Theta\Lambda$ be drawn perpendicular to $B\Gamma$, EZ . Then since $AB\Gamma$ has more angles than ΔEZ , $B\Gamma$ is contained more often in the perimeter of $AB\Gamma$ than EZ is contained in the perimeter of ΔEZ . And the perimeters are equal. Therefore $EZ > B\Gamma$; and therefore $E\Lambda > BK$. Let ΛM be placed equal to BK , and let ΘM be joined. Then since the straight line EZ bears to the perimeter of the polygon ΔEZ the same ratio as the angle $E\Theta Z$ bears to four right angles—owing to the fact that the polygon is equilateral and the sides cut off equal arcs from the circumscribing circle, while the angles at the centre are in the same ratio as the arcs on which they stand [Eucl. iii. 26]—and the perimeter of ΔEZ , that is the perimeter of $AB\Gamma$, bears to $B\Gamma$ the same ratio as four right angles bears to the angle $BH\Gamma$, therefore *ex aequali* [Eucl. v. 17]

$$EZ : B\Gamma = \text{angle } E\Theta Z : \text{angle } BH\Gamma,$$

i.e., $E\Lambda : \Lambda M = \text{angle } E\Theta Z : \text{angle } BH\Gamma,$

i.e., $E\Lambda : \Lambda M = \text{angle } E\Theta\Lambda : \text{angle } BHK.$

And since $E\Lambda : \Lambda M > \text{angle } E\Theta\Lambda : \text{angle } M\Theta\Lambda$,
as we shall prove in due course,^b

and ΘM as radius cutting ΘE and $\Theta\Lambda$ produced, as in Eucl. *Optic.* 8 (v. vol. i. pp. 502-505); the proposition is equivalent to the formula $\tan \alpha : \tan \beta > \alpha : \beta$ if $\frac{1}{2}\pi > \alpha > \beta$.

πρὸς ΛM ἢ ὑπὸ $\text{E}\Theta\Lambda$ πρὸς τὴν ὑπὸ BHK , ἢ ὑπὸ $\text{E}\Theta\Lambda$ πρὸς τὴν ὑπὸ BHK μείζονα λόγον ἔχει ἤπερ πρὸς τὴν ὑπὸ $\text{M}\Theta\Lambda$. μείζων ἄρα ἢ ὑπὸ $\text{M}\Theta\Lambda$ γωνία τῆς ὑπὸ BHK . ἔστιν δὲ καὶ ὀρθὴ ἢ πρὸς τῷ Λ ὀρθῇ τῇ πρὸς τῷ K ἴση. λοιπὴ ἄρα ἢ ὑπὸ HBK μείζων ἔσται τῆς ὑπὸ $\Theta\text{M}\Lambda$. κείσθω τῇ ὑπὸ HBK ἴση ἢ ὑπὸ ΛMN καὶ διήχθω ἢ $\Lambda\Theta$ ἐπὶ τὸ N . καὶ ἐπεὶ ἴση ἔστιν ἢ ὑπὸ HBK τῇ ὑπὸ NML , ἀλλὰ καὶ ἢ πρὸς τῷ Λ ἴση τῇ πρὸς τῷ K , ἔστι δὲ καὶ ἢ BK πλευρᾶ τῇ ML ἴση, ἴση ἄρα καὶ ἢ HK τῇ NL . μείζων ἄρα ἢ HK τῆς $\Theta\Lambda$. μείζον ἄρα καὶ τὸ ὑπὸ τῆς $\text{AB}\Gamma$ περιμέτρου καὶ τῆς HK τοῦ ὑπὸ τῆς $\Delta\text{E}\text{Z}$ περιμέτρου καὶ τῆς $\Theta\Lambda$. καὶ ἔστιν τὸ μὲν ὑπὸ τῆς $\text{AB}\Gamma$ περιμέτρου καὶ τῆς HK διπλάσιον τοῦ $\text{AB}\Gamma$ πολυγώνου, ἐπεὶ καὶ τὸ ὑπὸ τῆς $\text{B}\Gamma$ καὶ τῆς HK διπλάσιόν ἐστιν τοῦ $\text{HB}\Gamma$ τριγώνου. τὸ δὲ ὑπὸ τῆς $\Delta\text{E}\text{Z}$ περιμέτρου καὶ τῆς $\Theta\Lambda$ διπλάσιον τοῦ $\Delta\text{E}\text{Z}$ πολυγώνου. μείζον ἄρα τὸ $\text{AB}\Gamma$ πολύγωνον τοῦ $\Delta\text{E}\text{Z}$.

Ibid. 358. 12-360. 3

Τούτου δεδειγμένου λέγω, ὅτι ἐὰν κύκλος εὐθυγράμμω ἰσοπλεύρῳ τε καὶ ἰσογωνίῳ ἰσοπερίμετρος ᾖ, μείζων ἔσται ὁ κύκλος.

Κύκλος γὰρ ὁ $\text{AB}\Gamma$ ἰσοπλεύρῳ τε καὶ ἰσογωνίῳ τῷ $\Delta\text{E}\text{Z}$ εὐθυγράμμω ἰσοπερίμετρος ἔστω· λέγω, ὅτι μείζων ἔστιν ὁ κύκλος.

Εἰλήφθω τοῦ μὲν $\text{AB}\Gamma$ κύκλου κέντρον τὸ H , τοῦ δὲ περὶ τὸ $\Delta\text{E}\text{Z}$ πολύγωνον περιγραφομένου τὸ Θ , καὶ περιγεγράφθω περὶ τὸν $\text{AB}\Gamma$ κύκλον

LATER DEVELOPMENTS IN GEOMETRY

and $EA : \Lambda M = \text{angle } E\Theta\Lambda : \text{angle } BHK,$

$\therefore \text{angle } E\Theta\Lambda : \text{angle } BHK > \text{angle } E\Theta\Lambda : M\Theta\Lambda.$

$\therefore \text{angle } M\Theta\Lambda > \text{angle } BHK.$

Now the right angle at Λ is equal to the right angle at K . Therefore the remaining angle HBK is greater than the angle $\Theta M\Lambda$ [by Eucl. i. 32]. Let the angle ΛMN be placed equal to the angle HBK , and let $\Lambda\Theta$ be produced to N . Then since the angle HBK is equal to the angle NMA , and the angle at Λ is equal to the angle at K , while BK is equal to the side MA , therefore HK is equal to NA [Eucl. i. 26]. Therefore $HK > \Theta\Lambda$. Therefore the rectangle contained by the perimeter of $AB\Gamma$ and HK is greater than the rectangle contained by the perimeter of ΔEZ and $\Theta\Lambda$. But the rectangle contained by the perimeter of $AB\Gamma$ and HK is double of the polygon $AB\Gamma$, since the rectangle contained by $B\Gamma$ and HK is double of the triangle $H B\Gamma$ [Eucl. i. 41]; and the rectangle contained by the perimeter of ΔEZ and $\Theta\Lambda$ is double of the polygon ΔEZ . Therefore the polygon $AB\Gamma$ is greater than ΔEZ .

Ibid. 358. 12–360. 3

This having been proved, I say that *if a circle have an equal perimeter with an equilateral and equiangular rectilineal figure, the circle shall be the greater.*

For let $AB\Gamma$ be a circle having an equal perimeter with the equilateral and equiangular rectilineal figure ΔEZ . I say that the circle is the greater.

Let H be the centre of the circle $AB\Gamma$, Θ the centre of the circle circumscribing the polygon ΔEZ ; and let there be circumscribed about the circle $AB\Gamma$ the

GREEK MATHEMATICS

πολύγωνον ὅμοιον τῷ ΔΕΖ τὸ ΚΑΜ, καὶ ἐπέ-
 ζεύχθω ἡ ΗΒ, καὶ κάθετος ἀπὸ τοῦ Θ ἐπὶ τὴν
 ΕΖ ἤχθω ἡ ΘΝ, καὶ ἐπέζεύχθωσαν αἱ ΗΛ, ΘΕ.

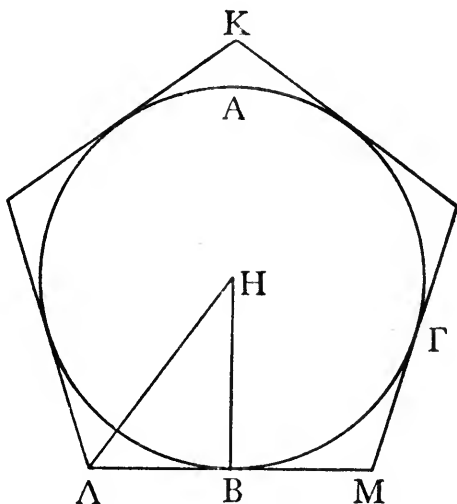

ἐπεὶ οὖν ἡ τοῦ ΚΑΜ πολυγώνου περίμετρος
 μείζων ἐστὶν τῆς τοῦ ΑΒΓ κύκλου περιμέτρου
 ὡς ἐν τῷ Περὶ σφαίρας καὶ κυλίνδρου Ἀρχιμήδης,
 ἴση δὲ ἡ τοῦ ΑΒΓ κύκλου περίμετρος τῇ τοῦ
 ΔΕΖ πολυγώνου περιμέτρῳ, μείζων ἄρα καὶ ἡ
 τοῦ ΚΑΜ πολυγώνου περίμετρος τῆς τοῦ ΔΕΖ
 πολυγώνου περιμέτρου. καὶ εἰσιν ὅμοια τὰ πολύ-
 γωνα· μείζων ἄρα ἡ ΒΛ τῆς ΝΕ. καὶ ὅμοιον τὸ
 ΗΛΒ τρίγωνον τῷ ΘΕΝ τριγώνῳ, ἐπεὶ καὶ τὰ

LATER DEVELOPMENTS IN GEOMETRY

polygon KAM similar to ΔEZ , and let HB be joined, and from Θ let ΘN be drawn perpendicular to EZ , and let $H\Lambda$, ΘE be joined. Then since the perimeter

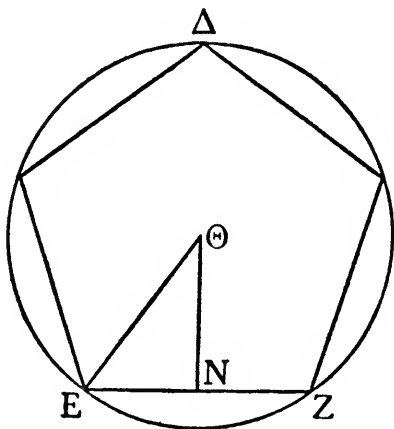

of the polygon KAM is greater than the perimeter of the circle $AB\Gamma$, as Archimedes proves in his work *On the Sphere and Cylinder*,^a while the perimeter of the circle $AB\Gamma$ is equal to the perimeter of the polygon ΔEZ , therefore the perimeter of the polygon KAM is greater than the perimeter of the polygon ΔEZ . And the polygons are similar; therefore $B\Lambda > NE$. And the triangle HAB is similar to the triangle ΘEN ,

^a Prop. 1, v. *supra*, pp. 48-49.

GREEK MATHEMATICS

ὅλα πολύγωνα. μείζων ἄρα καὶ ἡ HB τῆς ΘN . καὶ ἔστιν ἴση ἡ τοῦ $AB\Gamma$ κύκλου περίμετρος τῆ τοῦ ΔEZ πολυγώνου περιμέτρῳ. τὸ ἄρα ὑπὸ τῆς περιμέτρου τοῦ $AB\Gamma$ κύκλου καὶ τῆς HB μείζον ἔστιν τοῦ ὑπὸ τῆς περιμέτρου τοῦ ΔEZ πολυγώνου καὶ τῆς ΘN . ἀλλὰ τὸ μὲν ὑπὸ τῆς περιμέτρου τοῦ $AB\Gamma$ κύκλου καὶ τῆς HB διπλάσιον τοῦ $AB\Gamma$ κύκλου Ἀρχιμήδης ἔδειξεν, οὗ καὶ τὴν δεῖξιν ἐξῆς ἐκθησόμεθα· τὸ δὲ ὑπὸ τῆς περιμέτρου τοῦ ΔEZ πολυγώνου καὶ τῆς ΘN διπλάσιον τοῦ ΔEZ πολυγώνου. μείζων ἄρα ὁ $AB\Gamma$ κύκλος τοῦ ΔEZ πολυγώνου, ὅπερ ἔδει δεῖξαι.

Ibid. 364. 12-14

Λέγω δὴ καὶ ὅτι τῶν ἰσοπεριμέτρων εὐθυγράμμων σχημάτων καὶ τὰς πλευρὰς ἰσοπληθεῖς ἔχόντων τὸ μέγιστον ἰσόπλευρόν τέ ἐστιν καὶ ἰσογώνιον.

Ibid. 374. 12-14

Λέγω δὴ ὅτι καὶ ἡ σφαῖρα μείζων ἐστὶν πάντων τῶν ἴσην ἐπιφάνειαν ἔχόντων στερεῶν σχημάτων, προσχρησάμενος τοῖς ὑπὸ Ἀρχιμήδους δεδειγμένοις ἐν τῷ Περὶ σφαίρας καὶ κυλίνδρου.

(d) DIVISION OF ZODIAC CIRCLE INTO 360 PARTS : HYPsicLES

Hypsicl. *Anaph.*, ed. Manitius 5. 25-31

Τοῦ τῶν Ζωδίων κύκλου εἰς $\overline{\tau\zeta}$ περιφερείας ἴσας

* *Dim. Circ.* Prop. 1, v. vol. i. pp. 316-321.

† The proofs of these two last propositions are worked out by similar methods.

LATER DEVELOPMENTS IN GEOMETRY

since the whole polygons are similar; therefore $HB > \Theta N$. And the perimeter of the circle $AB\Gamma$ is equal to the perimeter of the polygon ΔEZ . Therefore the rectangle contained by the perimeter of the circle $AB\Gamma$ and HB is greater than the rectangle contained by the perimeter of the polygon ΔEZ and ΘN . But the rectangle contained by the perimeter of the circle $AB\Gamma$ and HB is double of the circle $AB\Gamma$ as was proved by Archimedes,^a whose proof we shall set out next; and the rectangle contained by the perimeter of the polygon ΔEZ and ΘN is double of the polygon ΔEZ [by Eucl. i. 41]. Therefore the circle $AB\Gamma$ is greater than the polygon ΔEZ , which was to be proved.

Ibid. 364. 12-14

Now I say that, *of all rectilinear figures having an equal number of sides and equal perimeter, the greatest is that which is equilateral and equiangular.*

Ibid. 374. 12-14

Now I say that, *of all solid figures having an equal surface, the sphere is the greatest*; and I shall use the theorems proved by Archimedes in his work *On the Sphere and Cylinder*.^b

(d) DIVISION OF ZODIAC CIRCLE INTO 360 PARTS: HYPsicLES

Hypsicles, *On Risings*, ed. Manitius * 5. 25-31

The circumference of the zodiac circle having been

^a *Des Hypsikles Schrift Anaphorikos nach Überlieferung und Inhalt kritisch behandelt*, in *Programm des Gymnasiums zum Heiligen Kreuz in Dresden* (Dresden, 1888), 1^o Abt.

GREEK MATHEMATICS

διηρημένου, ἐκάστη τῶν περιφερειῶν μοῖρα τοπικῆ καλείσθω. ὁμοίως δὴ καὶ τοῦ χρόνου, ἐν ᾧ ὁ ζῳδιακὸς ἀφ' οὗ ἔτυχε σημείου ἐπὶ τὸ αὐτὸ σημεῖον παραγίγνεται, εἰς τῷ χρόνους ἴσους διηρημένου, ἕκαστος τῶν χρόνων μοῖρα χρονικῆ καλείσθω.

(e) HANDBOOKS

(i.) Cleomedes

Cleom. *De motu circ.* ii. 6, ed. Ziegler 218. 8-224. 8

Τοιούτων δὲ τῶν περὶ τὴν ἔκλειψιν τῆς σελήνης εἶναι ἐπιδεδειγμένων δοκεῖ ἐναντιοῦσθαι τῷ λόγῳ τῷ κατασκευάζοντι ἐκλείπειν τὴν σελήνην εἰς τὴν σκιὰν ἐμπίπτουσαν τῆς γῆς τὰ λεγόμενα κατὰ τὰς παραδόξους τῶν ἐκλείψεων. φασὶ γάρ τινες, ὅτι γίνεται σελήνης ἔκλειψις καὶ ἀμφοτέρων τῶν φωτῶν ὑπὲρ τὸν ὀρίζοντα θεωρουμένων. τοῦτον δὲ δῆλον ποιεῖ, διότι μὴ ἐκλείπει ἡ σελήνη τῇ σκιᾷ

* Hypsicles, who flourished in the second half of the second century B.C., is the author of the continuation of Euclid's *Elements* known as Book xiv. Diophantus attributed to him a definition of a polygonal number which is equivalent to the formula $\frac{1}{2} n\{2 + (n - 1)(a - 2)\}$ for the n th a -gonal number.

The passage here cited is the earliest known reference in Greek to the division of the ecliptic into 360 degrees. This number appears to have been adopted by the Greeks from the Chaldaeans, among whom the zodiac was divided into twelve signs and each sign into thirty parts according to one system, sixty according to another (v. Tannery, *Mémoires scientifiques*, ii. pp. 256-268). The Chaldaeans do not, however, seem to have applied this system to other circles; Hipparchus is believed to have been the first to divide the

LATER DEVELOPMENTS IN GEOMETRY

divided into 360 equal arcs, let each of the arcs be called a *degree in space*, and similarly, if the time in which the zodiac circle returns to any position it has left be divided into 360 equal times, let each of the times be called a *degree in time*.^a

(e) HANDBOOKS

(i.) *Cleomedes*^b

Cleomedes, *On the Circular Motion of the Heavenly Bodies* ii. 6, ed. Ziegler 218. 8-224. 8

Although these facts have been proved with regard to the eclipse of the moon, the argument that the moon suffers eclipse by falling into the shadow of the earth seems to be refuted by the stories told about paradoxical eclipses. For some say that an eclipse of the moon may take place even when both luminaries are seen above the horizon. This should make it clear that the moon does not suffer eclipse by

circle in general into 360 degrees. The problem which Hypsicles sets himself in his book is: *Given the ratio between the length of the longest day and the length of the shortest day at any given place, to find how many time-degrees it takes any given sign to rise.* A number of arithmetical lemmas are proved.

^b Cleomedes is known only as the author of the two books *Κυκλική θεωρία μετεώρων*. This work is almost wholly based on Posidonius. He must therefore have lived after Posidonius and presumably before Ptolemy, as he appears to know nothing of Ptolemy's works. In default of better evidence, he is generally assigned to the middle of the first century B.C.

The passage explaining the measurement of the earth by Eratosthenes has already been cited (*supra*, pp. 266-273). This is the only other passage calling for notice.

GREEK MATHEMATICS

τῆς γῆς περιπίπτουσα, ἀλλ' ἕτερον τρόπον. . . . οἱ παλαιότεροι τῶν μαθηματικῶν οὕτως ἐπεχείρουν λύειν τὴν ἀπορίαν ταύτην. ἔφασαν γάρ, ὅτι . . . οἱ δ' ἐπὶ γῆς ἐστῶτες οὐδὲν ἂν κωλύοντο ὄραν ἀμφοτέρους αὐτοὺς ἐπὶ τοῖς κυρτώμασι τῆς γῆς ἐστῶτες. . . . τοιαύτην μὲν οὖν οἱ παλαιότεροι τῶν μαθηματικῶν τὴν τῆς προσαγομένης ἀπορίας λύσιν ἐποιήσαντο. μή ποτε δ' οὐχ ὑγιῶς εἰσιν ἐνηνεγμένοι. ἐφ' ὕψους μὲν γὰρ ἢ ὄψις ἡμῶν γενομένη δύναται ἂν τοῦτο παθεῖν, κωνοειδοῦς τοῦ ὀρίζοντος γινομένου πολὺ ἀπὸ τῆς γῆς ἐκ τὸν ἀέρα ἡμῶν ἐξαρθέντων, ἐπὶ δὲ τῆς γῆς ἐστῶτων οὐδαμῶς. εἰ γὰρ καὶ κύρτωμά ἐστιν, ἐφ' οὗ βεβήκαμεν, ἀφανίζεται ἡμῶν ἢ ὄψις ὑπὸ τοῦ μεγέθους τῆς γῆς. . . . ἀλλὰ πρῶτον μὲν ἀπαντητέον λέγοντας, ὅτι πέπλασται ὁ λόγος οὗτος ὑπὸ τινῶν ἀπορίαν βουλομένων ἐμποιῆσαι τοῖς περὶ ταῦτα καταγινομένοις τῶν ἀστρολόγων καὶ φιλοσόφων. . . . πολλῶν δὲ καὶ παντοδαπῶν περὶ τὸν ἀέρα παθῶν συνίστασθαι πεφυκότων οὐκ ἂν εἶη ἀδύνατον, ἥδη καταδεδυκότος τοῦ ἡλίου καὶ ὑπὸ τὸν ὀρίζοντα ὄντος φαντασίαν ἡμῖν προσπεσεῖν ὡς μηδέπω καταδεδυκότος αὐτοῦ, ἢ νέφους παχύτερου πρὸς τῇ δύσει ὄντος καὶ λαμπρυνομένου ὑπὸ τῶν ἡλιακῶν ἀκτίνων καὶ ἡλίου ἡμῖν φαντασίαν ἀποπέμποντος ἢ ἀνθελίου γενομένου. καὶ γὰρ

* *i.e.*, the horizon would form the base of a cone whose vertex would be at the eye of the observer. He could thus look down on both the sun and moon as along the generators of a cone, even though they were diametrically opposite each other.

LATER DEVELOPMENTS IN GEOMETRY

falling into the shadow of the earth, but in some other way. . . . The more ancient of the mathematicians tried to explain this difficulty after this fashion. They said that persons standing on the earth would not be prevented from seeing them both because they would be standing on the convexities of the earth. . . . Such is the solution of the alleged difficulty given by the more ancient of the mathematicians. But its soundness may be doubted. For, if our eye were situated on a height, the phenomenon in question might take place, the horizon becoming conical ^a if we were raised sufficiently far above the earth, but it could in no wise happen if we stood on the earth. For though there might be some convexity where we stood, our sight itself becomes evanescent owing to the size of the earth. . . . The fundamental objection must first be made, that this story has been invented by certain persons wishing to make difficulty for the astronomers and philosophers who busy themselves with such matters. . . . Nevertheless, as the conditions which naturally arise in the air are many and various, it would not be impossible that, when the sun has just set and is below the horizon, we should receive the impression of its not having yet set, if there were a cloud of considerable density at the place of setting and if it were illumined by the solar rays and transmitted to us an image of the sun, or if there were a mock sun.^b For such images are often

^b Lit. "anthelion," defined in the Oxford English Dictionary as "a luminous ring or nimbus seen (chiefly in alpine or polar regions) surrounding the shadow of the observer's head projected on a cloud or fog bank opposite the sun." The explanation here tentatively put forward by Cleomedes is, of course, the true one.

GREEK MATHEMATICS

τοιαῦτα πολλὰ φαντάζεται ἐν τῷ ἀέρι, καὶ μάλιστα περὶ τὸν Πόντον.

(ii.) *Theon of Smyrna*

Ptol. *Math. Syn.* x. 1, ed. Heiberg i. pars ii. 296. 14-16

Ἐν μὲν γὰρ ταῖς παρὰ Θεώνος τοῦ μαθηματικοῦ δοθείσαις ἡμῖν εὐρομεν ἀναγεγραμμένην τήρησιν τῷ ις' ἔτει Ἀδριανοῦ.

Theon Smyr., ed. Hiller 1. 1-2. 2

Ὅτι μὲν οὐχ οἶόν τε συνεῖναι τῶν μαθηματικῶς λεγομένων παρὰ Πλάτωνι μὴ καὶ αὐτὸν ἡσκημένον ἐν τῇ θεωρίᾳ ταύτῃ, πᾶς ἂν που ὁμολογήσειεν· ὡς δὲ οὐδὲ τὰ ἄλλα ἀνωφελῆς οὐδὲ ἀνόνητος ἢ περὶ ταῦτα ἐμπειρία, διὰ πολλῶν αὐτὸς ἐμφανίζειν ἔοικε. τὸ μὲν οὖν συμπάσης γεωμετρίας καὶ συμπάσης μουσικῆς καὶ ἀστρονομίας ἐμπειρον γενόμενον τοῖς Πλάτωνος συγγράμμασιν ἐντυγχάνειν μακαριστὸν μὲν εἴ τῳ γένοιτο, οὐ μὴν εὐπόρον οὐδὲ ῥάδιον ἀλλὰ πάνυ πολλοῦ τοῦ ἐκ παίδων πόνου δεόμενον. ὥστε δὲ τοὺς διημαρτηκότας τοῦ ἐν τοῖς μαθήμασιν ἀσκηθῆναι, ὀρεγομένους δὲ τῆς γνώσεως τῶν συγγραμμάτων αὐτοῦ μὴ παντάπασιν ὦν ποθοῦσι διαμαρτεῖν, κεφαλαιώδη καὶ σύντομον ποιησόμεθα τῶν ἀναγκαίων καὶ ὧν δεῖ μάλιστα τοῖς ἐντευξομένοις Πλάτωνι μαθηματικῶν θεωρημάτων παράδοσιν, ἀριθμητικῶν τε καὶ μουσικῶν καὶ γεωμετρικῶν τῶν τε κατὰ στερεομετρίαν καὶ ἀστρονομίαν, ὧν χωρὶς οὐχ

LATER DEVELOPMENTS IN GEOMETRY

seen in the air, and especially in the neighbourhood of Pontus.

(ii.) *Theon of Smyrna*

Ptolemy, *Syntaxis* x. 1, ed. Heiberg i. pars ii. 296. 14-16

For in the account given to us by Theon the mathematician we find recorded an observation made in the sixteenth year of Hadrian.^a

Theon of Smyrna, ed. Hiller 1. 1-2. 2

Everyone would agree that he could not understand the mathematical arguments used by Plato unless he were practised in this science ; and that the study of these matters is neither unintelligent nor unprofitable in other respects Plato himself would seem to make plain in many ways. One who had become skilled in all geometry and all music and astronomy would be reckoned most happy on making acquaintance with the writings of Plato, but this cannot be come by easily or readily, for it calls for a very great deal of application from youth upwards. In order that those who have failed to become practised in these studies, but aim at a knowledge of his writings, should not wholly fail in their desires, I shall make a summary and concise sketch of the mathematical theorems which are specially necessary for readers of Plato, covering not only arithmetic and music and geometry, but also their application to stereometry and astronomy, for

^a *i.e.*, in A.D. 132. Ptolemy mentions other observations made by Theon in the years A.D. 127, 129, and 130. In three places Theon of Alexandria refers to his namesake as "the old Theon," ὁ Θέων παλαιός (ed. Basil. pp. 390, 395, 396).

GREEK MATHEMATICS

οἶόν τε εἶναί φησι τυχεῖν τοῦ ἀρίστου βίου, διὰ πολλῶν πάνυ δηλώσας ὡς οὐ χρὴ τῶν μαθημάτων ἀμελεῖν.

* By way of example, Theon proceeds to relate Plato's reply to the craftsmen about the doubling of the cube (v.

LATER DEVELOPMENTS IN GEOMETRY

without these studies, as he says, it is not possible to attain the best life, and in many ways he makes clear that mathematics should not be ignored.^a

vol. i. p. 257), and also the *Epinomis*. Theon's work, which has often been cited in these volumes, is a curious hotch-potch, containing little of real value to the study of Plato and no original work.

1850

1851

1852

1853

1854

1855

1856

XXI. TRIGONOMETRY

XXI. TRIGONOMETRY

1. HIPPARCHUS AND MENELAUS

Theon Alex. in Ptol. Math. Syn. Comm. i. 10, ed. Rome, *Studi e Testi*, lxxii. (1936), 451. 4-5

Δέδεικται μὲν οὖν καὶ Ἰππάρχῳ πραγματεία τῶν ἐν κύκλῳ εὐθειῶν ἐν $\overline{\text{ιβ}}$ βιβλίοις, ἔτι τε καὶ Μενελάῳ ἐν $\overline{\text{ς}}$.

Heron, *Metr.* i. 22, ed. H. Schöne (Heron iii.) 58. 13-20

Ἔστω ἐννάγωνον ἰσόπλευρον καὶ ἰσογώνιον τὸ ΑΒΓΔΕΖΗΘΚ, οὗ ἐκάστη τῶν πλευρῶν μονάδων $\bar{\iota}$. εὐρεῖν αὐτοῦ τὸ ἐμβαδόν. περιγεγραφθῶ περὶ αὐτὸ κύκλος, οὗ κέντρον ἔστω τὸ Λ, καὶ ἐπε-

* The beginnings of Greek trigonometry may be found in the science of *sphaeric*, the geometry of the sphere, for which v. vol. i. p. 5 n. b. It reached its culminating point in the *Sphaerica* of Theodosius.

Trigonometry in the strict sense was founded, so far as we know, by Hipparchus, the great astronomer, who was born at Nicaea in Bithynia and is recorded by Ptolemy to have made observations between 161 and 126 b.c., the most important of them at Rhodes. His greatest achievement was the discovery of the precession of the equinoxes, and he made a calculation of the mean lunar month which differs by less than a second from the present accepted figure. Unfortunately the only work of his which has survived is his early *Commentary on the Phenomena of Eudoxus and Aratus*. It

XXI. TRIGONOMETRY

1. HIPPARCHUS AND MENELAUS

Theon of Alexandria, *Commentary on Ptolemy's Syntaxis* i. 10, ed. Rome, *Studi e Testi*, lxxii. (1936), 451. 4-5

AN investigation of the chords in a circle is made by Hipparchus in twelve books and again by Menelaus in six.^a

Heron, *Metrics* i. 22, ed. H. Schöne (Heron iii.) 58. 13-20

Let $AB\Gamma\Delta EZH\Theta K$ be an equilateral and equiangular enneagon,^b whose sides are each equal to 10. *To find its area.* Let there be described about it a circle with centre Λ , and let $E\Lambda$ be joined and pro-

is clear, however, from the passage here cited, that he drew up, as did Ptolemy, a table of chords, or, as we should say, a table of sines; and Heron may have used this table (v. the next passage cited and the accompanying note).

Menelaus, who also drew up a table of chords, is recorded by Ptolemy to have made an observation in the first year of Trajan's reign (A.D. 98). He has already been encountered (vol. i. pp. 348-349 and n. c) as the discoverer of a curve called "paradoxical." His trigonometrical work *Sphaerica* has fortunately been preserved, but only in Arabic, which will prevent citation here. A proof of the famous theorem in spherical trigonometry bearing his name can, however, be given in the Greek of Ptolemy (*infra*, pp. 458-463); and a summary from the Arabic is provided by Heath, *H.G.M.* ii. 262-273.

^b *i.e.*, a figure of nine sides.

GREEK MATHEMATICS

ζεύχθω ἢ ΕΛ καὶ ἐκβεβλήσθω ἐπὶ τὸ Μ, καὶ ἐπεζεύχθω ἢ ΜΖ. τὸ ἄρα ΕΖΜ τρίγωνον δοθέν ἐστὶν τοῦ ἐνναγώνου. δέδεικται δὲ ἐν τοῖς περὶ τῶν ἐν κύκλῳ εὐθειῶν, ὅτι ἡ ΖΕ τῆς ΕΜ τρίτον μέρος ἐστὶν ὡς ἔγγιστα.

2. PTOLEMY

(a) GENERAL

Suidas, s.v. Πτολεμαῖος

Πτολεμαῖος, ὁ Κλαύδιος χρηματίσας, Ἄλεξανδρεὺς, φιλόσοφος, γεγονὼς ἐπὶ τῶν χρόνων Μάρκου τοῦ βασιλέως. οὗτος ἔγραψε Μηχανικὰ βιβλία γ, Περὶ φάσεων καὶ ἐπισημασιῶν ἀστέρων ἀπλανῶν βιβλία β, Ἀπλωσιν ἐπιφανείας σφαίρας, Κανόνα πρόχειρον, τὸν Μέγαν ἀστρονόμον ἧτοι Σύνταξιν· καὶ ἄλλα.

^a A similar passage (i. 24, ed. H. Schöne 62. 11-20) asserts that the ratio of the side of a regular hendecagon to the diameter of the circumscribing circle is approximately $\frac{7}{25}$; and of this assertion also it is said δέδεικται δὲ ἐν τοῖς περὶ τῶν ἐν κύκλῳ εὐθειῶν. These are presumably the works of Hipparchus and Menelaus, though this opinion is controverted by A. Rome, "Premiers essais de trigonométrie rectiligne chez les Grecs" in *L'Antiquité classique*, t. 2 (1933), pp. 177-192. The assertions are equivalent to saying that $\sin 20^\circ$ is approximately 0.333... and $\sin 16^\circ 21' 49''$ is approximately 0.28.

^b Nothing else is certainly known of the life of Ptolemy except, as can be gleaned from his own works, that he made observations between A.D. 125 and 141 (or perhaps 151). Arabian traditions add details on which too much reliance should not be placed. Suidas's statement that he was born

TRIGONOMETRY

duced to M, and let MZ be joined. Then the triangle EZM is given in the enneagon. But it has been proved in the works on chords in a circle that $ZE : EM$ is approximately $\frac{1}{3}$.^a

2. PTOLEMY

(a) GENERAL

Suidas, *s.v.* *Ptolemaeus*

Ptolemy, called Claudius, an Alexandrian, a philosopher, born in the time of the Emperor Marcus. He wrote *Mechanics*, three books, *On the Phases and Seasons of the Fixed Stars*, two books, *Explanation of the Surface of a Sphere*, *A Ready Reckoner*, the *Great Astronomy* or *Syntaxis*; and others.^b

in the time of the Emperor Marcus [Aurelius] is not accurate as Marcus reigned from A.D. 161 to 180.

Ptolemy's *Mechanics* has not survived in any form; but the books *On Balancings* and *On the Elements* mentioned by Simplicius may have been contained in it. The lesser astronomical works of Ptolemy published in the second volume of Heiberg's edition of Ptolemy include, in Greek, *Φάσεις ἀπλανῶν ἀστέρων καὶ συναγωγὴ ἐπισημασιῶν* and *Προχείρων κανόνων διάταξις καὶ ψηφοφορία*, which can be identified with two titles in Suidas's notice. In the same edition is the *Planisphaerium*, a Latin translation from the Arabic, which can be identified with the *Ἀπλωσις ἐπιφανείας σφαίρας* of Suidas; it is an explanation of the *stereographic* system of projection by which points on the heavenly sphere are represented on the equatorial plane by projection from a pole—circles are projected into circles, as Ptolemy notes, except great circles through the poles, which are projected into straight lines.

Allied to this, but not mentioned by Suidas, is Ptolemy's *Analemma*, which explains how points on the heavenly sphere can be represented as points on a plane by means of *orthogonal* projection upon three planes mutually at right angles—

GREEK MATHEMATICS

Simpl. in *De caelo* iv. 4 (Aristot. 311 b 1),
ed. Heiberg 710. 14-19

Πτολεμαῖος δὲ ὁ μαθηματικὸς ἐν τῷ Περὶ ῥοπῶν τὴν ἐναντίαν ἔχων τῷ Ἀριστοτέλει δόξαν πειρᾶται κατασκευάζειν καὶ αὐτός, ὅτι ἐν τῇ ἑαυτῶν χώρᾳ οὔτε τὸ ὕδωρ οὔτε ὁ ἀήρ ἔχει βάρους. καὶ ὅτι μὲν τὸ ὕδωρ οὐκ ἔχει, δείκνυσιν ἐκ τοῦ τοὺς καταδύοντας μὴ αἰσθάνεσθαι βάρους τοῦ ἐπικειμένου ὕδατος, καίτοι τινὰς εἰς πολὺ καταδύοντας βάθος.

Ibid. i. 2, 269 a 9, ed. Heiberg 20. 11

Πτολεμαῖος ἐν τῷ Περὶ τῶν στοιχείων βιβλίῳ καὶ ἐν τοῖς Ὀπτικοῖς . . .

Ibid. i. 1, 268 a 6, ed. Heiberg 9. 21-27

Ὁ δὲ θαυμαστὸς Πτολεμαῖος ἐν τῷ Περὶ διαστάσεως μονοβίβλῳ ἀπέδειξεν, ὅτι οὐκ εἰσὶ

the meridian, the horizontal and the "prime vertical." Only fragments of the Greek and a Latin version from the Arabic have survived; they are given in Heiberg's second volume.

Among the "other works" mentioned by Suidas are presumably the *Inscription in Canopus* (a record of some of Ptolemy's discoveries), which exists in Greek; the *Ἐπιπέσεις τῶν πλανωμένων*, of which the first book is extant in Greek and the second in Arabic; and the *Optics* and the book *On Dimension* mentioned by Simplicius.

But Ptolemy's fame rests most securely on his *Great Astronomy* or *Syntaxis* as it is called by Suidas. Ptolemy himself called this majestic astronomical work in thirteen books the *Μαθηματικὴ σύνταξις* or *Mathematical Collection*. In due course the lesser astronomical works came to be called the *Μικρὸς ἀστρονομούμενος* (*τόπος*), the *Little Astronomy*, and the *Syntaxis* came to be called the *Μεγάλῃ σύνταξις*, or *Great Collection*. Later still the Arabs, combining their article *Al*

TRIGONOMETRY

Simplicius, *Commentary on Aristotle's De caelo* iv. 4
(311 b 1), ed. Heiberg 710. 14-19

Ptolemy the mathematician in his work *On Balancings* maintains an opinion contrary to that of Aristotle and tries to show that in its own place neither water nor air has weight. And he proves that water has not weight from the fact that divers do not feel the weight of the water above them, even though some of them dive into considerable depths.

Ibid. i. 2, 269 a 9, ed. Heiberg 20. 11

Ptolemy in his book *On the Elements* and in his *Optics* . . .^a

Ibid. i. 1, 268 a 6, ed. Heiberg 9. 21-27

The gifted Ptolemy in his book *On Dimension* showed that there are not more than three dimen-

with the Greek superlative μέγιστος, called it Al-majisti; corrupted into *Almagest*, this has since been the favourite name for the work.

The *Syntaxis* was the subject of commentaries by Pappus and Theon of Alexandria. The trigonometry in it appears to have been abstracted from earlier treatises, but condensed and arranged more systematically.

Ptolemy's attempt to prove the parallel-postulate has already been noticed (*supra*, pp. 372-383).

^a Ptolemy's *Optics* exists in an Arabic version, which was translated into Latin in the twelfth century by Admiral Eugenius Siculus (v. G. Govi, *L'ottica di Claudio Tolomeo di Eugenio Ammiraglio di Sicilia*); but of the five books the first and the end of the last are missing. Until the Arabic text was discovered, Ptolemy's *Optics* was commonly supposed to be identical with the Latin work known as *De Speculis*; but this is now thought to be a translation of Heron's *Catoptrica* by William of Moerbeke (v. *infra*, p. 502 n. a).

GREEK MATHEMATICS

πλείονες τῶν τριῶν διαστάσεις, ἐκ τοῦ δεῖν μὲν τὰς διαστάσεις ὠρισμένας εἶναι, τὰς δὲ ὠρισμένας διαστάσεις κατ' εὐθείας λαμβάνεσθαι καθέτους, τρεῖς δὲ μόνas πρὸς ὀρθὰς ἀλλήλαις εὐθείας δυνατόν εἶναι λαβεῖν, δύο μὲν καθ' ἃς τὸ ἐπίπεδον ὀρίζεται, τρίτην δὲ τὴν τὸ βάθος μετροῦσαν· ὥστε, εἴ τις εἴη μετὰ τὴν τριχῆ διάστασιν ἄλλη, ἄμετρος ἂν εἴη παντελῶς καὶ ἀόριστος.

(b) TABLE OF SINES

(i.) Introduction

Ptol. *Math. Syn.* i. 10, ed. Heiberg i. pars i. 31. 7-32. 9

ι'. Περὶ τῆς πηλικότητος τῶν ἐν τῷ κύκλῳ εὐθειῶν

Πρὸς μὲν οὖν τὴν ἐξ ἐτοίμου χρήσιν κανονικὴν τινα μετὰ ταῦτα ἔκθεσιν ποιησόμεθα τῆς πηλικότητος αὐτῶν τὴν μὲν περίμετρον εἰς $\overline{\tau\zeta}$ τμήματα διελόντες, παρατιθέντες δὲ τὰς ὑπὸ τὰς καθ' ἡμμοίριον παραυξήσεις τῶν περιφερειῶν ὑποτεινομένας εὐθείας, τουτέστι πόσων εἰσὶν τμημάτων ὡς τῆς διαμέτρου διὰ τὸ ἐξ αὐτῶν τῶν ἐπιλογισμῶν φανησόμενον ἐν τοῖς ἀριθμοῖς εὐχρηστον εἰς $\overline{\rho\kappa}$ τμήματα διηρημένης. πρότερον δὲ δεῖξομεν, πῶς ἂν ὡς ἐνὶ μάλιστα δι' ὀλίγων καὶ τῶν αὐτῶν θεωρημάτων εὐμεθόδευτον καὶ ταχεῖαν τὴν ἐπιβολὴν τὴν πρὸς τὰς πηλικότητας αὐτῶν ποιούμεθα, ὅπως μὴ μόνον ἐκτεθειμένα τὰ μεγέθη τῶν εὐθειῶν ἔχωμεν ἀνεπιστάτως, ἀλλὰ καὶ διὰ τῆς ἐκ τῶν γραμμῶν μεθοδικῆς αὐτῶν συστάσεως τὸν ἔλεγχον ἐξ εὐχεροῦς μεταχειριζόμεθα. καθόλου

TRIGONOMETRY

sions ; for dimensions must be determinate, and determinate dimensions are along perpendicular straight lines, and it is not possible to find more than three straight lines at right angles one to another, two of them determining a plane and the third measuring depth ; therefore, if any other were added after the third dimension, it would be completely unmeasurable and undetermined.

(b) TABLE OF SINES

(i.) *Introduction*

Ptolemy, *Syntaxis* i. 10, ed. Heiberg i. pars i. 31. 7-32. 9

10. On the lengths of the chords in a circle

With a view to obtaining a table ready for immediate use, we shall next set out the lengths of these [chords in a circle], dividing the perimeter into 360 segments and by the side of the arcs placing the chords subtending them for every increase of half a degree, that is, stating how many parts they are of the diameter, which it is convenient for the numerical calculations to divide into 120 segments. But first we shall show how to establish a systematic and rapid method of calculating the lengths of the chords by means of the uniform use of the smallest possible number of propositions, so that we may not only have the sizes of the chords set out correctly, but may obtain a convenient proof of the method of calculating them based on geometrical considera-

GREEK MATHEMATICS

μέντοι χρῆσόμεθα ταῖς τῶν ἀριθμῶν ἐφόδοις κατὰ τὸν τῆς ἐξηκοντάδος τρόπον διὰ τὸ δύσχρηστον τῶν μοριασμῶν ἔτι τε τοῖς πολυπλασιασμοῖς καὶ μερισμοῖς ἀκολουθήσομεν τοῦ συνεγγίζοντος ἀεὶ καταστοχαζόμενοι, καὶ καθ' ὅσον ἂν τὸ παραλειπόμενον μηδενὶ ἀξιολόγῳ διαφέρῃ τοῦ πρὸς αἴσθησιν ἀκριβοῦς.

(ii.) $\sin 18^\circ$ and $\sin 36^\circ$

Ibid. 32. 10–35. 16

Ἔστω δὴ πρῶτον ἡμικύκλιον τὸ ΑΒΓ ἐπὶ διαμέτρου τῆς ΑΔΓ περὶ κέντρον τὸ Δ, καὶ ἀπὸ τοῦ Δ τῇ ΑΓ πρὸς ὀρθὰς γωνίας ἤχθω ἡ ΔΒ, καὶ τετμήσθω δίχα ἡ ΔΓ κατὰ τὸ Ε, καὶ ἐπεζεύχθω ἡ ΕΒ, καὶ κείσθω αὐτῇ ἴση ἡ ΕΖ, καὶ ἐπεζεύχθω ἡ ΖΒ. λέγω, ὅτι ἡ μὲν ΖΔ δεκαγώνου ἐστὶν πλευρά, ἡ δὲ ΒΖ πενταγώνου.

^a By διὰ τῆς ἐκ τῶν γραμμῶν μεθοδικῆς συστάσεως Ptolemy meant more than a graphical method; the phrase indicates a *rigorous proof* by means of geometrical considerations, as will be seen when the argument proceeds; cf. the use of διὰ τῶν γραμμῶν *infra*, p. 434. It may be inferred, therefore, that when Hipparchus proved "by means of lines" (διὰ τῶν γραμμῶν, *On the Phaenomena of Eudoxus and Aratus*, ed. Manitius 148-150) certain facts about the risings of stars, he used rigorous, and not merely graphical calculations; in other words, he was familiar with the main formulae of spherical trigonometry.

^b *i.e.*, ΖΔ is equal to the side of a regular dodecagon, and ΒΖ to the side of a regular pentagon, inscribed in the circle ΑΒΓ.

TRIGONOMETRY

tions.^a In general we shall use the sexagesimal system for the numerical calculations owing to the inconvenience of having fractional parts, especially in multiplications and divisions, and we shall aim at a continually closer approximation, in such a manner that the difference from the correct figure shall be inappreciable and imperceptible.

(ii.) $\sin 18^\circ$ and $\sin 36^\circ$

Ibid. 32. 10–35. 16

First, let $AB\Gamma$ be a semicircle on the diameter $A\Delta\Gamma$ and with centre Δ , and from Δ let ΔB be drawn per-

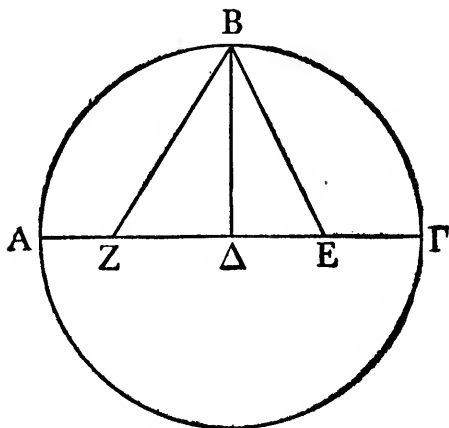

pendicular to $A\Gamma$, and let $\Delta\Gamma$ be bisected at E , and let EB be joined, and let EZ be placed equal to it, and let ZB be joined. I say that $Z\Delta$ is the side of a decagon, and BZ of a pentagon.^b

GREEK MATHEMATICS

Ἐπεὶ γὰρ εὐθεία γραμμὴ ἡ $\Delta\Gamma$ τέτμηται δίχα κατὰ τὸ E , καὶ πρόσκειται τις αὐτῇ εὐθεία ἡ ΔZ , τὸ ὑπὸ τῶν ΓZ καὶ $Z\Delta$ περιεχόμενον ὀρθογώνιον μετὰ τοῦ ἀπὸ τῆς $E\Delta$ τετραγώνου ἴσον ἐστὶν τῷ ἀπὸ τῆς EZ τετραγώνῳ, τουτέστιν τῷ ἀπὸ τῆς BE , ἐπεὶ ἴση ἐστὶν ἡ EB τῇ ZE . ἀλλὰ τῷ ἀπὸ τῆς EB τετραγώνῳ ἴσα ἐστὶ τὰ ἀπὸ τῶν $E\Delta$ καὶ ΔB τετράγωνα· τὸ ἄρα ὑπὸ τῶν ΓZ καὶ $Z\Delta$ περιεχόμενον ὀρθογώνιον μετὰ τοῦ ἀπὸ τῆς ΔE τετραγώνου ἴσον ἐστὶν τοῖς ἀπὸ τῶν $E\Delta$, ΔB τετραγώνοις. καὶ κοινοῦ ἀφαιρεθέντος τοῦ ἀπὸ τῆς $E\Delta$ τετραγώνου λοιπὸν τὸ ὑπὸ τῶν ΓZ καὶ $Z\Delta$ ἴσον ἐστὶν τῷ ἀπὸ τῆς ΔB , τουτέστιν τῷ ἀπὸ τῆς $\Delta\Gamma$ · ἡ $Z\Gamma$ ἄρα ἄκρον καὶ μέσον λόγον τέτμηται κατὰ τὸ Δ . ἐπεὶ οὖν ἡ τοῦ ἑξαγώνου καὶ ἡ τοῦ δεκαγώνου πλευρὰ τῶν εἰς τὸν αὐτὸν κύκλον ἐγγραφομένων ἐπὶ τῆς αὐτῆς εὐθείας ἄκρον καὶ μέσον λόγον τέμνονται, ἡ δὲ $\Gamma\Delta$ ἐκ τοῦ κέντρου οὔσα τὴν τοῦ ἑξαγώνου περιέχει πλευράν, ἡ ΔZ ἄρα ἐστὶν ἴση τῇ τοῦ δεκαγώνου πλευρᾷ. ὁμοίως δέ, ἐπεὶ ἡ τοῦ πενταγώνου πλευρὰ δύναται τὴν τε τοῦ ἑξαγώνου καὶ τὴν τοῦ δεκαγώνου τῶν εἰς τὸν αὐτὸν κύκλον ἐγγραφομένων, τοῦ δὲ $B\Delta Z$ ὀρθογωνίου τὸ ἀπὸ τῆς BZ τετράγωνον ἴσον ἐστὶν τῷ τε ἀπὸ τῆς $B\Delta$, ἥτις ἐστὶν ἑξαγώνου πλευρά, καὶ τῷ ἀπὸ τῆς ΔZ , ἥτις ἐστὶν δεκαγώνου πλευρά, ἡ BZ ἄρα ἴση ἐστὶν τῇ τοῦ πενταγώνου πλευρᾷ.

Ἐπεὶ οὖν, ὡς ἔφην, ὑποτιθέμεθα τὴν τοῦ κύκλου διάμετρον τμημάτων $\overline{ρκ}$, γίνεται διὰ τὰ προκείμενα ἡ μὲν ΔE ἡμίσεια οὔσα τῆς ἐκ τοῦ κέντρου

* Following the usual practice, I shall denote *segments* (τμήματα) of the diameter by ρ , sixtieth parts of a *τμήμα* by

TRIGONOMETRY

For since the straight line $\Delta\Gamma$ is bisected at E, and the straight line ΔZ is added to it,

$$\begin{aligned} \Gamma Z \cdot Z\Delta + E\Delta^2 &= EZ^2 && [\text{Eucl. ii. 6}] \\ &= BE^2, \end{aligned}$$

since $EB = ZE$.

But $E\Delta^2 + \Delta B^2 = EB^2$; [Eucl. i. 47]

therefore $\Gamma Z \cdot Z\Delta + E\Delta^2 = E\Delta^2 + \Delta B^2$.

When the common term $E\Delta^2$ is taken away,

the remainder $\Gamma Z \cdot Z\Delta = \Delta B^2$

i.e., $\Gamma Z \cdot Z\Delta = \Delta\Gamma^2$;

therefore $Z\Gamma$ is divided in extreme and mean ratio at Δ [Eucl. vi., Def. 3]. Therefore, since the side of the hexagon and the side of the decagon inscribed in the same circle when placed in one straight line are cut in extreme and mean ratio [Eucl. xiii. 9], and $\Gamma\Delta$, being a radius, is equal to the side of the hexagon [Eucl. iv. 15, coroll.], therefore ΔZ is equal to the side of the decagon. Similarly, since the square on the side of the pentagon is equal to the rectangle contained by the side of the hexagon and the side of the decagon inscribed in the same circle [Eucl. xiii. 10], and in the right-angled triangle $B\Delta Z$ the square on BZ is equal [Eucl. i. 47] to the sum of the squares on $B\Delta$, which is a side of the hexagon, and ΔZ , which is a side of the decagon, therefore BZ is equal to the side of the pentagon.

Then since, as I said, we made the diameter ^a consist of 120^p , by what has been stated ΔE , being half the numeral with a single accent, and second-sixtieths by the numeral with two accents. As the circular associations of the system tend to be forgotten, and it is used as a general system of enumeration, the same notation will be used for the *squares* of parts.

GREEK MATHEMATICS

τμημάτων λ καὶ τὸ ἀπ' αὐτῆς $\overline{\lambda}$, ἡ δὲ ΒΔ ἐκ τοῦ
 κέντρου οὔσα τμημάτων ξ καὶ τὸ ἀπὸ αὐτῆς $\overline{\gamma\chi}$,
 τὸ δὲ ἀπὸ τῆς ΕΒ, τουτέστιν τὸ ἀπὸ τῆς ΕΖ, τῶν
 ἐπὶ τὸ αὐτὸ $\overline{\delta\phi}$ μήκει ἄρα ἔσται ἡ ΕΖ τμημάτων
 $\overline{\xi\zeta}$ δ $\overline{\nu\epsilon}$ ἔγγιστα, καὶ λοιπὴ ἡ ΔΖ τῶν αὐτῶν $\overline{\lambda\zeta}$
 δ $\overline{\nu\epsilon}$. ἡ ἄρα τοῦ δεκαγώνου πλευρά, ὑποτείνουσα
 δὲ περιφέρειαν τοιούτων $\overline{\lambda\sigma}$, οἷων ἔστιν ὁ κύκλος
 $\overline{\tau\epsilon}$, τοιούτων ἔσται $\overline{\lambda\zeta}$ δ $\overline{\nu\epsilon}$, οἷων ἡ διάμετρος $\overline{\rho\kappa}$.
 πάλιν ἐπεὶ ἡ μὲν ΔΖ τμημάτων ἔστι $\overline{\lambda\zeta}$ δ $\overline{\nu\epsilon}$, τὸ
 δὲ ἀπὸ αὐτῆς $\overline{\alpha\tau\omicron\epsilon}$ δ $\overline{\iota\epsilon}$, ἔστι δὲ καὶ τὸ ἀπὸ τῆς
 ΔΒ τῶν αὐτῶν $\overline{\gamma\chi}$, ἃ συντεθέντα ποιεῖ τὸ ἀπὸ
 τῆς ΒΖ τετραγώνων $\overline{\delta\lambda\omicron\epsilon}$ δ $\overline{\iota\epsilon}$, μήκει ἄρα ἔσται
 ἡ ΒΖ τμημάτων ὁ $\overline{\lambda\beta}$ γ ἔγγιστα. καὶ ἡ τοῦ πεντα-
 γώνου ἄρα πλευρά, ὑποτείνουσα δὲ μοίρας $\overline{\omicron\beta}$,
 οἷων ἔστιν ὁ κύκλος $\overline{\tau\epsilon}$, τοιούτων ἔστιν ὁ $\overline{\lambda\beta}$ γ,
 οἷων ἡ διάμετρος $\overline{\rho\kappa}$.

Φανερόν δὲ αὐτόθεν, ὅτι καὶ ἡ τοῦ ἑξαγώνου
 πλευρά, ὑποτείνουσα δὲ μοίρας ξ , καὶ ἴση οὔσα
 τῇ ἐκ τοῦ κέντρου, τμημάτων ἔστιν ξ . ὁμοίως
 δέ, ἐπεὶ ἡ μὲν τοῦ τετραγώνου πλευρά, ὑποτείνουσα
 δὲ μοίρας ζ , δυνάμει διπλασία ἔστιν τῆς ἐκ τοῦ
 κέντρου, ἡ δὲ τοῦ τριγώνου πλευρά, ὑποτείνουσα
 δὲ μοίρας $\overline{\rho\kappa}$, δυνάμει τῆς αὐτῆς ἔστιν τριπλασίων,
 τὸ δὲ ἀπὸ τῆς ἐκ τοῦ κέντρου τμημάτων ἔστιν $\overline{\gamma\chi}$,
 συναχθήσεται τὸ μὲν ἀπὸ τῆς τοῦ τετραγώνου
 πλευρᾶς $\overline{\zeta\sigma}$, τὸ δὲ ἀπὸ τῆς τοῦ τριγώνου $\overline{\mu\omega}$.
 ὥστε καὶ μήκει ἡ μὲν τὰς ζ μοίρας ὑποτείνουσα
 εὐθεία τοιούτων ἔσται $\overline{\pi\delta}$ $\overline{\nu\alpha}$ $\overline{\iota}$ ἔγγιστα, οἷων ἡ

TRIGONOMETRY

of the radius, consists of 30^p and its square of 900^p , and $B\Delta$, being the radius, consists of 60^p and its square of 3600^p , while EB^2 , that is EZ^2 , consists of 4500^p ; therefore EZ is approximately $67^p 4' 55''$,^a and the remainder ΔZ is $37^p 4' 55''$. Therefore the side of the decagon, subtending an arc of 36° (the whole circle consisting of 360°), is $37^p 4' 55''$ (the diameter being 120^p). Again, since ΔZ is $37^p 4' 55''$, its square is $1375^p 4' 15''$, and the square on ΔB is 3600^p , which added together make the square on BZ $4975^p 4' 15''$, so that BZ is approximately $70^p 32' 3''$. And therefore the side of the pentagon, subtending 72° (the circle consisting of 360°), is $70^p 32' 3''$ (the diameter being 120^p).

Hence it is clear that the side of the hexagon, subtending 60° and being equal to the radius, is 60^p . Similarly, since the square on the side of the square,^b subtending 90° , is double of the square on the radius, and the square on the side of the triangle, subtending 120° , is three times the square on the radius, while the square on the radius is 3600^p , the square on the side of the square is 7200^p and the square on the side of the triangle is 10800^p . Therefore the chord subtending 90° is approximately $84^p 51' 10''$ (the diameter

^a Theon's proof that $\sqrt{4500}$ is approximately $67^p 4' 55''$ has already been given (vol. i. pp. 56-61).

^b This is, of course, the square itself; the Greek phrase is not so difficult. We could translate, "the second power of the side of the square," but the notion of powers was outside the ken of the Greek mathematician.

GREEK MATHEMATICS

διάμετρος $\overline{\rho\kappa}$, ἢ δὲ τὰς $\overline{\rho\kappa}$ τῶν αὐτῶν $\overline{\rho\gamma}$
 $\overline{\nu\epsilon}$ $\overline{\kappa\gamma}$.

$$(iii.) \sin^2 \theta + \cos^2 \theta = 1$$

Ibid. 35. 17-36. 12

Αἶδε μὲν οὕτως ἡμῖν ἐκ προχείρου καὶ καθ' αὐτὰς εἰλήφθωσαν, καὶ ἔσται φανερόν ἐντεῦθεν, ὅτι τῶν διδομένων εὐθειῶν ἐξ εὐχεροῦς δίδονται καὶ αἱ ὑπὸ τὰς λειπούσας εἰς τὸ ἡμικύκλιον περιφερείας ὑποτείνουσαι διὰ τὸ τὰ ἀπ' αὐτῶν συντιθέμενα ποιεῖν τὸ ἀπὸ τῆς διαμέτρου τετράγωνον οῖον, ἐπειδὴ ἢ ὑπὸ τὰς $\overline{\lambda\sigma}$ μοίρας εὐθεῖα τμημάτων ἐδείχθη $\overline{\lambda\zeta}$ δ' $\overline{\nu\epsilon}$ καὶ τὸ ἀπ' αὐτῆς $\overline{\alpha\tau\omicron\epsilon}$ δ' $\overline{\iota\epsilon}$, τὸ δὲ ἀπὸ τῆς διαμέτρου τμημάτων ἐστὶν \overline{M}^a $\overline{\delta\nu}$, ἔσται καὶ τὸ μὲν ἀπὸ τῆς ὑποτεινούσης τὰς λειπούσας εἰς τὸ ἡμικύκλιον μοίρας $\overline{\rho\mu\delta}$ τῶν λοιπῶν

^a Let AB be a chord of a circle subtending an angle α at the centre O, and let AKA' be drawn perpendicular to OB so as to meet OB in K and the circle again in A'. Then

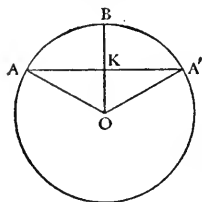

$$\sin \alpha (= \sin AB) = \frac{AK}{AO} = \frac{\frac{1}{2}AA'}{AO}.$$

And AA' is the chord subtended by double of the arc AB, while Ptolemy expresses the lengths of chords as so many 120th parts of the diameter; therefore $\sin \alpha$ is half the chord subtended by an angle 2α at the centre, which is conveniently abbreviated by

Heath to $\frac{1}{2}(\text{crd. } 2\alpha)$, or, as we may alternatively express the relationship, $\sin AB$ is "half the chord subtended by

TRIGONOMETRY

consisting of 120^p), and the chord subtending 120° is $103^p 55' 23''$.^a

$$(iii.) \sin^2 \theta + \cos^2 \theta = 1$$

Ibid. 35. 17-36. 12

The lengths of these chords have thus been obtained immediately and by themselves,^b and it will be thence clear that, among the given straight lines, the lengths are immediately given of the chords subtending the remaining arcs in the semicircle, by reason of the fact that the sum of the squares on these chords is equal to the square on the diameter; for example, since the chord subtending 36° was shown to be $37^p 4' 55''$ and its square $1375^p 4' 15''$, while the square on the diameter is 14400^p , therefore the square on the chord subtending the remaining 144° in the semicircle is

double of the arc AB," which is the Ptolemaic form; as Ptolemy means by this expression precisely what we mean by $\sin AB$, I shall interpolate the trigonometrical notation in the translation wherever it occurs. It follows that $\cos a$ [$=\sin(90 - a)$] = $\frac{1}{2}$ crd. ($180^\circ - 2a$), or, as Ptolemy says, "half the chord subtended by the remaining angle in the semicircle." Tan a and the other trigonometrical ratios were not used by the Greeks.

In the passage to which this note is appended Ptolemy proves that

- side of decagon (= crd. $36^\circ = 2 \sin 18^\circ$) = $37^p 4' 55''$,
- side of pentagon (= crd. $72^\circ = 2 \sin 36^\circ$) = $70^p 32' 3''$,
- side of hexagon (= crd. $60^\circ = 2 \sin 30^\circ$) = 60^p ,
- side of square (= crd. $90^\circ = 2 \sin 45^\circ$) = $84^p 51' 10''$,
- side of equilateral triangle (= crd. $120^\circ = 2 \sin 60^\circ$) = $103^p 55' 23''$.

^b *i.e.*, not deduced from other known chords.

GREEK MATHEMATICS

$\overset{\circ}{M}, \overline{\gamma\kappa\delta} \overline{\nu\epsilon} \overline{\mu\epsilon}$, αὐτὴ δὲ μήκει τῶν αὐτῶν $\overline{\rho\iota\delta} \xi \overline{\lambda\zeta}$ ἔγγιστα, καὶ ἐπὶ τῶν ἄλλων ὁμοίως.

Ὁν δὲ τρόπον ἀπὸ τούτων καὶ αἱ λοιπαὶ τῶν κατὰ μέρος δοθήσονται, δείξομεν ἐφεξῆς προεκθέμενοι λημμάτιον εὐχρηστον πάνυ πρὸς τὴν παροῦσαν πραγματείαν.

(iv.) " Ptolemy's Theorem "

Ibid. 36. 13-37. 18

Ἐστω γὰρ κύκλος ἐγγεγραμμένον ἔχων τετράπλευρον τυχὸν τὸ ΑΒΓΔ, καὶ ἐπεζεύχθωσαν αἱ ΑΓ καὶ ΒΔ. δεικτέον, ὅτι τὸ ὑπὸ τῶν ΑΓ καὶ ΒΔ περιεχόμενον ὀρθογώνιον ἴσον ἐστὶ συναμφοτέροις τῷ τε ὑπὸ τῶν ΑΒ, ΔΓ καὶ τῷ ὑπὸ τῶν ΑΔ, ΒΓ.

Κείσθω γὰρ τῇ ὑπὸ τῶν ΔΒΓ γωνίᾳ ἴση ἡ ὑπὸ ΑΒΕ. ἐὰν οὖν κοινὴν προσθῶμεν τὴν ὑπὸ ΕΒΔ,

* *i.e.*, crd. $144^\circ (= 2 \sin 72^\circ) = 114^\circ 7' 37''$. If the given chord subtends an angle 2θ at the centre, the chord subtended by the remaining arc in the semicircle subtends an angle $(180 - 2\theta)$, and the theorem asserts that

$$(\text{crd. } 2\theta)^2 + (\text{crd. } 180 - 2\theta)^2 = (\text{diameter})^2,$$

or $\sin^2 \theta + \cos^2 \theta = 1.$

TRIGONOMETRY

13024^p 55' 45" and the chord itself is approximately 114^p 7' 37", and similarly for the other chords.^a

We shall explain in due course the manner in which the remaining chords obtained by subdivision can be calculated from these, setting out by way of preface this little lemma which is exceedingly useful for the business in hand.

(iv.) " *Ptolemy's Theorem* "

Ibid. 36. 13-37. 18

Let $AB\Gamma\Delta$ be any quadrilateral inscribed in a circle, and let $A\Gamma$ and $B\Delta$ be joined. It is required to prove that the rectangle contained by $A\Gamma$ and $B\Delta$ is equal to the sum of the rectangles contained by AB , $\Delta\Gamma$ and $A\Delta$, $B\Gamma$.

For let the angle ABE be placed equal to the angle

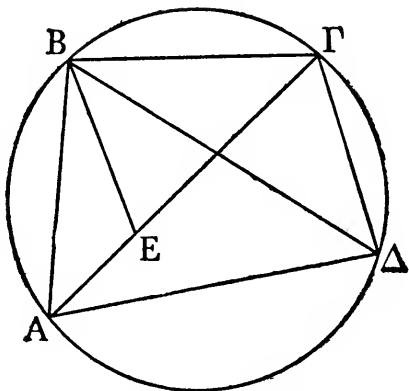

$\Delta B\Gamma$. Then if we add the angle $EB\Delta$ to both, the

GREEK MATHEMATICS

ἔσται καὶ ἡ ὑπὸ ΑΒΔ γωνία ἴση τῇ ὑπὸ ΕΒΓ. ἔστιν δὲ καὶ ἡ ὑπὸ ΒΔΑ τῇ ὑπὸ ΒΓΕ ἴση· τὸ γὰρ αὐτὸ τμήμα ὑποτείνουσιν· ἰσογώνιον ἄρα ἐστὶν τὸ ΑΒΔ τρίγωνον τῷ ΒΓΕ τριγώνῳ. ὥστε καὶ ἀνάλογόν ἐστιν, ὡς ἡ ΒΓ πρὸς τὴν ΓΕ, οὕτως ἡ ΒΔ πρὸς τὴν ΔΑ· τὸ ἄρα ὑπὸ ΒΓ, ΑΔ ἴσον ἐστὶν τῷ ὑπὸ ΒΔ, ΓΕ. πάλιν ἐπεὶ ἴση ἐστὶν ἡ ὑπὸ ΑΒΕ γωνία τῇ ὑπὸ ΔΒΓ γωνία, ἔστιν δὲ καὶ ἡ ὑπὸ ΒΑΕ ἴση τῇ ὑπὸ ΒΔΓ, ἰσογώνιον ἄρα ἐστὶν τὸ ΑΒΕ τρίγωνον τῷ ΒΓΔ τριγώνῳ· ἀνάλογον ἄρα ἐστὶν, ὡς ἡ ΒΑ πρὸς ΑΕ, ἡ ΒΔ πρὸς ΔΓ· τὸ ἄρα ὑπὸ ΒΑ, ΔΓ ἴσον ἐστὶν τῷ ὑπὸ ΒΔ, ΑΕ. ἐδείχθη δὲ καὶ τὸ ὑπὸ ΒΓ, ΑΔ ἴσον τῷ ὑπὸ ΒΔ, ΓΕ· καὶ ὅλον ἄρα τὸ ὑπὸ ΑΓ, ΒΔ ἴσον ἐστὶν συναμφοτέροις τῷ τε ὑπὸ ΑΒ, ΔΓ καὶ τῷ ὑπὲρ ΑΔ, ΒΓ· ὅπερ ἔδει δεῖξαι.

$$(v.) \sin(\theta - \phi) = \sin \theta \cos \phi - \cos \theta \sin \phi$$

Ibid. 37. 19-39. 3

Τούτου προεκτεθέντος ἔστω ἡμικύκλιον τὸ ΑΒΓΔ ἐπὶ διαμέτρου τῆς ΑΔ, καὶ ἀπὸ τοῦ Α δύο διήχθωσαν αἰ ΑΒ, ΑΓ, καὶ ἔστω ἑκάτερα αὐτῶν δοθείσα τῷ μεγέθει, οἷων ἡ διάμετρος δοθείσα $\overline{ρκ}$, καὶ ἐπεζεύχθω ἡ ΒΓ. λέγω, ὅτι καὶ αὕτη δέδοται.

Ἐπεζεύχθωσαν γὰρ αἰ ΒΔ, ΓΔ· δεδομένοι ἄρα εἰσὶν δηλονότι καὶ αὗται διὰ τὸ λείπειν ἐκείνων εἰς τὸ ἡμικύκλιον. ἐπεὶ οὖν ἐν κύκλῳ τετράπλευρόν ἐστὶν τὸ ΑΒΓΔ, τὸ ἄρα ὑπὸ ΑΒ, ΓΔ μετὰ τοῦ

TRIGONOMETRY

angle $AB\Delta =$ the angle $EB\Gamma$. But the angle $B\Delta A =$ the angle $B\Gamma E$ [Eucl. iii. 21], for they subtend the same segment; therefore the triangle $AB\Delta$ is equiangular with the triangle $B\Gamma E$.

$$\therefore B\Gamma : \Gamma E = B\Delta : \Delta A ; \quad [\text{Eucl. vi. 4}]$$

$$\therefore B\Gamma \cdot A\Delta = B\Delta \cdot \Gamma E. \quad [\text{Eucl. vi. 6}]$$

Again, since the angle ABE is equal to the angle $\Delta B\Gamma$, while the angle BAE is equal to the angle $B\Delta\Gamma$ [Eucl. iii. 21], therefore the triangle ABE is equiangular with the triangle $B\Gamma\Delta$;

$$\therefore BA : AE = B\Delta : \Delta\Gamma ; \quad [\text{Eucl. vi. 4}]$$

$$\therefore BA \cdot \Delta\Gamma = B\Delta \cdot AE. \quad [\text{Eucl. vi. 6}]$$

But it was shown that

$$B\Gamma \cdot A\Delta = B\Delta \cdot \Gamma E ;$$

$$\text{and } \therefore A\Gamma \cdot B\Delta = AB \cdot \Delta\Gamma + A\Delta \cdot B\Gamma ; \quad [\text{Eucl. ii. 1}]$$

which was to be proved.

$$(v.) \sin(\theta - \phi) = \sin\theta \cos\phi - \cos\theta \sin\phi$$

Ibid. 37. 19-39. 3

This having first been proved, let $AB\Gamma\Delta$ be a semi-circle having $A\Delta$ for its diameter, and from A let the two [chords] $AB, A\Gamma$ be drawn, and let each of them be given in length, in terms of the 120^{p} in the diameter, and let $B\Gamma$ be joined. I say that this also is given.

For let $B\Delta, \Gamma\Delta$ be joined; then clearly these also are given because they are the chords subtending the remainder of the semicircle. Then since $AB\Gamma\Delta$ is a quadrilateral in a circle,

GREEK MATHEMATICS

ὑπὸ τῶν $ΑΔ$, $ΒΓ$ ἴσον ἐστὶν τῷ ὑπὸ $ΑΓ$, $ΒΔ$.
καὶ ἐστὶν τό τε ὑπὸ τῶν $ΑΓ$, $ΒΔ$ δοθέν καὶ τὸ

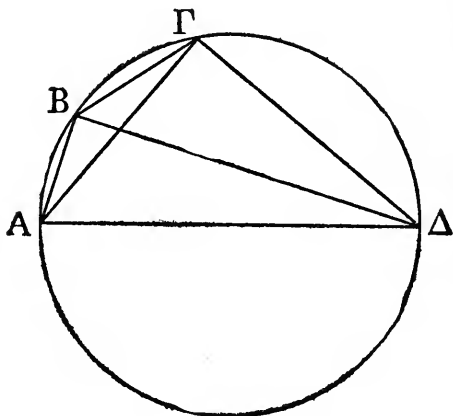

ὑπὸ $ΑΒ$, $ΓΔ$ · καὶ λοιπὸν ἄρα τὸ ὑπὸ $ΑΔ$, $ΒΓ$
δοθέν ἐστὶν· καὶ ἐστὶν ἡ $ΑΔ$ διάμετρος· δοθείσα
ἄρα ἐστὶν καὶ ἡ $ΒΓ$ εὐθεΐα.

Καὶ φανερόν ἡμῖν γέγονεν, ὅτι, ἐὰν δοθῶσιν δύο
περιφέρειαι καὶ αἱ ὑπ' αὐτὰς εὐθεΐαι, δοθείσα
ἔσται καὶ ἡ τὴν ὑπεροχὴν τῶν δύο περιφερειῶν
ὑποτείνουσα εὐθεΐα. δῆλον δέ, ὅτι διὰ τούτου τοῦ
θεωρήματος ἄλλας τε οὐκ ὀλίγας εὐθείας ἐγγρά-
φομεν ἀπὸ τῶν ἐν ταῖς καθ' αὐτὰς δεδομένων
ὑπεροχῶν καὶ δὴ καὶ τὴν ὑπὸ τὰς δώδεκα μοίρας,
ἐπειδήπερ ἔχομεν τὴν τε ὑπὸ τὰς ξ καὶ τὴν ὑπὸ
τὰς $\theta\beta$.

TRIGONOMETRY

$$AB \cdot \Gamma\Delta + A\Delta \cdot B\Gamma = A\Gamma \cdot B\Delta.$$

[“ Ptolemy’s theorem ”

And $A\Gamma \cdot B\Delta$ is given, and also $AB \cdot \Gamma\Delta$; therefore the remaining term $A\Delta \cdot B\Gamma$ is also given. And $A\Delta$ is the diameter; therefore the straight line $B\Gamma$ is given.*

And it has become clear to us that, if two arcs are given and the chords subtending them, the chord subtending the difference of the arcs will also be given. It is obvious that, by this theorem we can inscribe^b many other chords subtending the difference between given chords, and in particular we may obtain the chord subtending 12° , since we have that subtending 60° and that subtending 72° .

* If $A\Gamma$ subtends an angle 2θ and AB an angle 2ϕ at the centre, the theorem asserts that

$$\text{crd. } \overline{2\theta - 2\phi} \cdot (\text{crd. } 180^\circ) = (\text{crd. } 2\theta) \cdot (\text{crd. } \overline{180^\circ - 2\phi}) - (\text{crd. } 2\phi) \cdot (\text{crd. } 180^\circ - 2\theta)$$

i.e., $\sin(\theta - \phi) = \sin \theta \cos \phi - \cos \theta \sin \phi.$

^b Or “calculate,” as we might almost translate *ἐγγράψομεν*; cf. *supra*, p. 414 n. α on *ἐκ τῶν γραμμῶν*.

GREEK MATHEMATICS

$$(vi.) \sin^2 \frac{1}{2}\theta = \frac{1}{2}(1 - \cos \theta)$$

Ibid. 39. 4-41. 3

Πάλιν προκείσθω δοθείσης τινὸς εὐθείας ἐν κύκλῳ τὴν ὑπὸ τὸ ἥμισυ τῆς ὑποτεينوμένης περιφέρειας εὐθείαν εὐρεῖν. καὶ ἔστω ἡμικύκλιον τὸ ΑΒΓ ἐπὶ διαμέτρου τῆς ΑΓ καὶ δοθείσα εὐθεία ἡ ΓΒ, καὶ ἡ ΓΒ περιφέρεια δίχα τετμήσθω κατὰ τὸ Δ, καὶ ἐπεζεύχθωσαν αἱ ΑΒ, ΑΔ, ΒΔ, ΔΓ, καὶ ἀπὸ τοῦ Δ ἐπὶ τὴν ΑΓ κάθετος ἤχθω ἡ ΔΖ. λέγω, ὅτι ἡ ΖΓ ἡμίσειά ἐστι τῆς τῶν ΑΒ καὶ ΑΓ ὑπεροχῆς.

Κείσθω γὰρ τῇ ΑΒ ἴση ἡ ΑΕ, καὶ ἐπεζεύχθω ἡ ΔΕ. ἐπεὶ ἴση ἐστὶν ἡ ΑΒ τῇ ΑΕ, κοινὴ δὲ ἡ ΑΔ, δύο δὲ αἱ ΑΒ, ΑΔ δύο ταῖς ΑΕ, ΑΔ ἴσαι εἰσὶν ἑκατέρωθεν ἑκατέρωθεν. καὶ γωνία ἡ ὑπὸ ΒΑΔ γωνία τῇ ὑπὸ ΕΑΔ ἴση ἐστίν· καὶ βάσις ἄρα ἡ ΒΔ βάσει τῇ ΔΕ ἴση ἐστίν. ἀλλὰ ἡ ΒΔ τῇ ΔΓ ἴση ἐστίν· καὶ ἡ ΔΓ ἄρα τῇ ΔΕ ἴση ἐστίν. ἐπεὶ οὖν ἰσοσκελοῦς ὄντος τριγώνου τοῦ ΔΕΓ ἀπὸ τῆς κορυφῆς ἐπὶ τὴν βάσιν κάθετος ἤκται ἡ ΔΖ, ἴση ἐστὶν ἡ ΕΖ τῇ ΖΓ. ἀλλ' ἡ ΕΓ ὅλη ἡ ὑπεροχὴ ἐστὶν τῶν ΑΒ καὶ ΑΓ εὐθειῶν· ἡ ἄρα ΖΓ ἡμίσειά ἐστὶν τῆς τῶν αὐτῶν ὑπεροχῆς. ὥστε, ἐπεὶ τῆς ὑπὸ τὴν ΒΓ περιφέρειαν εὐθείας ὑποκειμένης

TRIGONOMETRY

$$(vi.) \sin^2 \frac{1}{2}\theta = \frac{1}{2}(1 - \cos \theta)$$

Ibid. 39. 4-41. 3

Again, given any chord in a circle, let it be required to find the chord subtending half the arc subtended by the given chord. Let $AB\Gamma$ be a semicircle upon the diameter $A\Gamma$ and let the chord ΓB be given, and

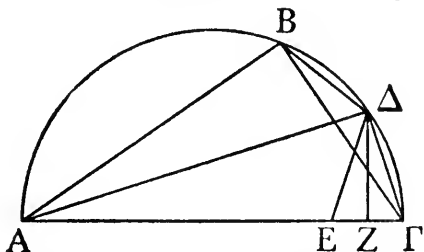

let the arc ΓB be bisected at Δ , and let $AB, A\Delta, B\Delta, \Delta\Gamma$ be joined, and from Δ let ΔZ be drawn perpendicular to $A\Gamma$. I say that $Z\Gamma$ is half of the difference between AB and $A\Gamma$.

For let AE be placed equal to AB , and let ΔE be joined. Since $AB = AE$ and $A\Delta$ is common, [in the triangles $AB\Delta, AE\Delta$] the two [sides] $AB, A\Delta$ are equal to $AE, A\Delta$ each to each; and the angle $BA\Delta$ is equal to the angle $EA\Delta$ [Eucl. iii. 27]; and therefore the base $B\Delta$ is equal to the base ΔE [Eucl. i. 4]. But $B\Delta = \Delta\Gamma$; and therefore $\Delta\Gamma = \Delta E$. Then since the triangle $\Delta E\Gamma$ is isosceles and ΔZ has been drawn from the vertex perpendicular to the base, $EZ = Z\Gamma$ [Eucl. i. 26]. But the whole $E\Gamma$ is the difference between the chords AB and $A\Gamma$; therefore $Z\Gamma$ is half of the difference. Thus, since the chord subtending the arc $B\Gamma$ is given, the chord AB subtending the remainder

αὐτόθεν δέδοται καὶ ἡ λείπουσα εἰς τὸ ἡμικύκλιον ἢ AB , δοθήσεται καὶ ἡ $ZΓ$ ἡμίσεια οὖσα τῆς τῶν $ΑΓ$ καὶ $ΑΒ$ ὑπεροχῆς· ἀλλ' ἐπεὶ ἐν ὀρθογωνίῳ τῷ $ΑΓΔ$ καθέτου ἀχθείσης τῆς $ΔΖ$ ἰσογώνιον γίνεται τὸ $ΑΔΓ$ ὀρθογώνιον τῷ $ΔΓΖ$, καὶ ἐστίν, ὡς ἡ $ΑΓ$ πρὸς $ΓΔ$, ἢ $ΓΔ$ πρὸς $ΓΖ$, τὸ ἄρα ὑπὸ τῶν $ΑΓ$, $ΓΖ$ περιεχόμενον ὀρθογώνιον ἴσον ἐστίν τῷ ἀπὸ τῆς $ΓΔ$ τετραγώνῳ. δοθὲν δὲ τὸ ὑπὸ τῶν $ΑΓ$, $ΓΖ$. δοθὲν ἄρα ἐστίν καὶ τὸ ἀπὸ τῆς $ΓΔ$ τετραγώνον. ὥστε καὶ μήκει ἡ $ΓΔ$ εὐθεία δοθήσεται τὴν ἡμίσειαν ὑποτείνουσα τῆς $ΒΓ$ περιφέρειας.

Καὶ διὰ τούτου δὴ πάλιν τοῦ θεωρήματος ἄλλαι τε ληφθήσονται πλείσται κατὰ τὰς ἡμισείας τῶν προεκτεθειμένων, καὶ δὴ καὶ ἀπὸ τῆς τὰς $\bar{\iota}\beta$ μοίρας ὑποτείνουσης εὐθείας ἢ τε ὑπὸ τὰς $\bar{\epsilon}$ καὶ ἢ ὑπὸ τὰς $\bar{\gamma}$ καὶ ἢ ὑπὸ τὴν μίαν ἡμισυ καὶ ἢ ὑπὸ τὸ ἡμισυ τέταρτον τῆς μιᾶς μοίρας. εὐρίσκομεν δὲ ἐκ τῶν ἐπιλογισμῶν τὴν μὲν ὑπὸ τὴν μίαν ἡμισυ μοῖραν τοιούτων $\bar{\alpha}$ $\bar{\lambda}\delta$ $\bar{\iota}\epsilon$ ἔγγιστα, οἷων ἐστίν ἡ διάμετρος $\bar{\rho}\kappa$, τὴν δὲ ὑπὸ τὸ \angle δ' τῶν αὐτῶν O $\bar{\mu}\zeta$ $\bar{\eta}$.

$$(vii.) \cos(\theta + \phi) = \cos \theta \cos \phi - \sin \theta \sin \phi$$

Ibid. 41. 4-43. 5

Πάλιν ἔστω κύκλος ὁ $ΑΒΓΔ$ περὶ διάμετρον μὲν τὴν $ΑΔ$, κέντρον δὲ τὸ Z , καὶ ἀπὸ τοῦ A ἀπειλήφθωσαν δύο περιφέρειαι δοθεῖσαι κατὰ τὸ ἐξῆς αἱ $ΑΒ$, $ΒΓ$, καὶ ἐπεζεύχθωσαν αἱ $ΑΒ$, $ΒΓ$ ὑπ' αὐτὰς εὐθεῖαι καὶ αὐταὶ δεδομένα. λέγω ὅτι, εἰ ἐπιζεύξωμεν τὴν $ΑΓ$, δοθήσεται καὶ αὐτή.

* If $ΒΓ$ subtends an angle 2θ at the centre the proposition asserts that

TRIGONOMETRY

of the semicircle is immediately given, and $Z\Gamma$ will also be given, being half of the difference between $A\Gamma$ and AB . But since the perpendicular ΔZ has been drawn in the right-angled triangle $A\Gamma\Delta$, the right-angled triangle $A\Delta\Gamma$ is equiangular with $\Delta\Gamma Z$ [Eucl. vi. 8], and

$$A\Gamma : \Gamma\Delta = \Gamma\Delta : \Gamma Z,$$

and therefore $A\Gamma \cdot \Gamma Z = \Gamma\Delta^2$.

But $A\Gamma \cdot \Gamma Z$ is given; therefore $\Gamma\Delta^2$ is also given. Therefore the chord $\Gamma\Delta$, subtending half of the arc $B\Gamma$, is also given.^a

And again by this theorem many other chords can be obtained as the halves of known chords, and in particular from the chord subtending 12° can be obtained the chord subtending 6° and that subtending 3° and that subtending $1\frac{1}{2}^\circ$ and that subtending $\frac{1}{2}^\circ + \frac{1}{4}^\circ (= \frac{3}{4}^\circ)$. We shall find, when we come to make the calculation, that the chord subtending $1\frac{1}{2}^\circ$ is approximately $1^p 34' 15''$ (the diameter being 120^p) and that subtending $\frac{3}{4}^\circ$ is $0^p 47' 8''$.^b

$$(vii.) \cos(\theta + \phi) = \cos \theta \cos \phi - \sin \theta \sin \phi$$

Ibid. 41. 4-43. 5

Again, let $AB\Gamma\Delta$ be a circle about the diameter $A\Delta$ and with centre Z , and from A let there be cut off in succession two given arcs AB , $B\Gamma$, and let there be joined AB , $B\Gamma$, which, being the chords subtending them, are also given. I say that, if we join $A\Gamma$, it also will be given.

$$(\text{crd. } \theta)^2 = \frac{1}{2}(\text{crd. } 180) \cdot \{(\text{crd. } 180^\circ) - \text{crd. } \overline{180^\circ - 2\theta}\}$$

i.e., $\sin^2 \frac{1}{2}\theta = \frac{1}{2}(1 - \cos \theta)$.

^b The symbol in the Greek for \circ should be noted; *v.* vol. i. p. 47 n. a.

GREEK MATHEMATICS

Διήχθω γὰρ διὰ τοῦ Β διάμετρος τοῦ κύκλου ἢ ΒΖΕ, καὶ ἐπέξεύχθωσαν αἱ ΒΔ, ΔΓ, ΓΕ, ΔΕ· δῆλον δὴ αὐτόθεν, ὅτι διὰ μὲν τὴν ΒΓ δοθήσεται καὶ ἡ ΓΕ, διὰ δὲ τὴν ΑΒ δοθήσεται ἢ τε ΒΔ καὶ ἡ ΔΕ. καὶ διὰ τὰ αὐτὰ τοῖς ἔμπροσθεν, ἐπεὶ ἐν κύκλῳ τετράπλευρόν ἐστὶν τὸ ΒΓΔΕ, καὶ διηγμένοι εἰσὶν αἱ ΒΔ, ΓΕ, τὸ ὑπὸ τῶν διηγμένων περιεχόμενον ὀρθογώνιον ἴσον ἐστὶν συναμφοτέροις τοῖς ὑπὸ τῶν ἀπεναντίον· ὥστε, ἐπεὶ δεδομένου τοῦ ὑπὸ τῶν ΒΔ, ΓΕ δέδοται καὶ τὸ ὑπὸ τῶν ΒΓ, ΔΕ, δέδοται ἄρα καὶ τὸ ὑπὸ ΒΕ, ΓΔ. δέδοται δὲ καὶ ἡ ΒΕ διάμετρος, καὶ λοιπὴ ἡ ΓΔ ἔσται δεδομένη, καὶ διὰ τοῦτο καὶ ἡ λείπουσα εἰς τὸ ἡμικύκλιον ἡ ΓΑ· ὥστε, ἐὰν δοθῶσιν δύο περιφέρειαι καὶ αἱ ὑπ' αὐτὰς εὐθεῖαι, δοθήσεται καὶ ἡ συναμφοτέρας τὰς περιφέρειάς κατὰ σύνθεσιν ὑποτείνουσα εὐθεῖα διὰ τούτου τοῦ θεωρήματος.

* If AB subtends an angle 2θ and BΓ an angle 2ϕ at the centre, the theorem asserts that

$$(\text{crd. } 180^\circ) \cdot (\text{crd. } \overline{180^\circ - 2\theta - 2\phi}) = (\text{crd. } \overline{180^\circ - 2\theta}) \cdot (\text{crd. } \overline{180^\circ - 2\phi}) - (\text{crd. } 2\theta) \cdot (\text{crd. } 2\phi),$$

$$\text{i. e.,} \quad \cos(\theta + \phi) = \cos \theta \cos \phi - \sin \theta \sin \phi.$$

TRIGONOMETRY

For through B let BZE, the diameter of the circle, be drawn, and let $B\Delta$, $\Delta\Gamma$, ΓE , ΔE be joined ; it is

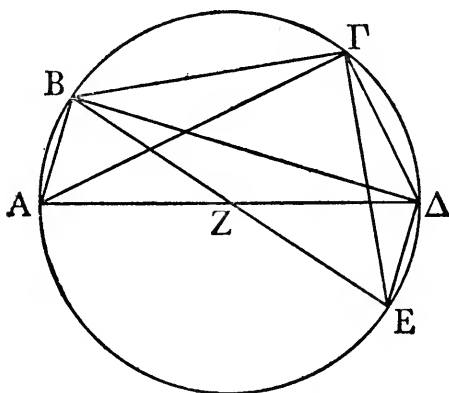

then immediately obvious that, by reason of $B\Gamma$ being given, ΓE is also given, and by reason of AB being given, both $B\Delta$ and ΔE are given. And by the same reasoning as before, since $B\Gamma\Delta E$ is a quadrilateral in a circle, and $B\Delta$, ΓE are the diagonals, the rectangle contained by the diagonals is equal to the sum of the rectangles contained by the opposite sides. And so, since $B\Delta \cdot \Gamma E$ is given, while $B\Gamma \cdot \Delta E$ is also given, therefore $BE \cdot \Gamma\Delta$ is given. But the diameter BE is given, and [therefore] the remaining term $\Gamma\Delta$ will be given, and therefore the chord ΓA subtending the remainder of the semicircle ^a; accordingly, if two arcs be given, and the chords subtending them, by this theorem the chord subtending the sum of the arcs will also be given.

GREEK MATHEMATICS

Φανερόν δέ, ὅτι συντιθέντες αἰεὶ μετὰ τῶν προεκτεθειμένων πασῶν τὴν ὑπὸ \bar{a} \angle' μοῖραν καὶ τὰς συναπτομένας ἐπιλογιζόμενοι πάσας ἀπλῶς ἐγγράψομεν, ὅσαι δις γινόμεναι τρίτον μέρος ἔξουσιν, καὶ μόναι ἔτι περιλειφθήσονται αἰ μεταξὺ τῶν ἀνὰ \bar{a} \angle' μοῖραν διαστημάτων δύο καθ' ἕκαστον ἐσόμεναι, ἐπειδήπερ καθ' ἡμιμοῖριον ποιούμεθα τὴν ἐγγραφὴν. ὥστε, εἴαν τὴν ὑπὸ τὸ ἡμιμοῖριον εὐθείαν εὕρωμεν, αὕτη κατὰ τε τὴν σύνθεσιν καὶ τὴν ὑπεροχὴν τὴν πρὸς τὰς τὰ διαστήματα περιεχούσας καὶ δεδομένας εὐθείας καὶ τὰς λοιπὰς τὰς μεταξὺ πάσας ἡμῖν συναπληρώσει. ἐπεὶ δὲ δοθείσης τινὸς εὐθείας ὡς τῆς ὑπὸ τὴν \bar{a} \angle' μοῖραν ἢ τὸ τρίτον τῆς αὐτῆς περιφερείας ὑποτείνουσα διὰ τῶν γραμμῶν οὐ δίδοται πως· εἰ δέ γε δυνατόν ἦν, εἴχομεν ἂν αὐτόθεν καὶ τὴν ὑπὸ τὸ ἡμιμοῖριον· πρότερον μεθοδεύσομεν τὴν ὑπὸ τὴν \bar{a} μοῖραν ἀπὸ τε τῆς ὑπὸ τὴν \bar{a} \angle' μοῖραν καὶ τῆς ὑπὸ \angle' δ' ὑποτεθέμενοι λημματίον, ὃ, κἂν μὴ πρὸς τὸ καθόλου δύνηται τὰς πηλικότητος ὀρίζειν, ἐπὶ γε τῶν οὕτως ἐλαχίστων τὸ πρὸς τὰς ὠρισμένας ἀπαράλλακτον δύναιτ' ἂν συντηρεῖν.

(viii.) *Method of Interpolation*

Ibid. 43. 6-46. 20

Λέγω γάρ, ὅτι εἴαν ἐν κύκλῳ διαχθῶσιν ἄνισοι δύο εὐθεῖαι, ἢ μείζων πρὸς τὴν ἐλάσσονα ἐλάσσονα λόγον ἔχει ἢπερ ἢ ἐπὶ τῆς μείζονος εὐθείας περιφέρεια πρὸς τὴν ἐπὶ τῆς ἐλάσσονος.

Ἔστω γὰρ κύκλος ὁ ΑΒΓΔ, καὶ διήχθωσαν ἐν αὐτῷ δύο εὐθεῖαι ἄνισοι ἐλάσσων μὲν ἢ ΑΒ,

TRIGONOMETRY

It is clear that, by continually putting next to all known chords a chord subtending $1\frac{1}{2}^\circ$ and calculating the chords joining them, we may compute in a simple manner all chords subtending multiples of $1\frac{1}{2}^\circ$, and there will still be left only those within the $1\frac{1}{2}^\circ$ intervals—two in each case, since we are making the diagram in half degrees. Therefore, if we find the chord subtending $\frac{1}{2}^\circ$, this will enable us to complete, by the method of addition and subtraction with respect to the chords bounding the intervals, both the given chords and all the remaining, intervening chords. But when any chord subtending, say, $1\frac{1}{2}^\circ$, is given, the chord subtending the third part of the same arc is not given by the [above] calculations—if it were, we should obtain immediately the chord subtending $\frac{1}{2}^\circ$; therefore we shall first give a method for finding the chord subtending 1° from the chord subtending $1\frac{1}{2}^\circ$ and that subtending $\frac{3}{4}^\circ$, assuming a little lemma which, even though it cannot be used for calculating lengths in general, in the case of such small chords will enable us to make an approximation indistinguishable from the correct figure.

(viii.) *Method of Interpolation*

Ibid. 43. 6–46. 20

For I say that, *if two unequal chords be drawn in a circle, the greater will bear to the less a less ratio than that which the arc on the greater chord bears to the arc on the lesser.*

For let $AB\Gamma\Delta$ be a circle, and in it let there be drawn two unequal chords, of which AB is the lesser

GREEK MATHEMATICS

μείζων δὲ ἢ ΒΓ. λέγω, ὅτι ἡ ΓΒ εὐθεῖα πρὸς τὴν ΒΑ εὐθείαν ἐλάσσονα λόγον ἔχει ἢπερ ἡ ΒΓ περιφέρεια πρὸς τὴν ΒΑ περιφέρειαν.

Τετμήσθω γὰρ ἡ ὑπὸ ΑΒΓ γωνία δίχα ὑπὸ τῆς ΒΔ, καὶ ἐπεζεύχθωσαν ἡ τε ΑΕΓ καὶ ἡ ΑΔ καὶ ἡ ΓΔ. καὶ ἐπεὶ ἡ ὑπὸ ΑΒΓ γωνία δίχα τέτμηται ὑπὸ τῆς ΒΕΔ εὐθείας, ἴση μὲν ἐστὶν ἡ ΓΔ εὐθεῖα τῇ ΑΔ, μείζων δὲ ἢ ΓΕ τῆς ΕΑ. ἤχθω δὴ ἀπὸ τοῦ Δ κάθετος ἐπὶ τὴν ΑΕΓ ἡ ΔΖ. ἐπεὶ τοίνυν μείζων ἐστὶν ἡ μὲν ΑΔ τῆς ΕΔ, ἡ δὲ ΕΔ τῆς ΔΖ, ὁ ἄρα κέντρῳ μὲν τῷ Δ, διαστήματι δὲ τῷ ΔΕ γραφόμενος κύκλος τὴν μὲν ΑΔ τεμεί, ὑπερπεσεῖται δὲ τὴν ΔΖ. γεγράφθω δὴ ὁ ΗΕΘ, καὶ ἐκβεβλήσθω ἡ ΔΖΘ. καὶ ἐπεὶ ὁ μὲν ΔΕΘ τομεὺς μείζων ἐστὶν τοῦ ΔΕΖ τριγώνου, τὸ δὲ ΔΕΑ τρίγωνον μείζον τοῦ ΔΕΗ τομέως, τὸ ἄρα ΔΕΖ

• Lit. "let ΔΖΘ be produced."

TRIGONOMETRY

and $B\Gamma$ the greater. I say that

$$\Gamma B : BA < \text{arc } B\Gamma : \text{arc } BA.$$

For let the angle $AB\Gamma$ be bisected by $B\Delta$, and let

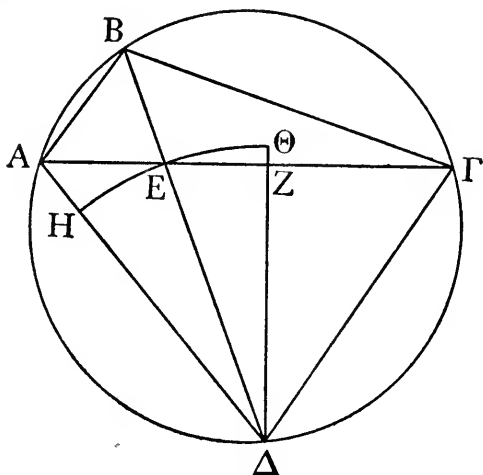

$A\Gamma$ and $A\Delta$ and $\Gamma\Delta$ be joined. Then since the angle $AB\Gamma$ is bisected by the chord $BE\Delta$, the chord $\Gamma\Delta = A\Delta$ [Eucl. iii. 26, 29], while $\Gamma E > EA$ [Eucl. vi. 3]. Now let ΔZ be drawn from Δ perpendicular to $A\Gamma$. Then since $A\Delta > E\Delta$, and $E\Delta > \Delta Z$, the circle described with centre Δ and radius ΔE will cut $A\Delta$, and will fall beyond ΔZ . Let [the arc] $HE\Theta$ be described, and let ΔZ be produced to Θ .^a Then since

$$\text{sector } \Delta E\Theta > \text{triangle } \Delta EZ,$$

and triangle $\Delta EA > \text{sector } \Delta EH,$

GREEK MATHEMATICS

τρίγωνον πρὸς τὸ ΔΕΑ τρίγωνον ἐλάσσονα λόγον ἔχει ἤπερ ὁ ΔΕΘ τομεὺς πρὸς τὸν ΔΕΗ. ἀλλ' ὡς μὲν τὸ ΔΕΖ τρίγωνον πρὸς τὸ ΔΕΑ τρίγωνον, οὕτως ἡ ΕΖ εὐθεῖα πρὸς τὴν ΕΑ, ὡς δὲ ὁ ΔΕΘ τομεὺς πρὸς τὸν ΔΕΗ τομέα, οὕτως ἡ ὑπὸ ΖΔΕ γωνία πρὸς τὴν ὑπὸ ΕΔΑ· ἡ ἄρα ΖΕ εὐθεῖα πρὸς τὴν ΕΑ ἐλάσσονα λόγον ἔχει ἤπερ ἡ ὑπὸ ΖΔΕ γωνία πρὸς τὴν ὑπὸ ΕΔΑ. καὶ συνθέντι ἄρα ἡ ΖΑ εὐθεῖα πρὸς τὴν ΕΑ ἐλάσσονα λόγον ἔχει ἤπερ ἡ ὑπὸ ΖΔΑ γωνία πρὸς τὴν ὑπὸ ΑΔΕ· καὶ τῶν ἡγουμένων τὰ διπλάσια, ἡ ΓΑ εὐθεῖα πρὸς τὴν ΑΕ ἐλάσσονα λόγον ἔχει ἤπερ ἡ ὑπὸ ΓΔΑ γωνία πρὸς τὴν ὑπὸ ΕΔΑ· καὶ διελόντι ἡ ΓΕ εὐθεῖα πρὸς τὴν ΕΑ ἐλάσσονα λόγον ἔχει ἤπερ ἡ ὑπὸ ΓΔΕ γωνία πρὸς τὴν ὑπὸ ΕΔΑ. ἀλλ' ὡς μὲν ἡ ΓΕ εὐθεῖα πρὸς τὴν ΕΑ, οὕτως ἡ ΓΒ εὐθεῖα πρὸς τὴν ΒΑ, ὡς δὲ ἡ ὑπὸ ΓΔΒ γωνία πρὸς τὴν ὑπὸ ΒΔΑ, οὕτως ἡ ΓΒ περιφέρεια πρὸς τὴν ΒΑ· ἡ ΓΒ ἄρα εὐθεῖα πρὸς τὴν ΒΑ ἐλάσσονα λόγον ἔχει ἤπερ ἡ ΓΒ περιφέρεια πρὸς τὴν ΒΑ περιφέρειαν.

Τούτου δὴ οὖν ὑποκειμένου ἔστω κύκλος ὁ ΑΒΓ, καὶ διήχθωσαν ἐν αὐτῷ δύο εὐθεῖαι ἡ τε ΑΒ καὶ ἡ ΑΓ, ὑποκείσθω δὲ πρῶτον ἡ μὲν ΑΒ ὑποτείνουσα μιᾶς μοίρας \angle' δ', ἡ δὲ ΑΓ μοῖραν \bar{a} . ἐπεὶ ἡ ΑΓ εὐθεῖα πρὸς τὴν ΒΑ εὐθεῖαν ἐλάσσονα λόγον ἔχει ἤπερ ἡ ΑΓ περιφέρεια πρὸς τὴν ΑΒ, ἡ δὲ ΑΓ περιφέρεια ἐπίτριτος ἐστὶν τῆς ΑΒ, ἡ ΓΑ ἄρα εὐθεῖα τῆς ΒΑ ἐλάσσων ἐστὶν ἡ ἐπίτριτος. ἀλλὰ ἡ ΑΒ εὐθεῖα ἐδείχθη τοιούτων $\text{O } \mu\zeta \eta$, οἷων ἐστὶν ἡ διάμετρος $\overline{\rho\kappa}$. ἡ ἄρα ΓΑ

TRIGONOMETRY

∴ triangle ΔEZ : triangle ΔEA < sector $\Delta E\Theta$:
sector ΔEH .

But triangle ΔEZ : triangle $\Delta EA = EZ : EA$,
[Eucl. vi. 1

and

sector $\Delta E\Theta$: sector $\Delta EH = \text{angle } Z\Delta E : \text{angle } E\Delta A$.

∴ $ZE : EA < \text{angle } Z\Delta E : \text{angle } E\Delta A$.

∴ *componendo*, $ZA : EA < \text{angle } Z\Delta A : \text{angle } A\Delta E$;

and, by doubling the antecedents,

$\Gamma A : AE < \text{angle } \Gamma\Delta A : \text{angle } E\Delta A$;

and *dirimendo*, $\Gamma E : EA < \text{angle } \Gamma\Delta E : \text{angle } E\Delta A$.

But $\Gamma E : EA = \Gamma B : BA$, [Eucl. vi. 3

and

$\text{angle } \Gamma\Delta B : \text{angle } B\Delta A = \text{arc } \Gamma B : \text{arc } BA$;
[Eucl. vi. 33

∴ $\Gamma B : BA < \text{arc } \Gamma B : \text{arc } BA$.^a

On this basis, then, let $AB\Gamma$ be a circle, and in it let there be drawn the two chords AB and $A\Gamma$, and let it first be supposed that AB subtends an angle of $\frac{3}{4}^\circ$ and $A\Gamma$ an angle of 1° . Then since

$A\Gamma : BA < \text{arc } A\Gamma : \text{arc } AB$,

while $\text{arc } A\Gamma = \frac{4}{3} \cdot \text{arc } AB$,

∴ $\Gamma A : BA < \frac{4}{3}$.

But the chord AB was shown to be $0^p 47' 8''$ (the diameter being 120^p); therefore the chord ΓA

^a If the chords ΓB , BA subtend angles 2θ , 2ϕ at the centre, this is equivalent to the formula,

$$\frac{\sin \theta}{\sin \phi} < \frac{\theta}{\phi}$$

where $\theta < \phi < \frac{1}{2}\pi$.

GREEK MATHEMATICS

εὐθεία ἐλάσσων ἐστὶν τῶν αὐτῶν $\bar{\alpha} \bar{\beta} \bar{\nu}$. ταῦτα γὰρ ἐπίτριτά ἐστὶν ἔγγιστα τῶν $\circ \overline{\mu\zeta} \eta$.

Πάλιν ἐπὶ τῆς αὐτῆς καταγραφῆς ἡ μὲν AB εὐθεία ὑποκείσθω ὑποτείνουσα μοῖραν $\bar{\alpha}$, ἡ δὲ AG μοῖραν $\bar{\alpha} \angle'$. κατὰ τὰ αὐτὰ δὴ, ἐπεὶ ἡ AG περιφέρεια τῆς AB ἐστὶν ἡμιολία, ἡ ΓΑ ἄρα εὐθεία τῆς ΒΑ ἐλάσσων ἐστὶν ἢ ἡμιόλιος. ἀλλὰ τὴν AG ἀπεδείξαμεν τοιούτων οὔσαν $\bar{\alpha} \overline{\lambda\delta} \bar{\iota\epsilon}$, οἷων ἐστὶν ἡ διάμετρος $\overline{\rho\kappa}$. ἡ ἄρα AB εὐθεία μείζων ἐστὶν τῶν αὐτῶν $\bar{\alpha} \bar{\beta} \bar{\nu}$. τούτων γὰρ ἡμιολία ἐστὶν τὰ προκείμενα $\bar{\alpha} \overline{\lambda\delta} \bar{\iota\epsilon}$. ὥστε, ἐπεὶ τῶν αὐτῶν ἐδείχθη καὶ μείζων καὶ ἐλάσσων ἢ τὴν μίαν μοῖραν ὑποτείνουσα εὐθεία, καὶ ταύτην δηλονότι ἔξομεν τοιούτων $\bar{\alpha} \bar{\beta} \bar{\nu}$ ἔγγιστα, οἷων ἐστὶν ἡ διάμετρος $\overline{\rho\kappa}$, καὶ διὰ τὰ προδεδειγμένα καὶ τὴν ὑπὸ τὸ ἡμιμοῖριον, ἥτις εὐρίσκεται τῶν αὐτῶν

TRIGONOMETRY

$\angle 1^\circ 2' 50''$; for this is approximately four-thirds of $0^\circ 47' 8''$.

Again, with the same diagram, let the chord AB

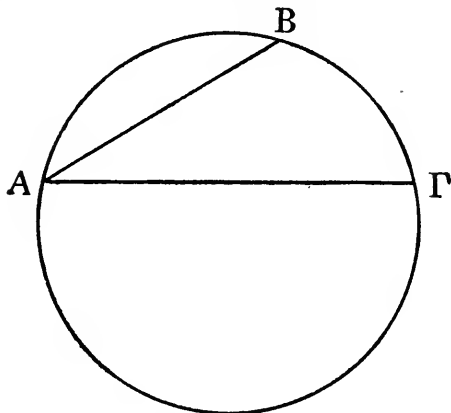

be supposed to subtend an angle of 1° , and $A\Gamma$ an angle of $1\frac{1}{2}^\circ$. By the same reasoning,

since $\text{arc } A\Gamma = \frac{3}{2} \cdot \text{arc } AB$,

$\therefore \Gamma A : BA < \frac{3}{2}$.

But we have proved $A\Gamma$ to be $1^\circ 34' 15''$ (the diameter being 120°); therefore the chord $AB > 1^\circ 2' 50''$; for $1^\circ 34' 15''$ is one-and-a-half times this number. Therefore, since the chord subtending an angle of 1° has been shown to be both greater and less than [approximately] the same [length], manifestly we shall find it to have approximately this identical value $1^\circ 2' 50''$ (the diameter being 120°), and by what has been proved before we shall obtain the chord subtending $\frac{1}{2}^\circ$, which is found to be approximately

GREEK MATHEMATICS

Ο $\overline{\lambda\alpha}$ $\overline{\kappa\epsilon}$ ἔγγιστα. καὶ συναναπληρωθήσεται τὰ λοιπά, ὡς ἔφαμεν, διαστήματα ἐκ μὲν τῆς πρὸς τὴν μίαν ἡμισυ μοῖραν λόγου ἔνεκεν ὡς ἐπὶ τοῦ πρώτου διαστήματος συνθέσεως τοῦ ἡμιμορίου δεικνυμένης τῆς ὑπὸ τὰς $\overline{\beta}$ μοίρας, ἐκ δὲ τῆς ὑπεροχῆς τῆς πρὸς τὰς $\overline{\gamma}$ μοίρας καὶ τῆς ὑπὸ τὰς $\overline{\beta}$ \angle' διδομένης· ὡσαύτως δὲ καὶ ἐπὶ τῶν λοιπῶν.

(ix.) *The Table*

Ibid. 46. 21-63. 46

Ἡ μὲν οὖν πραγματεία τῶν ἐν τῷ κύκλῳ εὐθειῶν οὕτως ἂν οἶμαι ῥᾶστα μεταχειρισθείη. ἵνα δέ, ὡς ἔφην, ἐφ' ἐκάστης τῶν χρειῶν ἐξ ἐτοίμου τὰς πηλικότητος ἔχωμεν τῶν εὐθειῶν ἐκκειμένας, κανόνια ὑποτάξομεν ἀνὰ στίχους $\overline{\mu\epsilon}$ διὰ τὸ σύμμετρον, ὧν τὰ μὲν πρῶτα μέρη περιέξει τὰς πηλικότητος τῶν περιφερειῶν καθ' ἡμιμορίου παρηυξημένας, τὰ δὲ δεύτερα τὰς τῶν παρακειμένων ταῖς περιφερείαις εὐθειῶν πηλικότητος ὡς τῆς διαμέτρου τῶν $\overline{\rho\kappa}$ τμημάτων ὑποκειμένης, τὰ δὲ τρίτα τὸ λ' μέρος τῆς καθ' ἕκαστον ἡμιμορίου τῶν εὐθειῶν παραυξήσεως, ἵνα ἔχοντες καὶ τὴν τοῦ ἐνὸς ἐξηκοστοῦ μέσῃ ἐπιβολὴν ἀδιαφοροῦσαν πρὸς αἰσθησιν τῆς ἀκριβοῦς καὶ τῶν μεταξὺ τοῦ ἡμίους μερῶν ἐξ ἐτοίμου τὰς ἐπιβαλλούσας πηλικότητος ἐπιλογίζεσθαι δυνώμεθα. εὐκατανόητον δ', ὅτι διὰ τῶν αὐτῶν καὶ προκειμένων θεωρημάτων, κἂν ἐν δισταγμῷ γενώμεθα γραφικῆς ἀμαρτίας περί τινα τῶν ἐν τῷ κανονίῳ παρακειμένων εὐθειῶν, ῥαδίαν ποιησόμεθα τὴν τε ἐξέτασιν καὶ τὴν

TRIGONOMETRY

$0^{\circ} 31' 25''$. The remaining intervals may be completed, as we said, by means of the chord subtending $1\frac{1}{2}^{\circ}$ —in the case of the first interval, for example, by adding $\frac{1}{2}^{\circ}$ we obtain the chord subtending 2° , and from the difference between this and 3° we obtain the chord subtending $2\frac{1}{2}^{\circ}$, and so on for the remainder.

(ix.) *The Table*

Ibid. 46. 21–63. 46

The theory of the chords in the circle may thus, I think, be very easily grasped. In order that, as I said, we may have the lengths of all the chords in common use immediately available, we shall draw up tables arranged in forty-five symmetrical rows.^a The first section will contain the magnitudes of the arcs increasing by half degrees, the second will contain the lengths of the chords subtending the arcs measured in parts of which the diameter contains 120, and the third will give the thirtieth part of the increase in the chords for each half degree, in order that for every sixtieth part of a degree we may have a mean approximation differing imperceptibly from the true figure and so be able readily to calculate the lengths corresponding to the fractions between the half degrees. It should be well noted that, by these same theorems now before us, if we should suspect an error in the computation of any of the chords in the table,^b we can easily make a test and

^a As there are 360 half degrees in the table, the statement appears to mean that the table occupied eight pages each of 45 rows; so Manitius, *Des Claudius Ptolemäus Handbuch der Astronomie*, 1^{er} Bd., p. 35 n. a.

^b Such an error might be accumulated by using the approximations for 1° and $\frac{1}{2}^{\circ}$; but, in fact, the sines in the table are generally correct to five places of decimals.

GREEK MATHEMATICS

ἐπανόρθωσιν ἤτοι ἀπὸ τῆς ὑπὸ τὴν διπλασίονα τῆς ἐπιζητουμένης ἢ τῆς πρὸς ἄλλας τινὰς τῶν δεδομένων ὑπεροχῆς ἢ τῆς τὴν λείπουσαν εἰς τὸ ἡμικύκλιον περιφέρειαν ὑποτεينوῦσης εὐθείας. καὶ ἔστιν ἡ τοῦ κανονίου καταγραφὴ τοιαύτη·

ια'. Κανόνιον τῶν ἐν κύκλῳ εὐθειῶν

περιφερειῶν	εὐθειῶν			ἐξηκοστῶν			
Λ'	ο	λα	κε	ο	α	β	ν
α	α	β	ν	ο	α	β	ν
α Λ'	α	λδ	ιε	ο	α	β	ν
β	β	ε	μ	ο	α	β	ν
β Λ'	β	λζ	δ	ο	α	β	μη
γ	γ	η	κη	ο	α	β	μη
γ Λ'	γ	λθ	νβ	ο	α	β	μη
δ	δ	ια	ις	ο	α	β	μζ
δ Λ'	δ	μβ	μ	ο	α	β	μζ
ξ ξ ο ο ο ο νδ κα							
ροσ	ριθ	νε	λη	ο	ο	β	γ
ροσ Λ'	ριθ	νς	λθ	ο	ο	α	μζ
ροζ	ριθ	νζ	λβ	ο	ο	α	λ
ροζ Λ'	ριθ	νη	ιη	ο	ο	α	ιδ
ροη	ριθ	νη	νε	ο	ο	ο	νζ
ροη Λ'	ριθ	νθ	κδ	ο	ο	ο	μα
ροθ	ριθ	νθ	μδ	ο	ο	ο	κε
ροθ Λ'	ριθ	νθ	νς	ο	ο	ο	θ
ρπ	ρκ	ο	ο	ο	ο	ο	ο

TRIGONOMETRY

apply a correction, either from the chord subtending double of the arc which is under investigation, or from the difference with respect to any others of the given magnitudes, or from the chord subtending the remainder of the semicircular arc. And this is the diagram of the table :

11. TABLE OF THE CHORDS IN A CIRCLE

Arcs	Chords			Sixtieths			
	0 ^p	31'	25''	0 ^p	1'	2''	50'''
$\frac{1}{2}^\circ$	1	2	50	0	1	2	50
1	1	34	15	0	1	2	50
$1\frac{1}{2}$	2	5	40	0	1	2	50
2	2	37	4	0	1	2	48
$2\frac{1}{2}$	3	8	28	0	1	2	48
3	3	39	52	0	1	2	48
$3\frac{1}{2}$	4	11	16	0	1	2	47
4	4	42	40	0	1	2	47
$4\frac{1}{2}$							
60	60	0	0	0	0	54	21
176	119	55	38	0	0	2	3
$176\frac{1}{2}$	119	56	39	0	0	1	47
177	119	57	32	0	0	1	30
$177\frac{1}{2}$	119	58	18	0	0	1	17
178	119	58	55	0	0	0	57
$178\frac{1}{2}$	119	59	24	0	0	0	41
179	119	59	44	0	0	0	25
$179\frac{1}{2}$	119	59	56	0	0	0	9
180	120	0	0	0	0	0	0

GREEK MATHEMATICS

(c) MENELAUS'S THEOREM

(i.) Lemmas

Ibid. 68. 14-74. 8

ιγ'. Προλαμβανόμενα εἰς τὰς σφαιρικὰς
δείξεις

Ἀκολουθοῦ δ' ὄντος ἀποδείξαι καὶ τὰς κατὰ μέρος γινομένας πηλικότητας τῶν ἀπολαμβανόμενων περιφερειῶν μεταξὺ τοῦ τε ἰσημερινοῦ καὶ τοῦ διὰ μέσων τῶν Ζωδίων κύκλου τῶν γραφομένων μεγίστων κύκλων διὰ τῶν τοῦ ἰσημερινοῦ πόλων προεκθησόμεθα λημμάτια βραχέα καὶ εὐχρηστα, δι' ὧν τὰς πλείστας σχεδὸν δείξεις τῶν σφαιρικῶς θεωρουμένων, ὡς ἔνι μάλιστα, ἀπλούστερον καὶ μεθοδικώτερον ποιησόμεθα.

Εἰς δύο δὴ εὐθείας τὰς ΑΒ καὶ ΑΓ διαχθεῖσαι δύο εὐθεῖαι ἧ τε ΒΕ καὶ ἧ ΓΔ τεμνέτωσαν ἀλλήλας

TRIGONOMETRY

(c) MENELAUS'S THEOREM

(i.) Lemmas

Ibid. 68. 14-74. 8

13. Preliminary matter for the spherical proofs

The next subject for investigation being to show the lengths of the arcs, intercepted between the celestial equator and the zodiac circle, of great circles drawn through the poles of the equator, we shall set out some brief and serviceable little lemmas, by means of which we shall be able to prove more simply and more systematically most of the questions investigated spherically.

Let two straight lines BE and $\Gamma\Delta$ be drawn so as

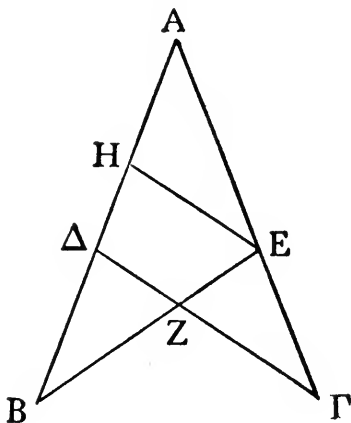

to meet the straight lines AB and $\Gamma\Delta$ and to cut one

GREEK MATHEMATICS

κατὰ τὸ Z σημείον. λέγω, ὅτι ὁ τῆς ΓA πρὸς $A E$ λόγος συνήπται ἔκ τε τοῦ τῆς $\Gamma \Delta$ πρὸς ΔZ καὶ τοῦ τῆς $Z B$ πρὸς $B E$.

Ἦχθω γὰρ διὰ τοῦ E τῆ $\Gamma \Delta$ παράλληλος ἡ $E H$. ἐπεὶ παράλληλοί εἰσιν αἱ $\Gamma \Delta$ καὶ $E H$, ὁ τῆς ΓA πρὸς $E A$ λόγος ὁ αὐτὸς ἐστὶν τῷ τῆς $\Gamma \Delta$ πρὸς $E H$. ἔξωθεν δὲ ἡ $Z \Delta$. ὁ ἄρα τῆς $\Gamma \Delta$ πρὸς $E H$ λόγος συγκείμενος ἔσται ἔκ τε τοῦ τῆς $\Gamma \Delta$ πρὸς ΔZ καὶ τοῦ τῆς ΔZ πρὸς $H E$. ὥστε καὶ ὁ τῆς ΓA πρὸς $A E$ λόγος σύγκειται ἔκ τε τοῦ τῆς $\Gamma \Delta$ πρὸς ΔZ καὶ τοῦ τῆς ΔZ πρὸς $H E$. ἔστιν δὲ καὶ ὁ τῆς ΔZ πρὸς $H E$ λόγος ὁ αὐτὸς τῷ τῆς $Z B$ πρὸς $B E$ διὰ τὸ παραλλήλους πάλιν εἶναι τὰς $E H$ καὶ $Z \Delta$. ὁ ἄρα τῆς ΓA πρὸς $A E$ λόγος σύγκειται ἔκ τε τοῦ τῆς $\Gamma \Delta$ πρὸς ΔZ καὶ τοῦ τῆς $Z B$ πρὸς $B E$. ὅπερ προέκειτο δεῖξαι.

Κατὰ τὰ αὐτὰ δὲ δειχθήσεται, ὅτι καὶ κατὰ διαίρεσιν ὁ τῆς ΓE πρὸς $E A$ λόγος συνήπται ἔκ τε τοῦ τῆς ΓZ πρὸς ΔZ καὶ τοῦ τῆς ΔB πρὸς $B A$, διὰ τοῦ A τῆ $E B$ παραλλήλου ἀχθείσης καὶ

• Lit. "the ratio of ΓA to $A E$ is compounded of the ratio of $\Gamma \Delta$ to ΔZ and $Z B$ to $B E$."

TRIGONOMETRY

another at the point Z. I say that

$$\Gamma A : AE = (\Gamma \Delta : \Delta Z)(ZB : BE).^a$$

For through E let EH be drawn parallel to $\Gamma \Delta$. Since $\Gamma \Delta$ and EH are parallel,

$$\Gamma A : EA = \Gamma \Delta : EH. \quad [\text{Eucl. vi. 4}]$$

But Z Δ is an external [straight line];

$$\therefore \Gamma \Delta : EH = (\Gamma \Delta : \Delta Z)(\Delta Z : HE);$$

$$\therefore \Gamma A : AE = (\Gamma \Delta : \Delta Z)(\Delta Z : HE).$$

$$\text{But} \quad \Delta Z : HE = ZB : BE, \quad [\text{Eucl. vi. 4}]$$

by reason of the fact that EH and Z Δ are parallels;

$$\therefore \Gamma A : AE = (\Gamma \Delta : \Delta Z)(ZB : BE); \quad (1)$$

which was set to be proved.

With the same premises, it will be shown by transformation of ratios that

$$\Gamma E : EA = (\Gamma Z : \Delta Z)(\Delta B : BA),$$

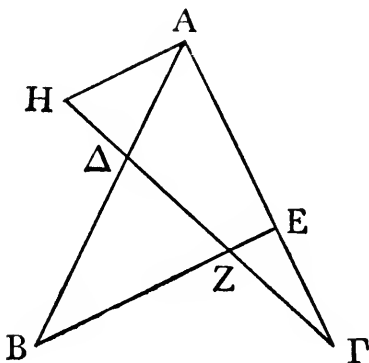

^a a parallel to EB being drawn through A and $\Gamma \Delta H$

GREEK MATHEMATICS

προσεκβληθείσης ἐπ' αὐτὴν τῆς ΓΔΗ. ἐπεὶ γὰρ πάλιν παράλληλός ἐστὶν ἡ ΑΗ τῇ ΕΖ, ἔστιν, ὡς ἡ ΓΕ πρὸς ΕΑ, ἡ ΓΖ πρὸς ΖΗ. ἀλλὰ τῆς ΖΔ ἕξωθεν λαμβανομένης ὁ τῆς ΓΖ πρὸς ΖΗ λόγος σύγκειται ἔκ τε τοῦ τῆς ΓΖ πρὸς ΖΔ καὶ τοῦ τῆς ΔΖ πρὸς ΖΗ· ἔστιν δὲ ὁ τῆς ΔΖ πρὸς ΖΗ λόγος ὁ αὐτὸς τῷ τῆς ΔΒ πρὸς ΒΑ διὰ τὸ εἰς παραλλήλους τὰς ΑΗ καὶ ΖΒ διηῆχθαι τὰς ΒΑ καὶ ΖΗ· ὁ ἄρα τῆς ΓΖ πρὸς ΖΗ λόγος συνῆπται ἔκ τε τοῦ τῆς ΓΖ πρὸς ΔΖ καὶ τοῦ τῆς ΔΒ πρὸς ΒΑ. ἀλλὰ τῷ τῆς ΓΖ πρὸς ΖΗ λόγῳ ὁ αὐτὸς ἐστὶν ὁ τῆς ΓΕ πρὸς ΕΑ· καὶ ὁ τῆς ΓΕ ἄρα πρὸς ΕΑ λόγος σύγκειται ἔκ τε τοῦ τῆς ΓΖ πρὸς ΔΖ καὶ τοῦ τῆς ΔΒ πρὸς ΒΑ· ὅπερ ἔδει δεῖξαι.

Πάλιν ἔστω κύκλος ὁ ΑΒΓ, οὗ κέντρον τὸ Δ, καὶ εἰλήφθω ἐπὶ τὰς περιφερείας αὐτοῦ τυχόντα
450

TRIGONOMETRY

being produced to it. For, again, since AH is parallel to EZ,

$$\Gamma E : EA = \Gamma Z : ZH. \quad [\text{Eucl. vi. 2}]$$

But, an external straight line ZΔ having been taken,

$$\Gamma Z : ZH = (\Gamma Z : Z\Delta)(\Delta Z : ZH);$$

and $\Delta Z : ZH = \Delta B : BA,$

by reason of BA and ZH being drawn to meet the parallels AH and ZB;

$$\therefore \Gamma Z : ZH = (\Gamma Z : \Delta Z)(\Delta B : BA).$$

But $\Gamma Z : ZH = \Gamma E : EA;$ [*supra*]

and $\therefore \Gamma E : EA = (\Gamma Z : \Delta Z)(\Delta B : BA);$ • (2)

which was to be proved.

Again, let ABΓ be a circle with centre Δ, and let

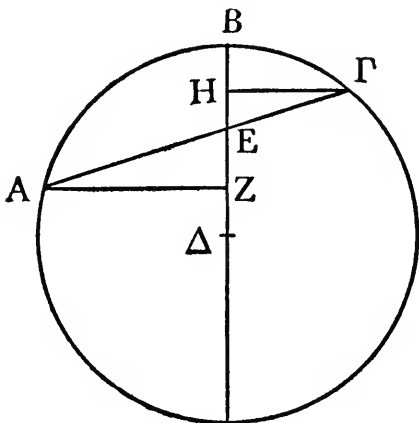

there be taken on its circumference any three points

GREEK MATHEMATICS

τρία σημεία τὰ Α, Β, Γ, ὥστε ἑκατέραν τῶν ΑΒ, ΒΓ περιφερειῶν ἐλάσσονα εἶναι ἡμικυκλίου· καὶ ἐπὶ τῶν ἐξῆς δὲ λαμβανομένων περιφερειῶν τὸ ὁμοιον ὑπακούεσθω· καὶ ἐπεζεύχθωσαν αἱ ΑΓ καὶ ΔΕΒ. λέγω, ὅτι ἐστίν, ὡς ἡ ὑπὸ τὴν διπλὴν τῆς ΑΒ περιφερείας πρὸς τὴν ὑπὸ τὴν διπλὴν τῆς ΒΓ, οὕτως ἡ ΑΕ εὐθεῖα πρὸς τὴν ΕΓ εὐθεῖαν.

Ἦχθωσαν γὰρ κάθετοι ἀπὸ τῶν Α καὶ Γ σημείων ἐπὶ τὴν ΔΒ ἢ τε ΑΖ καὶ ἡ ΓΗ. ἐπεὶ παράλληλός ἐστὶν ἡ ΑΖ τῇ ΓΗ, καὶ διηκται εἰς αὐτὰς εὐθεῖα ἡ ΑΕΓ, ἔστιν, ὡς ἡ ΑΖ πρὸς τὴν ΓΗ, οὕτως ἡ ΑΕ πρὸς ΕΓ. ἀλλ' ὁ αὐτός ἐστὶν λόγος ὁ τῆς ΑΖ πρὸς ΓΗ καὶ τῆς ὑπὸ τὴν διπλὴν τῆς ΑΒ περιφερείας πρὸς τὴν ὑπὸ τὴν διπλὴν τῆς ΒΓ· ἡμίσεια γὰρ ἑκατέρα ἑκατέρας· καὶ ὁ τῆς ΑΕ ἄρα πρὸς ΕΓ λόγος ὁ αὐτός ἐστὶν τῷ τῆς ὑπὸ τὴν διπλὴν τῆς ΑΒ πρὸς τὴν ὑπὸ τὴν διπλὴν τῆς ΒΓ· ὅπερ ἔδει δεῖξαι.

Παρακολουθεῖ δ' αὐτόθεν, ὅτι, κἂν δοθῶσιν ἡ τε ΑΓ ὅλη περιφέρεια καὶ ὁ λόγος ὁ τῆς ὑπὸ τὴν διπλὴν τῆς ΑΒ πρὸς τὴν ὑπὸ τὴν διπλὴν τῆς ΒΓ, δοθήσεται καὶ ἑκατέρα τῶν ΑΒ καὶ ΒΓ περιφερειῶν. ἐκτεθείσης γὰρ τῆς αὐτῆς καταγραφῆς ἐπεζεύχθω ἡ ΑΔ, καὶ ἤχθω ἀπὸ τοῦ Δ κάθετος ἐπὶ τὴν ΑΕΓ ἢ ΔΖ. ὅτι μὲν οὖν τῆς ΑΓ περι-

TRIGONOMETRY

A, B, Γ , in such a manner that each of the arcs AB, B Γ is less than a semicircle ; and upon the arcs taken in succession let there be a similar relationship ; and let A Γ be joined and Δ EB. I say that

the chord subtended by double of the arc AB :

the chord subtended by double of the arc B Γ

$$[i.e., \sin AB : \sin B\Gamma^a] = AE : E\Gamma.$$

For let perpendiculars AZ and Γ H be drawn from the points A and Γ to Δ B. Since AZ is parallel to Γ H, and the straight line AEF has been drawn to meet them,

$$AZ : \Gamma H = AE : E\Gamma. \quad [\text{Eucl. vi. 4}]$$

But $AZ : \Gamma H =$ the chord subtended by double of the arc AB :

the chord subtended by double of the arc B Γ ,

for each term is half of the corresponding term ; and therefore

$AE : E\Gamma =$ the chord subtended by double of the arc AB :

the chord subtended by double of the arc B Γ (3)

$$[= \sin AB : \sin B\Gamma],$$

which was to be proved.

It follows immediately that, if the whole arc A Γ be given, and the ratio of the chord subtended by double of the arc AB to the chord subtended by double of the arc B Γ [*i.e.* $\sin AB : \sin B\Gamma$], each of the arcs AB and B Γ will also be given. For let the same diagram be set out, and let A Δ be joined, and from Δ let ΔZ be drawn perpendicular to AEF. If the arc

^a v. *supra*, p. 420 n. a.

GREEK MATHEMATICS

φερείας δοθείσης ἢ τε ὑπὸ $\Lambda\Delta Z$ γωνία τὴν ἡμισίαν αὐτῆς ὑποτείνουσα δεδομένη ἔσται καὶ ὅλον τὸ $\Lambda\Delta Z$ τρίγωνον, δῆλον· ἐπεὶ δὲ τῆς $\Lambda\Gamma$

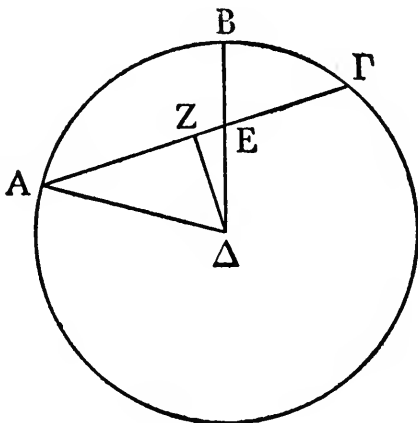

εὐθείας ὅλης δεδομένης ὑπόκειται καὶ ὁ τῆς ΛE πρὸς $E\Gamma$ λόγος ὁ αὐτὸς ὢν τῷ τῆς ὑπὸ τὴν διπλὴν τῆς ΛB πρὸς τὴν ὑπὸ τὴν διπλὴν τῆς $B\Gamma$, ἢ τε ΛE ἔσται δοθείσα καὶ λοιπὴ ἢ $Z E$. καὶ διὰ τοῦτο καὶ τῆς ΔZ δεδομένης δοθήσεται καὶ ἢ τε ὑπὸ $E\Delta Z$ γωνία τοῦ $E\Delta Z$ ὀρθογωνίου καὶ ὅλη ἢ ὑπὸ $\Lambda\Delta B$ · ὥστε καὶ ἢ τε ΛB περιφέρεια δοθήσεται καὶ λοιπὴ ἢ $B\Gamma$ · ὅπερ ἔδει δεῖξαι.

Πάλιν ἔστω κύκλος ὁ $\Lambda B\Gamma$ περὶ κέντρον τὸ Δ , καὶ ἐπὶ τῆς περιφέρειας αὐτοῦ εἰλήφθω τρία σημεῖα τὰ Λ , B , Γ , ὥστε ἑκατέραν τῶν ΛB , $\Lambda\Gamma$ περιφερειῶν ἐλάσσονα εἶναι ἡμικυκλίου· καὶ ἐπὶ

TRIGONOMETRY

$A\Gamma$ is given, it is then clear that the angle $A\Delta Z$, subtending half the same arc, will also be given and therefore the whole triangle $A\Delta Z$; and since the whole chord $A\Gamma$ is given, and by hypothesis

$AE : E\Gamma =$ the chord subtended by double of the arc $AB :$

the chord subtended by double of the arc $B\Gamma$,

[i.e. $= \sin AB : \sin B\Gamma$],

therefore AE will be given [Eucl. *Dat.* 7], and the remainder ZE . And for this reason, ΔZ also being given, the angle $E\Delta Z$ will be given in the right-angled triangle $E\Delta Z$, and [therefore] the whole angle $A\Delta B$; therefore the arc AB will be given and also the remainder $B\Gamma$; which was to be proved.

Again, let $AB\Gamma$ be a circle about centre Δ , and let

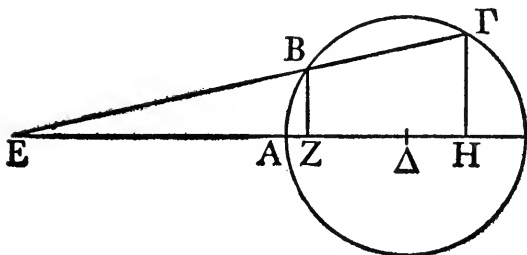

three points A, B, Γ be taken on its circumference so that each of the arcs $AB, A\Gamma$ is less than a semicircle ;

GREEK MATHEMATICS

τῶν ἐξῆς δὲ λαμβανομένων περιφερειῶν τὸ ὅμοιον ὑπακουέσθω· καὶ ἐπιζευχθεῖσαι ἢ τε ΔA καὶ ἢ ΓB ἐκβεβλήσθωσαν καὶ συμπιπτέτωσαν κατὰ τὸ E σημεῖον. λέγω, ὅτι ἐστίν, ὡς ἡ ὑπὸ τὴν διπλῆν τῆς ΓA περιφερείας πρὸς τὴν ὑπὸ τὴν διπλῆν τῆς AB , οὕτως ἡ ΓE εὐθεῖα πρὸς τὴν BE .

Ὅμοίως γὰρ τῷ προτέρῳ λημματίῳ, εἰ ἀπὸ τῶν B καὶ Γ ἀγάγωμεν καθέτους ἐπὶ τὴν ΔA τὴν τε BZ καὶ τὴν ΓH , ἔσται διὰ τὸ παραλλήλους αὐτὰς εἶναι, ὡς ἡ ΓH πρὸς τὴν BZ , οὕτως ἡ ΓE πρὸς τὴν EB . ὥστε καί, ὡς ἡ ὑπὸ τὴν διπλῆν τῆς ΓA πρὸς τὴν ὑπὸ τὴν διπλῆν τῆς AB , οὕτως ἡ ΓE πρὸς τὴν EB . ὅπερ ἔδει δεῖξαι.

Καὶ ἐνταῦθα δὲ αὐτόθεν παρακολουθεῖ, διότι, κἂν ἡ ΓB περιφέρεια μόνη δοθῇ, καὶ ὁ λόγος ὁ τῆς ὑπὸ τὴν διπλῆν τῆς ΓA πρὸς τὴν ὑπὸ τὴν διπλῆν τῆς AB δοθῇ, καὶ ἡ AB περιφέρεια δοθήσεται. πάλιν γὰρ ἐπὶ τῆς ὁμοίας καταγραφῆς ἐπιζευχθείσης τῆς ΔB καὶ καθέτου ἀχθείσης ἐπὶ

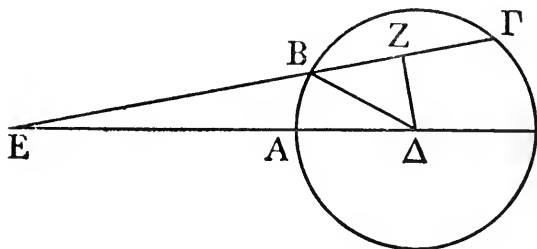

τὴν $B\Gamma$ τῆς ΔZ ἡ μὲν ὑπὸ $B\Delta Z$ γωνία τὴν ἡμίσειαν ὑποτείνουσα τῆς $B\Gamma$ περιφερείας ἔσται

TRIGONOMETRY

and upon the arcs taken in succession let there be a similar relationship; and let ΔA be joined and let ΓB be produced so as to meet it at the point E . I say that

the chord subtended by double of the arc ΓA :
 the chord subtended by double of the arc AB
[i.e., $\sin \Gamma A : \sin AB] = \Gamma E : BE$.

For, as in the previous lemma, if from B and Γ we draw BZ and ΓH perpendicular to ΔA , then, by reason of the fact that they are parallel,

$$\Gamma H : BZ = \Gamma E : EB. \quad [\text{Eucl. vi. 4}]$$

\therefore the chord subtended by double of the arc ΓA :
 the chord subtended by double of the arc AB
[i.e., $\sin \Gamma A : \sin AB] = \Gamma E : EB$; . . . (4)

which was to be proved.

And thence it immediately follows why, if the arc ΓB alone be given, and the ratio of the chord subtended by double of the arc ΓA to the chord subtended by double of the arc AB [*i.e.*, $\sin \Gamma A : \sin AB$], the arc AB will also be given. For again, in a similar diagram let ΔB be joined and let ΔZ be drawn perpendicular to $B\Gamma$; then the angle $B\Delta Z$ subtended by half the arc $B\Gamma$ will be given; and therefore the

GREEK MATHEMATICS

δεδομένη· καὶ ὅλον ἄρα τὸ ΒΔΖ ὀρθογώνιον. ἐπεὶ δὲ καὶ ὁ τε τῆς ΓΕ πρὸς τὴν ΕΒ λόγος δέδοται καὶ ἔτι ἡ ΓΒ εὐθεία, δοθήσεται καὶ ἡ τε ΕΒ καὶ ἔτι ὅλη ἡ ΕΒΖ· ὥστε καί, ἐπεὶ ἡ ΔΖ δέδοται, δοθήσεται καὶ ἡ τε ὑπὸ ΕΔΖ γωνία τοῦ αὐτοῦ ὀρθογωνίου καὶ λοιπὴ ἡ ὑπὸ ΕΔΒ. ὥστε καὶ ἡ ΑΒ περιφέρεια ἔσται δεδομένη.

(ii.) *The Theorem*

Ibid. 74. 9-76. 9

Τούτων προληφθέντων γεγράφθωσαν ἐπὶ σφαιρικῆς ἐπιφανείας μεγίστων κύκλων περιφέρειαι, ὥστε εἰς δύο τὰς ΑΒ καὶ ΑΓ δύο γραφείσας τὰς ΒΕ καὶ ΓΔ τέμνειν ἀλλήλας κατὰ τὸ Ζ σημεῖον· ἔστω δὲ ἐκάστη αὐτῶν ἐλάσσων ἡμικυκλίου· τὸ δὲ αὐτὸ καὶ ἐπὶ πασῶν τῶν καταγραφῶν ὑπακούεσθω.

Λέγω δὴ, ὅτι ὁ τῆς ὑπὸ τὴν διπλὴν τῆς ΓΕ περιφερείας πρὸς τὴν ὑπὸ τὴν διπλὴν τῆς ΕΑ λόγος συνῆπται ἔκ τε τοῦ τῆς ὑπὸ τὴν διπλὴν τῆς ΓΖ πρὸς τὴν ὑπὸ τὴν διπλὴν τῆς ΖΔ καὶ τοῦ τῆς ὑπὸ τὴν διπλὴν τῆς ΔΒ πρὸς τὴν ὑπὸ τὴν διπλὴν τῆς ΒΑ.

Εἰλήφθω γὰρ τὸ κέντρον τῆς σφαίρας καὶ ἔστω τὸ Η, καὶ ἤχθωσαν ἀπὸ τοῦ Η ἐπὶ τὰς Β, Ζ, Ε τομὰς τῶν κύκλων ἡ τε ΗΒ καὶ ἡ ΗΖ καὶ ἡ ΗΕ, καὶ ἐπιζευχθεῖσα ἡ ΑΔ ἐκβεβλήσθω καὶ συμπίπτέτω τῇ ΗΒ ἐκβληθείσῃ καὶ αὐτῇ κατὰ τὸ Θ σημεῖον, ὁμοίως δὲ ἐπιζευχθεῖσαι αἱ ΔΓ καὶ ΑΓ τεμνέτωσαν τὰς ΗΖ καὶ ΗΕ κατὰ τὸ Κ καὶ Λ

TRIGONOMETRY

whole of the right-angled triangle $B\Delta Z$. But since the ratio $\Gamma E : EB$ is given and also the chord ΓB , therefore EB will also be given and, further, the whole [straight line] EBZ ; therefore, since ΔZ is given, the angle $E\Delta Z$ in the same right-angled triangle will be given, and the remainder $E\Delta B$. Therefore the arc AB will be given.

(ii.) *The Theorem*

Ibid. 74. 9-76. 9

These things having first been grasped, let there be described on the surface of a sphere arcs of great circles such that the two arcs BE and $\Gamma\Delta$ will meet the two arcs AB and $A\Gamma$ and will cut one another at the point Z ; let each of them be less than a semi-circle; and let this hold for all the diagrams.

Now I say that the ratio of the chord subtended by double of the arc ΓE to the chord subtended by double of the arc EA is compounded of (a) the ratio of the chord subtended by double of the arc ΓZ to the chord subtended by double of the arc $Z\Delta$, and (b) the ratio of the chord subtended by double of the arc ΔB to the chord subtended by double of the arc BA ,

$$\left[\text{i.e., } \frac{\sin \Gamma E}{\sin EA} = \frac{\sin \Gamma Z}{\sin Z\Delta} \cdot \frac{\sin \Delta B}{\sin BA} \right].$$

For let the centre of the sphere be taken, and let it be H , and from H let HB and HZ and HE be drawn to B , Z , E , the points of intersection of the circles, and let $A\Delta$ be joined and produced, and let it meet HB produced at the point Θ , and similarly let $\Delta\Gamma$ and $A\Gamma$ be joined and cut HZ and HE at K and the point

TRIGONOMETRY

Λ ; then the points Θ , K , Λ will lie on one straight line because they lie simultaneously in two planes, that of the triangle $A\Gamma\Delta$ and that of the circle BZE , and therefore we have straight lines $\Theta\Lambda$ and $\Gamma\Delta$ meeting the two straight lines ΘA and ΓA and cutting one another at the point K ; therefore

$$\Gamma\Lambda : \Lambda A = (\Gamma K : K\Delta)(\Delta\Theta : \Theta A). \quad [\text{by (2)}]$$

But $\Gamma\Lambda : \Lambda A =$ the chord subtended by double of the arc ΓE :

the chord subtended by double of the arc EA

$$[\text{i.e., } \sin \Gamma E : \sin EA],$$

while $\Gamma K : K\Delta =$ the chord subtended by double of the arc ΓZ :

the chord subtended by double of the arc $Z\Delta$ [by (3)]

$$[\text{i.e., } \sin \Gamma Z : \sin Z\Delta],$$

GREEK MATHEMATICS

πρὸς ΘΑ, οὕτως ἢ ὑπὸ τὴν διπλὴν τῆς ΔΒ περιφερείας πρὸς τὴν ὑπὸ τὴν διπλὴν τῆς ΒΑ· καὶ ὁ λόγος ἄρα ὁ τῆς ὑπὸ τὴν διπλὴν τῆς ΓΕ πρὸς τὴν ὑπὸ τὴν διπλὴν τῆς ΕΑ συνῆπται ἔκ τε τοῦ τῆς ὑπὸ τὴν διπλὴν τῆς ΓΖ πρὸς τὴν ὑπὸ τὴν διπλὴν τῆς ΖΔ καὶ τοῦ τῆς ὑπὸ τὴν διπλὴν τῆς ΔΒ πρὸς τὴν ὑπὸ τὴν διπλὴν τῆς ΒΑ.

Κατὰ τὰ αὐτὰ δὴ καὶ ὡσπερ ἐπὶ τῆς ἐπιπέδου καταγραφῆς τῶν εὐθειῶν δείκνυται, ὅτι καὶ ὁ τῆς ὑπὸ τὴν διπλὴν τῆς ΓΑ πρὸς τὴν ὑπὸ τὴν διπλὴν τῆς ΕΑ λόγος συνῆπται ἔκ τε τοῦ τῆς ὑπὸ τὴν διπλὴν τῆς ΓΔ πρὸς τὴν ὑπὸ τὴν διπλὴν τῆς ΔΖ καὶ τοῦ τῆς ὑπὸ τὴν διπλὴν τῆς ΖΒ πρὸς τὴν ὑπὸ τὴν διπλὴν τῆς ΒΕ· ἄπερ προέκειτο δεῖξαι.

* From the Arabic version, it is known that "Menelaus's Theorem" was the first proposition in Book iii. of his *Sphaerica*, and several interesting deductions follow.

TRIGONOMETRY

and $\theta\Delta : \theta A =$ the chord subtended by double of the arc ΔB :

the chord subtended by double of
the arc BA [by (4)]

[i.e., $\sin \Delta B : \sin BA$],

and therefore the ratio of the chord subtended by double of the arc ΓE to the chord subtended by double of the arc EA is compounded of (a) the ratio of the chord subtended by double of the arc ΓZ to the chord subtended by double of the arc $Z\Delta$, and (b) the ratio of the chord subtended by double of the arc ΔB to the chord subtended by double of the arc BA ,

$$\left[\text{i.e., } \frac{\sin \Gamma E}{\sin EA} = \frac{\sin \Gamma Z}{\sin Z\Delta} \cdot \frac{\sin \Delta B}{\sin BA} \right].$$

Now with the same premises, and as in the case of the straight lines in the plane diagram [by (1)], it is shown that the ratio of the chord subtended by double of the arc ΓA to the chord subtended by double of the arc EA is compounded of (a) the ratio of the chord subtended by double of the arc $\Gamma \Delta$ to the chord subtended by double of the arc ΔZ , and (b) the ratio of the chord subtended by double of the arc ZB to the chord subtended by double of the chord BE ,

$$\left[\text{i.e., } \frac{\sin \Gamma A}{\sin EA} = \frac{\sin \Gamma \Delta}{\sin \Delta Z} \cdot \frac{\sin ZB}{\sin BE} \right];$$

which was set to be proved.^a

XXII. MENSURATION:
HERON OF ALEXANDRIA

XXII. MENSURATION : HERON OF ALEXANDRIA

(a) DEFINITIONS

Heron, *Deff.*, ed. Heiberg (Heron iv.) 14. 1-24

Καὶ τὰ μὲν πρὸ τῆς γεωμετρικῆς στοιχειώσεως τεχνολογούμενα ὑπογράφων σοι καὶ ὑποτυπούμενος, ὡς ἔχει μάλιστα συντόμως, Διονύσιε λαμπρότατε, τὴν τε ἀρχὴν καὶ τὴν ὄλην σύνταξιν ποιήσομαι κατὰ τὴν τοῦ Εὐκλείδου τοῦ Στοιχειωτοῦ τῆς ἐν γεωμετρίᾳ θεωρίας διδασκαλίαν· οἶμαι γὰρ οὕτως οὐ μόνον τὰς ἐκείνου πραγματείας

^a The problem of Heron's date is one of the most disputed questions in the history of Greek mathematics. The only details certainly known are that he lived after Apollonius, whom he quotes, and before Pappus, who cites him, say between 150 B.C. and A.D. 250. Many scraps of evidence have been thrown into the dispute, including the passage here first cited; for it is argued that the title *λαμπρότατος* corresponds to the Latin *clarissimus*, which was not in common use in the third century A.D. Both Heiberg (Heron, vol. v. p. ix) and Heath (*H.G.M.* ii. 306) place him, however, in the third century A.D., only a little earlier than Pappus.

The chief works of Heron are now definitively published in five volumes of the Teubner series. Perhaps the best known are his *Pneumatica* and the *Automata*, in which he shows how to use the force of compressed air, water or steam; they are of great interest in the history of physics, and have led some to describe Heron as "the father of the turbine," but

XXII. MENSURATION : HERON OF ALEXANDRIA ^a

(a) DEFINITIONS

Heron, *Definitions*, ed. Heiberg (Heron iv.) 14. 1-24

IN setting out for you as briefly as possible, O most excellent Dionysius, a sketch of the technical terms premised in the elements of geometry, I shall take as my starting point, and shall base my whole arrangement upon, the teaching of Euclid, the writer of the elements of theoretical geometry ; for in this way I think I shall give you a good general understanding,

as they have no mathematical interest they cannot be noticed here. Heron also wrote a *Belopoeïca* on the construction of engines of war, and a *Mechanics*, which has survived in Arabic and in a few fragments of the Greek.

In geometry, Heron's elaborate collection of *Definitions* has survived, but his *Commentary on Euclid's Elements* is known only from extracts preserved by Proclus and an-Nairizî, the Arabic comentator. In mensuration there are extant the *Metrica*, *Geometrica*, *Stereometrica*, *Geodaesia*, *Mensurae* and *Liber Geöponicus*. The *Metrica*, discovered in a Constantinople ms. in 1896 by R. Schöne and edited by his son H. Schöne, seems to have preserved its original form more closely than the others, and will be relied on here in preference to them. Heron's *Dioptra*, describing an instrument of the nature of a theodolite and its application to surveying, is also extant and will be cited here.

For a full list of Heron's many works, v. Heath, *H.G.M.* ii. 308-310.

GREEK MATHEMATICS

εὐσυνόπτους ἔσσεσθαι σοι, ἀλλὰ καὶ πλείστας ἄλλας τῶν εἰς γεωμετρίαν ἀνηκόντων. ἄρξομαι τοίνυν ἀπὸ σημείου.

α'. Σημεῖόν ἐστιν, οὗ μέρος οὐθέν ἢ πέρας ἀδιάστατον ἢ πέρας γραμμῆς, πέφυκε δὲ διανοία μόνη ληπτὸν εἶναι ὡσανεὶ ἀμερές τε καὶ ἀμέγεθες τυγχάνον. τοιοῦτον οὖν αὐτό φασιν εἶναι οἷον ἐν χρόνῳ τὸ ἐνεστος καὶ οἷον μονάδα θέσιν ἔχουσαν. ἔστι¹ μὲν οὖν τῇ οὐσίᾳ ταῦτόν τῇ μονάδι· ἀδιαίρετα γὰρ ἄμφω καὶ ἀσώματα καὶ ἀμέριστα· τῇ δὲ ἐπιφανείᾳ καὶ τῇ σχέσει διαφέρει· ἢ μὲν γὰρ μονὰς ἀρχὴ ἀριθμοῦ, τὸ δὲ σημεῖον τῆς γεωμετρομένης οὐσίας ἀρχή, ἀρχὴ δὲ κατὰ ἔκθεσιν, οὐχ ὡς μέρος ὄν τῆς γραμμῆς, ὡς τοῦ ἀριθμοῦ μέρος ἢ μονὰς, προεπινοούμενον δὲ αὐτῆς· κινηθέντος γὰρ ἢ μᾶλλον νοηθέντος ἐν ῥύσει νοεῖται γραμμῆ, καὶ οὕτω σημεῖον ἀρχὴ ἐστὶ γραμμῆς, ἐπιφάνεια δὲ στερεοῦ σώματος.

Ibid. 60. 22-62. 9

ζζ'. Σπεῖρα γίνεται, ὅταν κύκλος ἐπὶ κύκλου τὸ κέντρον ἔχων ὀρθὸς ὦν πρὸς τὸ τοῦ κύκλου ἐπίπεδον περιενεχθεῖς εἰς τὸ αὐτὸ πάλιν ἀποκατασταθῇ· τὸ δὲ αὐτὸ τοῦτο καὶ κρίκος καλεῖται. διεχῆς μὲν οὖν ἐστὶ σπεῖρα ἢ ἔχουσα διάλειμμα, συνεχῆς δὲ ἢ καθ' ἐν σημεῖον συμπίπτουσα, ἐπαλλάττουσα δέ, καθ' ἣν ὁ περιφερόμενος κύκλος

¹ ἐστὶ Friedlein, ὅτι codd..

^a The first definition is that of Euclid i. Def. 1, the third in effect that of Plato, who defined a point as ἀρχὴ γραμμῆς (Aristot. *Metaph.* 992 a 20); the second is reminiscent of Nicomachus, *Arith. Introd.* ii. 7. 1, v. vol. i. pp. 86-89.

MENSURATION: HERON OF ALEXANDRIA

not only of Euclid's works, but of many others pertaining to geometry. I shall begin, then, with the point.

1. A *point* is that which has no parts, or an extremity without extension, or the extremity of a line,^a and, being both without parts and without magnitude, it can be grasped by the understanding only. It is said to have the same character as the moment in time or the unit having position.^b It is the same as the unit in its fundamental nature, for they are both indivisible and incorporeal and without parts, but in relation to surface and position they differ; for the unit is the beginning of number, while the point is the beginning of geometrical being—but a beginning by way of setting out only, not as a part of a line, in the way that the unit is a part of number—and is prior to geometrical being in conception; for when a point moves, or rather is conceived in motion, a line is conceived, and in this way a point is the beginning of a line and a surface is the beginning of a solid body.

Ibid. 60. 22–62. 9

97. A *spire* is generated when a circle revolves and returns to its original position in such a manner that its centre traces a circle, the original circle remaining at right angles to the plane of this circle; this same curve is also called a *ring*. A spire is *open* when there is a gap, *continuous* when it touches at one point, and *self-crossing* when the revolving circle cuts itself.

^b The Pythagorean definition of a point: v. Proclus, in *Eucl.* i., ed. Friedlein 95. 22. Proclus's whole comment is worth reading, and among modern writers there is a full discussion in Heath, *The Thirteen Books of Euclid's Elements*, vol. i. pp. 155–158.

αὐτὸς αὐτὸν τέμνει. γίνονται δὲ καὶ τούτων τομαὶ γραμμαὶ τινες ἰδιάζουσαι. οἱ δὲ τετράγωνοι κρῖκοι ἐκπρίσματα εἰσι κυλίνδρων· γίνονται δὲ καὶ ἄλλα τινὰ ποικίλα πρίσματα ἔκ τε σφαιρῶν καὶ ἔκ μικτῶν ἐπιφανειῶν.

(b) MEASUREMENT OF AREAS AND VOLUMES

(i.) Area of a Triangle Given the Sides

Heron, *Metr.* i. 8, ed. H. Schöne (Heron iii.) 18. 12-24. 21

Ἔστι δὲ καθολικὴ μέθοδος ὥστε τριῶν πλευρῶν δοθεισῶν οἰουδηποτοῦν τριγώνου τὸ ἔμβαδὸν εὔρειν χωρὶς καθέτου· οἷον ἔστωσαν αἱ τοῦ τριγώνου πλευραὶ μονάδων ζ , η , θ . σύνθεσ τὰ ζ καὶ τὰ η καὶ τὰ θ · γίνονται $\kappa\delta$. τούτων λαβὲ τὸ ἥμισυ· γίνονται $\iota\beta$. ἄφελε τὰς ζ μονάδας· λοιπαὶ ϵ . πάλιν ἄφελε ἀπὸ τῶν $\iota\beta$ τὰς η · λοιπαὶ δ . καὶ ἔτι τὰς θ · λοιπαὶ γ . ποιήσον τὰ $\iota\beta$ ἐπὶ τὰ ϵ · γίνονται ξ . ταῦτα ἐπὶ τὸν δ · γίνονται $\sigma\mu$. ταῦτα ἐπὶ τὸν γ · γίνονται $\psi\kappa$. τούτων λαβὲ πλευρὰν καὶ ἔσται τὸ ἔμβαδὸν τοῦ τριγώνου. ἐπεὶ οὖν αἱ $\psi\kappa$ ῥητὴν τὴν πλευρὰν οὐκ ἔχουσι, ληψόμεθα μετὰ διαφόρου ἐλαχίστου τὴν πλευρὰν οὕτως· ἐπεὶ ὁ συνεγγίζων τῷ $\psi\kappa$ τετράγωνός ἐστιν ὁ $\psi\kappa\theta$ καὶ πλευρὰν ἔχει τὸν $\kappa\zeta$, μέρισον τὰς $\psi\kappa$ εἰς τὸν $\kappa\zeta$ · γίνονται $\kappa\bar{\zeta}$ καὶ τρίτα δύο· πρόσθεσ τὰς $\kappa\zeta$ · γίνονται $\nu\gamma$ τρίτα δύο. τούτων τὸ ἥμισυ· γίνονται $\kappa\bar{\zeta}$ $\angle\gamma'$. ἔσται ἄρα τοῦ $\psi\kappa$ ἡ πλευρὰ ἔγγιστα τὰ $\kappa\bar{\zeta}$ $\angle\gamma'$. τὰ γὰρ $\kappa\bar{\zeta}$ $\angle\gamma'$ ἐφ' ἑαυτὰ γίνονται $\psi\kappa$ $\lambda\sigma'$. ὥστε τὸ διάφορον μονάδος ἐστὶ μόριον $\lambda\sigma'$. εἰ δὲ βουλόμεθα

MENSURATION: HERON OF ALEXANDRIA

Certain special curves are generated by sections of these spires. But the *square rings* are prismatic sections of cylinders ; various other kinds of prismatic sections are formed from spheres and *mixed surfaces*.^a

(b) MEASUREMENT OF AREAS AND VOLUMES

(i.) *Area of a Triangle Given the Sides*

Heron, *Metrica* i. 8, ed. H. Schöne (Heron iii.) 18. 12-24. 21

There is a general method for finding, without drawing a perpendicular, the area of any triangle whose three sides are given. For example, let the sides of the triangle be 7, 8 and 9. Add together 7, 8 and 9 ; the result is 24. Take half of this, which gives 12. Take away 7 ; the remainder is 5. Again, from 12 take away 8 ; the remainder is 4. And again 9 ; the remainder is 3. Multiply 12 by 5 ; the result is 60. Multiply this by 4 ; the result is 240. Multiply this by 3 ; the result is 720. Take the square root of this and it will be the area of the triangle. Since 720 has not a rational square root, we shall make a close approximation to the root in this manner. Since the square nearest to 720 is 729, having a root 27, divide 27 into 720 ; the result is $26\frac{2}{3}$; add 27 ; the result is $53\frac{2}{3}$. Take half of this ; the result is $26\frac{1}{2} + \frac{1}{3} (= 26\frac{5}{6})$. Therefore the square root of 720 will be very nearly $26\frac{5}{6}$. For $26\frac{5}{6}$ multiplied by itself gives $720\frac{1}{36}$; so that the difference is $\frac{1}{36}$. If we wish to make the difference less than $\frac{1}{36}$,

^a The passage should be read in conjunction with those from Proclus cited *supra*, pp. 360-365 ; note the slight difference in terminology—*self-crossing* for *interlaced*.

GREEK MATHEMATICS

ἐν ἐλάσσοι μορίῳ τοῦ λς' τὴν διαφορὰν γίνεσθαι, ἀντὶ τοῦ $\overline{\psi\kappa\theta}$ τάξομεν τὰ νῦν εὐρεθέντα $\overline{\psi\kappa}$ καὶ λς', καὶ ταῦτὰ ποιήσαντες εὐρήσομεν πολλῶ ἐλάττονα <τοῦ>¹ λς' τὴν διαφορὰν γιγνομένην.

Ἡ δὲ γεωμετρικὴ τούτου ἀπόδειξις ἐστὶν ἡδε· τριγώνου δοθεισῶν τῶν πλευρῶν εὐρεῖν τὸ ἐμβαδόν. δυνατὸν μὲν οὖν ἐστὶν ἀγαγόντα[s]² μίαν κάθετον καὶ πορισάμενον αὐτῆς τὸ μέγεθος εὐρεῖν τοῦ τριγώνου τὸ ἐμβαδόν, δέον δὲ ἔστω χωρὶς τῆς καθέτου τὸ ἐμβαδὸν πορίσασθαι.

Ἔστω τὸ δοθὲν τρίγωνον τὸ ΑΒΓ καὶ ἔστω ἐκάστη τῶν ΑΒ, ΒΓ, ΓΑ δοθεῖσα· εὐρεῖν τὸ ἐμβα-

¹ τοῦ add. Heiberg.

² ἀγαγόντα[s] corr. H. Schöne.

^a If a non-square number A is equal to $a^2 \pm b$, Heron's method gives as a first approximation to \sqrt{A} ,

$$a_1 = \frac{1}{2} \left(a + \frac{A}{a} \right),$$

and as a second approximation,

$$a_2 = \frac{1}{2} \left(a_1 + \frac{A}{a_1} \right).$$

An equivalent formula is used by Rhabdas (*v. vol. i. p. 30 n. b*) and by a fourteenth century Calabrian monk Barlaam, who wrote in Greek and who indicated that the process could be continued indefinitely. Several modern writers have used the formula to account for Archimedes' approximations to $\sqrt{3}$ (*v. vol. i. p. 322 n. a*).

^b Heron had previously shown how to do this.

δόν. ἐγγεγράφθω εἰς τὸ τρίγωνον κύκλος ὁ ΔΕΖ, οὗ κέντρον ἔστω τὸ Η, καὶ ἐπέξεύχθωσαν αἱ ΑΗ, ΒΗ, ΓΗ, ΔΗ, ΕΗ, ΖΗ. τὸ μὲν ἄρα ὑπὸ ΒΓ, ΕΗ διπλάσιόν ἐστι τοῦ ΒΗΓ τριγώνου, τὸ δὲ ὑπὸ ΓΑ, ΖΗ τοῦ ΑΓΗ τριγώνου, (τὸ δὲ ὑπὸ ΑΒ, ΔΗ τοῦ ΑΒΗ τριγώνου)¹. τὸ ἄρα ὑπὸ τῆς περιμέτρου τοῦ ΑΒΓ τριγώνου καὶ τῆς ΕΗ, τουτέστι τῆς ἐκ τοῦ κέντρου τοῦ ΔΕΖ κύκλου, διπλάσιόν ἐστι τοῦ ΑΒΓ τριγώνου. ἐκβεβλήσθω ἡ ΓΒ, καὶ τῇ ΑΔ ἴση κείσθω ἡ ΒΘ· ἡ ἄρα ΓΒΘ ἡμίσειά ἐστι τῆς περιμέτρου τοῦ ΑΒΓ τριγώνου διὰ τὸ ἴσην εἶναι τὴν μὲν ΑΔ τῇ ΑΖ, τὴν δὲ ΔΒ τῇ ΒΕ, τὴν δὲ ΖΓ τῇ ΓΕ. τὸ ἄρα ὑπὸ τῶν ΓΘ, ΕΗ ἴσον ἐστὶ τῷ ΑΒΓ τριγώνῳ. ἀλλὰ τὸ ὑπὸ τῶν ΓΘ, ΕΗ πλευρά ἐστιν τοῦ ἀπὸ τῆς ΓΘ ἐπὶ τὸ ἀπὸ τῆς ΕΗ· ἔσται ἄρα τοῦ ΑΒΓ τριγώνου τὸ ἐμβαδὸν ἐφ' ἑαυτὸ γενόμενον ἴσον τῷ ἀπὸ τῆς ΘΓ ἐπὶ τὸ ἀπὸ τῆς ΕΗ. ἤχθω τῇ μὲν ΓΗ πρὸς ὀρθᾶς ἡ ΗΛ, τῇ δὲ ΓΒ ἡ ΒΛ, καὶ ἐπέξεύχθω ἡ ΓΛ. ἐπεὶ οὖν ὀρθὴ ἐστὶν ἑκατέρα τῶν ὑπὸ ΓΗΛ, ΓΒΛ, ἐν κύκλῳ ἄρα ἐστὶ τὸ ΓΗΒΛ τετράπλευρον· αἱ ἄρα ὑπὸ ΓΗΒ, ΓΛΒ δυσὶν ὀρθαῖς εἰσὶν ἴσαι. εἰσὶν δὲ καὶ αἱ ὑπὸ ΓΗΒ, ΑΗΔ δυσὶν ὀρθαῖς ἴσαι διὰ τὸ δίχα τετμηῆσθαι τὰς πρὸς τῷ Η γωνίας ταῖς ΑΗ, ΒΗ, ΓΗ καὶ ἴσας εἶναι τὰς ὑπὸ τῶν ΓΗΒ, ΑΗΔ ταῖς ὑπὸ τῶν ΑΗΓ, ΔΗΒ καὶ τὰς πάσας τέτρασιν ὀρθαῖς ἴσας εἶναι· ἴση ἄρα ἐστὶν ἡ ὑπὸ ΑΗΔ τῇ ὑπὸ ΓΛΒ. ἔστι δὲ καὶ ὀρθὴ ἡ ὑπὸ ΑΔΗ ὀρθὴ τῇ ὑπὸ ΓΒΛ ἴση· ὁμοιον ἄρα ἐστὶ τὸ ΑΗΔ τρίγωνον τῷ ΓΒΛ τριγώνῳ. ὡς ἄρα ἡ ΒΓ πρὸς

¹ τὸ δὲ . . . τριγώνου: these words, along with several
474

MENSURATION : HERON OF ALEXANDRIA

circle ΔEZ be inscribed in the triangle with centre H [Eucl. iv. 4], and let AH, BH, ΓH , ΔH , EH, ZH be joined. Then

$$B\Gamma \cdot EH = 2 \cdot \text{triangle } B\Gamma H, \quad [\text{Eucl. i. 41}]$$

$$\Gamma A \cdot ZH = 2 \cdot \text{triangle } A\Gamma H, \quad [\textit{ibid.}]$$

$$AB \cdot \Delta H = 2 \cdot \text{triangle } ABH. \quad [\textit{ibid.}]$$

Therefore the rectangle contained by the perimeter of the triangle $AB\Gamma$ and EH, that is the radius of the circle ΔEZ , is double of the triangle $AB\Gamma$. Let ΓB be produced and let $B\Theta$ be placed equal to $A\Delta$; then $\Gamma B\Theta$ is half of the perimeter of the triangle $AB\Gamma$ because $A\Delta = AZ$, $\Delta B = BE$, $Z\Gamma = \Gamma E$ [by Eucl. iii. 17]. Therefore

$$\Gamma\Theta \cdot EH = \text{triangle } AB\Gamma. \quad [\textit{ibid.}]$$

But $\Gamma\Theta \cdot EH = \sqrt{\Gamma\Theta^2 \cdot EH^2}$;
therefore $(\text{triangle } AB\Gamma)^2 = \Theta\Gamma^2 \cdot EH^2$.

Let $H\Lambda$ be drawn perpendicular to ΓH and BA perpendicular to ΓB , and let $\Gamma\Lambda$ be joined. Then since each of the angles $\Gamma H\Lambda$, $\Gamma B\Lambda$ is right, a circle can be described about the quadrilateral ΓHBA [by Eucl. iii. 31]; therefore the angles ΓHB , ΓAB are together equal to two right angles [Eucl. iii. 22]. But the angles ΓHB , $AH\Delta$ are together equal to two right angles because the angles at H are bisected by AH, BH, ΓH and the angles ΓHB , $AH\Delta$ together with $AH\Gamma$, ΔHB are equal to four right angles; therefore the angle $AH\Delta$ is equal to the angle ΓAB . But the right angle $A\Delta H$ is equal to the right angle $\Gamma B\Lambda$; therefore the triangle $AH\Delta$ is similar to the triangle $\Gamma B\Lambda$.

other obvious corrections not specified in this edition, were rightly added to the text by a fifteenth-century scribe.

ΒΛ, ἢ ΑΔ πρὸς ΔΗ, τουτέστιν ἢ ΒΘ πρὸς ΕΗ, καὶ ἐναλλάξ, ὡς ἢ ΓΒ πρὸς ΒΘ, ἢ ΒΛ πρὸς ΕΗ, τουτέστιν ἢ ΒΚ πρὸς ΚΕ διὰ τὸ παράλληλον εἶναι τὴν ΒΛ τῇ ΕΗ, καὶ συνθέντι, ὡς ἢ ΓΘ πρὸς ΒΘ, οὕτως ἢ ΒΕ πρὸς ΕΚ· ὥστε καὶ ὡς τὸ ἀπὸ τῆς ΓΘ πρὸς τὸ ὑπὸ τῶν ΓΘ, ΘΒ, οὕτως τὸ ὑπὸ ΒΕΓ πρὸς τὸ ὑπὸ ΓΕΚ, τουτέστι πρὸς τὸ ἀπὸ ΕΗ· ἐν ὀρθογωνίῳ γὰρ ἀπὸ τῆς ὀρθῆς ἐπὶ τὴν βάσιν κάθετος ἤκται ἢ ΕΗ· ὥστε τὸ ἀπὸ τῆς ΓΘ ἐπὶ τὸ ἀπὸ τῆς ΕΗ, οὗ πλευρὰ ἦν τὸ ἐμβαδὸν τοῦ ΑΒΓ τριγώνου, ἴσον ἔσται τῷ ὑπὸ ΓΘΒ ἐπὶ τὸ ὑπὸ ΓΕΒ. καὶ ἔστι δοθεῖσα ἐκάστη τῶν ΓΘ, ΘΒ, ΒΕ, ΓΕ· ἢ μὲν γὰρ ΓΘ ἡμίσειά ἐστι τῆς περιμέτρου τοῦ ΑΒΓ τριγώνου, ἢ δὲ ΒΘ ἢ ὑπεροχή, ἢ ὑπερέχει ἢ ἡμίσεια τῆς περιμέτρου τῆς ΓΒ, ἢ δὲ ΒΕ ἢ ὑπεροχή, ἢ ὑπερέχει ἢ ἡμίσεια τῆς περιμέτρου τῆς ΑΓ, ἢ δὲ ΕΓ ἢ ὑπεροχή, ἢ ὑπερέχει ἢ ἡμίσεια τῆς περιμέτρου τῆς ΑΒ, ἐπειδήπερ ἴση ἐστὶν ἢ μὲν ΕΓ τῇ ΓΖ, ἢ δὲ ΒΘ τῇ ΑΖ, ἐπεὶ καὶ τῇ ΑΔ ἐστὶν ἴση. δοθὲν ἄρα καὶ τὸ ἐμβαδὸν τοῦ ΑΒΓ τριγώνου.

(ii.) *Volume of a Spire*

Ibid. ii. 13, ed. H. Schöne (Heron iii.) 126. 10–130. 3

Ἔστω γάρ τις ἐν ἐπιπέδῳ εὐθείᾳ ἢ ΑΒ καὶ δύο τυχόντα ἐπ' αὐτῆς σημεία. εἰλήφθω ὁ ΒΓΔΕ <κύκλος>¹ ὀρθὸς ὦν πρὸς τὸ ὑποκείμενον ἐπίπεδον, ἐν ᾧ ἐστὶν ἢ ΑΒ εὐθεία, καὶ μένοντος τοῦ Α

¹ κύκλος add. H. Schöne.

MENSURATION : HERON OF ALEXANDRIA

Therefore $B\Gamma : B\Lambda = A\Delta : \Delta H$
 $= B\Theta : EH,$

and *permutando*, $\Gamma B : B\Theta = B\Lambda : EH$
 $= BK : KE,$

because $B\Lambda$ is parallel to EH ,

and *componendo* $\Gamma\Theta : B\Theta = BE : EK$;

therefore $\Gamma\Theta^2 : \Gamma\Theta \cdot \Theta B = BE \cdot E\Gamma : \Gamma E \cdot EK,$

i.e. $= BE \cdot E\Gamma : EH^2,$

for in a right-angled triangle EH has been drawn from the right angle perpendicular to the base ; therefore $\Gamma\Theta^2 \cdot EH^2$, whose square root is the area of the triangle $AB\Gamma$, is equal to $(\Gamma\Theta \cdot \Theta B)(\Gamma E \cdot EB)$. And each of $\Gamma\Theta$, ΘB , BE , ΓE is given ; for $\Gamma\Theta$ is half of the perimeter of the triangle $AB\Gamma$, while $B\Theta$ is the excess of half the perimeter over ΓB , BE is the excess of half the perimeter over $A\Gamma$, and $E\Gamma$ is the excess of half the perimeter over AB , inasmuch as $E\Gamma = \Gamma Z$, $B\Theta = A\Delta = AZ$. Therefore the area of the triangle $AB\Gamma$ is given.*

(ii.) *Volume of a Spire*

Ibid. ii. 13, ed. H. Schöne (Heron iii.) 126. 10–130. 3

Let AB be any straight line in a plane and A, B any two points taken on it. Let the circle $B\Gamma\Delta E$ be taken perpendicular to the plane of the horizontal, in which lies the straight line AB , and, while the point

* If the sides of the triangle are a, b, c , and $s = \frac{1}{2}(a + b + c)$, Heron's formula may be stated in the familiar terms,

$$\text{area of triangle} = \sqrt{s(s-a)(s-b)(s-c)}.$$

Heron also proves the formula in his *Dioptra* 30, but it is now known from Arabian sources to have been discovered by Archimedes.

GREEK MATHEMATICS

σημείου περιφέρεσθω κατὰ τὸ ἐπίπεδον ἢ AB , ἄχρι οὗ εἰς τὸ αὐτὸ ἀποκατασταθῆ συμπεριφερομένου καὶ τοῦ $BΓΔΕ$ κύκλου ὀρθοῦ διαμέμοντος πρὸς τὸ ὑποκείμενον ἐπίπεδον. ἀπογεννήσει ἄρα τινὰ ἐπιφάνειαν ἢ $BΓΔΕ$ περιφέρεια, ἣν δὴ σπειρικὴν καλοῦσιν· κἂν μὴ ἦ δὲ ὅλος ὁ κύκλος, ἀλλὰ τμῆμα αὐτοῦ, πάλιν ἀπογεννήσει τὸ τοῦ κύκλου τμῆμα σπειρικῆς ἐπιφανείας τμῆμα, καθάπερ εἰσὶ καὶ αἱ ταῖς κίοσιν ὑποκείμεναι σπεῖραι· τριῶν γὰρ οὐσῶν ἐπιφανειῶν ἐν τῷ καλουμένῳ ἀναγραφεῖ, ὃν δὴ τινες καὶ ἐμβολέα καλεῦσιν, δύο μὲν κοίλων τῶν ἄκρων, μιᾶς δὲ μέσης καὶ κυρτῆς, ἅμα περιφερόμεναι αἱ τρεῖς ἀπογεννώσι τὸ εἶδος τῆς τοῖς κίοσιν ὑποκειμένης σπεύρας.

Δέον οὖν ἔστω τὴν ἀπογεννηθεῖσαν σπεύραν ὑπὸ τοῦ $BΓΔΕ$ κύκλου μετρήσαι. δεδοσθω ἢ μὲν AB μονάδων κ , ἢ δὲ $BΓ$ διάμετρος μονάδων $\iotaβ$.

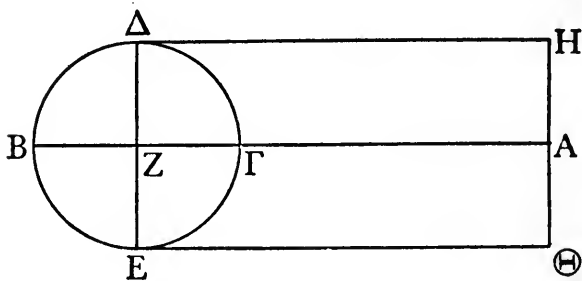

εἰλήφθω τὸ κέντρον τοῦ κύκλου τὸ Z , καὶ ἀπὸ τῶν A, Z τῷ ὑποκειμένῳ ἐπιπέδῳ πρὸς ὀρθὰς ἤχθωσαν αἱ $\Delta Z E, H A \Theta$. καὶ διὰ τῶν Δ, E τῇ AB παράλ-

MENSURATION : HERON OF ALEXANDRIA

A remains stationary, let AB revolve in the plane until it concludes its motion at the place where it started, the circle $B\Gamma\Delta E$ remaining throughout perpendicular to the plane of the horizontal. Then the circumference $B\Gamma\Delta E$ will generate a certain surface, which is called *spiric*; and if the whole circle do not revolve, but only a segment of it, the segment of the circle will again generate a segment of a spiric surface, such as are the *spira*e on which columns rest; for as there are three surfaces in the so-called *anagrapheus*, which some call also *emboleus*, two concave (the extremes) and one (the middle) convex, when the three are moved round simultaneously they generate the form of the *spira* on which columns rest.^a

Let it then be required to measure the spire generated by the circle $B\Gamma\Delta E$. Let AB be given as 20, and the diameter $B\Gamma$ as 12. Let Z be the centre of the circle, and through ^b A, Z let $HA\Theta$, ΔZE be drawn perpendicular to the plane of the horizontal. And through Δ , E let ΔH , $E\Theta$ be drawn parallel to

^a The *ἀναγραφεύς* or *ἐμβολεύς* is the pattern or templet for applying to an architectural feature, in this case an Attic-Ionic column-base. The Attic-Ionic base consists essentially of two convex mouldings, separated by a concave one. In practice, there are always narrow vertical ribbons between the convex mouldings and the concave one, but Heron ignores them. In the *templet*, there are naturally two concave surfaces separated by a convex, and the kind of figure Heron had in mind appears to be that here illustrated. I am indebted to Mr. D. S. Robertson, Regius Professor of Greek in the University of Cambridge, for help

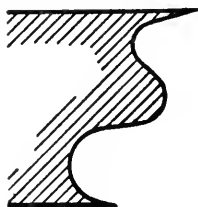

^b Lit. "from."

ληλοι ἤχθωσαν αἱ ΔΗ, ΕΘ. δέδεικται δὲ Διονυσόδωρῳ ἐν τῷ Περὶ τῆς σπείρας ἐπιγραφομένῳ, ὅτι ὄν λόγον ἔχει ὁ ΒΓΔΕ κύκλος πρὸς τὸ ἥμισυ τοῦ ΔΕΗΘ παραλληλογράμμου, τοῦτον ἔχει καὶ ἡ γεννηθεῖσα σπείρα ὑπὸ τοῦ ΒΓΔΕ κύκλου πρὸς τὸν κύλινδρον, οὗ ἄξων μὲν ἐστίν ὁ ΗΘ, ἡ δὲ ἐκ τοῦ κέντρου τῆς βάσεως ἡ ΕΘ. ἐπεὶ οὖν ἡ ΒΓ μονάδων $\overline{\text{ιβ}}$ ἐστίν, ἡ ἄρα ΖΓ ἔσται μονάδων $\overline{5}$. ἔστι δὲ καὶ ἡ ΑΓ μονάδων $\overline{\eta}$. ἔσται ἄρα ἡ ΑΖ μονάδων $\overline{\text{ιδ}}$, τουτέστιν ἡ ΕΘ, ἥτις ἐστίν ἐκ τοῦ κέντρου τῆς βάσεως τοῦ εἰρημένου κυλίνδρου· δοθεὶς ἄρα ἐστίν ὁ κύκλος· ἀλλὰ καὶ ὁ ἄξων δοθεὶς· ἔστιν γὰρ μονάδων $\overline{\text{ιβ}}$, ἐπεὶ καὶ ἡ ΔΕ. ὥστε δοθεὶς καὶ ὁ εἰρημένος κύλινδρος· καὶ ἔστι τὸ ΔΘ παραλληλόγραμμον (δοθέν)¹. ὥστε καὶ τὸ ἥμισυ αὐτοῦ. ἀλλὰ καὶ ὁ ΒΓΔΕ κύκλος· δοθεῖσα γὰρ ἡ ΓΒ διάμετρος. λόγος ἄρα τοῦ ΒΓΔΕ κύκλου πρὸς τὸ ΔΘ παραλληλόγραμμον δοθεὶς· ὥστε καὶ τῆς σπείρας πρὸς τὸν κύλινδρον λόγος ἔστι δοθεὶς. καὶ ἔστι δοθεὶς ὁ κύλινδρος· δοθὲν ἄρα καὶ τὸ στερεὸν τῆς σπείρας.

Συντεθήσεται δὴ ἀκολουθῶς τῇ ἀναλύσει οὕτως. ἀφελε ἀπὸ τῶν $\overline{\kappa}$ τὰ $\overline{\text{ιβ}}$. λοιπὰ $\overline{\eta}$. καὶ πρόσθε τὰ $\overline{\kappa}$. γίνετα $\overline{\kappa\eta}$. καὶ μέτρησον κύλινδρον, οὗ ἡ μὲν διάμετρος τῆς βάσεώς ἐστὶ μονάδων $\overline{\kappa\eta}$, τὸ δὲ ὕψος $\overline{\text{ιβ}}$. καὶ γίνετα τὸ στερεὸν αὐτοῦ $\overline{\zeta\tau\varsigma\beta}$. καὶ μέτρησον κύκλον, οὗ διάμετρος ἐστὶ μονάδων $\overline{\text{ιβ}}$. γίνετα τὸ ἐμβαδὸν αὐτοῦ, καθὼς ἐμάθομεν, $\overline{\rho\iota\gamma}$ $\overline{\zeta}$. καὶ λαβὲ τῶν $\overline{\kappa\eta}$ τὸ ἥμισυ· γίνετα $\overline{\text{ιδ}}$. ἐπὶ τὸ ἥμισυ τῶν $\overline{\text{ιβ}}$. γίνετα $\overline{\text{πδ}}$. καὶ πολλα-

¹ δοθέν add. H. Schöne.

MENSURATION : HERON OF ALEXANDRIA

AB. Now it is proved by Dionysodorus ^a in the book which he wrote *On the Spire* that the circle $B\Gamma\Delta E$ bears to half of the parallelogram $\Delta E H \Theta$ the same ratio as the spire generated by the circle $B\Gamma\Delta E$ bears to the cylinder having $H\Theta$ for its axis and $E\Theta$ for the radius of its base. Now, since $B\Gamma$ is 12, $Z\Gamma$ will be 6. But $A\Gamma$ is 8; therefore AZ will be 14, and likewise $E\Theta$, which is the radius of the base of the aforesaid cylinder. Therefore the circle is given; but the axis is also given; for it is 12, since this is the length of ΔE . Therefore the aforesaid cylinder is also given; and the parallelogram $\Delta\Theta$ is given, so that its half is also given. But the circle $B\Gamma\Delta E$ is also given; for the diameter $I'B$ is given. Therefore the ratio of the circle $B\Gamma\Delta E$ to the parallelogram is given; and so the ratio of the spire to the cylinder is given. And the cylinder is given; therefore the volume of the spire is also given.

Following the analysis, the synthesis may thus be done. Take 12 from 20; the remainder is 8. And add 20; the result is 28. Let the measure be taken of the cylinder having for the diameter of its base 28 and for height 12; the resulting volume is 7392. Now let the area be found of a circle having a diameter 12; the resulting area, as we learnt, is $113\frac{1}{2}$. Take the half of 28; the result is 14. Multiply it by the half of 12; the result is 84. Now multiply

^a For Dionysodorus *v. supra*, p. 162 n. a and p. 364 n. a.

If $\Delta E = H\Theta = 2r$ and $E\Theta = a$, then the volume of the spire bears to the volume of the cylinder the ratio $2\pi a \cdot \pi r^2 : 2r \cdot \pi a^2$ or $\pi r : a$, which, as Dionysodorus points out, is identical with the ratio of the circle to half the parallelogram, that is, $\pi r^2 : ra$ or $\pi r : a$.

GREEK MATHEMATICS

πλασιάσας τὰ $\overline{\zeta\tau\epsilon\beta}$ ἐπὶ τὰ $\overline{\rho\iota\gamma}$ ζ'. καὶ τὰ γενόμενα
 παράβαλε παρά τὸν $\overline{\pi\delta}$. γίγνεται $\overline{\theta\lambda\upsilon\sigma}$ $\frac{\zeta}{\delta}$. τοσ-
 ούτου ἔσται τὸ στερεὸν τῆς σπείρας.

(iii.) *Division of a Circle*

Ibid. iii. 18, ed. H. Schöne (Heron iii.) 172. 13-174. 2

Τὸν δοθέντα κύκλον διελεῖν εἰς τρία ἴσα δυσὶν
 εὐθείαις. τὸ μὲν οὖν πρόβλημα ὅτι οὐ ῥητόν ἐστι,
 δῆλον, τῆς εὐχρηστίας δὲ ἔνεκεν διελουῖμεν αὐτὸν
 ὡς ἔγγιστα οὕτω. ἔστω ὁ δοθεὶς κύκλος, οὗ
 κέντρον τὸ Α, καὶ ἐνηρμόσθω εἰς αὐτὸν τρίγωνον
 ἰσόπλευρον, οὗ πλευρὰ ἡ ΒΓ, καὶ παράλληλος αὐτῇ
 ἤχθω ἡ ΔΑΕ καὶ ἐπεζεύχθωσαν αἱ ΒΔ, ΔΓ. λέγω,
 ὅτι τὸ ΔΒΓ τμήμα τρίτον ἔγγιστα ἐστὶ μέρος τοῦ
 ὅλου κύκλου. ἐπεζεύχθωσαν γὰρ αἱ ΒΑ, ΑΓ. ὁ
 ἄρα ΑΒΓΖΒ τομεὺς τρίτον ἐστὶ μέρος τοῦ ὅλου
 κύκλου. καὶ ἔστιν ἴσον τὸ ΑΒΓ τρίγωνον τῷ
 ΒΓΔ τριγώνῳ. τὸ ἄρα ΒΔΓΖ σχῆμα τρίτον
 μέρος ἐστὶ τοῦ ὅλου κύκλου, ᾧ δὴ μείζον ἐστὶν
 αὐτοῦ τὸ ΔΒΓ τμήμα ἀνεπαισθήτου ὄντος ὡς
 πρὸς τὸν ὅλον κύκλον. ὁμοίως δὲ καὶ ἑτέραν

MENSURATION : HERON OF ALEXANDRIA

7392 by $113\frac{1}{7}$ and divide the product by 84; the result is $9956\frac{4}{7}$. This will be the volume of the spire.

(iii.) *Division of a Circle*

Ibid. iii. 18, ed. H. Schöne (Heron iii.) 172. 13–174. 2

To divide a given circle into three equal parts by two straight lines. It is clear that this problem is not rational, and for practical convenience we shall make the division as closely as possible in this way. Let the given circle have A for its centre, and let there be inserted in it an equilateral triangle with side BΓ, and let $\triangle AE$ be drawn parallel to it, and let BΔ, $\triangle\Gamma$

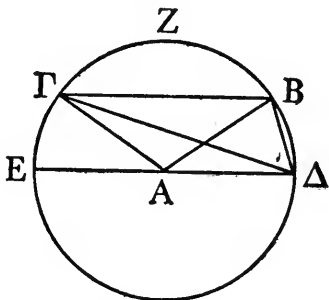

be joined. I say that the segment $\triangle B\Gamma$ is approximately a third part of the whole circle. For let BA, AΓ be joined. Then the sector $AB\Gamma ZB$ is a third part of the whole circle. And the triangle $AB\Gamma$ is equal to the triangle $B\Gamma\Delta$ [Eucl. i. 37]; therefore the figure $B\Delta\Gamma Z$ is a third part of the whole circle, and the excess of the segment $\triangle B\Gamma$ over it is negligible in comparison with the whole circle. Similarly, if we

GREEK MATHEMATICS

πλευρὰν ἰσοπλεύρου τριγώνου ἐγγράψαντες ἀφελούμεν ἕτερον τρίτον μέρος· ὥστε καὶ τὸ καταλειπόμενον τρίτον μέρος ἔσται [μέρος]¹ τοῦ ὅλου κύκλου.

(iv.) *Measurement of an Irregular Area*

Heron, *Dioptr.* 23, ed. H. Schöne (Heron iii.)
260. 18-264. 15

Τὸ δοθὲν χωρίον μετρήσαι διὰ διόπτρας. ἔστω τὸ δοθὲν χωρίον περιεχόμενον ὑπὸ γραμμῆς

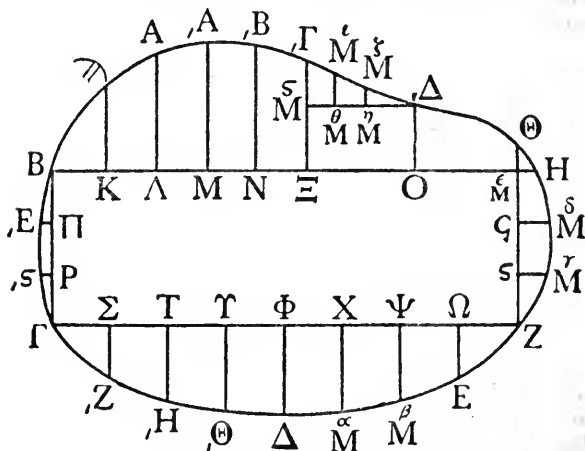

ἀτάκτου τῆς ΑΒΓΔΕΖΗΘ. ἐπεὶ οὖν ἐμάθομεν διὰ τῆς κατασκευασθείσης διόπτρας διάγειν πάσῃ τῇ δοθείσῃ εὐθείᾳ (έτέραν)² πρὸς ὀρθάς, ἔλαβόν τι σημεῖον ἐπὶ τῆς περιεχούσης τὸ χωρίον γραμμῆς

MENSURATION : HERON OF ALEXANDRIA

inscribe another side of the equilateral triangle, we may take away another third part ; and therefore the remainder will also be a third part of the whole circle.^a

(iv.) *Measurement of an Irregular Area*

Heron, *Dioptra* ^b 23, ed. H. Schöne (Heron iii.)
260. 18-264. 15

To measure a given area by means of the dioptra. Let the given area be bounded by the irregular line ABΓΔEZHΘ. Since we learnt to draw, by setting the dioptra, a straight line perpendicular to any other straight line, I took any point B on the line en-

^a Euclid, in his book *On Divisions of Figures* which has partly survived in Arabic, solved a similar problem—to draw in a given circle two parallel chords cutting off a certain fraction of the circle ; Euclid actually takes the fraction as one-third. The general character of the third book of Heron's *Metrics* is very similar to Euclid's treatise.

It is in the course of this book (iii. 20) that Heron extracts the cube root of 100 by a method already noted (vol. i. pp. 60-63).

^b The dioptra was an instrument fulfilling the same purposes as the modern theodolite. An elaborate description of the instrument prefaces Heron's treatise on the subject, and it was obviously a fine piece of craftsmanship, much superior to the "parallactic" instrument with which Ptolemy had to work—another piece of evidence against an early date for Heron.

¹ μέρος om. H. Schöne.
² ἐτέραν add. H. Schöne.

τὸ Β, καὶ ἤγαγον εὐθείαν τυχοῦσαν διὰ τῆς διόπτρας τὴν ΒΗ, καὶ ταύτη πρὸς ὀρθὰς τὴν ΒΓ, <καὶ ταύτη>¹ ἑτέραν πρὸς ὀρθὰς τὴν ΓΖ, καὶ ὁμοίως τῇ ΓΖ πρὸς ὀρθὰς τὴν ΖΘ. καὶ ἔλαβον ἐπὶ τῶν ἀχθεισῶν εὐθειῶν συνεχῆ σημεῖα, ἐπὶ μὲν τῆς ΒΗ τὰ Κ, Λ, Μ, Ν, Ξ, Ο· ἐπὶ δὲ τῆς ΒΓ τὰ Π, Ρ· ἐπὶ δὲ τῆς ΓΖ τὰ Σ, Τ, Υ, Φ, Χ, Ψ, Ω· ἐπὶ δὲ τῆς ΖΘ τὰ ς, ζ. καὶ ἀπὸ τῶν ληφθέντων σημείων ταῖς εὐθείαις, ἐφ' ὧν ἐστὶ τὰ σημεῖα, πρὸς ὀρθὰς ἤγαγον τὰς Κλ, ΛΑ, Μ,Α, Ν,Β, Ξ,Γ, Ο,Δ, Π,Ε, Ρ,ς, Σ,Ζ, Τ,Η, Υ,Θ, Φ,Δ, ΧΜ, ΨΜ, ΩΕ, ςΜ, ζΜ οὕτως ὥστε [τὰς ἐπὶ]² τὰ πέρατα τῶν ἀχθεισῶν πρὸς ὀρθὰς [ἐπιζευγνυμένας]³ ἀπολαμβάνειν γραμμὰς ἀπὸ τῆς περιεχούσης τὸ χωρίον γραμμῆς σύνεγγυς εὐθείας· καὶ τούτων γενηθέντων ἔσται δυνατὸν τὸ χωρίον μετρεῖν. τὸ

μὲν γὰρ ΒΓΖΜ παραλληλόγραμμον ὀρθογώνιον ἐστίν· ἔπειτα τὰς πλευρὰς ἀλύσει ἢ σχοινίῳ βέβασανισμένῳ, τουτέστιν μήτ' ἐκτείνεσθαι μήτε συστέλλεσθαι δυναμένῳ, μετρήσαντες ἕξομεν τὸ ἔμβαδὸν τοῦ παραλληλογράμμου. τὰ δ' ἐκτὸς τούτου τρίγωνα ὀρθογώνια καὶ τραπέζια ὁμοίως μετρήσομεν, ἔχοντες τὰς πλευρὰς αὐτῶν· ἔσται γὰρ τρίγωνα μὲν ὀρθογώνια τὰ ΒΚλ, ΒΠ,Ε,

ΓΡ,ς, ΓΣ,Ζ, ΖΩΕ, ΖςΜ, ΘΗΜ· τὰ δὲ λοιπὰ τραπέζια ὀρθογώνια. τὰ μὲν οὖν τρίγωνα μετρεῖται τῶν περι τὴν ὀρθὴν γωνίαν πολλαπλασιαζομένων ἐπ' ἄλληλα· καὶ τοῦ γενομένου τὸ ἡμισυ. τὰ δὲ τραπέζια· συναμφοτέρων τῶν παραλλήλων τὸ ἡμισυ ἐπὶ τὴν ἐπ' αὐτὰς κάθετον οὔσαν, οἷον

MENSURATION : HERON OF ALEXANDRIA

closing the area, and by means of the dioptra drew any straight line BH, and drew BΓ perpendicular to it, and drew another straight line ΓZ perpendicular to this last, and similarly drew ZΘ perpendicular to ΓZ. And on the straight lines so drawn I took a series of points—on BH taking K, Λ, M, N, Ξ, O, on BΓ taking Π, P, on ΓZ taking Σ, Τ, Υ, Φ, Χ, Ψ, Ω, and on ZΘ taking ς, ζ. And from the points so taken on the straight lines designated by the letters, I drew the perpendiculars Kλ, ΛΑ, ΜΑ, ΝΒ, ΞΓ, ΟΔ, ΠΕ, Ρς, ΣΖ, ΤΗ, ΥΘ, ΦΔ, ΧΜ^α, ΨΜ^β, ΩΕ, ςΜ^γ, ζΜ^δ in such a manner that the extremities of the perpendiculars cut off from the line enclosing the area approximately straight lines. When this is done it will be possible

to measure the area. For the parallelogram BΓΖΜ is right-angled; so that if we measure the sides by a chain or measuring-rod, which has been carefully tested so that it can neither expand nor contract, we shall obtain the area of the parallelogram. We may similarly measure the right-angled triangles and trapezia outside this by taking their sides; for BKλ, ΒΠΕ, ΓΡς, ΓΣΖ, ΖΩΕ, ΖςΜ, ΘΗΜ are right-angled triangles, and the remaining figures are right-angled trapezia. The triangles are measured by multiplying together the sides about the right angle and taking half the product. As for the trapezia—take half of the sum of the two parallel sides and multiply it by the perpendicular upon

¹ καὶ ταύτη add. H. Schöne.

² τὰς ἐπὶ om. H. Schöne.

³ ἐπιζευγνυμένας om. H. Schöne.

GREEK MATHEMATICS

τῶν $K\lambda$, $ΑΛ$ τὸ ἥμισυ ἐπὶ τὴν $ΚΛ$ · καὶ τῶν λοιπῶν δὲ ὁμοίως. ἔσται ἄρα μεμετρημένον ὄλον τὸ χωρίον διὰ τε τοῦ μέσου παραλληλογράμμου καὶ τῶν ἐκτὸς αὐτοῦ τριγώνων καὶ τραπεζίων. ἔαν δὲ τύχη ποτὲ μεταξὺ αὐτῶν τῶν ἀχθεισῶν πρὸς ὀρθὰς ταῖς τοῦ παραλληλογράμμου πλευραῖς καμπύλη γραμμὴ μὴ συνεγγίζουσα εὐθείᾳ (οἷον μεταξὺ τῶν Ξ, Γ, O, Δ γραμμῆ ἢ Γ, Δ), ἀλλὰ περιφερεῖ, μετρήσομεν οὕτως· ἀγαγόντες $\langle \tau\eta \rangle^1$ O, Δ πρὸς ὀρθὰς τὴν ΔM , καὶ ἐπ' αὐτῆς λαβόντες σημεῖα συνεχῆ τὰ M, M , καὶ ἀπ' αὐτῶν πρὸς ὀρθὰς ἀγαγόντες τῆ M, Δ τὰς MM, MM , ὥστε τὰς μεταξὺ τῶν ἀχθεισῶν σύνεγγυς εὐθείας εἶναι, πάλιν μετρήσομεν τό τε MEO, Δ παραλληλόγραμμον καὶ τὸ MM, Δ τρίγωνον, καὶ τὸ $\Gamma M M M$ τραπέζιον, καὶ ἔτι τὸ ἕτερον τραπέζιον, καὶ ἔξομεν τὸ περιεχόμενον χωρίον ὑπὸ τε τῆς $\Gamma M M, \Delta$ γραμμῆς καὶ τῶν $\Gamma \Xi, \langle \Xi O \rangle^2$ O, Δ εὐθειῶν μεμετρημένον.

(c) MECHANICS

Heron, *Diopt.* 37, ed. H. Schöne (Heron iii.) 306. 22–312. 22

Τῆ δοθείσῃ δυνάμει τὸ δοθὲν βάρος κινήσαι

¹ τῆ add. H. Schöne.

² ΞO add. H. Schöne.

* Heron's *Mechanics* in three books has survived in Arabic, but has obviously undergone changes in form. It begins with the problem of arranging toothed wheels so as to move

MENSURATION : HERON OF ALEXANDRIA

them, as, for example, half of $K\lambda$, AA by KA ; and similarly for the remainder. Then the whole area will have been measured by means of the parallelogram in the middle and the triangles and trapezia outside it. If perchance the curved line between the perpendiculars drawn to the sides of the parallelogram should not approximate to a straight line (as, for example, the curve Γ, Δ between Ξ, Γ, O, Δ), but to an arc, we may measure it thus: Draw ΔM perpendicular to O, Δ , and on it take a series of points M, M , and from them draw MM, MM perpendicular to M, Δ , so that the portions between the straight lines so drawn approximate to straight lines, and again we can measure the parallelogram $M\Xi O, \Delta$ and the triangle MM, Δ , and the trapezium $\Gamma M M M$, and also the other trapezium, and so we shall obtain the area bounded by the line $\Gamma M M, \Delta$ and the straight lines $\Gamma \Xi, \Xi O, O, \Delta$.

(c) MECHANICS ^a

Heron, *Dioptra* 37, ed. H. Schöne (Heron iii.) 306. 22–312. 22

With a given force to move a given weight by the

a given weight by a given force. This account is the same as that given in the passage here reproduced from the *Dioptra*, and it is obviously the same as the account found by Pappus (viii. 19, ed. Hultsch 1060. 1–1068. 23) in a work of Heron's (now lost) entitled *Βαρουλκός* ("weight-lifter")—though Pappus himself took the ratio of force to weight as 4 : 160 and the ratio of successive diameters as 2 : 1. It is suggested by Heath (*H.G.M.* ii. 346–347) that the chapter from the

GREEK MATHEMATICS

διὰ τυμπάνων ὀδοντωτῶν παραθέσεως. κατεσκευάσθω πῆγμα καθάπερ γλωσσόκομον· εἰς τοὺς μακροὺς καὶ παραλλήλους τοίχους διακείσθωσαν ἄξονες παράλληλοι ἑαυτοῖς, ἐν διαστήμασι κείμενοι

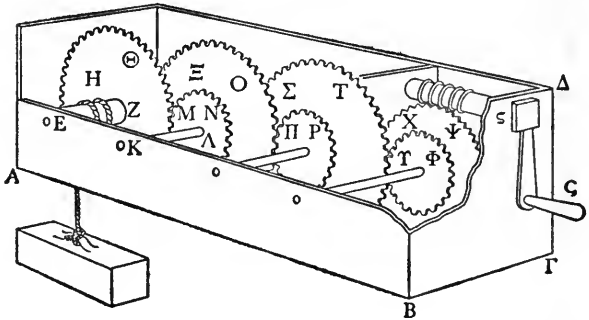

ὥστε τὰ συμφυῆ αὐτοῖς ὀδοντωτὰ τύμπανα παρακείσθαι καὶ συμπεπλέχθαι ἀλλήλοις, καθὰ μέλλομεν δηλοῦν. ἔστω τὸ εἰρημένον γλωσσόκομον τὸ ΑΒΓΔ, ἐν ᾧ ἄξων ἔστω διακείμενος, ὡς εἴρηται, καὶ δυνάμενος εὐλύτως στρέφεσθαι, ὁ ΕΖ. τούτῳ δὲ συμφυῆς ἔστω τύμπανον ὀδοντωμένον τὸ ΗΘ ἔχον τὴν διάμετρον, εἰ τύχοι, πενταπλασίονα <τῆς>¹ τοῦ ΕΖ ἄξονος διαμέτρον. καὶ ἵνα ἐπὶ παραδείγματος τὴν κατασκευὴν ποιησώμεθα, ἔστω τὸ μὲν ἀγόμενον βάρος ταλάντων χιλίων, ἡ δὲ κινουσα δύναμις ἔστω ταλάντων ἑ, τουτέστιν ὁ κινῶν ἄνθρωπος ἢ παιδάριον, ὥστε δύνασθαι καθ' ἑαυτὸν ἄνευ μηχανῆς ἔλκειν τάλαντα ἑ. οὐκοῦν εἰάν τὰ ἐκ τοῦ φορτίου ἐκδεδεμένα ὄπλα διὰ τινος <ὀπῆς

MENSURATION : HERON OF ALEXANDRIA

juxtaposition of toothed wheels.^a Let a framework be prepared like a chest ; and in the long, parallel walls let there lie axles parallel one to another, resting at such intervals that the toothed wheels fitting on to them will be adjacent and will engage one with the other, as we shall explain. Let $AB\Gamma\Delta$ be the afore-said chest, and let EZ be an axle lying in it, as stated above, and able to revolve freely. Fitting on to this axle let there be a toothed wheel $H\Theta$ whose diameter, say, is five times the diameter of the axle EZ . In order that the construction may serve as an illustration, let the weight to be raised be 1000 talents, and let the moving force be 5 talents, that is, let the man or slave who moves it be able by himself, without mechanical aid, to lift 5 talents. Then if the rope holding the load passes through some aperture in

Βαρουλκός was substituted for the original opening of the *Mechanics*, which had become lost.

Other problems dealt with in the *Mechanics* are the paradox of motion known as Aristotle's wheel, the parallelogram of velocities, motion on an inclined plane, centres of gravity, the five mechanical powers, and the construction of engines. Edited with a German translation by L. Nix and W. Schmidt, it is published as vol. ii. in the Teubner Heron.

^a Perhaps "rollers."

¹ τῆς add. Vincentius.

οὔσης)¹ ἐν τῷ AB τοίχῳ ἐπειληθῆ περι τὸν EZ ἄξονα (.)² κατειλούμενα τὰ ἐκ τοῦ φορτίου ὄπλα κινήσει τὸ βάρος³. ἵνα δὲ κινήθῃ τὸ ΗΘ τύμπανον, (δεῖ δυνάμει⁴ ὑπάρχειν πλεόν ταλάντων διακοσίων, διὰ τὸ τὴν διάμετρον τοῦ τυμπάνου τῆς διαμέτρου τοῦ ἄξονος, ὡς ὑπεθέμεθα, πενταπλὴν εἶναι)⁵. ταῦτα γὰρ ἀπεδείχθη ἐν ταῖς τῶν εἰ δυνάμεων ἀποδείξεσιν. ἀλλ' (.)⁶ ἔχομεν τὴν δύναμιν ταλάντων διακοσίων, ἀλλὰ πέντε. γεγονέτω οὖν ἕτερος ἄξων (παράλληλος)⁷ διακείμενος τῷ EZ, ὁ ΚΛ, ἔχων συμφυῆς τύμπανον ὠδοντωμένον τὸ MN. ὄδοντῶδες δὲ καὶ τὸ ΗΘ τύμπανον, ὥστε ἐναρμόζειν ταῖς ὄδοντώσεσι τοῦ MN τυμπάνου. τῷ δὲ αὐτῷ ἄξονι τῷ ΚΛ συμφυῆς τύμπανον τὸ ΕΟ, ἔχον ὁμοίως τὴν διάμετρον πενταπλασίονα τῆς τοῦ MN τυμπάνου διαμέτρου. διὰ δὴ τοῦτο δεήσει τὸν βουλόμενον κινεῖν διὰ τοῦ ΕΟ τυμπάνου τὸ βάρος ἔχει δύναμιν ταλάντων $\bar{\mu}$, ἐπειδήπερ τῶν $\bar{\sigma}$ ταλάντων τὸ πέμπτον ἐστὶ τάλαντα $\bar{\mu}$. πάλιν οὖν παρακείσθω (τῷ ΕΟ τυμπάνῳ ὠδοντωμένῳ)⁸ τύμπανον ὄδοντωθὲν ἕτερον (τὸ ΠΡ, καὶ ἔστω τῷ)⁹ τυμπάνῳ ὠδοντωμένῳ τῷ ΠΡ συμφυῆς ἕτερον τύμπανον τὸ ΣΤ¹⁰ ἔχον ὁμοίως πενταπλὴν τὴν διάμετρον τῆς ΠΡ τυμπάνου διαμέτρου· ἢ δὲ ἀνάλογος ἔσται δύναμις)¹¹ τοῦ ΣΤ τυμπάνου ἢ ἔχουσα τὸ βάρος ταλάντων $\bar{\eta}$.

¹ ὁπῆς οὔσης add. Hultsch et H. Schöne.

² After ἄξονα there is a lacuna of five letters.

³ τὰ ἐκ τοῦ φορτίου ὄπλα κινήσει τὸ βάρος H. Schöne, τὰ ἐκ τοῦ φορτίου ἐπλακων εν τισι το βάρος cod.

⁴ δεῖ δυνάμει—"septem litteris madore absumptis, supplevi dubitanter," H. Schöne.

⁵ εἶναι add. H. Schöne.

MENSURATION : HERON OF ALEXANDRIA

the wall AB and is coiled round the axle EZ, the rope holding the load will move the weight as it winds up. In order that the wheel HΘ may be moved, a force of more than 200 talents is necessary, owing to the diameter of the wheel being, as postulated, five times the diameter of the axle ; for this was shown in the proofs of the five mechanical powers.^a We have [not, however . . .] a force of 200 talents, but only of 5. Therefore let there be another axle ΚΑ, lying parallel to EZ, and having the toothed wheel MN fitting on to it. Now let the teeth of the wheel HΘ be such as to engage with the teeth of the wheel MN. On the same axle ΚΑ let there be fitted the wheel ΞΟ, whose diameter is likewise five times the diameter of the wheel MN. Now, in consequence, anyone wishing to move the weight by means of the wheel ΞΟ will need a force of 40 talents, since the fifth part of 200 talents is 40 talents. Again, then, let another toothed wheel ΠΠ lie alongside the toothed wheel ΞΟ, and let there be fitted to the toothed wheel ΠΠ another toothed wheel ΣΤ whose diameter is likewise five times the diameter of the wheel ΠΠ ; then the force needing to be applied to the wheel ΣΤ will be 8 talents ; but the force actually available

* The wheel and axle, the lever, the pulley, the wedge and the screw, which are dealt with in Book ii. of Heron's *Mechanics*.

^a After ἀλλ' is a special sign and a lacuna of 22 letters.

⁷ παράλληλος add. H. Schöne.

⁸ τῷ ΞΟ τυμπάνῳ ὠδοντωμένῳ add. H. Schöne.

⁹ τὸ ΠΠ, καὶ ἔστω τῷ add. H. Schöne.

¹⁰ τύμπανον τὸ ΣΤ, so I read in place of the συμφυῆς in Schöne's text.

¹¹ ἀνάλογος ἔσται δύναμις—so H. Schöne completes the lacuna.

ἀλλ' ἡ ὑπάρχουσα ἡμῖν δύναμις δέδοται ταλάντων
 ἔ. ὁμοίως ἕτερον παρακείσθω τύμπανον ὠδοντω-
 μένον τὸ ΥΦ τῷ ΣΤ ὠδοντωθέντι· τοῦδε τοῦ ΥΦ
 τυμπάνου τῷ ἄξονι συμφυῆς ἔστω τύμπανον τὸ
 ΧΨ ὠδοντωμένον, οὗ ἡ διάμετρος πρὸς τὴν τοῦ
 ΥΦ τυμπάνου διάμετρον λόγον ἔχέτω, ὃν τὰ ὀκτὼ
 τάλαντα πρὸς τὰ τῆς δοθείσης δυνάμεως τάλαντα ἔ.

Καὶ τούτων παρασκευασθέντων, εἰς ἐπινοήσωμεν
 τὸ ΑΒΓΔ <γλωσσόκομον>¹ μετέωρον κείμενον,
 καὶ ἐκ μὲν τοῦ ΕΖ ἄξονος τὸ βάρος ἐξάψωμεν,
 ἐκ δὲ τοῦ ΧΨ τυμπάνου τὴν ἔλκυσαν δύναμιν,
 οὐδοπότερον αὐτῶν κατενεχθήσεται, εὐλύτως στρε-
 φομένων τῶν ἄξόνων, καὶ τῆς τῶν τυμπάνων
 παραθέσεως καλῶς ἀρμοζούσης, ἀλλ' ὥσπερ ζυγοῦ
 τινος ἰσορροπήσει ἡ δύναμις τῷ βάρει. εἰς δὲ
 ἐνὶ αὐτῶν προσθῶμεν ὀλίγον ἕτερον βάρος, καταρ-
 ρέψει καὶ ἐνεχθήσεται ἐφ' ὃ προσετέθη βάρος,
 ὥστε εἰς τῶν ἔ. ταλάντων δυνάμει <.....>²
 εἰ τύχοι μναϊαῖον προστεθῆ βάρος, κατακρατήσει
 καὶ ἐπισπάσεται τὸ βάρος. ἀντὶ δὲ³ τῆς προσθέ-
 σεως τούτῳ παρακείσθω κοχλίας ἔχων τὴν ἔλικα
 ἀρμοστὴν τοῖς ὀδοῦσι τοῦ τυμπάνου, στρεφόμενος
 εὐλύτως περὶ τὸν τὸν τὸν τὸν τὸν τὸν τὸν τὸν τὸν
 γύλοις, ὧν ὁ μὲν ἕτερος ὑπερεχέτω εἰς τὸ ἐκτὸς
 μέρος τοῦ γλωσσόκομου κατὰ τὸν ΓΔ <τοῖχον
 τὸν παρακείμενον>⁴ τῷ κοχλίᾳ· ἡ ἄρα ὑπεροχὴ
 τετραγωνισθεῖσα λαβέτω χειρολάβην τὴν Ζς, δι'
 ἧς ἐπιλαμβανόμενός τις καὶ ἐπιστρέφων ἐπιστρέψει
 τὸν κοχλίαν καὶ τὸ ΧΨ τύμπανον, ὥστε καὶ τὸ
 ΥΦ συμφυῆς αὐτῷ. διὰ δὲ τοῦτο καὶ τὸ παρα-
 κείμενον τὸ ΣΤ ἐπιστραφήσεται, καὶ τὸ συμφυῆς
 αὐτῷ τὸ ΠΡ, καὶ τὸ τούτῳ παρακείμενον τὸ ΞΟ,

MENSURATION : HERON OF ALEXANDRIA

to us is 5 talents. Let there be placed another toothed wheel $\Upsilon\Phi$ engaging with the toothed wheel $\Sigma\Gamma$; and fitting on to the axle of the wheel $\Upsilon\Phi$ let there be a toothed wheel $X\Psi$, whose diameter bears to the diameter of the wheel $\Upsilon\Phi$ the same ratio as 8 talents bears to the given force 5 talents.

When this construction is done, if we imagine the chest $AB\Gamma\Delta$ as lying above the ground, with the weight hanging from the axle EZ and the force raising it applied to the wheel $X\Psi$, neither of them will descend, provided the axles revolve freely and the juxtaposition of the wheels is accurate, but as in a beam the force will balance the weight. But if to one of them we add another small weight, the one to which the weight was added will tend to sink down and will descend, so that if, say, a mina is added to one of the 5 talents in the force it will overcome and draw the weight. But instead of this addition to the force, let there be a screw having a spiral which engages the teeth of the wheel, and let it revolve freely about pins in round holes, of which one projects beyond the chest through the wall $\Gamma\Delta$ adjacent to the screw; and then let the projecting piece be made square and be given a handle $\zeta\varsigma$. Anyone who takes this handle and turns, will turn the screw and the wheel $X\Psi$, and therefore the wheel $\Upsilon\Phi$ joined to it. Similarly the adjacent wheel $\Sigma\Gamma$ will revolve, and ΠP joined to it, and then the adjacent wheel ΞO , and then MN fitting

¹ γλωσσόκομον add. H. Schöne.

² After δυνάμει is a lacuna of seven letters.

³ In Schöne's text δὲ is printed after τούτῳ.

⁴ τοῖχον τὸν παρακείμενον add. H. Schöne.

GREEK MATHEMATICS

καὶ τὸ τούτῳ συμφυῆς τὸ MN, καὶ τὸ τούτῳ παρακείμενον τὸ HΘ, ὥστε καὶ ὁ τούτῳ συμφυῆς ἄξων ὁ EZ, περιὸν ἐπειλούμενα τὰ ἐκ τοῦ φορτίου ὄπλα κινήσει τὸ βᾶρος. ὅτι γὰρ κινήσει, πρόδηλον ἐκ τοῦ προστεθῆναι ἑτέρα δυνάμει (τὴν)¹ τῆς χειρολάβης, ἣτις περιγράφει κύκλον τῆς τοῦ κοχλίου περιμέτρου μείζονα· ἀπεδείχθη γὰρ ὅτι οἱ μείζονες κύκλοι τῶν ἐλασσόνων κατακρατοῦσιν, ὅταν περὶ τὸ αὐτὸ κέντρον κυλίωσιν.

(d) OPTICS : EQUALITY OF ANGLES OF INCIDENCE AND REFLECTION

Damian. *Opt.* 14, ed. R. Schöne 20. 12-18

Ἀπέδειξε γὰρ ὁ μηχανικὸς Ἡρων ἐν τοῖς αὐτοῦ Κατοπτρικοῖς, ὅτι αἱ πρὸς ἴσας γωνίας κλώμεναι εὐθεῖαι ἐλάχισται εἰσι πασῶν² τῶν ἀπὸ τῆς αὐτῆς καὶ ὁμοιομεροῦς γραμμῆς πρὸς τὰ αὐτὰ κλωμένων [πρὸς ἀνίσους γωνίας].³ τοῦτο δὲ ἀποδείξας φησὶν ὅτι εἰ μὴ μέλλοι ἡ φύσις μάτην περιάγειν τὴν ἡμετέραν ὄψιν, πρὸς ἴσας αὐτὴν ἀνακλάσει γωνίας.

Olympiod. *In Meteor.* iii. 2 (Aristot. 371 b 18), ed. Stüve 212. 5-213. 21

Ἐπειδὴ γὰρ τοῦτο ὠμολογημένον ἐστὶ παρὰ πᾶσιν, ὅτι οὐδὲν μάτην ἐργάζεται ἡ φύσις οὐδὲ ματαιοπονεῖ, ἐὰν μὴ δώσωμεν πρὸς ἴσας γωνίας γίνεσθαι τὴν ἀνάκλασιν, πρὸς ἀνίσους ματαιοπονεῖ

¹ τὴν add. H. Schöne.

² πασῶν G. Schmidt, τῶν μέσων codd.

³ πρὸς ἀνίσους γωνίας om. R. Schöne.

MENSURATION : HERON OF ALEXANDRIA

on to this last, and then the adjacent wheel $H\Theta$, and so finally the axle EZ fitting on to it ; and the rope, winding round the axle, will move the weight. That it will move the weight is obvious because there has been added to the one force that moving the handle which describes a circle greater than that of the screw ; for it has been proved that greater circles prevail over lesser when they revolve about the same centre.

(d) OPTICS : EQUALITY OF ANGLES OF INCIDENCE AND REFLECTION

Damianus,^a *On the Hypotheses in Optics* 14,
ed. R. Schöne 20. 12-18

For the mechanician Heron showed in his *Catoptrica* that of all [mutually] inclined straight lines drawn from the same homogenous straight line [surface] to the same [points], those are the least which are so inclined as to make equal angles. In his proof he says that if Nature did not wish to lead our sight in vain, she would incline it so as to make equal angles.

Olympiodorus, *Commentary on Aristotle's Meteora* iii. 2
(371 b 18), ed. Stüve 212. 5-213. 21

For this would be agreed by all, that Nature does nothing in vain nor labours in vain ; but if we do not grant that the angles of incidence and reflection are equal, Nature would be labouring in vain by following

^a Damianus, or Heliodorus, of Larissa (date unknown) is the author of a small work on optics, which seems to be an abridgement of a large work based on Euclid's treatise. The full title given in some MSS.—*Δαμιανού φιλοσόφου τοῦ Ἡλιοδώρου Λαρισσαίου Περὶ ὀπτικῶν ὑποθέσεων βιβλία β* leaves uncertain which was his real name.

GREEK MATHEMATICS

ἡ φύσις, καὶ ἀντὶ τοῦ διὰ βραχείας περιόδου φθάσαι τὸ ὀρώμενον τὴν ὄψιν, διὰ μακρᾶς περιόδου τοῦτο φανήσεται καταλαμβάνουσα.¹ εὐρεθήσονται γὰρ αἱ τὰς ἀνίσους γωνίας περιέχουσαι εὐθείαι, αἵτινες ἀπὸ τῆς ὄψεως [περιέχουσαι]² φέρονται³ πρὸς τὸ κάτοπτρον κακείθεν πρὸς τὸ ὀρώμενον, μείζονες οὖσαι τῶν τὰς ἴσας γωνίας περιεχουσῶν εὐθειῶν. καὶ ὅτι τοῦτο ἀληθές, δῆλον ἐντεῦθεν.

Ὑποκείσθω γὰρ τὸ κάτοπτρον εὐθείᾳ τις ἡ AB , καὶ ἔστω τὸ μὲν ὀρῶν Γ , τὸ δ' ὀρώμενον τὸ Δ , τὸ δὲ E σημεῖον τοῦ κατόπτρου, ἐν ᾧ προσπίπτουσα ἡ ὄψις ἀνακλᾶται πρὸς τὸ ὀρώμενον, ἔστω,

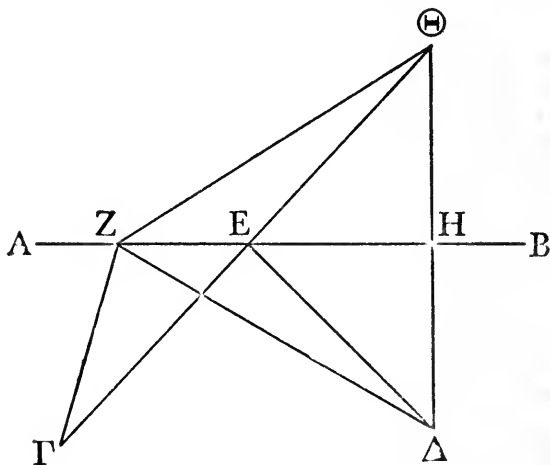

καὶ ἐπεζεύχθω ἡ ΓE , $E \Delta$. λέγω ὅτι ἡ ὑπὸ $A E \Gamma$ γωνία ἴση ἐστὶ τῇ ὑπὸ $\Delta E B$.

MENSURATION : HERON OF ALEXANDRIA

unequal angles, and instead of the eye apprehending the visible object by the shortest route it would do so by a longer. For straight lines so drawn from the eye to the mirror and thence to the visible object as to make unequal angles will be found to be greater than straight lines so drawn as to make equal angles. That this is true, is here made clear.

For let the straight line AB be supposed to be the mirror, and let Γ be the observer, Δ the visible object, and let E be a point on the mirror, falling on which the sight is bent towards the visible object, and let $\Gamma E, E\Delta$ be joined. I say that the angle $A\Gamma E$ is equal to the angle $\Delta E B$.^a

* Different figures are given in different mss., with corresponding small variants in the text. With G. Schmidt, I have reproduced the figure in the Aldine edition.

¹ καταλαμβάνουσα om. Ideler.

² περιέχουσαι om. R. Schöne, περιέχουσι Ideler, Stüve.

³ φέρονται R. Schöne, φερομένας codd.

Εἰ γὰρ μὴ ἔστιν ἴση, ἔστω ἕτερον σημεῖον τοῦ κατόπτρου, ἐν ᾧ προσπίπτουσα ἢ ὄψις πρὸς ἀνίσους γωνίας ἀνακλᾶται, τὸ Ζ, καὶ ἐπεζεύχθω ἡ ΓΖ, ΖΔ. δῆλον ὅτι ἡ ὑπὸ ΓΖΑ γωνία μείζων ἐστὶ τῆς ὑπὸ ΔΖΕ γωνίας. λέγω ὅτι αἱ ΓΖ, ΖΔ εὐθεῖαι, αἵτινες τὰς ἀνίσους γωνίας περιέχουσιν ὑποκειμένης τῆς ΑΒ εὐθείας, μείζονές εἰσι τῶν ΓΕ, ΕΔ εὐθειῶν, αἵτινες τὰς ἴσας γωνίας περιέχουσι μετὰ τῆς ΑΒ. ἤχθω γὰρ κάθετος ἀπὸ τοῦ Δ ἐπὶ τὴν ΑΒ κατὰ τὸ Η σημεῖον καὶ ἐκβεβλήσθω ἐπ' εὐθείας ὡς ἐπὶ τὸ Θ. φανερόν δὴ ὅτι αἱ πρὸς τῷ Η γωνίαι ἴσαι εἰσὶν· ὀρθαὶ γάρ εἰσι. καὶ ἔστω ἡ ΔΗ τῇ ΗΘ ἴση, καὶ ἐπεζεύχθω ἡ ΘΖ καὶ ἡ ΘΕ. αὕτη μὲν ἡ κατασκευή. ἐπεὶ οὖν ἴση ἐστὶν ἡ ΔΗ τῇ ΗΘ, ἀλλὰ καὶ ἡ ὑπὸ ΔΗΕ γωνία τῇ ὑπὸ ΘΗΕ γωνία ἴση ἐστὶ, κοινὴ δὲ πλευρὰ τῶν δύο τριγώνων ἡ ΗΕ, [καὶ βάσις ἡ ΘΕ βάσει τῇ ΕΔ ἴση ἐστὶ, καὶ]¹ τὸ ΗΘΕ τρίγωνον τῷ ΔΗΕ τριγώνῳ ἴσον ἐστὶ, καὶ <αἱ>² λοιπαὶ γωνίαι ταῖς λοιπαῖς γωνίαις εἰσὶν ἴσαι, ὅφ' ἂς αἱ ἴσαι πλευραὶ ὑποτείνουσιν. ἴση ἄρα ἡ ΘΕ τῇ ΕΔ. πάλιν ἐπειδὴ τῇ ΗΘ ἴση ἐστὶν ἡ ΗΔ καὶ γωνία ἡ ὑπὸ ΔΗΖ γωνία τῇ ὑπὸ ΘΗΖ ἴση ἐστὶ, κοινὴ δὲ ἡ ΗΖ τῶν δύο τριγώνων τῶν ΔΗΖ καὶ ΘΗΖ, [καὶ βάσις ἄρα ἡ ΘΖ βάσει τῇ ΖΔ ἴση ἐστὶ, καὶ]³ τὸ ΖΗΔ τρίγωνον τῷ ΘΗΖ τριγώνῳ ἴσον ἐστίν. ἴση ἄρα ἐστὶν ἡ ΘΖ τῇ ΖΔ. καὶ ἐπεὶ ἴση ἐστὶν ἡ ΘΕ τῇ ΕΔ, κοινὴ προσκείσθω ἡ ΕΓ. δύο ἄρα αἱ ΓΕ, ΕΔ δυσὶ ταῖς ΓΕ, ΕΘ ἴσαι εἰσὶν. ὅλη ἄρα ἡ ΓΘ δυσὶ ταῖς ΓΕ, ΕΔ ἴση ἐστὶ. καὶ ἐπεὶ παντὸς τριγώνου αἱ δύο πλευραὶ

MENSURATION : HERON OF ALEXANDRIA

For if it be not equal, let there be another point Z, on the mirror, falling on which the sight makes unequal angles, and let ΓZ , $Z\Delta$ be joined. It is clear that the angle ΓZA is greater than the angle ΔZE . I say that the sum of the straight lines ΓZ , $Z\Delta$ which make unequal angles with the base line AB, is greater than the sum of the straight lines ΓE , $E\Delta$, which make equal angles with AB. For let a perpendicular be drawn from Δ to AB at the point H and let it be produced in a straight line to Θ . Then it is obvious that the angles at H are equal; for they are right angles. And let $\Delta H = H\Theta$, and let ΘZ and ΘE be joined. This is the construction. Then since $\Delta H = H\Theta$, and the angle ΔHE is equal to the angle ΘHE , while HE is a common side of the two triangles, the triangle $H\Theta E$ is equal to the triangle ΔHE , and the remaining angles, subtended by the equal sides are severally equal one to the other [Eucl. i. 4]. Therefore $\Theta E = E\Delta$. Again, since $H\Delta = H\Theta$ and angle $\Delta HZ =$ angle ΘHZ , while HZ is common to the two triangles ΔHZ and ΘHZ , the triangle $ZH\Delta$ is equal to the triangle ΘHZ [*ibid.*]. Therefore $\Theta Z = Z\Delta$. And since $\Theta E = E\Delta$, let $E\Gamma$ be added to both. Then the sum of the two straight lines ΓE , $E\Delta$ is equal to the sum of the two straight lines ΓE , $E\Theta$. Therefore the whole $\Gamma\Theta$ is equal to the sum of the two straight lines ΓE , $E\Delta$. And since in any triangle the sum of two sides is always greater than

¹ *καὶ . . . καὶ*. These words are out of place here and superfluous.

² *αὶ* add. Schmidt. But possibly *καὶ . . . ὑποτείνουσιν*, being superfluous, should be omitted.

³ *καὶ . . . καὶ*. These words are out of place here and superfluous.

GREEK MATHEMATICS

τῆς λοιπῆς μείζονές εἰσι πάντα μεταλαμβανόμεναι, τριγώνου ἄρα τοῦ ΘΖΓ αἱ δύο πλευραὶ αἱ ΘΖ, ΖΓ μίᾳ τῆς ΓΘ μείζονές εἰσιν. ἀλλ' ἡ ΓΘ ἴση ἐστὶ ταῖς ΓΕ, ΕΔ· αἱ ΘΖ, ΖΓ ἄρα μείζονές εἰσι τῶν ΓΕ, ΕΔ. ἀλλ' ἡ ΘΖ τῇ ΖΔ ἐστὶν ἴση· αἱ ΖΓ, ΖΔ ἄρα τῶν ΓΕ, ΕΔ μείζονές εἰσι. καὶ εἰσιν αἱ ΓΖ, ΖΔ αἱ τὰς ἀνίσους γωνίας περιέχουσαι· αἱ ἄρα τὰς ἀνίσους γωνίας περιέχουσῶν· ὅπερ ἔδει δείξαι.

(e) QUADRATIC EQUATIONS

Heron, *Geom.* 21. 9-10, ed. Heiberg (Heron iv.) 380. 15-31

Δοθέντων συναμφοτέρων τῶν ἀριθμῶν ἤγουν τῆς διαμέτρου, τῆς περιμέτρου καὶ τοῦ ἔμβადου τοῦ κύκλου ἐν ἀριθμῶ ἐνὶ διαστεῖλαι καὶ εὐρεῖν ἕκαστον ἀριθμόν. ποίει οὕτως· ἔστω ὁ δοθεὶς ἀριθμὸς μονάδες $\sigma\beta$. ταῦτα ἀεὶ ἐπὶ τὰ $\rho\nu\delta$ γίνονται μυριάδες γ καὶ $\beta\chi\mu\eta$. τούτοις προστίθει καθολικῶς $\omega\mu\alpha$ · γίνονται μυριάδες τρεῖς καὶ $\gamma\upsilon\theta$ · ὧν πλευρὰ τετράγωνος γίνεται $\rho\pi\gamma$ · ἀπὸ τούτων κούφισον $\kappa\theta$ · λοιπὰ $\rho\nu\delta$ · ὧν μέρος $\iota\alpha'$ γίνεται $\iota\delta$ · τοσοῦτου ἡ διάμετρος τοῦ κύκλου. ἐὰν δὲ θέλῃς καὶ τὴν περιφέρειαν εὐρεῖν, ὑφείλον τὰ $\kappa\theta$ ἀπὸ τῶν $\rho\pi\gamma$ · λοιπὰ $\rho\nu\delta$ · ταῦτα ποιήσον $\delta\iota\varsigma$ · γίνονται $\tau\eta$ · τούτων λαβὲ μέρος ζ' · γίνονται $\mu\delta$ · τοσοῦτου ἡ

* The proof here given appears to have been taken by Olympiodorus from Heron's *Catoptrica*, and it is substantially identical with the proof in *De Speculis* 4. This work was formerly attributed to Ptolemy, but the discovery of Ptolemy's *Optics* in Arabic has encouraged the belief, now

MENSURATION : HERON OF ALEXANDRIA

the remaining side, in whatever way these may be taken [Eucl. i. 20], therefore in the triangle $\Theta Z\Gamma$ the sum of the two sides ΘZ , $Z\Gamma$ is greater than the one side $\Gamma\Theta$. But

$$\Gamma\Theta = \Gamma E + E\Delta ;$$

$$\therefore \Theta Z + Z\Gamma > \Gamma E + E\Delta .$$

But $\Theta Z = Z\Delta ;$

$$\therefore Z\Gamma + Z\Delta > \Gamma E + E\Delta .$$

And ΓZ , $Z\Delta$ make unequal angles ; therefore the sum of straight lines making unequal angles is greater than the sum of straight lines making equal angles ; which was to be proved.^a

(e) QUADRATIC EQUATIONS

Heron, *Geometrica* 21. 9-10, ed. Heiberg
(Heron iv.) 380. 15-31

Given the sum of the diameter, perimeter and area of a circle, to find each of them separately. It is done thus : Let the given sum be 212. Multiply this by 154 ; the result is 32648. To this add 841, making 33489, whose square root is 183. From this take away 29, leaving 154, whose eleventh part is 14 ; this will be the diameter of the circle. If you wish to find the circumference, take 29 from 183, leaving 154 ; double this, making 308, and take the seventh part, which is 44 ; this will be the perimeter. To

usually held, that it is a translation of Heron's *Catoptrica*. The translation, made by William of Moerbeke in 1269, can be shown by internal evidence to have been made from the Greek original and not from an Arabic translation. It is published in the Teubner edition of Heron's works, vol. ii. part i.

GREEK MATHEMATICS

περίμετρος. τὸ δὲ ἔμβραδὸν εὐρεῖν. ποίει οὕτως· τὰ ἰδ̄ τῆς διαμέτρου ἐπὶ τὰ μδ̄ τῆς περιμέτρου· γίνονται χις̄· τούτων λαβὲ μέρος τέταρτον· γίνονται ρνδ̄· τοσοῦτον τὸ ἔμβραδὸν τοῦ κύκλου. ὁμοῦ τῶν τριῶν ἀριθμῶν μονάδες σιβ̄.

(f) INDETERMINATE ANALYSIS

Heron, *Geom.* 24. 1, ed. Heiberg
(Heron iv.) 414. 28-415. 10

Εὐρεῖν δύο χωρία τετράγωνα, ὅπως τὸ τοῦ πρώτου ἔμβραδὸν τοῦ τοῦ δευτέρου ἔμβραδου ἔσται τριπλάσιον. ποιῶ οὕτως· τὰ γ̄ κύβισον· γίνονται

^a If d is the diameter of the circle, then the given relation is that

$$d + \frac{22}{7}d + \frac{11}{14}d^2 = 212,$$

i.e.
$$\frac{11}{14}d^2 + \frac{29}{7}d = 212.$$

To solve this quadratic equation, we should divide by $\frac{11}{14}$ so as to make the first term a square; Heron makes the first term a square by multiplying by the lowest requisite factor, in this case 154, obtaining the equation

$$11^2d^2 + 2 \cdot 29 \cdot 11d = 154 \cdot 212.$$

By adding 841 he completes the square on the left-hand side

$$\begin{aligned} (11d + 29)^2 &= 154 \cdot 212 + 841 \\ &= 32648 + 841 \\ &= 33489. \end{aligned}$$

$$\therefore 11d + 29 = 183.$$

$$\therefore 11d = 154,$$

$$\text{and } d = 14.$$

The same equation is again solved in *Geom.* 24. 46 and a similar one in *Geom.* 24. 47. Another quadratic equation is solved in *Geom.* 24. 3 and the result of yet another is given in *Metr.* iii. 4.

MENSURATION : HERON OF ALEXANDRIA

find the area. It is done thus : Multiply the diameter, 14, by the perimeter, 44, making 616 ; take the fourth part of this, which is 154 ; this will be the area of the circle. The sum of the three numbers is 212.^a

(f) INDETERMINATE ANALYSIS ^b

Heron, *Geometrica* 24. 1, ed. Heiberg

(Heron iv.) 414. 28-415. 10

To find two rectangles such that the area of the first is three times the area of the second.^c I proceed thus :

^b The Constantinople ms. in which Heron's *Metrica* was found in 1896 contains also a number of interesting problems in indeterminate analysis ; and two were already extant in Heron's *Geëponicus*. The problems, thirteen in all, are now published by Heiberg in Heron iv. 414. 28-426. 29.

^c It appears also to be a condition that the perimeter of the second should be three times the perimeter of the first. If we substitute any factor n for 3 the general problem becomes : To solve the equations

$$u + v = n(x + y) \quad . \quad . \quad . \quad (1)$$

$$xy = n \cdot uv \quad . \quad . \quad . \quad (2)$$

The solution given is equivalent to

$$x = 2n^3 - 1, \quad y = 2n^3$$

$$u = n(4n^3 - 2), \quad v = n.$$

Zeuthen (*Bibliotheca mathematica*, viii. (1907-1908), pp. 118-134) solves the problem thus : Let us start with the hypothesis that $v = n$. It follows from (1) that u is a multiple of n , say nz . We have then

$$x + y = 1 + z,$$

while by (2)

$$xy = n^3 z,$$

whence

$$xy = n^3(x + y) - n^3$$

or

$$(x - n^3)(y - n^3) = n^3(n^3 - 1).$$

An obvious solution of this equation is

$$x - n^3 = n^3 - 1, \quad y - n^3 = n^3,$$

which gives $z = 4n^3 - 2$, whence $u = n(4n^3 - 2)$. The other values follow.

GREEK MATHEMATICS

κζ· ταῦτα δὲ γίνονται νδ. νῦν ἄρον μονάδα \bar{a} · λοιπὸν γίνονται $\bar{v}\gamma$. ἔστω οὖν ἡ μὲν μία πλευρὰ ποδῶν $\bar{v}\gamma$, ἡ δὲ ἑτέρα πλευρὰ ποδῶν νδ. καὶ τοῦ ἄλλου χωρίου οὕτως· θές ὁμοῦ τὰ $\bar{v}\gamma$ καὶ τὰ νδ· γίνονται πόδες ρζ· ταῦτα ποίει ἐπὶ τὰ $\bar{\gamma}$. . . λοιπὸν γίνονται πόδες $\bar{\tau}\iota\eta$. ἔστω οὖν ἡ τοῦ προτέρου πλευρὰ ποδῶν $\bar{\tau}\iota\eta$, ἡ δὲ ἑτέρα πλευρὰ ποδῶν $\bar{\gamma}$ · τὰ δὲ ἔμβραδὰ τοῦ ἐνὸς γίνεται ποδῶν $\bar{\lambda}\nu\delta$ καὶ τοῦ ἄλλου ποδῶν $\bar{\beta}\omega\xi\beta$.

Ibid. 24. 10, ed. Heiberg (Heron iv.) 422. 15–424. 5

Τριγώνου ὀρθογωνίου τὸ ἔμβραδὸν μετὰ τῆς περιμέτρου ποδῶν $\bar{\sigma}\pi$ · ἀποδιαστείλαι τὰς πλευρὰς καὶ εὐρεῖν τὸ ἔμβραδόν· ποιῶ οὕτως· αἰεὶ ζῆτει τοὺς ἀπαρτίζοντας ἀριθμούς· ἀπαρτίζει δὲ τὸν $\bar{\sigma}\pi$ ὁ δὲ τὸν $\bar{\rho}\mu$, ὁ δ' τὸν \bar{o} , ὁ ε' τὸν $\bar{v}\zeta$, ὁ ζ' τὸν $\bar{\mu}$, ὁ η' τὸν $\bar{\lambda}\epsilon$, ὁ ι' τὸν $\bar{\kappa}\eta$, ὁ ιδ' τὸν $\bar{\kappa}$. ἐσκεψάμην, ὅτι ὁ $\bar{\eta}$ καὶ $\bar{\lambda}\epsilon$ ποιήσουσι τὸ δοθὲν ἐπίταγμα. τῶν $\bar{\sigma}\pi$ τὸ $\bar{\eta}$ · γίνονται πόδες $\bar{\lambda}\epsilon$. διὰ παντὸς λάμβανε δυνάδα τῶν $\bar{\eta}$ · λοιπὸν μένουσιν $\bar{\zeta}$ πόδες. τὰ οὖν $\bar{\lambda}\epsilon$ καὶ τὰ $\bar{\zeta}$ ὁμοῦ γίνονται πόδες $\bar{\mu}\alpha$. ταῦτα ποίει ἐφ' ἑαυτά· γίνονται πόδες $\bar{\alpha}\chi\pi\alpha$. τὰ $\bar{\lambda}\epsilon$ ἐπὶ τὰ $\bar{\zeta}$ · γίνονται πόδες $\bar{\sigma}\iota$ · ταῦτα ποίει αἰεὶ ἐπὶ τὰ $\bar{\eta}$ · γίνονται πόδες $\bar{\alpha}\chi\pi$. ταῦτα ἄρον ἀπὸ τῶν $\bar{\alpha}\chi\pi\alpha$ · λοιπὸν μένει \bar{a} · ὧν πλευρὰ τετραγωνικὴ γίνεται \bar{a} . ἄρτι θές τὰ $\bar{\mu}\alpha$ καὶ ἄρον μονάδα \bar{a} · λοιπὸν $\bar{\mu}$ · ὧν \angle ' γίνεται $\bar{\kappa}$ · τοῦτό ἐστιν ἡ κάθετος, ποδῶν $\bar{\kappa}$. καὶ θές πάλιν τὰ $\bar{\mu}\alpha$ καὶ πρόσθες \bar{a} · γίνονται πόδες $\bar{\mu}\beta$ · ὧν \angle ' γίνεται πόδες $\bar{\kappa}\alpha$ · ἔστω ἡ βᾶσις ποδῶν $\bar{\kappa}\alpha$. καὶ θές τὰ $\bar{\lambda}\epsilon$ καὶ ἄρον τὰ $\bar{\zeta}$ · λοιπὸν μένουσι

MENSURATION : HERON OF ALEXANDRIA

Take the cube of 3, making 27 ; double this, making 54. Now take away 1, leaving 53. Then let one side be 53 feet and the other 54 feet. As for the other rectangle, [I proceed] thus : Add together 53 and 54, making 107 feet : multiply this by 3, [making 321 ; take away 3], leaving 318. Then let one side be 318 feet and the other 3 feet. The area of the one will be 954 feet and of the other 2862 feet.^a

Ibid. 24. 10, ed. Heiberg (Heron iv.) 422. 15-424. 5

In a right-angled triangle the sum of the area and the perimeter is 280 feet ; *to separate the sides and find the area.* I proceed thus : Always look for the factors ; now 280 can be factorized into 2 . 140, 4 . 70, 5 . 56, 7 . 40, 8 . 35, 10 . 28, 14 . 20. By inspection, we find 8 and 35 fulfil the requirements. For take one-eighth of 280, getting 35 feet. Take 2 from 8, leaving 6 feet. Then 35 and 6 together make 41 feet. Multiply this by itself, making 1681 feet. Now multiply 35 by 6, getting 210 feet. Multiply this by 8, getting 1680 feet. Take this away from the 1681, leaving 1, whose square root is 1. Now take the 41 and subtract 1, leaving 40, of which the half is 20 ; this is the perpendicular, 20 feet. And again take 41 and add 1, getting 42 feet, of which the half is 21 ; and let this be the base, 21 feet. And take 35 and subtract 6, leaving 29 feet. Now multiply

* The term "feet," *πόδες*, is used by Heron indiscriminately of lineal feet, square feet and the sum of numbers of lineal and square feet.

GREEK MATHEMATICS

πόδες $\overline{\kappa\theta}$. ἄρτι θὲς τὴν κάθετον ἐπὶ τὴν βάσιν ὧν \angle' γίνεται πόδες $\overline{\sigma\iota}$. καὶ αἱ τρεῖς πλευραὶ περιμετρούμεναι ἔχουσι πόδας $\overline{\delta}$. ὁμοῦ σύνθεσ μετὰ τοῦ ἔμβραδου· γίνονται πόδες $\overline{\sigma\pi}$.

^a Heath (*H.G.M.* ii. 446-447) shows how this solution can be generalized. Let a, b be the sides of the triangle containing the right angle, c the hypotenuse, S the area of the triangle, r the radius of the inscribed circle; and let

$$s = \frac{1}{2}(a + b + c).$$

Then

$$S = rs = \frac{1}{2}ab, \quad r + s = a + b, \quad c = s - r.$$

Solving the first two equations, we have

$$\left. \begin{array}{l} a \\ b \end{array} \right\} = \frac{1}{2}[r + s \mp \sqrt{\{(r + s)^2 - 8rs\}}],$$

and this formula is actually used in the problem. The

MENSURATION : HERON OF ALEXANDRIA

the perpendicular and the base together, [getting 420], of which the half is 210 feet ; and the three sides comprising the perimeter amount to 70 feet ; add them to the area, getting 280 feet.^a

method is to take the sum of the area and the perimeter $S + 2s$, separated into its two obvious factors $s(r + 2)$, to put $s(r + 2) = A$ (the given number), and then to separate A into suitable factors to which s and $r + 2$ may be equated. They must obviously be such that sr , the area, is divisible by 6.

In the given problem $A = 280$, and the suitable factors are $r + 2 = 8$, $s = 35$, because r is then equal to 6 and rs is a multiple of 6. Then

$$a = \frac{1}{2}[6 + 35 - \sqrt{\{(6 + 35)^2 - 8 \cdot 6 \cdot 35\}}] = \frac{1}{2}(41 - 1) = 20,$$

$$b = \frac{1}{2}(41 + 1) = 21,$$

$$c = 35 - 6 = 29.$$

This problem is followed by three more of the same type.



· XXIII. ALGEBRA : DIOPHANTUS

XXIII. ALGEBRA : DIOPHANTUS

(a) GENERAL

Anthol. Palat. xiv. 126, *The Greek Anthology*, ed.
Paton (L.C.L.) v. 92-93

Οὗτός τοι Διόφαντον ἔχει τάφος· ἃ μέγα θαῦμα·
καὶ τάφος ἐκ τέχνης μέτρα βίοιο λέγει.
ἕκτην κουρίζειν βίοτου θεὸς ὤπασε μοίρην·
δωδεκάτην δ' ἐπιθείς, μῆλα πόρεν χνοάειν·
τῇ δ' ἄφ' ἐφ' ἑβδομάτη τὸ γαμήλιον ἤψατο φέγγος,
ἐκ δὲ γάμων πέμπτω παῖδ' ἐπένευσεν ἔτει.
αἰαῖ, τηλύγετον δειλὸν τέκος, ἦμισυ πατρὸς
τοῦδε καὶ ἡ κρυερὸς μέτρον ἑλὼν βίοτου.
πένθος δ' αὖ πισύρεσσι παρηγορέων ἐνιαυτοῖς
τῆδε πόσου σοφίῃ τέρμ' ἐπέρησε βίου.

* There are in the *Anthology* 46 epigrams which are algebraical problems. Most of them (xiv. 116-146) were collected by Metrodorus, a grammarian who lived about A.D. 500, but their origin is obviously much earlier and many belong to a type described by Plato and the scholiast to the Charmides (v. vol. i. pp. 16, 20).

Problems in indeterminate analysis solved before the time of Diophantus include the Pythagorean and Platonic methods of finding numbers representing the sides of right-angled triangles (v. vol. i. pp. 90-95), the methods (also Pythagorean) of finding "side- and diameter-numbers" (vol. i. pp. 132-139), Archimedes' *Cattle Problem* (v. *supra*, pp. 202-205) and Heron's problems (v. *supra*, pp. 504-509).

XXIII. ALGEBRA : DIOPHANTUS

(a) GENERAL

Palatine Anthology ^a xiv. 126, *The Greek Anthology*, ed.
Paton (L.C.L.) v. 92-93

THIS tomb holds Diophantus. Ah, what a marvel !
And the tomb tells scientifically the measure of his
life. God vouchsafed that he should be a boy for the
sixth part of his life ; when a twelfth was added, his
cheeks acquired a beard ; He kindled for him the
light of marriage after a seventh, and in the fifth year
after his marriage He granted him a son. Alas !
late-begotten and miserable child, when he had
reached the measure of half his father's life, the chill
grave took him. After consoling his grief by this
science of numbers for four years, he reached the end
of his life.^b

Diophantus's surviving works and ancillary material are admirably edited by Tannery in two volumes of the Teubner series (Leipzig, 1895). There is a French translation by Paul Ver Eecke, *Diophante d'Alexandre* (Bruges, 1926). The history of Greek algebra as a whole is well treated by G. F. Nesselmann, *Die Algebra der Griechen*, and by T. L. Heath, *Diophantus of Alexandria: A Study in the History of Greek Algebra*, 2nd ed. 1910.

^b If x was his age at death, then

$$\frac{1}{6}x + \frac{1}{12}x + \frac{1}{7}x + 5 + \frac{1}{2}x + 4 = x,$$

whence

$$x = 84.$$

GREEK MATHEMATICS

Theon Alex. in Ptol. Math. Syn. Comm. i. 10, ed.
Rome, *Studi e Testi*, lxxii. (1936), 453. 4-6

Καθ' ἃ καὶ Διόφαντός φησι· “ τῆς γὰρ μονάδος ἀμεταθέτου οὔσης καὶ ἐστῶσης πάντοτε, τὸ πολλαπλασιαζόμενον εἶδος ἐπ' αὐτὴν αὐτὸ τὸ εἶδος ἔσται.”

Dioph. *De polyg. num.* [5], Dioph. ed. Tannery i.
470. 27-472. 4

Καὶ ἀπεδείχθη τὸ παρὰ Ὑψικλεῖ ἐν ὄρω λεγόμενον, ὅτι, “ ἐὰν ὦσιν ἀριθμοὶ ἀπὸ μονάδος ἐν ἴσῃ ὑπεροχῇ ὁποσοιοῦν, μονάδος μενούσης τῆς ὑπεροχῆς, ὁ σύμπας ἐστὶν (τρίγωνος, δυάδος δέ),¹ τετράγωνος, τριάδος δέ, πεντάγωνος· λέγεται δὲ τὸ πλήθος τῶν γωνιῶν κατὰ τὸν δυάδι μείζονα τῆς ὑπεροχῆς, πλευραὶ δὲ αὐτῶν τὸ πλήθος τῶν ἐκτεθέντων σὺν τῇ μονάδι.”

Mich. Psell. *Epist.*, Dioph. ed. Tannery ii. 38. 22-39. 1

Περὶ δὲ τῆς Αἰγυπτιακῆς μεθόδου ταύτης Διόφαντος μὲν διέλαβεν ἀκριβέστερον, ὁ δὲ λογιώτατος Ἀνατόλιος τὰ συνεκτικώτατα μέρη τῆς κατ'

¹ τρίγωνος, δυάδος δέ add. Bachet.

* Cf. Dioph. ed. Tannery i. 8. 13-15. The word εἶδος, as will be seen in due course, is regularly used by Diophantus for a *term* of an equation.

ALGEBRA : DIOPHANTUS

Theon of Alexandria, *Commentary on Ptolemy's Syntaxis*
i. 10, ed. Rome, *Studi e Testi*, lxxii. (1936), 453. 4-6

As Diophantus says: "The unit being without dimensions and everywhere the same, a term that is multiplied by it will remain the same term." ^a

Diophantus, *On Polygonal Numbers* [5], Dioph. ed.
Tannery i. 470. 27-472. 4

There has also been proved what was stated by Hypsicles in a definition, namely, that "if there be as many numbers as we please beginning from 1 and increasing by the same common difference, then, when the common difference is 1, the sum of all the numbers is a triangular number; when 2, a square number; when 3, a pentagonal number [; and so on]. The number of angles is called after the number which exceeds the common difference by 2, and the sides after the number of terms including 1." ^b

Michael Psellus, ^c *A Letter*, Dioph. ed. Tannery ii.
38. 22-39. 1

Diophantus dealt more accurately with this Egyptian method, but the most learned Anatolius collected the most essential parts of the theory as stated by

^b *i.e.*, the n th a -gonal number (1 being the first) is $\frac{1}{2}n\{2 + (n-1)(a-2)\}$; *v.* vol. i. p. 98 n. *a*.

^c Michael Psellus, "first of philosophers" in a barren age, flourished in the latter part of the eleventh century A.D. There has survived a book purporting to be by Psellus on arithmetic, music, geometry and astronomy, but it is clearly not all his own work. In the geometrical section it is observed that the most favoured method of finding the area of a circle is to take the mean between the inscribed and circumscribed squares, which would give $\pi = \sqrt{8} = 2.8284271$.

GREEK MATHEMATICS

ἐκείνον ἐπιστήμης ἀπολεξάμενος ἐτέρως¹ Διοφάντῳ συνοπτικώτατα προσεφώνησε.

Dioph. *Arith.* i., Praef., Dioph. ed. Tannery i. 14. 25-16. 7

Νῦν δ' ἐπὶ τὰς προτάσεις χωρήσωμεν ὁδόν, πλείστην ἔχοντες τὴν ἐπ' αὐτοῖς τοῖς εἴδεσι συνηθροισμένην ὕλην. πλείστων δ' ὄντων τῷ ἀριθμῷ καὶ μεγίστων τῷ ὄγκῳ, καὶ διὰ τοῦτο βραδέως βεβαιουμένων ὑπὸ τῶν παραλαμβανόντων αὐτὰ καὶ ὄντων ἐν αὐτοῖς δυσμνημονευτῶν, ἔδοκίμασα τὰ ἐν αὐτοῖς ἐπιδεχόμενα διαιρεῖν, καὶ μάλιστα τὰ ἐν ἀρχῇ ἔχοντα στοιχειώδως ἀπὸ ἀπλουστέρων ἐπὶ σκολιώτερα διελεῖν ὡς προσῆκεν. οὕτως γὰρ εὐόδευτα γενήσεται τοῖς ἀρχομένοις, καὶ ἡ ἀγωγή αὐτῶν μνημονευθήσεται, τῆς πραγματείας αὐτῶν ἐν τρισκαίδεκα βιβλίοις γεγενημένης.

Ibid. v. 3, Dioph. ed. Tannery i. 316. 6

* Ἐχομεν ἐν τοῖς Πορίσμασιν.

¹ ἐτέρως Tannery, ἐτέρῳ codd.

* The two passages cited before this one allow us to infer that Diophantus must have lived between Hypsicles and Theon, say 150 B.C. to A.D. 350. Before Tannery edited Michael Psellus's letter, there was no further evidence, but it is reasonable to infer from this letter that Diophantus was a contemporary of Anatolius, bishop of Laodicea about A.D. 280 (v. vol. i. pp. 2-3). For references by Plato and a scholiast to the Egyptian methods of reckoning, v. vol. i. pp. 16, 20.

^b Of these thirteen books in the *Arithmetica*, only six
516

ALGEBRA : DIOPHANTUS

him in a different way and in the most concise form, and dedicated his work to Diophantus.^a

Diophantus, *Arithmetica* i., Preface, Dioph. ed. Tannery I.
14. 25-16. 7

Now let us tread the path to the propositions themselves, which contain a great mass of material compressed into the several species. As they are both numerous and very complex to express, they are only slowly grasped by those into whose hands they are put, and include things hard to remember; for this reason I have tried to divide them up according to their subject-matter, and especially to place, as is fitting, the elementary propositions at the beginning in order that passage may be made from the simpler to the more complex. For thus the way will be made easy for beginners and what they learn will be fixed in their memory; the treatise is divided into thirteen books.^b

Ibid. v. 3, Dioph. ed. Tannery i. 316. 6

We have it in the Porisms.^c

have survived. Tannery suggests that the commentary on it written by Hypatia, daughter of Theon of Alexandria, extended only to these first six books, and that consequently little notice was taken of the remaining seven. There would be a parallel in Eutocius's commentaries on Apollonius's *Conics*. Nesselmann argues that the lost books came in the middle, but Tannery (Dioph. ii. xix-xxi) gives strong reasons for thinking it is the last and most difficult books which have been lost.

^c Whether this collection of propositions in the Theory of Numbers, several times referred to in the *Arithmetica*, formed a separate treatise from, or was included in, that work is disputed; Hultsch and Heath take the former view, in my opinion judiciously, but Tannery takes the latter.

GREEK MATHEMATICS

(b) NOTATION

Ibid. 1., Praef., Dioph. ed. Tannery 1. 2. 3-6. 21

Τὴν εὕρεσιν τῶν ἐν τοῖς ἀριθμοῖς προβλημάτων, τιμιώτατέ μοι Διονύσιε, γινώσκων σε σπουδαίως ἔχοντα μαθεῖν, [ὀργανῶσαι τὴν μέθοδον]¹ ἐπειράθην, ἀρξάμενος ἀφ' ὧν συνέστηκε τὰ πράγματα θεμελίων, ὑποστῆσαι τὴν ἐν τοῖς ἀριθμοῖς φύσιν τε καὶ δύναμιν.

Ἴσως μὲν οὖν δοκεῖ τὸ πρᾶγμα δυσχερέστερον, ἐπειδὴ μήπω γνώριμόν ἐστιν, δυσέλπιστοι γὰρ εἰς κατόρθωσίν εἰσιν αἱ τῶν ἀρχομένων ψυχαί, ὅμως δ' εὐκατάληπτόν σοι γενήσεται, διὰ τε τὴν σὴν προθυμίαν καὶ τὴν ἐμὴν ἀπόδειξιν· ταχεῖα γὰρ εἰς μάθησιν ἐπιθυμία προσλαβοῦσα διδαχὴν.

Ἄλλὰ καὶ πρὸς τοῖσδε γινώσκοντί σοι πάντας τοὺς ἀριθμοὺς συγκειμένους ἐκ μονάδων πλήθους τινός, φανερόν καθέστηκεν εἰς ἄπειρον ἔχειν τὴν ὑπαρξιν. τυγχανόντων δὴ οὖν ἐν τούτοις

ὧν μὲν τετραγώνων, οἳ εἰσιν ἐξ ἀριθμοῦ τινος ἐφ' ἑαυτὸν πολυπλασιασθέντος· οὗτος δὲ ὁ ἀριθμὸς καλεῖται πλευρὰ τοῦ τετραγώνου·

ὧν δὲ κύβων, οἳ εἰσιν ἐκ τετραγώνων ἐπὶ τὰς αὐτῶν πλευρὰς πολυπλασιασθέντων,

ὧν δὲ δυναμοδυνάμεων, οἳ εἰσιν ἐκ τετραγώνων ἐφ' ἑαυτοὺς πολυπλασιασθέντων,

ὧν δὲ δυναμοκύβων, οἳ εἰσιν ἐκ τετραγώνων ἐπὶ

¹ ὀργανῶσαι τὴν μέθοδον om. Tannery, following the most ancient *ms.*

ALGEBRA : DIOPHANTUS

(b) NOTATION ^a

Ibid. i., Preface, Dioph. ed. Tannery i. 2. 3-6. 21

Knowing that you are anxious, my most esteemed Dionysius, to learn how to solve problems in numbers, I have tried, beginning from the foundations on which the subject is built, to set forth the nature and power in numbers.

Perhaps the subject will appear to you rather difficult, as it is not yet common knowledge, and the minds of beginners are apt to be discouraged by mistakes; but it will be easy for you to grasp, with your enthusiasm and my teaching; for keenness backed by teaching is a swift road to knowledge.

As you know, in addition to these things, that all numbers are made up of some multitude of units, it is clear that their formation has no limit. Among them are—

squares, which are formed when any number is multiplied by itself; the number itself is called the *side of the square* ^b;

cubes, which are formed when squares are multiplied by their sides,

square-squares, which are formed when squares are multiplied by themselves;

square-cubes, which are formed when squares are

* This subject is admirably treated, with two original contributions, by Heath, *Diophantus of Alexandria*, 2nd ed., pp. 34-53. Diophantus's method of representing large numbers and fractions has already been discussed (vol. i. pp. 44-45). Among other abbreviations used by Diophantus are \square^{σ} , declined throughout its cases, for *τετράγωνος*; and *ισ*. (apparently *ισ* in the archetype) for the sign =, connecting two sides of an equation.

^b Or "square root."

GREEK MATHEMATICS

τοὺς ἀπὸ τῆς αὐτῆς αὐτοῖς πλευρᾶς κύβους πολυπλασιασθέντων,

ὧν δὲ κυβοκύβων, οἱ εἰσιν ἐκ κύβων ἐφ' ἑαυτοὺς πολυπλασιασθέντων,

ἕκ τε τῆς τούτων ἦτοι συνθέσεως ἢ ὑπεροχῆς ἢ πολυπλασιασμοῦ ἢ λόγου τοῦ πρὸς ἀλλήλους ἢ καὶ ἐκάστων πρὸς τὰς ἰδίας πλευρὰς συμβαίνει πλέκεσθαι πλεῖστα προβλήματα ἀριθμητικά· λύεται δὲ βαδίζοντός σου τὴν ὑποδειχθησομένην ὁδόν.

Ἐδοκιμάσθη οὖν ἕκαστος τούτων τῶν ἀριθμῶν συντομωτέραν ἐπωνυμίαν κτησάμενος στοιχείον τῆς ἀριθμητικῆς θεωρίας εἶναι· καλεῖται οὖν ὁ μὲν τετράγωνος δύναμις καὶ ἔστιν αὐτῆς σημεῖον τὸ Δ ἐπίσημον ἔχον Υ , Δ^{Υ} δύναμις·

ὁ δὲ κύβος καὶ ἔστιν αὐτοῦ σημεῖον K ἐπίσημον ἔχον Υ , K^{Υ} κύβος·

ὁ δὲ ἐκ τετραγώνου ἐφ' ἑαυτὸν πολυπλασιασθέντος δυναμοδύναμις καὶ ἔστιν αὐτοῦ σημεῖον δέλτα δύο ἐπίσημον ἔχοντα Υ , $\Delta^{\Upsilon}\Delta$ δυναμοδύναμις·

ὁ δὲ ἐκ τετραγώνου ἐπὶ τὸν ἀπὸ τῆς αὐτῆς αὐτῶ πλευρᾶς κύβου πολυπλασιασθέντος δυναμόκυβος καὶ ἔστιν αὐτοῦ σημεῖον τὰ ΔK ἐπίσημον ἔχοντα Υ , $\Delta\text{K}^{\Upsilon}$ δυναμόκυβος·

ὁ δὲ ἐκ κύβου ἑαυτὸν πολυπλασιάσαντος κυβόκυβος καὶ ἔστιν αὐτοῦ σημεῖον δύο κάππα ἐπίσημον ἔχοντα Υ , $\text{K}^{\Upsilon}\text{K}$ κυβόκυβος.

ALGEBRA : DIOPHANTUS

multiplied by the cubes formed from the same side ;

cube-cubes, which are formed when cubes are multiplied by themselves ;

and it is from the addition, subtraction, or multiplication of these numbers or from the ratio which they bear one to another or to their own sides that most arithmetical problems are formed ; you will be able to solve them if you follow the method shown below.

Now each of these numbers, which have been given abbreviated names, is recognized as an element in arithmetical science ; the *square* [of the unknown quantity]^a is called *dynamis* and its sign is Δ with the index Υ , that is Δ^Υ ;

the cube is called *cubus* and has for its sign K with the index Υ , that is K^Υ ;

the square multiplied by itself is called *dynamodynamis* and its sign is two deltas with the index Υ , that is $\Delta^\Upsilon\Delta$;

the square multiplied by the cube formed from the same root is called *dynamocubus* and its sign is ΔK with the index Υ , that is ΔK^Υ ;

the cube multiplied by itself is called *cubocubus* and its sign is two kappas with the index Υ , $K^\Upsilon K$.

^a It is not here stated in so many words, but becomes obvious as the argument proceeds that *δύναμις* and its abbreviation are restricted to the square of the *unknown* quantity ; the square of a determinate number is *τετράγωνος*. There is only one term, *κύβος*, for the cube both of a determinate and of the unknown quantity. The higher terms, when written in full as *δυναμοδύναμις*, *δυναμόκυβος* and *κυβόκυβος*, are used respectively for the fourth, fifth and sixth powers both of determinate quantities and of the unknown, but their abbreviations, and that for *κύβος*, are used to denote powers of the unknown only.

GREEK MATHEMATICS

Ὁ δὲ μηδὲν τούτων τῶν ἰδιωμάτων κτησάμενος, ἔχων δὲ ἐν ἑαυτῷ πλήθος μονάδων ἀόριστον, ἀριθμὸς καλεῖται καὶ ἔστιν αὐτοῦ σημεῖον τὸ Ξ .

Ἔστι δὲ καὶ ἕτερον σημεῖον τὸ ἀμετάθετον τῶν ὠρισμένων, ἡ μονάς, καὶ ἔστιν αὐτῆς σημεῖον τὸ M ἐπίσημον ἔχον τὸ O , M .

Ὡσπερ δὲ τῶν ἀριθμῶν τὰ ὁμώνυμα μόρια παρομοίως καλεῖται τοῖς ἀριθμοῖς, τοῦ μὲν τρία τὸ τρίτον, τοῦ δὲ τέσσαρα τὸ τέταρτον, οὕτως καὶ τῶν νῦν ἐπονομασθέντων ἀριθμῶν τὰ ὁμώνυμα μόρια κληθήσεται παρομοίως τοῖς ἀριθμοῖς·

τοῦ μὲν ἀριθμοῦ	τὸ ἀριθμοστόν,
τῆς δὲ δυνάμεως	τὸ δυναμοστόν,
τοῦ δὲ κύβου	τὸ κυβοστόν,
τῆς δὲ δυναμοδυνάμεως	τὸ δυναμοδυναμοστόν,
τοῦ δὲ δυναμοκύβου	τὸ δυναμοκυβοστόν,
τοῦ δὲ κυβοκύβου	τὸ κυβοκυβοστόν·

ἔξει δὲ ἕκαστον αὐτῶν ἐπὶ τὸ τοῦ ὁμωνύμου ἀριθμοῦ σημεῖον γραμμὴν χ διαστέλλουσαν τὸ εἶδος.

* I am entirely convinced by Heath's argument, based on the Bodleian ms. of Diophantus and general considerations, that this symbol is really the first two letters of ἀριθμός; this suggestion brings the symbol into line with Diophantus's abbreviations for δύναμις, κύβος, and so on. It may be declined throughout its cases, e.g., $\xi\omega\upsilon\upsilon$ for the genitive plural, *infra* p. 552, line 5.

Diophantus has only one symbol for an unknown quantity, but his problems often lead to subsidiary equations involving other unknowns. He shows great ingenuity in isolating these subsidiary unknowns. In the translation I shall use

ALGEBRA : DIOPHANTUS

The number which has none of these characteristics, but merely has in it an undetermined multitude of units, is called *arithmos*, and its sign is $\mathfrak{S} [x]$.^a

There is also another sign denoting the invariable element in determinate numbers, the unit, and its sign is \mathfrak{M} with the index \mathfrak{O} , that is $\overset{\circ}{\mathfrak{M}}$.

As in the case of numbers the corresponding fractions are called after the numbers, a *third* being called after 3 and a *fourth* after 4, so the functions named above will have reciprocals called after them :

<i>arithmos</i> [x]	<i>arithmoston</i> $\left[\frac{1}{x} \right]$,
<i>dynamis</i> [x^2]	<i>dynamoston</i> $\left[\frac{1}{x^2} \right]$,
<i>cubus</i> [x^3]	<i>cuboston</i> $\left[\frac{1}{x^3} \right]$,
<i>dynamodynamis</i> [x^4]	<i>dynamodynamoston</i> $\left[\frac{1}{x^4} \right]$,
<i>dynamocubus</i> [x^5]	<i>dynamocuboston</i> $\left[\frac{1}{x^5} \right]$,
<i>cubocubus</i> [x^6]	<i>cubocuboston</i> $\left[\frac{1}{x^6} \right]$.

And each of these will have the same sign as the corresponding process, but with the mark \mathfrak{X} to distinguish its nature.^b

different letters for the different unknowns as they occur, for example, x , z , m .

Diophantus does not admit negative or zero values of the unknown, but positive fractional values are admitted.

^b So the symbol is printed by Tannery, but there are many variants in the mss.

GREEK MATHEMATICS

Ibid. i., Praef., Dioph. ed. Tannery i. 12. 19-21

Λεῖψις ἐπὶ λεῖψιν πολλαπλασιασθεῖσα ποιεῖ ὕπαρξιν, λεῖψις δὲ ἐπὶ ὕπαρξιν ποιεῖ λεῖψιν, καὶ τῆς λεΐψεως σημεῖον Ψ ἔλλιπές κάτω νεῦον, Λ.

(c) DETERMINATE EQUATIONS

(i.) *Pure Determinate Equations*

Ibid. i., Praef., Dioph. ed. Tannery i. 14. 11-20

Μετὰ δὲ ταῦτα ἐὰν ἀπὸ προβλήματός τινος γένηται εἶδη τινὰ ἴσα εἶδει τοῖς αὐτοῖς, μὴ ὁμοπληθῆ δέ, ἀπὸ ἐκατέρων τῶν μερῶν δεήσει ἀφαιρεῖν τὰ ὅμοια ἀπὸ τῶν ὁμοίων, ἕως ἂν ἔν εἶδος ἐνὶ εἶδει ἴσον γένηται. ἐὰν δὲ πως ἐν ὁποτέρῳ ἐνυπάρχη ἢ ἐν ἀμφοτέροις ἐν ἐλλείψεσί τινα εἶδη, δεήσει προσθεῖναι τὰ λείποντα εἶδη ἐν ἀμφοτέροις τοῖς μέρεσιν, ἕως ἂν ἐκατέρων τῶν μερῶν τὰ εἶδη ἐνυπάρχοντα γένηται, καὶ πάλιν ἀφελεῖν τὰ ὅμοια ἀπὸ τῶν ὁμοίων, ἕως ἂν ἐκατέρῳ τῶν μερῶν ἔν εἶδος καταλειφθῆ.

* Lit. "a deficiency multiplied by a deficiency makes a forthcoming."

^b The sign has nothing to do with Ψ, but I see no reason why Diophantus should not have described it by means of Ψ,
524

ALGEBRA : DIOPHANTUS

Ibid. i., Preface, Dioph. ed. Tannery i. 12. 19-21

A *minus* multiplied by a *minus* makes a *plus*,^a a *minus* multiplied by a *plus* makes a *minus*, and the sign of a *minus* is a truncated Ψ turned upside down, that is Λ .^b

(c) DETERMINATE EQUATIONS

(i.) *Pure* ^c *Determinate Equations*

Ibid. i., Preface, Dioph. ed. Tannery i. 14. 11-20

Next, if there result from a problem an equation in which certain terms are equal to terms of the same species, but with different coefficients, it will be necessary to subtract like from like on both sides until one term is found equal to one term. If perchance there be on either side or on both sides any negative terms, it will be necessary to add the negative terms on both sides, until the terms on both sides become positive, and again to subtract like from like until on each side one term only is left.^d

and cannot agree with Heath (*H.G.M.* ii. 459) that "the description is evidently interpolated." But Heath seems right in his conjecture, first made in 1885, that the sign Λ is a compendium for the root of the verb $\lambdaείπειν$, and is, in fact, a Λ with an I placed in the middle. When the sign is resolved in the manuscripts into a word, the dative $\lambdaείψει$ is generally used, but there is no conclusive proof that Diophantus himself used this non-classical form.

^c A *pure* equation is one containing only one power of the unknown, whatever its degree; a *mixed* equation contains more than one power of the unknown.

^d In modern notation, Diophantus manipulates the equation until it is of the form $Ax^n = B$; as he recognizes only one value of x satisfying this equation, it is then considered solved.

GREEK MATHEMATICS

(ii.) Quadratic Equations

Ibid. iv. 39, Dioph. ed. Tannery i. 298. 7-306. 8

Εὐρεῖν τρεῖς ἀριθμούς ὅπως ἡ ὑπεροχὴ τοῦ μείζονος καὶ τοῦ μέσου πρὸς τὴν ὑπεροχὴν τοῦ μέσου καὶ τοῦ ἐλάσσονος λόγον ἔχη δεδομένον, ἔτι δὲ καὶ σὺν δύο λαμβανόμενοι, ποιῶσι τετράγωνον.

Ἐπιτετάχθω δὴ τὴν ὑπεροχὴν τοῦ μείζονος καὶ τοῦ μέσου τῆς ὑπεροχῆς τοῦ μέσου καὶ τοῦ ἐλαχίστου εἶναι $\gamma^{\pi\lambda}$.

Ἐπεὶ δὲ συναμφότερος ὁ μέσος καὶ ὁ ἐλάσσων ποιεῖ \square^{ov} , ποιείτω $\overset{\circ}{M} \delta$. ὁ ἄρα μέσος μείζων ἐστὶ δυάδος· ἔστω $\varsigma \bar{\alpha} \overset{\circ}{M} \beta$. ὁ ἄρα ἐλάχιστος ἔσται $\overset{\circ}{M} \beta \Lambda \equiv \bar{\alpha}$.

Καὶ ἐπειδὴ ἡ ὑπεροχὴ τοῦ μείζονος καὶ τοῦ μέσου τῆς ὑπεροχῆς τοῦ μέσου καὶ τοῦ ἐλαχίστου $\gamma^{\pi\lambda}$ (ἐστὶ),¹ καὶ ἡ ὑπεροχὴ τοῦ μέσου καὶ τοῦ ἐλαχίστου $\varsigma \beta$, ἡ ἄρα ὑπεροχὴ τοῦ μείζονος καὶ τοῦ μέσου ἔσται $\varsigma \bar{\varsigma}$, καὶ ὁ μείζων ἄρα ἔσται $\varsigma \zeta \overset{\circ}{M} \beta$.

Λοιπὸν ἐστὶ δύο ἐπιτάγματα, τό τε συναμφότερον (τὸν μείζονα καὶ τὸν ἐλάχιστον ποιεῖν \square^{ov} , καὶ τὸ τὸν μείζονα)² καὶ τὸν μέσον ποιεῖν \square^{ov} . καὶ γίνεται μοι διπλῆ ἡ ἰσότης·

$$\varsigma \eta \overset{\circ}{M} \delta \iota \sigma. \square^{\varphi}, \text{ καὶ } \varsigma \bar{\varsigma} \overset{\circ}{M} \delta \iota \sigma. \square^{\varphi}.$$

καὶ διὰ τὸ τὰς $\overset{\circ}{M}$ εἶναι τετραγωνικάς, εὐχερῆς ἐστὶν ἡ ἴσωσις.

¹ ἐστὶ add. Bachet.

² τὸν μείζονα . . . τὸν μείζονα add. Tannery.

ALGEBRA : DIOPHANTUS

(ii.) Quadratic Equations ^a

Ibid. iv. 39, Dioph. ed. Tannery i. 298. 7-306. 8

To find three numbers such that the difference of the greatest and the middle has to the difference of the middle and the least a given ratio, and further such that the sum of any two is a square.

Let it be laid down that the difference of the greatest and the middle has to the difference of the middle and the least the ratio 3 : 1.

Since the sum of the middle term and the least makes a square, let it be 4. Then the middle term > 2 . Let it be $x + 2$. Then the least term $= 2 - x$.

And since the difference of the greatest and the middle has to the difference of the middle and the least the ratio 3 : 1, and the difference of the middle and the least is $2x$, therefore the difference of the greatest and the middle is $6x$, and therefore the greatest will be $7x + 2$.

There remain two conditions, that the sum of the greatest and the least make a square and the sum of the greatest and the middle make a square. And I am left with the double equation ^b

$$8x + 4 = \text{a square,}$$

$$6x + 4 = \text{a square.}$$

And as the units are squares, the equation is convenient to solve.

^a The quadratic equation takes up only a small part of this problem, but the whole problem will give an excellent illustration of Diophantus's methods, and especially of his ingenuity in passing from one unknown to another. The geometrical solution of quadratic equations by the application of areas is treated in vol. i. pp. 192-215, and Heron's algebraical formula for solving quadratics, *supra*, pp. 502-505.

^b For double equations, v. *infra* p. 543 n. b.

GREEK MATHEMATICS

Πλάσσω ἀριθμοὺς δύο ἵνα ὁ ὑπ' αὐτῶν ἦ $\varepsilon \beta$,
καθὼς ἴσμεν διπλὴν ἰσότητα· ἔστω οὖν $\varepsilon \zeta'$ καὶ
 $\overset{\circ}{M} \delta$ · καὶ γίνεται ὁ $\varepsilon \overset{\circ}{M} \overline{\rho \iota \beta}$. ἔλθων ἐπὶ τὰς ὑπο-
στάσεις, οὐ δύναμαι ἀφελεῖν ἀπὸ $\overset{\circ}{M} \beta$ τὸν $\varepsilon \alpha$
τουτέστι τὰς $\overset{\circ}{M} \overline{\rho \iota \beta}$. θέλω οὖν τὸν ε εὐρεθῆναι
ἐλάττονα $\overset{\circ}{M} \beta$, ὥστε καὶ $\varepsilon \overline{\varepsilon} \overset{\circ}{M} \delta$ ἐλάσσονες ἔσονται
 $\overset{\circ}{M} \overline{\iota \varepsilon}$. ἐὰν γὰρ ἡ δυὰς ἐπὶ $\varepsilon \overline{\varepsilon}$ γένηται καὶ προσ-
λάβῃ $\overset{\circ}{M} \delta$, ποιεῖ $\overset{\circ}{M} \overline{\iota \varepsilon}$.

Ἐπεὶ οὖν ζητῶ $\varepsilon \eta \overset{\circ}{M} \delta$ ἴσ. \square^{ψ} καὶ $\varepsilon \overline{\varepsilon} \overset{\circ}{M} \delta$
ἴσ. \square^{φ} , ἀλλὰ καὶ ὁ ἀπὸ τῆς δυάδος, τουτέστι
 $\overset{\circ}{M} \delta$, \square^{\omicron} ἐστι, γεγόνασι τρεῖς \square^{\omicron} , $\varepsilon \eta \overset{\circ}{M} \delta$, καὶ
 $\varepsilon \overline{\varepsilon} \overset{\circ}{M} \delta$, καὶ $\overset{\circ}{M} \delta$, καὶ ἡ ὑπεροχὴ τοῦ μείζονος
καὶ τοῦ μέσου τῆς ὑπεροχῆς τοῦ μέσου καὶ τοῦ
ἐλαχίστου γ' μέρος ἐστίν. ἀπῆκται οὖν μοι εἰς
τὸ εὐρεῖν (τρεῖς)¹ τετραγώνους, ὅπως ἡ ὑπεροχὴ
τοῦ μείζονος καὶ τοῦ μέσου τῆς ὑπεροχῆς τοῦ
μέσου καὶ τοῦ ἐλαχίστου γ' μέρος ἦ, ἔτι δὲ ὁ μὲν
ἐλάχιστος ἦ $\overset{\circ}{M} \delta$, ὁ δὲ μέσος ἐλάσσων $\overset{\circ}{M} \overline{\iota \varepsilon}$.

¹ τρεῖς add. Bachet.

• If we put

$$8x + 4 = (p + q)^2,$$

$$6x + 4 = (p - q)^2,$$

on subtracting,

$$2x = 4pq.$$

Substituting $2p = \frac{1}{2}x$, $2q = 4$ (i.e., $p = \frac{1}{4}x$, $q = 2$) in the first equation we get

$$8x + 4 = (\frac{1}{4}x + 2)^2,$$

or

$$112x = x^2,$$

whence

$$x = 112.$$

ALGEBRA : DIOPHANTUS

I form two numbers whose product is $2x$, according to what we know about a double equation ; let them be $\frac{1}{2}x$ and 4 ; and therefore $x = 112$.^a But, returning to the conditions, I cannot subtract x , that is 112 , from 2 ; I desire, then, that x be found < 2 , so that $6x + 4 < 16$. For $2 \cdot 6 + 4 = 16$.

Then since I seek to make $8x + 4 =$ a square, and $6x + 4 =$ a square, while $2 \cdot 2 = 4$ is a square, there are three squares, $8x + 4$, $6x + 4$, and 4 , and the difference of the greatest and the middle is one-third^b of the difference of the middle and least. My problem therefore resolves itself into finding three squares such that the difference of the greatest and the middle is one-third of the difference of the middle and least, and further such that the least $= 4$ and the middle < 16 .

This method of solving such equations is explicitly given by Diophantus in ii. 11, Dioph. ed. Tannery i. 96. 8-14 :
 ἔσται ἄρα ὁ μὲν $\vartheta \bar{a} \overset{\circ}{M} \bar{\beta}$, ὁ δὲ $\vartheta \bar{a} \overset{\circ}{M} \bar{\gamma}$, ἴσ. \square . καὶ τοῦτο τὸ εἶδος καλεῖται διπλοῖσότης· ἰσοῦται δὲ τὸν τρόπον τοῦτον. ἰδὼν τὴν ὑπεροχὴν, ζήτηι δύο ἀριθμοὺς ἵνα τὸ ὑπ' αὐτῶν ποιῆ τὴν ὑπεροχὴν εἰσι δὲ $\overset{\circ}{M} \delta$ καὶ $\overset{\circ}{M} \delta^x$. τούτων ἦτοι τῆς ὑπεροχῆς τὸ $\overset{\circ}{L}'$ ἐφ' ἑαυτὸ ἴσον ἐστὶ τῶν ἐλάσσωνι, ἢ τῆς συνθέσεως τὸ $\overset{\circ}{L}'$ ἐφ' ἑαυτὸ ἴσον τῶν μείζονι—“The equations will then be $x + 2 =$ a square, $x + 3 =$ a square ; and this species is called a double equation. It is solved in this manner : observe the difference, and seek two [suitable] numbers whose product is equal to the difference ; they are 4 and $\frac{1}{2}$. Then, either the square of half the difference of these numbers is equated to the lesser, or the square of half the sum to the greater.”

^b The ratio of the differences in this subordinate problem has, of course, nothing to do with the ratio of the differences in the main problem ; the fact that they are reciprocals may lead the casual reader to suspect an error.

GREEK MATHEMATICS

Τετάρθω ὁ μὲν ἐλάχιστος $\overset{\circ}{M} \delta$, ἡ δὲ τοῦ μέσου π^λ. $\varepsilon \bar{\alpha} \overset{\circ}{M} \beta$. αὐτὸς ἄρα ἔσται ὁ $\square^{\circ\sigma}$, $\Delta^{\gamma} \bar{\alpha} \varepsilon \delta \overset{\circ}{M} \delta$.

Ἐπεὶ οὖν ἡ ὑπεροχὴ τοῦ μείζονος καὶ τοῦ μέσου τῆς ὑπεροχῆς τοῦ μέσου καὶ τοῦ ἐλαχίστου γ^{ον} μέρος ἐστίν, καὶ ἔστιν ἡ ὑπεροχὴ τοῦ μέσου καὶ τοῦ ἐλαχίστου $\Delta^{\gamma} \bar{\alpha} \varepsilon \delta$, ὥστε ἡ ὑπεροχὴ τοῦ μεγίστου καὶ τοῦ μέσου ἔσται $\Delta^{\gamma} \gamma^{\chi} \varepsilon \bar{\alpha} \gamma^{\chi}$. καὶ ἔστιν ὁ μέσος $\Delta^{\gamma} \bar{\alpha} \varepsilon \delta \overset{\circ}{M} \delta$. ὁ ἄρα μέγιστος ἔσται $\Delta^{\gamma} \bar{\alpha} \gamma^{\chi} = \bar{\varepsilon} \gamma^{\chi} \overset{\circ}{M} \delta$ ἴσ. \square^{φ} . πάντα θ^{κ^{ις}}. Δ^{γ} ἄρα $\bar{\iota} \beta \varepsilon \bar{\mu} \eta \overset{\circ}{M} \lambda \varsigma$ ἴσ. \square^{φ} καὶ τὸ δ^{ον} αὐτῶν $\Delta^{\gamma} \bar{\gamma} \varepsilon \bar{\iota} \beta \overset{\circ}{M} \theta$ ἴσ. \square^{φ} .

Ἐπι δὲ θέλω τὸν μέσον τετράγωνον ἐλάσσονα εἶναι $\overset{\circ}{M} \bar{\iota} \varsigma$, καὶ τὴν π^λ. δηλαδὴ ἐλάσσονος $\overset{\circ}{M} \delta$. ἡ δὲ πλευρὰ τοῦ μέσου ἐστίν $\varepsilon \bar{\alpha} \overset{\circ}{M} \beta$. ἐλάττονές εἰσι $\overset{\circ}{M} \delta$. καὶ κοινῶν ἀφαιρεθειῶν τῶν $\bar{\beta} \overset{\circ}{M}$, ὁ ε ἔσται ἐλάσσονος $\overset{\circ}{M} \beta$.

Γέγονεν οὖν μοι $\Delta^{\gamma} \bar{\gamma} \varepsilon \bar{\iota} \beta \overset{\circ}{M} \theta$ ἴσ. ποιῆσαι \square^{φ} . πλάσσω $\square^{\acute{\omicron}\nu}$ τινα ἀπὸ $\overset{\circ}{M} \bar{\gamma}$ λειπουσῶν ε τινας· καὶ γίνεται ὁ ε ἔκ τινος ἀριθμοῦ $\varepsilon^{\kappa\iota\varsigma}$ γενομένου καὶ προσλαβόντος τὸν $\bar{\iota} \beta$, τουτέστι τῆς ἰσώσεως τῆς $\varepsilon \bar{\iota} \beta$, καὶ μερισθέντος εἰς τὴν ὑπεροχὴν ἣ ὑπερέχει ὁ ἀπὸ τοῦ ἀριθμοῦ $\square^{\circ\sigma}$ τῶν Δ^{γ} τῶν ἐν τῇ ἰσώσει $\bar{\gamma}$. ἀπῆκται οὖν μοι εἰς τὸ εὔρεῖν τινα ἀριθμόν, ὃς $\varepsilon^{\kappa\iota\varsigma}$ γενόμενος καὶ προσλαβὼν $\overset{\circ}{M} \bar{\iota} \beta$ καὶ μεριζόμενος εἰς τὴν ὑπεροχὴν ἣ ὑπερέχει ὁ ἀπὸ τοῦ αὐτοῦ $\square^{\circ\sigma}$ τριάδος, ποιεῖ τὴν παραβολὴν ἐλάσσονος $\overset{\circ}{M} \beta$.

ALGEBRA : DIOPHANTUS

Let the least be taken as 4, and the side of the middle as $z + 2$; then the square is $z^2 + 4z + 4$.

Then since the difference of the greatest and the middle is one-third of the difference of the middle and the least, and the difference of the middle and the least is $z^2 + 4z$, so that the difference of the greatest and the least is $\frac{1}{3}z^2 + 1\frac{1}{3}z$, while the middle term is $z^2 + 4z + 4$, therefore the greatest term = $1\frac{1}{3}z^2 + 5\frac{1}{3}z + 4 =$ a square. Multiply throughout by 9 :

$$12z^2 + 48z + 36 = \text{a square ;}$$

and take the fourth part :

$$3z^2 + 12z + 9 = \text{a square.}$$

Further, I desire that the middle square < 16 , whence clearly its side < 4 . But the side of the middle square is $z + 2$, and so $z + 2 < 4$. Take away 2 from each side, and $z < 2$.

My equation is now

$$3z^2 + 12z + 9 = \text{a square.}$$

$$= (mz - 3)^2, \text{ say.}^a$$

Then

$$z = \frac{6m + 12}{m^2 - 3},$$

and the equation to which my problem is now resolved is

$$\frac{6m + 12}{m^2 - 3} < 2,$$

i.e.,
$$< \frac{2}{1}.$$

^a As a literal translation of the Greek at this point would be intolerably prolix, I have made free use of modern notation.

GREEK MATHEMATICS

Ἐστω ὁ ζητούμενος $\varepsilon \bar{a}$. οὕτως $\varepsilon^{\kappa\iota\varsigma}$ γινόμενος καὶ προσλαβὼν $\overset{\circ}{M} \bar{\iota\beta}$, ποιεῖ $\varepsilon \bar{\varepsilon} \overset{\circ}{M} \bar{\iota\beta}$. ὁ δὲ ἀπ' αὐτοῦ $\square^{\circ\varsigma}$, $\Lambda \overset{\circ}{M} \bar{\gamma}$, ποιεῖ $\Delta^{\gamma} \bar{a} \Lambda \overset{\circ}{M} \bar{\gamma}$. θέλω οὖν $\varepsilon \bar{\varepsilon} \overset{\circ}{M} \bar{\iota\beta}$ μερίζεσθαι εἰς $\Delta^{\gamma} \bar{a} \Lambda \overset{\circ}{M} \bar{\gamma}$ καὶ ποιεῖν τὴν παραβολὴν ἐλάσσονος $\overset{\circ}{M} \bar{\beta}$. ἀλλὰ καὶ ὁ $\bar{\beta}$ μεριζόμενος εἰς $\overset{\circ}{M} \bar{a}$, ποιεῖ τὴν παραβολὴν $\bar{\beta}$. ὥστε $\varepsilon \bar{\varepsilon} \overset{\circ}{M} \bar{\iota\beta}$ πρὸς $\Delta^{\gamma} \bar{a} \Lambda \overset{\circ}{M} \bar{\gamma}$ ἐλάσσονα λόγον ἔχουσιν ἢ πρὸς $\bar{\beta}$ πρὸς \bar{a} .

Καὶ χωρίον χωρίῳ ἄνισον. ὁ ἄρα ὑπὸ $\varepsilon \bar{\varepsilon} \overset{\circ}{M} \bar{\iota\beta}$ καὶ $\overset{\circ}{M} \bar{a}$ ἐλάσσων ἐστὶν τοῦ ὑπὸ δυνάδος καὶ $\Delta^{\gamma} \bar{a} \Lambda \overset{\circ}{M} \bar{\gamma}$, τουτέστιν $\varepsilon \bar{\varepsilon} \overset{\circ}{M} \bar{\iota\beta}$ ἐλάσσονές εἰσιν $\Delta^{\gamma} \bar{\beta} \Lambda \overset{\circ}{M} \bar{\varepsilon}$. καὶ κοιναὶ προσκείσθωσαν αἱ $\overset{\circ}{M} \bar{\varepsilon}$. $\varepsilon \bar{\varepsilon} \overset{\circ}{M} \bar{\iota\eta}$ ἐλάσσονες $\Delta^{\gamma} \bar{\beta}$.

Ὅταν δὲ τοιαύτην ἴσωσιν ἰσώσωμεν, ποιούμεν τῶν ε τὸ \angle' ἐφ' ἑαυτό, γίνεται $\bar{\theta}$, καὶ τὰς $\Delta^{\gamma} \bar{\beta}$ ἐπὶ τὰς $\overset{\circ}{M} \bar{\iota\eta}$, γίνονται $\bar{\lambda\varsigma}$. πρόσθετες τοῖς $\bar{\theta}$, γίνονται $\bar{\mu\epsilon}$, ὧν π^{λ} οὐκ ἔλαττον ἐστὶ $\overset{\circ}{M} \bar{\zeta}$. πρόσθετες τὸ ἡμίσεισμα τῶν ε γίνεται οὐκ ἔλαττον $\overset{\circ}{M} \bar{\iota}$. καὶ μέρισον εἰς τὰς Δ^{γ} .¹ γίνεται οὐκ ἔλαττον $\overset{\circ}{M} \bar{\epsilon}$.

Γέγονεν οὖν μοι $\Delta^{\gamma} \bar{\gamma} \varepsilon \bar{\iota\beta} \overset{\circ}{M} \bar{\theta}$ ἴσ. \square^{ψ} τῷ ἀπὸ π^{λ} . $\overset{\circ}{M} \bar{\gamma} \Lambda \varepsilon \bar{\epsilon}$, καὶ γίνεται ὁ $\varepsilon \bar{\varepsilon} \overset{\circ}{M} \bar{\kappa\beta}$ τουτέστιν $\overset{\iota\alpha}{\mu\beta}$ $\overset{\kappa\alpha}{\mu\beta}$.

Τέταχα δὲ τὴν τοῦ μέσου $\square^{\omicron\upsilon}$ π^{λ} $\varepsilon \bar{a} \overset{\circ}{M} \bar{\beta}$.

¹ γίνεται . . . τὰς Δ^{γ} add. Tannery.

^a This is not strictly true. But since $\sqrt{45}$ lies between 6 and 7, no smaller integral value than 7 will satisfy the conditions of the problem.

ALGEBRA : DIOPHANTUS

The inequality will be preserved when the terms are cross-multiplied,

$$\text{i.e.,} \quad (6m + 12) \cdot 1 < 2 \cdot (m^2 - 3);$$

$$\text{i.e.,} \quad 6m + 12 < 2m^2 - 6.$$

By adding 6 to both sides,

$$6m + 18 < 2m^2.$$

When we solve such an equation, we multiply half the coefficient of x [or m] into itself—getting 9; then multiply the coefficient of x^2 into the units— $2 \cdot 18 = 36$; add this last number to the 9—getting 45; take the square root—which is $\sqrt{45}$; add half the coefficient of x —making a number $\sqrt{45} + 10$; and divide the result by the coefficient of x^2 —getting a number $\frac{\sqrt{45} + 10}{2}$.^b

My equation is therefore

$$3z^2 + 12z + 9 = \text{a square on side } (3 - 5z),$$

and

$$z = \frac{42}{22} = \frac{21}{11}.$$

I have made the side of the middle square to be

^b This shows that Diophantus had a perfectly general formula for solving the equation

$$ax^2 = bx + c,$$

namely

$$x = \frac{\frac{1}{2}b + \sqrt{\frac{1}{4}b^2 + ac}}{a}.$$

From vi. 6 it becomes clear that he had a similar general formula for solving

$$ax^2 + bx = c,$$

and from v. 10 and vi. 22 it may be inferred that he had a general solution for

$$ax^2 + c = bx.$$

GREEK MATHEMATICS

ἔσται ἡ τοῦ $\square^{\text{ον}}$ π^λ. $\overset{\circ}{M}$ ^{ια}_{μγ}. αὐτὸς δὲ ὁ $\square^{\text{ος}}$
 $\overset{\circ}{M}$ ^{ρακ}_{αωμθ}.

Ἔρχομαι οὖν ἐπὶ τὸ ἐξ ἀρχῆς καὶ τάσσω
 $\overset{\circ}{M}$ ^{ρκα}_{αωμθ}, ὄντα $\square^{\text{ον}}$, ἴσ. τοῖς $\varepsilon\bar{\varepsilon} \overset{\circ}{M} \delta$. καὶ πάντα
 εἰς $\overline{\rho\kappa\alpha}$. καὶ γίνεται ὁ ε $\psi\kappa\varsigma$ _{ατξέ}, καὶ ἔστιν ἐλάσσων
 δυάδος.

Ἐπὶ τὰς ὑποστάσεις τοῦ προβλήματος τοῦ ἐξ
 ἀρχῆς· ὑπέστημεν δὴ τὸν μὲν μέσον $\varepsilon \bar{\alpha} \overset{\circ}{M} \beta$, τὸν
 δὲ ἐλάχιστον $\overset{\circ}{M} \beta \Lambda \varepsilon \bar{\alpha}$, τὸν δὲ μέγιστον $\varepsilon \zeta \overset{\circ}{M} \beta$.
 ἔσται ὁ μὲν μέγιστος $\overline{\alpha \cdot \alpha \zeta}$, ὁ δὲ β^{ος} $\overline{\beta \omega \iota \zeta}$, ὁ
 δὲ ἐλάχιστος ὁ γ^{ος} $\overline{\pi \zeta}$. καὶ ἐπεὶ τὸ μόριον, ἔστι τὸ
 $\overline{\psi\kappa\varsigma}^{\text{ον}}$, οὐκ ἔστιν $\square^{\text{ος}}$, $\varepsilon^{\text{ον}}$ δὲ ἔστιν αὐτοῦ, ἐὰν
 λάβωμεν $\overline{\rho\kappa\alpha}$, ὃ ἔστι $\square^{\text{ος}}$, πάντων οὖν τὸ $\varepsilon^{\text{ον}}$,
 καὶ ὁμοίως ἔσται ὁ μὲν α^{ος} $\overline{\rho\kappa\alpha^{\text{ων}}}$ $\overline{\alpha\omega\lambda\delta\zeta'}$, ὁ δὲ
 β^{ος} $\overline{\upsilon\xi\theta\zeta'}$, ὁ δὲ γ^{ος} $\overline{\iota\delta\zeta'}$.

Καὶ ἐὰν ἐν ὀλοκλήροις θέλῃς ἵνα μὴ τὸ ζ' ἐπι-
 τρέχῃ, εἰς δ^α ἔμβαλε. καὶ ἔσται ὁ α^{ος} ^{υπδ}_{ζτλη}, ὁ δὲ
 β^{ος} ^{υπδ}_{αωση}, ὁ δὲ γ^{ος} ^{υπδ}_{νη}. καὶ ἡ ἀπόδειξις φανερά.

ALGEBRA : DIOPHANTUS

$x + 2$; therefore the side will be $\frac{43}{11}$ and the square itself $\frac{1849}{121}$.

I return now to the original problem and make $\frac{1849}{121}$, which is a square, $= 6x + 4$. Multiplying by 121 throughout, I get $x = \frac{1365}{726}$, which is < 2 .

In the conditions of the original problem we made the middle term $= x + 2$, the least $= 2 - x$, and the greatest $7x + 2$.

Therefore

$$\text{the greatest} = \frac{11007}{726},$$

$$\text{the middle} = \frac{2817}{726},$$

$$\text{the least} = \frac{87}{726}.$$

Since the denominator, 726, is not a square, but its sixth part is, if we take 121, which is a square, and divide throughout by 6, then similarly the numbers are

$$\frac{1834\frac{1}{2}}{121}, \quad \frac{469\frac{1}{2}}{121}, \quad \frac{14\frac{1}{2}}{121}.$$

And if you prefer to use integers only, avoiding the $\frac{1}{2}$, multiply throughout by 4. Then the numbers will be

$$\frac{7338}{484}, \quad \frac{1878}{484}, \quad \frac{58}{484}.$$

And the proof is obvious.

GREEK MATHEMATICS

(iii.) *Simultaneous Equations Leading to a Quadratic*

Ibid. i. 28, Dioph. ed. Tannery i. 62. 20-64. 10

Εὐρεῖν δύο ἀριθμούς ὅπως καὶ ἡ σύνθεσις αὐτῶν καὶ ἡ σύνθεσις τῶν ἀπ' αὐτῶν τετραγώνων ποιῆθῶντας ἀριθμούς.

Δεῖ δὴ τοὺς δις ἀπ' αὐτῶν τετραγώνους τοῦ ἀποσυναμφοτέρου αὐτῶν τετραγώνου ὑπερέχειν τετραγώνῳ. ἔστι δὲ καὶ τοῦτο πλασματικόν.

Ἐπιτετάχθω δὴ τὴν μὲν σύνθεσιν αὐτῶν ποιεῖν $\overset{\circ}{M}\bar{\kappa}$, τὴν δὲ σύνθεσιν τῶν ἀπ' αὐτῶν τετραγώνων ποιεῖν $\overset{\circ}{M}\bar{\sigma}\eta$.

Τετάχθω δὴ ἡ ὑπεροχὴ αὐτῶν $\varepsilon\bar{\beta}$. καὶ ἔστω ὁ μείζων $\varepsilon\bar{\alpha}$ καὶ $\overset{\circ}{M}\bar{\iota}$, τῶν ἡμίσεων πάλιν τοῦ συνθέματος, ὁ δὲ ἐλάσσων $\overset{\circ}{M}\bar{\iota}\Lambda\varepsilon\bar{\alpha}$. καὶ μένει πάλιν τὸ μὲν σύνθεμα αὐτῶν $\overset{\circ}{M}\bar{\kappa}$, ἡ δὲ ὑπεροχὴ $\varepsilon\bar{\beta}$.

Λοιπὸν ἔστι καὶ τὸ σύνθεμα τῶν ἀπ' αὐτῶν τετραγώνων ποιεῖν $\overset{\circ}{M}\bar{\sigma}\eta$. ἀλλὰ τὸ σύνθεμα τῶν ἀπ' αὐτῶν τετραγώνων ποιεῖ $\Delta^{\vee}\bar{\beta}\overset{\circ}{M}\bar{\sigma}$. ταῦτα ἴσα $\overset{\circ}{M}\bar{\sigma}\eta$, καὶ γίνεται ὁ $\varepsilon\bar{\beta}$.

Ἐπὶ τὰς ὑποστάσεις. ἔσται ὁ μὲν μείζων $\overset{\circ}{M}\bar{\iota}\bar{\beta}$, ὁ δὲ ἐλάσσων $\overset{\circ}{M}\bar{\eta}$. καὶ ποιούσι τὰ τῆς προτάσεως.

* In general terms, Diophantus's problem is to solve the simultaneous equations

$$\xi + \eta = 2a$$

$$\xi^2 + \eta^2 = \Lambda.$$

He says, in effect, let $\xi - \eta = 2x$;

then $\xi = a + x, \eta = a - x,$

ALGEBRA : DIOPHANTUS

(iii.) *Simultaneous Equations Leading to a Quadratic*

Ibid. i. 28, Dioph. ed. Tannery i. 62. 20-64. 10

To find two numbers such that their sum and the sum of their squares are given numbers.^a

It is a necessary condition that double the sum of their squares exceed the square of their sum by a square. This is of the nature of a formula.^b

Let it be required to make their sum 20 and the sum of their squares 208.

Let their difference be $2x$, and let the greater $= x + 10$ (again adding half the sum) and the lesser $= 10 - x$.

Then again their sum is 20 and their difference $2x$.

It remains to make the sum of their squares 208. But the sum of their squares is $2x^2 + 200$.

Therefore $2x^2 + 200 = 208,$

and $x = 2.$

To return to the hypotheses—the greater = 12 and the lesser = 8. And these satisfy the conditions of the problem.

and $(a+x)^2 + (a-x)^2 = A,$

i.e., $2(a^2 + x^2) = A.$

A procedure equivalent to the solution of the pair of simultaneous equations $\xi + \eta = 2a$, $\xi\eta = A$, is given in i. 27, and a procedure equivalent to the solution of $\xi - \eta = 2a$, $\xi\eta = A$, in i. 30.

^b In other words, $2(\xi^2 + \eta^2) - (\xi + \eta)^2 = a$ square; it is, in fact, $(\xi - \eta)^2$. I have followed Heath in translating *ἔστι δὲ καὶ τοῦτο πλάσματικόν* as "this is of the nature of a formula." Tannery evades the difficulty by translating "est et hoc formativum," but Bachet came nearer the mark with his "effictum aliunde." The meaning of *πλάσματικόν* should be "easy to form a mould," *i.e.* the formula is easy to discover.

GREEK MATHEMATICS

(iv.) Cubic Equation

Ibid. vi. 17, Dioph. ed. Tannery i. 432. 19-434. 22

Εύρειν τρίγωνον ὀρθογώνιον ὅπως ὁ ἐν τῷ ἐμβαδῷ αὐτοῦ, προσλαβὼν τὸν ἐν τῇ ὑποτεينوῦσῃ, ποιῆ τετράγωνον, ὁ δὲ ἐν τῇ περιμέτρῳ αὐτοῦ ἦ κύβος.

Τετάχθω ὁ ἐν τῷ ἐμβαδῷ αὐτοῦ $\xi \alpha$, ὁ δὲ ἐν τῇ ὑποτεينوῦσῃ αὐτοῦ \dot{M} τινῶν τετραγωνικῶν $\Lambda \xi \alpha$, ἔστω $\dot{M} \bar{\iota} \bar{\varsigma} \Lambda \xi \alpha$.

Ἄλλ' ἐπεὶ ὑπεθέμεθα τὸν ἐν τῷ ἐμβαδῷ αὐτοῦ εἶναι $\xi \alpha$, ὁ ἄρα ὑπὸ τῶν περὶ τὴν ὀρθὴν αὐτοῦ γίνεται $\xi \beta$. ἀλλὰ $\xi \beta$ περιέχονται ὑπὸ $\xi \alpha$ καὶ $\dot{M} \beta$. εἰς οὖν τάξωμεν μίαν τῶν ὀρθῶν $\dot{M} \beta$, ἔσται ἢ ἑτέρα $\xi \alpha$.

Καὶ γίνεται ἡ περίμετρος $\dot{M} \bar{\iota} \eta$ καὶ οὐκ ἔστι κύβος· ὁ δὲ $\bar{\iota} \eta$ γέγονεν ἔκ τινος \square^{ov} καὶ $\dot{M} \beta$. δεήσει ἄρα εὑρεῖν \square^{ov} τινα, ὅς, προσλαβὼν $\dot{M} \beta$, ποιεῖ κύβον, ὥστε κύβον \square^{ψ} ὑπερέχειν $\dot{M} \beta$.

Τετάχθω οὖν ἡ μὲν τοῦ \square^{ov} π^{λ} $\xi \alpha \dot{M} \alpha$, ἡ δὲ τοῦ κύβου $\xi \alpha \Lambda \dot{M} \alpha$. γίνεται ὁ μὲν \square^{os} , $\Delta^{\gamma} \alpha \xi \beta \dot{M} \alpha$, ὁ δὲ κύβος, $K^{\gamma} \alpha \xi \gamma \Lambda \Delta^{\gamma} \gamma \dot{M} \alpha$. θέλω οὖν τὸν κύβον τὸν \square^{ov} ὑπερέχειν δυάδι· ὁ ἄρα \square^{os} μετὰ δυάδος, τουτέστιν $\Delta^{\gamma} \alpha \xi \beta \dot{M} \gamma$, ἔστιν ἴσος $K^{\gamma} \alpha \xi \gamma \Lambda \Delta^{\gamma} \gamma \dot{M} \alpha$, ὅθεν ὁ ξ εὑρίσκεται $\dot{M} \delta$.

Ἔσται οὖν ἡ μὲν τοῦ \square^{ov} π^{λ} $\dot{M} \epsilon$, ἡ δὲ τοῦ

ALGEBRA : DIOPHANTUS

(iv.) *Cubic Equation* *

Ibid. vi. 17, Dioph. ed. Tannery i. 432. 19-434. 22

To find a right-angled triangle such that its area, added to one of the perpendiculars, makes a square, while its perimeter is a cube.

Let its area = x , and let its hypotenuse be some square number *minus* x , say $16 - x$.

But since we supposed the area = x , therefore the product of the sides about the right angle = $2x$. But $2x$ can be factorized into x and 2 ; if, then, we make one of the sides about the right angle = 2 , the other = x .

The perimeter then becomes 18 , which is not a cube; but 18 is made up of a square $[16] + 2$. It shall be required, therefore, to find a square number which, when 2 is added, shall make a cube, so that the cube shall exceed the square by 2 .

Let the side of the square = $m + 1$ and that of the cube = $m - 1$. Then the square = $m^2 + 2m + 1$ and the cube = $m^3 + 3m - 3m^2 - 1$. Now I want the cube to exceed the square by 2 . Therefore, by adding 2 to the square,

$$m^2 + 2m + 3 = m^3 + 3m - 3m^2 - 1,$$

whence

$$m = 4.$$

Therefore the side of the square = 5 and that of

* This is the only example of a cubic equation solved by Diophantus. For Archimedes' geometrical solution of a cubic equation, *v. supra*, pp. 126-163.

GREEK MATHEMATICS

κύβου $\overset{\circ}{M} \gamma$. αὐτοὶ ἄρα ὁ μὲν $\square^{\circ\circ} \overset{\circ}{M} \overline{\kappa\epsilon}$, ὁ δὲ κύβος $\overset{\circ}{M} \overline{\kappa\zeta}$.

Μεθυφίσταμαι οὖν τὸ ὀρθογώνιον, καὶ τάξας αὐτοῦ τὸ ἐμβαδὸν $\xi \bar{\alpha}$, τάσσω τὴν ὑποτείνουσαν $\overset{\circ}{M} \overline{\kappa\epsilon} \Lambda \xi \bar{\alpha}$. μένει δὲ καὶ ἡ βᾶσις $\overset{\circ}{M} \beta$, ἡ δὲ κάθετος $\xi \bar{\alpha}$.

Λοιπὸν ἐστὶν τὸν ἀπὸ τῆς ὑποτείνουσῆς ἴσον εἶναι τοῖς ἀπὸ τῶν περὶ τὴν ὀρθὴν· γίνεται δὲ $\Delta^{\vee} \bar{\alpha} \overset{\circ}{M} \overline{\chi\kappa\epsilon} \Lambda \xi \bar{\nu}$. ἔσται ἴση $\Delta^{\vee} \bar{\alpha} \overset{\circ}{M} \delta$. ὅθεν ὁ $\xi \overset{\circ}{M} \nu$
 $\chi\kappa\alpha$.

Ἐπὶ τὰς ὑποστάσεις καὶ μένει.

(d) INDETERMINATE EQUATIONS

(i.) Indeterminate Equations of the Second Degree

(a) Single Equations

Ibid. ii. 20, Dioph. ed. Tannery i. 114. 11-22

Εὐρεῖν δύο ἀριθμοὺς ὅπως ὁ ἀπὸ τοῦ ἑκατέρου αὐτῶν τετράγωνος, προσλαβὼν τὸν λοιπὸν, ποιῆ τετράγωνον.

Τετάχθω ὁ $\alpha^{\circ\circ} \xi \bar{\alpha}$, ὁ δὲ $\beta^{\circ\circ} \overset{\circ}{M} \bar{\alpha} \xi \bar{\beta}$, ἵνα ὁ ἀπὸ τοῦ $\alpha^{\circ\circ} \square^{\circ\circ}$, προσλαβὼν τὸν $\beta^{\circ\circ}$, ποιῆ $\square^{\circ\circ}$. λοιπὸν ἐστὶ καὶ τὸν ἀπὸ τοῦ $\beta^{\circ\circ} \square^{\circ\circ}$, προσλαβόντα τὸν $\alpha^{\circ\circ}$, ποιεῖν $\square^{\circ\circ}$. ἀλλ' ὁ ἀπὸ τοῦ $\beta^{\circ\circ} \square^{\circ\circ}$, προσλαβὼν τὸν $\alpha^{\circ\circ}$, ποιεῖ $\Delta^{\vee} \delta \xi \bar{\alpha} \overset{\circ}{M} \bar{\alpha}$. ταῦτα ἴσα $\square^{\circ\circ}$.

* Diophantus makes no mention of indeterminate equations of the first degree, presumably because he admits

ALGEBRA : DIOPHANTUS

the cube = 3 ; and hence the square is 25 and the cube 27.

I now transform the right-angled [triangle], and, assuming its area to be x , I make the hypotenuse = $25 - x$; the base remains = 2 and the perpendicular = x .

The condition is still left that the square on the hypotenuse is equal to the sum of the squares on the sides about the right angle ;

$$\text{i.e.,} \quad x^2 + 625 - 50x = x^2 + 4,$$

$$\text{whence} \quad x = \frac{621}{50}.$$

This satisfies the conditions.

(d) INDETERMINATE EQUATIONS ^a

(i.) *Indeterminate Equations of the Second Degree*

(a) *Single Equations*

Ibid. ii. 20, Dioph. ed. Tannery i. 114. 11-22

To find two numbers such that the square of either, added to the other, shall make a square.

Let the first be x , and the second $2x + 1$, in order that the square on the first, added to the second, may make a square. There remains to be satisfied the condition that the square on the second, added to the first, shall make a square. But the square on the second, added to the first, is $4x^2 + 5x + 1$; and therefore this must be a square.

rational *fractional* solutions, and the whole point of solving an indeterminate equation of the first degree is to get a solution in integers.

GREEK MATHEMATICS

Πλάσσω τὸν $\square^{\circ\circ}$ ἀπὸ $\varepsilon\beta\Lambda\dot{M}\beta$. αὐτὸς ἄρα ἔσται $\Delta^{\vee}\delta\dot{M}\delta\Lambda\varepsilon\eta$. καὶ γίνεται ὁ ε γ .

Ἔσται ὁ μὲν $\alpha^{\circ\circ}$ γ , ὁ δὲ $\beta^{\circ\circ}$ $\iota\theta$, καὶ ποιούσιν τὸ πρόβλημα.

(β) Double Equations

Ibid. iv. 32, Dioph. ed. Tannery 268. 18–272. 15

Δοθέντα ἀριθμὸν διελεῖν εἰς τρεῖς ἀριθμοὺς ὅπως ὁ ὑπὸ τοῦ πρώτου καὶ τοῦ δευτέρου, εἴαν τε προσλάβῃ τὸν τρίτον, εἴαν τε λείψῃ, ποιῆ τετράγωνον.

Ἔστω ὁ δοθεὶς ὁ $\bar{\varepsilon}$.

Τετάρθω ὁ $\gamma^{\circ\circ}$ $\varepsilon\bar{\alpha}$, καὶ ὁ $\beta^{\circ\circ}$ \dot{M} ἐλασσόνων τοῦ $\bar{\varepsilon}$. ἔστω $\dot{M}\beta$. ὁ ἄρα $\alpha^{\circ\circ}$ ἔσται $\dot{M}\delta\Lambda\varepsilon\bar{\alpha}$. καὶ λοιπὰ ἔστι δύο ἐπιτάγματα, τὸν ὑπὸ $\alpha^{\circ\circ}$ καὶ $\beta^{\circ\circ}$, εἴαν τε προσλάβῃ τὸν $\gamma^{\circ\circ}$, εἴαν τε λείψῃ, ποιεῖν $\square^{\circ\circ}$. καὶ γίνεται διπλῆ ἢ ἰσότης. $\dot{M}\eta\Lambda\varepsilon\bar{\alpha}$ ἴσ. $\square^{\circ\circ}$. καὶ $\dot{M}\eta\Lambda\varepsilon\bar{\gamma}$ ἴσ. $\square^{\circ\circ}$. καὶ οὐ ῥητόν

* The problem, in its most general terms, is to solve the equation

$$Ax^2 + Bx + C = y^2.$$

Diophantus does not give a general solution, but takes a number of special cases. In this case A is a square number ($=a^2$, say), and in the equation

$$a^2x^2 + Bx + C = y^2$$

he apparently puts

$$y^2 = (ax - m)^2,$$

where m is some integer,

whence

$$a = \frac{m^2 - C}{2am + B}.$$

ALGEBRA : DIOPHANTUS

I form the square from $2x-2$; it will be $4x^2 + 4 - 8x$; and $x = \frac{3}{13}$.

The first number will be $\frac{3}{13}$, the second $\frac{19}{13}$, and they satisfy the conditions of the problem.^a

(β) Double Equations ^b

Ibid. iv. 32, Dioph. ed. Tannery 268. 18-272. 15

To divide a given number into three parts such that the product of the first and second ± the third shall make a square.

Let the given number be 6.

Let the third part be x , and the second part any number < 6 , say 2; then the first part $= 4 - x$; and the two remaining conditions are that the product of the first and second ± the third = a square. There results the double equation

$$8 - x = \text{a square,}$$

$$8 - 3x = \text{a square.}$$

And this does not give a rational result since the ratio

^b Diophantus's term for a double equation is *διπλοϊσότης*, *διπλή ισότης* or *διπλή ἰσωσις*. It always means with him that two different functions of the unknown have to be made simultaneously equal to two squares. The general equations are therefore

$$A_1x^2 + B_1x + C_1 = u_1^2,$$

$$A_2x^2 + B_2x + C_2 = u_2^2.$$

Diophantus solves several examples in which the terms in x^2 are missing, and also several forms of the general equation.

GREEK MATHEMATICS

ἔστι διὰ τὸ μὴ εἶναι τοὺς Σ πρὸς ἀλλήλους λόγον ἔχοντας ὃν $\square^{\circ\sigma}$ ἀριθμὸς πρὸς $\square^{\circ\nu}$ ἀριθμόν.

Ἄλλὰ ὁ Σ ὁ \bar{a} μονάδι ἐλάσσων τοῦ β , οἱ δὲ Σ γ ὁμοίως μείζονες \dot{M} τοῦ β . ἀπῆκται οὖν μοι εἰς τὸ εὐρεῖν ἀριθμόν τινα, ὡς τὸν β , ἵνα ὁ \dot{M} αὐτοῦ μείζων, πρὸς τὸν \dot{M} (αὐτοῦ ἐλάσσονα, λόγον ἔχῃ ὃν $\square^{\circ\sigma}$ ἀριθμὸς πρὸς) $\square^{\circ\nu}$ ἀριθμόν.

Ἐστω ἡ ζητούμενος $\Sigma \bar{a}$, καὶ ὁ \dot{M} \bar{a} αὐτοῦ μείζων ἔσται $\Sigma \bar{a} \dot{M} \bar{a}$, ὁ δὲ \dot{M} αὐτοῦ ἐλάσσων $\Sigma \bar{a} \Lambda \dot{M} \bar{a}$. θέλομεν οὖν αὐτοὺς πρὸς ἀλλήλους λόγον ἔχειν ὃν $\square^{\circ\sigma}$ ἀριθμὸς πρὸς $\square^{\circ\nu}$ ἀριθμόν. ἔστω ὃν δ πρὸς \bar{a} . ὥστε $\Sigma \bar{a} \Lambda \dot{M} \bar{a}$ ἐπὶ $\dot{M} \delta$ γίνονται $\Sigma \delta \Lambda \dot{M} \delta$. καὶ $\Sigma \bar{a} \dot{M} \bar{a}$ ἐπὶ τὴν $\dot{M} \bar{a}$ (γίνονται $\Sigma \bar{a} \dot{M} \bar{a}$).² καὶ εἰσιν οὗτοι οἱ ἐκκείμενοι ἀριθμοὶ λόγον ἔχοντες πρὸς ἀλλήλους ὃν ἔχει $\square^{\circ\sigma}$ ἀριθμὸς πρὸς $\square^{\circ\nu}$ ἀριθμόν. νῦν $\Sigma \delta \Lambda \dot{M} \delta$ ἴσ. $\Sigma \bar{a} \dot{M} \bar{a}$, καὶ γίνεται ὁ $\Sigma \dot{M} \gamma$.

Τάσσω οὖν τὸν $\beta^{\circ\nu}$ $\dot{M} \gamma$. ὁ γὰρ $\gamma^{\circ\sigma}$ ἐστὶν

$\Sigma \bar{a}$. ὁ ἄρα $a^{\circ\sigma}$ ἔσται $\dot{M} \gamma \Lambda \Sigma \bar{a}$.

Λοιπὸν δεῖ εἶναι τὸ ἐπίταγμα, ἔστω τὸν ὑπὸ $a^{\circ\nu}$ καὶ $\beta^{\circ\nu}$, προσλαβόντα τὸν $\gamma^{\circ\nu}$, ποιεῖν $\square^{\circ\nu}$, καὶ λείψαντα τὸν $\gamma^{\circ\nu}$, ποιεῖν $\square^{\circ\sigma}$. ἀλλ' ὁ ὑπὸ $a^{\circ\nu}$ καὶ $\beta^{\circ\nu}$, προσλαβὼν τὸν $\gamma^{\circ\nu}$, ποιεῖ $\dot{M} \xi^{\theta} \Lambda \Sigma w'$ ἴσ. $\square^{\circ\varphi}$.

Λ δὲ τοῦ $\gamma^{\circ\nu}$, ποιεῖ $\dot{M} \xi^{\theta} \Lambda \Sigma \beta w'$ ἴσ. $\square^{\circ\varphi}$. καὶ

ALGEBRA : DIOPHANTUS

of the coefficients of x is not the ratio of a square to a square.

But the coefficient 1 of x is $2-1$ and the coefficient 3 of x likewise is $2+1$; therefore my problem resolves itself into finding a number to take the place of 2 such that (the number +1) bears to (the number -1) the same ratio as a square to a square.

Let the number sought be y ; then (the number +1) = $y+1$, and (the number -1) = $y-1$. We require these to have the ratio of a square to a square, say 4:1. Now $(y-1) \cdot 4 = 4y-4$ and $(y+1) \cdot 1 = y+1$. And these are the numbers having the ratio of a square to a square. Now I put

$$4y - 4 = y + 1,$$

giving
$$y = \frac{5}{3}.$$

Therefore I make the second part $\frac{5}{3}$, for the third = x ; and therefore the first = $\frac{13}{3} - x$.

There remains the condition, that the product of the first and second \pm the third = a square. But the product of the first and second + the third =

$$\frac{65}{9} - \frac{2}{3}x = \text{a square,}$$

and the product of the first and second - the third =

$$\frac{65}{9} - 2\frac{2}{3}x = \text{a square.}$$

¹ αὐτοῦ . . . πρὸς add. Bachet.

² γίνονται 3 ā M ā add. Tannery.

GREEK MATHEMATICS

πάντα ἐπὶ τὸν θ , καὶ γίνονται $\overset{\circ}{M} \overline{\xi \epsilon} \Lambda \overline{\varsigma \bar{\epsilon}}$ ἴσ. \square^{ψ} ,
καὶ $\overset{\circ}{M} \overline{\xi \epsilon} \Lambda \overline{\varsigma \kappa \delta}$ ἴσ. \square^{ψ} . καὶ ἐξιῶ, τοὺς ς τῆς
μείζονος ἰσότητος ποιήσας $\delta^{\kappa\iota\varsigma}$, καὶ ἔστι

$\overset{\circ}{M} \overline{\sigma \xi} \Lambda \overline{\varsigma \kappa \delta}$ ἴσ. \square^{ψ} καὶ $\overset{\circ}{M} \overline{\xi \epsilon} \Lambda \overline{\varsigma \kappa \delta}$ ἴσ. \square^{ψ} .

Νῦν τούτων λαμβάνω τὴν ὑπεροχὴν καὶ ἔστι
 $\overset{\circ}{M} \overline{\rho \zeta \epsilon}$ · καὶ ἐκτίθεμαι δύο ἀριθμοὺς ὧν τὸ ὑπὸ ἔστι
 $\overset{\circ}{M} \overline{\rho \zeta \epsilon}$, καὶ εἰσι $\tau\bar{\epsilon}$ καὶ $\iota\bar{\gamma}$ · καὶ τῆς τούτων ὑπεροχῆς
τὸ \angle' ἐφ' ἑαυτὸ ἴσον ἐστὶ τῶ ἐλάσσονι \square^{ψ} , καὶ
γίνεται ὁ ς $\gamma^{\omega\nu}$ η .

Ἐπὶ τὰς ὑποστάσεις. ἔσται ὁ μὲν $\alpha^{\circ\varsigma}$ $\bar{\epsilon}$, ὁ δὲ
 $\beta^{\circ\varsigma}$ $\bar{\epsilon}$, ὁ δὲ $\gamma^{\circ\varsigma}$ $\bar{\eta}$. καὶ ἡ ἀπόδειξις φανερὰ.

- These are a pair of equations of the form

$$\begin{aligned} am^2x + a &= u^2, \\ an^2x + b &= v^2. \end{aligned}$$

Multiply by n^2 , m^2 respectively, getting, say

$$\begin{aligned} am^2n^2x + an^2 &= u'^2, \\ am^2n^2x + bm^2 &= v'^2. \end{aligned}$$

∴

$$an^2 - bm^2 = u'^2 - v'^2.$$

Let

$$an^2 - bm^2 = pq,$$

and put

$$\begin{aligned} u' + v' &= p, \\ u' - v' &= q; \end{aligned}$$

∴

$$u'^2 = \frac{1}{4}(p+q)^2, \quad v'^2 = \frac{1}{4}(p-q)^2,$$

and so

$$\begin{aligned} am^2n^2x + an^2 &= \frac{1}{4}(p+q)^2, \\ am^2n^2x + bm^2 &= \frac{1}{4}(p-q)^2; \end{aligned}$$

whence, from either,

$$x = \frac{\frac{1}{4}(p^2 + q^2) - \frac{1}{4}(an^2 + bm^2)}{am^2n^2}.$$

ALGEBRA : DIOPHANTUS

Multiply throughout by 9, getting

$$65 - 6x = \text{a square}$$

and

$$65 - 24x = \text{a square.}^a$$

Equating the coefficients of x by multiplying the first equation by 4, I get

$$260 - 24x = \text{a square}$$

and

$$65 - 24x = \text{a square}$$

Now I take their difference, which is 195, and split it into the two factors 15 and 13. Squaring the half of their difference, and equating the result to the lesser square, I get $x = \frac{8}{3}$.

Returning to the conditions—the first part will be $\frac{5}{3}$, the second $\frac{5}{3}$, and the third $\frac{8}{3}$. And the proof is obvious.

This is the procedure indicated by Diophantus. In his example,

$$p = 15, q = 13,$$

and

$$\left\{\frac{1}{2}(15 - 13)\right\}^2 = 65 - 24x,$$

whence

$$24x = 64, \text{ and } x = \frac{8}{3}$$

GREEK MATHEMATICS

(ii.) Indeterminate Equations of Higher Degree

Ibid. iv. 18, Dioph. ed. Tannery i. 226. 2-228. 5

Εὐρεῖν δύο ἀριθμούς, ὅπως ὁ ἀπὸ τοῦ πρώτου κύβος προσλαβὼν τὸν δεύτερον ποιῆ κύβον, ὁ δὲ ἀπὸ τοῦ δευτέρου τετράγωνος προσλαβὼν τὸν πρώτον ποιῆ τετράγωνον.

Τετάρχθω ὁ $a^{\circ s}$ $\varepsilon \bar{a}$. ὁ ἄρα $\beta^{\circ s}$ ἔσται $\overset{\circ}{M}$ κυβικαὶ $\eta \Lambda K^y \bar{a}$. καὶ γίνεται ὁ ἀπὸ τοῦ $a^{\circ n}$ κύβος, προσλαβὼν τὸν $\beta^{\circ n}$, κύβος.

Λοιπὸν ἔστι καὶ τὸν ἀπὸ τοῦ $\beta^{\circ n}$ $\square^{\circ n}$, προσλαβόντα τὸν $a^{\circ n}$, ποιεῖν $\square^{\circ n}$. ἀλλ' ὁ ἀπὸ τοῦ $\beta^{\circ n}$ $\square^{\circ s}$, προσλαβὼν τὸν $a^{\circ n}$, ποιεῖ $K^y K \bar{a} \varepsilon \bar{a} \overset{\circ}{M} \xi \delta \Lambda K^y \bar{\iota \varsigma}$. (ταῦτα ἴσα $\square^{\circ \psi}$ τῷ ἀπὸ π^{λ} $K^y \bar{a} \overset{\circ}{M} \eta$, τουτέστι $K^y K \bar{a} K^y \bar{\iota \varsigma} \overset{\circ}{M} \xi \delta$.)¹ καὶ κοινῶν προστιθεμένων τῶν λειπομένων καὶ ἀφαιρουμένων τῶν ὁμοίων ἀπὸ ὁμοίων, λοιποὶ $K^y \bar{\lambda \beta}$ ἴσοι $\varepsilon \bar{a}$. καὶ πάντα παρὰ ε . $\Delta^y \bar{\lambda \beta}$ ἴσοι $\overset{\circ}{M} \bar{a}$.

Καὶ ἔστιν ἡ $\overset{\circ}{M} \square^{\circ s}$, καὶ $\Delta^y \bar{\lambda \beta}$ εἰ ἦσαν $\square^{\circ s}$, λελυμένη ἄν μοι ἦν ἡ ἴσωσις. ἀλλ' αἱ $\Delta^y \bar{\lambda \beta}$ εἰσὶν ἐκ τῶν δις $K^y \bar{\iota \varsigma}$. οἱ δὲ $K^y \bar{\iota \varsigma}$ εἰσιν ὑπὸ τῶν δις $\overset{\circ}{M} \eta$

¹ ταῦτα . . . $\overset{\circ}{M} \xi \delta$ add. Bachet.

* As with equations of the second degree, these may be single or double. Single equations always take the form that an expression in x , of a degree not exceeding the sixth, is to be made equal to a square or cube. The general form is therefore

$$A_0x^6 + A_1x^5 + \dots + A_6 = y^2 \text{ or } y^3.$$

Diophantus solves a number of special cases of different degrees.

In double equations, one expression is made equal to a

ALGEBRA : DIOPHANTUS

(ii.) *Indeterminate Equations of Higher Degree* ^a

Ibid. iv. 18, Dioph. ed. Tannery i. 226. 2-228. 5

To find two numbers such that the cube of the first added to the second shall make a cube, and the square of the second added to the first shall make a square.

Let the first number be x . Then the second will be a cube number less x^3 , say $8 - x^3$. And the cube of the first, added to the second, makes a cube.

There remains the condition that the square on the second, added to the first, shall make a square. But the square on the second, added to the first, is $x^6 + x + 64 - 16x^3$. Let this be equal to $(x^3 + 8)^2$, that is to $x^6 + 16x^3 + 64$.^b Then, by adding or subtracting like terms,

$$32x^3 = x ;$$

and, after dividing by x ,

$$32x^2 = 1.$$

Now 1 is a square, and if $32x^2$ were a square, my equation would be soluble. But $32x^2$ is formed from $2 \cdot 16x^3$, and $16x^3$ is $(2 \cdot 8)(x^3)$, that is, it is formed

cube and the other to a square, but only a few simple cases are solved by Diophantus.

^b The general type of the equation is

$$x^6 - Ax^3 + Bx + c^2 = y^2.$$

Put $y = x^3 + c$, then

$$x^2 = \frac{B}{A + 2c},$$

and if the right-hand expression is a square, there is a rational solution.

In the case of the equation $x^6 - 16x^3 + x + 64 = y^2$ it is not a square, and Diophantus replaces the equation by another, $x^6 - 128x^3 + x + 4096 = y^2$, in which it is a square.

GREEK MATHEMATICS

καὶ τοῦ $K^y \bar{a}$, τουτέστι δις τῶν $\dot{M} \bar{\eta}$. ὥστε αἱ $\bar{\lambda} \bar{\beta} \Delta^y$ ἐκ $\delta^{κς}$ τῶν $\bar{\eta} \dot{M}$. γέγονεν οὖν μοι εὐρεῖν κύβον ὃς $\delta^{κς}$ γενόμενος ποιεῖ $\square^{ον}$.

*Ἐστω ὁ ζητούμενος $K^y \bar{a}$. οὗτος $\delta^{κς}$ γενόμενος ποιεῖ $K^y \delta$ ἴσ. $\square^φ$. ἔστω $\Delta^y \bar{\iota} \bar{\varsigma}$. καὶ γίνεται ὁ $\bar{\varsigma} \dot{M} \delta$. ἐπὶ τὰς ὑποστάσεις· ἔσται ὁ $K^y \dot{M} \bar{\xi} \bar{\delta}$.

Τάσσω ἄρα τὸν $\beta^{ον} \dot{M} \bar{\xi} \bar{\delta} \Lambda K^y \bar{a}$. καὶ λοιπὸν ἔστι τὸν ἀπὸ τοῦ $\beta^{ον} \square^{ον}$ προσλαβόντα τὸν $\alpha^{ον}$ ποιεῖν $\square^{ον}$. ἀλλὰ ὁ ἀπὸ τοῦ $\beta^{ον}$ προσλαβὼν τὸν $\alpha^{ον}$ ποιεῖ $K^y K \bar{a} \dot{M} \bar{\delta} \bar{\varsigma} \bar{\varsigma} \bar{\varsigma} \bar{a} \Lambda K^y \bar{\rho} \bar{\kappa} \bar{\eta}$ ἴσ. $\square^φ$ τῷ ἀπὸ $\pi^λ$. $K^y \bar{a} \dot{M} \bar{\xi} \bar{\delta}$. καὶ γίνεται ὁ $\square^{ος} K^y K \bar{a} \dot{M} \bar{\delta} \bar{\varsigma} \bar{\varsigma} K^y \bar{\rho} \bar{\kappa} \bar{\eta}$. καὶ γίνονται λοιποὶ $K^y \bar{\sigma} \bar{\nu} \bar{\varsigma}$ ἴσ. $\bar{\varsigma} \bar{a}$. καὶ γίνεται ὁ $\bar{\varsigma}$ ἐνὸς $\iota \varsigma^{ον}$.

Ἐπὶ τὰς ὑποστάσεις· ἔσται ὁ $\alpha^{ος}$ ἐνὸς $\iota \varsigma^{ον}$, ὁ δὲ $\beta^{ος} \begin{matrix} \delta \varsigma \varsigma \\ \kappa \varsigma \cdot \beta \rho \mu \gamma \cdot \end{matrix}$

(e) THEORY OF NUMBERS : SUMS OF SQUARES

Ibid. ii. 8, Dioph. ed. Tannery i. 90. 9-21

Τὸν ἐπιταχθέντα τετράγωνον διελεῖν εἰς δύο τετραγώνους.

* It was on this proposition that Fermat wrote a famous note: "On the other hand, it is impossible to separate a cube into two cubes, or a biquadrate into two biquadrates, or generally any power except a square into two powers with the same exponent. I have discovered a truly marvellous proof of this, which, however, the margin is not large enough

550

ALGEBRA : DIOPHANTUS

from 2 . 8. Therefore $32x^2$ is formed from 4 . 8. My problem therefore becomes to find a cube which, when multiplied by 4, makes a square.

Let the number sought be y^3 . Then $4y^3 =$ a square $= 16y^2$ say ; whence $y = 4$. Returning to the conditions—the cube will be 64.

I therefore take the second number as $64 - x^3$. There remains the condition that the square on the second added to the first shall make a square. But the square on the second added to the first =

$$\begin{aligned} x^6 + 4096 + x - 128x^3 &= \text{a square} \\ &= (x^3 + 64)^2, \text{ say,} \\ &= x^6 + 4096 + 128x^3. \end{aligned}$$

On taking away the common terms,

$$256x^3 = x,$$

and
$$x = \frac{1}{16}.$$

Returning to the conditions—

$$\text{first number} = \frac{1}{16}, \text{ second number} = \frac{262143}{4096}.$$

(e) THEORY OF NUMBERS : SUMS OF SQUARES

Ibid. ii. 8, Dioph. ed. Tannery i. 90. 9-21

To divide a given square number into two squares.^a

to contain." Fermat claimed, in other words, to have proved that $x^m + y^m = z^m$ cannot be solved in rational numbers if $m > 2$. Despite the efforts of many great mathematicians, a proof of this general theorem is still lacking.

Fermat's notes, which established the modern Theory of Numbers, were published in 1670 in Bachet's second edition of the works of Diophantus.

GREEK MATHEMATICS

Ἐπιτετάχθω δὴ τὸν $\overline{16}$ διελεῖν εἰς δύο τετραγώνους.

Καὶ τετάχθω ὁ a° $\Delta^{\gamma} \bar{a}$, ὁ ἄρα ἕτερος ἔσται $\overset{\circ}{M}\overline{16} \Lambda \Delta^{\gamma} \bar{a}$ δεήσει ἄρα $\overset{\circ}{M}\overline{16} \Lambda \Delta^{\gamma} \bar{a}$ ἴσας εἶναι \square° .

Πλάσσω τὸν \square° ἀπὸ ε^{ω} ὄσων δήποτε Λ τοσοῦτων $\overset{\circ}{M}$ ὄσων ἐστὶν ἢ τῶν $\overline{16}$ $\overset{\circ}{M}$ πλευρά· ἔστω $\varepsilon\beta\Lambda\overset{\circ}{M}\delta$. αὐτὸς ἄρα ὁ \square° ἔσται $\Delta^{\gamma} \delta \overset{\circ}{M}\overline{16} \Lambda \varepsilon\overline{16}$. ταῦτα ἴσα $\overset{\circ}{M}\overline{16} \Lambda \Delta^{\gamma} \bar{a}$. κοινῇ προσκείσθω ἢ λείψις καὶ ἀπὸ ὁμοίων ὁμοια.

Δ^{γ} ἄρα $\bar{\varepsilon}$ ἴσαι $\varepsilon\overline{16}$, καὶ γίνεται ὁ $\varepsilon\overline{16}$ πέμπτων.

Ἔσται ὁ μὲν $\overset{κε}{\varepsilon}$, ὁ δὲ $\overset{κε}{\beta}$, καὶ οἱ δύο συντε-

θέντες ποιούσι $\overset{κε}{\nu}$, ἦτοι $\overset{\circ}{M}\overline{16}$, καὶ ἔστιν ἑκάτερος τετράγωνος.

Ibid. v. 11, Dioph. ed. Tannery i. 342. 13-346. 12

Μονάδα διελεῖν εἰς τρεῖς ἀριθμούς καὶ προσθεῖναι ἐκάστῳ αὐτῶν πρότερον τὸν αὐτὸν δοθέντα καὶ ποιεῖν ἕκαστον τετράγωνον.

Δεῖ δὴ τὸν διδόμενον ἀριθμὸν μήτε δυνάδα εἶναι μήτε τινὰ τῶν ἀπὸ δυνάδος ὀκτάδι παραυξανομένων.

Ἐπιτετάχθω δὴ τὴν $\overset{\circ}{M}$ διελεῖν εἰς τρεῖς ἀριθμούς καὶ προσθεῖναι ἐκάστῳ $\overset{\circ}{M}\bar{\gamma}$ καὶ ποιεῖν ἕκαστον \square° .

* Lit. "I take the square from any number of ἀριθμοὶ minus as many units as there are in the side of 16."

^b i.e., a number of the form $3(8n+2)+1$ or $24n+7$ cannot be the sum of three squares. In fact, a number of the form $8n+7$ cannot be the sum of three squares, but there are other

ALGEBRA : DIOPHANTUS

Let it be required to divide 16 into two squares.

And let the first square $= x^2$; then the other will be $16 - x^2$; it shall be required therefore to make

$$16 - x^2 = \text{a square.}$$

I take a square of the form $a (mx - 4)^2$, m being any integer and 4 the root of 16; for example, let the side be $2x - 4$, and the square itself $4x^2 + 16 - 16x$. Then

$$4x^2 + 16 - 16x = 16 - x^2.$$

Add to both sides the negative terms and take like from like. Then

$$5x^2 = 16x,$$

and
$$x = \frac{16}{5}.$$

One number will therefore be $\frac{256}{25}$, the other $\frac{144}{25}$, and their sum is $\frac{400}{25}$ or 16, and each is a square.

Ibid. v. 11, Dioph. ed. Tannery i. 342. 13-346. 12

To divide unity into three parts such that, if we add the same number to each of the parts, the results shall all be squares.

It is necessary that the given number be neither 2 nor any multiple of 8 increased by 2.^b

Let it be required to divide unity into three parts such that, when 3 is added to each, the results shall all be squares.

numbers not of this form which also are not the sum of three squares. Fermat showed that, if $3a + 1$ is the sum of three squares, then it cannot be of the form $4^n(24k + 7)$ or $4^n(8k + 7)$, where $k = 0$ or any integer.

GREEK MATHEMATICS

Πάλιν δεῖ τὸν $\bar{\iota}$ διελεῖν εἰς τρεῖς \square^{ous} ὅπως ἕκαστος αὐτῶν μείζων ἢ $\dot{M}\bar{\gamma}$. ἔαν οὖν πάλιν τὸν $\bar{\iota}$ διέλωμεν εἰς τρεῖς \square^{ous} , τῇ τῆς παρισότητος ἀγωγῇ, ἔσται ἕκαστος αὐτῶν μείζων τριάδος καὶ δυνασόμεθα, ἀφ' ἑκάστου αὐτῶν ἀφελόντες $\dot{M}\bar{\gamma}$, ἔχειν εἰς οὓς ἢ \dot{M} διαιρεῖται.

Λαμβάνομεν ἄρτι τοῦ $\bar{\iota}$ τὸ γ^{ov} , γί. $\bar{\gamma}\gamma^x$, καὶ ζητοῦμεν τί προστιθέντες μόριον τετραγωνικὸν ταῖς $\dot{M}\bar{\gamma}\gamma^x$, ποιήσομεν \square^{ov} πάντα θκ^{is}. δεῖ καὶ τῷ $\bar{\lambda}$ προσθεῖναι τι μόριον τετραγωνικὸν καὶ ποιεῖν τὸν ὅλον \square^{ov} .

*Ἐστω τὸ προστιθέμενον μόριον $\Delta^y x \bar{a}$ καὶ πάντα ἐπὶ Δ^y γίνονται $\Delta^y \bar{\lambda} \dot{M} \bar{a}$ ἴσ. \square^{ov} . τῷ ἀπὸ πλευρᾶς $\xi \bar{e} \dot{M} \bar{a}$ γίνεται ὁ $\square^{os} \Delta^y \kappa \bar{e} \xi \dot{M} \bar{a}$ ἴσ. $\Delta^y \bar{\lambda} \dot{M} \bar{a}$. ὅθεν ὁ $\xi \dot{M} \bar{\beta}$, ἢ $\Delta^y \dot{M} \delta$, τὸ $\Delta^y x \dot{M} \delta^x$.

Εἰ οὖν ταῖς $\dot{M} \bar{\lambda}$ προστίθεται $\dot{M} \delta^x$, ταῖς $\dot{M} \bar{\gamma} \gamma^x$ προστεθήσεται $\lambda \delta^x$ καὶ γίνεται $\lambda \delta^x$. δεῖ οὖν τὸν $\bar{\iota}$ διελεῖν εἰς τρεῖς \square^{ous} ὅπως ἑκάστου \square^{ov} ἢ πλευρὰ πάρισος ἢ $\dot{M} \frac{5}{ia}$.

Ἄλλὰ καὶ ὁ $\bar{\iota}$ σύγκειται ἐκ δύο \square^{ov} , τοῦ τε θ καὶ τῆς \dot{M} . διαιροῦμεν τὴν \dot{M} εἰς δύο \square^{ous} τὰ τε $\kappa \bar{e} \theta$ καὶ τὰ $\kappa \bar{e} \iota \varsigma$, ὥστε τὸν $\bar{\iota}$ συγκεῖσθαι ἐκ τριῶν \square^{ov} ,

* The method has been explained in v. 19, where it is proposed to divide 13 into two squares each > 6. It will be sufficiently obvious from this example. The method is also used in v. 10, 12, 13, 14.

ALGEBRA : DIOPHANTUS

Then it is required to divide 10 into three squares such that each of them > 3 . If then we divide 10 into three squares, according to the method of approximation,^a each of them will be > 3 and, by taking 3 from each, we shall be able to obtain the parts into which unity is to be divided.

We take, therefore, the third part of 10, which is $3\frac{1}{3}$, and try by adding some square part to $3\frac{1}{3}$ to make a square. On multiplying throughout by 9, it is required to add to 30 some square part which will make the whole a square.

Let the added part be $\frac{1}{x^2}$; multiply throughout by x^2 ; then

$$30x^2 + 1 = \text{a square.}$$

Let the root be $5x + 1$; then, squaring,

$$25x^2 + 10x + 1 = 30x^2 + 1;$$

whence

$$x = 2, x^2 = 4, \frac{1}{x^2} = \frac{1}{4}.$$

If, then, to 30 there be added $\frac{1}{4}$, to $3\frac{1}{3}$ there is added $\frac{1}{36}$, and the result is $\frac{121}{36}$. It is therefore required to divide 10 into three squares such that the side of each shall approximate to $\frac{11}{6}$.

But 10 is composed of two squares, 9 and 1. We divide 1 into two squares, $\frac{9}{25}$ and $\frac{16}{25}$, so that 10 is composed of three squares, $9, \frac{9}{25}$ and $\frac{16}{25}$. It is there-

GREEK MATHEMATICS

ἐκ τε τοῦ $\bar{\theta}$ καὶ τοῦ $\frac{\kappa\epsilon}{\iota\varsigma}$ καὶ τοῦ $\frac{\kappa\epsilon}{\theta}$. δεῖ οὖν ἐκάστην τῶν π^{λ} · τούτων παρασκευάσαι πάρισον $\frac{5}{\iota\alpha}$ ·

Ἄλλὰ καὶ αἱ π^{λ} · αὐτῶν εἰσιν $\overset{\circ}{M}\bar{\gamma}$ καὶ $\overset{\circ}{M}\frac{\epsilon}{\delta}$ καὶ $\overset{\circ}{M}\frac{\epsilon}{\gamma}$ · καὶ πάντα $\lambda^{\kappa\iota\varsigma}$ · καὶ γίνονται $\overset{\circ}{M}\bar{\zeta}$ καὶ $\overset{\circ}{M}\bar{\kappa\delta}$ καὶ $\overset{\circ}{M}\bar{\iota\eta}$. τὰ δὲ $\bar{\iota\alpha}$ ς^{α} γίνονται $\overset{\circ}{M}\bar{\nu\epsilon}$ · δεῖ οὖν ἐκάστην π^{λ} · κατασκευάσαι $\bar{\nu\epsilon}$.

Πλάσσομεν ἑνὸς πλευρὰν $\overset{\circ}{M}\bar{\gamma}\Lambda\bar{\varsigma}\bar{\lambda\epsilon}$, ἑτέρου δὴ $\bar{\varsigma}\bar{\lambda\alpha}\overset{\circ}{M}\bar{\delta}\epsilon^{\omega\nu}$, τοῦ δὲ ἑτέρου $\bar{\varsigma}\bar{\lambda\zeta}\overset{\circ}{M}\bar{\gamma}\epsilon^{\omega\nu}$. γίνονται οἱ ἀπὸ τῶν εἰρημένων $\square^{\circ\iota}$, Δ^{γ} , $\overline{\gamma\phi\nu\epsilon}\overset{\circ}{M}\bar{\iota}\Lambda\bar{\varsigma}\bar{\rho\iota\varsigma}$ · ταῦτα ἴσα $\overset{\circ}{M}\bar{\iota}$. ὅθεν εὐρίσκεται ὁ $\bar{\varsigma}\overline{\gamma\phi\nu\epsilon}$.

Ἐπὶ τὰς ὑποστάσεις· καὶ γίνονται αἱ πλευραὶ τῶν τετραγώνων δοθεῖσαι, ὥστε καὶ αὐτοί. τὰ λοιπὰ δῆλα.

Ibid. iv. 29, Dioph. ed. Tannery i. 258. 19–260. 16

Εὐρεῖν τέσσαρας ἀριθμοὺς (τετραγώνους), οἱ συντεθέντες καὶ προσλαβόντες τὰς ἰδίας πλευρὰς συντεθείσας ποιῶσι δοθέντα ἀριθμόν.

• The sides are, in fact, $\frac{1321}{711}$, $\frac{1288}{711}$, $\frac{1285}{711}$, and the squares are $\frac{1745041}{505521}$, $\frac{1658944}{505521}$, $\frac{1651225}{505521}$.

ALGEBRA : DIOPHANTUS

fore required to make each of the sides approximate to $\frac{11}{6}$.

But their sides are $3, \frac{4}{5}$ and $\frac{3}{5}$. Multiply throughout by 30, getting 90, 24 and 18; and $\frac{11}{6}$ [when multiplied by 30] becomes 55. It is therefore required to make each side approximate to 55.

[Now $3 > \frac{55}{30}$ by $\frac{35}{30}$, $\frac{4}{5} < \frac{55}{30}$ by $\frac{31}{30}$, and $\frac{3}{5} < \frac{55}{30}$ by $\frac{37}{30}$.

If, then, we took the sides of the squares as $3 - \frac{35}{30}$,

$\frac{4}{5} + \frac{31}{30}$, $\frac{3}{5} + \frac{37}{30}$, the sum of the squares would be $3 \cdot (\frac{11}{6})^2$

or $\frac{363}{36}$, which > 10 .

Therefore] we take the side of the first square as $3 - 35x$, of the second as $\frac{4}{5} + 31x$, and of the third as

$\frac{3}{5} + 37x$. The sum of the aforesaid squares

$$3555x^2 + 10 - 116x = 10;$$

whence
$$x = \frac{116}{3555}.$$

Returning to the conditions—as the sides of the squares are given, the squares themselves are also given. The rest is obvious.^a

Ibid. iv. 29, Dioph. ed. Tannery i. 258. 19-260. 16

To find four square numbers such that their sum added to the sum of their sides shall make a given number.

GREEK MATHEMATICS

Ἐστω δὴ τὸν $\bar{\iota}\beta$.

Ἐπεὶ πᾶς $\square^{\circ\sigma}$ προσλαβὼν τὴν ἰδίαν π^{λ} καὶ $\overset{\circ}{M}\delta^{\times}$, ποιεῖ $\square^{\circ\nu}$, οὗ ἢ $\pi^{\lambda} \cdot \Lambda \overset{\circ}{M} \angle'$ ποιεῖ ἀριθμόν τινα, ὅς ἐστι τοῦ ἐξ ἀρχῆς $\square^{\circ\nu}$ πλευρά, οἱ τέσσαρες ἀριθμοὶ ἄρα, προσλαβόντες μὲν τὰς ἰδίας π^{λ} ποιούσι $\overset{\circ}{M}\bar{\iota}\beta$, προσλαβόντες δὲ καὶ $\delta\delta^{\alpha}$, ποιούσι τέσσαρας $\square^{\circ\sigma\sigma}$. εἰσὶ δὲ καὶ αἱ $\overset{\circ}{M}\bar{\iota}\beta$ μετὰ $\delta\delta^{\omega\nu}$, ὅ ἐστι $\overset{\circ}{M}\bar{\alpha}$, $\overset{\circ}{M}\bar{\iota}\gamma$. τὰς $\bar{\iota}\gamma$ ἄρα $\overset{\circ}{M}$ διαιρεῖν δεῖ εἰς τέσσαρας $\square^{\circ\sigma\sigma}$, καὶ ἀπὸ τῶν πλευρῶν, ἀφελὼν ἀπὸ ἐκάστης $\pi^{\lambda} \cdot \overset{\circ}{M} \angle'$, ἔξω τῶν $\delta \square^{\circ\omega\nu}$ τὰς π^{λ} .

Διαιρεῖται δὲ ὁ $\bar{\iota}\gamma$ εἰς δύο $\square^{\circ\sigma\sigma}$, τὸν τε δ καὶ θ . καὶ πάλιν ἑκάτερος τούτων διαιρεῖται εἰς δύο $\square^{\circ\sigma\sigma}$, εἰς $\frac{\kappa\epsilon}{\xi\delta}$ καὶ $\frac{\kappa\epsilon}{\lambda\varsigma}$, καὶ $\frac{\kappa\epsilon}{\rho\mu\delta}$ καὶ $\frac{\kappa\epsilon}{\pi\alpha}$. λαβὼν τοίνυν ἐκάστου τὴν πλευράν, ϵ , ϵ , ϵ , ϵ , καὶ αἶρω ἀπὸ ἐκάστου τούτων πλευρᾶς $\overset{\circ}{M} \angle'$, καὶ ἔσονται αἱ π^{λ} τῶν ζητουμένων $\square^{\circ\omega\nu}$, $\overset{\iota}{\iota\alpha}$, $\overset{\iota}{\iota\zeta}$, $\overset{\iota}{\iota\theta}$, $\overset{\iota}{\iota\gamma}$. αὐτοὶ ἄρα οἱ $\square^{\circ\sigma}$, ὅς μὲν $\frac{\rho}{\rho\kappa\alpha}$, ὅς δὲ $\frac{\rho}{\mu\theta}$, ὅς δὲ $\frac{\rho}{\tau\xi\alpha}$, ὅς δὲ $\frac{\rho}{\rho\xi\theta}$.

ALGEBRA : DIOPHANTUS

Let it be 12.

Since any square added to its own side and $\frac{1}{4}$ makes a square, whose side *minus* $\frac{1}{2}$ is the number which is the side of the original square,^a and the four numbers added to their own sides make 12, then if we add $4 \cdot \frac{1}{4}$ they will make four squares. But

$$12 + 4 \cdot \frac{1}{4} \text{ (or } 1) = 13.$$

Therefore it is required to divide 13 into four squares, and then, if I subtract $\frac{1}{2}$ from each of their sides, I shall have the sides of the four squares.

Now 13 may be divided into two squares, 4 and 9. And again, each of these may be divided into two squares, $\frac{64}{25}$ and $\frac{36}{25}$, and $\frac{144}{25}$ and $\frac{81}{25}$. I take the side of each $\frac{8}{5}$, $\frac{6}{5}$, $\frac{12}{5}$, $\frac{9}{5}$, and subtract half from each side, and the sides of the required squares will be

$$\frac{11}{10}, \frac{7}{10}, \frac{19}{10}, \frac{13}{10}.$$

The squares themselves are therefore respectively

$$\frac{121}{100}, \frac{49}{100}, \frac{361}{100}, \frac{169}{100}.$$

^a *i.e.*, $x^2 + x + \frac{1}{4} = (x + \frac{1}{2})^2$.

^b In iv. 30 and v. 14 it is also required to divide a number into four squares. As *every number is either a square or the sum of two, three or four squares* (a theorem stated by Fermat and proved by Lagrange), and a square can always be divided into two squares, it follows that any number can be divided into four squares. It is not known whether Diophantus was aware of this.

GREEK MATHEMATICS

(f) POLYGONAL NUMBERS

Dioph. *De polyg. num.*, Praef., Dioph. ed. Tannery
i. 450. 3-19

Ἐκαστος τῶν ἀπὸ τῆς τριάδος ἀριθμῶν ἀξο-
μένων μονάδι, πολύγωνός ἐστι πρῶτος¹ ἀπὸ τῆς
μονάδος, καὶ ἔχει γωνίας τοσαύτας ὅσον ἐστὶν τὸ
πλήθος τῶν ἐν αὐτῷ μονάδων· πλευρά τε αὐτοῦ
ἐστὶν ὁ ἐξῆς τῆς μονάδος ἀριθμός, ὁ β. ἔσται δὲ
ὁ μὲν γ τρίγωνος, ὁ δὲ δ τετράγωνος, ὁ δὲ ε
πεντάγωνος, καὶ τοῦτο ἐξῆς.

Τῶν δὴ τετραγώνων προδήλων ὄντων ὅτι καθ-
εστήκασι τετράγωνοι διὰ τὸ γεγονέναι αὐτοὺς ἐξ
ἀριθμοῦ τινος ἐφ' ἑαυτὸν πολλαπλασιασθέντος,
ἐδοκιμάσθη ἕκαστον τῶν πολυγώνων, πολυπλασια-
ζόμενον ἐπὶ τινὰ ἀριθμὸν κατὰ τὴν ἀναλογίαν τοῦ
πλήθους τῶν γωνιῶν αὐτοῦ, καὶ προσλαβόντα
τετράγωνόν τινὰ πάλιν κατὰ τὴν ἀναλογίαν τοῦ
πλήθους τῶν γωνιῶν αὐτῶν, φαίνεσθαι τετρά-
γωνον· ὃ δὴ παραστήσομεν ὑποδείξαντες πῶς ἀπὸ
δοθείσης πλευρᾶς ὁ ἐπιταχθεὶς πολύγωνος εὐρί-
σκεται, καὶ πῶς δοθέντι πολυγώνῳ ἡ πλευρὰ
λαμβάνεται.

¹ πρῶτος Bachet, πρῶτον codd.

^a A fragment of the tract *On Polygonal Numbers* is the only work by Diophantus to have survived with the *Arithmetica*. The main fact established in it is that stated in Hypsicles' definition, that the *a*-gonal number of side *n* is

ALGEBRA : DIOPHANTUS

(f) POLYGONAL NUMBERS ^a

Diophantus, *On Polygonal Numbers*, Preface, Dioph.
ed. Tannery i. 450. 3-19

From 3 onwards, every member of the series of natural numbers increasing by unity is the first (after unity) of a particular species of polygon, and it has as many angles as there are units in it; its side is the number next in order after the unit, that is, 2. Thus 3 will be a triangle, 4 a square, 5 a pentagon, and so on in order.^b

In the case of squares, it is clear that they are squares because they are formed by the multiplication of a number into itself. Similarly it was thought that any polygon, when multiplied by a certain number depending on the number of its angles, with the addition of a certain square also depending on the number of its angles, would also be a square. This we shall establish, showing how any assigned polygonal number may be found from a given side, and how the side may be calculated from a given polygonal number.

$\frac{1}{2}n\{2 + (n - 1)(a - 2)\}$ (*v. supra*, p. 396 n. a, and vol. i. p. 98 n. a). The method of proof contrasts with that of the *Arithmetica* in being geometrical. For polygonal numbers, *v.* vol. i. pp. 86-99.

^b The meaning is explained in vol. i. p. 86 n. a, especially in the diagram on p. 89. In the example there given, 5 is the first (after unity) of the series of pentagonal numbers 1, 5, 12, 22 . . . It has 5 angles, and each side joins 2 units.

1.
2.
3.
4.
5.
6.
7.
8.
9.
10.
11.
12.
13.
14.
15.
16.
17.
18.
19.
20.
21.
22.
23.
24.
25.
26.
27.
28.
29.
30.
31.
32.
33.
34.
35.
36.
37.
38.
39.
40.
41.
42.
43.
44.
45.
46.
47.
48.
49.
50.
51.
52.
53.
54.
55.
56.
57.
58.
59.
60.
61.
62.
63.
64.
65.
66.
67.
68.
69.
70.
71.
72.
73.
74.
75.
76.
77.
78.
79.
80.
81.
82.
83.
84.
85.
86.
87.
88.
89.
90.
91.
92.
93.
94.
95.
96.
97.
98.
99.
100.

XXIV. REVIVAL OF GEOMETRY :
PAPPUS OF ALEXANDRIA

XXIV. REVIVAL OF GEOMETRY: PAPPUS OF ALEXANDRIA

(a) GENERAL

Suidas, *s.v.* Πάππος

Πάππος, Ἀλεξανδρεὺς, φιλόσοφος, γεγονὼς κατὰ τὸν πρεσβύτερον Θεοδοσίον τὸν βασιλέα, ὅτε καὶ Θέων ὁ φιλόσοφος ἤκμαζεν, ὁ γράψας εἰς τὸν Πτολεμαίον Κανόνα. βιβλία δὲ αὐτοῦ Χωρογραφία οἰκουμενική, Εἰς τὰ δὲ βιβλία τῆς Πτολεμαίου

* Theodosius I reigned from A.D. 379 to 395, but Suidas may have made a mistake over the date. A marginal note opposite the entry *Diocletian* in a Leyden ms. of chronological tables by Theon of Alexandria says, "In his time Pappus wrote"; Diocletian reigned from A.D. 284 to 305. In Rome's edition of Pappus's commentary on Ptolemy's *Syntaxis* (*Studi e Testi*, liv. pp. x-xiii), a cogent argument is given for believing that Pappus actually wrote his *Collection* about A.D. 320.

Suidas obviously had a most imperfect knowledge of Pappus, as he does not mention his greatest work, the *Synagoge* or *Collection*. It is a handbook to the whole of Greek geometry, and is now our sole source for much of the history of that science. The first book and half of the second are missing. The remainder of the second book gives an account of Apollonius's method of working with large numbers (*v. supra*, pp. 352-357). The nature of the remaining books to the eighth will be indicated by the passages here cited. There is some evidence (*v. infra*, p. 607 n. a) that the work was originally in twelve books.

The edition of the *Collection* with ancillary material published in three volumes by Friedrich Hultsch (Berlin, 1876-564

XXIV. REVIVAL OF GEOMETRY; PAPPUS OF ALEXANDRIA

(a) GENERAL

Suidas, *s.v.* *Pappus*

PAPPUS, an Alexandrian, a philosopher, born in the time of the Emperor Theodosius I, when Theon the philosopher also flourished,^a who commented on Ptolemy's *Table*. His works include a *Universal Geography*, a *Commentary on the Four Books of*

1878) was a notable event in the revival of Greek mathematical studies. The editor's only major fault is one which he shares with his generation, a tendency to condemn on slender grounds passages as interpolated.

Pappus also wrote a commentary on Euclid's *Elements*; fragments on Book x. are believed to survive in Arabic (*v. vol. i. p. 456 n. a*). A commentary by Pappus on Euclid's *Data* is referred to in Marinus's commentary on that work. Pappus (*v. vol. i. p. 301*) himself refers to his commentary on the *Analemma* of Diodorus. The Arabic Fihrist says that he commented on Ptolemy's *Planisphaerium*.

The separate books of the *Collection* were divided by Pappus himself into numbered sections, generally preceded by a preface, and the editors have also divided the books into chapters. References to the *Collection* in the selections here given (*e.g.*, *Coll. iii. 11. 28*, ed. Hultsch 68. 17-70. 8) are first to the book, then to the number or preface in Pappus's division, then to the chapter in the editors' division, and finally to the page and line of Hultsch's edition. In the selections from Book vii. Pappus's own divisions are omitted as they are too complicated, but in the collection of lemmas the numbers of the propositions in Hultsch's edition are added as these are often cited.

GREEK MATHEMATICS

Μεγάλης συντάξεως ὑπόμνημα, Ποταμοὺς τοὺς ἐν Λιβύῃ, Ὀνειροκριτικά.

(b) PROBLEMS AND THEOREMS

Papp. Coll. iii., Praef. 1, ed. Hultsch 30. 3-32. 3

Οἱ τὰ ἐν γεωμετρίᾳ ζητούμενα βουλόμενοι τεχνικώτερον διακρίνειν, ὧ κράτιστε Πανδροσίον, πρόβλημα μὲν ἀξιούσι καλεῖν ἐφ' οὗ προβάλλεται τι ποιῆσαι καὶ κατασκευάσαι, θεώρημα δὲ ἐν ᾧ τινῶν ὑποκειμένων τὸ ἐπόμενον αὐτοῖς καὶ πάντως ἐπισυμβαῖνον θεωρεῖται, τῶν παλαιῶν τῶν μὲν προβλήματα πάντα, τῶν δὲ θεωρήματα εἶναι φασκόντων. ὁ μὲν οὖν τὸ θεώρημα προτείνων, συνιδὼν ὄντιν οὖν τρόπον, τὸ ἀκόλουθον τούτῳ ἀξιοῖ ζητεῖν καὶ οὐκ ἂν ἄλλως ὑγιῶς προτεῖνοι, ὁ δὲ τὸ πρόβλημα προτείνων [ἂν μὲν ἀμαθῆς ἦ καὶ παντάπασιν ἰδιώτης],¹ κἂν ἀδύνατόν πως κατασκευασθῆναι προστάξῃ, σύγγνωστός ἐστιν καὶ ἀνυπεύθυνος. τοῦ γὰρ ζητούντος ἔργον καὶ τοῦτο διορίσαι, τό τε δυνατόν καὶ τὸ ἀδύνατον, κἂν ἦ δυνατόν, πότε καὶ πῶς καὶ ποσαχῶς δυνατόν. ἐὰν δὲ προσποιούμενος ἦ τὰ μαθήματα πως ἀπείρως προβάλλων, οὐκ ἔστιν αἰτίας ἔξω. πρῶην γοῦν τινες τῶν τὰ μαθήματα προσποιουμένων εἰδέναί διὰ σοῦ τὰς τῶν προβλημάτων προτάσεις ἀμαθῶς ἡμῖν ὤρισαν. περὶ ὧν ἔδει καὶ τῶν

¹ ἂν . . . ἰδιώτης om. Hultsch.

* Suidas seems to be confusing Ptolemy's *Μαθηματικὴ τετράβιβλος σύνταξις* (*Tetrabiblos* or *Quadripartitum*) which was in four books but on which Pappus did not comment, with the *Μαθηματικὴ σύνταξις* (*Syntaxis* or *Almagest*), which was the subject of a commentary by Pappus but extended to 566

REVIVAL OF GEOMETRY : PAPPUS

Ptolemy's Great Collection,^a *The Rivers of Libya, On the Interpretation of Dreams.*

(b) PROBLEMS AND THEOREMS

Pappus, *Collection* iii., Preface 1, ed. Hultsch 30. 3-32. 3

Those who favour a more exact terminology in the subjects studied in geometry, most excellent Pandrosion, use the term *problem* to mean an inquiry in which it is proposed to do or to construct something, and the term *theorem* an inquiry in which the consequences and necessary implications of certain hypotheses are investigated, but among the ancients some described them all as problems, some as theorems. Therefore he who propounds a theorem, no matter how he has become aware of it, must set for investigation the conclusion inherent in the premises, and in no other way would he correctly propound the theorem; but he who propounds a problem, even though he may require us to construct something which is in some way impossible, is free from blame and criticism. For it is part of the investigator's task to determine the conditions under which a problem is possible and impossible, and, if possible, when, how and in how many ways it is possible. But when a man professing to know mathematics sets an investigation wrongly he is not free from censure. For example, some persons professing to have learnt mathematics from you lately gave me a wrong enunciation of problems. It is desirable that I should state some of the proofs of thirteen books. Pappus's commentary now survives only for Books v. and vi., which have been edited by A. Rome, *Studi e Testi*, liv., but it certainly covered the first six books and possibly all thirteen.

REVIVAL OF GEOMETRY : PAPPUS

these and of matters akin to them, for the benefit both of yourself and of other lovers of this science, in this third book of the *Collection*. Now the first of these problems was set wrongly by a person who was thought to be a great geometer. For, given two straight lines, he claimed to know how to find by plane methods two means in continuous proportion, and he even asked that I should look into the matter and comment on his construction, which is after this manner.^a

(c) THE THEORY OF MEANS

Ibid. iii. 11. 28, ed. Hultsch 68. 17-70. 8

The second of the problems was this :

A certain other [geometer] set the problem of exhibiting the three means in a semicircle. Describing a semicircle $AB\Gamma$, with centre E , and taking any point Δ on $A\Gamma$, and from it drawing ΔB perpendicular to EF , and joining EB , and from Δ drawing ΔZ perpendicular to it, he claimed simply that the three means had been set out in the semicircle, EF being the arithmetic mean, ΔB the geometric mean and BZ the harmonic mean.

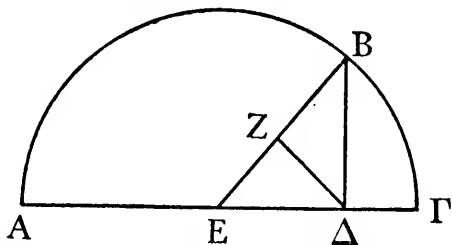

That $B\Delta$ is a mean between $A\Delta$, $\Delta\Gamma$ in geometrical

GREEK MATHEMATICS

τῆ γεωμετρικῇ ἀναλογίᾳ, ἣ δὲ ΕΓ τῶν ΑΔ, ΔΓ ἐν τῇ ἀριθμητικῇ μεσότητι, φανερόν. ἔστι γὰρ ὡς μὲν ἡ ΑΔ πρὸς ΔΒ, ἣ ΔΒ πρὸς ΔΓ, ὡς δὲ ἡ ΑΔ πρὸς ἑαυτὴν, οὕτως ἡ τῶν ΑΔ, ΑΕ ὑπεροχή, τουτέστιν ἡ τῶν ΑΔ, ΕΓ, πρὸς τὴν τῶν ΕΓ, ΓΔ. πῶς δὲ καὶ ἡ ΖΒ μέση ἐστὶν τῆς ἀρμονικῆς μεσότητος, ἢ ποίων εὐθειῶν, οὐκ εἶπεν, μόνον δὲ ὅτι τρίτη ἀνάλογόν ἐστὶν τῶν ΕΒ, ΒΔ, ἀγνοῶν ὅτι ἀπὸ τῶν ΕΒ, ΒΔ, ΒΖ ἐν τῇ γεωμετρικῇ ἀναλογίᾳ οὐσῶν πλάσσεται ἡ ἀρμονικὴ μεσότης. δειχθήσεται γὰρ ὑφ' ἡμῶν ὕστερον ὅτι δύο αἱ ΕΒ καὶ τρεῖς αἱ ΔΒ καὶ μία ἡ ΒΖ ὡς μία συντεθείσαι ποιούσι τὴν μείζονα ἄκραν τῆς ἀρμονικῆς μεσότητος, δύο δὲ αἱ ΒΔ καὶ μία ἡ ΒΖ τὴν μέσην, μία δὲ ἡ ΒΔ καὶ μία ἡ ΒΖ τὴν ἐλαχίστην.

(d) THE PARADOXES OF ERYCINUS

Ibid. iii. 24. 58, ed. Hultsch 104. 14-106. 9

Τὸ δὲ τρίτον τῶν προβλημάτων ἦν τόδε.

Ἔστω τρίγωνον ὀρθογώνιον τὸ ΑΒΓ ὀρθὴν

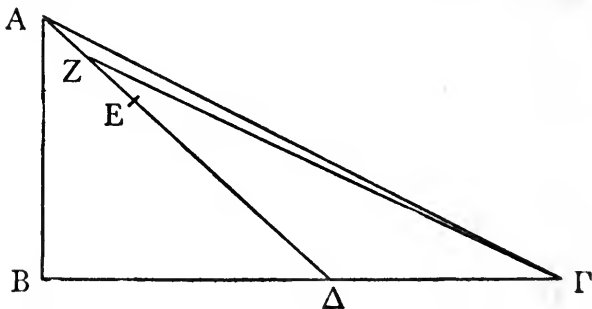

REVIVAL OF GEOMETRY : PAPPUS

proportion, and $E\Gamma$ between $A\Delta$, $\Delta\Gamma$ in arithmetical proportion, is clear. For

$$\begin{aligned} & A\Delta : \Delta B = \Delta B : \Delta\Gamma, \quad [\text{Eucl. iii. 31, vi. 8 Por.}] \\ \text{and} \quad & A\Delta : A\Delta = (A\Delta - AE) : (E\Gamma - \Gamma\Delta) \\ & = (A\Delta - E\Gamma) : (E\Gamma - \Gamma\Delta). \end{aligned}$$

But how ZB is a harmonic mean, or between what kind of lines, he did not say, but only that it is a third proportional to EB , $B\Delta$, not knowing that from EB , $B\Delta$, BZ , which are in geometrical proportion, the harmonic mean is formed. For it will be proved by me later that a harmonic proportion can thus be formed—

$$\begin{aligned} \text{greater extreme} &= 2EB + 3\Delta B + BZ, \\ \text{mean term} &= 2B\Delta + BZ, \\ \text{lesser extreme} &= B\Delta + BZ.^a \end{aligned}$$

(d) THE PARADOXES OF ERYCINUS

Ibid. iii. 24. 58, ed. Hultsch 104. 14–106. 9

The third of the problems was this :

Let $AB\Gamma$ be a right-angled triangle having the

* It is Pappus, in fact, who seems to have erred, for BZ is a harmonic mean between $A\Delta$, $\Delta\Gamma$, as can thus be proved :

Since $B\Delta E$ is a right-angled triangle in which ΔZ is perpendicular to BE ,

$$\begin{aligned} \therefore & BZ : B\Delta = B\Delta : BE, \\ \text{i.e.,} & BZ \cdot BE = B\Delta^2 = A\Delta \cdot \Delta\Gamma. \\ \text{But} & BE = \frac{1}{2}(A\Delta + \Delta\Gamma); \\ \therefore & BZ(A\Delta + \Delta\Gamma) = 2A\Delta \cdot \Delta\Gamma. \\ \therefore & A\Delta(BZ - \Delta\Gamma) = \Delta\Gamma(A\Delta - BZ), \\ \text{i.e.,} & A\Delta : \Delta\Gamma = (A\Delta - BZ) : (BZ - \Delta\Gamma), \end{aligned}$$

and $\therefore BZ$ is a harmonic mean between $A\Delta$, $\Delta\Gamma$.

The three means and the several extremes have thus been

GREEK MATHEMATICS

ἔχον τὴν Β γωνίαν, καὶ διήχθω τις ἡ ΑΔ, καὶ κείσθω τῇ ΑΒ ἴση ἡ ΔΕ, καὶ δίχα τμηθείσης τῆς ΕΑ κατὰ τὸ Ζ, καὶ ἐπιζευχθείσης τῆς ΖΓ δείξαι συναμφοτέρας τὰς ΔΖΓ δύο πλευρὰς ἐντὸς τοῦ τριγώνου μείζονας τῶν ἐκτὸς συναμφοτέρων τῶν ΒΑΓ πλευρῶν.

Καὶ ἔστι δῆλον. ἐπεὶ γὰρ αἱ ΓΖΑ, τουτέστιν αἱ ΓΖΕ, τῆς ΓΑ μείζονές εἰσιν, ἴση δὲ ἡ ΔΕ τῇ ΑΒ, αἱ ΓΖΔ ἄρα δύο τῶν ΓΑΒ μείζονές εἰσιν. . . .

Ἄλλ' ὅτι τοῦτο μὲν, ὅπως ἂν τις ἐθέλοι προτείνειν, ἀπειραχῶς δείκνυται δῆλον, οὐκ ἄκαιρον δὲ καθολικώτερον περὶ τῶν τοιούτων προβλημάτων διαλαβεῖν ἀπὸ τῶν φερομένων παραδόξων Ἐρυκίνου προτείνοντας οὕτως.

(e) THE REGULAR SOLIDS

Ibid. iii. 40. 75, ed. Hultsch 132. 1-11

Εἰς τὴν δοθείσαν σφαῖραν ἐγγράψαι τὰ πέντε πολύεδρα, προγράφεται δὲ τάδε.

Ἔστω ἐν σφαίρα κύκλος ὁ ΑΒΓ, οὗ διάμετρος ἡ ΑΓ καὶ κέντρον τὸ Δ, καὶ προκείσθω εἰς τὸν

represented by *five* straight lines (EB, BZ, AD, ΔΓ, ΒΔ). Pappus takes *six* lines to solve the problem. He proceeds to define the seven other means and to form all ten means as linear functions of three terms in geometrical progression (v. vol. i. pp. 124-129).

REVIVAL OF GEOMETRY : PAPPUS

angle B right, and let $A\Delta$ be drawn, and let ΔE be placed equal to AB , then if EA be bisected at Z , and $Z\Gamma$ be joined, to show that the sum of the two sides ΔZ , $Z\Gamma$ within the triangle, is greater than the sum of the two sides BA , $A\Gamma$ without the triangle.

And it is obvious. For

since	$\Gamma Z + ZA > \Gamma A$,	[Eucl. i. 20
<i>i.e.</i> ,	$\Gamma Z + ZE > \Gamma A$,	
while	$\Delta E = AB$,	
\therefore	$[\Gamma Z + ZE + E\Delta = \Gamma A + A$	
<i>i.e.</i> ,]	$\Gamma Z + Z\Delta > \Gamma A + AB. . . .$	

But it is clear that this type of proposition, according to the different ways in which one might wish to propound it, can take an infinite number of forms, and it is not out of place to discuss such problems more generally and [first] to propound this from the so-called paradoxes of Erycinus.^a

(e) THE REGULAR SOLIDS ^b

Ibid. iii. 40. 75, ed. Hultsch 132. 1-11

In order to inscribe the five polyhedra in a sphere, these things are premised.

Let ABI' be a circle in a sphere, with diameter $A\Gamma$ and centre Δ , and let it be proposed to insert in the

^a Nothing further is known of Erycinus. The propositions next investigated are more elaborate than the one just solved.

^b This is the fourth subject dealt with in *Coll.* iii. For the treatment of the subject by earlier geometers, v. vol. i. pp. 216-225, 466-479.

GREEK MATHEMATICS

κύκλον ἐμβαλεῖν εὐθείαν παράλληλον μὲν τῇ ΑΓ
 διαμέτρῳ, ἴσην δὲ τῇ δοθείσῃ μὴ μείζονι οὕσῃ τῆς
 ΑΓ διαμέτρου.

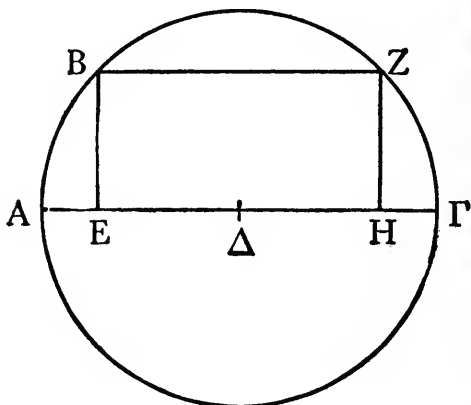

Κείσθω τῇ ἡμισείᾳ τῆς δοθείσης ἴση ἡ ΕΔ, καὶ
 τῇ ΑΓ διαμέτρῳ ἤχθω πρὸς ὀρθὰς ἡ ΕΒ, τῇ δὲ
 ΑΓ παράλληλος ἡ ΒΖ, ἥτις ἴση ἔσται τῇ δοθείσῃ·
 διπλῆ γάρ ἐστὶν τῆς ΕΔ, ἐπεὶ καὶ ἴση τῇ ΕΗ,
 παραλλήλου ἀχθείσης τῆς ΖΗ τῇ ΒΕ.

(f) EXTENSION OF PYTHAGORAS'S THEOREM

Ibid. iv. 1. 1, ed. Hultsch 176. 9-178. 13

Ἐὰν ᾗ τρίγωνον τὸ ΑΒΓ, καὶ ἀπὸ τῶν ΑΒ,
 ΒΓ ἀναγραφῇ τυχόντα παραλληλόγραμμα τὰ
 ΑΒΔΕ, ΒΓΖΗ, καὶ αἱ ΔΕ, ΖΗ ἐκβληθῶσιν
 ἐπὶ τὸ Θ, καὶ ἐπιζευχθῆ ἡ ΘΒ, γίνεται τὰ ΑΒΔΕ,
 574

REVIVAL OF GEOMETRY : PAPPUS

circle a chord parallel to the diameter AG and equal to a given straight line not greater than the diameter AG .

Let $E\Delta$ be placed equal to half of the given straight line, and let EB be drawn perpendicular to the diameter AG , and let BZ be drawn parallel to AG ; then shall this line be equal to the given straight line. For it is double of $E\Delta$, inasmuch as ZH , when drawn, is parallel to BE , and it is therefore equal to EH .^a

(f) EXTENSION OF PYTHAGORAS'S THEOREM

Ibid. iv. 1. 1, ed. Hultsch 176. 9-178. 13

If $AB\Gamma$ be a triangle, and on AB , $B\Gamma$ there be described any parallelograms $AB\Delta E$, $B\Gamma ZH$, and ΔE , ZH be produced to Θ , and ΘB be joined, then the

^a This lemma gives the key to Pappus's method of inscribing the regular solids, which is to find in the case of each solid certain parallel circular sections of the sphere. In the case of the cube, for example, he finds two equal and parallel circular sections, the square on whose diameter is two-thirds of the square on the diameter of the sphere. The squares inscribed in these circles are then opposite faces of the cube. In each case the method of analysis and synthesis is followed. The treatment is quite different from Euclid's.

GREEK MATHEMATICS

ΒΓΖΗ παραλληλόγραμμα ἴσα τῷ ὑπὸ τῶν ΑΓ,
 ΘΒ περιεχομένῳ παραλληλογράμμῳ ἐν γωνία ἧ
 ἐστὶν ἴση συναμφοτέρῳ τῇ ὑπὸ ΒΑΓ, ΔΘΒ.

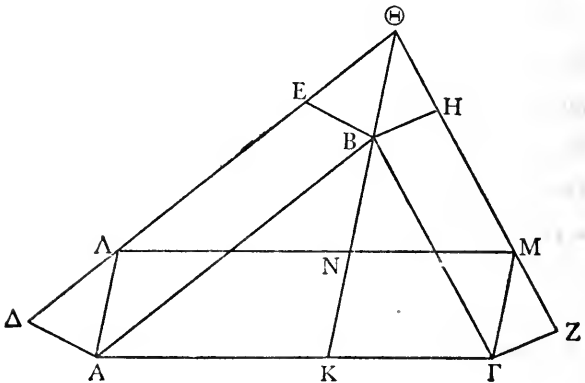

Ἐκβεβλήσθω γὰρ ἡ ΘΒ ἐπὶ τὸ Κ, καὶ διὰ τῶν
 Α, Γ τῇ ΘΚ παράλληλοι ἤχθωσαν αἱ ΑΛ, ΓΜ,
 καὶ ἐπέξεύχθω ἡ ΛΜ. ἐπεὶ παραλληλόγραμμόν
 ἐστὶν τὸ ΑΛΘΒ, αἱ ΑΛ, ΘΒ ἴσαι τέ εἰσιν καὶ
 παράλληλοι. ὁμοίως καὶ αἱ ΜΓ, ΘΒ ἴσαι τέ
 εἰσιν καὶ παράλληλοι, ὥστε καὶ αἱ ΛΑ, ΜΓ ἴσαι
 τέ εἰσιν καὶ παράλληλοι. καὶ αἱ ΛΜ, ΑΓ ἄρα
 ἴσαι τε καὶ παράλληλοί εἰσιν· παραλληλόγραμμον
 ἄρα ἐστὶν τὸ ΑΛΜΓ ἐν γωνία τῇ ὑπὸ ΛΑΓ, τουτ-
 ἐστὶν συναμφοτέρῳ τῇ τε ὑπὸ ΒΑΓ καὶ ὑπὸ
 ΔΘΒ· ἴση γάρ ἐστὶν ἡ ὑπὸ ΔΘΒ τῇ ὑπὸ ΛΑΒ.
 καὶ ἐπεὶ τὸ ΔΑΒΕ παραλληλόγραμμον τῷ ΛΑΒΘ
 ἴσον ἐστὶν (ἐπὶ τε γὰρ τῆς αὐτῆς βάσεώς ἐστιν

REVIVAL OF GEOMETRY : PAPPUS

parallelograms $AB\Delta E$, $B\Gamma ZH$ are together equal to the parallelogram contained by $\Lambda\Gamma$, ΘB in an angle which is equal to the sum of the angles $B\Lambda\Gamma$, $\Delta\Theta B$.

For let ΘB be produced to K , and through A , Γ let $\Lambda\Lambda$, ΓM be drawn parallel to ΘK , and let ΛM be joined. Since $\Lambda\Lambda\Theta B$ is a parallelogram, $\Lambda\Lambda$, ΘB are equal and parallel. Similarly $M\Gamma$, ΘB are equal and parallel, so that $\Lambda\Lambda$, $M\Gamma$ are equal and parallel. And therefore ΛM , $\Lambda\Gamma$ are equal and parallel; therefore $\Lambda\Lambda M\Gamma$ is a parallelogram in the angle $\Lambda\Lambda\Gamma$, that is an angle equal to the sum of the angles $B\Lambda\Gamma$ and $\Delta\Theta B$; for the angle $\Delta\Theta B = \text{angle } \Lambda\Lambda B$. And since the parallelogram ΔABE is equal to the parallelogram $\Lambda\Lambda B\Theta$ (for they are upon the same base AB and in the

GREEK MATHEMATICS

τῆς AB καὶ ἐν ταῖς αὐταῖς παραλλήλοις ταῖς AB , $\Delta\Theta$), ἀλλὰ τὸ $\Lambda B\Theta$ τῷ $\Lambda K\Lambda N$ ἴσον ἐστίν (ἐπὶ τε γὰρ τῆς αὐτῆς βάσεώς ἐστιν τῆς ΛA καὶ ἐν ταῖς αὐταῖς παραλλήλοις ταῖς ΛA , ΘK), καὶ τὸ $\Lambda \Delta E B$ ἄρα τῷ $\Lambda K\Lambda N$ ἴσον ἐστίν. διὰ τὰ αὐτὰ καὶ τὸ $B H Z \Gamma$ τῷ $N K \Gamma M$ ἴσον ἐστίν· τὰ ἄρα $\Delta A B E$, $B H Z \Gamma$ παραλληλόγραμμα τῷ $\Lambda A \Gamma M$ ἴσα ἐστίν, τουτέστιν τῷ ὑπὸ $A \Gamma$, ΘB ἐν γωνία τῇ ὑπὸ $\Lambda A \Gamma$, ἣ ἐστίν ἴση συναμφοτέραις ταῖς ὑπὸ $B A \Gamma$, $B \Theta \Delta$. καὶ ἔστι τοῦτο καθολικώτερον πολλῶ τοῦ ἐν τοῖς ὀρθογωνίοις ἐπὶ τῶν τετραγώνων ἐν τοῖς Στοιχείοις δεδειγμένον.

(g) CIRCLES INSCRIBED IN THE ἄρβηλος

Ibid. iv. 14. 19, ed. Hultsch 208. 9-21

Φέρεται ἐν τισιν ἀρχαία πρότασις τοιαύτη· ὑποκείσθω τρία ἡμικύκλια ἐφαπτόμενα ἀλλήλων

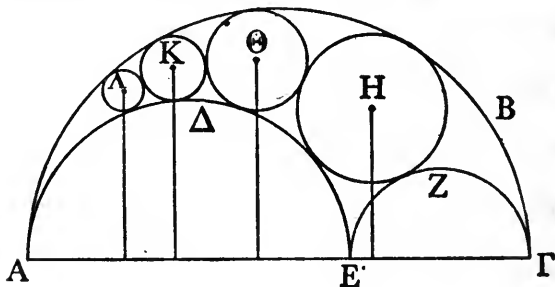

τὰ $AB\Gamma$, $A\Delta E$, $E Z \Gamma$, καὶ εἰς τὸ μεταξὺ τῶν περιφερειῶν αὐτῶν χωρίον, ὃ δὴ καλοῦσιν ἄρβηλον,
578

REVIVAL OF GEOMETRY : PAPPUS

same parallels $AB, \Delta\theta$), while $\Lambda AB\theta = \Lambda AKN$ (for they are upon the same base ΛA and in the same parallels $\Lambda A, \theta K$), therefore $\Lambda \Delta EB = \Lambda AKN$. By the same reasoning $BHZ\Gamma = NK\Gamma M$; therefore the parallelograms $\Delta ABE, BHZ\Gamma$ are together equal to $\Lambda A\Gamma M$, that is, to the parallelogram contained by $A\Gamma, \theta B$ in the angle $\Lambda A\Gamma$, which is equal to the sum of the angles $BA\Gamma, B\theta\Delta$. And this is much more general than the theorem proved in the *Elements* about the squares on right-angled triangles.*

(g) CIRCLES INSCRIBED IN THE ἄρβηλος

Ibid. iv. 14. 19, ed. Hultsch 208. 9-21

There is found in certain [books] an ancient proposition to this effect: Let $AB\Gamma, A\Delta E, E\zeta\Gamma$ be supposed to be three semicircles touching each other, and in the space between their circumferences, which

* Eucl. i. 47, v. vol. i. pp. 178-185. In the case taken by Pappus, the first two parallelograms are drawn outwards and the third, equal to their sum, is drawn inwards. If the areas of parallelograms drawn outwards be regarded as of opposite sign to the areas of those drawn inwards, the theorem may be still further generalized, for the algebraic sum of the three parallelograms is equal to zero.

ἐγγεγράφθωσαν κύκλοι ἐφαπτόμενοι τῶν τε ἡμι-
κυκλίων καὶ ἀλλήλων ὁσοιδηποτοῦν, ὡς οἱ περὶ
κέντρα τὰ Η, Θ, Κ, Λ· δεῖξαι τὴν μὲν ἀπὸ τοῦ Η
κέντρου κάθετον ἐπὶ τὴν ΑΓ ἴσην τῇ διαμέτρῳ
τοῦ περὶ τὸ Η κύκλου, τὴν δ' ἀπὸ τοῦ Θ κάθετον
διπλασίαν τῆς διαμέτρου τοῦ περὶ τὸ Θ κύκλου,
τὴν δ' ἀπὸ τοῦ Κ κάθετον τριπλασίαν, καὶ τὰς
ἐξῆς καθέτους τῶν οἰκείων διαμέτρων πολλα-
πλασίας κατὰ τοὺς ἐξῆς μονάδι ἀλλήλων ὑπερ-
έχοντας ἀριθμοὺς ἐπ' ἄπειρον γινομένης τῆς τῶν
κύκλων ἐγγραφῆς.

(h) SPIRAL ON A SPHERE

Ibid. iv. 35. 53-56, ed. Hultsch 264. 3-268. 21

Ὡσπερ ἐν ἐπιπέδῳ νοεῖται γινομένη τις ἕλιξ
φερομένου σημείου κατ' εὐθείας κύκλον περιγρα-
φούσης, καὶ ἐπὶ στερεῶν φερομένου σημείου κατὰ
μιάς πλευρᾶς τιν' ἐπιφάνειαν περιγραφούσης,
οὕτως δὴ καὶ ἐπὶ σφαίρας ἕλिका νοεῖν ἀκόλουθόν
ἐστι γραφομένην τὸν τρόπον τοῦτον.

Ἐστω ἐν σφαίρᾳ μέγιστος κύκλος ὁ ΚΛΜ περὶ
πόλον τὸ Θ σημείον, καὶ ἀπὸ τοῦ Θ μεγίστου

* Three propositions (Nos. 4, 5 and 6) about the figure known as the *ἄρβηλος* from its resemblance to a leather-worker's knife are contained in Archimedes' *Liber Assumptorum*, which has survived in Arabic. They are included as particular cases in Pappus's exposition, which is unfortunately too long for reproduction here. Professor D'Arcy W. Thompson (*The Classical Review*, lvi. (1942), pp. 75-76) gives reasons for thinking that the *ἄρβηλος* was a saddler's knife rather than a shoemaker's knife, as usually translated.

REVIVAL OF GEOMETRY : PAPPUS

is called the "leather-worker's knife," let there be inscribed any number whatever of circles touching both the semicircles and one another, as those about the centres H, Θ, K, Λ ; to prove that the perpendicular from the centre H to $A\Gamma$ is equal to the diameter of the circle about H , the perpendicular from Θ is double of the diameter of the circle about Θ , the perpendicular from K is triple, and the [remaining] perpendiculars in order are so many times the diameters of the proper circles according to the numbers in a series increasing by unity, the inscription of the circles proceeding without limit.^a

(h) SPIRAL ON A SPHERE ^b

Ibid. iv. 35. 53-56, ed. Hultsch 264. 3-268. 21

Just as in a plane a spiral is conceived to be generated by the motion of a point along a straight line revolving in a circle, and in solids [, such as the cylinder or cone,]^c by the motion of a point along one straight line describing a certain surface, so also a corresponding spiral can be conceived as described on the sphere after this manner.

Let KAM be a great circle in a sphere with pole Θ , and from Θ let the quadrant of a great circle ΘNK be

^b After leaving the $\alpha\rho\beta\eta\lambda\omicron\varsigma$, Pappus devotes the remainder of Book iv. to solutions of the problems of doubling the cube, squaring the circle and trisecting an angle. This part has been frequently cited already (*v.* vol. i. pp. 298-309, 336-363). His treatment of the spiral is noteworthy because his method of proof is often markedly different from that of Archimedes; and in the course of it he makes this interesting digression.

^c Some such addition is necessary, as Commandinus, Chasles and Hultsch realized.

REVIVAL OF GEOMETRY : PAPPUS

described, and, Θ remaining stationary, let the arc ΘNK revolve about the surface in the direction Λ, M

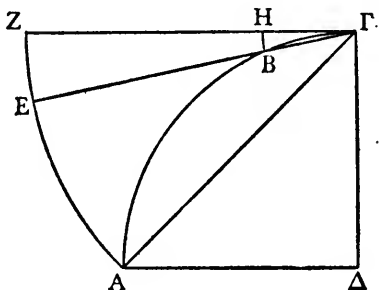

and again return to the same place, and [in the same time] let a point on it move from Θ to K ; then it will describe on the surface a certain spiral, such as ΘOIK , and if any arc of a great circle be drawn from Θ [cutting the circle KAM first in Λ and the spiral first in O], its circumference^a will bear to the arc $K\Lambda$ the same ratio as $\Lambda\Theta$ bears to ΘO . I say then that if a quadrant $AB\Gamma$ of a great circle in the sphere be set out about centre Δ , and ΓA be joined, the surface of the hemisphere will bear to the portion of the surface intercepted between the spiral ΘOIK and the arc $KN\Theta$ the same ratio as the sector $AB\Gamma\Delta$ bears to the segment $AB\Gamma$.

For let ΓZ be drawn to touch the circumference, and with centre Γ let there be described through A the arc AEZ ; then the sector $AB\Gamma\Delta$ is equal to the

^a Or, of course, the circumference of the circle KAM to which it is equal.

GREEK MATHEMATICS

ΑΕΖΓ (διπλασία μὲν γὰρ ἢ πρὸς τῷ Δ γωνία τῆς ὑπὸ ΑΓΖ, ἥμισυ δὲ τὸ ἀπὸ ΔΑ τοῦ ἀπὸ ΑΓ). ὅτι ἄρα καὶ ὡς αἱ εἰρημέναι ἐπιφάνειαι πρὸς ἀλλήλας, οὕτως ὁ ΑΕΖΓ τομεὺς πρὸς τὸ ΑΒΓ τμήμα.

Ἐστω, ὁ μέρος ἢ ΚΛ περιφέρεια τῆς ὅλης τοῦ κύκλου περιφερείας, καὶ τὸ αὐτὸ μέρος περιφέρεια ἢ ΖΕ τῆς ΖΑ, καὶ ἐπεζεύχθω ἢ ΕΓ. ἔσται δὴ καὶ ἢ ΒΓ τῆς ΑΒΓ τὸ αὐτὸ μέρος. ὁ δὲ μέρος ἢ ΚΛ τῆς ὅλης περιφερείας, τὸ αὐτὸ καὶ ἢ ΘΟ τῆς ΘΟΛ. καὶ ἔστιν ἴση ἢ ΘΟΛ τῇ ΑΒΓ. ἴση ἄρα καὶ ἢ ΘΟ τῇ ΒΓ. γεγράφθω περὶ πόλον τὸν Θ διὰ τοῦ Ο περιφέρεια ἢ ΟΝ, καὶ διὰ τοῦ Β περὶ τὸ Γ κέντρον ἢ ΒΗ. ἐπεὶ οὖν ὡς ἢ ΛΚΘ σφαιρικῆ ἐπιφάνεια πρὸς τὴν ΟΘΝ, ἢ ὅλη τοῦ ἡμισφαιρίου ἐπιφάνεια πρὸς τὴν τοῦ τμήματος ἐπιφάνειαν οὗ ἢ ἐκ τοῦ πόλου ἔστιν ἢ ΘΟ, ὡς δ' ἢ τοῦ ἡμισφαιρίου ἐπιφάνεια πρὸς τὴν τοῦ τμήματος ἐπιφάνειαν, οὕτως ἔστιν τὸ ἀπὸ τῆς τὰ Θ, Λ ἐπιζευγνυούσης εὐθείας τετράγωνον πρὸς τὸ ἀπὸ τῆς ἐπὶ τὰ Θ, Ο, ἢ τὸ ἀπὸ τῆς ΕΓ τετράγωνον πρὸς τὸ ἀπὸ τῆς ΒΓ, ἔσται ἄρα καὶ ὡς ὁ ΚΛΘ τομεὺς ἐν τῇ ἐπιφανείᾳ πρὸς τὸν ΟΘΝ, οὕτως ὁ ΕΖΓ τομεὺς πρὸς τὸν ΒΗΓ. ὁμοίως δείξομεν ὅτι καὶ ὡς πάντες οἱ ἐν τῷ ἡμισφαιρίῳ τομεῖς οἱ ἴσοι τῷ ΚΛΘ, οἱ

* Pappus's method of proof is, in the Archimedean manner, to circumscribe about the surface to be measured a figure consisting of sectors on the sphere, and to circumscribe about the segment ΑΒΓ a figure consisting of sectors of circles; in the same way figures can be inscribed. The divisions need, therefore, to be as numerous as possible. The conclusion can then be reached by the method of exhaustion.

REVIVAL OF GEOMETRY : PAPPUS

sector $AEZ\Gamma$ (for angle $A\Delta\Gamma = 2 \cdot$ angle $A\Gamma Z$, and $\Delta A^2 = \frac{1}{2}A\Gamma^2$); I say, then, that the ratio of the aforesaid surfaces one towards the other is the same as the ratio of the sector $AEZ\Gamma$ to the segment $AB\Gamma$.

Let ZE be the same [small] ^a part of ZA as $K\Lambda$ is of the whole circumference of the circle, and let $E\Gamma$ be joined; then the arc $B\Gamma$ will be the same part of the arc $AB\Gamma$.^b But ΘO is the same part of $\Theta O\Lambda$ as $K\Lambda$ is of the whole circumference [*by the property of the spiral*]. And arc $\Theta O\Lambda =$ arc $AB\Gamma$ [*ex constructione*]. Therefore $\Theta O = B\Gamma$. Let there be described through O about the pole Θ the arc ON , and through B about centre Γ the arc BH . Then since the [sector of the] spherical surface $\Lambda K\Theta$ bears to the [sector] $O\Theta N$ the same ratio as the whole surface of the hemisphere bears to the surface of the segment with pole Θ and circular base ON ,^c while the surface of the hemisphere bears to the surface of the segment the same ratio as $\Theta\Lambda^2$ to ΘO^2 ,^d or $E\Gamma^2$ to $B\Gamma^2$, therefore the sector $\Lambda K\Theta$ on the surface [of the sphere] bears to $O\Theta N$ the same ratio as the sector $EZ\Gamma$ [in the plane] bears to the sector $BH\Gamma$. Similarly we may show that all the sectors [on the surface of] the hemi-

^b For arc $ZA : \text{arc } ZE = \text{angle } Z\Gamma A : \text{angle } Z\Gamma E$. But angle $Z\Gamma A = \frac{1}{2} \cdot$ angle $A\Delta\Gamma$, and angle $Z\Gamma E = \frac{1}{2} \cdot$ angle $B\Delta\Gamma$ [Eucl. iii. 32, 20]. \therefore arc $ZA : \text{arc } ZE = \text{arc } AB\Gamma : \text{arc } B\Gamma$.

^c Because the arc ΛK is the same part of the circumference $K\Lambda M$ as the arc ON is of its circumference.

^d The square on $\Theta\Lambda$ is double the square on the radius of the hemisphere, and therefore half the surface of the hemisphere is equal to a circle of radius $\Theta\Lambda$ [Archim. *De sph. et cyl.* i. 33]; and the surface of the segment is equal to a circle of radius ΘO [*ibid.* i. 42]; and as circles are to one another as the squares on their radii [Eucl. xii. 2], the surface of the hemisphere bears to the surface of the segment the ratio $\Theta\Lambda^2 : \Theta O^2$.

είσιν ἡ ὅλη τοῦ ἡμισφαιρίου ἐπιφάνεια, πρὸς τοὺς περιγραφομένους περὶ τὴν ἕλικα τομέας ὁμοταγεῖς τῷ ΟΘΝ, οὕτως πάντες οἱ ἐν τῷ ΑΖΓ τομεῖς οἱ ἴσοι τῷ ΕΖΓ, τουτέστιν ὅλος ὁ ΑΖΓ τομεύς, πρὸς τοὺς περιγραφομένους περὶ τὸ ΑΒΓ τμήμα τοὺς ὁμοταγεῖς τῷ ΓΒΗ. τῷ δ' αὐτῷ τρόπῳ δειχθήσεται καὶ ὡς ἡ τοῦ ἡμισφαιρίου ἐπιφάνεια πρὸς τοὺς ἐγγραφομένους τῇ ἕλικι τομέας, οὕτως ὁ ΑΖΓ τομεύς πρὸς τοὺς ἐγγραφομένους τῷ ΑΒΓ τμήματι τομέας, ὥστε καὶ ὡς ἡ τοῦ ἡμισφαιρίου ἐπιφάνεια πρὸς τὴν ὑπὸ τῆς ἕλικος ἀπολαμβανομένην ἐπιφάνειαν, οὕτως ὁ ΑΖΓ τομεύς, τουτέστιν τὸ ΑΒΓΔ τεταρτημόριον, πρὸς τὸ ΑΒΓ τμήμα. συνάγεται δὲ διὰ τούτου ἡ μὲν ἀπὸ τῆς ἕλικος ἀπολαμβανομένη ἐπιφάνεια πρὸς τὴν ΘΝΚ περιφέρειαν ὀκταπλασία τοῦ ΑΒΓ τμήματος (ἐπεὶ καὶ ἡ τοῦ ἡμισφαιρίου ἐπιφάνεια τοῦ ΑΒΓΔ τομέως), ἡ δὲ μεταξὺ τῆς ἕλικος καὶ τῆς βάσεως τοῦ ἡμισφαιρίου ἐπιφάνεια ὀκταπλασία τοῦ ΑΓΔ τριγώνου, τουτέστιν ἴση τῷ ἀπὸ τῆς διαμέτρου τῆς σφαίρας τετραγώνῳ.

* This would be proved by the method of exhaustion. It is proof of the great part played by this method in Greek geometry that Pappus can take its validity for granted.

^b For the surface of the hemisphere is double of the circle of radius ΑΔ [Archim. *De sph. et cyl.* i. 33] and the sector ΑΒΓΔ is one-quarter of the circle of radius ΑΔ.

^c For the surface between the spiral and the base of the hemisphere is equal to the surface of the hemisphere less the surface cut off from the spiral in the direction ΘΝΚ,

i.e. Surface in question = surface of hemisphere -

8 segment ΑΒΓ,

= 8 sector ΑΒΓΔ - 8 segment ΑΒΓ

REVIVAL OF GEOMETRY : PAPPUS

sphere equal to $K\Lambda\Theta$, together making up the whole surface of the hemisphere, bear to the sectors described about the spiral similar to $O\Theta N$ the same ratio as the sectors in $AZ\Gamma$ equal to $EZ\Gamma$, that is the whole sector $AZ\Gamma$, bear to the sectors described about the segment $AB\Gamma$ similar to ΓBH . In the same manner it may be shown that the surface of the hemisphere bears to the [sum of the] sectors inscribed in the spiral the same ratio as the sector $AZ\Gamma$ bears to the [sum of the] sectors inscribed in the segment $AB\Gamma$, so that the surface of the hemisphere bears to the surface cut off by the spiral the same ratio as the sector $AZ\Gamma$, that is the quadrant $AB\Gamma\Delta$, bears to the segment $AB\Gamma$.^a From this it may be deduced that the surface cut off from the spiral in the direction of the arc ΘNK is eight times the segment $AB\Gamma$ (since the surface of the hemisphere is eight times the sector $AB\Gamma\Delta$),^b while the surface between the spiral and the base of the hemisphere is eight times the triangle $A\Gamma\Delta$, that is, it is equal to the square on the diameter of the sphere.^c

$$= 8 \text{ triangle } A\Gamma\Delta$$

$$= 4A\Delta^2$$

$$= (2A\Delta)^2,$$

and $2A\Delta$ is the diameter of the sphere.

Heath (*H.G.M.* ii. 384-385) gives for this elegant proposition an analytical equivalent, which I have adapted to the Greek lettering. If ρ , ω are the spherical co-ordinates of O with reference to Θ as pole and the arc ΘNK as polar axis, the equation of the spiral is $\omega = 4\rho$. If A is the area of the spiral to be measured, and the radius of the sphere is taken as unity, we have as the element of area

$$dA = d\omega(1 - \cos \rho) = 4d\rho(1 - \cos \rho).$$

GREEK MATHEMATICS

(i) ISOPERIMETRIC FIGURES

Ibid. v., Fraef. 1-3, ed. Hultsch 304. 5-308. 5

Σοφίας καὶ μαθημάτων ἔννοιαν ἀρίστην μὲν καὶ τελειοτάτην ἀνθρώποις θεὸς ἔδωκεν, ᾧ κράτιστε Μεγεθίον, ἐκ μέρους δέ που καὶ τῶν ἀλόγων ζώων μοῖραν ἀπένειμέν τισιν. ἀνθρώποις μὲν οὖν ἅτε λογικοῖς οὖσι τὸ μετὰ λόγου καὶ ἀποδείξεως παρέσχεν ἕκαστα ποιεῖν, τοῖς δὲ λοιποῖς ζώοις ἄνευ λόγου τὸ χρήσιμον καὶ βιωφελές αὐτὸ μόνον κατὰ τινα φυσικὴν πρόνοιαν ἐκάστοις ἔχειν ἔδωρῆσατο. τοῦτο δὲ μάθοι τις ἂν ὑπάρχον καὶ ἐν ἑτέροις μὲν πλείστοις γένεσιν τῶν ζώων, οὐχ ἥκιστα δὲ καὶ ταῖς μελίσσαις· ἢ τε γὰρ εὐταξία καὶ πρὸς τὰς ἡγουμένας τῆς ἐν αὐταῖς πολιτείας εὐπείθεια θαυμασὴ τις, ἢ τε φιλοτιμία καὶ καθαριότης ἢ περὶ τὴν τοῦ μέλιτος συναγωγὴν καὶ ἢ περὶ τὴν φυλακὴν αὐτοῦ πρόνοια καὶ οἰκονομία πολὺ μᾶλλον θαυμασιωτέρα. πεπιστευμένα γάρ, ὡς εἰκός, παρὰ θεῶν κομίζειν τοῖς τῶν ἀνθρώπων μουσικοῖς

$$\therefore \quad A = \int_0^{\frac{1}{2}\pi} 4d\rho(1 - \cos \rho) \\ = 2\pi - 4.$$

$$\therefore \quad \frac{A}{\text{surface of hemisphere}} = \frac{2\pi - 4}{2\pi} \\ = \frac{\frac{1}{4}\pi - \frac{1}{2}}{\frac{1}{4}\pi} \\ = \frac{\text{segment } AB\Gamma}{\text{sector } AB\Gamma\Delta}.$$

• The whole of Book v. in Pappus's *Collection* is devoted to isoperimetry. The first section follows closely the exposition of Zenodorus as given by Theon (*v. supra*, pp. 386-395),

REVIVAL OF GEOMETRY : PAPPUS

(i) ISOPERIMETRIC FIGURES ^a

Ibid. v., Preface 1-3, ed. Hultsch 304. 5-308. 5

Though God has given to men, most excellent Megethion, the best and most perfect understanding of wisdom and mathematics, He has allotted a partial share to some of the unreasoning creatures as well. To men, as being endowed with reason, He granted that they should do everything in the light of reason and demonstration, but to the other unreasoning creatures He gave only this gift, that each of them should, in accordance with a certain natural forethought, obtain so much as is needful for supporting life. This instinct may be observed to exist in many other species of creatures, but it is specially marked among bees. Their good order and their obedience to the queens who rule in their commonwealths are truly admirable, but much more admirable still is their emulation, their cleanliness in the gathering of honey, and the forethought and domestic care they give to its protection. Believing themselves, no doubt, to be entrusted with the task of bringing from the gods to the more cultured part of mankind a share of

except that Pappus includes the proposition that *of all circular segments having the same circumference the semicircle is the greatest*. The second section compares the volumes of solids whose surfaces are equal, and is followed by a digression, already quoted (*supra*, pp. 194-197) on the semi-regular solids discovered by Archimedes. After some propositions on the lines of Archimedes' *De sph. et cyl.*, Pappus finally proves that *of regular solids having equal surfaces, that is greatest which has most faces*.

The introduction, here cited, on the sagacity of bees is rightly praised by Heath (*H.G.M.* ii. 389) as an example of the good style of the Greek mathematicians when freed from the restraints of technical language.

GREEK MATHEMATICS

τῆς ἀμβροσίας ἀπόμοιράν τινα ταύτην οὐ μάτην ἐκχεῖν εἰς γῆν καὶ ξύλον ἢ τινα ἐτέραν ἀσχήμονα καὶ ἄτακτον ὕλην ἠξίωσαν, ἀλλ' ἐκ τῶν ἠδίστων ἐπὶ γῆς φυομένων ἀνθέων συνάγουσαι τὰ κάλλιστα κατασκευάζουσιν ἐκ τούτων εἰς τὴν τοῦ μέλιτος ὑποδοχὴν ἀγγεῖα τὰ καλούμενα κηρία πάντα μὲν ἀλλήλοις ἴσα καὶ ὅμοια καὶ παρακείμενα, τῷ δὲ τμήματι ἐξάγωνα.

Τοῦτο δ' ὅτι κατὰ τινα γεωμετρικὴν μηχανῶνται πρόνοιαν οὕτως ἂν μάθοιμεν. πάντως μὲν γὰρ ὦντο δεῖν τὰ σχήματα παρακείσθαι τε ἀλλήλοις καὶ κοινωεῖν κατὰ τὰς πλευράς, ἵνα μὴ τοῖς μεταξὺ παραπληρώμασιν ἐμπίπτοντά τινα ἕτερα λυμήνηται αὐτῶν τὰ ἔργα· τρία δὲ σχήματα εὐθύγραμμα τὸ προκείμενον ἐπιτελεῖν ἐδύνατο, λέγω δὲ τεταγμένα τὰ ἰσόπλευρά τε καὶ ἰσογώνια, τὰ δ' ἀνόμοια ταῖς μελίσσαις οὐκ ἤρρεσεν. τὰ μὲν οὖν ἰσόπλευρα τρίγωνα καὶ τετράγωνα καὶ τὰ ἐξάγωνα χωρὶς ἀνομοίων παραπληρωμάτων ἀλλήλοις δύναται παρακείμενα τὰς πλευρὰς κοινὰς ἔχειν [ταῦτα¹ γὰρ δύναται συμπληροῦν ἐξ αὐτῶν τὸν περὶ τὸ αὐτὸ σημεῖον τόπον, ἐτέρω δὲ τεταγμένω σχήματι τοῦτο ποιεῖν ἀδύνατον].¹ ὁ γὰρ περὶ τὸ αὐτὸ σημεῖον τόπος ὑπὸ $\bar{\epsilon}$ μὲν τριγώνων ἰσοπλεύρων καὶ διὰ $\bar{\epsilon}$ γωνιῶν, ὧν ἐκάστη διμοῖρου ἐστὶν ὀρθῆς, συμπληροῦται, τεσσάρων δὲ τετραγώνων καὶ δ ὀρθῶν γωνιῶν [αὐτοῦ],² τριῶν δὲ ἐξαγώνων καὶ ἐξαγώνου γωνιῶν τριῶν, ὧν ἐκάστη $\bar{\alpha}$ γ' ἐστὶν ὀρθῆς. πεντάγωνα δὲ τὰ τρία μὲν οὐ φθάνει συμπληρῶσαι τὸν περὶ τὸ αὐτὸ σημεῖον τόπον, ὑπερβάλλει δὲ τὰ τέσσαρα· τρεῖς μὲν γὰρ τοῦ πενταγώνου γωνίαι δ ὀρθῶν ἐλάσσονές εἰσιν

REVIVAL OF GEOMETRY : PAPPUS

ambrosia in this form, they do not think it proper to pour it carelessly into earth or wood or any other unseemly and irregular material, but, collecting the fairest parts of the sweetest flowers growing on the earth, from them they prepare for the reception of the honey the vessels called honeycombs, [with cells] all equal, similar and adjacent, and hexagonal in form.

That they have contrived this in accordance with a certain geometrical forethought we may thus infer. They would necessarily think that the figures must all be adjacent one to another and have their sides common, in order that nothing else might fall into the interstices and so defile their work. Now there are only three rectilineal figures which would satisfy the condition, I mean regular figures which are equilateral and equiangular, inasmuch as irregular figures would be displeasing to the bees. For equilateral triangles and squares and hexagons can lie adjacent to one another and have their sides in common without irregular interstices. For the space about the same point can be filled by six equilateral triangles and six angles, of which each is $\frac{2}{3}$. right angle, or by four squares and four right angles, or by three hexagons and three angles of a hexagon, of which each is $1\frac{1}{3}$. right angle. But three pentagons would not suffice to fill the space about the same point, and four would be more than sufficient ; for three angles of the pentagon are less than four right angles (inasmuch

¹ ταῦτα . . . ἀδύνατον om. Hultsch.

² " αὐτοῦ spurium, nisi forte αὐτῶν dedit scriptor"—Hultsch.

GREEK MATHEMATICS

(ἐκάστη γὰρ γωνία μιᾶς καὶ εἴ ἐστὶν ὀρθῆς), τέσσαρες δὲ γωνίαι μείζους τῶν τεσσάρων ὀρθῶν. ἐπτάγωνα δὲ οὐδὲ τρία περὶ τὸ αὐτὸ σημεῖον δύναται τίθεσθαι κατὰ τὰς πλευρὰς ἀλλήλοις παρακείμενα· τρεῖς γὰρ ἐπταγώνου γωνίαι τεσσάρων ὀρθῶν μείζονες (ἐκάστη γὰρ ἐστὶν μιᾶς ὀρθῆς καὶ τριῶν ἐβδόμων). ἔτι δὲ μᾶλλον ἐπὶ τῶν πολυγωνοτέρων ὁ αὐτὸς ἐφαρμόσαι δυνησεται λόγος. ὄντων δὴ οὖν τριῶν σχημάτων τῶν ἐξ αὐτῶν δυναμένων συμπληρῶσαι τὸν περὶ τὸ αὐτὸ σημεῖον τόπον, τριγώνου τε καὶ τετραγώνου καὶ ἑξαγώνου, τὸ πολυγωνότερον εἶλαντο διὰ τὴν σοφίαν αἱ μέλισσαι πρὸς τὴν παρασκευὴν, ἅτε καὶ πλείον ἑκατέρου τῶν λοιπῶν αὐτὸ χωρεῖν ὑπολαμβάνουσαι μέλι.

Καὶ αἱ μέλισσαι μὲν τὸ χρήσιμον αὐταῖς ἐπίστανται μόνον τοῦθ' ὅτι τὸ ἑξάγωνον τοῦ τετραγώνου καὶ τοῦ τριγώνου μείζον ἐστὶν καὶ χωρῆσαι δύναται πλείον μέλι τῆς ἴσης εἰς τὴν ἐκάστου κατασκευὴν ἀναλισκομένης ὕλης, ἡμεῖς δὲ πλέον τῶν μελισσῶν σοφίας μέρος ἔχειν ὑπισχνούμενοι ζητήσομέν τι καὶ περισσότερον. τῶν γὰρ ἴσην ἔχόντων περίμετρον ἰσοπλεύρων τε καὶ ἰσογωνίων ἐπιπέδων σχημάτων μείζον ἐστὶν αἰεὶ τὸ πολυγωνότερον, μέγιστος δ' ἐν πᾶσιν ὁ κύκλος, ὅταν ἴσην αὐτοῖς περίμετρον ἔχη.

(j) APPARENT FORM OF A CIRCLE

Ibid. vi. 48. 90-91, ed. Hultsch 580. 12-27

Ἐστω κύκλος ὁ ΑΒΓ, οὗ κέντρον τὸ Ε, καὶ ἀπὸ τοῦ Ε πρὸς ὀρθὰς ἔστω τῷ τοῦ κύκλου ἐπι-

REVIVAL OF GEOMETRY : PAPPUS

as each angle is $1\frac{1}{2}$. right angle), and four angles are greater than four right angles. Nor can three heptagons be placed about the same point so as to have their sides adjacent to each other ; for three angles of a heptagon are greater than four right angles (inasmuch as each is $1\frac{3}{7}$. right angle). And the same argument can be applied even more to polygons with a greater number of angles. There being, then, three figures capable by themselves of filling up the space around the same point, the triangle, the square and the hexagon, the bees in their wisdom chose for their work that which has the most angles, perceiving that it would hold more honey than either of the two others.

Bees, then, know just this fact which is useful to them, that the hexagon is greater than the square and the triangle and will hold more honey for the same expenditure of material in constructing each. But we, claiming a greater share in wisdom than the bees, will investigate a somewhat wider problem, namely that, *of all equilateral and equiangular plane figures having an equal perimeter, that which has the greater number of angles is always greater, and the greatest of them all is the circle having its perimeter equal to them.*

(j) APPARENT FORM OF A CIRCLE

Ibid. vi.^a 48. 90-91, ed. Hultsch 580. 12-27

Let ABΓ be a circle with centre E, and from E let EZ be drawn perpendicular to the plane of the circle ;

^a Most of Book vi. is astronomical, covering the treatises in the *Little Astronomy* (*v. supra*, p. 408 n. b). The proposition here cited comes from a section on Euclid's *Optics*.

GREEK MATHEMATICS

πέδω ἢ EZ . λέγω, ὅτι ἐὰν ἐπὶ τῆς EZ τὸ ὄμμα
τεθῆ ἴσαι αἱ διάμετροι φαίνονται τοῦ κύκλου.

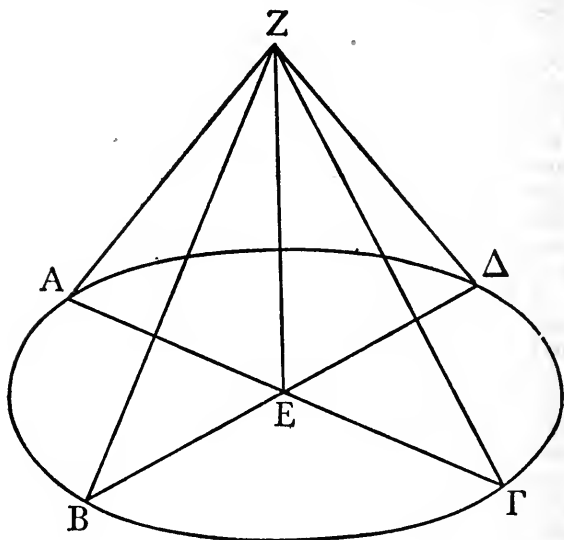

Τοῦτο δὲ δῆλον· ἅπασαι γὰρ αἱ ἀπὸ τοῦ Z πρὸς
τὴν τοῦ κύκλου περιφέρειαν προσπίπτουσαι εὐθεῖαι
ἴσαι εἰσὶν ἀλλήλαις καὶ ἴσας γωνίας περιέχουσιν.

Μὴ ἔστω δὲ ἡ EZ πρὸς ὀρθὰς τῷ τοῦ κύκλου
ἐπιπέδω, ἴση δὲ ἔστω τῇ ἐκ τοῦ κέντρου τοῦ
κύκλου· λέγω, ὅτι τοῦ ὀμματος ὄντος πρὸς τῷ Z
σημείῳ καὶ οὕτως αἱ διάμετροι ἴσαι ὀρῶνται.

Ἦχθωσαν γὰρ δύο διάμετροι αἱ AG , BD , καὶ
ἐπεζεύχθωσαν αἱ ZA , ZB , ZC , ZD . ἐπεὶ αἱ

REVIVAL OF GEOMETRY : PAPPUS

I say that, if the eye be placed on EZ, the diameters of the circle appear equal.^a

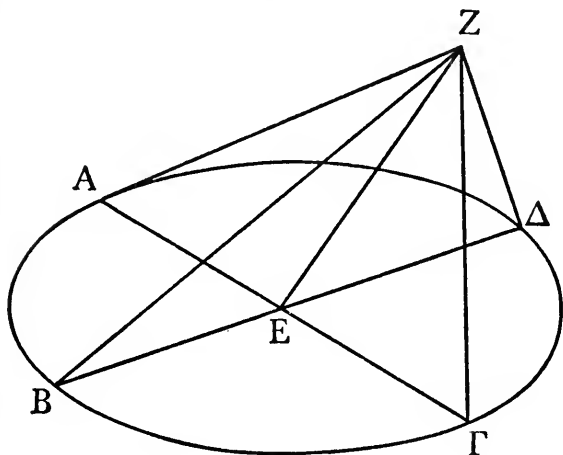

This is obvious ; for all the straight lines falling from Z on the circumference of the circle are equal one to another and contain equal angles.

Now let EZ be not perpendicular to the plane of the circle, but equal to the radius of the circle ; I say that, if the eye be at the point Z, in this case also the diameters appear equal.

For let two diameters AΓ, BΔ be drawn, and let ZA, ZB, ZΓ, ZΔ be joined. Since the three straight

- As they will do if they subtend an equal angle at the eye.

GREEK MATHEMATICS

τρεις αἱ ΕΑ, ΕΓ, ΕΖ ἴσαι εἰσίν, ὀρθὴ ἄρα ἡ ὑπὸ ΑΖΓ γωνία. διὰ τὰ αὐτὰ δὴ καὶ ἡ ὑπὸ ΒΖΔ ὀρθὴ ἐστίν· ἴσαι ἄρα φανήσονται αἱ ΑΓ, ΒΔ διάμετροι. ὁμοίως δὴ δείξομεν ὅτι καὶ πᾶσαι.

(k) THE "TREASURY OF ANALYSIS"

Ibid. vii., Praef. 1-3, ed. Hultsch 634. 3-636. 30

Ὁ καλούμενος ἀναλυόμενος, Ἐρμόδωρε τέκνον, κατὰ σύλληψιν ἰδία τίς ἐστίν ὕλη παρεσκευασμένη μετὰ τὴν τῶν κοινῶν στοιχείων ποίησιν τοῖς βουλομένοις ἀναλαμβάνειν ἐν γραμμαῖς δύναμιν εὐρετικὴν τῶν προτεινομένων αὐτοῖς προβλημάτων, καὶ εἰς τοῦτο μόνον χρησίμη καθεστῶσα. γέγραπται δὲ ὑπὸ τριῶν ἀνδρῶν, Εὐκλείδου τε τοῦ Στοιχειωτοῦ καὶ Ἀπολλωνίου τοῦ Περγαίου καὶ Ἀρισταίου τοῦ πρεσβυτέρου, κατὰ ἀνάλυσιν καὶ σύνθεσιν ἔχουσα τὴν ἔφοδον.

Ἀνάλυσις τοίνυν ἐστίν ὁδὸς ἀπὸ τοῦ ζητουμένου ὡς ὁμολογουμένου διὰ τῶν ἐξῆς ἀκολουθῶν ἐπιτι ὁμολογούμενον συνθέσει· ἐν μὲν γὰρ τῇ ἀναλύσει τὸ ζητούμενον ὡς γεγονὸς ὑποθέμενοι τὸ ἐξ οὗ τοῦτο συμβαίνει σκοπούμεθα καὶ πάλιν ἐκείνου τὸ προηγούμενον, ἕως ἂν οὕτως ἀναποδίζοντες καταστήσωμεν εἰς τι τῶν ἤδη γνωριζομένων ἢ τάξιν ἀρχῆς ἐχόντων· καὶ τὴν τοιαύτην ἔφοδον ἀνάλυσιν καλοῦμεν, οἷον ἀνάπαλιν λύσιν.

Ἐν δὲ τῇ συνθέσει ἐξ ὑποστροφῆς τὸ ἐν τῇ ἀναλύσει καταληφθὲν ὕστατον ὑποστησάμενοι γεγονὸς ἤδη, καὶ ἐπόμενα τὰ ἐκεῖ [ἐνταῦθα]¹ προ-

¹ ἐνταῦθα om. Hultsch.

REVIVAL OF GEOMETRY : PAPPUS

lines EA, EF, EZ are equal, therefore the angle AZΓ is right. And by the same reasoning the angle BZΔ is right; therefore the diameters AΓ, BΔ appear equal. Similarly we may show that all are equal.

(k) THE "TREASURY OF ANALYSIS"

Ibid. vii., Preface 1-3, ed. Hultsch 634. 3-636. 30

The so-called *Treasury of Analysis*, my dear Hermodorus, is, in short, a special body of doctrine furnished for the use of those who, after going through the usual elements, wish to obtain power to solve problems set to them involving curves,^a and for this purpose only is it useful. It is the work of three men, Euclid the writer of the *Elements*, Apollonius of Perga and Aristaeus the elder, and proceeds by the method of analysis and synthesis.

Now *analysis* is a method of taking that which is sought as though it were admitted and passing from it through its consequences in order to something which is admitted as a result of synthesis; for in analysis we suppose that which is sought to be already done, and we inquire what it is from which this comes about, and again what is the antecedent cause of the latter, and so on until, by retracing our steps, we light upon something already known or ranking as a first principle; and such a method we call analysis, as being a reverse solution.

But in *synthesis*, proceeding in the opposite way, we suppose to be already done that which was last reached in the analysis, and arranging in their natural

^a Or, perhaps, "to give a complete theoretical solution of problems set to them"; *v. supra*, p. 414 n. a.

ηγούμενα κατὰ φύσιν τάξαντες καὶ ἀλλήλοις ἐπισυνθέντες, εἰς τέλος ἀφικνούμεθα τῆς τοῦ ζητουμένου κατασκευῆς· καὶ τοῦτο καλοῦμεν σύνθεσιν.

Διττὸν δ' ἐστὶν ἀναλύσεως γένος τὸ μὲν ζητητικὸν τάληθοῦς, ὃ καλεῖται θεωρητικόν, τὸ δὲ ποριστικὸν τοῦ προταθέντος [λέγειν],¹ ὃ καλεῖται προβληματικόν. ἐπὶ μὲν οὖν τοῦ θεωρητικοῦ γένους τὸ ζητούμενον ὡς ὄν ὑποθέμενοι καὶ ὡς ἀληθές, εἶτα διὰ τῶν ἐξῆς ἀκολουθῶν ὡς ἀληθῶν καὶ ὡς ἔστιν καθ' ὑπόθεσιν προελθόντες ἐπὶ τι ὁμολογούμενον, εἰ μὲν ἀληθές ἢ ἐκεῖνο τὸ ὁμολογούμενον, ἀληθές ἔσται καὶ τὸ ζητούμενον, καὶ ἢ ἀπόδειξις ἀντίστροφος τῇ ἀναλύσει, εἰ μὲν δὲ ψεύδει ὁμολογουμένῳ ἐντύχομεν, ψεῦδος ἔσται καὶ τὸ ζητούμενον. ἐπὶ δὲ τοῦ προβληματικοῦ γένους τὸ προταθὲν ὡς γνωσθὲν ὑποθέμενοι, εἶτα διὰ τῶν ἐξῆς ἀκολουθῶν ὡς ἀληθῶν προελθόντες ἐπὶ τι ὁμολογούμενον, εἰ μὲν τὸ ὁμολογούμενον δυνατὸν ἢ καὶ ποριστόν, ὃ καλοῦσιν οἱ ἀπὸ τῶν μαθημάτων δοθέν, δυνατὸν ἔσται καὶ τὸ προταθὲν, καὶ πάλιν ἢ ἀπόδειξις ἀντίστροφος τῇ ἀναλύσει, εἰ μὲν δὲ ἀδυνάτῳ ὁμολογουμένῳ ἐντύχομεν, ἀδύνατον ἔσται καὶ τὸ πρόβλημα.

Τοσαῦτα μὲν οὖν περὶ ἀναλύσεως καὶ συνθέσεως.

Τῶν δὲ προειρημένων τοῦ ἀναλυομένου βιβλίων ἡ τάξις ἐστὶν τοιαύτη. Εὐκλείδου Δεδομένων βιβλίον α , Ἀπολλωνίου Λόγου ἀποτομῆς β , Χωρίου ἀποτομῆς β , Διωρισμένης τομῆς δύο, Ἐπαφῶν δύο, Εὐκλείδου Πορισμάτων τρία, Ἀπολλωνίου Νεύσεων δύο, τοῦ αὐτοῦ Τόπων ἐπιπέδων δύο,

¹ λέγειν om. Hultsch.

REVIVAL OF GEOMETRY : PAPPUS

order as consequents what were formerly antecedents and linking them one with another, we finally arrive at the construction of what was sought ; and this we call synthesis.

Now analysis is of two kinds, one, whose object is to seek the truth, being called *theoretical*, and the other, whose object is to find something set for finding, being called *problematical*. In the theoretical kind we suppose the subject of the inquiry to exist and to be true, and then we pass through its consequences in order, as though they also were true and established by our hypothesis, to something which is admitted ; then, if that which is admitted be true, that which is sought will also be true, and the proof will be the reverse of the analysis, but if we come upon something admitted to be false, that which is sought will also be false. In the problematical kind we suppose that which is set as already known, and then we pass through its consequences in order, as though they were true, up to something admitted ; then, if what is admitted be possible and can be done, that is, if it be what the mathematicians call *given*, what was originally set will also be possible, and the proof will again be the reverse of the analysis, but if we come upon something admitted to be impossible, the problem will also be impossible.

So much for analysis and synthesis.

This is the order of the books in the aforesaid *Treasury of Analysis*. Euclid's *Data*, one book, Apollonius's *Cutting-off of a Ratio*, two books, *Cutting-off of an Area*, two books, *Determinate Section*, two books, *Contacts*, two books, Euclid's *Porisms*, three books, Apollonius's *Vergings*, two books, his *Plane Loci*, two books, *Conics*, eight books, Aristaëus's

GREEK MATHEMATICS

Κωνικῶν ἦ, Ἀρισταίου Τόπων στερεῶν πέντε, Εὐκλείδου Τόπων τῶν πρὸς ἐπιφανείᾳ δύο, Ἐρατοσθένους Περὶ μεσοτήτων δύο. γίνεται βιβλία $\overline{\lambda\gamma}$, ὧν τὰς περιοχὰς μέχρι τῶν Ἀπολλωνίου Κωνικῶν ἐξεθέμην σοι πρὸς ἐπίσκεψιν, καὶ τὸ πλῆθος τῶν τόπων καὶ τῶν διορισμῶν καὶ τῶν πτώσεων καθ' ἕκαστον βιβλίον, ἀλλὰ καὶ τὰ λήμματα τὰ ζητούμενα, καὶ οὐδεμίαν ἐν τῇ πραγματεία τῶν βιβλίων καταλέλοιπα ζήτησιν, ὡς ἐνόμιζον.

(I) LOCUS WITH RESPECT TO FIVE OR SIX LINES

Ibid. vii. 38-40, ed. Hultsch 680. 2-30

Ἐὰν ἀπὸ τινος σημείου ἐπὶ θέσει δεδομένας εὐθείας πέντε καταχθῶσιν εὐθεῖαι ἐν δεδομέναις γωνίαις, καὶ λόγος ἢ δεδομένος τοῦ ὑπὸ τριῶν κατηγμένων περιεχομένου στερεοῦ παραλληλεπιπέδου ὀρθογωνίου πρὸς τὸ ὑπὸ τῶν λοιπῶν δύο κατηγμένων καὶ δοθείσης τινὸς περιεχόμενον παραλληλεπίπεδον ὀρθογώνιον, ἄψεται τὸ σημεῖον θέσει δεδομένης γραμμῆς. εἰάν τε ἐπὶ $\overline{\zeta}$, καὶ λόγος ἢ δοθεὶς τοῦ ὑπὸ τῶν τριῶν περιεχομένου προειρημένου στερεοῦ πρὸς τὸ ὑπὸ τῶν λοιπῶν τριῶν, πάλιν τὸ σημεῖον ἄψεται θέσει δεδομένης. εἰάν δὲ ἐπὶ πλείονας τῶν $\overline{\zeta}$, οὐκέτι μὲν ἔχουσι λέγειν, "εἰάν λόγος ἢ δοθεὶς τοῦ ὑπὸ τῶν δ περιεχομένου τινὸς πρὸς τὸ ὑπὸ τῶν λοιπῶν," ἐπεὶ οὐκ ἔστι τι

• These propositions follow a passage on the locus with respect to three or four lines which has already been quoted (v. vol. i. pp. 486-489). The passages come from Pappus's

REVIVAL OF GEOMETRY : PAPPUS

Solid Loci, five books, Euclid's *Surface Loci*, two books, Eratosthenes' *On Means*, two books. In all there are thirty-three books, whose contents as far as Apollonius's *Conics* I have set out for your examination, including not only the number of the propositions, the conditions of possibility and the cases dealt with in each book, but also the lemmas which are required; indeed, I believe that I have not omitted any inquiry arising in the study of these books.

(l) LOCUS WITH RESPECT TO FIVE OR SIX LINES ^a

Ibid. vii. 38-40, ed. Hultsch 680. 2-30

If from any point straight lines be drawn to meet at given angles five straight lines given in position, and the ratio be given between the volume of the rectangular parallelepiped contained by three of them to the volume of the rectangular parallelepiped contained by the remaining two and a given straight line, the point will lie on a curve given in position. If there be six straight lines, and the ratio be given between the volume of the aforesaid solid formed by three of them to the volume of the solid formed by the remaining three, the point will again lie on a curve given in position. If there be more than six straight lines, it is no longer permissible to say "if the ratio be given between some figure contained by four of them to some figure contained by the remainder," since no figure can be contained in more

account of the *Conics* of Apollonius, who had worked out the locus with respect to three or four lines. It was by reflection on this passage that Descartes evolved the system of co-ordinates described in his *Géométrie*.

GREEK MATHEMATICS

περιεχόμενον ὑπὸ πλειόνων ἢ τριῶν διαστάσεων.
 συγκεχωρήκασι δὲ ἑαυτοῖς οἱ βραχὺ πρὸ ἡμῶν
 ἐρμηνεύειν τὰ τοιαῦτα, μηδὲ ἐν μηδαμῶς διάληπτον
 σημαίνοντες, τὸ ὑπὸ τῶνδε περιεχόμενον λέγοντες
 ἐπὶ τὸ ἀπὸ τῆσδε τετράγωνον ἢ ἐπὶ τὸ ὑπὸ τῶνδε.
 παρῆν δὲ διὰ τῶν συνημμένων λόγων ταῦτα καὶ
 λέγειν καὶ δεικνύναι καθόλου καὶ ἐπὶ τῶν προειρη-
 μένων προτάσεων καὶ ἐπὶ τούτων τὸν τρόπον
 τοῦτον· ἐὰν ἀπὸ τινος σημείου ἐπὶ θέσει δεδομένης
 εὐθείας καταχθῶσιν εὐθεῖαι ἐν δεδομέναις γωνίαις,
 καὶ δεδομένος ἢ λόγος ὁ συνημμένος ἐξ οὗ ἔχει
 μία κατηγμένη πρὸς μίαν καὶ ἕτερα πρὸς ἕτεραν,
 καὶ ἄλλη πρὸς ἄλλην, καὶ ἡ λοιπὴ πρὸς δοθείσαν,
 ἐὰν ὦσιν ζ, ἐὰν δὲ η, καὶ ἡ λοιπὴ πρὸς λοιπὴν,
 τὸ σημεῖον ἄφεται θέσει δεδομένης γραμμῆς· καὶ
 ὁμοίως ὅσαι ἂν ὦσιν περισσαὶ ἢ ἄρτιαι τὸ πλήθος.
 τούτων, ὡς ἔφην, ἐπομένων τῷ ἐπὶ τέσσαρας
 τόπῳ οὐδὲ ἐν συντεθείκασιν, ὥστε τὴν γραμμὴν
 εἰδέναι.

REVIVAL OF GEOMETRY : PAPPUS

than three dimensions. It is true that some recent writers have agreed among themselves to use such expressions,^a but they have no clear meaning when they multiply the rectangle contained by these straight lines with the square on that or the rectangle contained by those. They might, however, have expressed such matters by means of the composition of ratios, and have given a general proof both for the aforesaid propositions and for further propositions after this manner: *If from any point straight lines be drawn to meet at given angles straight lines given in position, and there be given the ratio compounded of that which one straight line so drawn bears to another, that which a second bears to a second, that which a third bears to a third, and that which the fourth bears to a given straight line—if there be seven, or, if there be eight, that which the fourth bears to the fourth—the point will lie on a curve given in position; and similarly, however many the straight lines be, and whether odd or even. Though, as I said, these propositions follow the locus on four lines, [geometers] have by no means solved them to the extent that the curve can be recognized.*^b

^a As Heron in his formula for the area of a triangle, given the sides (*supra*, pp. 476-477).

^b The general proposition can thus be stated: If $p_1, p_2, p_3, \dots, p_n$ be the lengths of straight lines drawn to meet n given straight lines at given angles (where n is odd), and a be a given straight line, then if

$$\frac{p_1}{p_2} \cdot \frac{p_3}{p_4} \cdot \dots \cdot \frac{p_n}{a} = \lambda,$$

where λ is a constant, the point will lie on a curve given in position. This will also be true if n is even and

$$\frac{p_1}{p_2} \cdot \frac{p_3}{p_4} \cdot \dots \cdot \frac{p_{n-1}}{p_n} = \lambda.$$

GREEK MATHEMATICS

(m) ANTICIPATION OF GULDIN'S THEOREM

Ibid. vii. 41-42, ed. Hultsch 680. 30-682. 20

Ταῦθ' οἱ βλέποντες ἤκιστα ἐπαίρονται, καθάπερ οἱ πάλαι καὶ τῶν τὰ κρείττονα γραψάντων ἕκαστοι· ἐγὼ δὲ καὶ πρὸς ἀρχαῖς ἔτι τῶν μαθημάτων καὶ τῆς ὑπὸ φύσεως προκειμένης ζητημάτων ὕλης κινουμένους ὁρῶν ἅπαντας, αἰδούμενος ἐγὼ καὶ δείξας γε πολλῶ κρείσσονα καὶ πολλὴν προφερόμενα ὠφέλειαν . . . ἵνα δὲ μὴ κεναῖς χερσὶ τοῦτο φθεγξάμενος ὧδε χωρισθῶ τοῦ λόγου, ταῦτα δώσω ταῖς ἀναγνοῦσιν· ὁ μὲν τῶν τελείων ἀμφοιστικῶν λόγος συνῆπται ἔκ τε τῶν ἀμφοισμάτων καὶ τῶν ἐπὶ τοὺς ἄξονας ὁμοίως κατηγμένων εὐθειῶν ἀπὸ τῶν ἐν αὐτοῖς κεντροβαρικῶν σημείων, ὁ δὲ τῶν ἀτελῶν ἔκ τε τῶν ἀμφοισμάτων καὶ τῶν περιφερειῶν, ὅσας ἐποίησεν τὰ ἐν τούτοις κεντροβαρικὰ σημεία, ὁ δὲ τούτων τῶν περιφερειῶν λόγος συνῆπται δῆλον ὡς ἔκ τε τῶν κατηγμένων καὶ ὧν περιέχουσιν αἱ τούτων ἄκραι, εἰ καὶ εἶεν πρὸς τοῖς ἄξοσιν ἀμφοιστικῶν, γωνιῶν. περι-

* Paul Guldin (1577-1643), or Guldinus, is generally credited with the discovery of the celebrated theorem here enunciated by Pappus. It may be stated: *If any plane figure revolve about an external axis in its plane, the volume of the solid figure so generated is equal to the product of the area of the figure and the distance travelled by the centre of gravity of the figure.* There is a corresponding theorem for the area.

^b The whole passage is ascribed to an interpolator by Hultsch, but without justice; and, as Heath observes (*H.G.M.* ii. 403), it is difficult to think of any Greek mathematician after Pappus's time who could have discovered such an advanced proposition.

Though the meaning is clear enough, an exact translation

REVIVAL OF GEOMETRY: PAPPUS

(m) ANTICIPATION OF GULDIN'S THEOREM^a

Ibid. vii. 41-42, ed. Hultsch 680. 30-682. 20^b

The men who study these matters are not of the same quality as the ancients and the best writers. Seeing that all geometers are occupied with the first principles of mathematics and the natural origin of the subject matter of investigation, and being ashamed to pursue such topics myself, I have proved propositions of much greater importance and utility . . . and in order not to make such a statement with empty hands, before leaving the argument I will give these enunciations to my readers. *Figures generated by a complete revolution of a plane figure about an axis are in a ratio compounded (a) of the ratio [of the areas] of the figures, and (b) of the ratio of the straight lines similarly drawn to^c the axes of rotation from the respective centres of gravity. Figures generated by incomplete revolutions are in a ratio compounded (a) of the ratio [of the areas] of the figures, and (b) of the ratio of the arcs described by the centres of gravity of the respective figures, the ratio of the arcs being itself compounded (1) of the ratio of the straight lines similarly drawn [from the respective centres of gravity to the axes of rotation] and (2) of the ratio of the angles contained about the axes of revolution by the extremities of these straight lines.*^d These propositions, which are practi-

is impossible; I have drawn on the translations made by Halley (*v. Papp. Coll.*, ed. Hultsch 683 n. 2) and Heath (*H.G.M.* ii. 402-403). The obscurity of the language is presumably the only reason why Hultsch brackets the passage, as he says: "exciderunt autem in eodem loco pauciora plurave genuina Pappi verba."

^c *i.e.*, drawn to meet at the same angles.

^d The extremities are the centres of gravity.

έχουσι δὲ αὐται αἱ προτάσεις, σχεδὸν οὖσαι μία, πλείστα ὅσα καὶ παντοῖα θεωρήματα γραμμῶν τε καὶ ἐπιφανειῶν καὶ στερεῶν, πάνθ' ἅμα καὶ μιᾷ δείξει καὶ τὰ μήπω δεδειγμένα καὶ τὰ ἤδη ὡς καὶ τὰ ἐν τῷ δωδεκάτῳ τῶνδε τῶν στοιχείων.

(n) LEMMAS TO THE TREATISES

(i.) *To the "Determinate Section" of Apollonius*

Ibid. vii. 115, ed. Hultsch, Prop. 61, 756. 28-760. 4

Τριῶν δοθεισῶν εὐθειῶν τῶν AB , $BΓ$, $ΓΔ$, εἰάν γένηται ὡς τὸ ὑπὸ $ABΔ$ πρὸς τὸ ὑπὸ $ΑΓΔ$,

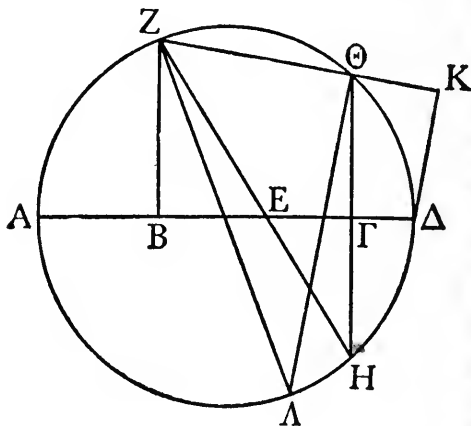

οὕτως τὸ ἀπὸ BE πρὸς τὸ ἀπὸ $ΕΓ$, μοναχὸς λόγος καὶ ἐλάχιστός ἐστιν ὁ τοῦ ὑπὸ $ΑΕΔ$ πρὸς τὸ ὑπὸ

REVIVAL OF GEOMETRY : PAPPUS

cally one, include a large number of theorems of all sorts about curves, surfaces and solids, all of which are proved simultaneously by one demonstration, and include propositions never before proved as well as those already proved, such as those in the twelfth book of these elements.^a

(n) LEMMAS TO THE TREATISES ^b

(i.) To the " *Determinate Section* " of Apollonius

Ibid. vii. 115, ed. Hultsch, Prop. 61, 756. 28-760. 4

Given three straight lines AB, BΓ, ΓΔ,^c if $AB \cdot B\Delta : A\Gamma \cdot \Gamma\Delta = BE^2 : E\Gamma^2$, then the ratio $AE \cdot E\Delta : BE \cdot E\Gamma$

^a If the passage be genuine, which there seems little reason to doubt, this is evidence that Pappus's work ran to twelve books at least.

^b The greater part of Book vii. is devoted to lemmas required for the books in the *Treasury of Analysis* as far as Apollonius's *Conics*, with the exception of Euclid's *Data* and with the addition of two isolated lemmas to Euclid's *Surface-Loci*. The lemmas are numerous and often highly interesting from the mathematical point of view. The two here cited are given only as samples of this important collection : the first lemma to the *Surface-Loci*, one of the two passages in Greek referring to the focus-directrix property of a conic, has already been given (vol. i. pp. 492-503).

^c It is left to be understood that they are in one straight line AΔ.

GREEK MATHEMATICS

ΒΕΓ· λέγω δὴ ὅτι ὁ αὐτός ἐστιν τῷ τοῦ ἀπὸ τῆς ΑΔ πρὸς τὸ ἀπὸ τῆς ὑπεροχῆς ἢ ὑπερέχει ἢ δυναμένη τὸ ὑπὸ ΑΓ, ΒΔ τῆς δυναμένης τὸ ὑπὸ ΑΒ, ΓΔ.

Γεγράφθω περὶ τὴν ΑΔ κύκλος, καὶ ἤχθωσαν ὀρθαὶ αἱ ΒΖ, ΓΗ. ἐπεὶ οὖν ἐστὶν ὡς τὸ ὑπὸ ΑΒΔ πρὸς τὸ ὑπὸ ΑΓΔ, τουτέστιν ὡς τὸ ἀπὸ ΒΖ πρὸς τὸ ἀπὸ ΓΗ, οὕτως τὸ ἀπὸ ΒΕ πρὸς τὸ ἀπὸ ΕΓ, καὶ μήκει ἄρα ἐστὶν ὡς ἡ ΒΖ πρὸς τὴν ΓΗ, οὕτως ἡ ΒΕ πρὸς τὴν ΕΓ· εὐθεία ἄρα ἐστὶν ἡ διὰ τῶν Ζ, Ε, Η. ἔστω ἡ ΖΕΗ, καὶ ἐκβεβλήσθω ἡ μὲν ΗΓ ἐπὶ τὸ Θ, ἐπιζευχθεῖσα δὲ ἡ ΖΘ ἐκβεβλήσθω ἐπὶ τὸ Κ, καὶ ἐπ' αὐτὴν κάθετος ἤχθω ἡ ΔΚ. καὶ διὰ δὴ τὸ προγεγραμμένον λῆμμα γίνεται τὸ μὲν ὑπὸ ΑΓ, ΒΔ ἴσον τῷ ἀπὸ ΖΚ, τὸ δὲ ὑπὸ ΑΒ, ΓΔ τῷ ἀπὸ ΘΚ· λοιπὴ ἄρα ἡ ΖΘ ἐστὶν ἢ ὑπεροχὴ ἢ ὑπερέχει ἢ δυναμένη τὸ ὑπὸ ΑΓ, ΒΔ τῆς δυναμένης τὸ ὑπὸ ΑΒ, ΓΔ. ἤχθω οὖν διὰ τοῦ κέντρου ἡ ΖΛ, καὶ ἐπεζεύχθω ἡ ΘΛ. ἐπεὶ οὖν ὀρθὴ ἡ ὑπὸ ΖΘΛ ὀρθῇ τῇ ὑπὸ ΕΓΗ ἐστὶν ἴση, ἔστιν δὲ καὶ ἡ πρὸς τῷ Λ τῇ πρὸς τῷ Η γωνία ἴση, ἰσογώνια ἄρα τὰ τρίγωνα· ἔστιν ἄρα ὡς ἡ ΛΖ πρὸς τὴν ΘΖ, τουτέστιν ὡς ἡ ΑΔ πρὸς τὴν ΖΘ, οὕτως ἡ ΕΗ πρὸς τὴν ΕΓ· καὶ ὡς ἄρα τὸ ἀπὸ ΑΔ πρὸς τὸ ἀπὸ ΖΘ, οὕτως τὸ ἀπὸ ΕΗ πρὸς τὸ ἀπὸ ΕΓ, καὶ τὸ ὑπὸ ΗΕ, ΕΖ, τουτέστιν τὸ ὑπὸ ΑΕ, ΕΔ, πρὸς τὸ ὑπὸ ΒΕ, ΕΓ. καὶ ἔστιν ὁ μὲν τοῦ ὑπὸ ΑΕ, ΕΔ πρὸς τὸ ὑπὸ ΒΕ,

* For, because $BZ : ΓΗ = BE : ΕΓ$, the triangles ZEB, HEG are similar, and angle ZEB = angle HEG; ∴ Γ is in the same straight line with B, E [Eucl. i. 13, Conv.].

REVIVAL OF GEOMETRY : PAPPUS

is singular and a minimum ; and I say that this ratio is equal to $A\Delta^2 : (\sqrt{A\Gamma \cdot B\Delta} - \sqrt{AB \cdot \Gamma\Delta})^2$.

Let a circle be described about $A\Delta$, and let $BZ, \Gamma H$ be drawn perpendicular [to $A\Delta$]. Then since

$$AB \cdot B\Delta : A\Gamma \cdot \Gamma\Delta = BE^2 : E\Gamma^2, \quad [\textit{ex hyp.}]$$

i.e.,

$$BZ^2 : \Gamma H^2 = BE^2 : E\Gamma^2,$$

[Eucl. x. 33, Lemma

\therefore

$$BZ : \Gamma H = BE : E\Gamma.$$

Therefore Z, E, H lie on a straight line.^a Let it be ZEH , and let $H\Gamma$ be produced to Θ , and let $Z\Theta$ be joined and produced to K , and let ΔK be drawn perpendicular to it. Then by the lemma just proved [Lemma 19]

$$A\Gamma \cdot B\Delta = ZK^2,$$

$$AB \cdot \Gamma\Delta = \Theta K^2;$$

[on taking the roots and] subtracting,

$$[ZK - \Theta K =]Z\Theta = \sqrt{A\Gamma \cdot B\Delta} - \sqrt{AB \cdot \Gamma\Delta}.$$

Let $Z\Lambda$ be drawn through the centre, and let $\Theta\Lambda$ be joined. Then since the right angle $Z\Theta\Lambda$ = the right angle $E\Gamma H$, and the angle at Λ = the angle at H , therefore the triangles [$Z\Theta\Lambda, E\Gamma H$] are equiangular ;

$$\therefore AZ : \Theta Z = EH : E\Gamma,$$

$$\textit{i.e.,} \quad A\Delta : Z\Theta = EH : E\Gamma ;$$

$$\therefore A\Delta^2 : Z\Theta^2 = EH^2 : E\Gamma^2$$

$$= HE \cdot EZ : BE \cdot E\Gamma^b$$

$$= AE \cdot E\Delta : BE \cdot E\Gamma.$$

[Eucl. iii. 35

And [therefore] the ratio $AE \cdot E\Delta : BE \cdot E\Gamma$ is

^b Because, on account of the similarity of the triangles $H\Gamma E, ZBE$, we have $HE : E\Gamma = EZ : EB$.

GREEK MATHEMATICS

ΕΓ μοναχὸς καὶ ἐλάσσων λόγος, ἢ δὲ ΖΘ ἢ ὑπεροχὴ ἢ ὑπερέχει ἢ δυναμένη τὸ ὑπὸ τῶν ΑΓ, ΒΔ τῆς δυναμένης τὸ ὑπὸ ΑΒ, ΓΔ [τουτέστιν τὸ ἀπὸ τῆς ΖΚ τοῦ ἀπὸ τῆς ΘΚ],¹ ὥστε ὁ μοναχὸς καὶ ἐλάσσων λόγος ὁ αὐτὸς ἐστὶν τῶ ἀπὸ τῆς ΑΔ πρὸς τὸ ἀπὸ τῆς ὑπεροχῆς ἢ ὑπερέχει ἢ δυναμένη τὸ ὑπὸ ΑΓ, ΒΔ τῆς δυναμένης τὸ ὑπὸ ΑΒ, ΓΔ, ὅπερ :~

(ii.) *To the "Porisms" of Euclid*

Ibid. vii. 198, ed. Hultsch, Prop. 130, 872. 23-874. 27

Καταγραφὴ ἢ ΑΒΓΔΕΖΗΘΚΛ, ἔστω δὲ ὡς τὸ ὑπὸ ΑΖ, ΒΓ πρὸς τὸ ὑπὸ ΑΒ, ΓΖ, οὕτως τὸ

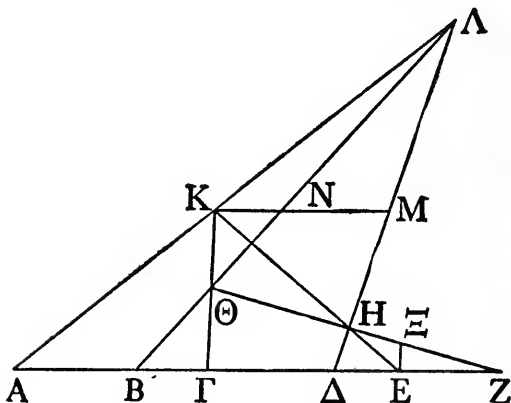

ὑπὸ ΑΖ, ΔΕ πρὸς τὸ ὑπὸ ΑΔ, ΕΖ· ὅτι εὐθείᾳ ἐστὶν ἡ διὰ τῶν Θ, Η, Ζ σημείων.

REVIVAL OF GEOMETRY : PAPPUS

singular and a minimum, while [, as proved above,]

$Z\Theta = \sqrt{A\Gamma \cdot B\Delta} - \sqrt{AB \cdot \Gamma\Delta}$, so that the same

singular and minimum ratio =

$$A\Delta^2 : (\sqrt{A\Gamma \cdot B\Delta} - \sqrt{AB \cdot \Gamma\Delta})^2. \quad \text{Q.E.D.}^a$$

(ii.) *To the "Porisms" of Euclid* ^b

Ibid. vii. 198, ed. Hultsch, Prop. 130, 872. 23-874. 27

Let $AB\Gamma\Delta EZH\Theta K\Lambda$ be a figure,^c and let $AZ \cdot B\Gamma :$
 $AB \cdot \Gamma Z = AZ \cdot \Delta E : A\Delta \cdot EZ$; [I say] that the line
 through the points Θ, H, Z is a straight line.

^a Notice the sign \sim used in the Greek for $\xi\delta\epsilon\iota \delta\epsilon\iota\zeta\alpha\iota$. In all Pappus proves this property for three different positions of the points, and it supports the view (*v. supra*, p. 341 n. a) that Apollonius's work formed a complete treatise on involution.

^b *v. vol. i. pp. 478-485.*

^c Following Breton de Champ and Hultsch I reproduce the second of the eight figures in the mss., which vary according to the disposition of the points.

¹ $\tau\omicron\upsilon\tau\epsilon\sigma\tau\iota\nu \dots \tau\eta\varsigma \Theta K$ om. Hultsch.

Ἐπεὶ ἔστιν ὡς τὸ ὑπὸ ΑΖ, ΒΓ πρὸς τὸ ὑπὸ ΑΒ, ΓΖ, οὕτως τὸ ὑπὸ ΑΖ, ΔΕ πρὸς τὸ ὑπὸ ΑΔ, ΕΖ ἐναλλάξ ἔστιν ὡς τὸ ὑπὸ ΑΖ, ΒΓ πρὸς τὸ ὑπὸ ΑΖ, ΔΕ, τουτέστιν ὡς ἡ ΒΓ πρὸς τὴν ΔΕ, οὕτως τὸ ὑπὸ ΑΒ, ΓΖ πρὸς τὸ ὑπὸ ΑΔ, ΕΖ. ἀλλ' ὁ μὲν τῆς ΒΓ πρὸς τὴν ΔΕ συνῆπται λόγος, εἰάν διὰ τοῦ Κ τῇ ΑΖ παράλληλος ἀχθῆ ἡ ΚΜ, ἔκ τε τοῦ τῆς ΒΓ πρὸς ΚΝ καὶ τῆς ΚΝ πρὸς ΚΜ καὶ ἔτι τοῦ τῆς ΚΜ πρὸς ΔΕ, ὁ δὲ τοῦ ὑπὸ ΑΒ, ΓΖ πρὸς τὸ ὑπὸ ΑΔ, ΕΖ συνῆπται ἔκ τε τοῦ τῆς ΒΑ πρὸς ΑΔ καὶ τοῦ τῆς ΓΖ πρὸς τὴν ΖΕ. κοινὸς ἐκκεκρούσθω ὁ τῆς ΒΑ πρὸς ΑΔ ὁ αὐτὸς ὢν τῷ τῆς ΝΚ πρὸς ΚΜ. λοιπὸν ἄρα ὁ τῆς ΓΖ πρὸς τὴν ΖΕ συνῆπται ἔκ τε τοῦ τῆς ΒΓ πρὸς τὴν ΚΝ, τουτέστιν τοῦ τῆς ΘΓ πρὸς τὴν ΚΘ, καὶ τοῦ τῆς ΚΜ πρὸς τὴν ΔΕ, τουτέστιν τοῦ τῆς ΚΗ πρὸς τὴν ΗΕ. εὐθεία ἄρα ἡ διὰ τῶν Θ, Η, Ζ.

Ἐὰν γὰρ διὰ τοῦ Ε τῇ ΘΓ παράλληλον ἀγάγω τὴν ΕΞ, καὶ ἐπιζευχθεῖσα ἡ ΘΗ ἐκβληθῆ ἐπὶ τὸ Ε, ὁ μὲν τῆς ΚΗ πρὸς τὴν ΗΕ λόγος ὁ αὐτὸς ἔστιν τῷ τῆς ΚΘ πρὸς τὴν ΕΞ, ὁ δὲ συνημμένος ἔκ τε τοῦ τῆς ΓΘ πρὸς τὴν ΘΚ καὶ τοῦ τῆς ΘΚ πρὸς τὴν ΕΞ μεταβάλλεται εἰς τὸν τῆς ΘΓ πρὸς ΕΞ λόγον, καὶ ὁ τῆς ΓΖ πρὸς ΖΕ λόγος ὁ αὐτὸς τῷ τῆς ΓΘ πρὸς τὴν ΕΞ. παραλλήλου οὔσης τῆς ΓΘ τῇ ΕΞ, εὐθεία ἄρα ἔστιν ἡ διὰ τῶν Θ, Ε, Ζ (τοῦτο γὰρ φανερόν), ὥστε καὶ ἡ διὰ τῶν Θ, Η, Ζ εὐθεία ἔστιν.

^a It is not perhaps obvious, but is easily proved, and is in fact proved by Pappus in the course of iv. 21, ed. Hultsch 212. 4-13, by drawing an auxiliary parallelogram.

^b Conversely, if HΘΚΑ be any quadrilateral, and any

REVIVAL OF GEOMETRY : PAPPUS

Since $AZ \cdot B\Gamma : AB \cdot \Gamma Z = AZ \cdot \Delta E : A\Delta \cdot EZ$,

permutando

$$AZ \cdot B\Gamma : AZ \cdot \Delta E = AB \cdot \Gamma Z : A\Delta \cdot EZ,$$

i.e., $B\Gamma : \Delta E = AB \cdot \Gamma Z : A\Delta \cdot EZ.$

But, if KM be drawn through K parallel to AZ,

$$B\Gamma : \Delta E = (B\Gamma : KN) \cdot (KN : KM) \cdot (KM : \Delta E),$$

and

$$AB \cdot \Gamma Z : A\Delta \cdot EZ = (BA : A\Delta) \cdot (\Gamma Z : ZE).$$

Let the equal ratios $BA : A\Delta$ and $NK : KM$ be eliminated ;

then the remaining ratio

$$\Gamma Z : ZE = (B\Gamma : KN) \cdot (KM : \Delta E),$$

i.e., $\Gamma Z : ZE = (\Theta\Gamma : K\Theta) \cdot (KH : HE) ;$

then shall the line through Θ, H, Z be a straight line.

For if through E I draw $E\Xi$ parallel to $\Theta I'$, and if ΘH be joined and produced to Ξ ,

$$KH : HE = K\Theta : E\Xi,$$

and $(\Gamma\Theta : \Theta K) \cdot (\Theta K : E\Xi) = \Theta\Gamma : E\Xi,$

$\therefore \Gamma Z : ZE = \Gamma\Theta : E\Xi ;$

and since $\Gamma\Theta$ is parallel to $E\Xi$, the line through Θ, Ξ, Z is a straight line (for this is obvious^a), and therefore the line through Θ, H, Z is a straight line.^b

transversal cut pairs of opposite sides and the diagonals in the points A, Z, Δ , Γ , B, E, then $B\Gamma : \Delta E = AB \cdot \Gamma Z : A\Delta \cdot EZ$. This is one of the ways of expressing the proposition enunciated by Desargues: *The three pairs of opposite sides of a complete quadrilateral are cut by any transversal in three pairs of conjugate points of an involution* (v. L. Cremona, *Elements of Projective Geometry*, tr. by C. Leudesdorf, 1885, pp. 106-108). A number of special cases are also proved by Pappus.

GREEK MATHEMATICS

(o) MECHANICS

Ibid. viii., Praef. 1-3, ed. Hultsch 1022. 3-1028. 3

Ἡ μηχανικὴ θεωρία, τέκνον Ἑρμόδωρε, πρὸς πολλὰ καὶ μεγάλα τῶν ἐν τῷ βίῳ χρήσιμος ὑπάρχουσα πλείστης εἰκότως ἀποδοχῆς ἠξίωται πρὸς τῶν φιλοσόφων καὶ πᾶσι τοῖς ἀπὸ τῶν μαθημάτων περισπούδαστός ἐστιν, ἐπειδὴ σχεδὸν πρώτη τῆς περὶ τὴν ὕλην τῶν ἐν τῷ κόσμῳ στοιχείων φυσιολογίας ἄπτεται. στάσεως γὰρ καὶ φορᾶς σωμάτων καὶ τῆς κατὰ τόπον κινήσεως ἐν τοῖς ὅλοις θεωρηματικῇ τυγχάνουσα τὰ μὲν κινούμενα κατὰ φύσιν αἰτιολογεῖ, τὰ δ' ἀναγκάζουσα παρὰ φύσιν ἕξω τῶν οἰκείων τόπων εἰς ἐναντίας κινήσεις μεθίστησιν ἐπιμηχανωμένη διὰ τῶν ἐξ αὐτῆς τῆς ὕλης ὑποπιπτόντων αὐτῇ θεωρημάτων. τῆς δὲ μηχανικῆς τὸ μὲν εἶναι λογικὸν τὸ δὲ χειρουργικὸν οἱ περὶ τὸν Ἡρώνα μηχανικοὶ λέγουσιν· καὶ τὸ μὲν λογικὸν συνεστάναι μέρος ἕκ τε γεωμετρίας καὶ ἀριθμητικῆς καὶ ἀστρονομίας καὶ τῶν φυσικῶν λόγων, τὸ δὲ χειρουργικὸν ἕκ τε χαλκευτικῆς καὶ οἰκοδομικῆς καὶ τεκτονικῆς καὶ ζωγραφικῆς καὶ τῆς ἐν τούτοις κατὰ χεῖρα ἀσκήσεως· τὸν μὲν οὖν ἐν ταῖς προειρημέναις ἐπιστήμαις ἕκ παιδὸς γενόμενον κὰν ταῖς προειρημέναις τέχναις ἕξιν εἰληφότα πρὸς δὲ τούτοις φύσιν εὐκίνητον ἔχοντα, κράτιστον ἔσεσθαι μηχανικῶν ἔργων εὔρετὴν καὶ ἀρχιτέκτονά φασιν. μὴ δυνατοῦ δ' ὄντος τὸν αὐτὸν μαθημάτων

* After the historical preface here quoted, much of Book viii. is devoted to arrangements of toothed wheels, already encountered in the section on Heron (*supra*, pp. 488-497). A

REVIVAL OF GEOMETRY : PAPPUS

(o) MECHANICS ^a

Ibid. viii., Preface 1-3, ed. Hultsch 1022. 3-1028. 3

The science of mechanics, my dear Hermodorus, has many important uses in practical life, and is held by philosophers to be worthy of the highest esteem, and is zealously studied by mathematicians, because it takes almost first place in dealing with the nature of the material elements of the universe. For it deals generally with the stability and movement of bodies [about their centres of gravity],^b and their motions in space, inquiring not only into the causes of those that move in virtue of their nature, but forcibly transferring [others] from their own places in a motion contrary to their nature ; and it contrives to do this by using theorems appropriate to the subject matter. The mechanicians of Heron's school^c say that mechanics can be divided into a *theoretical* and a *manual* part ; the theoretical part is composed of geometry, arithmetic, astronomy and physics, the manual of work in metals, architecture, carpentering and painting and anything involving skill with the hands. The man who had been trained from his youth in the aforesaid sciences as well as practised in the aforesaid arts, and in addition has a versatile mind, would be, they say, the best architect and inventor of mechanical devices. But as it is impossible for the same person to familiarize himself with such

number of interesting theoretical problems are solved in the course of the book, including the construction of a conic through five points (viii. 13-17, ed. Hultsch 1072. 30-1084. 2).

^b It is made clear by Pappus later (vii., Praef. 5, ed. Hultsch 1030. 1-17) that *φωρά* has this meaning.

^c With Pappus, this is practically equivalent to Heron himself : *cf.* vol. i. p. 184 n. b.

GREEK MATHEMATICS

τε τοσούτων περιγενέσθαι καὶ μαθεῖν ἅμα τὰς προειρημένας τέχνας παραγγέλλουσι τῷ τὰ μηχανικὰ ἔργα μεταχειρίζεσθαι βουλομένῳ χρῆσθαι ταῖς οἰκείαις τέχναις ὑποχειρίοις ἐν ταῖς παρ' ἕκαστα χρείαις.

Μάλιστα δὲ πάντων ἀναγκαιόταται τέχναι τυγχάνουσι πρὸς τὴν τοῦ βίου χρείαν [μηχανικὴ προηγουμένη τῆς ἀρχιτεκτονῆς]¹ ἢ τε τῶν μαγαναρίων, μηχανικῶν καὶ αὐτῶν κατὰ τοὺς ἀρχαίους λεγομένων (μεγάλα γὰρ οὗτοι βάρη διὰ μηχανῶν παρὰ φύσιν εἰς ὕψος ἀνάγουσι ἐλάττονι δυνάμει κινουῦντες), καὶ ἢ τῶν ὀργανοποιῶν τῶν πρὸς τὸν πόλεμον ἀναγκαίων, καλουμένων δὲ καὶ αὐτῶν μηχανικῶν (βέλη γὰρ καὶ λίθινα καὶ σιδηρὰ καὶ τὰ παραπλήσια τούτοις ἐξαποστέλλεται εἰς μακρὸν ὁδοῦ μῆκος τοῖς ὑπ' αὐτῶν γινομένοις ὀργάνοις καταπαλτικοῖς), πρὸς δὲ ταύταις ἢ τῶν ἰδίως πάλιν καλουμένων μηχανοποιῶν (ἐκ βάθους γὰρ πολλοῦ ὕδωρ εὐκολώτερον ἀνάγεται διὰ τῶν ἀντληματικῶν ὀργάνων ὧν αὐτοὶ κατασκευάζουσι). καλοῦσι δὲ μηχανικοὺς οἱ παλαιοὶ καὶ τοὺς θαυμασιουργούς, ὧν οἱ μὲν διὰ πνευμάτων φιλοτεχνοῦσι, ὡς Ἑρων Πνευματικοῖς, οἱ δὲ διὰ νευρίων καὶ σπάρτων ἐμφύχων κινήσεις δοκοῦσι μιμῆσθαι, ὡς Ἑρων Αὐτομάτοις καὶ Ζυγίοις, ἄλλοι δὲ διὰ τῶν ἐφ' ὕδατος ὀχουμένων, ὡς Ἀρχιμήδης Ὀχουμένοις, ἢ τῶν δι' ὕδατος ὠρολογίων, ὡς Ἑρων Ὑδρείοις, ἃ δὴ καὶ τῇ γνωμονικῇ

¹ μηχανικὴ . . . ἀρχιτεκτονῆς om. Hultsch.

* μάγγανον is properly the block of a pulley, as in Heron's
616

REVIVAL OF GEOMETRY : PAPPUS

mathematical studies and at the same time to learn the above-mentioned arts, they instruct a person wishing to undertake practical tasks in mechanics to use the resources given to him by actual experience in his special art.

Of all the [mechanical] arts the most necessary for the purposes of practical life are : (1) that of the *makers of mechanical powers*,^a they themselves being called mechanics by the ancients—for they lift great weights by mechanical means to a height contrary to nature, moving them by a lesser force ; (2) that of the *makers of engines of war*, they also being called mechanics—for they hurl to a great distance weapons made of stone and iron and such-like objects, by means of the instruments, known as catapults, constructed by them ; (3) in addition, that of the men who are properly called *makers of engines*—for by means of instruments for drawing water which they construct water is more easily raised from a great depth ; (4) the ancients also describe as mechanics the *wonder-workers*, of whom some work by means of pneumatics, as Heron in his *Pneumatica*,^b some by using strings and ropes, thinking to imitate the movements of living things, as Heron in his *Automata* and *Balancings*,^b some by means of floating bodies, as Archimedes in his book *On Floating Bodies*,^c or by using water to tell the time, as Heron in his *Hydria*,^d which appears to have affinities with the

Belopoëica, ed. Schneider 84. 12, *Greek Papyri in the British Museum* iii. (ed. Kenyon and Bell) 1164 n. 8.

^b *v. supra*, p. 466 n. a.

^c *v. supra*, pp. 242-257.

^d This work is mentioned in the *Pneumatica*, under the title *Περὶ ὑδρίων ἄροσκοπέων*, as having been in four books. Fragments are preserved in Proclus (*Hypotyposis* 4) and in Pappus's commentary on Book v. of Ptolemy's *Syntaxis*.

θεωρία κοινωνοῦντα φαίνεται. μηχανικοὺς δὲ καλοῦσιν καὶ τοὺς τὰς σφαιροποιίας [ποιεῖν]¹ ἐπισταμένους, ὕφ' ὧν εἰκῶν τοῦ οὐρανοῦ κατασκευάζεται δι' ὁμαλῆς καὶ ἐγκυκλίου κινήσεως ὕδατος.

Πάντων δὲ τούτων τὴν αἰτίαν καὶ τὸν λόγον ἐπεγνωκέναι φασὶν τινες τὸν Συρακόσιον Ἀρχιμήδη· μόνος γὰρ οὗτος ἐν τῷ καθ' ἡμᾶς βίῳ ποικίλη πρὸς πάντα κέχρηται τῇ φύσει καὶ τῇ ἐπινοίᾳ, καθὼς καὶ Γέμιος ὁ μαθηματικὸς ἐν τῷ Περὶ τῆς τῶν μαθημάτων τάξεώς φησιν. Κάρπος δὲ πού φησιν ὁ Ἀντιοχεὺς Ἀρχιμήδη τὸν Συρακόσιον ἐν μόνον βιβλίον συντεταχέναι μηχανικὸν τὸ κατὰ τὴν σφαιροποιίαν, τῶν δὲ ἄλλων οὐδὲν ἠξιωκέναι συντάξαι. καίτοι παρὰ τοῖς πολλοῖς ἐπὶ μηχανικῇ δοξασθεῖς καὶ μεγαλοφυῆς τις γενόμενος ὁ θαυμαστὸς ἐκεῖνος, ὥστε διαμεῖναι παρὰ πᾶσιν ἀνθρώποις ὑπερβαλλόντως ὑμνούμενος, τῶν τε προηγουμένων γεωμετρικῆς καὶ ἀριθμητικῆς ἐχομένων θεωρίας τὰ βραχύτατα δοκοῦντα εἶναι σπουδαίως συνέγραφεν· ὅς φαίνεται τὰς εἰρημένας ἐπιστήμας οὕτως ἀγαπήσας ὡς μηδὲν ἕξωθεν ὑπομένειν αὐταῖς ἐπεισάγειν. αὐτὸς δὲ Κάρπος καὶ ἄλλοι τινὲς συνεχρήσαντο γεωμετρία καὶ εἰς τέχνας τινὰς εὐλόγως· γεωμετρία γὰρ οὐδὲν βλάπτεται, σωματοποιεῖν πεφυκυῖα πολλὰς τέχνας, διὰ τοῦ συνεῖναι αὐταῖς [μήτηρ οὖν ὥσπερ οὔσα τεχνῶν οὐ βλάπτεται διὰ τοῦ φροντίζειν ὀργανικῆς καὶ ἀρχιτεκτονικῆς· οὐδὲ γὰρ διὰ τὸ συνεῖναι γεωμορία καὶ γνωμονικῇ καὶ μηχανικῇ καὶ σκηνογραφία βλάπτεται τι],² τούναντίον δὲ προάγουσα

¹ ποιεῖν om. Hultsch.

² μήτηρ . . . τι om. Hultsch.

REVIVAL OF GEOMETRY : PAPPUS

science of sun-dials; (5) they also describe as mechanicians the *makers of spheres*, who know how to make models of the heavens, using the uniform circular motion of water.

Archimedes of Syracuse is acknowledged by some to have understood the cause and reason of all these arts; for he alone applied his versatile mind and inventive genius to all the purposes of ordinary life, as Geminus the mathematician says in his book *On the Classification of Mathematics*.^a Carpus of Antioch^b says somewhere that Archimedes of Syracuse wrote only one book on mechanics, that on the construction of spheres,^c not regarding any other matters of this sort as worth describing. Yet that remarkable man is universally honoured and held in esteem, so that his praises are still loudly sung by all men, but he himself on purpose took care to write as briefly as seemed possible on the most advanced parts of geometry and subjects connected with arithmetic; and he obviously had so much affection for these sciences that he allowed nothing extraneous to mingle with them. Carpus himself and certain others also applied geometry to some arts, and with reason; for geometry is in no way injured, but is capable of giving content to many arts by being associated with them, and, so far from being injured, it is obviously, while itself

^a For Geminus and this work, *v. supra*, p. 370 n. c.

^b Carpus has already been encountered (vol. i. p. 334) as the discoverer (according to Iamblichus) of a *curve arising from a double motion* which can be used for squaring the circle. He is several times mentioned by Proclus, but his date is uncertain.

^c This work is not otherwise known.

GREEK MATHEMATICS

*μὲν ταύτας φαίνεται, τιμωμένη δὲ καὶ κοσμουμένη
δεόντως ὑπ' αὐτῶν.*

* With the great figure of Pappus, these selections illustrating the history of Greek mathematics may appropriately come to an end. Mathematical works continued to be written in Greek almost to the dawn of the Renaissance, and

REVIVAL OF GEOMETRY : PAPPUS

advancing those arts, appropriately honoured and adorned by them.^a

they serve to illustrate the continuity of Greek influence in the intellectual life of Europe. But, after Pappus, these works mainly take the form of comment on the classical treatises. Some, such as those of Proclus, Theon of Alexandria, and Eutocius of Ascalon have often been cited already, and others have been mentioned in the notes.

INDEX

This index does not include references to critical notes nor to authors cited, for which the separate catalogue should be consulted. References to vol. i. are cited by the page only, those to vol. ii. by volume and page. The abbreviations "incl." = "including" and "esp." = "especially" are occasionally used.

- Abacus, 35 and nn. *b* and *c*
Achilles and the Tortoise, 369-371
Adam, James: *The Republic of Plato*, 399 nn. *a* and *c*
Addition in Greek mathematics, 46-48
Adrastus, on the geometric mean, 125 n. *a*
Aeschylus, 258 n. *a*
Aëtius: *Placita*, 217 and n. *c*
Agorastes, character in Lucian's *Auction of Souls*, 91
Alexander Aphrodisiensis, 173, 236 n. *a*, 315
Alexander the Great, 155 n. *b*, 175
Algebra:
 Geometrical algebra of Pythagoreans, 186-215
 Pure determinate equations, ii. 525
 Quadratic equations: geometrical solution by Pythagoreans, 186-215; solutions by Heron, ii. 503-505 (incl. n. *a*); by Diophantus, ii. 527-535 (esp. ii. 533 n. *b*); *v.* also Square root, extraction of
Simultaneous equations leading to a quadratic, ii. 537
Cubic equations: Archimedes, ii. 127-163 (incl. n. *a*); Diophantus, ii. 539-541; *v.* also Cube root
Indeterminate equations: Pythagorean and Platonic formulae for right-angled triangles, 90-95; side- and diameter-numbers, 132-139; "bloom" of Thymaridas, 139-141; "cattle problem" of Archimedes, ii. 202-205; Heron, ii. 505-509; Diophantus, ii. 541-551
Sums of squares, ii. 551-559
Allman, J. G., his *Greek*

INDEX

- Geometry from Thales to Euclid*, 237 n. *b*
- Almagest*: Arabic name for Ptolemy's *Syntaxis*, ii. 409 n. *b*
- Alphabet, Greek: use as numerals, 42-44
- Ameristus, 147 and n. *b*
- Amthor, A., on Archimedes' cattle problem, 17 n. *c*, ii. 205 n. *b*
- Amyclas (*recte* Amyntas) of Heraclea, 153 and n. *b*
- Amyntas: *v.* Amyclas
- Analemma: of Ptolemy, 301 n. *b*, ii. 409 n. *b*; of *Diodorus*, 301 and n. *b*
- Analysis: discussion by Pappus, ii. 597-599; applied by Eudoxus to theory of "the section," 153 and n. *a*; *v.* also Leodamas
- Anatolius, bishop of Laodicea: on the meaning of the name *mathematics*, 3; on the Egyptian method of reckoning, 3 n. *a*, ii. 515-517; the classification of mathematics, 19 and n. *b*; his relation to Diophantus, ii. 517 n. *a*
- Anaxagoras: wrote on squaring of circle while in prison, 308, 149 n. *d*; character in Plato's *Rivals*, 149 n. *f*
- Anchor-ring, *v.* Tore
- Angle: angle in semi-circle, 167-169; *mixed* angles, 429 n. *c*; equality of right-angles, 443 and n. *b*
- Anharmonic ratios, 485 n. *e*
- Anthemius of Tralles, ii. 357 n. *a*
- Anticleides, 175
- Antiphon, 311 and n. *a*, 313 and n. *a*, 315 and n. *a*, 317 n. *a*
- Apollodorus the Calculator, 169 and n. *a*
- Apollonius of Perga:
Life: ii. 277 (esp. n. *a*)-281
Works:
Conics: Relation to previous works, 487-489 (incl. n. *a*), ii. 277-281; scope of the work, ii. 281-285; terminology, ii. 285-289, ii. 309 and n. *a*, ii. 317 and n. *a*, ii. 323; construction of the sections, ii. 289-305; fundamental properties, ii. 305-329—parabola, ii. 305-309, hyperbola, ii. 309-317, ii. 323-329, ellipse, ii. 317-323; transition to new diameter, ii. 329-335; introduction of axes, ii. 289 n. *a*, ii. 331 n. *a*; generality of his methods, ii. 289 n. *a*; form of his proofs, ii. 289 n. *a*; contrast with Archimedes' treatment, ii. 323 *a*, and terminology, ii. 283 n. *a*; his distinctive achievement to have based his treatment on the theory of *applied*

INDEX

- areas*, ii. 309 n. *a* ;
 first to have recognized two branches of hyperbola, ii. 329 n. *a* ;
 focus - directrix property not used, 495 n. *a*, ii. 281 n. *a*
- On the Cutting-off of a Ratio*, ii. 337-339 ;
 included in *Treasury of Analysis*, ii. 337 ;
 Halley's Latin translation, ii. 337 n. *a*
- On the Cutting-off of an Area*, ii. 339 and n. *b* ;
 included in *Treasury of Analysis*, ii. 337
- On Determinate Section*, ii. 339-341 (incl. n. *a*) ;
 included in *Treasury of Analysis*, ii. 337 ;
 lemma by Pappus, ii. 607-611
- On Tangencies*, ii. 341-343 (incl. n. *b*) ;
 problem of three circles and Newton's solution, ii. 343 n. *b* ;
 included in *Treasury of Analysis*, ii. 337
- On Plane Loci*, ii. 345 and n. *c* ;
 included in *Treasury of Analysis*, ii. 337 ;
 reconstructions by Fermat, van Schooten and Simson, ii. 345 n. *c*
- On Vergings*, ii. 345-347 (incl. n. *a*) ;
 included in *Treasury of Analysis*, ii. 337 ;
 described the datum as the *assigned*, ii. 349 ;
 restoration by Samuel Horsley, ii. 347 n. *a*
- On the Dodecahedron and the Icosahedron*, ii. 349
- General Treatise*, ii. 349-351 (incl. n. *a*)
- On the Cochlias*, ii. 351 ;
 "sister of the cochloid," 335 and n. *c*
- On Unordered Irrationals*, ii. 351-353 (incl. n. *a*)
- Quick-deliverer* (on the measurement of a circle), ii. 353 and nn. *b, c*
- On the Burning Mirror*, ii. 357 and n. *b*
- Other mathematical achievements :
 Two mean proportionals, 267 n. *b*
 Continued multiplications, ii. 353-357
 Astronomy, ii. 357 n. *b*
 Otherwise mentioned : ii. 363
- Application of Areas, 186-215 ;
 explanation and history, 186-187 ;
 a Pythagorean discovery, 187 ;
 Euclid's theorems, 189-215 ;
 equivalence to solution of quadratic equations, 195 n. *a*, 197 n. *a*, 211 n. *a*, 215 n. *a* ;
 possible use by Hippocrates, 245 n. *a* ;
 use by Apollonius in his treatment of the conic sections, ii. 305-323 (esp. ii. 309 n. *a*)

INDEX

Approximations to π , 321-333 (incl. n. a), ii. 353

Archibald, R. C., his *Euclid's Book on Divisions of Figures*, 157 n. c

Archimedes

Life: A Syracusan, ii. 19; born about 287 B.C., ii. 19 and n. c; his mechanical devices used in the defence of Syracuse, ii. 19-21, ii. 25-31; his death at the hands of a Roman soldier in 212 B.C., ii. 23, ii. 33-35; his sayings, ii. 21, ii. 23, ii. 35; his contempt for the utilitarian, ii. 31, ii. 619; his request for a cylinder enclosing a sphere as a monument, ii. 33 and n. a; his absorption in his work, ii. 31-33, ii. 37; his solution of the problem of the crown, ii. 37-39, ii. 251 n. a; his Doric dialect, ii. 21 and n. b, ii. 137

Works:

On the Sphere and Cylinder, ii. 41-127; preface, ii. 41-43; axioms, ii. 43-45; postulates, ii. 45-47; surface of cylinder, ii. 67-77; surface of cone, ii. 77-81; surface of sphere, ii. 113-117; volume of sphere, ii. 119-127; trigonometrical equivalents, ii. 91 n. b, ii.

101 n. a, ii. 109 n. a; equivalence to integration, ii. 41 n. a, ii. 117 n. b; problem leading to solution of cubic equation, ii. 127-163 (incl. n. a); cited by Zenodorus, ii. 393, ii. 395; Eutocius's commentaries, ii. 73 n. a, ii. 77 n. a, ii. 127 n. a, ii. 135-163; otherwise mentioned, ii. 165 n. a

On Conoids and Spheroids, ii. 165-181; preface, ii. 165; lemmas, ii. 165-169; volume of segment of paraboloid of revolution, ii. 171-181; equivalence to integration, ii. 181 n. a

On Spirals, ii. 183-195; definitions, ii. 183-185; fundamental property, ii. 185-187; vergings assumed, ii. 187-189 (incl. n. c), ii. 195 n. a; property of sub-tangent, ii. 191-195, and comments of Pappus, Tannery and Heath, ii. 195 n. b; curve used to square the circle, 335 and n. b

On the Measurement of a Circle, 317-333; Eutocius's commentary, 323 n. a; cited by Zenodorus, ii. 395 and n. a

INDEX

- Quadrature of a Parabola*, ii. 229-243 ; prefatory letter to Dositheus, ii. 229-233 ; first (mechanical) proof of area of parabolic segment, ii. 233-239 ; equivalence to integrations, ii. 239 n. *b* ; second (geometrical) proof, ii. 239-243 ; otherwise mentioned, ii. 41 n. *b*, ii. 221 n. *a*, ii. 225 and n. *b*
- Method*, ii. 221-229 ; discovery by Heiberg, ii. 221 n. *b* ; prefatory letter to Eratosthenes, ii. 221-223 ; mechanical proof of area of parabolic segment, ii. 223-229 ; gives Democritus credit for finding volume of cone and pyramid, 229-231, 411 n. *a*
- Sand-reckoner*, ii. 199-201 (incl. n. *a*)
- Cattle Problem*, 17 n. *c*, ii. 203-205 (incl. n. *a*)
- On Plane Equilibriums*, ii. 207-221 ; postulates, ii. 207-209 ; principle of lever, ii. 209-217 ; centre of gravity of parallelogram, ii. 217-221 ; of a triangle, ii. 227 and n. *a*
- On Floating Bodies*, ii. 243-257 ; discovery of Greek text by Heiberg, ii. 242 n. *a* ; William of Moerbeke's Latin translation, ii. 242 n. *a* ; postulates, ii. 243-245 ; surface of fluid at rest, ii. 245-249 ; loss of weight of solid immersed in a fluid—"Archimedes' principle," ii. 249-251 ; use of this principle to solve problem of crown, ii. 251 n. *a* ; stability of paraboloid of revolution, ii. 253-257 ; Heath's tribute to Book ii., ii. 252 n. *a*
- Liber Assumptorum*, ii. 581 n. *a*
- Other achievements :
- Discovery of 13 semi-regular solids, 217 n. *a*, ii. 195-197 (incl. n. *b*)
 - Circles inscribed in the $\alpha\rho\beta\eta\lambda\omicron\varsigma$, ii. 581 n. *a*
 - Solution of cubic equations, ii. 127-163 (incl. n. *a*)
 - Inequalities, ii. 165-169
 - Summation of series, ii. 165-169, ii. 241 and n. *a*
 - "Archimedes' Axiom," 321 n. *a*, 411 n. *a*, 455 n. *a*, ii. 47 and n. *a*, ii. 195 n. *b*, ii. 231
- Otherwise mentioned :
- Vitruvius on his proficiency in all branches of science, ii. 3 n. *a* ;

INDEX

- Pappus's tribute to his versatility, ii. 619; his method of evaluating areas, ii. 585 n. a
- Archytas, 5 n. a; on the branches of mathematics (Pythagorean *quadrivium*), 5 and n. b; on means, 113-115, 153 n. a; his proof that a super-particular ratio cannot be divided into equal parts, 131-133; Proclus's comments on his work in geometry, 151; his solution of the problem of two mean proportionals, 285-289; his work in stereometry, 7 n. a, 13 n. b; his method of representing the sum of two numbers, 131 n. e, 429 n. c
- Aristaeus: his five books of *Solid Loci* (conic sections), 487 and n. a, ii. 281 n. a, ii. 255 n. a; first demonstrated focus-directrix property, 495 n. a; his (?) *Comparison of the Five Regular Solids*, 487 n. b
- Aristarchus of Samos, ii. 3-15; a pupil of Strato of Lampsacus, ii. 3 and n. a; his theory of the nature of light, ii. 3; his heliocentric hypothesis, ii. 3-5 (incl. n. b); on the sizes and distances of the sun and moon, ii. 3-15; use of continued fractions (?), ii. 15 and n. b
- Aristophanes: reference to the squaring of the circle, 309 and n. a
- Aristotle: use of term *mathematics*, 3 n. c, 401 n. a; did not know how to square the circle, 335; on first principles of mathematics, 419-423; on the infinite, 425-429; proofs differing from Euclid's, 419 n. a, 429-431; method of representing angles, 429 n. c; on the principle of the lever, 431-433; on the parallelogram of velocities, 433; irrationality of $\sqrt{2}$, 111; on odd, even and prime numbers, 75 n. a, 78 n. a; on oblong and square numbers, 95 and n. b; on Zeno's paradoxes of motion, 366-375; on nature of geometrical proof, ii. 369
- Aristoxenus: on Plato's lecture on the Good, 389-391; his pupil Cleonides, 157 n. c
- Arithmetic:
- Its place in the Pythagorean *quadrivium*, 5 and n. b; in the education of Plato's Guardians, 7-9; in Plato's *Laws*, 21-23; in Anaximander and Geminus, 19 and n. b; difference from logistic, 7 and n. a, 17-19 (incl. n. b); Greek arithmetical notation and the chief arithmetical operations, 41-63

INDEX

- Pythagorean arithmetic :
 first principles, 67-71 ;
 classification of numbers,
 73-75 ; perfect numbers,
 75-87 ; figured numbers,
 87-99 ; some properties of
 numbers—the “ sieve ” of
 Eratosthenes, 101-103, divis-
 ibility of squares, 103-
 105 ; a theorem about cube
 numbers, 105-107 ; a prop-
 erty of the pythmen, 107-
 109 ; irrationality of $\sqrt{2}$,
 111 ; theory of proportion
 and means—arithmetic, geo-
 metric and harmonic means,
 111-115, seven other means,
 115-125, Pappus’s equations
 between means, 125-129, Plato
 on means between two squares
 or two cubes, 129-131, Archy-
 tas’s proof that a superpartic-
 ular ratio cannot be divided
 into equal parts, 131-133
- See also Theory of numbers ;
 Algebra ; Irrational, the ;
 Approximations to π ; Inequalities
- Arithmetica*, v. Diophantus
- Armillary sphere, 229 n. a
- Arrow of Zeno*, 367, 371
- Astronomy : a full notice
 excluded, x ; identical with
 sphaeric in the Pythagorean
quadrivium, 5 n. b ; in the
 education of Plato’s Guardians,
 15 ; in Anaximander and
 Geminus, 19 and n. b ;
 Isocrates’ views, 29 ; work
 of Thales, 147 n. a ; of
 Pythagoras, 149 n. b ; of
 Ecphantus, ii. 5 n. b ; of
 Oenopides, 149 n. e ; of
 Philippus of Opus, 155 n. a ;
 of Eudoxus, 15 n. a, 411-415 ;
 of Heraclides of Pontus,
 15 n. a, ii. 5 n. b ; of
 Autolycus of Pitane and
 Euclid, 490 n. a ; of
 Aristarchus of Samos, ii.
 3-15 ; of Eratosthenes, ii.
 261 n. a, ii. 263 and n. c,
 ii. 267-273 ; of Apollonius
 of Perga, ii. 277 n. a, ii.
 357 n. b ; of Posidonius,
 ii. 371 n. b ; of Hypsicles,
 ii. 395-397 ; of Cleomedes,
 ii. 399-401 ; of Hipparchus,
 ii. 407 n. a, 414 n. a ; of
 Menelaus, ii. 407 n. a ; of
 Ptolemy, ii. 409 and n. b,
 ii. 447 ; of Pappus, ii. 593
 n. a ; knowledge of astronomy
 necessary for reading Plato,
 ii. 401
- Athenaeus of Cyzicus, 153
 and n. e
- “ Attic ” numerals, 41-42
- August, E. F., 397 n. a
- Autolycus of Pitane, 491 n. a
- Axioms and postulates :
 Aristotle’s discussion, 419-
 423 ; Euclid’s postulates,
 443 ; attempt to prove the
 parallel-postulate, ii. 367-
 385 ; Archimedes’ postulates
 in his work *On the Sphere
 and Cylinder*, ii.

INDEX

- 45-47, in his work *On Plane Equilibriums*, ii. 207-209, in his work *On Floating Bodies*, ii. 243-245 (incl. n. a); "Archimedes' Axiom," 321 n. a, 411 n. a, 455 n. a, ii. 47 and n. a, ii. 231
- Bachet, ii. 537 n. b
- Barlaam, 14th century Calabrian monk: his formula for approximation to a square root, ii. 472 n. a
- Bede, the Venerable, 31 n. c
- Bees, Pappus on their choice of shape for cell, ii. 589-593
- Benecke, A., his *Ueber die Geometrische Hypothesis in Platons Menon*, 397 n. a
- Besthorn, R. O.: his edition of an-Nairizi's commentary on Euclid's *Elements*, 185 n. b
- Björnbo, A. A., on Hippocrates' quadratures, 311 n. b
- Blass, C.: his *De Platone mathematico*, 387 n. a
- Boeckh, A., 221 n. a
- Boethius, citation of Archytas's proof that a superparticular ratio cannot be divided into equal parts, 131-133
- Breton de Champ, P., ii. 611 n. c
- Bretschneider, C. A., his *Die Geometrie und die Geometer vor Eukleides*, 153 n. a
- Brochard, V., on Zeno's paradoxes, 367 n. a
- Bryson, attempt to square the circle, 315-317
- Burnet, J., on the astronomy in Plato's *Republic*, 15 n. a
- Butcher, S. H., on the hypothesis in Plato's *Meno*, 397 n. a
- Callimachus, ii. 261 and n. b
- Canonic, theory of musical intervals, 19 and n. b
- Cantor, G., 42
- Carpus of Antioch, 335, ii. 619
- Case ($\pi\tau\acute{\omega}\sigma\iota\varsigma$), ii. 347
- Casting out of nines, 107-109
- Catasterismi*, work by Eratosthenes, ii. 263 n. a
- Catoptrics*, v. Euclid: Works
- Cattle-problem*, v. Archimedes: Works
- Centre of gravity: Archimedes' postulates, ii. 209; of a lever, ii. 209-217; of a parallelogram, ii. 217-221; of a triangle, ii. 217 n. b, ii. 227 and n. a; of a trapezium and parabolic segment, ii. 217 n. b; of a segment of a paraboloid, ii. 225
- Chaldaeans, ii. 397 n. a
- Chasles, M., 485 n. e, ii. 581 n. c
- Chords, Table of: Hipparchus and Menelaus, ii. 407, ii. 409 and n. a; Ptolemy, ii. 443-445
- Chrysippus, 229 n. a
- Cicero: restored monument to Archimedes, ii. 33 n. a

INDEX

- Circle :
- Division into degrees, ii. 395-397
 - Squaring of the circle :
 - Anaxagoras's work in prison, 309 ; a reference by Aristophanes, 309 ; approximation by polygons — Antiphon, 311-315, Bryson, 315-317, Archimedes, 317-333 ; solutions by higher curves — Simplicius's summary, 335, the quadratrix, 337 - 347 ; closer approximations by Archimedes, 333 n. a, and Apollonius, ii. 353 ; Pappus's collection of solutions, ii. 581 n. b
 - Apparent form of circle, ii. 593-597
 - Cisoid, viii ; discovered by Diocles, 271 n. a, ii. 365 n. a ; and by him used for finding two mean proportionals, 271-279
 - Cleanthes, ii. 5
 - Cleomedes : life and works, ii. 267 n. b, ii. 397 n. a ; on the measurement of the earth, ii. 267-273 ; on paradoxical eclipses, ii. 397-401
 - Cleonides, 157 n. c
 - Cochlias, 335, ii. 351
 - Cochloids, 301 n. a, 335 and n. c, 297 n. c
 - Commandinus, his edition of Pappus's *Collection*, 499 n. a, ii. 581 n. c
 - Concentric spheres, Eudoxus's theory of, 411-415
 - Conchoid, 297, 301 n. a ; used by Nicomedes to trisect an angle, 297-309
 - Cone : double cone defined by Apollonius, ii. 285-287 ; single cone defined, ii. 287 ; volume enunciated by Democritus, 229-231 ; and proved by Eudoxus, 229-231, 409-411 ; subcontrary section a circle, ii. 301 n. a
 - Conic sections : discovered by Menaechmus, 279-283 (incl. n. a), 297, ii. 281 n. a ; originally called sections of a right-angled, acute-angled and obtuse-angled cone, 283 n. a, ii. 279 ; by Apollonius renamed parabola, ellipse and hyperbola, 283 n. a ; treatises written by Aristaeus and Euclid, 487 and n. a, ii. 255 n. a, ii. 281 n. a ; "locus with respect to three or four lines," 487-489 ; Euclid on generation of ellipse, 491 ; focus-directrix property assumed by Euclid, 495 and n. a ; terminology of Archimedes, ii. 281 n. a, ii. 283 n. a ; area of parabolic segment found by Archimedes mechanically, ii. 223-227, ii. 233-239, geometrically, ii. 239-245 ; properties assumed by Archimedes, ii. 171, ii. 175,

INDEX

- ii. 253, ii. 255; relation of Apollonius's treatise to previous works, ii. 277-281; scope of his treatise, ii. 281-285; definitions, ii. 285-289; construction of the sections, ii. 289-305; fundamental properties, ii. 305-329; meaning of *diameter*, ii. 287; ordinates, ii. 289; conjugate diameters, ii. 289; transition to new diameter, ii. 329-335; principle axes, ii. 289 and n. a, ii. 331 n. a; conjugate axes, ii. 289; opposite branches of hyperbola, ii. 323-329 (incl. n. a); basis of Apollonius's treatment the application of areas, ii. 309 n. a; "figure" of a conic section, ii. 317 n. a; *latus rectum*, ii. 309 and n. a, ii. 317 and n. a; transverse side, ii. 317 and n. a; Cartesian equivalents, 283 n. a, ii. 323 n. a; use of conic sections to solve cubic equations—by Archimedes, ii. 137-159; by Dionysodorus and Diocles, ii. 163 n. a; to find two mean proportionals, 279-283; to trisect an angle, 357-363
- Conon of Samos, ii. 35 n. b, ii. 229
- Conversion, in geometry, 159 and n. a
- Cube: one of five regular solids, 217, 223, 379, 467-475; inscription in sphere by Pappus, ii. 575 n. a; duplication of cube—task set to Delians and Plato's advice sought, 257; a poetic version, 257-259; reduced to finding of two mean proportionals, 259; collection of solutions by Eutocius, 263 n. a; by Pappus, ii. 581 n. b
- Cube root: $\sqrt[3]{100}$ found by Heron, 61-63; Heron's value for $\sqrt[3]{97050}$, 63 n. a; approximations by Philon of Byzantium, 63 n. a
- Cubic equations: c.e. arising out of Archimedes' *De Sph. et Cyl.*, ii. 133 n. d; solved by Archimedes by use of conics, ii. 137-159 (esp. 141 n. a); also by Dionysodorus and Diocles, ii. 163 n. a; Archimedes able to find real roots of general cubic, ii. 163 n. a; cubic equation solved by Diophantus, ii. 539-541
- Damianus of Larissa, ii. 497 n. a; his book *On the Hypotheses in Optics*, ii. 497; an abridgement of a larger work based on Euclid, ii. 497 n. a
- Definitions: discussed by Plato, 393; by Aristotle, 423; Euclid's d., 67-71, 437-441, 445-453, 479; Archimedes' d., ii. 43-45, ii. 165, ii. 183-185; Apollonius's d., ii. 285-289;

INDEX

- Heron's d., ii. 467-471; Diophantus's d., ii. 519-523
- De Fortia D'Urban, Comte, his *Traité d'Aristarque de Samos*, ii. 15 n. b
- Demel, Seth: his *Platons Verhältnis zur Mathematik*, 387 n. a
- Demetrius of Alexandria, 349 and n. b
- Democritus: life and works, 229 n. a; reflections on the indefinitely small, 229; enunciated formulæ for volumes of cone and pyramid, 229-231, 411 n. a
- De Morgan, 447 n. a
- Descartes, system of co-ordinates conceived through study of Pappus, ii. 601 n. a
- Dichotomy of Zeno*, 369 and n. b
- Diels, H.: his *Die Fragmente der Vorsokratiker*, xvi, 5, 73, 75, 113, 173, 217
- Digamma: use as numeral, 43
- Dimension, 85, ii. 411-413, ii. 515, ii. 601-603
- Dinostratus, 153 and n. d
- Diocles: his date, ii. 365 n. a; his discovery of the cissoid, viii, 270-279; his solution of a cubic equation, ii. 135, ii. 163 n. a
- Diodorus of Alexandria: his *Analemma*, 301 and n. b
- Diodorus Siculus: his account of the siege of Syracuse, ii. 23 and n. a
- Dionysius, a friend of Heron, ii. 467
- Dionysodorus: of Caunus?, ii. 364 n. a; his solution of a cubic equation, ii. 135, ii. 163 n. a; his book *On the Spire*, ii. 481
- Diophantus of Alexandria: life, ii. 513, ii. 517 n. b; on the unit, ii. 515; on the Egyptian method of reckoning, ii. 515; his *Arithmetica*, ii. 517 and n. b; his work (?) entitled *Porisms*, ii. 517 and n. c; his treatise *On Polygonal Numbers*, ii. 515, ii. 561; his contributions to algebra—notation, ii. 519-525; pure determinate equations, ii. 525; quadratic equations, ii. 527-535, esp. ii. 533; simultaneous equations leading to a quadratic, ii. 537; cubic equation, ii. 539-541; indeterminate analysis, 139 n. b; indeterminate equations of the second degree, ii. 541-547; indeterminate equations of higher degree, ii. 549-551; theory of numbers—sums of squares, ii. 551-559
- Dioptra: ancient theodolite, ii. 467; Heron's book, ii. 485-489
- Diorismi*, 151 and n. h, 395-397, ii. 135 n. a
- Division in Greek mathematics, 51-61
- Division of Figures: Euclid's book, 157 n. c; a problem in Heron's *Metrica*, ii. 483-485

INDEX

- Dodecahedron: one of the five regular solids, 217, 223 and n. *b*; Hippasus said to have been drowned for revealing it, 223-225; comparison with the icosahedron, ii. 349
- Dositheus of Pelusium: works dedicated to him by Archimedes, ii. 41, ii. 229
- Dyad, 75 and n. *a*, 427 n. *b*
- Earth: circumference calculated by Posidonius, ii. 267; by Eratosthenes, ii. 267-273
- Ecliptic, 149 n. *e*
- Epphantus, ii. 5 n. *b*
- Eecke, Paul Ver, *v.* Ver Eecke
- Egyptian method of reckoning, 17, 21, ii. 515-517
- Egyptian papyri, calculations in, 45-47
- Egyptian *se-quet*, 165 n. *b*
- Elements: meaning of term, 151 n. *c*; Leon's collection, 151; Euclid's *Elements*, 157, 437-479; *Elements of Conics*, 487 n. *a*, ii. 151, ii. 153; Pappus's *Collection* so described, ii. 607
- Eneström, G., 63 n. *a*
- Enneagon: relation of side of enneagon to diameter ($=\sin 20^\circ$), ii. 409 n. *a*
- Epanthema*, "bloom," of Thymaridas, 139-141
- Equations: *v.* Cubic equations, Quadratic equations
- Eratosthenes: Life and achievements, 156 and n. *a*, ii. 261 and n. *a*; his work *On Means* included in the *Treasury of Analysis*, ii. 263 and n. *d*; discussed *loci with reference to means*, ii. 263 n. *d*, ii. 265 and n. *a*; his *Platonicus*, 257 and ii. 265-267; his *sieve* for finding successive odd numbers, 100-103; letter of pseudo-Eratosthenes to Ptolemy Euergetes, 257-261; his solution of the problem of two mean proportionals, 291-297; his solution derided by Nicomedes, 297-299; his measurement of the circumference of the earth, ii. 267-273; Archimedes' *Method* dedicated to him, ii. 221; *Cattle Problem* said to have been sent through him, ii. 203; his teachers and pupils, ii. 261-263; his nicknames, ii. 261-263; his other works, ii. 263
- Erycinus, Paradoxes of, ii. 571-573
- Euclid:
 Life: Born in time of Ptolemy I, 155 and n. *b*; not to be confused with Euclid of Megara, 155 n. *b*; his school at Alexandria, 437 n. *a*, 489, ii. 35 n. *b*; told Ptolemy there was no royal road in geometry, 155 (but *v.* n. *b*); contempt for those who

INDEX

studied mathematics for monetary gain, 437

Works :

Elements : meaning of the name, 151 n. c, Proclus's notice, 155-157 ; definitions, postulates and common notions, 437-445 ; "Pythagoras's Theorem," 179-185 ; application of areas, 187-215 ; theory of proportion, 445-451 ; arithmetical definitions, 67-71 ; theory of incommensurables, 451-459 ; method of exhaustion, 459-465 ; regular solids, 467-479 ; Proclus's commentary on Book i., 145 n. a ; an-Nairizi's commentary, 185 n. b ; Scholia, 215-217, 379, 409 ; T. L. Heath, *The Thirteen Books of Euclid's Elements* : v. Heath, T. L. : *The Thirteen Books*, etc.

Data : General character, 479 n. a ; definitions, 479 ; included in *Treasury of Analysis*, 479 n. a, ii. 337 ; cited, ii. 455

Porisms : Proclus's notice, 481 ; included in *Treasury of Analysis*, 481 and n. c, ii. 337 ; Pappus's comprehensive enuncia-

tion, 481-483 ; developments in theory of conics, 487 n. a ; modern reconstructions, 485 n. e ; a lemma by Pappus, ii. 611-613

Conics : a compilation based on Aristaeus, ii. 281 n. a ; Pappus on Apollonius's debt, 487-489 ; ellipse obtained as section of cone or cylinder by a plane not parallel to the base, 491 and n. b ; focus-directrix property assumed without proof, 495 n. a ; cited by Archimedes, ii. 225

Surface Loci : 399 n. a, 487 n. a ; included in *Treasury of Analysis*, 491 and n. c ; Pappus's lemmas, 363 n. a, 493-503

Optics : Euclid's text and Theon's recension, 503 and n. b, 157 and n. c ; proof that $\tan \alpha : \tan \beta < \alpha : \beta$, 503-505

On Divisions of Figures : Proclus's notice, 157 ; Woepcke's discovery of Arabic text, 157 n. c ; R. C. Archibald's restoration, 157 n. c ; a medieval Latin translation (by Gherard of Cremona?),

INDEX

- 157 n. c; similarity of Book iii. of Heron's *Metrics*, ii. 485 n. a; division of a circle into three equal parts, ii. 485 n. a
- Pseudaria*: attributed to Euclid by Proclus, 161 and n. a
- Catoptrics*: attributed to Euclid by Proclus, 157; but not otherwise known, and possibly written by Theon of Alexandria, 157 n. c
- Phenomena*: astronomical treatise, 491 n. a
- Sectio Canonis*, musical treatise doubtfully attributed to Euclid, 157 n. c
- Introductio Harmonica*, musical treatise by Cleonides, wrongly attributed to Euclid, 157 n. c
- Elements of Music*: attributed to Euclid by Proclus, 157
- Euclidean geometry, viii; its nature defined in the postulates—space an infinite, homogeneous continuum, 443 and nn. a, b, the parallel-postulate, 443 and n. c; Proclus's objection to the postulate, ii. 367-371; attempts to prove the postulate—Posidonius and Geminus, ii. 371-373, Ptolemy, ii. 373-383, Proclus, ii. 383-385; Euclid's genius in making it a postulate, 443 n. c, ii. 367 n. a; non-Euclidean geometry, 443 n. c
- Eudemus: pupil of Aristotle, 145 n. a, ii. 281; his *History of Geometry*, 145 n. a; his account of Hippocrates' quadrature of lunes, 235-253; on sum of angles of a triangle, 177-179; attributed Eucl. xii. 2 to Hippocrates, 239, 459 n. a
- Eudemus, correspondent of Apollonius: *Conics* dedicated to him, ii. 281
- Eudoxus of Cnidos: Proclus's notice, 151-153; discovered three subcontrary means, 153; increased theorems about "the section," 153; established theory of proportion, 409; credited with discovery of three subcontrary means, 121 n. a; gave proofs of volume of pyramid and cone, 409-411; must have used "Axiom of Archimedes," 411 n. a, ii. 231; established method of *exhausting* an area by polygons, 411 n. a; his theory of concentric spheres to account for planetary motions, 411-415; Menaechmus his pupil, 153; his work continued by Hermotimus of Colophon, 153; otherwise mentioned, 349 n. c

INDEX

- Eugenius Siculus, Admiral, translated Ptolemy's *Optics* into Latin, ii. 411 n. *a*
- Euripides, 259 n. *a*
- Eutocius: *On Archimedes' Sphere and Cylinder*, 263 nn. *a* and *b*, 277 n. *a*, 299 n. *a*, ii. 159 n. *a*, ii. 163 n. *a*, ii. 621 n. *a*; *On A.'s Measurement of a Circle*, 323 n. *a*
- Exhaustion, method of: originated by Antiphon, 315 n. *a*; or possibly by Hippocrates, 411 n. *a*; established by Eudoxus, 315 n. *a*, 411 n. *a*; used to prove that circles are to one another as the squares on their diameters, 239 n. *b*, 459-465; used for approximating to area of circle, 313-315
- Fermat: reconstruction of Apollonius's *On Plane Loci*, ii. 345 n. *c*; his notes on Diophantus, ii. 551 n. *a*; sums of squares, ii. 559 n. *b*
- Fractions in Greek mathematics, 45
- Geëponicus, Liber*, ii. 467 n. *a*, ii. 505 n. *b*
- Geminus: life and works, ii. 371 n. *c*; on the classification of curves, ii. 361-363, ii. 365 nn. *a* and *b*; his attempt to prove the parallel-postulate, ii. 371 n. *c*
- Geometric mean: *v.* Means
- Geometry: origins of, 145 (incl. n. *b*)-146; Proclus's summary, 145-161; Plato on its nature, 9-11; included in theoretical part of mechanics by Heron, ii. 615; for detailed subjects *v.* Table of Contents
- Gnomon: in sundials, 87 n. *a*, ii. 269-271; gnomons of dots in figured numbers, 87 n. *a*, 93 n. *a*, 95 and n. *b*, 99 and n. *a*; gnomon of a parallelogram, 193 and n. *b*, 197 n. *a*
- Gow, J., *A Short History of Greek Mathematics*, 43 n. *b*
- Guldin, Paul, ii. 605 n. *a*
- Guldin's Theorem, ii. 605 (incl. n. *a*)
- Halley, E., 485 n. *b*, ii. 337 n. *a*, ii. 339 n. *b*
- Harmonic mean: *v.* Means
- Heath, T. L. (later Sir Thomas):
A History of Greek Mathematics, x, xvi, 5 n. *b*, 23 n. *a*, 27 n. *c*, 35 nn. *a* and *b*, 43 n. *b*, 93 n. *a*, 107 n. *a*, 117 n. *a*, 139 n. *b*, 145 nn. *a* and *b*, 153 n. *a*, 155 n. *b*, 157 n. *a*, 165 nn. *a* and *b*, 169 n. *a*, 237 n. *b*, 247 n. *a*, 271 n. *a*, 311 n. *b*, 315 n. *a*, 337 n. *a*, 357 n. *a*, 457 n. *a*, 485 n. *e*, ii. 163 n. *a*, ii. 253 n. *a*, ii. 273 n. *c*, ii. 341 n. *a*, ii. 343 n. *b*, ii. 347 n. *a*,

INDEX

- ii. 351 n. *a*, ii. 357 n. *a*,
 ii. 371 n. *c*, ii. 407 n. *a*,
 ii. 467 n. *a*, ii. 489 n. *a*,
 ii. 525 n. *b*, ii. 587 n. *c*,
 ii. 589 n. *a*, ii. 605 n. *b*
- A Manual of Greek Mathematics*, 181 n. *a*
- The Thirteen Books of Euclid's Elements*, 67 n. *a*, 71 n. *b*, 85 n. *a*, 155 n. *b*, 159 n. *b*, 167 n. *b*, 181 n. *a*, 195 n. *a*, 211 n. *a*, 215 n. *a*, 437 nn. *a* and *c*, 441 n. *a*, 447 n. *a*, 457 n. *a*, ii. 367 n. *a*
- Aristarchus of Samos*, 411 n. *b*, 415 n. *c*, ii. 3 n. *a*
- The Works of Archimedes*, 17 n. *c*, 61 n. *b*, 323 n. *a*, 351 n. *b*, 493 n. *b*, ii. 25 n. *a*, ii. 117 n. *b*, ii. 163 n. *a*, ii. 181 n. *a*, ii. 205 n. *b*
- The Method*, ii. 19 n. *a*
- Apollonius of Perga*, ii. 281 n. *a*
- Diophantus of Alexandria*, 139 n. *b*, ii. 513 n. *a*, ii. 517 n. *c*, ii. 519 n. *a*, ii. 523 n. *a*, ii. 537 n. *b*
- Greek Astronomy*, 157 n. *a*, 411 n. *b*
- Heibsen, J. L., 333 n. *a*
- Heiberg, J. L., 19 n. *c*, 297 n. *a*, 311 n. *b*, 487 n. *b*, 503 n. *b*, ii. 81 n. *a*, ii. 85 n. *a*, ii. 89 n. *a*, ii. 159 n. *a*, ii. 173 n. *a*, ii. 221 n. *b*, ii. 243 n. *a*, ii. 285 n. *a*, ii. 353 n. *c*, ii. 357 n. *a*, ii. 466 n. *a*
- Helicon of Cyzicus, 263 n. *b*
- Hendecagon, ii. 409 n. *a*
- Heraclides of Pontus, ii. 5 n. *b*
- Hermodorus, correspondent of Pappus, ii. 597
- Herotimus of Colophon, 153 and n. *e*
- Herodotus, on the abacus, 35
- Heron of Alexandria:
 Life: his date a disputed question, ii. 467 n. *a*; described as "the father of the turbine," ii. 467 n. *a*
- Works, ii. 467 n. *a*:
Definitions: based on Euclid, ii. 467; definition of a point, ii. 469; of a spire, ii. 469; his terminology different from Proclus's, ii. 471 n. *a*
- Metrica*: discovery by R. Schöne and edited by his son H. Schöne, ii. 467 n. *a*; has preserved its original form more closely than Heron's other geometrical works, ii. 467 n. *a*; formula $\sqrt{s(s-a)(s-b)(s-c)}$ for area of a triangle, ii. 471-477, ii. 603 n. *a*; formula for approximation to a square root, ii. 471-472 (incl. n. *a*); volume of a spire, ii. 477-483; division of a circle into three equal parts, ii. 483-

INDEX

- 485; similarity between Book iii. and Euclid's book *On Divisions of Figures*, ii. 485 n. a; extraction of a $\sqrt[3]{100}$, 60-63; Archimedes' approximation to π , 333
- Dioptra*: the dioptra, an instrument like a theodolite, ii. 467 n. a; measurement of an irregular area, ii. 485-489; problem of moving a given force by a given weight using an arrangement of toothed wheels, ii. 489 - 497; similar solutions found in the *Mechanics* and in Pappus, ii. 489 n. a; proof of formula for area of a triangle, ii. 477 n. a
- Mechanics*: has survived in Arabic, ii. 488 n. a, and in a few fragments of the Greek, ii. 467 n. a; problems discussed, ii. 489 n. a
- Geometrica*: quadratic equations, ii. 503-505; indeterminate analysis, ii. 505-509
- Pneumatica, Automata*, etc., ii. 467 n. a, ii. 617
- Otherwise mentioned: his addition to "Pythagoras's Theorem," 181 n. a and 185 n. b; his solution of the problem of two mean proportionals, 267-271; possible censure by Pappus, ii. 603 and n. a; on branches of mechanics, ii. 615
- Hexagon, its use by bees, ii. 589-593
- Hipparchus: life and achievements, ii. 407 n. a; founded the science of trigonometry, ii. 407 n. a; drew up a table of sines, ii. 407 and n. a; discovered precession of the equinoxes, ii. 407 n. a; his *Commentary on the Phenomena of Eudoxus and Aratus*, ii. 407 n. a, ii. 415 n. a
- Hippasus, a Pythagorean: credited with discovery of means, 153 n. a; said to have been drowned at sea for revealing secret of inscribing a dodecahedron in a sphere, 223-225 (incl. n. a)
- Hippias of Elis: life and achievements, 149 n. a; his praise of Ameristus, 149; discovered the quadratrix, 149 n. a, 337 n. a
- Hippocrates of Chios: life and achievements, 235; his quadrature of lunes, 235-253; the views of Aristotle and the commentators on his quadratures, 311 and n. b; first reduced the problem of doubling the cube to the

INDEX

- problem of finding two mean proportionals, 253, 259; possibly able to solve a quadratic equation, 245 n. *a*; discovered that circles are to one another as the squares on their diameters, 239 and n. *b*, 459 n. *a*
- Hippopede ("horse-fetter"), name given by Eudoxus to a curve, 415
- Homer, 31 n. *a*
- Horsley, S., ii. 347 n. *a*
- Hultsch, F.: his edition of Pappus's *Collection*, ii. 565 n. *a*, ii. 581 n. *c*, ii. 605 n. *b*, ii. 611 n. *c*
- Hypatia: daughter of Theon of Alexandria, 48 n. *a*; helped him in revision of commentary on Ptolemy, 48 n. *a*; her commentary on Apollonius's *Conics*, ii. 285 n. *a*; her commentary on Diophantus's *Arithmetica*, ii. 517 n. *b*
- Hypotenuse: square on, 179-185; parallelogram on, ii. 575-579
- Hypsicles: date, ii. 397 n. *a*; his division of the circle into 360 degrees, ii. 395-397; his continuation of Euclid's *Elements*, ii. 349 nn. *a* and *c*, ii. 397 n. *a*; his definition of a polygonal number, ii. 397 n. *a*, ii. 515 and n. *b*
- Iamblichus: on squaring of the circle, 335; on the "bloom" of Thymaridas, 139 n. *b*; on a property of the *pythmen*, 109 n. *a*
- Icosahedron, 221 and n. *e*, ii. 349
- Incommensurable: *v.* Irrational
- Indeterminate analysis: Pythagorean and Platonic formulae for right-angled triangles, 90-95; side- and diameter - numbers, 133-139; Archimedes' *Cattle Problem*, ii. 202-205; Heron's problems, ii. 505-509; Diophantus's problems, ii. 541-551
- Indian mathematics, 181 n. *a*
- Involution, ii. 341 n. *a*, ii. 611 n. *a*
- Irrational: Pythagoreans and the irrational, 149 n. *c*, 215-217, 225 n. *a*; "irrational diameters," 133-137 (esp. n. *a*), 399 n. *c*; proof by Theodorus and Theætetus of irrationality of $\sqrt{3}$, $\sqrt{5}$. . . $\sqrt{17}$, 381-383; Plato on irrational numbers, 401-403; Aristotle's proof of irrationality of $\sqrt{2}$, 111; Euclid's theory, 451-459; Apollonius's theory of unordered irrationals, ii. 351
- Isocrates: on mathematics in Greek education, 27-29
- Isoperimetric figures, ii. 387-395, ii. 589-593
- Karpinski, L. C., 75 n. *a*

INDEX

- Keil, 43 n. *b*
 Kepler, his investigation of semi-regular solids, ii. 197 n. *b*; on planets, 411 n. *b*
 Koppa, used as numeral, 43
 Kubitschek, 35 n. *b*
- Laird, A. G., on Plato's nuptial number, 399 n. *b*
 Larfeld, W., on Greek alphabet, 42 n. *b*
 Lemmas: Pappus's collection, ii. 607 (incl. n. *b*) -613, ii. 565 n. *a*, 493-503; lemmas to Menelaus's Theorem, ii. 447-459
 Leodamas of Thasos: Proclus's notice, 151; Plato said to have communicated method of analysis to him, 151 n. *e*
 Leon: made collection of *Elements*, and discovered *diorismi*, 151 and n. *h*
 Line: defined, 437; straight line, 439 and n. *a*; different species of curved lines ii. 361-363
 "Linear" loci and problems, 349
 "Linear" numbers, 87 n. *a*
 Loci: line loci, surface loci, and solid loci, 491 - 493 (incl. n. *a*); *Surface Loci* of Euclid, 349 and n. *a*, 487 n. *a*, ii. 601; *Solid Loci* of Aristaeus, 487, ii. 601
 Locus with respect to three or four lines, 487-489; with respect to five or six lines, ii. 601-603
 Logistic, 7, 17-19
- Loria, G.: his *Le scienze esatte nell' antica Grecia*, 47 n. *a*, 109 n. *a*, 139 n. *b*, 271 n. *a*
 Lucian, 91 n. *a*
- Mamercus, 147 n. *b*
 Marinus, his commentary on Euclid's *Data*, ii. 349, ii. 565 n. *a*
 Mathematics, meaning of the term, 3, 401 n. *a*
 Means: three Pythagorean means — arithmetic, geometric, subcontrary, 111-115; subcontrary renamed harmonic, 113; three subcontrary means added, 119-121 (incl. n. *a*); five further means discovered, 121-125; Pappus's equations between means, 125-129; Plato on means between two squares or two cubes, 129-131; duplication of cube reduced to problem of two mean proportionals, 259 and n. *b*; solutions, 261-309; Eratosthenes' work *On Means*, ii. 263; loci with reference to means, ii. 265 and n. *a*; representation of means by lines in a circle, ii. 569-571 (incl. n. *a*)
 Mechanics: Pappus on branches of mechanics, ii. 615-621; principle of lever, 431-433, ii. 209-217; parallelogram of velocities, 433; centres of gravity, ii. 207-221; five mechanical

INDEX

- powers, ii. 489 n. *a*; Archimedes' mechanical inventions, ii. 19-31; movement of larger weight by smaller by use of engaging wheels, ii. 489-497; Plato's dislike of mechanical solutions, 263 n. *b*; Archimedes' preference for theoretical mathematics, ii. 31, ii. 619; pseudo-Aristotelian *Mechanics*, 431-433; Archimedes' *On Plane Equilibriums*, ii. 207-221; his mechanical method in mensuration, ii. 221-229, ii. 233-239; Heron's *Mechanics*, ii. 467 n. *a*, ii. 489 (incl. n. *a*) -497
- Menaechmus: solution of problem of two mean proportionals, 261, 279-283; discovered the conic sections, 283 n. *a*, 297 and n. *b*, ii. 281 n. *a*
- Menelaus of Alexandria: made an observation under Trajan, ii. 407 n. *a*; discovered a curve called "paradoxical," 348-349 (incl. n. *c*); his *Sphaerica*, ii. 407 n. *a*, ii. 463 n. *a*; drew up a table of sines, ii. 407; "Menelaus's Theorem," ii. 459-463
- Mensuration: area of triangle given the sides, ii. 471-477; volume of spire, ii. 477-483; measurement of irregular area, ii. 485-489; area of parabolic segment, ii. 223-229, ii. 243
- Meton, 309 and n. *a*
- Metrodorus, ii. 513 n. *a*
- Minus*, Diophantus's sign for, ii. 525
- Moeris, 175
- Multiplication in Greek mathematics, 48; Apollonius's continued multiplications, ii. 353-357
- Music: theoretical music (canonic) included by Greeks in mathematics, *x*, 3 n. *b*, 19 n. *b*; full discussion excluded, *x*; included in Pythagorean *quadrivium*, 5; in Plato's curriculum for the Guardians, 17; popular music, 3, 19
- Musical interval, 3 n. *b*, 113 n. *b*, 175
- Myriad; notation, 44-45; orders and periods of myriads in Archimedes' notation, ii. 199-201
- Nagl, A., 35 n. *b*
- an-Nairizi, Arabic commentator on Euclid's *Elements*, 185 n. *b*, ii. 467 n. *a*
- Neoclides, 151 and n. *h*
- Nesselmann, G. F., his *Die Algebra der Griechen*, 139 n. *b*, ii. 513 n. *a*, ii. 517 n. *b*
- Newton, Sir Isaac, ii. 343 n. *b*
- Nicolas Rhabdas: *v.* Rhabdas
- Nicomachus of Gerasa, 67 n. *b*, 69 nn. *a* and *c*, 75 n. *a*, 79 n. *a*, 81 n. *a*, 87 n. *a*, 95 n. *b*, 101 n. *a*, 103 n. *a*, 105 n. *a*, 107 n. *a*, 121 n. *a*, 123 n. *c*

INDEX

- Nicomedes : date, 297 n. c ;
his conchoid and its use for
finding two mean propor-
tionals, 297-309
- Nix, L., ii. 285 n. a
- Number : defined by Euclid,
67 ; by Nicomachus, 73 ;
fundamental concepts, 67-
71 ; Plato on nature of
number, 7 ; his nuptial
number, 399 ; on genera-
tion of numbers, 401-405 ;
odd and even numbers,
67-69, 101, 391 ; prime
numbers, 69, 87 n. a, 101-
103 ; classification of num-
bers, 71, 73-75 ; perfect
numbers, 71, 75-87 ; figured
numbers, 87-99 ; some
properties of numbers, 101-
109 ; Diophantus on sums
of squares, ii. 551-559 ; on
polygonal numbers, ii. 515,
ii. 561
- Numerals, Greek, 41-45
- “ Oblong ” numbers, 95 (incl.
n. b)
- Octads, in Archimedes’ sys-
tem of enumeration, ii.
199-201
- Octahedron, one of the five
regular solids, 217, 221
and n. d
- Odd and even numbers : v.
Number
- Oenopides of Chios, 149 and
n. c
- Olympiodorus, proof of
equality of angles of inci-
dence and reflection, ii.
503 n. a
- Optics : Euclid’s treatise,
157 n. c, 503 n. b ; his
theorem about apparent
sizes of equal magnitudes,
503-505 ; Ptolemy’s treat-
ise, ii. 411 and n. a, ii. 503
n. a ; Heron’s treatise, ii.
503 n. a ; his proof of
equality of angles of inci-
dence and reflection,
ii. 497-503 ; Damianus’s
treatise, ii. 497 n. a
- Pamphila, 167-169 (incl.
n. a)
- Pappus of Alexandria :
Life : Suidas’s notice, ii.
565-567 ; date, ii. 565
and n. a
- Works :
Synagoge or *Collection*,
145 n. a, ii. 565 n.
a ; contents—Apollonius’s continued multi-
plications, ii. 353-357 ;
problems and theo-
rems, ii. 567-569 ;
theory of means,
ii. 569-571 ; equa-
tions between means,
125-129 ; paradoxes
of Erycinus, ii. 571-
573 ; regular solids,
ii. 573-575 ; extension
of Pythagoras’s theo-
rem, ii. 575-579 ;
circles inscribed in the
ἀρβηλος, ii. 579-581 ;
duplication of the
cube, 299-309 ; squar-
ing of the circle, 337-
347 ; spiral on a

INDEX

- sphere, ii. 581-587 ;
 trisection of an angle,
 347-363 ; isoperimet-
 ric figures, ii. 589-593 ;
 apparent form of a
 circle, ii. 593-597 ;
 "Treasury of Analy-
 sis," ii. 597, ii. 599-
 601, 479 n. a, 481 n. c,
 491 n. c, ii. 263, ii. 337 ;
 on the works of Apol-
 lonius, ii. 337-347,
 487-489 ; locus with
 respect to five or six
 lines, ii. 601-603 ; an-
 ticipation of Guldin's
 theorem, ii. 605-607 ;
 lemmas to the *Deter-
 minate Section* of Apol-
 lonius, ii. 607-611 ; to
 the *Porisms* of Euclid,
 ii. 611-613 ; to the
Surface Loci of Eu-
 clid, 493-503 ; me-
 chanics, ii. 615-621
 Commentary on Pto-
 lemy's *Syntaxis*, 48,
 ii. 409 n. b, ii. 565-567,
 ii. 617 n. d
 Commentary on Euclid's
Elements, ii. 565 n. a,
 457 n. a
 Commentary on *Ana-
 lemma* of Diodorus,
 301, ii. 565 n. a
 Other works, ii. 565
 (incl. n. a), 567
 Paradoxes of Erycinus, ii.
 571-573
 Parallelogram of velocities,
 433
 Parmenides, 367 n. a
 Pebbles, used for calculating,
 35
 Pentagon, regular, 223 n. b
 Pentagram, Pythagorean
 figure, 225 and n. b
 "Perfect" numbers, 71, 75-87
 Perseus : life, ii. 365 n. a ;
 discovered spiric curves, ii.
 363-365
*Phenomena of Eudoxus and
 Aratus*, ii. 407 n. a ; for
 Euclid's *Phenomena*, v.
 Euclid : Works
 Philippus of Opus (or Med-
 ma), 155 and n. a
 Philolaus, ii. 3 n. a
 Philon of Byzantium : solu-
 tion of problem of two
 mean proportionals, 263
 n. a, 267 n. b ; cube root,
 63 n. a
 Philoponus, Joannes, on
 quadrature of lunes, 311
 n. b
Planisphaerium : v. Ptolemy
 Plato : his inscription over
 the doors of the Academy,
 387 and n. b ; his belief
 that "God is for ever play-
 ing the geometer," 387 ;
 his dislike of mechanical
 constructions, 263 n. b,
 389 ; his identification of
 the Good with the One,
 389 ; his philosophy of
 mathematics, 391-393 ; the
 problem in the *Meno*, 395-
 397 ; the Nuptial Number
 in the *Republic*, 399 ; on
 the generation of numbers,
 401-405 ; his reported
 solution of the problem of

INDEX

- two mean proportionals, 263-267; his application of analysis to theorems about "the section," 153 and n. *a*; his knowledge of side- and diameter-numbers, 137 n. *a*, 399 n. *c*; his formula for the sides of right-angled triangles, 93-95, his definition of a point, ii. 469 n. *a*; his use of the term mathematics, 3 n. *c*, 401 n. *a*; his curriculum for the Guardians in the *Republic*, 7-17; Proclus's notice, 151; taught by Theodorus, 151 n. *b*; his pupils—Eudoxus, 151, Amyclas of Heraclea, 153, Menaechnus, 153, Philippus, 155; Euclid said to have been a Platonist, 157 and n. *b*; modern works on Plato's mathematics, 387 n. *a*, 397 n. *a*, 399 n. *a*, 405 n. *b*
- "Platonic" figures: *v.* Regular Solids
- "Playfair's Axiom," ii. 371 n. *c*
- Plutarch: on parallel section of a cone, 229 and n. *a*; on Plato's mathematics, 263 n. *b*, 387-389
- Point, 437, ii. 469 and n. *a*
- Polygonal numbers, 95-99, ii. 396 n. *a*, ii. 515, ii. 561
- Pontus, paradoxical eclipses near, ii. 401
- Porism, 479-481
- Porisms*: *v.* Euclid: Works, and Diophantus of Alexandria
- Posidonius: life and works, ii. 371 n. *b*; on the size of the earth, his definition of parallels, ii. 371-373
- Postulates: *v.* Axioms and postulates
- Prime numbers: *v.* Number
- Problems: plane, solid, linear, 349; distinction between problems and theorems, ii. 567
- Proclus: life, 145 n. *a*; his *Commentary on Euclid i.*, 145 n. *a*; summary of history of geometry, 145-161; his *Commentary on Plato's Republic*, 399 n. *a*; his criticism of the parallel-postulate, ii. 367-371; his attempt to prove the parallel-postulate, ii. 383-385
- Proof: Aristotle on rigour of geometrical proof, ii. 369; Archimedes on mechanical and geometrical proofs, ii. 221-223, ii. 229
- Proportion: Pythagorean theory of proportion and means, 111-125, 149; Eudoxus's new treatment applicable to all magnitudes, 409 and 447 n. *a*; Euclid's treatment, 445-451; *v.* also Means
- Psammites*: *v.* Archimedes: Works: *Sand-reckoner*
- Psellus, Michael, 3 n. *a*, ii. 515 and n. *c*, ii. 517 n. *a*
- Pseudaria*: *v.* Euclid: Works
- Pseudo-Eratosthenes, letter to Ptolemy Euergetes, 257-261

INDEX

Ptolemies : Euergetes I, 257 and n. a, ii. 261 and n. c ; Philopator, 257 n. a, 297 ; Epiphanes, ii. 261 and n. d
Ptolemy, Claudius : life and works, ii. 409 and n. b ; his work *On Balancings*, ii. 411 ; his *Optics*, ii. 411 and n. a, ii. 503 n. a ; his book *On Dimension*, ii. 411-413 ; his *Syntaxis (Great Collection, Almagest)*, ii. 409 and n. b ; commentaries by Pappus and Theon, 48 and n. a, ii. 409 n. b, ii. 565-567, ii. 621 n. a ; his construction of a table of sines, ii. 413-445 ; his *Planisphaerium*, ii. 565 n. a ; his *Analemma*, 301 n. b, ii. 409 n. b ; his value for $\sqrt{3}$, 61 n. b ; on the parallel-postulate, ii. 373-383
Pyramid : v. Tetrahedron
Pythagoras : life, 149 n. b, 173 ; called geometry *inquiry*, 21 ; transformed study of mathematics into liberal education, 149 ; discovered theory of proportionals (possibly irrationals), 149 ; discovered musical intervals, 175 ; sacrificed an ox on making a discovery, 169 n. a, 175, 177, 185 ; "Pythagoras's Theorem," 179-185 ; extension by Pappus, ii. 575-579
Pythagoreans :
 General : use of name mathematics, 3 ; esoteric

members called *mathematicians*, 3 n. d ; Archytas a Pythagorean, 5 ; Pythagorean quadrivium, 5 and n. b, 7 n. a ; stereometrical investigations, 7 n. a ; declared harmony and astronomy to be sister sciences, 17 and n. b ; how geometry was divulged, 21 ; views on monad and undetermined dyad, 173 ; their motto, 175-177
Pythagorean arithmetic : first principles, 67-71 ; classification of numbers, 73-75 ; perfect numbers, 75-83 ; figured numbers, 87-99 ; some properties of numbers, 101-109 ; irrationality of $\sqrt{2}$, 111 n. a ; ancient Pythagoreans recognized three means, 111-115 ; later Pythagorean list of means, 115-125 ; Archytas's proof that a superparticular ratio cannot be divided into equal parts, 131-133 ; developed theory of side- and diameter-numbers, 137-139 ; the "bloom" of Thymaridas, 139-141
Pythagorean geometry : definition of point, ii. 469 ; sum of angles of a triangle, 177-179 ; "Pythagoras's Theorem," 179-185 ; application of areas, 187-215 ; the irra-

INDEX

- tional, 215-217; the five regular solids, 217, 219 n. *a*, 223-224; Archytas's solution of the problem of two mean proportionals, 285-289; squaring of the circle, 335
- Otherwise mentioned: 245 n. *a*, 403 nn. *c* and *d*
- Quadratic equations: *v.* Algebra: Quadratic equations
- Quadratrix: discovered by Hippias, 149 n. *a*, 337 n. *a*; used to square the circle, 337-347
- Quadrivium, Pythagorean, 5 and n. *b*, 7 n. *a*
- Quinary system of numerals, 31 n. *a*
- Reduction of a problem: Proclus's definition, 253; Hippocrates' reduction of problem of doubling the cube, 253 and n. *a*
- Reflection, equality of angles of incidence and reflection, ii. 497-503
- Regular solids ("Platonic" or "cosmic" figures): definition and origin, 217 n. *a*; Pythagorean treatment, 217-225; Speusippus's treatment, 77; work of Theaetetus, 379 and n. *a*; Plato's use in *Timaeus*, 219-223; Euclid's treatment, 157 and n. *b*, 467-479; Pappus's treatment, ii. 573-575 (esp. n. *a*); Eva Sachs' work, 217 n. *a*, 379 n. *c*
- Rhabdas, Nicolas Artavasdadas, 31 n. *b*; his finger-notation, 31-35
- Right-angled triangle: square on hypotenuse equal to sum of squares on other two sides, 179-185; extension by Pappus, ii. 575-579
- Roberts, Colin, 45 n. *a*
- Robertson, D. S., ii. 479 n. *a*
- Rome, A., ii. 565 n. *a*
- Ross, W. D., 95 n. *b*, 367 n. *a*, 371 n. *b*
- Rudio, F., 237 n. *b*
- Saccheri, *Euclides ab omni naevo vindicatus*, 443 n. *c*
- Sachs, Eva, *Die fünf Platonischen Körper*, 217 n. *a*, 379 n. *c*; *De Theaeteto Atheniensi*, 379 n. *a*
- Salaminian table, 35 n. *b*, 37 n. *a*
- Sampi: use as numeral, 43
- Schiaparelli, G., 411 n. *b*, 415 n. *c*
- Schöne, H.: discovered Heron's *Metrica*, ii. 467 n. *a*
- Schöne, R.: edited Heron's *Metrica*, ii. 467 n. *a*
- Scopinas of Syracuse, ii. 3 n. *a*
- Sectio canonis*: *v.* Euclid: Works
- Semi-circle: angle in semi-circle a right angle, 167-169
- Serenus: commentary on

INDEX

- Apollonius's *Conics*, ii. 285
n. a
- Sexagesimal system of numerals, 48-49
- "Side-" and "diameter-numbers," 133-139, esp. 137 *n. a*, 399 *n. c*
- Simon, M., *Euclid und die sechs planimetrischen Bücher*, 447 *n. a*
- Simplicius: on Hippocrates' quadratures, 235-253, 310 *n. b*, 313 *n. a*; on Ptolemy, ii. 409 *n. b*; on oblong and square numbers, 95 *n. b*; on planets, 411 and *n. b*
- Simson, R., ii. 345 *n. c*
- Sines, Table of: *v.* Chords, Table of
- "Solid" loci and problems, 349, 487, ii. 601
- "Solid" numbers: *v.* Number: Figured numbers
- Solids, five regular solids: *v.* Regular solids
- Solon, 37
- Sophocles, ix, 259 *n. a*
- Speusippus, 75-77, 81 *n. a*
- Sphaeric (geometry of sphere), 5 and *n. b*, 407 *n. a*
- Sphaerica*: work by Theodosius, ii. 407 *n. a*; by Menelaus, ii. 407 *n. a*, ii. 462 *n. a*
- Spiral: of Archimedes, ii. 183-195, on a sphere, ii. 581-587
- Spiric sections: *v.* Tore
- Sporus, on the quadratrix, 339-341
- Square numbers: divisibility of squares, 103-105; sums of squares, ii. 551-559
- Square root, extraction of, 53-61
- Squaring of the circle: *v.* Circle
- Stadium of Zeno*, 371-375
- Star-pentagon: *v.* Pentagon
- Stenzel, Julius: his *Zahl und Gestalt bei Platon und Aristoteles*, 405 *n. b*
- Stigma: use as numeral, 43
- Subcontrary mean, 113-117, 117-119, 123
- Subcontrary section of cone, ii. 301 *n. a*
- Surface Loci*: *v.* Euclid: Works
- Synthesis, Pappus's discussion, ii. 597-599
- Table of Chords: *v.* Chords, Table of
- Tannery, P., 77 *n. b*, 237 *n. b*, 261 *n. b*, 335 *n. d*, 493 *n. b*, ii. 513 *n. a*, ii. 517 *nn. a* and *c*, ii. 523 *n. b*, ii. 537 *n. b*
- Taylor, A. E., 23 *n. b*, 27 *n. b*, 115 *n. b*, 223 *n. c*, 405 *n. b*, 427 *n. b*
- Tetrads, in Apollonius's system of enumeration, ii. 355 *n. a*
- Tetrahedron (pyramid), 83, 217 *n. a*, 221 *n. c*, 379
- Thales: life, 147 *n. a*; Proclus's notice, 147; discovered that circle is bisected by its diameter, 165 and *n. a*; that the angles

INDEX

- at the base of an isosceles triangle are equal, 165; that the vertical and opposite angles are equal, 167; that the angle in a semicircle is a right angle, 167-169; his method of finding distance of ships at sea, 167 and n. *b*
- Theaetetus: life, 379 and n. *a*; Proclus's notice, 151; Suidas's notice, 379; his work on the regular solids, 379 and n. *c*; on the irrational, 381-383
- Themistius: on quadrature of lunes, 310 n. *b*; on oblong and square numbers, 95 n. *b*
- Theodorus of Cyrene: life, 151 n. *b*, 381 n. *b*; Proclus's notice, 151; his proof of incommensurability of $\sqrt{3}, \sqrt{5} \dots \sqrt{17}$, 381 and n. *c*
- Theodosius: his *Sphaerica*, ii. 407 n. *a*
- Theodosius I, Emperor, ii. 565 and n. *a*
- Theon of Alexandria: flourished under Theodosius I, 48 n. *a*, ii. 565; father of Hypatia, 48; to be distinguished from Theon of Smyrna, ii. 401 n. *a*; his commentary on Ptolemy's *Syntaxis*, 48, ii. 409 n. *b*, ii. 565-567, ii. 621 n. *a*
- Theon of Smyrna: referred to as "Theon the mathematician" by Ptolemy, ii. 401; made observations under Hadrian, ii. 401 and n. *a*; referred to as "the old Theon" by Theon of Alexandria, ii. 401 n. *a*
- Theophrastus, 217 n. *c*
- Theorems, distinction from problems, ii. 567
- Theudius of Magnesia, 153
- Thymaridas: an early Pythagorean, 139 n. *b*; his "bloom," 139-141; on prime numbers, 87 n. *a*
- Timaeus of Locri, 219 n. *a*
- Tore (also spire, or anchoring ring): defined, ii. 365, ii. 469; used by Archytas for the doubling of the cube, 285-289; sections of (Perseus), ii. 363-365; volume of (Dionysodorus and Heron), ii. 477-483
- Treasury of Analysis*: v.
- Pappus: Works
- Triangle: angles at base of an isosceles triangle equal, 165 and n. *b*; equality of triangles, 167 and n. *b*; sum of angles equal to two right angles, 177-179, ii. 279; "Pythagoras's Theorem," 179-185; extension by Pappus, ii. 575-579; Heron's formula $\sqrt{s(s-a)(s-b)(s-c)}$ for area, ii. 471-477, ii. 603 n. *a*
- Triangular numbers, 91-95
- Trigonometry: origins in *sphaeric*, ii. 407 n. *a*; developed by Hipparchus and Menelaus, ii. 407 and n. *a*; their tables of sines, ii. 407 n. *a*, ii. 409 and n. *a*;

INDEX

- Ptolemy's terminology, ii. 421 n. *a*; his construction of a table of sines, ii. 413-445; value of $\sin 18^\circ$ and $\sin 36^\circ$, ii. 415-419, ii. 421 n. *a*; of $\sin 60^\circ$, $\sin 90^\circ$, $\sin 120^\circ$, ii. 419-421 (incl. n. *a*); proof of $\sin^2 \theta + \cos^2 \theta = 1$, ii. 421-423; of "Ptolemy's Theorem," ii. 423-425; of $\sin(\theta - \phi) = \sin \theta \cos \phi - \cos \theta \sin \phi$, ii. 425-427; of $\sin^2 \frac{1}{2}\theta = \frac{1}{2}(1 - \cos \theta)$, ii. 429-431; of $\cos(\theta + \phi) = \cos \theta \cos \phi - \sin \theta \sin \phi$, ii. 431-435; a method of interpolation, ii. 435-443; the table of sines, ii. 443-445; "Mene-laus's Theorem" and lemmas, ii. 447-463; proof that $\tan \alpha : \tan \beta < \alpha : \beta$, 503-505 (incl. n. *a*), ii. 11 n. *b*, ii. 389 and n. *b*; proof that $\sin \alpha : \sin \beta < \alpha : \beta$, ii. 439 n. *a*
- Trisection of an angle: a "solid" problem, 353; solution by means of a verging, 353-357; direct solution by means of conics, 357-363; Pappus's collection of solutions, ii. 581 n. *b*
- Unit, 67, 73, 89-91, ii. 469, ii. 515
- Usener, 237 n. *b*
- Valckenaer, 259 n. *a*
- Ver Eecke, Paul, ii. 19 n. *a*, ii. 285 n. *a*, ii. 513 n. *a*
- Vergings: Definition, 244 n. *a*; use by Hippocrates of Chios, 245; by Pappus, 355-357; by Archimedes, ii. 189 and n. *c*; Apollonius's treatise, ii. 345-347, ii. 337
- Vieta's expression for $2/\pi$, 315 n. *a*
- Vitruvius, ii. 3 n. *a*, ii. 251 n. *a*
- Viviani's curve of double curvature, 349 n. *c*
- Wescher, C., his *Poliorcétique des Grecs*, 267 n. *b*
- Wilamowitz - Moellendorf, U. v., 257 n. *a*
- William of Moerbeke; his trans. of Archimedes' *On Floating Bodies*, ii. 242 n. *a*, ii. 245 n. *b*; *De Speculis*, ii. 503 n. *a*
- Xenocrates, 75, 425 n. *b*
- Zeno of Elea: life, 367 n. *a*; a disciple of Parmenides, ii. 367 n. *a*; four arguments on motion, 367-375
- Zenodorus, ii. 387 n. *b*; on isoperimetric figures, ii. 387-397
- Zero, 47 and n. *a*
- Zeuthen: *Die Lehre von den Kegelschnitten im Altertum*, 493 n. *b*, ii. 265 n. *a*, ii. 281 n. *a*; *Geschichte der Mathematik*, 245 n. *a*; otherwise mentioned, 381 n. *a*, 505 n. *a*
- Zodiac circle: division into 360 parts, ii. 395-397; signs of Zodiac, 223 n. *c*

LIST OF ANCIENT TEXTS CITED

The figures in parentheses give the page or pages in this edition where the passage is cited; in the case of vol. i. the reference to the volume is omitted.

- Aëtius
Plac. i. 15. 5 (ii. 2); ii. 6. 5 (216)
- Alexander Aphrodisiensis
In Aristot. Soph. El. 11, 171 b 17 (314-316)
- Anatolius
Ap. Heron, Def., ed. Heiberg 160. 8-162. 2 (2)
Ap. Heron, Def., ed. Heiberg 164. 9-18 (18)
- Anthology, Palatine*
 xiv. 126 (ii. 512)
- Apollonius Paradoxographus
Mirab. 6 (172)
- Apollonius of Perga
Conic. i., Praef., Def., 7-9, 11-14, 50 (ii. 280-334)
- Archimedes
De Sph. et Cyl. i., Praef. (408-410); i., Praef., Def., Post., Props. 1, 2, 3, 5, 8, 9, 10, 12, 13, 14, 16, 21, 23, 24, 25, 28, 29, 30, 33, 34 (ii. 40-126); ii. 4 (ii. 126-134)
Dim. Circ. (316-332)
De Con. et Sphaer., Praef.,
- Lemma ad Prop. 1, 1, 21 (ii. 164-180)
De Lin. Spir., Def., 7, 14, 20 (ii. 182-194)
Quadr. Parab., Praef., 24 (ii. 228-242)
Aren. (ii. 2-4); 3 (ii. 198-200)
De Plan. Aequil., Def., 6, 7, 9, 10 (ii. 206-220)
De Corpor. Fluit. i., Post., 2, 7 (ii. 242-250); ii. 2 (ii. 252-256)
Meth., Praef. (228, ii. 220-222), 1 (ii. 222-228)
Prob. Bov. (ii. 202-204)
- Archytas
Ap. Porphy. *In Ptol. Harm.*, ed. Wallis, *Opera Math.* iii. 236. 40-237. 1; Diels, *Vors.* i⁴. 330. 26-331. 8 (4)
Ap. Porphy. *In Ptol. Harm.*, ed. Wallis, *Opera Math.* iii. 267. 39-268. 9; Diels, *Vors.* i⁴. 334. 16-335. 13 (112-114)

LIST OF ANCIENT TEXTS CITED

- Ap. Boeth. *De Inst. Mus.***
 iii. 11 (130-132)
- Aristarchus of Samos**
De Mag. et Dist. Solis et Lunae, Post., 7, 13, 15
 (ii. 4-14)
- Aristophanes**
Aves 1001-1005 (308)
- Aristotle**
Anal. Pr. i. 23, 41 a 26-27
 (110); i. 24, 41 b 5-22
 (428-430)
Anal. Post. i. 10, 76 a 30-
 77 a 2 (418-422)
Phys. A 2, 185 a 14-17
 (310); Γ 4, 203 a 13-15
 (94); Γ 6, 206 a 9-18
 (424); Γ 6, 206 b 3-12
 (424-426); Γ 6, 206 b
 27-207 a 7 (426-428);
 Γ 7, 207 b 27-34 (428);
 Z 9, 239 b 5-240 a 18
 (366-374)
Met. A 5, 985 b 23-26
 (172); A 5, 987 b 14-18
 (394); Λ 8, 1073 b 17-32
 (410-412)
Prob. xv. 3, 910 b 23-911 a
 1 (28-30)
- [Aristotle]
Mech. 1, 848 b (432); 3,
 850 a-b (430-432)
- Aristoxenus**
Harm. ii. *ad init.*, ed.
 Macran 122. 3-16 (388-
 390)
- Bobbiense, *Fragmentum
 Mathematicum***
 113. 28-33, ed. Belger,
Hermes, xvi., 1881, 279-
 280 (ii. 356)
- Boethius**
De Inst. Mus. iii. 11 (130-
 132)
- Cleomedes**
De Motu Circ. i. 10. 52 (ii.
 266-272); ii. 6 (ii. 396-
 400)
- Damianus**
Opt. 14 (ii. 496)
- Diodorus Siculus**
 i. 34. 2 (ii. 34); v. 37. 3
 (ii. 34)
- Diogenes Laertius**
De Clar. Phil. Vitis i. 24-
 25 (166-168), i. 59 (36);
 viii. 11-12 (174), viii. 24-
 25 (172-174)
- Diophantus of Alexandria**
Arithmetica i., Praef. (ii.
 516, ii. 518-524), i. 28
 (ii. 536); ii. 8 (ii. 550-
 552), ii. 20 (ii. 540-542);
 iv. 18 (ii. 548-550), iv. 29
 (ii. 556-558), iv. 32 (ii.
 542-546), iv. 39 (ii. 526-
 534); v. 3 (ii. 516), v. 11
 (ii. 552-556); vi. 17 (ii.
 538-540)
De Polyg. Num., Praef. (ii.
 560), 5 (ii. 514)
- Euclid**
Elem. i., Def., Post. et
 Comm. Notit. (436-444);
 i. 44 (188-190); i. 47
 (178-184); ii. 5 (192-
 194); ii. 6 (196); ii. 11
 (198-200); v., Def. (444-
 450); vi. 27 (202-204);

LIST OF ANCIENT TEXTS CITED

- vi. 28 (204-210); vi. 29 (210-214); vii., Def. (66-70); x., Def. (450-452); x. 1 (452-454); x. 111, coroll. (456-458); xii. 2 (458-464); xiii. 18 (466-478)
Dat., Def. (478)
Opt. 8 (502-504)
- Eutocius
In Archim. De Sph. et Cyl.
 ii., ed. Heiberg 54. 26-56. 12, 56. 13-58. 14, 58. 15-16, 66. 8-70. 5, 78. 13-80. 24, 84. 12-88. 2, 88. 3-96. 27, 98. 1-7 (256-298); 130. 17-150. 22 (ii. 134-162)
In Archim. Dim. Circ., ed. Heiberg 242 *ad init.* (48); 258. 16-22 (ii. 352)
In Apollon. Conic., ed. Heiberg 168. 5-170. 26 (ii. 276-280)
- Herodotus
Histor. ii. 36. 4 (34)
- Heron of Alexandria
Metrica i. 8 (ii. 470-476); i. 22 (ii. 406); ii. 13 (ii. 476-482); iii. 18 (ii. 482-484); iii. 20 (60-62)
Definitiones, ed. Heiberg 14. 1-24 (ii. 466-468); 60. 22-62. 9 (ii. 468-470); 160. 8-162. 2 (2); 164. 9-18 (18)
Dioptra 23 (ii. 484-488); 36 (ii. 272); 37 (ii. 488-496)
Geom. 21. 9-10, 24. 1, 24. 10 (ii. 502-508)
- Hypsicles
 [Euclid.] *Elem.* xiv, Eucl. ed. Heiberg v. 6. 19-8. 5 (ii. 348)
- Iamblichus
De Vita Pyth. 18. 88 (222-224), 18. 89 (20)
In Nicom. Arith. Introd., ed. Pistelli 62. 10-18 (98), 62. 18-63. 2 (138-140), 100. 19-25 (110-112), 103. 10-104. 13 (106-108)
Theol. Arith., ed. de Falco 82. 10-85. 23 (74-82)
- Isocrates
Panathen. 26-28, 238 B-D (26-28)
- Lucian
Vit. Auct. 4 (90)
- Marinus
Comm. in Eucl. Dat., Eucl. ed. Heiberg vi. 234. 13-17 (ii. 348-350)
Michigan Papyri
 No. 145, vol. iii. p. 36 (46)
- Nicomachus
Arith. Introd. i. 7 (72-74), i. 13. 2-4 (100-102); ii. 7. 1-3 (86-90), ii. 12. 2-4 (94-98), ii. 20. 5 (104-106), ii. 28. 3-11 (114-124)
- Olympiodorus
In Aristot. Meteor. iii. 2 (ii. 496-502)
- Pappus of Alexandria
Coll. ii. 25. 17-21 (ii. 352-)

LIST OF ANCIENT TEXTS CITED

- 356); iii., Praef. 1 (ii. 566-568), ii. 9. 26 (266-270), iii. 11. 28 (ii. 568-570), iii. 18. 48 (124-126), iii. 23. 57 (126-128), iii. 24. 58 (ii. 570-572), iii. 40. 75 (ii. 572-574); iv. 1. 1 (ii. 574-578), iv. 14. 19 (ii. 578-580), iv. 26. 39-28. 43 (298-308), iv. 30. 45-32. 50 (336-346), iv. 35. 53-56 (ii. 580-586), iv. 36. 57-59 (346-354), iv. 38. 62 (354-356), iv. 43. 67-44. 68 (356-362); v., Praef. 1-3 (ii. 588-592); vi. 48. 90-91 (ii. 592-596); vii., Praef. 1-3 (ii. 596-600), vii. 3 (ii. 336), vii. 5-6 (ii. 336-338), vii. 7 (ii. 388), vii. 9 (ii. 338-340), vii. 11 (ii. 340-342), vii. 13-20 (480-484), vii. 21 (ii. 262-264), vii. 23 (ii. 344), vii. 27-28 (ii. 344-346), vii. 30-36 (486-488), vii. 312-316 (492-502); viii., Praef. 1-3 (ii. 614-620), viii. 11. 19 (ii. 34)
- Philolaus
 Ap. Stob. *Ecl.* i., proem. 3 (216); i. 21. 7c (72)
- Philoponus
 In *Aristot. Phys.* A 2 (234)
- Plato
Meno 86 E-87 B (394-396)
Resp. vi. 510 C-E (390); vii. 525 A-530 D (6-16); viii. 546 B-D (398)
- Tim.* 31 B-32 B (128-130), 53 C-55 C (218-222)
Theaet. 147 D-148 B (380-382)
Leg. vii. 817 E-820 D (20-26)
Epin. 990 C-991 B (400-404)
Ep. vii. 342 A-343 B (390-394)
- Plutarch
Non posse suav. viv. sec. Epic. 11, 1094 B (176)
Quaest. Conv. viii. 2. 1 (386-388); viii. 2. 4, 720 A (176)
De Facie in Orbe Lunae 6, 922 F-923 A (ii. 4)
Marcellus xiv. 7-xvii. 7, xix. 4-6 (ii. 22-34)
De Comm. Notit. 39. 3, 1079 E (228)
De Exil. 17, 607E, F (308)
- Polybius
Histor. v. 26. 13 (36)
- Porphyry
 In *Ptol. Harm.*, ed. Wallis, *Opera Math.* iii. 267. 39-268. 9; Diels, *Vors.* i⁴. 334. 16-335. 13 (112-114)
- Proclus
 In *Eucl.* i., ed. Friedlein 64. 16-70. 18 (144-160), 74. 23-24 (ii. 350), 84. 13-23 (174-176), 105. 1-6 (ii. 350), 157. 10-13 (164), 176. 5-10 (ii. 370-372), 212. 24-213. 11 (252), 250. 22-251. 2 (164-166), 299. 1-5 (166), 301. 21-302. 13 (478-

LIST OF ANCIENT TEXTS CITED

- 480), 352. 14-18 (166),
362. 12-363. 18 (ii. 372-
374), 365. 5-367. 27 (ii.
374-382), 371. 23-373. 2
(ii. 382-384), 379. 2-16
(176-178), 394. 16-395. 2
(490-492), 419. 15-420.
12 (186-188), 422. 24-
423. 5 (316), 426. 6-14
(184), 428. 7-429. 8 (90-
94), 429. 9-15 (184)
In Plat. Remp., ed. Kroll
ii. 27. 11-22 (136-138)
- Psellus, Michael**
A Letter, Dioph. ed. Tan-
nery ii. 38. 22-39. 1 (ii.
514)
- Ptolemy**
Math. Syn. i. 10-11 (ii. 412-
444), i. 13 (ii. 446-462);
x. 1 (ii. 400)
- Rhabdas, Nicolas**
Ed. Tannery, *Notices et*
extraits, etc., xxxii. i.
146-152 (30-34)
- Scholia**
In Plat. Charm. 165 E (16-
18)
In Eucl. Elem. v. (408)
In Eucl. Elem. x. (214-216,
380, ii. 350-352)
In Eucl. Elem. xiii. (378)
- Simplicius**
In Aristot. De Caelo i. 1,
268 a 6 (ii. 410-412); i.
2, 269 a 9 (ii. 410); ii.
12, 293 a 4 (412-414);
iv. 4, 311 b 1 (ii. 410)
- In Aristot. Phys.* A 2, 185 a
14 (312-314, 234-252)
In Aristot. Cat. 7 (334)
- Stobaeus**
Ecl. i., proem. 3 (216); i.
21. 7c (72); ii. 31. 114
(436)
- Suidas**
s.v. Ἐρατοσθένης (ii. 260-
262), Θεαίητος (378),
Πάππος (ii. 564-566),
Πτολεμαῖος (ii. 408)
- Themistius**
In Aristot. Phys. A 2,
185 a 14 (310-312)
- Theon of Alexandria**
In Ptol. Math. Syn. i. 3,
ed. Rome 354. 19-357. 22
(ii. 386-395); i. 10,
451. 4-5 (ii. 406); i. 10,
453. 4-6 (ii. 514); i. 10,
461. 1-462. 17 (50-52);
i. 10, 469. 16-473. 8 (52-
60)
- Theon of Smyrna**
Ed. Hiller i. 1-2. 2 (ii. 400-
402), 2. 3-12 (256),
35. 17-36. 2 (102-104),
42. 10-44. 17 (132-136),
45. 9-46. 19 (84-86), 81.
17-82. 5 (ii. 264-266)
- Tzetzes**
Chil. ii. 103-144 (ii. 18-
22); viii. 972-973 (386)
- Vitruvius**
De Archit. ix., Praef. 9-12
(ii. 36-38)

INDEX OF GREEK TERMS

The purpose of this index is to give one or more typical examples of the use of Greek mathematical terms occurring in these volumes. Non-mathematical words, and the non-mathematical uses of words, are ignored, except occasionally where they show derivation. Greek mathematical terminology may be further studied in the Index Graecitatis at the end of the third volume of Hultsch's edition of Pappus and in Heath's notes and essays in his editions of Euclid, Archimedes and Apollonius. References to vol. i. are by page alone, to vol. ii. by volume and page. A few common abbreviations are used. Words should be sought under their principal part, but a few cross-references are given for the less obvious.

- ἄγειν, to draw; εὐθείαν γραμμὴν ἀγαγεῖν, to draw a straight line, 442 (Eucl.); εἰς ἐπιφανέουσαι ἀχθῶσι, if tangents be drawn, ii. 64 (Archim.); παράλληλος ἦχθω ἢ AK, let AK be drawn parallel, ii. 312 (Apollon.)
- ἀγεωμέτρητος, ον, ignorant of or unversed in geometry, 386 (Tzetzes)
- ἀδιαίρετος, ον, undivided, indivisible, 366 (Aristot.)
- ἀδύνατος, ον, impossible, 394 (Plat.), ii. 566 (Papp.); ὅπερ ἐστὶν ἀ., often without ἐστίν, which is impossible, a favourite conclusion to reasoning based on false premises, ii. 122 (Archim.); οἱ διὰ τοῦ ἀ. περαίνοντες, those who argue per impossibile, 110 (Aristot.)
- ἄθροισμα, ατος, τό, collection; ἀ. φιλοτεχνότατον, a collection most skilfully framed, 480 (Papp.)
- Αἰγυπτιακός, ἢ, ὄν, Egyptian; αἱ Αἰ. καλούμεναι μέθοδοι ἐν πολλαπλασιασμοῖς, 16 (Schol. in Plat. Charm.)
- αἶρειν, to take away, subtract, ii. 506 (Heron)
- αἰτεῖν, to postulate, 442 (Eucl.), ii. 206 (Archim.)
- αἴτημα, ατος, τό, postulate, 420 (Aristot.), 440 (Eucl.), ii. 366 (Procl.)
- ἀκίνητος, ον, that cannot be moved, immobile, fixed, 394 (Aristot.), ii. 246 (Archim.)
- ἀκολουθεῖν, to follow, ii. 414 (Ptol.)

INDEX OF GREEK TERMS

- ἀκόλουθος, *ον*, following, consequential, corresponding, ii. 580 (Papp.); as subst., ἀκόλουθον, τό, consequence, ii. 566 (Papp.)
- ἀκολουθῶς, *adv.*, consistently, consequentially, in turn, 458 (Eucl.), ii. 384 (Procl.)
- ἀκουσματικός, ἡ, ὄν, eager to hear; as subst., ἄ., ὁ, hearer, exoteric member of Pythagorean school, 3 n. d (Iambl.)
- ἀκριβής, ἑς, exact, accurate, precise, ii. 414 (Ptol.)
- ἄκρος, *α, ον*, at the farthest end, extreme, ii. 270 (Cleom.); of extreme terms in a proportion, 122 (Nicom.); ἄ. καὶ μέσος λόγος, extreme and mean ratio, 472 (Eucl.), ii. 416 (Ptol.)
- ἄλλως, alternatively, 356 (Papp.)
- ἄλογος, *ον*, irrational, 420 (Aristot.), 452 (Eucl.), 456 (Eucl.); δι' ἀλόγου, by irrational means, 388 (Plut.)
- ἀμβλυγώνιος, *ον*, obtuse-angled; ἄ. τρίγωνον, 440 (Eucl.); ἄ. κῶνος, ii. 278 (Eutoc.)
- ἀμβλῦς, εἶα, ὕ, obtuse; ἄ. γωνία, often without γωνία, obtuse angle, 438 (Eucl.)
- ἀμετάθετος, *ον*, unaltered, immutable; μονάδος ἄ. οὔσης, ii. 514 (Dioph.)
- ἀμῆχανος, *ον*, impracticable, 298 (Eutoc.)
- ἄμφοισμα, *ατος, τό*, revolving figure, ii. 604 (Papp.)
- ἄμφοιστικός, ἡ, ὄν, described by revolution; ἄμφοιστικόν, τό, figure generated by revolution, ii. 604 (Papp.)
- ἀναγράφειν, to describe, construct, 180 (Eucl.), ii. 68 (Archim.)
- ἀνακλᾶν, to bend back, incline, reflect (of light), ii. 496 (Damian.)
- ἀνάλλημμα, *ατος, τό*, a representation of the sphere of the heavens on a plane, analemma; title of work by Diodorus, 300 (Papp.)
- ἀναλογία, ἡ, proportion, 446 (Eucl.); κυρίως ἄ. καὶ πρώτη, proportion par excellence and primary, i.e., the geometric proportion, 125 n. a; συνεχῆς ἄ., continued proportion, 262 (Eutoc.)
- ἀνάλογον, *adv.*, proportionally, but nearly always used adjectivally, 70 (Eucl.), 446 (Eucl.)
- ἀναλύειν, to solve by analysis, ii. 160 (Archim.); ὁ ἀναλυόμενος τόπος, the Treasury of Analysis, often without τόπος, e.g., ὁ καλούμενος ἀναλυόμενος, ii. 596 (Papp.)
- ἀνάλυσις, *εως, ἡ*, solution of a problem by analytical methods, analysis, ii. 596 (Papp.)
- ἀναλυτικός, ἡ, ὄν, analytical, 158 (Procl.)

INDEX OF GREEK TERMS

- ἀναμέτρῃσις, εὖς, ἦ, *measurement*; Περὶ τῆς ἀ. τῆς γῆς, title of work by Eratosthenes, ii. 272 (Heron)
- ἀνάπαλιν, adv., *in a reverse direction*; transformation of a ratio known as *invertendo*, 448 (Eucl.)
- ἀναποδεικτικῶς, adv., *independently of proof*, ii. 370 (Procl.)
- ἀναστρέφειν, *to convert a ratio according to the rule of Eucl. v. Def. 16*; ἀναστρέψαντι, *lit. to one who has converted, convertendo*, 466 (Eucl.)
- ἀναστροφή, ἦ, *conversion of a ratio according to the rule of Eucl. v. Def. 16*, 448 (Eucl.)
- ἀνπαίσθητος, ον, *unperceived, imperceptible*; hence, *negligible*, ii. 482 (Heron)
- ἄνισος, ον, *unequal*, 444 (Eucl.), ii. 50 (Archim.)
- ἀνίσταναι, *to set up, erect*, ii. 78 (Archim.)
- ἀντακολουθία, ἦ, *reciprocity*, 76 (*Theol. Arith.*)
- ἀντικείμενα, *to be opposite*, 114 (Nicom.); τομαὶ ἀντικείμενα, *opposite branches of a hyperbola*, ii. 322 (Apollon.)
- ἀντιπλάσχειν, *to be reciprocally proportional*, 114 (Nicom.); ἀντιπεπονηθῶς, adv., *reciprocally*, ii. 208 (Archim.)
- ἀντιστροφή, ἦ, *conversion, converse*, ii. 140 (Archim. ap. Eutoc.)
- ἀξίωμα, ατος, τό, *axiom, postulate*, ii. 42 (Archim.)
- ἄξων, ονος, ὁ, *axis*; of a cone, ii. 286 (Apollon.); of any plane curve, ii. 288 (Apollon.); of a conic section, 282 (Eutoc.); συζυγεῖς ἀ., *conjugate axes*, ii. 288 (Apollon.)
- ἀόριστος, ον, *without boundaries, undefined*, πλήθος μονάδων ἀ., ii. 522 (Dioph.)
- ἀπαγωγή, ἦ, *reduction of one problem or theorem to another*, 252 (Procl.)
- ἀπαρτίζειν, *to make even*; οἱ ἀπαρτίζοντες ἀριθμοί, *factors*, ii. 506 (Heron)
- ἀπειραχῶς, *in an infinite number of ways*, ii. 572 (Papp.)
- ἄπειρος, ον, *infinite*; as subst., ἄπειρον, τό, *the infinite*, 424 (Aristot.); εἰς ἄπειρον, *to infinity, indefinitely*, 440 (Eucl.); ἐπ' ἀ., ii. 580 (Papp.)
- ἀπεναντίον, adv. used adjectively, *opposite*; αἱ ἀ. πλευραὶ, 444 (Eucl.)
- ἀπέχειν, *to be distant*, 470 (Eucl.), ii. 6 (Aristarch.)
- ἀπλανής, ἐς, *motionless, fixed*, ii. 2 (Archim.)
- ἀπλατής, ἐς, *without breadth*, 436 (Eucl.)
- ἀπλόος, η, ον, contr. ἀπλοῦς, ἦ, οὖν, *simple*; ἀ. γραμμῆ, ii. 360 (Procl.)

INDEX OF GREEK TERMS

- ἀπλῶς, simply, absolutely*, 424 (Aristot.); *generally*, ii. 132 (Archim.)
- ἀπλῳσις, εως, ἡ, simplification, explanation*; Ἐπιφανείας σφαίρας, *Explanation of the Surface of a Sphere*, title of work by Ptolemy, ii. 408 (Suidas)
- ἀπό, from*; τὸ ἀπὸ τῆς διαμέτρου τετράγωνον, *the square on the diameter*, 332 (Archim.); τὸ ἀπὸ ΓΗ (*sc. τετράγωνον*), *the square on ΓΗ*, 268 (Eutoc.)
- ἀποδεικτικός, ἡ, ὄν, affording proof, demonstrative*, 420 (Aristot.), 158 (Procl.)
- ἀποδεικτικῶς, adv., theoreti- cally*, 260 (Eutoc.)
- ἀπόδειξις, εως, ἡ, proof, demonstration*, ii. 42 (Archim.), ii. 566 (Papp.)
- ἀποκαθιστάναι, to re-establish, restore*; *pass., to return to an original position*, ii. 182 (Archim.)
- ἀπολαμβάνειν, to cut off*; ἡ ἀπολαμβανομένη περιφέρεια, 440 (Eucl.)
- ἀπορία, ἡ, difficulty, perplexity*, 256 (Theon Smyr.)
- ἀπόστημα, ατος, τό, distance, interval*, ii. 6 (Aristarch.)
- ἀποτομή, ἡ, cutting off, section*; Λόγου ἀποτομή, *Χωρίων ἀποτομή*, works by Apollonius, ii. 598 (Papp.); *compound ir- rational straight line equi- valent to binomial surd*
- with negative sign, apo- tome*, 456 (Eucl.)
- ἄπτειν, to fasten to*; *mid., ἄπτεσθαι, to be in contact, meet*, 438 (Eucl.), ii. 106 (Archim.)
- ἄρα, therefore, used for the steps in a proof*, 180 (Eucl.)
- ἄρβηλος, ὁ, semicircular knife used by leather-workers, a geometrical figure used by Archimedes and Pappus*, ii. 578 (Papp.)
- ἀριθμεῖν, to number, reckon, enumerate*, ii. 198 (Archim.), 90 (Luc.)
- ἀριθμητικός, ἡ, ὄν, of or for reckoning or numbers*; ἡ ἀριθμητικῆ (*sc. τέχνη*), *arithmetic*, 6 (Plat.), 420 (Aristot.); ἡ ἀριθμητικῆ μέση (*sc. εὐθεία*), *arith- metic mean*, ii. 568 (Papp.); *ἀ. μεσότης*, 110 (Iambl.)
- ἀριθμητός, ἡ, ὄν, that can be counted, numbered*, 16 (Plat.)
- ἀριθμός, ὁ, number*, 6 (Plat.), 66 (Eucl.); *πρῶτος ἀ., prime number*, 68 (Eucl.); *πρῶτοι, δεύτεροι, τρίτοι, τέ- ταρτοι, πέμπτοι ἀ., num- bers of the first, second, third, fourth, fifth order*, ii. 198-199 (Archim.); *μη- λίτης ἀ., problem about a number of sheep*, 16 (Schol. in Plat. Charm.); *φιαλίτης ἀ., problem about a num- ber of bowls (ibid.)*

INDEX OF GREEK TERMS

- ἀριθμοστόν, τό, *fraction whose denominator is unknown* [$\frac{1}{x}$], ii. 522 (Dioph.)
- ἀρμόζειν, *to fit together*, ii. 494 (Heron)
- ἁρμονία, ἡ, *musical scale, octave, music, harmony*, 404 (Plat.); used to denote a square and a rectangle, 398 (Plat.)
- ἁρμονικός, ἡ, ὄν, *skilled in music, musical*; ἡ ἁρμονική (sc. ἐπιστήμη), *mathematical theory of music, harmonic*; ἡ ἁρμονική μέση, *harmonic mean*, 112 (Iambl.)
- ἄρτιάκις, adv., *an even number of times*; ἄ. ἄρτιος ἀριθμός, *even-times even number*, 66 (Eucl.)
- ἄρτιόπλευρος, ον, *having an even number of sides*; πολύγωνον ἄ., ii. 88 (Archim.)
- ἄρτιος, α, ον, *complete, perfect*; ἄ. ἀριθμός, *even number*, 66 (Eucl.)
- ἀρχή, ἡ, *beginning or principle of a proof or science*, 418 (Aristot.); *beginning of the motion of a point describing a curve*; ἀρ. τῆς ἑλικος, *origin of the spiral*, ii. 182
- ἀρχικός, ἡ, ὄν, *principal, fundamental*; ἄ. σύμπτωμα, *principal property of a curve*, ii. 282 (Apollon.), 338 (Papp.)
- ἀρχικώτατος, ον, *sovereign, fundamental*; ἄ. ρίζα, 90 (Nicom.)
- ἀρχιτεκτονικός, ἡ, ὄν, *of or for an architect*; ἡ ἀρχιτεκτονική (sc. τέχνη), *architecture*, ii. 616 (Papp.)
- ἀστρολογία, ἡ, *astronomy*, 388 (Aristox.)
- ἀστρολόγος, ὁ, *astronomer*, 378 (Suidas)
- ἀστρονομία, ἡ, *astronomy*, 14 (Plat.)
- ἀσύμμετρος, ον, *incommensurable, irrational*, 110 (Aristot.), 452 (Eucl.), ii. 214 (Archim.)
- ἀσύμπτωτος, ον, *not falling in, non-secant, asymptotic*, ii. 374 (Procl.); ἄ. (sc. γραμμῆ), ἡ, *asymptote*, ii. 282 (Apollon.)
- ἀσύνθετος, ον, *incomposite*; ἄ. γραμμῆ, ii. 360 (Procl.)
- ἄτακτος, ον, *unordered*; Περὶ ἄτ. ἀλόγων, *title of work by Apollonius*, ii 350 (Procl.)
- ἀτελής, ἑς, *incomplete*; ἄ. ἀμφοιστικά, *figures generated by an incomplete revolution*, ii. 604 (Papp.)
- ἄτομος, ον, *indivisible*; ἄτομοι γραμμαί, 424 (Aristot.)
- ἄτοπος, ον, *out of place, absurd*; ὅπερ ἄτοπον, *which is absurd*, a favourite conclusion to a piece of reasoning based on a false premise, e.g. ii. 114 (Archim.)

INDEX OF GREEK TERMS

- αὐξάνειν, *to increase, to multiply*; τρις αὐξηθείς, 398 (Plat.)
- αὐξη, ἡ, *increase, dimension*, 10 (Plat.)
- αὐξησις, εως, ἡ, *increase, multiplication*, 398 (Plat.)
- αὐτόματος, ἡ, ον, *self-acting*; Αὐτόματα, τά, title of work by Heron, ii. 616 (Papp.)
- ἀφαιρεῖν, *to cut off, take away, subtract*, 444 (Eucl.)
- ἀφή, ἡ, *point of concurrence of straight lines; point of contact of circles or of a straight line and a circle*, ii. 64 (Archim.)
- * Ἀχιλλεύς, εως, ὁ, *Achilles, the first of Zeno's four arguments on motion*, 368 (Aristot.)
- Βάρος, ουσ, Ion. εος, τό, *weight, esp. in a lever*, ii. 206 (Archim.), or system of pulleys, ii. 490 (Heron); τὸ κέντρον τοῦ βάρους, *centre of gravity*, ii. 208 (Archim.)
- βαρουλκός (sc. μηχανή), ἡ, *lifting-screw invented by Archimedes, title of work by Heron*, ii. 489 n. a
- βάσις, εως, ἡ, *base*; of a geometrical figure; of a triangle, 318 (Archim.); of a cube, 222 (Plat.); of a cylinder, ii. 42 (Archim.); of a cone, ii. 304 (Apolon.); of a segment of a sphere, ii. 40 (Archim.)
- Γεωδαισία, ἡ, *land dividing, mensuration, geodesy*, 18 (Anatolius)
- γεωμετρεῖν, *to measure, to practise geometry*; ἀεὶ γ. τὸν θεόν, 386 (Plat.); γεωμετρομένη ἐπιφάνεια, *geometric surface*, 292 (Eutoc.), γεωμετρομένη ἀπόδειξις, *geometric proof*, ii. 228 (Archim.)
- γεωμέτρης, ον, ὁ, *land measurer, geometer*, 258 (Eutoc.)
- γεωμετρία, ἡ, *land measurement, geometry*, 256 (Theon Smyr.), 144 (Procl.)
- γεωμετρικός, ἡ, ὄν, *pertaining to geometry, geometrical*, ii. 590 (Papp.), 298 (Eutoc.)
- γεωμετρικῶς, adv., *geometrically*, ii. 222 (Archim.)
- γίνεσθαι, *to be brought about*; γεγονέτω, *let it be done*, a formula used to open a piece of analysis; of curves, *to be generated*, ii. 468 (Heron); *to be brought about by multiplication, i.e., the result (of the multiplication) is*, ii. 480 (Heron); τὸ γενόμενον, τὰ γενόμενα, *the product*, ii. 482 (Heron)
- γλωσσόκομον, τό, *chest*, ii. 490 (Papp.)
- γωνμονικός, ἡ, ὄν, *of or concerning sun-dials*, ii. 616 (Papp.)
- γνώμων, ονος, ὁ, *carpenter's*

INDEX OF GREEK TERMS

- square*; *pointer of a sundial*, ii. 268 (Cleom.); geometrical figure known as *gnomon*, number added to a figured number to get the next number, 98 (Iambl.)
- γραμμή, ἡ, *line, curve*, 436 (Eucl.); εὐθεία γ. (often without γ.), *straight line*, 438 (Eucl.); ἐκ τῶν γραμμῶν, rigorous proof by geometrical arguments, ii. 412 (Ptol.)
- γραμμικός, ἡ, ὄν, *linear*, 348 (Papp.)
- γράφειν, *to describe*, 442 (Eucl.), ii. 582 (Papp.), 298 (Eutoc.); *to prove*, 380 (Plat.), 260 (Eutoc.)
- γραφή, ἡ, *description, account*, 260 (Eutoc.); *writing, treatise*, 260 (Eutoc.)
- γωνία, ἡ, *angle*; ἐπίπεδος γ., *plane angle* (presumably including angles formed by curves), 438 (Eucl.); εὐθύγραμμος γ., *rectilineal angle* (formed by straight lines), 438 (Eucl.); ὀρθή, ἀμβλεία, ὀξεία γ., *right, obtuse, acute angle*, 440 (Eucl.)
- Δεικνύναι, *to prove*; δέδεικται γὰρ τοῦτο, *for this has been proved*, ii. 220 (Archim.); δεικτέον ὅτι, *it is required to prove that*, ii. 168 (Archim.)
- δεῖν, *to be necessary, to be required*; δεῖν ἔστω, *let it be required*; ὅπερ ἔδει δεῖξαι, *quod erat demonstrandum, which was to be proved*, the customary ending to a theorem, 184 (Eucl.); ὅπερ : ~ = ὅπερ ἔδει δεῖξαι, ii. 610 (Papp.)
- δεκάγωνον, τό, *a regular plane figure with ten angles, decagon*, ii. 196 (Archim.)
- δῆλος, η, ον, also ος, ον, *manifest, clear, obvious*; ὅτι μὲν οὖν αὐτα συμπίπτει, δῆλον, ii. 192 (Archim.)
- διάγειν, *to draw through*, 190 (Eucl.), 290 (Eutoc.)
- διάγραμμα, ατος, τό, *figure, diagram*, 428 (Aristot.)
- διαρεῖν, *to divide, cut*, ii. 286 (Apollon.); διηρημένος, ον, *divided*; δ. ἀναλογία, *discrete proportion*, 262 (Eutoc.); διελόντι, *lit. to one having divided, dirimendo* (or, less correctly, *dividendo*), indicating the transformation of the ratio $a : b$ into $a - b : b$ according to Eucl. v. 15, ii. 130 (Archim.)
- διαίρεσις, εως, ἡ, *division, separation*, 368 (Aristot.); δ. λόγου, *transformation of a ratio dividendo*, 448 (Eucl.)
- διαμένειν, *to remain, to remain stationary*, 258 (Eutoc.)
- διάμετρος, ον, *diagonal, diametrical*; as subst., δ. (sc. γραμμή), ἡ, *diagonal*; of a parallelogram, ii. 218

INDEX OF GREEK TERMS

- (Archim.); *diameter* of a circle, 438 (Eucl.); of a sphere, 466 (Eucl.); *principal axis* of a conic section in Archim., ii. 148 (Archim.); *diameter* of any plane curve in Apollon., ii. 286 (Apollon.); *πλαγία δ.*, transverse *diameter*, ii. 286 (Apollon.); *συζυγείς δ.*, conjugate *diameters*, ii. 288 (Apollon.)
- ειάσταις, εως, ἡ, *dimension*, 412 (Simpl.)
- διαστέλλειν, *to separate*, ii. 502 (Heron)
- διάστημα, ατος, τό, *interval*; *radius* of a circle, ii. 192 (Archim.), 442 (Eucl.); *interval* or *distance* of a conchoid, 300 (Papp.); in a proportion, the *ratio* between terms, τὸ τῶν μειζόνων ὄρων δ., 112 (Archytas ap. Porph.); *dimension*, 88 (Nicom.)
- διαφορά, ἡ, *difference*, 114 (Nicom.)
- διδόναι, *to give*; aor. part., δοθείς, εἶσα, ἐν, *given*, ii. 598 (Papp.); Δεδομένα, τά, *Data*, title of work by Euclid, ii. 588 (Papp.); θέσει καὶ μεγέθει δεδόσθαι, *to be given* in position and magnitude, 478 (Eucl.)
- διελόντι, v. διαρεῖν
- διεχῆς, ἐς, *discontinuous*; σπείρα δ., *open spire*, ii. 364 (Procl.)
- διορίζειν, *to determine*, ii. 566 (Papp.); Διορισμένη
- τομή, *Determinate Section*, title of work by Apollonius, ii. 598 (Papp.)
- διορισμός, ὁ, *statement of the limits of possibility* of a solution of a problem, *diorismos*, 150 (Procl.)
- διπλασιάζειν, *to double*, 258 (Eutoc.)
- διπλασιασμός, ὁ, *doubling, duplication*; κύβου δ., 258 (Eutoc.)
- διπλάσιος, α, ον, *double*, 302 (Papp.); δ. λόγος, *duplicate ratio*, 446 (Eucl.)
- διπλασίων, ον, later form for διπλάσιος, *double*, 326 (Archim.)
- διπλός, η, ον, contr. διπλοῦς, ἡ, οὖν, *twofold, double*, 326 (Archim.); δ. ἰσότης, *double equation*, ii. 528 (Dioph.)
- δίχα, adv., *in two (equal) parts*, 66 (Eucl.); δ. τέμνειν, *to bisect*, 440 (Eucl.)
- διχοτομία, ἡ, *dividing in two*; *point of bisection*, ii. 216 (Archim.); *Dichotomy*, first of Zeno's arguments on motion, 368 (Aristot.)
- διχοτόμος, ον, *cut in two, halved*, ii. 4 (Aristarch.)
- δύναμις, εως, ἡ, *power, force*, ii. 488 (Heron), ii. 616 (Papp.); αἱ πέντε δ., the five *mechanical powers* (wheel and axle, lever, pulley, wedge, screw), ii. 492 (Heron); *power* in

INDEX OF GREEK TERMS

- the algebraic sense, esp. square; δυνάμει, *in power*, i.e., *squared*, 322 (Archim.); δυνάμει σύμμετρος, *commensurable in square*, 450 (Eucl.); δυνάμει ἀσύμμετρος, *incommensurable in square* (*ibid.*)
- δυναμοδύναμις, εως, ἢ, *fourth power of the unknown quantity* [x^4], ii. 522 (Dioph.)
- δυναμοδυναμοστόν, τό, *the fraction* $\frac{1}{x^4}$, ii. 522 (Dioph.)
- δυναμόκυβος, ό, *square multiplied by a cube, fifth power of the unknown quantity* [x^5], ii. 522 (Dioph.)
- δυναμοκυβοστόν, τό, *the fraction* $\frac{1}{x^4}$, ii. 522 (Dioph.)
- δυναμοστόν, τό, *the fraction* $\frac{1}{x^2}$, ii. 522 (Dioph.)
- δύνασθαι, *to be able, to be equivalent to*; δύνασθαι τι, *to be equivalent when squared to a number or area*, ii. 96 (Archim.); ἡ δυνάμενη (sc. εὐθεία), *side of a square*, 452 (Eucl.); αὐξήσεις δυνάμεναι, 398 (Plat.); παρ' ἣν δύνανται αἱ καταγόμεναι τεταγμένως ἐπὶ τὴν ΖΗ διάμετρον, *the parameter of the ordinates to the diameter ZH*, ii. 308 (Apollon.)
- δυναστεύειν, *to be powerful*; pass., *to be concerned with powers of numbers*; αὐξήσεις δυναστευόμεναι, 398 (Plat.)
- δυνατός, ἢ, όν, *possible*, ii. 566 (Papp.)
- δυσοκαιεννηκοντάεδρον, τό, *solid with ninety-two faces*, ii. 196 (Archim.)
- δυσοκαιεξηκοντάεδρον, τό, *solid with sixty-two faces*, ii. 196 (Archim.)
- δυσοκαιτριακοντάεδρον, τό, *solid with thirty-two faces*, ii. 196 (Archim.)
- δωδεκάεδρος, ον, *with twelve faces*; as subst., δωδεκάεδρον, τό, *body with twelve faces, dodecahedron*, 472 (Eucl.), 216 (Aët.)
- Ἑβδομηκοστόμονος, ον, *seventy-first*; τό, ἔ., *seventy-first part*, 320 (Archim.)
- ἐγγράφειν, *to inscribe*, 470 (Eucl.), ii. 46 (Archim.)
- ἐγκύκλιος, ον, also α, ον, *circular*, ii. 618 (Papp.)
- εἶδος, ους, Ion. εος, τό, *shape or form of a figured number*, 94 (Aristot.); *figure giving the property of a conic section, viz., the rectangle contained by the diameter and the parameter*, ii. 317 n. a, 358 (Papp.), 282 (Eutoc.); *term in an equation*, ii. 524 (Dioph.); *species—of number*, ii. 522 (Dioph.), *of angles* 390 (Plat.)

INDEX OF GREEK TERMS

- εικοσάεδρος, ον, having twenty faces; εικοσάεδρον, τό, body with twenty faces, icosahedron, 216 (Aët.)*
εικοσαπλάσιος, ον, twenty-fold, ii. 6 (Aristarch.)
εκατοντάς, άδος, ή, the number one hundred, ii. 198 (Archim.)
εκβάλλειν, to produce (a straight line), 442 (Eucl.), ii. 8 (Aristarch.), 352 (Papp.)
εκκαιεικοσάεδρον, τό, solid with twenty-six faces, ii. 196 (Archim.)
εκκείσθαι, used as pass. of εκτιθέναι, to be set out, be taken, ii. 96 (Archim.), 298 (Papp.)
εκκρούειν, to take away, eliminate, ii. 612 (Papp.)
εκπέτασμα, ατος, τό, that which is spread out, unfolded; Έκπετάσματα, title of work by Democritus dealing with projection of armillary sphere on a plane, 229 n. a
εκπρισμα, ατος, τό, section sawn out of a cylinder, prismatic section, ii. 470 (Heron)
εκτιθέναι, to set out, ii. 568 (Papp.)
εκτός, adv., without, outside; as prep., έ. του κύκλου, 314 (Alex. Aphr.); adv. used adjectivally, ή έ. (sc. ευθεία), external straight line, 314 (Simpl.); ή έ. γωνία του τριγώνου, the external angle of the triangle, ii. 310 (Apollon.)
ελάσσων, ον, smaller, less, 320 (Archim.); ήτοι μείζων έστιν ή έ., ii. 112 (Archim.); έ. ορθής, less than a right angle, 438 (Eucl.); ή έ. (sc. ευθεία), minor in Euclid's classification of straight lines, 458 (Eucl.)
ελάχιστος, η, ον, smallest, least, ii. 44 (Archim.)
ελίξ, έλικος, ή, spiral, helix, ii. 182 (Archim.); spiral on a sphere, ii. 580 (Papp.)
ελλειμμα, ατος, τό, defect, deficiency, 206 (Eucl.)
ελλείπειν, to fall short, be deficient, 394 (Plat.), 188 (Procl.)
ελλειψις, εως, ή, falling short, deficiency, 186 (Procl.); the conic section ellipse, so called because the square on the ordinate is equal to a rectangle whose height is equal to the abscissa applied to the parameter as base but falling short (ελλείπον), ii. 316 (Apollon.), 188 (Procl.)
εμβαδόν, τό, area, ii. 470 (Heron)
εμβάλλειν, to throw in, insert, ii. 574 (Papp.); multiply, ii. 534 (Dioph.)
εμπίπτειν, to fall on, to meet, to cut, 442 (Eucl.), ii. 58 (Archim.)
εμπλέκειν, to plait or weave in; σπείρα εμπεπλεγμένη,

INDEX OF GREEK TERMS

- interlaced* spire, ii. 364 (Procl.)
- ἐναλλάξ, adv., often used adjectivally, transformation of a ratio according to the rule of Eucl. v. Def. 12, *permutando*, 448 (Eucl.), ii. 144 (Archim.); ἐ. γωνίαι, *alternate angles*
- ἐναντίος, α, ον, *opposite*; κατ' ἐ., ii. 216 (Archim.)
- ἐναρμόζω, *to fit in, to insert*, 284 (Eutoc.)
- ἐντασις, εως, ἡ, *inscription*, 396 (Plat.)
- ἐντελής, ἐς, *perfect, complete*; τριγώνον ἐ., 90 (Procl.)
- ἐντός, adv. used adjectivally, *within, inside, interior*; αἱ ἐ. γωνίαι, 442 (Eucl.)
- ἐνυπάρχειν, *to exist in*; εἶδη ἐνυπάρχοντα, τὰ, *positive terms*, ii. 524 (Dioph.)
- ἐξάγωνικός, ἡ, ὄν, *hexagonal*; ἐ. ἀριθμός, 96 (Nicom.)
- ἐξάγωνος, ον, as subst. ἐξάγωνον, τό, *hexagon*, 470 (Eucl.)
- ἐξηκοστός, ἡ, ὄν, *sixtieth*; in astron., πρῶτον ἐξηκοστόν, τό, *first sixtieth, minute*, δεύτερον ἐ., *second sixtieth, second*, 50 (Theon Alex.)
- ἐξῆς, adv., *in order, successively*, ii. 566 (Papp.)
- ἐπαφή, ἡ, *touching, tangency, contact*, 314 (Simpl.); Ἐπαφαί, *On Tangencies*, title of a book by Apollonius, ii. 336 (Papp.)
- ἐπεσθαι, *to be or come after, follow*; τὸ ἐπόμενον, *con-*
- sequence*, ii. 566 (Papp.); τὰ ἐπόμενα, *rearward elements*, ii. 184 (Apollon.); in theory of proportion, τὰ ἐπόμενα, *following terms, consequents*, 448 (Eucl.)
- ἐπί, prep. with acc., *upon, on to, on*, εὐθεία ἐπ' εὐθείαν σταθεῖσα, 438 (Eucl.)
- ἐπιζευγνύναι, *to join up*, ii. 608 (Papp.); αἱ ἐπιζευχθεῖσαι εὐθείαι, *connecting lines*, 272 (Eutoc.)
- ἐπιλογίζεσθαι, *to reckon, calculate*, 60 (Theon Alex.)
- ἐπιλογισμός, ὁ, *reckoning, calculation*, ii. 412 (Ptol.)
- ἐπίπεδος, ον, *plane*; ἐ. ἐπιφάνεια, 438 (Eucl.); ἐ. γωνία, 438 (Eucl.); ἐ. σχῆμα, 438 (Eucl.); ἐ. ἀριθμός, 70 (Eucl.); ἐ. πρόβλημα, 348 (Papp.)
- ἐπιπέδως, adv., *plane-wise*, 88 (Nicom.)
- ἐπιπλατής, ἐς, *flat, broad*; σφαιροειδές ἐ., ii. 164 (Archim.)
- ἐπίταγμα, ατος, τό, *injunction; condition*, ii. 50 (Archim.), ii. 526 (Dioph.); ποιεῖν τὸ ἐ., *to satisfy the condition; subdivision of a problem*, ii. 340 (Papp.)
- ἐπίτριτος, ον, *containing an integer and one-third, in the ratio 4:3*, ii. 222 (Archim.)
- ἐπιφάνεια, ἡ, *surface*, 438 (Eucl.); κωνικὴ ἐ., *conical surface (double cone)*, ii. 286 (Apollon.)

INDEX OF GREEK TERMS

- ἐπιψαύειν, *to touch*, ii. 190 (Archim.); ἡ ἐπιψαύουσα (*sc. εὐθεία*), *tangent*, ii. 64 (Archim.)
- ἕτερομήκης, *es*, *with unequal sides, oblong*, 440 (Eucl.)
- εὐθύγραμμος, *on*, *rectilinear*; εὐ. γωνία, 438 (Eucl.); εὐ. σχῆμα, 440 (Eucl.); *as subst.*, εὐθύγραμμον, τό, *rectilineal figure*, 318 (Archim.)
- εὐθύς, εἶα, ὕ, *straight*; εὐ. γραμμῆ, *straight line*, 438 (Eucl.); εὐθεία (*sc. γραμμῆ*), ἡ, *straight line*, ii. 44 (Archim.); *chord of a circle*, ii. 412 (Ptol.); *distance (first, second, etc.) in a spiral*, ii. 182 (Archim.); κατ' εὐθείας, *along a straight line*, ii. 580 (Papp.)
- εὐπαραχώρητος, *on*, *readily admissible, easily obvious*; εὐ. λήμματα, ii. 230 (Archim.)
- εὔρεσις, εως, ἡ, *discovery, solution*, ii. 518 (Dioph.), 260 (Eutoc.)
- εὔρημα, ατος, τό, *discovery*, 380 (Schol. in Eucl.)
- εὕρισκειν, *to find, discover, solve*, ii. 526 (Dioph.), 340 (Papp.), 262 (Eutoc.); ὅπερ εἶδει εὔρειν, *which was to be found*, 282 (Eutoc.)
- εὐχερής, ἐς, *easy to solve*, ii. 526 (Dioph.)
- ἐφάπτεσθαι, *to touch*, ii. 224 (Archim.); ἐφαπτομένη, ἡ (*sc. εὐθεία*), *tangent*, 322 (Archim.)
- ἐφαρμογή, ἡ, *coincidence of geometrical elements*, 340 (Papp.)
- ἐφαρμόζειν, *to fit exactly, coincide with*, 444 (Eucl.), ii. 208 (Archim.), 298 (Papp.); *pass. ἐφαρμόζεσθαι, to be applied to*, ii. 208 (Archim.)
- ἐφεξῆς, *adv.*, *in order, one after the other, successively*, 312 (Them.); *used adjectivally, as αἱ ἐ. γωνίαι, the adjacent angles*, 483 (Eucl.)
- ἐφιστάναι, *to set up, erect*; *perf.*, ἐφεστηκέναι, *intr.*, *stand*, and *perf. part. act.*, ἐφεστηκώς, *via*, ὅς, *standing*, 438 (Eucl.)
- ἐφοδος, ἡ, *method*, ii. 596 (Papp.); *title of work by Archimedes*
- ἔχειν, *to have*; λόγον ἔ., *to have a proportion or ratio*, ii. 14 (Aristarch.); γένεσιν ἔ., *to be generated (of a curve)*, 348 (Papp.)
- ἕως, *as far as, to*, ii. 290 (Apollon.)
- Ζητεῖν, *to seek, investigate*, ii. 222 (Archim.); ζητούμενον, τό, *the thing sought*, 158 (Procl.), ii. 596 (Papp.)
- ζήτησις, εως, ἡ, *inquiry, investigation*, 152 (Procl.)
- ζύγιον, τό = ζυγόν, τό, ii. 234 (Archim.)

INDEX OF GREEK TERMS

- ζυγόν, τό, *beam of a balance, balance*, ii. 234 (Archim.)
- ζῳδίων, τό, dim. of ζῳον, lit. *small figure painted or carved*; hence *sign of the Zodiac*; ὁ τῶν Ζ. κύκλος, *Zodiac circle*, ii. 394 (Hypsicles)
- ἡγεῖσθαι, *to lead*; ἡγούμενα, τά, *leading terms in a proportion*, 448 (Eucl.)
- ἡμικύκλιος, ον, *semicircular*; as subst., ἡμικύκλιον, τό, *semicircle*, 440 (Eucl.), ii. 568 (Papp.)
- ἡμικύλινδρος, ὁ, *half-cylinder*, 260 (Eutoc.); dim. ἡμικυλίνδριον, τό, 286 (Eutoc.)
- ἡμιόλιος, α, ον, *containing one and a half, half as much or as large again, one-and-a-half times*, ii. 42 (Archim.)
- ἡμισυς, εια, υ, *half*, ii. 10 (Aristarch.); as subst., ἡμισυ, τό, 320 (Archim.)
- Θέσις, εως, ἡ, *setting, position*, 268 (Eutoc.); θέσει δεδῶσθαι, *to be given in position*, 478 (Eucl.)
- θεωρεῖν, *to look into, investigate*, ii. 222 (Archim.)
- θεώρημα, ατος, τό, *theorem*, 228 (Archim.), ii. 566 (Papp.), 150 (Procl.), ii. 366 (Procl.)
- θεωρητικός, ἡ, ὄν, *able to perceive, contemplative, speculative, theoretical*; applied to species of analysis, ii. 598 (Papp.)
- θεωρία, ἡ, *inquiry, theoretical investigation, theory*, ii. 222 (Archim.), ii. 568 (Papp.)
- θυρεός, ὁ, *shield*, 490 (Eucl.); ἡ (sc. γραμμῆ) τοῦ θ., *ellipse*, ii. 360 (Procl.)
- ἴσάκις, adv., *the same number of times, as many times*; τὰ ἰ. πολλαπλάσια, *equimultiples*, 446 (Eucl.)
- ἰσοβαρής, ἐς, *equal in weight*, ii. 250 (Archim.)
- ἰσογκος, ον, *equal in bulk, equal in volume*, ii. 250 (Archim.)
- ἰσογώνιος, ον, *equiangular*, ii. 608 (Papp.)
- ἰσομήκης, ἐς, *equal in length*, 398 (Plat.)
- ἰσοπερίμετρος, ον, *of equal perimeter*, ii. 386 (Theon Alex.)
- ἰσόπλευρος, ον, *having all its sides equal, equilateral*; ἰ. τρίγωνον, 440 (Eucl.), ἰ. τετράγωνον, 440 (Eucl.), ἰ. πολύγωνον, ii. 54 (Archim.)
- ἰσοπληθής, ἐς, *equal in number*, 454 (Eucl.)
- ἰσορροπεῖν, *to be equally balanced, be in equilibrium, balance*, ii. 206 (Archim.)
- Ἰσορροπικά, τά, *title of work on equilibrium by Archimedes*, ii. 226 (Archim.)
- ἰσορροπος, ον, *in equilibrium*, ii. 226 (Archim.)
- ἴσος, η, ον, *equal*, 268 (Eutoc.); ἐξ ἴσου, *evenly*,

INDEX OF GREEK TERMS

- 438 (Eucl.); δι' ἴσου, *ex aequali*, transformation of a ratio according to the rule of Eucl. v. Def. 17, 448 (Eucl.)
- ἰσοσκελῆς, ἒς, *with equal legs, having two sides equal, isosceles*; ἰ. τρίγωνον, 440 (Eucl.); ἰ. κῶνος, ii. 58 (Archim.)
- ἰσοταχῶς, *uniformly*, ii. 182 (Archim.)
- ἰσότης, ἦτος, ἦ, *equality, equation*, ii. 526 (Dioph.)
- ἰστάναι, *to set up*; εὐθεία ἐπ' εὐθείαν σταθείσα, 438 (Eucl.)
- ἰσώσεις, εως, ἦ, *making equal, equation*, ii. 526 (Dioph.)
- Κάθετος, ον, *let down, perpendicular*; ἦ κ. (sc. γραμμῆ), *perpendicular*, 438 (Eucl.), ii. 580 (Papp.)
- καθολικός, ἦ, ὄν, *general*; κ. μέθοδος, ii. 470 (Heron)
- καθολικῶς, *generally*; καθολικώτερον, *more generally*, ii. 572 (Papp.)
- καθόλου, adv., *on the whole, in general*; τὰ κ. καλούμενα θεωρήματα, 152 (Procl.)
- καμπύλος, η, ον, *curved*; κ. γραμμαί, ii. 42 (Archim.); 260 (Eutoc.)
- κανόνιον, τό, *table*, ii. 444 (Ptol.)
- κανονικός, ἦ, ὄν, *of or belonging to a rule*; ἦ κανονικῆ (sc. τέχνη), *the mathematical theory of music, theory of musical intervals,*
- canonic*, 18 (Anatolius); κ. ἔκθεσις, *display in the form of a table*, ii. 412 (Ptol.)
- κανών, ὄνος, ὄ, *straight rod, bar*, 308 (Aristoph.), 264 (Eutoc.); *rule, standard, table*, ii. 408 (Suidas)
- κατάγειν, *to draw down or out*, ii. 600 (Papp.)
- καταγραφῆ, ἦ, *construction, drawing, figure*, ii. 158 (Eutoc.), ii. 444 (Ptol.), ii. 610 (Papp.)
- καταλαμβάνειν, *to overtake*, 368 (Aristot.)
- καταλείπειν, *to leave*, 454 (Eucl.), ii. 218 (Archim.), ii. 524 (Dioph.); τὰ καταλειπόμενα, *the remainders*, 444 (Eucl.)
- καταμετρεῖν, *to measure, i.e., to be contained in an integral number of times*, 444 (Eucl.)
- κατασκευάζειν, *to construct*, 264 (Eutoc.), ii. 566 (Papp.)
- κατασκευή, ἦ, *construction*, ii. 500 (Heron)
- καταστερισμός, ὄ, *placing among the stars*; Καταστερισμοί, οἱ, title of work wrongly attributed to Eratosthenes, ii. 262 (Suidas)
- κατατομή, ἦ, *cutting, section*; Κ. κανόνος, title of work by Cleonides, 157 n. c
- κατοπτρικός, ἦ, ὄν, *of or in a mirror*; Κατοπτρικά, τά, title of work ascribed to Euclid, 156 (Procl.)

INDEX OF GREEK TERMS

- κάτοπτρον, τό, mirror**, ii. 498 (Heron)
κείσθαι, to lie, ii. 268 (Cleom.); of points on a straight line, 438 (Eucl.); as pass. of *τιθέναι*, to be placed or made; of an angle, 326 (Archim.); *ὁμοίως κ.*, to be similarly situated, ii. 208 (Archim.)
κεντροβαρικός, ἡ, ὄν, of or pertaining to a centre of gravity; κ. σημεία, ii. 604 (Papp.)
κέντρον, τό, centre; of a circle, 438 (Eucl.), ii. 8 (Aristarch.), ii. 572 (Papp.); of a semicircle, 440 (Eucl.); ἡ (sc. γραμμῆ or εὐθεία) ἐκ τοῦ κ., radius of a circle, ii. 40 (Archim.); κ. τοῦ βάρους, centre of gravity, ii. 208 (Archim.)
κινεῖν, to move, 264 (Eutoc.)
κίνησις, εως, ἡ, motion, 264 (Eutoc.)
κισσοειδής, ἐς, Att. κισσοειδής, ἐς, like ivy; κ. γραμμῆ, cissoïd, 276 n. a
κλᾶν, to bend, to inflect, 420 (Aristot.), 358 (Papp.); κλῶμεναι εὐθείαι, inclined straight lines, ii. 496 (Damian.)
κλίνειν, to make to lean; pass., to incline, ii. 252 (Archim.)
κλίσις, εως, ἡ, inclination; τῶν γραμμῶν κ., 438 (Eucl.)
κογχοειδής, ἐς, resembling a mussel; κ. γραμμαί (often without γ.), conchoidal curves, conchoids, 296 (Eutoc.)
κοῖλος, ἡ, ὄν, concave; ἐπὶ τὰ αὐτὰ κ., concave in the same direction, ii. 42 (Archim.), 338 (Papp.)
κοινός, ἡ, ὄν, common, 412 (Aristot.); κ. πλευρά, ii. 500 (Heron); κ. ἐννοιαί, 444 (Eucl.); κ. τομή, ii. 290 (Apollon.); τὸ κοινόν, common element, 306 (Papp.)
κορυφή, ἡ, vertex; of a cone, ii. 286 (Apollon.); of a plane curve, ii. 286 (Apollon.); of a segment of a sphere, ii. 40 (Archim.)
κοχλίας, ον, ὁ, snail with spiral shell; hence anything twisted spirally; screw, ii. 496 (Heron); screw of Archimedes, ii. 34 (Diod. Sic.); Περὶ τοῦ κ., work by Apollonius, ii. 350 (Procl.)
κοχλιοειδής, ἐς, of or pertaining to a shell fish; ἡ κ. (sc. γραμμῆ), cochloid, 334 (Simpl.); also κοχλιοειδής, ἐς, as ἡ κ. γραμμῆ, 302 (Papp.); probably anterior to ἡ κογχοειδής γραμμῆ with same meaning
κρίκος, ὁ, ring; τετράγωνοι κ., prismatic sections of cylinders, ii. 470 (Heron)
κυβίζειν, to make into a cube, cube, raise to the third power, ii. 504 (Heron)

INDEX OF GREEK TERMS

- κυβικός, ἡ, ὄν, of or for a cube, cubic, 222 (Plat.)
- κυβόκυβος, ὁ, cube multiplied by a cube, sixth power of the unknown quantity [x^6], ii. 522 (Dioph.)
- κυβοκυβοστόν, τό, the fraction $\frac{1}{x^8}$, ii. 522 (Dioph.)
- κύβος, ὁ, cube, 258 (Eutoc.); cubic number, ii. 518 (Dioph.); third power of unknown, ii. 522 (Dioph.)
- κυβοστόν, τό, the fraction $\frac{1}{x^3}$, ii. 522 (Dioph.)
- κυκλικός, ἡ, ὄν, circular, ii. 360 (Procl.)
- κύκλος, ὁ, circle, 392 (Plat.), 438 (Eucl.); μέγιστος κ., great circle (of a sphere), ii. 8 (Aristarch.), ii. 42 (Archim.)
- κυλινδρικός, ἡ, ὄν, cylindrical, 286 (Eutoc.)
- κύλινδρος, οὐ, ὁ, cylinder, ii. 42 (Archim.)
- κυρίως, adv., in a special sense; κ. ἀναλογία, proportion par excellence, i.e., the geometric proportion, 125 n. a
- κωνικός, ἡ, ὄν, conical, conic; κ. ἐπιφάνεια, conical surface (double cone), ii. 286 (Apollon.)
- κωνοειδής, ἔς, conical; as subst. κωνοειδές, τό, conoid; ὀρθογώνιον κ., right-angled conoid, i.e., paraboloid of revolution, ii. 164; ἀμβλυγώνιον κ., obtuse-angled conoid, i.e., hyperboloid of revolution, ii. 164
- κῶνος, οὐ, ὁ, cone, ii. 286 (Apollon.)
- κωνοτομῆν, to cut the cone, 226 (Eratost. ap. Eutoc.)
- Λαμβάνειν, to take, ii. 112 (Archim.); εἰλήφθω τὰ κέντρα, let the centres be taken, ii. 388 (Theon Alex.); λ. τὰς μέσας, to take the means, 294 (Eutoc.); to receive, postulate, ii. 44 (Archim.)
- λέγειν, to choose, ii. 166 (Archim.)
- λείπειν, to leave, ii. 62 (Archim.); λείποντα εἶδη, τά, negative terms, ii. 524 (Dioph.)
- λεῖψις, εὐς, ἡ, negative term, minus, ii. 524 (Dioph.)
- λήμμα, ατος, τό, auxiliary theorem assumed in proving the main theorem, lemma, ii. 608 (Papp.)
- λημμάτιον, τό, dim. of λήμμα, lemma
- λήψις, εὐς, ἡ, taking hold, solution, 260 (Eutoc.)
- λογικός, ἡ, ὄν, endowed with reason, theoretical, ii. 614 (Papp.)
- λογιστικός, ἡ, ὄν, skilled or practised in reasoning or calculating; ἡ λογιστικὴ (sc. τέχνη), the art of manipulating numbers, practical arithmetic, logistic, 17 (Schol. ad Plat. Charm.)

INDEX OF GREEK TERMS

- λόγος, ὁ, ratio, 444 (Eucl.); Λόγου ἀποτομή, Cutting-off of a Ratio, title of work by Apollonius, ii. 598 (Papp.); λ. συνημμένος, compound ratio, ii. 602 (Papp.); λ. μοναχός, singular ratio, ii. 606 (Papp.); ἄκρος καὶ μέσος λ., extreme and mean ratio, 472 (Eucl.), ii. 416 (Ptol.)*
- λοιπός, ἡ, ὄν, remaining, ii. 600 (Papp.); as subst., λοιπόν, τό, the remainder, ii. 506 (Papp.), 270 (Eutoc.)*
- λοξός, ἡ, ὄν, oblique, inclined; κατὰ λ. κύκλου, ii. 4 (Plut.)*
- λύσις, εως, ἡ, solution, ii. 596 (Papp.)*
- Μαγγανάριος, ὁ, mechanical engineer, maker of mechanical powers, ii. 616 (Papp.)*
- μάγγανον, τό, block of a pulley, ii. 616 n. a (Heron)*
- μάθημα, τό, study, 8 (Plat.), 4 (Archytas); μαθήματα, τά, mathematics; τὰ δὲ καλούμενα ἰδίως μ., 2 (Anatolius); 148 (Procl.), ii. 42 (Archim.), ii. 566 (Papp.)*
- μαθηματικός, ἡ, ὄν, mathematical; μαθηματικός, ὁ, mathematician, ii. 2 (Aët.), ii. 61 (Papp.); ἡ μαθηματικὴ (sc. ἐπιστήμη), mathematics, 4 (Archytas); τὰ μ., mathematics*
- μέγεθος, ουσ, Ion. εος, τό, magnitude, 444 (Eucl.), ii. 50 (Archim.), ii. 412 (Ptol.)*
- μέθοδος, ἡ, following after, investigation, method, 90 (Procl.)*
- μείζων, ον, greater, more, 318 (Archim.); ἥτοι μ. ἐστὶν ἢ ἐλάσσων, ii. 112 (Archim.); μ. ὀρθῆς, greater than a right angle, 438 (Eucl.); ἡ μ. (sc. εὐθεία), major in Euclid's classification of irrationals, 458 (Eucl.)*
- μένειν, to remain, to remain stationary, 98 (Nicom.), 286 (Eutoc.)*
- μερίζειν, to divide, τι παρά τι, 50 (Theon Alex.)*
- μερισμός, ὁ, division, 16 (Schol. in Plat. Charm.), ii. 414 (Ptol.)*
- μέρος, ουσ, Ion. εος, τό, part; of a number, 66 (Eucl.); of a magnitude, 444 (Eucl.), ii. 584 (Papp.); τὰ μέρη, parts, directions, ἐφ' ἑκάτερα τὰ μ., in both directions, 438 (Eucl.)*
- μεσημβρινός, ἡ, ὄν, for μεσημερινός, of or for noon; μ. (sc. κύκλος), ὁ, meridian, ii. 268 (Cleom.)*
- μέσος, η, ον, middle; ἡ μέση (sc. εὐθεία), mean (ἀριθμητικῆ, γεωμετρικῆ, ἀρμονικῆ), ii. 568 (Papp.); μέση τῶν ΔΚ, ΚΓ, mean between ΔΚ, ΚΓ, 272 (Eutoc.); ἄκρος καὶ μ. λόγος, extreme and mean ratio, 472 (Eucl.), ii. 416 (Ptol.); ἡ μέση (sc. εὐθεία), medial in Euclid's classi-*

INDEX OF GREEK TERMS

- fication of irrationals, 458 (Eucl.); ἐκ δύο μέσων πρώτη, *first bimedial*, ἐκ δύο μέσων δευτέρα, *second bimedial*, etc., *ibid.*
- μεσότης, ἡτος, ἡ, *mean*, ii. 566 (Papp.); μ. ἀριθμητική, γεωμετρική, ἀρμονική (ὑπεναντία), 110-111 (Iambl.)
- μετρεῖν, *to measure, contain an integral number of times*, 68 (Eucl.), ii. 54 (Archim.)
- μέτρον, τό, *measure, relation*, ii. 294 (*Prob. Bov.*); κοινόν μ., *common measure*, ii. 210 (Archim.)
- μέχρι, *as far as*, prep. with gen.; ἡ μέχρι τοῦ ἄξονος (*sc. γραμμῆ*), ii. 256 (Archim.)
- μήκος, Dor. μάκος, εος, τό, *length*, 436 (Eucl.); *distance of weight from fulcrum of a lever*, ii. 206 (Archim.)
- μηνίσκος, ό, *crescent-shaped figure, lune*, 238 (Eudemus ap. Simplic.)
- μηχανή, ἡ, *contrivance, machine, engine*, ii. 26 (Plut.)
- μηχανικός, ἡ, όν, *of or for machines, mechanical*, ii. 616 (Papp.); ἡ μηχανική (with or without τέχνη), *mechanics*, ii. 614 (Papp.); as subst., μηχανικός, ό, *mechanician*, ii. 616 (Papp.), ii. 496 (Damian.)
- μηχανοποιός, ό, *maker of engines*, ii. 616 (Papp.)
- μικρός, ά, όν, *small, little*; M. ἀστρονομούμενος (*sc. τόπος*), *Little Astronomy*, ii. 409 n. b
- μικτός, ἡ, όν, *mixed*; μ. γραμμῆ, ii. 360 (Procl.); μ. ἐπιφάνεια, ii. 470 (Heron)
- μοῖρα, ας, ἡ, *portion, part*; in astron., *degree*, 50 (Theon Alex.); μ. τοπική, χρονική, ii. 396 (Hypsiocl.)
- μονάς, άδος, ἡ, *unit, monad*, 66 (Eucl.)
- μοναχός, ἡ, όν, *unique, singular*; μ. λόγος, ii. 606 (Papp.)
- μόριον, τό, *part*, 6 (Plat.)
- μουσικός, ἡ, όν, Dor. μουσικός, ά, όν, *musical*; ἡ μουσική (*sc. τέχνη*), *poetry sung to music, music*, 4 (Archytas)
- μυριάς, άδος, ἡ, *the number ten thousand, myriad*, ii. 198 (Archim.); μ. ἀπλαῖ, διπλαῖ, κτλ., *a myriad raised to the first power, to the second power, and so on*, ii. 355 n. a
- μύριοι, αι, α, *ten thousand, myriad*; μ. μυριάδες, *myriad myriads*, ii. 198 (Archim.)
- Νεύειν, *to be in the direction of*, ii. 6 (Aristarch.); of a straight line, *to verge, i.e., to be so drawn as to pass through a given point and make a given intercept*, 244 (Eudemus ap. Simplic.), 420 (Aristot.), ii. 188 (Archim.)

INDEX OF GREEK TERMS

- νεύσις, εως, ἡ, inclination, verging, problem in which a straight line has to be drawn through a point so as to make a given intercept, 245 n. a; στερεὰ ν., solid verging, 350 (Papp.); Νεύσεις, title of work by Apollonius, ii. 598 (Papp.)*
- Ὁδός, ἡ, method, ii. 596 (Papp.)*
- οἰκεῖος, α, ον, proper to a thing; ὁ οἰ. κύκλος, ii. 270 (Cleom.)*
- ὀκτάγωνος, ον, eight-cornered; as subst., ὀκτάγωνον, τό, regular plane figure with eight sides, octagon, ii. 196 (Archim.)*
- ὀκτάεδρος, ον, with eight faces; as subst., ὀκτάεδρον, τό, solid with eight faces, ii. 196 (Archim.)*
- ὀκταπλάσιος, α, ον, eightfold, ii. 584 (Papp.)*
- ὀκτωκαιδεκαπλάσιος, ον, eighteen-fold, ii. 6 (Aristarch.)*
- ὀκτωκαιτριακοντάεδρον, τό, solid with thirty-eight faces, ii. 196 (Archim.)*
- ὀλόκληρος, ον, complete, entire; as subst., ὀλόκληρον, τό, integer, ii. 534 (Dioph.)*
- ὅλος, η, ον, whole; τὰ ὅ., 444 (Eucl.)*
- ὀμαλός, ἡ, ὄν, even, uniform, ii. 618 (Papp.)*
- ὀμαλῶς, adv., uniformly, 338 (Papp.)*
- ὀμοιος, α, ον, like, similar; ὁ. τρίγωνον, 288 (Eutoc.); ὀμοιοι ἐπίπεδοι καὶ στερεοὶ ἀριθμοί, 70 (Eucl.)*
- ὀμοίως, adv., similarly, ii. 176 (Archim.); τὰ ὁ. τεταγμένα, the corresponding terms, ii. 166 (Archim.); ὁ. κεῖσθαι, to be similarly situated, ii. 208 (Archim.)*
- ὀμολογεῖν, to agree with, admit; pass., to be allowed, admitted; τὸ ὀμολογούμενον, that which is admitted, premise, ii. 596 (Papp.)*
- ὀμόλογος, ον, corresponding; ὁ. μεγέθη, ii. 166 (Archim.); ὁ. πλευραί, ii. 208 (Archim.)*
- ὀμοταγής, ἐς, ranged in the same row or line, co-ordinate with, corresponding to, similar to, ii. 586 (Papp.)*
- ὄνομα, ατος, τό, name; ἡ (sc. εὐθεῖα) ἐκ δύο ὀνομάτων, binomial in Euclid's classification of irrationals, 458 (Eucl.)*
- ὀξυγώνιος, ον, acute-angled; ὁ. κῶνος and ὁ. κώνου τομή, ii. 278 (Eutoc.)*
- ὀξύς, εἶα, ὑ, acute; ὁ. γωνία, acute angle, often with γωνία omitted, 438 (Eucl.)*
- ὀπτικός, ἡ, ὄν, of or for sight; ὀπτικά, τά, theory of laws of sight; as prop. name, title of work by Euclid, 156 (Procl.)*
- ὀργανικός, ἡ, ὄν, serving as instruments; ὁ. λήψις, mechanical solution, 260 (Eutoc.)*

INDEX OF GREEK TERMS

- ὀργανικῶς, adv., *by means of instruments*, 292 (Eutoc.)
- ὄργανον, τό, *instrument*, 294 (Eutoc.); dim. ὄργανιον, 294 (Eutoc.)
- ὄρθιος, α, ον, *upright, erect*; ἡ ὀρθία (sc. τοῦ εἶδους πλευρά), *the erect side of the rectangle formed by the ordinate of a conic section applied to the parameter as base, latus rectum, an alternative name for the parameter*, ii. 316 (Apollon.), ii. 322 (Apollon.)
- ὀρθογώνιος, ον, *having all its angles right, right-angled, orthogonal*; ὁ τετράγωνος, 440 (Eucl.); ὁ παραλληλόγραμμον, 268 (Eutoc.)
- ὀρθός, ἡ, ὄν, *right*; ὁ γωνία, *right angle*, 438, 442 (Eucl.); ὁ κώνος, *right cone*, ii. 286 (Apollon.)
- ὀρίζειν, *to separate, delimit, bound, define*, 382 (Plat.); εὐθεία ὠρισμένη, *finite straight line*, 188 (Eucl.)
- ὄρος, ὁ, *boundary*, 438 (Eucl.); *term in a proposition*, 112 (Archytas ap. Porph.), 114 (Nicom.)
- οὖν, *therefore*, used of the steps in a geometrical proof, 326 (Eucl.)
- ὀχεῖσθαι, *to be borne, to float in a liquid*; Περὶ τῶν οχουμένων, *On floating bodies*, title of work by Archimedes, ii. 616 (Papp.)
- Παρά, *beside*; παραβάλλειν π. *to apply a figure to a straight line*, 188 (Eucl.); τι π. τι παραβάλλειν, *to divide by*, ii. 482 (Heron)
- παραβάλλειν, *to throw beside*; π. παρά, *to apply a figure to a straight line*, 188 (Eucl.); hence, since to apply a rectangle xy to a straight line x is to divide xy by x , π. = *to divide*, ii. 482 (Heron)
- παραβολή, ἡ, *juxtaposition; division* (v. παραβάλλειν), hence *quotient*, ii. 530 (Dioph.); *application of an area to a straight line*, 186 (Eucl.); the conic section *parabola*, so called because the square on the ordinate is equal to a rectangle whose height is equal to the abscissa *applied to the parameter as base*, ii. 304 (Apollon.), 186 (Procl.), 280 (Eutoc.)
- παράδοξος, ον, *contrary to expectation, wonderful*; ἡ π. γραμμή, *the curve called paradoxical by Menelaus*, 348 (Papp.); τὰ π., *the paradoxes of Erycinus*, ii. 572 (Papp.)
- παρακείσθαι, *to be adjacent*, ii. 590 (Papp.), 282 (Eutoc.)
- παραλληλεπίπεδον, τό, *figure bounded by three pairs of parallel planes, parallel-epiped*, ii. 600 (Papp.)

INDEX OF GREEK TERMS

- παράλληλόγραμμος, ον, bounded by parallel lines; as subst., παράλληλόγραμμον, τό, parallelogram, 188 (Eucl.)*
παράλληλος, ον, beside one another, side by side, parallel, 270 (Eutoc.); π. εὐθείαι, 440 (Eucl.)
παραμήκης, ες, Dor. παραμάκης, ες, oblong; σφαιροειδὲς π., ii. 164 (Archim.)
παραπλήρωμα, ατος, τό, interstice, ii. 590 (Papp.); complement of a parallelogram, 190 (Eucl.)
παρτείνειν, to stretch out along, produce, 10 (Plat.)
παυξήσις, εως, ἡ, increase, ii. 412 (Ptol.)
παρύπτιος, ον, hyper-supine; παρύπτιον, τό, a quadrilateral with a re-entrant angle, 482 (Papp.)
πᾶς, πᾶσα, πᾶν, all, the whole, every, any; π. σημεῖον, any point, 442 (Eucl.)
πεντάγωνος, ον, pentagonal; π. ἀριθμὸς, 96 (Nicom.); as subst., πεντάγωνον, τό, pentagon, 222 (Iambl.)
περαίνειν, to bring to an end; τεπερασμένος, ον, terminated, 280 (Eutoc.); γραμμὰι τεπερασμέναι, finite lines, ii. 42 (Archim.)
πέρας, ατος, τό, end, extremity; of a line, 436 (Eucl.); of a plane, 438 (Eucl.)
περατοῦν, to limit, bound; εὐθεῖα τερατουμένη, 438 (Eucl.)
περιγράφειν, to circumscribe, ii. 48 (Archim.)
περιέχειν, to contain, bound; τὸ περιεχόμενον ὑπὸ, the rectangle contained by, ii. 108 (Archim.); αἱ περιέχουσαι τὴν γωνίαν γραμμαί, 438 (Eucl.); τὸ περιεχόμενον σχῆμα, 440 (Eucl.)
περιλαμβάνειν, to contain, include, ii. 104 (Archim.)
περίμετρος, ον, very large, well-fitting; ἡ π. (sc. γραμμῆ) = περίμετρον, τό, perimeter, ii. 318 (Archim.), ii. 502 (Heron), ii. 386 (Theon Alex.)
περισσάκις, Att. περιττάκις, adv., taken an odd number of times; π. ἀρτιὸς ἀριθμὸς, odd-times even number, 68 (Eucl.); π. περισσὸς ἀριθμὸς, odd-times odd number, 68 (Eucl.)
περισσός, Att. περιττός, ἡ, ὄν, superfluous; subtle; ἀριθμὸς π., odd number, 66 (Eucl.)
περιτιθέναι, to place or put around, 94 (Aristot.)
περιφέρεια, ἡ, circumference or periphery of a circle, arc of a circle, 440 (Eucl.), ii. 412 (Ptol.)
περιφορά, ἡ, revolution, turn of a spiral, ii. 182 (Archim.)
πηλικότης, ητος, ἡ, magnitude, size, ii. 412 (Ptol.)

INDEX OF GREEK TERMS

- πίπτειν, *to fall*; of points, ii. 44 (Archim.); of a straight line, 286 (Eutoc.)
- πλάγιος, α, ον, *oblique*; π. διάμετρος, *transverse diameter of a conic section*, ii. 286 (Apollon.); π. πλευρά, *transverse side of the rectangle formed by the ordinate of a conic section applied to the parameter as base*, ii. 316 (Apollon.) and ii. 322 (Apollon.)
- πλάσσειν, *to form*; of numbers, ii. 528 (Dioph.)
- πλάτος, ουσ, Ion. εος, τό, *breadth*, 438 (Eucl.)
- πλατύνειν, *to widen, broaden*, 88 (Nicom.)
- πλευρά, ᾶς, ἥ, *side*; of a triangle, 440 (Eucl.); of a parallelogram, ii. 216 (Archim.); of a square, hence, *square root*, ii. 530 (Dioph.); of a number, 70 (Eucl.); πλαγία π., *latus rectum of a conic section*, ii. 322 (Apollon.); π. καὶ διάμετρος, 132 (Theon Smyr.)
- πλῆθος, ουσ, Ion. εος, τό, *number, multitude*, 66 (Eucl.)
- πνευματικός, ἥ, ὄν, *of wind or air*; Πνευματικά, τά, *title of work by Heron*, ii. 616 (Papp.)
- ποιεῖν, *to do, construct*, ii. 566 (Papp.); *to make*, π. τομήν, ii. 290 (Apollon.); *to be equal to, to equal*, ii. 526 (Dioph.)
- πολλαπλασιάζειν, *to multiply*, 70 (Eucl.)
- πολλαπλάσιος, α, ον, *many times as large, multiple*; of a number, 66 (Eucl.); of a magnitude, 444 (Eucl.); as subst., πολλαπλάσιον, τό, *multiple*; τὰ ἰσάκεις π., *equimultiples*, 446 (Eucl.)
- πολλαπλασιῶν, ον = πολλαπλάσιος, ii. 212 (Archim.)
- πόλος, ὁ, *pole*; of a sphere, ii. 580 (Papp.); of a conchoid, 300 (Papp.)
- πολύγωνος, ον, *having many angles, polygonal*; comp., πολυγωνότερος, ον, ii. 592 (Papp.); as subst., πολυγωνον, τό, *polygon*, ii. 48 (Archim.)
- πολύεδρος, ον, *having many bases*; as subst., πολυεδρον, τό, *polyhedron*, ii. 572 (Papp.)
- πολυπλασιασμός, ὁ, *multiplication*, 16 (Schol. in Plat. Charm.), ii. 414 (Apollon.)
- πολύπλευρος, ον, *many sided, multilateral*, 440 (Eucl.)
- πορίζειν, *to bring about, find*, either by proof or by construction, ii. 598 (Papp.), 252 (Procl.)
- πόρισμα, ατος, τό, *corollary to a proposition*, 480 (Procl.), ii. 294 (Apollon.); kind of proposition intermediate between a theorem and a problem, *porism*, 480 (Procl.)

INDEX OF GREEK TERMS

- ποριστικός, ἡ, ὄν, *able to supply or find*; ποριστικὸν τοῦ προταθέντος, ii. 598 (Papp.)
- πραγματεία, ἡ, *theory, investigation*, 148 (Procl.), ii. 406 (Theon Alex.)
- πρίσμα, ατος, τό, *prism*, ii. 470 (Heron)
- πρόβλημα, ατος, τό, *problem*, 14 (Plat.), 258 (Eutoc.), ii. 566 (Papp.)
- προβληματικός, ἡ, ὄν, *of or for a problem*; applied to species of analysis, ii. 598 (Papp.)
- πρόδηλος, ον, *clear, manifest*, ii. 496 (Heron)
- προηγείσθαι, *to take the lead*; προηγούμενα, τά, *forward points, i.e. those lying on the same side of a radius vector of a spiral as the direction of its motion*, ii. 184 (Archim.)
- προκατασκευάζειν, *to construct beforehand*, 276 (Eutoc.)
- προμήκης, ες, *prolonged, oblong*, 398 (Plat.)
- πρὸς, Dor. ποτί, prep., *towards*; ὡς ἡ ΔΚ πρὸς ΚΕ, the ratio ΔΚ : ΚΕ, 272 (Eutoc.)
- προσπίπτειν, *to fall*, 300 (Eutoc.); αἱ προσπίπτουσαι εὐθείαι, 438 (Eucl.), ii. 594 (Papp.)
- προστιθέναι, *to add*, 444 (Eucl.)
- πρότασις, εως, ἡ, *proposition, enunciation*, ii. 566 (Papp.)
- προτείνειν, *to propose, to enunciate a proposition*, ii. 566 (Papp.); τὸ προτεθέν, that which was *proposed, proposition*, ii. 220 (Archim.)
- πρώτιστος, η, ον, also ος, ον, *the very first*, 90 (Nicom.)
- πρώτος, η, ον, *first*; π. ἀριθμός, *prime number*, 68 (Eucl.); but π. ἀριθμοί, numbers of the *first order* in Archimedes, ii. 198 (Archim.); in astron., π. ἑξηκοστόν, *first sixtieth, minute*, 50 (Theon Alex.); in geom., π. εὐθεία, *first distance of a spiral*, ii. 182 (Archim.)
- πτώσις, εως, ἡ, *case of a theorem or problem*, ii. 600 (Papp.)
- πυθμὴν, ἑνος, ὁ, *base, basic number of a series, i.e., lowest number possessing a given property*, 398 (Plat.); number of tens, hundreds, etc., contained in a number, ii. 354 (Papp.)
- πυραμῖς, ἴδος, ἡ, *pyramid*, 228 (Archim.)
- ῥέπειν, *to incline*; of the weights on a balance, ii. 208
- ῥητός, ἡ, ὄν, *rational*, 398 (Plat.), 452 (Eucl.)
- ῥίζα, Ion. ῥίζη, ἡ, *root*; ἀρχικωτάτη ῥίζα, 90 (Nicom.)

INDEX OF GREEK TERMS

- ῥομβοειδής, ἒς, *rhombus-shaped, rhomboidal*; ῥ. σχῆμα, 440 (Eucl.)
 ῥόμβος, ὁ, *plane figure with four equal sides but with only the opposite angles equal, rhombus*, 440 (Eucl.); ῥ. στερεός, *figure formed by two cones having the same base and their axes in a straight line, solid rhombus*, ii. 44 (Archim.)
- Σημαίνειν, *to signify*, 188 (Procl.)
 σημείον, Dor. σαμείον, τό, *point*, 436 (Eucl.); *sign*, ii. 522 (Dioph.)
 σκαληνός, ἡ, ὄν, also ὅς, ὄν, *oblique, scalene*; κῶνος σ., ii. 286 (Apollon.)
 σκέλος, οὖς, Ion. εὖς, τό, *leg*; σ. τῆς γωνίας, 264 (Eutoc.)
 σπείρα, ἡ, *surface traced by a circle revolving about a point not its centre, spire, tore, torus*, ii. 468 (Heron)
 σπειρικός, ἡ, ὄν, *pertaining to a spire, spiric*; σ. τομαί, *spiric sections*, ii. 364 (Procl.); σ. γραμμαί, *spiric curves*, ii. 364 (Procl.)
 στερεός, ἄ, ὄν, *solid*; σ. γωνία, *solid angle*, 222 (Plat.); σ. ἀριθμός, *cubic number*; σ. τοποί, *solid loci*, ii. 600 (Apollon.); σ. πρόβλημα, *solid problem*, 348 (Papp.); σ. νεύσις, *solid verging*, 350 (Papp.); as
- subst., στερεόν, τό, *solid*, 258 (Eutoc.)
 στιγμή, ἡ, *point*, 80 (Nicom.)
 στοιχείον, τό, *element*, ii. 596 (Papp.); *elementary book*, 150 (Procl.); Στοιχεία, τά, *the Elements*, especially Euclid's
 στοιχείωσις, εὖς, ἡ, *elementary exposition, elements*; Euclid's *Elements of geometry*, 156 (Procl.); αἱ κατὰ μουσικὴν σ., *the elements of music*, 156 (Procl.); σ. τῶν κωνικῶν, *elements of conics*, ii. 276 (Eutoc.)
 στοιχειωτής, οὖ, ὁ, *teacher of elements, writer of elements*, esp. Euclid, ii. 596 (Papp.)
 στρογγύλος, ἡ, ον, *round*, 392 (Plat.)
 συγκείσθαι, *to lie together*; as pass. of συντιθέναι, *to be composed of*, ii. 284 (Apollon.)
 σύγκρισις, εὖς, ἡ, *comparison*; Τῶν πέντε σχημάτων σ., *Comparison of the Five Figures*, title of work by Aristaeus, ii. 348 (Hypsiel.)
 συζυγής, ἒς, *yoked together, conjugate*; σ. διάμετροι, σ. ἄξονες, ii. 288 (Apollon.)
 σύμμετρος, ον, *commensurate with, commensurable with*; 380 (Plat.), 452 (Eucl.), ii. 208 (Archim.)
 συμπαρατείνειν, *to stretch out alongside of*, 188 (Procl.)

INDEX OF GREEK TERMS

- σύμπας, σύμπασα, σύμπαν, all together, the sum of*, ii. 514 (Dioph.)
συμπέρασμα, ατος, τό, conclusion, ii. 228 (Archim.)
συμπίπτειν, to meet, 190 (Eucl.); *τὴν μὲν ἐν αὐτῇ σ., of curves which meet themselves*, ii. 360 (Procl.)
συμπληροῦν, to fill, complete; *σ. παραλλήλογραμμον*, 268 (Eutoc.)
σύμπτωμα, ατος, τό, property of a curve, 336 (Papp.)
σύμπτωσης, εως, ἡ, falling together, meeting, ii. 64 (Archim.), ii. 270 (Cleom.), 286 (Eutoc.)
συναγωγή, ἡ, collection; title of work by Pappus, ii. 568 (Papp.)
συναμψότερος, ον, the sum of, 328 (Archim.)
συνάπτειν, to collect, gather; *συνημμένους λόγους, compound ratio*, ii. 602 (Papp.)
συνεγγίξω, to approximate, ii. 414 (Ptol.), ii. 470 (Heron)
σύνεγγυς, adv., near, approximately, ii. 488 (Heron)
συνεχῆς, ἐς, continuous, 442 (Eucl.); *σ. ἀναλογία, continued proportion*, ii. 566 (Papp.); *σ. ἀνάλογον*, 302 (Papp.); *σπεῖρα σ.*, ii. 364 (Procl.)
συνθέντι, v. συντιθέναι
σύνθεσις, εως, ἡ, putting together, composition; *σ. λόγου, transformation of a ratio known as componendo*, 448 (Eucl.); method of reasoning from assumptions to conclusions, in contrast with analysis, *synthesis*, ii. 596 (Papp.)
σύνθετος, ον, composite; *σ. ἀριθμός*, 68 (Eucl.); *σ. γραμμῆ*, ii. 360 (Procl.)
συνιστάναι, to set up, construct, 190 (Eucl.), 312 (Them.)
σύνταξις, εως, ἡ, putting together in order, systematic treatise, composite volume, collection; title of work by Ptolemy, ii. 408 (Suidas)
συντιθέναι, to place or put together, add together, used of the *synthesis* of a problem, ii. 160 (Archim.); *συνθέντι*, lit. *to one having compounded*, the transformation of a ratio known as *componendo*, ii. 130 (Archim.)
σύστασις, εως, ἡ, grouping (of theorems), 150 (Procl.)
σφαῖρα, ἡ, sphere, 466 (Eucl.), ii. 40 (Archim.), ii. 572 (Papp.)
σφαιρικός, ἡ, ὄν, spherical, ii. 584 (Papp.); *Σφαιρικά*, title of works by Menelaus and Theodosius
σφαιροποιία, ἡ, artificial sphere, making of the heavenly spheres, ii. 618 (Papp.)

INDEX OF GREEK TERMS

- σχήμα, ατος, τό, shape, figure,**
 438 (Eucl.), ii. 42 (Archim.)
- σχηματοποιεῖν, to bring into a certain form or shape;**
σχηματοποιούσα γραμμή, curve forming a figure,
 ii. 360 (Procl.)
- Τάλαντον, τό, weight known as the talent,** ii. 490 (Heron)
- τάξις, εως, ἡ, order, arrangement, scheme,** 112 (Iambl.)
- ταράσσειν, to disturb; τεταραγμένη ἀναλογία, disturbed proportion,** 450 (Eucl.)
- τάσσειν, to draw up in order,** ii. 598 (Papp.); **ὁμοίως τεταγμένα,** ii. 166 (Archim.); perf. part. pass. used as adv., **τεταγμένως, ordinate-wise,** ii. 286 (Apollon.); **αἱ καταγόμεναι τεταγμένως (sc. εὐθείαι), the straight lines drawn ordinate-wise, i.e., the ordinates, of a conic section,** ii. 308 (Apollon.); **τεταγμένως ἢ ΓΑ,** ii. 224 (Archim.)
- τέλειος, α, ον, perfect, complete,** ii. 604 (Papp.); **τ. ἀριθμός, 76 (Speusippus ap. Theol. Arith.), 70 (Eucl.), 398 (Plat.)**
- τέμνειν, to cut; of straight lines by a straight line,** ii. 288 (Apollon.); **of a curve by a straight line,** 278 (Eutoc.); **of a solid**
- by a plane,** ii. 288 (Apollon.)
- τεσσαρεσκαίδεκάεδρον, τό, solid with fourteen faces,** ii. 196 (Archim.)
- τεταγμένως, v. τάσσειν**
- τεταραγμένος, ον, v. ταράσσειν**
- τεταρτημόριον, τό, fourth part, quadrant of a circle,** ii. 582 (Papp.)
- τετραγωνίζειν, to make square,** ii. 494 (Heron); **to square,** 10 (Plat.); **ἡ τετραγωνίζουσα (sc. γραμμή), quadratrix,** 334 (Simpl.), 336 (Papp.)
- τετραγωνικός, ἡ, ὄν, square; of numbers,** ii. 526 (Dioph.); **τ. πλευρά, square root,** 60 (Theon Alex.)
- τετραγωνισμός, ὁ, squaring,** 310 (Aristot.); **τοῦ κύκλου τ., 308 (Plut.); τοῦ μηνίσκου τ., 150 (Procl.)**
- τετράγωνος, ον, square,** 308 (Aristophanes), ii. 504 (Heron); **ἀριθμός τ., square number,** ii. 514 (Dioph.); **τ. κρίκοι, square rings,** ii. 470 (Heron); **as subst., τετράγωνον, τό, square,** 440 (Eucl.); **square number,** ii. 518 (Dioph.)
- τετράκις, adv., four times,** 326 (Archim.)
- τετραπλάσιος, α, ον, four-fold, four times as much,** 332 (Archim.)
- τετραπλασίων, ον, later form of τετραπλάσιος**
- τετράπλευρος, ον, four-sided,**

INDEX OF GREEK TERMS

- quadrilateral*; σχήματα τ., 440 (Eucl.)
- τιθέναι, *to set, put, place*, ii. 224 (Archim.); θετέον, *must be posited*, 392 (Plat.); τὸ AB τεθὲν ἐπὶ τῷ Z, A+B *placed at Z*, ii. 214 (Archim.)
- τμήμα, Dor. τμᾶμα, *atos, τό, segment*; of a circle, ii. 584 (Papp.); of a sphere, ii. 40 (Archim.); in astron., $\frac{1}{2}$ th part of diameter of a circle, ii. 412 (Ptol.)
- τομεύς, *έως, ό, sector of a circle*, ii. 582 (Papp.); τ. στερεός, *sector of a sphere (intercepted by cone with vertex at centre)*, ii. 44 (Archim.)
- τομή, ἡ, *end left after cutting, section*; section of a straight line, 268 (Eutoc.); section of a cone, conic section, ii. 278 (Apollon.); τ. ἀντικείμεναι, *opposite branches of a hyperbola*, ii. 322 (Apollon.); σπειρικαὶ τ., ii. 364 (Procl.); κοινὴ τ., *common section*, 286 (Eutoc.); Διωρισμένη τ., *Determinate Section*, title of work by Apollonius, ii. 598 (Papp.); τὰ περὶ τῆν τ., *theorems about the section (? of a line cut in extreme and mean ratio)*, 152 (Procl.)
- τοπικός, ἡ, *όν, of or pertaining to place or space*; pertaining to a locus, 490 (Papp.); μοῖρα τ., *degree* in space, ii. 396 (Hyp-sicl.)
- τόπος, *ό, place, region, space*, ii. 590 (Papp.); locus, 318 (Papp.); T. ἐπίπεδοι, *Plane Loci*, title of work by Apollonius, ii. 598 (Papp.); T. στερεοί, *Solid Loci*, title of work by Aristaeus, ii. 600 (Papp.)
- τραπέζιον, τό, *trapezium*, 440 (Eucl.), ii. 488 (Heron)
- τριάς, *άδος, ἡ, the number three, triad*, 90 (Nicom.); Μεναιχμείαι τ., *the three conic sections of Menaechmus*, 296 (Erat. ap. Eutoc.)
- τρίγωνος, *ον, three-cornered, triangular*; ἀριθμοὶ τρίγωνοι, *triangular numbers*; as subst., τρίγωνον, τό, *triangle*, 440 (Eucl.), 316 (Archim.); τὸ διὰ τοῦ ἄξονος τ., *axial triangle*, ii. 288 (Apollon.)
- τριπλάσιος, *α, ον, thrice as many, thrice as great as*, 326 (Archim.), ii. 580 (Papp.)
- τριπλασίον, *ον=τριπλάσιος*, 320 (Archim.); τ. λόγος, 448 (Eucl.)
- τρίπλευρος, *ον, three-sided, trilateral*; σχήματα τ., 440 (Eucl.)
- τρίχα, *thrice, in three parts*, τ. τεμεῖν τὴν γωνίαν, *to trisect the angle*, 300 (Papp.)
- τυγχάνειν, *to happen to be*; aor. part., τυχών, τυχούσα, τυχόν, *any, taken at ran-*

INDEX OF GREEK TERMS

- dom*, εὐθεία τ., ii. 486 (Heron); as adv., τυχόν, *perchance*, 264 (Eutoc.)
- Ὑδρεῖον, τό, *bucket, pitcher*; pl., Ὑδρεῖα, title of work on *water clocks* by Heron, ii. 616 (Papp.)
- ὑπαρξίς, εως, ἡ, *existence*, ii. 518 (Dioph.); *positive term*, ii. 524 (Dioph.)
- ὑπεναντίος, α, ον, *subcontrary*; ὑ. μέσα, 112 (Archytas ap. Porph.); ὑ. τομή, ii. 304 (Apollon.)
- ὑπεναντίως, *subcontrary-wise*, ii. 301-302 (Apollon.)
- ὑπερβάλλειν, *to exceed*, 188 (Procl.)
- ὑπερβολή, ἡ, *exceeding*, 186 (Procl.); the conic section *hyperbola*, so called because the square on the ordinate is equal to a rectangle with height equal to the abscissa applied to the parameter as base, but *exceeding* (ὑπερβάλλον), *i.e.*, overlapping, that base, ii. 310 (Apollon.), 186 (Procl.)
- ὑπερέχειν, *to exceed*, 112 (Archytas ap. Porph.), 444 (Eucl.), ii. 608 (Papp.); τῷ αὐτῷ μέρει τῶν ἄκρων αὐτῶν ὑπερέχον τε καὶ ὑπερεχόμενον, 402 (Plat.)
- ὑπεροχή, Dor. ὑπεροχά, ἡ, *excess*, 112 (Archytas ap. Porph.), 318 (Archim.), ii. 530 (Dioph.), ii. 608 (Papp.)
- ὑπερπίπτειν, *to fall beyond, exceed*, ii. 436 (Ptol.)
- ὑπό, *by*; ἡ ὑπό HBE γωνία, the angle HBE, 190 (Eucl.); τὸ ὑπὸ ΔΕΓ (sc. εὐθύγραμμον), the rectangle contained by ΔΕ, ΕΓ, 268 (Eutoc.)
- ὑπόθεσις, εως, ἡ, *hypothesis*, 420 (Aristot.), ii. 2 (Archim.)
- ὑποπολλαπλάσιος, ον, *submultiple of another*; as subst., ὑποπολλαπλάσιον, τό, *submultiple*, 78 (Theol. Arith.)
- ὑπόστασις, εως, ἡ, *condition*, ii. 534 (Dioph.)
- ὑποτείνειν, *to stretch under, subtend, be subtended by*; ἡ ὑπὸ δύο πλευρὰς τοῦ πολυγώνου ὑποτείνουσα εὐθεία, the straight line *subtending*, or *subtended by*, two sides of the polygon, ii. 96 (Archim.); πλευρὰ ὑποτείνουσα μοίρας ξ, side *subtending* sixty parts, ii. 418 (Ptol.); ἡ τὴν ὀρθὴν γωνίαν ὑποτεينوῖση πλευρά, the side *subtending* the right angle, 178 (Eucl.); hence ἡ ὑποτείνουσα (sc. πλευρά or γραμμὴ), *hypotenuse* of a right-angled triangle, 176 (Plut.)
- ὑποτιθέναι, pass. ὑποκείσθαι, *to suppose, assume, make a hypothesis*, ii. 2 (Archim.), ii. 304 (Apollon.)
- ὑπτίος, α, ον, *laid on one's*

INDEX OF GREEK TERMS

- back, supine*; ὑπιον, τό, a quadrilateral with no parallel sides, 482 (Papp.)
- ὑφιστάναι, to place or set under, ii. 362 (Procl.)
- ὑψος, οὐς, Ion. εος, τό, height; of a triangle, ii. 222 (Archim.); of a cylinder, ii. 42 (Archim.); of a cone, ii. 118 (Archim.)
- Φανερός, ά, όν, clear, manifest, ii. 64 (Archim.), ii. 570 (Papp.)
- φέρειν, to bear, carry; pass., to be borne, carried, move, revolve; σημειόν φερόμενον, ii. 582 (Papp.); τὸ φερόμενον, moving object, 366 (Aristot.)
- φορά, ή, motion, 12 (Plat.)
- Χείρ, χειρός, ή, band or number of men, 30 n. a
- χειρουργικός, ή, όν, manual, ii. 614 (Papp.)
- χρονικός, ή, όν, of or pertaining to time; μοίρα χ., degree in time, ii. 396 (Hypsiel.)
- χωρίον, τό, space, area, 394 (Plat.), ii. 532 (Dioph.)
- Ψάειν, to touch, 264 (Eutoc.)
- ψευδάριον, τό, fallacy; Ψευδάρια, τά, title of work by Euclid, 160 (Procl.)
- Ὥρολόγιον, τό, instrument for telling the time, clock, ii. 268 (Cleom.); τὸ δι' ὕδατος ὦ., water-clock, ii. 616 (Papp.)
- ὡς, as; ὡς ή ΖΕ πρὸς ΕΓ, ή ΖΗ πρὸς ΗΓ, i.e., $ZΕ : ΕΓ = ΖΗ : ΗΓ$, 322 (Archim.)
- ὥστε, such that, ii. 52 (Archim.); and so, therefore, used for the stages in a proof, ii. 54 (Archim.)

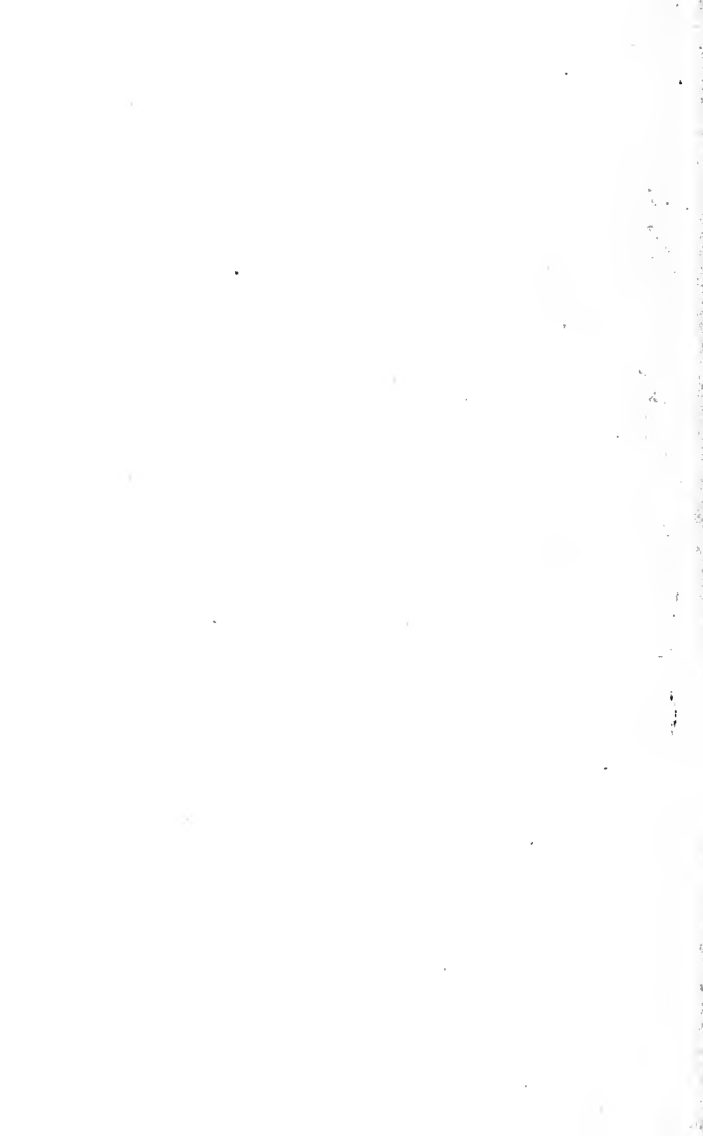

THE LOEB CLASSICAL LIBRARY

VOLUMES ALREADY PUBLISHED

Latin Authors

- AMMIANUS MARCELLINUS. Translated by J. C. Rolfe. 3 Vols. (2nd Imp. revised.)
- APULIUS: THE GOLDEN ASS (METAMORPHOSES). W. Adlington (1566). Revised by S. Gaselee. (7th Imp.)
- ST. AUGUSTINE: CITY OF GOD. 7 vols. Vol. I, G. H. McCracken. ST. AUGUSTINE, CONFESSIONS OF. W. Watts (1631). 2 Vols. (Vol. I. 7th Imp., Vol. II. 6th Imp.)
- ST. AUGUSTINE, SELECT LETTERS. J. H. Baxter. (2nd Imp.)
- AUSONIUS. H. G. Evelyn White. 2 Vols. (2nd Imp.)
- BEDE. J. E. King. 2 Vols. (2nd Imp.)
- BOETHIUS: TRACTS and DE CONSOLATIONE PHILOSOPHIAE. Rev. H. F. Stewart and E. K. Rand. (6th Imp.)
- CAESAR: ALEXANDRIAN, AFRICAN and SPANISH WARS. A. G. Way. CAESAR: CIVIL WARS. A. G. Peskett. (5th Imp.)
- CAESAR: GALLIC WAR. H. J. Edwards. (10th Imp.)
- CATO: DE RE RUSTICA; VARRO: DE RE RUSTICA. H. B. Ash and W. D. Hooper. (3rd Imp.)
- CATULLUS. F. W. Cornish; TIBULLUS. J. B. Postgate; PER-VIGILIUM VENERIS. J. W. Mackail. (12th Imp.)
- CELSUS: DE MEDICINA. W. G. Spencer. 3 Vols. (Vol. I. 3rd Imp. revised, Vols. II. and III. 2nd Imp.)
- CICERO: BRUTUS, and ORATOR. G. L. Hendrickson and H. M. Hubbell. (3rd Imp.)
- [CICERO]: AD HERENNIUM. H. Caplan.
- CICERO: DE FATO; PARADOXA STOICORUM; DE PARTITIONE ORATORIA. H. Rackham (With De Oratore, Vol. II.) (2nd Imp.)
- CICERO: DE FINIBUS. H. Rackham. (4th Imp. revised.)
- CICERO: DE INVENTIONE, etc. H. M. Hubbell.
- CICERO: DE NATURA DEORUM and ACADEMICA. H. Rackham. (2nd Imp.)
- CICERO: DE OFFICIIS. Walter Miller. (6th Imp.)
- CICERO: DE ORATORE. 2 Vols. E. W. Sutton and H. Rackham. (2nd Imp.)
- CICERO: DE REPUBLICA and DE LEGIBUS. Clinton W. Keyes. (4th Imp.)
- CICERO: DE SENECTUTE, DE AMICITIA, DE DIVINATIONE. W. A. Falconer. (6th Imp.)
- CICERO: IN CATALINAM, PRO FLACCO, PRO MURENA, PRO SULLA. Louis E. Lord. (3rd Imp. revised.)
- CICERO: LETTERS TO ATTICUS. E. O. Winstedt. 3 Vols. (Vol. I. 6th Imp., Vols. II and III. 4th Imp.)

- CICERO : LETTERS TO HIS FRIENDS.** W. Glynn Williams. 3 Vols.
(Vols. I. and II. *3rd Imp.*, Vol. III. *2nd Imp. revised.*)
- CICERO : PHILIPPICS.** W. C. A. Ker. (*3rd Imp. revised.*)
- CICERO : PRO ARCHIA, POST REDITUM, DE DOMO, DE HARUSPICUM
RESPONSIS, PRO PLANCIO.** N. H. Watts. (*4th Imp.*)
- CICERO : PRO CAECINA, PRO LEGE MANILIA, PRO CLUENTIO, PRO
RABIRIO.** H. Grose Hodge. (*3rd Imp.*)
- CICERO : PRO MILONE, IN PISONEM, PRO SCAURO, PRO FONTEIO,
PRO RABIRIO POSTUMO, PRO MARCELLO, PRO LIGARIO, PRO REGE
DEIOTARO.** N. H. Watts. (*2nd Imp.*)
- CICERO : PRO QUINCTIO, PRO ROSCIO AMERINO, PRO ROSCIO
COMOEDO, CONTRA RULLUM.** J. H. Freese. (*3rd Imp.*)
- CICERO : TUSCULAN DISPUTATIONS.** J. E. King. (*4th Imp.*)
- CICERO : VERRINE ORATIONS.** L. H. G. GREENWOOD. 2 Vols.
(Vol. I. *3rd Imp.*, Vol. II. *2nd Imp.*)
- CLAUDIAN.** M. Platnauer. 2 Vols. (*2nd Imp.*)
- COLUMELLA : DE RE RUSTICA, DE ARBORIBUS.** H. B. Ash, E. S.
Forster and E. Heffner. 3 Vols. (Vol. I. *2nd Imp.*)
- CURTIUS, Q. : HISTORY OF ALEXANDER.** J. C. Rolfe. 2 Vols. (*2nd
Imp.*)
- FLORUS.** E. S. Forster and CORNELIUS NEPOS. J. C. Rolfe. (*2nd
Imp.*)
- FRONTINUS : STRATAGEMS and AQUEDUCTS.** C. E. Bennett and
M. B. McElwain. (Vol. I. *3rd Imp.*, Vol. II. *2nd Imp.*)
- FRONTO : CORRESPONDENCE.** C. R. Haines. 2 Vols. (Vol. I. *3rd
Imp.*, Vol. II. *2nd Imp.*)
- GELLIUS.** J. C. Rolfe. 3 Vols. (Vol. I. *3rd Imp.*, Vols. II. and
III. *2nd Imp.*)
- HORACE : ODES and EPODES.** C. E. Bennett. (*14th Imp. revised.*)
- HORACE : SATIRES, EPISTLES, ARS POETICA.** H. R. Fairclough.
(*9th Imp. revised.*)
- JEROME : SELECTED LETTERS.** F. A. Wright. (*2nd Imp.*)
- JUVENAL and PERSIUS.** G. G. Ramsay. (*7th Imp.*)
- LIVY.** B. O. Foster, F. G. Moore, Evan T. Sage, and A. C. Schlesinger.
14 Vols. Vols. I.-XIII. (Vol. I. *4th Imp.*, Vols. II., III., V., and
IX. *3rd Imp.*; Vols. IV., VI.-VIII., X.-XII. *2nd Imp. revised.*)
- LUCAN.** J. D. Duff. (*3rd Imp.*)
- LUCRETIUS.** W. H. D. Rouse. (*7th Imp. revised.*)
- MARTIAL.** W. C. A. Ker. 2 Vols. (Vol. I. *5th Imp.*, Vol. II. *4th
Imp. revised.*)
- MINOR LATIN POETS : from PUBLILIUS SYRUS to RUTILIUS
NAMATIUS, including GRATTIUS, CALPURNIUS SICULUS, NEMESI-
ANUS, AVIANUS, and others with "Aetna" and the "Phoenix."**
J. Wight Duff and Arnold M. Duff. (*3rd Imp.*)
- OVID : THE ART OF LOVE AND OTHER POEMS.** J. H. Mozley. (*3rd
Imp.*)
- OVID : FASTI.** Sir James G. Frazer. (*2nd Imp.*)
- OVID : HEROIDES and AMORES.** Grant Showerman. (*5th Imp.*)
- OVID : METAMORPHOSES.** F. J. Miller. 2 Vols. (Vol. I. *10th Imp.*,
Vol. II. *8th Imp.*)
- OVID : TRISTIA and EX PONTO.** A. L. Wheeler. (*3rd Imp.*)

- PERSIUS.** Cf. **JUVENAL.**
- PETRONIUS.** M. Heseltine; **SENECA APOCOLOCYNTOSIS.** W. H. D. Rouse. (8th Imp. revised.)
- PLAUTUS.** Paul Nixon. 5 Vols. (Vols. I. and II. 5th Imp., Vol. III. 3rd Imp., Vols. IV and V. 2nd Imp.)
- PLINY: LETTERS.** Melmoth's Translation revised by W. M. L. Hutchinson. 2 Vols. (6th Imp.)
- PLINY: NATURAL HISTORY.** H. Rackham and W. H. S. Jones. 10 Vols. Vols. I.-V. and IX. H. Rackham. Vols. VI. and VII. W. H. S. Jones. (Vols. I.-III. 3rd Imp., Vol. IV. 2nd Imp.)
- PROPERTIUS.** H. E. Butler. (6th Imp.)
- PRUDENTIUS.** H. J. Thomson. 2 Vols.
- QUINTILLIAN.** H. E. Butler. 4 Vols. (3rd Imp.)
- REMAINS OF OLD LATIN.** E. H. Warmington. 4 Vols. Vol. I. (ENNIUS AND CAECILIUS.) Vol. II. (LIVIVS, NAEVIUS, PACUVIUS, ACCIUS.) Vol. III. (LUCILIUS and LAWS OF XII TABLES.) Vol. IV. (2nd Imp.) (ARCHAIC INSCRIPTIONS.)
- SALLUST.** J. C. Rolfe. (4th Imp. revised.)
- SCRIPTORES HISTORIAE AUGUSTAE.** D. Magie. 3 Vols. (Vol. I. 3rd Imp. revised, Vols. II. and III. 2nd Imp.)
- SENECA: APOCOLOCYNTOSIS.** Cf. **PETRONIUS.**
- SENECA: EPISTULAE MORALES.** R. M. Gummerc. 3 Vols. (Vol. I. 4th Imp., Vols. II. and III. 2nd Imp.)
- SENECA: MORAL ESSAYS.** J. W. Basore. 3 Vols. (Vol. II. 3rd Imp., Vols. I. and III. 2nd Imp. revised.)
- SENECA: TRAGEDIES.** F. J. Miller. 2 Vols. (Vol. I. 4th Imp., Vol. II. 3rd Imp. revised.)
- SIDONIUS: POEMS AND LETTERS.** W. B. Anderson. 2 Vols. (Vol. I. 2nd Imp.)
- SILIUS ITALICUS.** J. D. Duff. 2 Vols. (Vol. I. 2nd Imp., Vol. II. 3rd Imp.)
- STATIUS.** J. H. Mozley. 2 Vols. (2nd Imp.)
- SUETONIUS.** J. C. Rolfe. 2 Vols. (Vol. I. 7th Imp., Vol. II. 6th Imp. revised.)
- TACITUS: DIALOGUS.** Sir Wm. Peterson. **AGRICOLA** and **GERMANIA.** Maurice Hutton. (6th Imp.)
- TACITUS: HISTORIES AND ANNALS.** C. H. Moore and J. Jackson. 4 Vols. (Vols. I. and II. 3rd Imp., Vols. III. and IV. 2nd Imp.)
- TERENCE.** John Sargeaunt. 2 Vols. (7th Imp.)
- TERTULLIAN: APOLOGIA** and **DE SPECTACULIS.** T. R. Glover. **MINUCIUS FELIX.** G. H. Rendall. (2nd Imp.)
- VALERIUS FLACCUS.** J. H. Mozley. (2nd Imp. revised.)
- VARRO: DE LINGUA LATINA.** R. G. Kent. 2 Vols. (2nd Imp. revised.)
- VELLEIUS PATERCULUS** and **RES GESTAE DIVI AUGUSTI.** F. W. Shipley. (2nd Imp.)
- VIRGIL.** H. R. Fairclough. 2 Vols. (Vol. I. 18th Imp., Vol. II. 14th Imp. revised.)
- VITRUVIUS: DE ARCHITECTURA.** F. Granger. 2 Vols. (Vol. I. 3rd Imp., Vol. II. 2nd Imp.)

Greek Authors

- ACHILLES TATIUS. S. Gaselee. (2nd Imp.)
- AENEAS TACTICUS, ASCLEPIODOTUS and ONASANDER. The Illinois Greek Club. (2nd Imp.)
- AESCHINES. C. D. Adams. (2nd Imp.)
- AESCHYLUS. H. Weir Smyth. 2 Vols. (Vol. I. 6th Imp., Vol. II. 5th Imp.)
- ALCIPHON, AELIAN, PHILOSTRATUS LETTERS. A. R. Benner and F. H. Fobes.
- ANDOCIDES, ANTIPHON. Cf. MINOR ATTIC ORATORS.
- APOLLODORUS. Sir James G. Frazer. 2 Vols. (Vol. I. 3rd Imp., Vol. II. 2nd Imp.)
- APOLLONIUS RHODIUS. R. C. Seaton. (5th Imp.)
- THE APOSTOLIC FATHERS. Kirsopp Lake. 2 Vols. (Vol. I. 8th Imp., Vol. II. 6th Imp.)
- APPIAN: ROMAN HISTORY. Horace White. 4 Vols. (Vol. I. 4th Imp., Vols. II. and IV. 3rd Imp., Vol. III. 2nd Imp.)
- ARATUS. Cf. CALLIMACHUS.
- ARISTOPHANES. Benjamin Bickley Rogers. 3 Vols. Verse trans. (5th Imp.)
- ARISTOTLE: ART OF RHETORIC. J. H. Freese. (3rd Imp.)
- ARISTOTLE: ATHENIAN CONSTITUTION, EUDEMIAN ETHICS, VICES AND VIRTUES. H. Rackham. (3rd Imp.)
- ARISTOTLE: GENERATION OF ANIMALS. A. L. Peck. (2nd Imp.)
- ARISTOTLE: METAPHYSICS. H. Tredennick. 2 Vols. (3rd Imp.)
- ARISTOTLE: METEOROLOGICA. H. D. P. Lee.
- ARISTOTLE: MINOR WORKS. W. S. Hett. On Colours, On Things Heard, On Physiognomies, On Plants, On Marvellous Things Heard, Mechanical Problems, On Indivisible Lines, On Situations and Names of Winds, On Melissus, Xenophanes, and Gorgias. (2nd Imp.)
- ARISTOTLE: NICOMACHEAN ETHICS. H. Rackham. (6th Imp. revised.)
- ARISTOTLE: OECONOMICA and MAGNA MORALIA. G. C. Armstrong; (with Metaphysics, Vol. II.). (3rd Imp.)
- ARISTOTLE: ON THE HEAVENS. W. K. C. Guthrie. (3rd Imp. revised.)
- ARISTOTLE: On Sophistical Refutations, On Coming to be and Passing Away, On the Cosmos. E. S. Forster and D. J. Furley.
- ARISTOTLE: ON THE SOUL, PARVA NATURALIA, ON BREATH. W. S. Hett. (2nd Imp. revised.)
- ARISTOTLE: ORGANON, CATEGORIES: On Interpretation, Prior Analytics. H. P. Cooke and H. Tredennick. (3rd Imp.)
- ARISTOTLE: PARTS OF ANIMALS. A. L. Peck; MOTION AND PROGRESSION OF ANIMALS. E. S. Forster. (3rd Imp. revised.)
- ARISTOTLE: PHYSICS. Rev. P. Wicksteed and F. M. Cornford. 2 Vols. (Vol. I. 2nd Imp., Vol. II. 3rd Imp.)
- ARISTOTLE: POETICS and LONGINUS. W. Hamilton Fyfe; DEMETRIUS ON STYLE. W. Rhys Roberts. (5th Imp. revised.)
- ARISTOTLE: POLITICS. H. Rackham. (4th Imp. revised.)
- ARISTOTLE: PROBLEMS. W. S. Hett. 2 Vols. (2nd Imp. revised.)
- ARISTOTLE: RHETORICA AD ALEXANDEUM (with PROBLEMS, Vol. II.). H. Rackham.

- ARRIAN: HISTORY OF ALEXANDER and INDICA.** Rev. E. Iliffe Robson. 2 Vols. (Vol. I. *3rd Imp.*, Vol. II. *2nd Imp.*)
- ATHENAEUS: DEIPNOSOPHISTAE.** C. B. Gulick. 7 Vols. (Vols. I., IV.-VII. *2nd Imp.*)
- ST. BASIL: LETTERS.** R. J. Deferrari. 4 Vols. (*2nd Imp.*)
- CALLIMACHUS, Hymns and Epigrams, and LYCOPHRON.** A. W. Mair; **ARATUS.** G. R. Mair. (*2nd Imp.*)
- CLEMENT OF ALEXANDRIA.** Rev. G. W. Butterworth. (*3rd Imp.*)
- COLLUTHUS.** Cf. **OPPIAN.**
- DAPHNIS AND CHLOE.** Thornley's Translation revised by J. M. Edmonds: and **PARTHENIUS.** S. Gaselee. (*4th Imp.*)
- DEMOSTHENES I: OLYNTHIACS, PHILIPPICS and MINOR ORATIONS.** I.-XVII. and XX. J. H. Vince. (*2nd Imp.*)
- DEMOSTHENES II: DE CORONA and DE FALSA LEGATIONE.** C. A. Vince and J. H. Vince. (*3rd Imp. revised.*)
- DEMOSTHENES III: MEIDIAS, ANDROTION, ARISTOCRATES, TIMOCRATES and ARISTOGEITON, I. and II.** J. H. Vince. (*2nd Imp.*)
- DEMOSTHENES IV-VI: PRIVATE ORATIONS and IN NEAERAM.** A. T. Murray. (Vol. IV. *2nd Imp.*)
- DEMOSTHENES VII: FUNERAL SPEECH, EROTIC ESSAY, EXORDIA and LETTERS.** N. W. and N. J. DeWitt.
- DIO CASSIUS: ROMAN HISTORY.** E. Cary. 9 Vols. (Vols. I. and II. *3rd Imp.*, Vols. III.-IX. *2nd Imp.*)
- DIO CHRYSOSTOM.** J. W. Cohoon and H. Lamar Crosby. 5 Vols. Vols. I.-IV. *2nd Imp.*)
- DIODORUS SICULUS.** 12 Vols. Vols. I.-VI. C. H. Oldfather. Vol. VII. C. L. Sherman. Vols. IX and X. R. M. Geer. (Vols. I.-IV. *2nd Imp.*)
- DIOGENES LAERTIUS.** B. D. Hicks. 2 Vols. (Vol. I. *4th Imp.*, Vol. II. *3rd Imp.*)
- DIONYSIUS OF HALICARNASSUS: ROMAN ANTIQUITIES.** Spelman's translation revised by E. Cary. 7 Vols. (Vols. I.-V. *2nd Imp.*)
- EPIOTETUS.** W. A. Oldfather. 2 Vols. (*2nd Imp.*)
- EURIPIDES.** A. S. Way. 4 Vols. (Vols. I. and II. *7th Imp.*, Vols. III. and IV. *6th Imp.*) Verse trans.
- EUSEBIUS: ECCLESIASTICAL HISTORY.** Kirsopp Lake and J. E. L. Oulton. 2 Vols. (Vol. I. *3rd Imp.*, Vol. II. *4th Imp.*)
- GALEN: ON THE NATURAL FACULTIES.** A. J. Brock. (*4th Imp.*)
- THE GREEK ANTHOLOGY.** W. B. Paton. 5 Vols. (Vols. I. and II. *5th Imp.*, Vol. III. *4th Imp.*, Vols. IV and V. *3rd Imp.*)
- GREEK ELEGY AND IAMBUS with the ANACREONTEA.** J. M. Edmonds. 2 Vols. (Vol. I. *3rd Imp.*, Vol. II. *2nd Imp.*)
- THE GREEK BUCOLIO POETS (THEOCRITUS, BION, MOSCHUS).** J. M. Edmonds. (*7th Imp. revised.*)
- GREEK MATHEMATICAL WORKS.** Ivor Thomas. 2 Vols. (*2nd Imp.*)
- HERODES.** Cf. **THEOPHRASTUS: CHARACTERS.**
- HERODOTUS.** A. D. Godley. 4 Vols. (Vols. I.-III. *4th Imp.*, Vol. IV. *3rd Imp.*)
- HESIOD AND THE HOMERIC HYMNS.** H. G. Evelyn White. (*7th Imp. revised and enlarged.*)

- HIPPOCRATES** and the **FRAGMENTS OF HERACLEITUS**. W. H. S. Jones and E. T. Withington. 4 Vols. (*3rd Imp.*)
- HOMER: ILLIAD**. A. T. Murray. 2 Vols. (Vol. I. *7th Imp.*, Vol. II. *6th Imp.*)
- HOMER: ODYSSEY**. A. T. Murray. 2 Vols. (*8th Imp.*)
- ISAEUS**. E. W. Forster. (*3rd Imp.*)
- ISOCRATES**. George Norlin and LaRue Van Hook. 3 Vols. (*2nd Imp.*)
- ST. JOHN DAMASCENE: BARLAAM AND IOASAPH**. Rev. G. R. Woodward and Harold Mattingly. (*3rd Imp. revised.*)
- JOSEPHUS**. H. St. J. Thackeray and Ralph Marcus. 9 Vols. Vols. I.-VII. (Vol. V. *3rd Imp.*, Vols. I.-IV., VI. and VII. *2nd Imp.*)
- JULIAN**. Wilmer Cave Wright. 3 Vols. (Vols. I. and II. *3rd Imp.*, Vol. III. *2nd Imp.*)
- LUCIAN**. A. M. Harmon. 8 Vols. Vols. I.-V. (Vols. I. and II. *4th Imp.*, Vol. III. *3rd Imp.*, Vols. IV and V. *2nd Imp.*)
- LYCOPHRON**. Cf. **CALLIMACHUS**.
- LYRA GRAECA**. J. M. Edmonds. 3 Vols. (Vol. I. *4th Imp.*, Vol. II. *revised and enlarged*, and III. *3rd Imp.*)
- LYSIAS**. W. R. M. Lamb. (*2nd Imp.*)
- MANETHO**. W. G. Waddell: **PTOLEMY: TETRABIBLOS**. F. E. Robbins. (*2nd Imp.*)
- MARCUS AURELIUS**. C. R. Haines. (*4th Imp. revised.*)
- MENANDER**. F. G. Allinson. (*3rd Imp. revised.*)
- MINOR ATTIC ORATORS (ANTIPHON, ANDOCIDES, LYCURGUS, DEMADES, DINARCHUS, HYPEREIDES)**. K. J. Maidment and J. O. Burrt. 2 Vols. (Vol. I. *2nd Imp.*)
- NONNOS: DIONYSIACA**. W. H. D. Rouse. 3 Vols. (*2nd Imp.*)
- OPPIAN, COLLUTHUS, TRYPHIODORUS**. A. W. Malr. (*2nd Imp.*)
- PAPYRI. NON-LITERARY SELECTIONS**. A. S. Hunt and C. C. Edgar. 2 Vols (Vol. I. *2nd Imp.*) **LITERARY SELECTIONS**. Vol. I. (Poetry). D. L. Page. (*3rd Imp.*)
- PARTHENIUS**. Cf. **DAPHNIS AND CHLOE**.
- PAUSANIAS: DESCRIPTION OF GREECE**. W. H. S. Jones. 5 Vols. and Companion Vol. arranged by R. E. Wycherley. (Vols. I. and III. *3rd Imp.*, Vols. II., IV. and V. *2nd Imp.*)
- PHILO**. 10 Vols. Vols. I.-V.; F. H. Colson and Rev. G. H. Whitaker. Vols. VI.-IX.; F. H. Colson. (Vols. II.-III., V.-IX. *2nd Imp.*, Vols. I. and IV., *3rd Imp.*)
- PHILO: two supplementary Vols.** (*Translation only.*) Ralph Marcus.
- PHILOSTRATUS: THE LIFE OF APOLLONIUS OF TYANA**. F. C. Conybeare. 2 Vols. (Vol. I. *4th Imp.*, Vol. II. *3rd Imp.*)
- PHILOSTRATUS: IMAGINES; CALLISTRATUS: DESCRIPTIONS**. A. Fairbanks.
- PHILOSTRATUS and EUNAPIUS: LIVES OF THE SOPHISTS**. Wilmer Cave Wright. (*2nd Imp.*)
- PINDAR**. Sir J. E. Sandys. (*7th Imp. revised.*)
- PLATO: CHARMIDES, ALCIBIADES, HIPPARCHUS, THE LOVERS, THEAGES, MINOS and EPINOMIS**. W. R. M. Lamb. (*2nd Imp.*)
- PLATO: CRATYLUS, PARMENIDES, GREATER HIPPIAS, LESSER HIPPIAS**. H. N. Fowler. (*4th Imp.*)

- PLATO: EUTHYPHRO, APOLOGY, CRITO, PHAEDO, PHAEDRUS. H. N. Fowler. (11th Imp.)
- PLATO: LACHES, PROTAGORAS, MENO, EUTHYDEMUS. W. R. M. Lamb. (3rd Imp. revised.)
- PLATO: LAWS. Rev. R. G. Bury. 2 Vols. (3rd Imp.)
- PLATO: LYSIS, SYMPOSIUM, GORGIAS. W. R. M. Lamb. (5th Imp. revised.)
- PLATO: REPUBLIC. Paul Shorey. 2 Vols. (Vol. I. 5th Imp., Vol. II. 4th Imp.)
- PLATO: STATESMAN, PHILEBUS. H. N. Fowler; ION. W. R. M. Lamb. (4th Imp.)
- PLATO: THEAETETUS and SOPHIST. H. N. Fowler. (4th Imp.)
- PLATO: TIMAEUS, CRITIAS, CLITOPHO, MENEXENUS, EPISTULAE. Rev. R. G. Bury. (3rd Imp.)
- PLUTARCH: MORALIA. 14 Vols. Vols. I.-V. F. C. Babbitt; Vol. VI. W. C. Helmbold; Vol. X. H. N. Fowler. (Vols. I.-VI. and X. 2nd Imp.) Vol. XII. H. Cherniss and W. C. Helmbold.
- PLUTARCH: THE PARALLEL LIVES. B. Perrin. 11 Vols. (Vols. I., II., VI., VII., and XI. 3rd Imp. Vols. III.-V. and VIII.-X., 2nd Imp.)
- POLYBIUS. W. R. Paton. 6 Vols. (2nd Imp.)
- PROCOPIUS: HISTORY OF THE WARS. H. B. Dewing. 7 Vols. (Vol. I. 3rd Imp., Vols. II.-VII. 2nd Imp.)
- PTOLEMY: TETRABIBLOS. Cf. MANETHO.
- QUINTUS SMYRNAEUS. A. S. Way. Verse trans. (3rd Imp.)
- SEXTUS EMPIRICUS. Rev. R. G. Bury. 4 Vols. (Vol. I. 3rd Imp., Vols. II. and III. 2nd Imp.)
- SOPHOCLES. F. Storr. 2 Vols. (Vol. I. 10th Imp., Vol. II. 6th Imp.) Verse trans.
- STRABO: GEOGRAPHY. Horace L. Jones. 8 Vols. (Vols. I., V., and VIII. 3rd Imp., Vols. II., III., IV., VI., and VII. 2nd Imp.)
- THEOPHRASTUS: CHARACTERS. J. M. Edmonds. HERODES, etc. A. D. Knox. (3rd Imp.)
- THEOPHRASTUS: ENQUIRY INTO PLANTS. Sir Arthur Hort, Bart. 2 Vols. (2nd Imp.)
- THUCYDIDES. C. F. Smith. 4 Vols. (Vol. I. 4th Imp., Vols. II., III., and IV. 3rd Imp. revised.)
- TRYPHIODORUS. Cf. OPIAN.
- XENOPHON: CYROPAEDIA. Walter Miller. 2 Vols. (Vol. I. 4th Imp., Vol. II. 3rd Imp.)
- XENOPHON: HELLENICA, ANABASIS, APOLOGY, and SYMPOSIUM. C. L. Brownson and O. J. Todd. 3 Vols. (Vols. I. and III. 3rd Imp., Vol. II. 4th Imp.)
- XENOPHON: MEMORABILIA and OECONOMICUS. E. C. Marchant. (3rd Imp.)
- XENOPHON: SCRIPTA MINORA. E. C. Marchant. (2nd Imp.)

IN PREPARATION

Greek Authors

ARISTOTLE : HISTORY OF ANIMALS. A. L. Peck.
CALLIMACHUS : FRAGMENTS. C. A. Trypanis.
PLOTINUS : A. H. Armstrong.

Latin Authors

ST. AUGUSTINE : CITY OF GOD.
CICERO : PRO SESTIO, IN VATINIUM.
CICERO : PRO CAELIO, DE PROVINCIIS CONSULARIBUS, PRO BALBO.
J. H. Freese and R. Gardner.
PHAEDRUS : Ben E. Perry.

DESCRIPTIVE PROSPECTUS ON APPLICATION

London
Cambridge, Mass.

WILLIAM HEINEMANN LTD
HARVARD UNIVERSITY PRESS



BULMER-THOMAS, IVOR

PA
3637
.M3
T45
v.2

Greek mathematical
works

Aristarchus to Pappus

